

MODERN SPORTING GUN HUNTING ISSUE!

FIREARMS NEWS

GUN SALES, REVIEWS, & INFORMATION

OCTOBER 2020
ISSUE 19

INFORMATION-AGE HUNTING TOOL:

THE CITADEL BOSS-25

**AUTOLOADING
12-GAUGE**

BY DR. WILL DABBS

**HUNTERS,
SAVE YOUR EARS!
SILENCERCO**

**WILL MAKE THAT
MSR QUIET!**

PATRICK SWEENEY
EVALUATES THESE
EFFECTIVE SUPPRESSORS!

**BRING ENOUGH GUN!
THE NEMO ARMS OMEN
MATCH 3.0 vs. THE LAST FRONTIER**

RIKK RAMBO TAKES ON ALASKA'S
COYOTES AND
BUFFALO WITH
THIS SEMI-AUTO
.300 WINCHESTER
MAGNUM!

**DAVID FORTIER TESTS
WILSON COMBAT'S
.350 LEGEND RIFLE**

WHAT DOES WINCHESTER'S
.350 LEGEND BRING TO THE
TABLE WHEN MATED TO
A HIGH-QUALITY AR-15
HUNTING RIFLE?

RUGER'S MINI 30

PATRICK SWEENEY REVIEWS
A GREAT "WOODS CARBINE"
READY FOR DEER OR HOGS!
PLUS, A REVIEW OF THE
PULSAR XM50
THERMAL OPTIC!



Affordable Overkill®

Our LaRue trademarked 1-3-5™ Pricing:
1 at \$80 ea, 3 at \$75 each, and 5 (or more) at \$70 each.

Now available in a Straight Bow version, also machined from solid
S7 Tool steel. You won't find a better AR trigger on the market,
at any price.



MBT-2S

MBT-2S-SB

Each MBT Trigger comes with
a heavier spare spring that adds
a pound for those that need it.

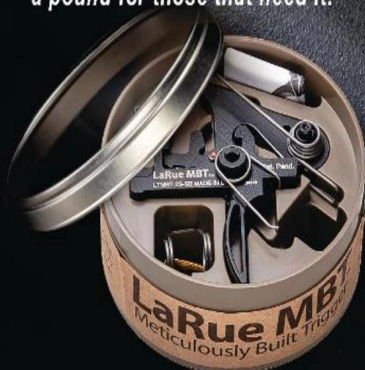

LaRue
Tactical
Made Dead-Center
of Texas, USA

www.LaRue.com

www.facebook.com/LaRueAccuracy
© 2019 APPI, all rights reserved

Visit www.MBTtrigger.com
to get this special deal and
read the MBT reviews
explaining why we've made
and sold over 100,000
LaRue MBT Triggers.



AMERICAN TACTICAL

AMERICAN TACTICAL ACCESSORY SPECIALS

10% OFF LISTED ACCESSORIES

*EXCLUDES MAGAZINES

GRAB YOURS AT AMERICANTACTICAL.US



USE PROMO ATIACC2020

Only at AmericanTactical.us Expires 11/20/2020
Or call your local firearms dealer

FLIP UP FRONT AND REAR BACK UP SIGHTS SET POLYMER

ITEM# ATISIGHTSETP

SPECIAL \$26.95

REG. \$29.95



*Firearm not included



ELECTRO DOT SIGHT RED/GREEN

ITEM# ATIDUOSIGHT

SPECIAL \$35.95

REG. \$39.95

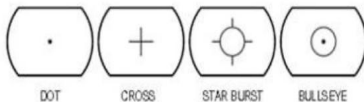

DOT CROSS STAR BURST BULLSEYE

ARMORER TOOL

ITEM# ATIARWRENCH-BP

SPECIALIZED AR-15 COMBO WRENCH IS THE ONLY
TOOL YOU NEED FOR PROPER CLEANING AND
DISASSEMBLY OF YOUR SEMIAUTO RIFLE.

REG. \$29.95

**SPECIAL
\$26.95**



GSG-MP40 9MM 922R COMPLIANT STOCK KIT

ITEM# ATIMP40STKKIT

CONTAINING ALL THE NECESSARY PARTS FOR A 922R COMPLIANT RIFLE, THE ATI
GSGMP40P STOCK KIT IS A MUST HAVE ACCESSORY FOR ANYONE WHO WANTS
TO SBR THEIR 9MM GSG-MP40P PISTOL!



SPECIAL \$224.95

REG. \$249.95

GLOCK 37 CONVERSION KIT

ITEM# ATIBG37CONV

REG \$149.95 | **SPECIAL \$134.95**



THREADED GLOCK 34 MATCH GRADE BARREL

ITEM# ATIBG34T

REG \$149.95 | **SPECIAL \$134.95**



NON-THREADED GLOCK 35 MATCH GRADE BARREL

ITEM# ATIBG35

REG \$129.95 | **SPECIAL \$116.95**



ATI GLOCK 43 BARREL THREADED

ITEM# ATIBG43T

REG \$159.95 | **SPECIAL \$143.95**



MULTI CALIBER SPEED LOADER 5.56/410/9MM

ITEM# ATIMULTILDR

REG \$9.95 | **SPECIAL \$8.95**



ORDERS ONLY VALID ONLINE AT AMERICANTACTICAL.US. QUANTITIES LIMITED. NOT RESPONSIBLE FOR PRINTING ERRORS. SALE
SUBJECT TO STOCK. ALL PRICES SUBJECT TO CHANGE WITHOUT NOTICE. ATI ADHERES TO ALL STATE AND FEDERAL REGULA-
TIONS FOR ALL PRODUCTS AND WILL ONLY TRANSFER OWNERSHIP OF A FIREARM TO INDIVIDUALS OR AGENCIES IN POSSESSION
OF A VALID FEDERAL FIREARMS LICENSE (FFL). IT IS OUR POLICY TO NOT SHIP DIRECTLY TO YOU UNLESS YOU ARE AN FFL HOLDER.

All inquiries for Advertising, Editorial: 1-800-521-2885, ext. 5064 2 News Plaza, 3rd Floor Peoria, IL 61614

PLACING AN AD

Advertisers will furnish FIREARMS NEWS with copy legibly printed or typewritten on one side of the paper only. Please leave a margin of at least 1" on all sides. Classified ad copy can be submitted on disk, e-mailed to firearmsnews@outdoorsg.com, through www.firearmsnews.com, or picked up from your web site.

Contact the Art Director before submitting electronic display advertising.

Due care and diligence is used in checking advertising copy for accuracy, but the Publisher makes no warranty, express or implied. Advertisers and FIREARMS NEWS are not responsible for typographical errors, mistakes or misprints.

All ads received too late for the current issue will be inserted in the following issue, unless you qualify the submission of the ad. Existing ad copy may be substituted if new copy fails to arrive by the specified date.

Advertising is credit card, check or money order in advance. If uncertain as to the cost of your ad, submit it and we will advise the amount to be remitted, and we will refund any overage.

Artwork is kept in our files for 13 months and then destroyed. Reproduction quality is not guaranteed.

FIREARMS NEWS reserves the right to omit any ads that in its opinion are objectionable.

In addition, FIREARMS NEWS will no longer accept ads offering the following items for sale: Plans, videos or books for converting semi-automatic firearms into full-automatic firearms.

Sound suppressor plans, and videos. Plans or formulas for making explosives, booby traps, etc.

Lock picks, Slim-Jims, etc. and lock picking instructions.

Also, items related to the above.

If in doubt about your ad, call us.

AD DEADLINE DATES

ISSUE	DEADLINE	ISSUE	DEADLINE
Vol. 74 - Issue 19	Aug. 24	Vol. 74 - Issue 22	Oct. 12
Vol. 74 - Issue 20	Sept. 4	Vol. 74 - Issue 23	Oct. 26
Vol. 74 - Issue 21	Sept. 28	Vol. 74 - Issue 24	Nov. 9

NOTE: ALL ad space MUST be reserved and art materials MUST be received BEFORE the above DEADLINE DATES!

COMPLAINTS AGAINST ADVERTISERS

We want FIREARMS NEWS readers to receive prompt, friendly service from our advertisers. If you have experienced bad service from a FIREARMS NEWS advertiser, you may submit a complaint in writing to FIREARMS NEWS, Dept. CL, 2 News Plaza, 3rd Floor, Peoria, IL 61614. You can e-mail to firearmsnews@outdoorsg.com or fax to (309) 679-5476. We do not accept complaints by telephone. Note that FIREARMS NEWS is not a law enforcement agency and cannot investigate complaints. We will contact the advertiser on your behalf, and a continuing pattern of complaints can cost an advertiser its advertising privileges.

SUBSCRIPTION INQUIRIES

BE AWARE THAT FIREARMS NEWS ONLY ACCEPTS SUBSCRIPTION REQUESTS FROM AUTHORIZED AGENTS! WE MAY NOT HONOR REQUESTS FROM UNAUTHORIZED AGENTS, AND YOU THEREFORE MAY LOSE YOUR MONEY IF YOU BUY FROM AN UNAUTHORIZED AGENT. If you are offered a subscription to FIREARMS NEWS, please call 1-800-345-6923 to determine if the agent is authorized. For more information on subscription scams, please visit www.ftc.gov.

To change your address: Call our toll-free customer service number or E-mail us with your new address 6 to 8 weeks before your move. **If you receive a bill after you've paid:** Our letters probably crossed in the mail. Please disregard any bill or renewal notice you receive soon after mailing your payment or order. (If you continue to receive notices, please let us know.)

If your issue is damaged or missing: Call our toll-free number or E-mail us. We'll replace the issue or extend your subscription, whichever you prefer. Remember, FIREARMS NEWS is published 24 times a year.

Toll-Free Subscription Number
1-800-345-6923
Outside U.S.; call 386-447-6318
E-mail: sgncustserv@cdsfulfillment.com

FIREARMS NEWS®

An Outdoor Sportsman Group® Publication

PUBLISHER

Mike Schoby

EDITORIAL EDITOR

Vincent L. DeNiro

FIELD EDITORS:

Senior Field Editor

David Fortier

Gunsmithing

Gus Norcross

Historic Military Arms

Paul Scarlata

Hunting

Rikk Rambo

Machine Guns & Tactics

Leroy Thompson

Movie Guns

Dr. Will Dabbs

NFA & Airguns

Patrick Sweeney

Pistols

James Tarr

Columnists

Mark Chestnut, David Codrea, Jim Grant,

Jeff Knox, Vin Suprynowicz

DESIGN

SENIOR ART DIRECTOR

Bill Smalley

ASSISTANT ART DIRECTOR

Ashley N. Honea

ASSISTANT ART DIRECTOR

Mark Kee

PRODUCTION

PRODUCTION MANAGER

Terry Boyer

ADVERTISING

ADVERTISING DIRECTOR

Pat Bentzel (East Region) (717) 695-8095

patrick.bentzel@outdoorsg.com

ADVERTISING SALES MANAGER

Mark Thiffault (720) 630-9863

mark.thiffault@outdoorsg.com

ACCOUNT EXECUTIVE, AD SALES

Brendan Vorobiev (734) 800-6666

CLASSIFIED ADVERTISING REPRESENTATIVE

Sue Fitch (309) 679-5064

Western Region

Hutch Looney & Associates

email: hutch@hlooney.com

NATIONAL AD SALES

Account Director - Detroit Office

Kevin Donley (248) 798-4458

National Account Executive - Chicago Office

Carl Benson (312) 955-0496

Direct Response Advertising/Non-Endemic

Anthony Smyth (914) 693-8700



PRESIDENT & CHIEF EXECUTIVE OFFICER

Jim Liberatore

CHIEF OPERATING OFFICER,

PUBLISHING & BRANDED MEDIA

Mike Carney

EVP, GROUP PUBLISHER & OPERATIONS

Derek Sevcik

VP, CONSUMER MARKETING

Peter Watt

VP, MANUFACTURING

Deb Daniels

SENIOR DIRECTOR, PRODUCTION

Connie Mendoza

DIRECTOR, PUBLISHING TECHNOLOGY

Kyle Morgan

SENIOR CREATIVE DIRECTOR

Tim Neher

DIGITAL

Editorial Director, Fishing Jeff Simpson

Digital Editor, Hunting Drew Pellman

For questions regarding digital editions, please contact digitalsupport@outdoorsg.com

MEDIA

outdoorsg.com

TELEVISION

outdoorchannel.com

thesportsmanchannel.com

worldfishingnetwork.com

HUNTING

bowhunter.com

bowhuntingmag.com

gundogmag.com

petersenshunting.com

northamericanwhitetail.com

wildfowlmag.com

FISHING

bassfan.com

floridasportsman.com

flyfisherman.com

gameandfishmag.com

in-fisherman.com

SHOOTING

gunsandammo.com

handguns.com

rifleshooter.com

shootingtimes.com

firearmsnews.com

Firearms News (USPS Periodicals Permit 23130) is published 24 times a year. Semimonthly January through December by OUTDOOR SPORTSMAN GROUP, 1040 6th Ave., 12th Floor, New York, NY 10018-4618. Periodical postage paid at New York, NY and at additional mailing offices. **POSTMASTER:** Send address change (Form 3579) to *Firearms News*, P.O. Box 37539, Boone, IA 50037-0539. Return undeliverable Canadian addresses to: 500 Rt. 46 East Clifton, NJ 07011. Canada Post Publications Mail-Agreement No. 41405030.

To know when your subscription expires: Check the printed address label on the magazine cover. The date your subscription expires appears to the right of your name and address. Allow 6-8 weeks after renewing for the label to reflect your new expiration date.

Occasionally, our subscriber list is made available to reputable firms offering goods and services that we believe would be of interest to our readers. If you prefer to be excluded, please send your current address label and a note requesting to be excluded from these promotions to: Outdoor Sportsman Group - 1040 6th Ave., 12th Floor, New York, NY 10018-3703 Attn: Privacy Coordinator, or email your label information and note to privacycoordinator@outdoorsg.com

PRINTED IN THE U.S.A.



Copyright 2020 by Outdoor Sportsman Group®
All Rights Reserved. No part of this book may be reproduced without written permission.

FIREARMS NEWS® is a registered trademark of Outdoor Sportsman Group® in the United States.

The Publisher and authors make no representations or warranties regarding the accuracy, completeness or timeliness of the information

contained in this publication. Any reliance or use of the information is solely at your own risk, and the authors and Publisher disclaim any and all liability relating thereto. Any prices given in this issue were suggested prices at the press time and are subject to change. Some advertisements in this magazine may concern products that are not legally for sale to California residents or residents in other jurisdictions.

CITADEL



Model # - CBOSS2512

MSRP STARTING AT \$579

- 12 ga.
- Semi- Auto
- Tough Black Synthetic Stock
- 3" Chamber
- 18.75" Chrome lined Barrel
- Muzzle Break
- 37.75" Overall Length
- LOP 14"
- 8 lbs
- Textured Grip Forend
- 5 Chokes
- 2 - 5 rd Detachable Mag
- Fully Adjustable Folding Sights
- Picatinny Rail



CALIFORNIA COMPLIANT VERSION IS AVAILABLE - **CBOSS2512-CA**



NEW



CERAKOTE

Model # - CBOSS2512-TG

NEW



CERAKOTE

Model # - CBOSS2512-FDE

LET US HELP YOU BE PREPARED

BOSS 25

LEGACY SPORTS INTERNATIONAL

FOR MORE INFORMATION VISIT: LEGACYSports.COM
FOR A FREE CATALOG CALL : 1.800.553.4229



LegacySportsIntl



LegacySportsInternational



LegacySportsInt



X WAYPOINT

MODEL 2020

SEE THE WAY.

Springfield Armory® is proud to introduce the Model 2020 family of bolt action hunting rifles. Precision manufactured in the USA, each Model 2020 is built to deliver the accuracy and performance expected from a custom grade rifle. The Model 2020 Waypoint features a premium carbon fiber stock and the option of a steel or carbon fiber barrel with an impressive .75 MOA accuracy guarantee. Learn more at springfield-armory.com



.75 MOA
GUARANTEE

SPRINGFIELD ARMORY.

DISPLAY ADS

A

Aero Precision, LLC..... 53

Air-Ordnance, LLC 55

Altor Corporation..... 29

American Gun Craft 103

American Gunsmithing Institute 67

American Tactical, Inc. 3

AMG International Armory 107

AR15MOLD.COM 102, 109

B

Black Hills Ammunition, Inc 57

Bob Hayley 104

Bob's Gun Shop..... 106

Bravo Company USA
..... 10, 11, 14, 15, 57

Buffalo Arms Company 105

C

CBRPS, LLC..... 109

Cedar Mill Fine Firearms..... 59

Centerfire Systems, Inc..... 105

Crosscut Saw Co. 102

D

D.B. Stewart Enterprises, LLC 109

Davidson's..... 23

De Santis Holster Leather Good..... 25

E

Electric Metering Corporation..... 59

Evenheat Kiln Co..... 107

F

Fobus International 63

G

G Sight Soultions 111

GovMint..... 47

Grizzly Industrial 66

H

Handi Racker 107

Harbor Freight Tools 65

Heckler & Koch, Inc 39

Hornady Mfg Co Natl..... 107

L

L&S Supply 102

LaRue Tactical 2, 112

Legacy Sports Intl LSI 5

M

M&A Parts 71

MKS Supply, Inc. 33

Mossberg O F Sons, Inc 43

MTM Molded Products..... 57

N

Nextten Stauer, LLC..... 37

O

Outdoor Sportsman Group
..... 64, 86

R

Rapidfire Triggers, Inc.
..... 102, 104, 106, 108, 110

Robert G. Segel..... 106

Rock Island Auction Company..... 109

Ruben Mendiola, Jr..... 103, 108

S

S&K Scope Mounts 105

Sabot Designs LLC..... 108

Sarco, Inc. 75, 87-101

Smith Wesson, Inc 49

Springfield, Inc 6

Stern Defense..... 29

Stocky's LLC..... 59

T

Trijicon, Inc..... 27

TRUGLO, Inc 45

U

Uintah Precision..... 55

UltiMAK 29

V

VISIR, Inc. 29

W

Walther Arms, Inc. 18, 19

Wiley & Sons, Inc..... 103

CONTENTS



- 8 THE CITADEL BOSS-25 AUTOLOADING 12-GAUGE**
The Information Age Hunting Tool
Will Dabbs, MD
- 30 MSR QUIET**
Hunting in 2020? SilencerCo Has the Goods!
Patrick Sweeney
- 40 BRING ENOUGH GUN! THE NEMO ARMS "OMEN MATCH 3.0" vs. THE LAST FRONTIER**
Rikk Rambo
- 68 WILSON COMBAT'S .350 LEGEND**
What Does Winchester's .350 Legend Bring to the Table When Mated to a High-Quality AR-15 Hunting Rifle?
David M. Fortier
- 76 RUGER MINI 30**
A Great "Woods Carbine" Ready for Deer or Hogs! Plus, a Review of the Pulsar XM50 Thermal Optic!
Patrick Sweeney



facebook.com/
FirearmsNewsMag



twitter.com/
FirearmsNewsMag



instagram.com/
firearmsnews

THE CITADEL BOSS-25

AUTOLOADING 12-GAUGE

By Will Dabbs, MD Cover and lead photo by Mike Anschuetz



THE INFORMATION AGE HUNTING TOOL



The new Citadel Boss-25 is an advanced AR-style autoloading 12-gauge shotgun that brings the 18th century scattergun into the Information Age. Featuring familiar controls, a detachable five-round magazine, and exceptionally cool particulars, the Boss-25 looks as good as it runs. While home defense and tactical applications are obviously in its wheelhouse, the Boss-25 is also a supremely efficient hunting arm. However, toting this gun into the field in pursuit of wild game requires a slight adjustment to the traditional mindset.

Cultural Evolution

An awful lot of folks are questioning an awful lot of things these days. In an era of revisionist history, toppling statues, and a country that seems to be covered in a thin patina of woke social justice warriors it can be easy to lose track of our roots. While hitting the field in pursuit of wild game might seem a bit anachronistic in the era of civilian space travel, designer lattes, and ubiquitous digital interconnectivity, it is actually such stuff as this that makes us human.

Genesis 1:28 says, “God blessed them and said to them, ‘Be fruitful and increase in number; fill the earth and subdue it. Rule over the fish in the sea and the birds in the sky and over every living creature that moves on the ground.’” God put us here to live off of the bounty of the earth. To deny this fact is to deny who we are.

I grew up in the Mississippi Delta, and hunting deer and turkey was an integral component of most normal kids’ lives. Regulated hunting provides the funds that drive wildlife conservation around the world. As

[Cont. to page 12]

ALPS
OUTDOORS



- Trijicon AccuPoint TR24G 1-4x24 Rifle Scope \$1,099.00
- BCM® Diamondhead Folding Rear Sight \$119.00
- BCMGUNFIGHTER™ QD End Plate \$16.95
- BCMGUNFIGHTER™ Stock \$55.95
- GEARWARD Ranger Band 20-Pak \$10.00
- BCMGUNFIGHTER™ Grip Mod 0 \$25.95
- American Defense RECON X Scope Mount \$189.95
- BCM® Diamondhead Folding Front Sight \$99.00
- BCM® KMR-A15 KeyMod Rail Handguard 15 Inch \$199.95
- BCMGUNFIGHTER™ KMSM KeyMod QD Sling Mount \$17.95
- BCMGUNFIGHTER™ Vertical Grip Mod 3 \$18.95
- BCMGUNFIGHTER™ Compensator Mod 0 \$89.95
- BCM® Low Profile Gas Block \$44.95
- BCM® A2X Flash Suppressor \$34.95



B5 Systems SOPMOD Bravo Stock \$58.00



Blue Force Gear VCAS Sling \$59.95



BCM® KMR-A KeyMod Free Float Rail Handguards

Same as the fantastic original KMR Handguards but machined from aircraft aluminum!

BCM 9 Inch KMR-A9	\$176.95
BCM 10 Inch KMR-A10	\$179.95
BCM 13 Inch KMR-A13	\$189.95
BCM 15 Inch KMR-A15	\$199.95



BCM GUNFIGHTER™ KeyMod 1-Inch Ring Light Mount

For 1" diameter lights **\$39.95**



BCM® PNT™ Trigger Assembly

Polished - Nickel - Teflon **\$65.95**



Wilson Combat Tactical Trigger \$269.95



PWS DI KeyMod Rail Handguard

Free float KeyMod rail for AR15/M4 pattern rifles.

PWS DI 12 Inch Rail	\$249.95
PWS DI 15 Inch Rail	\$249.95



BCM GUNFIGHTER™ KeyMod Modular Scout Light Mount

For SureFire Scout Light **\$39.95**



PWS KeyMod Polymer Bipod Adapter \$23.95



BCM GUNFIGHTER™ KeyMod Modular Light Mount

For 1913 mounted lights **\$39.95**



Inforce WML-HSP \$129.00



Trijicon TA31RCO-M4 ACOG 4x32 \$1,422.05



Aimpoint PRO Patrol Rifle Optic \$441.00



Daniel Defense SLiM Rail Handguard

Slim, Light, Modular KeyMod free float handguard.

DD SLiM Rail 12.0	\$265.00
DD SLiM Rail 15.0	\$265.00



Arisaka Inline KeyMod Scout Mount \$37.00



Arisaka Ring KeyMod 1" Light Mount \$45.00



Daniel Defense KeyMod Bipod Adapter \$48.00



Daniel Defense KeyMod 1 O'Clock Offset Rail Assembly \$40.00



Thorntail KeyMod Offset Adaptive Light Mounts

Thorntail 1.030 Mount	\$70.00
Thorntail M3M6 1913 Mount	\$50.00



Arson Machine Company KeyMod Light Mounts

Scout M600 Mount	\$48.00
1" Ring Mount	\$44.00



- Midwest Industries Folding Front Sight \$79.95
- Midwest Industries ERS BUIS \$93.95
- GEARWARD Ranger Band 20-Pak \$10.00
- BattleComp 1.5 \$155.00
- BCMGUNFIGHTER™ 1913 Modular Light Mount, KeyMod \$39.95
- BCMGUNFIGHTER™ KMSM KeyMod QD Sling Mount \$17.95
- BCM® KMR-A13 KeyMod Rail Handguard 13 Inch \$189.95
- BCMGUNFIGHTER™ KAG Kinesthetic Angled Grip, KeyMod \$18.95
- TangoDown ARC MK2 30 Round Mag \$19.48
- BCM® PNT™ Trigger \$65.95
- BCMGUNFIGHTER™ QD End Plate \$16.95
- BCMGUNFIGHTER™ Stock \$55.95
- BCMGUNFIGHTER™ Grip Mod 3 \$17.95
- BCM® Polymer Trigger Guard \$6.95
- PWS FSC556 Tactical Compensator \$94.95



BCMGUNFIGHTER™
Comp Mod 0 - 556
Threaded 1/2x28 for 5.56 AR15 platform
\$89.95

Comp Mod 1 - 556
Threaded 1/2x28 for 5.56 AR15 platform
\$94.95



IWC KeyMod QD RL Sling Mount
Accepts heavy duty or standard QD swivels
\$17.00

IWC KeyMod Hand Stop
Mount-N-Slot design **\$34.95**



BCM® KeyMod Picatinny Rail Sections

Mil-Std 1913 rails, Nylon Rails available in Black, Flat Dark Earth and Foliage Green.

- Nylon Rail, 3 Inch **\$8.95**
- Nylon Rail, 4 Inch **\$11.95**
- Nylon Rail, 5.5 Inch **\$14.95**
- Aluminum Rail, 3 Inch, Black **\$19.95**
- Aluminum Rail, 4 Inch, Black **\$24.95**
- Aluminum Rail, 5.5 Inch, Black **\$29.95**



PWS KeyMod Picatinny Rail

- Polymer Rail, 5 Slot **\$11.95**
- Aluminum Rail, 5 Slot **\$28.95**



BCMGUNFIGHTER™ Enhanced Lower Parts Kit
BCM® PNT™ Trigger Assembly, BCM® Mod 3 Grip, BCM® Trigger Guard, and Mil-Spec hardware kit.
BCMGUNFIGHTER™ ELPK, semi-auto. **\$119.95**



BCMGUNFIGHTER™ KAG Kinesthetic Angled Grip
Uses a biomechanically efficient forward rake, small profile, textured front and back for positive engagement. Impact resistant polymers, available in Black, Flat Dark Earth, Foliage Green and Wolf Gray.
KAG-KM, KeyMod Version **\$18.95**
KAG-1913, Picatinny Rail Version **\$19.95**



BCM® KeyMod Rail Panel Kits
In Black, Flat Dark Earth, Foliage Green and Wolf Gray.
5.5 Inch Rail Panels, 5-Pack **\$9.95**



Vltor Carbine EMOD Stock \$119.65

VTAC MK2 Wide Sling \$44.95



BCMGUNFIGHTER™ VG MOD 3
Low-profile length for increased mobility and decreased "snag". Made in the U.S.A. from impact resistant polymers, available in Black, Flat Dark Earth, Foliage Green and Wolf Gray.
VG-KM-MOD-3, KeyMod Version **\$18.95**
VG-1913-MOD-3, Picatinny Version **\$19.95**



Aimpoint Comp M4S
Red dot sight, fully NVD compatible, with QRP2 Picatinny Rail Mount
\$889.00



EOTech HOLOgraphic Weapon Sights

- Model 512 **\$429.00**
- Model 552 **\$529.00**



In addition to serving as a superb home defense and defensive weapon, the Citadel Boss-25 autoloading shotgun is also an outstanding hunting tool.

[Cont. from page 9]

incongruous as it might seem, were it not for hunting we would be faced with the widespread extinction of countless rare creatures.

There is a weird cognitive dissonance that surrounds hunting as a subset of the American gun culture. Sportsmen who cling dogmatically to their hunting arms while eschewing the more defensive genres are derogatorily referred to as "Fudds," a veiled reference to the Elmer Fudd hunting character of Bugs Bunny



In these days of riotous protests and digital everything, it can be easy to forget where we came from. (Unsplash photo by Flavio Gasperini)



Down here in the Deep South where I live most normal kids grow up hunting. My buddy Braxton here is a master turkey slayer.



Deer hunting is part of the fabric of rural spaces across the country.

fame. Interestingly, I'm told old Elmer will have his firearms digitally excised from future releases of the cartoon, his side-by-side 12-bore yet another lamentable casualty of the ongoing culture wars.

Benjamin Franklin once opined, "We must, indeed, all hang together or, most assuredly, we shall all hang separately." If ever there was a perfect application for that pithy appellation it is in the modern fight

[Cont. to page 16]



Military necessities influence many to most modern consumer products. (U.S. Department of Defense)



Guns like the Boss-25 have not historically been viewed as hunting tools. However, while hunting has no bearing on a gun's sporting applications, the Boss-25 is an undeniably efficient tool for taking game like deer and turkey.



RESOLUTE

PROFESSIONAL GRADE WEAPONRY®

BRAVOCOMPANYMFG.COM

BCM GUNFIGHTER™



BCM GUNFIGHTER™ Pistol Grip

- ▶ Reduced grip angle keeps wrist in line for improved trigger control
- ▶ Hinged Trap Door interior storage with water resistant rubber gasket
- ▶ Mod 0 similar to A1/A2 backstrap, Mod 1 with high rise backstrap
- ▶ Mod 2 up to 1/4 inch wider with interchangeable backstraps/inserts
- ▶ Mod 3 up to 1/4 inch wider with high rise backstrap/extended insert
- ▶ All Mods available in Black, Flat Dark Earth, Foliage Green, Wolf Gray

BCM GUNFIGHTER Pistol Grips Prices start at **\$17.95**



BCM GUNFIGHTER™ Stock

- ▶ Over a year in design, specifically engineered geometry, with no weak links. New patent pending latch reinvents the interface with the receiver extension, providing superior strength.
- ▶ Simple modular, snag free design utilizes only 5 parts and 1 screw
- ▶ 2 ambidextrous sling mounting options including QD swivel socket
- ▶ Color matched rubber buttpad for secure shoulder placement
- ▶ Available in Black, Flat Dark Earth, Foliage Green and Wolf Gray

BCM GUNFIGHTER Stock **\$55.95**



BCM GUNFIGHTER™ Vertical Grip

- ▶ Forward angle increases rigidity of the forearm, provides more natural wrist angle
- ▶ Featuring an aggressive texture, and generous storage volume
- ▶ Cross bolt designed to work with improvised tools
- ▶ Reversible clamp for fastener setup on either side
- ▶ Made in the U.S.A. from high quality, impact resistant polymers
- ▶ Available in Black, Flat Dark Earth, Foliage Green and Wolf Gray

BCM GUNFIGHTER VG - Screw Mount . . . **\$20.00**



BCM GUNFIGHTER™ Vertical Grip -Short

- ▶ Low-profile length for increased mobility and decreased "snag" factor
- ▶ Forward angle increases rigidity of the forearm, provides more natural wrist angle
- ▶ Aggressive texture, generous storage volume
- ▶ Made in the U.S.A. from high quality, impact resistant polymers
- ▶ Available in Black, Flat Dark Earth, Foliage Green and Wolf Gray

BCM GUNFIGHTER VG-S - Short, Screw Mount Version . . . **\$35.95**

BCM GUNFIGHTER VG-S-KM - Short, KeyMod Version . . . **\$39.95**



BCM GUNFIGHTER™ VG

- ▶ Low-profile length for increased mobility and decreased "snag" factor
- ▶ The forward angle increases the rigidity of the forearm, while providing a more natural wrist angle
- ▶ Can be mounted in reverse angle to increase control when grabbing handguard and grip
- ▶ Flat sides with aggressive texture give better control to the shooter
- ▶ Anchor and bolt system offers a simple and robust design, while maintaining a light-weight 1.9 ounces
- ▶ Made in the U.S.A. from high quality, impact resistant polymers
- ▶ Available in Black, Flat Dark Earth, Foliage Green and Wolf Gray

BCM GUNFIGHTER VG-KM-MOD-3 - KeyMod Version **\$18.95**

BCM GUNFIGHTER VG-1913-MOD-3 - Picatinny Rail Version . . **\$19.95**



BCM GUNFIGHTER™ KAG Kinesthetic Angled Grip

- ▶ Forward rake gives positive retention when using "C-clamp" method of handguard support, works as a rest for supported firing positions
- ▶ Slight angle without bulk adds just the right amount of strain relief to the wrist without substantially increasing the girth of the handguard
- ▶ Small profile, textured front and back for positive engagement
- ▶ Innovative patent pending attachment method allows for robust clamping and alignment with minimal hardware and accessory size
- ▶ Made in the U.S.A. from high quality, impact resistant polymers
- ▶ Available in Black, Flat Dark Earth, Foliage Green and Wolf Gray

BCM GUNFIGHTER KAG-KM - KeyMod Version **\$18.95**

BCM GUNFIGHTER KAG-1913 - Picatinny Rail Version **\$19.95**



All pricing is subject to change without notice. Please see our website for current pricing.

Hartland, WI U.S.A. / Toll Free: 1-877-BRAVO CO (1-877-272-8626) / Fax: 262-367-0989 / BravoCompanyMFG.com



The military influence is obvious in the design of the Boss-25. However, such stuff as pistol grips and accessory rails also make for more efficient hunting tools.



The Boss-25 is an advanced Information Age design no matter its ultimate application. The gun's high-tech features also make it an effective hunting tool.



[Cont. from page 13]

over gun rights. All gun owners need to be fighting for all guns.

Marital pressures drive the most powerful innovations in science and engineering. Nothing motivates a people to excel like the prospect of violent gory death. World War II brought us such stuff as pressurized jet aircraft, radar, penicillin, nuclear power, computers, and Silly Putty. As that relates to firearms, it is military applications that render such contrivances most efficient.

Although AR-15s were shown to be used for hunting in the 1970s and 80s in gun magazines like *Guns & Ammo*, we owe a great deal to Randy Luth who promoted AR hunting in his DPMS black rifle catalogs decades ago. His tireless efforts to promote hunting with modern-styled semi-auto rifles has made hunting with MSRs mainstream. Nowadays, game ranging



The Boss-25 comes with four chokes and a muzzle brake in addition to a nice choke wrench.



from pigs to seals to deer and elk are regularly hunted with AR-style weapons.

While “scary” features like detachable magazines, pistol grips, and flash suppressors unsettle the less durable among us, such stuff as this makes our tools more efficient. By incorporating technological advancements spawned via military applications into our hunting arms we make them more effective, comfortable, and humane. In the Citadel Boss-25 we see tomorrow’s sporting shotgun.

Pertinent Particulars

At its heart, the Boss-25 is an efficient gas-operated autoloading semiautomatic magazine-fed shotgun. The gun comes with five interchangeable chokes as well as a choke wrench all in a handy carrying case.

The magazine release and safety are both standard M4 fare. There is a manual bolt hold open in the same spot as that of an M4 as well. The charging handle is a rigid post that reciprocates with the bolt on the right side.

The trim forearm stretches out far enough to let you run the gun like you mean it. It is also liberally adorned with M-Lok slots for accessories should the spirit lead. While M-Lok occupies the sides, the bottom slots are Keymod. There is a generous optics rail up top, and the gun comes with a nice set of polymer flip-up sights.

The chamber and bore are hard chrome plated, and the mystical melding of polymer and aluminum keeps the weight down. The buttstock is fixed but includes an adjustable comb to optimize the cheek weld. The

forward portion of the barrel shroud is outfitted with an intriguing set of spiral cuts. I’m not sure what this does exactly, but it looks undeniably awesome. The soft rubber pistol grip is as comfortable as a cotton hammock on a pleasant spring day. *[Cont. to page 20]*



The controls will be familiar to anyone who has ever hefted an M4.



The magazine release is in the expected spot, while the skeletonized charging handle reciprocates with the bolt.



M MEISTER
MANUFAKTUR 

ENHANCING EXCELLENCE



The Meister Manufaktur program creates an exclusive line of hand-engraved, hand-finished pistols with newly developed coatings and finishes never seen before on a production line. Every Meister Manufaktur limited edition pistol promises respected Walther performance combined with hand-finished quality to exceptional detail.



waltherarms.com

© 2020 Walther Arms Inc. | All Rights Reserved



There is ample forearm space for accessories and a proper grip.



Not sure what these spiral cuts are all about, but they sure look cool.



The fixed buttstock includes an adjustable cheek riser.



Five-round box magazines are handy and reliable. Extended ten rounders are available as aftermarket accessories.



The pistol grip sports a soft rubber component that is unnaturally comfortable.

[Cont. from page 17]

The box magazine packs five rounds, and the gun comes with a spare. I have found aftermarket ten-round boxes for sale as well. The chamber is cut to accept three-inch shells, so the gun runs a wide variety of hunting and defensive loads well. There are interchangeable piston rings for light and heavy loads.

The gun's operating system is a fascinating derivation of the WWII-era MKb 42(W), one of two weapons that ultimately begat the StG44 assault rifle. The annular gas system in the Boss-25 taps gas circumferentially around the barrel via three ports to drive a sleeve that itself powers the bolt. The Czech vz-52 rifle operates similarly.

Scattergun Deer Hunting

At least twenty states mandate the use of shotguns for deer in at least some areas for certain parts of the season. The motivations spawn from concerns of overpenetration for high velocity rifle rounds. The use of slugs or buckshot does significantly decrease the risk to folks or property downrange.

For deer, this obviously mandates much closer engagement distances. However, even down here in the deep south where I live, it is rare for most hunters to take a shot at a deer beyond a couple hundred meters. Our recent obsession with long-range shooting has indeed moved those ranges much farther out for



These piston rings interchange to accommodate various loads.



The Boss-25 utilizes a novel annular gas system similar to this Czech Vz-52 rifle.

MAGAZINE CONSIDERATIONS

There is a federal limit on shotgun capacity to three rounds for hunting waterfowl. Myriad state laws espouse similar restrictions. The theory is that hunters shouldn't be out there blasting away after Bambi or Donald Duck like it was downtown Fallujah. Any responsible hunter would adhere to this anyway, but the government likes making rules.

As the magazines for the Citadel Boss-25 pack five rounds, you'll have to improvise yourself a magazine plug. Fret not, you can make one out of a pencil. I used the wooden handle from a disposable paintbrush. Cut some stubby bit of wood to 3.25 inches, disassemble the magazine, and slip your improvised plug up inside the magazine lift spring. This will keep the magazine from holding more than two rounds without adversely affecting reliability.

Interestingly, there is currently an exception for snow geese. These things are like big honking flying rats. Their populations have exploded in recent years to the point where they are adversely affecting their arctic habitats. As a result Uncle Sam now says we are free to use electronic callers and unfettered

weapons in the pursuit of these airborne vermin. Winchester makes a superbly powerful three-inch snow goose load specifically for this application.

Winchester.com **FN**



Making a plug for your magazine to restrict it to two rounds is a simple chore. I made this one out of the handle from a disposable paintbrush.



These massive three-inch Snow Goose rounds from Winchester push a lethal combination of #1 and 2 steel shot.

a certain small segment of the shooting population. I have a dear friend who is a gifted long-range shooter who bagged an elk at 860 meters. However, the typical run-of-the-mill recreational hunter sticks pretty close.

The classic argument for a shotgun as a deer hunting weapon has been stalking game in heavy brush. Even a smidge of grass can throw off the trajectory of a high-velocity bullet catastrophically. However, shooting a deer in heavy brush at close range is more a theoretical construct than a practical one. Given the absolute requirement to verify the nature and orientation of the



Using shotguns in the pursuit of whitetail deer is the law in several congested states due to concerns about errant rifle rounds.



Deer hunting is a popular pursuit in every state where deer are endemic.

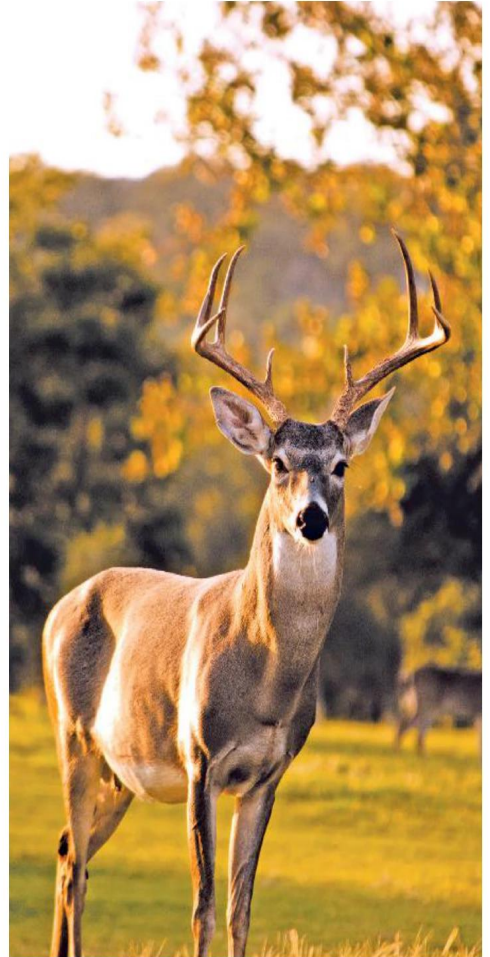

Deer are prevalent throughout most of the U.S. and are hunted as both trophies and for meat. (Unsplash photo by Laura College)

target no responsible deer hunter should be unloading on an animal unless it is within range, clearly identified, and safe.

Another boon to the use of a shotgun for whitetail is downrange thump. We gun nerds can prattle on for days about the nuances of ballistic coefficients, muzzle velocities, bullet weights, and knockdown power. However a one-ounce pure lead slug or nine .33-caliber buckshot mean not having to say you're sorry in

all the world's recognized languages. I've seen a lot of people shot, and close-range shotgun wounds are the most impressive of the lot.

The American Wild Turkey

You simply have not lived until you have sauntered up to a southern table and partaken of a properly-prepared wild turkey with all the support stuff. Just typing these words makes me nostalgic for home and

[Cont. to page 24]



Successfully hunting wild turkey requires a fair amount of guile.



You simply haven't lived until you have had a properly-prepared wild turkey with all the fixins for Thanksgiving or Christmas dinner.



SHOOT THE DISTANCE

HAWKEYE LONG-RANGE TARGET RIFLE



Hawkeye Long-Range Target

#47199 6.5 Creedmoor 10+1 26" Barrel

Our latest Exclusive with Ruger is the Hawkeye Long-Range Target rifle chambered in 6.5 Creedmoor!

- Speckled Black on Gray Target stock
- Features a non-rotating, Mauser-type controlled round feed extractor
- 20 MOA picatinny rail secured with four #8-40 screws
- Heavy-contour target barrel with Ruger Precision Rifle Hybrid Muzzle Brake
- Free-floated, cold hammer-forged stainless steel barrel with 5R rifling
- Rugged, one-piece, stainless steel bolt
- Two-tone target stock features a two-way adjustable comb, adjustable length of pull
- QD attachment points and flush-mounted lower M-LOK rail
- Ships with one AI-style magazine

► NO HIDDEN FEES OR TRANSFER FEES!

GET YOURS TODAY AT GALLERYOFGUNS.COM!

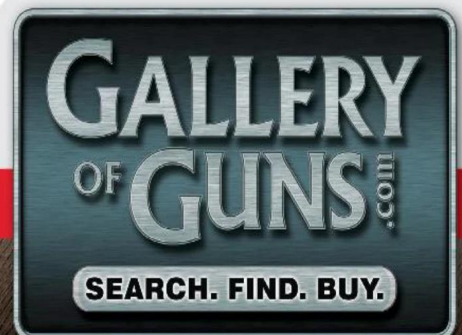

It's simple. If anything ever goes wrong with any new gun you buy with the Davidson's Guaranteed® Lifetime Replacement Program during the time you own the gun, it will be replaced with a brand new gun. Visit GalleryofGuns.com for details.

©2020 Davidson's, Inc. All Rights Reserved.



The wild turkey has been an integral part of America from the very beginning. These horribly ugly birds are hunted for their incomparable meat. (Unsplash photo by Kirk Thornton)



The controls and layout of the Boss-25 are foundational dogma for most American shooters.



entails a remarkable lot of random. You've got to be at the right place at the right time. By contrast, to bag a wild turkey you speak to the animal.

I always felt just a wee bit sorry for the typical turkey gobbler transitioning from forest to dinner table. The hunter is mimicking the female of the species and enticing the randy male to come a'courting. This poor guy just thought he was going to land a hot date before catching a load of Number 5 shot to the beak. As a guy myself that just seemed a particularly ignominious way to go.



[Cont. from page 22]

hearth. When I was a kid, it was always a competition to see who would be the first to find a piece of lead shot in their holiday dinner. (I'm not kidding).

Hunting wild turkey requires a great deal of practical skill. Where stalking deer well is an undeniable art, the pursuit still

Trigger Time

The manual of arms for the Citadel Boss-25 is almost but not quite the same as that of an M4. Firmly seat a loaded magazine and jack the bolt using the right-sided bolt handle. The combination of a well-reasoned design and the gun's sleek, svelte architecture make it eminently pointable.

All 12-bore shotguns are vigorous. However, recoil with the Boss-25 is pleasant thanks to the well-reasoned gas-operated mechanism, soft rubber pistol

[Cont. to page 26]



The advanced annular gas system of the Boss-25 makes it both reliable and comfortable with the right ammo.

NO MATTER WHAT YOU CARRY,
**DeSANTIS HAS
YOU COVERED**



PEGASUS
by DeSantis

SLIM-TUK®

Reliable holsters for the
largest variety of makes,
models, and conditions,
all made in the U.S.A.

WE DIDN'T INVENT CONCEALMENT,
WE JUST PERFECTED IT!®

**De
Santis**
GUNHIDE



PEGASUS
by DeSantis

DESANTISHOLSTER.COM



MADE IN THE U.S.A.

FEDERAL PERSONAL DEFENSE FORCE X2 00 BUCKSHOT



Federal Personal Defense Force X2 Buckshot looks terrifying just sitting still.

There is more science imbedded in your typical round of modern high performance defensive ammunition than sent men to the moon. Nowhere is this axiom better exemplified than in Federal Personal Defense Force X2 00 Buckshot. This is scattergun food for the modern era. Whether your mission is defending the homestead, feeding your department-issued 12 bore, or putting venison on the table, this stuff is as good as it gets.

Force X2 shells pack nine .33-caliber copper-plated lead balls all suspended within a fine granulated buffer material for consistent shot patterns and high velocities. 00 buckshot is arguably the most devastating load that can be wielded by a civilian handheld firearm. Force X2, however, is even nastier.

Each 00 buckshot pellet is creased down the middle like split shot fishing sinkers. Upon impact with something soft and goey each pellet separates into two hemispheres. This doubles the wound channels and minimizes over penetration.



At twenty meters Force X2 from Federal will reliably harvest venison.

Personal Defense Force X2 ammo cycled flawlessly in the Boss-25 shotgun while producing manageable recoil. With half a dozen of these diabolical puppies on tap it is the rare whitetail that won't end up in the freezer. At appropriate ranges this is the good stuff.

FederalPremium.com **FN**



The fixed-length stock is fairly long, but it still fit me nicely.

[Cont. from page 24]

grip, and recoil pad. The presence of a separate pistol grip allows a not insubstantial component of the recoil impulse to be transferred to the firing hand. The in-line nature of the design focuses the primary recoil force directly into the firer's shoulder so as to mitigate muzzle climb.

The trigger is entirely serviceable, and follow up shots are essentially instantaneous. On the last round fired the bolt locks to the rear automatically. Magazines need a little snatch when the release catch is activated. Slam in a fresh box, slap the bolt catch, and you are rocking another mag.

The adjustable comb is a nice addition, but the length of pull for the fixed stock is ample. Little pygmy folks may have a challenge leaning forward far enough to properly index a magnified optic. I'm



A slightly magnified optic like this fascinating Swampfox Optics Trihawk 3X prism sight is perfect for running slugs at reasonable ranges. The Swampfox Trihawk sports an unnaturally generous field of view.

a pretty average-size six-foot-tall lanky guy, and the gun fit me well.

This is a gas-operated autoloading shotgun, so it naturally prefers full-power rounds. This is not atypical among semiautomatic shotguns in my experience. When fed high-brass, full-power loads it ran 100%. As with any weapon you plan to use for real in either defensive or hunting applications, run it enough on the range to take its measure before toting it into the field. Fed proper fodder I would rely on the Boss-25 every time.

[Cont. to page 28]



This big porker is actually a pal named Kevin. The Boss-25 shotgun would be great medicine for his feral buddies, however.

THE CONFIDENCE OF THE RMR®.

IN A SMALLER FOOTPRINT.

Born from the industry-leading RMR®, the new Trijicon RMR®cc comes with the proven reliability and ruggedized electronics that you expect—with a smaller, thinner footprint for concealed-carry confidence.

- Slim, low-profile design
- Unique shape protects lens from drops and bumps
- 4-year battery life
- Mounting adapters for popular compact pistols

»THE NEW
Trijicon RMR®cc



Trijicon
RMR®

See the technology at [Trijicon.com/RMRcc](https://www.trijicon.com/RMRcc).



Brilliant Aiming Solutions™

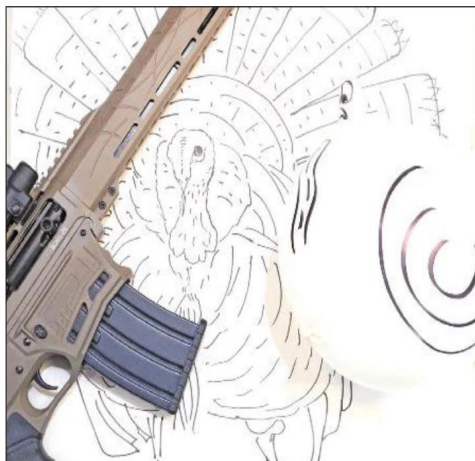

These poor guys don't stand a chance against Federal Number 5's.



At about twenty meters this Tom is on the table.

[Cont. from page 26]

Ruminations

The Citadel Boss-25 is sleek, effective, and fun. Better men than I could likely connect with slugs at 100 meters or more. However, I personally view a scattergun as a fairly close-range tool. When stoked with 00 buck or slugs the Boss-25 packs more raw power than anything that doesn't come with a tripod or an impact fuse.

I hunted throughout my childhood with a beautiful Browning Auto-5 12-bore. That racy rascal kept holidays amply supplied with turkeys, doves, and similar delectable critters. It was also an absolutely gorgeous firearm.

By contrast, the Boss-25 is entirely utilitarian. However, that means the gun interfaces with the human form seamlessly and brings combat-grade ruggedness and ergonomics to the hunting field. Combine this "information age" scattergun with a proper modern

optic and you have a tool that is markedly more efficient and effective than even my trusty humpbacked Browning. Whether the mission is home defense, 3-Gun shooting, or hitting the field in the pursuit of fowl, swine, or venison, the Boss-25 represents the state of the art. **FN**

THE MEPROLIGHT FORESIGHT: EINSTEIN'S GUNSIGHT



If the Meprolight Foresight were a college buddy he would be the one you'd get to help you with your calculus homework. This thing is preternaturally capable and packed with features.

The new Foresight from Meprolight features a rechargeable battery, a seamless data link to your smart phone, and more customizable features than a Swiss Army Knife. Injecting tactical data management into a compact rugged electronic gunsight, the Foresight does things nobody else does. This is the future of combat optics.

You zero the Foresight through your phone. The smartphone app does most of the heavy lifting for you. Lock in zero data for a particular weapon and then you can swap the sight to another gun seamlessly. Mount the unit to the same place every time, and you can run this one sight on ten different weapons. Tell the Foresight where it is via the app, and the sight resumes its zero automatically.

There are scads of different reticle options, and the sight displays battery power remaining as well as an electronic compass. A digital shot counter is coming as a software upgrade. The Meprolight Foresight represents a quantum advance in electronic gunsights.

US.Meprolight.com **FN**

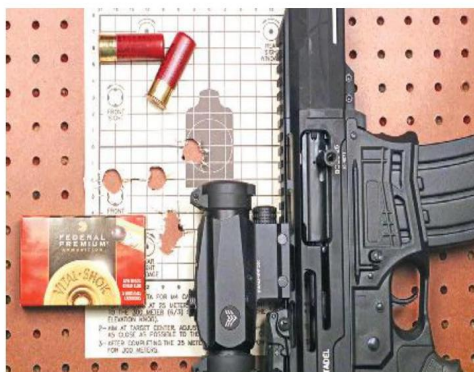

This 25-meter group with Federal Tru-Ball slugs measured just over two inches.

THE CITADEL BOSS-25 SHOTGUN

Finish:	Cerakote: Black, FDE, and Tactical Grey
Gauge:	12 ga
Action:	Semi- Auto
Chamber:	3"
Barrel:	18.75" Chrome Lined
Overall Length:	37.75 in
Length of Pull:	14 in
Weight:	8 lbs
Muzzle Attachments:	5 Chokes including Muzzle Brake
Feed System:	2 - 5 rd Detachable Box Magazines
Sights:	Fully Adjustable Folding Sights
Optics Mount:	Picatinny Rail
MSRP:	\$579
Contact:	(800) 5-LEGACY, LegacySports.com

GALLERY OF GUNS .COM **WANT A CITADEL BOSS-25?**
 Check out Davidson's Gallery of Guns at GalleryOfGuns.com

Davidson's offers the GuaranteeD® Lifetime Replacement Warranty which backs all the firearms you buy through GalleryofGuns.com. It works like this: if anything ever goes wrong with any gun you buy with the Davidson's GuaranteeD® Lifetime Replacement Warranty, it will be replaced. If no replacement is available, it will be repaired at no charge to you. Simply return it to the retailer where you purchased it, pay for the return shipping and upon receipt Davidson's will ship the returning retailer a brand-new gun for you provided one is available. If a replacement is not available your firearm will be repaired for free. For complete warranty information please refer to the Guaranteed Warranty link found at the home page of GalleryofGuns.com **FN**

InfRay
www.infrayusa.com
info@infrayusa.com
xinfared.com

Mini Series

Smallest spotter, but with incredible performance, Either handheld or head-mounted, this unit can revolutionize how you see the world around you.

Toll Free: 800-769-7125 Phone: 682-499-0047

Lowest Price Pistol Ever!

The Altor® Pistol is Virtually Indestructible
Perfectly Simple and Simply Perfect® Survival,
Backup or Stash Gun

Contact your local firearms dealer to get one

MSRP .380 \$119.00
MSRP 9 MM \$129.00

MADE IN THE USA
©2020 ALTOR CORPORATION All Rights Reserved

Visit www.althorcorp.com for more info and videos

Advanced Mounting Solutions

Ultra-low, Forward Optic Mounts
for M-14, M1A, Mini-14, M1 Carbine,
AK, and M1 Garand

Patented, combat proven rail systems, optics,
stock kits & grips.

"Because Good People Need Better Weapons"

UltiMAK™ 2216 S. Main, Suite B2
Moscow, ID 83843
208-883-4734
www.ultimak.com

Enhanced Performance

STERN DEFENSE GET STERN!

Use common pistol magazines for your AR-15 rifles. Add our pistol-caliber upper to create a pistol-caliber carbine (PCC) without buying another firearm! Adapters available for these magazines:

- GLOCK 9/40
- S&W M&P 9/40 AND .45 ACP
- SIG SAUER P320
- BERETTA 92

Various barrel lengths available for uppers chambered for 9mm, .40 S&W and .45 ACP.

MORE INFORMATION FROM INFO@GETSTERN.COM OR CALL 417-932-1128

WWW.GETSTERN.COM



Combine the Savage MSR10 in 6.5 Creedmoor, with a SilencerCo suppressor like the Omega 300, and you have an epic hunting combo.

MSR

A hand is holding a rifle with a silencer, positioned horizontally across the middle of the frame. The rifle is partially obscured by dense green foliage. The silencer is a long, black, cylindrical device attached to the muzzle of the rifle. The background is a dense thicket of green leaves and branches, with some brown leaves visible at the top. The overall scene is outdoors and appears to be a hunting or tactical environment.

Hunting in 2020? SilencerCo Has the Goods!

QUIET

By Patrick Sweeney

Oh, how the world has changed. When I began this journey into the world of working on guns, writing and competing, ARs were chambered only in .223/5.56, blue steel and walnut ruled the markets, and silencers were used by spies, secret agents and some secret groups out of Southeast Asia who didn't talk, much, about that experience.

Today, the list of chamberings you can have an AR, or an AR-like rifle in is as long as your arm, you have to work to find blue steel and walnut, and suppressors are everywhere. No, really. If you haven't been to your gun club lately, you might not know. But every time I'm at the club, there is at least one other shooter there who is using a suppressor. And you can even hunt with a suppressor.

To that end, we're looking at a pair of suppressors from SilencerCo, and parking each of them on a big-boy hunting rifle, a Savage MSR-10 in 6.5 Creedmoor.

OK, rifle first. Savage makes the MSR-10 in both .308 and 6.5 Creedmoor, and in a selection of models. The one I have on hand is the Hunter Overwatch, done up in Overwatch camo, and is new in the lineup. Despite the sixteen-inch barrel, the MSR-10 is not a little firearm. This is a hunting blind or stand rifle, meant to be used in open areas when you may have to reach across a forest opening or beanfield. You should consider the optics you put on it with that in mind; where do you hunt, what do you hunt, and how far is the longest reasonable shot?

To test it, I tried a pair of SilencerCo suppressors on it, a Saker and an Omega 300.

Omega 300

The Omega is a fully-welded centerfire suppressor rated for use with any caliber from 5.7x28 FN, to 300 Winchester Magnum. There are limits, and I suspect the SilencerCo would be cross with you if you happened to own an SBR chambered in .300 Win Mag, and mounted the Omega on it. SilencerCo warranties the Omega 300 on .300 WinMag rifles with barrels 20" or longer. The Omega 300 is composed of Titanium cobalt 6 and stainless steel. I had to look up what cobalt 6 is, as it's been a long time since I was in materials class back in engineering school. This is a Cobalt-based chromium-tungsten alloy, and SilencerCo uses it because of its fabulous wear resistance. (Such various mixtures of exotic metals can also be termed Stellite, at least those made by the Kennametal Inc.) Reading up on its characteristics, I have to wonder how SilencerCo manages to shape it into a form useable in a suppressor. I didn't ask, because they likely would say, and if they did, I couldn't tell you.

The titanium keeps the weight down on the Omega 300, while the Cobalt 6 adds durability, and the stainless steel means you can expect long life out of the mounting system. At 14 ounces and seven inches in length, this is compact for a .30-rated suppressor. It comes with both a direct-thread rear cap, so you can

[Cont. to page 34]



The Omega 300 with the QD muzzle brake mount, the rear cap for it, and the direct-thread rear cap already installed.



The front cap on the Omega 300 comes off, and you can use the Anchor Brake or a regular front cap.



The Omega 300, like all SilencerCo suppressors comes with what you need in the way of tools. You get to decide direct thread or QD, or how many and what caliber rifles it goes on.



Here is the Omega 300, with the direct-thread rear cap, and the Anchor Brake front cap installed.

PREMIUM RUSSIAN AMMUNITION **THAT DELIVERS**

INTRODUCING OUR FIRST COMMERCIALY AVAILABLE
300 AAC BLACKOUT STEEL CASE AMMUNITION
-145GR
-FMJ
-NON-CORROSIVE
-POLYMER COATED STEEL CASE
-SUPERSONIC

300 BLACKOUT JUST GOT AFFORDABLE!



BARNaulammo.com

HI-POINT® FIREARMS

AMERICAN MADE
AMERICAN PROMISE

Hi-Point Firearms is a leading manufacturer of semi-automatic firearms for every budget. With extensive reliability, our firearms are ready to be enjoyed by anyone. For over 30 years, Hi-Point Firearms has been the leader in producing quality, reliable firearms that fit every budget and feature a lifetime warranty.

Our goal has never been to make a cheap gun, but to make a good gun and sell it cheaply - a gun that could be loved and used by many, across a broad income spectrum. And that's exactly what we are doing.



AMERICAN MADE
AMERICAN PROMISE

HI-POINTFIREARMS.COM

© 2014 Hi-Point Firearms, Inc.



Suppressors tame the noise, but the gases that come out are still hot. And they can cause flash under the right circumstances. Here we see the Anchor Brake doing its job.

[Cont. from page 32]

screw it onto a rifle that is threaded but doesn't have a SilencerCo QD mount, and a muzzle brake/mount for the QD rear cap. You can have it both ways. Right out of the box you can readily mount it to two different rifles. It also comes with the wrenches you need to install rear caps, as well as the front caps.

One detail that you might notice is that it has an odd front cap. That is what SilencerCo calls their Anchor Brake. OK, time for a bit of technospeak here. Silencers/suppressors work by delaying the gas flow, and sucking up the energy of the muzzle blast by taking heat from the gases and transferring it to the baffles in the tube. Muzzle brakes (brake, please, not break, spell-check knows not the difference) work by not slowing gases at all, but by diverting them. Yes, suppressors do act to reduce felt recoil, but that isn't their main purpose, and they aren't really very good at it. So SilencerCo offers the Anchor Brake as extra recoil reduction. Taking the last of the gases exiting the Omega 300, the brake gives them a surface into which they can crash, and give the assembly (Omega 300, rifle, you) a bit of a jolt forward.

This is not without cost. Muzzle brakes are notorious for being obnoxious to bystanders. I had no one available to stand next to the Omega 300, so I can't address that. However, since it takes quite a bit of steam out of the decibel level, it can't be all that bad, on the obnoxious scale, as a brake. What it does do

is give the rifle/suppressor combo one last chance to flash, and it did so during photography. It may come as a surprise to you to discover that suppressors can flash, but they do. I was reminded of this some years ago when I shot in the first Midnight 3-gun match, and saw flash all over the place.

Now if you want you can unscrew the Anchor Brake and put on a regular end cap, or one of SilencerCo's flash-reduction endcaps, so it is clear: they know this is America, and we expect choices.



Now that the direct-thread rear cap is off, you can install the QD rear cap.



The Omega 300 set up for the QD mount system.



The SilencerCo tool, unscrewing the rear cap of the Omega 300.

A .30 SUPPRESSOR ON A 6.5 RIFLE?

You might think that putting an oversized suppressor on a rifle might make the suppressor a lot less effective. Well, you'd be wrong. Yes, the 6.5 bullet is a lot smaller in diameter than that of a .30 (.264" vs. .308") but the end result isn't that much different. The clearance down the baffle stack for a .308" bullet, in a .30 suppressor, is as generous as the maker needs it to be. So, let's say we have a bore hole (picking a number pretty much at random, as manufacturers vary on this) of .350". That ends up giving us a clearance of 0.021". (Actually, a pretty snug fit.) OK, let's use a 6.5mm bullet, instead. Our clearance now becomes 0.043". Really? You're going to gripe about an extra twenty thousandths of clearance? What matters is the noise reduction. Let's also just assume that the difference would be 3 whole decibels. It turns out that under very good conditions, someone with good hearing, paying attention to two impulses, can just detect a 3 dB differential. Given that none of us is going to be shooting in ideal conditions, most of us no longer have top-notch hearing, and we aren't listening for the difference, we're never going to notice.



Always, always, always check suppressor alignment before doing any shooting. The baffle strike you avoid might be your own.

Plus, you can change the end results of a decibel test by 3 dB just by changing loads.

And here's the good part: a .30 suppressor on a 6.5mm rifle is going to be forgiving of a small misalignment in the threads. Misalignment is never a good thing, but you are almost never going to see a problem, with a .30 suppressor on a 6.5 rifle. **FN**



The Saker ASR from SilencerCo.

Saker ASR

OK, the Omega 300 is a good, solid suppressor, but you have higher expectations. You are going to mount your can on a variety of rifles and SBRs, and you want to use your suppressor on pistols as well. Calling Mr. Saker. The Saker ASR is made without titanium so it is going to be heavier. In fact, the 7.62 model is just under a pound and a half. That's a big step up from the Omega 300, with its nearly wispy 14 ounces. But, the Omega 300, with the titanium to make it light, brings with it barrel length restrictions. The Saker, composed entirely of Cobalt 6 and stainless steel, has no unreasonable barrel length restrictions. That bears repeating: from 5.56 up to .300 RUM, you can put it on any normal, or even shorter-than-normal barrel length and SilencerCo is fine with that. So, those of you with 5.56 SBRs or pistols and 7.5" barrels? You have a suppressor you can use. That includes the .300 blackout, even with supersonic loads. 7.62 rifles with barrels down to twelve inches (I shudder to think of that) are OK with SilencerCo, and the magnums can



You can swap the front cap on the Saker, and other SilencerCo suppressors, using the supplied wrench.

be as short as twenty inches. And the Saker will stand up to that. It is obviously full-auto rated so have fun.

The Saker ASR can be assembled with either a direct-thread rear cap or a QD rear, this being the SilencerCo Charlie ASR mount, that is a fast-pitch thread QD mount to go onto a SilencerCo muzzle brake or flash hider. The Saker can also be assembled



The Saker ASR, with wrenches, muzzle brake mount, front caps (flush and flash hider) and flat shims to properly time the QD mount. All in the box.



The locking collar on the Charlie mount of the Saker keeps the Saker tight after you've quick-threaded it onto the mount.

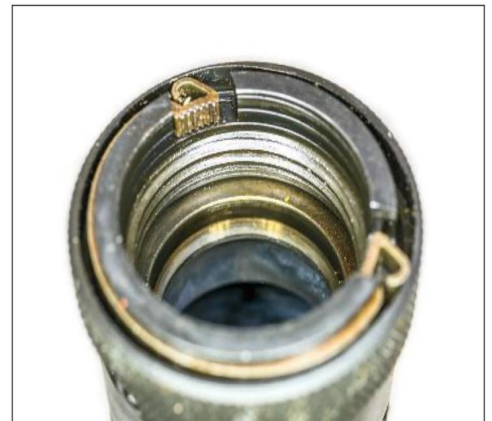

The rear cap of the Saker, in this instance the Charlie mount for QD attachment.



The rear of the Saker ASR and the muzzle brake mounts that it fits onto.

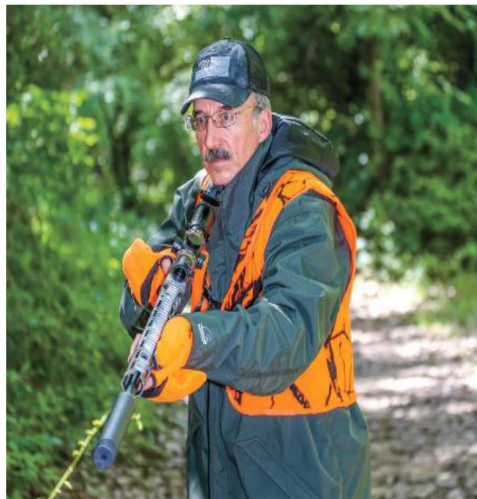

As a still-hunting combo the Savage and all the extras may be a bit heavy. But then again, we never flinched at walking the woods with nine pounds worth of .30-06 bolt gun in the old days, did we?

with a front cap that is a plain (or as plain as SilencerCo can make things) or flash hider cap. Front caps come in a selection of clearance sizes, so if you were going to be putting your Saker 762 onto a 5.56 rifle, you could scavenge a few extra decibels by putting a 5.56 front cap onto it. Me, I've spent my life trying to stay out of the crosshairs of My Man Murphy, and the 5.56 front cap that came with mine went into the box holding the Saker 556, because I just don't need the risk. If you were to move the Saker 762 from your 5.56 rifle, and put it onto your 7.62, forgetting to replace the front cap, there would be...a problem. The first bullet would struggle to exit. The rest would find the task easier. You would find it difficult to remove the damaged front cap, but the good part is it probably wouldn't damage the threads of the tube. Probably.

Me, I just leave the .30 front cap on, regardless of the chambering of the rifle. And yes, you can



One good thing about the AR system is that the adjustable stock on a carbine buffer tube allows easy length of pull adjustment for cold weather clothing.

mount an adapter Charlie mount to do this. The muzzle threads on the .30 (and the 6.5 Creedmoor) are 5/8x24. For 5.56, they are 1/2x28. So, SilencerCo makes a muzzle brake or flash hider Charlie mount that has the 5.56 muzzle threads, but the 7.62 QD threads and seat.

Like the Omega 300 and all other SilencerCo suppressors, the Saker ASR comes with the wrenches you'll need to assemble or disassemble it.

Savage MSR10

The Savage is their design on the .308 AR-10 origins, but with the updates of design and engineering we have discovered in the 60+ years since the AR-10 was first seen. The particular model sent here to Gun Abuse Central is their Overwatch Hunter, where the receivers and handguard are given a Mossy oak Overwatch camo pattern. The handguard is a free-float

LIFT THAT BARGE, TOTE THAT BALE

There's work involved in testing guns. I know, you are shocked, shocked, to find that gun writers actually perform manual labor. In the recent testing rush, I've had to put scopes onto and off of a dozen rifles or so. Getting the screws on and tight is always a fuss, but if you do it wrong you either end up with a loose scope (and often busted as a result) or one with dents in it for over-tightening the rings. Real Avid just came out with a torque wrench that helps here. Their Smart Torq driver is click adjustable for its settings. As in, each click is an inch-pound. Forget where it is? Spin it back to zero and count back up again. It comes with the usual suspects in tip sizes, but it also uses standard 1/4" bits, so you can build a small box of extras to cover all the ones you need to be mounting.



Mounting scopes all the time, a good torque wrench is a big help. Real Avid helps here with their new click-adjustment torque wrench.

It comes in a zippered, semi-hard case, with those tips and an extra lever to let you easily get the torque you need for a given task.

I only have one question: where were these guys when I was wrenching on guns for a living? They are making the things I needed, or built for myself, but they do it better than I did. **FN**

design that attaches to the upper receiver by means of four husky bolts that go parallel to the bore, through the handguard flange and into the upper receiver. The handguard is M-Lok and has a full-length rail on top, for plenty of room for optics, lights, etc. Making it easy to shoot, the melonited barrel and its 5R rifling, are teamed up with Magpul furniture and a two-stage match trigger.

Now, a .308 AR-based rifle is not going to be the airweight that one chambered in 5.56 can be. Even with only a sixteen-inch barrel, the Savage MSR10

[Cont. to page 38]

1 carat of scintillating moissanite
in precious .925 sterling silver

ONLY \$199

Save 400!



*Moissanite clarity is
exceptional & comparable
to a VVS1 diamond*

STARMAN

Moissanite, the stone born from the stars, is more beautiful and far rarer than a diamond now at a stellar price of **only \$199**.

Are you up for an interstellar phenomenon? Are you ready to go boldly, seek out something new and explore a new frontier? Your mission, should you accept it, is this: claim one carat of extraterrestrial cool for a price that will set you apart from the average earthling. The **Starman Ring** is out-of-this-world, and here's why:

The unique gemstone Moissanite was first discovered in the Diablo Canyon Crater in Arizona by French chemist, Henri Moissan in a 50,000 year-old meteorite. Along with winning a Nobel prize, Moissan gave the world a stone that according to the GIA (Gemological Institute of America), outperforms all jewels in terms of brilliance, fire, and luster. In fact, Moissanite grown today possesses the fire and brilliance of a diamond, but is many times rarer than its mined counterpart.

Through the genius of science, we can bring you a piece of the universe for a down-to-earth price. The **Starman Ring** features one-carat of genuine Moissanite set in rhodium-finished .925 sterling silver. The Moissanite gemstone in this ring emanates luxury as well as a special, otherworldly charisma.

Now, you could spend over \$5,000 on a one-carat diamond of this color and clarity. But that would defeat your mission. We have a feeling you'll shoot for the stars.

"...[moissanite] for those who want the diamond look but are not looking to spend diamond prices."

— *The Zoe Report, 2019*

PRAISE FOR STAUER MEN'S RINGS

"This is one cool ring! Feels great and looks even better! Get one!"

— B. H., Lyons, IL

Satisfaction guaranteed or your money back. Have a close encounter with the *Moissanite Starman Ring* for 30 days. If you aren't over-the-moon, send it back for a full refund of the item price.

Limited Reserves. We have the best price for Moissanite on earth, which means these rings have been flying off the shelf. Don't let an out-of-this-world ring slip through your fingers. Call today!

Men's Moissanite Starman Ring (1 ct) ~~\$599~~ **\$199** +S&P

You must use the insider offer code to get our special price.

1-800-333-2045

Your Insider Offer Code: SMR146-01

Please use this code when you order to receive your special discount.

† Special price only for customers using the offer code versus the price on Stauer.com without your offer code.

Stauer®

14101 Southcross Drive W., Ste 155, Dept. SMR146-01,
Burnsville, Minnesota 55337 www.stauer.com



• 1 carat of brilliant moissanite in rhodium-finished .925 sterling silver setting • Wholes sizes 8-14

Stauer... *Afford the Extraordinary.*®



Two groups, one at 100 yards, and one at 200 yards, demonstrate accuracy and ease of point-blank zeros with the 6.5 Creedmoor.



The best group of the day, no surprise from Hornady. Who says 6X isn't enough magnification?

DECIBEL READINGS

Firing up the Larsen-Davis meter, we got the readings on the Savage MSR10 when being fed Hornady 140 grain ELD-Match. The average of five shots both un-suppressed, and with each suppressor.

Un-suppressed	161.3 dB
Omega 300	134.7 dB
Saker	133.9 dB

CHRONOGRAPH AND ACCURACY DATA

Ammunition	Bullet weight (gr.)	Velocity	sD	Ave. Accuracy
Winchester Extreme Pt	125	2,690	15.9	1.6"
Federal Terminal Ascent	130	2,772	27.7	1.9"
Hornady A-Max	140	2,451	37.1	1.6"
Black Hills ELD-M	147	2,566	16.1	1.1"

Accuracy results were to be averages of 3, 5-shot groups at 100 yards off a Champion shooting rest. Velocities are averages of 10 shots measured on a Labrador chronograph set to read 15 feet from the muzzle.

SILENCERCO OMEGA 300

OAL:	6.2 to 7.82"
Diameter:	1.56"
Material:	Inconel, Titanium, Stellite, stainless steel
Weight:	14.7 – 16.3 oz
Finish:	Cerakote
Calibers Available:	5.56 up to .300 Win Mag
Full-Auto Rated:	Yes
Mount System Available:	Direct thread & QD
MSRP:	\$1,130

[Cont. from page 36]

tips the scales at just under eight pounds, bare and empty. For this test, I grabbed a Geissele super Precision mount off the shelf, and bolted a Primary Arms 1-6 scope on top. Yes, a 6.5 Creedmoor can benefit from more magnification, when shooting at distances. But as a hunting rifle, I don't see a lot of shooters needing something like, say, a 6-18x50 to be shooting whitetails in the Midwest.

At the start of the testing I first chrono'd the loads, and almost immediately took off the muzzle brake Savage installed. It was too effective, driving the muzzle down off of the target. I did the chrono and accuracy work without a muzzle device, then scrubbed up the threads before installing the two SilencerCo suppressors for the decibel testing.

Whenever I mount a suppressor, I always do an alignment check, just to make sure things are good. Now, a .30 suppressor, on a 6.5 rifle, would have to be visibly mis-aligned in order to generate a baffle strike, but no fears here. The alignment rod was dead center through the front cap clearance hole on each.

The acceptance of suppressors in the last few years has been nothing short of amazing. Not only are they now legal to own in more States than ever (42, last I kept track) but they are now permitted in hunting. Not just varmint and pest control, but classic, Let's Go Up North hunting on Opening Day in November hunting. Not everywhere, so check with your DNR to make sure, but if at all, then this is a combo that will be just the ticket. And the ticket could easily be:

SAVAGE MSR10 OVERWATCH HUNTER

Type:	Gas-operated self-loading rifle
Caliber:	6.5 Creedmoor (.308 also available)
Capacity:	20+1 rounds
Barrel:	16-1/8"
Length:	37"
Weight:	8 lbs
Trigger:	4 lbs
Sights:	n/a
Finish:	Hard anodized aluminum, Mossy Oak Overwatch camo finish
MSRP:	\$ 1,647

CONTACTS

Realavid.com	Hornady.com
Silencerco.com	FederalPremium.com
SavageArms.com	Geissele.com
Black-hills.com	PrimaryArms.com
Winchester.com	

getting a new shooter hooked on hunting. Setting them up in a blind, so it is not overwhelming, with a zeroed rifle, and a suppressor on it, so there's no ear-busting muzzle blast. After all, we've got a whole slew of first-time gun buyers out there. Some of them are going to be thinking about hunting. Let's get them started right, shall we? **FN**



HECKLER & KOCH



IT'S TIME FOR AN UPGRADE

The best-selling HK pistol just got even better. All 2020 HK VP9 pistols now include the following upgrades.

- 17-round magazines replace previous 15-round versions
- Improved iron sights, with high-visibility front sight and clean black rear
- Optional optics-ready mounting system

If you've been thinking about upgrading to an HK, now is the time.

VP pistols have easy to change backstraps and side panels for a personalized fit. 27 custom-fitted grip combinations are possible.



www.hk-usa.com • 706-568-1906

BRING ENOUGH GUN!

THE

“OMEN

By Rikk Rambo



NEMO ARMS

MATCH 3.0" vs. THE LAST FRONTIER



PROLOGUE: WHAT HAPPENS IN VEGAS...

The day is January 22nd, 2019, and I am standing inside the entrance to the most magical place on earth (not Disney World, you nut...SHOT Show)! My mouth is agape and even though this is my second visit to this iconic premier Las Vegas event, I am predictably in awe. In fact, my level of wonderment and unbridled enthusiasm nearly mirrors what I experienced in 1980, at age 12, when I was thumbing through the Atari 2600 video game cartridge pages of the Sears Christmas Wish Catalog, lost my place, and magically (and TOTALLY by accident, I assure you) found myself in the women's lingerie, or depending on your upbringing, "unmentionables" section.

I was a brand-spanking new 'wet behind the ears' contributing writer for *Firearms News* magazine with one whopping cover article under my belt. I was also a man on a mission...a mission that involved navigat-

ing my way through SHOT Show's vast wilderness of firearms, optics, tactical gear, and other insidious distractions to find a booth commandeered by a weapons firm whose name invoked the mystique of an iconic Jules Verne submariner. More importantly, this booth belonged to a gunmaker with a reputation for innovation and building powerful, long distance rifles capable of delivering some serious hurt, en-masse, downrange.

The company was NEMO Arms (New Evolution Military Ordinance) and the rifle for which I sought an audience was one whose very name served as a dire warning to all ne'er-do-wells, steel gongs, and 1,000 Yard paper targets who fell under its gaze. The AR-based Omen Match 3.0 in .300 Winchester Magnum.

As I wound my way through SHOT Show's maze of shooting, hunting, and tactical goodness, the allure of Trijicon thermal rifle optics, Dillon-Aero Mini-Guns,



NEMO Arms employee Cade Miller in his booth at NASGW Expo in 2018 (NASGW.org). (Photo by Editor Vincent DeNiro)

and a myriad of other treasures called, but I stayed true to my goal and arrived at the NEMO Arms booth. Greetings, call signs, and secret handshakes were bearishly exchanged with the friendly yet capable NEMO arms staff and several weeks later, after my new friend Bryan at NEMO Arms confirmed my cover-story with his London, Moscow, Washington, and Buenos Aires field offices, the machinations were put in place that would send the Omen to one of the most brutal testing and evaluation environments in North America.

The Omen was headed north, and just in time for a springtime, saltwater/maritime black bear hunt in



"The Punk" getting her snark on and leading the way into the high alpine.

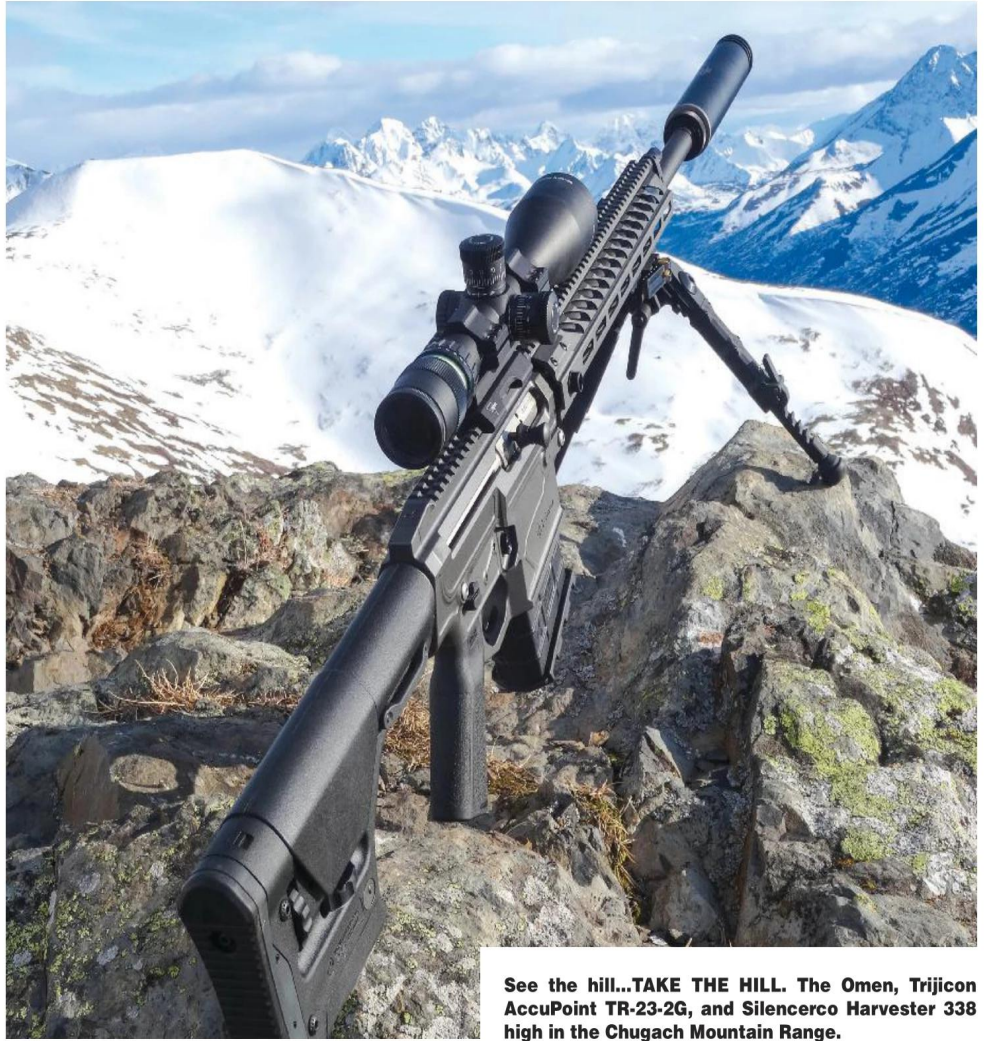

See the hill...TAKE THE HILL. The Omen, Trijicon AccuPoint TR-23-2G, and Silencerco Harvester 338 high in the Chugach Mountain Range.

the bays, coves, and high in the mountains of coastal Alaska.

**"THAT'S THE LIFE OF A MODEL, BABY!"
(A HIGH-MOUNTAIN PHOTO SESSION)**

The climb up the mountain was not an easy one. Early spring in the highlands of Alaska's south-

central coastal region is beautiful, but the scenery does not come without a cost. Avalanche danger abounds and climbing conditions can be abysmal at best. After you hike past tree-line and begin the vertical ascent into the high-country, the realization of what the day may hold in store can sometimes smack you in the face like a wet dish towel. Madame Winter is reluctant

[Cont. to page 44]

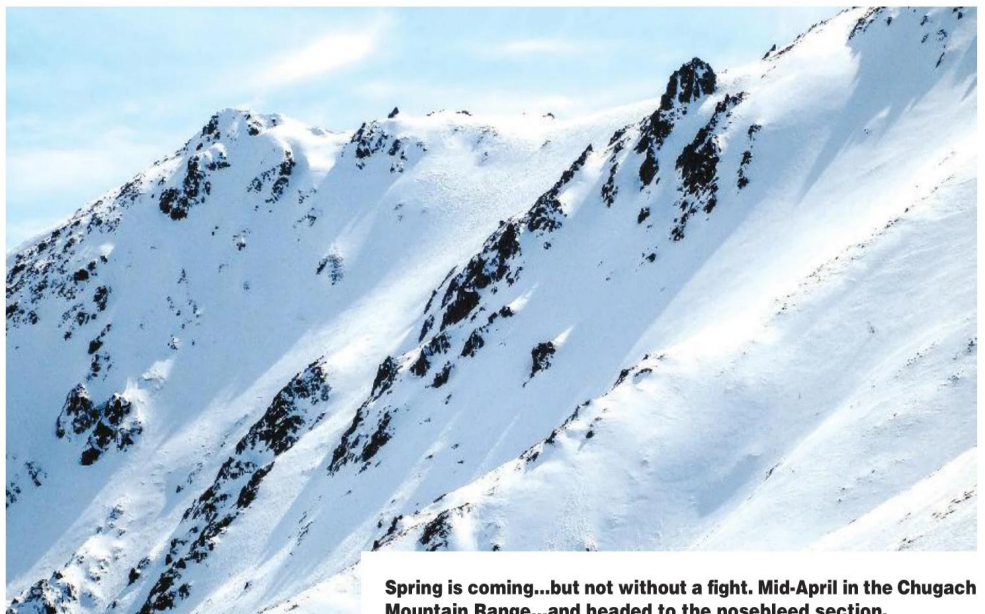

Spring is coming...but not without a fight. Mid-April in the Chugach Mountain Range...and headed to the nosebleed section.

©2020 O.F. Mossberg & Sons, Inc.

MOSSBERG | MC2c[®] COMPACT

**13+
REASONS
TO FEEL
CONFIDENT.**



MC2c Double-Stack Magazines in 13-Round & 15-Round



#89012
MC2c 9mm
Semi-Auto

SAFETY TIP 
Store firearms securely,
inaccessible to children
and unauthorized users.

YOU'VE GOT AN EXTRA STACK OF PEACE OF MIND.

Engineered to be ultra-slim in spite of its double-stack capacity, the MC2c 9mm sits comfortably in your hand and is easily concealable for everyday carry. Lightweight, ergonomic, and providing 13 or 15 rounds at the ready, it sets the new standard for high-capacity semi-auto personal protection.

Mossberg – Makers of dependable, hardworking firearms for more than a century.

LEARN MORE AT
MOSSBERG.COM

MOSSBERG[®]
SINCE 1919

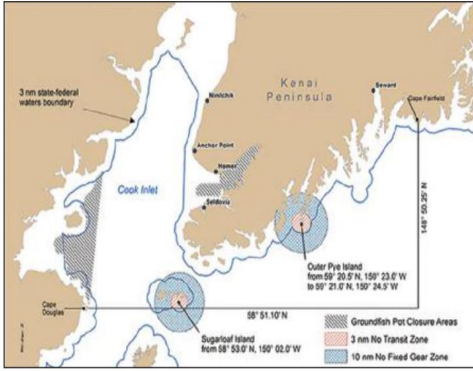

The Cooke Inlet, Kenai Peninsula, and Chugach mountain area. (Alaska Department of Fish & Game)

[Cont. from page 42]

to give up her stranglehold on the high alpine, and even during the warmest of springs it is readily apparent our frigid winter mistress views Punxsutawney Phil as a fraud, charlatan and the “MSNBC/CNN of meteorologists.”

Daunting terrain features and chest-deep, granular, late season snow all served as stark reminders as to why I seemed to be the only dunce intent on reaching the unnamed Chugach mountain range peak above me on this fine April morning...but duty calls, and I had an op to complete.

My ornery Belgian Sheepdog (AKA: “The Punk”) and her agile, lightweight frame made good time as she bounded glided effortlessly over the three- to five-foot-deep snow fields and drifts ahead of me. In contrast, my upper middle-age carcass, encumbered with a 75 pound Eberlestock rifle-pack full of firepower, survival gear, and photography equipment, was not exactly exuding ballet-worthy gracefulness. No matter. I was going to flounder and “post-hole” through the deep, crusty snow like a drunken sailor for the duration of the morning



Forget those Antifa commies, the real revolution has arrived: “Occupy The Chugach Range!”

until I completed my mission at the mountain’s peak: the photoshoot of a stunning super-model.

Several hours and a plenty-pack of NC-17 rated words later, “The Punk” and I arrived at the summit, and as sometimes happens when you’ve brushed your teeth, made your bed, shown kindness to a stranger, and didn’t incur the wrath of an old Gypsy lady, Lady Luck heaped some feel-good vibes our way. The angry looking front that had been brewing all morning disappeared over the distant horizon that boundaries Cooke Inlet and the Kenai Peninsula to the south.

[Cont. to page 46]



A tale of two magazines...tried and true Remington Sendero .300 WinMag with a 5 round capacity and the groundbreaking Omen Match 3.0 with 14+1.



WHEN BRIGHTNESS COUNTS[®]



TFX[™] PRO
PROFESSIONAL-GRADE
TRITIUM + FIBER-OPTIC
XTREME DAY/NIGHT SIGHTS



TFX[™]
TRITIUM + FIBER-OPTIC
XTREME DAY/NIGHT SIGHTS



TRITIUM PRO
PROFESSIONAL-GRADE
HANDGUN NIGHT SIGHTS



TRITIUM
HANDGUN NIGHT SIGHTS

TRUGLO[®]
TACTICAL

WWW.TRUGLO.COM





The Nemo Arms Recon is the shortest in this series sporting an 18-inch barrel.



The Nemo Arms M210 is the least expensive in this series. Prices start around \$3,900.



The NEMO Arms Match is the perfect pick if you can't decide between the Recon and the Watchman.



The Nemo Arms Watchman is the top-shelf variant of the aforementioned quadruplets and among other things sports a Geissele Super semi-automatic enhanced (SSA-E) two stage trigger, Proof Research carbon barrel, and other high-end components.

[Cont. from page 44]

Blue skies, light winds, and unlimited visibility were the word of the day and all was right with the world. It was go-time for the fashion shoot and my featured model was fully accessorized for the cameras.

Since Naomi Campbell and Cindy Crawford were engaged with gigs in Milan and Paris, the photogenic model that was the subject for the day's shoot hailed from the more continental surrounds of Nampa, Idaho. Idaho... where brute strength and sturdy ruggedness trumps frou-frou fashion sense and other such fluff and fineries. The NEMO Arms Omen Match 3.0 had arrived on the Last Frontier.

The Chugach Mountain Range and Omen did not fail to please on that brisk but beautiful early-spring afternoon. The imposing presence imparted by the rifle was obvious the minute it was unsheathed from my gun pack and the legs of its NEMO provided Accu-Tac bipod deployed. While "The Punk" munched on snow and sniffed curiously at some fresh Coyote tracks, I outfitted the Omen with a Silencerco Harvester suppressor, <https://silencerco.com/>, and quick detach Trijicon TR-23-2G optic, [https://www.](https://www.trijicon.com/products/details/tr23-2g)

[trijicon.com/products/details/tr23-2g](https://www.trijicon.com/products/details/tr23-2g). The Omen was in its natural element and possessed the appearance of a weapon ready to fulfill its intended role: Ruling, with an iron fist, as king of all it surveyed.

When the photo session was complete, I surveyed the surrounding ridges and peaks for climbers. Satisfied I wouldn't instigate a Texas A&M Tower/Grassy Knoll reminiscent panic upon unwary outdoor enthusiasts in the area, I went prone and assumed several real-world fighting positions in the rocky outcroppings around me to get a feel for the weapon's ergonomics. I cannot lie. In an instant, I was transported from that cold, desolate mountain top to the sun-dappled bow of James Cameron's version of *The Titanic*, my previous male-pattern baldness now transformed into luxurious, long, sandy-blond Leonardo DiCaprio-esque hair flowing in the wind. Thankfully, Kate Winslet was nowhere to be found, leaving the Omen and me free to lovingly spoon on the prow of the mighty vessel while joyously shouting "I'm king of the world!"

"The Punk," was not amused at my show of affection for an inanimate object, so after a moment or two



The highly effective NEMO recoil reducing bolt carrier group. Dually functional as a rifle component OR impact weapon! (For scale, it is pictured with a full-size SIG P220 and my old-school Pittsburgh Police blackjack.)

[Cont. to page 48]

ANYTIME ANYWHERE

DIGITAL ACCESS NOW INCLUDED WITH YOUR PAID SUBSCRIPTION!

ENJOY DIGITAL ACCESS ON YOUR PHONE, TABLET & MORE*



SUBSCRIBE TODAY AT

WWW.FIREARMSNEWS.COM

CURRENT SUBSCRIBERS GO TO MYMAGNOW.COM AND SELECT "CREATE DIGITAL ACCOUNT"

*Digital Edition is available on updated iPad/iPhone, most Android devices, and the Microsoft Store for Windows



JUST 70¢ PER COIN

Secure Your "Banker's Bag" and Enjoy Hours of Family Fun!

Start Your Own Treasure Hunt

With These 100-Coin Bags of Vintage U.S. Coins Dating as Far Back as the 1800s!

Every collection begins with a single coin. One solitary piece of American history we receive as a gift, or find among our pocket change as a child. For many of us, that coin was one of America's many vintage coins—retired designs that somehow stayed in circulation long enough to find their way into our hands.

Finding one of these vintage U.S. coins is an incredible feeling. Now imagine a bag containing 100 of them!

100-Coin "Banker's Bags"

We understand the joy of taking a bag of coins, dumping them out on the table, gathering the kids and grandkids and setting to work sorting through all the dates, designs, mint marks and more. That's why we've compiled these 100-coin "Banker's Bags" of vintage U.S. coins.

Every coin in these bags has a story to tell, from the Steel Cents struck in 1943 so the U.S. Mint could donate its copper to our troops during World War II, to the "Mercury" dime nicknamed for Liberty's resemblance to the Roman god of finance. These bags give you 100 stories to explore for hours of family entertainment.

Secure Coins Dating As Far Back as the 1800s

Every bag is guaranteed to include at least one coin that dates back to the 1800s. That's more than 120 years old!

Guaranteed in Every Bag

Each bag contains eight different "types" of vintage coins, all in Good to Very Good condition.

You're guaranteed to receive at least one of each of the following (dates vary):

- ✓ Indian Head Cent (1864–1909)
- ✓ Lincoln Wheatback Cent (1910–1958)
- ✓ Steel Lincoln Cent (1943)
- ✓ Liberty Head Nickel (1883–1912)
- ✓ Buffalo Nickel (1913–1938)
- ✓ Jefferson "War" Nickel (1942–1945)
- ✓ Barber Dime (1892–1916) 90% Silver!
- ✓ Mercury Dime (1916–1945) 90% Silver!

Get More For Less

Other companies are selling 60-coin banker's bags of vintage coins at prices ranging from \$53.99 to \$81.94. That's up to \$1.37 per coin! But with this special offer you'll receive not 60, but 100 vintage U.S. coins for just 70 cents per coin. It's just one more reason that GovMint.com is *the best source for coins worldwide™*.

Secure Your Bankers Bag Now!

This offer will only last as long as our supply of these 100-coin bags of vintage U.S. coins. Don't miss this fantastic opportunity to explore American history as only coins can tell. Call 1-888-870-7349 and use the special offer code below to secure your Banker's Bags now!

100-Coin Bag of Vintage U.S. Coins

\$69.95 each + s/h

FREE SHIPPING on 2 or More Bags!

Limited time only. Product total over \$149 before taxes (if any). Standard domestic shipping only. Not valid on previous purchases.

Call today toll-free for fastest service

1-888-870-7349

Offer Code BVC124-01

Please mention this code when you call.

GovMint.com • 14101 Southcross Dr. W., Suite 175
Dept. BVC124-01 • Burnsville, MN 55337



GOVMINT.COM®
THE BEST SOURCE FOR COINS WORLDWIDE

GovMint.com® is a retail distributor of coin and currency issues and is not affiliated with the U.S. government. The collectible coin market is unregulated, highly speculative and involves risk. GovMint.com reserves the right to decline to consummate any sale, within its discretion, including due to pricing errors. Prices, facts, figures and populations deemed accurate as of the date of publication but may change significantly over time. All purchases are expressly conditioned upon your acceptance of GovMint.com's Terms and Conditions (www.govmint.com/terms-conditions or call 1-800-721-0320); to decline, return your purchase pursuant to GovMint.com's Return Policy. © 2020 GovMint.com. All rights reserved.



A look at the large NEMO Arms .300 Win. Mag. bolt and bolt carrier (TOP) with its built-in buffer system, compared to a S&W M&P 10 .308 bolt and bolt carrier (MIDDLE), and a 5.56 bolt and bolt carrier from LWRC (BOTTOM).

[Cont. from page 46]

of awkwardness, I packed up and initiated the steep climb down the mountain.

The Omen's second day in Alaska was over...but its nine-month tour of duty through all four of Alaska's remarkable seasons had just begun.

**IT TAKES TWO TO TANGO...
TOO BAD THE OMEN ISN'T HERE TO DANCE.**

Times change. Sometimes for the worse, and sometimes for the better. To better understand how these paradigms relate to the Omen Match 3.0, I first need to tell you a true story about...high school musicals.

I am not ashamed to admit that back in the day I

was quite the thespian, successfully pulling off roles as a street tough Shark-gang member in *West Side Story* and the crusty old Sheriff in *Oklahoma* with nary a snide or catty remark from Siskel and Ebert. However, appearing in these Broadway classics, as performed by an extremely rural high school spring musical cast, was not about art. It was about SURVIVAL. I am not talking about the inherent risk of pulled calf muscles from pirouetting about the stage during the "Farmer and Cowman Should Be Friends" number, or strained vocal cords incurred from shouting down poor old Officer Krupke.

No. It's much darker (and dangerous) than that.



My grandfather's pre-64 Winchester Model 70 .300 Winchester Magnum. Shooting the Omen precludes me from saying something sappy like "They don't make 'em like they used to."

You see, our country school was so poor, it spent nearly its entire spring musical budget on a single luxury...a professional choreographer. Our rented dance guru was an extremely enthusiastic off-Broadway choreographer fresh off the plane from "The Big Apple" who rocked an open-fronted silk shirt, a "Fred from Scooby-Doo" ascot and brooch, and bell-bottoms. Unfortunately, this imported extravagance came with a price tag: diminishing our musical's already skinny budget to near Karen Carpenter levels and leaving the students on their own in the prop department.

When it comes to the procurement of stage props for musicals that involve human conflict, I think we can all agree it is probably not the most prudent situation in which to place a bunch of country kids with access to country kid gear. Country kid gear in the form of genuine, super-sharp lock-blade Buck knives for the back-alley fight scenes in *West Side Story* and fully operational family heirloom Colt Peacemakers and Ruger Single Six's with hand-loaded blanks in lieu of movie-prop blank guns for the "shoot 'em up" action sequences in *Oklahoma*.

Anyway, the point of the story is that times change. While the "good old days" of being encouraged to tote a large caliber revolver or knife onto school property in an effort to support theater and the fine arts are long gone, we currently live in an era of radically improved firearms design and innovation. Enter the NEMO Arms OMEN, a modern, state of the art rifle with a semi-automatic/adjustable gas system and an AR-style magazine capable of housing fourteen .300 Winchester Magnum copper-jacketed "Horsemen of the Apocalypse."

The Omen made its grand debut on the firearms market in 2013. It was (and remains) a ground-breaking



The Trijicon TR23-2G dual illumination (tritium/fiber optic) scope...decisive, clear, and reliable in any conditions... a formidable partner for the Omen 3.0

[Cont. to page 50]

USE GUN SMARTS.



Scan the QR code with your phone camera, or go to: gunsmarts.smith-wesson.com



GUNSMARTS

Your On-Demand Guide to Firearms Tips,
Fundamentals, Safety, and Protection.

Subscribe to the Smith & Wesson® GunSmarts video series
to learn from today's leading experts.





The Lineup! (L-R) Hornady Match, Federal Premium, and Underwood Ammo "Controlled Chaos."

[Cont. from page 48]

rifle combining the time-proven accuracy, power, and reliability of the .300 Winchester Magnum cartridge with the familiarity, handling characteristics, and recoil-killing attributes of an AR-based platform. Combine the previous traits with the fact it outdoes its predecessors (such as the standard Winchester Model 70 and Remington Model 700) in the ammunition capacity department to the tune of 10-11 rounds and you have one serious Buck Rogers in the 25th Century firearm!

There are currently four variants of the Omen available to American shootists. The Omen Recon, the shortest of its class with an 18-inch barrel, the 'M-210' sporting a 20-inch barrel, the 'Match 3.0' outfitted with a 22-inch barrel, and The Watchman, rocking a 24-inch Proof Research carbon fiber fortified barrel. The Watchman is the top-shelf variant of the aforementioned quadruplets and among other things sports a Geissele Super semi-automatic enhanced (SSA-E) two stage trigger, Proof Research carbon barrel, and other high-end components.

The version Alaska would put to the test was the Match 3.0, equipped with the Geissele Super semi-automatic enhanced (SSA-E) two stage trigger found on the Watchman, a Magpul PRS adjustable rifle stock and Miad pistol grip, and a 22-inch 416R Stainless steel barrel manufactured by Wisconsin-based Bartlein Barrels. The Bartlein blank is custom turned by NEMO Arms in-house to insure the already world-class barrel is finely honed to an even higher degree of reliability and accuracy. In addition to this 1:8 twist 5R rifling Bartlein blank, NEMO outfits the Omen with a patented NEMO upper and lower receiver manufactured from set billet 7076-T6 Aluminum Alloy complete with a tungsten Cerakote finish. Top this off with NEMO Arm's patented Boron-coated recoil reducing bolt carrier, 4 position adjustable gas system (perfect for suppressed/non-suppressed operation), suppressor-ready threading, and proprietary titanium dual-chamber muzzle brake, and you have a prime candidate for the age-old truism, "You get what you pay for."

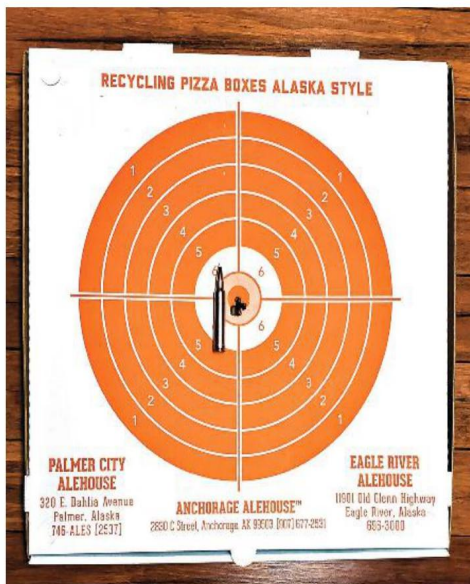

Guns 'N' Pizza! Two things that go together... especially at the 100-yard line.



The AccuBond tipped Federal Premium cartridge at 200 yards.



It wasn't Sunday, but we still kept the day "hole-y" with the Hornady 195-grain ELD tipped Match cartridge at 100 yards.

I'd be remiss if I didn't add one more thing to the Omen's laundry-list of high-speed accessories...the NEMO Arms proprietary 14-round magazine. When I was a young man, the only "distance rifle" in the family was a pre-64 Winchester Model 70 in .300 Winchester Magnum my Dad inherited from my grandfather. When I reminisce about how I used it to add voluminous particulates of atomized groundhog into the atmosphere (thus insuring my place on PETA'S "Woodchuck War Criminal List"), the pollen count goes up and my eyes tend to get a little watery.

It is true...I did send an inordinate number of destructive, beady-eyed, yellow toothed whistle-pigs to that great burrow in the sky with that five-shot Winchester "go-loud" masterpiece, but how do you think the numbers would have played out if I'd had the Omen/Silencerco Harvester/Trijicon AccuPoint trio at my disposal during the war against the groundhog menace? Well, let's just say that the age-old question of "how much wood would a woodchuck chuck" would be a moot point...at least in a quaint little corner of north-eastern Ohio.

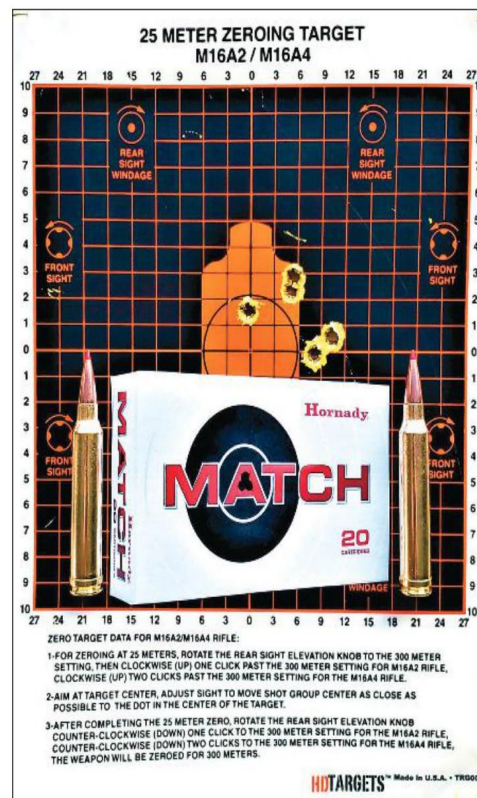

The metric system was never my strong suit...! (Hornady Match-1 1/2-inch group at 200 yards)

DARK TIMES AHEAD FOR PAPER: "THE OMEN" HITS THE RANGE!

The AR-based .300 Winchester Magnum Omen was destined for great things in Alaska...a planned Prince William Sound boat-based black bear hunt, back-country photo sessions, an unsuspected encounter with a devious coyote, and finally an impromptu and frigid bison harvest in Alaska's windswept and frozen interior. But before all of that, the rifle would be outfitted with an extremely Alaska-capable Trijicon TR-23-2G AccuPoint 5-20x50 optic and put through some rigorous range sessions with a variety of ammunition from Lehigh Defense, Federal, and Hornady.

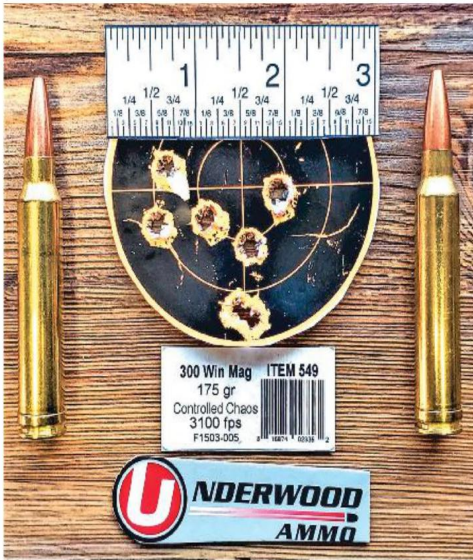

Seven rounds of devastating Underwood Ammo medicine huddled together in a 1½-inch group at the 200-yard line.

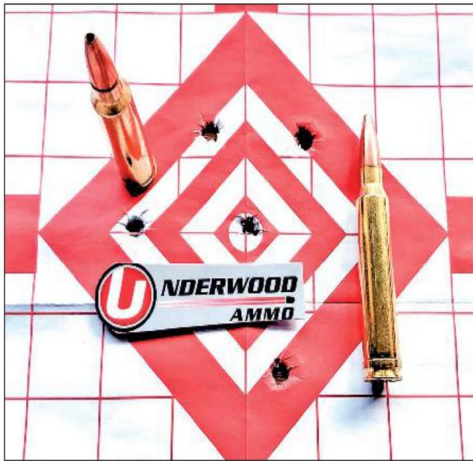

The “Controlled Chaos” cartridge and its 3¼-inch group at 300 yards.

These were the three lucky candidates sent down-range by the Omen Match 3.0.

- Hornady Match Grade armed with red-tipped 195 Grain ELD/Extremely Low Drag projectiles rated by Hornady to achieve 2,930 feet per second from the barrel.
- Federal Premium cartridges topped with 180-grain Nosler AccuBond bullets and rated by Federal to achieve a muzzle velocity of 2,960 feet per second.
- Underwood Ammo 175-Grain “Controlled Chaos” fracturing rounds rocking out of the barrel at an estimated 3,120 feet per second.

The performance of every one of the tested rounds was phenomenal...both in accuracy and reliability. Remember those old sayings thrown at you by adults back when you were a young punk kid and up to shenanigans? Sage proverbs like “Honesty is the best policy,” “Two wrongs don’t make a right,” and my personal favorite “Keep that up and you’ll go blind.” Well, testing these bullets conjured up a fourth adage: “Birds of a feather flock together.” The three tested cartridges performed at impressive, nearly identical levels of accuracy. Here’s the breakdown (five-round groups):

FEDERAL PREMIUM (180-GRAIN ACCUBOND)	
<i>(One Five-Shot Group)</i>	
100 Yards:	¾ of an inch
200 Yards:	1½ inches
300 Yards:	3 inches
HORNADY MATCH (195-GRAIN ELD)	
<i>(One Five-Shot Group)</i>	
100 Yards:	¾ of an inch
200 Yards:	1½ inches
300 Yards:	2¾ inches
UNDERWOOD AMMO (175 GRAIN “CONTROLLED CHAOS”)	
<i>(One Five-Shot Group)</i>	
100 Yards:	1 inch
200 Yards:	1½ inches <i>(Overachiever, actually a seven-shot group!)</i>
300 Yards:	¾ inches

**THE OMEN GOES SWASHBUCKLING:
SPRING BLACK BEAR HUNTING ON
PRINCE WILLIAM SOUND!**

What happens when you take a big-seas capable saltwater boat, fill it with good friends, good food, and a few black bear harvest tags, then send it out onto remote Prince William Sound for some piratical adventures? The answer is: The stuff movies are made from! You never know if the movie is going to be a comedy, action/adventure, or tragedy, but those participating can rest assured it will never be dull or boring! While there is also shrimping and fishing involved in these trips, black bear hunting is the order of the day.

While an entire article could be dedicated to the fine art of maritime black bear hunting, it can be all be boiled down to a few key facets:

1. Binoculars at the ready, you and your jolly crew of scallywags scour the steep, heavily foliated mountainsides above the tide line for black bears eating greens sprouting up just below the previous winter’s receding snowlines.



High up in bear country...a rare clearing affording us a look at a distant fiord and our boat!



Prince William Sound. (Alaska Department of Environmental Conservation)

2. When a respectable bear (one that has been observed for an adequate period of time to insure it not a sow with cubs) has been identified, your friends are motored to shore so they can begin their stalk. It is mandatory that you crack jokes at their expense as you kick back and watch them face untold dangers and hardships at the fangs and/or claws of their quarry and the terrain features of Prince William Sound’s steep, treacherous, avalanche-prone mountain slopes. All from the safety and comfort of your boat’s heated cabin.
3. Every once in a while, get lucky, zig when you should have zipped, zag when you should have zagged, and harvest a tasty, lushly furred black bear!

The bear were lucky on this trip...and so were we. That wasn’t a mistype. Hunting on Prince William



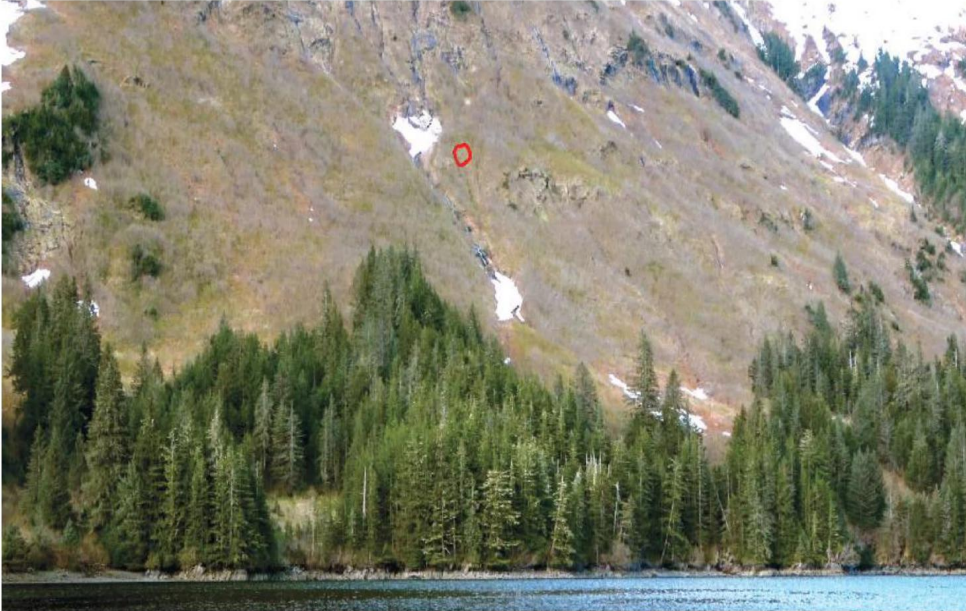

Getting there is half the fun! A view of our distant 'target audience' from the boat.

Sound means you never lose, even if you don't harvest a bruin. The hunting is 1/4 of the experience and the sights and high-seas adventure make up for the rest. As for the bear, my boat-mates and I climbed hand-over-fist through alder and Devil's Club into the nose-bleed section of the sound's coastal mountains in pursuit of several worthy bruins, but none were to be had. Actually, in the spirit of transparency, there were several to be had, but the shots we were afforded came at terrible angles or required firing through bullet-deflecting foliage. Bear, no matter what the size or species, are tough customers. If you can't take one ethically and humanely with a well-placed round into the vitals, you don't take the shot...even with a rifle possessing the credentials of the OMEN.

While the black bear were cut a break on this trip, the Omen was not. It was shouldered, patrol-carried, and even dragged through heavy rain, thick foliage, and up small but climbable cascading waterfalls with a penchant for drenching hunter and rifle alike with freezing, ice-cold water from the melting snow and ice fields high in the mountains above.

Remember the previous disclaimer stating "no bears were hurt" during this segment? Well, I never made any mention of icebergs, did I?! In the spirit of "Remember Pearl Harbor and/or The Alamo" my Army aviator brothers and boatmates (call-sign designators Icy-73 and Icy-98), decided get a little payback for the Titanic and wreak some vengeance on several errant icebergs that were just begging to become victims of the Omen's wrath. Those errant chunks of ice freshly calved from a nearby tidewater glacier never saw it coming. Icy-73 and Icy-98 unleashed the full fury of the OMEN (in the destructive form of 28 rounds of Federal Premium 180-grain Nosler AccuBond-tipped mayhem) and those frozen maritime hazards would never again menace an innocent ferry, merchant vessel, or sea-otter again.

When the once insidious icebergs were rendered into nothing more than dime-sized ice chips suitable for inclusion in a margarita or other umbrella drink of our choice, only the echoes of the Omen's rolling thunder from the distant mountainsides and steady slap of the frigid waves remained. Icy-73 lowered the

Omen, looked at me with a satisfied smile and said: "The Captain has spoken." For a brief moment, I thought he was just caught up in the moment and having an Alexander Haig/ "I'm in control here" moment. Slow on the uptake, I then realized Icy-73 was reverently referring to the rifle.

We all smiled, because while the Omen was aptly named, at least for the time it remained with us, it would be known as "The Captain."

Upon our return to Anchorage, I thoroughly cleaned the barrel and conducted a short accuracy and reliability test at the range with the Federal Premium rounds the Omen was initially sighted in with. Nothing changed. Point of impact was right on at 100, 200, and 300 yards with no adjustments necessary to the AccuPoint, and bonus: forty rounds fired and not a single malfunction or hiccup. The Omen and Trijicon AccuPoint TR23-2G optic were exposed to saltwater spray, rain, and every particulate coastal Alaska could unleash, and both came through without a single pencil-dot of rust or corrosion.

[Cont. to page 54]



Icy-98 keeping a weather-eye out for our mortal Neptunian enemies...ICEBERGS.



The call goes up...iceberg off the starboard bow...ICY-73 and the Omen to the gunwales!



YOUR BUILD *WHEN IT COUNTS*

M4E1 LOWER | M4E1 UPPER | ATLAS R-ONE HANDGUARD



AEROPRECISIONUSA.COM



With the iceberg menace dealt with soundly, it was clear skies and smooth sailing for the rest of the trip!

[Cont. from page 52]

THE OMEN DRAWS FIRST BLOOD... UNINTENTIONALLY.

Do you remember the news story from back in 2005 that featured an ornamental garden gnome that was stolen from its original owner and subsequently photographed by the humorous thieves at iconic locations throughout the country? The well-traveled gnome even participated in a photo-op with Paris Hilton (hope the little guy was caught up on his shots).

Throughout 2019, the Omen became my erstwhile garden gnome. While I had originally intended the Omen to be employed for a hunting-based article, time passed without incident or opportunity... until a dark, frigid day in late fall.

It was late October and there was already a densely packed layer of icy, crust-covered snow blanketing the mountains above tree line in South Central Alaska. I was waiting for a clear day that would allow me

to pack the Omen into the backcountry for a photo session. After a tantalizing wait, regional weather indicated I was going to get my wish. I shanghaied "The Punk," packed up the Omen (along with my winter survival kit) and headed north 212 miles to an area near the Denali Highway...a lonely stretch of gravel road that connects the small community of Cantwell to the even more miniscule community of Paxson (population 40, plus or minus). When I arrived in Cantwell, the weather proved the local meteorologists wrong and was turning ugly. No matter...I had driven over 200 miles and come hell or high water (or driving winds and snow), I was taking the Omen and "The Punk" on a back-country hike. If the weather cooperated for a photography session or some drone

videography, great...but one way or the other, we were going to stretch our legs.

We started hiking until we reached a ridgeline approximately four miles from my pickup. That was when things turned from bad to "49th State Rotten." The wind was howling, and ice granules were zooming along the ground so swiftly and densely that on some stretches of the more barren terrain you could barely see your ankles and feet. It was time to scoot and call this photo session a wash, because in the distance an OMEN-ous (Didn't see that one coming, did ya?!) looking weather front was rolling in. This front had "you best get out of Dodge" written all over it. Anything can happen in Alaska's interior in October, including white-outs, double-digit sub-zero temperatures, and other abominable

[Cont. to page 56]

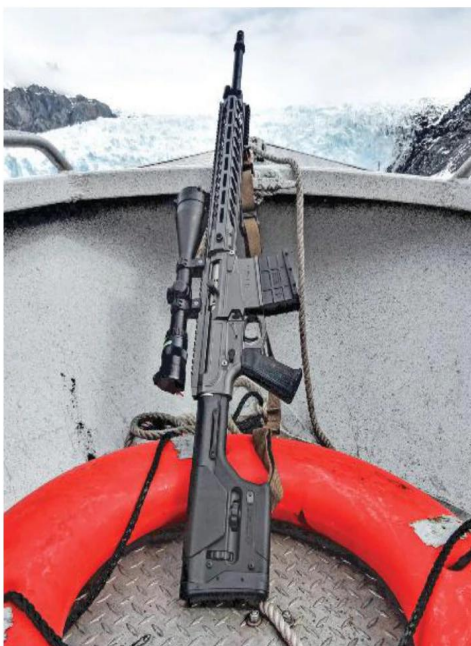

Even the glaciers "showed their props" to "Team Omen" after the carnage-filled "Iceberg Massacre of 2019!"



Rain, sleet, fog, snow, and corrosive maritime conditions didn't put a spot of rust on the Omen.



UINTAHPRECISION.COM



TRUE BOLT ACTION
AR10 / AR15
RIFLES & UPPERS

UNTAMED ADVENTURE

BACKCOUNTRY HUNTER 2019

DIY! 10 HUNTS TO DO NOW

INSIDER INFO: BEST UNITS FOR BIG GAME

BOWHUNTING BULLS: TROPHY ELK IN THE COLORADO WILDERNESS

MASTER CLASS: THE SKILLS TO SURVIVE

GEAR GUIDE: MOUNTAIN KIFLES, BACKCOUNTRY PACKS, RIBBED BOOTS, SATURATE COMMUNICATION

COMING TO A NEWSSTAND NEAR YOU!

LOG ON TO osgnewsstand.com

Also available for iPad, Android Tablets, Kindle & Nook

AIR ORDNANCE
made in U.S.A.

BELT FED **100 ROUND DRUM** **CUSTOMIZABLE**

SMG .22

FULLY AUTOMATIC .22

WITH 100 ROUNDS, IT SURE IS TOUGH TO MISS. THIS BELT FED, FULLY AUTOMATIC .22 PELLET GUN COMES IN A VARIETY OF DIFFERENT PACKAGES FROM BASIC GUN TO THE TACTICAL "ELITE" PACKAGE. FUN AT THE RANGE AND IN THE FIELD.

AIR ORDNANCE
800-671-1498
3518 ADAM CENTER ROAD
FORT WAYNE IN, 46806



Better weather and less hearing damage along the Denali Highway, courtesy of the merry month of May and Silencerco Harvester!

[Cont. from page 54]

traveling conditions. "The Punk" and I turned our little posse around and started heading back to my pickup. We crunched through the crusty snow for nearly a mile and a half when I thought I heard something over the wind. "The Punk" heard it too, because she stopped, turned, put her black radar-dish ears straight up, and listened intently. The only sound that followed was the rush of the wind and high-velocity atomized ice crystals rebounding off of my boots...until about 30 seconds later. That is when it became clear we weren't alone. In the near distance came a canid-like howl that, when mixed with the gusting wind, could either be a wolf or a coyote. "The Punk" is a spunky little gal. She's also

MENSA (an international society for those with high IQs) material in the smarts department and knows when it is time to circle the wagons. She sidestepped several feet and snuggled up against my leg. Good girl.

Speaking of high IQs... if you ever thumb through my old high school yearbook, there's a suspicious vacancy in the National Honor Society group photo. Rest assured the principal didn't put a search party together to find me in order to ensure the photograph was historically correct. All joking aside, whatever deficits I suffer from in the intellect department are made up for in my skills at risk management. While my intentions on that cold, crisp day in October were

entirely wholesome and pure (get some exercise with the pooch and snap some shots of the Omen), I'm always ready for something adverse to occur such as: Cuban, Russian, and Chinese paratroopers dropping out of the sky, a late-season grizzly bear attack, or an embarrassing encounter with a Sasquatch or Yeti in rut (yes, I know Yeti are native to the Himalayas, but I'm not taking any chances)...anyway, you get the picture. True to my credo, I removed the Omen from my Eberlestock rifle-pack, snapped the magazine I'd filled earlier with Underwood Ammo "Controlled Chaos" rounds into place, charged the rifle, and waited. It didn't take long...through the windblown snow and ice, the howling and yipping grew louder and then they showed themselves. The first coyote that trotted down a steep slope nearly 200 yards distant wasn't missing any meals. It was enormous and at first glance looked like an Alaskan interior wolf. The super-sized coyote's three-member entourage followed approximately 25 yards behind and dispelled the wolf myth with their more species-appropriate sized frames. The entire pack of coyotes fanned out, then disappeared into the brush. Once again 'The Punk' and I were alone in the ever-strengthening gusts.

I knew what was unfolding. In 1998, while living high in a remote region of the Cascade Mountains of Washington, a hit-squad of multiple coyotes attempted to lure one of Malory's predecessors (a tough two-year-old Dutch Shepherd) out of our yard on multiple occasions. This ended when I knocked a plethora of holes through one of them with a 12-gauge double-aught buckshot round from danger-close distance and his surviving pals learned a cold hard lesson in life. The current encounter shared a common theme

[Cont. to page 58]



Business end of the Omen 3.0 in early summer... somewhere between Cantwell and Paxson, Alaska.

BCMGUNFIGHTER™



Carbine Length



Mid-Length

BCMGUNFIGHTER™ PKMR Polymer KeyMod Rail Handguards

- Direct "drop-in" design replacement handguard for AR15's with mil-spec front sight base
- Natural ergonomics, slim, comfortable and light-weight, with an aggressively textured area for enhanced traction
- Featuring a reinforced KeyMod interface for durable accessory support with three, six-hole KeyMod mounting surfaces
- Aluminum heat shield reduces heat transfer to the handguard and shooters' hand
- Patent Pending design, made in the U.S.A.
- Will only fit round carbine-type handguard retaining cap
- Available in Black and Flat Dark Earth

BCMGUNFIGHTER™ PKMR
Carbine Length\$24.95
Mid-Length\$26.95

★ **BRAVOCOMPANYUSA.COM** ★

BravoCompanyMFG.com • Hartland, Wisconsin U.S.A.
 Toll Free: 1-877-BRAVO CO (1-877-272-8626) • Fax: 262-367-0989
 Pricing subject to change without notice. Please see website for current pricing.



52 YEARS IN THE MAKING MTM'S NEW TACTICAL RIFLE CASE

42-INCH TACTICAL RIFLE CASE

- HEAVY-DUTY DESIGN
- FOUR STRONG SNAP LATCHES
- FOUR MOVABLE, INTERNAL TIE-DOWN STRAPS
- QUALITY FOAM PADDING
- MULTIPLE PADLOCK TABS
- EXTERNAL TIE DOWN POINTS



CHECK IT OUT AT MTMCASE-GARD.COM

*Everything happens for a reason.
Such as, working your ass off.*

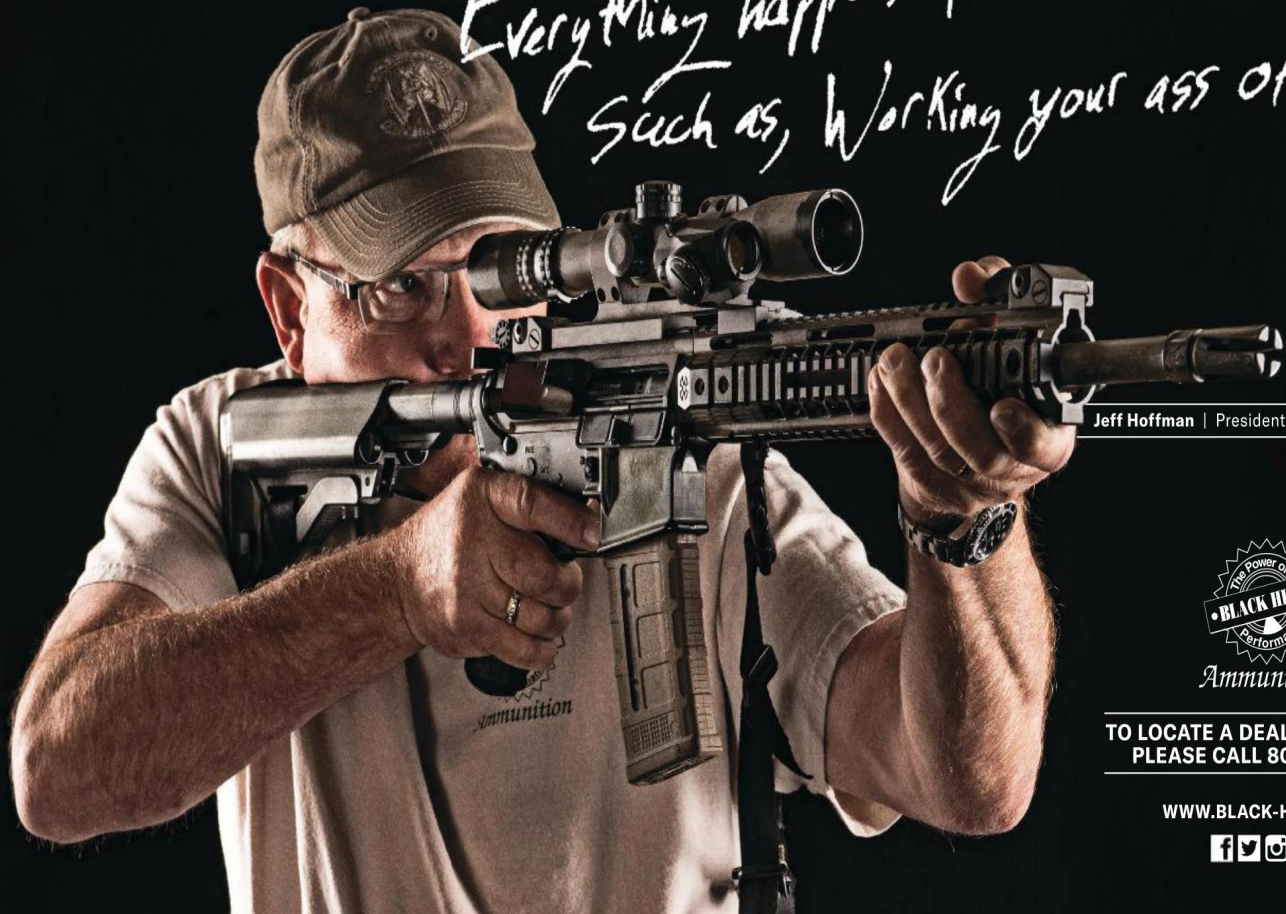

Jeff Hoffman | President



Ammunition

TO LOCATE A DEALER NEAR YOU,
PLEASE CALL 800.568.6625

WWW.BLACK-HILLS.COM





...And the final score is: **The Punk, The Omen, and Rikk: 1**
A predatory coyote that made a poor life decision: 0!



"Chilling" with the Omen...somewhere near Delta, AK.

[Cont. from page 56]

with the 1998 incident: The coyotes wouldn't show themselves en masse...only one or two coyotes would allow themselves to be visible to their domesticated cousins and intended targets. Once the soon-to-be victim demonstrated interest in the "bait" coyote, the coyote would emit vocalizations reminiscent of a canid that was injured or in severe distress. If the dog acted on its curiosity or territoriality and pursued the "bait" coyote into the bush, the trap would be sprung. Multiple coyotes would mercilessly attack, kill, and consume the unwitting victim. The unwitting dog... previously someone's best friend or companion, was prey and nothing more than a food source to them. It was as simple as that...nothing personal. But a terrible way to lose a close friend and companion.

*"Any man don't wanna get killed better
clear on out the back."*

-William Munny/Clint Eastwood in *Unforgiven*

"The Punk" was not going to become a coyote "No-So-Happy-Meal" on my watch...or the Omen's. Unfortunately, I was in a trick bag for our rapidly evolving backwoods' sitcom. I didn't want to reenact the "Vasquez from *Aliens*/Let's Rock!!!" scene and "go loud" on the coyote if I could avoid it. Sadly enough, while I had enough ammunition to fend off the Red Army for an hour or two, 200+ miles separated the Omen from its Harvester suppressor. "The Punk" had never been exposed to the concussive sound signature of a high-powered rifle and I wanted to keep it that way.

It was settled. I would only shoot if I could see the vile, bloodshot whites of their murderous little eyes.

With the Omen on its patrol sling and "The Punk" close by my side, I continued walking back to the truck.

After traveling a mere 100 yards, it was readily apparent these coyotes were atypical. The largest of the group boldly appeared in the open and closed to within 70 yards of our position while the yips, screams, and howls of his other partners-in-crime emanated enthusiastically from the brush around him. I stopped, leashed up "The Punk," and yelled at them (I can't remember the exact verbiage, but it was probably something untoward). The big male bolted into some brush near a steep draw and the wailing stopped. Satisfied, I began walking again, but this time I kept my little girl on her leash. We only made it another 3/4 of a mile and the big male was back...this time closing the distance to 50 yards. His minions were also close by as was readily apparent from their boisterous vocalizations. The big male stared directly at us, fixated on "The Punk," and began emitting a pathetic yipping sound. Then he displayed behavior that would decide his fate.

"This aggression will not stand, man."

-The Dude/Jeff Bridges; from *The Big Lebowski*

The 'alpha coyote' started moving sideways in a canter that made him appear to be injured while continuing with his over-the-top vocalizations. This... was not his first rodeo. It wasn't mine, either. I hooked "The Punk" to my Wilderness Tactical "Instructor Belt," by her leash, gave her a command to go prone, popped open the Butler Creek lens covers on my Trijicon AccuPoint, and made ready. I yelled at the coyote one final time. It was not impressed. He bowed up, turned his body towards us, and stared me right in the eye. I quietly muttered "Well, that's enough of this s#!+." to myself, whispered "Sorry about this...it's going to sting" to "The Punk," placed the brilliant green fiber-optic/radioactive tritium AccuPoint reticle

[Cont. to page 60]

F R E E D O M

MSRP \$395.00
R*Models

Great Silencer, Great Price

SILENCE... IS GOLDEN

3 RING SILENCER CORPORATION

www.3RingSilencer.com • (215) 949-8378

Cedar Mill™
Fine Firearms

"Peace of mind is just a click away"

The ULTIMATE Discreet Rifle Case

Photo courtesy of Dustin Eilemann

✓ Convenient Locking Latch ✓ With Pick and Pluck Foam ✓ 100% Satisfaction Guarantee!

FREE SHIPPING WHILE SUPPLIES LAST

www.CedarMillFirearms.com

STAY ON TARGET

SUBSCRIBE TODAY

FIREARMS NEWS is available on updated iPad/iPhone, most Android devices, and the Microsoft Store for Windows.

For More Information Visit

FIREARMSNEWS.COM

You Will Be Amazed At The Accuracy Inherent In Our Accublock® Stocks!

LRC™ Thumbhole
M50™ Adjustable
LRC™ Vertical Grip
LRC™ Sporter

Long Range Composite Accublock® Stocks

Your Choice \$219

Compare at \$329
★★★★★
Customer FIVE STAR Rated

True Drop-in Models To Fit Most 700's

Accublock® Aluminum Bedding System

Instant Precision

Do It Yourself
Installs In 10 Minutes
Screws Included

Stocky's
ph (561) 584-8500
America's Gunstock Specialists!

INSTANT SHIPPING EXPERT SUPPORT

www.NewRifleStocks.com



The Omen about to be deployed on a bison in the gale-force winds and sub zero temperatures of Alaska's interior.



Scott and the Omen Match 3.0 snagging some 'groceries' for Icy-73 and 'Icy-98!'

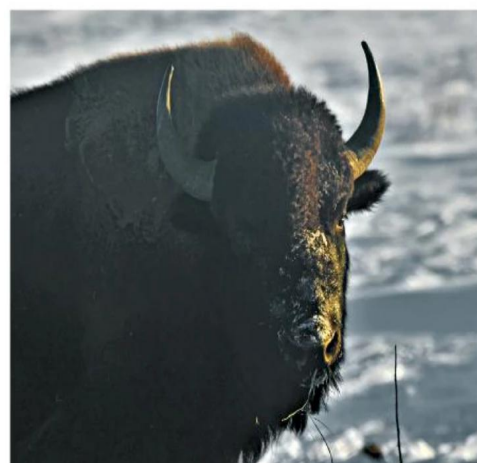

Our bison quarry senses there's nefarious activity afoot...five seconds to late!

[Cont. from page 58]

at the point where the neck and chest of the coyote met, and pushed the trigger.

Several things happened...none of which were surprising. The Omen performed perfectly with its trademark pillow-soft recoil, "The Punk" jumped up, initiated a "tactical retreat," and pulled me nearly eight inches sideways across the crusty, wind-smoothed snow before giving it up and sitting back down with a confused look on her puss, the coyote went to its happy hunting grounds (or across the rainbow bridge, or wherever those of his ilk reside in the afterlife), and the decedent's sneaky minions skedaddled, never to be seen again.

The Underwood "Controlled Chaos" round was like the fist of God coming down on the coyote. I stood up, unleashed "The Punk," and walked back to the coyote to inspect the damage. The crime scene was a puzzlement. My adversary, sporting a perfect winter coat, plunged head first into the crusty snow upon the bullet's impact and remained upright, his head partially stuck and buried in the crust and his rear-end and tail up in the air in a pose reminiscent of an ostrich with its cranium in the sand. I gave him a nudge with the barrel of the Omen and he toppled sideways. The Scooby-Doo mystery was that there was only one tiny trickle of blood on the snow approximately the size of a dime. This riddle didn't take long to solve. I skinned my quarry fairly quickly (given the worsening climatic conditions) and stowed the skull and hide in a spare contractor bag I keep in my pack for emergencies. I then thought to myself, *What would those famous real-life coroners and medical examiners like Michael Baden...or Cyril Wecht...or Jack Klugman do in a situation like this?* Well...conduct an autopsy of course.

I opened up the coyote's body cavity and it was readily apparent you didn't need a medical title after your name to determine a cause of death or the reason

for so little blood on the snow. You would, however, need a medical professional handy if you wanted to identify a single organ or anatomical structure inside our dearly departed. The "Controlled Chaos" round did what it was intended to do...and then some. The 175-grain Underwood frag-grenade impersonator entered the wild canid's chest cavity, traveled a mere 3-4 inches, went sick-house frangible (as designed), and turned everything from the lungs to the small intestines into something reminiscent of cherry Jell-O and tomato paste...with no exit hole and negligible hide damage. I'm not sure what the results would have been in the 'pelt destruction' department if this accurate and devastating round had been launched broadside through the coyote, but the Controlled Chaos round proved to be humane and effective for the straight-on shot.

"The Punk" made out like a bandit that evening at Castle Rambo. My doting wife, "Luscious," lavished her with smooches, a copious amount of ear scratching, moose-burger in her dog dish...and, in light of the day's events, a copy of the Helen Keller biography *The Miracle Worker*.

It was a good day...but the Omen had two more "tasks" to complete...tasks that collectively weighed nearly one ton.

THE GREAT ALASKAN BISON MURDER MYSTERY OF 2019!

I may as well put all of my cards on the table and revise the above intro to read: "HEY...WE NEEDED THE MEAT," primarily because there was no murder



Hooves don't fail me now...“Leave No Bison Behind” isn't the norm when your buddy was just dropped by a .300 WinMag.

mystery whatsoever in this final segment of the Omen's Alaska adventure. Bear hunting partners Icy-98 and Icy-73 wanted to fill their freezers with meat, and there were two bison in Delta Junction that weren't just going to shoot themselves!

Shortly after killing Wile E. Coyote's nefarious cousin near Cantwell, they called and invited the Omen and me (in that order) to join them on a trip to a sprawling game ranch in Delta, Alaska. Once there, I would aid and abet one of the game ranch's owners in the assassination of two bison. "Team Icy" was in dire need of filling their freezers with red meat, and since their busy flight schedules precluded a proper moose hunting expedition in 2019, Scott and Ruby Hollembaek of the Alaska Interior Game Ranch (BisonAndElk.com) were their next best bet. Scott would harvest the bison for my buddies, and his wife, Ruby (with absolutely no

regard for our strict winter diets and whispery-thin bohemian figures) would graciously prepare a delicious lunch of bison stew and all the fixins'!

After we arrived at the ranch, Scott sighted in the Omen to his liking. Our rancher friend is a serious, old-school, real-Alaska type guy with grit in his teeth and nails in his knuckles. That didn't keep him from flashing a brief, wry grin across his face after knocking out five or six trigger presses with the Omen. With Scott satisfied, we headed off on his tractor to harvest those bison. The wind was howling, ice crystals mixed with snow were hurtling along the ground at hurricane speeds, and the temperature was approximately -22 below with wind chill factor when we located the herd. Earlier, Scott told us that to effectively and humanely harvest a bison, you shoot it behind and below the horn base. Our tough Alaskan friend said if

the shot was accurate, the bison's hindquarters would immediately drop to the ground and the rest of the body would follow suit. Scott hopped out of the tractor, picked out the bison whose time had come, and put a textbook shot into it with the Omen. The bison did exactly what Scott predicted, and the big ungulate was D.R.T. (Dead Right There). The second bison was harvested in exactly the same fashion.

Icy-98 and Icy-73 were happy (and who wouldn't be with chest freezers so full they could have made a mid-1800's cattle baron green with envy!?) and the Omen again proved itself under incredibly adverse conditions.

THE OMEN'S NORTHERN EXPOSURE CONCLUDES: THE TAKEAWAYS.

The performance of the NEMO Arms Omen during its tour of Alaska was impressive. My friends who



The Omen paying tribute to its harvest.



Mechanized warfare...how civilized folk get their bison back to the barn!



The NEMO Arms Omen Match 3.0 and Trijicon AccuPoint TR23-2G... ALASKA TOUGH.

SILENCERCO HARVESTER 338



The Silencerco HARVESTER 338 is an extremely tough, decibel-killing suppressor designed to withstand the percussive effects common to big-bore rifles up to .338 Lapua Magnum.

It is capable of reducing felt recoil by 20–50% and providing reliable, multi-shot accuracy with the assistance of an onboard/integrated Anchor Brake. The HARVESTER is comprised of aluminum and features fully welded and hardened tool-grade stainless steel baffles. Weapon attachment can be accomplished via direct thread or proprietary Silencerco fast-attach mounts. **FN**

Caliber Compatibility:	5.56 NATO to 338 LM
Total Length:	10.0"
Weight:	22.0 oz
Diameter:	1.82"
Muzzle Average:	308 WIN: 136.4 dB, 300 WM: 138.3 dB, 338 LM: 136.6 dB
Materials:	Aluminum & Stainless Steel
Finish:	Black
MSRP:	\$ 1,199
Contact:	SilencerCo.com

shot it, former military and law enforcement tactical operators all, were enthusiastically enamored by its accuracy, reliability, and lack of recoil. I agreed with their opinions, and will conclude with these final observations:

THE CONS: The Omen Match 3.0 and the three other models in the Omen line are fairly expensive for the average shooter, ranging from \$3,900 to \$6,200. However, these rifles are engineered and designed to function at a level commensurate with their price tag. The Omen Match 3.0 also has some heft to it...to the tune of 11.2 pounds, precluding it from becoming your next Dall sheep or mountain hunting rifle. However, my 50+ year "aged to perfection" body humped it high into the mountains of the Chugach mountain range with ammunition, photography equipment, and enough survival gear and rations to survive in the Alaskan outback for a week, so opinions may vary by consumer when it comes to weight/load tolerances!

THE ATTAHOYS: The Omen is supremely accurate. If you don't believe me, just ask that pizza box. This rifle is also reliable. Except for regular barrel cleaning, I shot this rifle "dirty" for its entire stay on the Last Frontier. Even dirty, the rifle sent round after round down-range without so much as a hiccup. The 14-round magazine full of .300 Winchester Magnum "Don't Mess with the U.S." projectiles is a major coup for the Omen. The familiar AR-style ergonomics, lack of felt recoil, simple and consistent adjustable gas block settings, and suppressor readiness make for a brilliant and capable rifle. With all of these positive elements in

NEMO ARMS OMEN MATCH 3.0

- Caliber: .300 Winchester Magnum
- Barrel Length: 22 inches
- Full Length: 43.5 inches
- Weight: 11.2 pounds
- NEMO upper and lower receiver set billet 7076-T6 Tungsten Cerakote
- 15" 6061 M-LOK modular rail 1.83" internal diameter steel QD mounts rotation limited
- Lightweight heat dissipating barrel nut 7075-T6
- 7075-T6 7 rifle length "Carrier Cradle" anti-tilt receiver extension Nickel Boron coated
- Tuned steel faced buffer system
- Chrome silicon recoil spring
- NEMO 22" 416R Stainless steel barrel 1:8 twist 5R Rifling Bartlein blank
- NEMO dual chamber compact muzzle brake 6AL-4V titanium
- 4 position adjustable gas system for suppressed and un-suppressed use
- Severe duty threaded stainless gas tube extended length gas system
- PATENTED recoil reduction carrier 8620 heat treated Nickel Boron coated
- High Pressure bolt 9310 heat treated Cryo'd shot peened MPI Nickel Boron coated
- Tool steel extractor heat treated IONBOND coated
- Titanium through drilled takedown and pivot pins
- Ambidextrous safety selector
- Tool steel side charging handle Ionbond coated
- Geissele Super semi-automatic enhanced (SSA-E) two stage trigger First 2.3 lbs Second 1.2 lbs
- MAGPUL MIAD grip
- MAGPUL PRS adjustable rifle stock
- NEMO 14 round magazine with aluminum follower
- RETAIL: \$5,100.00 U.S.

CONTACT INFO: Nemo Arms, 2820 Brandt Ave, Nampa, ID 83687, (208) 461-1213, NemoArms.com

play, the Omen's "fit and feel," when deployed, was one of its most impressive traits. Whether I was at the bench or prone in rocks and snow, the rifle projected a "let's do this" attitude and was one of the most ergonomic, custom-fit firearms I've carried into the wilderness. Would I want to backpack 25 miles into difficult terrain with it and additional gear? Probably not...but would I take it on any hunt where the trekking distance was reasonable or back-country travel in the form of horses, boats, aircraft, or ATVs was a component of the hunt? **ABSOLUTELY.**

The NEMO Arms Omen is tough. Alaska tough. **FN**

CONCEALED CONFIDENCE™

FOBUSHOLSTER.COM

- Rapid Draw
- Innovative Active & Passive Retention
- Maximum Comfort & Concealability
- Durable Injection Molded Polymer
- Hundreds of Holsters and Mag Pouches



ISRAEL'S LEADING HOLSTER MANUFACTURER SINCE 1978

— TWENTIETH ANNUAL —

FIREARMS NEWS® TREASURY

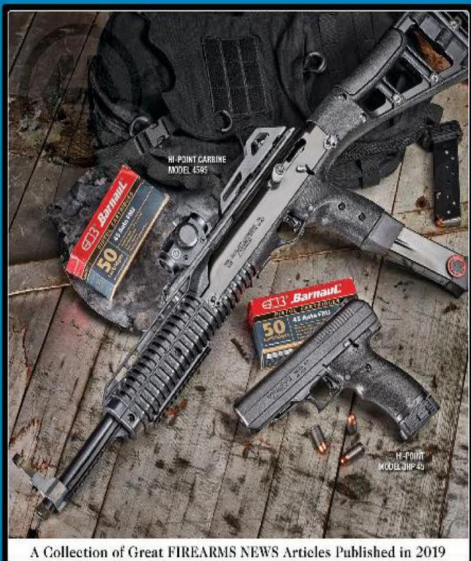

A Collection of Great FIREARMS NEWS Articles Published in 2019

FIREARMS NEWS TREASURY Vol. 20

THE 2020 *FIREARMS NEWS TREASURY* IS BACK. PACKED WITH SOME OF THE MOST POPULAR STORIES OF THE YEAR!

ON NEWSSTANDS NOW!

Don't wait — they'll go fast!

On sale at fine retailers like Barnes & Noble and Wal-Mart.

GUNS & AMMO

FREEDOM IN ACTION

Wednesday Night At The Range is a loud and proud celebration of our freedoms. In one explosive night, we bring you the latest firearms and gear, competitive shooting action, personal defense strategies, historic weaponry and much more.

WEDNESDAY NIGHT
AT THE RANGE

USA
Midway

7 P ET Outdoor



SHOOTING GALLERY



SHOOTOUT LANE



AMERICAN RIFLEMAN

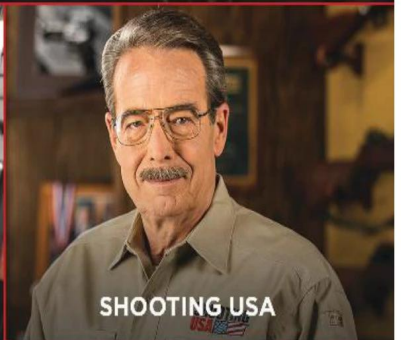

SHOOTING USA

SCHEDULE SUBJECT TO CHANGE

HARBOR FREIGHT

QUALITY TOOLS AT RIDICULOUSLY LOW PRICES

Shop When You Need To Online & In-Store

3-Ply Disposable Face Masks
Pack of 10
\$3.49
~~\$3.99~~

Less Than 40¢ per Mask

Non-medical

WHILE SUPPLIES LAST

NEW

In-Store Only

Use Online & In-Store

ITEM 52593
15586256
LIMIT 4 - Exp. 11/20/20

UNION 10 Gun Electronic Security Safe
\$279.99
~~\$339.99~~

CAD0J Compliant

Save \$158

Compare to Stack-On SS-16-MB-E \$438.70
ITEM 64008/64011 shown

Contents not included.

Use Online & In-Store

ITEM 64008/64011 shown
15732556
LIMIT 1 - Exp. 11/20/20

WOW! SUPER COUPON

SAVE 94%

Swivel Lens Headlamp
\$2.99
~~\$89.99~~

LIMIT 3

Compare to Energizer HDB32EH \$16.97

ITEM 63590/61319/64072/64145/45807 shown

Use Online & In-Store

ITEM 63590/61319/64072/64145/45807 shown
15595618
Exp. 11/20/20

20% OFF

ANY SINGLE ITEM*

Use Online & In-Store

15585265

Limit 1 coupon per customer per day. Save 20% on any 1 item purchased. *Cannot be used with other discount, coupon or any of the following items or brands: Inside Track Club membership, Extended Service Plan, gift card, open box items, 3 day Parkers Lot Sale items, compressors, floor jacks, power stations, sales, storage cabinets, chests or carts, trailers, welders, Admiral Ames, Atlas, Bauer, Central Machinery, Coors, CoverPro, Dayton, Diamondback, Eastpak, Fischer, Hercules, Inco, Inverter, Lanza, Pexco, Predator, TacklePro, Viking, Valco, Zurich. Not valid on prior purchases. Non-transferable. Original coupon must be presented. Valid through 11/20/20.

Apache Model 9800
Waterproof Protective Rifle Cases
YOUR CHOICE OF COLOR
\$114.99
~~\$149.99~~

Save \$155

Compare to Pelican DOUBLE RIFLE \$269.99
Tan ITEM 58862
Black ITEM 64520

Case contents and locks not included.

Use Online & In-Store

ITEM 64520
15596990
LIMIT 1 - Exp. 11/20/20

luminar OUTDOOR
250 Lumen Pop-Up Lantern
\$4.99
~~\$5.99~~

Save 66%

Compare to Go Green Power \$14.99
ITEM 64110

Use Online & In-Store

ITEM 64110
15694007
LIMIT 4 - Exp. 11/20/20

7 ft. 4" x 9 ft. 6" Camouflage Weather Resistant Tarp
\$4.49
~~\$6.29~~

Save 50%

Compare to Weathermaster 3000B3999 \$8.99

ITEM 61765/64111 shown

Use Online & In-Store

ITEM 61765/64111 shown
15703315
LIMIT 4 - Exp. 11/20/20

0.30 cal. Ammo Box
\$3.49
~~\$5.99~~

Save 65%

Compare to RangeMax 1312-92 \$9.99

ITEM 63135/61451 shown

Use Online & In-Store

ITEM 63135/61451 shown
15706978
LIMIT 4 - Exp. 11/20/20

8" Hunting Knife with Survival Kit
\$6.99
~~\$9.99~~

Save 74%

Compare to Whitestone 25-87612 \$27.46
ITEM 61733
90714 shown

Sheath included.

Use Online & In-Store

ITEM 61733
15714438
LIMIT 4 - Exp. 11/20/20

CENTECH 3-in-1 Portable Power Pack with Jump Starter
\$59.99
~~\$69.99~~

Save 33%

Compare to DieHard SLC10120 \$89.99

ITEM 56399/64063/62306 shown

Use Online & In-Store

ITEM 56399/64063/62306 shown
15714785
LIMIT 1 - Exp. 11/20/20

Heavy Duty Foldable Aluminum Sports Chairs
YOUR CHOICE OF COLOR
\$19.99
~~\$29.99~~

Save 64%

Compare to Coleman S35394 \$56.49

Green ITEM 63066/62314 shown
Blue ITEM 56119

Use Online & In-Store

ITEM 63066/62314 shown
15645175
LIMIT 2 - Exp. 11/20/20

US GENERAL 30", 5 Drawer Mechanic's Cart
\$199.99
~~\$239.99~~

Save \$630

Compare to Snap-on 58RC10TPES \$830
ITEM 64721, 64722, 64030, 64061, 56429, 64720, 64031

Side tray sold separately.

YOUR CHOICE OF 7 COLORS

Use Online & In-Store

ITEM 64721, 64722, 64030, 64061, 56429, 64720, 64031
15646332
LIMIT 1 - Exp. 11/20/20

TAILGATOR 900w Max. Starting 2 Cycle Gas Powered Generator
\$109.99
~~\$124.99~~

Save \$23

Compare to PowerSmart PSS0 \$133.95
ITEM 63024/63025 shown

Use Online & In-Store

ITEM 63024/63025 shown
15650350
LIMIT 1 - Exp. 11/20/20

drillmaster 4-1/2" Angle Grinder
\$9.99
~~\$14.99~~

Save 56%

Compare to Ironport 61451 \$22.99
ITEM 69645/60625 shown

Use Online & In-Store

ITEM 69645/60625 shown
15692360
LIMIT 4 - Exp. 11/20/20

CENTRAL PNEUMATIC 3 Gallon, 100 Psi Oil-Free Air Compressors
YOUR CHOICE
\$39.99
~~\$54.99~~

Save 59%

Compare to Porter-Cable PCFPD2003 \$98.62

Hot Dog ITEM 69269/97080 shown

Pancake ITEM 60637 61015 shown

Use Online & In-Store

ITEM 69269/97080 shown
15657204
LIMIT 3 - Exp. 11/20/20

WARRIOR 29 Piece Titanium Drill Bit Set
\$10.99
~~\$18.99~~

Save 81%

Compare to DeWalt DW1369 \$60.09
ITEM 5889/62931/61637 shown

Use Online & In-Store

ITEM 5889/62931/61637 shown
15669119
LIMIT 3 - Exp. 11/20/20

Quantum 588 Lumen Tactical Flashlight
\$9.99
~~\$13.99~~

Save 83%

Compare to Streamlight Pro Tac 1L \$59.99
ITEM 64799/63934 shown

5"

Use Online & In-Store

ITEM 64799/63934 shown
15673196
LIMIT 4 - Exp. 11/20/20

PITTSBURGH SERIES 2 Rapid Pump® 3 Ton Steel Heavy Duty Low Profile Floor Jack
\$104.99
~~\$114.99~~

Save \$85

Compare to TEQ Correct T8300182 \$189.99
ITEM 56618/56619/56620/56617 shown

ASME PASSE

Use Online & In-Store

ITEM 56618/56619/56620/56617 shown
15676715
LIMIT 1 - Exp. 11/20/20

CENTRAL MACHINERY 8", 5 Speed Benchtop Drill Press
\$54.99
~~\$69.99~~

Save 38%

Compare to Wen 4208 \$88.84

ITEM 62520/60238 shown

Use Online & In-Store

ITEM 62520/60238 shown
15684801
LIMIT 2 - Exp. 11/20/20

HaulMaster 1000 lb. Capacity Swing-Back Bolt-On Trailer Jack
\$18.99
~~\$26.99~~

Save 62%

Compare to Reese Towpower 74410 \$49.99
ITEM 69780/41005 shown

Use Online & In-Store

ITEM 69780/41005 shown
15686762
LIMIT 4 - Exp. 11/20/20

1,000+ Stores Nationwide • HarborFreight.com
*Original coupon only. No use on prior purchases after 30 days from original purchase or without original receipt. Valid through 11/20/20.
Pricing, promotions, and availability may vary by location and at www.harborfreight.com and are subject to change without notice. We reserve the right to limit quantities. "Compare to" advertised price means that the specified comparison, which is an item with the same or similar function, was advertised for sale at or above the "Compare to" price by another national retailer in the U.S. within the past 90 days. Prices advertised by others may vary by location. No other meaning of "Compare to" should be implied. Although we make every effort to assure that our prices and products are advertised as accurately as possible, we are only human and in the event an error is made, we reserve the right to correct it.



Grizzly Industrial

PURVEYORS OF FINE MACHINERY®
SINCE 1983
QUALITY MACHINES, GREAT PRICES!

12" X 36" GUNSMITHING LATHE WITH STAND

- Motor: 2 HP, Single-phase, 220V, 8.5A
- Spindle bore: 1.57"
- Spindle taper: MT#5
- Spindle speeds: 70 – 1400 RPM
- Spindle type: D1-5 Camlock
- Approx. shipping weight: 1330 lbs.



WARNING! †
G4003G Only **\$3950⁰⁰**



13" X 40" GUNSMITHING LATHE WITH DRO

- Motor: 2 HP, Single-phase, 220V, 8.5A
- Spindle bore: 1.57"
- Spindle taper: MT#5
- Spindle speeds: 70 – 2000 RPM
- Spindle type: D1-4 Camlock
- Approx. shipping weight: 1370 lbs.



WARNING! †
G0776 Only **\$5395⁰⁰**



14" X 40" GUNSMITHING GEARHEAD LATHE

- Motor: 2 HP, Single-phase, 220V, 10A
- Spindle bore: 1.57"
- Spindle taper: MT#5
- Spindle speeds: 70 – 2000 RPM
- Spindle type: D1-5 Camlock
- Approx. shipping weight: 1550 lbs.



WARNING! †
G0709 Only **\$5795⁰⁰**



8" X 30" 1½ HP VARIABLE-SPEED VERTICAL MILL



- Motor: 1.5 HP, 3-phase, 220V, 3.3A
- Power requirement: 220V, Single-phase
- Spindle taper: R-8
- Spindle travel: 3½"
- Spindle speeds: Variable, 200 – 2250 RPM
- Table size: 30" x 8"
- X-axis travel: 18"
- Y-axis travel: 7¾"
- Z-axis travel: 17¾"
- Head tilt: 90 degrees L/R
- Footprint: 19" L x 26" W
- Approx. shipping weight: 966 lbs.

WARNING! †

G0678 Only **\$4150⁰⁰**



8" X 30" 1½ HP VARIABLE-SPEED KNEE MILL WITH RAM HEAD



- Motor: 1.5 HP, 3-phase, 220V, 4.8A
- Power requirement: 220V, Single-phase
- Spindle taper: R-8
- Spindle travel: 3½"
- Spindle speeds: Variable, 200 – 2250 RPM
- Table size: 30" L x 8" W
- X-axis travel: 18½"
- Y-axis travel: 7½"
- Z-axis travel: 17¾"
- Head tilt: 45 degrees L/R
- Footprint: 19" L x 26" W
- Approx. shipping weight: 1006 lbs.

WARNING! †

G0695 Only **\$4795⁰⁰**



9" X 49" VERTICAL MILL WITH POWER FEED AND DRO

Made in an ISO 9001 Factory



- Motor: 3 HP, single-phase, 220V, 13.8A
- Spindle taper: R-8
- Spindle travel: 5"
- Spindle speeds: 8, 80 – 2720 RPM
- Table size: 49" L x 9" W
- X-axis travel: 28"
- Y-axis travel: 12"
- Z-axis travel: 16"
- Head tilt: 90 degrees L/R, 45 degrees F/B
- Footprint: 41" L x 27" W
- Approx. shipping weight: 2580 lbs.

WARNING! †

G0796 Only **\$6595⁰⁰**



DROS FOR LATHES AND MILLS

Grizzly Industrial, Inc. FAGOR ACU-RITE® & OTHERS



WARNING! †

While Supplies Last

OVER 70 MODELS AT grizzly.com from **\$429⁵ – \$2629⁰⁰**

MANNERS AND KEYSTONE SPORTING ARMS STOCKS

ACT FAST!



WARNING! †

While Supplies Last

OVER 100 MODELS AT grizzly.com starting at **\$99⁹⁷**

PRICING CODE
20FIREN
MENTION THIS CODE WHEN PLACING YOUR ORDER

1-800-523-4777 grizzly.com

TECHNICAL SERVICE: 570-546-9663

Due to rapidly changing market conditions, our advertised prices may be increased at any time without prior notice.



WARNING! †: Cancer & Reproductive Harm
Some products we sell can expose you to chemicals known to the State of California to cause cancer and/or birth defects or other reproductive harm. For more information go to www.P65Warnings.ca.gov/product

Study-at-home Gunsmithing Courses on video - DVD or online! **AGI**

Be Prepared for Whatever is Coming!

MAINTAIN YOUR GUNS!

Armorer Courses on DVD from the Nation's leading Gunsmithing School

Learn how to completely disassemble, maintain, clean, and reassemble your guns, with total confidence using these DVD video manuals from AGI!

66 titles available!

- #1054 AKS-MAK90 - AK47 Semi-Auto
- #1034 AR-15 Rifles
- #1634 Benelli Semi-auto Shotguns - Vol 1
- #1664 Benelli Semi-auto Shotguns - Vol 2
- #1104 Beretta 92 / Taurus P92 Pistols
- #1544 Beretta Px4 Storm Pistols
- #1624 Bond Arms Derringers
- #1594 Browning 1918 Automatic Rifles
- #1394 Browning 1919-A4 Machine Guns
- #1274 Browning A-5 Rem 11, Savage 720
- #1024 Browning Hi Power Pistols
- #1574 Charter Arms Bulldog Revolver
- #1014 Colt 1911 .45 Auto Pistols
- #1244 Colt Single Action Revolvers
- #1454 CZ-52 Pistols
- #1314 CZ-75 & EAA Witness Pistols
- #3074 Enfield Rifles
- #1224 FN-FAL Rifles
- #1524 FNH FNP-9/40 Pistols
- #1064 Glock Pistols
- #1514 H&K MP5
- #1504 H&K USP Pistols
- #1074 H&K, CETME, & G-3 Rifles
- #1614 H&R Topper Type Shotguns
- #1214 Hi-Standard Auto Pistols
- #1304 Luger Pistols
- #1584 M1A Rifles
- #1184 M1 Garand M1A Rifles
- #1204 M1/M2 Carabines
- #1164 Makarov Pistols
- #1334 Marlin 39 & 39A Lever Action .22
- #1264 Marlin Lever Action Rifles 1894 & 336
- #1284 Marlin/Glenfield Semi-Auto .22 Rifles
- #1434 Mauser 98 Rifles
- #1604 Mosin-Nagant Rifles
- #1194 Mossberg 500 Series Shotguns
- #1124 Remington 1100 & 1187 Shotguns
- #1354 Remington 700 Rifles
- #1484 Remington 742/762 Rifles
- #1114 Remington 870 Shotguns
- #1094 Ruger® 10/22® Rifles
- #1464 Ruger® Double Action Revolvers
- #1564 Ruger® LCP®/LC9® & Kel-Tec P-3AT
- #1154 Ruger® Mini-14® & Mini-30 Rifles
- #1144 Ruger® MKI, MKII & MKIII, .22 Pistols
- #1534 Ruger® SR9®/SR40®/SR45™ Pistols
- #1294 Ruger® Single Action Revolvers
- #1494 S&W M&P Semi Auto Pistols
- #1474 Savage Arms 10-116 Series
- #1234 SIG Auto Pistols
- #1674 Sig Sauer P320 - NEW!
- #1044 SKS Rifles
- #1174 Smith & Wesson Auto Pistols
- #1084 Smith & Wesson Revolvers
- #1554 Springfield 1903 Rifles
- #1444 Springfield Army XD Pistols
- #1384 Sterling Submachine Guns
- #1324 Taurus Revolvers
- #1374 Thompson Submachine Guns
- #1404 UZI Submachine Guns
- #1364 Walther PPK/S & FEG PA3 Pistols
- #1424 Winchester 1873, 1866 & 1876
- #1414 Winchester 1892 & 1886 Rifles
- #1134 Winchester 1894 Rifle
- #1254 Winchester 97 Pump Shotguns
- #1344 Winchester Model 12 Shotguns

\$39.95 each plus s/h

BE A GUNSMITH!

Study at home and TURN YOUR PASSION INTO PROFIT!

NEW! Free! Quickly learn the step-by-step secrets of how to make money gunsmithing part-time, full-time, or as a retirement income.

Study at home through our **VIRTUAL GUNSMITHING CAMPUS™** and start making money in as little as 90 days - **GUARANTEED!** Your one time investment in AGI's course could provide you with a lifetime of income, opportunity and FUN!

Get a FREE video and complete information package on how to get started in gunsmithing FAST. Call a student advisor today at 1-800-797-0867 or go to: www.AmericanGunsmithingInstitute.com

You can become a Certified Firearms Appraiser!

Cash in on this fast growing field!

AN ABSOLUTE MUST HAVE for FFL Dealers! First time available to the industry! Course includes: 13 CDs, 4 DVDs, training manual, resource lists, reference books, appraising forms, testing, patch, and certification. **Over 17 hours of video instruction!** This will bring you loads of new business! This is must have information that will separate you from the competition. Just the certification alone puts you in a different class. **ITEM# FAPCOURSE \$1,497**

Law Enforcement Armorer's Courses! AR15, Glock, P320

With Testing and Certification!

Covers disassembly, reassembly, repairing, troubleshooting, & maintaining these firearms in many variations and configurations at a Law Enforcement Armorer's Level. Course includes: DVDs, testing, patch, and certification. **GET CERTIFIED NOW!** #165CERT #167CERT #164CERT \$149 each plus s/h

Become a Certified Law Enforcement Armorer

Even if you have never been a sworn officer.

Become a Certified Glocksmith, AR15 Riflesmith or 1911 Pistolsmith

There is just too much information to cover here! These courses will take you from start to finish. You will know everything about these firearms and how to maintain and customize them. Go to AmericanGunsmith.com to view a FREE GLOCK and 1911 SEMINAR to see just how extensive these courses are! You'll be glad you did!

Learn how to operate a lathe and mill from a Master Machinist and get certified NOW!

#MSCOURSEDVD - OVER 30 HOURS OF DETAILED VIDEO INSTRUCTION FROM MASTER RIFLESMITH DARREL HOLLAND!

22+ Hours!

Learn to Weld! GAS, MIG, TIG - all of it!

#WELDINGCOURSE - EXTREME CLOSE UPS SHOW YOU THE HOW AND WHY OF WELDING PROCEDURES! View the details at AmericanGunsmith.com

Become a Certified Reloader and Learn to Create Precision Ammunition

Learn from a gunsmith's perspective to read the fired brass. Any reloader whether novice, intermediate, or experienced will benefit from the clear explanations of the "How's and Why's" of reloading. See clips online!

#CERTRELOAD **DVD & Online Courses Available!**

INCLUDES ABOVE COURSES! Due to budget cuts many Law Enforcement agencies do not have dedicated armorers.

This course qualifies you to be that armorer and covers 16 current commonly used law enforcement handguns, shotguns, and patrol rifles. Make a steady income, build your reputation, and bring in more business. Available to review on DVD as many times as you want! Watch and learn at home in your spare time. This certified course includes: 16 Armorer's Course DVDs, testing, certification, and Certified Law Enforcement Armorer's Patch. 25+ hours of video instruction! #LEACKITDVD \$1,297 plus s/h

Mention offer code **FN20RR** when ordering please

www.AmericanGunsmith.com or call **1-800-797-0867**



Wilson Combat is now offering the .350 Legend cartridge in their line of AR-15 rifles for whitetail, pig and bear hunters looking for a hard-hitting brush cartridge.

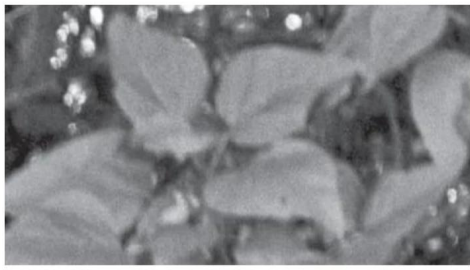

WILSON COMBAT'S .350 LEGEND

What does Winchester's .350 Legend bring to the table when mated to a high-quality AR-15 hunting rifle?

By David M. Fortier Photography by Rachel R. Fortier



Does the world really need another cartridge for the AR-15 family of rifles and pistols? Of course it does! You can never have too many options right? While general purpose “do it all” cartridges have their place, I do appreciate a design intended to excel at a specific task. In this regard I do not agree with Robert A. Heinlein’s postulation that “Specialization is for insects.” So, when Winchester introduced their .350 Legend cartridge in 2019 I took note of it. The .350 Legend was specifically designed to be an effective game cartridge on large whitetail deer and similar sized animals. It accomplishes this by throwing a moderate diameter and weight projectile at a respectable velocity. Due to this it is especially well-suited for those that hunt in heavy cover where the shots are relatively short. Plus, as it features a straight-walled cartridge case, it is legal for hunting in those states, such as Ohio, which have this stipulation in their hunting codes.

A number of firearms manufacturers have added this caliber to their line-up since it was introduced, with Wilson Combat among them. The rifle seen on these pages is Wilson Combat’s Protector AR carbine chambered in .350 Legend. They also offer this caliber in their Recon Tactical, Ranger and Ultralight Ranger lines, so they have a few to choose from. Wilson Combat’s Protector is a very light, quick-handling and compact 16-inch AR carbine which is very well-suited for brush hunting. Before I delve into what Wilson Combat has cooked up though, let’s examine the .350 Legend cartridge.

Winchester Ammunition introduced the .350 Legend at the 2019 SHOT Show in Las Vegas, Nevada. But why did they develop it? A host of cartridges have been expressly developed for, or which fit neatly into the AR-15. These include the 5.56x45mm, .22 Nosler, .224 Valkyrie, 6x45mm, 6mm ARC, 6.5mm Grendel, 6.8x43mm Rem SPC, 300 AAC Blackout, 7.62x39mm,



Introduced by Winchester at the 2019 SHOT Show the .350 Legend is a hunting cartridge well suited for large whitetail deer and similar size animals.



Bill Wilson, the founder of Wilson Combat, got his start customizing 1911s and S&W Model 10s working in the back of his father's jewelry store way back in the 1970s. (Photo by James Tarr)



From his humble start Bill Wilson has grown his business into a powerhouse which covers pistols, rifles and shotguns. (Photo by James Tarr)

300 HAM'R, .450 Bushmaster, .458 SOCOM and .50 Beowulf. However, if you look at this list you will note there are no common mainstream cartridges in the void going from the .30-calibers to .45-caliber. Winchester noticed this large hole and decided to fill it with an appropriate hunting cartridge.

Now, what I find interesting is Winchester says the .350 Legend is built on a new cartridge case design. In considering what would work best in the market, Winchester recognized the need for standardization. Standardization is what, after all, made the AR-15 as hugely popular as it is. Cartridges which deviate from the standard and require a specialized part, such as a proprietary bolt in the case of the 6.5mm Grendel and 6.8x43mm Rem SPC often face difficulty being widely accepted. In the case of the 6.5mm Grendel, it took years for it to be embraced by mainstream shooters. So, when Winchester developed the .350 Legend they decided to utilize the same rim diameter as the 5.56x45mm NATO. Thus, with a .378-inch nominal rim diameter the .350 Legend utilizes standard 5.56x45mm NATO AR-15 bolts. The only proprietary part needed to build a .350 Legend AR-15 is just the barrel.

Overall cartridge length was kept to the 5.56x45mm standard of 2.26-inches. Due to this there are no problems with STANAG dimensioned magazines in this regard. Case length is 1.71-inch and the base diameter is .390-inch. Case capacity is 36.5 grains (water). Projectile diameter is listed as .357-inch which is 9.1mm. This diameter has long been popular with American shooters, sportsmen and hunters and there is a plethora of projectiles readily available in this diameter for reloaders.

Moving up from .30-caliber to .357-inch also provides a nice increase in projectile diameter without getting into the heavier recoil of the big-bores. So, it's a nice compromise offering a step-up from the smaller calibers while having better exterior ballistics

and softer felt-recoil compared to the big dogs like the .458 SOCOM. Another important point is .350 Legend ammunition is noticeably less expensive than fodder for the big-bores. The .458 SOCOM is a great cartridge, but it is very expensive if you want to recreationally shoot with it. This in and of itself is an important selling point to many shooters and hunters.

What about performance? This is after all where the rubber meets the road. Winchester's intended goal was for the .350 Legend to appeal to deer hunters and for it to have sufficient bullet diameter, mass and retained velocity to harvest large deer at 200 yards. With the cartridge Winchester introduced five loads ranging in weight from 145 all the way up to 265-grains. This line shows the versatility of the cartridge and consists of:

- 145-grain FMJ at 2,350 fps
- 150-grain Deer Season XP at 2,350 fps



The .350 Legend is a hunting cartridge designed to work well in the AR-15 L to R: 5.56x45mm, .350 Legend, 300 AAC BLK, 7.62x39mm and the classic .30-30 Winchester.

- 160-grain Power Max Bonded at 2,225 fps
- 180-grain Power-Point at 2,100 fps
- 265-grain Super Suppressed Subsonic at 1,060 fps

A quick look at these loads shows the .350 Legend in its lighter bullet weights offers a larger diameter and heavier projectile than the standard 123-grain 7.62x39mm while matching its velocity. If you move up to similar 145- or 150-grain bullet weights in 7.62x39mm and 300 AAC Blackout the .350 Legend has a distinct velocity advantage, especially over the 300 AAC Blackout. Unlike the .30-calibers though, you can move up to a supersonic 180-grain load in .350 Legend. This will provide a good combination of mass, expansion and penetration.

When it comes to subsonic loads the .350 Legend significantly out-performs the .30-calibers. It is capable of driving a much heavier and larger diameter projectile when shooting subsonic through a suppressor. In this regard performance is similar to the Russian 9x39mm. Keep in mind, the only reason the 9x39mm exists is due to Russia's Special Operation community's dissatisfaction with the terminal performance and penetration of subsonic 7.62x39mm on the battlefield.

Now to be fair, comparing Winchester's .350 Legend to the 300 AAC Blackout and 7.62x39mm is really apples to oranges. The .350 Legend is a hunting cartridge while the 300 AAC Blackout and 7.62x39mm are smaller bottleneck military cartridges. So what would be an ideal cartridge to compare the .350 Legend with? Perhaps the best cartridge to judge the .350 Legend by is one of my old favorites, the .35 Remington.

A cult favorite in the North East, the .35 Remington may be old, but it remains popular with brush hunters going after whitetail, black bear and elk. When I was a teenager it was a popular caliber in Marlin's Model 336 lever-action rifle and my brother-in-law swore by it. A competitor to Winchester's hugely popular .30-30 Winchester, the .35 Remington was introduced in

[Cont. to page 72]



M&A PARTS INC. / WWW.MAPARTSINC.COM



964 Donata Ct. / Lake Zurich, IL 60047 / Tel: 847-550-8246 / Fax: 847-550-0654



Hours: 9:00 AM to 5:00 PM CST. Most orders shipped within 24 hours. Send certified check or money order, add approximate shipping. All federal, state and local laws must be adhered to. Illinois residents add 7.75% sales tax. All prices and specifications are subject to change without notice.



CHECK OUR WEBSITE FOR WEEKLY SALES AND NEW PRODUCTS !!!

COMPLETE KITS

Add our Kit to your stripped lower receiver to complete your rifle.

All kits are assembled, head-spaced & test fired.

CAR Kits



Mil-Spec Forged Flattop T-Marked Upper
Barrel with M4 Feed Ramps / A2 Flash Hider
Mil-Spec Forged F-Marked FSB / A2 Sight Post
CAR Handguards w/Heatshield / Collapsible CAR Stock

- 5.56mm / 16 Inch Chrome-Moly 1:9 \$475.00
- 5.56mm / 16 Inch Chrome Lined 1:9 or S.S. 1:8 \$520.00
- 300BLK 16 Inch Chrome-Moly 1:8 \$475.00
- 7.62x39mm / 16 Inch Chrome-Moly 1:10 \$525.00
- 9mm / 16 Inch Chrome-Moly 1:10 w/ Colt Mag Block \$695.00
- 9mm / 16 Inch Chrome-Moly 1:10 for Glock Style Mags \$525.00
- 458 SOCOM / 16 Inch Chrome-Moly 1:14 \$845.00

Mid-Length Kits



Mil-Spec Forged Flattop T-Marked Upper
Barrel with M4 Feed Ramps / A2 Flash Hider
Mil-Spec Forged F-Marked Front Sight Base / A2 Sight Post
Mid-Length Handguards w/Heatshield / Collapsible CAR Stock

- 5.56mm / 16 Inch Chrome-Moly 1:9 \$475.00
- 5.56mm / 16 Inch Chrome Lined 1:9 or S.S. 1:8 \$520.00
- 5.56mm / 16 Inch Chrome-Moly LWt 1:9 or 1:7 \$475.00
- 5.56mm / 16 Inch Chrome Lined LWt 1:9 or 1:7 \$520.00

M4 Style Kits



Mil-Spec Forged Flattop T-Marked Upper
Barrel with M4 Feed Ramps / A2 Flash Hider
Mil-Spec Forged F-Marked Front Sight Base / A2 Sight Post
M4 Handguards w/Heatshield / Collapsible CAR Stock

- 5.56mm / 14.5 or 16 Inch Chrome-Moly 1:9 \$495.00
- 5.56mm / 14.5 or 16 Inch Chrome Lined 1:9 or S.S. 1:8 \$540.00
- 5.56mm / 14.5 or 16 Inch Chrome-Moly 1:7 \$495.00
- 5.56 / 14.5 or 16 Inch Chrome Lined 1:7 \$540.00
- 6.8 SPC II 16 Inch Chrome-Moly 1:10 \$525.00

CAR Lightweight Kits



Mil-Spec Forged Flattop T-Marked Upper
Lwt Bbl w/M4 Feed Ramps / A2 Flash Hider
Mil-Spec Forged F-Marked FSB / A2 Sight Post
CAR Handguards w/Heatshield / Collapsible CAR Stock

- 5.56mm / 16 Inch Chrome-Moly 1:9 \$475.00
- 5.56mm / 16 Inch Chrome-Moly 1:9 \$475.00
- 5.56mm / 16 Inch Chrome Lined 1:9 \$520.00
- 5.56mm / 16 Inch Chrome Lined 1:7 \$520.00

Commando Kits



Shown with optional RRA Entry Stock
Mil-Spec Forged Flattop T-Marked Upper
Barrel with M4 Feed Ramps / A2 Flash Hider
Mil-Spec Forged F-Marked FSB / A2 Sight Post
CAR Handguards w/Heatshield / Collapsible CAR Stock

- 5.56mm / 11.5 Inch Chrome-Moly 1:9 \$475.00
- 5.56mm / 11.5 Inch Chrome Lined 1:9 or 1:7 \$520.00
- 300B0 / 10.5 Inch Chrome-Moly 1:8 \$475.00
- 7.62x39 / 11.5 Inch Chrome Lined 1:10 \$565.00

Pistol Kits



Mil-Spec Forged Flattop T-Marked Upper
Barrel with M4 Feed Ramps / A2 Flash Hider
Picatinny Rail Gas Block Front Sight
Base Aluminum Free Float Tube / Pistol Recoil Buffer

- 5.56mm / 7 or 11.5 Inch Chrome-Moly 1:9 \$495.00
- 5.56mm / 11.5 Inch Chrome Lined 1:9 \$540.00
- 300B0/ 8 or 10.5 inch Chrome-Moly 1:8 \$495.00
- 9mm / 4 or 10.5 Inch Chrome-Moly 1:10 w/ Colt Mag Block \$695.00
- 9mm / 4 or 10.5 Inch Chrome-Moly 1:10 for Glock Style Mags \$525.00

20 Inch Rifle Kit



Mil-Spec Forged Flattop T-Marked Upper
Barrel with M4 Feed Ramps / A2 Flash Hider
Mil-Spec Forged F-Marked FSB / A2 Sight Post
Rifle Handguards w/Heatshield / A2 Trapdoor Stock

- 5.56mm / 20 Inch Chrome-Moly 1:9 \$495.00
- 5.56mm / 20 Inch Chrome-Moly 1:9 LWt \$515.00
- 5.56mm / 20 Inch Chrome Lined 1:9 or 1:7 \$540.00
- 5.56mm / 20 Inch Stainless Steel 1:8 \$540.00
- 5.56mm / 20 Inch DCM Stainless Steel 1:8 \$975.00

16 Inch Varmint Kit



Mil-Spec Forged Flattop T-Marked Upper
Varmint Barrel with M4 Feed Ramps
Picatinny Rail Gas Block Front Sight Base
Aluminum Free Float Tube / A2 Trapdoor Stock

- 5.56mm / 16 Inch Stainless Steel 1:8 \$515.00
- With optional Fluted Barrel \$575.00
- With optional Versa-Pod Bipod add \$85.00

20 or 24 Inch Varmint Kit



Mil-Spec Forged Flattop T-Marked Upper
Varmint Barrel with M4 Feed Ramps
Picatinny Rail Gas Block Front Sight Base
Aluminum Free Float Tube

- 5.56mm / 20 Inch Stainless Steel 1:8 \$540.00
- With optional Fluted Barrel \$590.00
- Shown with optional Versa-Pod Bipod add \$85.00

KITS OPTIONS & UPGRADES

BUTTSTOCKS

A2 Trapdoor or Car Stock.....	No Charge w/o kit	\$85.00
M4 Stock (Standard with M4 Kit).....	add \$25.00 w/o kit	\$60.00
Magpul MOE Rifle Stock.....	add \$55.00 w/o kit	\$65.00
Magpul PRS Stock.....	add \$210.00 w/o kit	\$245.00
Magpul UBR Stock.....	add \$160.00 w/o kit	\$180.00
Magpul ACS Stock.....	add \$60.00 w/o kit	\$75.00
Magpul CTR Stock.....	add \$45.00 w/o kit	\$55.00
Magpul MOE Stock.....	add \$30.00 w/o kit	\$35.00
ACE Skeleton Stock.....	add \$60.00 w/o kit	\$75.00
ACE M4 SOCOM Stock.....	add \$135.00 w/o kit	\$155.00
Luth-AR.....	MBA-1 \$135.00 MBA-3 \$150.00	
Rock River Arms Operator Stock.....	add \$95.00 w/o kit	\$110.00
Troy Battle Ax CQB Stock.....	add \$135.00 w/o kit	\$155.00
Troy SOCC Airborne Stock.....	add \$170.00 w/out kit	\$195.00

LOWER PARTS / GRIPS

Rock River Arms NM Two Stage Trigger.....	add \$80.00 w/o kit	\$110.00
Geissele SSA Trigger.....	add \$245.00 w/o kit	\$275.00
KE Arms Drop In Trigger.....	add \$135.00 w/o kit	\$165.00
Hogue Pistol Grip.....	add \$15.00 w/o kit	\$20.00
ERGO SureGrip.....	add \$20.00 w/o kit	\$25.00
ERGO Deluxe Tactical Grip.....	add \$50.00 w/o kit	\$60.00
Magpul MOE Grip.....	add \$15.00 w/o kit	\$20.00
Magpul MOE+ or MOE K+ Grip.....	add \$20.00 w/o kit	\$24.00
Rock River Arms Winter Trigger Guard.....	add \$10.00 w/o kit	\$15.00
Magpul Enhanced Trigger Guard.....	add \$15.00 w/o kit	\$20.00
Magpul Enhanced Mag Release.....		\$18.00
Magpul BAD Lever.....		\$27.00
KE Arms Ambi Selector.....	add \$30.00 w/o kit	\$35.00
Mil-Spec AR15 Ambi Selector.....	add \$20.00 w/o kit	\$25.00
Mil-Spec M16 Ambi Selector.....		\$35.00

CHARGING HANDLES / CARRIERS / HANDGUARDS

Tactical Charging Handle Latch.....	add \$10.00 w/o kit	\$15.00
PR Big Latch.....	add \$15.00 w/o kit	\$20.00
Ambi Charging Handle.....	add \$50.00 w/o kit	\$65.00
BCM Ambi Charging Handle.....	add \$65.00 w/o kit	\$75.00
Chrome Carrier Group Assembly.....	add \$30.00 w/o kit	\$130.00
Nickel Boron Carrier Group Assy.....	add \$55.00 w/o kit	\$155.00
Diamondhead VRS T or X.....	10" \$160.00 13.5" \$185.00 15" \$195.00	
2 Piece Car Quad Rail (imported).....	add \$25.00 w/o kit	\$35.00
Carbine 7" Free Float Quad Rail.....	add \$35.00 w/out kit	\$45.00
M&A Keymod or M-Lok 7".....	\$60.00 9" \$75.00 12" \$95.00 15" \$110.00	
Magpul MOE CAR/Mid.....	add \$25.00 w/o kit	\$35.00
Troy Alpha or M-Lok 7".....	\$150.00 9 or 11" \$175.00 15" \$190.00	
Troy Alpha w/ Integrated Flip Up Front Sight 11 or 13".....		\$235.00
YHM Diamond Quad 7" Car.....	\$130.00 9" Mid \$155.00 15" \$170.00	

GAS BLOCKS / FRONT & REAR SIGHTS

Low Profile GB .750 Alum.....	add \$0.00/ Steel add \$25.00	
Single Rail GB .750 Alum.....	add \$0.00/ Steel add \$35.00	
Quad Rail Block .750 or .936 Steel.....	add \$65.00 w/o kit	\$80.00
Rock River Gas Block Flip-Up Front Sight.....		\$85.00
Magpul Polymer Front Sight.....	add \$45.00 PRO \$75.00	
YHM Flip-Up Rear Sight.....	.9680 \$95.00 5010 \$110.00	
YHM Flip-Up Front Sight. Rail Height.....		\$75.00
Troy Flip-Up Front Sight. Rail Height.....		\$90.00
Magpul Polymer Flip-Up Rear Sight.....		\$55.00 PRO \$95.00
Mil-Spec Detachable Carry Handle.....		\$85.00
Diamondhead Poly Rear Sight.....	\$60.00/ Steel \$115.00	
UTG or Amsport Imported Flip Rear Sight.....		\$30.00
A.R.M.S. #40 Flip-Up Rear Sight.....		\$110.00
Troy Flip-Up Rear Sight.....		\$110.00

Slings & Adaptors



Ambi Lock Plate Loop
\$10.00

- Condor Bungee 1pt..... \$40.00
- Condor Bungee 2pt..... \$40.00
- Magpul .M3S Sling..... \$46.00
- Magpul MS4 Sling..... \$55.00
- Magpul ASAP Adapter..... \$27.00
- Magpul RSA Adapter..... \$22.00
- G.I Standard Sling..... \$10.00
- OD Lock Plate..... \$20.00
- Ambi Lock Plate, Loop Slip Over Tube Style..... \$25.00
- OD Sling Swivel, Heavy Duty..... \$12.00
- Ambi Lock Plate, For OD Swivel Slip Over Tube Style..... \$20.00

Magazines

- Brass Catcher..... \$15.00
- CMMG 22LR Conversion w/ Mag..... \$185.00
- CMMG 22LR 26rd Mag..... \$25.00
- CMMG SS Anti Tilt Follower or Braided Spring..... \$4.00
- G.I. Aluminum 30rd..... \$16.00
- FAL 20rd Metric..... \$25.00
- GI Green No Tilt Follower..... \$1.25
- Troy 30rd..... \$13.00
- HK91/G3 Alum..... \$7.00
- 10 for..... \$50.00
- Magpul .308..... 20rd \$20.00, 25rd \$23.00
- Magpul 7.62x39 30rd..... \$14.00
- Magpul 5.56 40rd..... \$20.00
- Magpul 5.56 30rd..... No Window \$14.00, w/ Window \$17.00
- Magpul 5.56 10 or 20rd..... \$14.00

Flash Hider / Misc.

- G.I. A1 or A2 Flash Hider..... \$8.00
- Noveske PIG KX5..... \$135.00
- Smith Ent. Vortex..... \$66.00
- Troy Midevil Flash Hider..... \$45.00
- YHM 2BA..... \$35.00
- Crush Washer..... \$2.00
- Field Repair Kit..... \$35.00
- Brass Catcher..... \$15.00
- Gas Ring (set of 3)..... \$2.00
- Lower Spring Kit..... \$9.00
- Lower Pin & Detent Kit..... \$15.00
- M&A T-shirt (Skull w/ Logo \$ Smoking M4)..... \$12.00
- Misc Parts Kits Fal STG, Romanian AK, Sten III..... See Website
- Misc Parts for the 1911, M1 Carbine, Garand and M1A..... See Website
- Rifle Cases, Mag Pouches, Flashlights & Mounts..... See Website

Maintenance/Tools

- A1 or A2 Sight Tool..... \$7.00
- AR15/M16 Tech Manual..... \$5.00
- Armor Wrench..... \$20.00
- Box of 1000 Patches 223..... \$7.00
- Bore Guide..... \$25.00
- Broken Shell Extractor..... \$10.00
- Buttstock Cleaning Kit..... \$15.00
- CAR Spanner Wrench 3pt..... \$10.00
- Chamber Blocking Device..... \$3.00
- Chamber Cleaning Stars..... \$10.00
- Gas Tube Cleaner 50pk..... \$9.00
- Handguard Removal Tool..... \$12.00
- Military Sniper Manual..... \$5.00
- Lower Receiver Vice Block..... \$20.00
- Upper Receiver Vice Clamp..... \$25.00



Wilson Combat's .350 Legend Protector is a light and handy 16-inch AR-15 intended to be easy to carry, quick handling and hard-hitting.

The .350 Legend Protector is built on forged upper and lower receivers and features a hunting profile match barrel with a free-floating M-LOK handguard.



One of Nightforce's excellent NX8 1-8x24mm F1 was utilized during testing. This is a very compact optic which zooms from 1x to 8x and features a Front Focal Plane daylight illuminated Mil reticle.



A Wilson Combat/BCM Starburst Gunfighter Grip is standard.

[Cont. from page 70]

1906. It was chambered in the Remington Model 8 semi-auto in 1908 and unlike many of its competitors of the day, the .35 Remington remains in production today.

Like the .350 Legend, the .35 Remington was designed as a short-range (200 yards) brush gun cartridge for hunters. It was also intended to out-perform a popular .30-caliber hunting cartridge, in this case the .30-30 Winchester. It did this by driving a .358-inch 200-grain SP at 2,080 fps or a lighter 180-grain SP at about 2,120 fps. On the flip-side, recoil was not bad and even as a skinny teenage kid I always enjoyed shooting it. The .35 Remington gained a cult following among hunters the old-fashioned way, it earned it through its performance in the hunting field. Its recipe for success is simple, drive a .35-caliber bullet which is fairly heavy in weight at moderate velocity to achieve reliable expansion and good penetration. Performance wise the 180-grain .350 Legend load basically duplicates the muzzle velocity of the well-proven .35 Remington 180-grain load. Performance in the hunting field should be similar to the classic .35 Remington as well.

Now what about the Wilson Combat Protector AR-15 chambered in .350 Legend seen on these pages? It is a good looking and well thought-out little hunting carbine. At just six pounds and nine ounces, it is very light for carrying all day in the field. So, if you are hiking over hill and dale it will not weigh you down. Plus, thanks to its 16-inch barrel and 33.2 inch overall length with the stock collapsed it will not hang-up getting into and out of a vehicle or get in the way strapped to an ATV. It has all the features you might want with no unnecessary bells or whistles. It's a typical Wilson Combat product, well thought out and nicely executed.

My first introduction to Bill Wilson's work came while attending an Advanced Defensive Rifle course some 20 years ago. One of my fellow students was carrying a Wilson 1911 and I can remember being impressed by its handsome looks, fit, finish, accuracy and reliability. I had read about Wilson Combat 1911s, but this was the first time I had actually seen and handled one. I came away impressed.

Bill Wilson, the founder of Wilson Combat, is one of those legends of the industry who began building

custom firearms way back in the big mustache days of the 1970s. Like many, he had a humble start. It's interesting to note he started customizing 1911s and S&W Model 10s working in the back of his father's jewelry store. I doubt his father had any idea what destiny had in store for his son. Due to the quality of his work, his grasp of the industry and a whole lot of sweat and toil his business steadily grew and expanded. Today Wilson Combat is known for much more than just their handgun work. In 2000, he had grown to the point where he was able to purchase Scattergun Technologies. In doing so he kicked the door in on the shotgun market and proceeded to make a name for himself there.

Wilson also recognized the rise of the AR-15 and entered that market. At this point in our story I will admit that I was not overly impressed by the first Wilson Combat AR-15 I saw. It was what they called an M-4 Tactical Carbine, and while quite expensive, it didn't really seem very different than any other AR-15 of the time. I frankly expected a lot more from a rifle with the Wilson Combat logo, and price tag. Perhaps Wilson recognized this or perhaps he simply needed



The .350 Legend requires a proprietary magazine, a Lancer was used during testing and it is seen here compared to a standard 20-round 5.56x45mm AR-15 magazine.

time to put his own touch on this design. It wasn't long though before his AR-15s evolved and took on a distinctive look more befitting their name and price.

The Wilson Combat .350 Legend Protector is an example of what he currently offers. It's a handsome piece which exudes the look, fit and performance of what you'd expect from this respected, and expensive, brand. This model features a forged flattop upper receiver. The flattop design facilitates easy mounting of day/night optics and iron sights. Riding inside is a Wilson Combat Premium bolt carrier with Black Nitride finish.

Fitted to the front of the receiver is a Wilson Combat Match grade barrel. This is a light contour piece well suited to a hunting rifle and features a Mid-Length gas system with a low profile gas block. Twist is one turn in 16 inches and the muzzle features 5/8x24 threads. A Wilson Combat Q-Comp completes the barrel. Surrounding the barrel is a Wilson Combat 10.4-inch M-LOK Rail. This allows accessories such as a white light, bipod or sling swivel to be easily mounted.



Wilson Combat's Tactical Hunter is light, even after you mount a sling and optic. It carries well, is very quick to the shoulder and lively in the hands.



Surrounding the 16-inch match barrel is a Wilson Combat M-LOK Rail. Barrel twist is 1 turn in 16 inches to enhance accuracy.

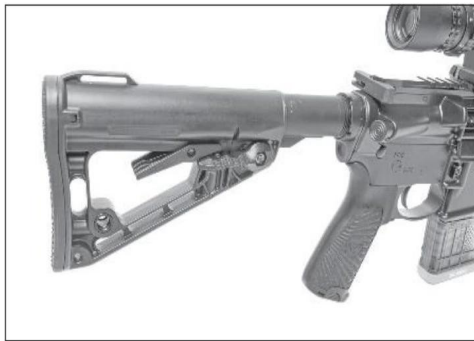

Wilson Combat outfits the Protector with a Rogers Super-Stock.

The upper receiver pins onto a forged lower receiver with integral trigger guard. Inside this you will find a Wilson Combat TTU (Tactical Trigger Unit) M2 with a 4-pound pull. Inside the receiver extension is a standard weight buffer and a Mil-Spec buffer spring. A Wilson Combat/BCM Starburst Gunfighter Grip is standard along with a Rogers Super-Stock. This model measures 33.2 inches in length with the stock collapsed and weighs a very handy 6 pounds 9 ounces without mag or optic. All in all it is a very good looking piece.

Pulling it from its box I noted Wilson Combat's .350 Legend Protector carbine to be nicely made with no apparent flaws. It carries well, is very quick to the shoulder and lively in the hands. It swings quickly and stops on a dime. The handguard feels good in the



If you prefer to sit rather than stalk deer, you will find the Wilson easy to maneuver and very accurate when a shot presents itself.



Accuracy from the bench was excellent as this three-shot group shows.

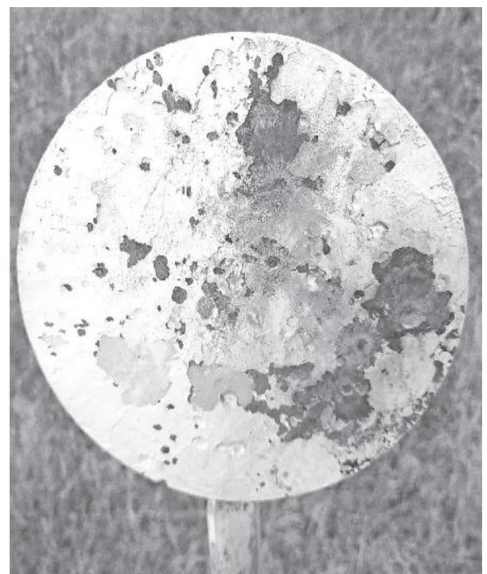

Snap-shooting a steel plate at 50 yards proved a lot of fun, recoil is fairly mild allowing a fast follow-up shot.

ACCURACY AND VELOCITY CHART WILSON COMBAT .350 LEGEND PROTECTOR

Load	Muzzle Velocity (fps)	Standard Deviation	Average Group (in.)
Winchester 145-grain FMJ	2,365	19.8	.9
Winchester 180-grain Power-Point	2,107	22	1

Groups are an average of four five-shot groups fired from a rest at 100 yards. Velocity readings recorded at the muzzle with a LabRadar Doppler chronograph at an ambient temperature of 75 degrees F, 1,030 feet above Sea Level.



Winchester offers a variety of loads in .350 Legend running from 145 to 180-grains in supersonic loads and a heavy 265-grain subsonic load for use with a suppressor.

of compromises, and that is certainly true here. However, this small scope brings a lot to the table.

hand and the stock locks solidly in place with zero movement. The test rifle arrived with a 20-round Lancer magazine clearly marked “.350 Legend”. This inserted easily and dropped free with the push of a button. The trigger was fairly light and crisp and well suited for hunting.

The optic I chose to use during testing is Nightforce’s excellent NX8 1-8x24mm F1 (NightforceOptics.com). This is a very compact optic which zooms from 1x to 8x and features a Front Focal Plane day-light illuminated Mil reticle. On 1x you can utilize it like a red dot and on higher magnifications you have Mil marks for hold-over and windage/lead corrections.

Very compact in size the NX8 is only 8.75 inches long and weighs just 17 ounces. The scope features .2 Mil adjustments with 20 Mils of adjustment per full turret rotation. Plus, the elevation turret features a zero stop. The windage turret is capped, which I prefer and there are 10 illumination intensity settings with an off position between each one. All optical sights are composed of a number

of loads available in .350 Legend due to the panic buying I was only able to get my hands on two, Winchester’s 145-grain FMJ and 180-grain Power-Point. After a quick bore sight I got to work firing four five-shot groups from the bench at 100 yards while recording velocities. Accuracy was rather good with the 145-grain FMJ load averaging .9 of an inch at 2,365 fps. The 180-grain Power-Point load averaged one inch at 2,107 fps. Recoil while shooting from the bench is relatively mild and it’s a comfortable rifle to shoot. Feeding the first round from a fully loaded 20-round magazine was a bit dry, download one round and everything went smoothly. Extraction and ejection were flawless.

Moving from the bench I did some snap-shooting on an eight-inch plate at 50 yards. I did this for fun getting a feel for the Wilson and the .350 Legend. Next I fired a five-shot group prone at a Shootsteel.com silhouette at 100 yards. Using the mounting bolt as my point of aim I put 5 rounds just above it. Moving a target out to 200 yards I tried my luck at this distance shooting prone. I wasn’t sure what my drop would be

WILSON COMBAT .350 LEGEND PROTECTOR

Caliber:	.350 Legend
Operation:	Direct gas with rotating multi-lug bolt
Barrel:	18 inches, 1-16 inch twist
Muzzle Threads:	5/8x24
Handguard:	Wilson Combat 10.4 inch M-LOK Rail
Trigger:	Wilson Combat TTU M2
Overall Length:	33.2 inches with stock collapsed
Weight:	6 pounds 9 ounces without mag or optic
Stock:	Rogers Super-Stock
Sights:	None
Finish:	Armor-Tuff
MSRP:	\$1,999.95 starting price
Contact:	Wilson Combat WilsonCombat.com (870) 545-3618

so I just held a bit high. All five shots dropped neatly into the lower chest, just a bit off-center.

Throughout testing the Wilson Combat .350 Legend Protector plugged away without issue. It fed, extracted and ejected flawlessly. Ejection was to three o’clock. Zero issues were encountered. In my opinion it carried nicely, shot well and looked good doing it. It is a pleasant piece to fire with a bit more thump than a 300 AAC Blackout or 7.62x39mm. If Bill Wilson’s .350 Legend Protector interests you, pricing starts at \$1,999.95. Will Winchester’s .350 Legend take the world by storm? I doubt it, but neither did the .35 Remington and that remains a cult favorite among hunters. **FN**



The Wilson Combat Protector strips easily for cleaning and routine maintenance. Overall it is a very nicely made AR-15.



Five shots fired prone at 100 yards with Winchester’s 145-grain FMJ load grouped well.



Here is five-shots fired prone at 200 yards. They dropped a bit low and off center but the group is good!

SARCO, INC.

CALL
Us!

LETS MAKE A DEAL

CALL
Us!

610.250.3960

AND ASK FOR CHOLLY, DAVE OR MARK

DAVE MICHELS

mgdave@sarcoinc.com
ext. 223

CHOLLY STEEN

PRESIDENT & CEO
csteen@sarcoinc.com

MARK DOTTEN

mdotten@sarcoinc.com
ext.224

www.SARCOINC.com

50 Hilton Street, Easton, PA 18042



EXTRA SURPLUS TO SELL??



MATERIAL SITTING AROUND ACCUMULATING ANOTHER YEAR OF DUST??

SARCO, one of the top 2 gun parts and general surplus dealers & importers in the U.S., is interested in your surplus material! Our primary interest is in gun parts, ammunition, ammo components, guns, cannon, aircraft, military vehicles, uniforms, field gear, etc. We are also interested in commercial firearms or parts, and surplus commercial inventory.

NO DEAL IS TOO BIG OR TOO SMALL !!

We will consider all offers and we assure you of our prompt and discreet attention to your offering. Mutually beneficial business is just a call away!

WE CAN SELL YOU SURPLUS AS WELL ! INQUIRE !!



An empty in the air, the bolt is already closed, and a follow-up shot is ready whenever needed. Recoil? What recoil?

A black and white photograph of a hand holding a Ruger Mini 30 rifle. The hand is on the left, gripping the stock. The rifle is held horizontally, pointing towards the right. The background is a dense, out-of-focus forest with many trees and leaves. The title 'RUGER MINI 30' is overlaid in large, bold, white letters at the top of the image.

RUGER MINI 30

A Great “Woods Carbine”
Ready for Deer or Hogs!
Plus, a Review of the
Pulsar XM50 Thermal Optic!

By Patrick Sweeney



The Ruger Mini 30 is a handy little hunting carbine.

The term “woods rifle” was used for hunting rifles of a certain time and place. Generally, east of the Mississippi, in the thick forested areas of the Midwest, Appalachia, Pennsylvania, and other hotbeds of deer-hunting activity. The idea was to have a light, handy, quick-handling rifle, of plenty good-enough accuracy, and sufficient power to cleanly take a deer. So, a carbine-sized rifle, not much over three feet long, not much over six or seven pounds, and chambered in something like .30-30, .35 Remington, .32 Special. You had some anomalous situations, like Pennsylvania hunters who favored bigger cartridges. However, in the Keystone State, hunters could find themselves close by but separated by a sharp ridgeline. If you shot your deer and didn’t drop it right there, when it fled over the ridgeline it belonged to the next hunter over. Not so much a problem in the Midwest.

The classic there is the lever action rifle. A Winchester 94 in .30-30 or .32 WS, or a Marlin 336, in .30-30 or .35 Remington, filled tens of thousands of freezers in every state with venison every hunting season. Well, this is the 21st century, and only old curmudgeons, and retro hipsters hunt with lever guns any more. (Do retro hipsters hunt?) What’s a new shooter to do? That’s easy: turn to Ruger.

The desired combination is simple: you want a carbine-sized rifle that is not much longer than three feet overall. You want something not more than seven pounds, if you can swing it. And you want something with power in the .35 Remington/.30-30 class. Enter the Ruger Mini 30. OK, time to back up a bit. The Mini 30 is a variation of the Mini 14, a rifle largely designed by Jim Sullivan of the AR-15 and ArmaLite fame. The idea was to produce a rifle that looked like the then-current classic military small arm of the time, the M14, but chambered in the hot new .223 cartridge that was getting all the press. So, the Mini 14 was introduced in 1974, and the first question was “What happened to the promised .308?” (That was the XGI, which never made it to full production, despite being promised for delivery in the 1980s.) The second question was “When can we have this in 7.62x39?”



The Mini 30 comes with iron sights, along with the built-in scope base hardware.

That came in 1986, along with the movies *Aliens*, *Platoon*, *Ferris Bueller’s Day Off*, and *Heartbreak Ridge*. (Yes, it was a good year.)

The Minis have the same design gas system regardless of caliber. Some call it a piston design, others a direct-gas, I simply referred to it, the first time I wrestled one apart, as a spigot system. The operation is simple: the gas port in the barrel bleeds gas off into the gas block and then through its piston. What Ruger calls a piston is simply the outlet for the gas, it does not move on its own. It pressurizes the interior tunnel of the slide assembly, aka the charging handle, and as a result, blows the charging handle off of the “piston” exactly like a mischievous kid blows the wrapper off of a straw. (Do we still have straws? Do they still have wrappers? Do kids even glance up from their phones to do that anymore? If not, I’ll have to come up with some other comparison.) The charging handle, with its cam slot engaging the bolts locking lug extension, lifts the bolt, then cycles it back, ejecting the empty by means of a fixed ejector blade, then forward to chamber a round, close and allow the next shot. Really, it is that simple. The trick is in the timing and the angles. In the engagement of the charging handle and the bolt, the Mini 14 is just like the M1 Garand, M14 and M1 Carbine.

PRISON SYSTEM

For a while, I was fixing Ruger Mini 14 rifles for the State Bureau of Prisons. They’d bring in that quarter’s busted guns, for me to review, bid, and then repair or return. I figured out very quickly that the State had a smokin’ deal with Ruger to replace seriously mangled rifles for what seemed like an absurdly low price. Any repair quoted to the Bureau larger than that cost (I don’t recall what the figure was, but it was really low) would be turned down. Bent barrels and broken stocks were “Back to Ruger for replacement” candidates. I mostly fixed bent trigger guards, and replaced busted rear sight parts, cracked and chipped buttplates, and cleaned up marred front sight blades. My assumption was that I was fixing the ones that fell down the stairs, while Ruger got the ones that fell out of the guard towers.

There was also cleaning. Each batch would have one or two that wouldn’t function due to crud in the gas system. I assumed at the time that the guards were forbidden to do any disassembly, so a rained-on Mini 14 would get corrosion of the copper residue in the gas system, and stop working after a while.

Test firing was the hassle. I also quickly learned that none of the aftermarket magazines could be trusted. I had to hunt down and pay the premium for an LE-Only (this before the Assault Weapons Ban) magazine, so I would have a reliable magazine to test with. I only ever shot 55 grain FMJ for testing, for two reasons; it was as common as dirt and everything else wasn’t, and it was what the State used. Or so they told me.

When a Mini came by at a reasonable price, I snapped it up so I could have a working sample on hand, to compare each non-working State Mini against. I’ve still got it around here someplace, along with its factory mag. **FN**

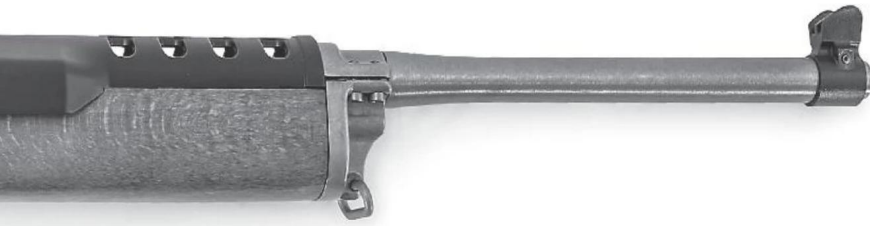

The Mini 30 is also a very useful defensive carbine.



Anyone familiar with a self-loading rifle prior to the AR-15 knows how to operate the charging handle of the Mini 30.



The safety is a blade forward of the trigger guard. Push it forward to make the Mini ready to fire.



Pulled to the rear, the safety locks the trigger mechanism, and readily determined by touch.

The adoption, acceptance and marketing of the Mini 14 and Mini 30 were not entirely happy events. At the time, Bill Ruger was still the man in charge, and as an old-school New Englander, he was as far as I could tell a man of his time and place. Getting along with his social group was important, and as a result, for many years you could not buy factory-new Ruger magazines for the Minis larger than five or ten rounds. This created a demand for higher-capacity magazines that companies tried to fill, mostly with poor results.

When the Mini 30 came out, the teeth gnashing was epic. Everyone who had heard of it, and had anticipated it, had assumed that Ruger would make an American rifle that used the AK magazine. (Hey, this was the mid-1980s, after all. There was no such thing as "Plenty of AKs" yet.) When the Mini 30 didn't, the complaining was almost too much. It only

takes a quick look to realize that had Ruger done that the resulting fat-body receiver and stock would have made the Mini 30 look like a pregnant hippo. And even then, Ruger didn't do ugly guns. (We'll ignore for the moment the P85.) We were early in the era of 7.62x39 ammunition, and the options were sparse. I remember getting calls from customers who wanted to hunt with a Mini 30, but the DNR forbade the use of FMJ bullets. "Can I file the tips?" No. "Do you know a bullet I can substitute, pulling the existing ones?" No. Given the sudden increase in AKs, mostly Chinese, that flooded the market soon after, the ammunition companies stepped up and provided softpoints for hunting.

From the beginning, the Mini 30 had the famous Ruger scope mounts cast into and then machined on top of the receiver. The rings were all you need to

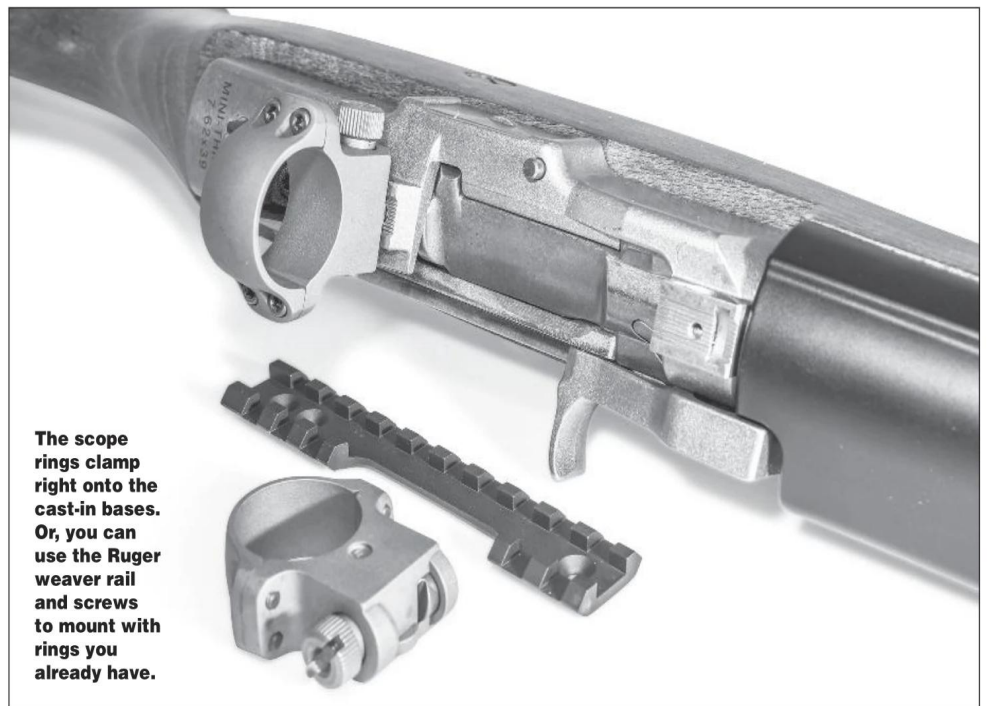

The scope rings clamp right onto the cast-in bases. Or, you can use the Ruger weaver rail and screws to mount with rings you already have.



The "piston" is just a spigot, and blows the charging handle off of the gas system.

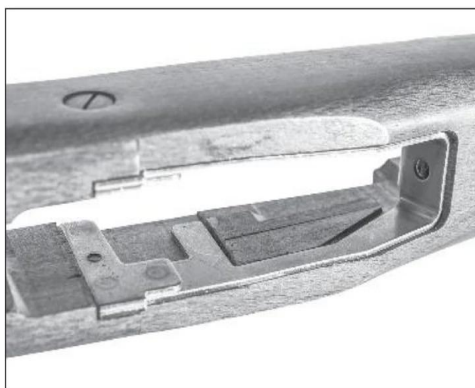

The stock has a sheet metal liner, to reinforce it.



To remove the magazine, push the magazine catch lever forward.



Locking a fresh magazine in place means hooking the front and then swinging the magazine up until it latches in place.

mount a suitable scope on top of the Mini 30, but that didn't stop some of my customers from going overboard. I had hunters who had always hunted with a 3-9x40 scope, and they were damned if they weren't going to continue that with the Mini 30. Explaining that 9X wasn't needed for the distances they'd see in the woods, nor what you could use with an AK round didn't faze them. Nor did the higher rings I'd have to use, to get clearance for the scope bell. They had always shot a rifle using a crappy cheek weld, and gotten their deer (more or less) regularly. The Mini 30 wasn't going to be any different.

Realistically, a 1-4 or a 1.5-5 power scope with a one-inch tube would be plenty, and in keeping with the compact dimensions of the Mini 30. Going to a 30mm or even a 34mm tube would be excess. But, this is America, and you can do it if you wish. Ruger makes rings in one inch and 30mm (no 34mm, sorry) in blue and stainless, and for those who just have to have a particular scope mounted, Ruger offers offset rings, to shift the loop forward of the ring mounting base. And, you have the usual medium, high and

x-high ring heights. I simply dove into the scope vault and found a scope both historical and appropriate for hunting use: a Leupold 1.5-5x20. I used the provided rings to bolt it on. Now, if you want to use something else, Ruger has cleverly drilled and tapped the clamp-on ring studs, and provided the screws and a Weaver base for you. With that installed, you can use whatever rings you'd like, provided they fit the Weaver base. Talk about both belt and suspenders. The scope bases are front and back of the receiver opening, with an adjustable aperture rear sight behind them, and a protected blade front sight pinned to the barrel at the muzzle.

The stock is wood, with a stamped steel liner fixed inside of the stock to provide extra strength. The charging handle has part of it covered by the synthetic heat shield on the barrel, and the stock has a rubber recoil pad on the back end. There's a sling swivel in the stock belly, and another one in the gas block assembly, at the front of the stock.

OK, Mini 30 function. Load the magazines by pressing a round downwards between the feed lips. This is like any other double-stack, double-feed rifle. The safety is the tab on the front of the trigger guard. Press the safety back to put it on, and not fire. Hook the front lip of the magazine up inside the magazine well until it catches on its locking shoulder, and then pivot the rear of the magazine up until it locks in place. The Mini (14 or 30) magazine does not work on insertion or removal like an AR. It works like the M14/M1A or AK in this regard. (And the FAL, let's not leave that one out.) Pull the charging handle all the way to the rear, and then let go. Do not ride it forward. You are now loaded. If you wish to unload, press the magazine catch at the rear of the magazine, and the magazine will pivot down. You may have to encourage it to pivot. Then retract the charging handle to extract the chambered round. You're empty.

Shooting is simple. Insert your trigger finger into the trigger guard. Press the safety forward to select Fire. Then press the trigger as-needed. To go on Safe, remove your finger from the trigger guard reach forward and press the safety to the rear.

It is necessary to describe these steps because the world has changed. An old fart moment: When the Mini 14 showed up, back in 1974, none of these instructions would have been necessary. Anyone with any shooting knowledge back then would have been familiar with the M1 Garand and/or the M14 and the M1 Carbine. The safety on the Mini works exactly like that of the Garand and M14. The magazine works exactly like the M14. The Carbine magazine and safety are different, but the charging handle is the same. Today, were you to quiz the habitués of a gun shop on what rifle they were most familiar with, it would be seventeen ARs, three AKs, and the strange guy in the corner who keeps muttering "Bullpup, bullpup." Were you to hand them a Garand, M14/M1A or other classic blaster, then they will have to stop and figure it out.

And we'll have to do this again when it comes time to discuss disassembly.

One question that comes up is bore dimension. I went right to the source, Ruger, and contacted my

RUGER PREFIX

You'll notice that the serial number on your Mini 30 has a prefix. If it is a current production Mini 30 it will be a "583-" in front of the serial number. That's the whole, actual serial number, prefix and numeral. The initial production Mini 30s started with a 186. They ran the serial number sequence and then jumped up to a 196 prefix. That lasted until Ruger re-engineered both the Minis in 2004. When they picked up again in 2005, they jumped to 581 for the Mini 30.

Why all this? Before 1968, firearms were not required to have a serial number. I have a bunch of firearms entered in my gunsmithing log book from the 1980s and 1990s where it is denoted "NSN," as in: no serial number. The GCA 1968 required each firearm have a unique serial number. Well, if you were Colt, and you were making SAA and 1911, that's easy. You could have an SAA and a 1911 with identical numeric designations, and it wouldn't be a problem. Ruger? By 1968 they already had so many models you could own a dozen Rugers with the same serial number. In fact, there were collectors who did just that. They would buy each new model when it came out, and hunt down serial number XYZ, "their number." Some were on the short list, and simply had "their number" shipped to the FFL on file for them.

Ruger just made it easy in dealing with the government, and instituted a model prefix for each new model. So, if it was made before 1970 (the year Ruger switched) it has no prefix. After, it has a prefix. And the collectors? They just kept acquiring new models, with the prefix and "their number." **FN**



Left to right; Barnaul 123 grain FMJ, Hornady 123 grain SST, Federal 123 grain Fusion, Federal 123 grain softpoint, Winchester 120 grain PDX1.

inside guy there, and got this as a reply on the Mini 30: "We spec .310" - .311", aim for .3105" and stay close." So, the bore on your Mini 30 is correct for all the chi-com and imported ammo that comes in and will still work just fine in case you happen to get a batch of U.S.-made ammo using .308" bullets. The standard on US .30 rifle bores is for the rifling to be .004" tall on each land. That means the bottom of the groove is meant to be .308" and the tops of the lands are at .300". So, on your Mini 30, the land tops will be .302" and the grooves .310 or so, and your .308" bullet will have plenty of "bite" in the rifling to get spun up. This won't be a problem unless you have a stash of ancient 7.62x39 US made ammo, dating from back in the 1990s or so. The ammo companies have long-since made bullets specifically for the AK round, and with appropriate .310" - .311" diameters.

I had to go back into the depths of the ammo bunker to come out with AK hunting ammo, as it has been quite some time since I was shooting anything but FMJ or steel-cased surplus.

The current comparison of the 7.62x39 is the .30-30. Now, there are problems here. First of all is that the .30-30 does not come loaded with a bullet lighter than 150 grains. Finding something heavier than 123 grains for the AK round is not at all easy. Looking at advertising specs won't help much. The "book" velocity for the .30-30 is listed at 2,300+ fps, some creeping up to 2,400 fps. If you have a rifle with a 20" barrel, you'll likely see most of that. A carbine with a 16" barrel? Nope. The 7.62x39 is listed as having 2350 fps, more or less, and you'll get that. So, the fair comparison is between a 150 grain softpoint at 2,200 or even 2,250 fps, and a 123 grain softpoint at 2,350 fps. Whitetails are not classified as dangerous game, and not that hard to cleanly dispatch, so it sounds like a tie to me.

Accuracy? Back in the bad old days, Ruger had something of a reputation as a barrel maker with a hit-or-miss track record. I had lots of customers who were very happy with their Ruger (of any type) and some who just didn't think the barrel was good enough. Most were simply shooters who couldn't shoot, or scopes that were junk. By the mid-1990s, Ruger had one end of a huge building filled with nothing but gun-drills, rifling machines, lathes and reamers, all for their own barrels. Now, Ruger cold

hammer forges all their barrels in-house, and forges them to the tight side of SAAMI specs. If you have a Mini 30 (or any other Ruger firearm) that doesn't shoot up to snuff, then the barrel is probably the last place to be looking. For the Mini 30, it would be glib to say that all you need is "minute of whitetail" because there's no such thing as too much accuracy. However, what you will find is that individual rifles can vary in what they like and don't like. If your rifle doesn't like a given load, then move on. Your rifle doesn't care that it is "the perfect load for XYZ" it doesn't like it, pick another.

I was not surprised that the Mini 30 sent shot well. I was surprised that it shot one load, the Federal Fusion, almost to an MOA level of accuracy. The Leupold maxing out at 5X is something of a limit, if you are looking to punch the smallest-possible groups, but it is an entirely appropriate hunting scope. As far as recoil is concerned, really? The Mini 30 is listed as seven pounds, bare, which seems heavy until you actually pick one up. It may be seven pounds, but all the weight is between your hands, and it seems a lot lighter. The stock doesn't have a lot of drop, no more than needed, and there's a rubber recoil pad on the back. I won't say it recoils like a rimfire, but someone jumping up from a rimfire won't find the recoil oppressive. The soft recoil and not-loud bark also makes it easy to wring as much accuracy out of the Mini 30 as it has.

The 7.62x39 does not have a reputation as being a flashy cartridge. As in, not a lot of muzzle flash. Yet, in the first ten rounds shot while running the camera to get an action photo, I caught flash in the frame four times. Truly, timing is everything.

Disassembly

OK, unload your Mini. Check again. Leave the hammer cocked and push the safety to Safe. The idea here is to hinge the trigger guard down. It hinges on the front, and clips at the rear. You'll need a grip like Godzilla to do it, so instead, use a cleaning rod (steel, not aluminum) or screwdriver. Hook it into the hole in the trigger guard and lever down. With that much leverage it will be a lot easier. Pull the trigger assembly down out of the stock. The handguard is held on by means of a spring clip over the barrel, just give it a tug or a bump and it clips off. Turn the action upside down

THE CHANGE

In 2004, production of the Mini 14 and Mini 30 went on a short halt. The reason? Good engineering. The original design had been finalized in 1974. By 2004, the Mini molds were old and the rest of the firearms Ruger was making had been originated or switched over to CAD/CAM design and manufacture. Ruger started with a clean sheet of paper (so to speak) and settled on the best dimensions for each part. Then they switched over to new molds, and also determined the best method for making each part. Some cast, some forged, some machined from billet, each one selected for good engineering reasons. Those requiring machining had new fixtures fabricated for that part. This change eliminated a lot of hand-fitting in assembly, and sped up production. It also meant that replacement parts for legacy Mini 14 and Mini 30s would be a case-by-case situation. Your pre-2005 Mini was assembled by someone who fit the parts. The part made now may need hand-fitting, and it may not. The new part may not fit at all, at least not to Ruger's satisfaction. That's why, if you need service, your legacy Mini often has to go back to Ruger. It's a good thing, so stop complaining. **FN**



The AK round does not have a reputation for flashing. But the camera never lies, right?



To disassemble, pivot the rear of the trigger guard down. Often, a screwdriver is a big help in mustering the necessary leverage.



Pull the trigger assembly down out of the stock.

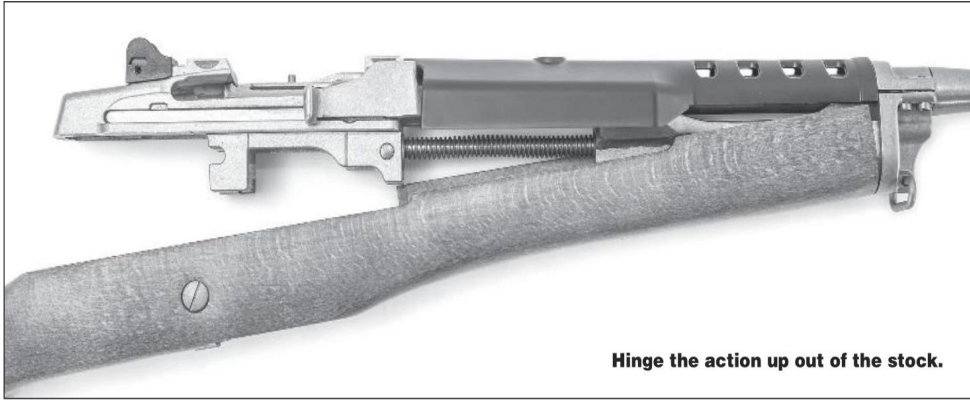

Hinge the action up out of the stock.



Pull the recoil spring assembly out of the retaining cup.

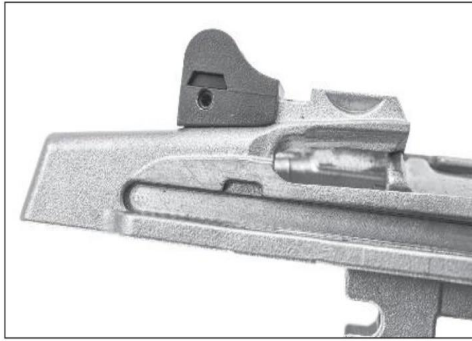

Here you see the disassembly clearance notch in the guide rail, where the charging handle can be removed from the guide rail track.



And then ease it relaxed and pull it out of the charging handle.

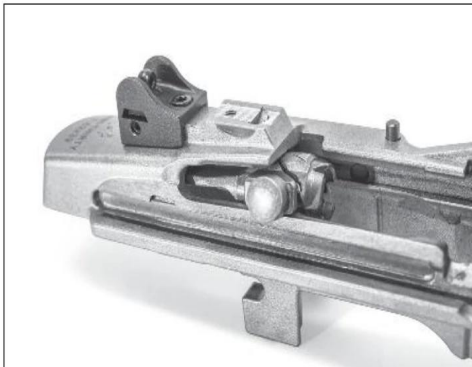

When you go to remove the bolt, pay close attention to the angle you need for removal, because that's the exact angle you'll need for reassembly.

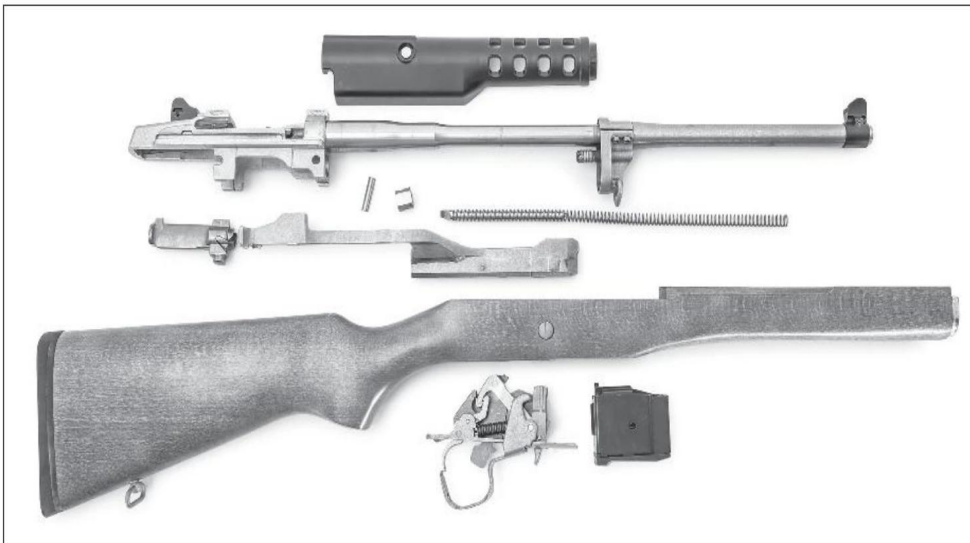

The Mini in either caliber does not take down like your AR-15 does. You have to learn the tricks, but once you do it is easy to take apart, clean and get back together again.

and grab the recoil spring assembly. Pull it towards the muzzle, and when the end clears its retaining cup, lift and ease it relaxed. When you do this, the retaining cup and its holding pin will fall out, so find them and pick them up off the floor.

Run the charging handle back until the retaining lip on its back-end lines up with the clearance notch. It will then pop out of the track, and you can lift it off of the bolt. The bolt is the hard part. To remove it, push it back, then lift the outside locking lug, tilt the bolt up and towards the outside, and weasel it past its retaining bar. Watch this process closely, because to get it back together you have to do the reverse, and if you don't watch, you'll spend a long time fiddling with it to get it back into the receiver.

The rest of the reassembly is easy compared to getting the bolt back in place.

Oh, and a note: you do not remove the gas system, nor disassemble it. No, really. The screws are torqued on, apparently, by an air gun, and are a real bear to remove. If you knarf one, Ruger won't sell you a replacement (at least, not last I knew) and there are small parts in there you best not lose. Scrub it, lube it, inspect it, but do not take it apart.

Hunting and More

Yes, the Mini 30 is a great little hunting carbine. But it can be more. The scope on this one, a 1.5-5X, is also a great combo for short to medium defense. No one has complained (or at least, not much) about the performance of 7.62x39 in a military context. And if you want more than just FMJ, then good hunting ammo, or the Winchester defensive load, would serve well. And if you really want to be too cool for the rest, then lay hands on a Samson folding stock, right out of "The A Team" and put it on your Mini 30. Yes, there's currently a massive waiting list for them, but when yours arrives you will be the envy of the gun club. And have something compact to have handy, should you need it.

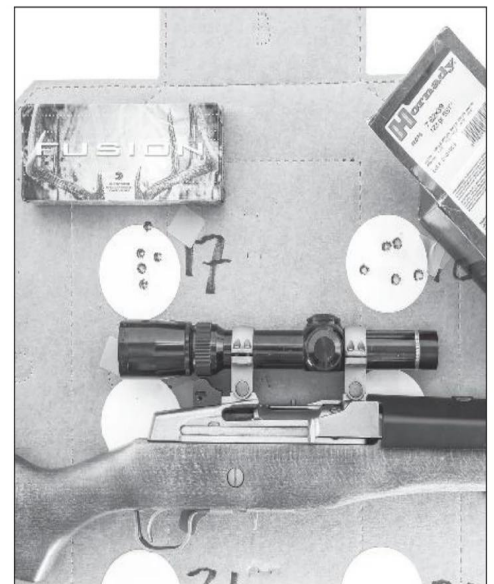

Handy little woods carbine? Check. Really accurate with the right ammo? Check. Solid defensive carbine? You betcha.

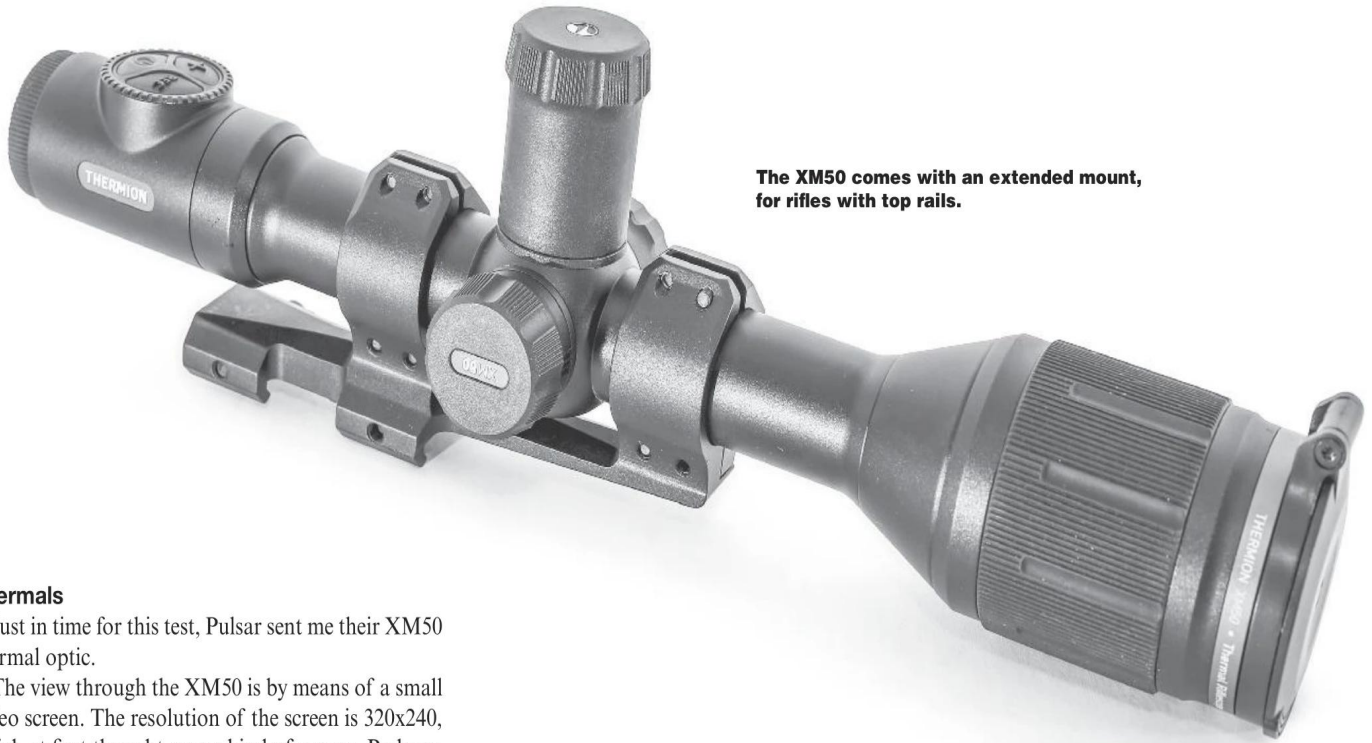

The XM50 comes with an extended mount, for rifles with top rails.

Thermals

Just in time for this test, Pulsar sent me their XM50 thermal optic.

The view through the XM50 is by means of a small video screen. The resolution of the screen is 320x240, which at first thought seems kind of coarse. Perhaps, but there are technical difficulties in any thermal viewer. First of all, longer wavelengths pose a problem with resolution. You just can't get as sharp an image with longer wavelengths, as you can with shorter. You can see that with images from astronomy. Visible-light images are sharp. Those from radio astronomy are just big, fuzzy blobs. That's as sharp as they can make it, with wavelengths that are thousands of times longer than those in the visible spectrum. While not as long as radio frequencies, Infra-red is longer than visible, so a starting problem. Then, the pixels in the detector have to be large enough to gather enough of a signal to generate an image. So you can only pack so many into a sensor without getting NASA-expensive. And finally, the energy differences between the hotter and cooler areas is so small that you need to use a lot of amplification to generate an image that isn't a blob.

So, in the non-Department of Defense world, 320x240 is pretty darned good.

The XM50 uses a regular rifle scope with the expected adjustment knobs, and one that is different. The top knob, the one that is so tall, is a battery compartment. There are actually two batteries in the XM50, the removable one on top, and an internal one that is charged by means of the USB slot underneath the left-hand cap. You use the same, included, charger to charge both, but you can't charge them at the same time, so plan ahead. A quick look at the owner's manual indicated to me that we are fully into the 21st century. There is no figuring it out as you go, "because it is obvious" as one might with mechanical items.

Just turning it on requires that you (if you haven't done some of these already) adjust the diopter ring (on the back end of the tube) to bring the icons in the screen into sharp focus, then turn the lens focus ring (on the front end of the tube) to bring your target distance into focus. Then you have to select the calibration mode, screen brightness, display contrast and digital zoom smoothness. Whew. It is important that you get these settings to the values that are best for you. When first looking through the XM50,



The battery can be charged by means of the usb port in the right-hand turret.



What looks like a target turret is the second battery compartment.



Here is the XM50 internal battery being charged.



Charge the external battery with its own charging cradle.

I had the impression “this thermal stuff is not a big improvement.” Then I started adjusting the settings and wow did it make a difference. The diopter adjustment makes it possible to view and read the settings along the lower bar. Focus? I’ve peered through regular scopes that were cranked wildly out of diopter adjustment, and the shooter who owned it didn’t even notice. In the visual spectrum, and with good eyesight, our brain can correct for a lot of signal loss. But when it is a screen, and you are viewing what is in essence a translated image from infra-red to the visible, your brain doesn’t know what to make of it, if it is too far out of your adjustment. So, take the time to get the focus and diopter adjustments correct for your vision, your brain and eyes will appreciate it, and you can avoid headaches from un-adjusted viewing.

At a certain point you are on your own, because the quick start guide, despite being 40 pages, is printed in six languages, and that doesn’t leave much room for each.

OK, let’s run through a few of the settings you’ll want to know about, even if you end up using the default settings. First, Color Mode. This is where you select hot is white, or hot is black. Me, I prefer hot is white, which is the default. You can also go with hot is red, or a red monochrome (to keep your night vision less effected) rainbow, ultramarine, violet or sepia. And you thought your local coffee shop offered an array of options.

You won’t want to mess around with the language settings (this is, after all, something to be offered

internationally, where lawful and affordable) but you do want to set the day and date, and time. Why? Because you can record the image, which I’ll cover later. There are also units of measure, where you pick yards or meters. There is a Wi-Fi option, and you can use a password and once set up the scope allows you to stream the image. That’s right, once you have established a Bluetooth connection, you can stream the image to some other device, for someone else to see what you’re seeing, and to record there as well as in the Pulsar itself.

The reticle has a rangefinder in it, a set of bars that indicated the height of various targets, and a range

readout. This is the Stadiametric Rangefinder. Pulsar has built in a Smart Reticle, which means that when you change magnification, the spacing of the bars also changes, so you still have the same relation of bars to target height as you had before.

Electronics require batteries (since an extension cord to a hunting blind would be absurd, right?) so charging batteries is a big deal. The XM50 can be charged through the USB port in the right-side turret, to top off the internal battery, but the battery in the tall top knob has its own charging bay. The internal battery is listed as an APS3, while the external batteries are listed as APS2, which appears to be a proprietary



The controls are on the rear of the scope, push-button and with menus on the screen inside.



The XM50 is easy to distinguish from other scopes, look for the blue band on the objective bell. Or, look at the very oddly-curved front lens.



Since I could not lay hands on 30mm rings for the Mini 30, I used the Pulsar mount on a test-bed AR to check things out. With sunlight on the target, you can use white or black markers as aiming points to check and adjust your zero.

The Mini-30 is also available with a synthetic stock and 20-round magazine.



CHRONOGRAPH AND ACCURACY DATA

Ammunition	Bullet Weight (gr.)	Velocity	Es	sD	Accuracy, Ave & Best	
Barnaul FMJ	123	2,367	21	10.1	2.1"	1.6"
Hornady SST	123	2,338	19	8.7	1.9"	1.5"
Federal Fusion SP	123	2,349	31	16.0	1.5"	1.1"
Federal SP	123	2,327	27	12.5	2.2"	1.7"
Winchester PDX-1	120	2,389	34	17.1	1.9"	1.6"

Accuracy results were to be averages of 3, 5-shot groups at 100 yards off a Champion shooting rest. Scope power set at 5X. Velocities are averages of 10 shots measured on a Labradar chronograph set to read 15 feet from the muzzle.

RUGER MINI 30

Type:	Hammer-fired semi-automatic
Caliber:	7.62x39
Capacity:	5 to 20 rounds
Barrel:	18.5"
Overall Length:	37.5"
Weight:	7 lb
Finish:	Stainless steel or alloy steel
Stock:	Wood or synthetic
Sights:	Fixed front, adjustable rear
Trigger:	4.5 lb
MSRP:	\$ 1,069
Contact:	Ruger.com

PULSAR XM50

Type:	Thermal riflescope
Caliber Limits:	None apparent
Tube Diameter:	30mm
Resolution:	320 X 240
Battery:	Internal, plus 18650 type extra
Zoom:	4X digital (5.5X - 22X)
Waterproof:	to 3 ft for 30 minutes
Length:	15.75"
Weight:	31.8 oz
MSRP:	\$ 4,180
Contact:	Pulsar-NV.com

battery from Pulsar. The lowest price I could find for a replacement was \$80, so you want to make sure you do not lose or damage the batteries that come with the XM50. Each battery is listed as giving the XM50 five hours of run time. I found that it lasted a bit longer than that, and since the internal battery is also good for some time, you have a night's worth of thermal viewing on a charge. The charging station plugs into the wall by means of a micro USB adapter, like every other digital device you own. Not the same USB plug, perhaps as your phone, etc., but the same system. The charging bay has the expected led indicator lights, to let you know how the charging is going. When you get four green leds, you're good to go.

I can see some of you in the back, worried about the DNR. "Hunting after nightfall is illegal." Except when it isn't hunting. Now, check your regs, but if you are shooting wild hogs, in most locales they don't care how many you shoot, so long as you do it safely. The XM50 sees heat, so anything walking around in the dark is going to be visible through the XM50.

Now, you are asking just how it is that you can zero a thermal scope, when you don't; have something hot to shoot at? Let me introduce you to the realm of physics. Keep in mind that a thermal imager such as the XM50 (all, in fact) do not read absolute temperatures (unless they are calibrated to do so) they respond to, and display *relative* temperatures. So, to have an aiming point, you simply place a plain sheet of cardboard on your target holder or frame. You then put a white or black overlay on it in direct sunlight. The overlay (I used gaffer's tape and an Avery label) will get hotter or cooler than the cardboard, exposed to the sun, and you can see the difference. The black gaffer's tape absorbs, and is hotter. The Avery white label reflects, and is cooler. Viola, an inexpensive thermal target.

I used that to zero and shoot with the XM50 for groups. One aspect of electronic sights that is always a concern, at least among those of us old enough to remember when electronics were fragile: recoil. How well does it stand up to recoil? Pulsar assures us that it can withstand the recoil of .375 H&H, 9.3x64 and 12-gauge, which I find to be both specific and reassuring.

As much as I wanted to put the XM50 on top of the Mini 30, did I have any 30mm rings to fit? Alas, no. so I had to use a test AR lying around, and the Pulsar-supplied scope mount which worked really well. But if you are looking for night-time varmint control, or hog whacking, the Pulsar XM50, on top of the Mini 30, is a really good way to go. **FN**

GALLERY OF GUNS.com®

WANT A RUGER MINI 30?

Check out Davidson's Gallery of Guns at GalleryOfGuns.com!

Davidson's offers the GuaranteeD® Lifetime Replacement Warranty which backs all the firearms you buy through GalleryofGuns.com. It works like this: if anything ever goes wrong with any gun you buy with the Davidson's GuaranteeD® Lifetime Replacement Warranty, it will be replaced. If no replacement is available, it will be repaired at no charge to you. Simply return it to the retailer

where you purchased it, pay for the return shipping and upon receipt Davidson's will ship the returning retailer a brand-new gun for you provided one is available. If a replacement is not available your firearm will be repaired for free. For complete warranty information please refer to the Guaranteed Warranty link found at the home page of GalleryofGuns.com **FN**

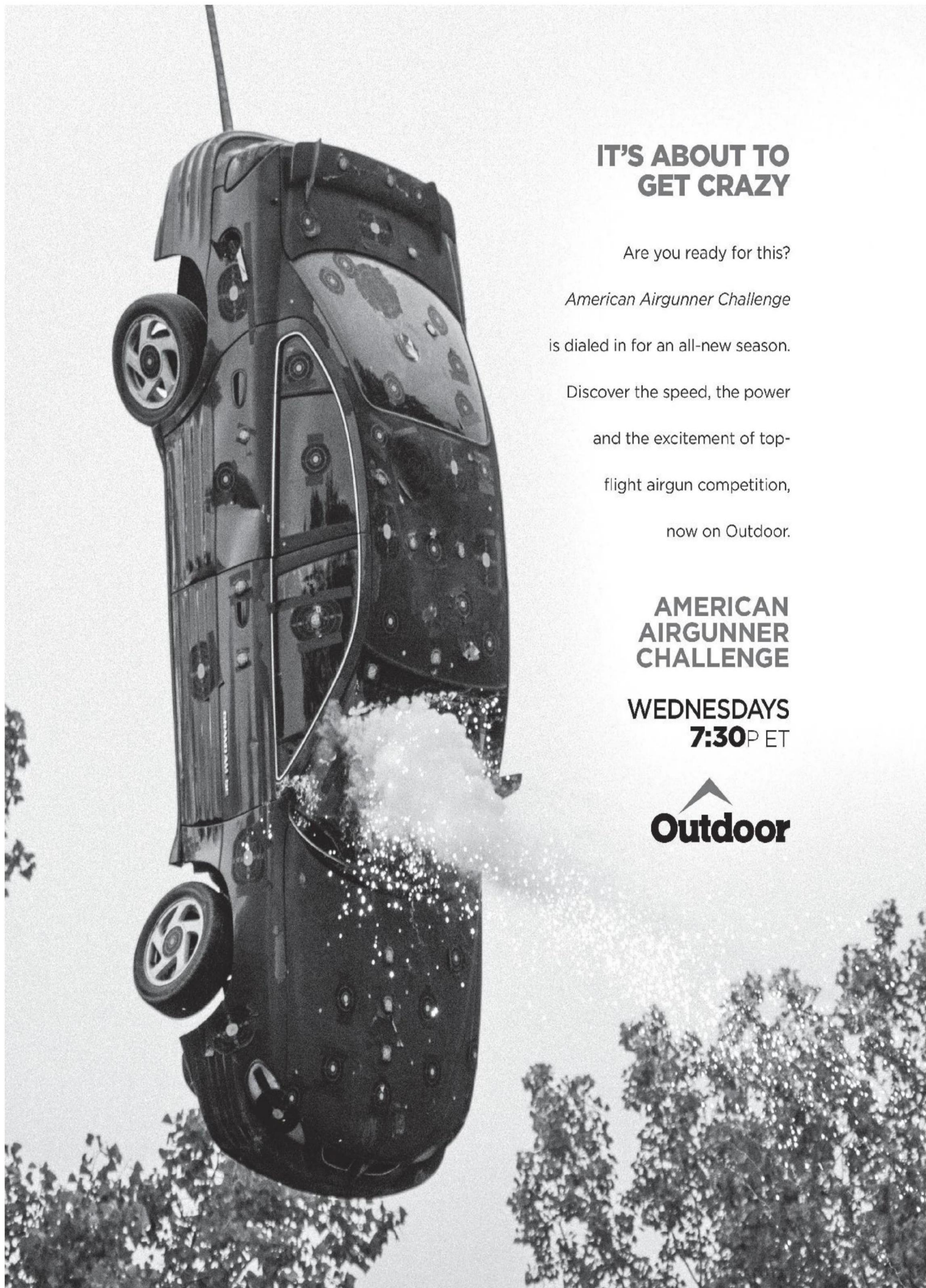

IT'S ABOUT TO GET CRAZY

Are you ready for this?

American Airgunner Challenge

is dialed in for an all-new season.

Discover the speed, the power

and the excitement of top-

flight airgun competition,

now on Outdoor.

AMERICAN AIRGUNNER CHALLENGE

WEDNESDAYS
7:30P ET



50 Hilton Street, Easton PA 18042
 Showroom Open: Mon - Sat,
 10am to 5pm, Friday til 8pm
 Tel: 610.250.3960
 Fax: 610.438.2548
 info@sarcoinc.com
 Phones Open: Mon - Fri,
 8:30am to 5pm



SARCO, INC. EST. 1962

LEADING SUPPLIER IN FIREARMS. PARTS. ACCESSORIES.

GOT PARTS??

WE SPECIALIZE IN 'HARD TO FIND' PARTS!! FROM AK TO ZASTAVA...

www.SARCOINC.com 1



Use your Smart Phone to Scan the QR Code and go straight to our website!



Israeli FAL Rifle Parts Set

Light Barrel Version



Manufactured by Israel, these parts sets were stripped down from Israeli Military Service rifles and are in very good shape and contain all parts for the gun except for the barrel and receiver. The set comes with a Sling and Metric 20 rd. magazine where permitted by law. Perfect kit for building your shooting FAL with one of the semi auto receivers and barrels offered elsewhere. Kit is sold without flash hider **\$425.00 FAL320**
 Add a flash hider for an extra **\$25.00**
Please Note: These kits are in nice condition. Others have sold for cheaper but we are told they were a low quality seller with sometimes missing or broken parts. **BUY QUALITY!!**

NOW'S THE TIME!! BE THE FIRST TO KNOW ABOUT OUR DEALS !!!

Join Our EMAIL BLAST List Today By Texting SARCO to 22828 And Receive A SPECIAL DISCOUNT ! By doing so, you'll get our latest email blast offers, sale items and notifications of new goodies coming in! AND... after you sign up, receive a FREE deck of authentic Cold War, Unissued & Illustrated AIRCRAFT CARDS! Just add them to your cart using part number MISC168 and enter source code EMAIL-BLAST at check out to receive them for FREE. What are you waiting for?? Get On The List!!

Sleek synthetic hip holster keeps a low profile and holds medium frame semi auto pistols, generally with barrels of 3.25" to 3.75" size. Belt loop on back can accept up to 2" wide belts and the adjustable snap strap with pull lever makes release of the pistol a breeze. New, black



Medium Frame Pistol Hip Holster

\$10.95 HOL196



Synthetic Hip Holster is lean, flexible, and maintains a low profile on your hip.

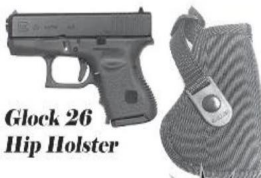

Glock 26 Hip Holster

Holds the Glock 26 Compact pistol and numerous other similar sized compacts too. Belt loop on back accepts up to 2 inch wide belts and has an adjustable top strap with snap and lever pull for simple quick release. New, black ... **\$10.95 HOL195**



'DON'T TREAD ON ME' TRICOLOR PATCH

Show your 'Moxie' by standing up for the Bill of Rights amongst other principles with this machine sewn patch! Good for attachment to shorts, shirts, vests, jackets etc. In this age of bureaucratic over-reach, it's a necessity! Size 3-7/8" x 2-3/4" **\$5.95 MISC911BC**



BRAND NEW IN THE DOOR! M1 CARBINE PARATROOPER M1A1 GUN CASE - see our page 9!

BACK IN STOCK! FRENCH 1877 WWI CANTEEN

French 2 Liter canteen was the mainstay implement for carting potable water and even wine for the French Army, from the disastrous Franco Prussian War through WWI. Unique design with air vent and carry strap and a green blue felt covering. New



\$49.95 MISC889

VIETNAM ISSUE MK4 MOD 0 M16 BUTTSTOCK SET

Scarce as 'hens teeth', we have found a half dozen original Vietnam issue Mk4 Mod 0 buttstocks as used by SEAL units, LRRP, and MAC-SOG. Specifically marked on the left side of the stock with the designation and hole emplaced from the bottom of the stock up through the buffer well for water drainage. These were probably issued in 1966-67. Super rare opportunity to have original Spec-op gear from the Vietnam conflict. Includes original pistol grip, original buttstock engraved with MK4 Mod 0 markings, and a late production triangular handguard. **\$200.00 STK399**



Very Limited!

P-1882 MARTINI HENRY BANDOLIER

Ruggedly made and stitched to hold 50 rounds of 577/.450 Martini ammunition (also holds shotgun ammo 24 ga - and can be softened to hold 12 ga rds in most holes except where the fasteners are). Has strap to fasten to a waist belt for a secure fit. Three of these make a 'rough riding' cross chest & waist Pancho Villa style set! Very thick brown leather with brass hardware. Although it is meant as an over the shoulder bandolier, it is also a comfortable waist belt bandolier fitting up to a 45" waist. Now available in Brown or Black!..... **\$45.00 MISC334**



JUST IN !! USMC HERRINGBONE KOREAN WAR ERA SHORT SLEEVE UTILITY SHIRT

Rugged Olive Drab short sleeve shirt for combat duty with breast pocket and two large Map pockets inset under the chest. Officers and NCOs loved these shirts and they fade wonderfully and take abuse of the rugged outdoors. Newly manufactured and made with USMC embossed buttons like the original shirts. Rare as 'hens teeth' these days, this might be your one chance to obtain one. Very limited **\$49.00 MISC86**
Sizes available: Medium, Large, XL,2XL,3XL



OLIVE DRAB HERRINGBONE COMBAT SHORTS

Perfect complement to the USMC Korean War Short Sleeve Shirt that we sell. Herringbone fabric is durable and breathes well with generous room for flexing legs, buttock, & waist. Very comfortable and has two front cargo pockets, cell phone utility pocket, two front slash pockets and two rear deep slash pockets. Belt loops accept up to a 2.5 inch wide Belt. New **\$29.95 MISC899**
Sizes Available: Small, Medium, Large, X-Large, 2 XL



USGI ENTRENCHING TOOL W/ 2 USGI COVERS !!!

Original U.S. Military E-Tool in excellent condition comes with 2 original military carriers. One carrier in ACU camouflage with MOLLE attachment and the other, rubberized case with alligator clips. The ACU pouch on its own is a great utility pouch that can be used to carry beer, ammo, and oh yes... spare toilet paper for the next pandemic. Very small quantity, but loaded with value!!! **\$35.00 MISC913**



SAMURAI MAGAZINE VEST AND ITALIAN M33 HELMET SET

SET OF ITALIAN WW2 SAMURAI MAGAZINE VEST AND ITALIAN M33 WW2 ERA HELMET

Another First on the U.S. market as Sarco brings you another 'Kamabee Keep' item that is as rare as 'hens teeth'! The WW2 Italian Paratrooper canvas & leather vest referred to as the 'Samurai' vest, was a staple of the 185th Parachute Division that was famous for their preparation of the invasion of Malta, and importantly for the 2nd battle of El Alamein where they resisted 4 British Infantry Divisions and 2 Armor Divisions thrown against them. This vest would still be viable in today's military operations if you inserted body armor plates or Kevlar! Very comfortable and a brilliant design! It is applicable and useful with numerous other sub machine gun magazine like Sten, Thompson, MP40 etc. Normally repro versions although rare as well, are priced at several hundred dollars for this version. We have a limited supply of these at an attractive price! Set of Vest and Helmet **\$140.00 MISC797**



WINCHESTER 70 RIGHT HAND SHORT ACTION STOCK / SYNTHETIC

New condition black synthetic stock with buttpad and swivel posts installed. Overall length 29-3/4 inches. For Post 1964 models. Great Price!



JUST IN !!

\$49.95 STK427

U.S. WWII PARATROOPER SIGNAL CRICKET

Brass metal clapper. Puts out a distinctive clicking sound so that all troops could communicate to "friendlies". U.S. embossed **\$7.50 MISC284**



SEE OUR WEBSITE FOR THE CURRENT AVAILABILITY OF OUR AR KITS

We had to pull our AR15 & M4 kits due to a lack of barrels - However, we have purchased 2000 barrels & expect them in by the time this ad is out... SOOO!! Check our website regularly if you wish to purchase an AR Kit. Also, we have purchased, I guess, 150-200 separate AR items and many cool accessories! Check our website for these, too!

M16 ACCESSORY KIT - HEAVY DUTY

Cleaning toothbrush (G.I) Silent sling, Front sight tool, Muzzle cover, Magazine dust covers (6), Plastic mag carriers (4) (Israeli G.I.), Broken shell extractor, Cleaning rod, Stripper guide, 2 Grenade launcher tension band (rare). Value \$83.50 Sarco Special Price \$19.95 AR238

TAKE 20% OFF LISTED PRICES IN THIS BOX! AFFORDABLE 'AR' FURNITURE FOR EVERY WALLET!

- A. Vertical Grip, Full Size - 4-3/4" long clamps to Picatinny rails. 3 colors; Tan, Black, Green. Tan.....\$9.00 AR464T Black.....\$9.00 AR464B Green.....\$9.00 AR464G B. Compact Vertical Foregrip - 3-1/8" long in 3 colors: Tan.....\$8.50 AR463T Green.....\$8.50 AR463G



AR15 AND M16

SARCO www.sarcoinc.com

AR15 LOWER RECEIVER PARTS SET

Super price! Includes all parts shown except for the receiver. Comes with late model pistol grip and our hammer & trigger pin diameter is the industry standard at .154. Some Colt made guns use a .170 diameter which is not compatible with our parts \$36.50 ea. 3 for \$99.00 AR001



SIGHT ADJUSTING TOOL BACK IN STOCK!!

AR15/M16A2 SIGHT ADJUSTING TOOL 4 PRONG \$4.90 AR158

See our website for M16 RETRO VIETNAM ERA TYPE PARTS

Super Sale on AR15 Rail Covers

4 pcs of rubberized 6-7/8" rail covers in Black for the best price of \$4.80 a set! (What a deal! Previous price was \$3.95 each!) 4 Black Rail Covers \$4.80 LA017

M16/AR15 COMBINATION TOOL

Save time with this wrench assy. that will speed up your maintenance of the M16 / AR15 and CAR15 platforms. Built with 4140 powder coated steel, this will outlast your Rifle! \$17.95 AR440



M16A2 STOCK SET W/ HANDGUARDS, PISTOL GRIP AND BUFFER & SPRING \$49.95 AR315

AR15 XM-177 STYLE TRIANGULAR HANDGUARD Black \$34.95 HG-BK-00

Just Bought 10,000 M16 GI MUZZLE COVERS! Buy 100 for \$24.95 AR192

AR15 COMPLETE BOLT ASSEMBLY - SUPER SALE!! Best deal around! Bolt with all associated parts. Reg. \$75.00 \$34.95 \$49.95 AR062

COLLAPSIBLE AR-15 CARBINE STOCK

Six Positions • Precision machined Parts for Maximum Strength • Super Quality Aluminum Buffer • Includes complete stock assembly w/ buffer & recoil spring. • Reinforced grids Black \$39.95 AR145



AR15/M16 SPRING KIT

A set of all of the coil & torsion springs in the AR15 or M16. Ideal item for your spare parts box. Price if bought separately \$18.30 Kit Price only. Includes recoil springs for Shortie M4 Kit \$12.95 AR134 3 for \$32.95 Standard Stock Kit \$12.95 AR397 3 for \$32.95

AR15/M16 RIFLE PARTS

- AM136 223 (.56) Dummy Rounds from Lake City - Original G.I. green tip..... 10 for \$8.95 AR098 AR Safety..... \$10.95 AR100 AR15 Disconnecter..... \$9.95 AR092 AR15 Hammer (Semi auto)..... \$15.00 AR001 AR15 Lower Receiver Parts Kit (Semi-Auto)..... \$36.50 ea., 3 for \$99.00 AR102 AR15 Trigger (Semi-Auto)..... \$17.95 AR082 AR15/M16 Action Spring..... \$4.00 AR032 AR15/M16 Barrel nut..... \$7.50 AR060 AR15/M16 Bolt Cam Pin..... \$6.00 AR071 AR15/M16 Bolt Carrier Key..... \$13.50 AR070 AR15/M16 Bolt Carrier Key Screw..... \$1.00 AR106 AR15/M16 Bolt Catch..... \$12.95 AR105 AR15/M16 Bolt Catch Pin..... \$1.00 AR107 AR15/M16 Bolt Catch Plunger..... \$7.50 AR108 AR15/M16 Bolt Catch Spring..... \$1.00 AR057 AR15/M16 Bolt gas rings, set of 3..... \$3.00 AR149 223 cal bore brushes, bronze 10 for..... \$8.95 AR080 AR15/M16 Buffer..... \$12.95 AR081 AR15/M16 Buffer Short..... \$12.95 AR088 AR15/M16 Buffer Retainer..... \$2.00 AR087 AR15/M16 Buffer Retainer Spring..... \$1.00 AR306 AR15/M16 Buttstock hinged trapdoor assy..... \$9.95 AR307 AR15/M16 Buttstock trapdoor hinge..... \$4.00 AR119 AR15/M16 Butt Swivel A1/A2..... \$4.00 AR056 AR15/M16 Butt Swivel Pin..... \$1.00 AR118 AR15/M16 Butt Swivel Screw M16A2..... \$2.85 AR002 AR15/M16 Changing Handle assy..... \$16.95 AR188 AR15/M16 Cleaning Toothbrush, G.I..... \$2.00, 3 for \$3.75 AR104 AR15/M16 Disconnecter Spring..... \$1.00 AR178 AR15/M16 Early prong flash hider..... \$12.50 AR036 AR15/M16 Ejection Port Cover..... \$7.95 AR034 AR15/M16 Ejection Port Cover Snap ring..... \$1.00 AR035 AR15/M16 Ejection Port Cover Spring..... \$1.50 AR172 AR15/M16 Ejection port cover pin..... \$2.75 AR067 AR15/M16 Ejector..... \$3.00 AR066 AR15/M16 Ejector Pin..... \$1.00 AR068 AR15/M16 Ejector Spring..... \$1.00 AR064 AR15/M16 Extractor..... \$10.95 AR063 AR15/M16 Extractor Pin..... \$2.00 AR065 AR15/M16 Extractor Spring..... \$1.00 AR059 AR15/M16 Firing Pin..... \$7.95 AR058 AR15/M16 Firing Pin Retaining..... \$2.00 AR011 AR15/M16 Flash Hider Washer..... \$1.00 AR047 AR15/M16 Forward Assist Pin..... \$1.00 AR048 AR15/M16 Forward Assist Spring..... \$1.00 AR077 AR15/M16 Front and Rear TakeDown Detent Spring..... \$1.00 AR078 AR15/M16 Front and Rear TakeDown Detent Spring..... \$1.00 AR079 AR15/M16 Front Pivot Pin..... \$1.00 AR020 AR15/M16 Front Sight Detent..... \$4.95 AR021 AR15/M16 Front Sight Detent Spring..... \$2.00 AR024 AR15/M16 Front Swivel Pin..... \$1.00 AR023 AR15/M16 Front Swivel Rivet..... \$1.00 AR029 AR15/M16 Gas Tube 16" (Shorty)..... \$11.95 AR028 AR15/M16 Gas Tube 20" (Standard)..... \$13.50 AR027 AR15/M16 Gas Tube Pin..... \$1.00 AR072 AR15/M16 Grip Screw & Washer..... \$1.00 AR089 AR15/M16 Hammer Pin..... \$1.50 AR093 AR15/M16 Hammer Spring..... \$2.00 M16/M16A1 Handguard, new Colt (Right)..... \$14.95 AR025 AR15/M16 Handguard Cap (Triangular)..... \$6.95 AR033 AR15/M16 Handguard Slip Ring (G.I)..... \$7.50 AR030 AR15/M16 Handguard Snap Ring..... \$2.50 AR031 AR15/M16 Handguard Spring..... \$6.00 AR083 AR15/M16 Lower Receiver Extension..... \$20.00 AR165 AR15/M16 Mag Carrier..... \$1.50 AR109 AR15/M16 Magazine Catch..... \$7.50 AR177 AR15/M16 Magazine Catch Button, metal..... \$2.50 AR111 AR15/M16 Magazine Catch Spring..... \$1.00 AR133 AR15/M16 Pin Kit..... \$14.95, \$39.95 3/ AR043 AR15/M16 Rear Sight Aperture, Standard..... \$5.00 AR040 AR15/M16 Rear Sight Detent Spring..... \$1.00 AR038 AR15/M16 Rear Sight Drum..... \$6.50 AR037 AR15/M16 Rear Sight Drum Pin..... \$1.00 AR046 AR15/M16 Rear Sight Spring..... \$1.00 AR041 AR15/M16 Rear Sight Windage Screw..... \$7.50 AR115 AR15/M16 Rear TakeDown Pin..... \$5.75 AR050 AR15/M16 Round Forward Assist..... \$14.95 AR130 AR15/M16 Rubberized Swivel front new..... \$5.00 AR076 AR15/M16 Safety Detent..... \$2.00 AR075 AR15/M16 Safety Detent Spring..... \$1.00 AR095 AR15/M16 Seal Assembly..... \$19.95 AR116 AR15/M16 Seal Spring..... \$3.00 AR145 AR15/M16 Shorty Buttstock Assembly, high strength fiberglass w/steel locking ring..... \$39.95 AR304 AR15/M16 Slp Ring A1 (early)..... \$20.00 AR132 AR15/M16 Spring Kit..... \$12.95 AR103 AR15/M16 Top sling adapter..... \$1.95 AR103 AR15/M16 Trigger Spring..... \$2.00 AR176 AR15/M16 Triggerguard, aluminum..... \$6.75 AR112 AR15/M16 Triggerguard Pin..... \$1.00 AR006 AR15/M16A1 Birdcage Flash hider..... \$6.95 AR085 AR15/M16A1 Buttcap Screw (Short)..... \$2.25 AR220 M16A1 Butt Swivel Screw..... \$3.00 AR073 AR15/M16A1 Pistol Grip (Used)..... \$9.95 AR124 AR15/M16A2 Burst Trigger..... \$15.00 AR143 AR15/M16A2 Trigger Control Crnt Prod. Comes with buffer, spring & all hrdw milspec..... \$54.95 AR007 AR15/M16A2 Flash hider..... \$8.95 AR144 AR15/M16A2 New Buttstock (Current production) stripped..... \$34.95 AR074 AR15/M16A2 Pistol Grip new..... \$8.95 AR158 AR15/M16A2 Sight Tool (4 Prong)..... \$4.90 AR229 M16 Bolt Carrier..... \$49.95 AR127 M16 Magazine 6 Orlets w/ Carriers..... \$59.95 SLNG099 M16 Single Point Sling, BLACK..... \$17.95 SLNG100 M16 Single Point Sling, GREEN..... \$17.95 SLNG101 M16 Single Point Sling, SCORCHED DARK EARTH..... \$17.95 AR358 M16A2... Peel off flash hider washers. Used take off. Work fine..... \$7.95 AR205 AR15/M16 chamber brush..... \$3.95 AR141 M16 Original G.I. Buttstock, plus lower receiver extension, buffer and spring..... \$59.95

AR15/M16 CLEANING KIT & ACCESSORY KIT

- Bore brush Chamber brush Cleaning rod Broken shell extractor Tooth brush Oiler Stripper clip guide Muzzle cap Grenade launcher tool Dual front sight Tension band \$17.50, 3 for \$49.95 AR240

M16 4 PIECE CLEANING ROD 29 1/2" long, Threaded \$6.95 CLN030

M16A2 HANDGUARD SET COMPLETE WITH METAL LINER CURRENT PRODUCTION \$16.10 AR184

NEW M16A2 ROUND HANDGUARD SETS MILITARY PRODUCTION Shortie length w/ liner \$14.95 AR185

AR SHORTY BUTTSTOCK INSTALLATION WRENCH Free Bonus - other end of wrench fits the 1911 barrel bushing \$2.95 TOOL031

M203 RUBBERIZED TUBE GRIP W/O CLIPS \$30.00 GRP139

AR15/M16 UPPER RECEIVER VICE BLOCKS To securely hold your upper firmly without damage to the upper or the barrel on barrel installation. Will work on any AR upper (receiver not included)..... \$29.95 AR467

AR15 LONG VENTILATED FLASH SUPPRESSOR Steel flash suppressor with standard threading for Govt./ Commercial 5.56/ .223 barrels. 5.5 inches long \$19.95 AR212

AR15 LONG SLOTTED FLASH HIDER Steel flash hider similar to the Vietnam CAR-15 with standard threading for Govt./Commercial 5.56/ .223 barrels 5.5 inches long \$19.95 AR213

SARCO'S M16 MULTIPLE MAGAZINE CARRIER

Secure metal clip holds two magazines for quick change firing and tactical applications. We've made thousands for the U.S. Govt.! See our web site for details \$14.95, 4 for \$45.80 AR203 (metal clip holder only)

AR-15 TAPCO INTRAFUSE HANDGUARD SET

New sporting design makes these 6.5" handguards with 3 accessory rail covers, a convenient change of variety for your M4 style rifle. Color: black \$29.95 AR420

CLOSE OUT! \$9.95 3 for \$27.00

AR 16" BARREL GAS TUBES Just got a shipment in, these have been tight \$11.95 AR029

AR15/M16 BIPOD, NEW ORIGINAL U.S.

G.I. METAL \$24.95 AR139 Above Bipod with Pouch \$29.95 AR297 Pouch only \$5.95 AR324

5.56MM/.223 BROKEN SHELL EXTRACTOR

Brand new tool: made for removing stuck headless cases from the chamber of any .223/5.56mm rifle. We've never seen these offered before now \$5.95 ea. BSE001 Our new BSE's work - others on the market don't fit. We learned the hard way!

AR/M16 ARMORER'S KIT

Be ready when the time comes! Quality tool set for removal & installation of parts. Easily worth the cost just for the quality vise block set! INCLUDES - VISE BLOCK, DELTA WRENCH, TOOL BRUSH, BROKEN SHELL EXTRACTOR, BORE & CHAMBER BRUSHES, 1 SIGHT TOOL, CLEANING ROD SET \$91.50 value for just..... \$49.95 \$59.95 AR373

AR-15 DUAL FRONT SIGHT TOOL

Two-in-One tool with dual functions to adjust both 4-prong and 5-prong front sights. Makes adjusting the front sight on your A1 and A2 a snap \$5.95, 3 for \$14.95 AR175

See our bayonet page 8 for M16 (M7) bayonets

M16 AUTO SEAR

Few only \$19.95 AR095 Buy a replacement(s) for your legal M16. All NFA rules apply. Note: These go out of time with use.

AR15/M16 CHAMBER BRUSH Original style \$3.95 AR205

EARLY VIETNAM OIL SPOON FOR M14/M16 RIFLES

Sometimes called 'Toots' Just in! for the whistling noise soldiers would make with it when air was blown across the cup, we have a very small number of these rare items in stock. Just over 4 inches long, this was used to pour oil into the weapon's tight spaces and the cup portion is angled at about a 30 degree's. Very limited \$5.00 OIL043

M16/AR15 EARLY 'DUCKBILL' FLASH HIDER

Early U.S. Advisors & Air Force 'Model 01' flash hiders originally issued with the guns starting in 1963. These were succeeded by the standard GI 'prong' flash hider & later in 1969 by the 'birdcage' model. New mfg..... \$9.95 AR423

FLASH HIDERS M16A2..... \$8.95 AR007

G.I. M16 RIFLE SLINGS

Late production \$5.95 SLNG001



www.sarcoinc.com

50 Hilton Street, Easton PA 18042
610.250.3960
Fax: 610.438.2548

M14 PARTS & ACCESSORIES

M14 7.62 NATO CHAMBER BRUSHES

G.I. ratchet chamber brush originally made for use with the M14 rifle, but will work just as well in most 7.62mm NATO rifles, new \$2.95 or 3 for \$6.95 M14016

M14 FLASH HIDER PLIERS

Available once again. New condition. A necessity for your M14 ensemble \$16.50 ea. TOOL039



See our website for ITALIAN GARAND BARRELS

NEW!!! M14 BARRELS IN STOCK

Brand new .308 cal M14 Barrels made by one of the best U.S. barrel manufacturers \$175.00 ea. M14124

AVAILABLE AGAIN M14 FULL AUTO PARTS KITS

M14 Selector, Pin & Spring \$75.00 M14014
M14 Selector Shaft
M14 Seal Release
M14 Connector Rod Full Auto
M14 Selector Lock

M14 WALNUT STOCK

Nice Military rework... \$45.00 M14363

M14/M1A SIGHT PROTECTORS

Military style plastic snap-on covers to protect the front and rear sights and the flash hider muzzle of the M14/M1A rifle. New \$6.50 3 for \$17.95 M14022

M14 RIFLE CLEANING KIT

Kit consists of following items: G.I. sectional cleaning rod, Rod handle/combination tool, Ratchet chamber brush, .30 cal. bore brush G.I. carrying pouch... \$12.50 CLN070

M14 STRIPPER CLIPS

12 original clips for \$9.95 STC016

M14 SPECIAL ITEMS

- 1. M14 Bolt stop G.I. \$22.95 M14091
2. M14 Buttplate assy hinged, G.I. \$29.95 M14047
3. M14 Connector rod G.I. \$19.95
4. M14 Firing Pin, original G.I. \$21.00 M14058
5. M14 Front stock swivel set, new G.I. \$7.45 M14117
6. M14 Handguard w/retaining clip, Fiberglass G.I. \$12.50 M14005
7. M14 Handguard w/o retaining clip, Fiberglass \$9.95 HNGD13
8. M14 Handguard, Walnut \$24.95 M14120
9. M14 Op rod spring guide \$19.95 M14051
10. M14 Recoil Spring, TRW Orig G.I. \$29.95
11. M14 Recoil Spring, TRW Orig G.I. \$49.95 M14052
11. M14 Rear Sight Aperture, .052 NM \$41.50 M14127
12. M14 Rear Sight Aperture, .059 NM \$41.50 M14364

We still have a few ORIGINAL WW2 ERA GARAND STOCKS W/ MARKINGS.

See our website!

M1 GARAND PART SETS

We can piece together a few M1 Garand parts sets - All but the receiver - The stock and handguard set will be our new stock set GRD278. Condition of all parts is from good to new. Most are G.I. Sorry, but these have to be \$730 as some Garand parts are getting tough to acquire and cost is high. .30-06 \$730.00 GRD380

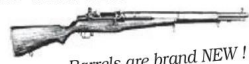

Barrels are brand NEW!

Just In !! NEW VARIATION OF THE .308 M1 GARAND KIT

Again, all parts but the receiver with an original Italian .308 barrel. This unit is 1/2 inch shorter than a standard Garand \$495.00 GRD387

FINALLY BACK IN STOCK!!

WWII PATTERN WEB GARAND SLING

Just reproduced for U.S. complete with markings. OD with all proper metal fittings Beautiful. Proper for Springfield and Garand..... \$9.95 SLING057



FOUND A FEW MORE M1C SHIPER RIFLE GRIFFIN & HOWE PATTERN MOUNT BASES

Parkerized - Complete with the 3 screws & 2 pins \$24.95 GRD285
We also have the pin & screw set for \$12.95 GRD327



M1 GARAND RIFLE (More on page 4!)

M1 GARAND CLEANING KIT SALE!!

Kit contains M10 cleaning rod, bore brush and a G.I. carrying pouch. CLN064 \$14.95 \$17.49
3 for \$39.95 \$49.50
Handle for M10 cleaning Rod for Garand Rifle - hard to find \$4.95 \$7.95
3 for \$14.00 \$22.50 CLN047
Orig G.I. M10 handles \$6.95 \$9.95 GRD281



M1 GARAND RIFLE 'LINED' JEEP SCABBARD

Marked improvement over the WW2 issue scabbard! Has the same outward appearance with brass guard for the charging handle and rich brown color with two leather straps and has been improved with a soft lining on the inside to protect your valuable investment from scratches and undue wear. Great for all sorts of similar sized rifles and works beautifully on horseback too! SALE! \$49.95 \$59.95 GRD382



M1 GARAND OP ROD

.308 length - 1/2 inch shorter than standard. \$125.00 GRD175
Finally Back In Stock! We dug out a pile of Garand standard GI Op Rods... \$175.00 GRD052

M1 GARAND ACCESSORY PACK

Terrific set of accessories for the Shooter or Reenactor! Made up of both original and reproduction items, the Pack includes the following items: GARAND GUN CASE, GARAND CARTRIDGE BELT, MILITARY MANUAL, M10 CLEANING SET w/brush, CHAMBER BRUSH, GI BORE CLEANER, CLEANING ROD STOP, 3 EN-BLOC STRIPPER CLIPS, M15 G.L. SGT.CASE, PULL THRU ROD & CORD
ALSO: Your choice of 1907 Leather Sling or Canvas WW2 style sling. Specify when ordering. A Retail Value of over \$145.00 For Just \$59.95 \$79.95 GRD329
A great gift for a Garand owner!

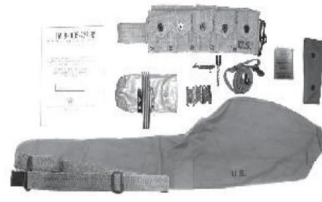

LATE T-37 M1 GARAND SNIPER FLASH HIDER

\$34.50 GRD111

OUR LATEST FABULOUS BUY ON BARREL BLANKS!

All previous buys have been a sellout - most of these have been profiled so they are ready for your project.

NOTE: These are all first class production. LIMITED SUPPLY
NOTE: We even have .20cal blanks
NOTE: We are told that these blanks sell for up to \$200. These are ALL 1st class blanks. NO rejects, blms or GD2.

Table with columns: Part #, Caliber, Length, Diameter, Profile, Twist, Material, Description, Price. Lists various barrel blank options.

NEW ADDITIONS!!!

- BB095 Barrel Blank 24.5" .17 Cal 1-9, 4140 1.032 dia \$49.95
BB096 Barrel Blank 26.75" .17 cal, 1-9, 4140 1.250 dia \$49.95
BB097 Barrel Blank 26.75" .17 cal, 1-9, SS 1.250 dia \$49.95
BB098 10/22 Barrel Blank 18" 17 1-9 SS .920 dia needs finishing \$49.95
BB099 Barrel Blank 25.5" .22 RF 1-16 4140, 1 dia \$49.95
BB100 Barrel Blank 24.5" .243, 1-10, 4140, 1.20 dia \$49.95
BB101 Barrel Blank 24.5" .25 cal 1-10 4140, 1.20 dia \$49.95
BB102 Barrel Blank 21.5" .25 Cal 1-10, SS 1.312 dia \$49.95
BB103 Barrel Blank 16.5" .264 cal 1-8 4140, 1.032 dia \$49.95
BB104 Barrel Blank 18.5" .264, 1-8 SS 1.032 dia \$49.95
BB105 Barrel Blank 26.75" .264, 4140, 1.250 dia \$49.95
BB106 Barrel Blank 26.5" .264, 4140, 1-8, 1 dia \$49.95
BB107 Barrel Blank 21.75" .270, 1-10, 4140 1.2 dia \$49.95
BB108 Barrel Blank 26.75" .270, 1-10, 4140, 1.312 dia \$49.95
BB109 Barrel Blank 11" .30 cal 1-7 SS 1.032 \$49.95
BB110 Barrel Blank 9.5" .30 Cal 1-7, 4140 1.2 dia \$49.95
BB111 Barrel Blank 11" .30 cal 1-8 SS 1.032 \$49.95
BB112 Barrel Blank 26.5" .30 Cal 4140 1.0 1.250 dia \$49.95
BB113 Barrel Blank 22.5" .303 SS 1-10 1.312 dia \$49.95
BB114 10/22 Barrel 18" 22Mag 1-16, SS .920 dia \$49.95
BB115 10/22 Barrel 16.5" 22RF 1-16 Threaded Muzzle 1/2-28, SS .920 dia \$49.95
BB116 10/22 Barrel 22RF 1-16 18" 4140 .920 dia \$49.95
BB118 Barrel Blank 9" 12 GA, Smooth bore, SS, 1.312 dia \$49.95
BB120 Barrel Blank 26.5" 22 Cal 1-14, 4140 #3 contoured blank \$49.95
BB121 Barrel Blank 24.5" 22 RF 1-16 4140, 1 dia \$49.95

- BB122 Barrel Blank 16.625" 22LR, 4140, 1-16, 1 dia \$49.95
BB123 Barrel Blank 19" 45-70, 1-22 SS 1.312 dia \$49.95
BB124 Barrel Blank 20.5" 5.56, 4140, 1-7, .815 dia \$49.95
BB125 Barrel Blank 13" 5.56, 4140, 1-7, .98 dia \$49.95
BB126 AR10 Barrel 18" 6.5 Creedmoor 1-8 SS, 1.190 dia hub, thread, chamber \$49.95
BB127 77/22 Barrel 24" 22 RF 1-16 Bentz chamber, SS .920 dia \$49.95
BB128 77/22 Barrel 24" 22 RF 1-16 Match chamber, SS .920 dia \$49.95
BB129 Barrel Blank 17" 9mm 1-10 SS 1.032 dia \$49.95
BB130 Barrel Blank 11" 9mm 1-10 SS 1.312 dia \$49.95
BB131 Barrel Blank 12" 9mm, 4140, 1-10 - 1.20 dia \$49.95
BB132 AR10 Barrel Blank 20.5 .243, 1-10 SS, 1.190 dia hub, thread, chamber \$49.95
BB133 AR10 Barrel Blank 13.5" 308, SS 1-10 1.190 dia hub, thread, chamber \$49.95
BB134 AR10 Barrel Blank 24" 6.5 Creedmoor 1-8 SS, 1.190 dia hub, thread, chamber \$49.95
BB135 AR10 Barrel Blank 22" 6.5 Creedmoor 1-8, contoured, TM, SS, Hub, thread, chamber \$49.95
BB136 AR15 Barre Blank 22" .224 Valkyrie 1-7 4140 TM, Contoured hub, thread, chamber \$49.95
BB137 AR15 Barrel Blank 20" 450 Bushmaster 1-24, 4140 hub, thread, chamber \$49.95
BB138 AR10 Barrel Blank 24" 5.56 1-7 SS, Bull, hub, thread, chamber, crowned \$49.95
BB139 AR15 Barrel Blank 8.5" 5.7x28 1-7 SS \$49.95
BB140 AR15 Barrel Blank 12" OTD, SS, Legend 1-12 \$49.95

NEW GI GARAND BUTTPLATES

We bought 'em 30-40 years ago. Found another small batch in the warehouse sort. Believe this is the end. \$40.00 \$44.95 GRD326
Conetta Mfr. While they last!



BRAND NEW M1 GARAND BARRELS

Currently produced in USA by a 30 Year Top Line Barrel MFG .30-06 barrels in stock!

Newly manufactured barrels ready to install on your M1 Garand Receiver. Made by one of the premier barrel manufacturers in the USA, these .30-06 caliber barrels are manufactured from 4140 steel with 4 groove rifling and a 1 in 10 twist. Beautiful high quality parkerized replacement barrels. Because they are made here in the US, they do not have the ungainly import barrel markings. A great chance to get rid of that 'Blue Sky' or other import marked barrel and also restore accuracy! Barrels should always be installed by a qualified gunsmith.

.30-06 \$149.95 GRD157



US Made by old school barrel maker

M1D SCOPE MOUNT

Scope mounts for the M1D Garand Sniper rifle. These are for the 7/8" diameter M81 - M82 - M84 Scope. New condition \$74.00 GRD112



BACK IN STOCK!!

M1D GARAND BARREL BLOCK \$59.95 GRD113

GARAND BROKEN SHELL EXTRACTORS

.30-06 \$7.95 BSE006



Just In !! .30 CALIBER BRAND NEW RIFLE BARREL BLANKS

These are U.S. GI 1903A3 Springfield barrels that have had the front & backend cutoff. Perfect for your special project! \$19.95 3 for \$49.95 BB141

Overall length: approximately 18.3 inches, Breech O.D: 1.04 inches, Muzzle O.D: 0.67 inches

.30 CAL BARREL BLANKS

Cutoff front ends with @9 +/- 1". Bore is rifled. Nice hands and grooves. Perfect for firearm projects. \$9.95 3 for \$23.95 CRB204

New 'Barrel Blanks'

3 new 'Barrel Blanks' ready for your next project. Steel barrels, unfinished, with an O.D. of 1 inch, in the white and in 3 different calibers: Barrel Blank, 17 Cal., 23" long \$39.95 BB076
Barrel Blank, 30 Cal., 18" long \$35.95 BB078

CHECK OUR WEBSITE FOR A FULL LISTING OF M14 & M1 GARAND PARTS & ACCESSORIES!

SARCO

50 Hilton Street, Easton PA 18042
610.250.3960 Fax: 610.438.2548

www.sarcoinc.com

We have 30 Different
Variations of Handguards -
See our website!

ORIGINAL G.I. M1 GARAND

BOLTS USGI Original Stripped Bolts
- VG cond \$69.95 GRD070
Complete
\$89.95
GRD071



Go to our website for a complete
selection of Garand bolts by maker
and dash variation. We have sorted
out 13 variations - we even offer
heat treat lots for serious collectors.

M1 GARAND FRONT & REAR
SIGHT COVERS

Perfect for protect-
ing your prized
Match Sights in-
stalled on the rifle. Plastic covers slip on
& off easily. Set of Front & Back covers
..... \$6.00 GRD114



A perfect reproduction of
the GRENADE LAUNCHING
RUBBER BOOT (slip on) for the
Springfield and M1 Garand.
Absolutely meticulously
beautiful!! \$34.50 MISC088



M1 STAINLESS STEEL GARAND
OP ROD SPRINGS

The Best On The Market!
Just got a new fresh shipment made
from G.I. blueprints. Replace your tired
spring or put away a spare now! Stainless Steel
17-7 \$7.95
3 for \$22.95 GRD171
Standard op rod Spring..... \$5.95
3 for \$13.95 GRD059



M1 GARAND OPERATING ROD TIPS

(pistons) Brand new, made to
Government specs. Replace your
worn piston - diameter .5265"
(high end + .0005") Made of
the proper 174PH steel. SALE \$7.95
\$9.95, 3 for \$21.95 \$22.95 GRD211



WW2 ORIGINAL M1 GARAND BARRELS

These are decorator condition w/ poor
bores. Few only..... \$49.95 GRD330

SPECIAL M1D SNIPER COMBO SET

T-37 Flash hider, New G.I. Handguard
Barrel Block, Scope Mount. Value \$200.00.
GRD145 SPECIAL \$149.50

BRAND NEW GARAND STOCK & HANDGUARD SETS IN WALNUT

The stocks are new walnut G.I. stocks that
were .308 cal & we retrofitted them to .30-
06. Fit is perfect for .30-06. There is a tiny
hairline from the conversion that is visible. Handguards are new production walnut.
Complete stock set (wood only) \$79.95
3 for \$219.95 GRD278



We can also offer the stock alone which makes a great replacement for your CMP
worn out drill rifle or regular Garand stock \$59.95
3 for \$169.95
20 for \$995.00 GRD279

Quantity purchases, please call Cholly. Will trade on quantities

GARAND PARTS

- GRD330 Barrel G.I. Orig WWII Dated, poor bore & some
rust \$49.95
GRD002 Barrel "Clunker Grade" \$20.00
GRD071 Bolt (Complete) \$89.95
GRD070 Bolt (Stripped Used) \$69.95
See our website for a complete
offering of Collector Garand bolts
CIN172 Bronze bore brush 30 cal
10/ \$9.95
100/ \$69.95
GRD198 Bullet Guide, milled, New \$15.00
GRD065 Bullet Guide, stamped, New \$12.00
GRD046 Butt Swivel \$8.00
GRD220 Buttplate Assy, brand new \$24.95
GRD043 Buttplate Screw Bottom (Long) \$2.95
GRD044 Buttplate Screw Upper (Small) \$2.00
GRD115 Carrying Case \$14.95
GRD021 Clip Ejector \$4.95
GRD081 Clip Latch \$24.50

- GRD082 Clip Latch Pin \$3.35
GRD083 Clip Latch Spring \$1.35
MISC630 Conversion op rod tip (modifies .308 to .30-06) \$8.25
GRD214 Danish contract Garand oiler \$3.70,
3 for \$8.95
GRD076 Ejector \$3.25
GRD077 Ejector Spring \$1.50
GRD078 Ejector w/ Spring \$4.95
GRD086 Elevating Pinion (Late Style) \$29.95
GRD363 Elevating Pinion Assy, Meter graduations \$29.95
GRD075 Extractor current production \$15.95
GRD310 Extractor G.I. \$24.95
GRD079 Extractor Spring w/ Plunger \$3.45
GRD074 Firing Pin orig G.I. \$19.95
GRD186 Flash hider lock bracket G.I. M2 \$25.00
GRD111 Flashhider T-37 (Fronged) \$34.50
GRD042 Follower Arm \$24.95
GRD064 Follower Arm Pin \$2.45
GRD068 Follower Assy \$24.95
GRD061 Follower Rod \$2.00
GRD066 Follower Slide \$12.00
GRD109 Front Sight \$12.00
GRD110 Front Sight Screw \$1.25
GRD101 Gas Cylinder Lock w/Hump \$26.00

- GRD100 Gas Cylinder Lock (Used) \$20.00
GRD286 Gage G.I barrel diameter-gas cylinder .5991,
..... \$75.00
GRD016 Hammer \$24.95
GRD015 Hammer Pin \$2.00
GRD013 Hammer Spring \$2.00
GRD014 Hammer Spring Plunger \$4.00
GRD041 Handguard Band Rear \$5.00
GRD039 Handguard Ferrule Front \$6.00
GRD032 Handguard, Rear walnut w/o metal, good
..... \$20.00
GRD033 Handguard, Front walnut w/ metal, good
..... \$25.00
GRD040 Handguard Spacer Front \$5.00
GRD039 Hooded Rear Sight Aperture National Match
..... \$39.95
GRD037 Lower Band \$15.00
GRD038 Lower Band Pin \$1.00
CIN116 M10 cleaning rod handle \$7.45,
3 for \$22.00
M84017 M84 Sniper Scope Cover, Orig. \$59.95
OIL035 Oiler, late plastic WWII, new \$13.95
OIL015 Oiler, brass & throng set, exc
..... \$35.00

WW2 M1C GARAND RIFLE FLASH HIDER

M1C Garand Sniper Rifle flash hider as used in WW2. simply
and quickly, attaches on the muzzle end & bayonet lug
of the rifle. Hard to find item is finally available after more
than a decade! Get one before they disappear again! Late
mfr. \$125.00 GRD388



.30 CAL ONE PIECE USGI CLEANING ROD \$99.95, 3 for \$27.50 CLN113

M84 repro scope buyers from other sources-
have original G.I. unnumbered M84 SCOPE
DATA PLATES from Libbey Owen Ford (the
manufacturer) NOS. You can number your
scope to your gun on an original data plate.
M84 repro scope buyers from other sources-
have unnumbered M84 scope data plates.
You can number your scope to your gun on
this data plate \$29.95 M84014

ITALIAN WW2 CARCANO RIFLE SLING
BACK IN STOCK!
New made, Italian WW2
brown leather sling is
@54.5 inches long
and comes complete with Italian Ordnance
stamp and date. One end has adjusting
buckle and the other end has two holes
with stud \$17.95 SING125



WINCHESTER 97 TRENCH GUN BAYONET LUG & HEAT SHIELD W/ SCREWS

PLEASE NOTE: These will only fit original Win-
chester 97s with the correct grooves cut - If your
barrel does not have the grooves cut for the screws,
they will have to be machined. These will not fit
reproduction Winchester 97s currently on the market. Will ONLY fit P14 & P17 bayonets
..... \$129.00 W97058



M1 GARAND M82 SNIPER SCOPE

New precision 2.5x scope marked with
Govt. part numbers, complete with sun
shade and rubber eye cup. Perfect quality
scope for making an MID, M1C or 03A4
sniper rifle. Beautifully constructed and clinically accurate!
..... \$260.00 SCP040



M1 GARAND REAR SIGHT PARTS -
STANDARD & MATCH

- GRD094 Complete Rear Sight Assy, late model
..... \$64.95
GRD084 Rear Sight Base \$27.00
GRD088 Rear Sight Aperture \$10.00
GRD348 Rear Sight Aperture, Match peep hole
.059 \$13.50
GRD093 Rear Sight Aperture Cover \$5.95
GRD090 Windage Knob Assy \$14.00
GRD086 Elevating Pinion Assy, Yard
graduations \$24.95
GRD363 Elevating Pinion Assy, Meter
graduations \$29.95
NATIONAL MATCH REAR SIGHT ITEMS
GRD095 Complete National
Match Rear Sight w/Hooded
Cover, (Elevation pinion Assy not
included as it is the same as a
standard Garand elevation pinion)
..... \$90.00

FRONT HALF G.I. M1 GARAND
RECEIVER

\$99.95, 3 for
\$24.95 GRD143
Neat paper weight!



COMBO. New Style M3A1
TOOLS WITH CHAMBER BRUSH

The Latest and best.
A. Used G.I. \$25.00
GRD134
B. Like new tool w/new
brush \$30.00 GRD138

GRAND SNIPER LEATHER CHEEKPAD

Special new low price. GRD124
Exact repro with proper mark-
ings \$18.95 3 for \$49.95

M1 GARAND BLANK ADAPTER

GRD126 U.S. G.I. pattern, new
..... \$7.95 3 for \$21.95
For bulk pricing on Garand BFA's
call Mark, Dave or Cholly

M1C/M1D SNIPER PARTS

- 1. MID rear handguard New G.I. original
HNGD031 \$24.95
2. T37 flash hider GRD111 \$34.50
3. MID barrel block GRD113 \$59.95
4. MID scope mount GRD112 \$47.50

M1 GARAND STYLE REAR SIGHT BASE...

For Your Next Project!
Originally designed for the M1
Garand rifle, this great little
sight base is perfect for your
next project. It allows you to
actually add the superb and
precise M1 Garand Rear Sight Assy, components
onto the weapon of your choice. Imagine having
the ability to dial elevation and traverse measure-
ments on a commercial or project rifle the same
way you can on the Garand! With the same ease
and precision that you don't find on most rifles.
The base has a concave bottom with 2 mounting
holes. Accepts the superior M1 Garand windage
pinion & elevation aperture sold separately. Fits
well on the Ruger 10-22 as well, but can be used on
almost any project you come up with! \$19.95 ea.,
3 for \$17.50 ea., 10 for \$15.00 MISC727

Once again available!

M1 GARAND OPERATING ROD
CATCH ASSEMBLIES
at a reasonable price!
\$30.00 GRD063

WORLD WAR II PATTERN
M1 GARAND CARRYING CASE

WWII military style canvas carrying case
for the M1 rifle. These "U.S." marked cases
are made of heavy, olive drab canvas and
equipped with a zipper, leather tabs and a
shoulder carrying strap. GRD115 \$14.95 ea.,
3 for \$42.95
Also available USMC marked case GRD347
..... \$14.95

M1 GARAND LINED GUN COVERS

Olive drab & U.S. marked... \$22.95 GRD345

M1 GARAND SET OF FRONT/REAR
HANDGUARDS W/METAL, BIRCH

Select US GI,
Used, Select
Condition
\$39.95
GRD355

M1 GARAND CLIPS

New current production by G.I. contractor
GRD275
5 for \$9.95
10 for \$14.95
20 for \$24.95
40 for \$45.00
Nice fresh spring tension in your clip
SPECIAL GARAND CLIPS
1.2 round clip for match shooters \$8.00 ea,
5 for \$24.95 GRD131
2.5 round hunting clips
..... \$8.00 ea, 5 for \$24.95 GRD130

M1 GARAND STOCK HARDWARE SET

Complete set of M1 Garand Stock
Hardware. Either new or excellent
parts..... \$39.95 GRD136

FRENCH FOREIGN LEGION
BERET OF THE FAMED 2E
REP PARATROOPER

Sarco has a very limited 'run' of wool
Green Berets with the famed French
Foreign Legion 2e REP badge.



A unit famed
for fierce fight-
ing, especially
in Indochina
and Algeria,
but also a
familiar sight
on the frontiers
where Mercenaries are operating. Three
sizes available. Beret with Badge
..... \$29.95 HAT10
(U.S. sizes 7-1/4, 7-1/2, 7-3/4)

Victorian handcuffs with key... \$19.95 MISC719
Victorian leg irons with key... \$24.95 MISC824
Set of handcuffs with leg irons \$35.00 MISC849
See Our Website For Pictures & Details!



- GRD025 Stock Ferrule Assembly, New \$20.00
GRD047 Stock Ferrule Stripped \$10.00
GRD049 Stock Ferrule Swivel Screw \$6.00
GRD050 Stock Ferrule Swivel Screw \$2.95
GRD027 Stock U.S. / G.I. Average, Used Condition, No
Cracks \$49.95
GRD024 Stock U.S. / G.I. Select, Used Cond
..... \$75.00
GRD323 Trigger forging, orig G.I. new \$4.95
GRD009 Trigger & Sear Assembly \$12.00
GRD019 Trigger Guard Milled \$25.00
GRD020 Trigger Guard Stamped \$16.50
GRD023 Trigger Housing Assembly \$99.00
GRD022 Trigger Housing Stripped \$32.95
GRD152 Trigger Housing, Win. Repaired Stripped
..... \$79.95
GRD008 Trigger Pin \$2.00
GRD092 Windage Knob early original
..... \$55.00
GRD090 Windage Knob (Late Style) \$12.00
GRD212 G.I. winter trigger in orig. pkg
..... \$19.95

WE ARE SORRY, but we are sold out of the Standard .45 AUTO "BUILDERS KITS" - We are supposed to be getting a delivery around the time this ad comes out. Please check our website regularly for availability !

Check sarcoinc.com for parts list for the Mitchell AR, AK & Galil .22!



GERMAN PANZERFAUST 60M LAUNCHER & ROCKET (INERT)

All steel construction, this full size WWII German Panzerfaust Rocket Launcher was the precursor for the RPG series. It packed a terrible punch and gained respect by Allied tank crews who faced this on many campaigns, especially when driving through small German towns where it was the easiest way to close down a road. Our Panzerfaust comes complete with a reprint of the original WWII operator instructions, flip up sight/trigger unit, and rocket with flexible fins. A terrific display piece for museums, static displays or reenacting.. \$180.00 RL002 PLEASE NOTE: There is a \$10 handling fee on this item



PANZERFAUST KLEIN WW2 ROCKET LAUNCHER (INERT)

The first model German WW2 Rocket Launcher! Our steel Panzerfaust has a full size inert rocket with fins that can be removed from the tube. Also a sight / trigger assy., with movable cocking piece and trigger button that works. This is the correct style launcher - not the 'cobbled-together' reproduction found elsewhere and sold as 'original style'. Full size and totally inert. New \$145.00 MISC684



5 INCH .45 ACP, NO RAMP, STAINLESS STEEL PARA ORDNANCE BARREL \$145.00 PAR1B (F500173) P-14



CHECK OUR WEBSITE FOR: PARA LDA Spring Kits #PARA312 PARA Put Away Kits #PARA311

Have 50 to 100 Special 1911 Slides on our website. Just came in! Have specially marked Para slides and also unmarked special and hard to get standard 1911 slides.

ROCK ISLAND ARMORY 5" THREADED RAMPED BARREL W/THREAD CAP

1911 threaded barrel with thread cap included. Full size Government model 5" 45acp ,ramped (clark /Para) with link and pin, diameter & thread pattern .578x28tpi..... \$89.95 AC26



ROTO HAMMER FORGED 1911, 5" BARREL

Precise and consistent specs make these the barrel of choice for the 1911 pistol. These .45 cal. barrels are made in the USA and available at a Super price!..... \$54.70 C45011



ROCK ISLAND SLIDE & BARREL SETS

Rock Island 1911 38 Super Slide & Bull Barrel Combo, .38cal, 5" Barrel Type: Ramped BULL with link & pin and Bushing / Front Sight: GI / Front Sight Cut: STAKE / Rear Sight: GI / Rear Sight Cut: DOVETAIL / Finish: BLACK / Serration: GI REAR / Action Type: SINGLE / Front End: SCALLOP CUT FRONT \$304.95 AC23



MILITARY RIFLE SLINGS ORIGINAL & REPRO

- SING024 1907 WW I Sling (Brass Hardware) Repr..... \$16.95
SING025 1907 WW II Sling (Steel Hardware) Repr..... \$16.95
SING001 AR15/M16 Black Silent Sling... \$5.95
SING002 AR15/M16 Padded Assault Sling..... \$19.95
SING075 Chilean Mauser M1895 Carbine, fair, few only..... \$14.95
BAR008 BAR Sling Repr..... \$25.00
SING023 Egyptian Maadi AK sling..... \$9.95
SING023 Egyptian Rashid Sling, Carbine..... \$9.95
SING096 Enfield canvas, Black canvas... \$6.95
SING094 Enfield canvas, Olive Drab canvas..... \$6.95
SING095 Enfield canvas, RAF Blue canvas..... \$6.95
SING027 Japanese Arisaka Sling Type 38 Repr..... \$17.50
SING008 Japanese Arisaka Sling Type 99, Leather w/steel hardware, brown, 1.5" wide..... \$14.50
SING098 Japanese Naval, leather..... \$13.00
SING093 Japanese Pacific WW2 Rubberized Canvas..... \$19.00
SING012 La Corona 98/43 Sling (Spanish style) La Corona (Fair-Good)... \$14.95
SING042 Lee Enfield #3 or #4 Sling WWI w/ Brass Stamp late production.... \$7.95
SING079 Lee Enfield Pattern 14 leather sling..... \$12.95
SING006 M1/M2 Carbine Sling Khaki (Repr)..... \$9.95
SING005 M1/M2 Carbine Sling O.D. (Repr)..... \$7.95
M36032 Mas 36 & 36/51 Original, VG Cond. Rifle Sling..... \$15.95
SING011 Mauser 98K Sling (WW II style) Repr..... \$12.50
SING018 Mosin Dog Collar 91/30 Sling, New Mfr..... \$12.95
SING103 Mosin Dog Collar 91/30 Sling, Original Russian..... \$19.95
SING119 Mosin Nagant Leather Sling, new w/ brass buckle & loop..... \$19.95
SING007 Russian SMG Sling PPSH41..... \$9.95
SING017 SKS Sling Tab, new leather..... \$2.00
SING041 SKS Sling w/Leather Tabs New..... \$6.95
STN021 Sten Web Sling, Good cond. Needs cleaning, Few Only..... \$9.95
SING038 Thompson WWII Khaki Sling..... \$18.95
SING061 Tokarev rifle, Original - Super Rare..... \$14.95
SING020 UZI Original Sling w/leather loops..... \$9.95
SING126 Yugoslavian K98, M48, M24 Rifle Sling..... \$12.95

JUST IN! 1911 DOUBLE LEATHER MAGAZINE POUCH Slips Onto Your Belt Traditional double leather magazine pouch as issued for WW2 Field Grade Officers not using a standard grommet style pistol belt. Holds 2 single stack standard 1911 magazines. Will last a lifetime! Fits belts up to 2.5 inches wide..... \$7.50 C45431



See our website for a big sale on our nice assortment of factory frame castings, others call 80% receivers!

.45 SLIDE CASTINGS Sizes 3" to 5" Colt 1911/1911A1 .45 ACP. See Our Website!!

SERIOUS ABOUT COMBAT SHOOTING? ROTO 4M COMPENSATED BARREL

DOD contractors have been buying up our Roto 4M barrels because they work! MODEL 1911 COMPENSATED BARRELS in 3 calibers will reduce recoil and speed your target acquisition especially during multiple shots. Takes a minute to install our barrel that comes with Barrel Bushing and permanently attached and ported Compensator. Also there is less weight on the muzzle end than with conventional screw on muzzle compensators. Most people comment on the change of performance, but also that it looks great too! Sold elsewhere for \$175-\$200, Sarco's price is..... \$89.95 \$99.95 Specify caliber when ordering: New, made in USA. .38 cal C45024, .45 cal C45015, .400 corbon C45194

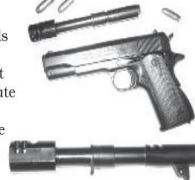

'Cause we're such nice guys, take 35% off the listed price on these 80% frames... 80% LOWER FRAMES STEEL & ALUMINUM

1911 Series 80 single stack, single action, full size pistol frames available in either ordnance grade steel or lightweight aluminum! These are finished frames except for several features that are unfinished to comply with BATF directives classifying these as Non-Firearms in their present condition. Slide rails, hammer & sear pin holes, mainspring housing retaining pin, and ejector leg holes remain to be applied. Grip screw holes are drilled and tapped. #500649 Extra Small Para Frame for .32" slide. Series 80, aluminum, Double stack, Single action..... \$125.00 C45331
#500675 Para LDA Officers length grip frame in steel with checkered front grip strap. Accepts 4.25" or smaller slide. Single stack and Double action..... \$99.95 \$125.00 3 for..... \$249.95 C45332
#500678 'Agent' extra small steel frame with checkered front strap. Single stack, Double action, and fits 3" slide..... \$99.95 \$125.00 3 for..... \$249.95 C45333
NOT FOR SALE IN NJ - See new change in law. Not for sale in PA until further notice.



www.sarcoinc.com

G-3 ZF SCOPES & MOUNTS

Save about \$200! Haven't had these in years! Original German military service ZF-1 Sniper Scopes with original claw mounts for the G-3 Rifle. Manufactured by Hensoldt/Wetzlar, these scopes are premium quality and although used, are in excellent condition and come complete with green case, rubber eye pc. protectors, claw mount, filter eyepiece, accessory case NOTE: We can now offer a SECOND Version of the ZF-1 that has a see-through reticle that can be illuminated. You can check our website for more info. & pictures. ZF-1 Hensoldt/Wetzlar Sniper Scope package - Please specify if you prefer version 1 (w/o reticle) or version 2 (w/reticle) when ordering..... \$495.00 \$695.00 SCP058



These will also fit the PTR91

RAMPED 5" STANDARD BUSHING 1911 9MM BARRELS

Found a few in the back from our parts paradise! These are the Clark / Para Ord pattern. Each barrel comes with a free link & pin. Sold elsewhere from \$80-\$200, Our Special Price \$69.95 3 for..... \$199.95 C45429



THREADED 1911 BARRELS

5-1/2 Inch. Brand new black oxide finished barrels in 3 calibers. Thread is standard .578x28 TPI. 9mm Model 1911 5-1/2" barrel..... \$60.00 C45360 .38 Super Model 1911 5-1/2" barrel..... \$60.00 C45361 .400 Corbon Model 1911 5-1/2" barrel..... \$60.00 C45362 .45 ACP model 1911, 5.5" barrel..... \$65.00 C45321



THREADED PROTECTION CAP FOR THREADED BARRELS

Barrels with .578x28 threads per inch..... \$13.00 C45363

OUTSTANDING ASSORTMENT OF QUALITY 1911 BARRELS

ROTO 4M HAMMER FORGED .45 ACP, 9MM & .38 SUPER

Built to precise tolerance by a special hammer forging process, these barrels are the best you can buy! The hammer forging forms the barrel around a precision mandrel and holds the tolerance to .0001". This is much better than the typical broached barrels found elsewhere Note: 5" & 6" .45 barrels are L.H. twist - all others are R.H. twisted

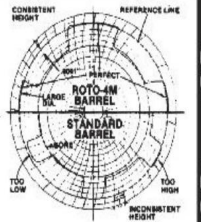

COMPARE THE ROTO-4M BARREL FOR ROUNDNESS AGAINST A STANDARD BROACHED BARREL FROM A WELL KNOWN MANUFACTURER. ALL ROTO-4M BARRELS ARE MADE IN THE USA. Brand new extra length barrels for all Colt/1911/Government Model type automatic pistols. These barrels are made by the Special Roto-4M Hammer forge process which produces the most precise and consistent barrels for the best accuracy. Minor hand fitting may be necessary for some guns.

- Barrels do not include link & pin. Link & pin available w/barrel purchase for additional \$5.00 C45281 Available in:
.400 Corbon Barrels..... \$54.70 C45107
4 1/4" Comm..... \$61.70 C45109
6"..... \$61.70 C45104
7"..... \$65.70 C45018
STD 5"..... \$56.70 C45025
.45 ACP
4 1/4" Comm..... \$54.70 C45010
5"..... \$54.70 C45011
6"..... \$62.70 C45013
7"..... \$63.70 C45014
16"..... \$82.50 C45016
.40 S&W 1911 5" BARREL..... \$56.70 C45277
.38 SUPER
4 1/4" Comm..... \$54.70 C45164
Note: 9mm & .38's will not fit the .45 slide

RPG-6 CARRY BAG

Looking for a great carry bag capable of roughing it and keeping your goods dry in wet weather? We love this one because it is capacious enough for carrying hundreds of rounds of belted machine gun ammo, brews packed in ice or personal goods for a day trip. Heavy duty rubberized and laminated fabric with heavy duty shoulder strap make this ideal for canoe trips, hunting, or a day at the range. Main compartment is roughly 16" x 9". 2 other pouches provide plenty of extra room. Originally used for RPG6 rocket launchers. Also great for carrying your spotting scope. Like new. Bargain Price! \$15.00 MMP003 - Carry Bag Only - Rockets and belts not included!



USGI COMBAT BELT FOR INDIVIDUAL EQUIPMENT

Recently released from U.S. Govt. service, these military combat belts are built to last under extreme conditions. 2-1/4" wide, this belt is size 'Large' for waists over 30 inches. Grommets allow for attachment of load bearing equipment/suspenders. Excellent condition \$12.95 MISC917





www.sarcoinc.com

JUST FOUND FROM 45 YEARS AGO!!!

BRAND NEW ORIGINAL COLT 1911 NICKEL PLATED 1911 THUMB SAFETY



CAMOUFLAGE GREEN BURLAP ROLLS U.S. G.I.

Roll size: 300 feet, 2 inches wide \$9.95 MISC306

BRONZE .45 CAL. CLEANING BRUSHES

SPECIAL .45 COLT AUTO REPAIR PARTS KIT

Containing the following parts: 4 grip screws, 2 grip screw escutcheons, 2 mainsprings, plunger tube spring, seat spring, 2 ejector pins, 2 mag catch springs, 1 firing pin stop, 2 firing pin springs, 4 hammer strut pins, 2 firing pins, 2 mainspring housing pins, 1 recoil spring.

Sarco has the goods to 'trick out' your 1911 pistol with a wood stock and accessories! Buy a complete set of parts to create a pistol with 16" .45 barrel, stock, holster and connecting parts or buy individual parts to help you create your own custom stock.

- A. Lightweight 1911 Stock \$49.95 C45402
B. Standard 1911 Stock Assy \$35.00 C45390
C. 16 inch .45 ACP Barrel \$82.50 C45016
D. Mainspring for Wood Stock Connection \$18.95 C45391
E. 1911 Stock Building Hardware Kit \$34.95 C45394
F. Complete Lightweight 1911 Stock Rig \$164.95 C45428
G. Complete Standard 1911 Stock Rig \$149.95 C45392
H. Holster for Stock Rig \$45.00 C45393

M1911 "DIAMOND" GRIPS

These brand new walnut grips are made in the original World War I style with the "Diamond" pattern checkering.



FULL PIN SET for Colt .45 Auto.

All seven pins for the M1911. New \$4.85/ set, 10 sets for \$38.50 100 sets for \$285.00 C45195



1911 Stock Rig Conversions

Funnest Way to Extend your 1911 Shooting to the Limit!

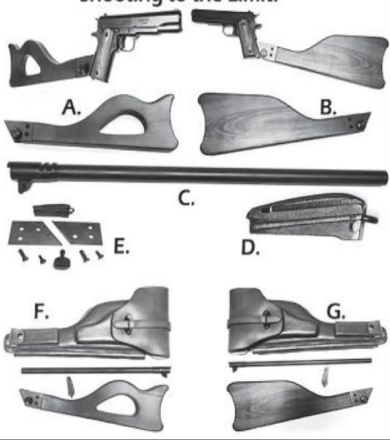

BETSY ROSS FLAG Well made, heavy duty cotton layered with 13 embroidered Stars \$34.95 FLAG56

1911 ORIGINAL SCREW-DRIVER & TAKEDOWN TOOL

Just In! 1911 new G.I. surplus screwdriver/takedown tool - Limited supply! Wont last long! \$14.95 C45320

Grade 1 Ballester Molina Barrel - 95%+ finish \$59.95 BAL013

1911 7RD .45 MAGAZINE, US GI ORIGINAL 1911 MAGAZINES

In very good condition released from the military decades ago. We purchased these long ago and lost track of them.

.45 AUTO FRAME KIT

All parts to build a 1911A1 frame (except the frame itself). Includes trigger, hammer, grips, seat, mainspring, safety, etc., etc., (no slide stop) \$89.95 ea. C45099

.45 BARREL BUSHING WRENCH

Free Bonus - Other end is an M16 shorty buttstock installation wrench.. \$2.95 T00031

COLT 1911 STEEL MAINSPRING HOUSING

Housing is grooved for a sure grip 1911A1 style - nicely blued. With Lanyard Loop \$16.50

WIDE BEAUTIFUL GRIP SAFETY FOR 1911 .45 AUTO

Stop the pinch in the web of your hand (I used to get bloody) \$16.50, 3 for \$49.95 C45079

For Colt mfg revolver barrels, see our website.

STAINLESS STEEL 1911 PARTS

C45150 Reverse recoil spring plug.... \$6.95 C45312 Hammer pin..... \$2.00 C45313 Mag catch lock..... \$3.00 C45314 Mainspring Housing pin..... \$2.00

MODEL 1911 FIRING PINS FOR SERIES 70 & 80

Ravenous for firing pins? Sarco's Sale will satiate your appetite...Series 70 and Series 80 firing pins used in 9mm, 38 super, & 40 S&W.....

.45 1911 FLAT MAINSPRING HOUSING, NEW

Brand new, flat (M1911 Style) steel housings, checkered nicely for a sure grip. Matt gray/black finish. These are nice! \$13.50, 3 for \$37.50 C45082

.45 AUTO SPRING KIT

One each of all 6 springs in a Colt .45. A \$13.25 value for only. Includes seat spring \$7.75 ea. C45002, 10 sets for \$65.00. 100 sets for \$450.00

MODEL 1911, 9MM UPPER PARTS SET!

Finally In!! A great set of parts to help you complete a 9mm version of the venerable Model 1911 pistol. All parts are quality machined parts including a 10rd. 9mm magazine, both sights, firing pin assy, ramped barrel and extractor.

MODEL 1911 9MM BUILDER KIT

Finally, a Model 1911 Builders Kit to allow you to assemble all parts onto your stripped single stack Model 1911 frame to create a 9mm pistol!



SARCO SPECIAL

Four of our famous 1911 .45 mags with 2 pouches (below) for only \$34.95, C45310

DOUBLE MAG POUCHES FOR COLT 1911 .45

Exact repro with WWII markings. We had these 2 years ago but got lost in the warehouse C45280 \$4.95

FOUND IN WAREHOUSE!! ORIGINAL WWII G.I. COLT .45 AUTO COMPOSITION GRIPS

These were long ago taken off G.I. 1911A1's - when the guns were demilled. V.G. excellent condition \$24.95 GRP131

1911 SCREW & BUSHING SET

4 screws & 4 bushings \$5.95 C45206

WIDE SPUR HAMMER

Desirable M1911 type checkered wide spur hammers for the Colt .45 auto pistol. These are new, ready to install and upgrade your pistol.

SARCO SPECIAL WORLD WAR I PATTERN .45 1911 MAGS WITH LANYARD LOOP

C45295 - 1911 mag with lanyard loop \$11.95 Buy 3 mags for \$34.95 and get a free pistol lanyard for the mags.

1911 9MM 10RD MAGAZINE

For your 1911 chambered in 9mm Luger. Perfect for your 9mm Rock Island 1911 or other 1911 style pistol as replacement or additional magazines! \$24.95 RPM269

A NEW WORLD OF 1911 .45 AUTO MAGS

SARCO HAS GONE TO EXTENSIVE LENGTHS TO DEVELOP A SUPERIOR 1911 .45 COMPETITOR MAGAZINE. We have sold probably 150,000 of our price busters, but we decided we need a new & better 1911 mag & we are very pleased with our new program.

Plus with all of the above a killer price \$8.95 ea., 5 for \$39.95 C45298

NEW VARIATIONS OF OUR 1911 .45 ACP MAGS - JUST IN THE DOOR

Stainless steel magazines \$14.95, 3 for \$40.00 RPM121

1911 .45 ACP 7RD MILITARY MARKED MAGAZINES

45 ACP #1005-00-8694 MFRSR320 \$10.95, 3 for \$29.95 RPM155

8 ROUND .45 MAGAZINE

New, blued steel magazine for all .45 ACP Government Model/M1911 type pistols. Base plate also acts as finger rest to improve your grip on the gun \$16.95 ea. RPM319

Table listing various 1911 .45 Auto Pistol Parts and their prices. Includes items like Auto Builders Kit, Frame Kit, Barrel, Mainspring, etc.

Table listing various 1911 .45 Auto Pistol Parts and their prices. Includes items like Ejector Kit, Firing Pin, Grip Set, etc.

Table listing various 1911 .45 Auto Pistol Parts and their prices. Includes items like Main Spring, Recoil Spring, etc.

ENFIELD STRIPPER CLIPS

We just bought the last small quantity we know of. They are now dinosaurs. All new original. While they last!



\$3.00 ea
5 for **\$12.95 STC010**
10 in a pouch for **\$28.95 STC039**
ENFIELD STRIPPER CLIPS WITH POUCH / 10 PACK
Convenient military pouch with 10-.303 Enfield Stripper Clips, unissued.
\$28.95 STC010

Now we have delightful #1 MKIII Complete Stock Sets

- Original refurbished buttstock
 - Original new rear handguard
 - New production forend
 - Original front handguard
- Bring your Enfield up to the delightful!
\$149.95 LE3091

JUST IN !!!!! Finally available ENFIELD #1 MK3 FORENDS !

(May require minor fitting)
Finally available.... Brand new stained Beech Forends to replace all of those ugly worn out Forends on the #1 MK3 Enfield Rifles. These forends are properly inletted on the inside and contoured evenly on the outside to provide your military Enfield #1 Mk3 Rifle the perfect profile & enhancement. Already stained a medium walnut color, they can be further darkened to match your handguards as needed. Best way to improve the silhouette and value of your Enfield !
\$85.00 LE3110

SEE OUR WEBSITE...
FOR 1000s OF ENFIELD PARTS & ACCESSORIES!

ENFIELD RIFLE ID DISC
Engraved brass 1-inch diameter disc w/4 markings (proof marks and/or mg names, dates, etc) which is fitted into the right side of the Lee Enfield Rifle stock
\$6.95 LE3084

LEE ENFIELD RIFLE MAGAZINES

#1 MK3 Enfield Rifle Magazine
.303, 10 rd. capacity
\$29.95
\$40.00
RM011

ENFIELD #4 MAG FOLLOWER AND SPRING!
Put one or more away for the future to protect against mag failures!
\$7.50 LE4119
Limited Supply

Just dug out - A few original British brass oilers for British Enfield Rifles
\$21.75 OIL008

BRITISH ENFIELD CANVAS SLING
We are now able to offer you 2 of the Wartime canvas slings used on the Lee Enfield Rifles as well as 1 post war issue sling. These are new made and all feature brass hardware and an accurate cotton weave.
Colors available: KAHKI w/WWI Brass Stamp SING042
Your choice...
SING044
BLACK... SING096
\$6.95 each

LEE ENFIELD #1 MK3 AND #4 MK1 FIRING PIN REMOVAL TOOL

Vital tool necessary to strip a Lee Enfield bolt or replace a firing pin. Fits the .303 MKIII, No. 4 and No. 5 Enfields. Made of 1144 stress proof steel - we couldn't break one
\$8.95 LE3067

BRAND NEW !!!!! ORIGINAL #1 MK3 ENFIELD BARRELS!

Been sleeping for over 30 years in the warehouse! They have G1 blue finish and are original! Like new! While they last...
1 for **\$124.95 each**
or 3 for **\$299.95 LE3103**

COMPLETE SET OF #4 ENFIELD STOCK HARDWARE

Buttplate, bands, swivels, handguard ring, stock bolt and all related screws and washers. 17 parts
\$39.95 LE4103
See our website for complete list of parts in kit

ENFIELD PARTS, PARTS & MORE PARTS!

NOTE: We have most all parts for #1 MKIII, #4 MKI and #5 Enfield - along with many variations & accessories. Check our website.

BRITISH ENFIELD ACCESSORY KIT
Sling, firing pin tool, oiler, field cleaning rod (pull through), and brush.
Value \$22, Special **\$16.95 LE4061**

PARKER HALE NO. 4 ENFIELD TARGET/MATCH SIGHTS
w/o adjustable aperture **\$49.95 PH007**
See our website for details

ENFIELD #1 MK3 CANVAS RIFLE COVER (CASE) w/ KHAKI SLING CARRY STRAP, WWII PATTERN
Made from heavy canvas material, this gun case's overall length is 46" and fits the Enfield #1 MKIII, #1 MKIV rifles and many other rifles. Beside the main compartment it has a smaller pouch originally used for a cleaning kit case. Has two sling hoops on the back for attaching a strap so you can carry it over the shoulder. We even include a khaki sling carry strap...
\$16.95 LE3092

BRITISH 9 POCKET CAVALRY BANDOLIER

New made 1903 era British/Australian Cavalry heavy duty leather bandolier held 90 rds. of Enfield ammunition. 40 more rounds of ammunition than the standard infantry bandolier, and frequently was also worn around the neck of the trooper's horse...
\$45.00 MISC634

www.sarcoinc.com



SUPER FIND! ORIGINAL BRITISH ENFIELD BRASS OILERS!

Enfield collectors...we have been so fortunate to find about 100 original Enfield brass oilers in the mountain. Earl has been nice enough to sort out all of these into the original sources. Some we only have one of, while others we have a few. I can't believe he found 22 different variations! Take a look and satisfy your desires while they last - They were covered in 80 years of grease & grunge. He cleaned 'em up so he could read the markings.
See our website (#OIL008) for the various markings.



Project Lovers Special #4 ENFIELD GDII BARRELED RECEIVERS

Lets call 'em "Battlefield Relics" Will have flaws - these are the ones we didn't want to build. As-is, no returns. 10 for **\$150.00**, 25 for **\$295.00**, 50 for **\$500.00 GUN717 - FFL Required**

HARD TO FIND ORIGINAL BRITISH MILITARY #4 ENFIELD MKII FORENDS
\$110.00 LE4124

ORIGINAL EARLY ENFIELD SLOTTED REAR HANDGUARDS
Excellent - new
\$35.00 LE4065

BRITISH 1903 ENFIELD AMMUNITION BANDOLIER

Used just prior to WW1 through WW2 and beyond in British Commonwealth forces. Rugged leather combined with brass hardware to provide the soldier and easy method of lugging around ammo. Convenient to take to the range too!
\$38.00 MISC501



#4 MK1 RIFLE MAGAZINE

.303, 10 rd. capacity and broad arrow marked. We've worked on having these made accurately for over 2 years of development & testing. Exactly like the WW2 issue magazine! Extremely difficult to find on the market and we've been very challenged to keep originals in stock. Now all of our hard work to bring these to you can pay off and at an unbeatable price!
10 for **\$29.95 each**
3 for **\$84.95**
10 for **\$229.95 RM61**
PLEASE NOTE: There are many variations in manufacture of #4 Enfield Rifles - Although we don't get any returns (like zero) we want to make you aware of this and we found at times some minor fitting may be needed.



ENFIELD #4 MKIT SNIPER RIFLE CHEEK PIECES

Just in the door! Complete with proper brass screws. Use to build your sniper rifle or also to create a high comb buttstock **\$34.95 LE4106**



NO.4 MK1 WW2 ACTION COVER

Canvas cover as issued during both World Wars. This action cover is newly manufactured in the correct weave, snaps, grommets, and leather tie down. Also comes with period markings. Perfect for completing your Enfield Rifle ensemble...
\$14.95 LE4115



NO.4 ENFIELD SPIKE BAYONET w/ SCABBARD

Excellent condition original WWII, fits all #4 Enfield Rifles. Standard MKII bayonet with MKI scabbard...
\$17.95 BAY106



ENFIELD #4 RIFLE BUTTSTOCK

Used good condition... **\$35.00 LE4125**



NO.4 MK2 STOCK SET

Hard to find! #4 MKII Stock Set, used w/o cross bolt. Excellent condition. Color does not match...
\$149.95 LE4074



BAYONETS See More On The Next Page!

M1 GARAND BAYONETS

Sarco has a limited quantity of M1 Garand Bayonets in both original, and new/ late production versions with blade lengths from 6.5 to @ 16 inches, sold with, and without scabbards.
A. **Original 10" Model 1943**, Unmodified Bayonet w/ late production US scabbard... **\$74.95 BAY193**
B. **Original 10" Model M1905E1**, Modified Spear Point blade w/ late production US scabbard... **\$74.95 BAY194**
DEAL: Buy 1 each of the above 2 bayonets w/scabbards... **\$140.00 BAY268**
C. **Original M5A1 bayonet w/ M5A1 scabbard**... **\$36.50 BAY189**
D. ALSO...We have **RARE M5A1 Garand bayonets marked KM5A1 \$59.95 BAY020**
E. **Original Korean Army version of the 1943/ 1905 blade** shortened to their requirement of between 6.5-7" length. These were imported from the military by Arlington Ordnance years ago, and we have found a handful remaining in the warehouse. Complete with original Korean short scabbard... **\$49.95 BAY240**
F. Also have a few original **Korean scabbards** by themselves
Used... **\$14.95 ea BAY135**
Go to our website for a full listing!
SPECIAL RARE COLLECTOR M1 GARAND BAYONETS. FEW ONLY AVAILABLE. SEE OUR WEBSITE.

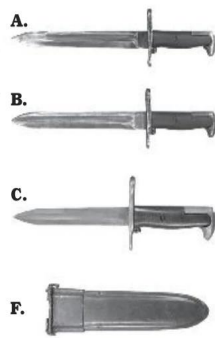

BRITISH ENFIELD HOOKED QUILLION BAYONET

For the #1 Mk3 Lee Enfield Rifle, this steel bayonet comes with the early style hilt with "Hooked Quillion" which was the original 1907 bayonet issued with the rifle. Blade is 17" long with black finish & wood grips. Late manufacture. Limited...
\$38.95 BAY244



See our website for CMP GARAND M1 M1943 & M1 10" BLADE BAYONET REPAIR KITS

SPRINGFIELD WOOD BAYONET GRIPS

New production, new condition wood grips for the M 1905 pattern bayonet as used on the M1903 Springfield rifle. Fix up or up-grade your old bayonets with these beautiful new grips. Heavily grooved for better holding, just like some originals we found and sent to the wood workers to copy. Nut included. Ready to fit on to your blade...
3 or 4 sets for **\$9.95 per set**
or **\$24.95 GRP143**
Screw is available if needed. Special price if bought with grips
\$2.00 BAY163



See our website for **BLACK PLASTIC BAYONET GRIPS FOR U.S. 1943 10" & U.S. 1942 16" BAYONETS**

BAYONET FROGS

- A. SWEDISH MAUSER - original, fair condition... **\$5.95 MSR258**
- B. JAPANESE ARISAKA - late mfg. new, for Type 38 & Type 99 bayonets... **\$9.95 BAY115**
- C. GERMAN K98 MAUSER - late mfg. new, fits WWII K98 bayonets... **\$9.95 MSR111**
- D. SWISS BAYONET FROG - Swiss military frog as issued for the STGW-57 rifle bayonet. Also works with the K31 bayonets and many other similar style bayonets and scabbards... **\$8.95 BAY272**

- E. ROMANIAN AK47 BAYONET FROG - Original leather military frog in used/very good condition... **\$7.95 AK060**
 - F. GERMAN 1898/05 WW1 FROG - Excellent new made version of the German WW1 frog for bayonets. Perfect for our 'Butcher' and 'Pioneer' bayonets and with WW1 German markings... **\$14.95 BAY290**
 - G. WW2 Enfield Canvas Frog For Spike Bayonets, new Mir... **\$7.95 BAY334**
- We have 4 leather historical bayonet Frogs for wearing on waist belts.

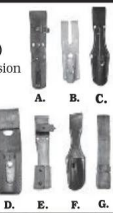

BAYONET GRIPS & SCREWS

- BAY164 Original Yugo '98 Mauser bayonet grip sets... **\$8.95**
- LE3083 Original grips for Enfield 1MKIII (1907) bayonet... **\$9.95**
- BAY163 Original new G.I. grip screws for 1903 Springfield & WWII Garand bayonet... **\$3.95 ea.**
- 4 for **\$10.00**
- BAY179 Original new grip set for the British #7 bayonet for the #4 Enfield... **\$12.95**



www.sarcoinc.com
BAYONETS CONTINUED FROM PAGE 7

JOHNSON M1941 BAYONET & SCABBARD

Finally back in stock after a long wait!!! Very rare steel Johnson Rifle bayonet and leather scabbard as issued to the U.S. Marines in WW2. Always been difficult to find, these are newly manufactured and identical to the original with a blade length of about 7.5". Used by select Marine units in WW2 and by 'Mercs' invading Cuba at the Bay of Pigs. Very Limited.....



\$125.00 BAY024

M1941 Johnson Scabbard

For collectors who have a Johnson bayonet without its scabbard, we have had some extra scabbards made up. New leather scabbard - Johnson M1941.....

\$29.95 BAY043



ALLIED D-DAY FIGHTING KNIFE

Cruciform 7" blade was a sleek low profile sentry removal tool using the French Cruciform style blade. One of many specialized fighting knives used by allied troops during the D-Day invasion.....



\$24.95 BAY256

M3 FIGHTING KNIFE

M3 Knife w/ leather grip & M6 scabbard w/ WW2 markings. New..... \$35.00 BAY331
M6 leather scabbard (scabbard only)..... \$14.95 BAY184



U.S. 1917 BOLO KNIFE & SCABBARD

Made in substantial numbers during WW1 and in several variations from 1897 to 1917, we can offer this full tang, tempered version of the 1917 model complete with period markings on knife & cloth and leather bound scabbard. This is a real 'Chopper', meant to use both blade and heft to hack things apart from fire wood to the 'Hun' in the Trench. With a little care, it will last a lifetime!.....



\$99.95 BAY321

FINALLY AVAILABLE

1917 Scabbard, U.S.



\$22.95 BAY278

BRITISH SYKES FAIRBAIRN FIGHTING KNIFE W/ SCABBARD

British & Allied soldiers loved this knife which was specifically made for sentry removal and still to this day, serves with the SAS. Steel 7.5" long blade. Sykes Brass Handle Knife w/ Scabbard..... \$24.95 BAY274
Back in stock! Steel handle..... \$24.95 BAY275



BEAUTIFUL LATE PRODUCTION SCABBARDS FOR YOUR CMP AND COLLECTOR BAYONETS

M3 scabbard for 16" M1942 bayonet..... \$18.95, 3 for \$45.00 BAY176
10" Garand scabbard..... \$12.95, 3 for \$34.95 BAY175

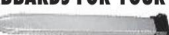

INDIA PATTERN SCABBARD #1 MARK 3

\$19.95 BAY131



GERMAN BUTCHER SCABBARD, WWI

Steel replacement scabbard for the First World War German bayonet M1898 /05. This scabbard has been reproduced from an original and fits both the plain and 'sawtooth' variety blades. Scabbard only..... \$18.95 BAY273



WWI GERMAN 'PIONEER' BAYONET SCABBARD

@23" Long. Scabbard only \$19.95 BAY276

M8A1 BAYONET SCABBARDS

M8A1 Scabbards to fit the following bayonets!

M5 & M5A1 Garand, M3 Trench Knife, M4 for M1 Carbine, M6 for M14 Rifle, M7 for M16

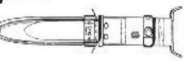

New Military Contract..... \$19.95 ea BAY083
Excellent used military contract..... \$17.95 BAY191
We have a small quantity of U.S. G.I. M8A1 scabbards.
VG condition..... \$19.95 BAY040
(Call Cholly for bulk purchases on M8A1 scabbard BAY083)
Original G.I. new M8A1 scabbard. Just found a few in the warehouse from the old days.
Has original USGI scabbard body..... \$24.95 BAY041

Back In Stock!

SPRINGFIELD 1905 RIFLE BAYONET

U.S. Springfield 1905 Bayonet (no scabbard) \$39.95 BAY324



M1905 (1943) O.L. REPRODUCTION BAYONET WITH M3 SCABBARD 16" BLADE

This awesome reproduction of the M1905 bayonet with M3 scabbard is a must have, correct bayonet for the 1903 Springfield, 1903A3 Springfield and the M1 Garand. It has the 16" blade with all correct markings on scabbard and blade, at this price you can finally own a faithful reproduction of a WWII US Bayonet. Use it on your rifle or simply as a display of our Proud Military History!!!..... \$39.95 BAY182
Note: Our new shipment has arrived and these bayonets will have the country of origin stamping in the blade.



1905 BAYONET PROJECT

Set of original and new made parts for assembling a 1905 bayonet. Years ago we had 2,000 blades manufactured and rewelded onto handles with great success, allowing us to sell 1905 bayonets again. Now we have a very limited group of these complete sets of parts remaining. The handles and hilts are from original U.S. bayonets that were demilled by the U.S. govt. Plastic grips and internal handle parts and blade are new mfg. Set of parts:..... \$29.95 ea., or 8 for..... \$199.99 BAY232
*Add a scabbard for..... \$12.95 ea., or 10 for..... \$99.95 BAY233



1905 BAYONET BLADE

We have some extra new manufactured blades that can be used in a bayonet project. Length 16", U.S. 1905 style, in the white..... \$9.95 BAY253

RARE FAL TUBULAR BAYONET

Bayonet w/ scabbard w/o belt connection..... \$18.95 BAY171
Bayonet w/o scabbard..... \$9.95 BAY156



South African R1 FAL bayonets coming soon - Inquire!

A. U.S. 1910 Springfield Leather Bound Scabbard with belt clip



\$27.95 BAY347

B. U.S. Springfield Canvas Bound Scabbard WW1 with belt hooks



\$29.95 BAY266

FRENCH FOREIGN LEGION PARATROOP KNIFE

Version modified from the British Sykes model and carried by Legion Paras throughout campaigns in Indochina, Algeria, Kolwezi, etc. Very light and a superior grip to the standard Sykes Fairbairn knife. High Carbon sharpened steel blade is blackened and adorned with low luster French Legion Para emblems. Blade @7" long. Overall length @12". Comes with Sykes style leather scabbard as used by the French..... \$59.95 BAY322



MOSIN 91/30 BAYONET

Exc condition w/ Scabbard..... \$16.95 BAY019
91/30 bayonet w/ Scabbard..... \$32.00 BAY084
MOSIN NAGANT 91/30 BAYO Exc w/New Scabbard, excellent condition..... \$32.00 BAY084
MOSIN NAGANT M91/30 & EARLY CARBINE BAYONET - Mosin short 11.5 inch..... \$44.95 BAY261
MOSIN NAGANT MODEL /44 / CARBINE BAYONET - 2 variations available in limited supplies:
A. Mosin 44 Bayonet w/Single Ear connection. 1945 & earlier..... \$44.50 BAY262
B. Mosin 44 Bayonet w/Double Ear connection..... \$44.50 BAY263

M16 BAYONETS

Sarco is pleased to offer a selection of original USGI, foreign military contract, and new mfg bayonets.
U.A.E. (United Arab Emirates) Contract M16 bayonet with black synthetic scabbard. UAE emblem on handle and also on scabbard. New/unused..... \$39.95 BAY237
New G.I. M16 bayonet in original, G.I. packaging. Only A Few Left!..... \$39.50 BAY172



(Fits Galil, too)

1918 U.S. TRENCH KNIFE MODEL

8

Developed by the American Expeditionary Force, this combat fighting knife was contracted to U.S. and French manufacturers. With over 1.2 million ordered, only about 119,000 were produced before the war ended. Handle of solid brass with a 6.5 inch blade. Our Mark 1 knife is the rarer version and is engraved with the 'Au Lion' cartouche on the ricasso. New..... \$39.00 BAY333



*Check your local laws on 'knuckle knives' before ordering. Cannot ship to CA, IL, MI, VT, MO, TX, DE, MA, NY, NJ

M1 (1943) O.L. REPRODUCTION BAYONET WITH M7 SCABBARD 10" BLADE

This awesome reproduction of the M1 bayonet with M7 scabbard is a must have, correct bayonet for the 1903 Springfield, 1903A3 Springfield and the M1 Garand. At this price you can finally own a faithful reproduction of a WWII US Bayonet. Use it on your rifle or simply as a display of our Proud Military History!!!..... \$32.95 BAY183
Note: Our new shipment has arrived and these bayonets will have a country of origin stamping in the blade.



METAL BAYONET SCABBARD GRAB BAG

From decades of importing original military bayonets from overseas, we have accrued a 'mount' of metal scabbards which are not perfect, but may help you complete your bayonet collection where scabbards are missing. Some dings, some dents, some rust may appear as well as perhaps missing or damaged throats on some, but on the whole, an interesting group of metal scabbards that range anywhere from 8.5 inches to 19.5 inches long. Set of 10 scabbards, sold as is..... \$49.95 BAY355
(Picture shown is random set, and there may be variations in sets)



BACK IN STOCK!

INDIAN FAL BAYONET W/ SAWTEETH

Savage in length and scope, this 10.5 inch blade is longer than other FAL bayonets. Sporting a wood handle and cross serrated saw teeth, it fits the British L1A1 and Indian FAL rifles. Comes with steel scabbard..... \$49.95 BAY330



GERMAN MODEL 1898 PIONEER SAWBACK BAYONET & SCABBARD

The longest of the WW1 German bayonets primarily associated with the Pioneer troops and NCOs..... \$75.00 BAY301



GERMAN MODEL 1898 / 05 SAWBACK BAYONET & SCABBARD

Commonly referred to in the family of German Butcher Blades, this was a second variation to the non-sawback butcher blade bayonet that chiefly became to the mainstay of WW1 German bayonets. The 'sawback' blade makes it quite intimidating and was far stronger than the 1898 sawback. Our new made bayonet comes with markings on the ricasso and is complete with steel scabbard..... \$69.95 BAY302



JAPANESE ARISAKA STEEL SCABBARD

See our website for details..... \$16.95 BAY303



JAPANESE TYPE 38 AND TYPE 99 PROPER HOOK QUILLION BAYONET WITH SCABBARD

..... \$44.95 BAY178



DANISH M8 SCABBARD BODIES

Original Danish military wood Scabbard bodies as used on M8 series scabbards for the M1, M14, Danish G3, & M16 bayonets. Nice wood grain with a hardening coat makes this the perfect replacement scabbard body for upgrading your M8 scabbard from a plastic fiberglass body. Scabbard body is 7 inches long and unissued..... \$10.00 Each or 3 pcs. for..... \$24.95 BAY356



LATE PRODUCTION M16 BAYONET

With scabbard..... \$24.95 BAY229



VARIOUS COLLECTORS BAYONETS & ACCESSORIES

BAY304 1891/M1938 Carcano Cavalry Carbine bayonet, original, steel..... \$49.95
BAY251 1891/M1938 Carcano Cavalry Carbine bayonet, new production..... \$30.00



50 Hilton Street, Easton PA 18042
610.250.3960 Fax: 610.438.2548
www.sarcoinc.com

M1 CARBINE SLINGS AND OILERS
SLING AND OILER SET \$10.95 ea.
50 sets for \$349.50 (\$7.00/set)
100 sets for \$599.00 (\$6.00/set) CRB088
OILER ONLY \$4.95 ea.

CRB028 Demilled Front Receiver M1/M2 \$12.50
CRB067 Ejector \$5.00
CRB066 Ejector and Spring \$6.75
CRB068 Ejector Spring \$1.50
CRB063 Extractor \$17.00
CRB065 Extractor Spring \$11.25
CRB064 Extractor Spring and Plunger \$3.50
CRB069 Firing Pin \$17.50
CRB097 Flash Hider \$29.95
CRB080 Front sight \$12.50
CRB079 Front Sight Pin \$11.25
CRB175 Front Sight Removal Tool \$29.95
CRB082 Gas Piston \$13.00
CRB083 Gas Piston Nut \$6.00
HNGD06 Handguard, M3 carbine w/ hole for M3 sniper scope \$35.00
CRB184 Handguard rivets \$20 for \$5.00
CRB044 Hammer \$17.00

50 for \$149.50
100 for \$275.00 OIL19
SLING ONLY \$7.95 ea.
50 for \$300.00
100 for \$350.00 SLNG005
Early WWII pattern Khaki color M1 Carbine sling \$9.95 SLNG006

CRB046 Hammer Pin \$1.50
CRB041 Hammer Spring \$2.50
CRB042 Hammer Spring Plunger \$5.95
CRB100 M1A1 Pistol Grip Current Production \$19.95
CRB014 M2 Potbelly stock, used G.I. walnut \$49.50
CRB113 M3 Sniper Scope Battery Charging Rack. Charges 8-10 batteries. Orig new G.I. in crate can ship UPS (136#) \$295.00
CRB056 Mag Catch \$13.00
CRB058 Mag Catch Spring and Plunger \$3.25
CRB057 Mag Catch, late w/ mag support \$13.00
CRB135 Mag Spring Put-Away New G.I. 15 rd 3 for \$2.95 \$5.95

CRB010 Magazine, 15 shot, new \$11.95
OIL19 Oiler \$4.95
CRB003 Piston Nut Wrench \$12.95
3/ \$34.95
CRB177 Rear Sight Installation Adjustment Tool \$79.95
CRB154 Rear Sight, milled \$29.95
CRB155 Rear Sight, late stamped \$17.50
CRB102 Recoil Check/Muzzle Brake \$29.95
CRB001 Recoil Plate \$9.95
CRB030 Recoil Plate Nut \$2.75
CRB029 Recoil Plate Screw \$2.25
CRB020 Recoil Spring (Hi-Speed) \$4.50
CRB021 Recoil Spring Guide \$6.00
CRB022 Recoil Spring Housing (Early) \$22.50
CRB019 Recoil Spring Std \$3.75
CRB055 Safety (Flip Type) \$10.00
CRB059 Safety Spring and Plunger \$2.95
CRB104 Scope Mount w/Rings \$24.95

CRB049 Sear \$13.00
CRB050 Sear with hump \$12.00
CRB051 Sear Spring \$1.50
CRB038 Selector Spring \$4.00
CRB015 Slide M1 \$75.00
CRB016 Slide, G.I., late M2 \$75.00
CRB017 Slide Stop \$2.95
CRB018 Slide Stop Spring \$1.50
CRB088 Sling and Oiler Set \$10.95
SLNG006 Sling Khaki (New Reproduction) \$9.95
SLNG005 Sling O.D. (New Reproduction) \$7.95
CRB052 Trigger \$14.95
CRB061 Trigger Housing M1 \$75.00
CRB062 Trigger Housing M2 \$85.00
CRB043 Trigger Housing Pin \$2.00
CRB048 Trigger Pin \$1.25
CRB053 Trigger Spring \$3.75
CRB004 Trigger Spring Removal Tool \$3.95

M1 CARBINE PARTS
CRB090 Banana Clip Pouch \$9.95
CRB023 Barrel Band 1st Model \$14.95
CRB036 Barrel Band Retaining Spring \$3.85
CRB025 Barrel Band w/Bayo Lug New, G.I. Parkerized \$19.95
CRB093 Blank Adapter \$9.95
CRB002 Bolt Assembly & Disassembly Tool \$22.50
CRB096 Brass Deflector \$8.95
CLN172 Bronze bore brush 30 cal 10 \$9.95
CRB032 Buttplate (Used) \$8.00
CRB031 Buttplate Screw \$1.50
CRB094 Carrying Case \$17.50

M1 CARBINE PARTS & ACCESSORIES
OUR FAMOUS M1A1 PARATROOPER CARBINE STOCKS
THIS LOT ALMOST SOLD OUT & IT WILL BE MONTHS BEFORE THE NEXT ONE ARRIVES !!
This is a perfect and exact reproduction of the WWII M1A1 Paratrooper Stock. Each stock has a matching handguard, so your treasured carbine will look beautiful.
(See website for other M1A1 Stock Parts)



\$149.95 CRB098 (Gun Not Included)
This is absolutely the best quality available
Other Accessories Available: Carbine Stock Pouch \$9.45 CRB134
Sling and Oiler \$10.95 CRB088
Bulk buyers of this great stock, call Dave or Cholly.

COMBO SPECIAL!
M1/M2 CARBINE FLASH HIDER AND M1/M2 CARBINE MUZZLE BRAKE/RECOIL CHECK...
Together for \$49.95 CRB132



M1/M2 CARBINE MUZZLE BRAKE/RECOIL CHECK
\$29.95 CRB102



M1/M2 CARBINE FLASH HIDER
\$29.95 CRB097



M1 CARBINE BARRELS
New & Made to the G.I. Print!
USA MADE BY OLD SCHOOL BARREL MAKER
Sarco has obtained brand new U.S. made barrels in 4140 steel that are completely machined, bored, properly cut with inlets for the front sight, machined & swaged gas block/piston, breech with proper hood not found on commercial barrels, and bore with a 1 in 20 twist! Barrels are in the 'white', without finish. Finally you can be assured of the perfect replacement barrel for your M1 Carbine.
NOTE: features of this barrel also include: **Short chambered .015**, **Heat treated 4140 (28-30 RC)**, **Gas Cylinder/Block** made from 4140 steel, rolled and swaged onto the barrel. These are NOT castings nor are they soldered or welded onto the barrel, but made from forged bar, pressed, swaged, and rolled into place as the original GI barrels were prepared!
Sarco's special introductory price: \$149.95 CRB183

M1 CARBINE MILLED REAR COMBAT SIGHT
Back in stock \$29.95 CRB154

M1 CARBINE DUAL CLIP HOLDER
\$5.95 CRB101



M1 CARBINE SPRING & PIN KIT
All the pins & springs in a M1 Carbine \$9.95, 3 for \$27.95 CRB173

WWII PATTERN M1 CARBINE CARRYING CASE - UNLINED
These are a very close copy of the World War II M1 carbine case. O.D. canvas with proper brass zipper and leather tabs. "US" marked. Carrying strap included. Will hold all M1 and M2 carbines. New condition.
Unlined Cover \$14.95 ea, 3 for \$42.95 CRB094



M1 CARBINE REAR ADJUSTABLE SIGHTS
New condition \$17.50 CRB155



Check our website for new 15 & 30 ROUND CARBINE MAGAZINES - In stock - GI pattern 15rd magazine \$11.95 CRB010
30rd magazine \$14.95 CRB008
Ordering instructions are in the ad or on our website

RARE G-41 HAMMER SPRING
Few only - these break \$9.95, 3 for \$17.95 G43069

G-43 RIFLE PARTS
We finally completed this project all brand new live springs. Tune up your G-43 or keep a set as a "put away" springs. These kits will run out. Old weak springs not only affect function but also take a toll on the hard parts in your gun. Springs are copied exactly from the originals. This kit is sold elsewhere for \$80.00 and are sold out there! Buy one for your gun & one to put away for when they're gone or go in business at \$14.95/set \$28.95
2 sets for \$28.95
10 sets for \$140.00 G43067

G-43 RIFLE PARTS
G43040 Sight Hood \$14.95
G43073 Recoil Spring Set \$8.95
G43072 Wehrmacht Belt with Buckle & Two Double Leather Pouches \$42.95
CLN015 G43/K43 Cleaning Rod, 12 1/2", threaded... \$12.95
G43068 Safety Plunger spring \$4.00
G43061 Double Pouch w/2 Mags, Leather Repro Limited Quantity! \$103.95
G43060 Double Leather Mag Pouch, Repro Limited Quantity! \$16.50
G43056 Mag Pouch with 2 mags \$103.95
G43029 Sear (trigger) Spring \$9.95
G43069 Hammer Spring \$9.95
G43021 Magazine Catch Spring \$8.00
G43016 Actuator Rod Spring (gas piston Spring) \$6.00
G43012 Safety Retainer \$9.50
G43011 Sliding Dust Cover \$14.95
G43010 Recoil Spring, Rear \$5.95
G43007 Recoil Spring, Front \$5.95
G43003 Extractor \$24.95
G43002 German Mag Pouch, WW2 reproduction \$12.95
G43001 Magazine, New MFG \$54.95
CLN014 Mauser 98K 12 1/2" Cleaning Rod \$12.95

M-1 CARBINE POUCHES & MAGAZINE SETS
Individual pouches for sale as well as combination sets with magazines. Every order with magazines gets a free original USGI rubber dust cover with each mag!
1. CARBINE STOCK POUCH - holds 2-15 rd. magazines and slides onto the wood stock. New repro. With markings on front & back \$24.95 CRB134 (pictured on Left)
2. CARBINE BELT POUCH - holds 2-15 rd. magazines and slides onto belt. New, GI. \$8.00 CRB092
3. CARBINE BANANA CLIP POUCH - holds 4-30rd. magazines. Slides onto belt \$9.95 or 3 for \$24.95 CRB090 (pictured on Right)
4. COMBO A: 2- 15 rd. Magazines and Stock Pouch w/dust covers \$29.95 CRB191
5. COMBO B: 2- 15 rd. Magazines and Belt Pouch w/dust covers \$28.95 CRB192
6. COMBO C: 4- 30rd. Magazines and Banana Clip Pouch w/dust covers \$69.50 CRB193
Follow State & Local laws when ordering magazines



M1 CARBINE MAGAZINE DUST COVER
Original rubber dust covers back in stock after many years! These are G.I. and in excellent condition. They fit easily over the top feed area of the magazine.
5 pcs. for \$3.95, 10 pcs. for \$5.95, 25 pcs. for \$12.50 CRB095

Check our website for G.I. M1 sorted Collector Parts!

ORIGINAL BOX OF 100 DUST COVERS
M1 Carbine fans will love this deal! Original G.I. cardboard box containing 100 pcs. of the rubber carbine dust cover \$19.95, 2 for \$34.95 CRB188

ORIGINAL G-43 EAST GERMAN POLICE SLINGS
From late 40's/early 50's, VG condition, Original \$24.95 SLNG110

G-43 RECOIL SPRING SET, THE LONG AND SHORT
Put one or more sets away for the future! Only \$8.95 a set, or 3 sets for \$23.95 G43073

G-43 Canvas Mag Pouch (repro) w/2 new Mags \$103.95 G43056
G-43 Canvas Pouch by itself \$12.95 G43002
G-43 Leather Mag Pouch with 2 new 10rd mags \$103.95 G43061
G-43 10rd Magazine, New MFG - Well-made and tested, steel. Meticulously made identical to the original \$54.95 G43001



G-43 RIFLE PARTS
G43040 Sight Hood \$14.95
G43073 Recoil Spring Set \$8.95
G43072 Wehrmacht Belt with Buckle & Two Double Leather Pouches \$42.95
CLN015 G43/K43 Cleaning Rod, 12 1/2", threaded... \$12.95
G43068 Safety Plunger spring \$4.00
G43061 Double Pouch w/2 Mags, Leather Repro Limited Quantity! \$103.95
G43060 Double Leather Mag Pouch, Repro Limited Quantity! \$16.50
G43056 Mag Pouch with 2 mags \$103.95
G43029 Sear (trigger) Spring \$9.95
G43069 Hammer Spring \$9.95
G43021 Magazine Catch Spring \$8.00
G43016 Actuator Rod Spring (gas piston Spring) \$6.00
G43012 Safety Retainer \$9.50
G43011 Sliding Dust Cover \$14.95
G43010 Recoil Spring, Rear \$5.95
G43007 Recoil Spring, Front \$5.95
G43003 Extractor \$24.95
G43002 German Mag Pouch, WW2 reproduction \$12.95
G43001 Magazine, New MFG \$54.95
CLN014 Mauser 98K 12 1/2" Cleaning Rod \$12.95



We Wish All Of Our Customers Good Health and Safety During These Times of Uncertainty
Sarco is here for you!



M1 CARBINE BANDS
First model barrel band assembly with swivel and screw. Perfect for restoration of an early WWII pattern carbine. New. Just bought a good deal on 1st model M1 Carbine barrel bands and will pass it on to you. Previously \$20-\$25 ea, now! \$14.95, 3 for \$39.95 CRB023



Use your Smart Phone to Scan the QR Code and go straight to our website!



PISTOL & RIFLE STRIPPER CLIPS

STC005	EA. AR15/M16 Guide	3 for \$1.50	10 for \$3.50	10 for \$9.95
STC003	Carcano (may have light pitting)	\$6.95	N/A	N/A
STC034	Carcano, brass 6.5mm/7.35, 6rd	\$9.95	N/A	N/A
STC009	6.5 Dutch Rifle	\$4.00	\$11.00	\$39.95
STC010	Enfield, .303	\$3.00	\$8.25	5/\$12.25
STC039	Pack of 10 Enfield .303 stripper clips w/ pouch	\$28.95		
STC011	Steyr Hahn 9mm Auto for the 1911/1912	\$8.95	\$24.95	N/A
STC014	Mosin Nagant	N/A	\$2.35	\$7.50
STC016	M14	12 for \$9.95		
STC025	1903 Springfield, Brass, Original	\$4.00	\$10.00	\$30.00
STC029	1891 & 1909 Argentine	\$1.50	\$3.25	\$9.00
STC031	Mannlicher 7.65 pistol	\$6.50	\$18.00	\$49.95
STC013	'98 Mauser steel stripper clip	\$2.70	\$7.50	\$22.50
STC018	'93 Mauser brass	\$3.00	\$8.00	\$20.00
STC028	Orig. '98 Mauser brass, never seen before. Few only	\$3.00 ea.		
STC033	Replacement Mauser C-96 Broomhandle 8rd original military	N/A	N/A	\$10.00

Note: all above stripper clips are original except 91/30

UNIVERSAL 9MM STRIPPER CLIPS

1/2" wide 3-1/4" long holds 10 rds. Got a pile of 'em so cheap cheap! STC036

T.V. WATCH'IN PROJECT

Same 9mm clips as above but some rust - easily cleanable. STC038

STYER HAHN 9MM AUTO STRIPPER CLIPS

For the 1911/1912 \$8.95, 3 for \$24.95 STC011

JUST IN! SHOTGUN FRONT BEAD SIGHT AND RAMP

New silver front bead sight with front sight ramp with beveled bottom is great for replacement on barrels or for creating your custom Shotgun barrel. Set of Bead & Ramp..... \$12.95 MISC900

C96 MAUSER BROOMHANDLE STOCK & HARNESS

Well-made, beautifully crafted hardwood stock and leather holster. Pistol fitting connects quickly and the pistol can be stored in the wood stock and then inserted in the leather holster. Includes cleaning rod. Made famous during WWI. Stock & harness only. Comes with two 8rd stripper clips for a limited time. \$149.95 MSR340

MAUSER BROOMHANDLE (C96) PISTOL GRIPS

Available Again! Just got in 600 pair. Custom made WOOD grips to match the originals. Complete with escutcheons & grip screws. Immaculate copies in the many variations. GRP125 C96 Mauser standard fine line early grips - 20 lines GRP126 C96 Mauser standard fine line early grips with Red 9 - 20 lines GRP121 C96 Mauser model 1930 grips - 11 lines GRP122 C96 Mauser model 1930 grips with Red 9 - 11 lines GRP123 Bolo (small grips) Mauser pistol with standard lines - 20 lines GRP124 Bolo (small grips) Mauser pistol with standard lines and Red 9 - 20 lines \$19.95 a pair, 3 for \$54.95

These grips are superb reproductions. Others may sell cheaper but I guess they know what their stuff is worth.

C-96 BROOMHANDLE STRIPPER CLIPS

Works with both .30 Mauser and 9mm Luger ammunition. The 8rd is an original military strip- per clip. 8rd. C96 Clip. 10 for \$10.00 25 for \$20.00 50 for \$35.00 100 for \$50.00 STC033

MAUSER C96 BROOMHANDLE CLEANING ROD

\$7.95 CLN164



SWEDISH MAUSER PARTS

Go to our website for a complete list of Swedish Mauser rifle parts

C96 MAUSER PISTOL REAR SIGHT ASSEMBLIES

Graduations from 0 to 14. Just found these in the warehouse. Original New in the grease. Not \$125.00! Only \$75.00!! MSR665

BROOMHANDLE C-96 MAUSER PISTOL PARTS & ACCESSORIES

20rd detachable Magazine for Schnell- feurer & Broomhandle detachable magazine handgun..... \$65.00 RPM270 Bolt stop, new..... \$30.00 MSR638 Extractor, late model current production \$29.95 MSR329 Firing pin & spring \$35.00 MSR331 Firing pin spring \$8.00 MSR332 Floorplate \$60.00 MSR396 Trigger spring \$25.00 MSR343 Hammer (Schnellfeuer) 1 only \$150.00 MSR619 Locking block, Original \$65.00 MSR345 Locking block, repro \$35.00 MSR515 Main spring \$4.50 MSR337 Main spring plunger \$14.00 MSR338 Recoil spring..... \$6.00 MSR341

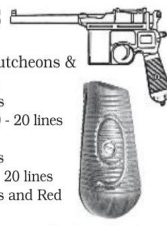

PROPER 8x57mm BORE BRUSHES

Bronze brush - 5 for \$5.50 CLN124 Stainless steel brush for cleaning those tough military bores 5 for \$8.95 CLN121

GERMAN HELMET 1889 PRUSSIAN KURASSIER, PICKELHAUBE

Beautiful Pre-WWI model military helmet made from steel with leather liner, brass scalloped chinstrap, cockades, steel spike and brass emblem. Inscription embossed on brass emblem translates from German as, 'With God for King and Country'. (Mit Gott Fur Koenig und Vaterland) \$84.95 HLM012



AVAILABLE AGAIN!! SWEDISH MAUSER HIGH FRONT SIGHTS

Specially made tall front sights so you can zero your rifle at 100 yards. Most of these rifles shoot very high at short range as their minimum sight setting is 300 meters. Use of our high sight blade will allow you to get accurate sightings at 100 yards. Made to look like the original sights. These sights install in the existing dovetail. Made in U.S.A. Blued steel. Millspec quality, Swedish M96 and M38 Tall Front Sight. Now back in stock. \$13.95 MSR283



M1895 PRUSSIAN GERMAN FUSILIER REGIMENT HELMETS

Just got another shipment of Picklehaubes - Finely crafted of heavy leather with solid brass trim, cockades, spike assembly and detailed eagle emblem. These are M1895 Prussian German Fusilier Regiment Helmets - Nicely done. All the metal is a beautiful brass. An extremely accurate & detailed recreation and fit for use or display and will be the topic of conversations in your collection or "man cave". German spiked helmet. These helmets were used up to the end of WWI. Beautiful huge brass Prussian spread eagle on the front. Last shipment we sold out for \$99.95. SARCO struck a tremendous deal to bring you this helmet at 1/10th the price of an original. \$59.95 HLM015



ABOUT HIGH CAPACITY MAGAZINES:

Although we try to stay abreast of current State gun laws, it is a herculean task with over 20,000 laws on the books. By ordering, you are stating that you are complying with your Local & State laws. Most States allow large capacity magazines. Some do not. If you are unsure on this issue, contact your Local or State law enforcement to confirm what is allowed. This is a partial list of States with some hi-capacity restrictions: NJ, NY, MA, MD, HI, KS, CO, CT, IL and various county laws therein including Chicago, D.C. CA residents - check your laws as they are changing.

ONLINE ORDERS -

Go to www.sarcoinc.com Its fast, secure & convenient! PHONE ORDERS - Call (610) 250-3960 Phones opened M-F 8:30am-5pm EST. If possible, please have the part #'s of each item ready for our order takers. If you have any technical questions, they will connect you to the most appropriate department.

EMAIL ORDERS - info@sarcoinc.com Include your name, full address (indicate if its commercial or residential) and contact info. Include part #'s of items and what ad you saw them in.

FAX ORDERS 610-438-2548 (order department) 610-250-3961 (showroom) 610-250-3962 (gunroom - fax all FFLs here)

MAIL ORDERS - SARCO, INC. 50 Hilton St, Easton PA 18042 When writing your check, please include \$9.50 for shipping. (\$12.50 for rifle stocks & barrels). Actual shipping cost is determined by the weight of the package. You will be contacted if amount included is insufficient or a refund is due. There is a \$25.00 fee for all returned checks. See our page 29 in the 2nd issue of the month for FIREARMS Ordering Info.

Note About Shipping:

Sarco deals with a lot of material that is very difficult to find and much of the original wartime material undergoes refinishing, manipulation, and repair as needed. With this in mind, we are not Amazon... While our aspiration is to ship your order quickly, some items may take a little more time to prepare so please be patient! Most orders go out quickly.

SHIPPING

ALL ORDERS WILL BE RECEIVED, PROCESSED AND SHIPPED OUT OF OUR PENNSYLVANIA LOCATION. MINIMUM SHIPPING AND HANDLING CHARGES START AT: \$9.50. Rifle Stocks and Barrels...\$12.50 Call for larger items on prepaid orders * NJ residents please add 6.625% sales tax. Not all items available to NJ residents. * PA residence please add 6% sales tax All orders to Alaska and Hawaii shipped via US Mail, unless customer specifically requests Blue or Red Label UPS (not available for online orders). Employees not authorized to modify prices or conditions stated in this advertisement. **Most orders ship within 7-14 days**

CUSTOMER SERVICE:

info@sarcoinc.com PARTS QUESTIONS: parts@sarcoinc.com MACHINE GUN QUESTIONS: mgdave@sarcoinc.com Sarco only sells products to persons 18 years and older

We are forever adding pictures to our website, but we have a lot of stuff and it takes time. If you don't see a picture of something you need, email us. We'll add it to the website and reply back with the link!

ORDERING INSTRUCTIONS

Our ads in the Firearms News are catalogue prices and may not reflect any sales or higher pricing found on our website.

Prices are subject to change without notice. We are not responsible for typographical errors or misprints.

Over 95% of our inventory is listed in the Firearms News. We have to move items to our website to make room for new stuff. So if you don't see something, check www.sarcoinc.com or call us.

DISCLAIMER

Parts sold by Sarco should be installed only by a competent gunsmith. These products are sold as is and without a warranty. No liability is expressed or implied for damage or injury which may result from the improper installation or use of these products.

OUR GUARANTEE

Our guarantee is simple and easy to understand. If you are not satisfied with any item received from us you have 5 days to return it for a replacement or a refund of the advertised price. All returns must be accompanied by a letter WITH YOUR INVOICE NUMBER and explanation of the problem. Before returning anything, please see our guarantee on our website.

MAUSER 712 (SCHNELLFEURER) WOOD STOCK

SARCO has a half dozen of the wood stocks specifically designed to hold the selective fire version of the C96 Mauser. Very difficult to find, and this is for the real pistol, not the air soft version. Late production/walnut. Get one while you can. Won't last long! Mauser 712 Wood Stock..... \$150.00 MSR654

SWEDISH M96 AMMUNITION BANDOLIER

NEW \$49.95 MSR632

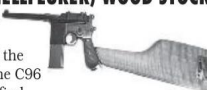

See our website for Collector Grade M96, CG63 & CG80 Mauser Bolts

See our website for Swedish Mauser Cleaning Rod Extensions #MSR644

LJUNGMAN AG-42 RIFLE OILER \$14.95 OIL038

SWEDISH LJUNGMAN RIFLE BARREL Original, New \$125.00 AG42010

NEW SWEDISH MAUSER FIRING PINS \$19.95 MSR494

COMPLETE SWEDE BOLTS The stripped bolts & bolt sleeves & extractors & firing pins are new unnumbered. Rest of parts are exc Complete straight bolt \$129.95 SALE \$49.95 3/\$134.50 MSR493

A NOTE ON SARCO GOODS

Many of Sarco's prices are below market price. Some too that this means Sarco sells lower quality... Not True. Sarco shops the world and the U.S. for deals and because of our buying power & 55 years of presence in the market, we are able to acquire good deals and pass the savings on to you. For example, we have over 20 vendors we buy AR parts from and are always shopping for the best price and quality.

- FOR PARTS & ACCESSORIES - Visa and MasterCard accepted. Sorry no COD's.

EASTON SHOWROOM VISIT

Showroom opened Mon-Sat 10am-5pm / Friday Opened til 8pm. For directions to the showroom, see website. In Stock Inventory - If you are planning on visiting the showroom, feel free to call ahead to make sure that we stock the item(s) that you need. Please give us a least a few days' notice before your visit in case we need to retrieve goods in from our other warehouses. Note that the prices in Firearms News are dealer prices and may not be the same prices as in our showroom.

REGARDING LOCAL, CITY & STATE REGULATIONS

You warrant by ordering from Sarco Inc., that you are in compliance with the laws of your local, city and State regulations and that you are a legal adult without any legal restrictions in regards to your purchase. With 20,000 plus laws on the books it is difficult for us to know what laws may affect your purchase where you reside. Please check your local and State laws before ordering.

RETURNS

We offer a 5-day inspection period on all of our merchandise, except for special order items which are not refundable. Items that state they are sold "as-is" are not returnable. PHONE ORDERS, EMAILED, FAXED OR MAILED-IN ORDERS: You will need a Return Authorization Number to return something. Please email returns@sarcoinc.com or call (610) 250-3960 for a RT #. Feel free to check on the status of your return, credit or refund. ONLINE ORDERS: Please visit our website www.sarcoinc.com and click the Return Policy link. Fill out the printable form and mail it back with your package. Feel free to email our e-Comm department at ecom@sarcoinc.com to check on the status of your return or call (610) 250-3960 and ask to be transferred to the e-Commerce Department. We do not refund any shipping cost unless the error/problem causing the return is our fault. Returns may be subject to a 10% restocking charge.

ORDER PROBLEMS, Damaged or Missing Packages

Call (610) 250-3960 and ask for Liz ext 208 or email lheisler@sarcoinc.com BACKORDERS Check the status of an existing Backorder. Call (610) 250-3960 or email: backorder@sarcoinc.com SARCO deals in modern as well as obsolete and hard to find merchandise and offers full & prompt refund on any cancelled backorders prior to ship. WEBSITE Questions or Issues Call (610) 250-3960 and ask to be transferred to the e-Commerce Department or email ecom@sarcoinc.com INTERNATIONAL Call (610)250-3960 and ask for Mike ext 210 or email international@sarcoinc.com

SARCO

www.sarcoinc.com
610-250-3960

HEAVILY TESTED AK-47 MAGAZINE NEW!

Sarco has just received what may be the best, most durable, and high performance AK magazine on the market. Critically tested for reliable feed, locking, and ease of use, this magazine is synthetic and has survived the grueling 'Serb' method of mag testing. 7.62x39 with 30 rd. capacity. New **\$19.95**
3 for **\$49.95 RM102**



STEEL TYPE 99

PROTECTIVE SHIELD
As used by Japanese forces during WW2. Complete with handle and monopod. New **SALE!**..... **\$80.00**
\$99.95 MISC443



JAPANESE ARISAKA

JAPANESE RISING SUN FLAG

Cotton 3'x5' flag with loop on top and cord on bottom like the original WW2 flags. Originally adopted by the Army, but later dominated for use by the Japanese Navy..... **\$18.00 FLAG12**



ALMOST GONE!!

JAPANESE ARISAKA RIFLE PARTS FOR TYPE 38 & 99 - PLEASE SPECIFY WHEN ORDERING

BAKELITE MUZZLE COVER..... **\$11.00 JAP9915**
TYPE 99 DUST COVER..... **\$19.95 JAP9903 BACK IN!!**
TYPE 38 DUST COVER - Steel .. **\$19.95 JAP3811 We've got these too!**
EXTRACTOR..... **\$40.00 JAP3801**

JAPANESE ARISAKA SLINGS
WWII JAPANESE NAVAL SLING FOR ARISAKA & VZ-24 RIFLES **\$14.95 SING098 BACK IN!!**
TYPE 99 'PACIFIC' RUBBERIZED CANVAS SLING - Developed to resist mildew and create a lighter sling. Laminated just like the original w/ brass hardware and markings. Wartime use of 1942-45. Unlike our competitors, we have included the leather sling keeper which the others omit!..... **\$19.00 SING093**
TYPE 38 Leather Sling - brass hardware, brown, 1-1/8" wide..... **\$17.50 SING027**
TYPE 99 Leather Sling - w/steel hardware, brown, 1.5" wide..... **\$17.50 SING008**

JAPANESE ARISAKA CLEANING RODS
TYPE 99
LONG ROD @29-3/16"..... **\$17.95 CIN044**
SHORT ROD 23-3/4"..... **\$14.95 CIN126**
LAST DITCH TRANSITIONAL ROD @4-7/8"..... **\$12.00 CIN147**
ARISAKA TYPE 1 & 2 PARATROOPER ROD 21-1/2"..... **\$17.50 CIN046**
TYPE 38
LONG ROD @29-1/4"..... **\$17.95 JAP3803**
SHORT ROD @23-1/4"..... **\$17.50 CIN148**
CARBINE @17"..... **\$19.95 CIN008**
TYPE 100 & ARISAKA PARATROOPER BAYONET \$75.00 BAY279
BAYONET FROG - Late mfg., new for Type 99 and Type 38 bayonets.
Excellent reproduction..... **\$9.95 BAY115**

Japanese Chrysanthemum Metal Hand Stamp
Metal hand stamp with an overall length of @ 3.25 inches and with an imprint diameter of 5/8 of an inch. Slightly concave embossing face. Perfect for marking WW2 military items with the classic emblem of the military Empire of the Sun! Good for leather, wood, copper, brass and other soft metals... **\$45.00 STAMP15**

Toyada Automatic Loom Works WW2 Arsenal Stamp..... \$45.00 STAMP14

NOTE: Stamps are NON-Returnable unless damaged or incorrect in which case they will be exchanged for the correct one.

TYPE 99 MONOPOD - Nice reproduction of the rifle monopod made in steel just like the original. Great way to complete your rifle since most monopods are missing from guns on the market..... **\$29.95 JAP9902**

WW2 ARISAKA RIFLE 'PAPERWEIGHTS'
1 set of Cut Arisaka Receivers..... **\$9.95 each**
or 5 sets for..... **\$38.95 JAP9918**

JAPANESE NATIONAL FLAG
3 x 5 foot cotton flag with cord, with a slight antique faded salmon white back ground similar to aged WW2 Japanese flags **\$14.95 FLAG18**

JAPANESE NAMBU TYPE 14 HOLSTER
Clam shell holster as used by Japanese forces in WWII. Very well made hard shell flap and tab with brass hardware **\$40.00 H01001**

SKS RIFLE PARTS & ACCESSORIES

SKS PHENOLIC STOCK W/ FOREND
China's military machine under Mao, ramped up production of Phenolic or synthetic stocks during the late 60s when it became clear that the tensions along the Sino Soviet border were intensifying toward 'all-out war'. Wood was too precious to strip for the manufacture of millions of Chinese SKS rifles so synthetics were applied to AKs and SKSs alike. Good stocks are getting hard to find. We have a few dozen original SKS stocks w/forend. Some minor color blemishes, but overall very good **\$99.95 SKS100**

SKS CHINESE STOCK & HANDGUARD
used with metal and handguard.
Good condition **\$99.95 SKS090**
Stock is cut for the Chinese spike bayonet.

- SKS043 Accessory kit..... **\$9.95**
- SKS011 Bolt new..... **\$45.00**
- SKS093 Buttplate..... **\$10.00**
- SKS072 Buttplate/rear swivel screw
- SKS007 Hold open latch..... **\$2.00**
- SKS038 Buttplate trapdoor assembly, new
- SKS002 Piston extension..... **\$5.00**
- SKS056 Buttstock anti rattle spring..... **\$3.00**
- CIN095 Cleaning jag..... **\$2.50**
- CIN092 Cleaning rod..... **\$12.00**
- SKS013 Firing pin, new..... **\$15.00**
- SKS042 Front sight tool, "T" type..... **\$3.95**
- SKS048 Gas port cleaning tool..... **\$2.95**
- SKS007 Hold open latch..... **\$8.00**
- OIL032 Oil bottle..... **\$3.00**
- SKS002 Piston extension..... **\$20.00**
- SKS003 Piston return spring, new
- CIN095 Cleaning jag..... **\$5.00**
- CIN092 Cleaning rod..... **\$12.00**
- SKS035 Rear sight button, new..... **\$4.00**

AN/VSS-3 SEARCH LIGHT
Designed for visible and infrared lighting..... 50 million + andlepower(minimum!!!). Whether you want to control a fence line, spot enemy aircraft or search in the infrared spectrum, this is a rare opportunity to get a real military searchlight similar to the ones used on M60 tanks, APCs, and Jeeps. Rarely on the market, we only have one remaining. Sold as is and untested. SEE OUR WEBSITE FOR MORE DETAILS!
Comes with original wood chest **\$1500.00 MISC373**

SKS Chinese bayonet blade stock..... \$98.00 SKS092
SKS Chinese Stock with handguard - with bayonet slot filled..... \$99.95 SKS094

- SKS036 Rear sight leaf spring, new..... **\$4.00**
- SKS055 Rear sight leaf w/slide..... **\$25.00**
- SKS033 Rear sight leaf, new..... **\$15.00**
- SKS034 Rear sight slide, new..... **\$6.00**
- SKS071 Rear swivel..... **\$8.00**
- SKS041 Sight tool, "C" type..... **\$9.95**
- SING041 Sling, exc..... **\$6.95**
- STC024 Stripper clips..... **3/\$4.50**

AK RIFLE PARTS & ACCESSORIES

AK 47 (AMD65 HUNGARIAN HANDGUARD)

Stamped steel handguard in excellent condition actually can work nicely for all sorts of AK and specialty gun projects. Strong and only 4.4 ounces!
Original GI..... **\$12.50 HNGD54**



JUST FOUND!

ORIGINAL MILITARY AK FIRE CONTROL PARTS SETS
Consists of hammer, trigger, disconnecter **SALE!! \$14.95**
3 for **\$39.95 AK067**

Also found - Just a few...
ORIGINAL AK AUTO SEARS..... \$14.95 AK068

5 & 10rd WASR Magazines in 5.45 x 39 cal.

AVAILABLE NOW!
See Our Website!

REDDISH/BROWN AK-47 GRIP WITH LONG SCREW
Used in excellent shape. Reddish Brown Grip alone **\$22.95 GRP219**
Reddish Brown Grip with Screw ... **\$25.00 GRP223**
Long Grip Screw alone **\$3.00 AK080**

BLACK AK-47 GRIP W/ COMPONENTS
Used excellent condition original AK parts: Black Grip alone **\$7.00 GRP220**
Black Grip w/ screw, washer, bottom cap **\$16.95 GRP224**
Screw & Washer for black grip **\$7.00 AK081**
Bottom Cap for black AK grip **\$3.00 AK082**

AK47 SLINGS
Khaki..... **\$6.95 SING033-TAN**
Black..... **\$6.95 SING033-BLK**

JAPANESE TYPE 99 PACIFIC RUBBERIZED CANVAS SLING
\$19.00 SING093

More Parts Just in the Door...

AK47 Disconnecter, GI used exc..... **\$7.00 AK069**
AK47 Hammer, full auto, GI used exc..... **\$8.95 AK070**

AK47 Muzzle bearing, round, GI used exc **\$4.50 AK071**

AK47 Rate reducer assy, GI used exc.... **\$5.00 AK072**

AK47 Sear spring, GI used exc..... **\$4.00 AK073**

AK47 Trigger single hook, GI used exc **\$9.95 AK074**

AK47 Trigger double hook, GI used exc **\$9.95 AK075**

AK47 Trigger Guard Assy, with catch GI used exc. **\$20.50 AK076**

Dust Cover **\$10.00 AK042**
Extractor gage (orig.)..... **\$19.95 AK036**
Blank Adapter **\$3.95 AK013**

Broken Shell Extractor for 7.62 x 39 Good for SKS & AK **\$2.99 ea.**
4 for ... **\$10.00 BSE020**

AK 3 PRONG FLASH HIDER - M16 pattern.
Looks neat on gun **\$8.95,**
3 for... **\$25.95 AK033**

AK47 MAGAZINE LOADER FOR LOADING & UNLOADING - Double thumb depressing levers. Makes the process easier **\$17.99 AK048**

JUST IN! AK RIVET SETS
Complete set of the PROPER rivets needed to build an AK..... **\$9.95 AK051**

Back In Stock! AK SEMI PARTS PACK
Correct parts for building an AK Semi auto. Counts as 3 compliant parts under US Sec 922r. Made in the USA by High Standard..... **\$25.95 AK052**

AK63 / AMD-65 COMPENSATOR
Steel flash hider/compensator for AK47 Rifles such as the AK-63, AMD-65, and similar AK47 variants with the same threaded muzzles. 2-7/8" long, 3.95 oz. weight, 14 x 1 left hand thread. Helps make the AK more controllable in automatic or fast semi firing.
SALE!..... \$8.95 \$19.95 MISC562

AK STRAIGHT MAGAZINE POUCH
Excellent condition **\$4.00 AK064**

HUNGARIAN AMD65 FOLDING BUTTSTOCK ASSEMBLY
Excellent condition AMD65 right side folding wire stock is exceptionally strong, low weight, and stable making it perfect for Hungarian AKs, and any project that you might have. Complete w/ trunion assy. Very limited
..... **\$57.00 AK077**

STANDARD RPK M72 BIPODS
Just in the door, we have excellent condition Yugoslavian M72 series bipods. Perfect replacements and terrific for gun projects where a solid versatile bipod is required.
M72 Bipod..... **\$27.00 AK078**

RHODESIAN SELOUS SCOUT RIFLE / SHOTGUN CASE
Heavy cotton gun bag very similar to the British rifle bag, but slightly shorter and in a mustard color. About 41" long. Large Rhodesian Selous Scout emblem stenciled on one side. These gun bags will hold some rifles, but were primarily used to hold Greener and Belgian Browning Shotguns barracks, watchtowers, Eland Armored Cars etc
\$15.95 MISC374

SARCO LUGER PARTS

www.sarcoinc.com

See our website for OUR Original Luger Cleaning Kit (#CLN171)

LUGER SIDE PLATE ASSEMBLY... BACK IN STOCK!
Complete side plate with trigger lever and trigger lever pin installed!
Minor fitting required
..... \$59.95 LGR067

LUGER PUT AWAY OR SHOP KIT
Extractor, Ejector, Firing pin, Main-spring, Extractor spring, Firing pin spring, Locking bolt spring \$104.50 value - Sarco's Price
..... \$69.95 LGR161 Stash It Now!

LUGER SPRING KIT All the coil springs in a Luger - mainspring, trigger spring, firing pin spring & extractor spring..... \$9.95 3 for \$26.75 LGR138

WE HAVE LUGER 'ARMY' & 'NAVY' WOOD MAGAZINE BOTTOMS - SEE OUR WEBSITE !

LUGER DRESS-UP SET
Get one of our Luger holsters, a pair of new checkered wood grips, and a new magazine loading tool. All 3 pieces, a \$85.00 value. Only \$49.95/set LGR082

LUGER ARTILLERY STOCK HOLSTER RIG

Exact reproduction of the Luger Artillery model leather holster rig used by German troops. Our Artillery holster rig includes the holster itself, cleaning rod, carrying strap, leather pieces to connect to a stock board, and 2 pocket magazine pouch which goes on the carry strap. We offer this set with a wood stock and without a wood stock:

1. Wood Stock with Black Leather Artillery Holster Rig..... \$129.95 LGR175
2. Black Leather Artillery Holster Rig (without stock) includes carry strap & magazine pouch..... \$34.95 LGR176

- LGR170 1908 Trigger bar..... \$45.00
- LGR044 ARMY LUGER WOOD BOTTOM..... \$9.95 ea or 5 for \$45.00
- LGR043 NAVY LUGER WOOD BOTTOM..... \$9.95 ea or 3 for \$27.95
- LGR153 Breech bolt new, perfect current production..... \$99.50
May require minor fitting of rails due to variation in receivers
- LGR048 Double mag pouch, Leather..... \$9.95
- LGR087 Double mag pouch w/ 2 wood base mag (current production)..... \$56.50
- LGR146 Ejector, M1900 beautiful new production..... \$67.50
- LGR016 Ejector, late model, new production..... \$29.95
- LGR145 Extractor, M1900 beautiful new production..... \$67.50
- LGR084 Extractor, new production..... \$26.95
- LGR142 Extractor, new production - a wee bit narrow but works fine. Need clean-up of the casting - dirt cheap..... \$10.00
- LGR019 Extractor spring..... \$2.00
- LGR160 Extractor & Firing pin combo..... \$44.50

- LGR020 Firing Pin, beautiful & new length..... \$19.95 ea, 3 for..... \$49.95
- LGR022 Firing pin spring..... \$3.00
- LGR023 Firing Pin Spring Guide..... \$19.95
- LGR159 Full Spring Kit (new) - springs for: hold open latch, extractor, locking bolt recoil, sear bar, trigger mag catch, firing..... \$44.50
- LGR030 Grip screw..... \$5.00
- LGR040 Hold open latch spring, new May require minor fitting due to variations in frame slot length..... \$8.00
- LGR156 Locking bolt spring..... \$12.00
- LGR041 Locking bolt take down lever..... \$24.95
- LGR061 Mag catch spring..... \$8.00
- LGR050 Mainspring (recoil)..... \$4.50
- LGR072 Sear bar (trigger bar) spring, repro..... \$8.00
- LGR149 Side Plate, Original, milled, in the white..... \$49.00
Check our website for more Original Luger parts
- LGR066 Side plate, stripped..... \$36.50
- LGR062 Thumb safety, Late Orig..... \$50.00
- LGR074 Trigger lever..... \$19.95
- LGR073 Trigger lever pin repro..... \$7.75

LUGER ARTILLERY BOARD STOCK WITH METAL
(stock may require final fitting)..... \$74.95 LGR157

LUGER ATTACHING STOCK IRON
Sarco sells the metal part that allows you to attach a stock onto the Navy or Artillery Luger. This is newly machined and has all of the contours of the original military part. We have sold these on our own wooden stocks for years. Great for fixing a bad stock or for making your own custom fit Luger stock. Limited SALE..... \$44.95 ~~\$49.95~~ LGR148

ORIGINAL SWISS LUGER 9RD MAGAZINE
Fits all original Lugers
..... \$150.00 LGR538

LUGER TOOL W/ EARLY MARKING
Just in, some Luger tools with the pre WW2 Eagle with drooping wings common on 1930s Lugers
..... \$8.45 LGR180

LUGER LOADING & DISASSEMBLY TOOL WITH WW2 MARKINGS
\$8.45 LGR068

LUGER GRIPS SPECIAL!!
Just made a large purchase of beautiful checkered wood grips for the ever-popular Luger pistol. These are the nicest looking reproduction grips we've seen. Sharp checkering, nice color, and properly finished edges make this a sure-fire winner. Due to variations in frames some minor fitting may be necessary. Dress up that old import Luger today GRP118 *Special of the month* \$19.95, 3 for \$49.95

NAVY LUGER STOCK
We are selling this hardwood Luger Navy Stock originally manufactured in Spain, without the attaching iron for the pistol, but with the metal disc installed. These are the last of what we brought into Sarco in the late 1990s. Good for making your own custom luger stock with some ingenuity. May be blemishes... \$39.95 LGR187

LUGER ARTILLERY SIGHT
Finally back in stock, but only a handful! Graduated leaf assy out to 800 yards. New mfr.
..... \$150.00 LGR077

1936 BROWNING HI POWER HOLSTER / STOCK RIG
Leather combination of 'Sam Brown model belt' and holster to hold the 1935 Hi Power pistol and wood stock. Assembly includes leather belt (adjust between @39-46 inches), a mag pouch (hold 2 mags), cross strap, and leather holster which will hold the 1935 Hi Power pistol and the original style board stock in separate pouches. Wood stock or pistol not included..... \$115.00 BHP077

See our website for our LUGER SNAIL DRUM HOLSTER !!

BROWNING HI-POWER HOLSTER
Well-made copy of the holster as used by German forces after occupation of the Browning factories. Marked with German code and Waffen marks.
..... \$24.95 HOL021

WANTED TO BUY!!! STRIPPERS!
Do you have a bunch of old strippers just hanging around? Well if so, sell them to us and we will put them to good use. We will make a cash or trade offer for stripper clips in good used condition. Offers only made on quantities of 100pcs and above. Contact Dave at Ext.130 or email - mgdave@sarcoinc.com



FRENCH FOREIGN LEGION PARA BADGE
Metal badge, the symbol of the 2e REP French Foreign Legion Foreign Parachute Regiment. Worn by countless soldiers and adventurers in history and a familiar sight throughout Africa where Mercenaries and contract soldiers find post service opportunities. The circled winged armed 'Dextrochere' is a symbol of 'earned' fortitude in the ranks of soldiers worldwide. 1-3/4 inch diameter with retaining pin..... \$7.95 MISC826



ORIGINAL WW2 TRAINING AIDS
Weapon Training Aids for 1919A4, BAR, Garand & M1 Carbine. Large Scale for Classroom Use. Check our website! Contact Dave for details at Ext.223.



Manufacturers...
Sarco has contracted thousands of reproduction line items in metal, wood, leather & canvas products from different vendors. We would be pleased to hear from new Manufacturing vendors who can offer their services. Contact Mark or Dave. Email at mdottens@sarcoinc.com or mgdave@sarcoinc.com



GALIL LOVERS
Do you need the attaching pin & spring for the detachable Galil bipods? We had 'em made as we needed them too. They don't exist! Have a few from over production..... \$14.95/set GAL111

Just Found from the old Colt Deal - ORIGINAL COLT POLICE POSITIVE FIRING PINS! \$11.00 CPP11

MOSIN NAGANT 91 ACCESSORY KIT \$24.95 N91052



MOSIN NAGANT RIFLE SEE OUR WEBSITE FOR A FULL LIST OF ALL MODELS OF MOSIN PARTS & ACCESSORIES

ORIGINAL MOSIN M91/30 BAYONET \$16.95 BAYO19
MOSIN NAGANT 91/30 BAYO Exc w/ New Scabbard, excellent condition **\$32.00 BAY084**

MOSIN NAGANT M91/30 & EARLY CARBINE BAYONET
Moshin short 11.5 inch **\$44.95 BAY261**

1. Takedown tool
2. Cleaning Jag
3. Cleaning Rod Handle Set
4. Muzzle Cleaning Rod Guide
5. Hold All Pouch
6. Oiling Kit, Original

MOSIN NAGANT 91 CLEANING KIT, ORIGINAL \$9.95 N91051

MOSIN NAGANT SUPER CLEANING KIT
Takedown tool, Cleaning Jag, Cleaning Rod Handle Set, Muzzle Cleaning Rod Guide, Hold All Pouch, Oiler, 2 ammo pouches and 10 stripper clips..... \$26.50 N91056

MOSIN DOG COLLAR 91/30 SLINGS Original Russian **\$19.95 SLNG103**



MOSIN NAGANT LEATHER SLING
The leather Mosin Nagant sling was used early on in the issuance of the Model 91/30 rifles **\$19.95 SLNG119**



Mosin rifle stripper clips in stock again - 3 for \$2.35, 10 for \$7.50 STC014

MOSIN-NAGANT RIFLE ACCESSORIES

1. PAIR OF RUSSIAN AMMO POUCHES, original Mosin Nagant.. \$9.95 N91045
2. CLEANING ROD HANDLE Handle for cleaning rod issued on every rifle..... \$4.95 CLN086
3. FINNISH M28/30 new original handguard..... \$24.95 N91041
4. Original Finnish Mosin oiler (few only)..... \$6.95 N91069
5. FIRING PIN PROTRUSION GAGE & Screwdriver Tool..... \$15.00 TOOL050

MOSIN DOG COLLAR 91/30 SLINGS
We have been out for six months just found a new batch. New mfr **\$12.95 SLNG018**



JUST IN THE DOOR ORIGINAL SLINGS FOR MOSIN MODEL 38 & MODEL 44 CARBINE
We've been out for a year **\$14.95 ea, 3 for \$34.95 SLNG060**

MOSIN NAGANT RIFLE PARTS

N91052 Accessory Kit M91..... \$34.95 N91004 Firing pin..... \$19.95
 N91040 Ammo pouch..... \$6.50 N91082 Follower Arm M91..... \$7.50
 N91086 Bolt body, Grade 2 pitted..... \$29.95 N91041 Handguard, Finnish M28/30..... \$14.95
 N91084 Bolt Comp w/Extractor..... \$59.95 N91020 Lower band 91/30..... \$8.00
 N91005 Bolt connector & guide bar..... \$5.00 N91067 Lower mag Follower Spring..... \$5.00
 N91006 Bolt head..... \$16.50 N91079 M93 Finnish Rear Sight Base Spring..... \$10.00
 N91007 Bolt Head w/ extractor..... \$19.95 N91015 Mag follower assy w/ floorplate M91..... \$18.00
 N91033 Buttplate..... \$29.95 N91016 Magazine floorplate..... \$12.00
 N91043 Cleaning Kit..... \$4.95 N91050 Oiler, Original, Brass, Double Spout..... \$3.95
 N91051 Cleaning Kit Original M91..... \$9.95 N91036 Rear sight leaf and slide assembly M1891/30 (type 4)..... \$15.00
 N91030 Cleaning rod, Carbine, 1907..... \$16.95 N91037 Rear sight leaf M1891 (type 2)..... \$13.00
 N91029 Cleaning rod (model 91/30)..... \$15.00 N91055 Rings Only for PU Scope Original..... \$95.00
 N91028 Cleaning rod handle..... \$10.00 N91045 Pair of Russian Ammo Pouches..... \$9.95
 N91011 Ejector..... \$14.00 N91081 Scabbard, leather w/ belt loop and brass ball tip - 91 & 91/30..... \$14.95
 N91009 Ejector spring..... \$12.00
 N91007 Extractor, generic..... \$19.95
 N91080 Extractor, reproduction..... \$19.95
 N91003 Firing pin spring..... \$6.00
 N91078 Sniper Bolt, Comp w/ Extractor..... \$159.95
 STC014 Stripper Clips M91 3 for..... \$2.35 10 for..... \$7.50
 N91025 Stock lug assembly..... \$12.00
 N91056 Super Kit - Cleaning w/2 ammo pouch & 10 stripper clips..... \$26.50
 N91057 Super Kit - Cleaning w/Bolt orig, 2 ammo pouch, 10 stripper clips..... \$51.50
 N91066 Take down tool..... \$3.95
 N91014 Trigger guard stripped..... \$19.95
 N91013 Trigger spring & bolt stop..... \$22.00
 N91012 Trigger..... \$8.00
 N91062 Triggerguard & Magazine Assy Comp. Exp. 100% blue..... \$29.95
 N91018 Upper band 91/30..... \$8.00

SHOULDER HOLSTER FOR MODEL 712 SCHNELLFEUER WOOD STOCK
For the rare Mauser C96 pistol 'version' that uses the 20rd. magazine, we have the leather holster for the stock that is designed to hold the entire loaded & loaded Pistol with 20rd magazine attached..... \$24.95 HOL193



BROWNING HI-POWER

FINALLY BACK IN STOCK!!!!
GET YOURS NOW BEFORE THEY'RE GONE AGAIN!!
BROWNING HI-POWER WOOD STOCK
WE HAVE A FEW DOZEN COMING IN NOW! PUT YOUR ORDER IN NOW 'CAUSE THEY WON'T LAST LONG!!

Brand New!
NFA Rules Apply

F.N. HIGH POWER 9MM MAGAZINES
Brand new magazines. New commercial quality.
13 rd., blue Ea..... \$17.95, 3 for..... \$49.50,
RPM105 Browning HI Power Magazine Loader..... \$4.95 BHP072

BROWNING HI-POWER GRIPS
Newly manufactured synthetic grips with the look of black wood grips. Panels are knurled like the original grips..... \$19.95 GRP179

BROWNING HI-POWER LANYARD RING & STUD ASSEMBLY New \$19.95 BHP069

BROWNING HI-POWER STOCK FROG
As used with the Inglis wood stock. Allows you to attach the wood stock to your belt. Canvas with metal clip just like the original..... \$12.95 BHP076

FABULOUS CURRENT PRODUCTION
FN pattern wood Hi-power Checkered grips. Just like previous FN production. Need minor fitting inside mag well..... \$17.50 3 for..... \$44.50 GRP174

SEE OUR WEB PAGE FOR EXTENSIVE HI POWER PARTS LISTING

BROWNING HI-POWER PARTS

BHP015 Ejector..... \$22.00
 BHP013 Extractor (Late)..... \$22.50
 BHP021 Firing Pin..... \$10.00
 BHP012 Firing Pin Spring..... \$3.00
 BHP091 Hammer..... \$35.00
 BHP029 Hammer Spring..... \$6.00
 BHP026 Hammer Spur..... \$35.00
 BHP017 Hammer Strut..... \$12.00
 BHP082 Hammer Strut Nut..... \$8.00
 BHP090 Hammer Strut Pin..... \$5.00
 BHP092 Hammer w/Strut..... \$25.00
 BHP016 Mag Catch..... \$26.00
 BHP085 Mag Safety Spring..... \$4.00
 BHP083 Magazine Safety..... \$30.00
 BHP079 Rear Sight Dove Tail..... \$18.00
 BHP068 Rear Tangent Sight Slide..... \$45.00
 BHP032 Recoil Spring..... \$6.00
 BHP011 Safety Catch..... \$32.00
 BHP020 Sear..... \$34.00
 BHP024 Sear Lever Pin..... \$3.00
 BHP018 Sear Spring..... \$4.00
 BHP040 Trigger..... \$35.00
 BHP038 Trigger Lever..... \$35.00
 BHP084 Trigger Spring..... \$7.50

Airguns For Sale \$3000

AIRGUN REPAIR & SERVICE
 Factory authorized Crosman, Benjamin and Sheridan warranty service. We also repair Daisy, Beeman and many other makes of pellet and bb guns. No firearms. Most repairs \$65-\$100. We buy used airguns and parts. In business since 2005.
ACCURATE AIRGUNS LLC
 Ph: 360-656-5123
 Email: airguns@comcast.net
 Website: accurateairguns.com

A Miscellaneous For Sale \$3100

AMF M1 Navy Trophy Rifle. .308 Caliber. Approximately 5,000 survived. Looks unfired with box and some documents. \$13,500. Doug Oefinger 863-444-1849. No pictures.

Colt Named Model For Sale \$3280

Colt 1918 B.A.R. serial number 1. Excellent condition. Original wood. No Bipod. Used as a display gun at Colt.

\$325,000. Serious inquiries only. Doug Oefinger 863-444-1849. No pictures.

Heckler & Koch (H&K) \$3780 For Sale

California D.O.J. HK Model 94. Ex D.O.J. gun, refinished. \$6,500. Doug Oefinger 863-444-1849. No pictures.

Iver Johnson Wanted \$3921

Wanted Pistols: Iver Johnson, TP22 Pistols, As New or New-in-Box.

Jacksonville, AR Manufacturer. 22 Cal. Long Rifle. Jeff, 6582 Beacon St., Pittsburg, PA 15217-1843.

Military Arms For Sale \$4200

1903 A4 Sniper, Overall condition excellent. "W" stamped behind the trigger, came from the National Guard in the 1960's. \$7,500. Doug Oefinger 863-444-1849. No pictures.

www.StormWerkz.com Small Arms Upgrades Made in USA

1903 COLT U.S. property marked 32 and 380 cal. boxes with proper instruction sheet, paper and cleaning rod. \$39.95 plus postage. Ray 847-854-6608.

GOVERNMENT 1911 A-1 .45 cal. surplus Kraft boxes: Colt, Remington, ITHACA, US&S with wrapping paper. \$27.75 plus postage. Ray 847-854-6608.

OSS Shoulder Holster, New in the Box. \$195 Plus Postage. See Dr. John Brunner's Book on OSS Weapons Cover. Ray 847-854-6608.

BLUEPRINTS
 American 180, AN-M2, Austen, Berretta, Bar, BMG 30, 50, Czech25, 383, FN-FAL, Hotchkiss, Kommando, Lanchester, Mac-10, Madsen, Mat-49 28-A1, M1A1, M3A1, M-16, M-37, M-203, MG-34, MP- 34, 38, 40, 41, Owen, PAF, PPSH-41, PPS-43, Reising, Sola, Star, Sten II & V, Sterling, Suomi, Swedish K, UD-42, Vickers, Vigneron, Yugo 49, 56. \$15 each or 2/\$25, Complete package \$125. SIG-57, MG-42 and M-14 are \$25 each. Make payment to: C. Shillig
 PO Box 25932, Colo. Springs, CO 80936
 wmeml1@zandsindprecmach.com

Military/Automatic Arms \$4220 For Sale

Aircraft Lewis Gun Reg. Live but welded together, blued, no magazine. \$11,000. Doug Oefinger 863-444-1849. No pictures.

AKM Underfolder Conversion Gun. \$25,000. Serious inquiries only. Doug Oefinger 863-444-1849. No pictures.

MP40 Good numbers matching with matching magazine painted black and

GUNS FOR MOVIES OR FUN!
 PISTOLS • RIFLES • MACHINE GUNS
 DERRINGERS • ROCKET LAUNCHERS

We have been selling guns to the movie industry for 25 years and have just about anything. Pistols, Rifles, Machine guns, Derringers to Rocket Launchers. Sold to anyone 18 years or older - 25 caliber and up - Full functioning.

M1 CARBINE  \$79.95	No FFL required.	M92  \$39.95
M4 CARBINE  \$49.95	MAC11  \$39.95	SIG 552 MACHINE GUN  \$49.95
DESERT EAGLE  \$39.95	MP5 SD3 W/ SILENCER  \$49.95	SIG 226  \$39.95
GERMAN MP40 SUBMACHINEGUN  \$49.95	UZI PISTOL  \$39.95	US .45 AUTOMATIC  \$39.95

Order at WWW.RAPIDFIRETRIGGERS.net or call 770-249-2991

INTRODUCING SECRET SERVICE DARK WEB PHONE!

- No monthly fees. Free Calls and Texts
- Untraceable and can't be tracked.
- Automatically deletes searches and clears footprints.
- Dark Web access where anything is possible.
- Changeable email and phone numbers.
- Built in Secret Camera/Microphone
- Complete with charger

85% more internet!

Only \$89.95 plus S&H

ONLY AVAILABLE FROM
HYPERGAT.NET

CROSSCUT SAW COMPANY



THE FINEST IN PEOPLE POWERED GOODS
 P.O. Box 7872, Seneca Falls, N.Y. 13148
 315-568-5755

www.crosscutsaw.com
 Quality Saws, Knives, and Hard-to-Find Tools.
 Catalog \$1 U.S. (\$3 Foreign)

M1 CARBINE PARTS

Download Our FREE Catalog!!
www.bestcarbineparts.com

Carbine Barrels
 Stock Pouches
 Slings & Early Oilers
 Stocks & Handguards
 Type I Early Flip Sights

*Type I, II Dog Leg Hammers
 *Flat & Round Bolts: \$95.00 & Up
 *Front Bands Type I, II & III
 *Front & Rear Sights
 *Swivels (All Mfgs.): \$18.00 & Up
 *Mag. Rel. Type I, II & III: \$32.00 & Up
 *M1A1 Recoil Plate Covers: \$65.00
 *M1A1 Butt Plate Springs: \$10.00
 *M1A1 Coil Springs (Pistol Grip): \$10.00
 *Type I Band Screws: \$7.50

*** Celebrating 30+ Years***
L&S SUPPLY, INC.
 22211 Lofton Ave. N
 Scandia, MN 55073
 E-Mail: lssupply@spacestar.net
 Or call: (651)773-9972
 15 DAY 100% Satisfaction Guaranteed

ATAC DEFENSE

ATACDEFENSE.COM
 (601) 963-0300

ADER 5.56 - ATAC DEFENSE ENHANCED RIFLE



AMBI SAFETY & AMBI MAG RELEASE WITH OVERSIZED MAG BUTTON, LARGE AMBI CHARGING HANDLE AND BOLT RELEASE, MUZZLE BRAKE, NICKEL BORON COATED C158 BOLT CARRIER GROUP, ENGAGE HAND GRIP AND MINIMALIST STOCK

ADER - \$1299

ADBR 5.56 - ATAC DEFENSE BASIC RIFLE

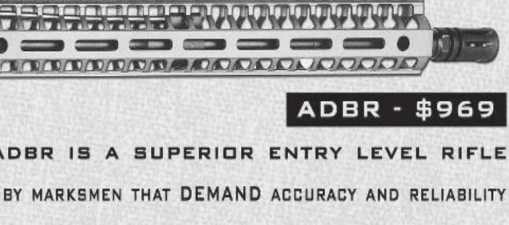

ADBR - \$969

EACH ADBR IS A SUPERIOR ENTRY LEVEL RIFLE
 HAND FIT BY MARKSMEN THAT DEMAND ACCURACY AND RELIABILITY

FANATICAL BUILD QUALITY
 SLICK CERAKOTE FINISH

WE WELCOME
 DEALER INQUIRIES

FIREARMS NEWS

Check us out on the internet!



www.firearmsnews.com

appears to have never been blued.
\$18,000. Doug Oefinger 863-444-1849.
No pictures.

T161/M60 .308 caliber, excellent condition, C&R eligible. \$65,000. Doug Oefinger 863-444-1849. No pictures.

CLASS II FULL AUTO DRILLING FIXTURES For MAK-90/AK-47 (w/ pins & bushing)--\$48.50 shipped or AR-15/M-16, M-11/9 & HK--\$33.50 shipped. All NFA Rules Apply. Order online at www.ftfindustries.com or mail to:
FTF Industries, Box 68, Hildebran, NC 28637 (cert. funds, M/C or Visa).

M16A1 Legal Transferable Gun, Senora Receiver with Colt Parts. Very Good Condition. \$15,000 Call Jimmy 256-594-7597.

M2 CARBINE Legal Transferable Iver Johnson Factory Gun. \$6,000. Call Jimmy 256-594-7597.

CZ24 REPLACEMENT Receiver Tube Section w/template. 4130 tubing with correct OD & ID \$45.00 Shipping \$5.50
Keller Enterprises, PO Box 563, Safety Harbor, FL 34695. 727-726-2500 www.stenparts.com

PPSH41 RECEIVER Section \$50.00, PPS43 Receiver Section \$50.00, PPS43S Trunnions \$30.00 Shipping \$11.50
Keller Enterprises, PO Box 563, Safety Harbor, FL 34695. 727-726-2500. www.stenparts.com

STEN MkII \$30, STEN MkIII \$35, Sterling \$35, Yugo 56 \$45; Receiver Tubes w/bonded templates made from 4130 Tubing. Correct OD/ID Shipping extra.
Keller Enterprises,

PO Box 563,
Safety Harbor, FL 34695.
727-726-2500. www.stenparts.com

STEN MARK II, III, & V spring kits \$20, \$5 shipping
KELLER ENTERPRISE
PO BOX 563
Safety Harbor, FL 34695.
727-726-2500
www.stenparts.com

.50 BMG UPPERS, .50 BMG RIFLES
www.SHTF50.com

STEN MARK II & III BARRELS, New Manufacture, Original Length \$45.00; AMD-65 extended muzzlebrakes AK74 style \$27.00, Shipping \$5.50 each.
KELLER ENTERPRISES,

QUICK DRAW \$42.95
LOTS OF 24 RIGS
VISA, MASTERCARD
WILEY'S, 7009 Co. Rd. 2120
WILLS POINT, TX 75169
1-903-848-7912-FAX-7922
www.wileysguns.com

TOOLED LEATHER - SUEDE LINED - FITS SINGLE ACTION	SELL OUT PRICES
ASK FOR CAL. 22-38-357-44-45	24 RIGS \$42.95 EA.
ASK FOR SIZES: 32-44	12 RIGS \$44.95 EA.
FEATURES BROWN COLOR	6 RIGS \$46.95 EA.
LOW DROP ON HIP	4 RIGS \$48.95 EA.
BBL LENGTHS: 6" OR 7 1/2"	2 RIGS \$52.95 EA.
	1 RIG \$59.95 EA.
	Plus Shipping

12 GAUGE PISTOLS

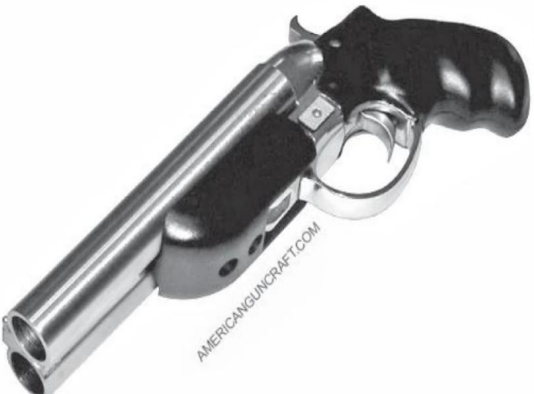

Your LEGAL-TO-OWN answer for the modern sawed-off double barrel shotgun.



209 Primer IGNITION ML | No license or FFL required, order direct

Check out our entire product line at

AMERICANGUNCRAFT.COM/products/

Dealers-Distributors: Inquire about special resale programs

RUBEN MENDIOLA DEALERNFA, INC.

PO Box 566300, Miami, FL 33256-6300, 305-271-3436
TOLL FREE: 866-NFA-WANT (866-632-9268), FAX: 866-415-7066,
CELL: 786-256-6746 for pics or text, EMAIL: Ruben@dealernfa.com
HOURS: 8am-9pm Eastern, 7 days a week

!WANTED!

ALL TYPES OF QUALITY LEGAL MACHINE GUNS!



NO COLLECTION TOO LARGE!

GENEROUS FINDER'S FEES GLADLY PAID!

Estate and Machine Gun Appraisals!
 Before Selling Your Guns, Please Call Me To Make Sure You Are Getting The Most For Them!
CONSISTENTLY PROVIDING EXCELLENT AND DISCREET SERVICE & FAIRLY PRICED HIGH QUALITY MACHINE GUNS SINCE 1985!
 Attorney Available for Trust or Estate Matters.

****WE PAY UP FRONT****
 100% of the Agreed Price Before You Ship Your Guns!
 You Will Never Have To Wait Until I Sell Your Guns in Order to Be Paid!
 100% Risk, Worry & Hassle Free Transactions!
 Avoid the Uncertainty of Consignment or Brokering!
 Specializing in Investment Grade Transferable Machineguns
 Specialist in Law Enforcement Purchases and Cashless Trades





www.dealernfa.com

ALWAYS PAYING TOP DOLLAR!

Military/Automatic Arms \$4220 For Sale

recoilless rifle back together. Sub-cal units available. M60 Mil Spec Channels Parked \$150. Gunsmith 203-605-4578.

1883 on carriages. Both beautifully made museum pieces. Rare. Email for prices and pics; randyman@ncidata.com 509-826-5512.

Military/Automatic Arms \$4221 Wanted

STEN MK-2 LOWER TRIGGER GROUP AND MAG HOUSING AND EJECTOR. CALL 386-255-8888.

Remington Rifles Wanted \$4441

Buying Remington No. 1
Rolling Blocks & Hepburns in Long Range Creedmoors, Mid-Range, Short-Range and Schuetzen Target Models. 509-826-5512, randyman@ncidata.com

Miniatures, Replicas \$4234 For Sale

Gatling Guns made by Furrs Arms, 1/3 scale in 22 short. Models 1874 &

PO Box 563,
Safety Harbor, FL 34695.
727-726-2500.
www.stenparts.com

DEPOT LEVEL Maintenance on your U.S. Military Machine Guns. Most M16, M60 and .50 cal. parts in stock. We can put your M18 or M20

INTRODUCING THE ALL NEW...

HELLFIRE STEALTH

The name says it all!



ONLY \$39.95
(plus S&H)

LEGAL IN ALL 50 STATES!! ATF LEGAL WITH CERTIFICATE.

You simply just squeeze the trigger.

Activate/Deactivate/Adjust with the hidden Micro knob.

This incredible new system installs invisibly within your grip on any AR15 style rifle invisibly. It can be activated or deactivated in seconds. It legally allows you to pull your guns trigger at it's highest rate legally. It installs in minutes and nobody but you will know it's there. It features a micro-adjust for activation and deactivation. It looks absolutely built in. It is revolutionarily the best rapid fire system for these new volatile times. Get them now before new laws outlawing "Fast Shooting" arrive. This may very well be the best system ever devised for AR15 platforms. It is constructed of all Steel for a lifetime of reliability. The shooter always maintains control and single function of the trigger so you can fire single, double, bursts or empty mags and it is the only system that is 100% legal for now in all 50 states!

ONLY AT ROCKINLOCK.COM AND FIREQUEST.COM

ON THE GO?

GET YOUR DIGITAL EDITION!

(Digital access now included with your paid Subscription!)



Tremendous Variety Of Custom Classic Cartridge Brass and Specially Cast Bullets

Whether it's a classic American, British or European metric caliber, we can supply new formed brass, specially cast bullets in almost any caliber. That includes Maynard types, as well as rimfire and pinfire cartridges! Need a 8.15x46R bullet with central driving band? We have them... along with .310 Cadet factory bullets and six-sided Metford bullets. We also offer reloading tools and dies.

If you want it we can make it!

This is a partial caliber list:

6mm Lee Navy	.32 Remington	8x60 RS	.401 WSL	.43 Egyptian	.45-120 Sharps
.25 Remington	8mm Kirtz	.33 Win.	.41 Colt	.44 Bull Dog	.50-70 Govt.
6.5x53R Dutch	8.15x46R	.351 WSL	.401 Herters	.44 Russian	.50-95 WCF
7.35 Italian	8mm Lebel	9mm Jap Rev.	.40-60 WCF	.45 Colt blank	.50-110 WCF
32 French Auto	8x50R Siamese	9mm Mannlicher	.40-65 WCF	455 Webley	.50 x 3/4"
.310 Cadet	8x52R Siamese	9.5mm Mannlicher	.40-82 WCF	.45-60 WCF	.56-46
.303 Savage	8x56 Mannlicher	.35 Win.	11mm French Rev.	.45-70 blank	.56-50
7.63 Mannlicher	8x57 R360	.38-56 WCF	.43 Spanish	.45-75 WCF	.56-52
.32 WSL	6x58 Sauer	4-in-1 blank	.43 Mauser	.45-90 WCF	.577 Snider

Bob Hayley
211 North River, PO Box 889, Seymour, TX 76380 Phone (940) 888-3352

Firearms News is loaded with exciting bargains on rifles, shotguns, revolvers, and pistols. Save on all kinds, makes, models, manufacturers, and vintages. Plus discover your best buys on ammo, optics, gun parts, and many more accessories, supplies, and services.

SUBSCRIBE NOW!

WWW.FIREARMSNEWS.COM

CURRENT SUBSCRIBERS GO TO MYMAGNOW.COM AND SELECT "CREATE DIGITAL ACCOUNT"

Digital edition is available on updated iPad/iPhone, most Android devices, and the Microsoft Store for Windows

R Miscellaneous For Sale \$4560

M55 Reising. Came from H&R in the 1980's. No metal on the wood stock. \$12,000. Doug Oefinger 863-444-1849. No pictures.

Winchester Rifles For Sale \$5080

Model 1886, 45-70, good/very good, manufactured 1889, \$2300. Model 1892 rifle, 44-40, fine, \$2200. Also 38-40 takedown octagon, fine, \$2400. All + shipping. Call 303-732-1847.

S Miscellaneous For Sale \$4820

Sauer Model 90 .300 Weatherby Magnum w/sling, recoil pad, Rosewood Forend, beautiful wood, checkered. Zeiss Diavari-ZA 2.5 10x52 scope included. Excellent Condition. 38 boxed Weatherby Magnum rounds included. No Returns. \$2,950 OTD. (941) 323-9417.

Accessories For Sale \$5200

AMMO, Antique/Obsolete, in original boxes. Most American sporting calibers including obsolete rimfires. NO lists, reloads, military/foreign. Ray Giles, RTG Sporting Collectibles LLC, 214-361-6577 www.rtgammo.com

RUGER MINI-14 RANCH SCOPE MOUNT

The absolute best mount for the Ruger Mini-14 Ranch. Machined from solid bar stock & made in the USA.



Visit our website for other mounts!

S&K Scope Mounts

70 Swede Hollow Rd - Sugar Grove, PA 16350, 800-578-9862
Email: comments@scopemounts.com

www.scopemounts.com

We Have a Huge Selection of Old and Hard to Find Shooting Supplies and Accessories!

Holsters | Gun Cases
Ammo | Reloading | Sights

Free Digital Catalog!



208 263-6953

8am - 4:30pm M - F PST
660 Vermeer Court, Ponderay, ID 83852

www.BUFFALOARMS.COM

STACKIN' EM DEEP AND SELLIN' EM CHEAP

CENTERFIRE SYSTEMS since 1992

GIVE US A CALL! IN-HOUSE CUSTOMER SERVICE REPS 6 DAYS A WEEK!



LOCK ORIGINAL FACTORY PARTS
OEM Factory GLOCK
Very Good Condition, 40S&W Replacement Parts Kit \$339.99 #KIT-G22

GUNSMITH'S Garage

1975 Original! Romanian AK 7.62x39mm Rifle Parts Kit with Wood Furniture \$299.99 #KIT-AK33

FEAR-HUG
SEMI-AUTO AR STYLE 12GA SHOTGUN
Accepts ALL MKA-style Mags & Drums!
Includes: (2) 5rd mags (4) chokes + case #SG0116 \$399.99 compare to \$529.99

Be the First to get Special Offers & Exclusive Deals sent directly to you when you subscribe @ centerfiresystems.com/t-subscribe.aspx It's fast, easy, and FREE!



PPS43-C
7.62x25mm PISTOL

MADE IN POLAND
PPS43-C 7.62x25mm Pistol with (3) FREE! 35rd Mags includes (1) 35rd magazine #PPS43-PIS \$419.99 compare to \$529.99

Bonus! Three for FREE!



Over aftermarket & factory 100 Mags & Drums for Glock starting at \$9.99

50rd 9MM Drum for GLOCK Pistols \$69.99 #DRLM0003

40S&W/9MM/45ACP Hi-Cap Mags for Glock YOUR CHOICE \$14.99 ea.

AR-15 .223 100rd Drum \$9.99 ea.



Original - U.S. PALM AK30 30rd 7.62x39mm AK-47 TangoDown Polymer Magazine Date Stamped May 2015 #MAG0585 \$21.99 compare to \$39.99

Over aftermarket & factory 100 AK-47 HiCap Mags & Drums to choose from

20 or 30 round AK-47 Magazines starting at \$9.99 ea.

20rd 30rd 40rd

75rd AK-47 Drum #DRUM0005 \$59.99

40rd AK-47 Magazines #MAGAKA-KR40 \$14.99 ea.



COLT Authentic Parts
Vietnam Issue Colt AR-223 M16A1 Parts Kit unmarked #KIT-AR-COLFD \$249.99



★★★★★
New Production Complete .45ACP
M1911A1 Pistol Parts Kit #KIT-191101 \$349.99

GEAR HUNTING TARGETS HOLSTERS FIREARMS MAGAZINES AMMUNITION OPTICS PARTS ACCESSORIES EAR & EYE PRO SURPLUS
M-F 9-6 Sat 9-2
800-950-1231 & CENTERFIRESYSTEMS.COM
and SO. MUCH. MORE...
24

PRICES & AVAILABILITY SUBJECT TO CHANGE WITHOUT NOTICE

Antiques S5270

SARCO, INC. -MIG 21 jet fighter cockpit section from the DDR (East German) Air Force. We have only one single-seater. ATF will not allow the import of military aircraft, so this is the end. Ours was saved from the smelter at the last possible minute. The single-seater will be missing the stick and maybe some instruments. The cockpit was cut out of existing planes that were phased out of service. **Single cockpit MIG - \$9000.00 MMP011.**

Please call us at (610) 250-3960 to order this item. These are oversized items. Cockpit shipped via truck at our 55% discount. See pictures of the actual unit and read more by visiting our website www.E-Sarcoinc.com.

Barrels For Sale S5280

CORSON'S BARRELS 1000 New, Used, and Obsolete Shotgun Barrels. Buy, Sell, Trade. 928-718-4282 Arizona. dccorson@citilink.net, www.corsonsbarels.com

Clips & Magazines For Sale S5380

VEPR & SAIGA METAL MAGAZINES U.S. Made. Also, AK floor plates. See us at: CSSPECS.COM or Call 386-490-1102

Gun Parts For Sale S5500

B&C Gunsmithing 928-854-8209 Charles Daly Miroku Shotgun Repairs. Original Parts. Gunsmith with over

forty years experience with CDM shotguns. We have 10,000 parts plus 12 other firearms manufacturers. B&C Gunsmithing, Call Monday-Thursday, 12 noon - 4pm, 928-854-8209.

Poppert's, Box 413, Glenside, PA 19038. www.PoppertsGunParts.com

GUN PARTS: You name it. Professional service since 1965. General Parts List, \$5. Traders Den, 1655 Olson Dr., Cook, MN 55723. Mail order or by appointment only. 218-666-5083.

Gun Parts Wanted S5501

Wanted: Colt Law Enforcement Carbine Complete Receiver. Serial Number Range 03 or 04. Call Jeff 412-421-3777.

Want A Bolt For 1912 Savage Model 25 Tube Loader Pump. John 928-681-3631.

Gun Safes For Sale S5520

Brown Gun Safe, 1100 lbs. American Made. Approx. 5'7" Tall x 18" Deep. 4 Number Combo w/Tool to Change. Fire Proof. No Shelves, 4 Trays on Inside of Door. No Guns or Ammo. \$800 or Best Offer. 619-818-6037.

Gunsmith & Dealer Services S5540

GUN BLUING and RESTORATION firearmfinishinginc.com

Firearms Refinishing. No More Rust! Parkerizing, Moly, Ceramic. Call 337-230-4815, alomar.resources@cox.net

PMD Gunsmithing Specializing in Firearm Restoration Rebluing, Stock Refinishing, and Repair. Better than New!

UNLEASH INCREDIBLE FIREPOWER WITH THE NEW HELL-FIRE GEN2™

- Installs quickly and easily
- Looks built in and part of your rifle
- Non Bumpfire Technology
- Can be shot firmly against shoulder
- Select fire Micro Adjust knob
- Can be fired with one hand for pistols
- Adjustable rate of fire-Up to 900 rpm
- ATF legal certificate
- Can be retrofitted to most anything
- Made in USA-All Metal- Patent Pending



INSTALLS IN SECONDS !!

CUSTOM FIT FOR AR15'S AND AK'S. RETROFIT PKG FOR OTHERS.

\$59.95

(plus S&H)

ALL NEW SNAP-ON VERSION ONLY \$34.95

ROCKINLOCK.COM ♦ FIREQUEST.COM ♦ (770) 249-2991

New!

HANDBOOK of Machine Gun Support Equipment and Accessories 1895-1945

By Robert G. Segel

For more information, reviews and to order your copy, visit:

www.EmmaGeeMan.com

Limited Edition *Free Shipping in the U.S.*

Foreword by Dolf Goldsmith



Summer Special! 12% Discount Limited Time Only!

Over 1,000 color pictures • 415 pages • Covers 77 different classic weapons • Spare parts/tools identified and labeled • Ideal visual reference for collectors, shooters, museums and re-enactors

MILLIONS OF GUN PARTS!!

WE NOW HAVE 300 MODELS ON THE WEB

VISA-MASTER-DISCOVER Company Check or MO.

BOB'S GUN SHOP P.O. Box 200 Royal, AR 71968

FAX 501-767-2750 www.gun-parts.com gunparts@hsnp.com

Like, comment and share all the latest news!

www.facebook.com/FirearmsNewsMag

Find us on

www.pmdgunsmithing.com
Call 330-240-5960 to receive FREE SHIPPING both ways with your restoration project.

RICK'S PLACE
Master Gunsmith
Full Line Gunsmith Shop
REPAIRS & RESTORATIONS
Metal & Wood Refinishing
Custom Barrels-Stocks-Grips-Guns
Choke Tube Installation/Removal
Barrels Threaded
Shotgun Barrel Straightening
Appraisals - FFL Transfers
Fire & Flood Insurance Claims
Bad@\$\$ Stuck Choke Tube
Removal Tool & Other
Custom Gunsmith Tools
More Services on Website
501-658-7347
rick@ricksplace.biz
www.ricksplace.biz

BARREL RELINING in .22 RF, 25-20, 32-20, 38-40, 44-40. Installing the finest liners, manufactured by Redman's. Professional Craftsmanship Guaranteed. Established shop of 41 Years.
Redman's Rifling & Reboring, 189 Nichols, Omak, WA 98841. 509-826-5512.
Prices & info www.redmansrifling.com

BROOMHANDLE BARREL RELINING
Broomhandles to 30 Mauser using the finest liners. Rust bluing available. Guaranteeing the finest job around. Established shop of 41 years.
Redman's Rifling & Reboring, 189 Nichols, Omak, WA 98841. 509-826-5512. Prices & Info: www.redmansrifling.com

GUNSMITH Roy Holland
Royboy01@charter.net
Smokey Hills Outdoor Store
19143 US Highway 71 North
Park Rapids, MN 56470
Store: 218-237-5099
Home: 218-732-8580

REAMERRENTALS.COM
ONLINE CATALOG

Handi-Racker.com
The Safest Way to Rack Your Pistols

Load and unload
Clear Jams
Aids in disassembly
Aids in assembly



patent #9,194,636

Dealer Inquires Welcome

MSRP was ~~\$29.99~~
NOW only \$24.99

(515) 480-4905

400+ Calibers Available.
Call (800) 996-0426.

Gunsmith & Dealer Supplies S5560

BARREL LINERS: 17 Mach II, 22RF, 25-20, 32-20, 38-40, 44-40. Satisfaction Guaranteed. Prices & info on website at www.redmansrifling.com

Gun Barrel Reboring Machine (hydraulically operated), tooling & training. This equipment is for reboring an existing barrel up to a bigger size. Not cheap but a rare opportunity. 509-429-6856.

Pratt & Whitney Sine Bar Rifling Machine. Call 509-429-6856.

SARCO, INC.- COMMERCIAL GUN STOCK LOTS FOR SHOW SALES! Fabulous opportunity to buy new commercial stocks & forends for brand names like Mossberg, S&W, Ithaca, Marlin, H&R, Winchester, Savage, etc. **One lot of 15 Stocks & forends with no duplicates for \$150.+Sh. (STK363).** Sell 3 pcs

HEAT TREAT OVENS
Take control of your heat treating. Evenheat offers a full line of heat treat ovens for private and commercial shops. Prices start at: \$750

evenheat
www.evenheat-kiln.com
PH: 989-853-2281 FAX: 989-856-4040

AMG INTERNATIONAL ARMORY
(All Military Gunsmithing)
Military Gunsmith
35 yrs. Experience
Former NATO Defense Contractor

Kit Building / Rebuild / Repair / Refinish
• FN-FAL • FN-49 • M-1 • Garand
• M-1 Carbine • British Enfields • M-1A
• AR-15 • 98's • O3's
• All U.S. and Foreign Rifles & Pistols
Repaired and much more!

Full Mil-Spec Finishes Including:
Parkerizing, Manganese Phosphate, Polymer, Teflon, Porcelainized Enamel and Bluing.

Premium AK Builds and Other Custom Builds Available!

GUY SNELEN • email: guyamg@centurytel.net
Phone: 417.754.1097 • M-F 9AM-4PM CST

At Hornady, we've got the brass!
Everything from the 17 Hornet to the 50 BMG. But it's the quality — not the quantity — where our brass really shines. We produce our cases in smaller lots for strict quality standards.



Best CASE Scenario
Hornady offers a full line of case preparation tools that give handloaders dependable and efficient results.

NEW



NEW



L-N-L® Impact Bullet Puller
Remove bullets from rifle and pistol cartridges without causing damage while capturing the bullet and powder for reuse.
Item No. 050092

Precision Measurement Station
For the most consistent cartridges, measure and sort components more precisely than ever before with several tools combined into a single unit.
Item No. 050078

Auto Charge® Pro **NEW**
The new Hornady® Auto Charge Pro provides precise, customizable powder dispensing in an easy-to-use, space-saving unit.
Item No. 050053



Hornady
Accurate. Deadly. Dependable.

1-308-382-1390 | hornady.com

RUBEN MENDIOLA DEALERNFA, INC. SINCE 1985

PO Box 566300, Miami, FL 33256-6300, 305-271-3436

TOLL FREE: 866-NFA-WANT (866-632-9268), FAX: 866-415-7066,

CELL: 786-256-6746 for pics or text, EMAIL: Ruben@dealernfa.com,

HOURS: 8am-9pm Eastern, 7 days a week

100s OF MACHINE GUNS ON SALE!!

Colt M16, M16A1, M16A2, 614, AR15 conversions, DIAS, Auto Links, all types and configurations.

HK MP5, MP5K-PDW, HK33, G3, HK51, HK21, Sear, Double Push Pin & Registered Receiver Guns.

HK Registered Machine Guns Sears.

Thompsons, Colt 21 & 28, WWII Savage & Bridgeport M1 & M1928 & Commercial Guns, Reisings, M2 Carbines, M3 Grease Guns, FNC, Ruger 556, AK47, MP40, MP44, Stens MKII, S&W 76, MK760, M10 45ACP & 9mm, M11 9mm & .380.

Maremont and Rock Island M60 & M60E6. Belt Fed 1919A4, 1917A1, Browning M2HB .50 Cal, FightLite MCR060 Belt Fed Uppers for AR15 or M16 Platforms.

Extremely Rare Museum Quality Very Early Presentation Colt 1918 BAR

Pre-May Sales Samples Available only to Dealers.

HK MP5, MP5K, HK33, HK53, Steyr AUGs, FN FAL, BAR, UZI Full Size & Mini, M3 Grease Guns, Thompson, Walther MPK & MPL, Beretta 93R LNIB & SC70, Restricted Post Sample: Glock 18

We are Always in the Market to Purchase Quality Machine Guns. We will never sell guns until they have been received and inspected. My staff and I welcome prospective clients to come and inspect the firearms they are interested in purchasing in our state of the art, high security facility. We are dedicated, full time dealers with a full-time staff. Every item we offer for sale is in stock and owned by us. We are not brokers, or a consignment store. We send every HK conversion to Terry Dyer for inspection and upgrade.

Please visit our website for the full list of inventory specials.



WE PROVIDE THE BEST QUALITY GUNS ON THE MARKET.

A Dealer You Can Trust!



www.dealernfa.com
ALWAYS PAYING TOP DOLLAR!

Gunsmith & Dealer Supplies S\$560

and your out of it! Rest is profit. Multiple lots get better price! Great for gun show and store sales. Sarco Inc. 610.250.3960 or visit www.E-Sarcoinc.com for a vast wealth of goodies !!

Militaria For Sale S\$700

Original WWII executed war criminal, Fritz Sauckel, Personal 8pc. silverware setting marked Bruckmann 90. Serving Spoon, Table Spoon, Table Knife, Butter Knife, Table Fork, Dessert Fork, Demitasse Spoon, very rare Sugar Tongs. Thuringen Eagle w/ Swastika. No Returns. \$2,250. (941) 323-9417.

SOVIET MILITARIA!

Trade & Buy. Send \$3 for Catalog. **RUSSIAN STORE**

FLECHETTE SHOTGUN AMMO
LONG RANGE - BORE SAFE - HIGH PERFORMANCE

STEEL DARTS

12 GA PATENTED SABOT HOLDS 19 NEW HEAT HEAT TREATED 8 GR FLECHETTES MV 1925 FPS
2 3/4" SHELL - CALL OR ORDER ONLINE

12GA 10RDS 12GA 25 RDS 12GA 100RDS

PRICE INCLUDES GROUND SHIPPING

SABOT DESIGNS LLC
541-770-6047 10AM-5PM PST
WWW.SABOTDESIGNS.COM

7657 Winnetka Ave, Suite #203, Winnetka, CA 91306
818-999-1257 russianstoreinla@yahoo.com

Indian Relics - B.C.
\$1.00 for Color Catalog.
Indian, P.O. Box 246
Independence, KY 41051

Militaria Wanted S\$700

I Want to Buy Firearm and Militaria Collections. 605-321-4402, Leave Message. ds57110@live.com

STEN MK-2 LOWER TRIGGER GROUP AND MAG HOUSING.
CALL 386-255-8888.

Miscellaneous For Sale S\$720

Ugly But Cheap! Prehistoric Authentic Indian Arrow Heads. Complete Undamaged. Found Lake Ozark Missouri. 21 For \$27.50. Makes Nice Display Frame. Indian Head Cent \$3.00; Silver Eagle, \$25.00. Satisfaction Guaranteed. Richard's 126-FN Honeysuckle, Eldon, MO 65026.

Mercury Metal 99% \$20/lb. \$20 Shipping; 5lbs. \$80 \$30 Shipping. Chloroform 99% 8oz./\$15 Shipping \$15. Salow, 270 Bighorn Drive, Estes Park, CO 80517.

Reloading Components S\$800 For Sale

BRASS
Once Fired Range Cleaned.

This may well be your last chance...



M249 SAW
10/22 kit sold separately

2020 TRIGGER CRANK BMF

Only
\$44.95
plus S&H

- Improved easier mount with smooth action.
- Made in USA.
- Works on .22's to .50 cal. All types.
- Works on most all pistols and rifles.
- Allows for single shots, bursts to emptying magazines.
- Mounts on and off in seconds.
- Still legal in most states. Check legality on website.

GET YOURS NOW WHILE YOU STILL CAN!

VISIT WWW.RAPIDFIRETRIGGERS.NET

9mm. \$35/1000
40 S&W \$35/1000
223/556 \$80/1000
For Other Calibers Call
Chuck. 623-341-9122.
www.bremersbrass.com

add 6.25% sales tax. No COD's or
credit cards.

J&D Components
75 East 350 North, Orem Utah 84057
www.jdcomponents.com

Tumbled 1000-89.99, 308 LC Primed
Unfired Brass, from ammo, 500-
140.00; See web for other Military-

Commercial Brass: New and Fired
BULLETS: 308 IMI M-80 147gr.
FMJ-500-89.00, Sierra 224-77gr.

Special match 500-118.00, WOLF 224
55 FMJ 1000-79.99, Hornady 224
55gr. PSP-FMJ 94.99m, Federal 223

RELOADERS

All Pistol & Rifle Calibers,
Inspected & Polished.
817-834-5716
thbrassman@aol.com

POWDER, BRASS-BULLETS:

Powder: WC844 (223) Virgin
surplus 159.00, 4+156.99, WC860-
69.00, 4+64.00, SALE WC872-WC867
48.00 Surplus, Unfired Primed LC
223 from ammo 500-79.99, 1000-
149.99; 223 LC military 60m , 45 Auto,

Granpa's Gun Parts

US Springfield Parts
Krag, 1903, Trapdoors,
Musketts & More!
www.granpasgunparts.com

SABOTS!

4,000 FPS out of your .30 caliber rifle?
It's possible with our sabots! You can
load and shoot .22 caliber bullets in any
.30 caliber cartridge. Our six fluted
design enables instantaneous separation
of sabot from the bullet at the muzzle.
Add \$5 for each order. Utah residents

CBRPS LLC.

Bullpup stock kits

AK
SKS
Saiga
Ruger
Remington
Mosin Nagant

www.cbrps.com

AAO www.AAOMFG.com

FOR MORE INFORMATION CALL US AT: (601) 514-0660

 <p>AR9 Dedicated Glock Magazine 80% lower with Last Round Bold Hold Open \$109.99</p>	 <p>80% AR15 Lowers - .223/5.56 - Mil-Spec \$38.50</p>
 <p>AR9 Dedicated S&W M&P Magazine 80% lower with Last Round Bold Hold Open \$109.99</p>	 <p>Mil-Spec Lower Parts Kits \$42.00</p>

We are a family owned and operated business that specializes in manufacturing innovative products for the 2A lifestyle.

ROCK ISLAND AUCTION COMPANY

Sporting & Collector Firearms Auction
OCTOBER 8TH, 9TH & 10TH
3 EXCITING DAYS
OVER 3,500 LOTS
7,000 GUNS

RIA
ROCK ISLAND AUCTION COMPANY

Undisputed World Leader for Quality Collectable and Antique Firearms

CATALOG ONLINE NOW!
WWW.ROCKISLANDAUCTION.COM

ALWAYS ACCEPTING QUALITY CONSIGNMENTS
Call 800-238-8022 or Email: guns@rockislandauction.com

To order your Catalog (\$35 Inc. S&H) (800) 238-8022
7819 42nd Street West, Rock Island, IL 61201 • **PHONE:** 309-797-1500 or 800-238-8022 • **FAX:** 309-797-1655 • **EMAIL:** info@rockislandauction.com • Fully Licensed Class III Auctioneer

Reloading Components \$5800 For Sale

55 FMJ m193 - 94.99m; 223 M855 62 FMJ -124.99; 223-M856 tracer, Military Surplus-99.00m; 50 API Silver Unsized 289m, Sized 339m, 50 Tracer 279.00, sized 329.00 See web for complete 50 Bullet List, plus WW-Remington-Hornady Commercial Bullets:

see web for current Prices: Brian McDonald 74880 Johnson Run Rd. Kimbolton, OH 43749 9AM-5PM, 330-833-4360 Fax No. 740-492-0063 Web: PatsReloading.com

SARCO, INC. - FLECHETTE DARTS: 1 inch long military flechettes

in stock. Sold in 2 oz. (#MISC288) and 1 lb. (#MISC307) packs. Original USGI. Sarco Inc., 610.250.3960. Visit www.E-Sarcoinc.com for a vast wealth of goodies !!

Reloading Equipment \$5821 Wanted

RELOADING EQUIPMENT & Gun

related stuff **WANTED!** Attention Estates, Gun Shops, Collectors! Sell me your no longer used reloading equipment, casting, gunsmithing equipment & tools. Presses, dies, molds, Stocks, grips and Misc. parts too. I buy the items left over after others buy the guns. Gladly travel for large collections. Call Rick (330)806-4169 or email ricketts711@sbcglobal.net

Visit www.E-Sarcoinc.com for a vast wealth of goodies !!

SARCO, INC. - RPG-2 ROCKETS (INERT) (#RL005): Original Vietnam era rockets with the warhead removed and replacement inert head installed. Great for completing your RPG launchers! Sarco Inc. 610.250.3960 Visit www.E-Sarcoinc.com for a vast wealth of goodies !!

THE ALL NEW "HELLFIRE RANCH™" RAPID FIRE TRIGGER SYSTEM FOR "NON-ASSAULT RIFLES". (PAT. PEND.)



\$39.95 (plus S&H)

INTRODUCING THE "MAGNABRACE™" ADJUSTABLE INSTANT ON/OFF OR PERMANENT PISTOL ARM BRACE. (PAT. PENDING.)



\$69.95 (plus S&H)

- Perfect for MINI-14, MINI-30, 10/22, and most Ranch Style Rifles with or without pistol grips.
- Goes ON and OFF in seconds.
- All Metal Construction.
- Allows for accurate aimed single shots, bursts, or emptying of magazines.
- Perfect for Varmints, Hog Shooting or Protection from any intrusion.
- Rapid Fire availability when you need it.
- ATF legal

- Installs instantly via a super strong directional magnetic system with a 70 lb. pull strength.
- Can be permanently installed with 3m adhesive disc included that is as strong as a metal rivet.
- 3 position snap detent system for quick and positive adjustment.
- Mounts on AK pistols, Dracos, Macs, Uzi and a host of others.
- Adds accuracy and rapid fire controllability.
- Looks fabulous on the guns.
- Tough polymer metal construction with velcro arm strap.
- NFA legality card included.

Snaps in place easily!

CALL (770) 249-2992 or go to ROCKINLOCK.COM or FIREQUEST.COM and watch the videos and get yours today!

Scopes, Rings & Bases \$5840 For Sale

RIFLESCOPES
Browse Online Catalog at 4scopes.com
Get Free Shipping!

Stocks & Grips For Sale \$5860

Precision Gunstock Duplicating of any wood. Gunstock repair, custom, restoration, and checking. My pattern and wood or yours. Quality work, fair price, quick turnaround. 570-637-3004, leave message.

Surplus Gear For Sale \$5880

SARCO, INC. - FRENCH 73MM BAZOOKA: LRAC-50 bazooka as used by the post war French in Vietnam & Algeria. Never on the market before. Comes with shield and optics, deactivated to ATF specs. Very limited!
Sarco Inc., 610.250.3960

SARCO, INC. - WW2 VEHICLE RADIO SETS: SCR528 (#RAD04), SCR506 (#RAD02), & SCR508 (#RAD03) radio sets with mounting bases. Perfect for completing your military vehicle. Supplies are dwindling. Sarco Inc., Call Dave or Mark: 610.250.3960 or visit www.E-Sarco.com for a vast wealth of goodies !!

Gun Shows \$6150

ATLANTA, G.A. Nov. 13-14, Atlanta Antique Gun & International Military Show, IMAW Local 709, Union Hall, 1032 S. Marietta Parkway, Marietta, Ga. Arms & Memorabilia of the Civil War, Indian Wars, WWI, WWII, etc. Info: [Carolina Trader Promotions](http://CarolinaTraderPromotions.com), 704-282-1339 www.TheCarolinaTrader.com

"(T)o disarm the people...(is) the best and most effectual way to enslave them..." George Mason, Virginia Ratification Convention, June 14, 1788.

FIREARMS NEWS CLASSIFIED ADVERTISING

For Questions: Please Call 1-800-521-2885, ext. 5064

CATEGORY _____ (For a list of available categories - Please Call 1-800-521-2885, ext. 5064)

PRINT ONE WORD PER SPACE - TWO WORDS FREE

1	2	3	4	5	6	7
8	9	10	11	12	13	14
15	16	17	18	19	FREE	FREE

Please use additional sheet of paper for larger ads.

MAIL COMPLETED FORM TO: **Firearms News, Dept. CL, 2 News Plaza, 3rd Floor, Peoria, IL 61614**
OR **EMAIL** AD AND ALL INFORMATION BELOW TO: FirearmsNews@outdoorsg.com

PLEASE INCLUDE FULL ADDRESS & PHONE NUMBER FOR OUR RECORDS

CLASSIFIED AD RATES

NAME _____
 ADDRESS _____
 CITY _____ STATE _____ ZIP _____
 DAYTIME PHONE _____

METHOD OF PAYMENT (payment due with ad placement)

Check/Money Order Enclosed MasterCard VISA Discover American Express

CARD # _____ Exp. Date _____
 SIGNATURE _____

_____ X 8pt plain @ 40¢	=	_____
_____ X 8pt bold @ 80¢	=	_____
_____ X 10pt bold @ \$1.00	=	_____
_____ X 10pt bold caps @ \$1.60	=	_____
_____ X 12pt bold @ \$1.80	=	_____
_____ X 12pt bold caps @ \$2.20	=	_____
X _____		# of issue(s)
START DATE: _____		\$ _____ Total Due
<input type="checkbox"/> Continue running until notified & charge credit card monthly.		MINIMUM: \$4.00

ELMS



EXPERT LASER MARKSMAN SYSTEM



Available Calibers

9MM .45ACP .40S&W
380ACP *10MM *.38SUPER
*9MM MAKAROV *.223
*.45 LONG COLT

*Available in Gen 2 - ELMS Gen3 available Winter 2020

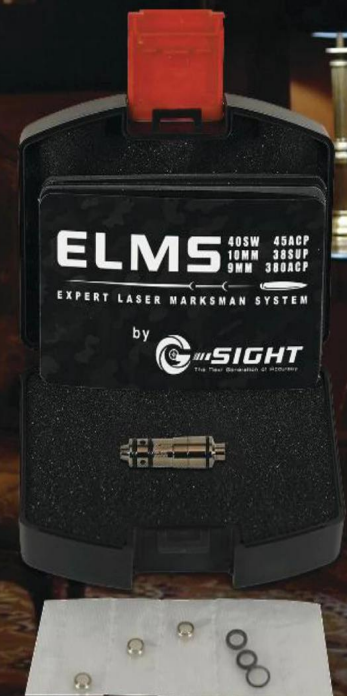

g-sight.com

TRAIN AT HOME WITH YOUR OWN GUN

Affordable Overkill®

Our LaRue trademarked 1-3-5™ Pricing:
1 at \$80 ea, 3 at \$75 each, and 5 (or more) at \$70 each.

Now available in a Straight Bow version, also machined from solid
S7 Tool steel. You won't find a better AR trigger on the market,
at any price.



MBT-2S

MBT-2S-SB

Each MBT Trigger comes with
a heavier spare spring that adds
a pound for those that need it.

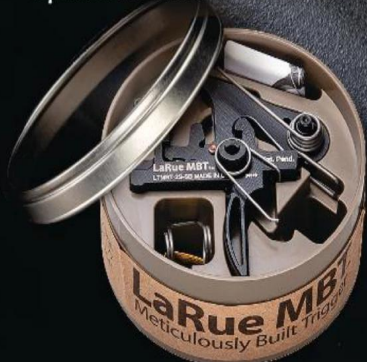

LaRue
Tactical
Made Dead-Center
of Texas, USA

www.LaRue.com

www.facebook.com/LaRueAccuracy
© 2019 APPI, all rights reserved

Visit www.MBTtrigger.com
to get this special deal and
read the MBT reviews
explaining why we've made
and sold over 100,000
LaRue MBT Triggers.