

CONTENTS

SERVICE MANUAL

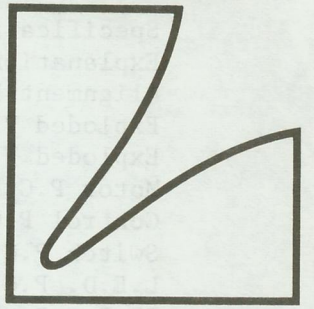

AUTO LIFT DIRECT DRIVE TURN TABLE WITHOUT CARTRIDGE *PD-284*

SPECIFICATIONS

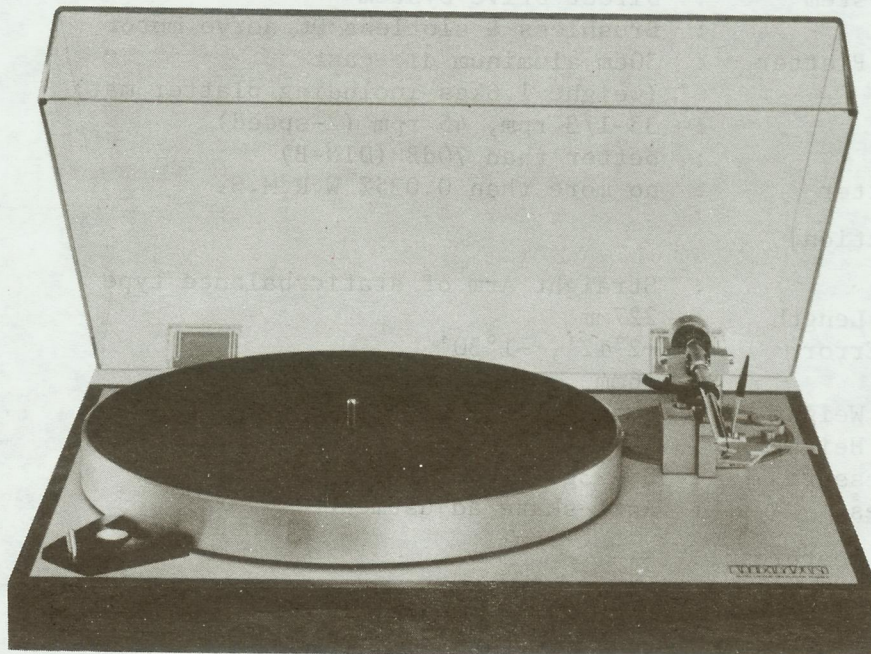

Specifications and appearance design subject to change without notice.

CONTENTS

Specifications	1
Explanation of Operation	2
Alignment Procedure	2
Exploded View	3
Exploded View Parts List	4
Motor P.C.B. Parts List	5
Control P.C.B. Parts List	6
Switch P.C.B. Parts List	6
L.E.D. P.C.B. Parts List	6
SP P.C.B. Parts List	6
Sensor P.C.B. Parts List	6
Motor Circuit Diagram	7
Schematic Diagram	7

SPECIFICATIONS

[Phono Motor Section]

- * Driving System : Direct-Drive System
- * Motor : Brushless & slotless DC servo motor
- * Turntable Platter : 30cm aluminum die-cast
(weight 1.6kgs including platter mat)
- * Rotation : 33-1/3 rpm, 45 rpm (2-speed)
- * S/N Ratio : better than 70dB (DIN-B)
- * Wow & Flutter : no more than 0.035% W.R.M.S.

[Tonearm Section]

- * Tonearm : Straight Arm of static balance type
- * Effective Length : 227mm
- * Tracking Error : +2°12', -1°30'
- * Overhang : 16mm
- * Cartridge Weight : 4.5g - 9.0g
- * Cartridge Height : 16mm - 19mm (by use of spacers)
- * Stylus Pressure : 0 - 3g (direct reading)
- * Accessories : Anti-skate adjustment

[additional Features]

- * Dust Cover : Detachable with semi-freestop hinge

[General]

- * Power Consumption : (CSA rated)
- * Dimensions : 438(W) x 128(H) x 350(D)mm
(17.5" x 5.1" x 14.0")
- * Weight : Net 5.4kgs (11.9 lbs.)
Gross 7.0kgs (15.4 lbs.)

Specifications and appearance design subject to change without notice.

EXPLANATIONS OF OPERATION

When the playback is over and the cartridge stylus is coming to the end grooves of the disc, the delivering arm cuts off the light between the L.E.D. of the sensor assembly and photo transistor PTr-1 (33 r.p.m.) or PTr-2 (45 r.p.m.). At this time, the photo transistor PTr-1 or PTr-2 is turned off.

Accordingly, the transistor X201 is also switched off and the collector voltage of the X201 comes to be "H" while the base voltage of the transistor X202 becomes "H" for about 2 seconds, which enables the solenoid to work for about 2 seconds.

Through this step, the hook of the trigger lever is removed, and the elevation axis is pushed up by the elevation spring, which induces the tone arm to come "UP".

At this time, the SCR turns to be "ON", and the X204 is also switched "ON", which puts the voltage at the pin (6) into the "L" status and eventually the motor stops.

When the tone arm is returned to the arm rest, the micro switch at the delivering arm turns the SCR off and whole secondary side of the mains is turned off.

ALIGNMENT PROCEDURE

(1) Adjustment of Rotation

- a. Set the speed selector switch to the 45 r.p.m.
- b. Set the external speed adjustment knob to the mechanical center position.
- c. Adjust the semi-fixed resistor VR1 in the motor control P.C.B. so that the stroboscope gets stationary.
- d. Set the speed selector switch to the 33 r.p.m.
- e. Adjust the semi-fixed resistor VR2 in the motor control P.C.B. so that the stroboscope gets stationary.

(2) Adjustment of auto-up position

Adjust the auto-up position rotating the hexahead bolt as illustrated.

- a. In case the auto-up position is found too late, rotate the hexahead bolt counter-clockwise.
- b. In case the auto-up position is found too fast, turn the hexahead bolt clockwise.

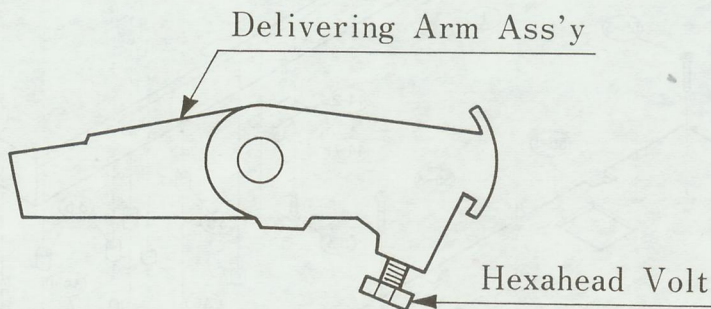

PACKING MATERIAL PARTS LIST

Remarks: Stock No. ... Important Parts in Stock
 Part No. ... Not in Stock

Symbol No.	Stock No.	Part No.	Description
	XAQ0006	873274	Carton
	XBQ0007	848677	Pad
	ME0209	ME0209	Owner's Manual
	WZ1047	WZ1047	Over Hang Gage

PD-284 EXPLODED VIEW

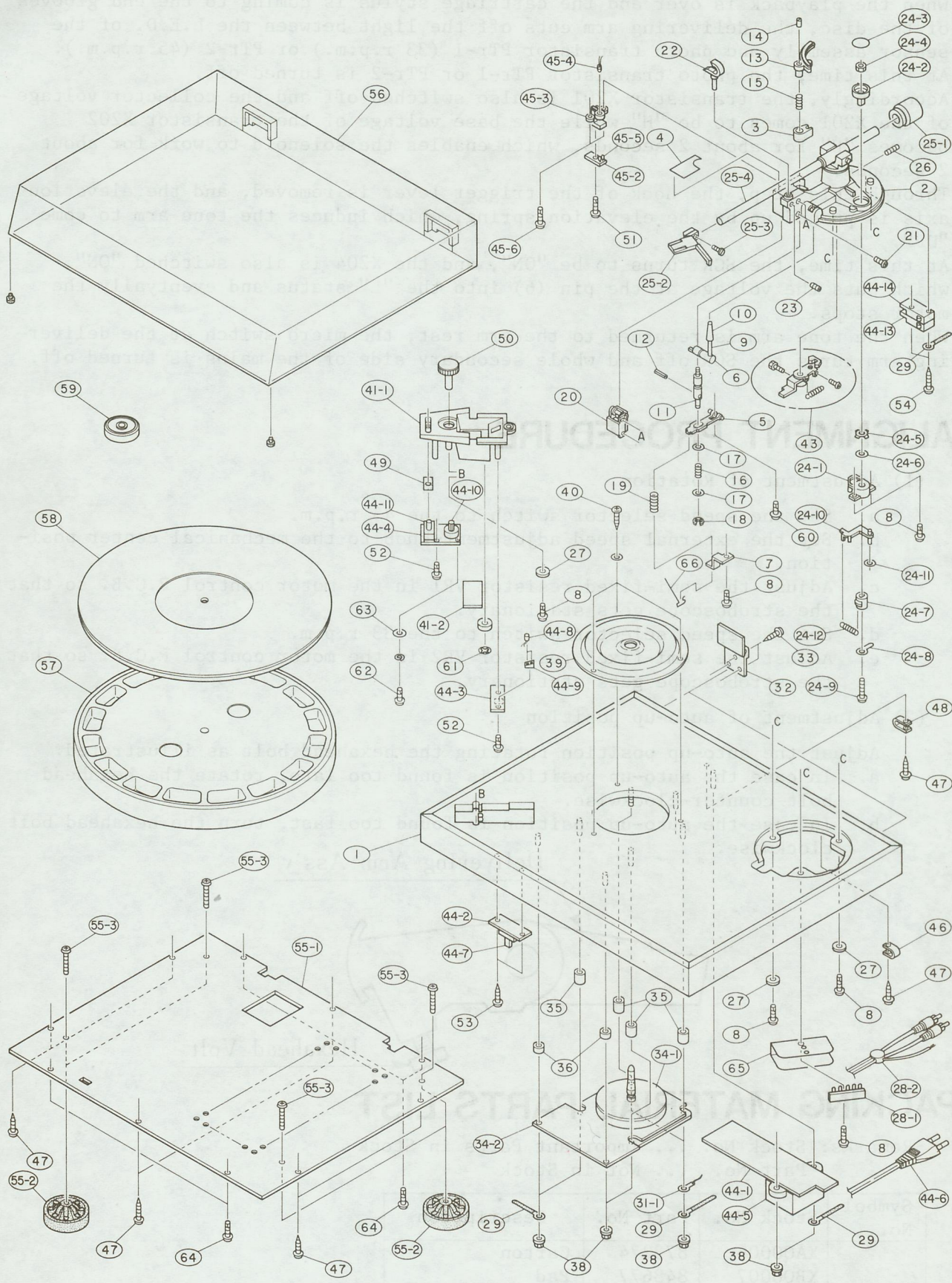

PD-284 EXPLODED VIEW PARTS LIST

Remarks: Stock No. ... Important Parts in Stock
 Part No. ... Not in Stock

Symbol No.	Stock No.	Part No.	Description	Symbol No.	Stock No.	Part No.	Description
				40	-	YJA30A08	FMT 3x8
1	WBQ0006	848438	Cabinet	41-1	WDQ0011	852570	Strobo Escutcheon
2	WZQ0020	852461	PU Base	41-2	UMQ0003	911562	Strobo Mirror
3	WZQ0021	911359	EL Guide	43	UOQ0016	911451	Delivering Ass'y
4	WLQ0003	911360	Name Plate	44-1	PCQ0002	852521-1	Control PCB
5	WZQ0006	911100	Trigger Lever	44-2	PCQ0003	852521-2	Switch PCB
6	UOQ0015	911101	Cue Cam	44-3	PCQ0004	852521-3	LED PCB
7	-	011102	Holder Plate	44-4	PCQ0005	852521-4	SP PCB
8	-	YJA30A08	FMT 3x8	44-5	PTQ0012	872878	Trans (SK)
9	WZQ0106	911104	Cue Lever		PTQ0013	872729	Trans (SG)
10	WZQ0107	896456	Lifter Knob		PTQ0014	872731-1	Trans (UZ, CSA) Old
11	-	911103	EL Shaft		PTQ0018	873340	Trans (UZ, CSA) New
13	WZQ0023	896269-1	EL Plate		PTQ0015	872732	Trans (EK, EG, EZ)
14	YZQ0101	896268-1	EL Nut	44-6	BK0012	895617-2	AC Cord (SK, EK)
15	UUQ0005	287680	Cam Spring		BK0023	897325	AC Cord (SG, EG)
16	UUQ0006	897936	Elevation Spring		BK0018	892435-1	AC Cord (UZ, CSA)
17	-	YWB030T	BSW 3x7x0.5	44-7	SSQ0001	873187	Slide SW SSB02206
18	-	YWJ022F	E Ring 2.2x0.5	44-8	TDQ0003	910217	LED AA5504S
19	UUQ0007	911106	Trigger Spring	44-9	-	911364	LED Escutcheon
20	AYQ0004	911436	Solenoid	44-10	RVQ0003	911386-2	VR. K161B 50K
21	-	YAA26A05	FM 2.6x5	44-11	SLQ0003	873188	Lever SW SLE622
22	WZQ0024	911450	Arm Rest	44-13	SPQ0011	911457	Micro SW (1)
23	YZQ0102	YMA26C04	Allen Hex 2.6x4	44-14	SPQ0012	911458	Micro SW (2)
24-1	WZQ0025	899888	IFC Base	45	APQ0014	911463	Sensor Ass'y
24-2	WJQ0007	MB1376B	IFC Knob	45-2	PCQ0006	852521-5	Sensor PCB
24-3	WLQ0002	MC4254	IFC Mark	45-3	UZQ0008	911108	Sensor Holder
24-4	-	YNA020G	Hex. Nut 2	45-4	TDQ0014	897917	LED GL5PR6
24-5	-	MB-0970	Friction Washer	45-5	TRQ0004	911462	Photo Tr. PT350
24-6	-	MC-0863	Polyslider W.	45-6	-	YJA30A08	FMT 3x8
24-7	-	MB-0786	IFC Shaft	46	-	911466	Nylon Clip
24-8	-	YZB030H	Earth Lug	47	-	YJA30C16	TPT 5 3x16
24-9	-	YAH20A14	Pan Screw 2x14	48	-	911466-1	Nylon Clip
24-10	UZQ0007	MC-0936	IFC Lever	49	WQQ0001	911464	Hemeron Sheet
24-11	-	YWB013T	W. 1.3x4.5x0.3	50	WJQ0008	911468	VR K1.0W
24-12	UUQ0008	MC-1499	IFC Spring	51	-	YJB30A10	FMT 3x10 2
25	WZQ0026	852531	PU Ass'y	52	-	YJB30A06	FMT 3x6 2
25-1	WZQ0022	WZQ0022	Weight	53	-	YJA30A10	FMT 3x10 1
25-2	WZ1191	WZ1191	Head Shell	54	-	YAA26A25	FM 2.6x25
26	-	YMA32C13	Allen Hex 4x10	55-1	WBQ0105	852534	Bottom Plate
27	-	YWB032A	FW 3.2x13x0.8	55-2	WNQ0003	893771	Foot
28-1	-	890979	5P Lug	55-3	-	YAA40A12	FM 4x12
28-2	BKQ0002	870771-2	Shield Wire Ass'y	56	WZQ0204	851888-4	Dust Cover
29	-	890755	Lug	57	UZ1248	620028	Turn Table
32	UZQ0106	898532	Hinge Ass'y	58	WZ1146	852563	Turn Table Sheet
33	-	YCA31A13	WM 3.1x13	59	WZQ0302	890876	EP Adapter
34-1	AMQ0003	AMQ0003	Motor DDM515M40	60	-	YJA30A08	TPT 3x8
34-2	AMQ0003	AMQ0003	Motor P.C.B.	61	-	YWG030M	CS-3
35	-	911127	Motor Column	62	-	YJA20A06	FMT 2x6
36	-	911128	Motor Column	63	-	YWZ033W	Fiver W. 3.3x10
38	-	YNKO40A	FLN 4	64	-	YJA30C12	TPT 3x12
39	UJQ0003	911117	Motor Cover	65	-	890959-1	Shield Plate

MOTOR P.C.B. PARTS LIST

Remarks; Capacitor: El ... Electrolytic, My ... Mylar, Ce ... Ceramic
 Resistor : Rd ... Carbon, Rm ... Metal Film, Ro... Oxide Metal

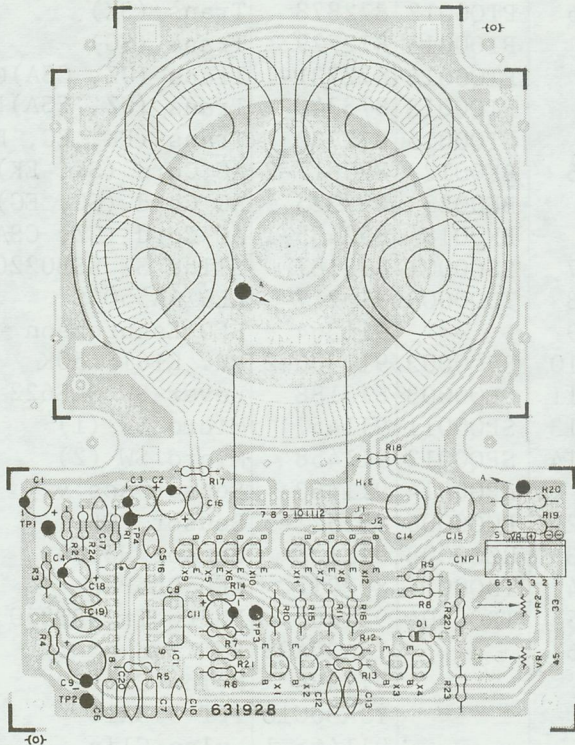

Symbol No.	Stock No.	Description			
IC					
IC1	TCQ0026	UPC1043C			
Capacitor					
C1	-	Non Use			
C2	CE0101	22 μ F	10-50WV	El	
C3	CE0091	4.7 μ F	10-50WV	El	
C4	CE0098	1 μ F	10-50WV	El	
C5	CQ1313	0.01 μ F	50WV	My	
C6	CQ1313	0.01 μ F	50WV	My	
C7	CQ1317	0.022 μ F	50WV	My	
C8	CQ1313	0.01 μ F	50WV	My	
C9	CK0067	0.01 μ F	16-50WV	Ce	
C10	CK0002	0.047 μ F	16-50WV	Ce	
C11	-	Non Use			
C12	CK0002	0.047 μ F	16-50WV	Ce	
C13	CK0002	0.047 μ F	16-50WV	Ce	
C14	CE0282	47 μ F	25WV BP	El	
C15	CE0238	47 μ F	25WV	El	
C16	CK0067	0.01 μ F	16-50WV	Ce	
C17	CK0121	0.0047 μ F	16-50WV	Ce	
C18	CK0067	0.01 μ F	16-50WV	Ce	
Resistor					
R1	RB0182	1K	1/4W	Rd	
R2	RB0248	560K	1/4W	Rd	
R3	RB0254	1M	1/4W	Rd	
R4	-	390 ~ 1K	1/2W	Ro	
R5	RB0230	100K	1/4W	Rd	
R6	RB0164	180	1/4W	Rm	
R7	RB0182	1K	1/4W	Rd	
R8	RB0158	100	1/4W	Rd	
R9	RB0158	100	1/4W	Rd	
R10	RB0182	1K	1/4W	Rd	
R11	RB0182	1K	1/4W	Rd	
R12	RB0212	18K	1/4W	Rd	
R13	RB0212	18K	1/4W	Rd	
R14	RB0220	39K	1/4W	Rd	
R15	RB0202	6.8K	1/4W	Rd	
R16	RB0202	6.8K	1/4W	Rd	
R17	RB0182	1K	1/4W	Rd	
R18	RB0182	1K	1/4W	Rd	
R19	RD0204	4.7	1/3W	Rd	
R20	RD0204	4.7	1/3W	Rd	
R21	RB0238	220K	1/4W	Rd	
R22	-	Non Use			
R23	RB0220	39K	1/4W	Rd	
R24	RB0214	22K	1/4W	Rd	

Symbol No.	Stock No.	Description
Transistor		
X1, X2	TR0029	2SC945 or 2SC2308 or 2SC1815 or 2SC278
X3, X8	TR0043	2SA733 or 2SA844 or 2SA1015 or 2SA641 or 2SA640 or 2SA1175
X9, X12	TRQ4021	2SC2001 or 2SC2120

CONTROL P.C.B. PARTS LIST

Remarks; Capacitor: El ... Electrolytic, Ce ... Ceramic
Resistor : Rd ... Carbon, Ro ... Oxide Metal

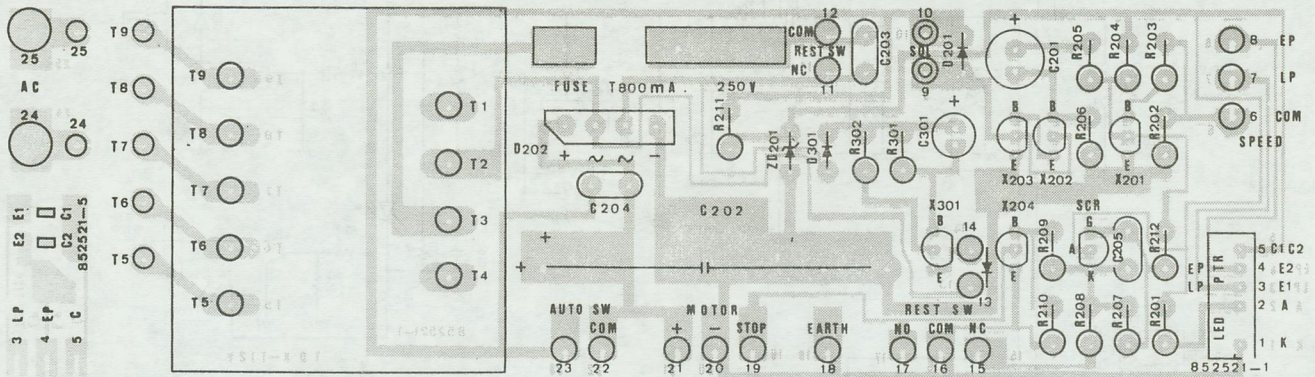

Symbol No.	Stock No.	Description
Transistor		
X201	TR0029	2SC945 or 2SC2308
X202	TR0029	2SC945 or 2SC2308
X203	TRQ4021	2SC2001 or 2SC2236
X204	TR0029	2SC945 or 2SC2308
X301	TR0029	2SC945 or 2SC2308
Thyristor		
SCR	TFQ1003	03P05M
Diode		
D201	TD5012	1S953 or 1SS53
D202	TD0137	S1VB10
D301	TDQ0515	F14A
Zener Diode		
ZD201	TDQ0232	RD9.1EB3
Capacitor		
C201	CE0118	47µF 25WV El
C202	CE0119	1000µF 35WV El
C203	CK0067	0.01µF 50WV Ce
C204	CK0067	0.01µF 50WV Ce
C205	CK0070	0.1µF 12WV Ce
C301	CE0114	3.3µF 25WV El

Symbol No.	Stock No.	Description
Resistor		
R201	RC0249	1K 1/4W Rd
R202	RC0298	100K 1/4W Rd
R203	RC0274	10K 1/4W Rd
R204	RC0261	3.3K 1/4W Rd
R205	RC0274	10K 1/4W Rd
R206	RC0278	15K 1/4W Rd
R207	RC0249	1K 1/4W Rd
R208	RC0249	1K 1/4W Rd
R209	RC0286	33K 1/4W Rd
R210	RC0278	15K 1/4W Rd
R211	RS5039	270 1 W Ro
R212	RC0259	2.7K 1/4W Rd
R301	RC0286	33K 1/4W Rd
R302	RC0233	270 1/4W Rd
Fuse		
-	BR0237	T800mA 250V (S, E)
-		1.25A 250V (UZ, CSA)

SWITCH P.C.B. PARTS LIST

Symbol No.	Stock No.	Part No.	Description
	SSQ0001	873187	Slide SW SSB02206

L.E.D. P.C.B. PARTS LIST

Symbol No.	Stock No.	Part No.	Description
	TAQ0003	911773	L.E.D. PR5504S

SP P.C.B. PARTS LIST

Symbol No.	Stock No.	Part No.	Description
	RVQ0003	911386-2	VR K161B 50K
	SLQ0003	911457	Lever SW SLE622

SENSOR P.C.B. PARTS LIST

Symbol No.	Stock No.	Part No.	Description
	TDQ0014	897917	L.E.D. GL5PR6
	TRQ0004	911462	Photo Tr. PT-350

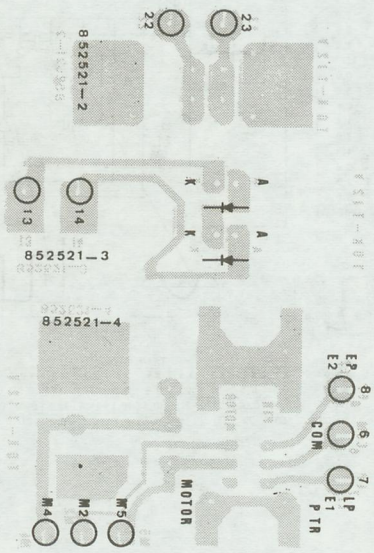

PD-284 SCHEMATIC DIAGRAM

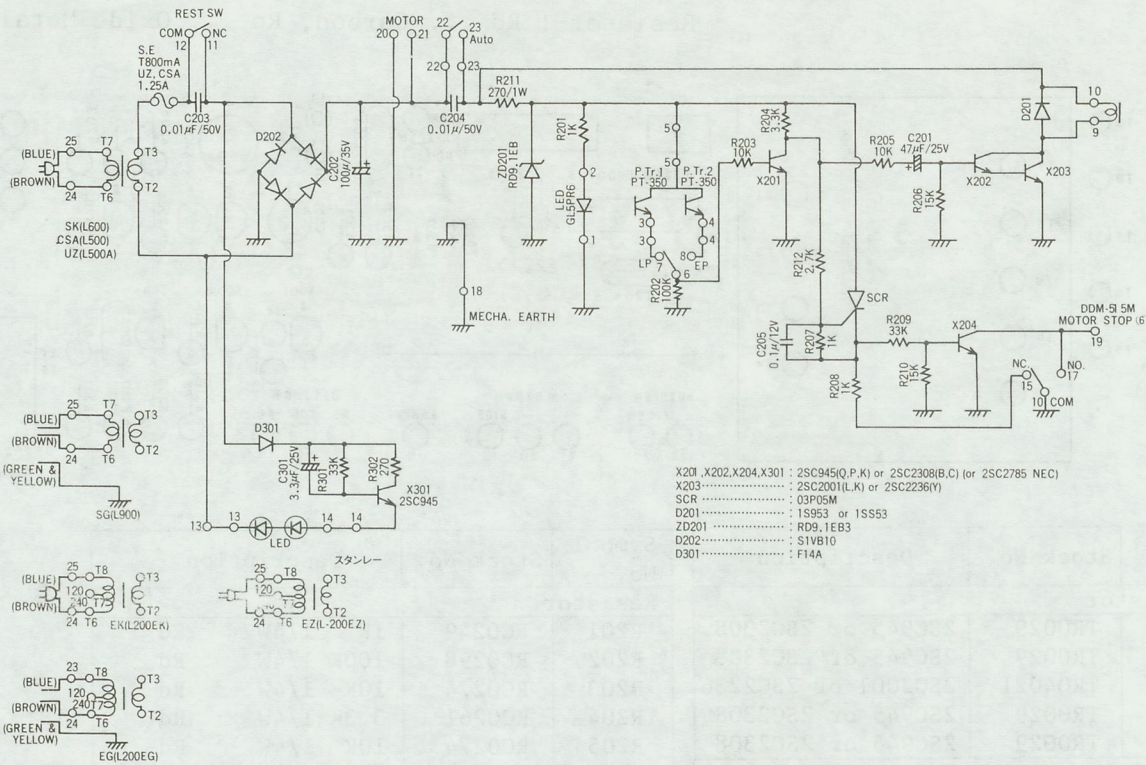

PD-284 MOTOR CIRCUIT

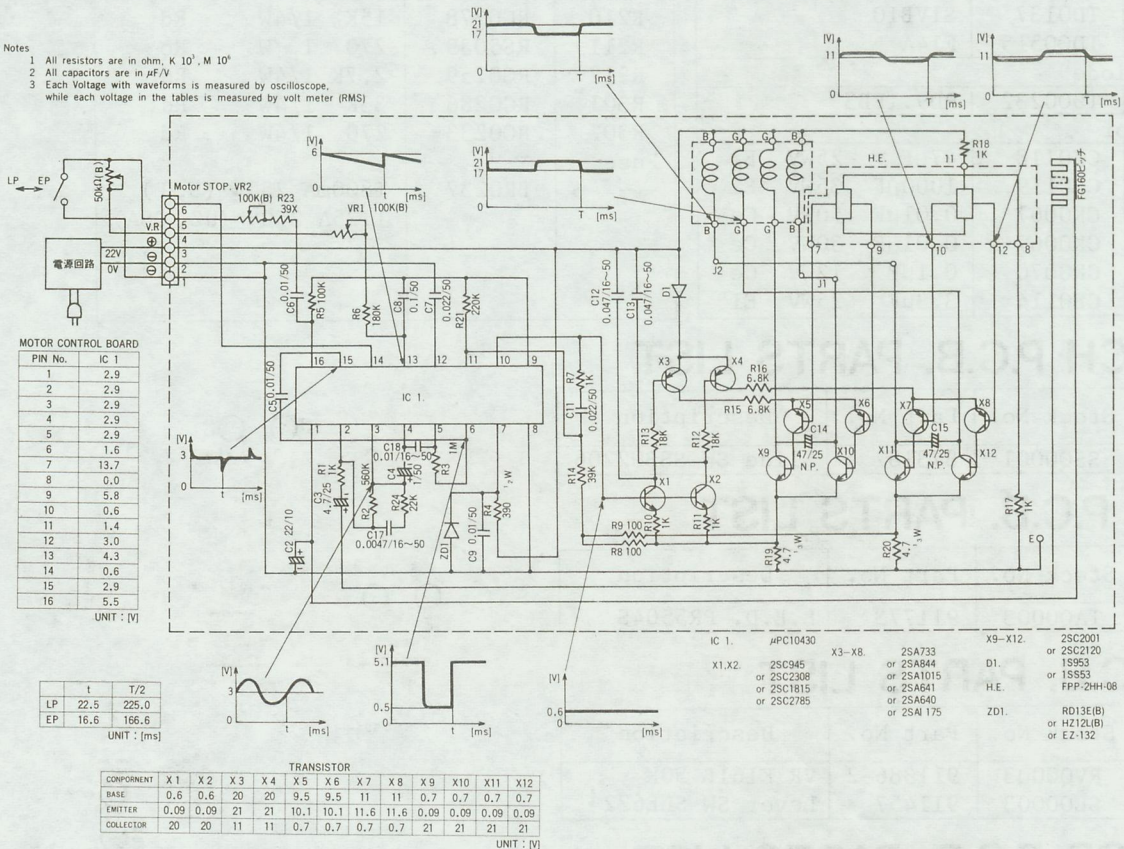

LUX CORPORATION, JAPAN

1-1, 1-CHOME, SHINSENRI-NISHIMACHI, TOYONAKA-SHI, OSAKA
PHONES: 06-834-0004 CABLE: LUXMAN TOYONAKA TELEX: J63694