









MÜHENDİSLİK  
San. ve Tic. Ltd. Şti.

# Content

	S-JAXIF3 F300 Axial Jet Fan	6
	S-JAXIF4 F400 Axial Jet Fan	7
	S-JRADF3 F300 Centrifugal Jet Fan	8
	S-JRADF4 F400 Centrifugal Jet Fan	9
	S-AXI Axial Pressurization Fan	10
	S-TAXIF300 F300 Axial Smoke Exhaust Fan	14
	S-TAXIF400 F400 Axial Smoke Exhaust Fan	18
	S-PAXI Axial Fan With Ex-proof Motor	22
	S-HAXI Axial Box Fan	26
	S-DAXI Belt Driven Axial Fan	30
	S-BAXI Bifurcated Axial Fan	34
	S-CAXI Roof Mounted Horizontal Discharge Axial	39
	S-AXIF Roof Mounted F300 Smoke Exhaust Fan	43
	S-CTAXIF4 Roof Mounted F400 Smoke Exhaust Fan	47
	S-CAXIDIK Roof Mounted Vertical Discharge Axial Fan	51

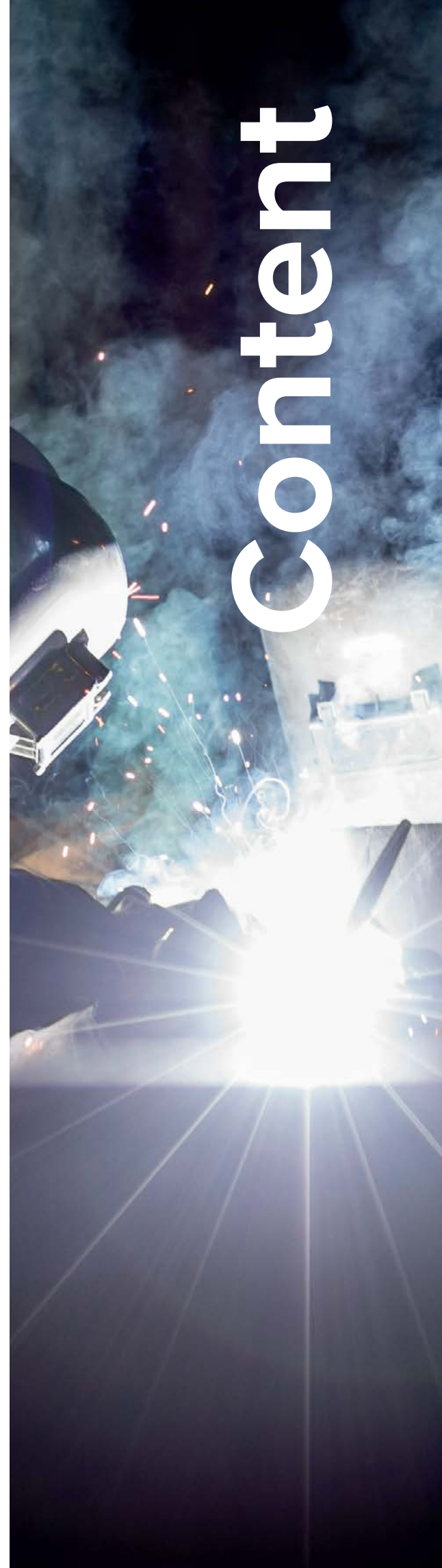

# Content

	S-SOF Evaporator and Cooler Fan	55
	S-AXIS Axial In-line Duct Fan	57
	S-DAXIS Wall-Mounted Axial Fan	59
	S-AXIP Wall Mounted Axial Fan With Plastic Blades	61
	S-KAF Mixed Flow Plastic in-line Fan	64
	S-RAD Centrifugal In-line Circular Duct Fan	66
	S-REC Centrifugal In-line Rectangular Duct Fan	68
	S-DREC Cent. In-line Rectangular Duct Fan Motor Out Of Air	71
	S-MEF Kitchen Exhaust Fan	73
	S-HMEF Kitchen Exhaust Box Fan	75
	S-HASP Box Fan	79
	S-EC-CRAD Roof Mounted Horizontal Discharge EC Motor Fan	82
	S-CRAD Roof Mounted Horizontal Discharge Centrifugal Fan	84
	S-CRADIK Roof Mounted Vertical Discharge Centrifugal Fan	87



	S-MRAD	
	Roof Mount. Horizontal Dis. Cent. Fan Motor Out Of Air	91
	S-DRAD	
	Roof Mount. Horizontal Dis. Cent. Fan Motor Out Of Air	93
	S-DRADIK	
	Roof Mounted Vertical Dis. Cent. Fan Motor Out Of Air	95
	S-KAZ	
	Single-Inlet Centrifugal Fan With Aluminium Body	98
	S-SAL	
	Single-Inlet Centrifugal Fan	99
	S-IGK	
	Heat Recovery Unit	102
	S-SHU	
	Shelter Ventilation Unit	104
	S-FFU	
	Fan Filter Unit	108
	S-CFD-VFD	
	Fan Accessories	110
	S-HFFU	
	Fan Filter Unit	112
	S-BAF	
	Bathroom Fan	114
	S-SEF	
	Silent Bathroom Fan	116
	S-YUF	
	Circular Bathroom Fan	118
	Rectangular Duct Assembly Parts	
	Flange, Corner, G-Clamps I	120
	Circular Air Duct Accessories	
	Circular Duct Accessories	121



## VENTILATING CALCULATIONS

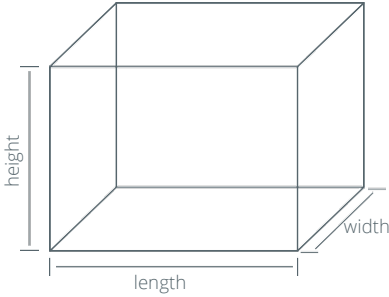

- ▶ Volume (V)= width(a)x length(b)x height(h)  
Flow Rate= V x k  
k: Air change rate

For a simple ventilating calculation first the volume of the subject place is calculated. Then the volume is multiplied with the air change rate to find flow rate. The air flow rate changes regarding to the subject place. Air change rate for different places are given in the table below.

*There should be 30 to 60 m<sup>3</sup>/h fresh air per person in the subject place. By multiplying number of people with the amount of fresh air needed per person we can calculate the total amount of fresh air needed in the subject place.*

### ▶ AIR CHANGE RATE TABLE

PLACE	AIR CHANGE RATE	PLACE	AIR CHANGE RATE
Bank	8 - 10	Laboratory	4 - 6
Paint Shop	30 - 60	Restaurant	6 - 10
Laundry	20 - 30	Office	6 - 10
Class	6 - 10	Parking Lot	9 - 10
Foundry	20 -30	Industrial Kitchen	15 - 20
Wedding Hall	10 - 15	Cinema	10 - 15
Warehouse for Meat and Egg	10 - 20	Gym	8 - 10
Domestic Kitchen	10 - 15	Theatre	10 - 15
Factory	6 - 10	Meeting Hall	6 - 10
Hospital	4 - 6	Restroom	10 - 15
Cafe	10 - 12	Swimming Pool	20 -30
Residence	1 - 2		

## CALCULATION OF AIR DUCT CROSS SECTION

There are two ways of calculating air duct cross section

### 1- VELOCITY METHOD

In this method velocity of the air through air ducts are estimated. This velocity starts at 6 m/s at the outlet of the unit and 'drops down to 3 m/s in comfortable applications.

On the air duct calculator, we make the flow rate and velocity marks that we choose meet. In this example when 10000 m<sup>3</sup>/h flow rate meets with 5 m/s velocity which gives us cross section of 90 cm x 60 cm. In air ducts the width to height ratio cannot be bigger than 3 to 1.

### 2- EQUIVALENT FRICTION LOSS METHOD

In this method the pressure loss for every meter of air duct is determined and diameter of the duct is calculated with regard to this pressure loss. The pressure loss can be between 0.70 Pa/m to 1 Pa/m. In this example for 4000 m<sup>3</sup>/h flow rate and 0.70 Pa/m pressure loss the diameter of air duct should be 52 cm. On the other side of the calculator we can determine that the rectangular air duct with the cross section 50 cm x 40 cm is equal to a 52 cm diameter circular air duct. We can apply this method through all air ducts.

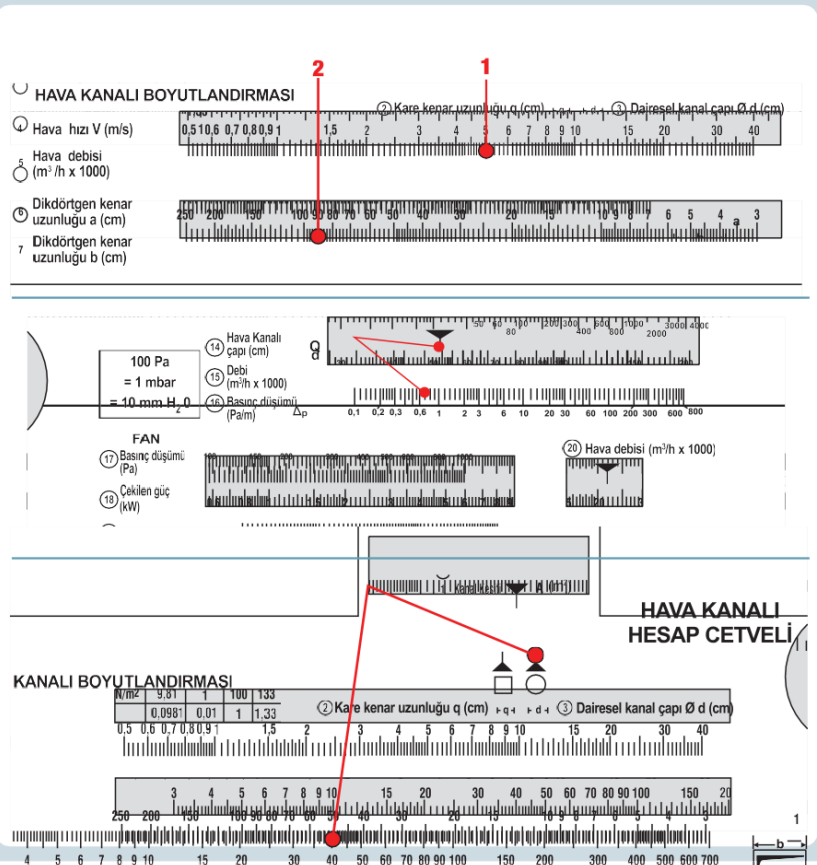



Jet fans are designed to be used at underground parking lots. They are more efficient than duct system where the air has to go through ducts and will lose power because of friction.



MOTOR INSULATION CLASS	H CLASS
MOTOR PROTECTION CLASS	IP 54-IP 55
MOTOR EFFICIENCY CLASS	IE1-IE2
MOTOR ENCLOSURE TYPE	TEAO
MOTOR BRAND	
BODY MATERIAL	GALVANIZED SHEET METAL
BODY COATING	OPTIONAL
IMPELLER MATERIAL	ALUMINIUM
DUTY CYCLE	IEC Duty Cycle-S1
WORKING AMBIENT TEMPERATURE	-20 - +50 °C
DIRECTIVE	IEC-60335-2-80, ISO 1940-1, EN 12101-3

MODEL	FLOW RATE (m³/h)	AIR SPEED (m/s)	THRUST FORCE (N)	REVOLUTION (rpm)	MOTOR POWER (kW)	NOISE LEVEL (dB(A)-1m)	PRICE
S-JAXI 315	2.600 - 5.200	10,0 - 20,0	9 - 36	1.500 - 3.000	0,20 - 0,80	71 - 85	
S-JAXI 355	3.650 - 7.300	10,9 - 21,9	14 - 56	1.500 - 3.000	0,37 - 1,50	74 - 87	
S-JAXI 400	5.200 - 10.400	12,2 - 24,4	22 - 88	1.500 - 3.000	0,50 - 2,20	76 - 90	
S-JAXI 450	7.250 - 14.500	13,3 - 26,6	32 - 128	1.500 - 3.000	0,80 - 3,10	79 - 93	
S-JAXI 500	9.550 - 19.100	14,1 - 28,2	45 - 180	1.500 - 3.000	1,10 - 4,40	81 - 95	

## OPTIONS



- SYSTEM AUTOMATION
- BI-DIRECTIONAL FAN
- CFD ANALYSIS

DEFLECTOR	
SIZE	PRICE
315	
355	
400	
450	
500	

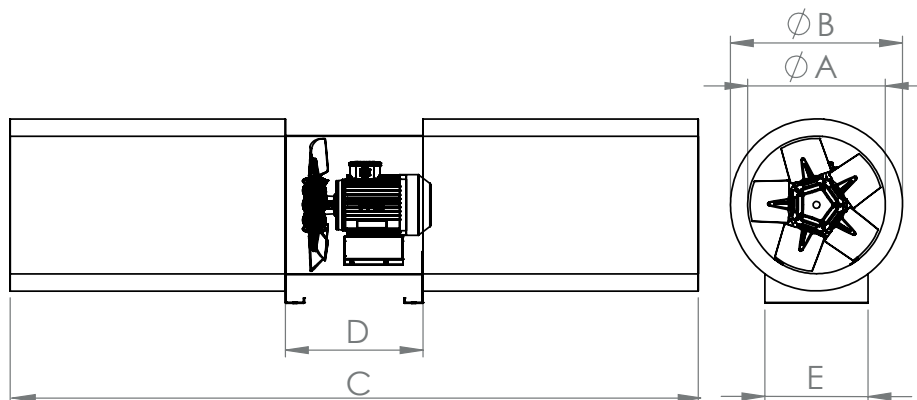

MODEL	A (mm)	B (mm)	C (mm)	D (mm)	E (mm)
S-JAXI 315	315	415	2000	400	300
S-JAXI 355	355	455	2000	400	330
S-JAXI 400	400	500	2000	400	350
S-JAXI 450	450	550	2000	400	450
S-JAXI 500	500	600	2000	400	450



Jet fans are designed to be used at underground parking lots. They are more efficient than duct system where the air has to go through ducts and will lose power because of friction.



MOTOR INSULATION CLASS	H CLASS
MOTOR PROTECTION CLASS	IP 54-IP 55
MOTOR EFFICIENCY CLASS	IE1-IE2
MOTOR ENCLOSURE TYPE	TEAO
MOTOR BRAND	
BODY MATERIAL	GALVANIZED SHEET METAL
BODY COATING	OPTIONAL
IMPELLER MATERIAL	ALUMINIUM
DUTY CYCLE	IEC Duty Cycle-S1
WORKING AMBIENT TEMPERATURE	-20 - +50 °C
DIRECTIVE	IEC-60335-2-80, ISO 1940-1, EN 12101-3

MODEL	FLOW RATE (m³/h)	AIR SPEED (m/s)	THRUST FORCE (N)	REVOLUTION (rpm)	MOTOR POWER (kW)	NOISE LEVEL (dB(A)-1m)	PRICE
S-JAXI 315	2.600 - 5.200	10,0 - 20,0	9 - 36	1.500 - 3.000	0,20 - 0,80	71 - 85	
S-JAXI 355	3.650 - 7.300	10,9 - 21,9	14 - 56	1.500 - 3.000	0,37 - 1,50	74 - 87	
S-JAXI 400	5.200 - 10.400	12,2 - 24,4	22 - 88	1.500 - 3.000	0,50 - 2,20	76 - 90	
S-JAXI 450	7.250 - 14.500	13,3 - 26,6	32 - 128	1.500 - 3.000	0,80 - 3,10	79 - 93	
S-JAXI 500	9.550 - 19.100	14,1 - 28,2	45 - 180	1.500 - 3.000	1,10 - 4,40	81 - 95	

## OPTIONS



- SYSTEM AUTOMATION
- BI-DIRECTIONAL FAN
- CFD ANALYSIS

DEFLECTOR	
SIZE	PRICE
315	
355	
400	
450	
500	

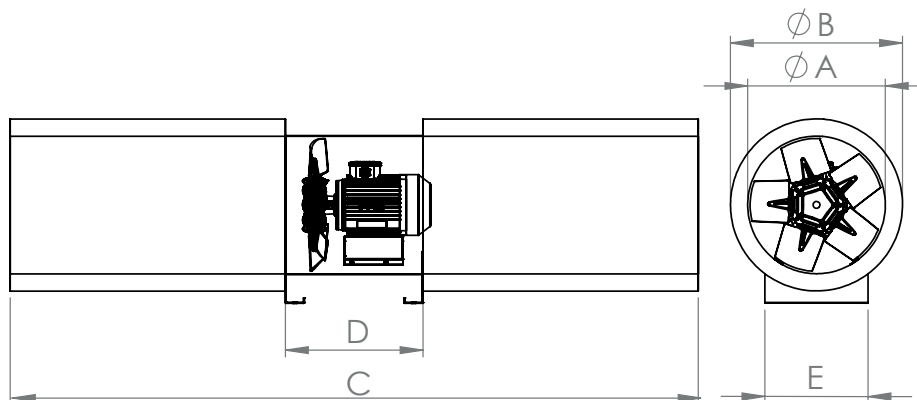

MODEL	A (mm)	B (mm)	C (mm)	D (mm)	E (mm)
S-JAXI 315	315	415	2000	400	300
S-JAXI 355	355	455	2000	400	330
S-JAXI 400	400	500	2000	400	350
S-JAXI 450	450	550	2000	400	450
S-JAXI 500	500	600	2000	400	450



Centrifugal Jet Fans can be used when there is height issue in the parking lots.



MOTOR INSULATION CLASS	H CLASS
MOTOR PROTECTION CLASS	IP 54-IP 55
MOTOR EFFICIENCY CLASS	IE1-IE2
MOTOR ENCLOSURE TYPE	TEAO
MOTOR BRAND	
BODY MATERIAL	GALVANIZED SHEET METAL
BODY COATING	OPTIONAL
IMPELLER MATERIAL	GALVANIZED SHEET METAL
DUTY CYCLE	IEC Duty Cycle-S1
WORKING AMBIENT TEMPERATURE	-20 - +50 °C
DIRECTIVE	IEC-60335-2-80, ISO 1940-1, EN 12101-3

MODEL	FLOW RATE (m³/h)	AIR SPEED (m/s)	THRUST FORCE (N)	REVOLUTION (rpm)	MOTOR POWER (kW)	NOISE LEVEL (dB(A)-1m)	PRICE
S-JRAD 50	2.850 - 5.760	10,0 - 20,0	13 - 50	750 - 1.500	0,30 - 1,20	38 - 54	
S-JRAD 70	3.500 - 7.009	12,2 - 24,4	19 - 70	750 - 1.500	0,55 - 2,20	43 - 58	
S-JRAD 90	3.800 - 7.641	13,3 - 26,6	25 - 90	750 - 1.500	0,55 - 2,20	46 - 62	

## OPTIONS

- SYSTEM AUTOMATION
- CFD ANALYSIS

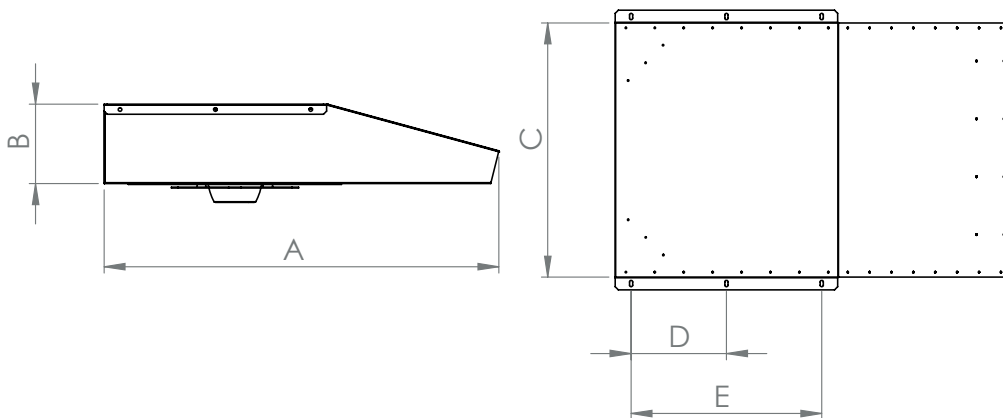

MODEL	A (mm)	B (mm)	C (mm)	D (mm)	E (mm)
S-JRAD 50	1215	250	800	300	600
S-JRAD 70	1300	300	840	300	600
S-JRAD 90	1300	300	840	300	600





Centrifugal Jet Fans can be used when there is height issue in the parking lots.



MOTOR INSULATION CLASS	H CLASS
MOTOR PROTECTION CLASS	IP 54-IP 55
MOTOR EFFICIENCY CLASS	IE1-IE2
MOTOR ENCLOSURE TYPE	TEAO
MOTOR BRAND	
BODY MATERIAL	GALVANIZED SHEET METAL
BODY COATING	OPTIONAL
IMPELLER MATERIAL	GALVANIZED SHEET METAL
DUTY CYCLE	IEC Duty Cycle-S1
WORKING AMBIENT TEMPERATURE	-20 - +50 °C
DIRECTIVE	IEC-60335-2-80, ISO 1940-1, EN 12101-3

MODEL	FLOW RATE (m³/h)	AIR SPEED (m/s)	THRUST FORCE (N)	REVOLUTION (rpm)	MOTOR POWER (kW)	NOISE LEVEL (dB(A)-1m)	PRICE
S-JRAD 50	2.850 - 5.760	10,0 - 20,0	13 - 50	750 - 1.500	0,30 - 1,20	38 - 54	
S-JRAD 70	3.500 - 7.009	12,2 - 24,4	19 - 70	750 - 1.500	0,55 - 2,20	43 - 58	
S-JRAD 90	3.800 - 7.641	13,3 - 26,6	25 - 90	750 - 1.500	0,55 - 2,20	46 - 62	

## OPTIONS

- SYSTEM AUTOMATION
- CFD ANALYSIS

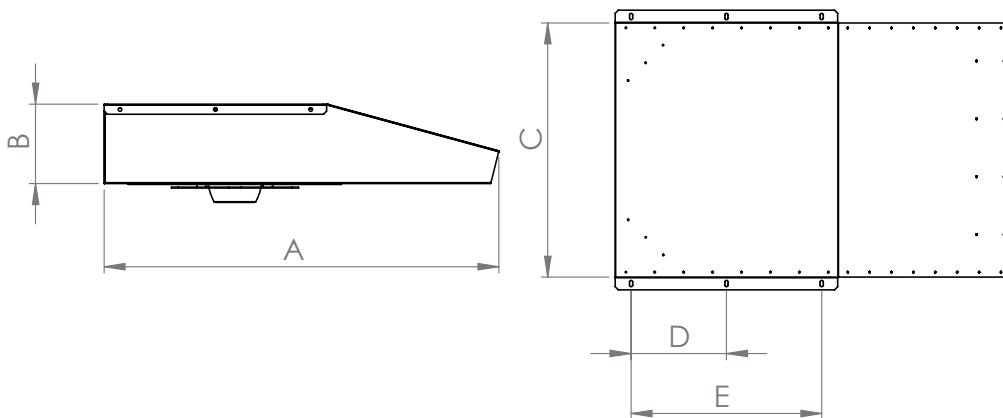

MODEL	A (mm)	B (mm)	C (mm)	D (mm)	E (mm)
S-JRAD 50	1215	250	800	300	600
S-JRAD 70	1300	300	840	300	600
S-JRAD 90	1300	300	840	300	600



Axial Pressurization Fans are used in staircases, elevator shafts and other needs for pressurization. It can be used in high volume-low pressure systems.

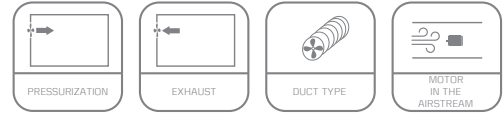

MOTOR INSULATION CLASS	F CLASS
MOTOR PROTECTION CLASS	IP 55
MOTOR EFFICIENCY CLASS	IE2-IE3
MOTOR ENCLOSURE TYPE	TEFC
MOTOR BRAND	
BODY MATERIAL	GALVANIZED SHEET METAL
BODY COATING	OPTIONAL
IMPELLER MATERIAL	ALUMINIUM
DUTY CYCLE	IEC Duty Cycle-S1
WORKING AMBIENT TEMPERATURE	-20 - +50 °C
DIRECTIVE	IEC-60335-2-80, ISO 1940-1

MODEL	VOLTAGE (V)	FREQUENCY (Hz)	POWER (kW)	REVOLUTION (rpm)	FLOW RATE (m³/h)	NOISE LEVEL (dB(A))	PRICE
S-AXI 400-5-25	380	50	0,37	1.450	2.950	66	
S-AXI 450-5-25	380	50	0,55	1.456	4.250	69	
S-AXI 500-5-25	380	50	0,55	1.453	6.000	72	
S-AXI 560-5-25	380	50	0,75	1.466	8.200	75	
S-AXI 630-5-30	380	50	1,10	1.465	13.600	80	
S-AXI 710-5-30	380	50	1,50	1.472	19.400	83	
S-AXI 800-5-30	380	50	2,20	1.459	26.000	85	
S-AXI 800-5-35	380	50	3,00	1.463	31.500	89	
S-AXI 900-5-35	380	50	4,00	1.471	40.000	90	
S-AXI 900-5-40	380	50	5,50	1.472	45.500	93	
S-AXI 1000-5-40	380	50	7,50	1.478	55.000	94	
S-AXI 900-8-40	380	50	11,00	1.454	47.000	94	
S-AXI 1000-8-40	380	50	15,00	1.456	62.500	97	
S-AXI 1000-8-45	380	50	18,50	1.458	70.000	99	
S-AXI 1120-8-40	380	50	22,00	1.471	87.500	100	
S-AXI 1120-8-45	380	50	30,00	1.474	96.000	102	

Values are for 0 Pa.

## OPTIONS



GRILLE GUARD		SUPPORT FEET		DUCT FLANGE		CONNECTOR		RUBBER PAD		SPRING		PANEL	
SIZE	PRICE	SIZE	PRICE	SIZE	PRICE	SIZE	PRICE	SIZE	PRICE	SIZE	PRICE	SIZE	PRICE
400		400		400		400		400		400		5,5 kW	
450		450		450		450		450		450		7,5 kW	
500		500		500		500		500		500		11,0 kW	
560		560		560		560		560		560		15,0 kW	
630		630		630		630		630		630		18,5 kW	
710		710		710		710		710		710		22,0 kW	
800		800		800		800		800		800		30,0 kW	
900		900		900		900		900		900			
1000		1000		1000		1000		1000		1000			
1120		1120		1120		1120		1120		1120			

## OPTIONS

- Electro-Static Powder Coating
- Custom Fans For Specific Flow Rate and Pressure
- 5, 8, 12, or 16 Blade Fan
- Aluminium or Plastic Blades
- System Automation
- Two-Speed Motor

## DRAWING

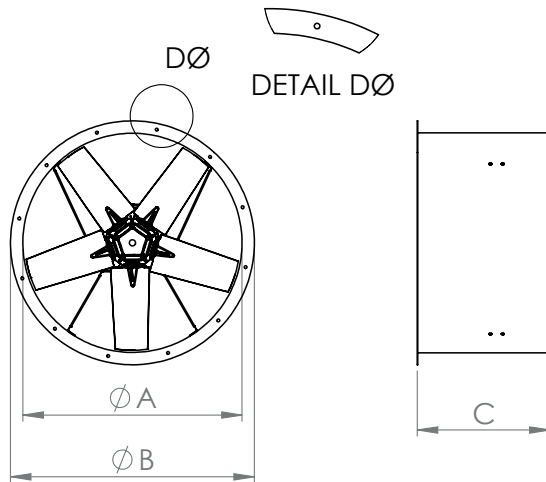

MODEL	A (mm)	B (mm)	C (mm)	D (mm)	N
S-AXI 400	400	480	320	11	8
S-AXI 450	450	530	320	11	8
S-AXI 500	500	580	320	11	8
S-AXI 560	560	640	320	11	12
S-AXI 630	630	710	420	11	12
S-AXI 710	710	790	420	11	12
S-AXI 800	800	880	420	11	16
S-AXI 900	900	980	520	11	16
S-AXI 1000	1000	1080	520	11	16
S-AXI 1120	1120	1200	520	11	16

N: Number of Holes

## PERFORMANCE CURVES

S-AXI 400-5-25

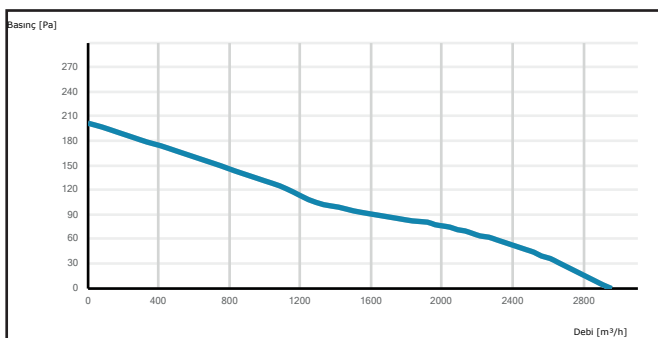

S-AXI 450-5-25

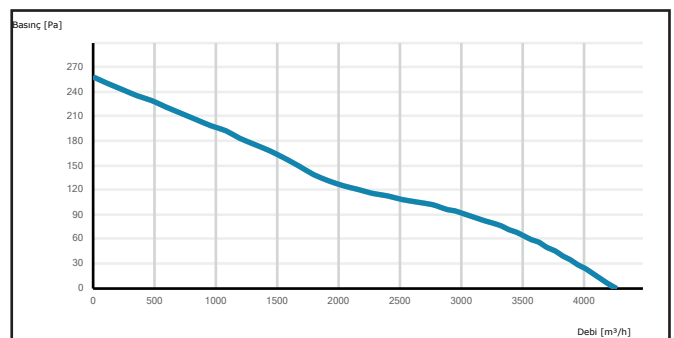

S-AXI 500-5-25

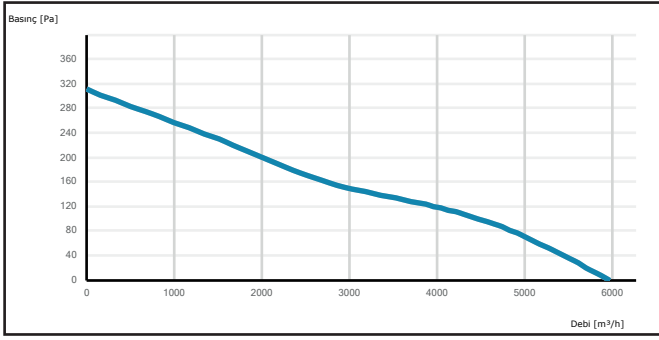

S-AXI 560-5-25

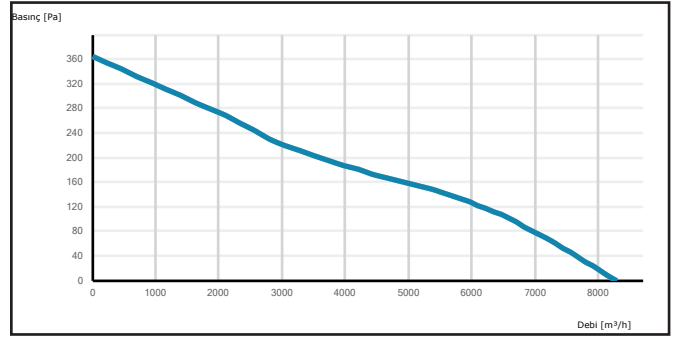

S-AXI 630-5-30

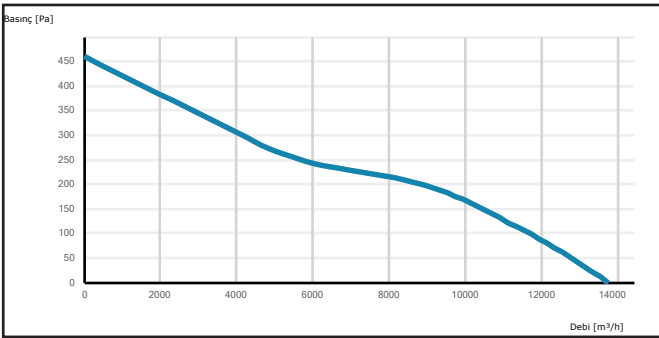

S-AXI 710-5-30

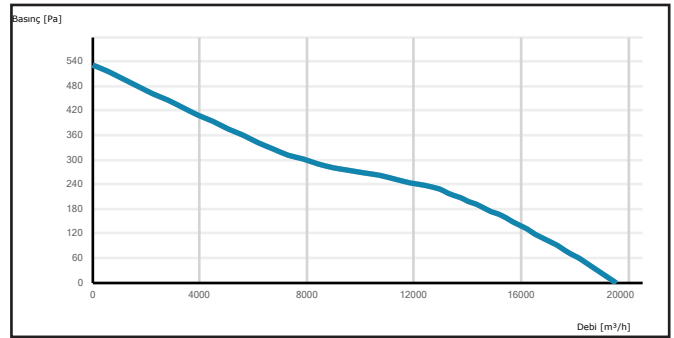

S-AXI 800-5-30

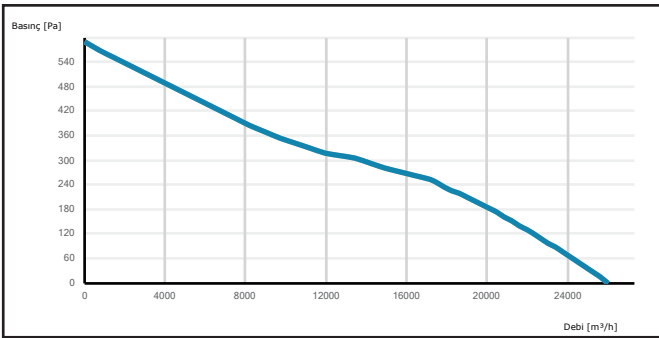

S-AXI 800-5-35

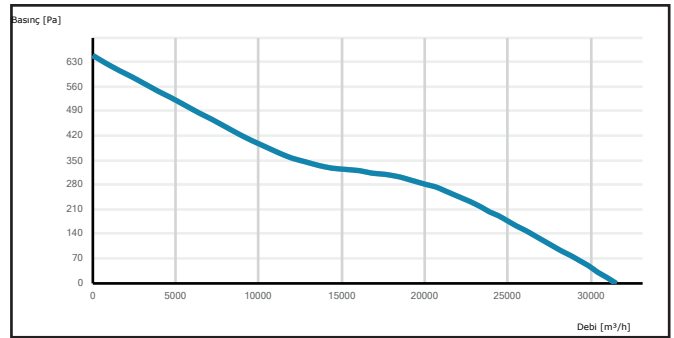

S-AXI 900-5-35

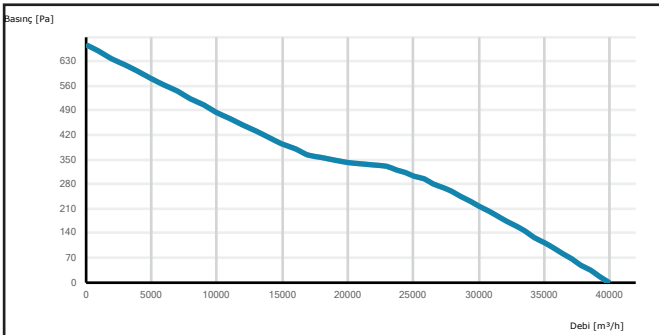

S-AXI 900-5-40

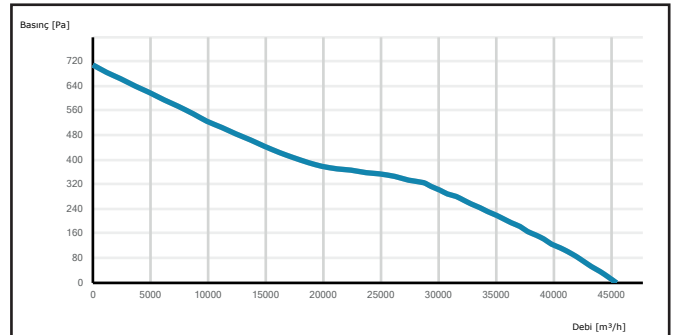

S-AXI 1000-5-40

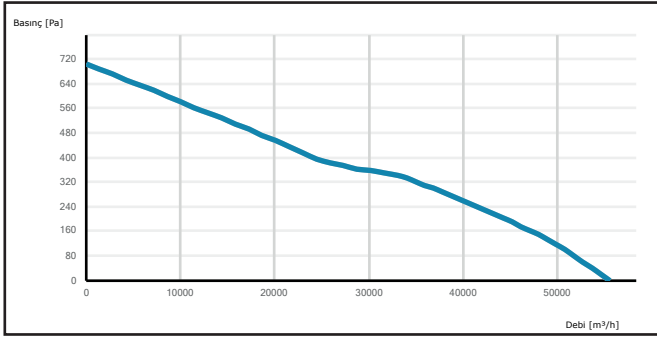

S-AXI 900-8-40

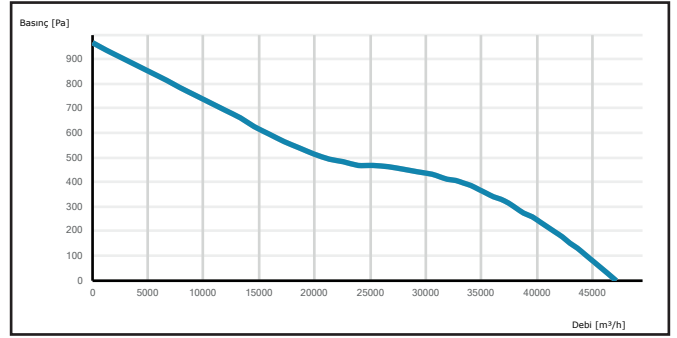

S-AXI 1000-8-40

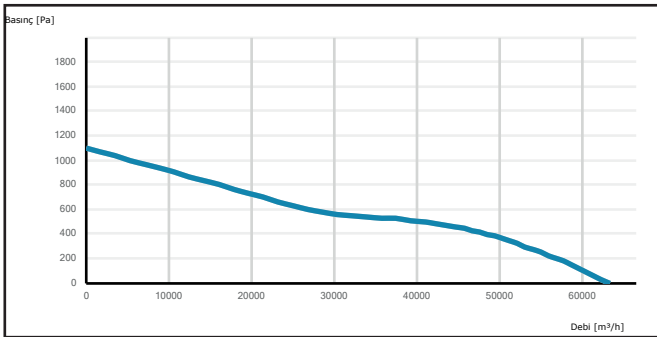

S-AXI 1000-8-45

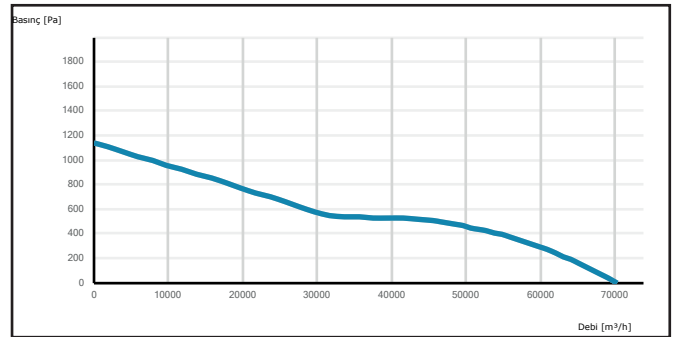

S-AXI 1120-8-40

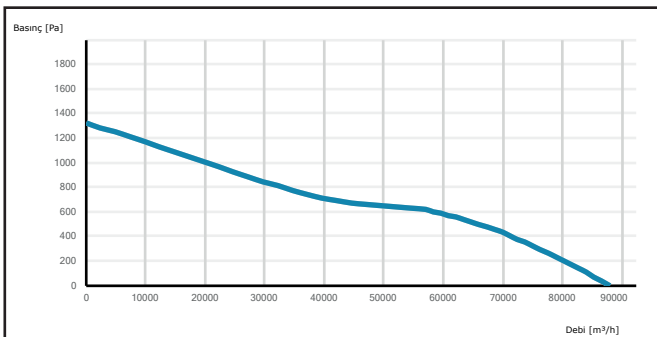

S-AXI 1120-8-45

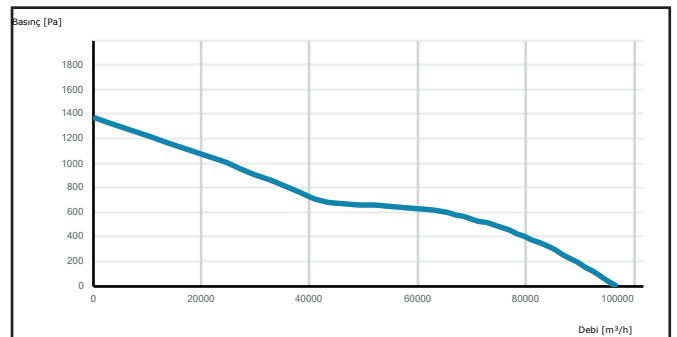



Axial Smoke Exhaust Fans can keep working for two hours at 300 °C and in combination with Jet Fans can be used to extract smoke from parking lots in case of fire.

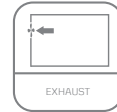

MOTOR INSULATION CLASS	H CLASS
MOTOR PROTECTION CLASS	IP 54-IP 55
MOTOR EFFICIENCY CLASS	IE1-IE2
MOTOR ENCLOSURE TYPE	TEAO
MOTOR BRAND	
BODY MATERIAL	GALVANIZED SHEET METAL
BODY COATING	OPTIONAL
IMPELLER MATERIAL	ALUMINIUM
DUTY CYCLE	IEC Duty Cycle-S1
WORKING AMBIENT TEMPERATURE	-20 - +50 °C
DIRECTIVE	IEC-60335-2-80, ISO 1940-1, EN 12101-3

MODEL	VOLTAGE (V)	FREQUENCY (Hz)	POWER (kW)	REVOLUTION (rpm)	FLOW RATE (m³/h)	NOISE LEVEL (dB(A))	PRICE
S-TAXI 450-5-25	380	50	0,55	1.456	4.250	69	
S-TAXI 500-5-25	380	50	0,55	1.453	6.000	72	
S-TAXI 560-5-25	380	50	0,75	1.466	8.200	75	
S-TAXI 630-5-30	380	50	1,10	1.465	13.600	80	
S-TAXI 710-5-30	380	50	1,50	1.472	19.400	83	
S-TAXI 800-5-30	380	50	2,20	1.459	26.000	85	
S-TAXI 800-5-35	380	50	3,00	1.463	31.500	89	
S-TAXI 900-5-35	380	50	4,00	1.471	40.000	90	
S-TAXI 900-5-40	380	50	5,50	1.472	45.500	93	
S-TAXI 1000-5-40	380	50	7,50	1.478	55.000	94	
S-TAXI 900-8-40	380	50	11,00	1.454	47.000	94	
S-TAXI 1000-8-40	380	50	15,00	1.456	62.500	97	
S-TAXI 1000-8-45	380	50	18,50	1.458	70.000	99	
S-TAXI 1120-8-40	380	50	22,00	1.471	87.500	100	
S-TAXI 1120-8-45	380	50	30,00	1.474	96.000	102	

Values are for 0 Pa.

## OPTIONS



GRILLE GUARD	
SIZE	PRICE
450	
500	
560	
630	
710	
800	
900	
1000	
1120	

SUPPORT FEET	
SIZE	PRICE
450	
500	
560	
630	
710	
800	
900	
1000	
1120	

DUCT FLANGE	
SIZE	PRICE
450	
500	
560	
630	
710	
800	
900	
1000	
1120	

CONNECTOR	
SIZE	PRICE
450	
500	
560	
630	
710	
800	
900	
1000	
1120	

RUBBER PAD	
SIZE	PRICE
450	
500	
560	
630	
710	
800	
900	
1000	
1120	

SPRING	
SIZE	PRICE
450	
500	
560	
630	
710	
800	
900	
1000	
1120	

## OPTIONS

- Custom Fans For Specific Flow Rate and Pressure
- 5, 8, 12, or 16 Blade Fan
- System Automation
- Two-Speed Motor

## DRAWING

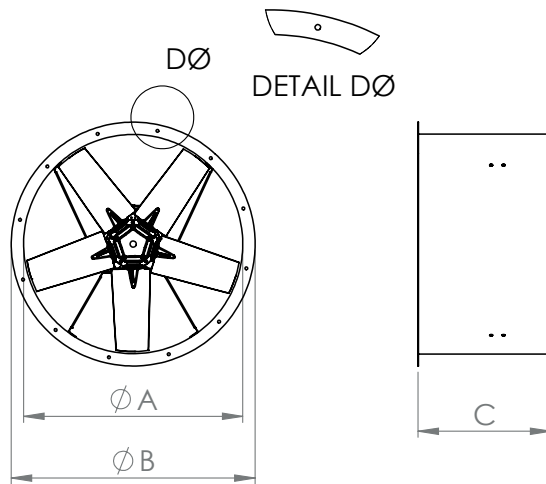

MODEL	A (mm)	B (mm)	C (mm)	D (mm)	N
S-TAXI 450	450	530	320	11	8
S-TAXI 500	500	580	320	11	8
S-TAXI 560	560	640	320	11	12
S-TAXI 630	630	710	420	11	12
S-TAXI 710	710	790	420	11	12
S-TAXI 800	800	880	420	11	16
S-TAXI 900	900	980	520	11	16
S-TAXI 1000	1000	1080	520	11	16
S-TAXI 1120	1120	1200	520	11	16

N: Number of Holes

## PERFORMANCE CURVES

S-TAXI 450-5-25

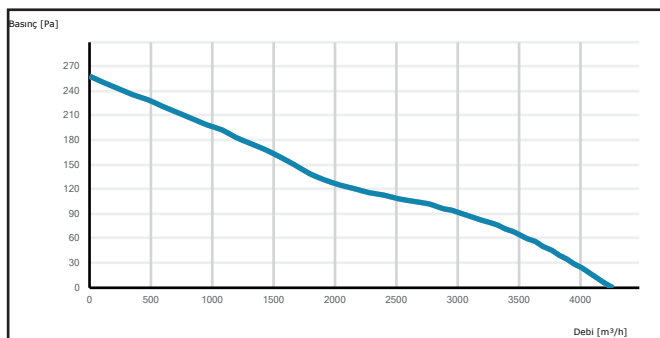

S-TAXI 500-5-25

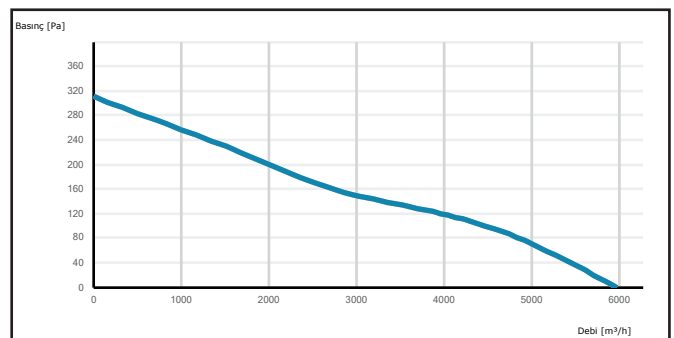

S-TAXI 560-5-25

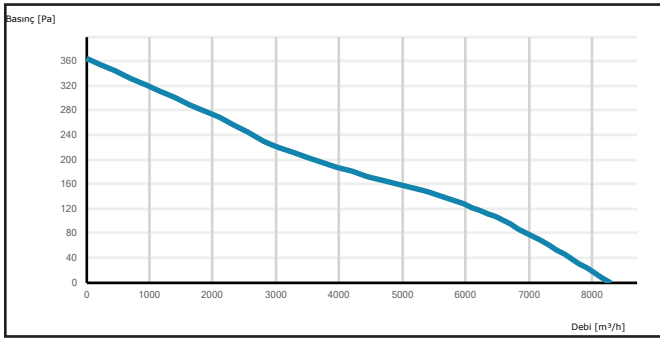

S-TAXI 630-5-30

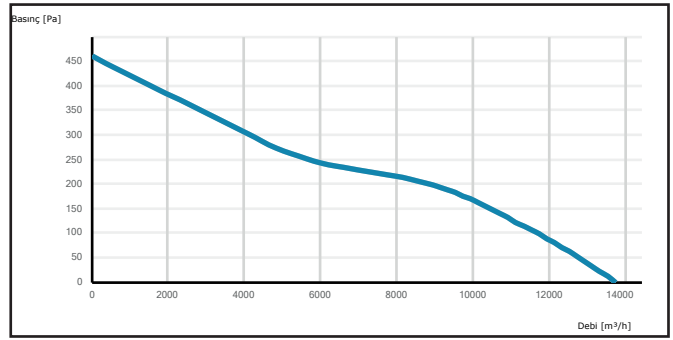

S-TAXI 710-5-30

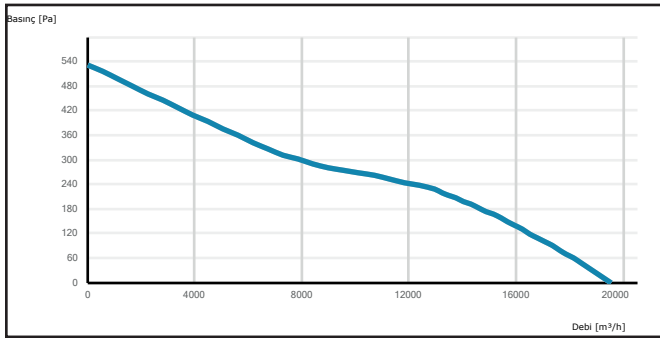

S-TAXI 800-5-30

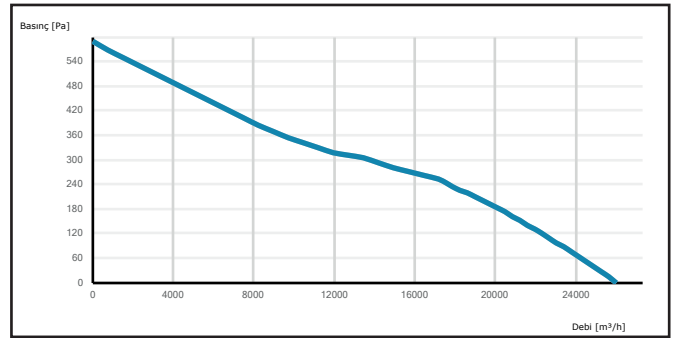

S-TAXI 800-5-35

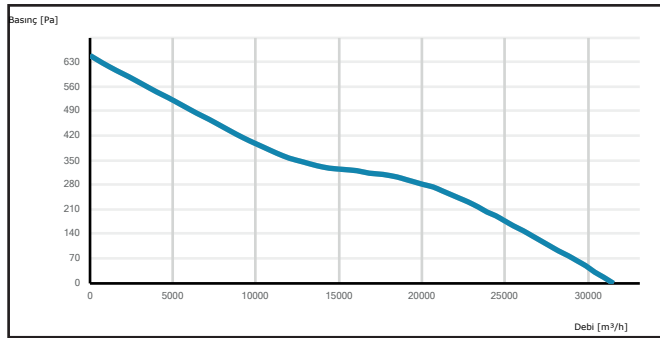

S-TAXI 900-5-35

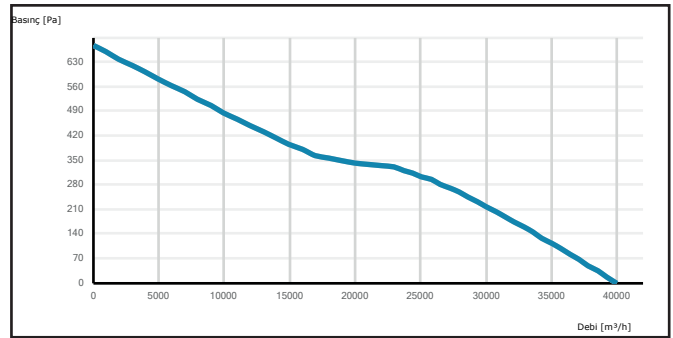

S-TAXI 900-5-40

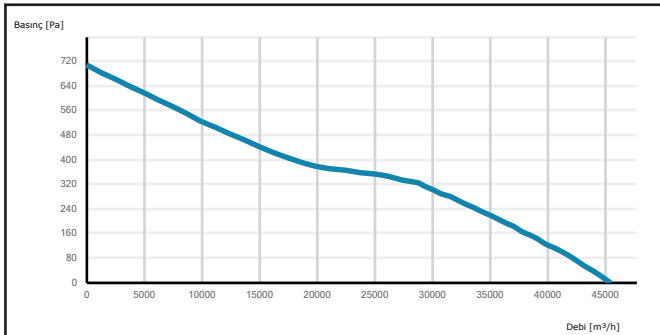

S-TAXI 1000-5-40

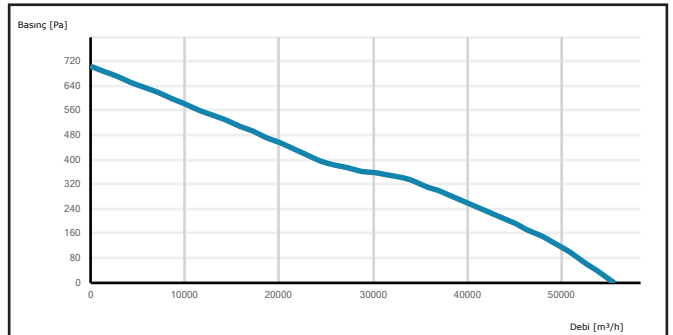



S-TAXI 900-8-40

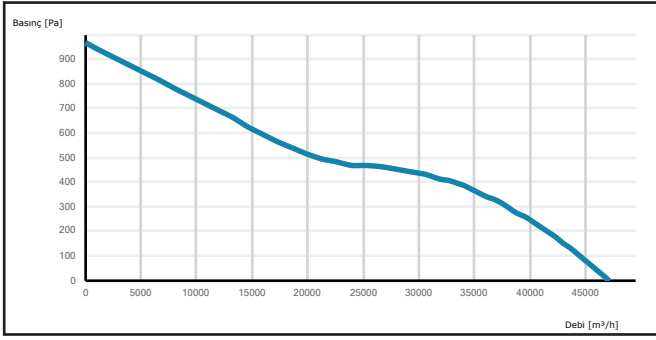

S-TAXI 1000-8-40

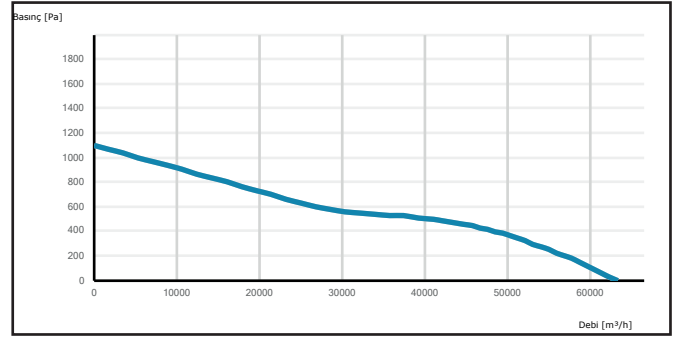

S-TAXI 1000-8-45

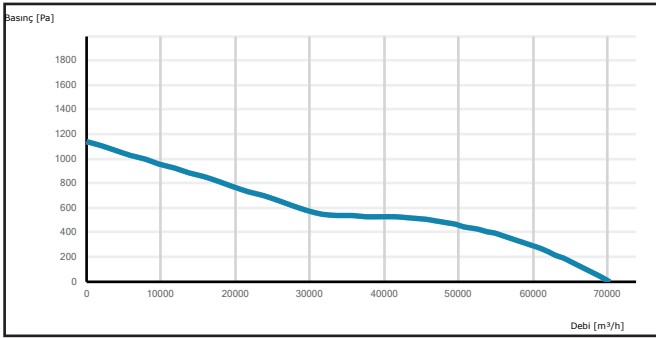

S-TAXI 1120-8-40

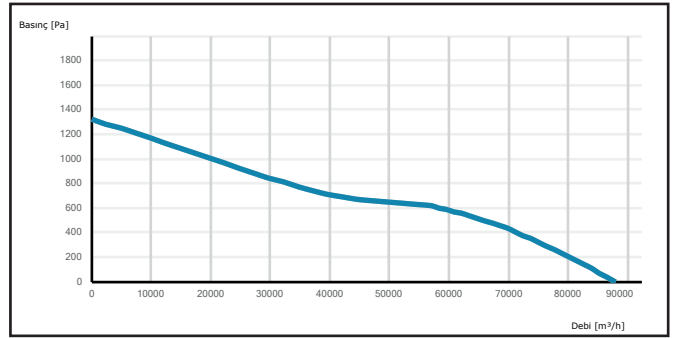

S-TAXI 1120-8-45

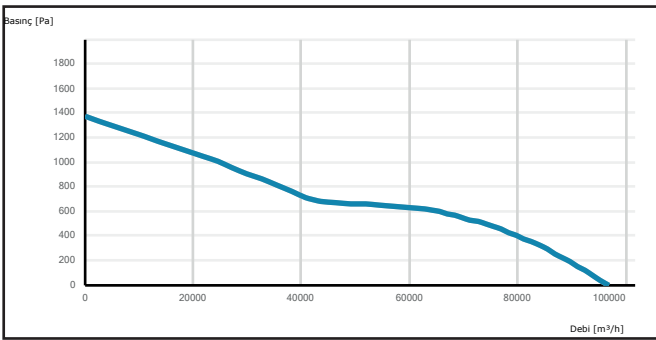



Axial Smoke Exhaust Fans can keep working for two hours at 400 °C and in combination with Jet Fans can be used to extract smoke from parking lots in case of fire.

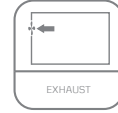

MOTOR INSULATION CLASS	H CLASS
MOTOR PROTECTION CLASS	IP 54-IP 55
MOTOR EFFICIENCY CLASS	IE1-IE2
MOTOR ENCLOSURE TYPE	TEAO
MOTOR BRAND	
BODY MATERIAL	GALVANIZED SHEET METAL
BODY COATING	OPTIONAL
IMPELLER MATERIAL	ALUMINIUM
DUTY CYCLE	IEC Duty Cycle-S1
WORKING AMBIENT TEMPERATURE	-20 - +50 °C
DIRECTIVE	IEC-60335-2-80, ISO 1940-1, EN 12101-3

MODEL	VOLTAGE (V)	FREQUENCY (Hz)	POWER (kW)	REVOLUTION (rpm)	FLOW RATE (m³/h)	NOISE LEVEL (dB(A))	PRICE
S-TAXI 450-5-25	380	50	0,55	1.456	4.250	69	
S-TAXI 500-5-25	380	50	0,55	1.453	6.000	72	
S-TAXI 560-5-25	380	50	0,75	1.466	8.200	75	
S-TAXI 630-5-30	380	50	1,10	1.465	13.600	80	
S-TAXI 710-5-30	380	50	1,50	1.472	19.400	83	
S-TAXI 800-5-30	380	50	2,20	1.459	26.000	85	
S-TAXI 800-5-35	380	50	3,00	1.463	31.500	89	
S-TAXI 900-5-35	380	50	4,00	1.471	40.000	90	
S-TAXI 900-5-40	380	50	5,50	1.472	45.500	93	
S-TAXI 1000-5-40	380	50	7,50	1.478	55.000	94	
S-TAXI 900-8-40	380	50	11,00	1.454	47.000	94	
S-TAXI 1000-8-40	380	50	15,00	1.456	62.500	97	
S-TAXI 1000-8-45	380	50	18,50	1.458	70.000	99	
S-TAXI 1120-8-40	380	50	22,00	1.471	87.500	100	
S-TAXI 1120-8-45	380	50	30,00	1.474	96.000	102	

Values are for 0 Pa.

## OPTIONS



GRILLE GUARD	
SIZE	PRICE
450	
500	
560	
630	
710	
800	
900	
1000	
1120	

SUPPORT FEET	
SIZE	PRICE
450	
500	
560	
630	
710	
800	
900	
1000	
1120	

DUCT FLANGE	
SIZE	PRICE
450	
500	
560	
630	
710	
800	
900	
1000	
1120	

CONNECTOR	
SIZE	PRICE
450	
500	
560	
630	
710	
800	
900	
1000	
1120	

RUBBER PAD	
SIZE	PRICE
450	
500	
560	
630	
710	
800	
900	
1000	
1120	

SPRING	
SIZE	PRICE
450	
500	
560	
630	
710	
800	
900	
1000	
1120	

## OPTIONS

- Custom Fans For Specific Flow Rate and Pressure
- 5, 8, 12, or 16 Blade Fan
- System Automation
- Two-Speed Motor

## DRAWING

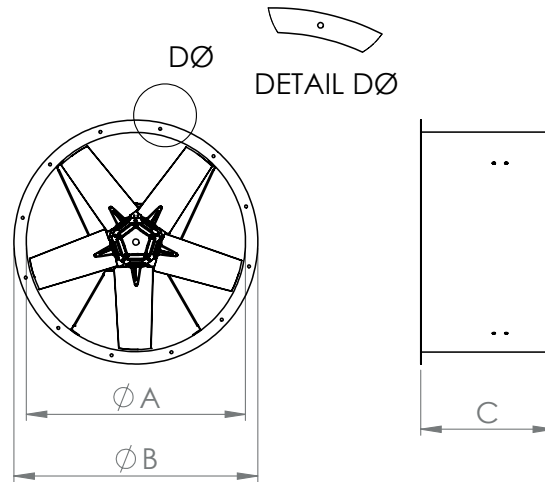

MODEL	A (mm)	B (mm)	C (mm)	D (mm)	N
S-TAXI 450	450	530	320	11	8
S-TAXI 500	500	580	320	11	8
S-TAXI 560	560	640	320	11	12
S-TAXI 630	630	710	420	11	12
S-TAXI 710	710	790	420	11	12
S-TAXI 800	800	880	420	11	16
S-TAXI 900	900	980	520	11	16
S-TAXI 1000	1000	1080	520	11	16
S-TAXI 1120	1120	1200	520	11	16

N: Number of Holes

## PERFORMANCE CURVES

S-TAXI 450-5-25

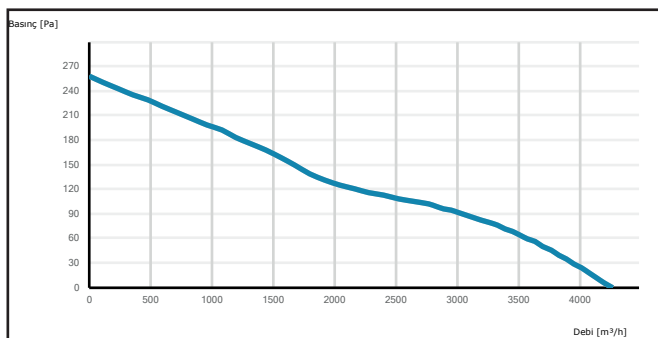

S-TAXI 500-5-25

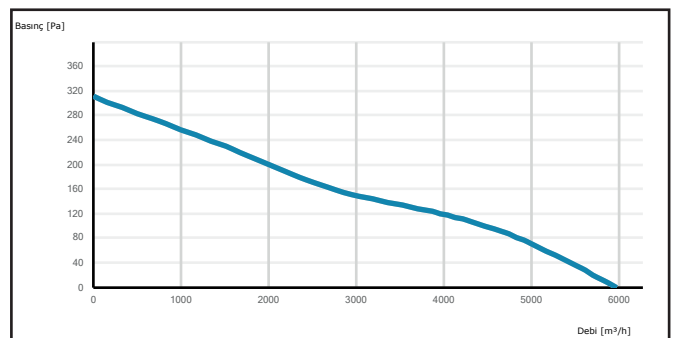

S-TAXI 560-5-25

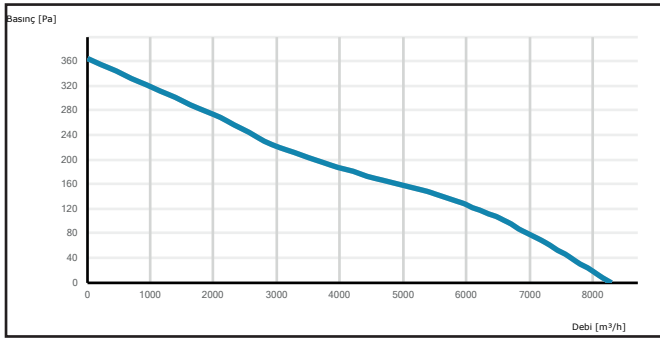

S-TAXI 630-5-30

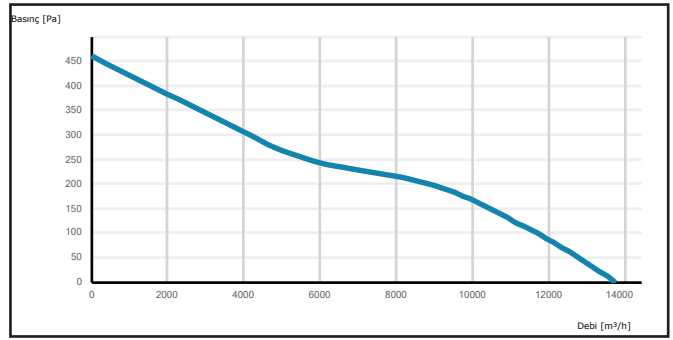

S-TAXI 710-5-30

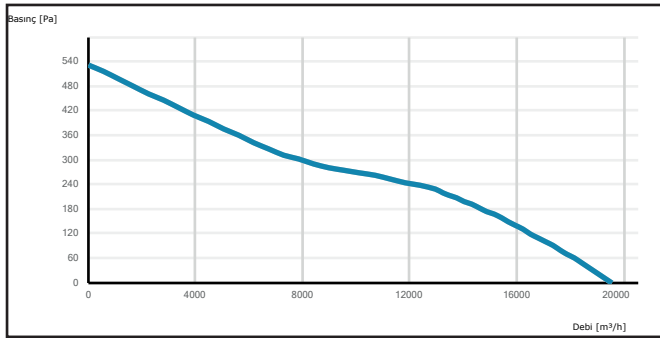

S-TAXI 800-5-30

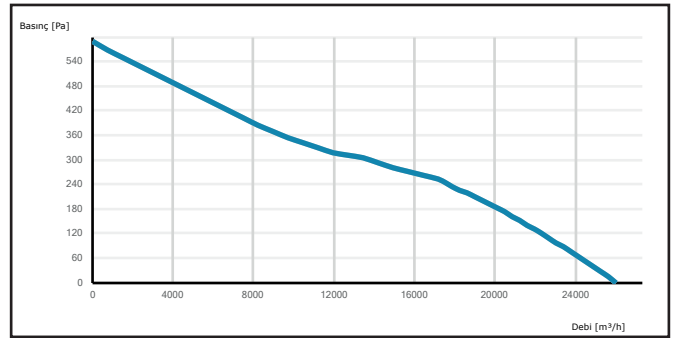

S-TAXI 800-5-35

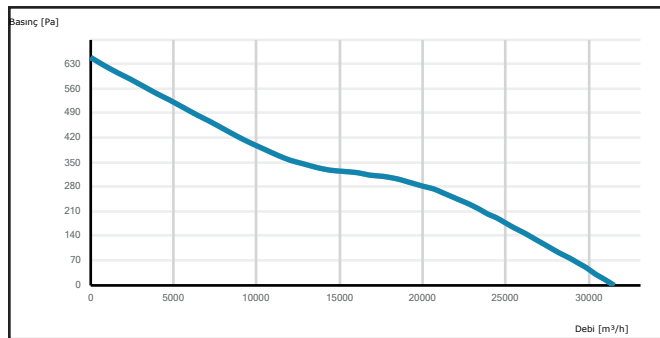

S-TAXI 900-5-35

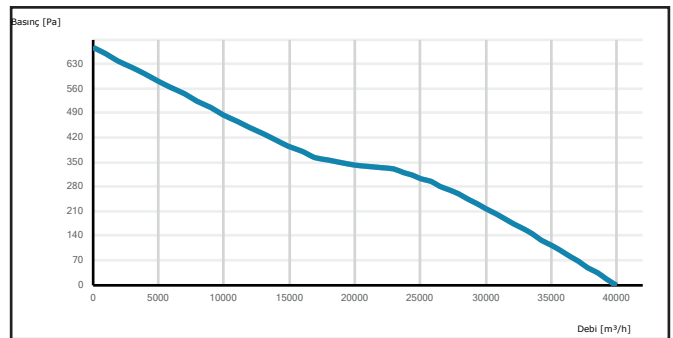

S-TAXI 900-5-40

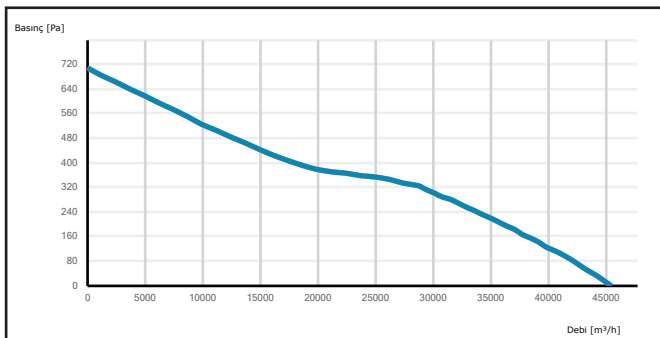

S-TAXI 1000-5-40

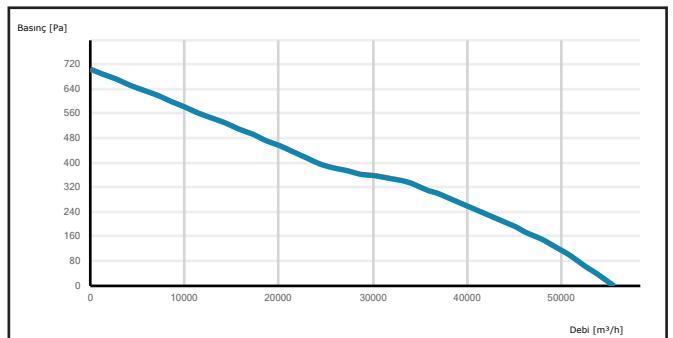

S-TAXI 900-8-40

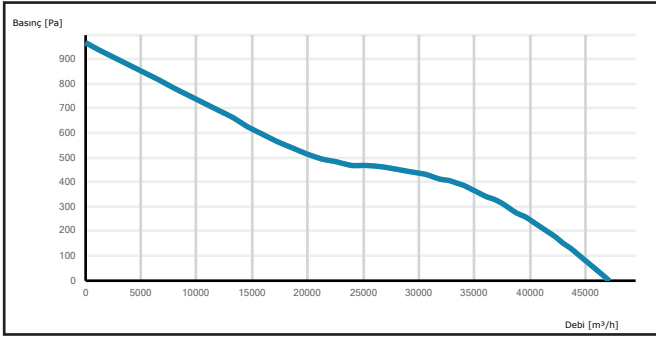

S-TAXI 1000-8-40

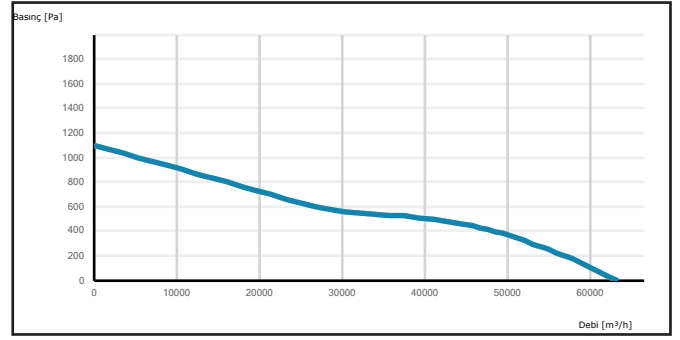

S-TAXI 1000-8-45

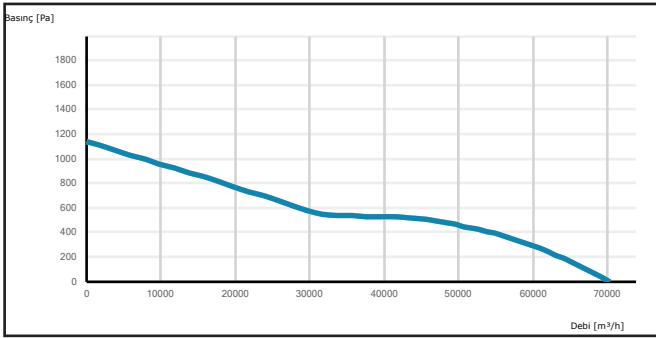

S-TAXI 1120-8-40

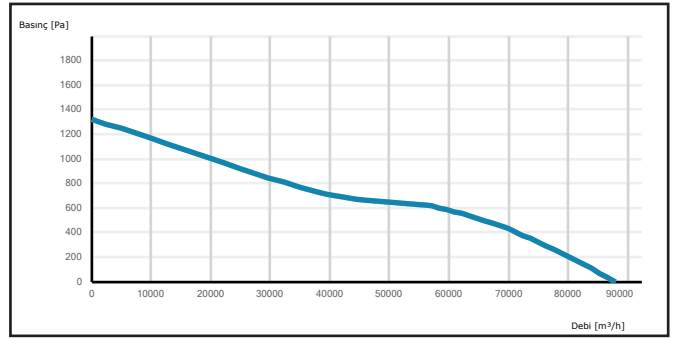

S-TAXI 1120-8-45

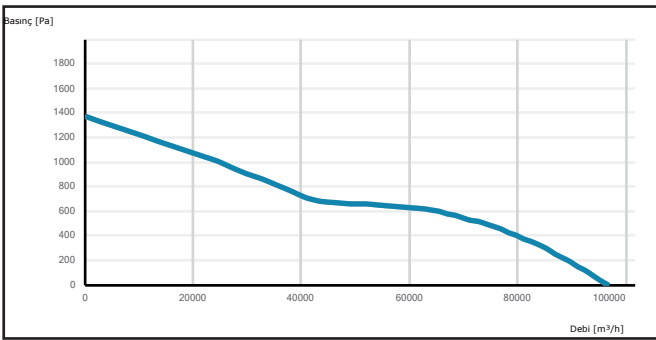



K-PAXI fans have motors that do not produce sparks and with the aluminium band in the body it can be used to in ventilation with ATEX needs Zone 1 ve Zone 2 Group: IIA, IIB ve IIC. ATEX CLASS CHOICE IS THE CLIENTS RESPONSIBILITY.



MOTOR INSULATION CLASS	F CLASS
MOTOR PROTECTION CLASS	IP 55
MOTOR EFFICIENCY CLASS	IE2
MOTOR ENCLOSURE TYPE	TEFC
MOTOR BRAND	
BODY MATERIAL	GALVANIZED SHEET METAL
BODY COATING	OPTIONAL
IMPELLER MATERIAL	ALUMINIUM
DUTY CYCLE	IEC Duty Cycle-S1
WORKING AMBIENT TEMPERATURE	-20 - +50 °C
DIRECTIVE	IEC-60335-2-80, ISO 1940-1

MODEL	VOLTAGE (V)	FREQUENCY (Hz)	POWER (kW)	REVOLUTION (rpm)	FLOW RATE (m³/h)	NOISE LEVEL (dB(A))	PRICE
S-PAXI 450-5-25	380	50	0,55	1.456	4.250	69	
S-PAXI 500-5-25	380	50	0,55	1.453	6.000	72	
S-PAXI 560-5-25	380	50	0,75	1.466	8.200	75	
S-PAXI 630-5-30	380	50	1,10	1.465	13.600	80	
S-PAXI 710-5-30	380	50	1,50	1.472	19.400	83	
S-PAXI 800-5-30	380	50	2,20	1.459	26.000	85	
S-PAXI 800-5-35	380	50	3,00	1.463	31.500	89	
S-PAXI 900-5-35	380	50	4,00	1.471	40.000	90	
S-PAXI 900-5-40	380	50	5,50	1.472	45.500	93	
S-PAXI 1000-5-40	380	50	7,50	1.478	55.000	94	
S-PAXI 900-8-40	380	50	11,00	1.454	47.000	94	
S-PAXI 1000-8-40	380	50	15,00	1.456	62.500	97	

Values are for 0 Pa.

## OPTIONS



GRILLE GUARD	
SIZE	PRICE
450	
500	
560	
630	
710	
800	
900	
1000	



SUPPORT FEET	
SIZE	PRICE
450	
500	
560	
630	
710	
800	
900	
1000	



DUCT FLANGE	
SIZE	PRICE
450	
500	
560	
630	
710	
800	
900	
1000	



CONNECTOR	
SIZE	PRICE
450	
500	
560	
630	
710	
800	
900	
1000	



RUBBER PAD	
SIZE	PRICE
450	
500	
560	
630	
710	
800	
900	
1000	



SPRING	
SIZE	PRICE
450	
500	
560	
630	
710	
800	
900	
1000	

## OPTIONS

- Custom Fans For Specific Flow Rate and Pressure
- 5, 8, 12, or 16 Blade Fan
- System Automation
- Choice For Different ATEX Classes

## DRAWING

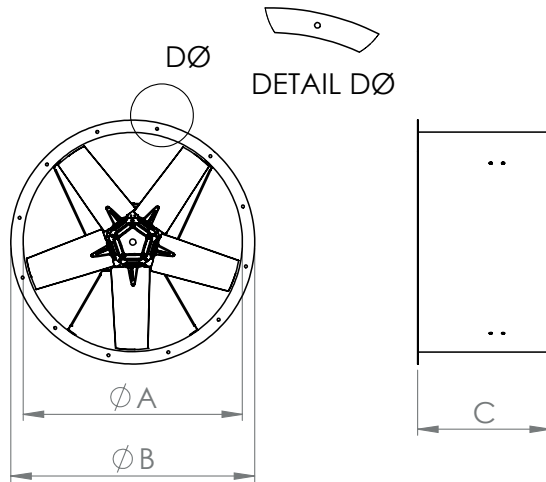

MODEL	A (mm)	B (mm)	C (mm)	D (mm)	N
S-PAXI 450	450	530	320	11	8
S-PAXI 500	500	580	320	11	8
S-PAXI 560	560	640	320	11	12
S-PAXI 630	630	710	420	11	12
S-PAXI 710	710	790	420	11	12
S-PAXI 800	800	880	420	11	16
S-PAXI 900	900	980	520	11	16
S-PAXI 1000	1000	1080	520	11	16

N: Number of Holes

## PERFORMANCE CURVES

S-PAXI 450-5-25

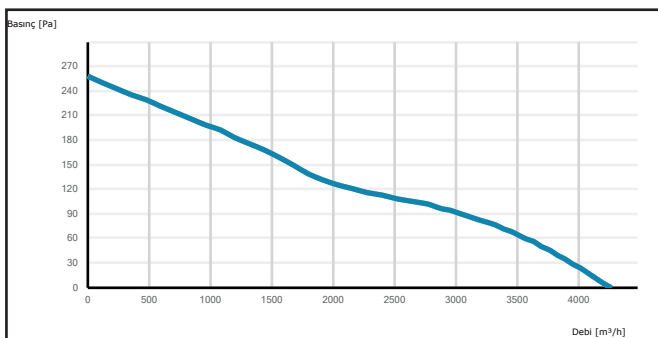

S-PAXI 500-5-25

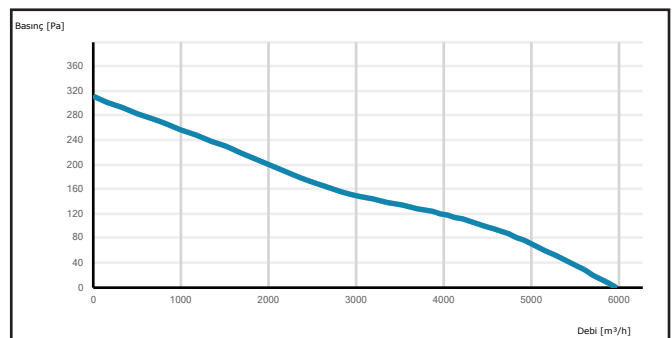

S-PAXI 560-5-25

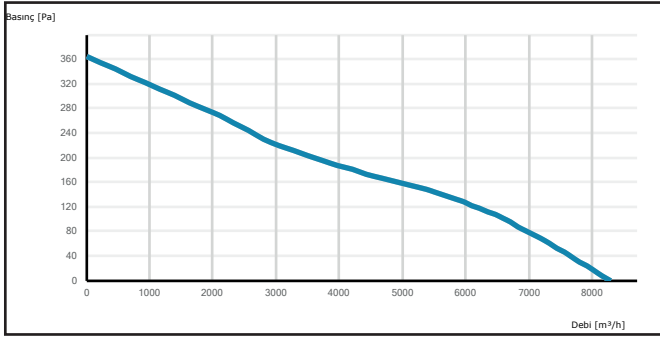

S-PAXI 630-5-30

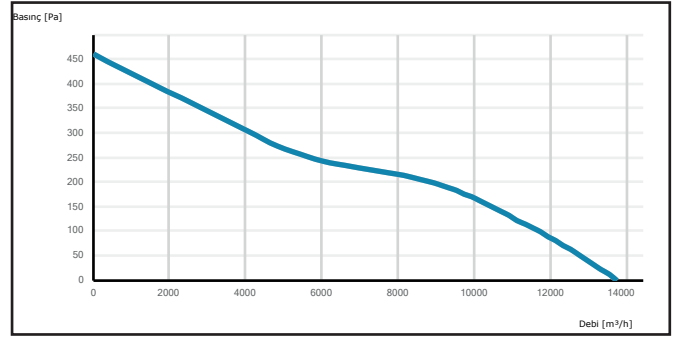

S-PAXI 710-5-30

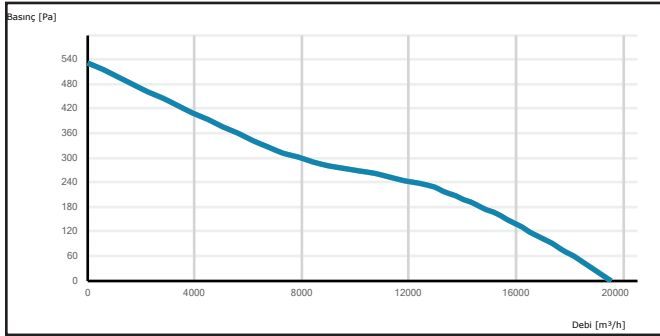

S-PAXI 800-5-30

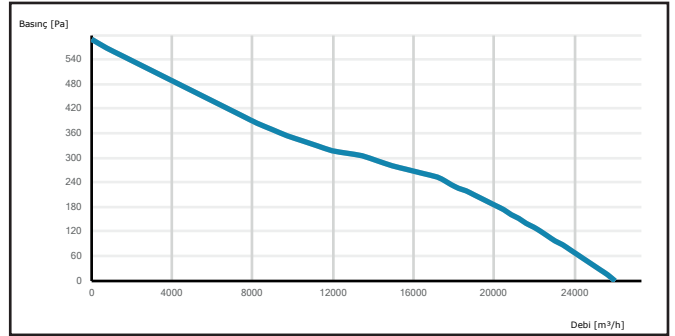

S-PAXI 800-5-35

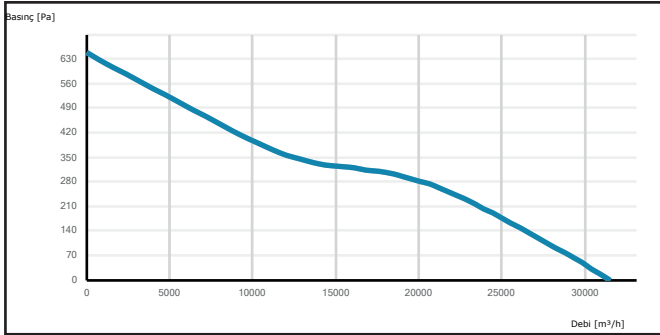

S-PAXI 900-5-35

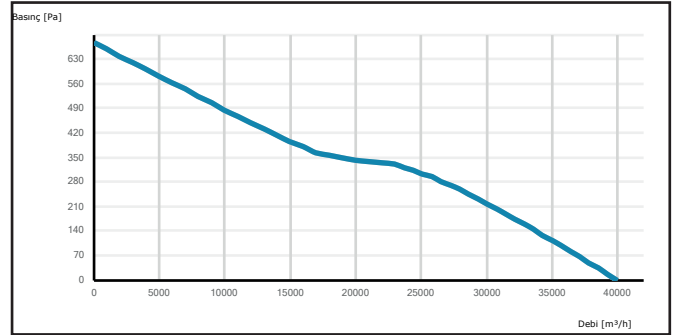

S-PAXI 900-5-40

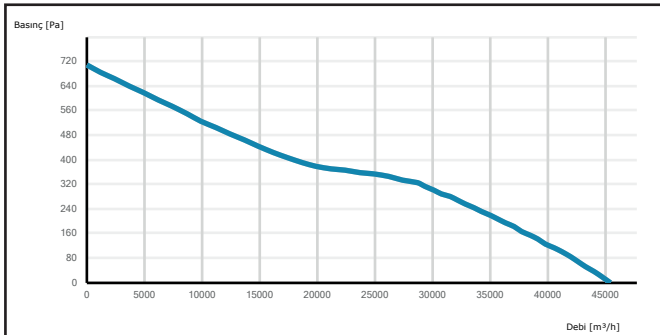

S-PAXI 1000-5-40

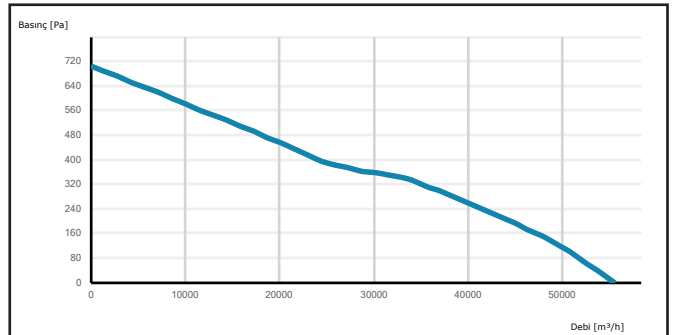



S-PAXI 900-8-40

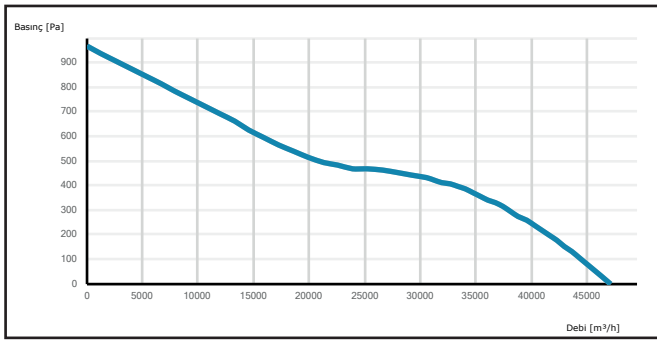

S-PAXI 1000-8-40

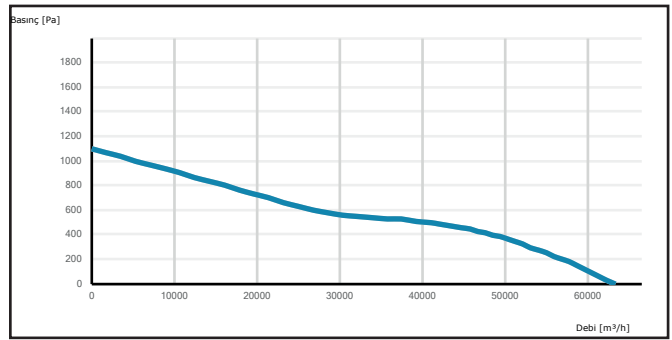



Axial box fans can be used in hard-to-install situations with its multiple connection point body. Default fan has an on-off switch and inbuilt sound attenuator.

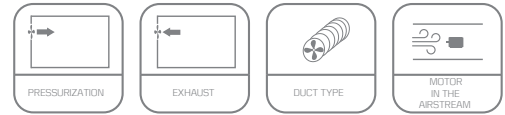

MOTOR INSULATION CLASS	F CLASS
MOTOR PROTECTION CLASS	IP 55
MOTOR EFFICIENCY CLASS	IE2-IE3
MOTOR ENCLOSURE TYPE	TEFC
MOTOR BRAND	
BODY MATERIAL	GALVANIZED SHEET METAL
BODY COATING	OPTIONAL
IMPELLER MATERIAL	ALUMINIUM
DUTY CYCLE	IEC Duty Cycle-S1
WORKING AMBIENT TEMPERATURE	-20 - +50 °C
DIRECTIVE	IEC-60335-2-80, ISO 1940-1

MODEL	VOLTAGE (V)	FREQUENCY (Hz)	POWER (kW)	REVOLUTION (rpm)	FLOW RATE (m³/h)	NOISE LEVEL (dB(A))	PRICE
S-HAXI 400-5-25	380	50	0,37	1.450	2.950	61	
S-HAXI 450-5-25	380	50	0,55	1.456	4.250	64	
S-HAXI 500-5-25	380	50	0,55	1.453	6.000	67	
S-HAXI 560-5-25	380	50	0,75	1.466	8.200	70	
S-HAXI 630-5-30	380	50	1,10	1.465	13.600	75	
S-HAXI 710-5-30	380	50	1,50	1.472	19.400	78	
S-HAXI 800-5-30	380	50	2,20	1.459	26.000	80	
S-HAXI 800-5-35	380	50	3,00	1.463	31.500	84	
S-HAXI 900-5-35	380	50	4,00	1.471	40.000	85	
S-HAXI 900-5-40	380	50	5,50	1.472	45.500	88	
S-HAXI 1000-5-40	380	50	7,50	1.478	55.000	89	
S-HAXI 900-8-40	380	50	11,00	1.454	47.000	89	
S-HAXI 1000-8-40	380	50	15,00	1.456	62.500	92	
S-HAXI 1000-8-45	380	50	18,50	1.458	70.000	94	
S-HAXI 1120-8-40	380	50	22,00	1.471	87.500	95	
S-HAXI 1120-8-45	380	50	30,00	1.474	96.000	97	

Values are for 0 Pa.



PANEL	
SIZE	PRICE
5,5 kW	
7,5 kW	
11,0 kW	
15,0 kW	
18,5 kW	
22,0 kW	
30,0 kW	

## OPTIONS

- Electro-Static Powder Coating
- Custom Fans For Specific Flow Rate and Pressure
- 5, 8, 12, or 16 Blade Fan
- Aluminium or Plastic Blades
- System Automation
- Two-Speed Motor
- Smoke Exhaust Model

## DRAWING

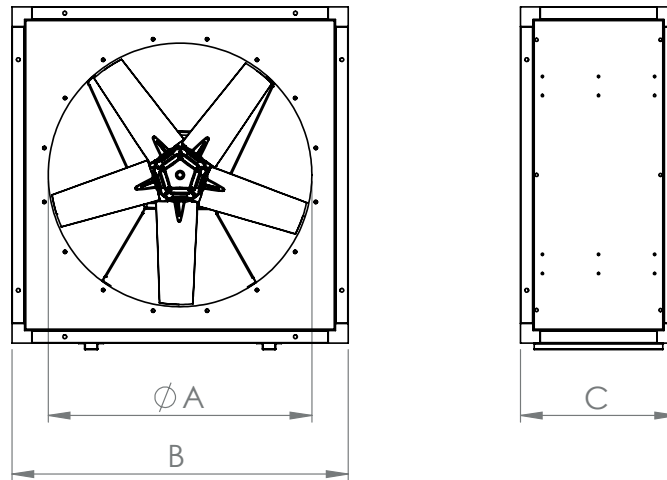

MODEL	A (mm)	B (mm)	C (mm)
S-HAXI 400	400	620	425
S-HAXI 450	450	670	425
S-HAXI 500	500	720	425
S-HAXI 560	560	780	425
S-HAXI 630	630	850	425
S-HAXI 710	710	930	425
S-HAXI 800	800	1020	425
S-HAXI 900	900	1120	525
S-HAXI 1000	1000	1220	525
S-HAXI 1120	1120	1340	525

## PERFORMANCE CURVES

S-HAXI 400-5-25

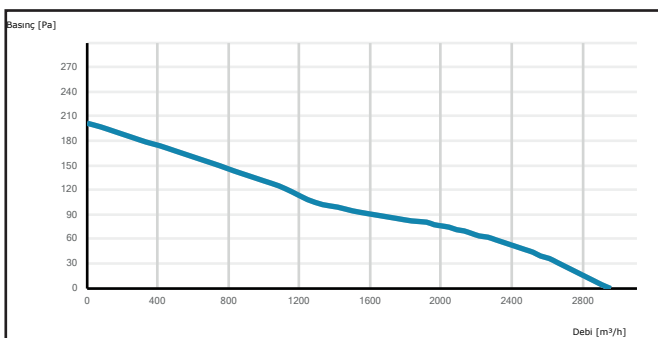

S-HAXI 450-5-25

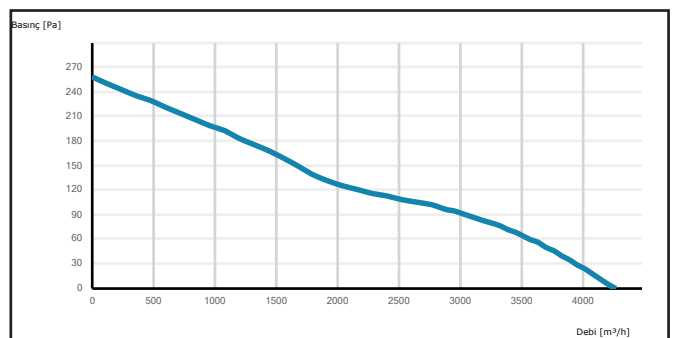

S-HAXI 500-5-25

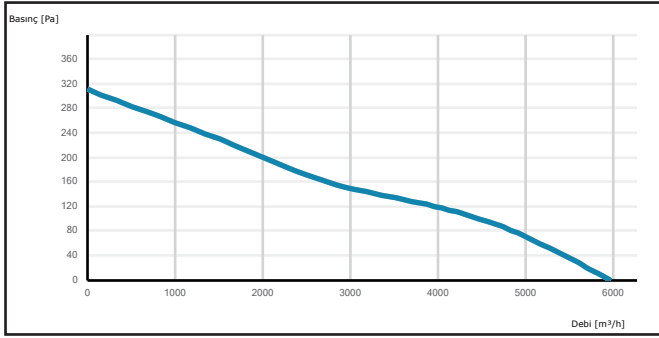

S-HAXI 560-5-25

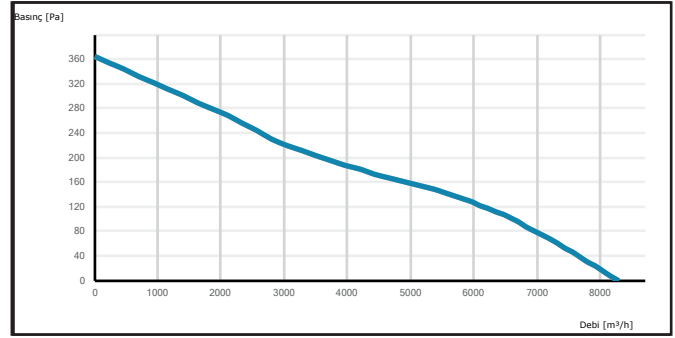

S-HAXI 630-5-30

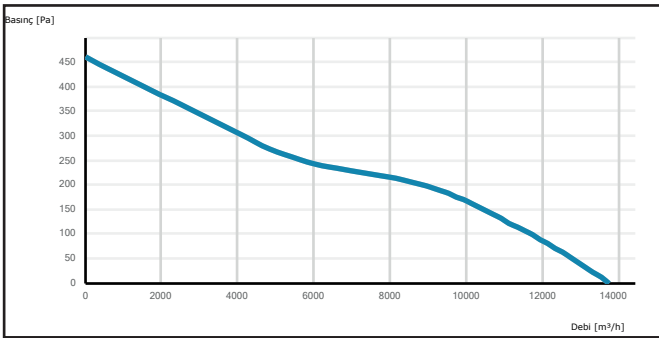

S-HAXI 710-5-30

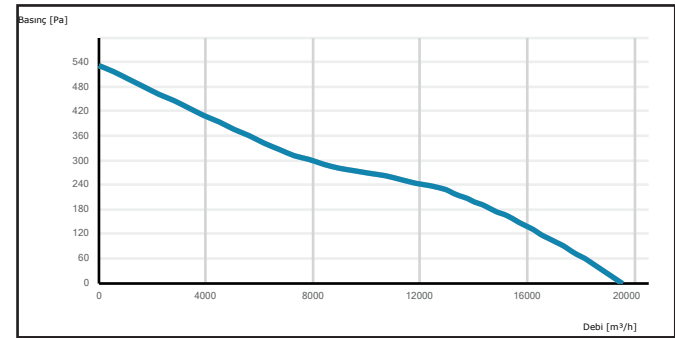

S-HAXI 800-5-30

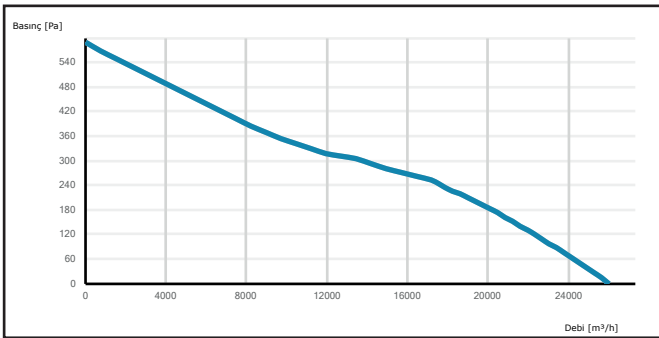

S-HAXI 800-5-35

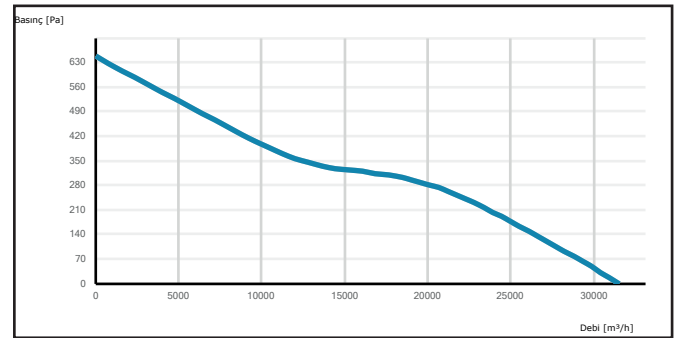

S-HAXI 900-5-35

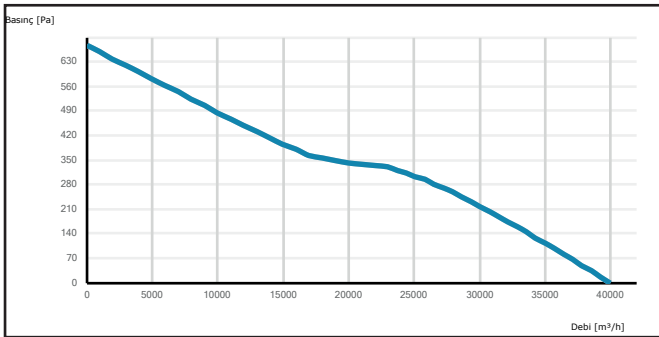

S-HAXI 900-5-40

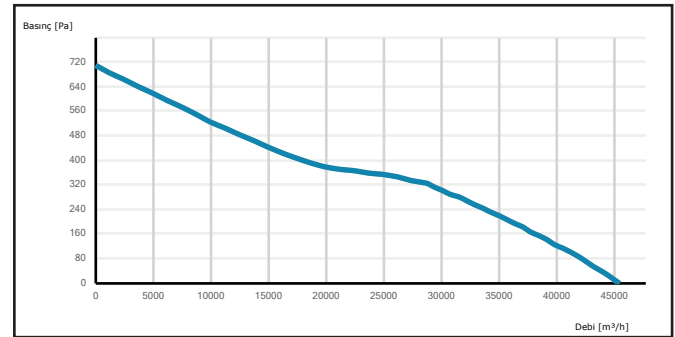

S-HAXI 1000-5-40

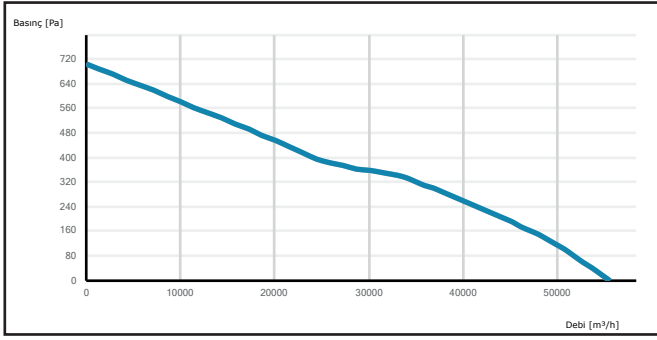

S-HAXI 900-8-40

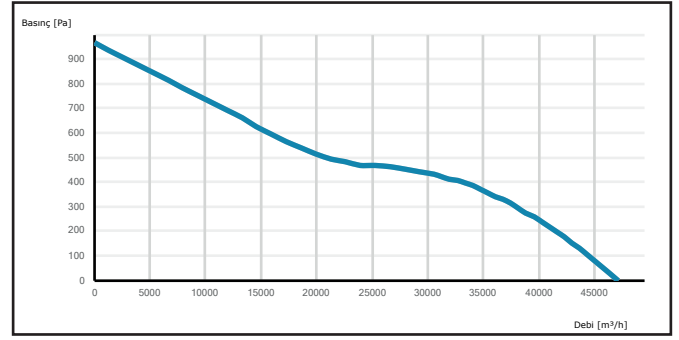

S-HAXI 1000-8-40

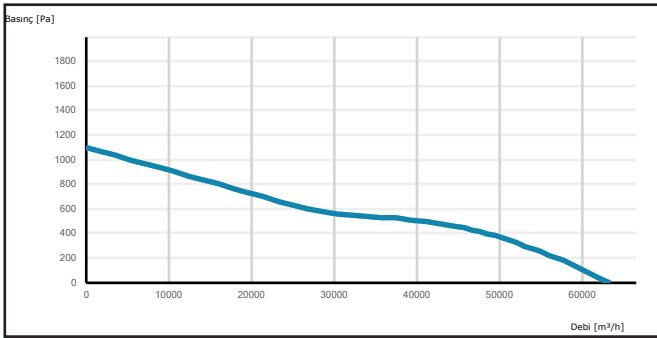

S-HAXI 1000-8-45

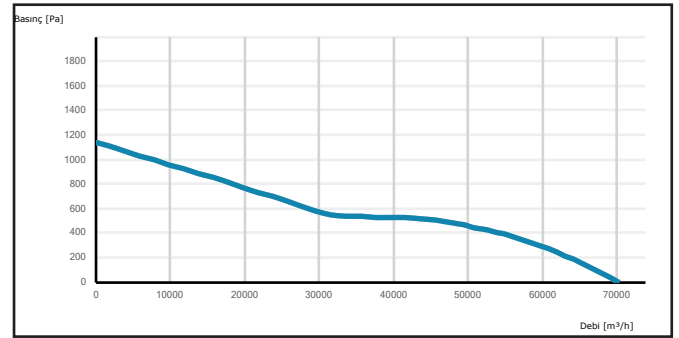

S-HAXI 1120-8-40

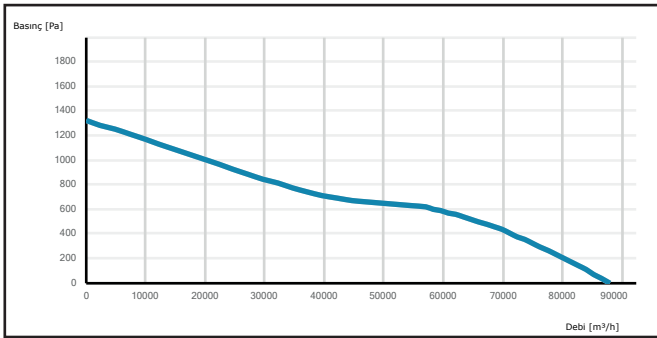

S-HAXI 1120-8-45

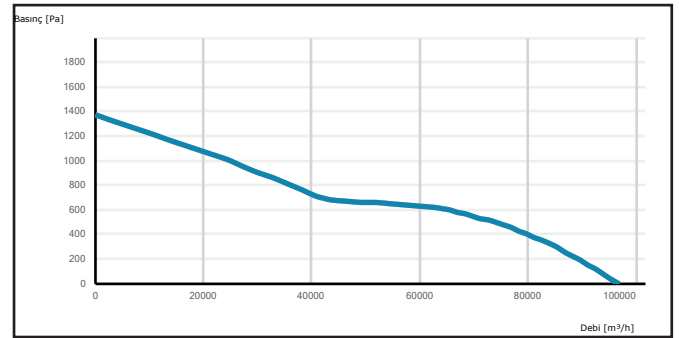



Belt driven axial fans can be used when the motor should be out of the airstream. With its belt drive system clients can choose the revolution at the order. It comes with mounting feet as standard.



MOTOR INSULATION CLASS	F CLASS
MOTOR PROTECTION CLASS	IP 55
MOTOR EFFICIENCY CLASS	IE2-IE3
MOTOR ENCLOSURE TYPE	TEFC
MOTOR BRAND	
BODY MATERIAL	GALVANIZED SHEET METAL
BODY COATING	OPTIONAL
IMPELLER MATERIAL	ALUMINIUM
DUTY CYCLE	IEC Duty Cycle-S1
WORKING AMBIENT TEMPERATURE	-20 - +50 °C
DIRECTIVE	IEC-60335-2-80, ISO 1940-1

MODEL	VOLTAGE (V)	FREQUENCY (Hz)	POWER (kW)	REVOLUTION (rpm)	FLOW RATE (m³/h)	NOISE LEVEL (dB(A))	PRICE
S-DAXI 400-5-25	380	50	0,37	1.450	2.950	68	
S-DAXI 450-5-25	380	50	0,55	1.456	4.250	71	
S-DAXI 500-5-25	380	50	0,55	1.453	6.000	73	
S-DAXI 560-5-25	380	50	0,75	1.466	8.200	77	
S-DAXI 630-5-30	380	50	1,10	1.465	13.600	82	
S-DAXI 710-5-30	380	50	1,50	1.472	19.400	85	
S-DAXI 800-5-30	380	50	2,20	1.459	26.000	87	
S-DAXI 800-5-35	380	50	3,00	1.463	31.500	91	
S-DAXI 900-5-35	380	50	4,00	1.471	40.000	92	
S-DAXI 900-5-40	380	50	5,50	1.472	45.500	95	
S-DAXI 1000-5-40	380	50	7,50	1.478	55.000	96	
S-DAXI 900-8-40	380	50	11,00	1.454	47.000	96	
S-DAXI 1000-8-40	380	50	15,00	1.456	62.500	99	
S-DAXI 1000-8-45	380	50	18,50	1.458	70.000	101	
S-DAXI 1120-8-40	380	50	22,00	1.471	87.500	102	
S-DAXI 1120-8-45	380	50	30,00	1.474	96.000	104	

Values are for 0 Pa.

## OPTIONS



GRILLE GUARD	
SIZE	PRICE
400	
450	
500	
560	
630	
710	
800	
900	
1000	
1120	

DUCT FLANGE	
SIZE	PRICE
400	
450	
500	
560	
630	
710	
800	
900	
1000	
1120	

CONNECTOR	
SIZE	PRICE
400	
450	
500	
560	
630	
710	
800	
900	
1000	
1120	

RUBBER PAD	
SIZE	PRICE
400	
450	
500	
560	
630	
710	
800	
900	
1000	
1120	

SPRING	
SIZE	PRICE
400	
450	
500	
560	
630	
710	
800	
900	
1000	
1120	

PANEL	
SIZE	PRICE
5,5 kW	
7,5 kW	
11,0 kW	
15,0 kW	
18,5 kW	
22,0 kW	
30,0 kW	

## OPTIONS

- Electro-Static Powder Coating
- Custom Fans For Specific Flow Rate and Pressure
- 5, 8, 12, or 16 Blade Fan
- Aluminium or Plastic Blades
- System Automation
- Two-Speed Motor

## DRAWING

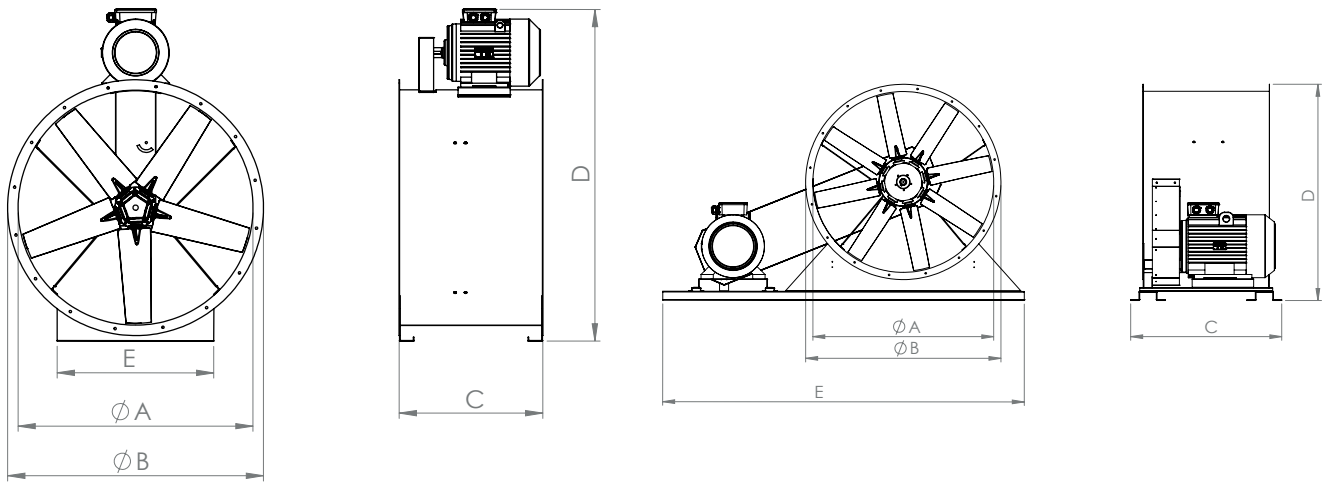

MODEL	A (mm)	B (mm)	C (mm)	D (mm)	E (mm)
S-DAXI 400	400	480	380	660	300
S-DAXI 450	450	530	400	720	330
S-DAXI 500	500	580	400	770	360
S-DAXI 560	560	640	430	840	400
S-DAXI 630	630	710	500	925	440
S-DAXI 710	710	790	500	1005	480
S-DAXI 800	800	880	500	1110	520
S-DAXI 900	900	980	740	1360	560
S-DAXI 1000	1000	1080	740	1470	600

MODEL	A (mm)	B (mm)	C (mm)	D (mm)	E (mm)
DAXI 1000	1000	1080	740	1470	600
DAXI 1120	1120	1200	520	11	16

Since motor cannot be mounted on top of the fan in model 1000-8-45 and bigger ones both fan and the motor are mounted on a separate platform.

## PERFORMANCE CURVES

S-DAXI 400-5-25

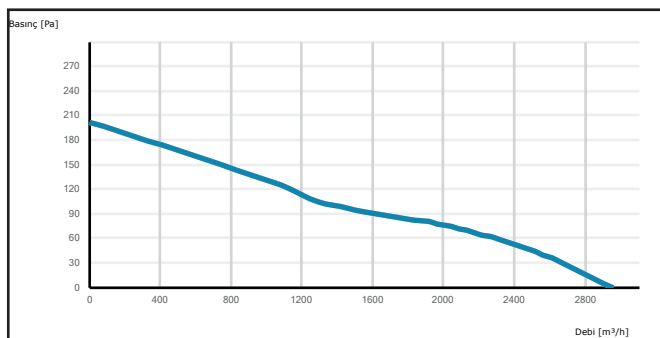

S-DAXI 450-5-25

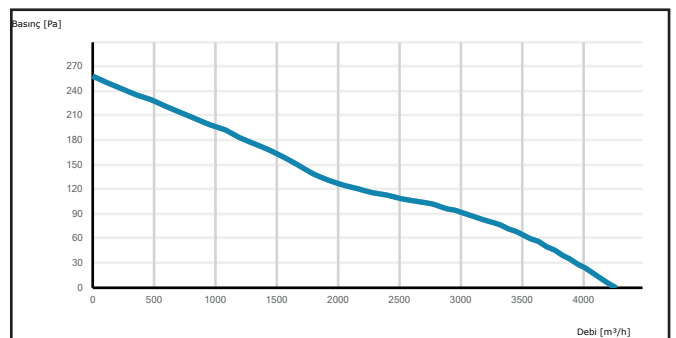

S-DAXI 500-5-25

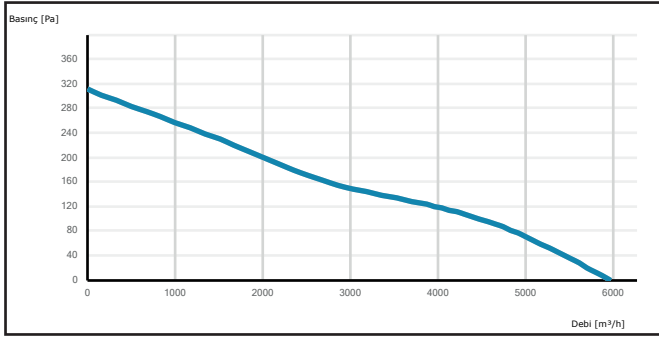

S-DAXI 560-5-25

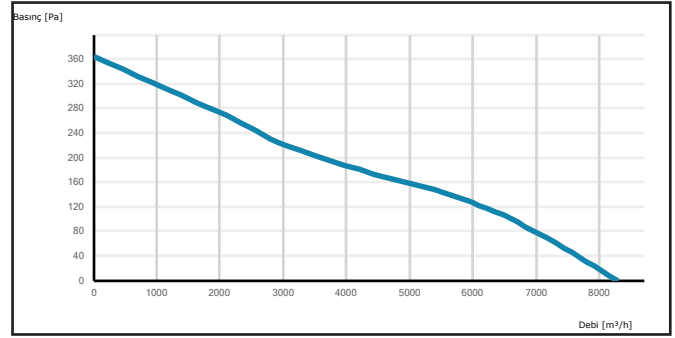

S-DAXI 630-5-30

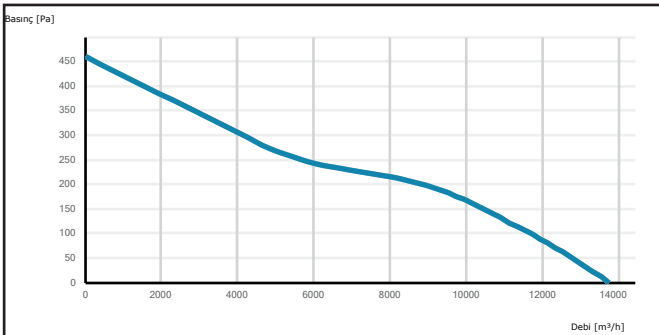

S-DAXI 710-5-30

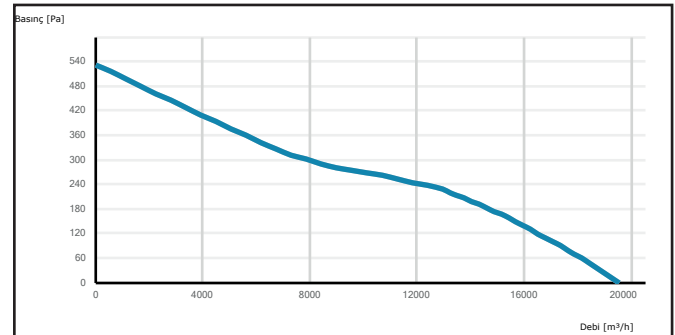

S-DAXI 800-5-30

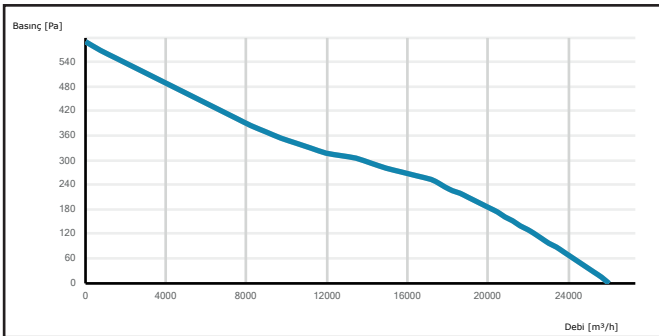

S-DAXI 800-5-35

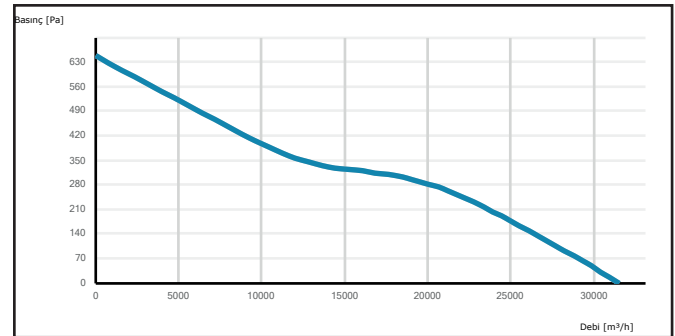

S-DAXI 900-5-35

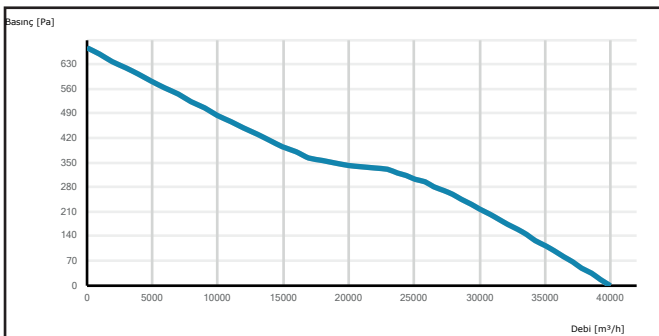

S-DAXI 900-5-40

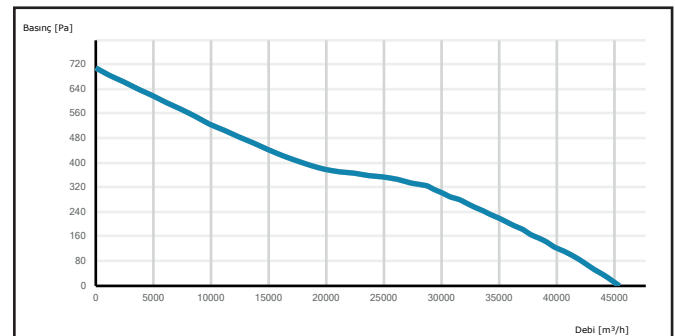



S-DAXI 1000-5-40

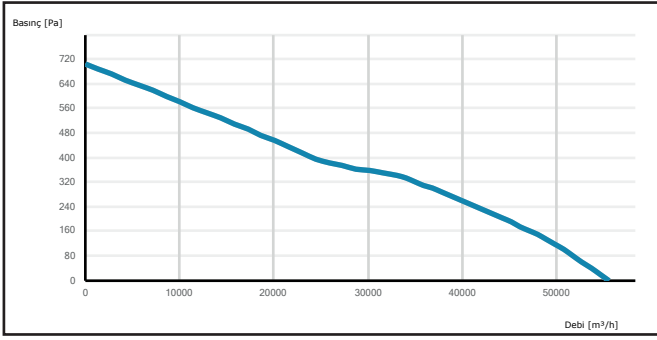

S-DAXI 900-8-40

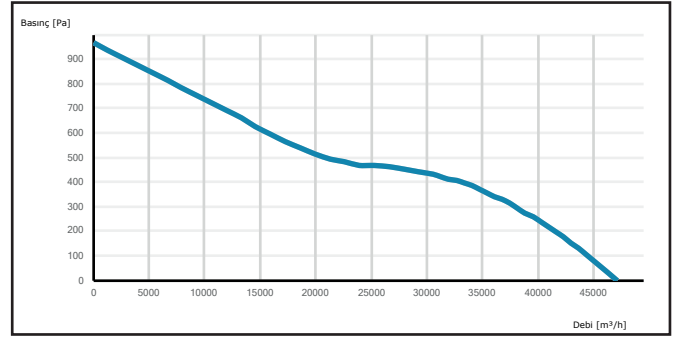

S-DAXI 1000-8-40

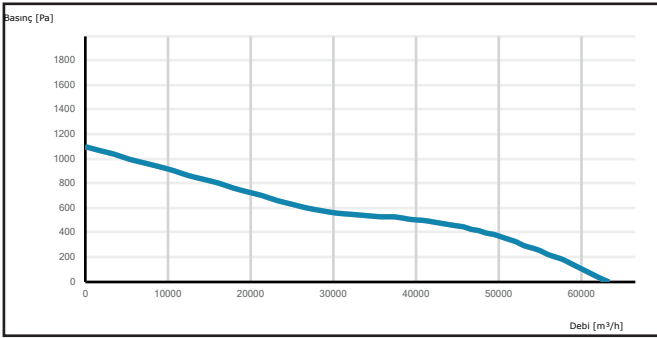

S-DAXI 1000-8-45

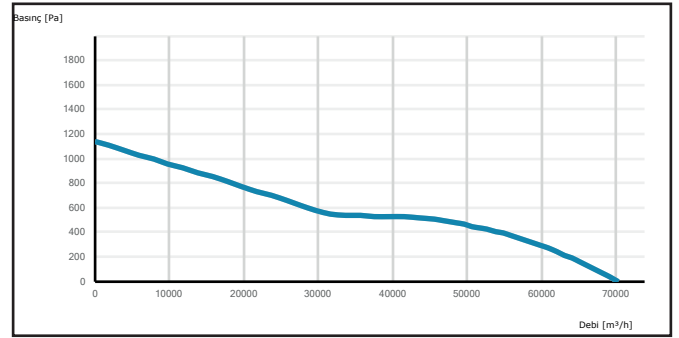

S-DAXI 1120-8-40

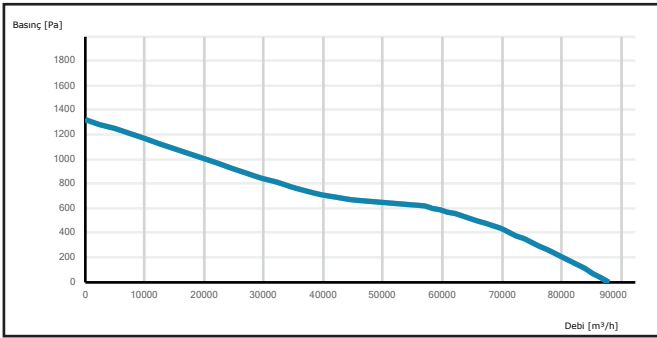

S-DAXI 1120-8-45

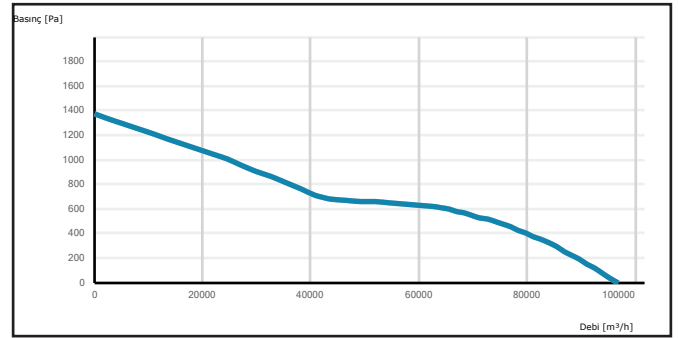



Bifurcated axial fans can be used when motor should be out of the airstream but a belt driven model cannot be used. When continuous use required in high temperature motor can be cooled by attaching a KAZ fan.



MOTOR INSULATION CLASS	F CLASS
MOTOR PROTECTION CLASS	IP 55
MOTOR EFFICIENCY CLASS	IE2-IE3
MOTOR ENCLOSURE TYPE	TEFC
MOTOR BRAND	
BODY MATERIAL	GALVANIZED SHEET METAL
BODY COATING	OPTIONAL
IMPELLER MATERIAL	ALUMINIUM
DUTY CYCLE	IEC Duty Cycle-S1
WORKING AMBIENT TEMPERATURE	-20 - +50 °C
DIRECTIVE	IEC-60335-2-80, ISO 1940-1

MODEL	VOLTAGE (V)	FREQUENCY (Hz)	POWER (kW)	REVOLUTION (rpm)	FLOW RATE (m³/h)	NOISE LEVEL (dB(A))	PRICE
S-BAXI 710-5-30	380	50	1,50	1.472	17.500	89	
S-BAXI 800-5-30	380	50	2,20	1.459	23.400	91	
S-BAXI 800-5-35	380	50	3,00	1.463	28.400	95	
S-BAXI 900-5-35	380	50	4,00	1.471	36.000	96	
S-BAXI 900-5-40	380	50	5,50	1.472	41.000	99	
S-BAXI 1000-5-40	380	50	7,50	1.478	50.000	100	
S-BAXI 900-8-40	380	50	11,00	1.454	42.300	100	
S-BAXI 1000-8-40	380	50	15,00	1.456	56.300	103	
S-BAXI 1000-8-45	380	50	18,50	1.458	63.000	105	
S-BAXI 1120-8-40	380	50	22,00	1.471	78.800	106	
S-BAXI 1120-8-45	380	50	30,00	1.474	86.400	108	

Values are for 0 Pa.

## OPTIONS



GRILLE GUARD		SUPPORT FEET		DUCT FLANGE		CONNECTOR		RUBBER PAD		SPRING		PANEL	
SIZE	PRICE	SIZE	PRICE	SIZE	PRICE	SIZE	PRICE	SIZE	PRICE	SIZE	PRICE	SIZE	PRICE
710		710		710		710		710		710		5,5 kW	
800		800		800		800		800		800		7,5 kW	
900		900		900		900		900		900		11,0 kW	
1000		1000		1000		1000		1000		1000		15,0 kW	
1120		1120		1120		1120		1120		1120		18,5 kW	
												22,0 kW	
												30,0 kW	

## OPTIONS

- Electro-Static Powder Coating
- Custom Fans For Specific Flow Rate and Pressure
- 5, 8, 12, or 16 Blade Fan
- Aluminium or Plastic Blades
- System Automation
- Two-Speed Motor

## DRAWING

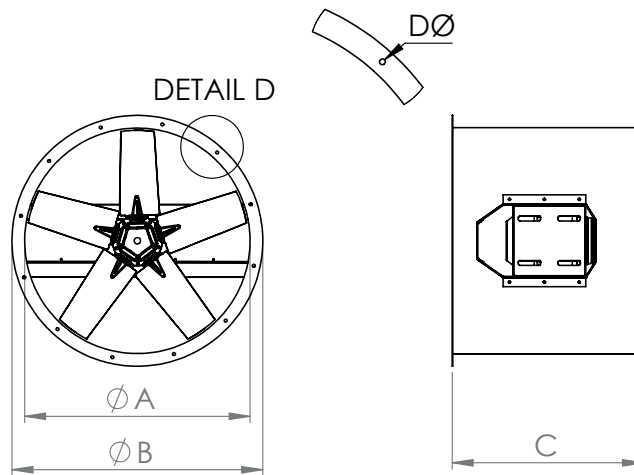

MODEL	A (mm)	B (mm)	C (mm)	D (mm)	N
BAXI 710	710	790	600	11	12
BAXI 800	800	880	650	11	16
BAXI 900	900	980	700	11	16
BAXI 1000	1000	1080	740	11	16
BAXI 1120	1120	1200	800	11	16

N: Number of Holes

## PERFORMANCE CURVES

S-BAXI 710-5-30

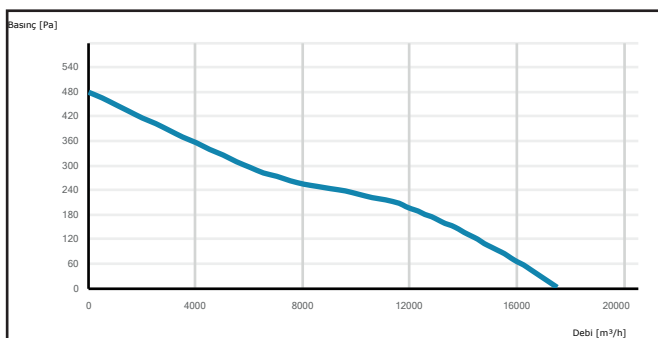

S-BAXI 800-5-30

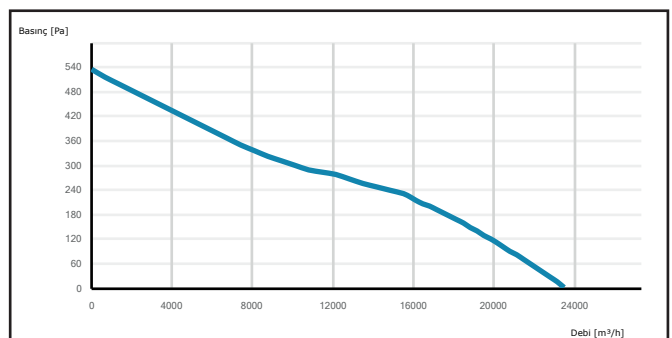

S-BAXI 800-5-35

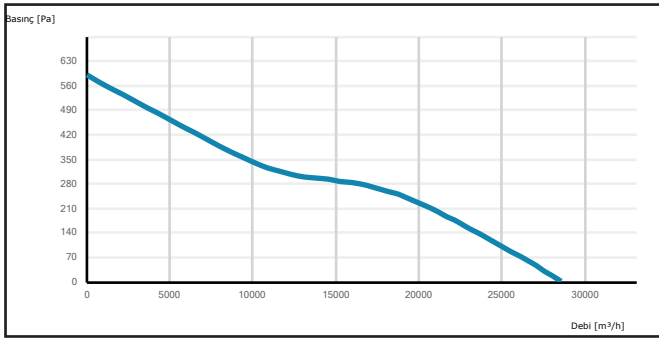

S-BAXI 900-5-35

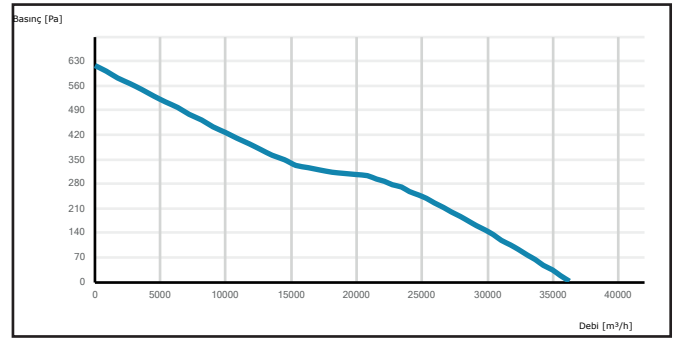

S-BAXI 900-5-40

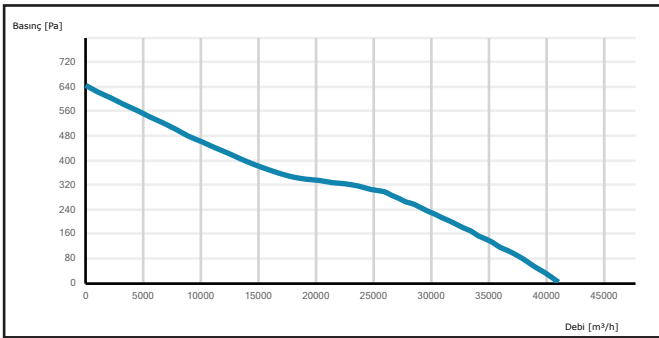

S-BAXI 1000-5-40

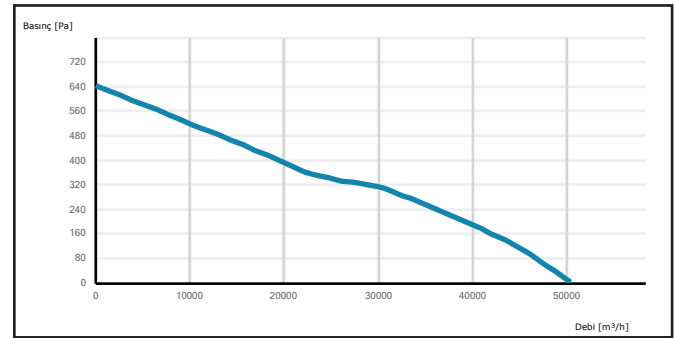

S-BAXI 900-8-40

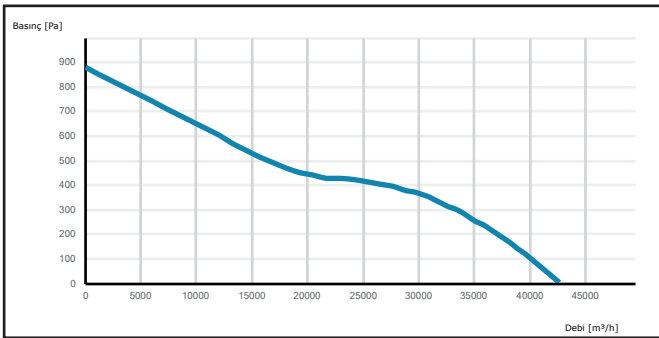

S-BAXI 1000-8-40

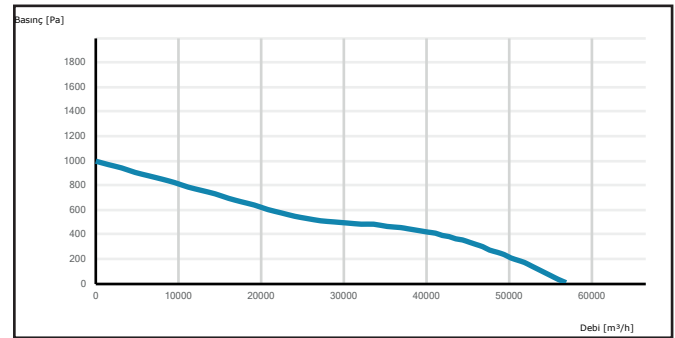

S-BAXI 1000-8-45

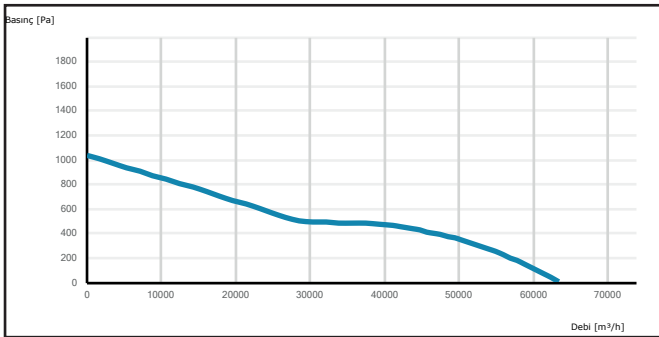

S-BAXI 1120-8-40

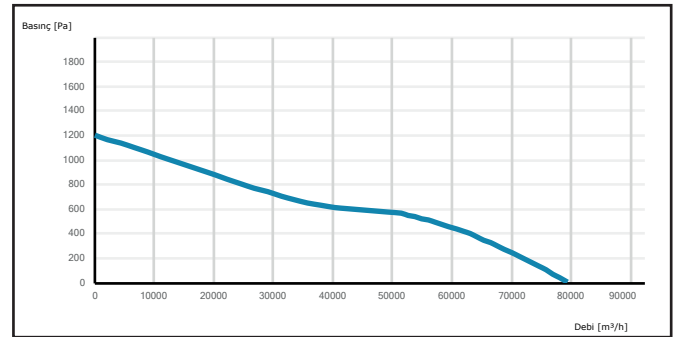

S-BAXI 1120-8-45

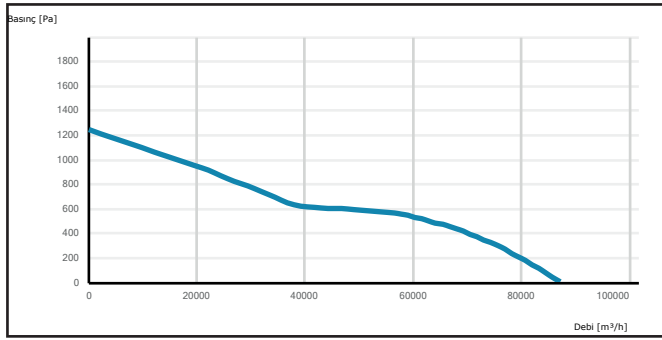

**E** ROOF  
STORAGE  
FACTORY

**A**

**S**

**VEN**

**TILA**

**Y**

**TION**

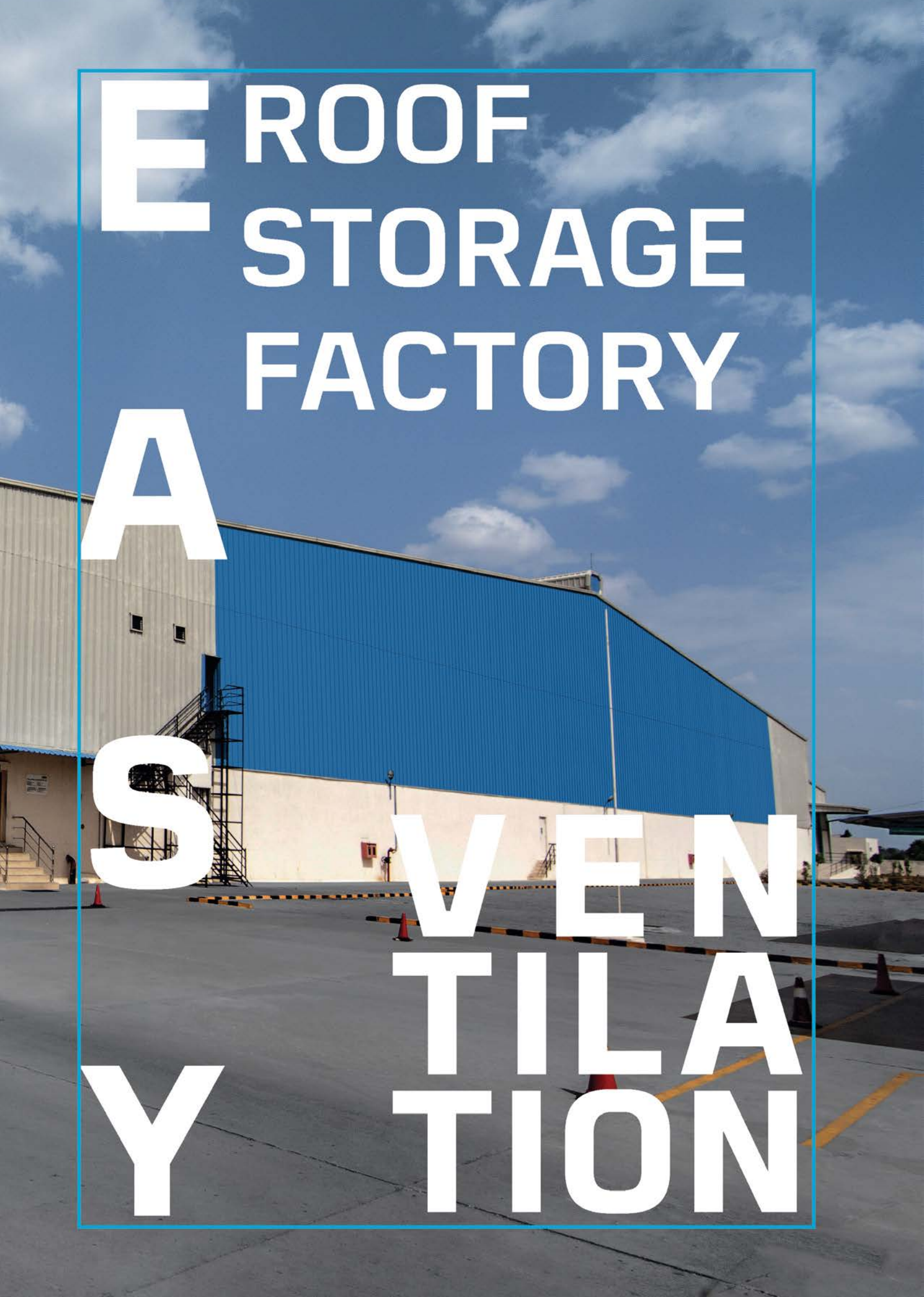



S-CAXI fans can be used to pressurize and exhaust staircases and elevator shafts. With its hood to protect the motor from rain and snow and powder coating for weather conditions, it can work for a long time.

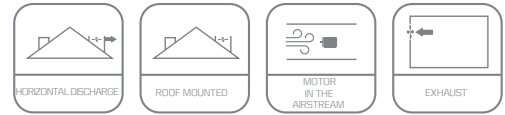

MOTOR INSULATION CLASS	F CLASS
MOTOR PROTECTION CLASS	IP 55
MOTOR EFFICIENCY CLASS	IE2-IE3
MOTOR ENCLOSURE TYPE	TEFC
MOTOR BRAND	
BODY MATERIAL	GALVANIZED SHEET METAL
BODY COATING	ELECTROSTATIC POWDER PAINT
IMPELLER MATERIAL	ALUMINIUM
DUTY CYCLE	IEC Duty Cycle-S1
WORKING AMBIENT TEMPERATURE	-20 - +50 °C
DIRECTIVE	IEC-60335-2-80, ISO 1940-1

MODEL	VOLTAGE (V)	FREQUENCY (Hz)	POWER (kW)	REVOLUTION (rpm)	FLOW RATE (m³/h)	NOISE LEVEL (dB(A))	PRICE
S-CAXI 400-5-25	380	50	0,37	1.450	3.000	66	
S-CAXI 450-5-25	380	50	0,55	1.456	4.400	69	
S-CAXI 500-5-25	380	50	0,55	1.453	6.000	72	
S-CAXI 560-5-25	380	50	0,75	1.466	8.200	75	
S-CAXI 630-5-30	380	50	1,10	1.465	14.000	80	
S-CAXI 710-5-30	380	50	1,50	1.472	20.000	83	
S-CAXI 800-5-30	380	50	2,20	1.459	26.000	85	
S-CAXI 800-5-35	380	50	3,00	1.463	32.000	89	
S-CAXI 900-5-35	380	50	4,00	1.471	40.000	90	
S-CAXI 900-5-40	380	50	5,50	1.472	48.000	93	
S-CAXI 1000-5-40	380	50	7,50	1.478	56.000	94	
S-CAXI 900-8-40	380	50	11,00	1.454	49.000	94	
S-CAXI 1000-8-40	380	50	15,00	1.456	65.000	97	
S-CAXI 1000-8-45	380	50	18,50	1.458	73.000	99	
S-CAXI 1120-8-40	380	50	22,00	1.471	90.000	100	
S-CAXI 1120-8-45	380	50	30,00	1.474	100.000	102	

Values are for 0 Pa.

## OPTIONS



BACK DRAFT DAMPER	
SIZE	PRICE
400	
450	
500	
560	
630	
710	
800	
900	
1000	
1120	

PANEL	
SIZE	PRICE
5,5 kW	
7,5 kW	
11,0 kW	
15,0 kW	
18,5 kW	
22,0 kW	
30,0 kW	

## OPTIONS

- Electro-Static Powder Coating
- Custom Fans For Specific Flow Rate and Pressure
- 5, 8, 12, or 16 Blade Fan
- Aluminium or Plastic Blades
- System Automation
- Two-Speed Motor
- Motorized Damper

## DRAWING

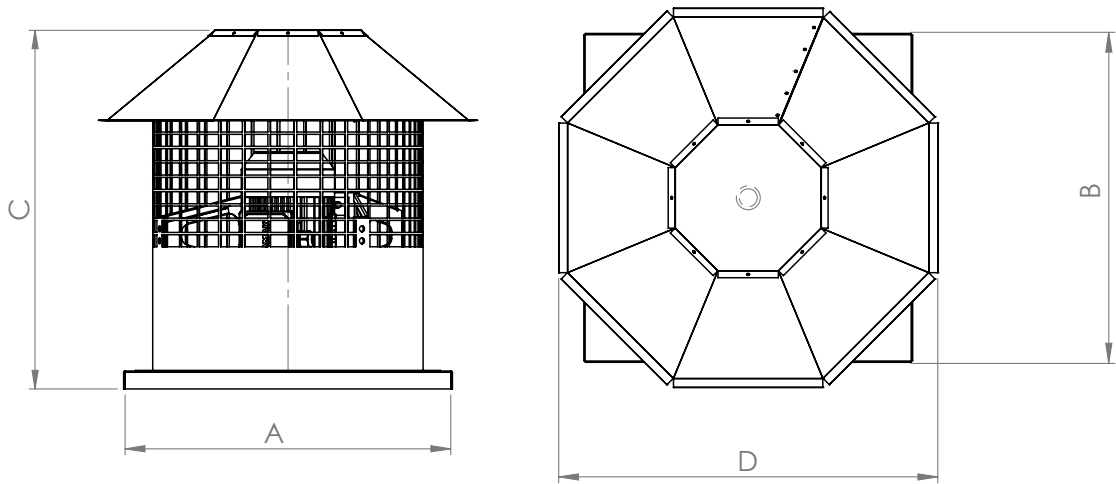

MODEL	A (mm)	B (mm)	C (mm)	D (mm)
S-CAXI 400	400	480	320	11
S-CAXI 450	450	530	320	11
S-CAXI 500	500	580	320	11
S-CAXI 560	560	640	320	11
S-CAXI 630	630	710	420	11
S-CAXI 710	710	790	420	11
S-CAXI 800	800	880	420	11
S-CAXI 900	900	980	520	11
S-CAXI 1000	1000	1080	520	11
S-CAXI 1120	1120	1200	520	11

## PERFORMANCE CURVES

S-CAXI 400-5-25

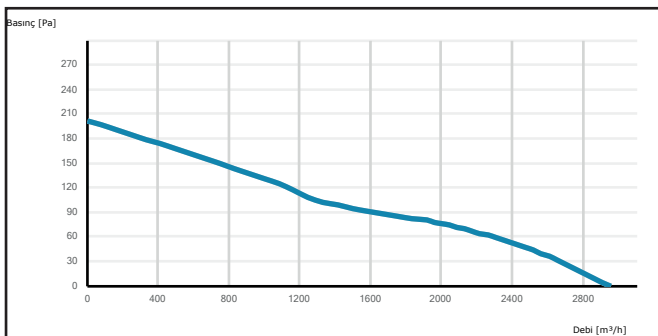

S-CAXI 450-5-25

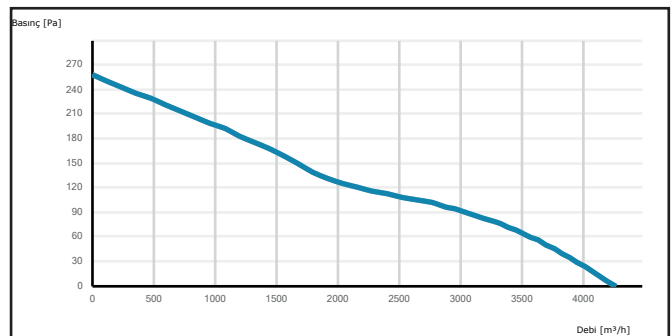



S-CAXI 500-5-25

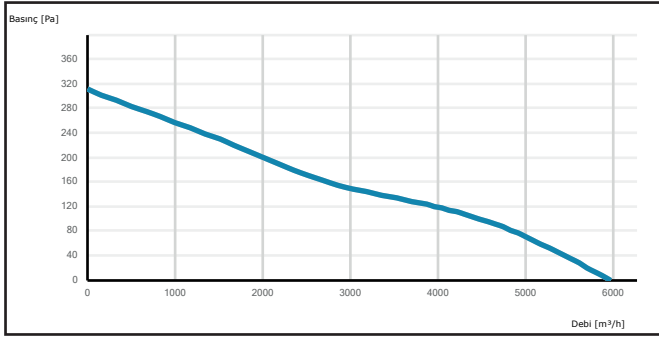

S-CAXI 560-5-25

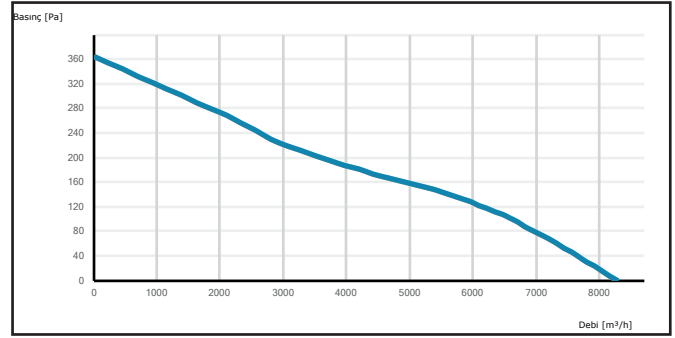

S-CAXI 630-5-30

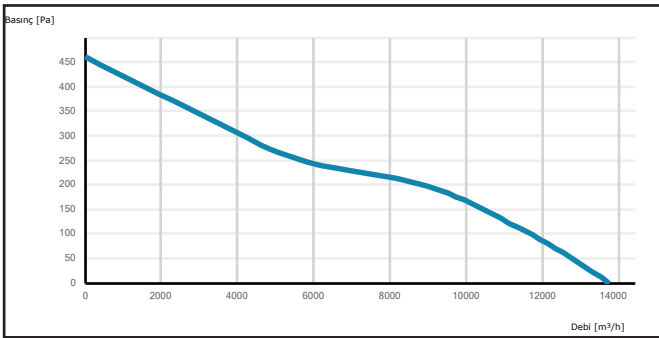

S-CAXI 710-5-30

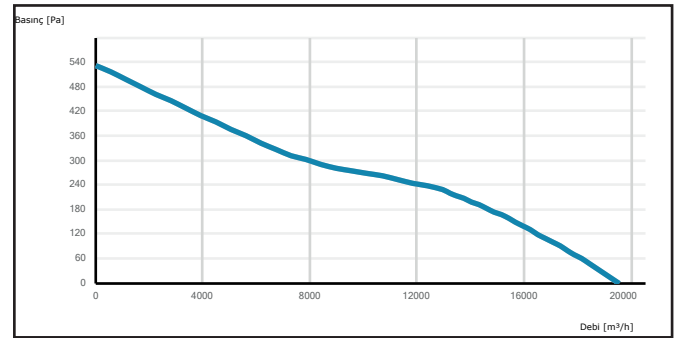

S-CAXI 800-5-30

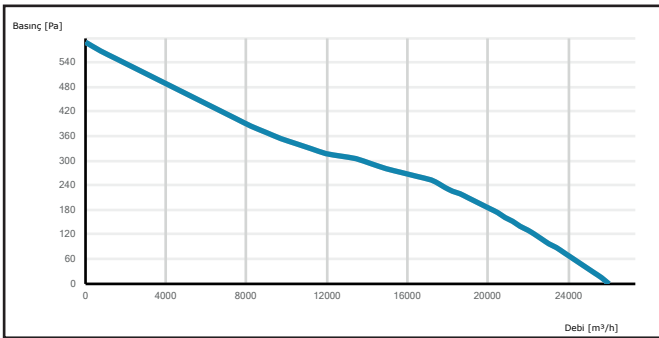

S-CAXI 800-5-35

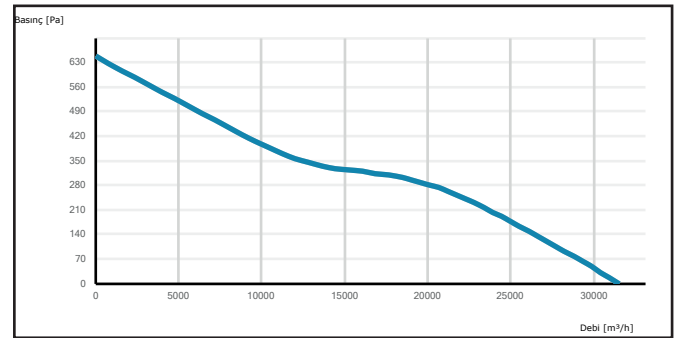

S-CAXI 900-5-35

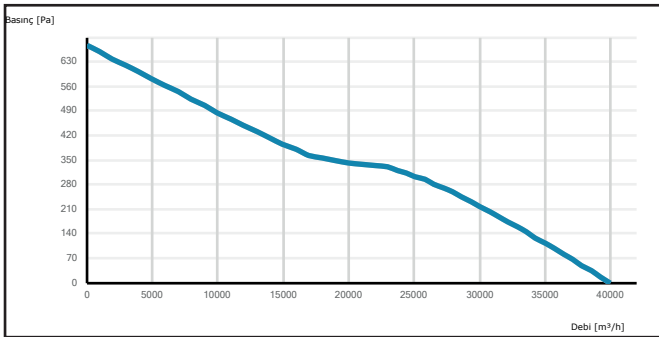

S-CAXI 900-5-40

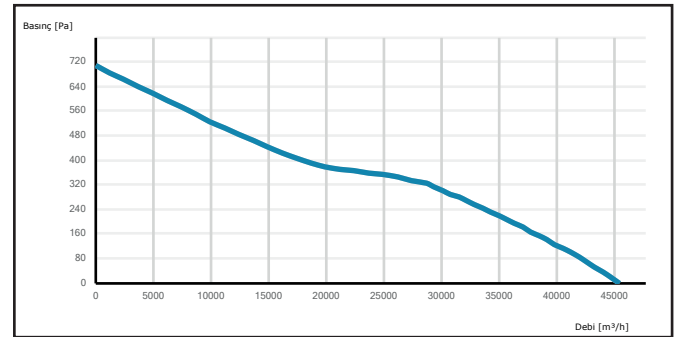

S-CAXI 1000-5-40

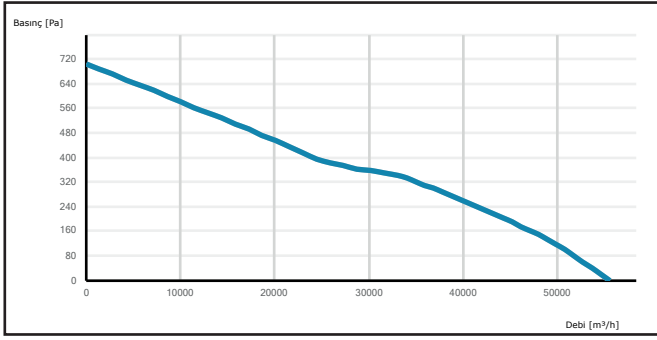

S-CAXI 900-8-40

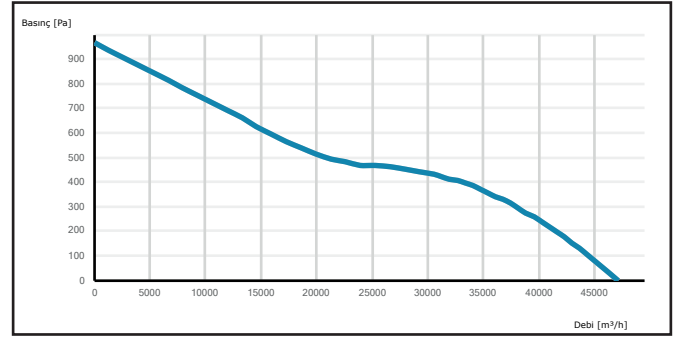

S-CAXI 1000-8-40

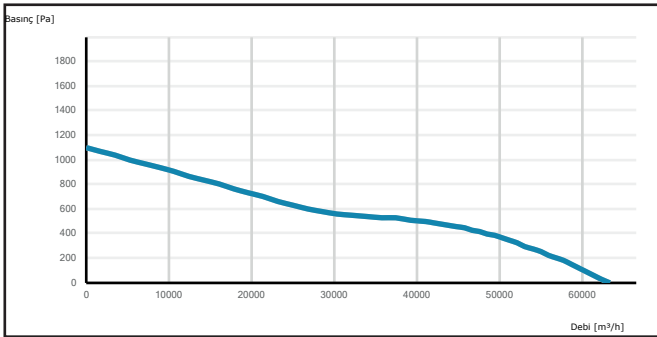

S-CAXI 1000-8-45

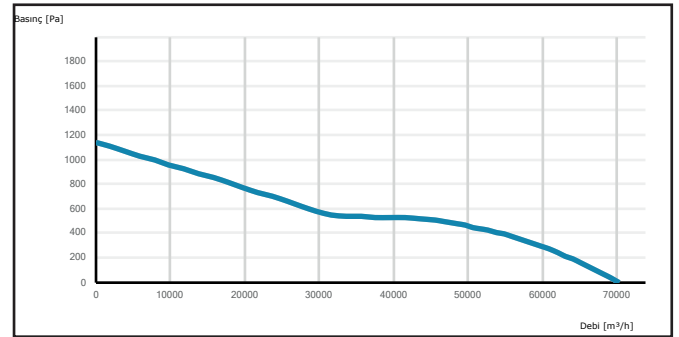

S-CAXI 1120-8-40

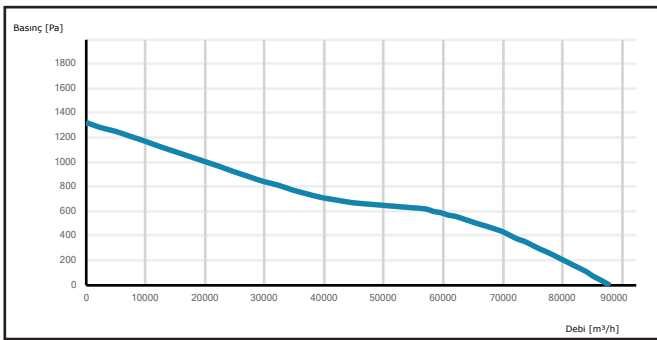

S-CAXI 1120-8-45

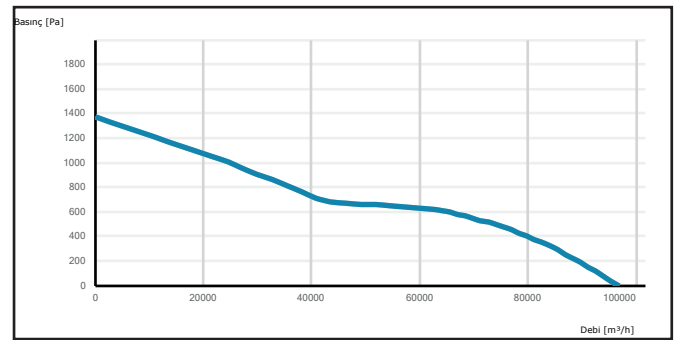



# S-CTAXI Roof Mounted Smoke Exhaust Fan - F300



Roof Mounted Smoke Exhaust Fans can keep working for two hours at 300 °C and in combination with Jet Fans can be used to extract smoke from parking lots in case of fire.



MOTOR INSULATION CLASS	H CLASS
MOTOR PROTECTION CLASS	IP 54-IP 55
MOTOR EFFICIENCY CLASS	IE1-IE2
MOTOR ENCLOSURE TYPE	TEAO
MOTOR BRAND	
BODY MATERIAL	GALVANIZED SHEET METAL
BODY COATING	OPTIONAL
IMPELLER MATERIAL	ALUMINIUM
DUTY CYCLE	IEC Duty Cycle-S1
WORKING AMBIENT TEMPERATURE	-20 - +50 °C
DIRECTIVE	IEC-60335-2-80, ISO 1940-1, EN 12101-3

MODEL	VOLTAGE (V)	FREQUENCY (Hz)	POWER (kW)	REVOLUTION (rpm)	FLOW RATE (m³/h)	NOISE LEVEL (dB(A))	PRICE
S-CTAXI 450-5-25	380	50	0,55	1.456	4.400	69	
S-CTAXI 500-5-25	380	50	0,55	1.453	6.000	72	
S-CTAXI 560-5-25	380	50	0,75	1.466	8.200	75	
S-CTAXI 630-5-30	380	50	1,10	1.465	14.000	80	
S-CTAXI 710-5-30	380	50	1,50	1.472	20.000	83	
S-CTAXI 800-5-30	380	50	2,20	1.459	26.000	85	
S-CTAXI 800-5-35	380	50	3,00	1.463	32.000	89	
S-CTAXI 900-5-35	380	50	4,00	1.471	40.000	90	
S-CTAXI 900-5-40	380	50	5,50	1.472	48.000	93	
S-CTAXI 1000-5-40	380	50	7,50	1.478	56.000	94	
S-CTAXI 900-8-40	380	50	11,00	1.454	49.000	94	
S-CTAXI 1000-8-40	380	50	15,00	1.456	65.000	97	
S-CTAXI 1000-8-45	380	50	18,50	1.458	73.000	99	
S-CTAXI 1120-8-40	380	50	22,00	1.471	90.000	100	
S-CTAXI 1120-8-45	380	50	30,00	1.474	100.000	102	

Values are for 0 Pa.

## OPTIONS



BACK DRAFT DAMPER

SIZE	PRICE
450	
500	
560	
630	
710	
800	
900	
1000	
1120	

## OPTIONS

- Custom Fans For Specific Flow Rate and Pressure
- 5, 8, 12, or 16 Blade Fan
- System Automation
- Two-Speed Motor
- Motorized Damper

## DRAWING

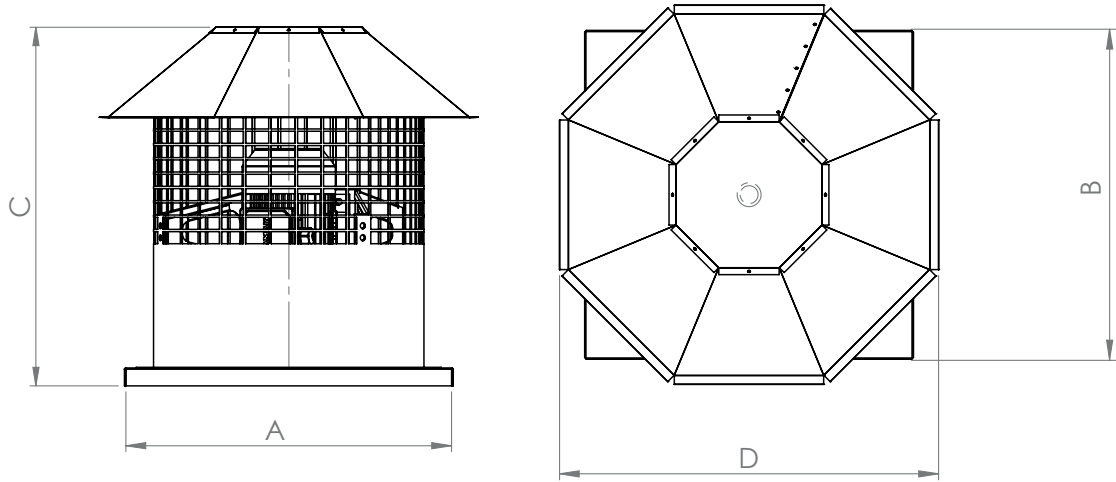

MODEL	A (mm)	B (mm)	C (mm)	D (mm)
S-CTAXI 450	450	530	320	11
S-CTAXI 500	500	580	320	11
S-CTAXI 560	560	640	320	11
S-CTAXI 630	630	710	420	11
S-CTAXI 710	710	790	420	11
S-CTAXI 800	800	880	420	11
S-CTAXI 900	900	980	520	11
S-CTAXI 1000	1000	1080	520	11
S-CTAXI 1120	1120	1200	520	11

## PERFORMANCE CURVES

S-CTAXI 450-5-25

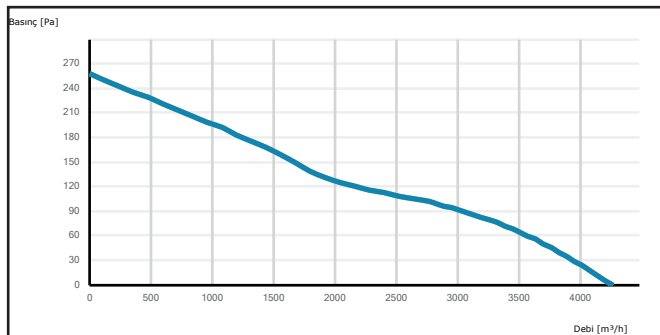

S-CTAXI 500-5-25

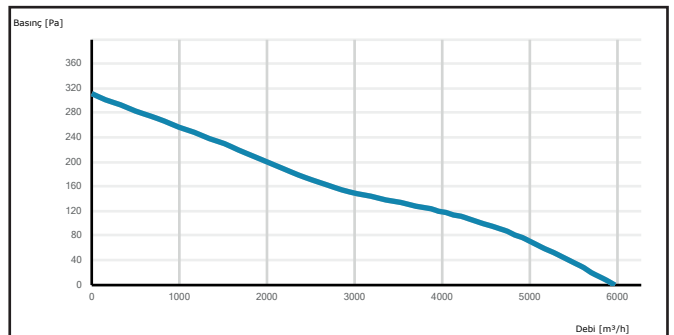

S-CTAXI 560-5-25

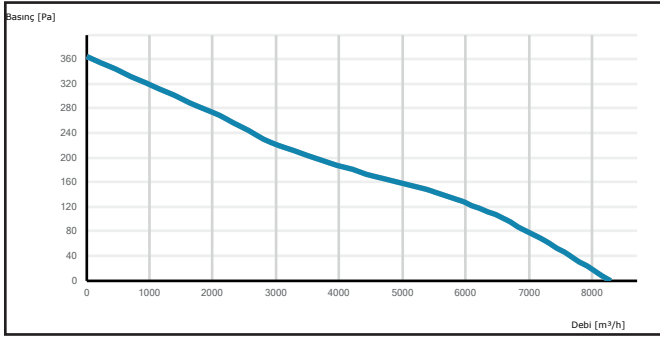

S-CTAXI 630-5-30

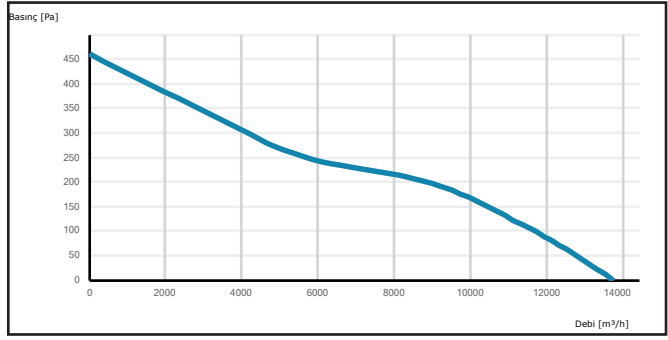

S-CTAXI 710-5-30

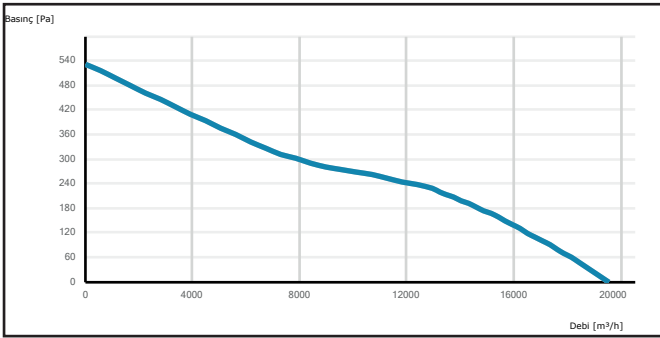

S-CTAXI 800-5-30

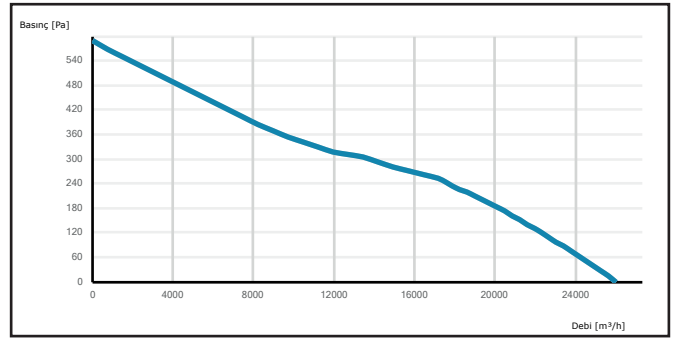

S-CTAXI 800-5-35

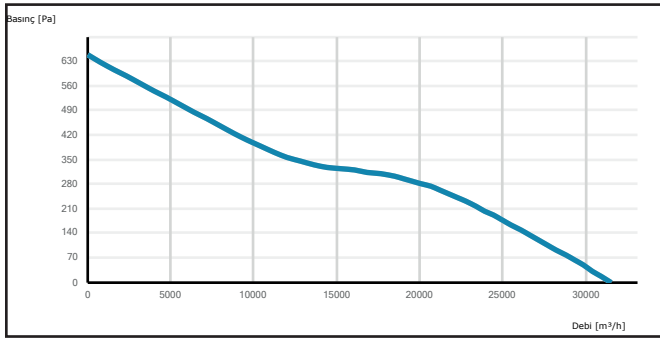

S-CTAXI 900-5-35

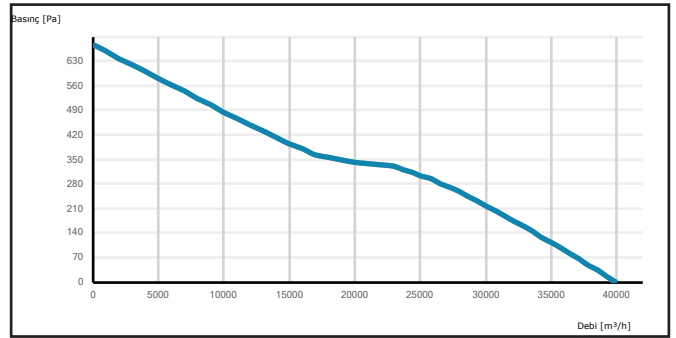

S-CTAXI 900-5-40

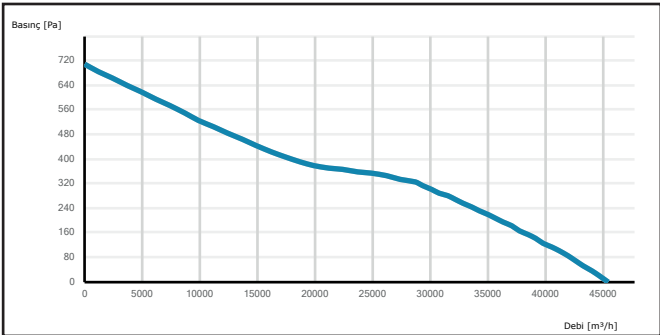

S-CTAXI 1000-5-40

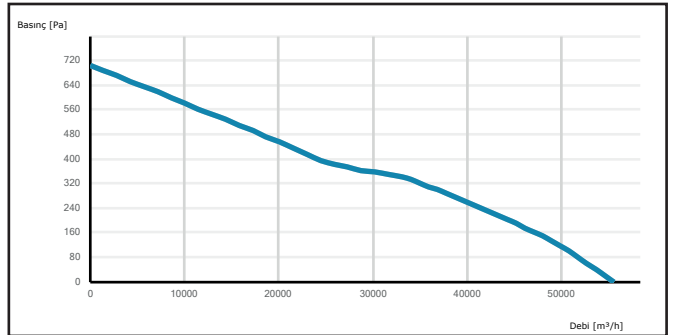

S-CTAXI 900-8-40

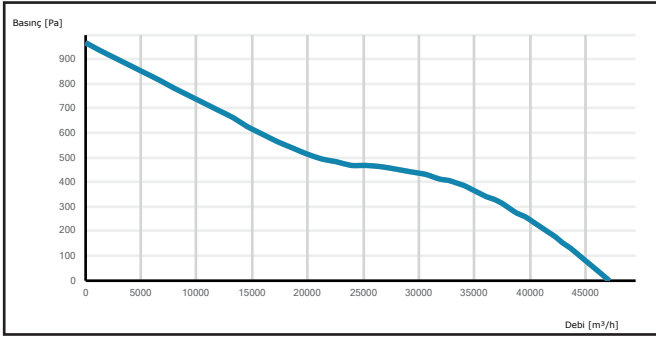

S-CTAXI 1000-8-40

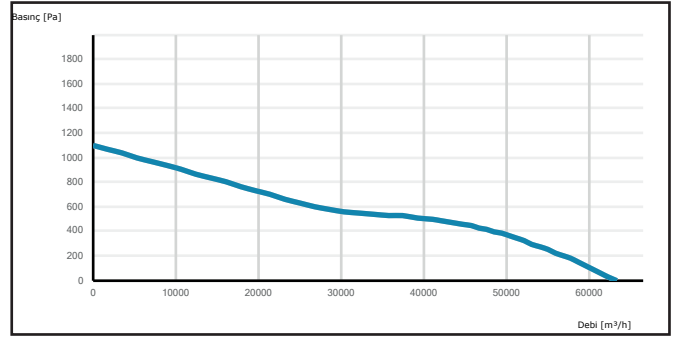

S-CTAXI 1000-8-45

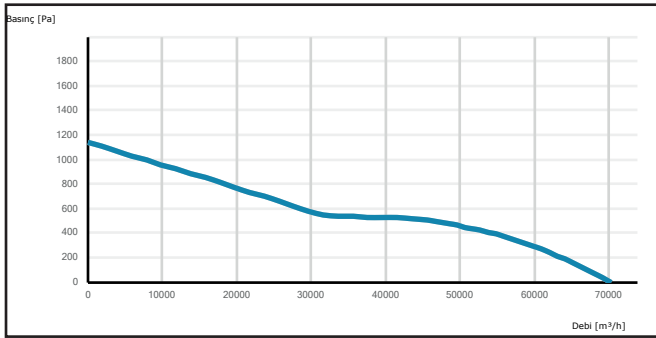

S-CTAXI 1120-8-40

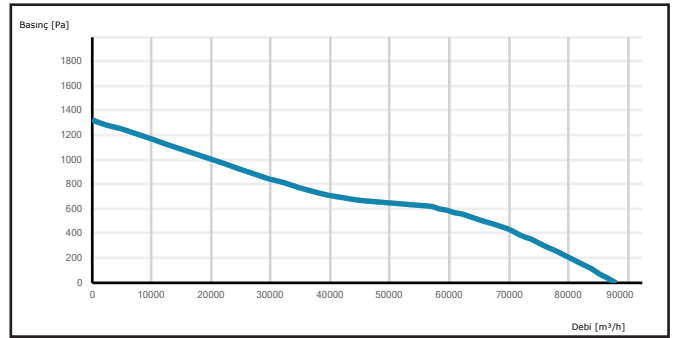

S-CTAXI 1120-8-45

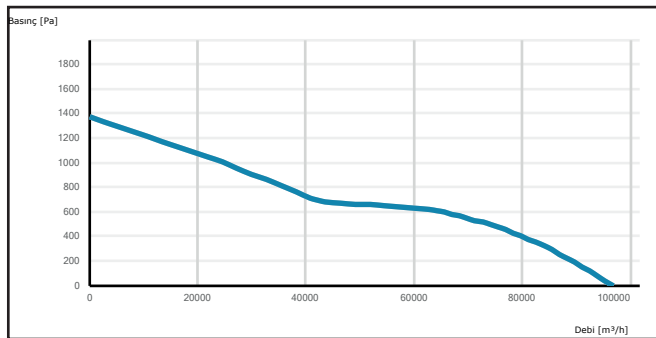



## S-CTAXI - Roof Mounted Smoke Exhaust Fan - F400



Roof Mounted Smoke Exhaust Fans can keep working for two hours at 400 °C and in combination with Jet Fans can be used to extract smoke from parking lots in case of fire.



MOTOR INSULATION CLASS	H CLASS
MOTOR PROTECTION CLASS	IP 54-IP 55
MOTOR EFFICIENCY CLASS	IE1-IE2
MOTOR ENCLOSURE TYPE	TEAO
MOTOR BRAND	
BODY MATERIAL	GALVANIZED SHEET METAL
BODY COATING	OPTIONAL
IMPELLER MATERIAL	ALUMINIUM
DUTY CYCLE	IEC Duty Cycle-S1
WORKING AMBIENT TEMPERATURE	-20 - +50 °C
DIRECTIVE	IEC-60335-2-80, ISO 1940-1, EN 12101-3

MODEL	VOLTAGE (V)	FREQUENCY (Hz)	POWER (kW)	REVOLUTION (rpm)	FLOW RATE (m³/h)	NOISE LEVEL (dB(A))	PRICE
S-CTAXI 450-5-25	380	50	0,55	1.456	4.400	69	
S-CTAXI 500-5-25	380	50	0,55	1.453	6.000	72	
S-CTAXI 560-5-25	380	50	0,75	1.466	8.200	75	
S-CTAXI 630-5-30	380	50	1,10	1.465	14.000	80	
S-CTAXI 710-5-30	380	50	1,50	1.472	20.000	83	
S-CTAXI 800-5-30	380	50	2,20	1.459	26.000	85	
S-CTAXI 800-5-35	380	50	3,00	1.463	32.000	89	
S-CTAXI 900-5-35	380	50	4,00	1.471	40.000	90	
S-CTAXI 900-5-40	380	50	5,50	1.472	48.000	93	
S-CTAXI 1000-5-40	380	50	7,50	1.478	56.000	94	
S-CTAXI 900-8-40	380	50	11,00	1.454	49.000	94	
S-CTAXI 1000-8-40	380	50	15,00	1.456	65.000	97	
S-CTAXI 1000-8-45	380	50	18,50	1.458	73.000	99	
S-CTAXI 1120-8-40	380	50	22,00	1.471	90.000	100	
S-CTAXI 1120-8-45	380	50	30,00	1.474	100.000	102	

Values are for 0 Pa.

## OPTIONS



BACK DRAFT DAMPER

SIZE	PRICE
450	
500	
560	
630	
710	
800	
900	
1000	
1120	

## OPTIONS

- Custom Fans For Specific Flow Rate and Pressure
- 5, 8, 12, or 16 Blade Fan
- System Automation
- Two-Speed Motor
- Motorized Damper

## DRAWING

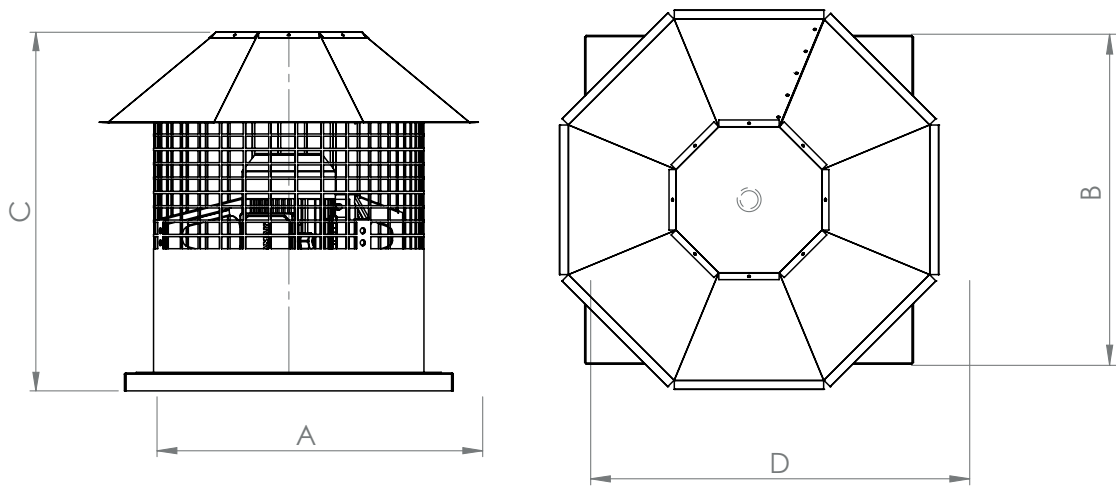

MODEL	A (mm)	B (mm)	C (mm)	D (mm)
S-CTAXI 450	450	530	320	11
S-CTAXI 500	500	580	320	11
S-CTAXI 560	560	640	320	11
S-CTAXI 630	630	710	420	11
S-CTAXI 710	710	790	420	11
S-CTAXI 800	800	880	420	11
S-CTAXI 900	900	980	520	11
S-CTAXI 1000	1000	1080	520	11
S-CTAXI 1120	1120	1200	520	11

## PERFORMANCE CURVES

S-CTAXI 450-5-25

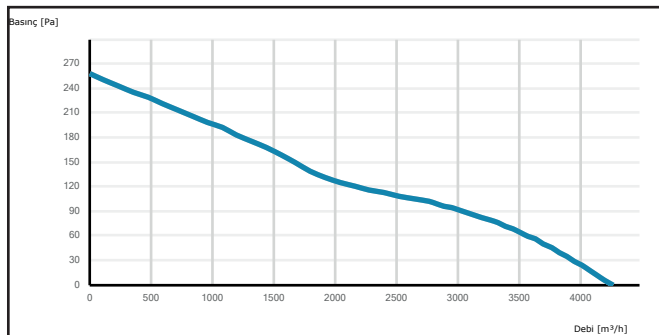

S-CTAXI 500-5-25

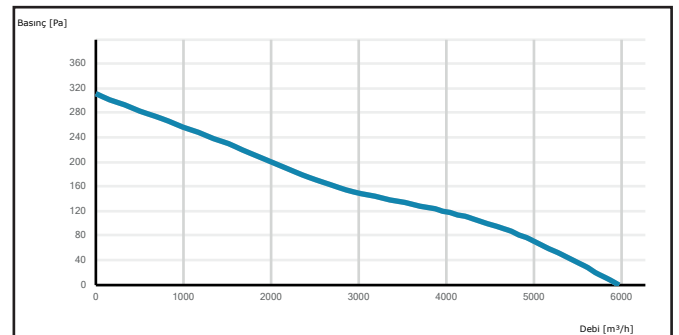



S-CTAXI 560-5-25

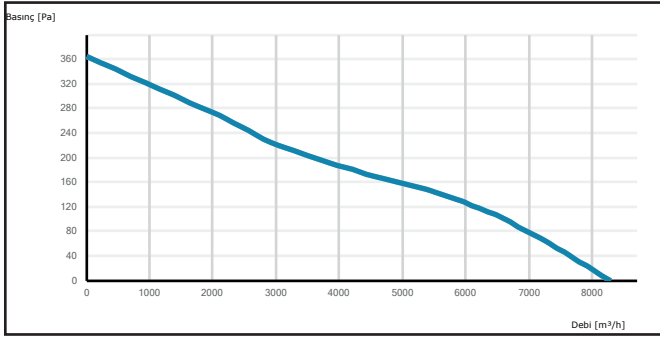

S-CTAXI 630-5-30

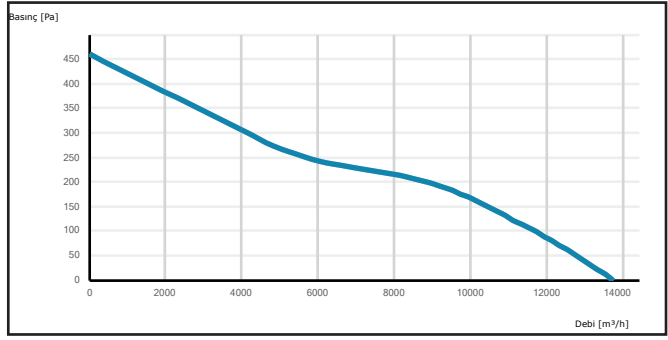

S-CTAXI 710-5-30

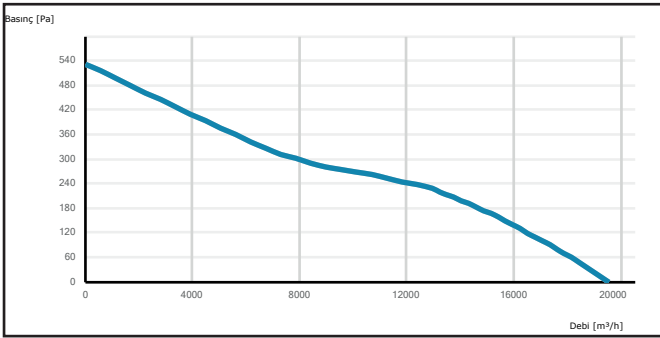

S-CTAXI 800-5-30

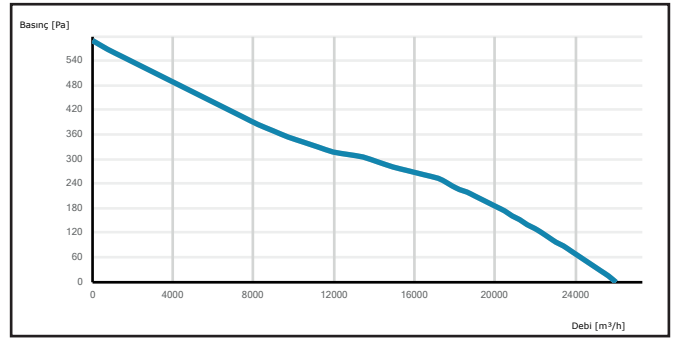

S-CTAXI 800-5-35

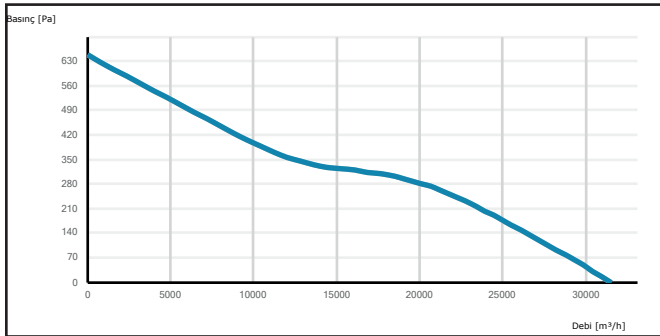

S-CTAXI 900-5-35

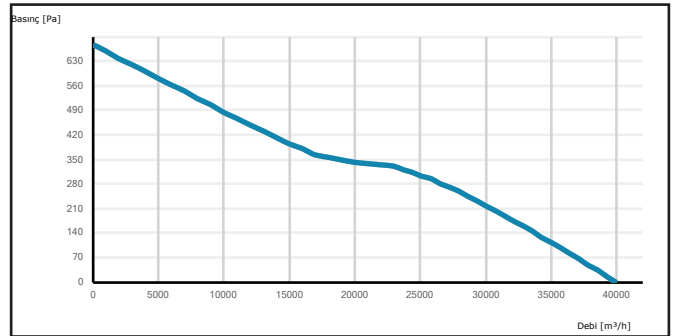

S-CTAXI 900-5-40

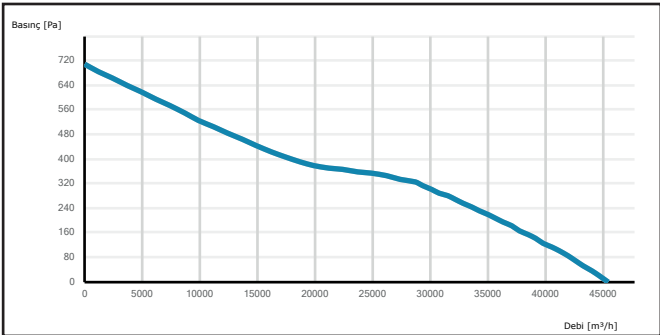

S-CTAXI 1000-5-40

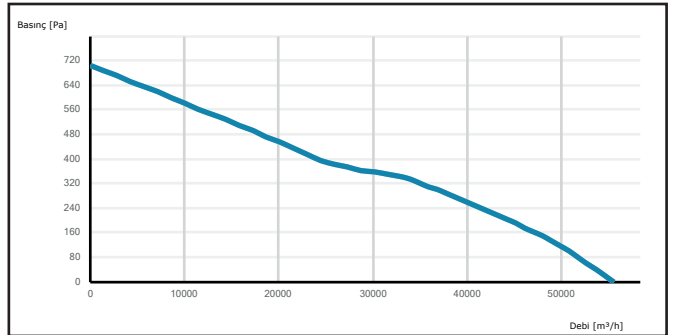

S-CTAXI 900-8-40

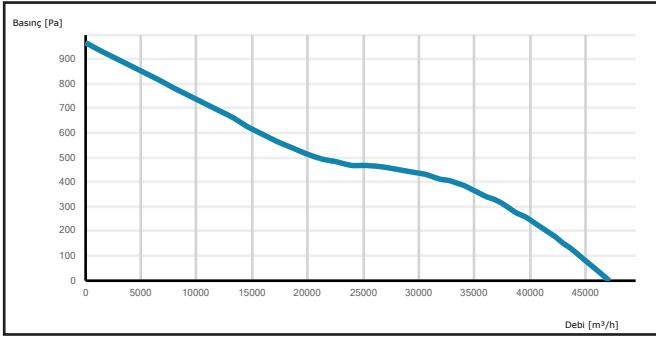

S-CTAXI 1000-8-40

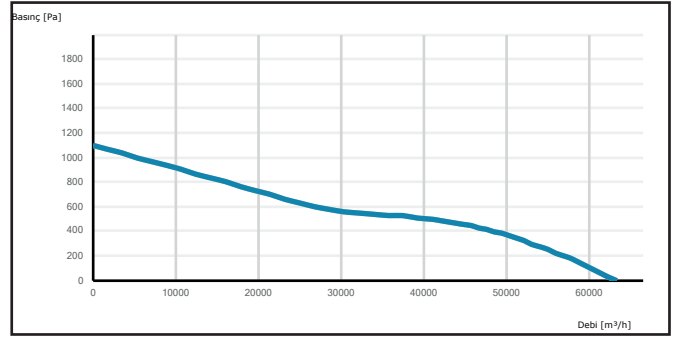

S-CTAXI 1000-8-45

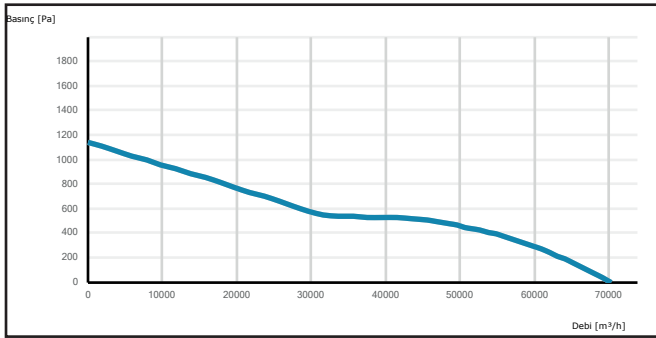

S-CTAXI 1120-8-40

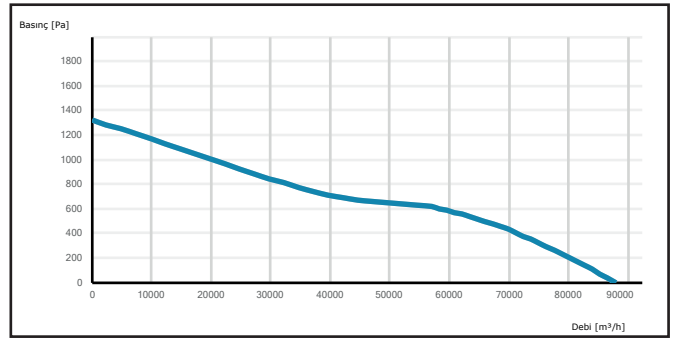

S-CTAXI 1120-8-45

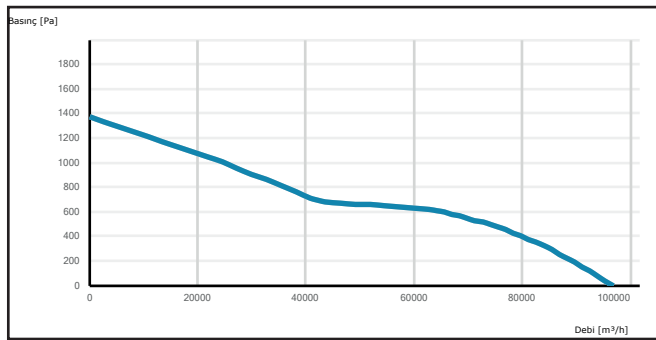



## S-CAXIDIK Roof Mounted Vertical Discharge Axial Fan



S-CAXIDIK fans push the air vertically unlike traditional roof fans which push horizontally. The air can be pushed up to 10 meters which allows the fan to be placed in close quarters with other things and doesn't disturb people who may be on the same level as the fan.



MOTOR INSULATION CLASS	F CLASS
MOTOR PROTECTION CLASS	IP 55
MOTOR EFFICIENCY CLASS	IE2-IE3
MOTOR ENCLOSURE TYPE	TEFC
MOTOR BRAND	
BODY MATERIAL	GALVANIZED SHEET METAL
BODY COATING	ELECTROSTATIC POWDER PAINT
IMPELLER MATERIAL	ALUMINIUM
DUTY CYCLE	IEC Duty Cycle-S1
WORKING AMBIENT TEMPERATURE	-20 - +50 °C
DIRECTIVE	IEC-60335-2-80, ISO 1940-1

MODEL	VOLTAGE (V)	FREQUENCY (Hz)	POWER (kW)	REVOLUTION (rpm)	FLOW RATE (m³/h)	NOISE LEVEL (dB(A))	PRICE
S-CAXIDIK 400-5-25	380	50	0,37	1.450	2.850	66	
S-CAXIDIK 450-5-25	380	50	0,55	1.456	3.800	69	
S-CAXIDIK 500-5-25	380	50	0,55	1.453	4.750	72	
S-CAXIDIK 560-5-25	380	50	0,75	1.466	7.125	75	
S-CAXIDIK 630-5-30	380	50	1,10	1.465	11.400	80	
S-CAXIDIK 710-5-30	380	50	1,50	1.472	16.150	83	
S-CAXIDIK 800-5-30	380	50	2,20	1.459	21.850	85	
S-CAXIDIK 800-5-35	380	50	3,00	1.463	26.600	89	

Values are for 0 Pa.

## OPTIONS



BACK DRAFT DAMPER

SIZE	PRICE
400	
450	
500	
560	
630	
710	
800	

## OPTIONS

- Electro-Static Powder Coating
- Custom Fans For Specific Flow Rate and Pressure
- 5, 8, 12, or 16 Blade Fan
- Aluminium or Plastic Blades
- System Automation
- Two-Speed Motor
- Motorized Damper
- Smoke Exhaust Model

## DRAWING

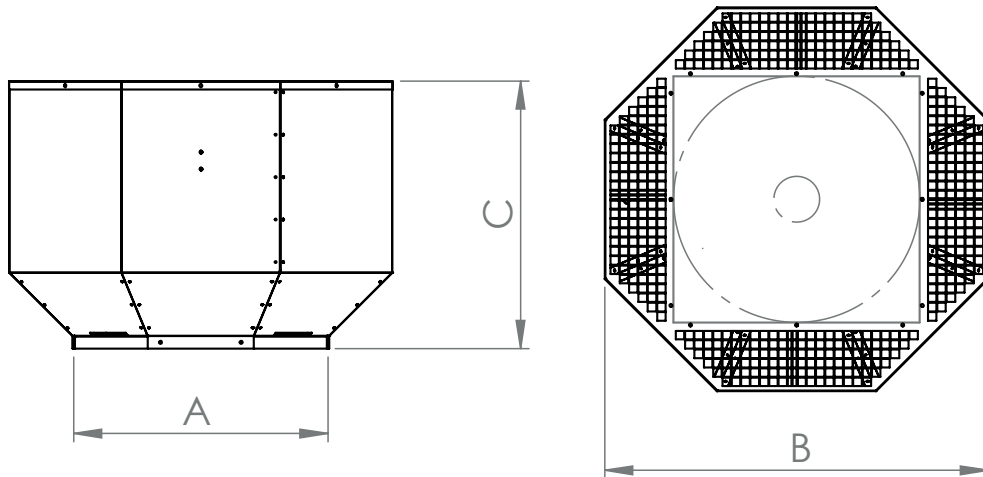

MODEL	A (mm)	B (mm)	C (mm)
S-CAXIDIK 400	500	800	600
S-CAXIDIK 450	550	850	600
S-CAXIDIK 500	600	900	630
S-CAXIDIK 560	660	960	630
S-CAXIDIK 630	730	1030	700
S-CAXIDIK 710	810	1110	700
S-CAXIDIK 800	900	1200	750

## PERFORMANCE CURVES

S-CAXIDIK 400-5-25

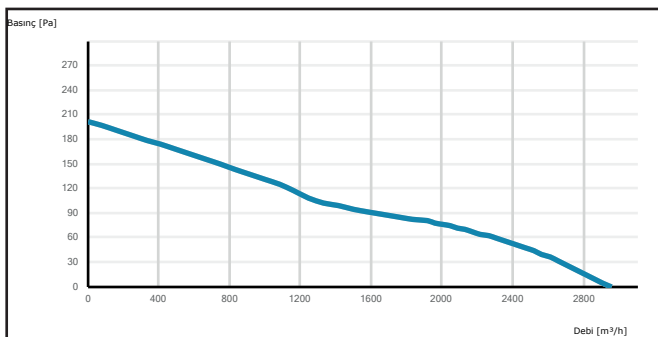

S-CAXIDIK 450-5-25

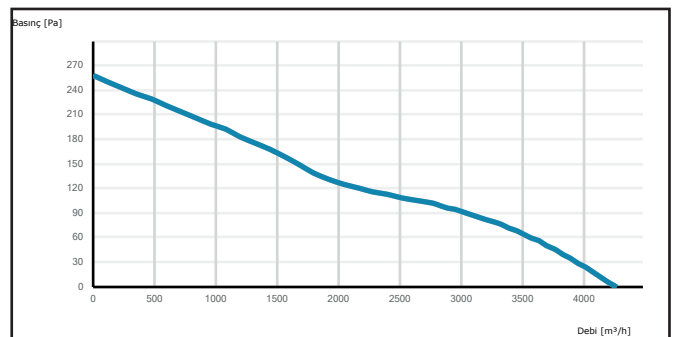

S-CAXIDIK 500-5-25

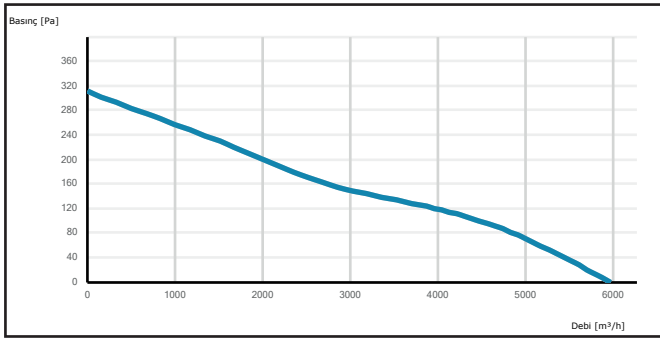

S-CAXIDIK 560-5-25

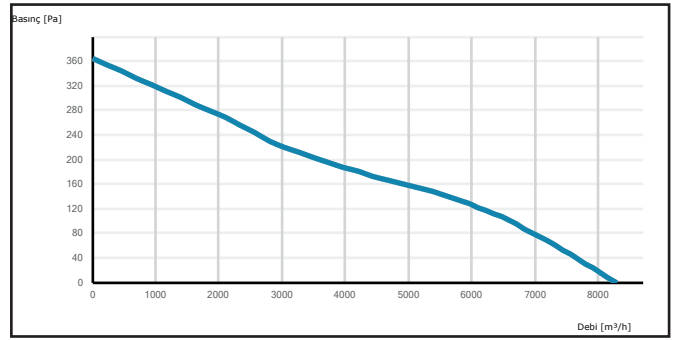

S-CAXIDIK 630-5-30

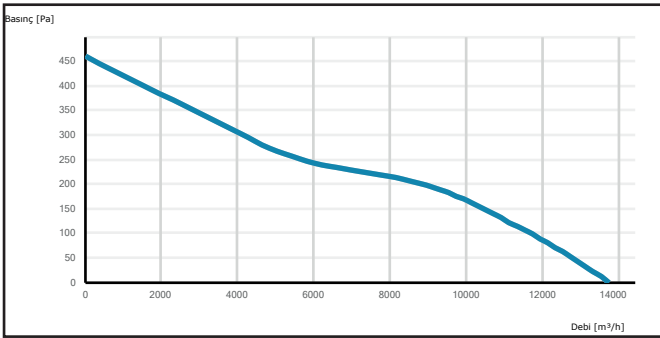

S-CAXIDIK 710-5-30

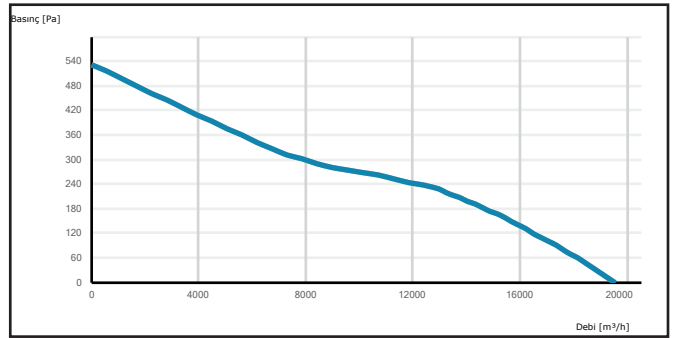

S-CAXIDIK 800-5-30

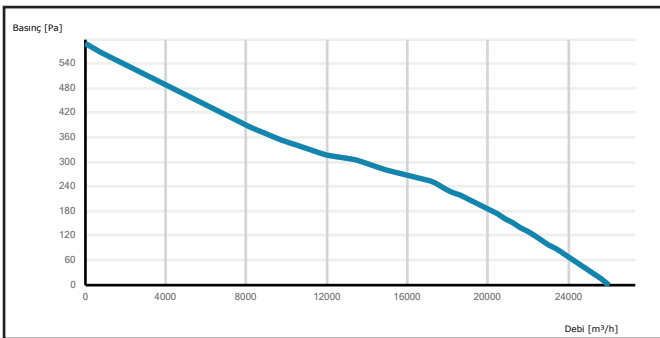

S-CAXIDIK 800-5-35

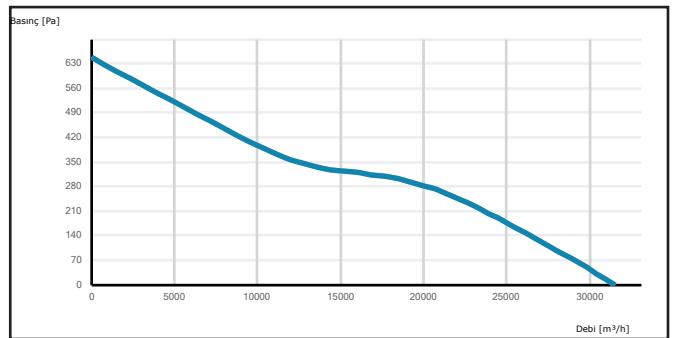

**E COOLING  
STORAGE  
FRESH**

**A**

**S**

**VEN**

**TILA**

**Y**

**TION**



S-SOF fans can be used to push or pull air for commercial and industrial refrigerators, cold kitchen storage and cold storage. They can be ordered to be blower suction type.

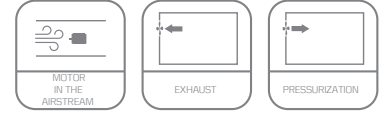

MOTOR INSULATION CLASS	F CLASS
MOTOR PROTECTION CLASS	IP 44
MOTOR EFFICIENCY CLASS	IE2-IE3
MOTOR ENCLOSURE TYPE	EXTERNAL ROTOR MOTOR
MOTOR BRAND	
BODY MATERIAL	STEEL GRILLE
BODY COATING	ELECTROSTATIC POWDER PAINT
IMPELLER MATERIAL	ALUMINIUM/GALVANIZED METAL
DUTY CYCLE	IEC Duty Cycle-S1
WORKING AMBIENT TEMPERATURE	-20 - +50 °C
DIRECTIVE	IEC-60335-2-80, ISO 1940-1

MODEL	VOLTAGE (V)	FREQUENCY (Hz)	POWER (kW)	REVOLUTION (rpm)	FLOW RATE (m³/h)	NOISE LEVEL (dB(A))	PRICE
S-SOF 250	220	50	50	1.380	1.000	89	
S-SOF 300	220	50	90	1.370	1.700	91	
S-SOF 350	220	50	138	1.370	2.980	95	
S-SOF 400	220	50	180	1.350	3.900	96	
S-SOF 450	220	50	250	1.380	5.100	99	

Values are for 0 Pa.

### DRAWING

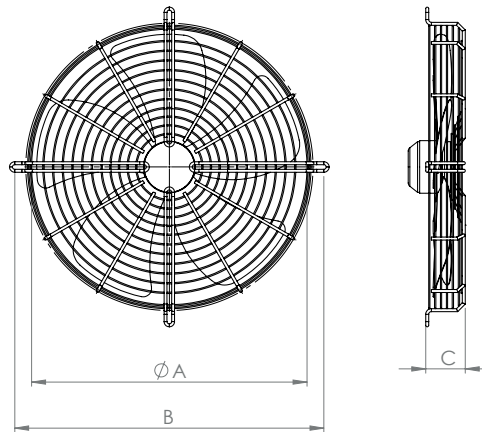

MODEL	A (mm)	B (mm)	C (mm)
S-SOF 250	250	330	80
S-SOF 300	300	380	80
S-SOF 350	350	430	80
S-SOF 400	400	480	100
S-SOF 450	450	530	100



**E DUCT  
I NSTALL  
U SE**

**A**

**S**

**V E N  
T I L A  
T I O N**

**Y**





S-AXIS fans can be used when low volume me ventilation needs. It is easy-to-install, has low noise level and power usage.

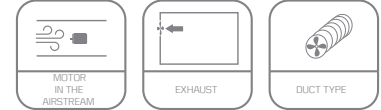

MOTOR INSULATION CLASS	F CLASS
MOTOR PROTECTION CLASS	IP 44
MOTOR EFFICIENCY CLASS	IE2-IE3
MOTOR ENCLOSURE TYPE	EXTERNAL ROTOR MOTOR
MOTOR BRAND	
BODY MATERIAL	GALVANIZED SHEET METAL
BODY COATING	ELECTROSTATIC POWDER PAINT
IMPELLER MATERIAL	GALVANIZED SHEET METAL
DUTY CYCLE	IEC Duty Cycle-S1
WORKING AMBIENT TEMPERATURE	-20 - +50 °C
DIRECTIVE	IEC-60335-2-80, ISO 1940-1

MODEL	VOLTAGE (V)	FREQUENCY (Hz)	POWER (kW)	REVOLUTION (rpm)	FLOW RATE (m³/h)	NOISE LEVEL (dB(A))	PRICE
S-AXIS 200	230	50	70	2.650	680	50	
S-AXIS 250	230	50	100	2.700	1.500	52	
S-AXIS 300	230	50	163	2.550	2.025	54	
S-AXIS 350	230	50	240	2.250	3.110	58	

Values are for 0 Pa.

## DRAWING

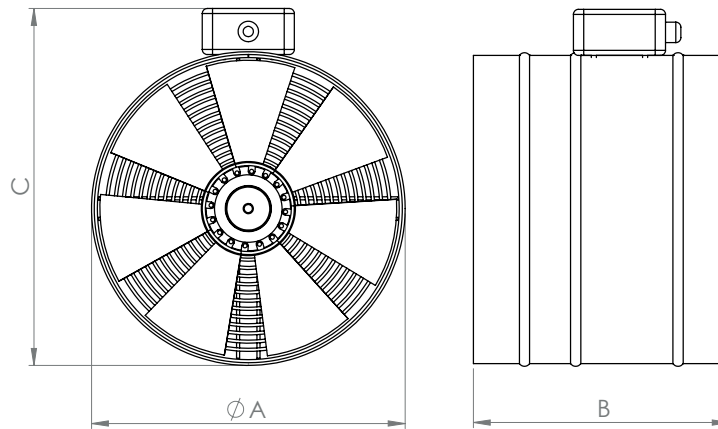

MODEL	A (mm)	B (mm)	C (mm)
S-AXIS 200	200	200	250
S-AXIS 250	250	250	300
S-AXIS 300	300	250	350
S-AXIS 350	350	300	400



**E WINDOW  
WALL  
INSTALL  
A  
S V E N  
T I L A  
Y T I O N**



S-DAXIS fans can be used when low volume required. It is easy to install to walls and windows. Low noise level and power usage makes it an ideal solution for commercial usage.

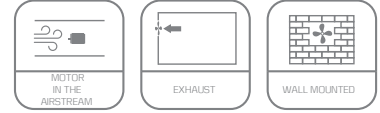

MOTOR INSULATION CLASS	F CLASS
MOTOR PROTECTION CLASS	IP 44
MOTOR EFFICIENCY CLASS	IE2-IE3
MOTOR ENCLOSURE TYPE	EXTERNAL ROTOR MOTOR
MOTOR BRAND	
BODY MATERIAL	GALVANIZED SHEET METAL
BODY COATING	ELECTROSTATIC POWDER PAINT
IMPELLER MATERIAL	GALVANIZED SHEET METAL
DUTY CYCLE	IEC Duty Cycle-S1
WORKING AMBIENT TEMPERATURE	-20 - +50 °C
DIRECTIVE	IEC-60335-2-80, ISO 1940-1

MODEL	VOLTAGE (V)	FREQUENCY (Hz)	POWER (kW)	REVOLUTION (rpm)	FLOW RATE (m³/h)	NOISE LEVEL (dB(A))	PRICE
S-DAXIS 200	230	50	67	2.700	680	60	
S-DAXIS 250	230	50	110	2.640	1.500	70	
S-DAXIS 300	230	50	160	2.630	2.020	72	
S-DAXIS 350	230	50	240	2.280	3.110	78	

Values are for 0 Pa.

## DRAWING

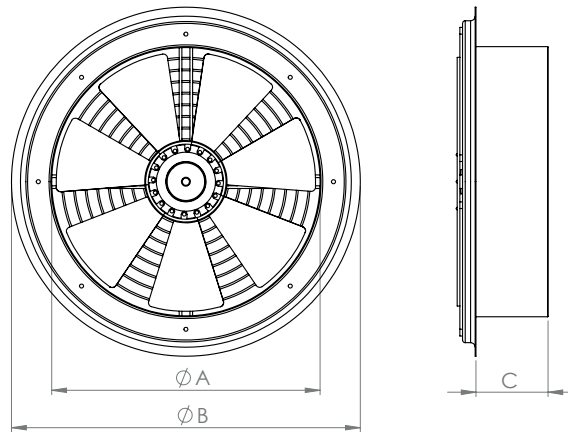

MODEL	A (mm)	B (mm)	C (mm)
S-DAXIS 200	200	290	70
S-DAXIS 250	250	340	70
S-DAXIS 300	300	390	80
S-DAXIS 350	350	440	80



**E SERVICE  
DUCT  
INSTALL  
A  
S V E N  
T I L A  
Y T I O N**

## S-AXIP Wall Mounted Axial Fan With Plastic Blades



S-AXIP fans can be easily mounted on the walls with its square body. Standard fan has grille guard and powder coating. Blades can be aluminium as clients request.

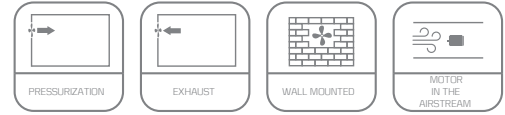

MOTOR INSULATION CLASS	F CLASS
MOTOR PROTECTION CLASS	IP 55
MOTOR EFFICIENCY CLASS	IE2-IE3
MOTOR ENCLOSURE TYPE	TEFC
MOTOR BRAND	
BODY MATERIAL	GALVANIZED SHEET METAL
BODY COATING	ELECTROSTATIC POWDER PAINT
IMPELLER MATERIAL	PLASTIC
DUTY CYCLE	IEC Duty Cycle-S1
WORKING AMBIENT TEMPERATURE	-20 - +50 °C
DIRECTIVE	IEC-60335-2-80, ISO 1940-1

MODEL	VOLTAGE (V)	FREQUENCY (Hz)	POWER (kW)	REVOLUTION (rpm)	FLOW RATE (m³/h)	NOISE LEVEL (dB(A))	PRICE
S-AXIP 400-5-25	380	50	0,37	1.450	2.950	66	
S-AXIP 450-5-25	380	50	0,55	1.456	4.250	69	
S-AXIP 500-5-25	380	50	0,55	1.453	6.000	72	
S-AXIP 560-5-25	380	50	0,75	1.466	8.200	75	
S-AXIP 630-5-30	380	50	1,10	1.465	13.600	80	
S-AXIP 710-5-30	380	50	1,50	1.472	19.400	83	
S-AXIP 800-5-30	380	50	2,20	1.459	26.000	85	
S-AXIP 800-5-35	380	50	3,00	1.463	31.500	89	
S-AXIP 900-5-35	380	50	4,00	1.471	40.000	90	
S-AXIP 900-5-40	380	50	5,50	1.472	45.500	93	
S-AXIP 1000-5-40	380	50	7,50	1.478	55.000	94	

Values are for 0 Pa.

### DRAWING

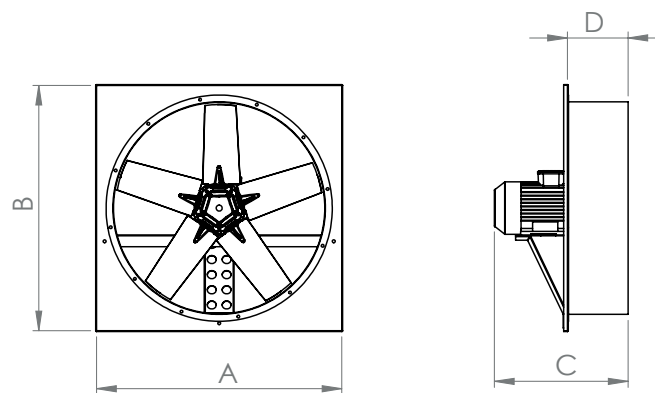

MODEL	A (mm)	B (mm)	C (mm)	D (mm)
S-AXIP 400	570	570	400	200
S-AXIP 450	610	610	410	200
S-AXIP 500	650	650	410	200
S-AXIP 560	680	680	410	200
S-AXIP 630	750	750	420	200
S-AXIP 710	830	830	450	200
S-AXIP 800	920	920	480	200
S-AXIP 900	1020	1020	590	300
S-AXIP 1000	1120	1120	700	300

## OPTIONS

- Electro-Static Powder Coating
- Custom Fans For Specific Flow Rate and Pressure
- 5, 8, 12, or 16 Blade Fan
- Aluminium or Plastic Blades
- System Automation
- Two-Speed Motor

### PERFORMANCE CURVES

S-AXIP 400-5-25

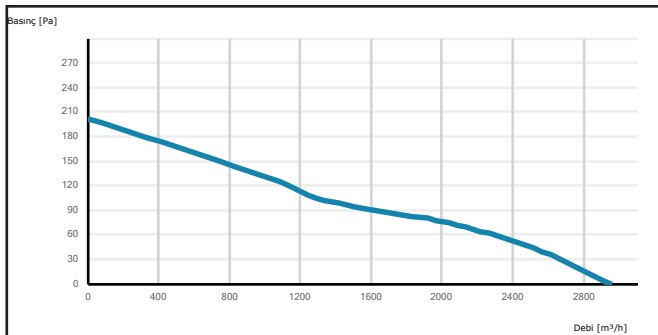

S-AXIP 450-5-25

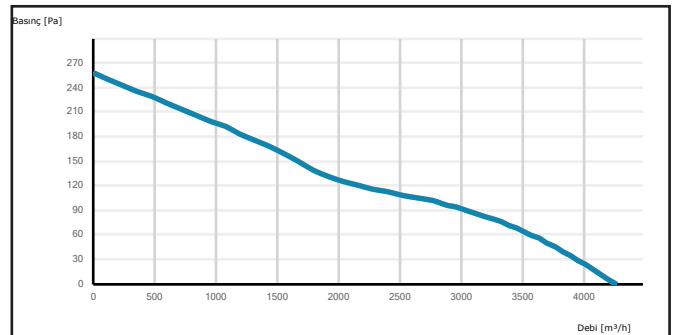

S-AXIP 500-5-25

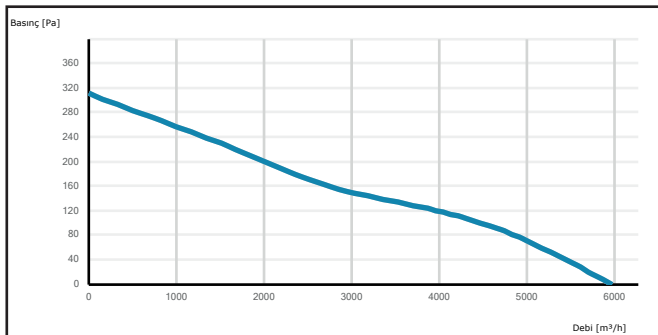

S-AXIP 560-5-25

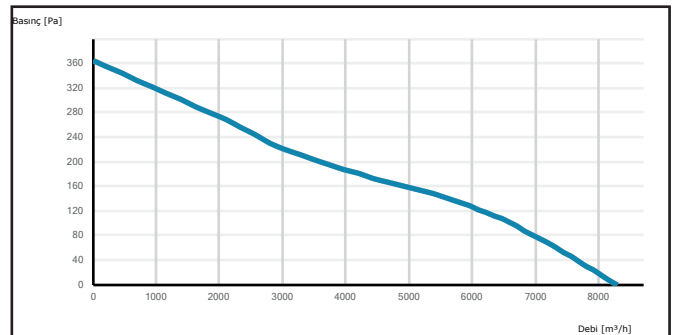

S-AXIP 630-5-30

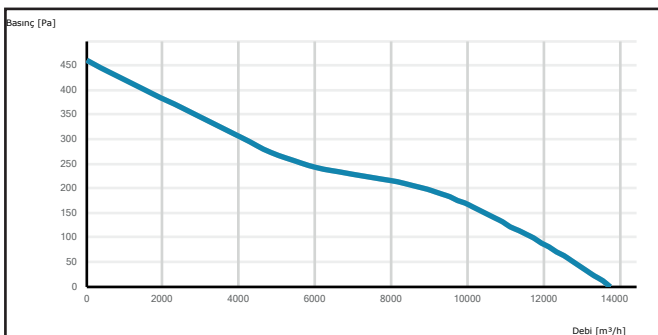

S-AXIP 710-5-30

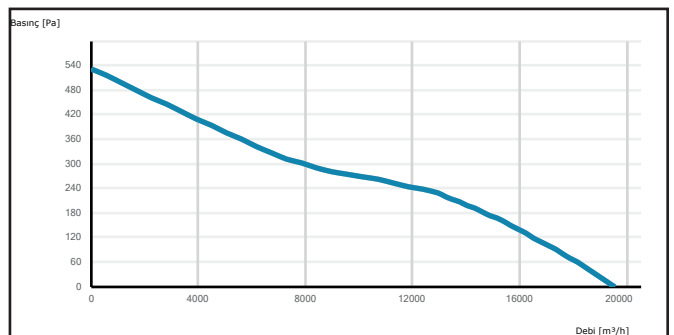

S-AXIP 800-5-30

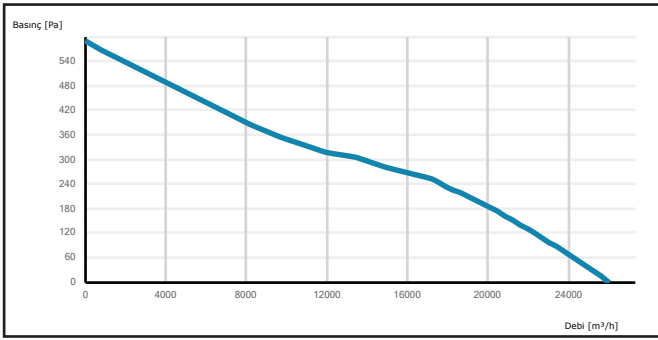

S-AXIP 800-5-35

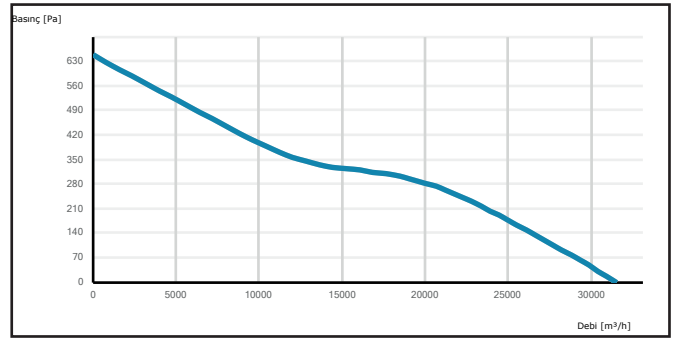

S-AXIP 900-5-35

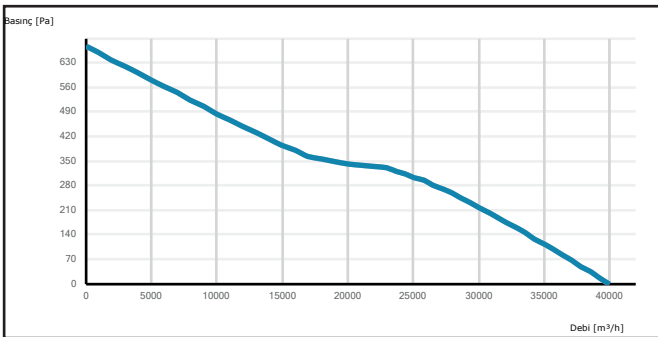

S-AXIP 900-5-40

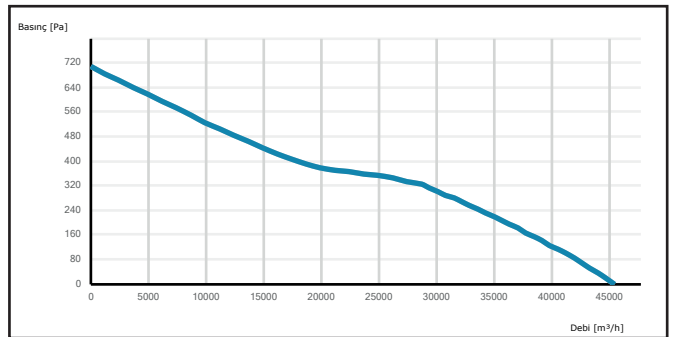

S-AXIP 1000-5-40

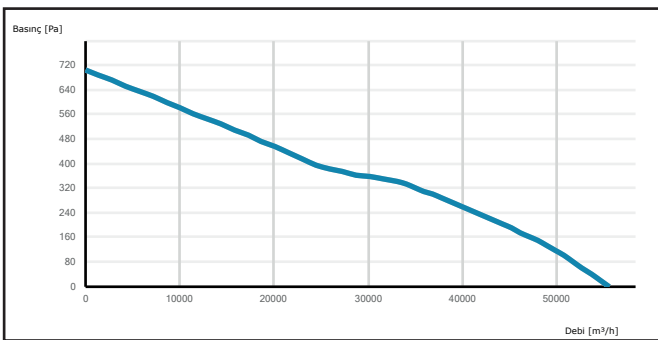

## S-KAF - Mixed Flow Plastic In-line Fan



S-KAF fans have a mixed flow impeller with a high efficiency motor for your ventilation needs. Efficient motor allows for a controlled use depending on needs.

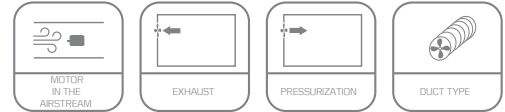

MOTOR INSULATION CLASS	F CLASS
MOTOR PROTECTION CLASS	IP 44
MOTOR EFFICIENCY CLASS	
MOTOR ENCLOSURE TYPE	EXTERNAL ROTOR MOTOR
MOTOR BRAND	
BODY MATERIAL	PLASTIC
BODY COATING	NONE
IMPELLER MATERIAL	PLASTIC
DUTY CYCLE	IEC Duty Cycle-S1
WORKING AMBIENT TEMPERATURE	-20 - +50 °C
DIRECTIVE	IEC-60335-2-80, ISO 1940-1

MODEL	VOLTAGE (V)	FREQUENCY (Hz)	POWER (kW)	REVOLUTION (rpm)	FLOW RATE (m³/h)	NOISE LEVEL (dB(A))	PRICE
S-KAF 100	230	50	54	2.460	234	41	
S-KAF 125	230	50	56	2.560	337	46	
S-KAF 150	230	50	75	2.490	504	48	
S-KAF 160	230	50	75	2.490	560	49	
S-KAF 200	230	50	111	2.410	1.012	54	

Values are for 0 Pa.

## DRAWING

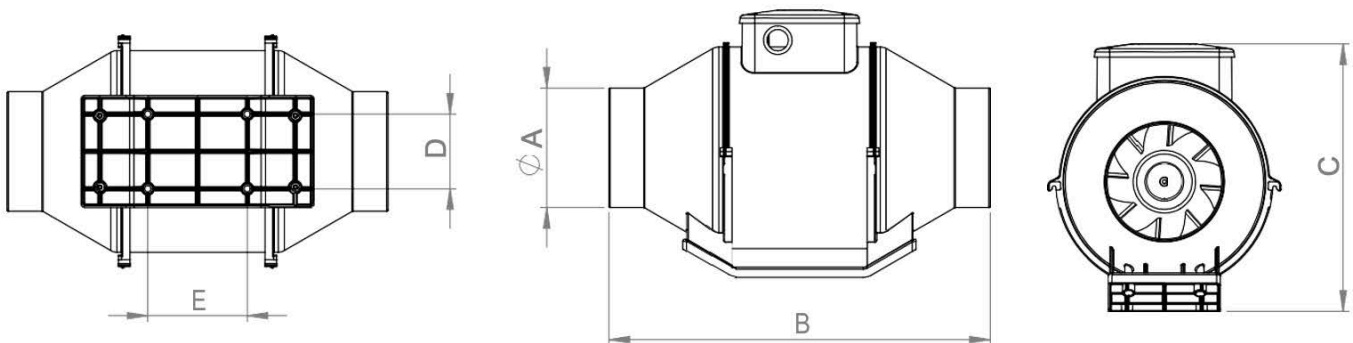

MODEL	A (mm)	B (mm)	C (mm)	D (mm)
S-KAF 100	96	306.5	215	60
S-KAF 125	121	260	215	60
S-KAF 150	146	290.5	242	60
S-KAF 160	156	271	242	60
S-KAF 200	191	300	263	94



# PERFORMANCE CURVES

## S-KAF 100

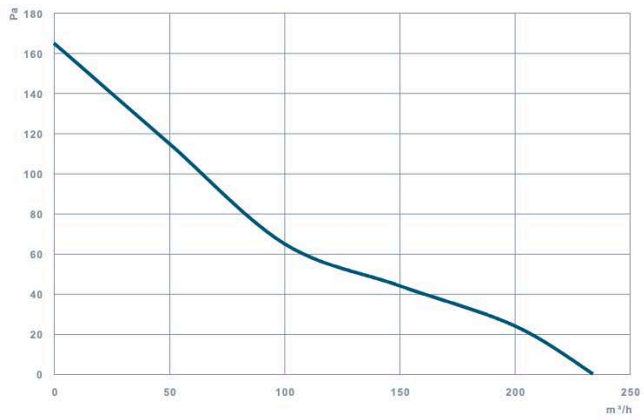

## S-KAF 125

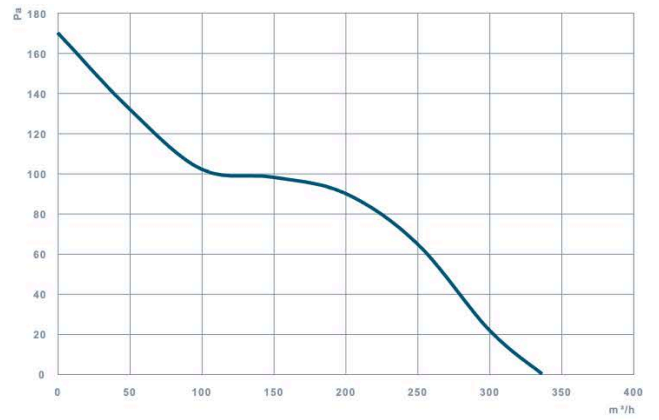

## S-KAF 150

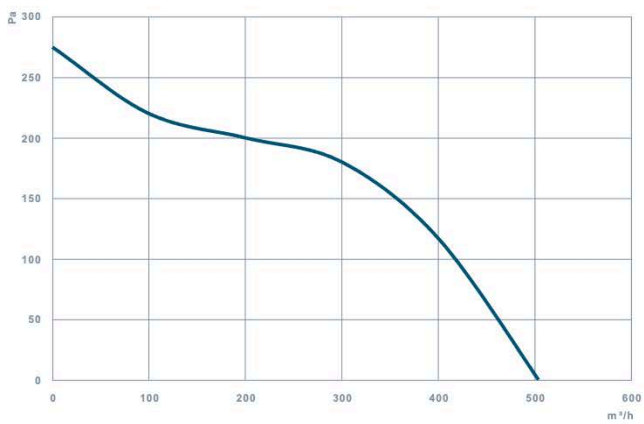

## S-KAF 160

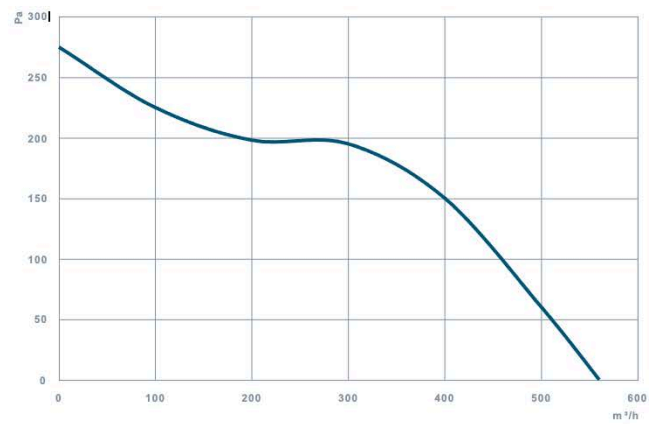

## S-KAF 200

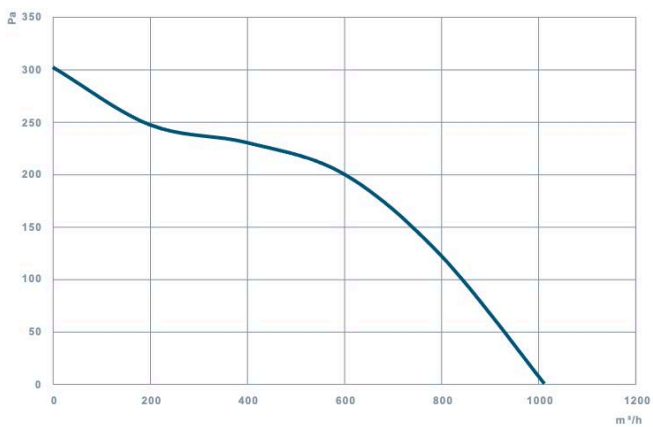

## S-RAD Centrifugal In-line Circular Duct Fan



S-RAD fans can be used in low to medium volume requirements. Easy-to-install and low noise level and power usage makes it a good option for commercial use.

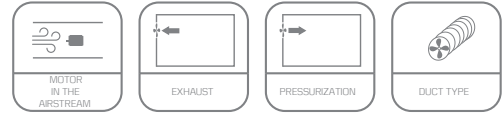

MOTOR INSULATION CLASS	F CLASS
MOTOR PROTECTION CLASS	IP 44
MOTOR EFFICIENCY CLASS	IE2-IE3
MOTOR ENCLOSURE TYPE	EXTERNAL ROTOR MOTOR
MOTOR BRAND	
BODY MATERIAL	GALVANIZED SHEET METAL
BODY COATING	ELECTROSTATIC POWDER PAINT
IMPELLER MATERIAL	GALVANIZED SHEET METAL
DUTY CYCLE	IEC Duty Cycle-S1
WORKING AMBIENT TEMPERATURE	-20 - +50 °C
DIRECTIVE	IEC-60335-2-80, ISO 1940-1

MODEL	VOLTAGE (V)	FREQUENCY (Hz)	POWER (kW)	REVOLUTION (rpm)	FLOW RATE (m³/h)	NOISE LEVEL (dB(A))	PRICE
S-RAD 100	230	50	80	2.600	290	47	
S-RAD 125	230	50	80	2.600	410	47	
S-RAD 150	230	50	85	2.600	700	50	
S-RAD 160	230	50	85	2.600	710	51	
S-RAD 200	230	50	122	2.675	1.000	52	
S-RAD 250	230	50	145	2.685	1.120	54	
S-RAD 315	230	50	210	2.615	1.750	57	

Values are for 0 Pa.

## DRAWING

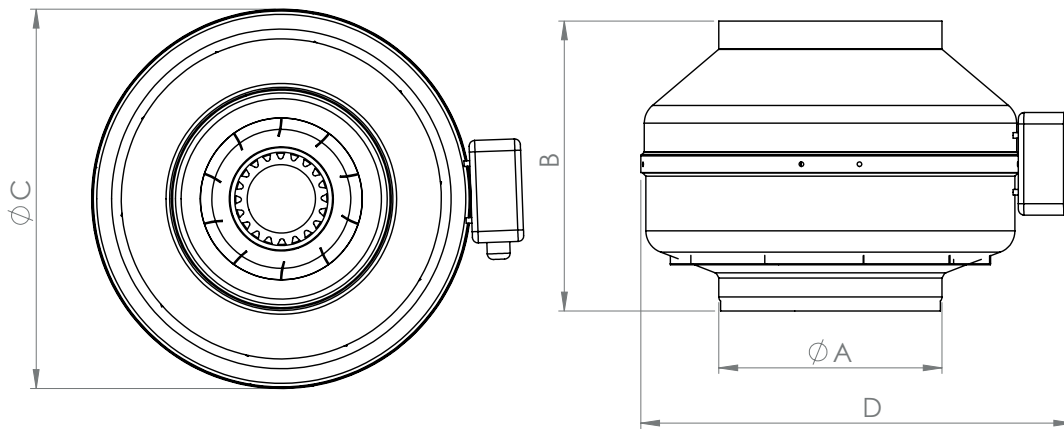

MODEL	A (mm)	B (mm)	C (mm)	D (mm)
S-RAD 100	98	208	246	290
S-RAD 125	123	208	246	290
S-RAD 150	148	196	270	320
S-RAD 160	158	196	270	320
S-RAD 200	198	255	333	380
S-RAD 250	248	234	331	380
S-RAD 315	313	283	401	450

# PERFORMANCE CURVES

S-RAD 100

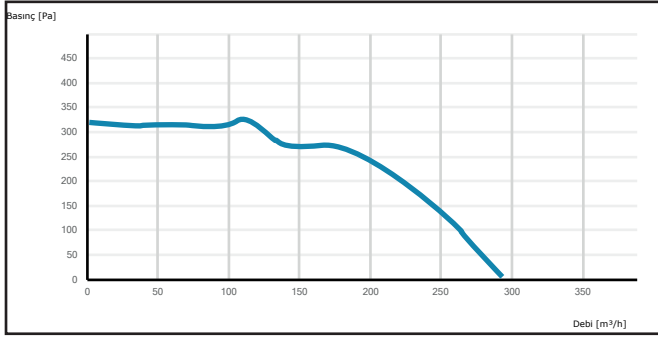

S-RAD 125

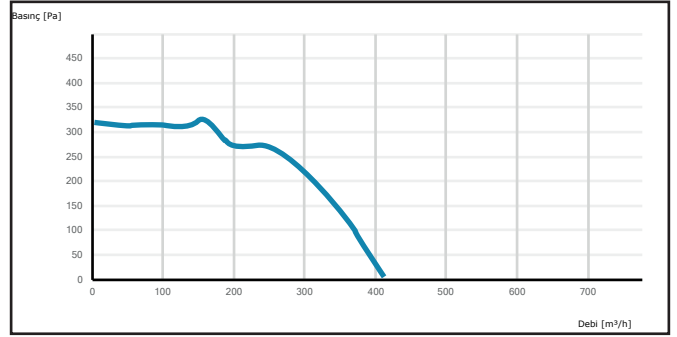

S-RAD 150

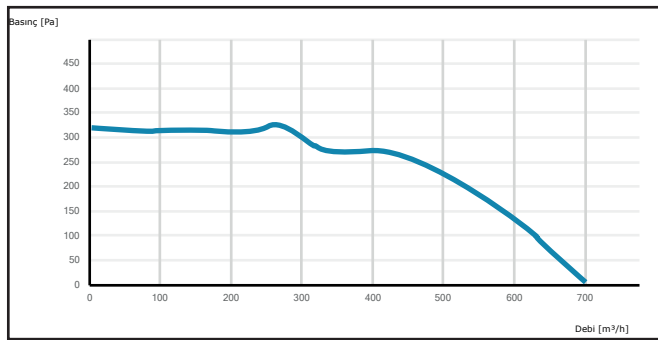

S-RAD 160

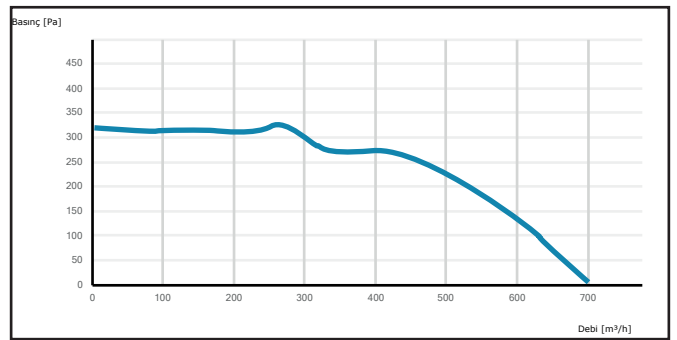

S-RAD 200

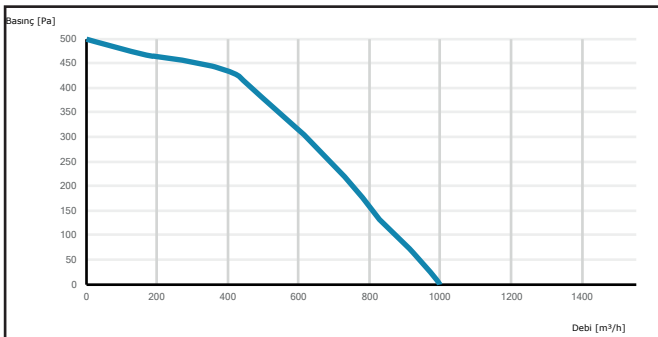

S-RAD 250

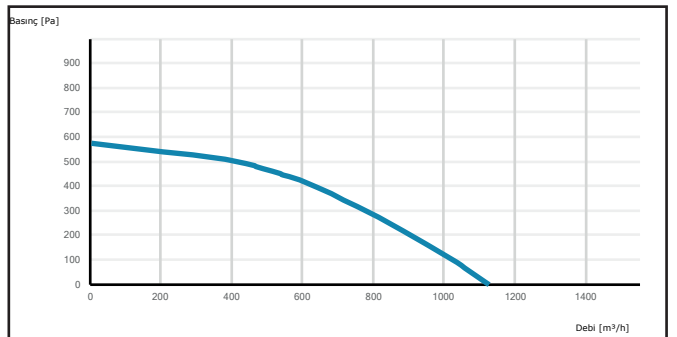

S-RAD 315

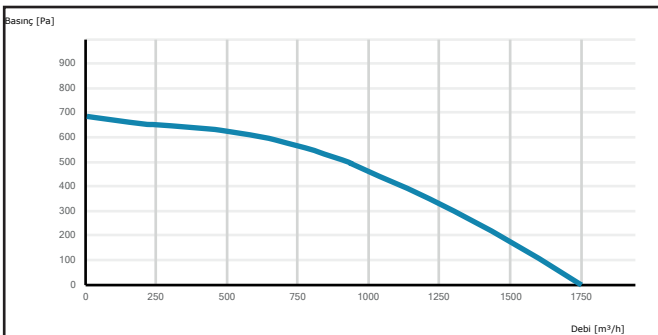

# S-REC Centrifugal In-line Rectangular Duct Fan



S-REC fans can be mounted directly on to rectangular ducts with ease. With low power usage it can be used in medium volume needs. Inspection hatch allows cleaning fan and maintenance.

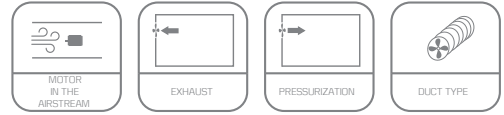

MOTOR INSULATION CLASS	F CLASS
MOTOR PROTECTION CLASS	IP 44
MOTOR EFFICIENCY CLASS	IE2-IE3
MOTOR ENCLOSURE TYPE	EXTERNAL ROTOR MOTOR
MOTOR BRAND	
BODY MATERIAL	GALVANIZED SHEET METAL
BODY COATING	OPTIONAL
IMPELLER MATERIAL	GALVANIZED SHEET METAL
DUTY CYCLE	IEC Duty Cycle-S1
WORKING AMBIENT TEMPERATURE	-20 - +50 °C
DIRECTIVE	IEC-60335-2-80, ISO 1940-1

MODEL	VOLTAGE (V)	FREQUENCY (Hz)	POWER (kW)	REVOLUTION (rpm)	FLOW RATE (m³/h)	NOISE LEVEL (dB(A))	PRICE
S-REC 30-15	230	50	90	2.600	520	70	
S-REC 40-20 A	230	50	104	2.675	950	73	
S-REC 40-20 B	230	50	130	2.685	1.150	75	
S-REC 50-25	230	50	180	2.615	1.600	78	
S-REC 60-30	230	50	147	1.360	2.350	70	
S-REC 60-35	230	50	380	1.362	3.400	83	
S-REC 70-40	230	50	690	1.367	5.000	83	
S-REC 80-50	230-380	50	830	1.364	7.000	86	
S-REC 100-50	380	50	1.460	1.369	9.300	86	

Values are for 0 Pa.

## DRAWING

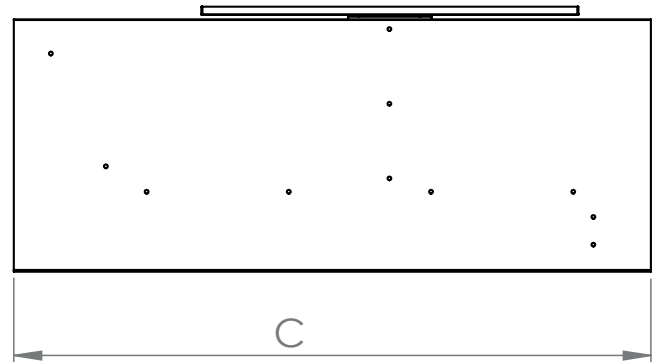
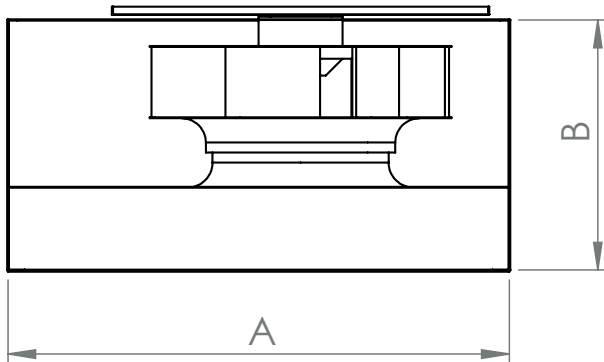

MODEL	A (mm)	B (mm)	C (mm)
S-REC 30-15	300	150	400
S-REC 40-20 A	400	200	500
S-REC 40-20 B	400	200	500
S-REC 50-25	500	250	565
S-REC 60-30	600	300	760
S-REC 60-35	600	350	765
S-REC 70-40	700	400	790
S-REC 80-50	800	500	900
S-REC 100-50	1000	500	1050

# PERFORMANCE CURVES

## S-REC 30-15

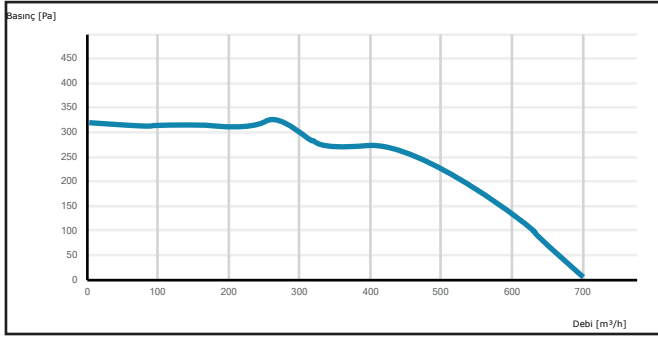

## S-REC 40-20 A

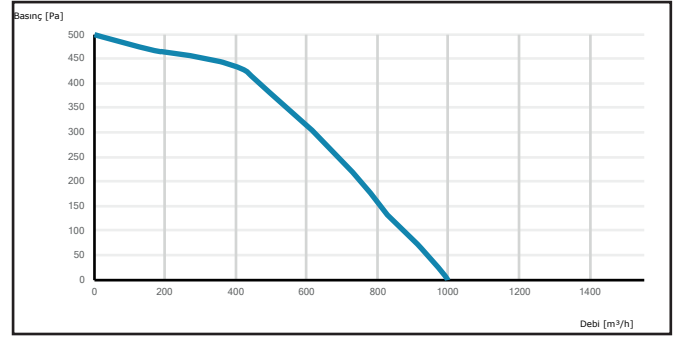

## S-REC 40-20 B

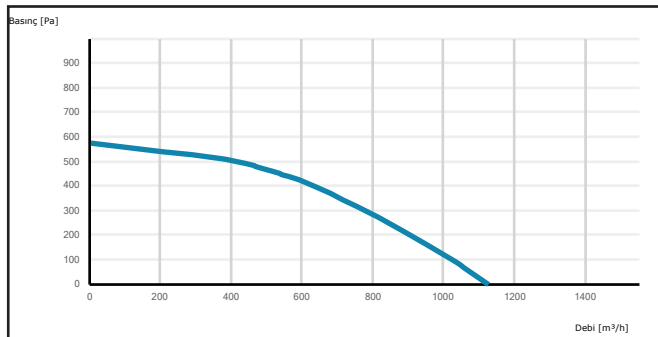

## S-REC 50-25

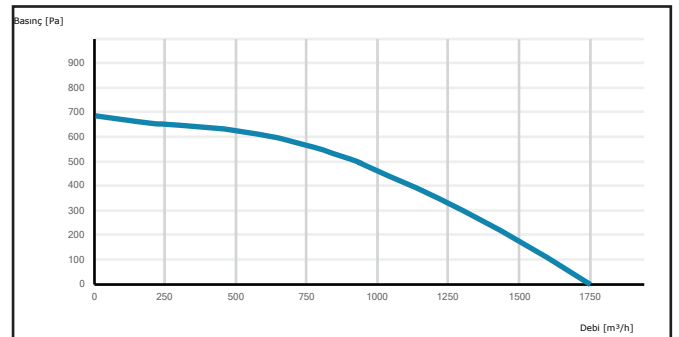

## S-REC 60-30

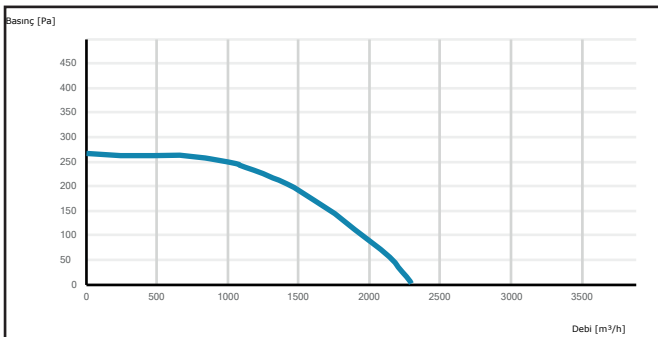

## S-REC 60-35

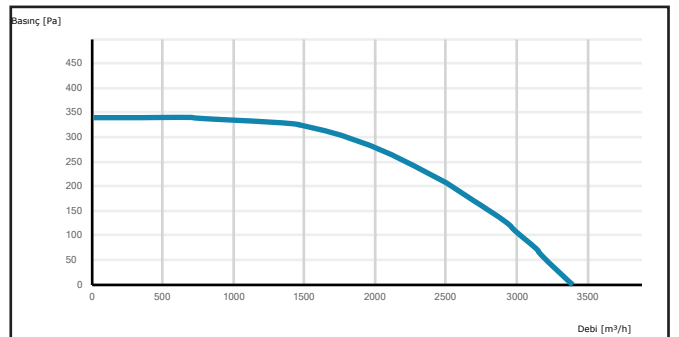

## S-REC 70-40

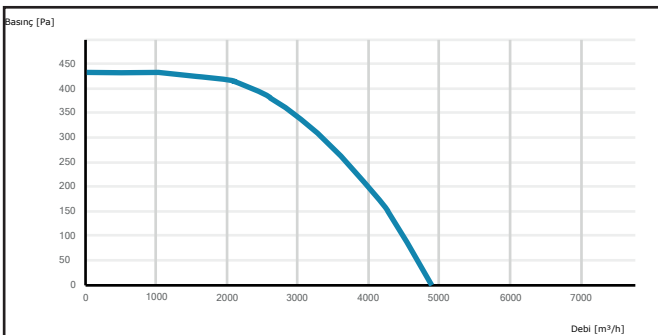

## S-REC 80-50

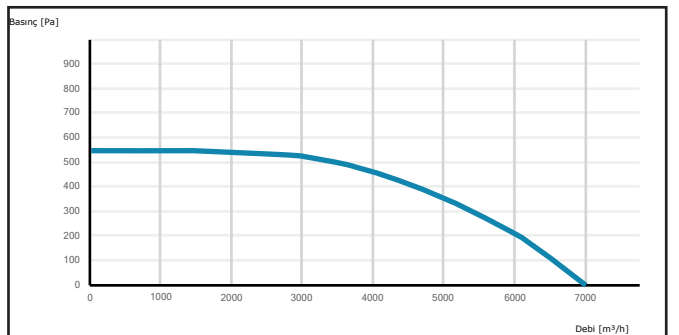

S-REC 100-50

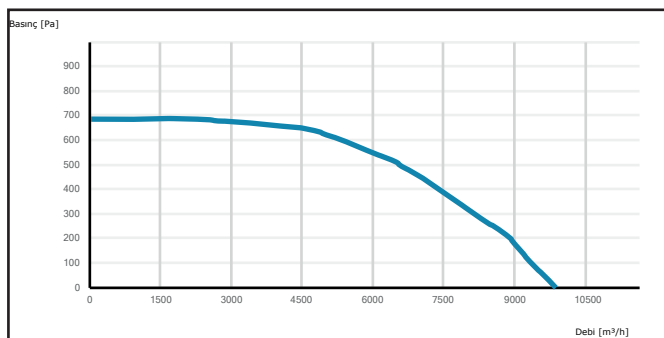



**E GREASE  
SMOKE  
KITCHEN**

**A**

**S**

**VEN  
TILA  
TION**

**Y**



## S-DREC Centrifugal In-line Rectangular Duct Fan With Motor Out Of Air



S-DREC fans can be mounted directly on to rectangular ducts with ease. Inspection hatch allows cleaning fan and maintenance. Motor is located of the airstream and is not effected by matters in the air.

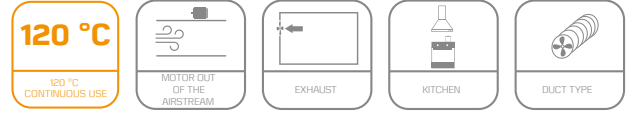

MOTOR INSULATION CLASS	F CLASS
MOTOR PROTECTION CLASS	IP 55
MOTOR EFFICIENCY CLASS	IE2-IE3
MOTOR ENCLOSURE TYPE	TEFC
MOTOR BRAND	
BODY MATERIAL	GALVANIZED SHEET METAL
BODY COATING	OPTIONAL
IMPELLER MATERIAL	GALVANIZED SHEET METAL
DUTY CYCLE	IEC Duty Cycle-S1
WORKING AMBIENT TEMPERATURE	-20 - +50 °C
DIRECTIVE	IEC-60335-2-80, ISO 1940-1

MODEL	VOLTAGE (V)	FREQUENCY (Hz)	POWER (kW)	REVOLUTION (rpm)	FLOW RATE (m³/h)	NOISE LEVEL (dB(A))	PRICE
S-DREC 280	380	50	0,18	1.450	1.100	70	
S-DREC 315	380	50	0,25	1.469	1.600	73	
S-DREC 355	380	50	0,37	1.471	2.300	75	
S-DREC 400	380	50	0,55	1.478	3.300	78	
S-DREC 450	380	50	0,75	1.454	5.000	70	
S-DREC 500	380	50	1,10	1.462	7.000	83	
S-DREC 560	380	50	1,50	1.464	9.800	83	

Values are for 0 Pa.

Single-phase motors cost an additional 20%.

### DRAWING

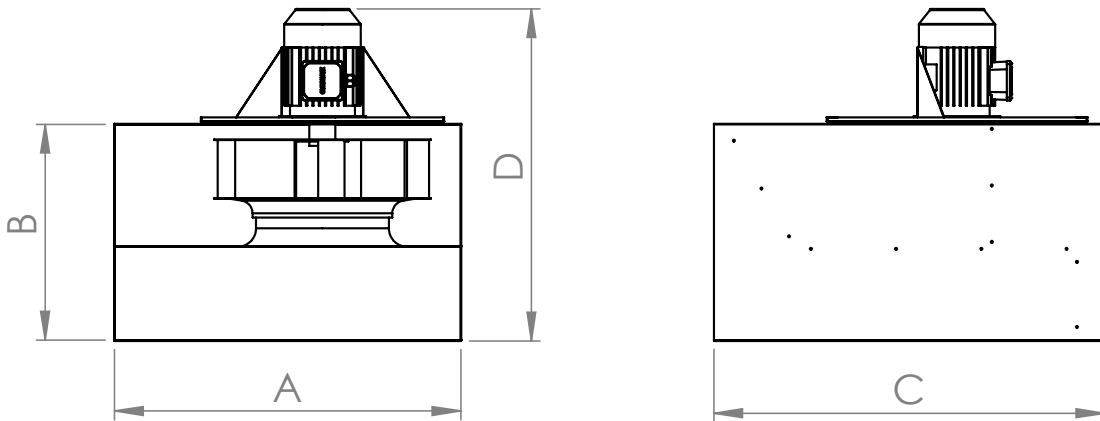

MODEL	A (mm)	B (mm)	C (mm)	D (mm)
S-DREC 280	500	250	565	450
S-DREC 315	500	250	565	476
S-DREC 355	600	300	760	526
S-DREC 400	600	350	750	590
S-DREC 450	700	400	790	641
S-DREC 500	800	500	900	765
S-DREC 560	1000	500	1050	790



# PERFORMANCE CURVES

## S-DREC 280

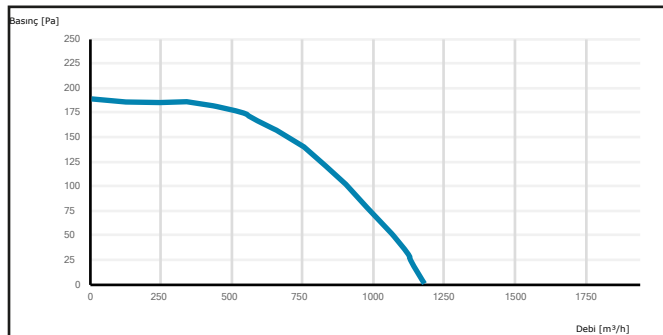

## S-DREC 315

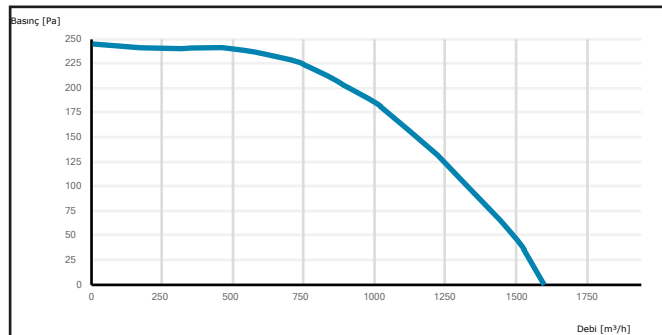

## S-DREC 355

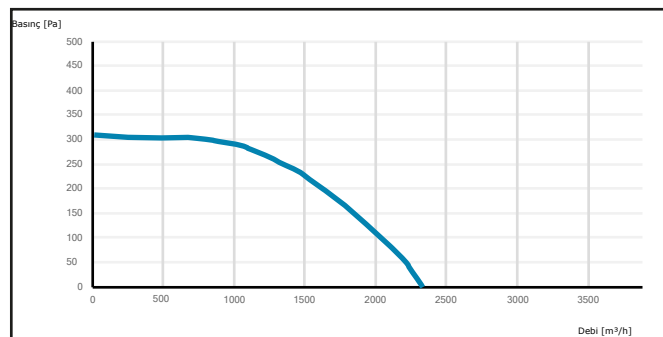

## S-DREC 400

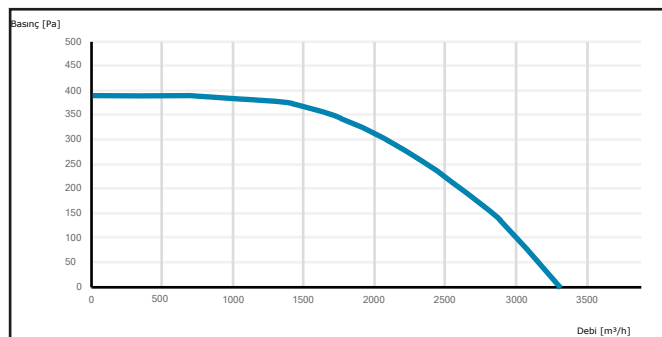

## S-DREC 450

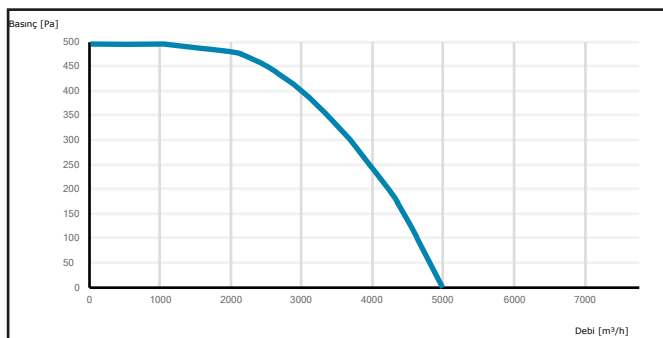

## S-DREC 500

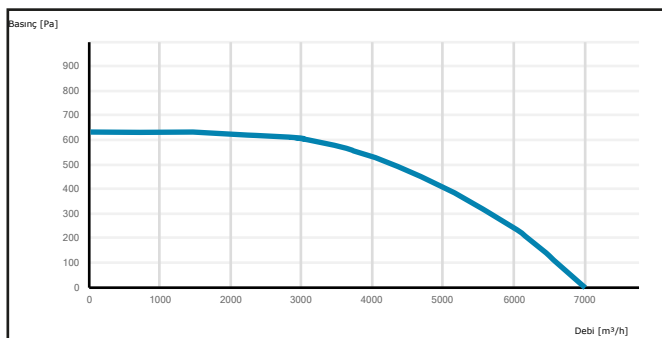

## S-DREC 560

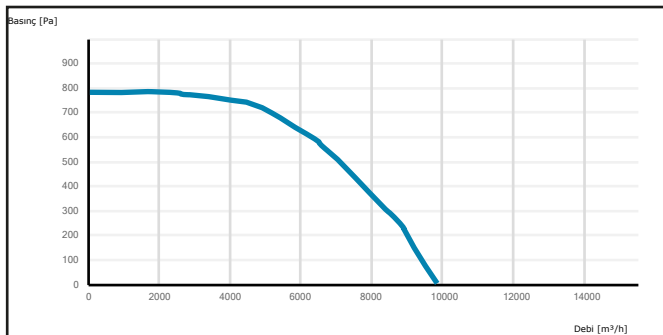



S-MEF fans can be connected to kitchen hoods to exhaust the air from cookers, grilles, fryers etc. It will exhaust the greasy air and keeps the kitchen area clean and odorless. Inspection hatch allows cleaning the fan and maintenance. Motor is located out of the airstream and is not effected by matters in the air.

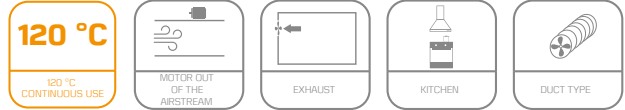

MOTOR INSULATION CLASS	F CLASS
MOTOR PROTECTION CLASS	IP 55
MOTOR EFFICIENCY CLASS	IE2-IE3
MOTOR ENCLOSURE TYPE	TEFC
MOTOR BRAND	
BODY MATERIAL	GALVANIZED SHEET METAL
BODY COATING	OPTIONAL
IMPELLER MATERIAL	GALVANIZED SHEET METAL
DUTY CYCLE	IEC Duty Cycle-S1
WORKING AMBIENT TEMPERATURE	-20 - +50 °C
DIRECTIVE	IEC-60335-2-80, ISO 1940-1

MODEL	VOLTAGE (V)	FREQUENCY (Hz)	POWER (kW)	REVOLUTION (rpm)	FLOW RATE (m³/h)	NOISE LEVEL (dB(A))	PRICE
S-MEF 315	380	50	0,25	1.469	1.600	73	
S-MEF 355	380	50	0,37	1.471	2.300	75	
S-MEF 400	380	50	0,55	1.478	3.300	78	
S-MEF 450	380	50	0,75	1.454	5.000	70	
S-MEF 500	380	50	1,10	1.462	7.000	83	

Values are for 0 Pa.

Single-phase motors cost an additional 20%.

## DRAWING

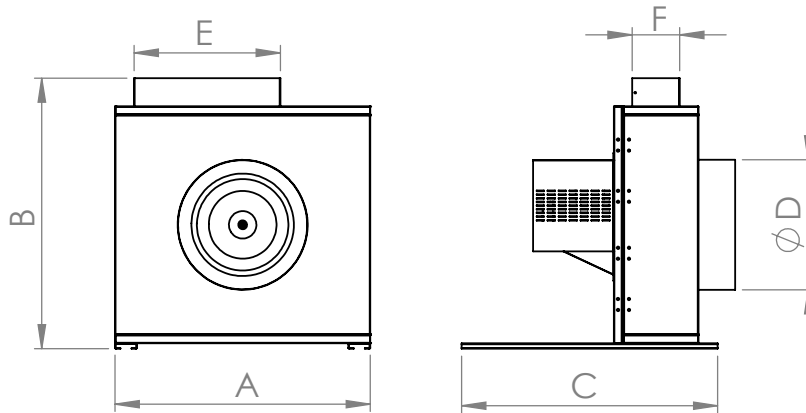

MODEL	A (mm)	B (mm)	C (mm)	D (mm)	C (mm)	D (mm)
S-MEF 315	650	690	700	315	300	110
S-MEF 355	700	740	700	355	400	130
S-MEF 400	750	790	700	400	400	150
S-MEF 450	800	840	700	450	400	170
S-MEF 500	850	890	700	500	440	190

# PERFORMANCE CURVES

## S-MEF 315

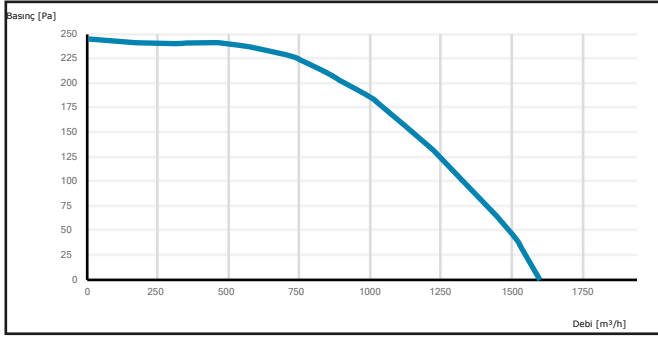

## S-MEF 355

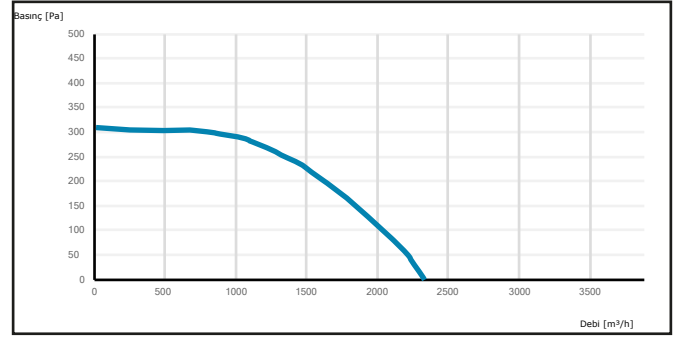

## S-MEF 400

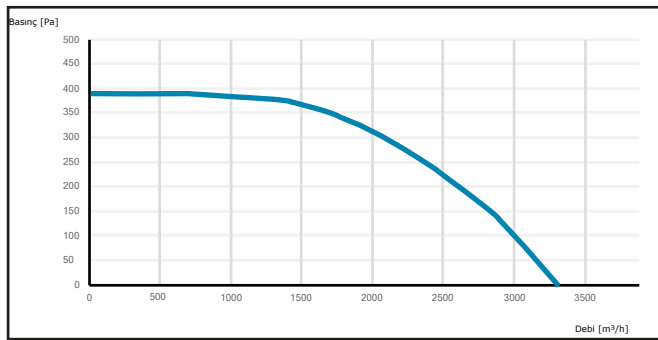

## S-MEF 450

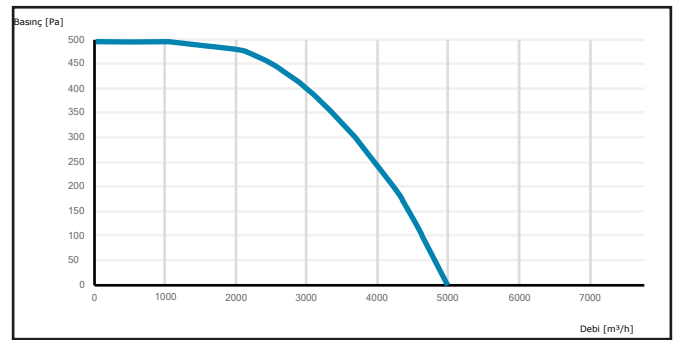

## S-MEF 500

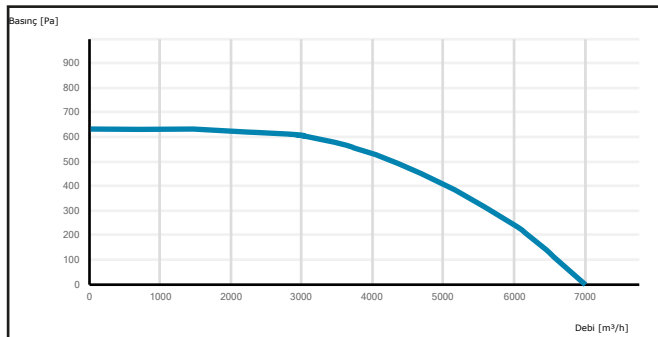

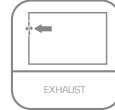

S-HMEF fans can be connected to kitchen hoods to exhaust the air from cookers, grilles, fryers etc. It will exhaust the greasy air and keeps the kitchen area clean and odorless. Inspection hatch allows cleaning the fan and maintenance. Motor is located out of the airstream and is not affected by matters in the air.

MOTOR INSULATION CLASS	F CLASS
MOTOR PROTECTION CLASS	IP 55
MOTOR EFFICIENCY CLASS	IE2-IE3
MOTOR ENCLOSURE TYPE	TEFC
MOTOR BRAND	
BODY MATERIAL	GALVANIZED SHEET METAL
BODY COATING	OPTIONAL
IMPELLER MATERIAL	GALVANIZED SHEET METAL
DUTY CYCLE	IEC Duty Cycle-S1
WORKING AMBIENT TEMPERATURE	-20 - +50 °C
DIRECTIVE	IEC-60335-2-80, ISO 1940-1

MODEL	VOLTAGE (V)	FREQUENCY (Hz)	POWER (kW)	REVOLUTION (rpm)	FLOW RATE (m³/h)	NOISE LEVEL (dB(A))	PRICE
S-HMEF 280	380	50	0,18	1.450	1.100	73	
S-HMEF 315	380	50	0,25	1.469	1.600	73	
S-HMEF 355	380	50	0,37	1.471	2.300	75	
S-HMEF 400	380	50	0,55	1.478	3.300	78	
S-HMEF 450	380	50	0,75	1.454	5.000	70	
S-HMEF 500	380	50	1,10	1.462	7.000	83	
S-HMEF 560	380	50	1,50	1.464	9.800	74	
S-HMEF 630	380	50	3,00	1.465	14.000	89	
S-HMEF 710	380	50	4,00	950	13.000	89	

Values are for 0 Pa.

Single-phase motors cost an additional 20%.

## DRAWING

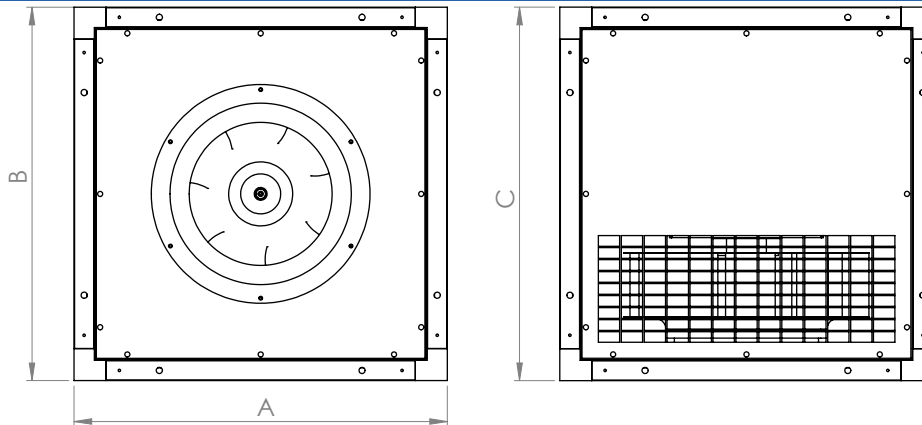

MODEL	A (mm)	B (mm)	C (mm)
S-HMEF 280	300	300	300
S-HMEF 315	400	400	400
S-HMEF 355	500	500	500
S-HMEF 400	600	600	600
S-HMEF 450	700	700	700
S-HMEF 500	800	800	800
S-HMEF 560	900	900	900
S-HMEF 630	1000	1000	1000
S-HMEF 710	850	890	700

# PERFORMANCE CURVES

## S-HMEF 280

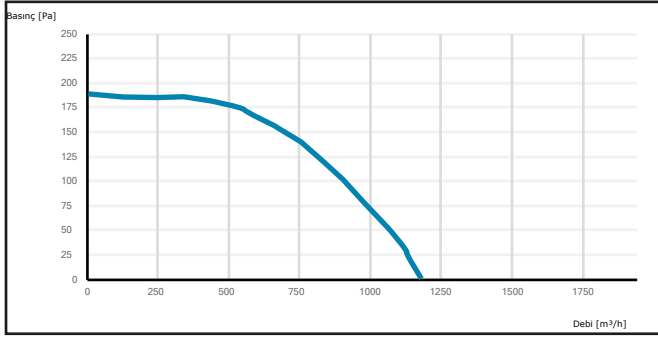

## S-HMEF 315

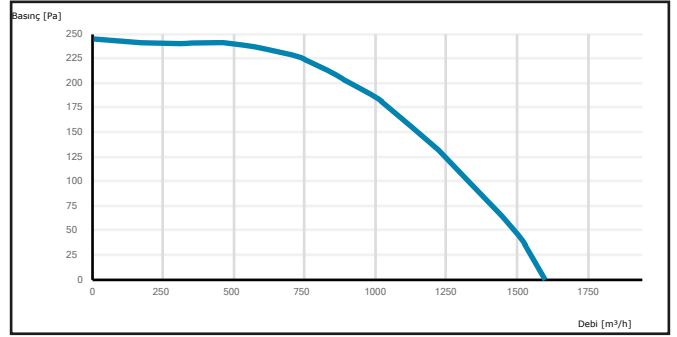

## S-HMEF 355

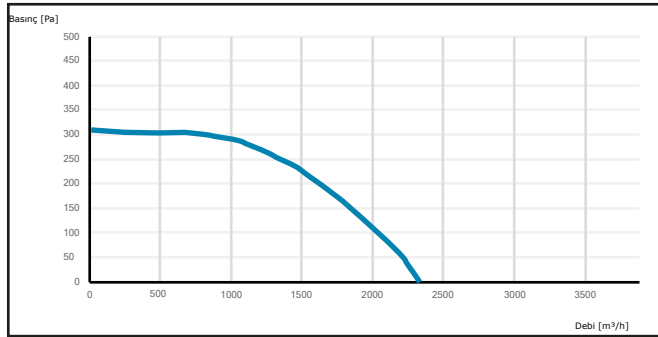

## S-HMEF 400

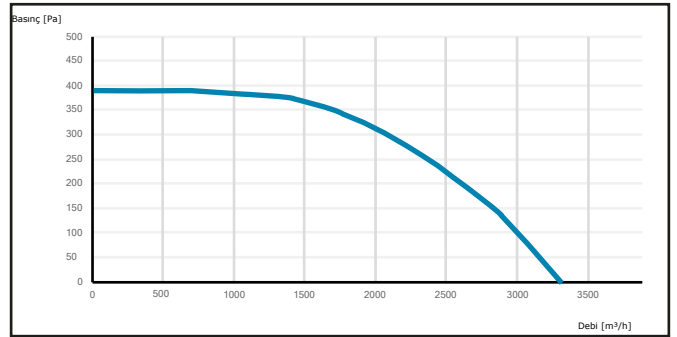

## S-HMEF 450

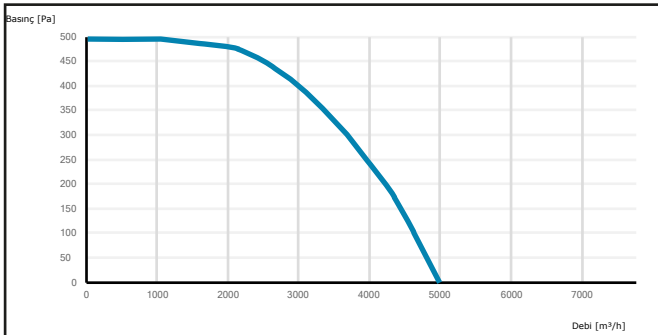

## S-HMEF 500

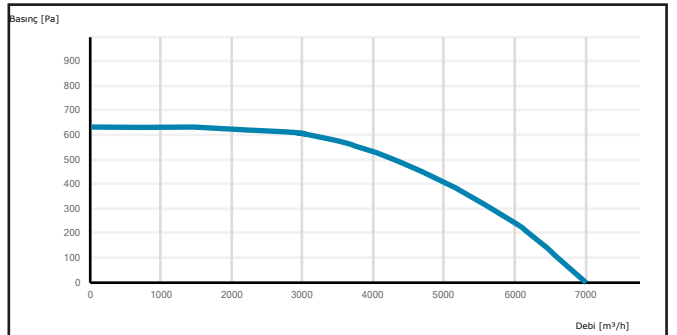

## S-HMEF 560

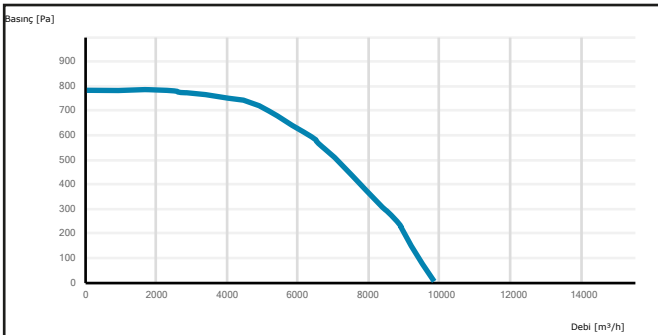

## S-HMEF 630

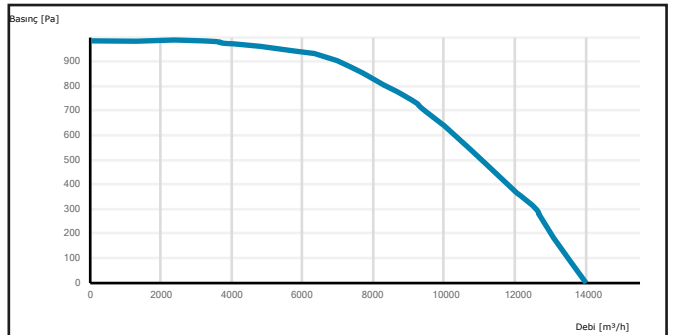

# S-HMEF 710

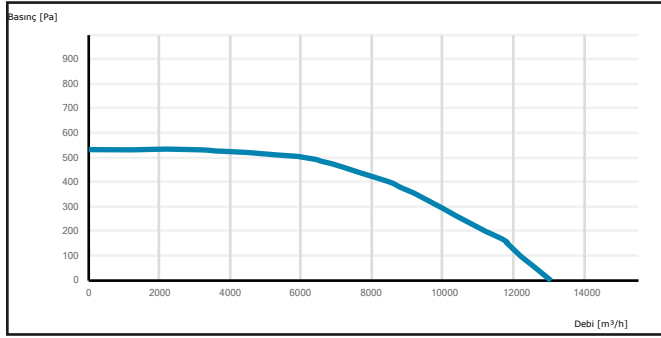

E INSTALL  
VOLUME  
RETURN

A

S

VEN  
TILA  
TION

Y





S-HASP fans can be used in medium volume needs with its easy-to-install robust body. Efficient rigid impeller allows for high level of volume.

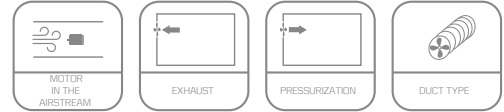

MOTOR INSULATION CLASS	F CLASS
MOTOR PROTECTION CLASS	IP 55
MOTOR EFFICIENCY CLASS	IE2-IE3
MOTOR ENCLOSURE TYPE	TEFC
MOTOR BRAND	
BODY MATERIAL	GALVANIZED SHEET METAL
BODY COATING	OPTIONAL
IMPELLER MATERIAL	GALVANIZED SHEET METAL
DUTY CYCLE	IEC Duty Cycle-S1
WORKING AMBIENT TEMPERATURE	-20 - +50 °C
DIRECTIVE	IEC-60335-2-80, ISO 1940-1

MODEL	VOLTAGE (V)	FREQUENCY (Hz)	POWER (kW)	REVOLUTION (rpm)	FLOW RATE (m³/h)	NOISE LEVEL (dB(A))	PRICE
S-HASP 280	380	50	0,18	1.450	1.100	73	
S-HASP 315	380	50	0,25	1.469	1.600	73	
S-HASP 355	380	50	0,37	1.471	2.300	75	
S-HASP 400	380	50	0,55	1.478	3.300	78	
S-HASP 450	380	50	0,75	1.454	5.000	70	
S-HASP 500	380	50	1,10	1.462	7.000	83	
S-HASP 560	380	50	1,50	1.464	9.800	74	
S-HASP 630	380	50	3,00	1.465	14.000	89	
S-HASP 710	380	50	4,00	950	13.000	89	

Values are for 0 Pa.

Single-phase motors cost an additional 20%.

## DRAWING

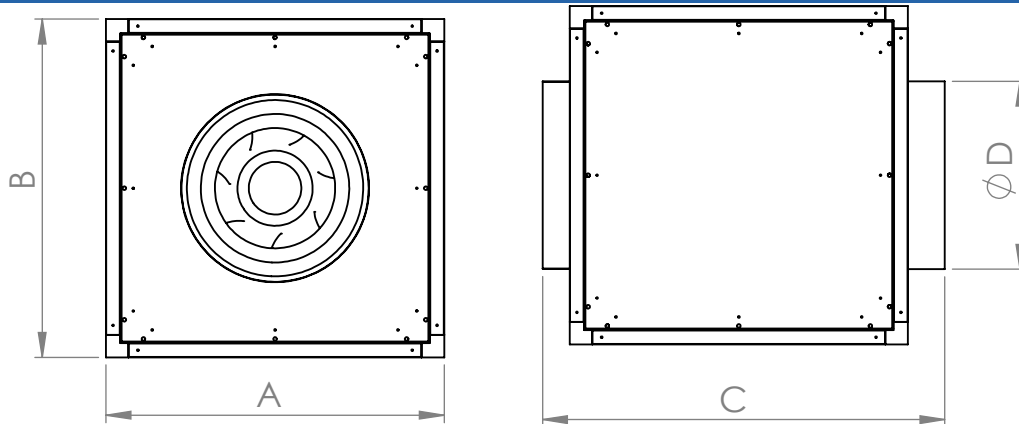

MODEL	A (mm)	B (mm)	C (mm)	D (mm)
S-HASP 280	300	300	370	200
S-HASP 315	400	400	470	250
S-HASP 355	500	500	570	300
S-HASP 400	600	600	670	350
S-HASP 450	700	700	770	400
S-HASP 500	800	800	870	450
S-HASP 560	900	900	970	500
S-HASP 630	1000	1000	1070	550
S-HASP 710	1100	1100	1170	600



# PERFORMANCE CURVES

S-HASP 280

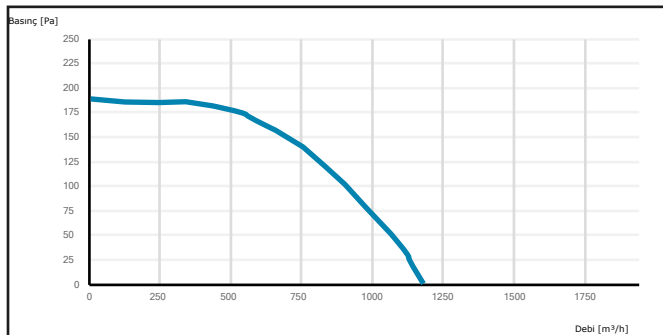

S-HASP 315

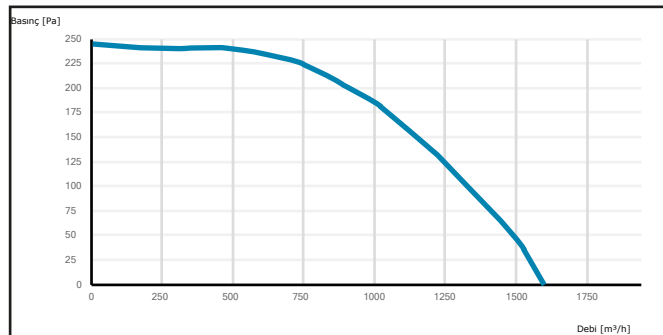

S-HASP 355

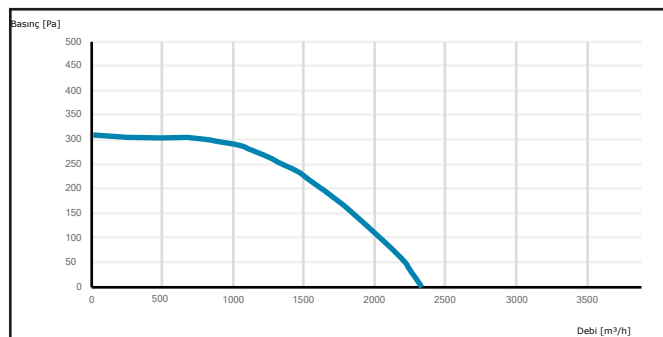

S-HASP 400

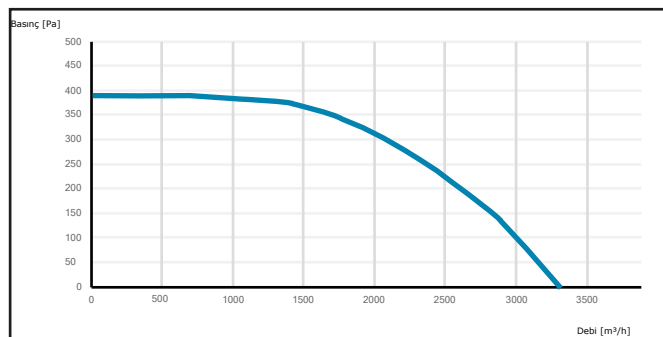

S-HASP 450

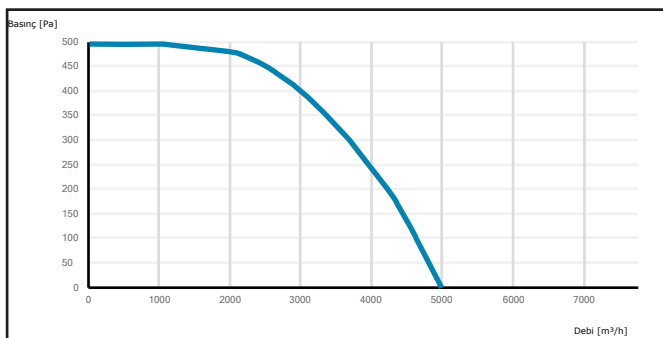

S-HASP 500

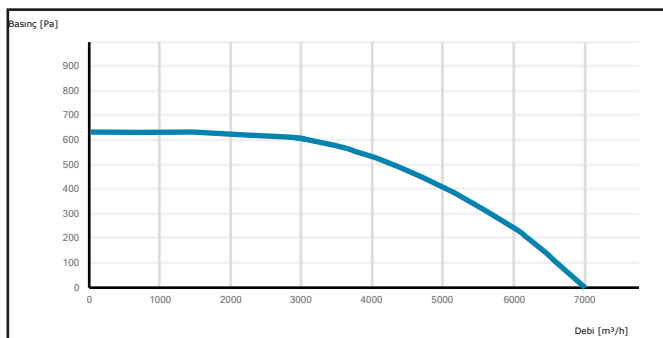

S-HASP 560

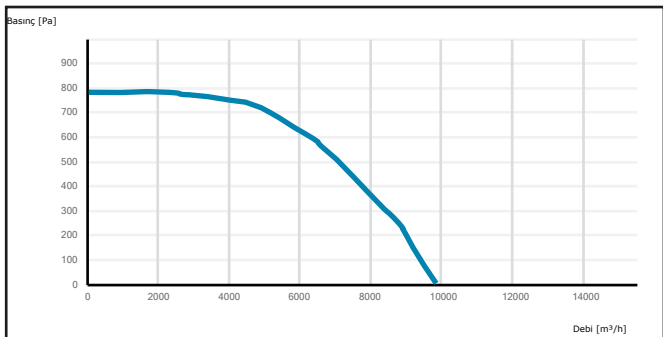

S-HASP 630

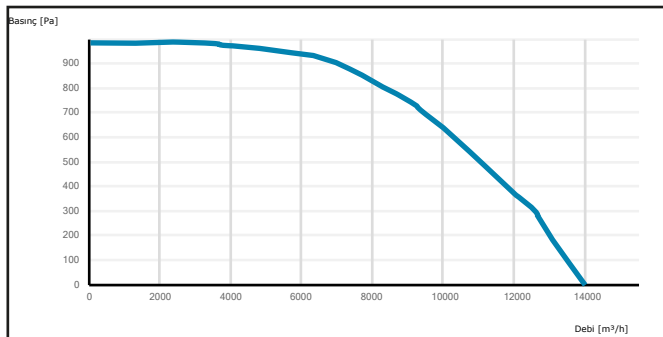

# S-HASP 710

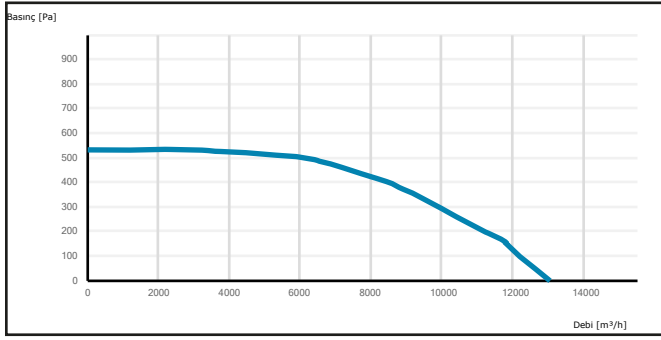



## S-EC-CRAD Roof Mounted Horizontal Discharge EC Motor Fan



S-EC-CRAD fans can be mounted on the roof. It is easy-to-install and with long-lasting motor and high efficiency impeller it can be used in green-tech projects. EC motor allows for very high efficiency rates and extreme control.

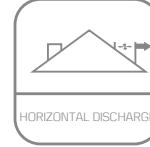
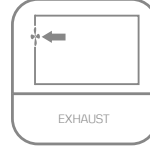
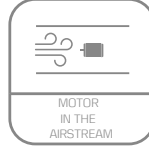

Pressure Difference Controller

MODEL	VOLTAGE (V)	FREQUENCY (Hz)	POWER (W)	REVOLUTION (rpm)	FLOW RATE (m³/h)	NOISE LEVEL (dB(A))	PRICE
S-EC-CRAD 190	230	50/60	161	4.555	974	81	
S-EC-CRAD 225	230	50/60	168	3.540	1.270	77	
S-EC-CRAD 250	230	50/60	302	3.400	1.810	75	
S-EC-CRAD 315	230	50/60	307	2.180	3.250	71	
S-EC-CRAD 355	380	50/60	770	2.400	5.590	84	
S-EC-CRAD 400	380	50/60	2.384	2.680	10.220	84	

Values are for 0 Pa.

## DRAWING

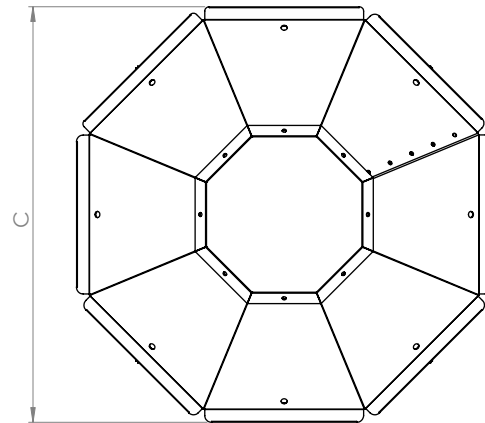
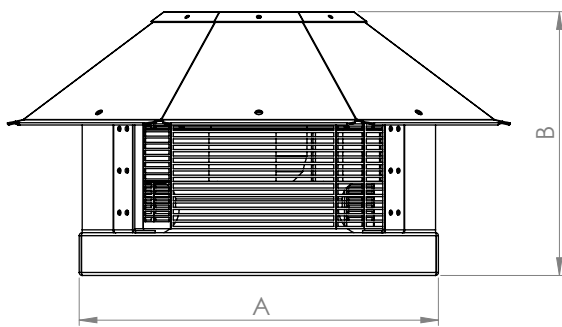

MODEL	A (mm)	B (mm)	C (mm)
S-EC-CRAD 190	250	220	340
S-EC-CRAD 225	336	247	471
S-EC-CRAD 250	355	252	500
S-EC-CRAD 315	370	256	523
S-EC-CRAD 355	450	337	640
S-EC-CRAD 400	450	367	640

# PERFORMANCE CURVES

## S-EC-CRAD 190

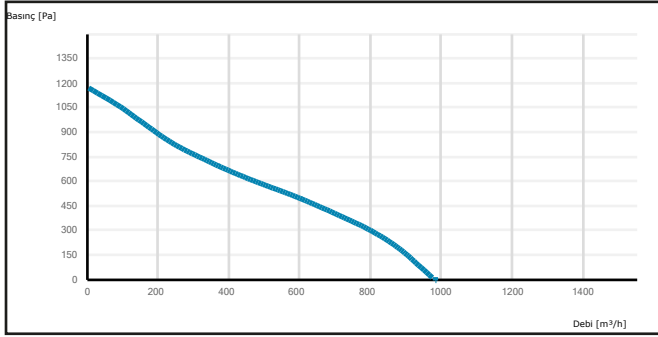

## S-EC-CRAD 225

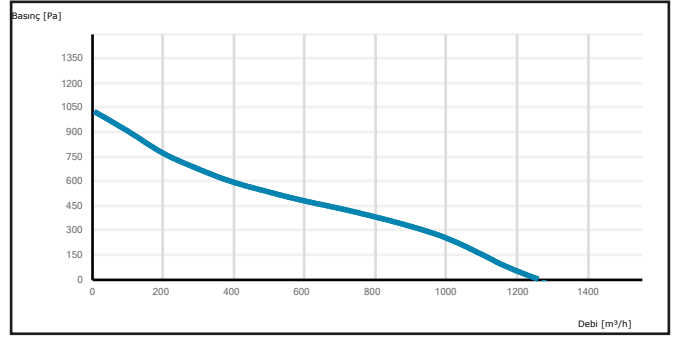

## S-EC-CRAD 250

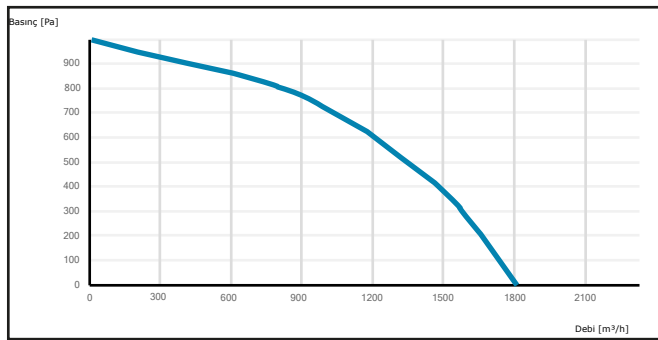

## S-EC-CRAD 315

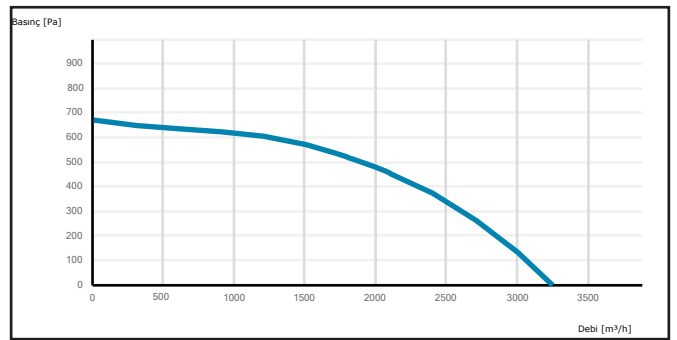

## S-EC-CRAD 355

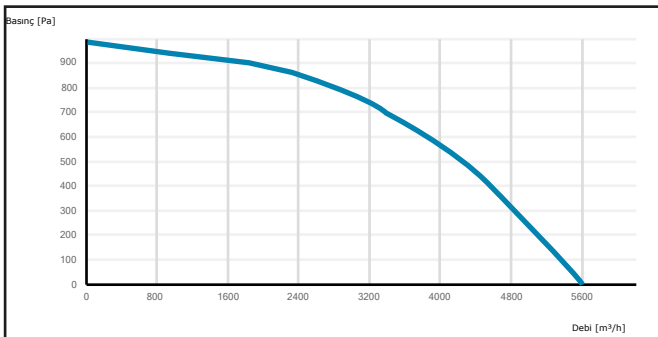

## S-EC-CRAD 400

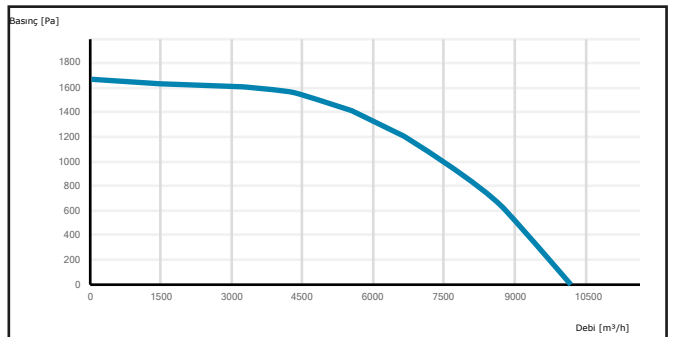



## S-CRAD Roof Mounted Horizontal Discharge Centrifugal Fan



S-CRAD fans can be used in low to medium volume projects and can be mounted on the roof. Easy-to-install with long-lasting motor and efficient impeller.

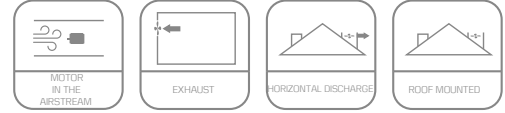

MOTOR INSULATION CLASS	F CLASS
MOTOR PROTECTION CLASS	IP 44
MOTOR EFFICIENCY CLASS	IE2-IE3
MOTOR ENCLOSURE TYPE	EXTERNAL ROTOR MOTOR
MOTOR BRAND	
BODY MATERIAL	GALVANIZED SHEET METAL
BODY COATING	ELECTROSTATIC POWDER PAINT
IMPELLER MATERIAL	GALVANIZED SHEET METAL
DUTY CYCLE	IEC Duty Cycle-S1
WORKING AMBIENT TEMPERATURE	-20 - +50 °C
DIRECTIVE	IEC-60335-2-80, ISO 1940-1

MODEL	VOLTAGE (V)	FREQUENCY (Hz)	POWER (W)	REVOLUTION (rpm)	FLOW RATE (m³/h)	NOISE LEVEL (dB(A))	PRICE
S-CRAD 190	230	50	90	2.600	520	70	
S-CRAD 225	230	50	104	2.675	950	73	
S-CRAD 250	230	50	130	2.685	1.150	75	
S-CRAD 280	230	50	180	2.615	2.000	78	
S-CRAD 355	230	50	147	1.365	2.350	70	
S-CRAD 400	230	50	380	1.365	3.400	83	
S-CRAD 450	230	50	690	1.365	5.000	83	
S-CRAD 500	230 or 380	50	1.080	1.365	7.000	86	
S-CRAD 560	380	50	1.670	1.365	9.300	86	

Values are for 0 Pa.

### DRAWING

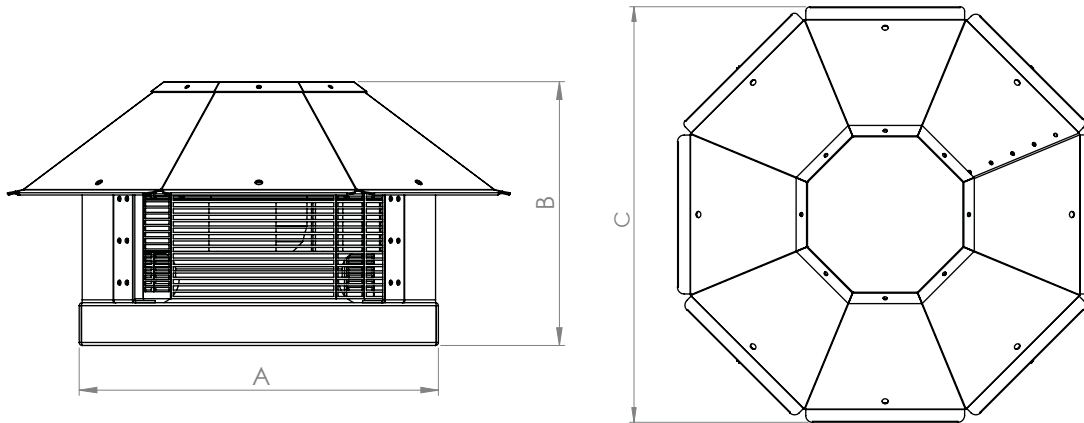

MODEL	A (mm)	B (mm)	C (mm)
S-CRAD 190	250	220	340
S-CRAD 225	336	247	471
S-CRAD 250	355	252	500
S-CRAD 280	370	256	523
S-CRAD 355	450	337	640
S-CRAD 400	450	367	640
S-CRAD 450	550	444	820
S-CRAD 500	600	500	860
S-CRAD 560	630	510	920

# PERFORMANCE CURVES

## S-CRAD 190

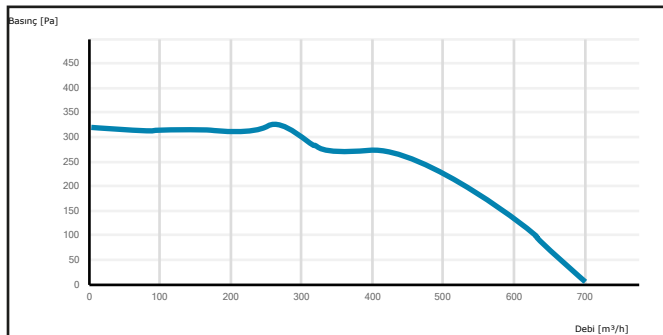

## S-CRAD 225

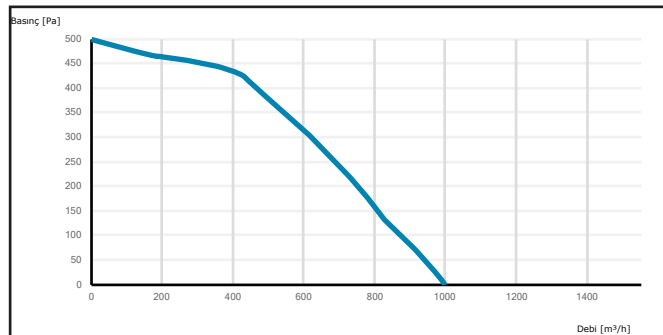

## S-CRAD 250

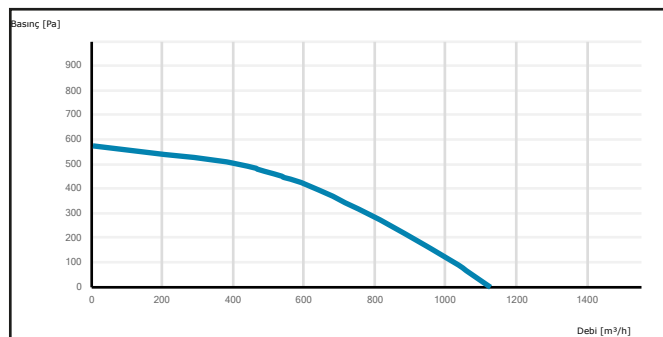

## S-CRAD 280

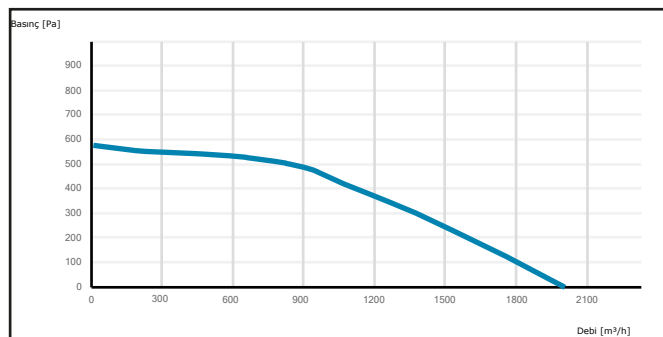

## S-CRAD 355

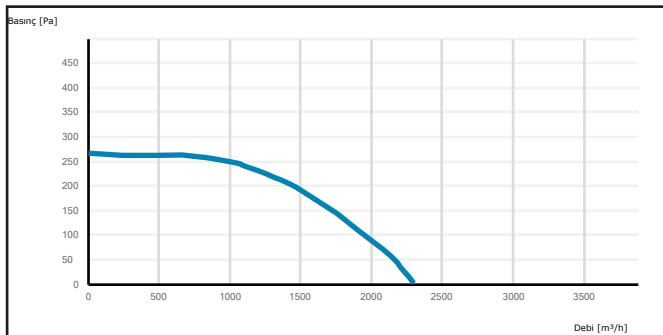

## S-CRAD 400

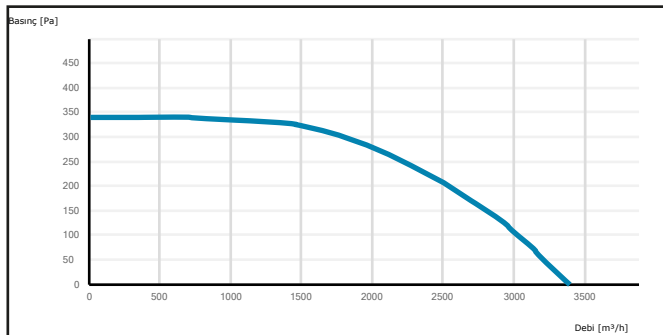

## S-CRAD 450

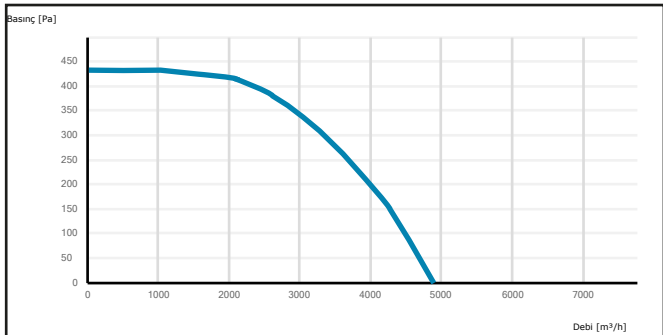

## S-CRAD 500

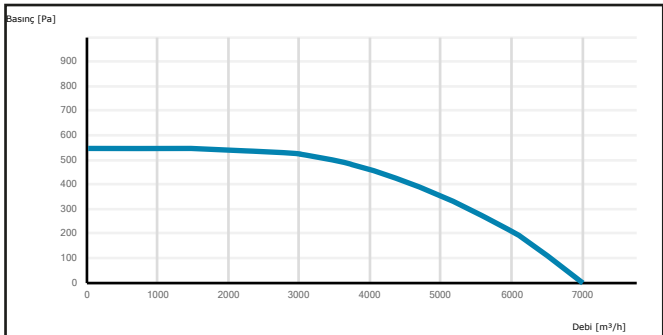

S-CRAD 560

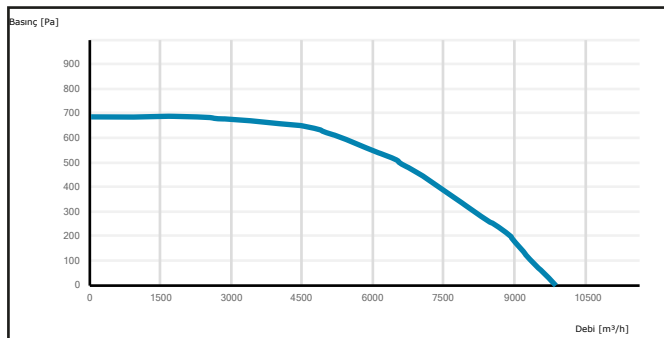



# S-CRADIK Roof Mounted Vertical Discharge Centrifugal Fan



S-CRADIK fans can be used in low to medium volume projects and can be mounted on the roof. Easy-to-install with long-lasting motor and efficient impeller. Vertical discharge allows it to be used in close quarters with other things like chimneys and fans.

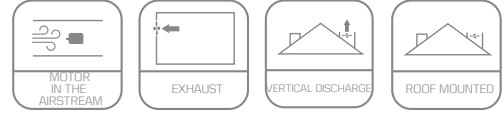

MOTOR INSULATION CLASS	F CLASS
MOTOR PROTECTION CLASS	IP 44
MOTOR EFFICIENCY CLASS	IE2-IE3
MOTOR ENCLOSURE TYPE	EXTERNAL ROTOR MOTOR
MOTOR BRAND	
BODY MATERIAL	GALVANIZED SHEET METAL
BODY COATING	ELECTROSTATIC POWDER PAINT
IMPELLER MATERIAL	GALVANIZED SHEET METAL
DUTY CYCLE	IEC Duty Cycle-S1
WORKING AMBIENT TEMPERATURE	-20 - +50 °C
DIRECTIVE	IEC-60335-2-80, ISO 1940-1

MODEL	VOLTAGE (V)	FREQUENCY (Hz)	POWER (W)	REVOLUTION (rpm)	FLOW RATE (m³/h)	NOISE LEVEL (dB(A))	PRICE
S-CRADIK 190	230	50	90	2.600	520	70	
S-CRADIK 225	230	50	104	2.675	950	73	
S-CRADIK 250	230	50	130	2.685	1.150	75	
S-CRADIK 280	230	50	180	2.615	2.000	78	
S-CRADIK 355	230	50	147	1.365	2.350	70	
S-CRADIK 400	230	50	380	1.365	3.400	83	
S-CRADIK 450	230	50	690	1.365	5.000	83	
S-CRADIK 500	230 or 380	50	1.080	1.365	7.000	86	
S-CRADIK 560	380	50	1.670	1.365	9.300	86	

Values are for 0 Pa.

## DRAWING

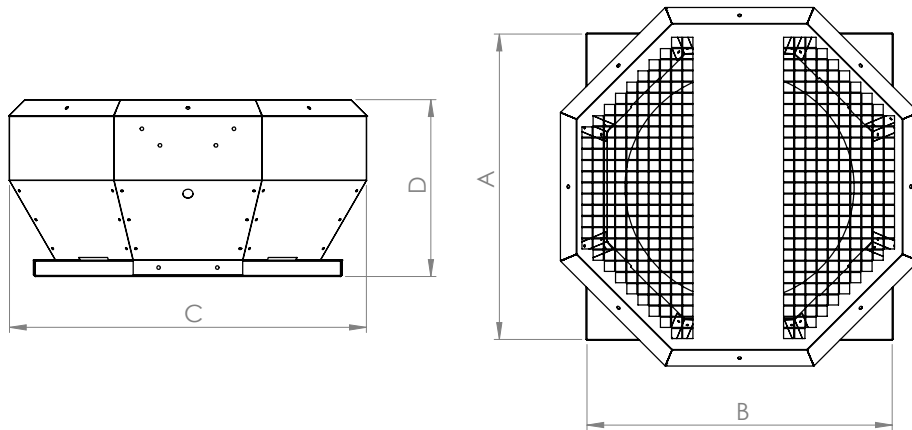

MODEL	A (mm)	B (mm)	C (mm)	D (mm)
S-CRADIK 190	340	340	442	192
S-CRADIK 225	420	420	502	228
S-CRADIK 250	435	435	532	242
S-CRADIK 280	450	450	552	256
S-CRADIK 355	550	550	652	317
S-CRADIK 400	600	600	702	348
S-CRADIK 450	650	650	752	356
S-CRADIK 500	700	700	802	412
S-CRADIK 560	800	800	902	427



# PERFORMANCE CURVES

## S-CRADIK 190

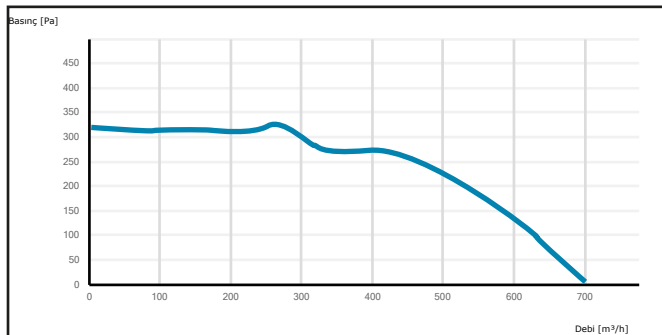

## S-CRADIK 225

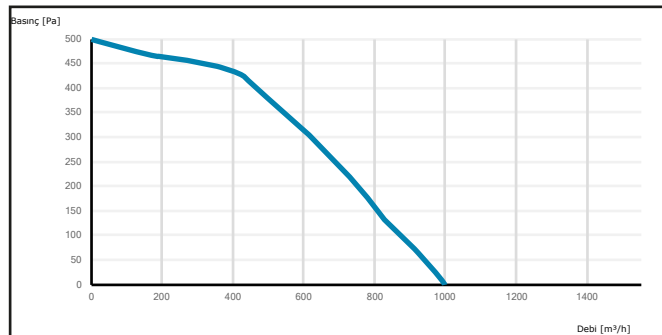

## S-CRADIK 250

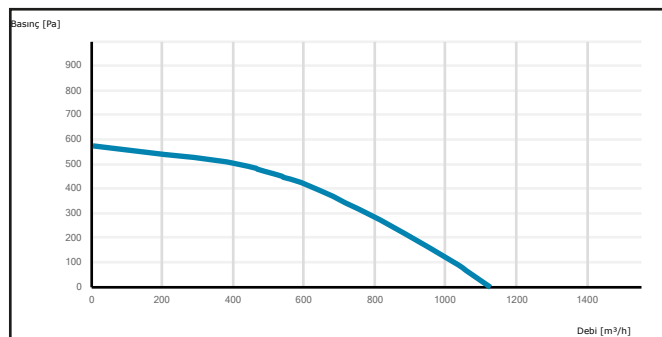

## S-CRADIK 280

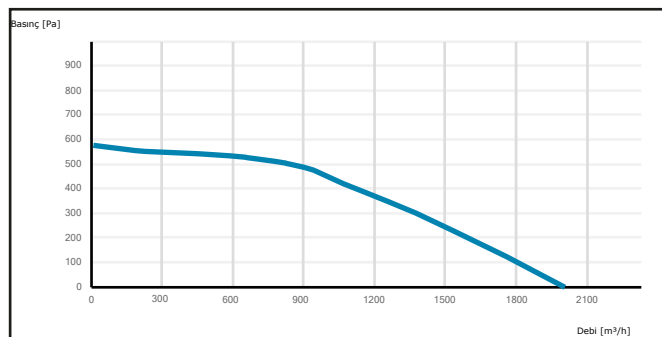

## S-CRADIK 355

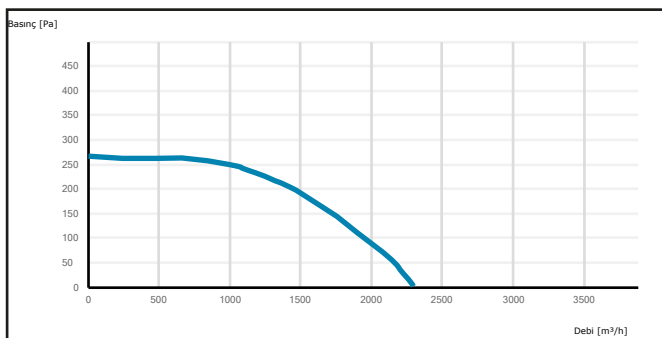

## S-CRADIK 400

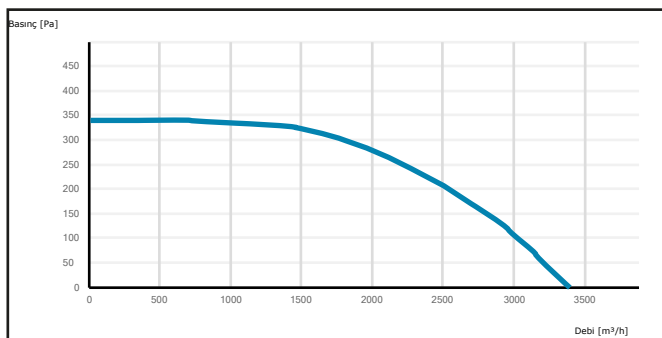

## S-CRADIK 450

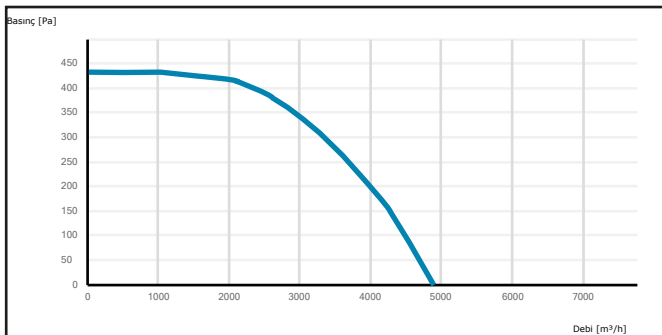

## S-CRADIK 500

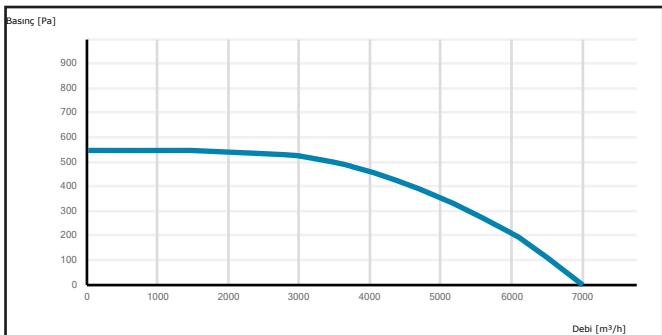

# S-CRADIK 560

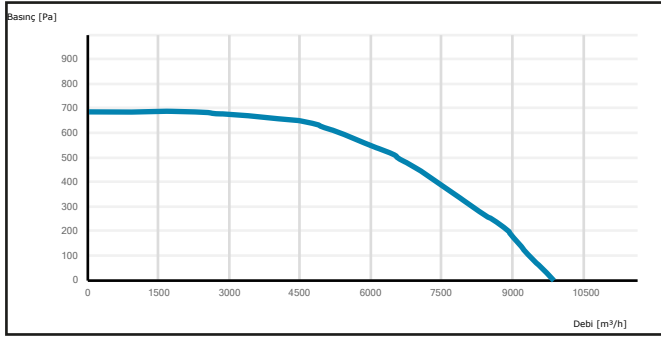



**E** INSTALL  
**R** ROOF  
**S** SERVICE

**A**

**S**

**V** EN  
**T** ILA  
**T** ION

**Y**



# S-MRAD Horizontal Discharge Centrifugal Fan With Motor Out Of Air



S-MRAD fans can be used where the air that it exhausts has particles in it that would damage the motor. Capable of carrying air up to max. 120 Celcius degree. Its single-phase motor and easy-to install body allows a simple use.

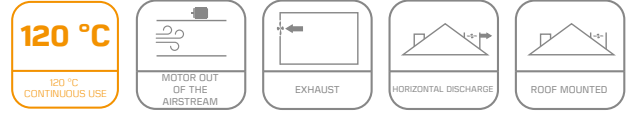

MOTOR INSULATION CLASS	F CLASS
MOTOR PROTECTION CLASS	IP 44
MOTOR EFFICIENCY CLASS	IE2-IE3
MOTOR ENCLOSURE TYPE	EXTERNAL ROTOR MOTOR
MOTOR BRAND	
BODY MATERIAL	GALVANIZED SHEET METAL
BODY COATING	ELECTROSTATIC POWDER PAINT
IMPELLER MATERIAL	GALVANIZED SHEET METAL
DUTY CYCLE	IEC Duty Cycle-S1
WORKING AMBIENT TEMPERATURE	-20 - +50 °C
DIRECTIVE	IEC-60335-2-80, ISO 1940-1

MODEL	VOLTAGE (V)	FREQUENCY (Hz)	POWER (kW)	REVOLUTION (rpm)	FLOW RATE (m³/h)	NOISE LEVEL (dB(A))	PRICE
S-MRAD 315	230	50	0,19	2.700	1.930	63	

Values are for 0 Pa.

## DRAWING

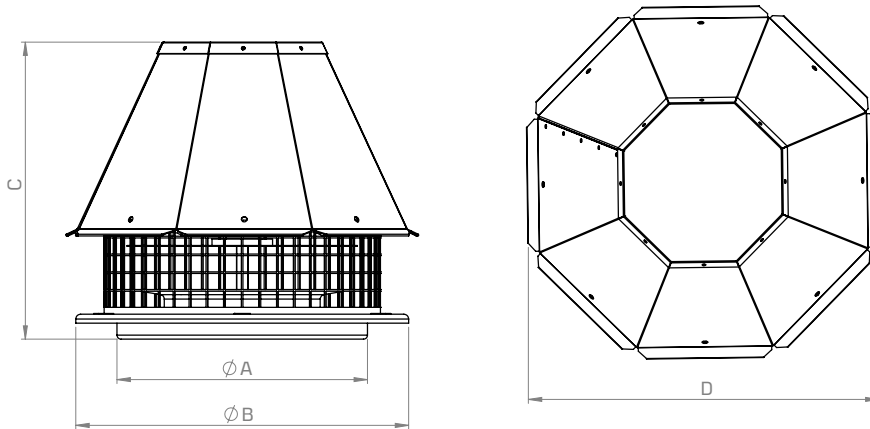

MODEL	A (mm)	B (mm)	C (mm)	D (mm)
S-MRAD 315	310	412	370	435

## PERFORMANCE CURVES

S-MRAD 315

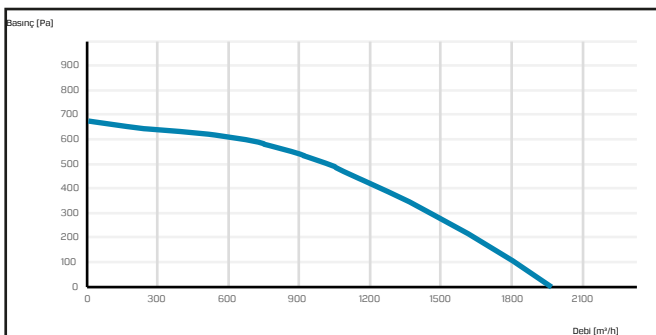

A commercial kitchen scene with a chef in a white uniform and hat working in the background. In the foreground, there are stacks of white plates on a stainless steel counter. Two pendant lights hang above the counter, casting a warm glow. The entire scene is framed by a thin blue border.

**E KITCHEN  
GREASE  
SERVICE**

**A**

**S**

**Y**

**V E N  
T I L A  
T I O N**

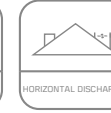
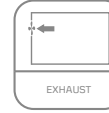

S-DRAD fans can be used where the air that it exhausts has particles in it that would damage the motor.

MOTOR INSULATION CLASS	F CLASS
MOTOR PROTECTION CLASS	IP 55
MOTOR EFFICIENCY CLASS	IE2-IE3
MOTOR ENCLOSURE TYPE	TEFC
MOTOR BRAND	
BODY MATERIAL	GALVANIZED SHEET METAL
BODY COATING	ELECTROSTATIC POWDER PAINT
IMPELLER MATERIAL	GALVANIZED SHEET METAL
DUTY CYCLE	IEC Duty Cycle-S1
WORKING AMBIENT TEMPERATURE	-20 - +50 °C
DIRECTIVE	IEC-60335-2-80, ISO 1940-1

MODEL	VOLTAGE (V)	FREQUENCY (Hz)	POWER (kW)	REVOLUTION (rpm)	FLOW RATE (m³/h)	NOISE LEVEL (dB(A))	PRICE
S-DRAD 280	380	50	0,18	1.450	1.100	73	
S-DRAD 315	380	50	0,25	1.469	1.600	73	
S-DRAD 355	380	50	0,37	1.471	2.300	75	
S-DRAD 400	380	50	0,55	1.478	3.300	78	
S-DRAD 450	380	50	0,75	1.454	5.000	70	
S-DRAD 500	380	50	1,10	1.462	7.000	83	
S-DRAD 560	380	50	1,50	1.464	9.800	74	

Values are for 0 Pa.

Single-phase motors cost an additional 20%.

## DRAWING

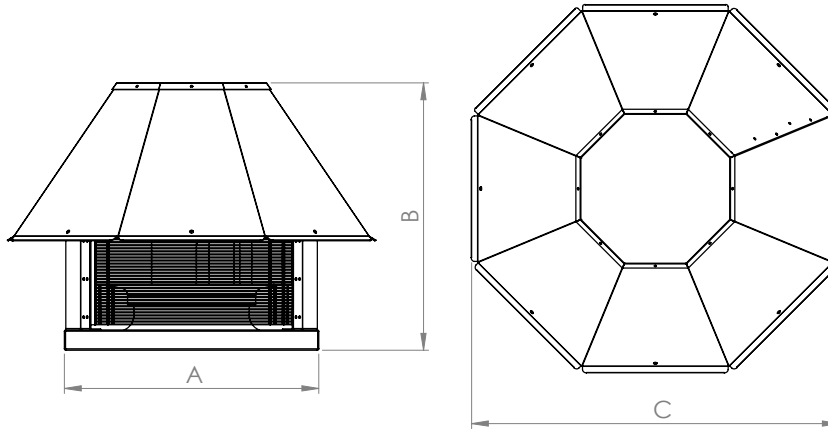

MODEL	A (mm)	B (mm)	C (mm)
S-DRAD 280	366	412	536
S-DRAD 315	400	460	580
S-DRAD 355	450	466	630
S-DRAD 400	500	526	723
S-DRAD 450	550	562	820
S-DRAD 500	600	614	900
S-DRAD 560	650	620	973

# PERFORMANS CURVES

## S-DRAD 280

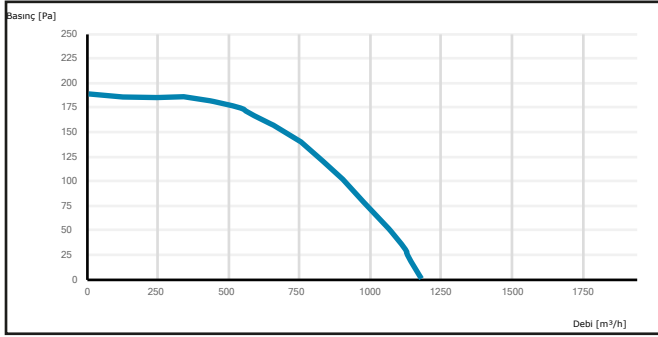

## S-DRAD 315

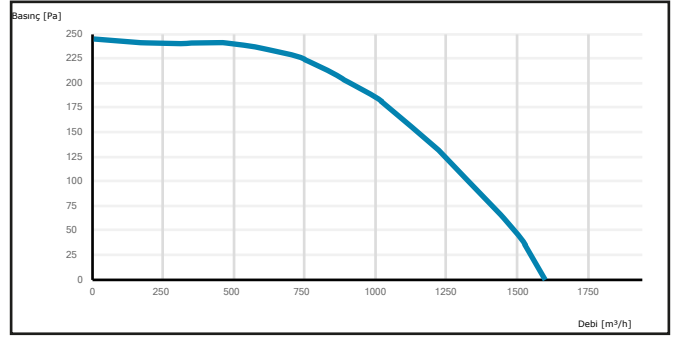

## S-DRAD 355

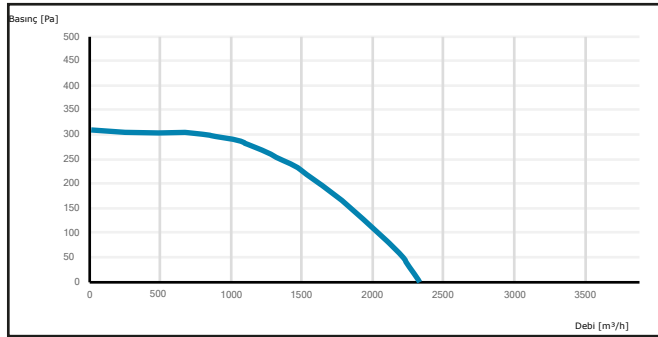

## S-DRAD 400

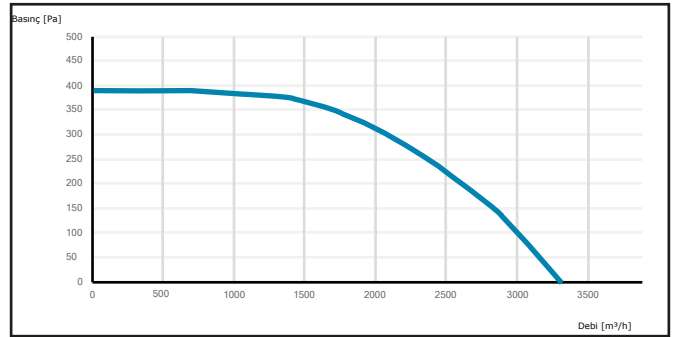

## S-DRAD 450

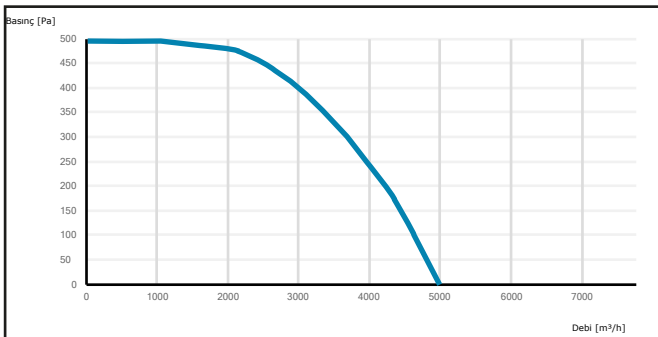

## S-DRAD 500

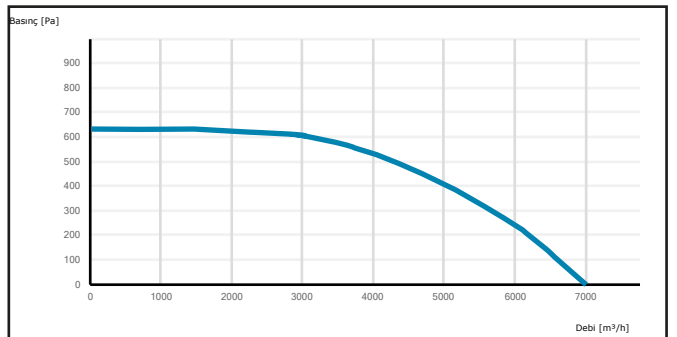

## S-DRAD 560

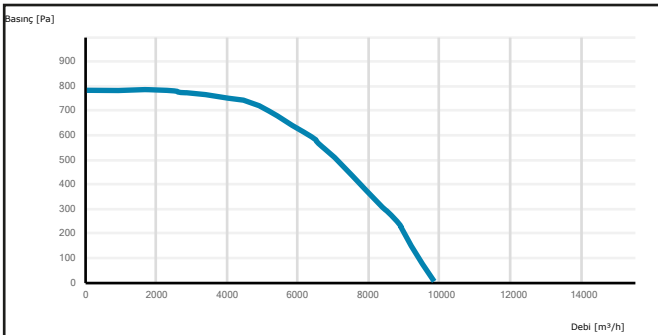



## S-DRADIK Horizontal Discharge Centrifugal Fan With Motor Out Of Air

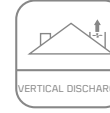
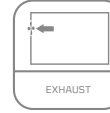

S-DRADIK fans can be used where the air that it exhausts has particles in it that would damage the motor. Vertical discharge allows it to be used in close quarters with other things like chimneys and fans.

MOTOR INSULATION CLASS	F CLASS
MOTOR PROTECTION CLASS	IP 55
MOTOR EFFICIENCY CLASS	IE2-IE3
MOTOR ENCLOSURE TYPE	TEFC
MOTOR BRAND	
BODY MATERIAL	GALVANIZED SHEET METAL
BODY COATING	ELECTROSTATIC POWDER PAINT
IMPELLER MATERIAL	GALVANIZED SHEET METAL
DUTY CYCLE	IEC Duty Cycle-S1
WORKING AMBIENT TEMPERATURE	-20 - +50 °C
DIRECTIVE	IEC-60335-2-80, ISO 1940-1

MODEL	VOLTAGE (V)	FREQUENCY (Hz)	POWER (kW)	REVOLUTION (rpm)	FLOW RATE (m³/h)	NOISE LEVEL (dB(A))	PRICE
S-DRADIK 280	380	50	0,18	1.450	1.100	73	
S-DRADIK 315	380	50	0,25	1.469	1.600	73	
S-DRADIK 355	380	50	0,37	1.471	2.300	75	
S-DRADIK 400	380	50	0,55	1.478	3.300	78	
S-DRADIK 450	380	50	0,75	1.454	5.000	70	
S-DRADIK 500	380	50	1,10	1.462	7.000	83	
S-DRADIK 560	380	50	1,50	1.464	9.800	74	

Values are for 0 Pa.  
Single-phase motors cost an additional 20%.

### DRAWING

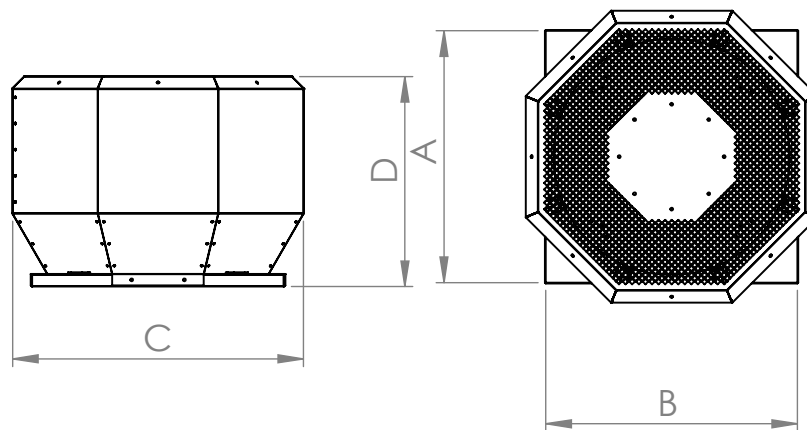

MODEL	A (mm)	B (mm)	C (mm)	D (mm)
S-DRADIK 280	450	450	552	405
S-DRADIK 315	500	500	602	440
S-DRADIK 355	550	550	652	478
S-DRADIK 400	600	600	702	517
S-DRADIK 450	650	650	752	543
S-DRADIK 500	700	700	802	610
S-DRADIK 560	750	750	852	642



# PERFORMANCE CURVES

S-DRADIK 280

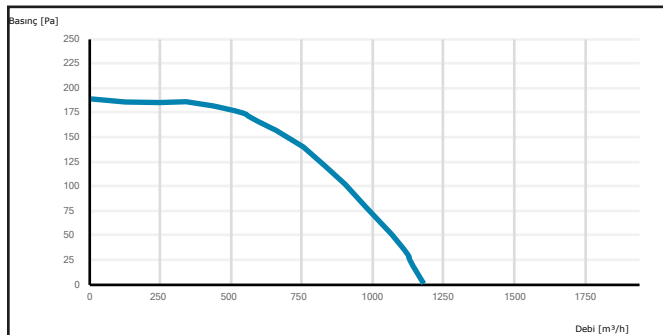

S-DRADIK 315

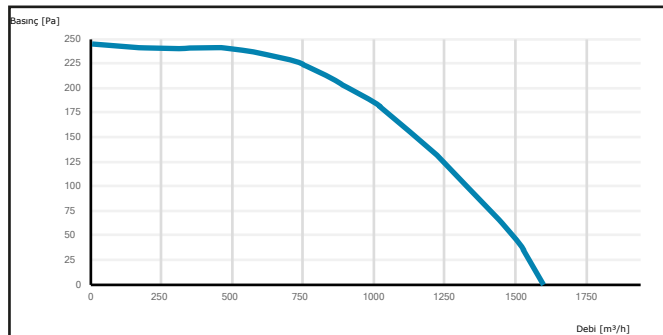

S-DRADIK 355

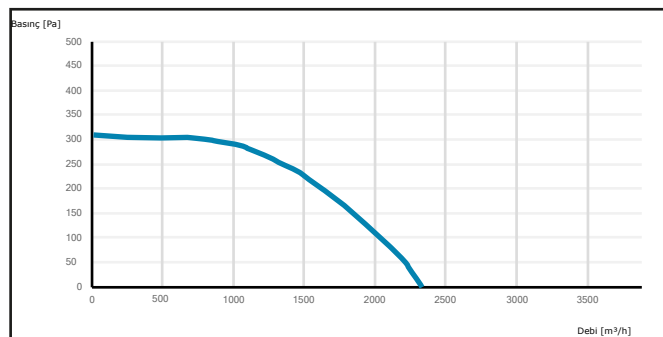

S-DRADIK 400

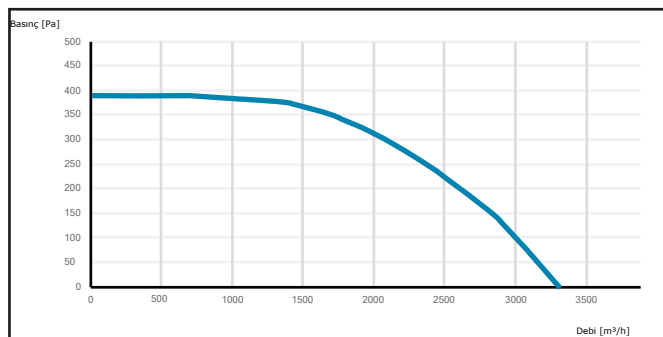

S-DRADIK 450

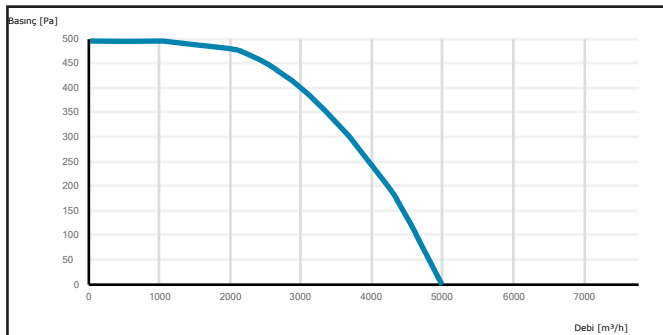

S-DRADIK 500

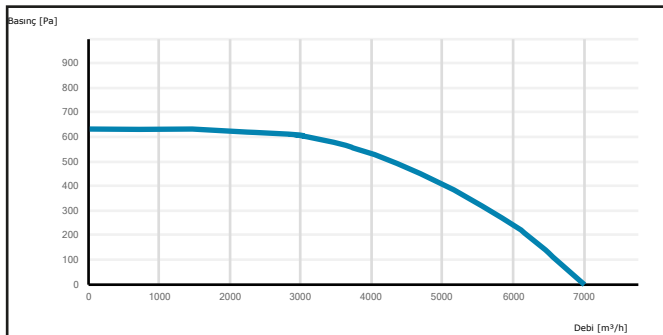

S-DRADIK 560

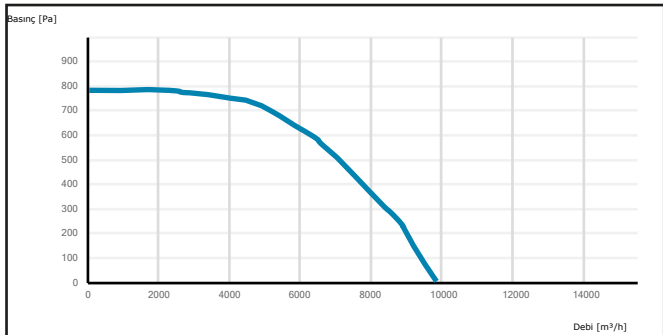



**E** HEATING  
BOILER  
SERVICE

**A**

**S**

**Y**

**VEN  
TILA  
TION**

## S-KAZ Single Inlet Centrifugal Fan With Aluminium Body



S-KAZ fans with their aluminium injected bodies, forward-curved impeller and small size can be used in boilers. Using with BAXI fans it allows BAXI to be used in high-temperature for continuous use.

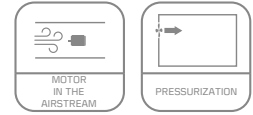

MOTOR INSULATION CLASS	F CLASS
MOTOR PROTECTION CLASS	IP 44
MOTOR EFFICIENCY CLASS	IE2-IE3
MOTOR ENCLOSURE TYPE	EXTERNAL ROTOR MOTOR
MOTOR BRAND	
BODY MATERIAL	ALUMINIUM
BODY COATING	OPTIONAL
IMPELLER MATERIAL	GALVANIZED SHEET METAL
DUTY CYCLE	IEC Duty Cycle-S1
WORKING AMBIENT TEMPERATURE	-20 - +50 °C
DIRECTIVE	IEC-60335-2-80, ISO 1940-1

MODEL	VOLTAGE (V)	FREQUENCY (Hz)	POWER (W)	REVOLUTION (rpm)	FLOW RATE (m³/h)	NOISE LEVEL (dB(A))	PRICE
S-KAZ 120	230	50	84	2.450	275	55	
S-KAZ 140	230	50	137	2.265	485	58	
S-KAZ 160	230	50	193	2.100	600	61	

Values are for 0 Pa.

## DRAWING

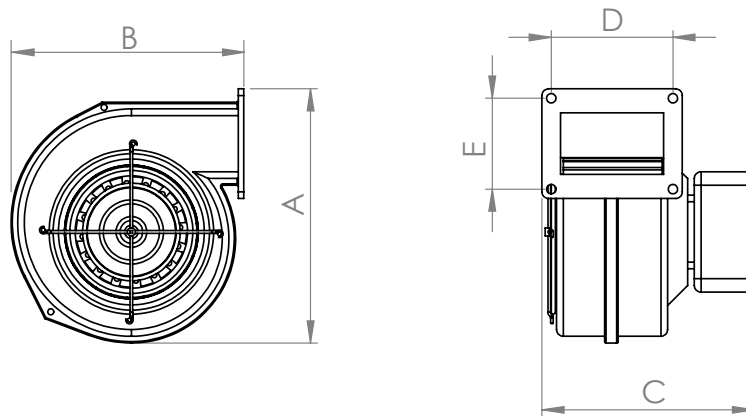

MODEL	A (mm)	B (mm)	C (mm)	D (mm)	E (mm)
S-KAZ 120	190	175	160	90	70
S-KAZ 140	260	225	145	115	105
S-KAZ 160	260	225	145	115	105



S-SAL fans has high flow rate impeller and a robust body that can change blow direction.

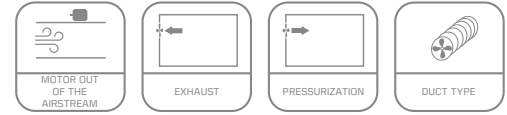

MOTOR INSULATION CLASS	F CLASS
MOTOR PROTECTION CLASS	IP 55
MOTOR EFFICIENCY CLASS	IE2-IE3
MOTOR ENCLOSURE TYPE	TEFC
MOTOR BRAND	
BODY MATERIAL	GALVANIZED SHEET METAL
BODY COATING	ELECTROSTATIC POWDER PAINT
IMPELLER MATERIAL	GALVANIZED SHEET METAL
DUTY CYCLE	IEC Duty Cycle-S1
WORKING AMBIENT TEMPERATURE	-20 - +50 °C
DIRECTIVE	IEC-60335-2-80, ISO 1940-1

MODEL	VOLTAGE (V)	FREQUENCY (Hz)	POWER (kW)	REVOLUTION (rpm)	FLOW RATE (m³/h)	NOISE LEVEL (dB(A))	PRICE
S-SAL 280	380	50	0,18	1.450	1.100	73	
S-SAL 315	380	50	0,25	1.469	1.600	73	
S-SAL 355	380	50	0,37	1.471	2.300	75	
S-SAL 400	380	50	0,55	1.478	3.300	78	
S-SAL 450	380	50	0,75	1.454	5.000	70	
S-SAL 500	380	50	1,10	1.462	7.000	83	
S-SAL 560	380	50	1,50	1.464	9.800	74	
S-SAL 630	380	50	3,00	1.465	14.000	89	
S-SAL 710	380	50	4,00	950	13.000	89	

Values are for 0 Pa.

Single-phase motors cost an additional 20%.

## DRAWING

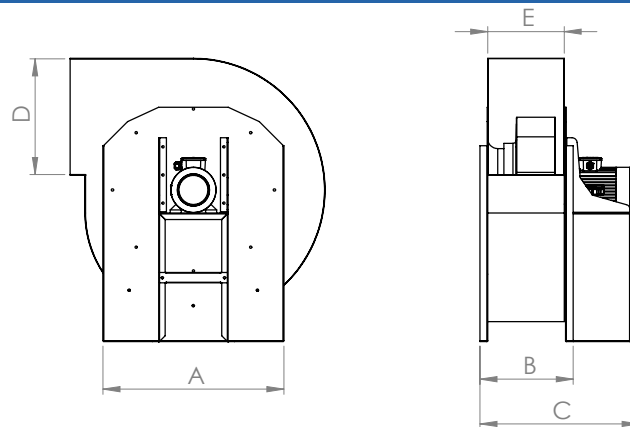

MODEL	A (mm)	B (mm)	C (mm)	D (mm)	E (mm)
S-SAL 280	340	200	370	245	150
S-SAL 315	400	220	400	260	160
S-SAL 355	440	240	435	280	175
S-SAL 400	500	290	500	320	220
S-SAL 450	600	320	550	350	250
S-SAL 500	700	350	580	400	280
S-SAL 560	700	365	620	450	300
S-SAL 630	800	380	670	500	330
S-SAL 710	900	405	710	560	360

# PERFORMANCE CURVES

S-SAL 280

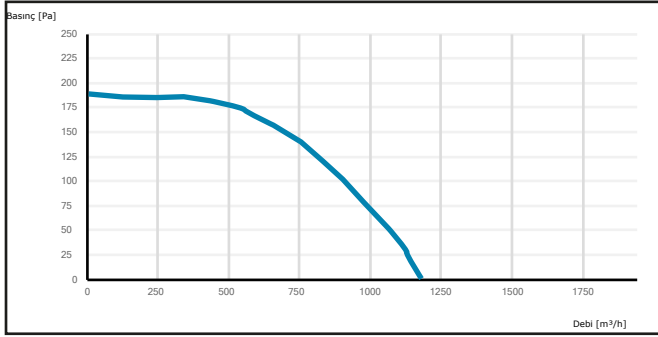

S-SAL 315

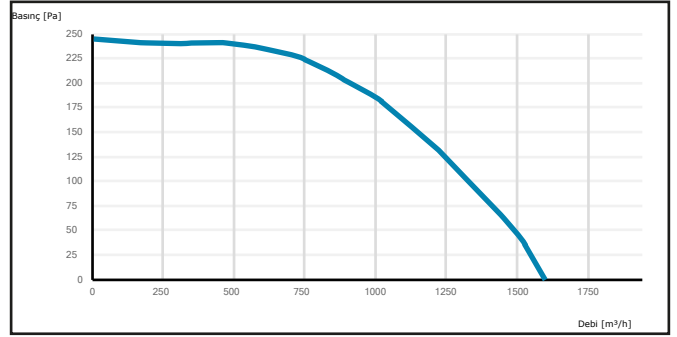

S-SAL 355

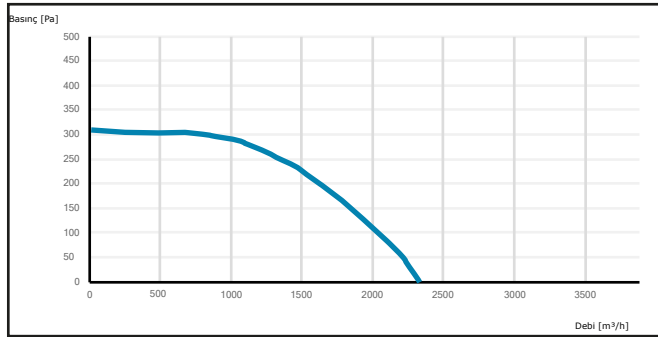

S-SAL 400

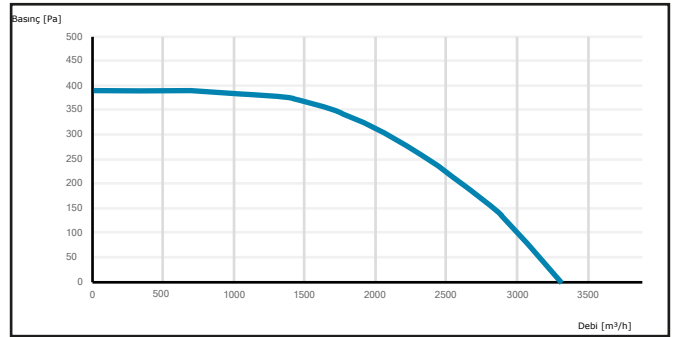

S-SAL 450

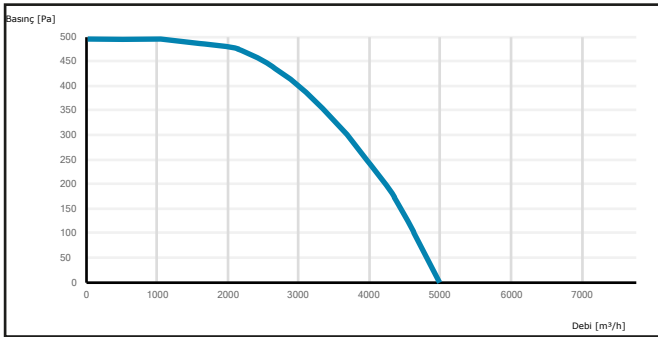

S-SAL 500

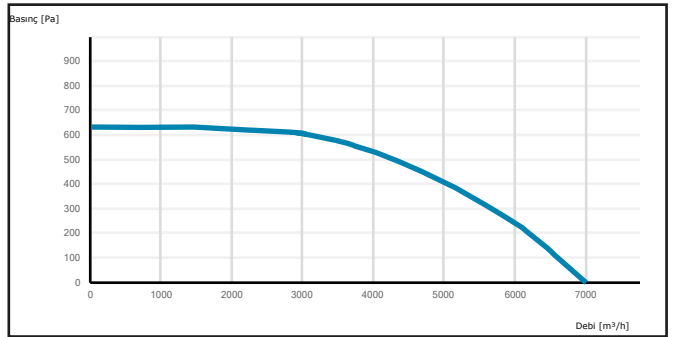

S-SAL 560

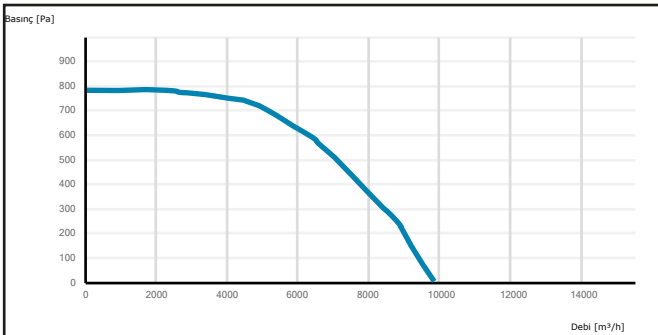

S-SAL 630

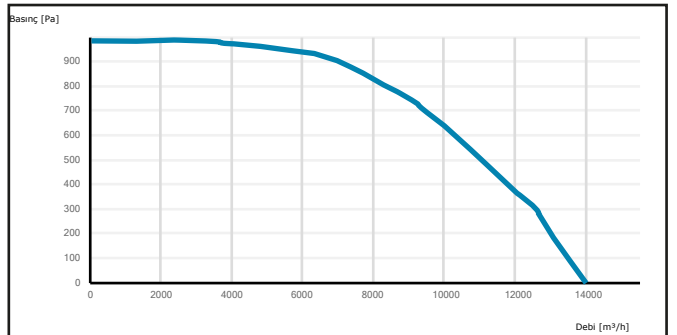

# S-SAL 710

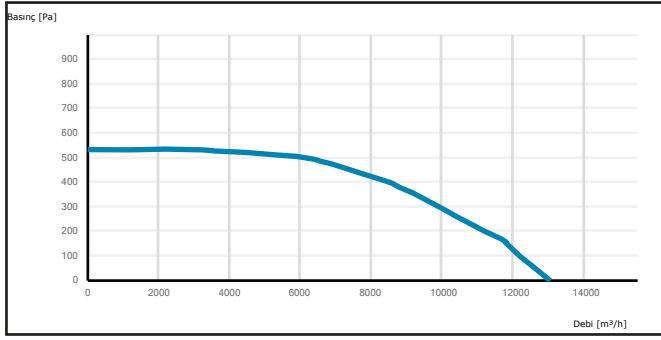



Heat recovery units has high efficiency cross-flow heat exchanger, low power using fans and with an easy plug and use system.

MOTOR INSULATION CLASS	F CLASS
MOTOR PROTECTION CLASS	IP 44
MOTOR EFFICIENCY CLASS	IE2-IE3
MOTOR ENCLOSURE TYPE	EXTERNAL ROTOR MOTOR
MOTOR BRAND	
BODY MATERIAL	GALVANIZED SHEET METAL
BODY COATING	OPTIONAL
IMPELLER MATERIAL	GALVANIZED SHEET METAL
DUTY CYCLE	IEC Duty Cycle-S1
WORKING AMBIENT TEMPERATURE	-20 - +50 °C
DIRECTIVE	IEC-60335-2-80, ISO 1940-1

MODEL	VOLTAGE (V)	FREQUENCY (Hz)	POWER (W)	REVOLUTION (rpm)	FLOW RATE (m³/h)	PRICE
IGK 10	230	50	250	2.668	1.000	
IGK 20	230	50	400	2.396	2.000	
IGK 30	230	50	780	1.465	2.700	
IGK 40	230	50	1.300	1.410	4.000	
IGK 50	230	50	1.700	1.380	6.000	

Values are for 0 Pa.

## OPTIONS



CONTROL PANELS MUST BE USED WHEN ELECTRIC HEATERS ARE CONNECTED.

CONTROL PANEL	
MODEL	PRICE
10	
20	
30	
40	
50	

ELECTRIC HEATER	
MODEL	PRICE
3 kW - 380 V	
6 kW - 380 V	
9 kW - 380 V	
12 kW - 380 V	
15 kW - 380 V	

## DRAWING

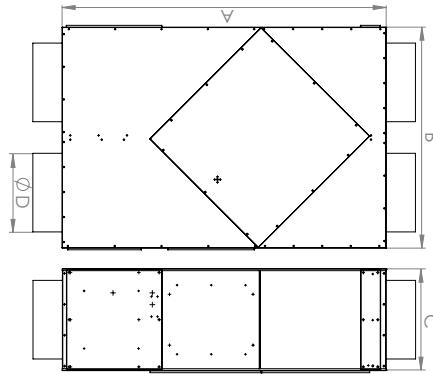

MODEL	A (mm)	B (mm)	C (mm)	D (mm)
S-IGK 10	940	680	330	250
S-IGK 20	1150	1000	430	305
S-IGK 30	1720	1160	440	355
S-IGK 40	1650	1230	520	400
S-IGK 50	1850	1230	620	450

## PERFORMANCE CURVES

S-IGK 10

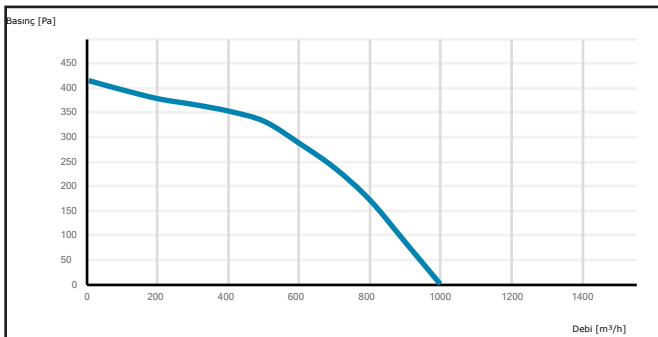

S-IGK 20

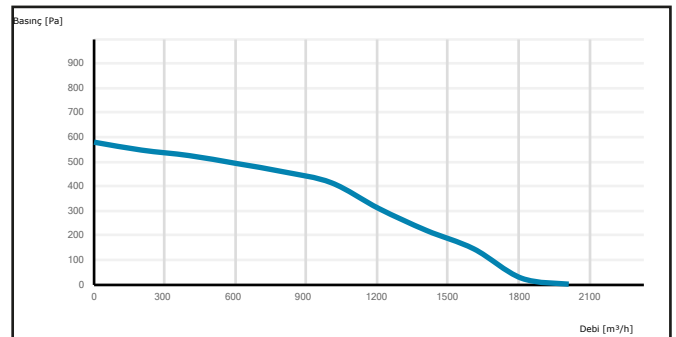

S-IGK 30

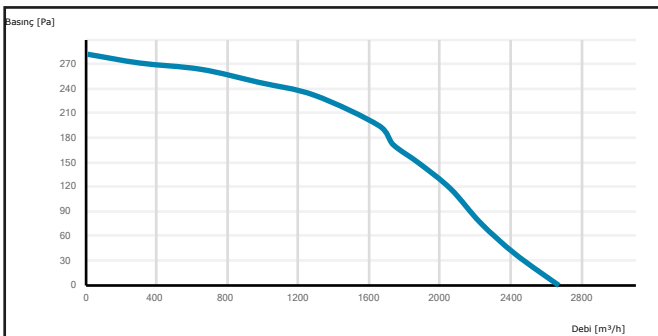

S-IGK 40

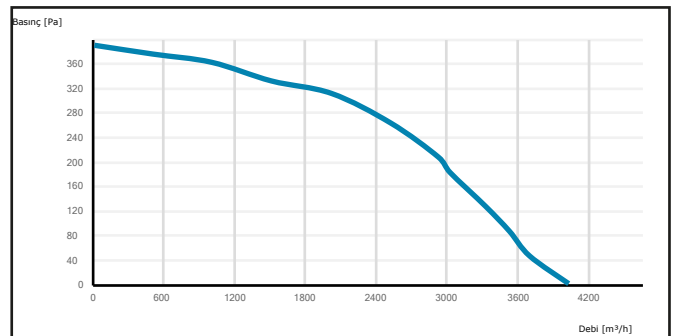

S-IGK 50

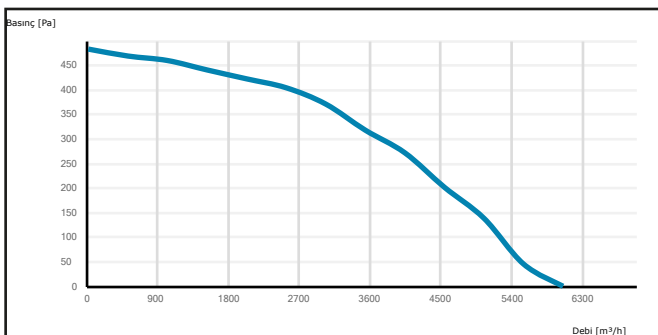





Shelter ventilation units has a damper that allows air through different channels. First channel is for peace times which only has a G4 dust filter. The second channel is for war times which has G4 dust filter followed by an active carbon filter and the final filtering stage is NBC filter (Nuclear, biological and chemical fallout filter). SHU 3E has a crank which allows the unit to be used without electricity and just by manpower.



MOTOR INSULATION CLASS	F CLASS
MOTOR PROTECTION CLASS	IP 44
MOTOR EFFICIENCY CLASS	IE2-IE3
MOTOR ENCLOSURE TYPE	EXTERNAL ROTOR MOTOR
MOTOR BRAND	
BODY MATERIAL	GALVANIZED SHEET METAL
BODY COATING	OPTIONAL
IMPELLER MATERIAL	GALVANIZED SHEET METAL
DUTY CYCLE	IEC Duty Cycle-S1
WORKING AMBIENT TEMPERATURE	-20 - +50 °C
DIRECTIVE	IEC-60335-2-80, ISO 1940-1

MODEL	VOLTAGE (V)	FREQUENCY (Hz)	POWER (W)	REVOLUTION (rpm)	FLOW RATE (m³/h)	NOISE LEVEL (dB(A))	PRICE
S-SHU 3	230	50	150	2.710	300	89	
S-SHU 5	230	50	150	2.680	500	91	
S-SHU 7	230	50	150	2.712	700	95	
S-SHU 9	230	50	260	2.712	900	96	
S-SHU 13	230	50	260	2.610	13.00	99	
S-SHU 18	230	50	480	1.465	1.800	89	
S-SHU 30	230	50	640	1.420	3.000	91	
S-SHU 36	230	50	900	1.365	3.600	95	
S-SHU 43	380	50	1.430	1.370	4.300	96	
S-SHU 54	380	50	1.430	1.320	5.400	96	
S-SHU 3E	230	50	150	2.710	300	99	

Values are for 0 Pa.

## OPTIONS

LEAD SEPERATOR		LEAD CASING	
MODEL	PRICE	MODEL	PRICE
S-SHU 3		S-SHU 3	
S-SHU 5		S-SHU 5	
S-SHU 7		S-SHU 7	
S-SHU 9		S-SHU 9	
S-SHU 13		S-SHU 13	
S-SHU 18		S-SHU 18	
S-SHU 30		S-SHU 30	
S-SHU 36		S-SHU 36	
S-SHU 43		S-SHU 43	
S-SHU 54		S-SHU 54	
S-SHU 3E		S-SHU 3E	

## DRAWING

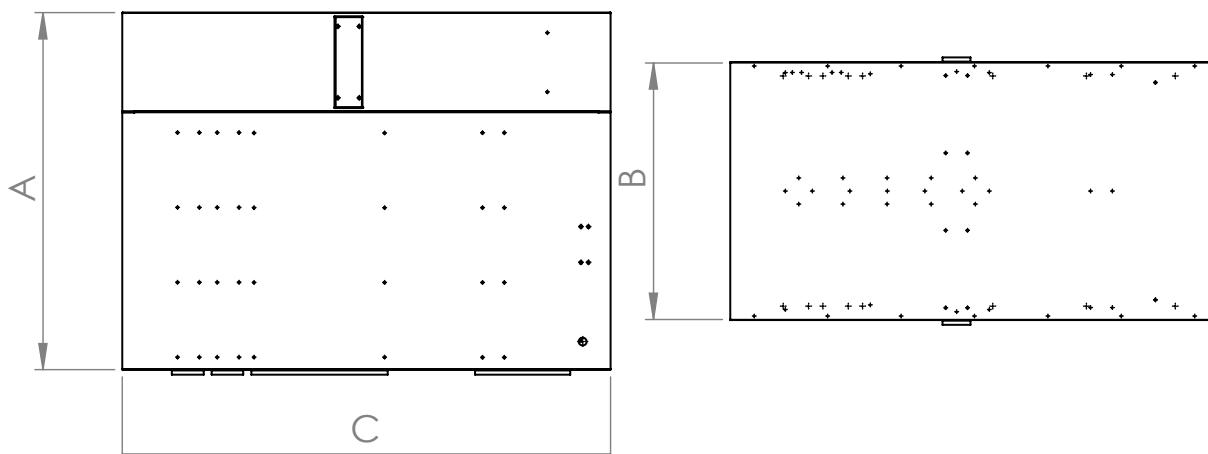

MODEL	A (mm)	B (mm)	C (mm)
S-SHU 3	400	300	1010
S-SHU 5	500	350	1250
S-SHU 7	500	350	1250
S-SHU 9	500	350	1250
S-SHU 13	900	350	1300
S-SHU 18	900	450	1280
S-SHU 30	900	650	1360
S-SHU 36	900	650	1360
S-SHU 43	900	650	1360
S-SHU 54	1300	650	1350
S-SHU 3E	600	400	1380

## PERFORMANCE CURVES

S-SHU 3

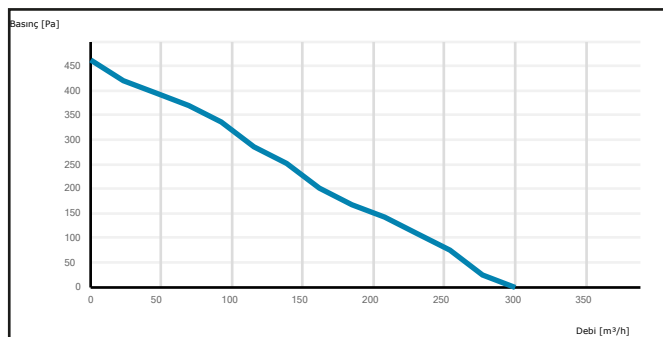

S-SHU 5

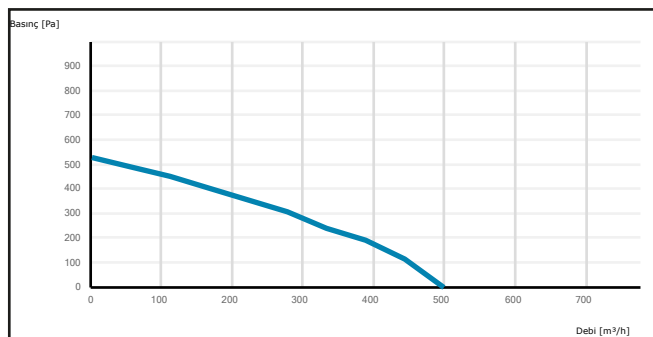

S-SHU 7

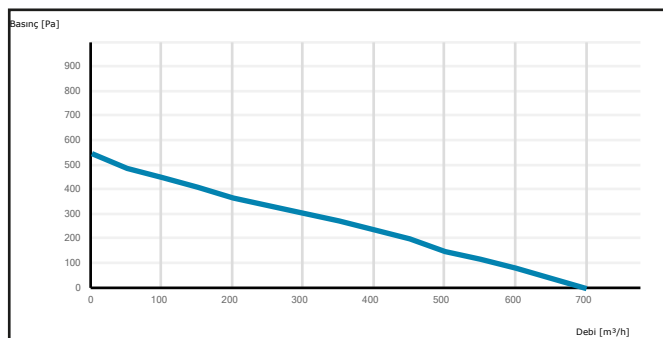

S-SHU 9

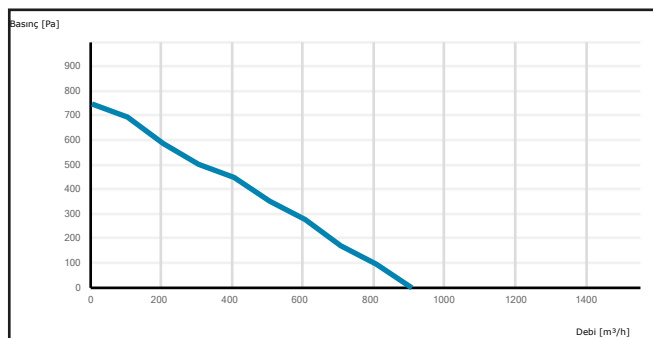

S-SHU 13

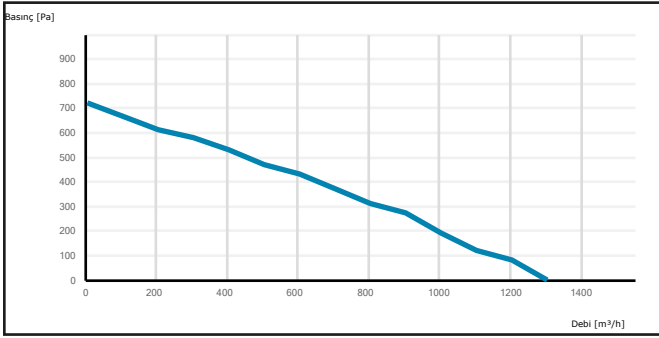

S-SHU 18

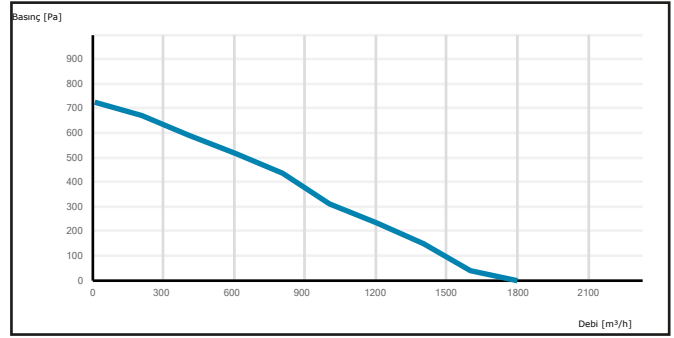

S-SHU 30

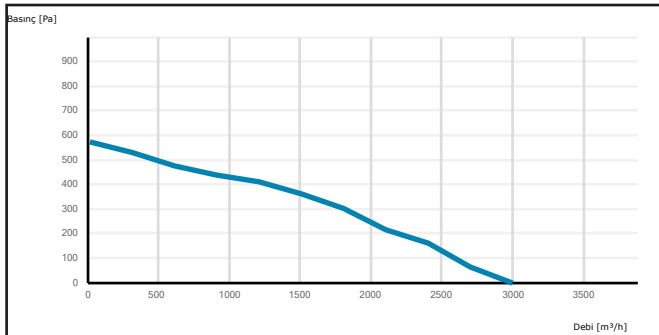

S-SHU 36

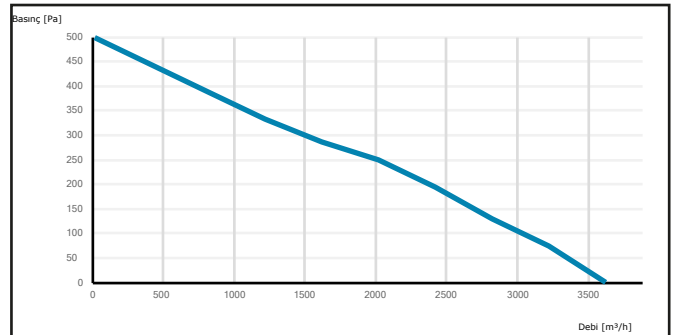

S-SHU 43

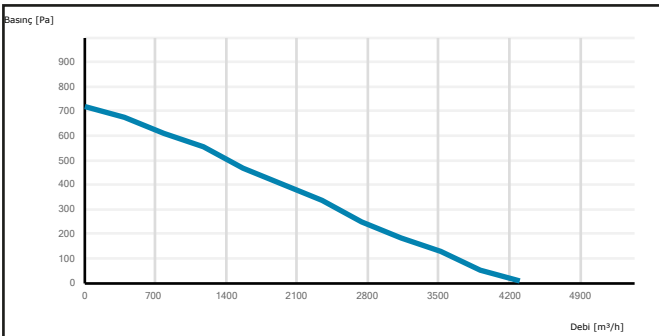

S-SHU 54

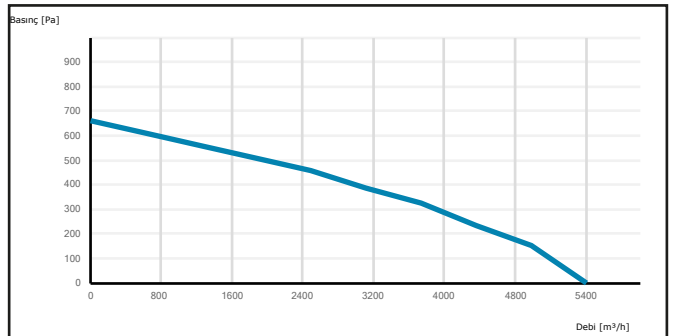

A photograph of a Japanese restaurant kitchen. In the foreground, a grill is cooking skewers, with a large plume of white steam rising from it. To the right, a counter is set with various dishes, including a bowl of ramen and a glass of beer. A person's hand is visible holding chopsticks. The background shows a wooden wall and a hanging light fixture. The text 'E FILTER ODOR INSTALL A S V E N T I L A T I O N Y' is overlaid in large white letters on a blue border.

**E FILTER  
ODOR  
INSTALL  
A  
S V E N  
T I L A  
T I O N  
Y**



S-FFUs are delivered with a G4 dust filter and an active carbon filter. The filters can be changed optionally at production and a third filter also can be added.

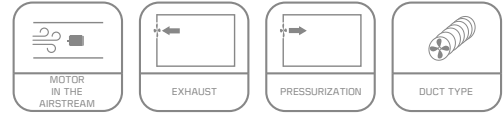

MOTOR INSULATION CLASS	F CLASS
MOTOR PROTECTION CLASS	IP 44
MOTOR EFFICIENCY CLASS	IE2-IE3
MOTOR ENCLOSURE TYPE	EXTERNAL ROTOR MOTOR
MOTOR BRAND	
BODY MATERIAL	GALVANIZED SHEET METAL
BODY COATING	OPTIONAL
IMPELLER MATERIAL	GALVANIZED SHEET METAL
DUTY CYCLE	IEC Duty Cycle-S1
WORKING AMBIENT TEMPERATURE	-20 - +50 °C
DIRECTIVE	IEC-60335-2-80, ISO 1940-1

MODEL	VOLTAGE (V)	FREQUENCY (Hz)	POWER (W)	REVOLUTION (rpm)	FLOW RATE (m³/h)	NOISE LEVEL (dB(A))	PRICE
S-FFU 5	230	50	85	2.722	665	73	
S-FFU 10	230	50	122	2.670	950	73	
S-FFU 20	230	50	210	2.580	1.665	75	
S-FFU 30	230	50	380	1.420	3.230	78	
S-FFU 40	230	50	690	1.365	4.655	80	

Values are for 0 Pa.

## DRAWING

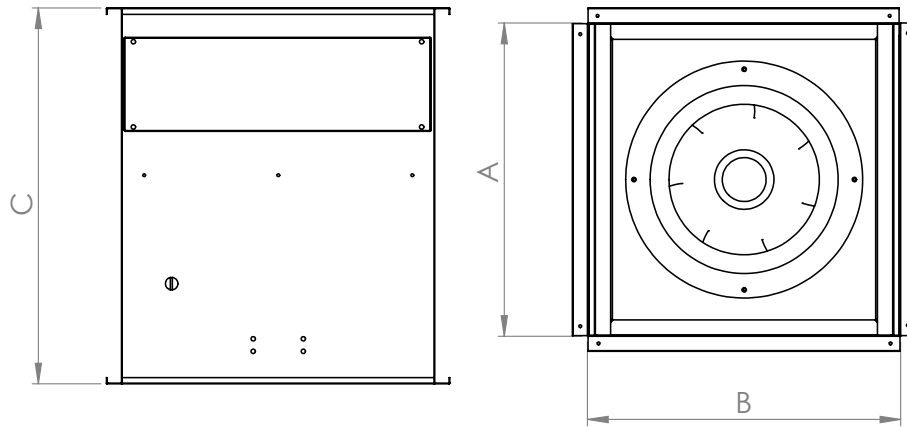

MODEL	A (mm)	B (mm)	C (mm)
S-FFU 5	300	300	500
S-FFU 10	350	350	500
S-FFU 20	400	400	500
S-FFU 30	450	450	600
S-FFU 40	500	500	600

# PERFORMANCE CURVES

## S-FFU 5

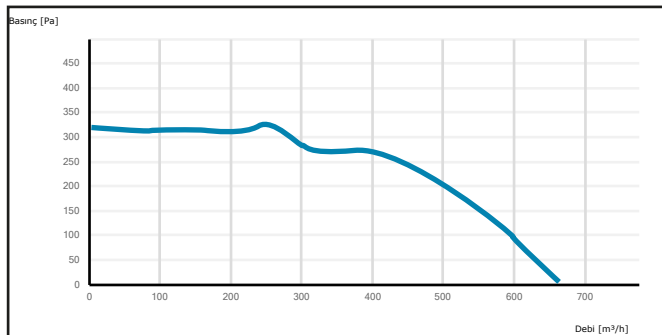

## S-FFU 10

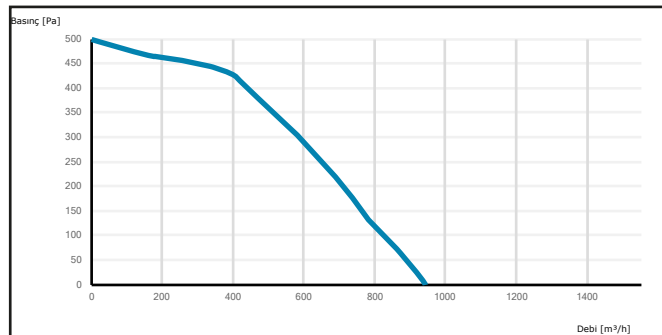

## S-FFU 20

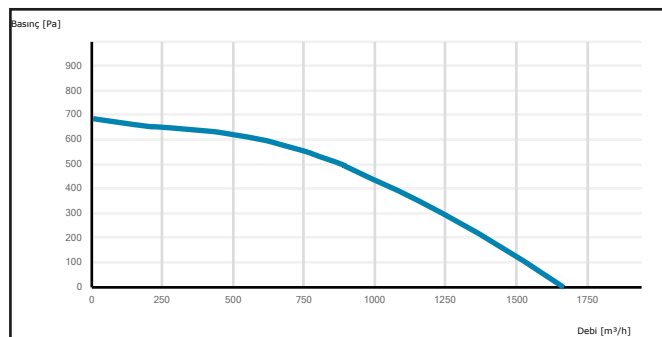

## S-FFU 30

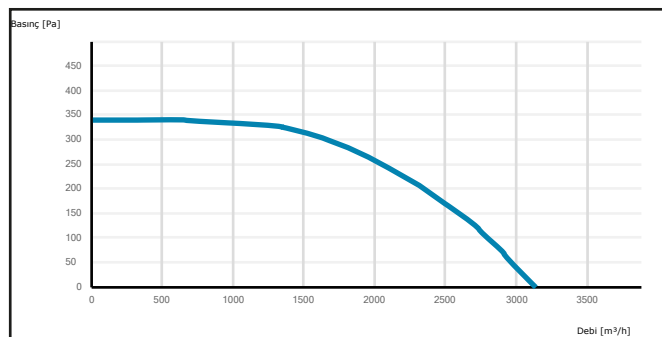

## S-FFU 40

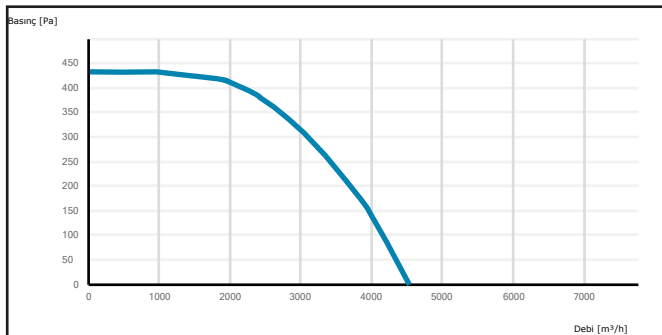

## Single-Phase Fan Speed Controller



They can be used to control the revolution for single-phase fans.



MODEL	PRICE
KHA 2,5 A	
KHA 5,0 A	
KHA 7,5 A	
KHA 10,0 A	

## Three-Phase Fan Speed Controller



Danfoss brand FC51 controller can be used to control the revolution for three-phase motors. It is optional to get the model which allows three-phase motors to be used with single-phase outlets. Keypad price is included.

MODEL	PRICE
VFD 0,75 kW	
VFD 1,50 kW	
VFD 2,20 kW	
VFD 3,00 kW	
VFD 4,00 kW	
VFD 5,50 kW	
VFD 7,50 kW	
VFD 11,00 kW	
VFD 15,00 kW	
VFD 18,50 kW	
VFD 22,00 kW	
VFD 30,00 kW	
VFD 37,00 kW	
VFD 45,00 kW	

A photograph of a hospital room. In the foreground, a white ventilator on wheels is visible, with the brand name 'select' on its side. Behind it is a hospital bed with white linens and a red headboard. The background shows a medical station with various equipment, including monitors, a sink, and a wall-mounted emergency exit sign. A number '51' is visible on the wall. The entire image is framed by a thin blue border.

# E H H F A S Y H H F A S Y





**NEW PRODUCT**



S-HFFUs can be used in places like hospital and medicine factories where ventilation should be much more hygienic than normal. With INOX sheet body and HEPA filter, HFFU is the best choice for those places. G4 filters at the front allows HEPA filter to be operational for a long time.

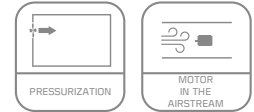

MOTOR INSULATION CLASS	F CLASS
MOTOR PROTECTION CLASS	IP 44
MOTOR EFFICIENCY CLASS	IE2-IE3
MOTOR ENCLOSURE TYPE	EXTERNAL ROTOR MOTOR
MOTOR BRAND	
BODY MATERIAL	AISI 304
BODY COATING	OPTIONAL
IMPELLER MATERIAL	GALVANIZED SHEET METAL
DUTY CYCLE	IEC Duty Cycle-S1
WORKING AMBIENT TEMPERATURE	-20 - +50 °C
DIRECTIVE	IEC-60335-2-80, ISO 1940-1

MODEL	VOLTAGE (V)	FREQUENCY (Hz)	POWER (W)	REVOLUTION (rpm)	FLOW RATE (m³/h)	NOISE LEVEL (dB(A))	PRICE
S-HFFU 610-610	230	50	125	2.410	600	65	
S-HFFU 610-1220	230	50	270	2.410	1.200	68	

Values are for 0 Pa.

## DRAWING

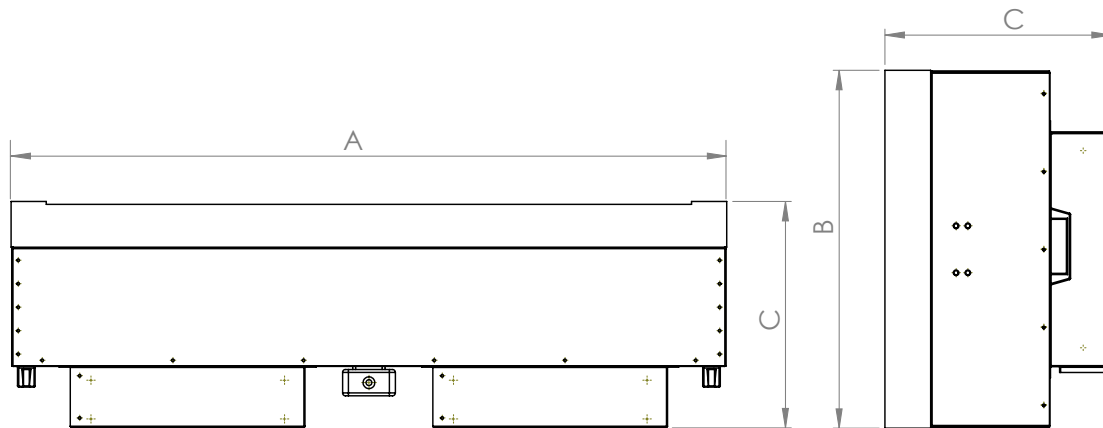

MODEL	A (mm)	B (mm)	C (mm)
S-HFFU 610-610	610	610	386
S-HFFU 610-1220	1220	610	386

**E** BATHROOM  
**E** INSTALL  
**USE**  
**A**  
**S** V E N  
**Y** T I L A  
**T I O N**





High quality PP materials are used in the production of BAFs. They can be used in bathroom walls or windows.

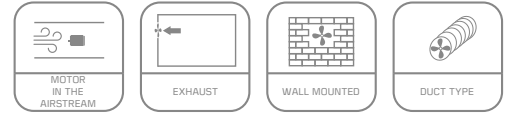

MOTOR INSULATION CLASS	F CLASS
MOTOR PROTECTION CLASS	IP 25
MOTOR EFFICIENCY CLASS	IE2
MOTOR ENCLOSURE TYPE	EXTERNAL ROTOR MOTOR
MOTOR BRAND	
BODY MATERIAL	PP
BODY COATING	OPTIONAL
IMPELLER MATERIAL	PP
DUTY CYCLE	IEC Duty Cycle-S1
WORKING AMBIENT TEMPERATURE	-20 - +50 °C
DIRECTIVE	IEC-60335-2-80, ISO 1940-1

MODEL	VOLTAGE (V)	FREQUENCY (Hz)	POWER (W)	REVOLUTION (rpm)	FLOW RATE (m³/h)	NOISE LEVEL (dB(A))	PRICE
S-BAF 100	230	50	14	2.800	97	35	
S-BAF 125	230	50	16	2.800	183	36	
S-BAF 150	230	50	16	2.800	290	38	

Values are for 0 Pa.

WITH BACKVALVE MODEL	VOLTAGE (V)	FREQUENCY (Hz)	POWER (W)	REVOLUTION (rpm)	FLOW RATE (m³/h)	NOISE LEVEL (dB(A))	PRICE
S-BAF 100	230	50	14	2.800	97	35	
S-BAF 125	230	50	16	2.800	183	36	
S-BAF 150	230	50	16	2.800	290	38	

Values are for 0 Pa.

## DRAWING

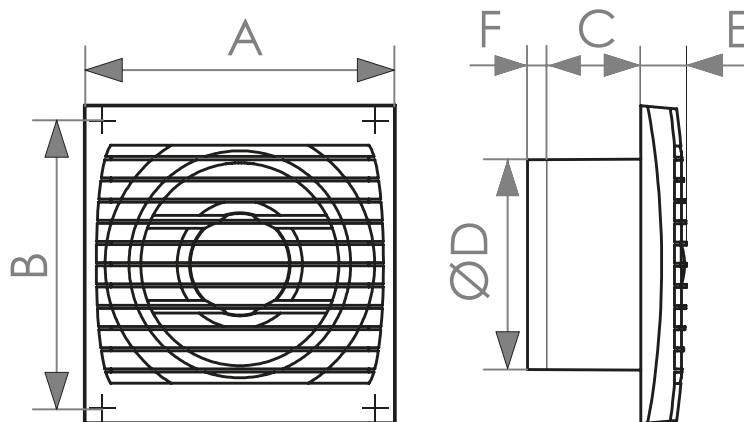

MODEL	A (mm)	B (mm)	C (mm)	D (mm)	E (mm)	F (mm)
S-BAF 100	150	135	55	100	22	7
S-BAF 125	175	160	61	125	23	8,5
S-BAF 150	200	185	62	150	24	10

# PERFORMANCE CURVES

## S-BAF 100

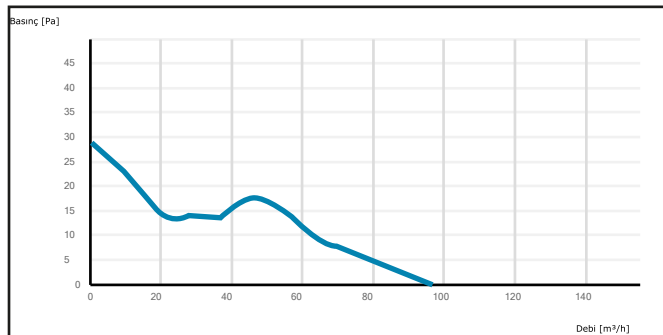

## S-BAF 125

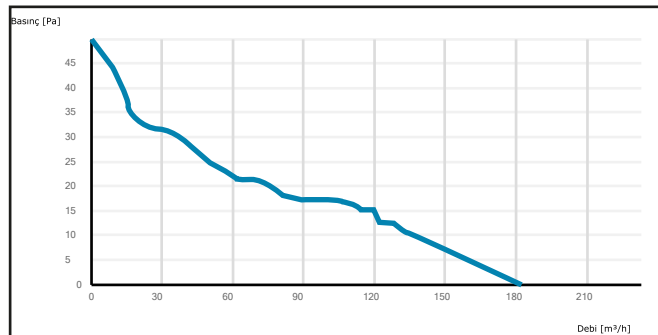

## S-BAF 150

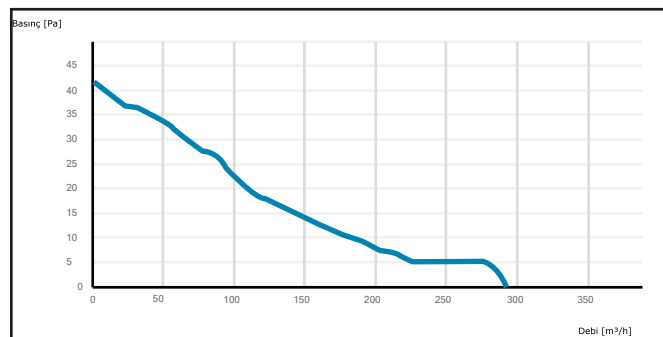



High quality ABS materials are used in the production of SEFs. They can be used in bathroom walls or windows. With a low-noise level they won't be disturbing the occupants.

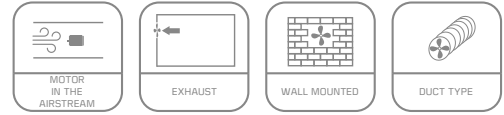

MOTOR INSULATION CLASS	F CLASS
MOTOR PROTECTION CLASS	IP 25
MOTOR EFFICIENCY CLASS	IE2
MOTOR ENCLOSURE TYPE	EXTERNAL ROTOR MOTOR
MOTOR BRAND	
BODY MATERIAL	ABS
BODY COATING	OPTIONAL
IMPELLER MATERIAL	ABS
DUTY CYCLE	IEC Duty Cycle-S1
WORKING AMBIENT TEMPERATURE	-20 - +50 °C
DIRECTIVE	IEC-60335-2-80, ISO 1940-1

MODEL	VOLTAGE (V)	FREQUENCY (Hz)	POWER (W)	REVOLUTION (rpm)	FLOW RATE (m³/h)	NOISE LEVEL (dB(A))	PRICE
S-SEF 100	230	50	8,4	2.800	90	25	
S-SEF 125	230	50	10	2.800	180	30	

Values are for 0 Pa.

WITH BACKVALVE MODEL	VOLTAGE (V)	FREQUENCY (Hz)	POWER (W)	REVOLUTION (rpm)	FLOW RATE (m³/h)	NOISE LEVEL (dB(A))	PRICE
S-SEF 100	230	50	8,4	2.800	90	25	
S-SEF 125	230	50	10	2.800	180	30	

Values are for 0 Pa.

### DRAWING

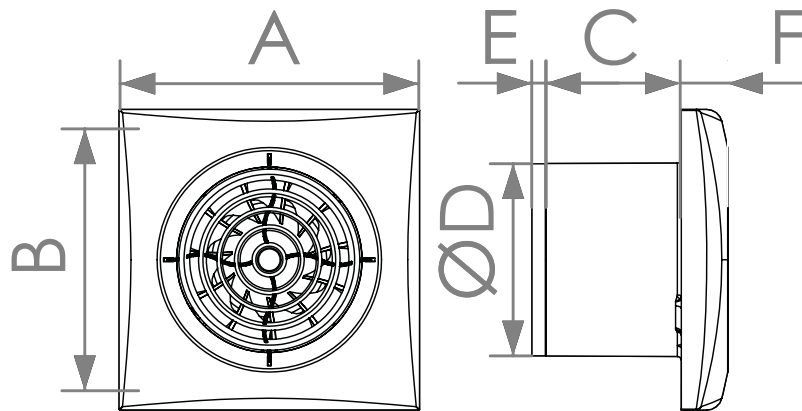

MODEL	A (mm)	B (mm)	C (mm)	D (mm)	E (mm)	F (mm)
S-SEF 100	155	135	70	100	7	24
S-SEF 125	175	155	78	125	8,5	24

# PERFORMANCE CURVES

S-SEF 100

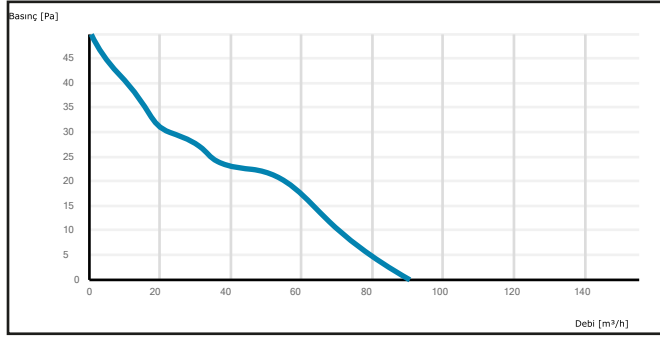

S-SEF 125

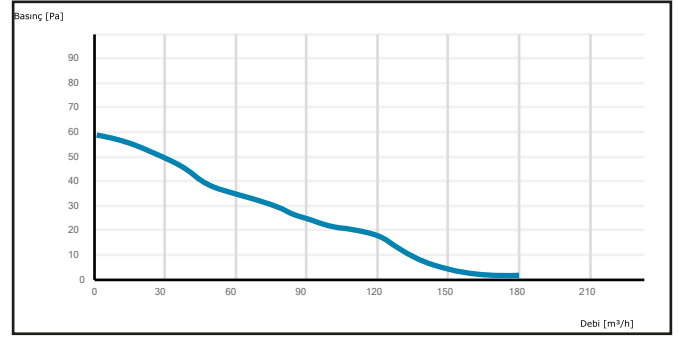



High quality PP materials are used in the production of BAFs. They can be used in bathroom walls or windows.

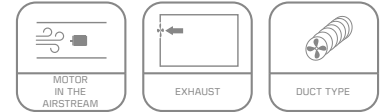

MOTOR INSULATION CLASS	F CLASS
MOTOR PROTECTION CLASS	IP 25
MOTOR EFFICIENCY CLASS	IE2
MOTOR ENCLOSURE TYPE	EXTERNAL ROTOR MOTOR
MOTOR BRAND	
BODY MATERIAL	PP
BODY COATING	OPTIONAL
IMPELLER MATERIAL	PP
DUTY CYCLE	IEC Duty Cycle-S1
WORKING AMBIENT TEMPERATURE	-20 - +50 °C
DIRECTIVE	IEC-60335-2-80, ISO 1940-1

MODEL	VOLTAGE (V)	FREQUENCY (Hz)	POWER (W)	REVOLUTION (rpm)	FLOW RATE (m³/h)	NOISE LEVEL (dB(A))	PRICE
S-YUF 100	230	50	14	2.800	107	35	
S-YUF 125	230	50	18	2.800	190	36	
S-YUF 150	230	50	22	2.800	300	38	
S-YUF 160	230	50	22	2.800	300	38	

Values are for 0 Pa.

### DRAWING

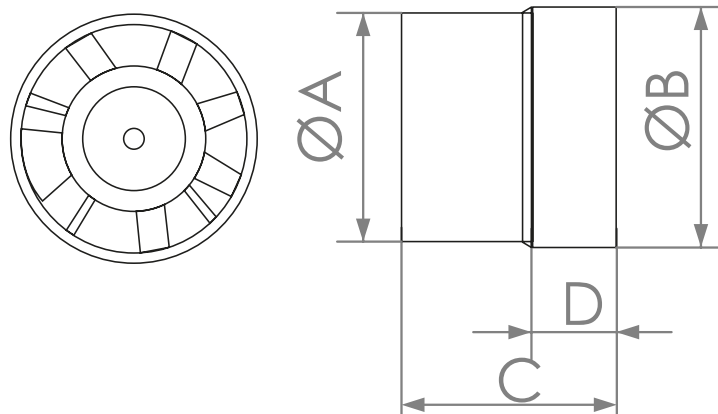

MODEL	A (mm)	B (mm)	C (mm)	D (mm)
S-YUF 100	100	103	80	30
S-YUF 125	125	128	87	30
S-YUF 150	150	153	101	35
S-YUF 160	160	163	101	35

# PERFORMANCE CURVES

## S-YUF 100

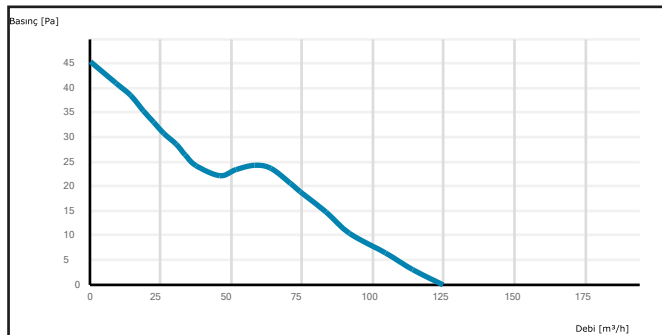

## S-YUF 125

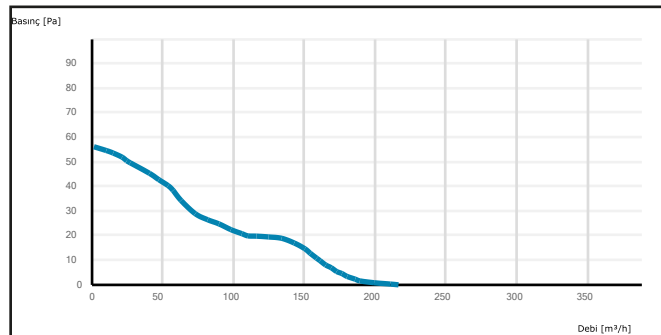

## S-YUF 150

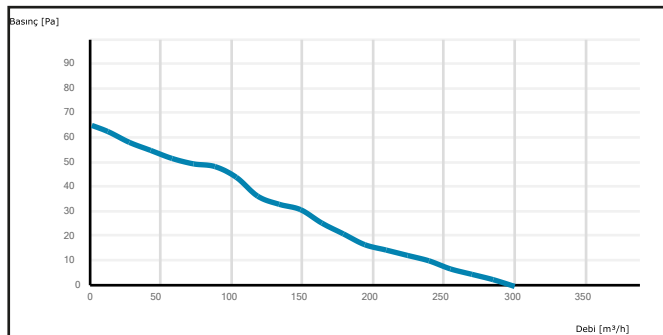

## S-YUF 160

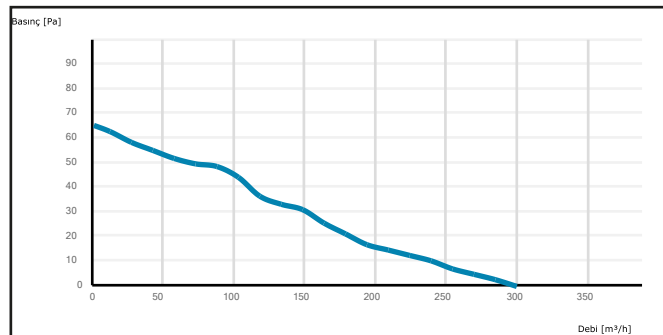



## Flange



Produced from galvanized sheet metal or AISI 304 flanges can be used to connect ducts together. Sold in four meters, they can be purchased as 100 meters rolls or 1000 meters pallets.

WIDTH (mm)	THICKNESS (mm)	PRICE
20	0,6	
25	0,6	
30	0,7	
AISI 304 25	0,6	

FLANGE THICKNESSES MAY VARY  $\pm 0,05$  mm

## Corner



Produced from galvanized sheet metal or AISI 304 corners can be used to connect ducts together. Sold as boxes they can be purchased as 72 boxes pallets.



WIDTH (mm)	THICKNESS (mm)	PCS/BOX	PRICE
20	2,0	500	
25	2,0	400	
25	2,5	400	
30	2,5	250	
AISI 304 25	2,5	400	

## G-Clamps



Produced from galvanized sheet metal or AISI 304 clamps can be used to connect ducts together. Sold as boxes they can be purchased as 72 boxes pallets.



THICKNESS (mm)	PCS/BOX	PRICE
2	500	

**Round Damper With Lever**

DIAMETER (mm)	FLOW RATE (m <sup>3</sup> /h)	LENGTH (mm)	PRICE
100	250	170	
125	350	170	
150	450	170	
200	800	170	
250	1200	170	
315	1800	170	
355	2200	355	
400	2900	400	

Ask for the prices of the bigger sizes.

**Round Duct G4**

SIZE (mm)	PRICE
100	
125	
150	
200	
250	
315	

**Back Draft Damper**

DIAMETER (mm)	PRICE
100	
125	
150	
200	
250	
315	

**Diffuser**

DIAMETER (mm)	FLOW RATE (m <sup>3</sup> /h)
100	120
125	175
150	250
200	350



