

Magnetic Field Secrets

by Tim Harwood M.A.plus - specialist ancient technology historian



This article is a brief summary of the most important discoveries I made over 15 years of research into magnetic esoterica. My approach to this subject matter is unique - instead of doing pure research, I took the view secret societies and governments already had exotic magnetic technologies, and suppressed them for their own purposes. I further assumed using comparative historical analysis it would be possible to decipher some of these secret technologies. This assumption proved to be correct.

Contents

[1 Magnetic motor](#)

[2 Solid state](#)

[3 Negentropy poles](#)

[4 Triangular fields](#)

[5 Spacecraft](#)

[6 Gravitic harmonics](#)

[7 Stargates](#)

[8 Negentropy](#)

[9 Harmonic coils](#)

[10 Field effect](#)

[11 Negentropy Generator](#)

Kindling, Life, Mind and Neg-entropy

[12 Final words](#)

[13 Quote](#)

[14 In the News](#)

[15 Source articles](#)

Magnetic motor

My journey started with the Adams motor, where I derived a theory of operation as follows:

Basic Design Theory Behind CD Motor

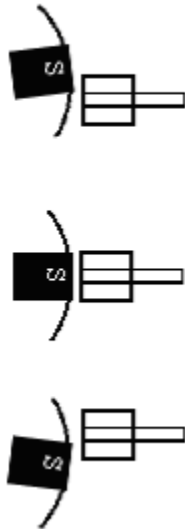

- 1) Mechanical 'yaw to register,' based upon attraction of permanent magnets rotor pieces, to iron stator cores
- 2) Generator wind on stator cores, means the field of the permanent magnet supplies potential to the motor circuitry lowering circuit impedance, so less electrical energy is required to demagnetize cores, than the sum of the kinetic energy gained on approach
- 3) Rotor magnets now free wheel away from demagnetized stator core. With enough voltage, repulsion is possible

The fact of experiment showed the Adams motor manifested repeatable "cold current" with high energy output from large back emf spikes. See [OS:CD Motor](#).

Solid state

POD Demagnetization Core - January 2002

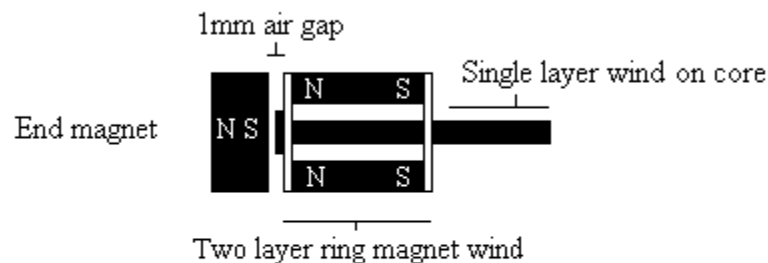

Wind one layer on nail core, two on outside of ring magnet stack
Connect in series for about 7 ohms total resistance per core
Pulse coils, demagnetize core, and rectify back emf to capacitor
2.2 kHz @ 20 % duty, small dc fan motor for a suitable load type

The POD core was developed by John Jankowski (Power On Demand). It did what it set out to do - captured the exotic Adams motor in register event in a solid state setup so that it could be better studied. **Some optimal frequencies derived by experiment were as follows 2.2 KHz at 20% duty for throughput, 4 KHz at 5% duty or 2.2 KHz at 2% duty for high gain. Magnetite is the optimal material for the core - the iron content being absolutely necessary to manifest the effect.** Voltage harmonics are a simple 120v arithmetic series

i.e. 120, 240, 360, etc. If using a MOSFET to pulse a good quality driver with a square rise is important, the IRF 740 (400v) is an excellent choice for the pulse input itself. A Schottky diode (>600v) for fast response is an excellent choice to recover the back EMF spike. A crisp input pulse is vital to manifesting the effect. This pulse methodology is the "trade secret" of free energy physics, and is the real reason fast rise high power high voltage switches are still subject to heavy classification.

Simplified POD Magnetic Schematic

(The Adams motor magnetic moment in solid state)

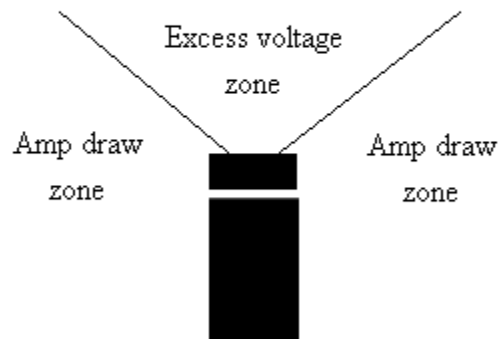

The POD core enabled a fairly simple schematic to be drawn up for the magnetic field during the in register events, simply by moving a toy motor around the pm face and observing the results.

Negentropy poles

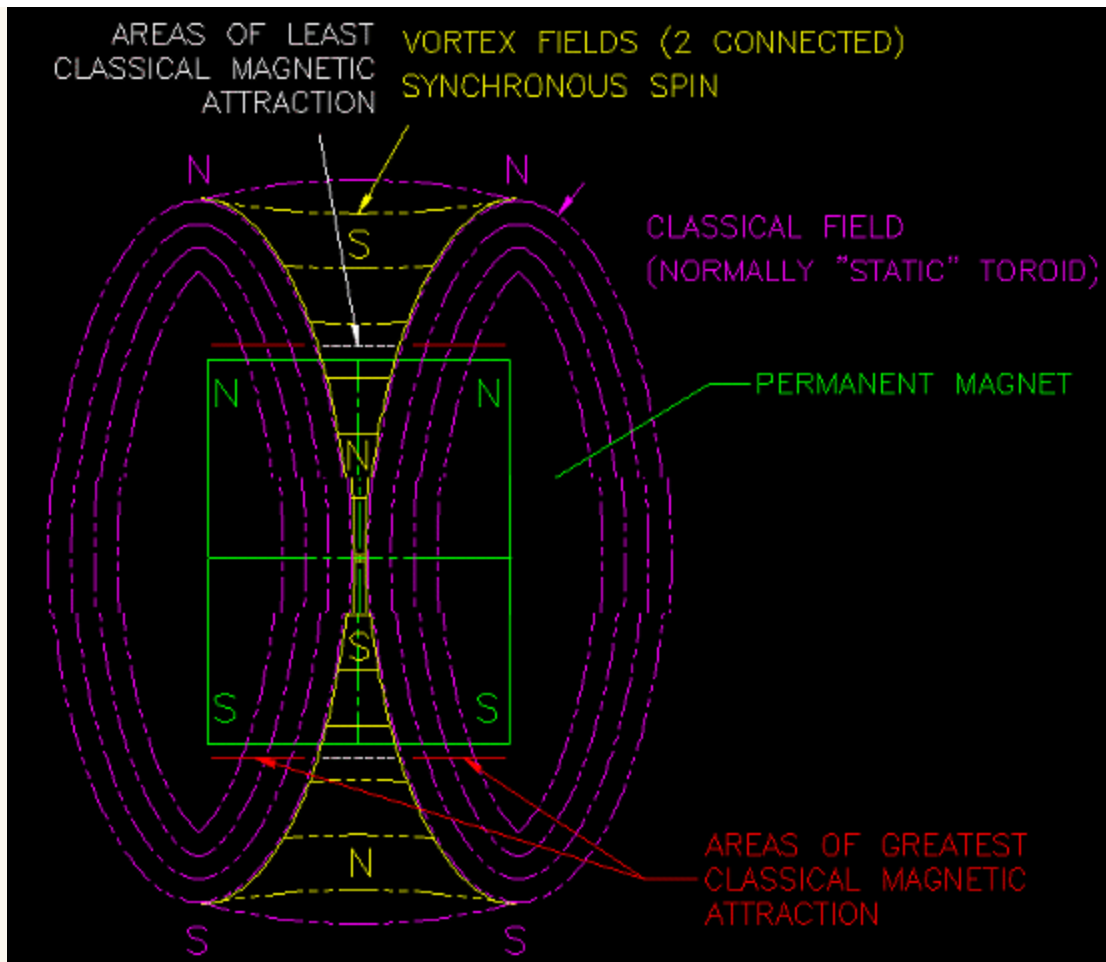

With a little bit of deduction, an unconventional understanding of magnetism was derived. Negentropy poles are the mechanism by which magnetic fields restore depleted strength. Because they do this very effectively, they flare up only for very brief time periods. Further observations:

- The effect is manifested at the moment of switch closure and thereafter rapidly decays
- The in register flux anomaly couples with the supplied stator input current
- The electrons once coupled hold this state i.e. can be stored in a capacitor
- Two time polarities being simultaneously present doubles the rate of change of magnetic flux halving current draw
- Circuits based upon this form of energy work backwards to normal circuits

Ampère's Circuital law

the original equation in differential form is

$$\vec{\nabla} \times \vec{H} = \vec{J}$$

\vec{H} is the [magnetic field](#) in [amperes](#) per metre.

\vec{J} is the [current density](#) (in amperes per square meter) through the surface

Adapted for Coupled Current

\vec{H} becomes $2 \vec{H}$ due to doubled magnetic field

$$\vec{\nabla} \times \vec{H} = \frac{\vec{J}}{2} \quad \text{If calculating energy from H then J is halved}$$

Coupled current explains why you can have a system that manifests exotic results, but can not do a closed loop battery charge test unless optimized to an advanced level. On the voltage gain effect:

- To achieve a stable coupled state excess negative flux must be bled
- It is this loss of excess coupling that causes the voltage gain
- The voltage gain is a direct conversion of ambient heat

Further optimization is possible via a "Tesla Transformer." In this case you have a low ohm primary, and a high ohm (7 Ohm?) or iron based secondary, that will specifically attract the negative energy component. Thus fractional distillation of coupled current occurs, and a capacitor can be step charged with "wattless" energy. This is the gaseous non electron form of electrical energy Tesla spoke about.

The easiest way to get a conventional amp rich energy output from such exotic systems is to drive a motor via a capacitor float from the voltage gain output, the motor drives a conventional dynamo. You get the benefit of the current draw reduction effect, and a conventional current output that will feed into standard appliances without modification. A mechanical transducer system that converts exotic electrical energy to conventional.

Triangular fields



Tesla's Triangular Fields

One of several
lost technologies

Space drive
and shielding

Tesla was very much interested in triangular magnetic fields - this has been overlooked by most researchers - yet was Tesla's greatest secret.

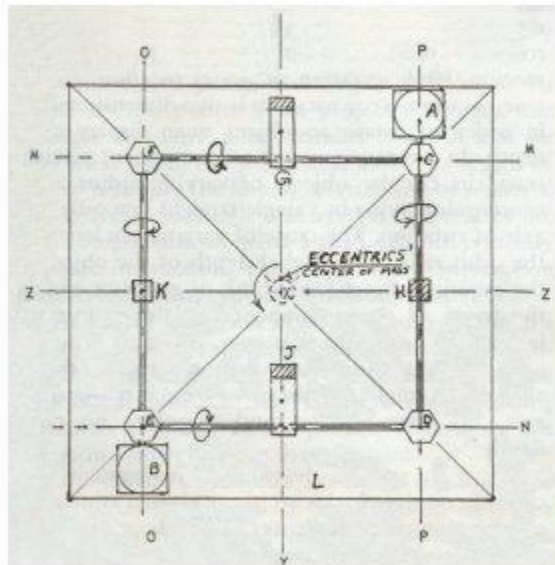

Tesla, Man of Mystery

4. The Tesla Space Drive

Key: "Eccentrics" are mercury vortexes
4x outside, 1x central, set counter rotating
Same design as Vedic / Atlantean craft

Key:

A and B are motors (should be identical)
C, D, E and F are right-angle drives 1:1 ratio
G, H, J, and K are eccentrics
L is the base plate to which the motors, gear boxes,
and pillow blocks (not shown) are fastened
M, N, O, and P are the axes of rotation of eccentrics
G, H, J, and K
Y and Z are the planes of rotation of the eccentrics
X is the line of intersection of planes Y and Z

One of the schematics of his flying device gives a triangle setup. The "eccentric" in the middle counter rotates to the 4 at the corners.

Figure 7: US Patent 609,251

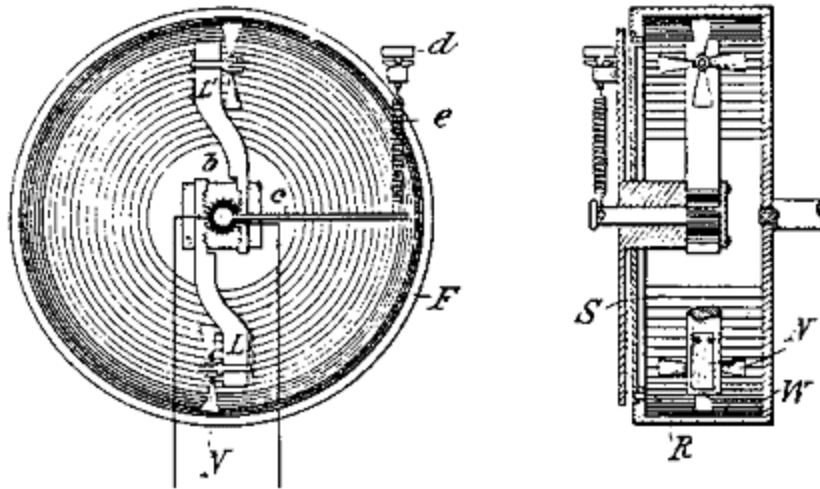

By reviewing Tesla's switching patents, I proved Tesla was working with rotating charged mercury - the rotational device in his UFO craft and the key to his shielding technology. Tesla's otherwise mysterious quote now makes perfect sense:

The flying machine of the future—my flying machine will be heavier than air, but it will not be an aeroplane. It will have no wings. It will be substantial, solid, stable. You cannot have a stable airplane. The gyroscope can never be successfully applied to the airplane, for it would give a stability that would result in the machine being torn to pieces by the wind, just as the unprotected aeroplane on the ground is torn to pieces by a high wind. My flying machine will have neither wings nor propellers. You might see it on the ground and you would never guess that it was a flying machine. Yet it will be able to move at will through the air in any direction with perfect safety, higher speeds than have yet been reached, regardless of weather and oblivious of holes in the air or downward currents. It will ascend in such currents if desired. It can remain absolutely stationary in the air, even in a wind, for great length of time. Its lifting power will not depend upon any such delicate devices as the bird has to employ, but upon positive mechanical action. You will get stability through gyroscopes? I asked. Through gyroscopic action of my engine, assisted by some devices I am not yet prepared to talk about, he replied. TESLA'S NEW MONARCH OF MACHINES, by Nikola Tesla, New York Herald, Oct. 15, 1911

Spacecraft



Bill's mercury vortex diagram

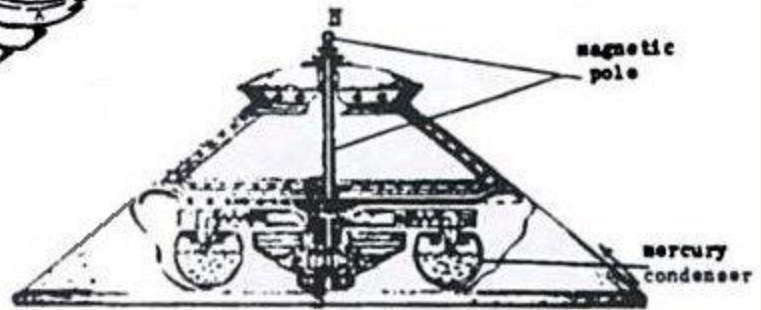

Bill's mercury powered flying saucer-vimana

This hypothesis was confirmed by ancient texts cited by William Clendenon in his book *Mercury, UFO Messenger of the Gods*, reporting a 3x1 charged mercury capacitor array used to power ancient spacecraft. Bernoulli's principle, states an increase in the velocity of a fluid will decrease pressure. By spinning charge, we reduce local aether pressure.

Archimedes' principle states that a body immersed in a fluid is buoyed up by a force equal to the weight of the displaced fluid. This explains why lowering the rotation speeds at the front of the craft increases velocity - the crafted is "buoyed" forward by the higher aether displacement occurring at the rear of the craft.

The central capacitor is can be set either slightly higher or lower. If lower, when the outer 3 capacitors have a lower rotational / voltage net energy the craft rises, when they have a higher energy, the ship descends. Powering down an outer capacitor makes the craft move in that direction.

Bernoulli's principle was published in 1738, Archimedes' principle 212 BC - so we can see by 1738 there was sufficient physics published to understand design and construction of anti-gravity craft.

"VRIL-ODIN"

Vereinfachte Planskizze (Querschnitt) eines Elektrogravitationsraumschiffes nach dem Dynamoprinzip

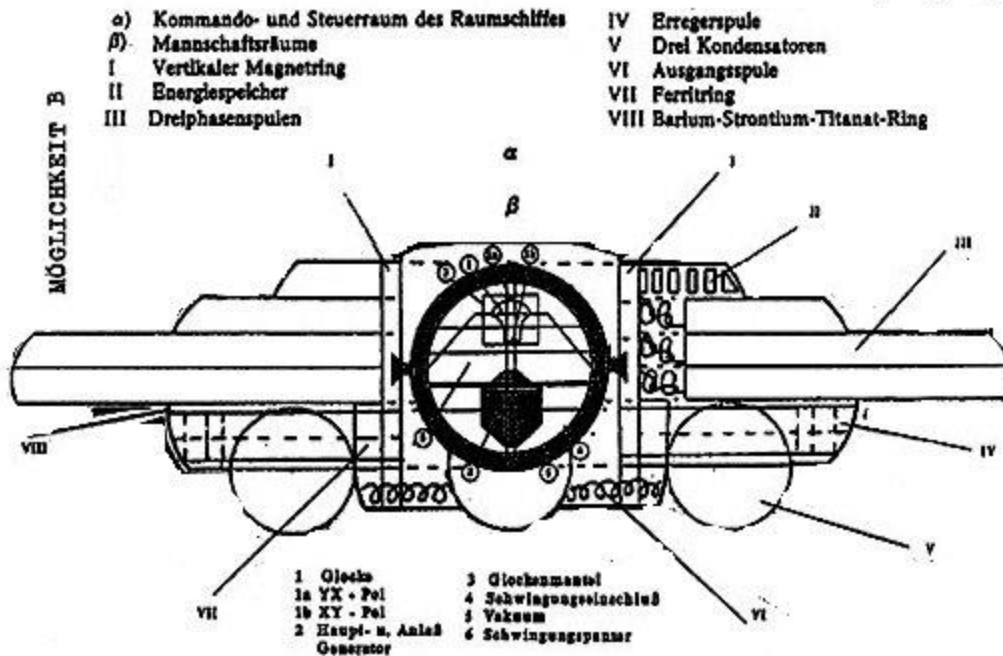

The Virl secret society added an extra 35m Barium-strontium-titanate ring around their re-creation of these ancient craft in 1946, and in this way reportedly made a 65 light year hyperspace journey to Aldebaran. Based upon Tesla's technology and other clues, I was able to derive the equation that unifies gravity with electromagnetism as follows:

$$\text{Gravity} = \text{rpm (thousands)} \times \text{voltage} \times \text{current}$$

OR

$$\text{Gravity} = r/\text{min} \times V \times I$$

OR

$$\text{Gravity} = \text{kHz} \times P$$

The keys to practical gravity engineering can be summarised as follows:

- Simple gravity craft and shielding devices are most commonly built via a 3x1 or 4x1 spinning capacitor array based upon a triangle shaped magnetic field
- Liquid mercury or other appropriate ferrofluid and or plasma are needed to achieve sufficient charge density in the capacitors

Gravitic craft can be made in various shapes, triangular is one of the preferred forms. I have developed [OS:Triangle plane](#) which reduces the number of spin points from 4 (3x1) to just 1. The airframe also flies in its own right, making the project cheaper, simpler, and safer, than a pure gravitic craft.

Gravitic harmonics

The geometry of triangular gravito-magnetic fields is straightforward. A 6.95m arithmetic progression, combined with a 3.5 scaler for the field diameter. The fifth harmonic (35m) seems to be necessary to open a hyperspace window on a fluid (non plasma) rig.

	Gravitic Harmonic Diameter (m)	3x1 array (m) (Diameter * 3.5)
1	6.95	24.325
2	13.90	48.65
3	20.85	72.975
4	27.8	97.3
5	34.75	121.625
6	41.70	145.95
7	48.65	170.275
8	55.6	194.6
9	62.55	218.925
10	69.50	243.25

Stargates

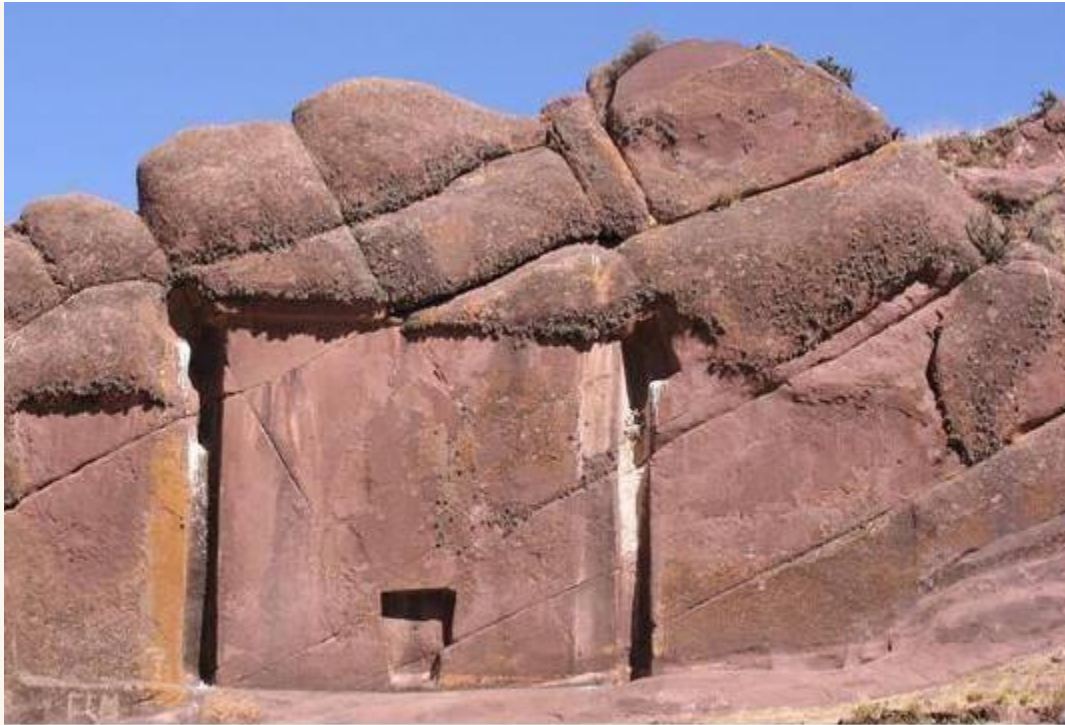

**In 1996 Jose Mamani discovered the "Gate to the Gods"
in the Hayu Marca mountains of Southern Peru**

Still little known is that the location of an ancient Stargate was discovered in Peru in 1996. Likely removed in the 1950s by agents of the shadow government. The key point and the reason I include it in this article is that the diameter of the main doorway is 7m - the control device and presumably power supply was adjacent - all removed. This device is therefore further confirmation that 7m is the base gravitic harmonic for technological engineering. The pure physics of gravitic engineering can be deduced from ancient archeology - among other sources.

Legend goes that when the Spanish conquistadors came and looted gold and precious stones, a priest, Aramu Maru, fled with the key to the door and hid in the mountains. He found the gate which was being protected by shaman priests. He showed them the key, a sacred golden disk. They performed a ritual, putting the key into the doorway inset, and a blue light appeared, which looked like water suspended. The priest handed them the key and then turned and walked through the water and into the portal. He was never seen again.

Negentropy

CD Motor - Template for Negentropy

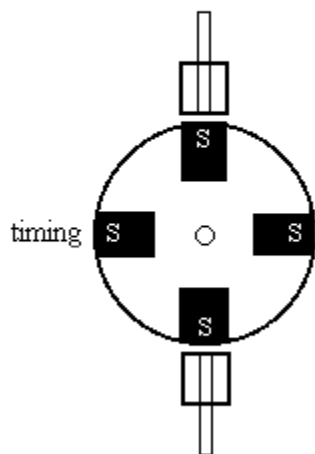

Grade 8 ceramic / ferrite magnets are fine
Rotor magnet faces should be 3/4" diameter
Magnets spaced for 20% pulse duty cycle
Series stators should be 6.8-7 ohms
24 awg wire is suggested
Diode based path for back-emf to supply
Timing adjusts at 3,600 rpm
12v input basic, then 18, 27, 36...120, 240, 360, etc
4,000 rpm + for negative friction rotor acceleration
Preferably apparatus is enclosed
Stator cores magnetite - high iron content is important

My Adams motor research taught me about a runaway negative friction effect that occurs when timing is adjusted at 3,600 rpm. Tapping this effect is the key to electromagnetic perpetual motion, and it is common to several exotic magnetic technologies. Different devices tap the effect in different ways.

Harmonic coils

A further reading of Tesla's patents disclosed a thermoelectric conversion process, based upon pulsed coils.

Figure 3: US Patent 568,177

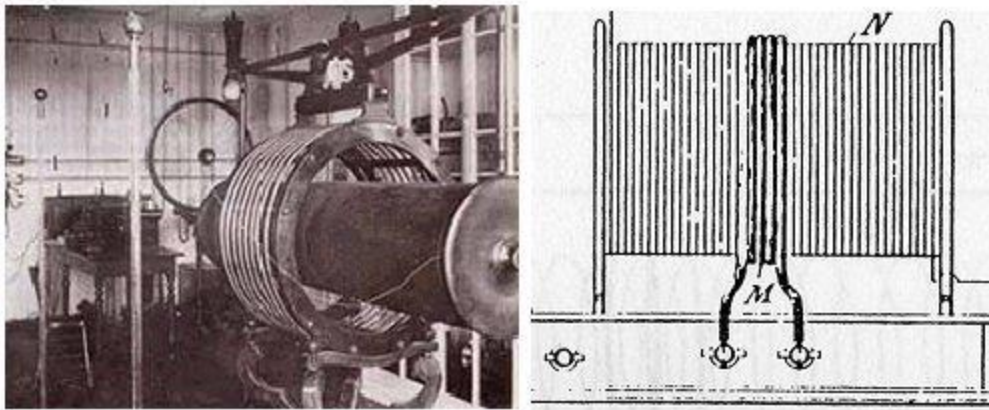

In [U.S. Patent 568,178](#) ([G.patent](#); [PDF](#)) Tesla revealed air cores are better suited to manifesting the negentropy voltage gain effect than iron cores. The aether becomes the core, but due to its very fine properties, higher frequencies must be used, as the remnant magnetism of the previous pulse decays must faster than in an iron based core. Specifically, we are given important advice on optimisation procedures, not stated in any other patents, either preceding or following. **This guidance on pulse configuration is effectively Tesla's free energy secret, and it has been hidden in plain sight all along.**

It is a well known fact that every circuit provided its ohmic resistance does not exceed certain definite limits, has a period of vibration of its own analogous to the period of vibration of a weighted spring. In order to alternately charge a given circuit of this character by periodic impulses impressed upon it and to discharge it most effectively, the frequency of the impressed impulses should bear a definite relation to the frequency of the vibrations possessed by the circuit itself. Moreover, for like reasons the period of vibration of the discharge-circuit should bear a similar relation to the impressed impulses or the charging-circuit. When the conditions are such that the general law of harmonic vibrations is followed, the circuits are said to be in resonance or in electromagnetic synchronism, and this condition I have found in my system to be highly advantageous. Hence in practice I adjust the electrical constants of the circuits so that in normal operation this condition of resonance is approximately obtained. To accomplish this, the number of impulses of current directed into the charging-circuit per unit of time is made equal to the period of the charging of the charging circuit itself, or generally, to a harmonic thereof, and the same relations are maintained between the charging and discharge circuit. Any departure from this condition will result in a decreased output, and this fact I take advantage of in regulating such output by varying the frequencies of the impulses or vibrations in several circuits. Inasmuch as the period of any given circuit depends upon the relations of its resistance, self induction, and capacity, a variation of any one or more of these may result in a variation in its period.

Field effect

I further learned about the field effect of the aether by reading forgotten ionic thrust patents from the 1960s, where I learned the 40Kv air breakdown limit could be passed like the sound barrier and other so called limits of technology, by a short duty pulse that did not allow enough time for arc over to occur across the cell. The larger the cell, the higher the voltage and duties that are workable. As the voltage is ramped past 40Kv, a field

effect manifests and strengthens, that enables vacuum operation. The device should be pulsed at 2.2 KHz. See [OS:Beer glass thruster](#) for the scaled down experiment see [Article:Development of Ionic Electrical Thrust Technology](#) for the theory.

Schematic For An Electric Jet Engine Thruster

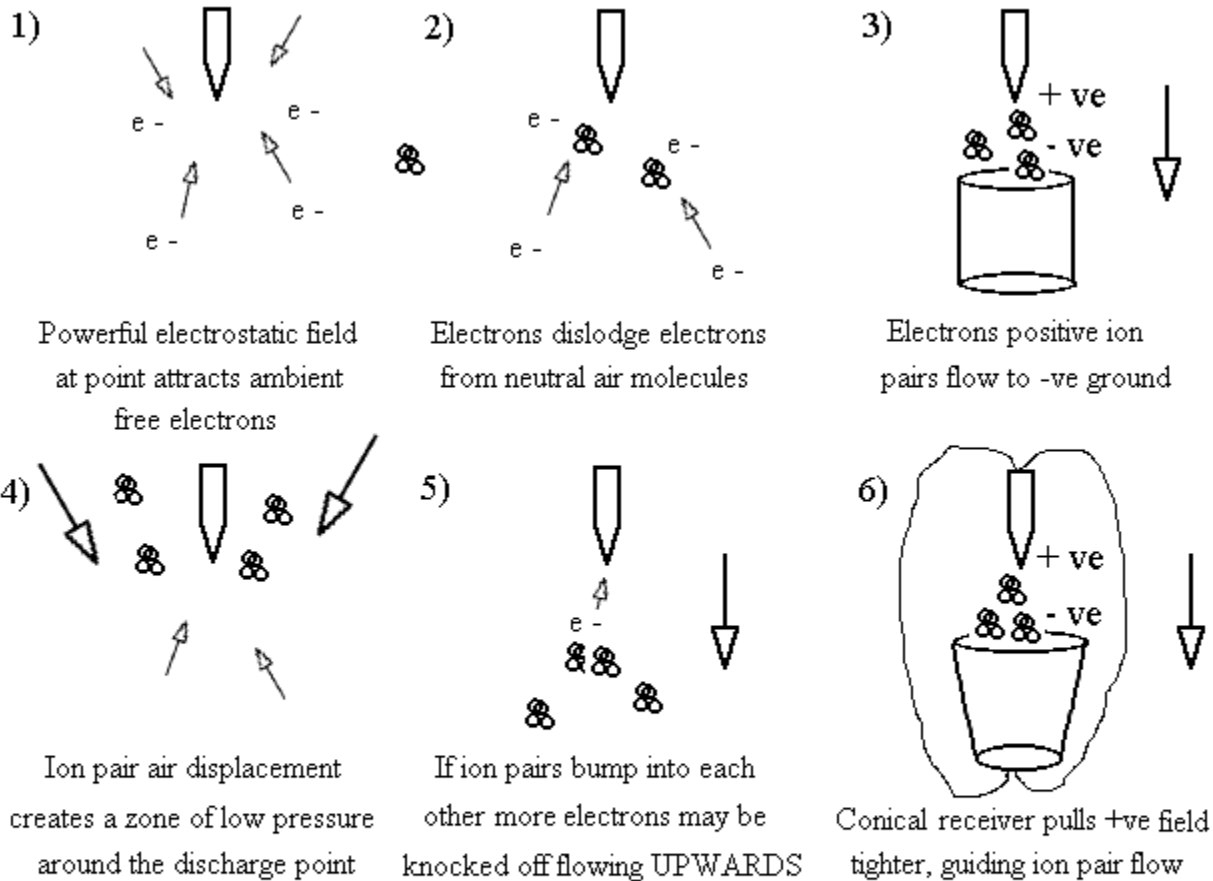

Ionic cells optimised via fluid dynamics - teardrop emitter to conical receiver

40Kv barrier is broken by pulsing circuit for less time than it takes for arc over to occur

Pulsed at 2-10 KHz, 1-10% duty >150Kv - larger cells work better due to longer duty times

Capable of operating at orbital altitudes due to field effect that strengthens with voltage

An electrical jet engine without moving parts - cheaper to build - more reliable to operate

Negentropy Generator



The Pulsed Plasma Negentropy Toroid Gravitic Thermoelectric Generator is the culmination of 15 years research.

It combines 4 exotic concepts seamlessly into one device.

- 1) The 7m diameter gravitational toroid as the base device (above)
- 2) A partial pulse before arc over concept borrowed from my ionic cell research
- 3) Pulsed windings per Tesla's thermoelectric coil research for the negentropy effect
- 4) A variation on the 3,600 rpm limit timing adjustment of the Adams motor

The above picture is apparently from a NASA on-line archive. From the hair styling, I think its clear evidence the American government built such a device in the 1950s. Again, the 7m diameter keeps recurring in my gravitational research.

Negentropy Generator

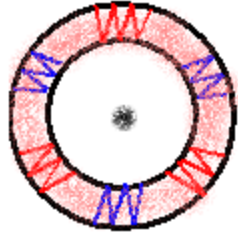

Red sequentially pulsed input windings, blue output windings
Input windings pulsed for short periods to prevent magnetic arc over
If whole toroid becomes magnetized then motion is not possible
Each magnetized section pulled along by next pulsed winding
Input windings pulsed as a tuned coil - back emf routed to capacitor
Device goes superfluid (negative friction) depending voltage / rpm

This device could only be built with governmental support, but seems likely the ultimate energy generation device in terms of a cost, complexity, output trade off.

- Device designed to tap a superfluid charged negative friction effect
- At operating speed device will exponentially self accelerate
- Loading for output is the brake on rotational speed
- Direct and lossless conversion of ambient heat to electricity

Toroid and windings

- Compressed mercury plasma filled
- 3 input windings 120 degrees spaced
- So long as only PART of the plasma is magnetised it can be attracted to the next sequentially pulsed coil along
- The current can NEVER be on long enough for the whole toroid to become magnetised
- If you "arc over" and magnetise the whole fluid there is no scope for acceleration
- The device could be scaled per the gravitic harmonic diameter table shown above i.e. 20.85m diameter

It would need experimental feedback to get right, but the basic concept will be something along the lines as given.

Kindling, Life, Mind and Neg-entropy

The mass of the atomic nucleus can be charged up with a particular dynamically structured biopotential.

In scalar electromagnetics, I use the term **kindling** to refer to the effect of charging up mass by a specific structured charge pattern to form such a structured potential in the nuclei.

Note that we are actually and physically restructuring the nucleus itself. That is because, if the structure of the potential in the nucleus is changed, local spacetime of the nucleus is polarized in complex electromagnetic structures. The electromagnetic currents, actions, and charges of the affected nucleus adjust automatically to this structure or "grid." *

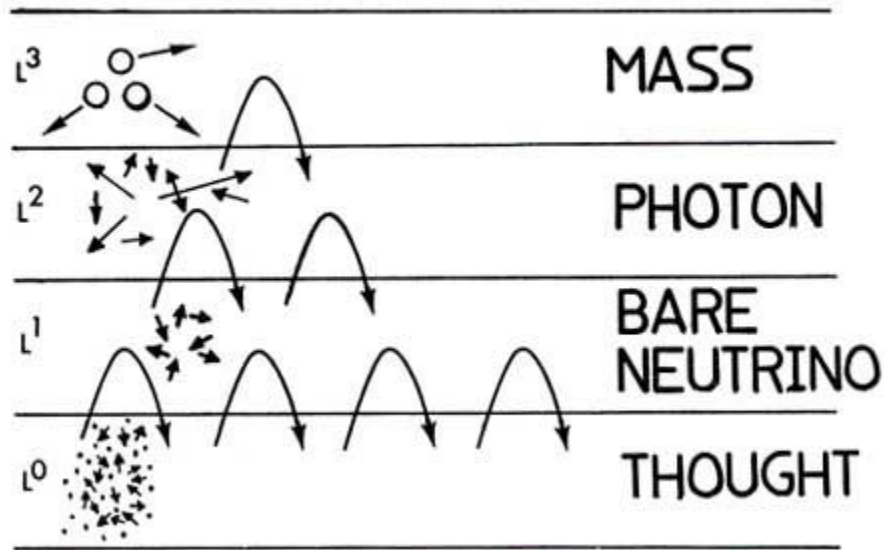
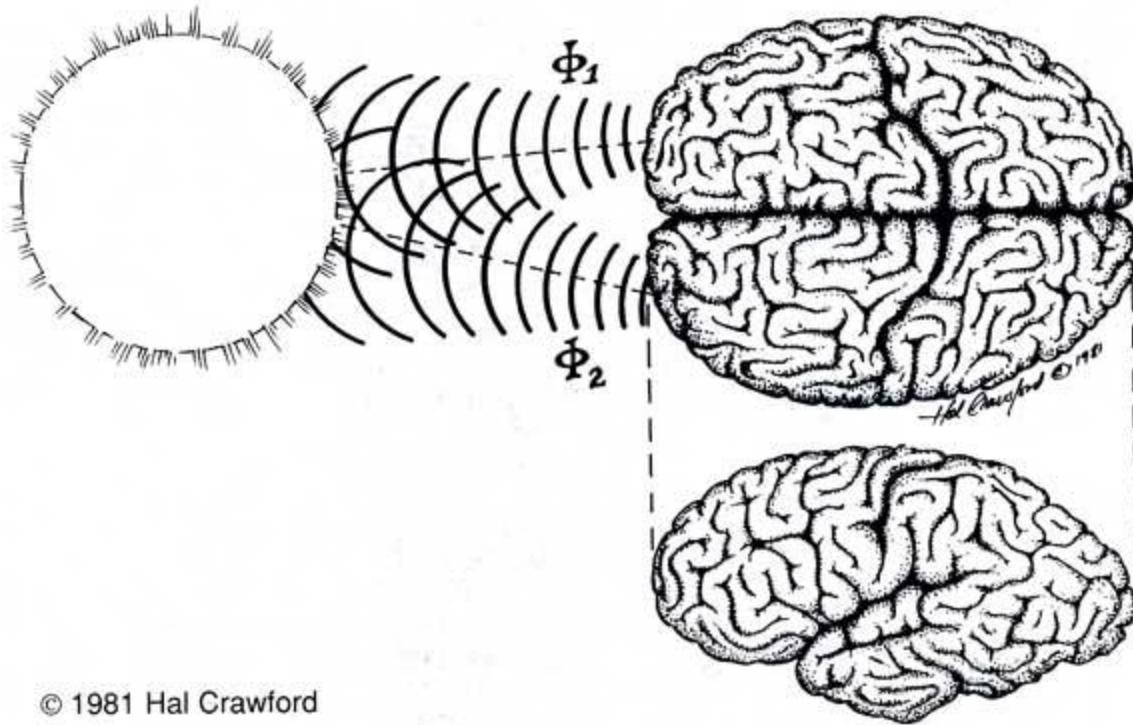

Figure 77. Interested levels of virtual state vacuum contain mind and thought. The vacuum also contains their interaction toward and upon mass.

*See Richard E. Prange and Peter Strance. "The semiconducting vacuum," Am. J. Phy. 52(1), Jan 1984 p. 19-21. The vacuum may be regarded as a semiconductor. This semiconductor, particularly in the region close to the nucleus, may be manipulated by subjecting it to external fields, doping, etc Extra energy density can even be extracted; see H. Paul and R Fischer, "Comment on 'How can a particle absorb more than the light incident on it?' " Am. J. Phy. 51(4), Apr 1983, p 327 For the involvement of negative time/negative energy, see C W Rietdijk, "How do 'virtual' photons and mesons transmit forces between charged particles and nucleons?" **Found. Phy.** 7(5-6), June 1977, p 351-374.



© 1981 Hal Crawford

Figure 78. The human cerebral cortex is a natural scalar interferometer. It is a virtual state tuner, processor, and transmitter-receiver. It also can produce ... and control to some extent ... phase conjugate energy and phase conjugate waves.

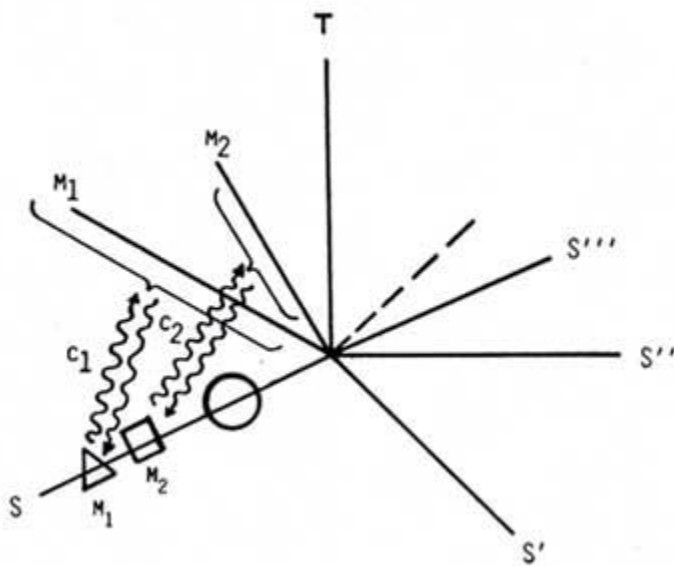

Figure 79. Consciousness and life. These phenomena refer to/constitute a deterministic hyperspatial (virtual state) coupling between mass and an ordered

Figure 81. Layers of unconsciousness intersect hyperspatially.



Figure 82. Scalar electromagnetics can directly interact with the various levels of human mind and personality.

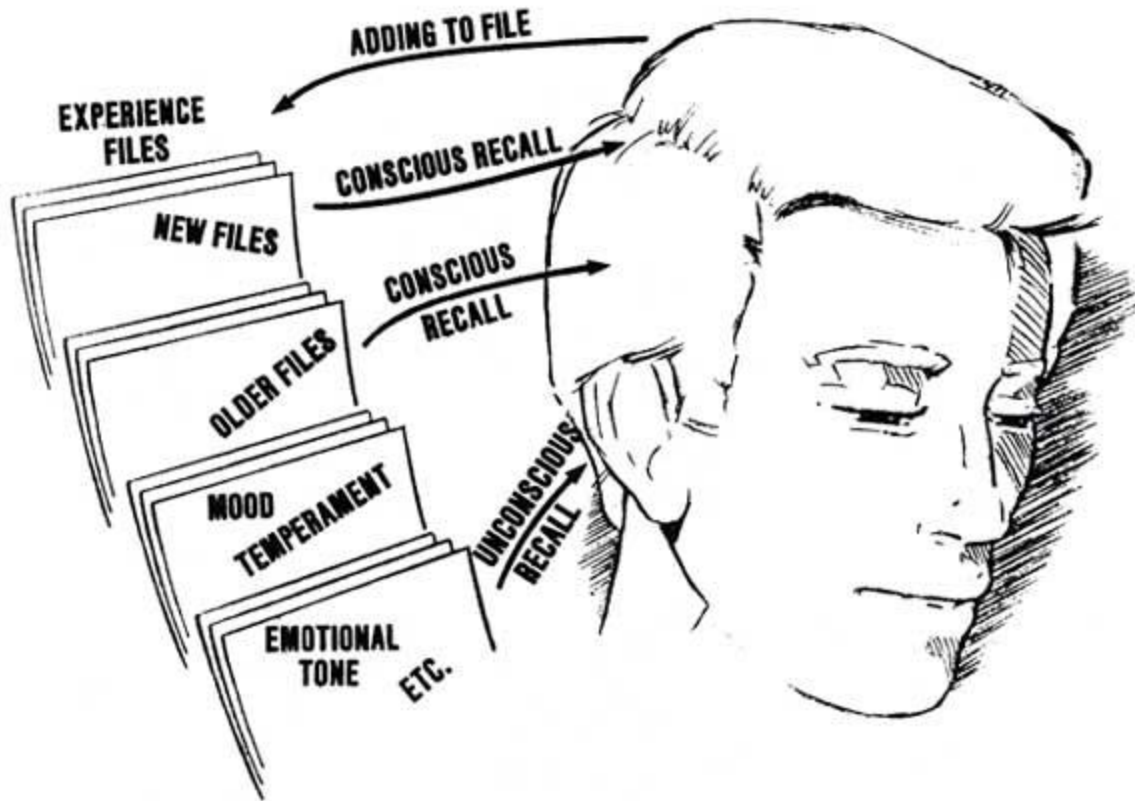

Figure 83. What personality is.

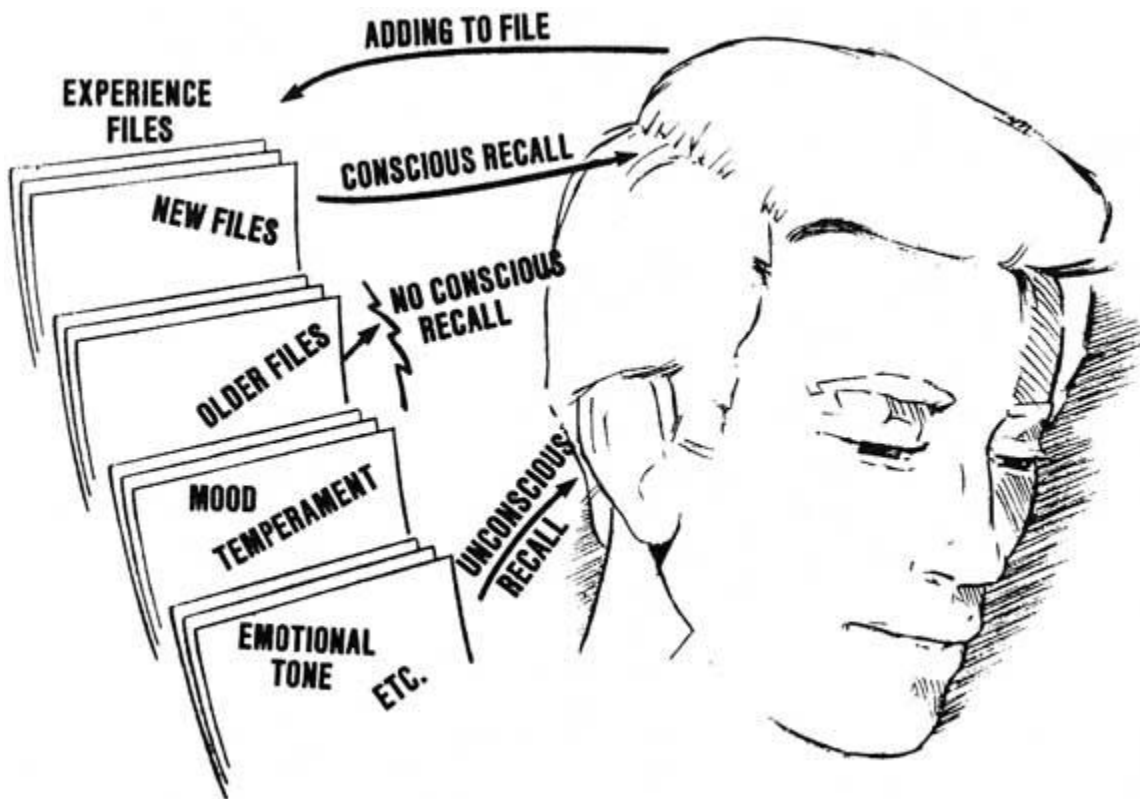

Figure 84. Jamming the "older files recall" process produces simple amnesia. If the recall process is then restored, the person regains his or her former memories.

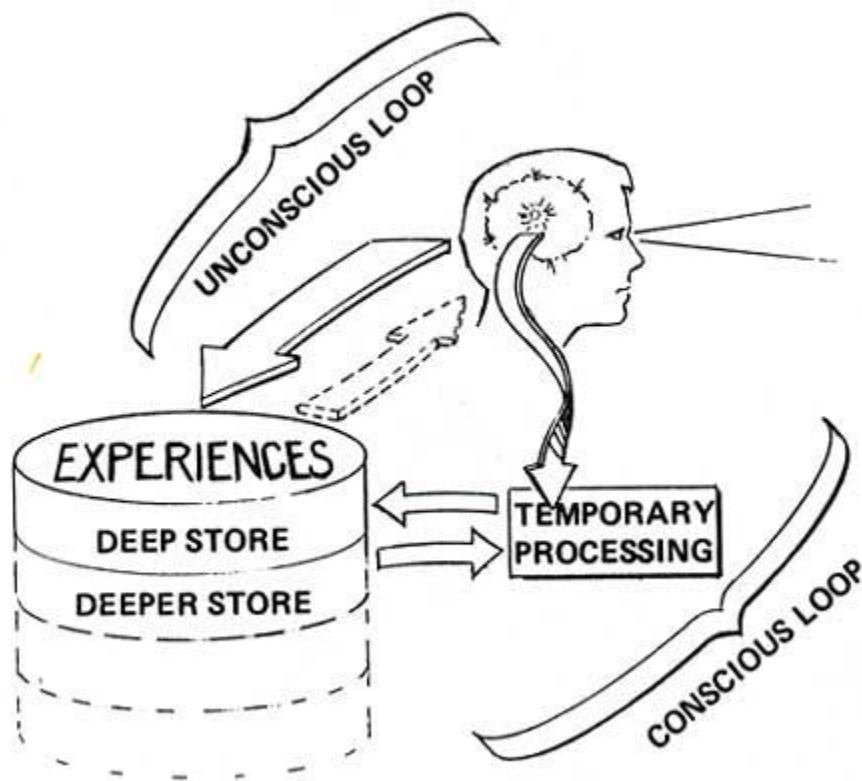

Figure 85. To sustain one's personality, continual functioning is required. All channels must be functioning.

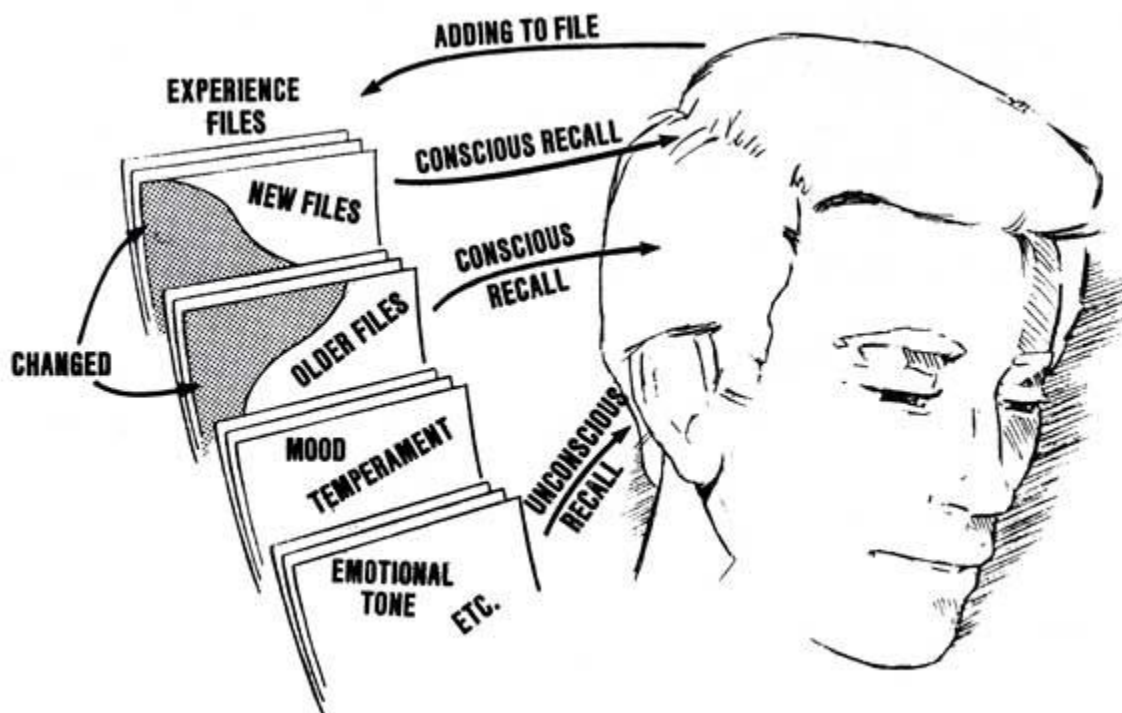

Figure 86. If the files themselves are changed, the personality itself is changed. It is possible to alter who or what a living person is.

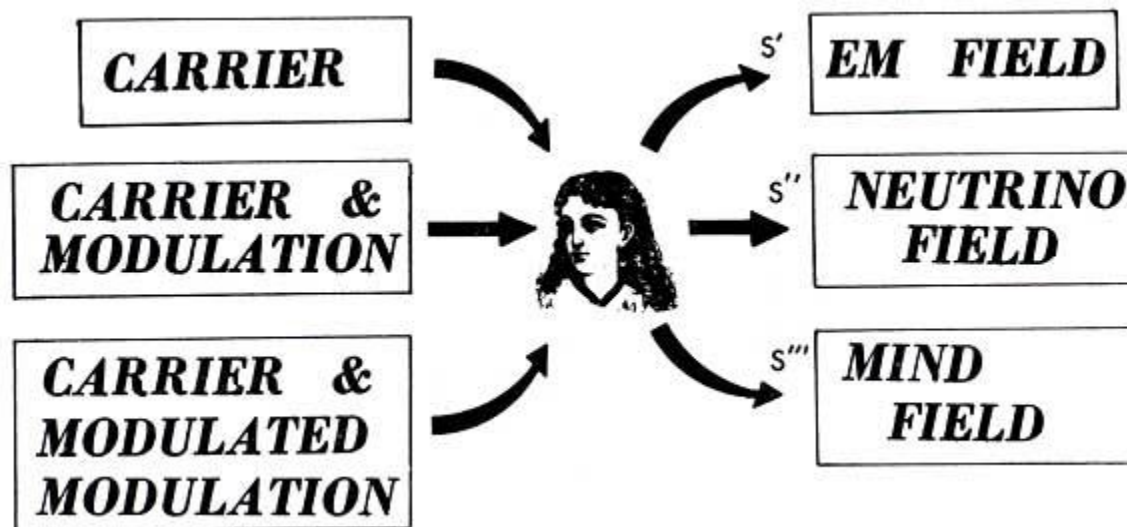

Figure 87. The mind and personality can be affected - and changed or controlled - from a distance. The Soviets have developed at least a substantial part of this technology.

Table 44. [LISITSYN'S REPORT](#)

- **THEORY DEVELOPED & FITTED**
- **HYSTERESIS MEMORY LOOP**
- **CONTROLLED INDUCTION**
 - **IMAGES**
 - **SENSATIONS**
 - **PREDETERMINED EMERGENCE**
- **23 EEG BANDS**
 - **UP TO 8.1×10^{20}**
- **11 INDEPENDENT CHANNELS**
- **BRAIN CODE BROKEN**
- **44 DIGITS OR LESS**

Thus by tailoring the specific scalar waveform and wave substructure with which we irradiate a mass, and utilizing phase conjugate (time reversed) waves, we can directly engineer the nucleus itself when sufficient charge structure has been built up in it to form a structured potential that is powerful enough to alter/ shape the nuclear processes.

We can, for example, transmute the nucleus into another form. Here an isomer form is the easiest. An isomer for an atomic nucleus (a specific

isotope) has the same number of nucleons (protons and neutrons) overall as that isotope does, but a different number of protons. So it's a different element, but very specially related to its isomeric "brother."

All that it takes to change a neutron into a proton or vice versa, is to "flip" a single quark (subparticle of the nucleon).

Living systems can do that and transmute elements, to a small degree.

For example, living systems must use phase conjugation, negative time, and negative energy. To do so, they must function nonlinearly. That is the only way they can defeat the otherwise inexorable second law of thermodynamics: that all (linear) processes continue to more and more disorder as time passes. (That's called "increasing the entropy (disorder)." Unless a biosystem could defeat that law, its genetic pattern would inevitably be disordered in a few generations, and the species would disappear.

By using phase conjugation and time reversal, the living system is able to reverse the law of entropy in its time-reversed channel. That is, in that channel things go in reverse: from disorder back to order! That's called "negative entropy" or "negentropy" for short.*

*To show how fully one can integrate physics and metaphysics, we point out that, since the vacuum **imprints** with every change, **nothing is ever lost!** Death, where is thy sting?

It follows a priori that, to do this, the living system of necessity possesses phase conjugate energy systems (negative energy, negative time systems) that are rooted in the atomic nuclei of its body. Further, it must deterministically manipulate these phase conjugate systems.

This allows the precise definition of a living or nonliving system. **If the system deliberately utilizes and manipulates phase conjugate energy/time in its atomic nuclei, it is a living system. If it does not deliberately use this, it is an inert or nonliving system.**

For example, this sheds a great deal of light on the nature of a virus.

A virus is a single molecule. Ordinarily it clouds the distinction between life and death. Viruses can be crystallized out of solution, formed into "rock-like" crystals, and placed on the shelf, so to speak. There they can remain for many years or centuries, seemingly an inert rock. Then when placed back into their "preferred medium," so to speak, the virus crystals dissolve, separate, and "come back to life" and resume their living function. Yet the virus can be killed, in which case it is just a "hunk of rock," sitting on the shelf. In that case, it won't come back to life when placed back into its preferred medium.

In one case its "deterministic phase conjugate energy system"—its mind, to

put it simply—remained in the nuclei of the atoms of the crystalline form. In the other case its "mind" was destroyed or disconnected from the crystalline form.*

***In the living case, the atomic nuclei remained patterned by the structured biopotential. In the case of true death, the structured biopotential is lost and the nuclei revert to their "inert" form.**

A somewhat similar effect can be demonstrated in bacteria.

You can "kill" bacteria, for example, with UV radiation, then hold them in the dark for 24 hours (say, for 12 generations, since a nominal bacterial generation is about 2 hours.) They will remain absolutely "lifeless" and static, with no movement or cell division.

Then if you place them in the sunlight, you will be astounded to see them revive by the hundreds of thousands. In the "special kill" case here, the virtual state substructure of the UV photons just totally "jammed" the biopotential substructure functioning of the "minds" of the bacteria on one key channel. It didn't physically damage their bodies or "physical tuners." Then when placed in the sunlight, the broad frequency spectrum of the virtual substructure of the photons "dithered" and stimulated the bacteria's body-tuners, much like a "frequency massage" in all the bands. This set the physical tuners vibrating—and therefore responding once again to the biopotential substructure changes of the mind. Hence the bacteria "revived" and swam about—fat, dumb, and happy.

We have stated that **the mind is a physical thing, albeit a virtual or hyperspatial thing. In virtual/hyperspatial reality, it is a functioning, hyperspatial thing.**



Figure 88. The mind and personality are physical things, albeit hyperspatial and virtual.

Interchanges between it and an otherwise inert, functional, 4-dimensional ordinary physical system (a "body") comprise life functions, "thought," cellular control, etc. Those interchanges in a living system occur in the biopotentials residing in the atomic nuclei of the physical body, in the higher levels of biopotential in the body structures such as cells, membranes, and organs, and in the overall biopotential of the entire mass of the body.

We accent that this is not mysticism, but physics.

Negentropy

In [thermodynamics](#), **negentropy** is a shorthand term or abbreviation of the term "[negative entropy](#)". In a strict thermodynamic sense, "negentropy" is the name given to the function $(-S)$ and, as such,

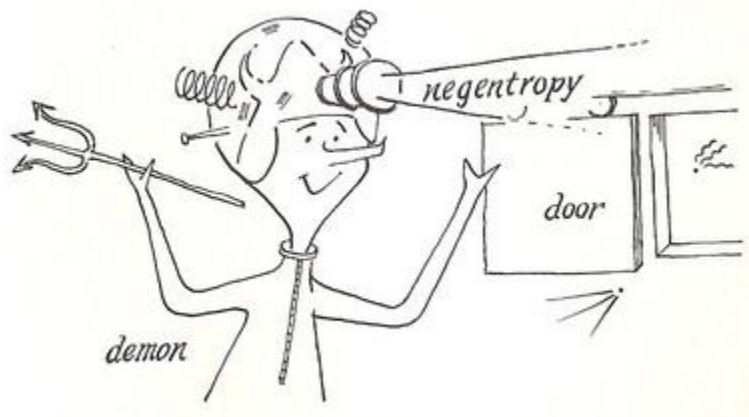

A cartoon of a [Szilard demon](#) (information energy version of [Maxwell demon](#)), from the 1967 book *Order and Chaos*, with a **negentropy** flashlight, from which the demon obtains [information](#) about the [movement](#) and positions of the [molecules](#) in the room beyond the door (see also: [Heisenberg uncertainty principle](#)). [8]

is the [thermodynamic potential](#) of an [isolated](#) system. [2]

Etymology

In 1943, [Erwin Schrodinger](#), gave his famous "What is Life?" lecture, wherein he famously posited that [life](#) is something that feeds on [negative entropy](#). In the followup, [Note to Chapter 6](#), in the 1944 book version of the lecture, Schrodinger clarified the following:

"[Entropy](#) taken with a negative sign is not my invention."

In other words, that " $-S$ " was something that predated 1943, whatever one wants to call it.

In 1950, French-born American physicist [Leon Brillouin](#), in his article "Thermodynamics and Information Theory", stated the following—his brackets and italics: [1]

"Every observation in the laboratory requires [degradation](#) of [energy](#) of energy and is made at the expense of a certain amount of [negative entropy](#) (abbreviation: ***negentropy***), taken away from the [surroundings](#)."

This seems to be the so-called "coining" of the now infamous silly term "negentropy" (the silliness is comparable to akin hypothetical terms: "negenergy" (negative energy) or "negheat" (negative heat), which we do not find in usage, because the [ignorance](#) is more obvious. Brillouin, in the

preface to his 1956 book *Science and Information Theory*, specifically states that he "coined the word negentropy", which seems to be a reference to the above.

Into the 1950s, the term negentropy had gained a certain level of popularity. By 1956, owing to the work of [Claude Shannon](#) and [Schrödinger](#), French physicist [Léon Brillouin](#), for instance, in his book *Science and Information Theory*, had stated that "a new scientific theory has been born during the last few years, the theory of [information](#)." [14] The basics of this theory, according to Brillouin, revolve around the question of how one is able to define the quantity of information communicated by a system of telegraph signals, signals which themselves consist of either electromagnetic or current transmissions. In this theory, the basic definition of information in a given operation, a quantity that Brillouin supposedly proves is "very closely related to the physical entropy of thermodynamics", is defined by him as:

$$I = K \ln P$$

where I denotes information, K is a constant, and P is the probability of the outcome. Brillouin reasons that with these types of probability arguments, "it enables one to solve the problem of Maxwell's demon and to show a very direct connection between information and entropy" and that "the thermodynamic entropy measures the lack of information about a physical system." Moreover, according to Brillouin, "whenever an experiment is performed in the laboratory, it is paid for by an increase in entropy, and a generalized Carnot principle states that the price paid in increase of entropy must always be larger than the amount of information gained." Information, according to Brillouin, corresponds to "[negative entropy](#)" or *negentropy*, a term he coined.

In sum, Brillouin unjustifiably declares that the "generalized Carnot principle ([second law](#)) may also be called the negentropy principle of information".

Negentropy flashlight

The origin of the so-called "negative entropy flashlight" seems to have originated in footnote eleven of [Leon Brillouin](#)'s 1949 article "Life, Thermodynamics, and Cybernetics" where in comment on American mathematician [Norbert Wiener](#)'s 1948 *Cybernetics* discussion of Maxwell's demon comments: [10]

“One remark should be added. In order to choose the fast molecules, the demon should be able to see them; but he is in an enclosure in [equilibrium](#) at constant [temperature](#), where the radiation must be that of the [black body](#), and it is impossible to see anything in the interior of a black body. The demon simply does not see the particles, unless we equip him with a torchlight, and a torchlight is obviously a source of radiation not at equilibrium. It pours [negative entropy](#) into the [system](#).”

At this point, Brillouin is not yet using the term "negentropy" (short for negative entropy).

In 1971, American engineer [Myron Tribus](#) commented, in retrospect, that the demon was finally "[exorcised](#)" in 1951 by Brillouin who pointed out that if the demon were to identify the [molecules](#), he would have to illuminate them in some way, causing an [increase in entropy](#) that would more than compensate for any [decrease in entropy](#) such a being could effect. [11]

Derivation

The concept of negentropy stems from [Léon Brillouin](#)'s extended efforts to make a crossover information-thermodynamics science, a blend of the two of sorts. In his derivation, on the analogy of Helmholtz's 1882 description "free energy" (available energy) and "bound energy" (entropy) of physical systems, Brillouin divides information into two classes: (a) *free information*, which occurs when the possible cases are regarded as abstract and have no specified physical significance, and (b) *bound information*, which occurs when the possible cases can be interpreted as complexions of a physical system. He states that bound information is a special case of free information.

Next, skipping a few points on probability arguments on the relation between entropy, information obtained, and numbers of complexions (as defined by Planck), Brillouin states that "bound information appears as a negative term in the total entropy of the physical system", and we can conclude that:

Bound information I_b = decrease in entropy S
= increase in negentropy N

where, as he states, we define *negentropy* as the negative of entropy and that "this statement represents the negentropy principle of information."

[7]

Difficulties on term | Objections to use

Well into the 1960s, the term generally found little objection. Statements can be found such as: [6]

“A fully [living system](#) must be capable of [energy](#) conversion in such a way as to accumulate *negentropy*, that is, it must produce a less probable, less random organization of [matter](#) and must cause the increase of [available energy](#) in the local system rather than the decrease demanded in [closed systems](#) by the [second law of thermodynamics](#).”

After 1980, however, the term negentropy has been generally considered as a sloppy cross-over analogy and not recommended for use in either information theory or in the study of the thermodynamics of living systems. [3] American chemical engineer [Linus Pauling](#) stated the point as "[life](#) does not feed on *negentropy* as a cat laps up milk." [4] American author [Hubert Yockey](#) has gone so far as to state that "the notion of *negentropy* has crept into the textbooks and the technical and popular literature" and that "it must be exorcised to avoid more damage". [5]

In 1994, Russian scientist [Mikhail Bushev](#) cogently explains that the term “negentropy” adds little if anything to the discussion: [12]

“[Leon Brillouin](#) gave this [negative entropy](#) the name *negentropy* and identified it with the [information](#) received by the [system](#). The new term, however, does not contribute any new insight, neither into [entropy](#), nor into [information](#). The difference in the signs of these two quantities is similar to the difference between conveyed and received [heat](#), conveyed and received [work](#), etc.”

In other words, negentropy has about the same significance as if one were to introduce the term “negwork”, short for “[negative work](#)”, into the vernacular of science. The effect, in this hypothetical example, as we see, only acts to add a layer of confusion to a relatively straightforward situation.

Other

A 1942 mention of the term "negentropy" is attributed to American physicist [Robert Lindsay](#), supposedly by [Dick Hammond](#), in reference to a type of [ethics](#) based on reducing [entropy](#) to the minimum or, in other words, increasing negentropy to the maximum. [9] In this sense, this

would be the inverse of the metaphorical association of [death](#) with the state of [maximum entropy](#), such that [life](#) would be associated with minimum entropy or a maximum negentropy principle. The actual "1942" Lindsay citation of negentropy terminology usage, however, may be missattribution. ([C](#))

References

1. (a) Brillouin, Leon. (1950). "Thermodynamics and Information Theory" ([abs](#)), *American Scientist*, 38(4): 594-. Oct.; in: *Modern Systems Research for the Behavioral Scientist: a Sourcebook* (editor: Walter Buckley) (pgs. [161-65](#)). Aldine Pub. Co., 1968.
(b) Brillouin, Léon. (1953). "Negentropy Principle of Information", *J. of Applied Physics*, v. 24:9, pp. 1152-1163.
(c) Brillouin, Léon. (1953). *Science and Information Theory*, (ch. 12: "Negentropy Principle of Information", pgs. 152-161). New York: Dover.
2. Perrot, Pierre. (1998). *A to Z of Thermodynamics*, Oxford: Oxford University Press.
3. (a) [Negentropy](#) - Web Dictionary of Cybernetics and Systems.
(b) Yockey, Hubert P. (2005). *Information Theory, Evolution, and the Origin of Life*, (pg. 32). Cambridge: Cambridge University Press.
4. Pauling, Linus. (1987). "Schrödinger's contribution to chemistry and biology", in: *Schrödinger: Centenary of a Polymath*. Cambridge, UK: Cambridge University Press.
5. Yockey, Hubert P. (2005). *Information Theory, Evolution, and the Origin of Life* (pg. 32). Cambridge University Press.
6. Simpson, G. G. (1964). "The Nonprevalence of Humanoids", *Science*, 143: 769-75.
7. Brillouin, Léon. (1956). *Science and Information Theory* (ch. 12: "Negentropy Principle of Information", pgs. 152-161). New York: Dover.
8. Angrist, Stanley, W. and Helpler, Loren G. *Order and Chaos - Laws of Energy and Entropy*, (pg. 196-214). New York: Basic Books.
9. (a) [Page reference](#) in the 1942 issue of Sigma Xi Quarterly.
(b) Hammond, Dick K. (2005). *The Human System from Entropy to Ethics* (pgs. 12-14). Publisher: Dick Hammond.
(c) Lindsay, Robert. (1942). "The Impact of Science on Contemporary Civilization" ([C](#)), *Sigma Xi Quarterly*: v.30, no. 1.
10. Brillouin, Leon. (1949). "Life, Thermodynamics, and Cybernetics" (footnote 11) ([abs](#)), *American Scientist*, Vol. 37, pgs. 554-68; In: *Biology and Computation: a Physicist's Choice* (pgs. [37-51](#)), by H. Gutfreudn and G. Toulouse. World Scientific, 1994; In: *Maxwell's Demon 2: Entropy, Classical and Quantum Information, Computing* (pgs. [73-87](#)), Harvey S. Leff, Andrew F. Rex. CRC Press, 2003.

11. Tribus, Myron and McIrvine, Edward C. (1971). "[Energy and Information](#)", *Scientific American*, 225: 179-88.
12. Bushev, Mikhail. (1994). *Synergetics: Chaos, Order, and Self-Organization* (pg. 247). World Scientific.

Further reading

- Popper, Karl R. (1967). "Time's Arrow and Feeding on Negentropy", *Nature*, 213 (5079): 320-.
- Woolhous, H. W. (1967). "Negentropy Information and Feeding on Organisms", *Nature* 213 (5079): 952+.
- Mae-Wan Ho. (1994). [What is \(Schrödinger's\) Negentropy?](#), *Modern Trends in BioThermoKinetics* 3, 50-61.
- [Negentropica](#) - an e-Journal on negentropy, thermodynamics, and self-organized phenomena ([2001-2003](#)).

Final words

After 15 years of in depth historical research, I can now show some of the the greatest scientific discoveries of the 20th century came and went without even being noticed. What mankind awaits is not a technological breakthrough - these have already happened - but an opening of minds.

Quote

If I have seen further than others, it was because their mind control techniques failed on a trained historian. Tim Harwood 2013