

STONE

Intelligent TFT-LCD Module

Model
STVC070WT-01

Equipment Manual

Contents

Preface	3
1 Introduction	5
2 Technical Parameters	10
3 Interface Description	15
4 Accessories	17
5 Installation	19
6 Physical Dimensions	20
7 Command Set Table	21
8 Electrical Components	23
9 Naming Rule	25
10 International Certification	26
APPENDIX	28
Glossary	34

Preface

This equipment manual is part of our Intelligent TFT-LCD Module documentation. It provides the information in regards of operation, installation, configuration, function, system as well as its technical design and working principle.

Organization of the manual

The STVC070WT-01 equipment manual is organized into the following chapters:

Chapter	Contents
1	Overview of features and functional scope of the STVC070WT-01
2-3	Technical Parameters, Interface Description
4-6	Accessories, Installation, Physical Dimensions
7	Command Set Table
8-10	Electrical Components, Naming Rule, International Certification
Appendix	MCU Sample Program, MCU Circuit Design, ESD Guidelines

Intelligent Customer Online Services

Intelligent Customer Support offers comprehensive additional information of Intelligent Products through its Online services as follows:

- Official website: <https://www.stoneitech.com/>
<http://www.stone-hmi.com/>

- Telephone:0086-10-84351669

Other support

In need of technical queries, please contact STONE representatives in the subsidiaries and branches responsible for your area.

Trademarks

STONE registered trademarks are as below:

- STONE
- STONE TECH
- Intelligent HMI
- Intelligent TFT-LCD Module

Abbreviations

The abbreviation table in this equipment manual is as below:

LED	Light Emitting Diode
CPU	Central Processing Unit
ESD	Electrostatic Sensitive Device
HMI	Human Machine Interface
IF	Interface
LCD	Liquid Crystal Display
UART	Universal Asynchronous Receiver/Transmitter
COM	Commercial
DIN	Data Input
DOUT	Data Output
VIN	Voltage Input
GND	Ground
TP	Touch Panel

A list of all the technical terms together with their explanations is provided in the glossary at the end of this manual.

1 Introduction

This chapter contains general information of:

- Brief Introduction
- Warranty
- Product Characteristics
- Application Area
- Working principle
- Operation Processing
- Software Operation



1.1 Brief Introduction

The STVC070WT-01 has been conceived as **TFT monitor & Touch controller**. It includes processor, control program, driver, flash memory, RS232/RS485/TTL port, touch screen, power supply etc., so it is a whole display system based on the powerful & easy operating system, which can be controlled by Any MCU.

The STVC070WT-01 can be used to perform all basic functions, such as text display, image display, curve display as well as touch function, Video & Audio function etc. The User Interface can be more abundant and various. And the flash memory can store your data, configuration files and images etc.

1.2 Warranty

All products purchased from our company are guaranteed to keep in good repair for **3 year s**. If quality problems (except human error) happen in guarantee period, our company will maintain for free or replace the broken one unconditionally.

1.3 Product Characteristics

- With Cortex CPU & Driving device
- Controlled by any MCU
- Display Picture/ Text /Curve
- 65536 colour TFT display
- With/without Touch Screen
- RS232/ RS485/ TTL UART Interface & USB port
- Wide voltage range
- Easy to use! Powerful function! Saving cost and time!

1.4 Application Area

Widely used in various industrial field

- Medical & Beauty Equipment
 - Engineering Machinery and Vehicle Equipment
 - Electronic Instrument
 - Industrial Control System
 - Electric Power Industry
 - Civil Electronic Equipment
 - Automation Equipment
 - Traffic
- Etc.

1.5 Working Principle

The Intelligent TFT-LCD Module communicates with the Customer's MCU via Commands (HEX Code), and then the MCU would control its connected equipment to work according to the received commands.

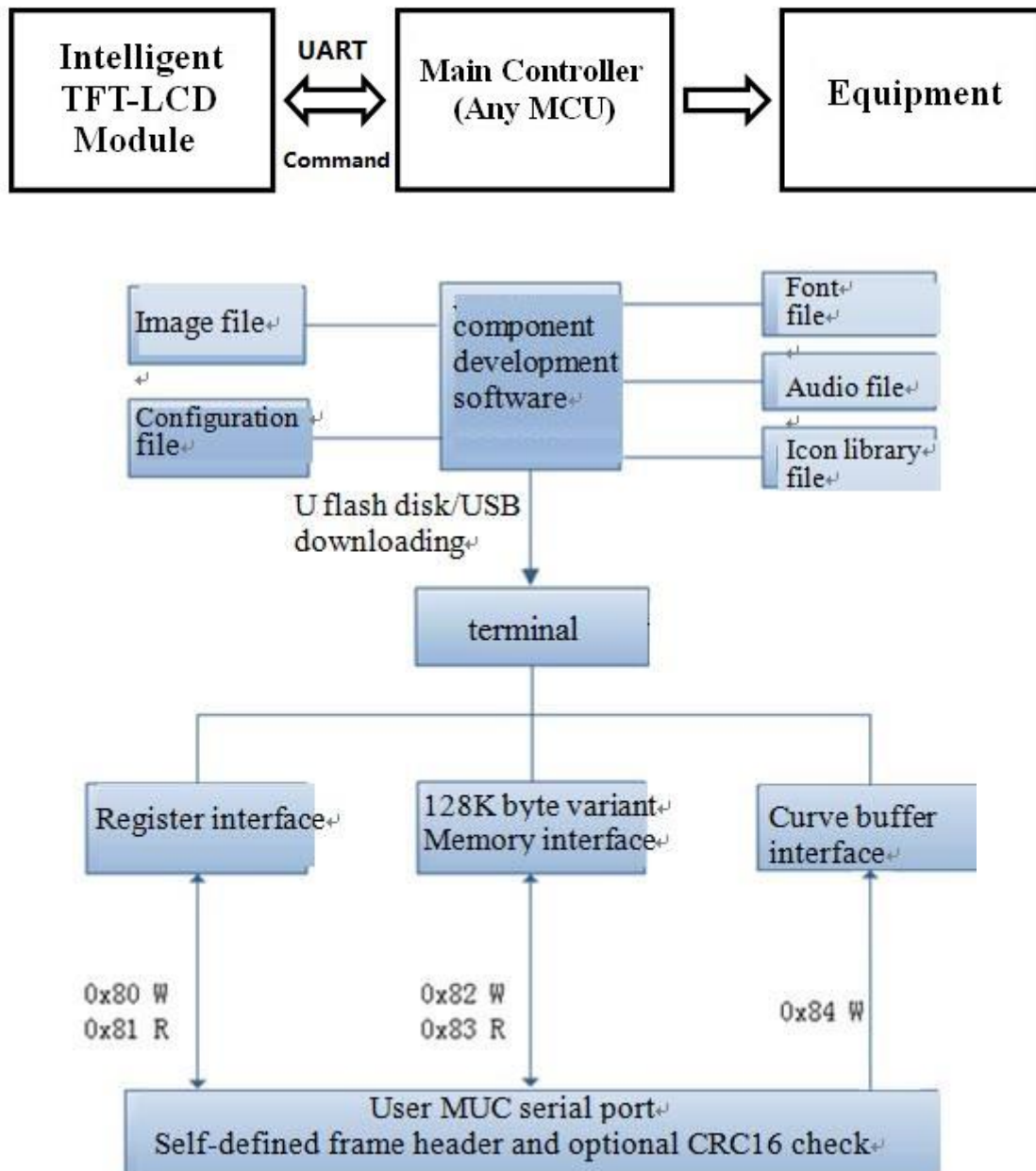

Figure 1.3-1 Configuration and process control phases

1.6 Operation Processing

Only **3 steps** to use our TFT-LCD Module:

1. Design a group of Beautiful “Graphical User Interface”. (Ref. Picture 1.4-1)
2. Connect with customer’s MCU through RS232, RS485 or TTL level directly. Plug and play.
3. Write a simple program for MCU to control the TFT-LCD Module via Command. (HEX Code).
That’s all.

The TFT LCD module serial port command frame is composed of 5 data blocks, shown as the table 1-1.6. All serial port commands or data are represented with hex format. The data transfer in MSB manner. E.g. for 0x1234, first send 0x12 and then send 0x34.

Table 1-1.6 Command Frame

Definition	Frame header	Data length	Command	Data	CRC check code
Length (byte)	2	1	1	N	2
Description	R3:RA definition	Including command, data and check	0x80-0x84	-	Check if R2.4 is enabled
Example	0xA5,0x5A	0x05	0x81	0x00,0x10	0x20,0x24

More information, please reference the document of Development Guide.



Picture 1.4-1

1.7 Software Operation

We will offer simple "Tool Software" to help you to design the new project file for Intelligent TFT-LCD Module on computer.

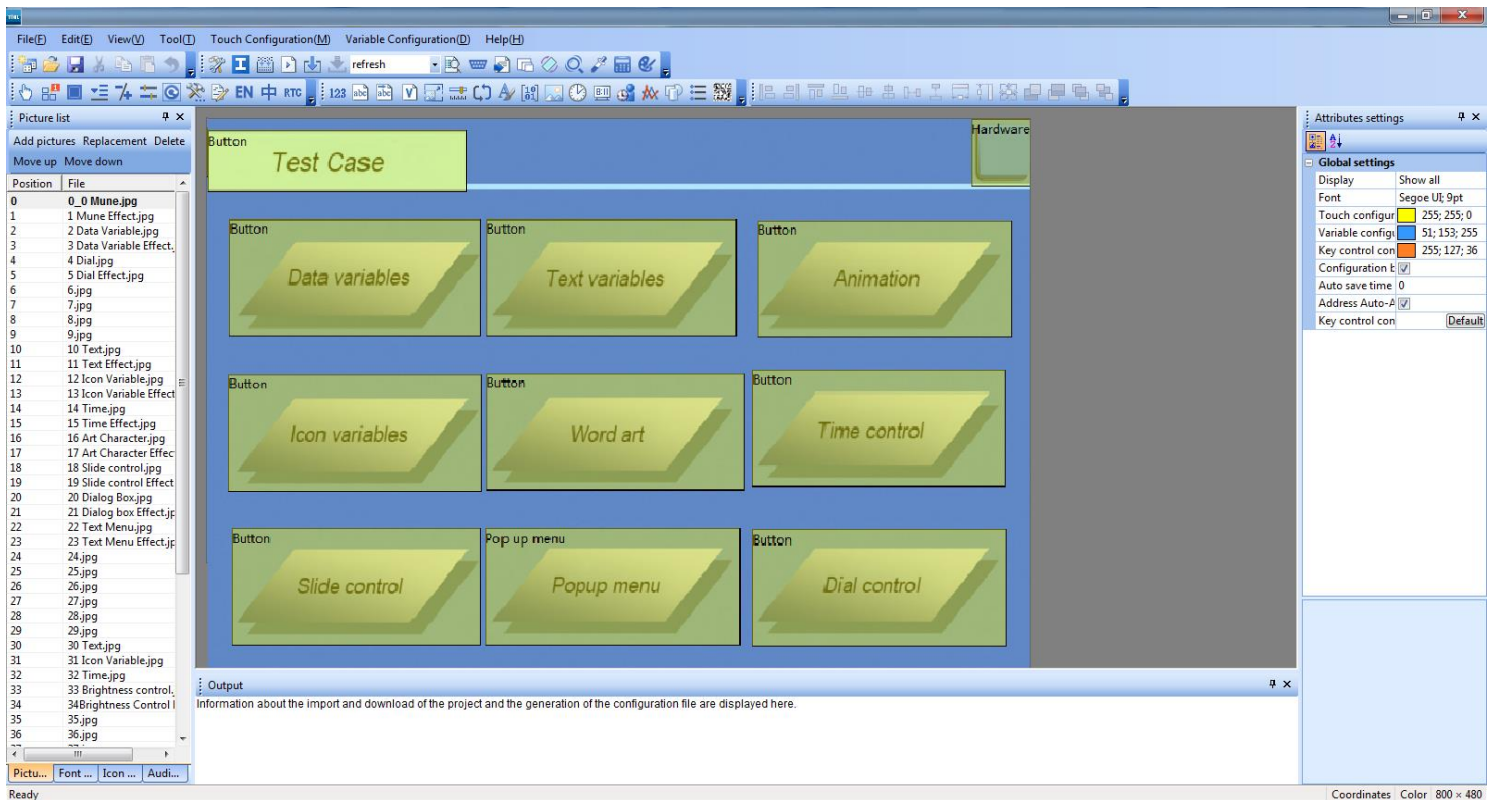

2 Technical Parameters

This chapter contains technical data on:

- **Physical Parameters:**

Physical Parameters

Display

- **Hardware Parameters:**

Processor

Memory

Interface

Power Supply

- **Storage & Test**

Electrical Characteristics

Ambient Conditions

Noise Immunity

Radio Interference

- **Support Device**

Support Device

Physical Parameter	
Size	7 inch
Resolution	800×RGB×480
Pixel Spacing	0.1905mm×0.0635mm (H×V)
Color	65536 colors (16 bit)
Viewing Area	154.1mm× 85.9 mm
Display Dimension	156.2 mm× 89 mm
Overall Dimension	186.3 mm×105.4 mm×15.3mm(N)/ 16.9 mm(T)
Net Weight	250g(N)/325g(T)

Display	
Backlight Type	LED
Brightness	400cd/m ² (Brightness can be adjustable in 100 levels)
Contrast	500:1
Backlight life	20,000 hours
Viewing Angle	70°/70°/50°/60°(L/R/U/D)
TFT Panel	A Class Industry Panel
Touch Screen	Industry Level 4 wire resistance Or without touch screen is optional.
Screen Mode:	Digital

Processor	
CPU	CortexM4
Refresh Rate	200MHz
Update Speed of per frame	40 ms/frame (25 images/s)

Memory	
Flash Memory	Standard 128MB, Extension 1GB
Memory Amount for picture	According to the capability of the image, Suggest "JPG" format.

Interface	
Interface	RS232/ RS485/ TTL/USB Interface
Image downloading	USB2.0 (12Mbps) & U storage Disk downloading

Power Supply	
Rated voltage	+12 V DC
Permissible voltage range	+6.0...+35.0 V DC
Max. permissible transients	+35V
Time between two transients	50 sec minimum
Internal Fuse	Electronic
Power consumption	2.6 W

Electrical Characteristics					
Parameter		Condition	Min	Type	Max
Supply Current		VIN=12V (Max brightness)		260mA	
		VIN=12V (close brightness)		75mA	
Signal Input Voltage	TTL level	VIH	2.1V		
		VIL			0.9V
	RS232 level	V range	-15V		+15V
	RS485 level	Different Threshold	-0.2V		+0.2V
Signal Output Voltage	TTL level	VOH	3V		3.3V
		VOL	0V		0.1V
	RS232 level	V range	-15V		+15V
	RS485 level	Different Driver			5V
Baud Rate			1200 bps		921600 bps
Note: As the brightness lower, the current will also reduce.					

Ambient Conditions	
Max. permissible ambient temperature Operation Storage	-20°C ~ +70°C -30°C ~ +80°C
Relative humidity Operation Storage	55°C, 85% 60°C, 90%
Shock loading Operation Storage	15 g/11 msec 25 g/6 msec
Vibration Operation Storage	0.035 mm (10 - 58 Hz)/ 1 g (58 - 500 Hz) 3.5 mm (5 - 8,5 Hz)/ 1 g (8.5 - 500 Hz)
Barometric pressure Operation Storage	706 to 1030 hPa 581 to 1030 hPa

Noise Immunity	
Static discharge (contact discharge/air discharge)	EN 61000-4-2 6 kV/8 kV
RF irradiation	EN 61000-4-3 10 V/m, 80% AM 1 kHz
Pulse modulation	ENV 50204 900 MHz ± 5 MHz 10 V/meff., 50% ED, 200 Hz
RF conduction	EN 61000-4-6 150 kHz - 80 MHz 10 V, 80% AM, 1 kHz
Burst interference Supply lines Process data lines Signal lines	EN 61000-4-4 2kV 2kV 1kV

Radio Interference	
Radio interference level complying to EN 55011	Class A

Support Device	
Buzzer	Support
RTC	Support
USB port	Support
Touch Screen	4 Wire Resistance
Default Font	6x12/ 8x16/ 12x24/16x32 /24x48 /32x64 /48x96 /64x128 (Dot Matrix)
Picture	Support JPG Format
Storage Data	Support
Command Set	Unified Simplified Command Sets

3 Interface Description

This chapter contains the description of the interfaces:

- VVC
- NC
- DOUT
- DIN
- GND
- Baud Rate

Please notify the interface type before ordering. RS232/ RS485/ TTL level interface.

Communication Interface Definition:

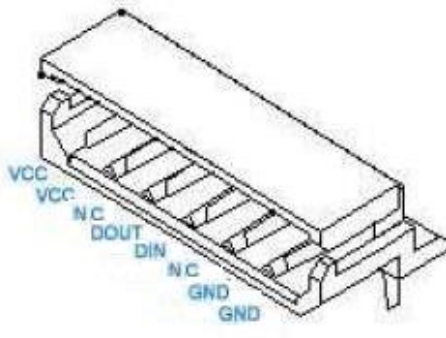
	Pin Name	Pin NO.	Pin Type	Interpret
	GND	1,2	P	Power Ground
	DIN	4	I	Data Input
	DOUT	5	O	Data Output
	NC	3,6		None
	VCC	7,8	P	Power Supply Input

I: Input O: Output P: Power

- Note A:**
1. Adopting the 8 Pin 2mm spacing socket.
 2. Direction of the signal was defined with TFT-LCD Module;
 "I" refers to the signal from the user's system transmitted to the TFT-LCD Module.
 3. Pins with the same definition are connected together in the module inside.
 4. RS232, TTL or RS485 port can be default which need to point out in the order.

Note B: The selection of Baud rate for the serial interface:









Baud rate (bps)	1200	2400	4800	9600	19200	38600	57600	115200
-----------------	------	------	------	------	-------	-------	-------	--------

4 Accessories

This chapter contains the accessories:

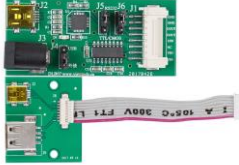
- Double 8-pin Connect Cable
- DB9 Connecting Cable
- 8-pin Socket
- Mini USB Cable
- Converter
- Bezel

Accessories

Accessory Name	Model	Note	Picture
Double 8-pin Cable	L8	Optional: 10cm/20cm/30cm/65cm	
DB9 Cable	LD	Connector: Standard DB9 Joint	
8-pin Socket	S8	SMD-8 2.0mm with Lock	
Mini USB Cable	LU		
Converter	UR2.0 UR4.0 UR1.0	USB to RS232 USB to RS485 USB to TTL	
Plastic Bezel	PB-V043 PB-V050 PB-V056 PB-V070 PB-V080 PB-V104	For: 4.3", 5", 5.6", 7", 8", 10.4" TFT-LCD Module.	
Metal Bezel	MB-V035 MB-V043 MB-V050 MB-V056 MB-V070 MB-V080 MB-V101 MB-V104	For: 3.5", 4.3", 5", 5.6", 7", 8", 10.1", 10.4" TFT- LCD Module.	
U Storage Disk		USB Downloading Batch Function	

5 Installation

This chapter contains the installation of plastic bezel.



6 Physical Dimensions

This chapter contains the information of Physical Dimensions.

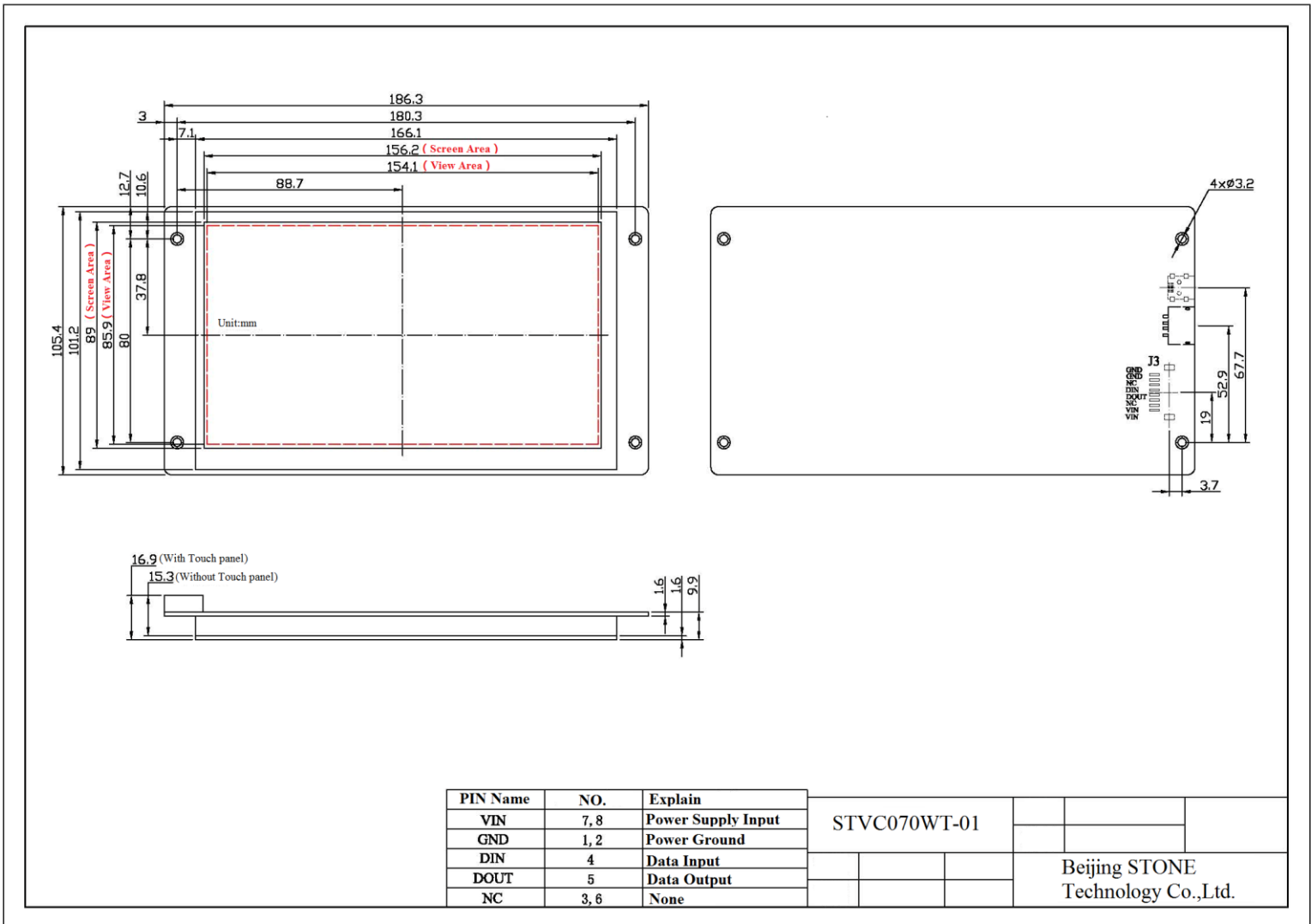

Figure 6-1 STVC070WT-01 dimension

7 Command Set Table

This chapter describes the Commands:

- Access register interface
- Access variant register interface
- Write curve buffer interface









Command Lis

Function	Command	Data	Description
Access register interface	0x80	Distributed: register address (0x00-0xFF)+ write data	Write register data at the specified address
	0x81	Distributed: register address (0x00-0xFF) + length of reading byte (0x00-0xFF)	Start to read the register data of the specified byte length from specified address
		Response: register address (0x00-0xFF) + length of byte data + reading register data	Read TFT LCD module response of the register
The TFT LCD module has 256Byte register, which mainly controls related hardware and is addressed by the byte.			
Access variant register interface	0x82	Distributed: variant address (0x0000-0xFFFF) + written variant data	Start to write data (byte data) to variant memory area from the specified variant address
	0x83	Distributed: variant address (0x0000-0xFFFF) + length of reading variant data word (0x00-0x7F)	Start to read the data of the specified byte length from the specified address of the variant memory area
		Response: variant memory address + variant data length + reading variant data	Read TFT LCD module response of the data memory
<p>The TFT LCD module is driven by variants. The variant value is separated from the variant display format. The variant display format is downloaded to the TFT LCD module via the pre-configured file. The variant values are transmitted to the TFT LCD module in real time via the serial port. The variant memory is used to store the received variant value.</p> <p>The TFT LCD module includes 64K word (128K Byte) variant memory, which is addressed by word. The address is 0x0000-0xFFFF. When the user plans the variants, the variant memory address is manually allocated by the variant length.</p>			
Write curve buffer interface	0x84	<p>CH_Mode (Byte) +DATA0 (Word) +...+DATAn</p>	<p>Write data to curve buffer.</p> <p>The CH_Mode defines the channel ranking sequence of further data; Each bit of CH_Mode corresponds to a channel; CH_Mode.0 corresponds to the channel 0. 7 corresponds to the channel 7.</p> <p>1 of corresponding position indicates that the corresponding channel data exists;</p> <p>0 of corresponding position indicates that the corresponding channel data does not exist;</p> <p>The low-channel data is ranked first.</p> <p>E.g. CH_Mode=0x83 (10000011B) indicates that the format of further data is (channel 0+channel 1+channel 7) +...+(channel 0+channel 1+channel 7)</p>
<p>The TFT LCD module includes a 8 K Word, can store the buffer of 8 curves, and can simply and quickly display the curve for users.</p> <p>The data in the curve buffer are 16-bit unsigned numbers.</p>			

8 Electrical Components

This chapter contains the brands of the components:

- TFT Panel
- Touch Screen
- CPU
- LCD Controller
- Flash memory
- Connector
- Capacitance
- IC

Components	Supplier
TFT Panel	
CPU	
LCD Controller	
Touch Screen	
Flash Memory	
Connector	
Capacitance	
IC	

9 Naming Rule

This chapter contains the naming rule:

As sample STVC070WT-01

Code	Explain
STV	Company Code
I	I=Industrial Type ; A=Advanced Type; C=Civil Type
070	TFT Panel Dimension: 7 inch
W	W=Wide Voltage
T	T=With Resistive Touch Screen N=Without Touch Screen C=With Capacitive Touch Screen
0	0=RS232 4=RS485 1=TTL
1	Hardware Code

10 International Certification

This chapter contains the certification we passed:

- CE Certificate
- ROHS Certificate
- FCC Certificate
- ISO9001:2008 Quality System

CE Certificate



FCC Certificate



ROHS Certificate

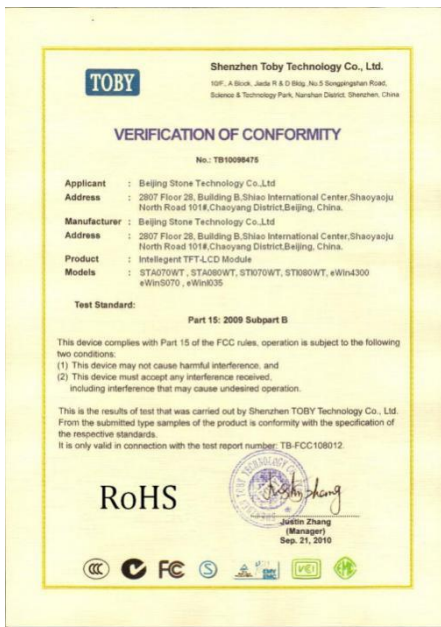

ISO9001:2008



APPENDIX

- A MCU Sample Program**
- B MCU Circuit Design**
- C ESD Guidelines**

A. MCU Sample Program

C8051 MCU C Language

```
//-----  
// Includes  
//-----  
#include<reg52.h>  
  
//-----  
// sbit Definitions  
//-----  
sbit LED=P0^0;  
  
//-----  
// Global CONSTANTS  
//-----  
#define SYSCLK    22118400           // "SYSCLK frequency in Hz"  
#define BAUD_RATE 115200           // "Baudrate"  
#define uchar unsigned char  
#define uint unsigned int  
uchar pic[3]={0xAA,0x70,0x08};  
/-----  
// Function PROTOTYPES  
//-----  
void Uart0_transmit(uchar i);           // "Send a byte to the terminal"  
void send_str(uchar *p,uchar s);       // "Send a string to the terminal"  
void delay_ms(uchar n);               // "Delay"  
void SysInit(void);                   // "Initialization of system"  
void en(void);                         // "Frame end"  
void pic_str(uchar i);                 // "Picture switching sub-function"  
  
//-----  
// Uart0_transmit  
//-----  
void Uart0_transmit(uchar i) // "Send 1 byte to terminal"  
{  
    ES=0;  
    TI=0;  
    SBUF=i;           // "Send data to uart0"  
    while (!TI);    // "Wait for the finish of sending a byte"  
    TI=               // "Clear the interruption mark"  
    ES=1;  
}  
void send_str(uchar *p,uchar s) // "Send a string to the terminal"  
{  
    uchar m;  
    for(m=0;m<s;m++)  
    {  
        Uart0_transmit(*p);  
        p++;  
    }  
}  
//-----  
// delay // "Delay sub-function"  
//-----
```

```

void delay_ms(uchar n)
{
    uint i,j;
    for(i=1000;i>0;i--) {
        for(j=25*n;j>0;j--) {};
    }
}

//-----
// Syslnit                                     // "Initialization of system"
//-----
void Syslnit(void)
{
    PCON |=0x80;
    SCON=0x50;
    TMOD=0x21;
    TH1=255;
    TL1=255;
    TR1=1;

    ES=0;
    TH0=0xDC;
    TL0=0x00;
    TR0=1;
    ET0=1;
}

//-----
// pic_str                                     // "Picture switching sub-function"
//-----
void pic_str(uchar i)
{
    pic[2]=i;
    send_str(pic,3);    // "Send the command of picture switching"
    en();
}

//-----
// main() Routine
//-----
void main (void)                                     // "main function"
{
    EA=0;                                           // "Close Interruption"
    Syslnit();
    EA=1;                                           // "Open Interruption"
    delay_ms(40);

    while (1)
    {
        pic_str();                                // "Picture switching"
    }
    Return 0;
}

//-----
// End Of File
//-----

```

B. MCU Circuit Design

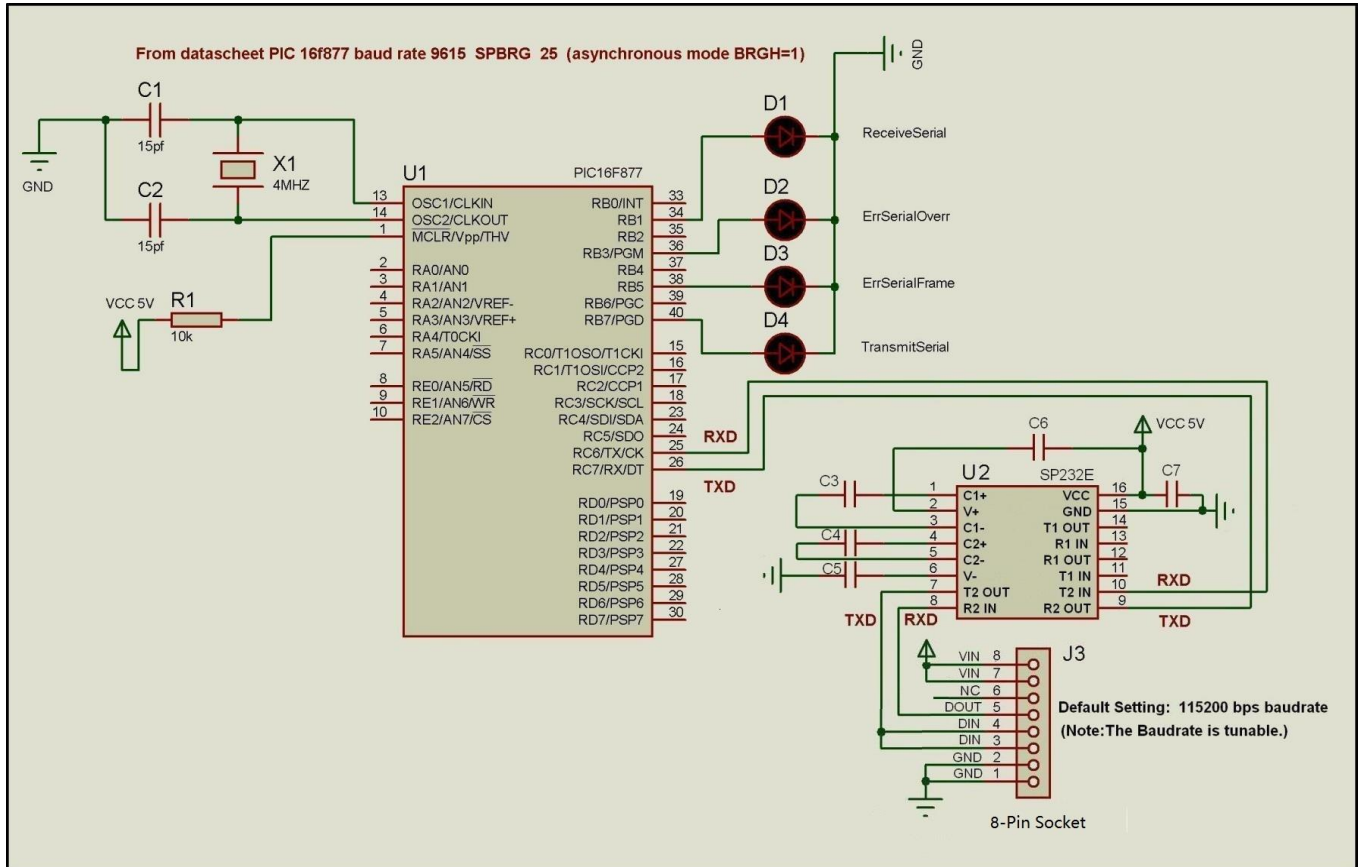

C. ESD Guidelines

What does ESD mean?

Virtually all present-day modules incorporate highly integrated MOS devices or components. For technological reasons, these electronic components are very sensitive to overvoltages and consequently therefore to electrostatic discharge:

These devices are referred to in German as Elektrostatisch Gefährdeten Baulemente/ Baugruppen: °EGB°

The more frequent international name is:

°ESD° (Electrostatic Sensitive Device)

The following symbol on plates on cabinets, mounting racks or packages draws attention to the use of electrostatic sensitive devices and thus to the contact sensitivity of the assemblies concerned:

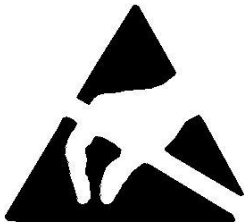

ESDs may be destroyed by voltages and energies well below the perception threshold of persons. Voltages of this kind occur as soon as a device or an assembly is touched by a person who is not electrostatically discharged. Devices exposed to such overvoltages cannot immediately be detected as defective in the majority of cases since faulty behavior may occur only after a long period of operation.

Precautions against electrostatic discharge

Most plastics are capable of carrying high charges and it is therefore imperative that they be kept away from sensitive components.

When handling electrostatic sensitive devices, make sure that persons, workplaces and packages are properly grounded.

Handling ESD assemblies

A general rule is that assemblies should be touched only when this cannot be avoided owing to the work that has to be performed on them. Under no circumstances should you handle printed-circuit boards by touching device pins or circuitry.

You should touch devices only if

- you are grounded by permanently wearing an ESD wrist strap or
- you are wearing ESD shoes or ESD shoe-grounding protection straps in conjunction with an ESD floor.

Before you touch an electronic assembly, your body must be discharged. The simplest way of doing this is to touch a conductive, grounded object immediately beforehand ± for example, bare metal parts of a cabinet, water pipe etc.

Assemblies should not be brought into contact with charge-susceptible and highly insulating materials such as plastic films, insulating table tops and items of clothing etc. containing synthetic fibers.

Assemblies should be deposited only on conductive surfaces (tables with an ESD coating, conductive ESD cellular material, ESD bags, ESD shipping containers).

Do not place assemblies near visual display units, monitors or television sets (minimum distance to screen > 10 cm).

Measuring and modifying ESD assemblies

Perform measurements on ESD assemblies only when

- the measuring instrument is grounded ± for example, by means of a protective conductor ± or
- the measuring head has been briefly discharged before measurements are made with a potential-free measuring instrument ± for example, by touching a bare metal control cabinet.

When soldering, use only grounded soldering irons.

Shipping ESD assemblies

Always store and ship assemblies and devices in conductive packing ± for example, metallized plastic boxes and tin cans.

If packing is not conductive, assemblies must be conductively wrapped before they are packed. You can use, for example, conductive foam rubber, ESD bags, domestic aluminum foil or paper (never use plastic bags or foils).

With assemblies containing fitted batteries, make sure that the conductive packing does not come into contact with or short-circuit battery connectors. If necessary, cover the connectors beforehand with insulating tape or insulating material.

Glossary



Baud rate

Rate of speed at which data is downloaded. Baud rate is specified in Bit/s.

Boot

A loading process which downloads the operating system in the working memory of the operating unit.



Command Set

Hex Code, the MCU can control the TFT Module via the command set.

Configuration file

It can be created by the softwares.



Download

Download the image, configuration files and data through mini USB port or USB port.

Download mode

Through mini USB port or USB port.



Flash memory

Programmable memory which can be electrically deleted and written to again segment-by-segment.



Half Brightness Life

The period of time after which the brightness tube only achieves 50% of the original value.



Input field

Enables the user to enter values which are subsequently sent to the **MCU**.



MCU

Micro Control Unit, it is widely used in the industrial control.



Normal operation

Operating unit operating mode in which messages are displayed and screens can be operated.

**Output field**

Displays current values from the **MCU** on the operating unit.

**Process screen**

The display of process values and process progress on the operating unit in the form of screens, which may contain graphics, texts and values.

**RS485**

Standard interface for serial data transfer at a very high transmission rate.

**Screen**

A screen displays all the logically related process data on the operating unit, whereby the individual values can be modified.

**Touch panel**

This is an operating unit without keyboard. The touch panel (abbreviated to TP) is operated via the contact-sensitive screen elements.