

The
Complete Manual
of

PIRATE RADIO

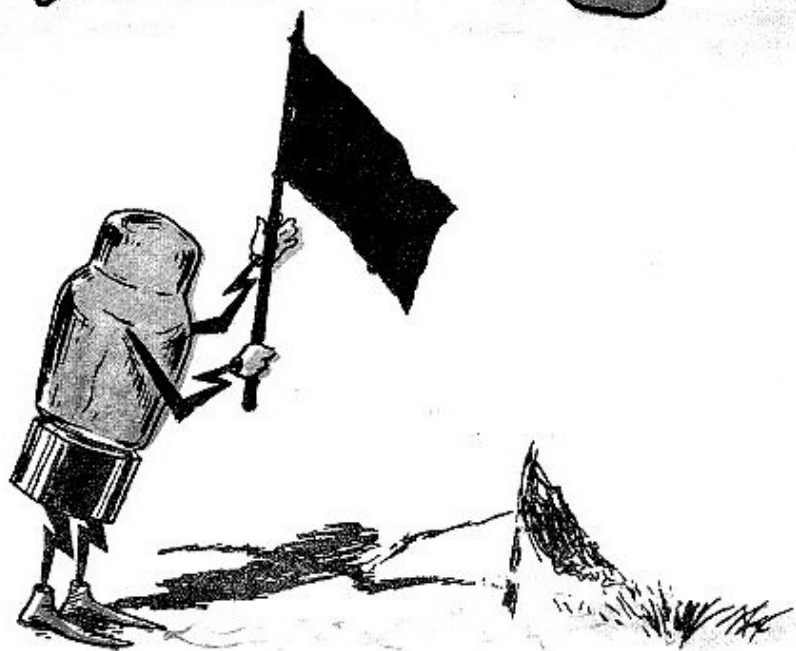

By

ZEKE TEFLON —

INDEX

INTRODUCTION.....	1
PRELIMINARY CONSIDERATIONS.....	2
TO BUY OR BUILD?.....	4
GETTING AWAY WITH IT.....	6
THE STUDIO.....	9
TRANSMITTERS.....	12
ANTENNAS.....	14
MOBILE OPERATION.....	20
FINDING PARTS.....	21
TEST EQUIPMENT.....	22
BIBLIOGRAPHY.....	23

I would like to thank everyone who helped make this not-for-profit pamphlet possible, especially The Wiz, of KGPR, Little Eddie Satan of KDIL, and those who made generous donations of typesetting and printing.

This material is not copyrighted. Feel free to reproduce it, but please give credit where credit is due.

This pamphlet is intended for everyone who has a message to communicate but no means with which to do it. This piece will provide the information necessary to obtain that means. So, if you're interested in providing an alternative to corporate-controlled newspapers and magazines, the insane howling on religious radio and television stations, the reactionary pap on commercial stations (designed to offend neither advertisers nor corporate owners) and the innocuous animals-and-British-accent programming on "public" (government-owned) stations, read on. Anyone with a year or two of high school electronics or ham experience should be able to take full advantage of the information presented here, although most of it should be accessible to anyone. Those with no previous experience would be well advised to build a couple of kits (Heathkits, etc.) and to read the first few chapters of the American Radio Relay League's **Radio Amateur's Handbook**, hereafter referred to as **RAH**.

In theory, freedom of the press exists in this country. But in practice, only those individuals and groups with very large amounts of money can take advantage of that freedom. For example, to start a daily paper in just one major city would require assets of at least five, and probably ten, million dollars. We all know how many anarchists and anarchist groups have that kind of money: none. So, taking advantage of the much vaunted freedom of the press in this country is out of our reach. (This is not to depreciate the valuable work being done by many anarchist publications; but given the extremely limited time, money, and volunteer labor available, even the best of these publications is doing well to have a readership of a few thousand.)

The use of television is almost equally out of reach. Television is considerably more technically sophisticated than radio, and so TV equipment is considerably more expensive and requires considerably more maintenance than radio equipment. Putting a bare-bones commercial TV station on the air would require an investment of a million dollars or more; and because of licensing requirements, it would be virtually impossible for an anarchist group to receive a license. While a pirate TV station could be put on the air for a few thousand dollars, such an undertaking would require a fairly high degree of technical sophistication on the part of its staff. Further, because of the attention-drawing nature of television, such a project would in all likelihood be quickly busted by the FCC.

Commercial—or "nonprofit" for that matter—radio is almost as out of reach as television. The costs of starting a commercial station run into the tens or hundreds of thousands of dollars, and even the costs of setting up a low-power noncommercial station using mostly donated and used equipment runs into thousands of dollars. Even if you can raise a reasonable amount of money—say \$10,000 or \$20,000—you're still a hell of a long way from being on the air. The government's licensing procedure is lengthy—it takes years. Secondly, the FCC will give licenses only

to "respectable" hierarchically organized groups with boards of directors, officers, etc. The problems this poses for anarchists are too obvious to go into. Finally, what the government gives, the government can take away. If by some miracle you would make it on the air with a noncommercial license, the government could easily pull your license should you do anything to displease it.

FREEDOM OF COMMUNICATION

Freedom of communication is a basic human right. Like all rights, freedom of communication consists of being able to exercise your own abilities without interference. Government cannot give you your own abilities, but it sure as hell can (and will) interfere with you when you exercise them. **Government CANNOT give you rights. It can only take them from you.** If all governments (goons with guns forcing others to follow their dictates through violence and coercion) were to cease to exist, human rights would certainly **not** cease along with them.

The naive objection could be raised that while governments cannot give you rights, they can **protect** them by preventing your fellow citizens from interfering with you. In **theory**, that is possible. But in **practice**, governments have rarely "protected" citizens' rights, and then only when it has suited their political purposes. Invariably, when governments feel the least bit threatened, they place their own "security" needs above the human rights which they supposedly safeguard. Throughout history the vilest and most consistent violators of human rights have been governments. Governments have been responsible for the overwhelming bulk of human rights violations in every human civilization.

We cannot look to government to protect our rights. We have to do it ourselves, and an effective means of doing that is by exercising our rights.

PRELIMINARY CONSIDERATIONS

(Which Band Are You On)

There are several things to consider when setting up a pirate station before you spend a dime or solder a single connection. The first thing you need to determine is whether you want to reach a local audience or an audience several hundred or thousand miles away--that will dictate your choice of bands. If you're aiming for local coverage you'll want to operate on either the AM (540 - 1600 KHz) or FM (88 - 108 MHz) broadcast bands. If you're aiming for an area a long distance away you'll want to use the shortwave bands. The shortwave bands are (all frequencies in MHz): 2.3 - 2.495; 3.2 - 3.4; 3.9 - 4.0; 4.75 - 5.06; 5.95 - 6.2; 7.1 - 7.3; 9.2 - 9.7; 11.5 - 11.95; 15.1 - 15.45; 17.7 - 17.9; 21.45 - 21.7; 25.6 - 26.1.

There are advantages to all of the bands. The advantage of working on the AM broadcast band is that AM radios are slightly more common than

FM radios, and that high quality used ham transmitters which can be easily modified to work on the top end of the AM band are available dirt cheap—in the \$50 to \$150 range.

The disadvantages of the AM band are that it takes more power to cover a given area than it does on the FM band (the reasons for this are that static can be a problem on AM but not on FM and that pirate AM antennas are generally less efficient than FM antennas) and that AM antennas are bulkier than FM antennas and thus harder to hide and less suitable for mobile work.

The advantages of the FM band are that FM antennas are much smaller and generally more efficient than AM antennas, less power is needed to cover a given area on FM than on AM, FM antennas can easily be disguised for mobile work, and the simplest FM transmitters are easy and cheap to build (as low as \$15 or \$20).

The disadvantages of FM are that it's virtually impossible to find ready-made transmitters and that it's essentially a line-of-sight means of communication. That is, a low-power FM transmitter can only be heard when there's an unobstructed line between its antenna and the antenna of the receiver. But that's generally not a serious problem, especially if you operate from a hill.

The advantages of short wave bands are that it's possible to cover huge distances for a very small investment and that used ham transmitters are readily available which can be used with only very minor (or no) modifications on several shortwave broadcast bands. (A further advantage of using old ham transmitters for shortwave broadcasting is that those transmitters can generally be easily modified to work on the AM broadcast band also.)

The only disadvantages of shortwave broadcasting are that shortwave antennas are fairly large (this is less of a problem at the higher frequencies) and that listenership will generally be small in comparison with local audiences listening to AM and FM transmissions.

Your choice of shortwave bands will be determined by two things: 1) the equipment you're using; and 2) the distance to your listeners. Most old ham transmitters with amplitude modulation (AM) can be easily modified to work on the 3.2 to 3.4 and 15.1 to 15.6 MHz bands, and can be operated on the 3.9 to 4.0, 7.1 to 7.3 and 21.45 to 21.75 MHz bands without modification to their radio frequency (RF) circuitry. A word of warning: Do not operate on the 3.9 to 4.0 and 7.1 to 7.3 MHz bands. They overlap the 40 and 80 meter ham bands. For some reason hams tend to be rather fascistic, and if they hear you operating on "their" band they'll probably either jam your signal or turn you in to the FCC.

If you're planning on broadcasting a relatively short distance—say from Florida to Cuba or Texas to northern Mexico—the 3.2 to 3.4 MHz band would be a logical choice. With moderate power (say 50 to 200 watts or so) this band is good for distances of up to about 400 miles during the day and up to about 1000 at night. For longer distances the

15.1 to 15.6 and 21.45 to 21.75 MHz bands are good choices. On those bands it's quite easy to reach as far as Africa or South America from the U.S. with transmitters running as little as 50 watts input. In general, the 15.1 MHz band is useable both day and night while the 21.45 MHz band is best during the day. Where signals broadcast on these bands will land, however, is highly dependent on the time of day when they're broadcast. There are two ways to determine this. One is to listen on these bands with a shortwave receiver. The other is to look at propagation charts. QST, the publication of the American Radio Relay League (ARRL), the national ham organization, publishes detailed propagation charts every month. For the 15.1 MHz band you would look at the 20 meters chart, and for the 21.45 MHz band you would look at the 15 meters chart.

Long distance broadcasting can also be done on the frequencies between 29.7 and 30 MHz using old ham transmitters (the government reserves these frequencies for diathermy), but this band is generally only useful at or near the height of the sunspot cycle and listeners would be few and far between even then. For propagation information for these frequencies see the 10 meter ham band chart in QST (all propagation charts are in the "How's DX" section) or listen to the 10 meter ham band with a shortwave receiver. At the time of this writing, July 1985, we're near the bottom of the 11-year sunspot cycle and the 10 meter band is all but useless except for local communication. It should begin to improve in a year or two.

TO BUY OR BUILD?

No matter what your level of technical competence it makes no sense at all to build certain of the components you'll need. Similarly, it makes no sense at all to buy certain others. The decision with still other components will depend on your technical competence and financial state.

Those which you should buy include tape decks, turntables, and shortwave (used ham) transmitters. It would be a waste of time and money to build such equipment which can be purchased for less than the cost of the parts needed to build it from scratch.

Probably the only pieces of equipment which should be built by everyone engaging in piracy are antennas. They're easy to build; even most directive arrays are pretty simple.

If you're going to be broadcasting on the FM band you'll probably want to build your own transmitter. While kits are available for those with little or no construction experience, the designs for FM transmitters contained in this article are easy to build and much cheaper than the kits I've read about. If you have previous electronics construction experience I'd suggest that you build your own transmitter. If you have no previous experience but are on a tight budget, I'd suggest that you try building one of the schematics

contained here. And if you have no previous experience but can afford to shell out \$100 or \$150 for a transmitter, I'd suggest that you buy a kit. If you do buy a kit, get one with at least one or two watts output. A source for kits (for AM transmitters too) is Panaxis Productions, P.O. Box 130, Paradise, CA 95969.

The only two pieces of necessary equipment on which you really have the option of building or buying are your studio control board and AM transmitter. If you have previous building experience, you might want to build your own control board if you're on a tight budget. If you don't have building experience and/or can afford to spend \$150 or more for a board, I'd suggest buying a used commercial mixer. (Check music stores; many mixers made for music applications will work OK.) And if you're on a tight budget, but have no construction experience, you could buy a cheapo passive (no tubes or transistors) mixer somewhere and then run the output through a preamp before feeding it into your transmitter or tape deck. (Electro-Harmonix makes a good guitar preamp, the LPB-2, which would serve the purpose and costs about \$20 new.)

With AM transmitters you have the choice of building your own low-power rig, buying a kit (not recommended—too expensive for the low power output delivered), or buying a used ham transmitter and modifying it. The approach I favor is buying an old plate-modulated ham transmitter with 160 meter capability for \$50 or \$100 and then modifying it. (Some cheap transmitters have screen modulation—you don't want one of these.)

A large number of suitable transmitters are available. My favorites are the E.F. Johnson Company's Viking Ranger and Viking Valiant. These two transmitters are very similar, with the Ranger being basically a lower-powered version (75 watts) of the Valiant (200 watts). The advantages of these rigs are that they're readily available, built like tanks, have excellent audio, have built-in variable frequency oscillators (VFOs) and are very easy to modify to work on the top end of the AM broadcast band. The modifications should take no more than an hour or two to accomplish. All you need to do to the RF circuitry is to add capacitance to the 160 meter tuned circuits. (It's even possible to get the VFO to work on the top end of the broadcast band by adding capacitance.) And all you need to do to the audio circuitry is to bypass the first preamplifier (assuming you're using a line-level and not a microphone-level input) and—this is important—to bypass the speech-frequency filter, which as I recall is located between the second preamp and the driver. If you can read a schematic you'll spot it instantly.

When shopping around for an old ham transmitter keep the following things in mind: 1) Don't pay much more than about \$100 for one; 2) Make sure that it has 160 meter capability; 3) Make sure that it has amplitude modulation (AM); 4) Make sure that it has plate modulation: look inside and make sure that there are two transformers of

approximately equal size and that they're well separated—if they're sitting next to each other, one of the "transformers" is almost certainly a power supply choke; 5) Look at the wiring—a lot of old transmitters were built by the manufacturer, but a lot of others were sold as kits—and don't buy such a transmitter at any price if the wiring is a mess unless you can pick one up for \$10 or \$15 and intend to use it solely as a source of parts; 6) If you can, check the tubes while you're at it—re-placing tubes can be an expensive proposition.

Suitable used transmitters are available at virtually every ham/CB store, ham swap meet and through the classified ads in QST, CQ, and 73. It's generally preferable to buy at a store or swap meet because there you're not buying a pig in a poke. Needless to say, do not tell the person you're buying the transmitter from why you're buying it. If pressed, a decent dodge is to say that your younger brother living somewhere out in the sticks just became a ham and asked you to pick up a cheap transmitter for him. But it's better to say nothing if at all possible.

GETTING AWAY WITH IT

Piracy is illegal. If you're busted the government can seize your equipment, drag you through the courts, fine you hundreds or even thousands of dollars, and, theoretically, throw you in jail, although I've never heard of that happening to anyone. So, it makes sense to take every possible precaution to avoid The Knock (on your door from the FCC).

The ideal situation—in terms of maximizing listenership—for a radio station is to broadcast 24 hours a day, on a set frequency, with high power, from a fixed location. Attempting such operation as a pirate, however, would be suicidal.

On the other extreme, you could go on the air with an extremely low power (under 100mw) transmitter which would be legal under FCC rules and regulations. If you would be satisfied with a broadcasting radius of a couple of blocks, that would be the route to go. In fact, in cities with high population densities such as San Francisco and New York, such an approach makes a lot of sense.

For those who wish to reach large numbers of people with their broadcasts, the trick is to find as safe a compromise as possible between the two approaches. If you fall into that category, there are several steps you can take to protect your self:

- 1) First the obvious—don't talk unnecessarily. It's tempting, but if people don't need to know about your operation, don't tell them about it.

- 2) Another obvious one—don't broadcast your location or phone number. Broadcasting a false location is not a very effective subterfuge, but there's no reason to make the FCC's job any easier.

3) If you're soliciting comments or contributions from your listeners, use a maildrop. Do not use your own address even if it's only a post office box. Setting up a maildrop is easy. Simply have a trusted friend (one who knows how to keep his/her mouth shut and who doesn't mind the possibility of getting hassled) rent a post office box and have all of your mail sent there and have your friend forward it to you. You'll have to pay for the box rent and also for the forwarding postage, but the small expenses involved with this system are well worth the price in terms of security.

4) Separate your studio and transmitter sites. It's a hell of a lot easier to hide a transmitter and a cassette player than a complete studio. Separation of studio and transmitter is especially important if people are in the habit of smoking dope even occasionally in the studio. If you do separate your studio and transmitter, it's generally better to prerecord programs rather than transmit them via phone lines. It's easy for the feds to trace and (tap) phone lines.

5) If you're operating from a fixed location, hide your transmitter and antenna. I've heard of pirates making hidden compartments in walls and floors to hide transmitters, which is a good idea, but even if you don't go to such extremes, at least have your transmitter set up so that it can be disconnected and moved to a good hiding place very quickly.

In the case of antennas, there are a number of steps which can be taken to hide them. One is to make your antenna (and guy wires) out of very thin wire (#20 or #22), and make your antenna insulators from clear plexiglass or plastic and as small as possible. This will make the antenna and guy wires almost invisible from distances of more than a few feet away, but unfortunately, the feed line will still be visible. Another step is to hide your antenna in trees. Most of the antennas I'll describe will work fairly well when hidden in this manner, although their efficiency will suffer to some degree. If you do hide your antenna in a tree, construct it from **insulated** wire. Another good step is to bury your transmission line if you're operating from a fixed location and your antenna is some distance from your house.

6) If you're using expropriated equipment, eradicate all serial numbers on it. If the numbers are stamped on a metal chassis, get an electric drill and a large steel bit, drill out the numbers and then file down the edges. Do not attempt to file off serial numbers; it's virtually impossible to eradicate them that way.

7) Go mobile. It's a hell of a lot harder for the FCC to track down a moving automobile or bicycle than a stationary target. Portable operation (driving up the side of a mountain and setting up there for a short period, for example) will also make it harder for the feds to track you down. The disadvantages of this method are that mobile antennas tend to be less efficient than fixed antennas and the FCC will not need a search warrant to bust you if you're engaged in mobile or portable operation.

8) Have someone watching (preferably with binoculars) for suspicious vehicles if you're operating from a fixed or portable location.

9) Switch frequencies often. This will make it much harder for the FCC to track you down. On the other hand it will also make it much harder for listeners to find you. A reasonable compromise would be to pick a slot, say between 90 and 91 MHz if that was clear in your area, and to operate on frequencies between those boundaries.

10) Operate sporadically. Maintaining a regular schedule (especially if you're always on the same frequency) makes it easy for the FCC to lay for you.

11) Operate for short periods of time, especially in cities with FCC regional offices and "cars in town." If the FCC is on to you, they can track you down in as little as 10 or 15 minutes using direction-finding equipment. So, keep your operating periods short, especially if you're operating from a fixed location. If you're using mobile operation, you can get away with longer transmissions, say up to an hour or so, without too much danger.

12) If you feel like getting exotic you could use the square wave generator and decoder outlined here to operate from a remote location via a phone line. You would turn your transmitter on (at the remote location) by feeding a square wave into the phone line at your end; at the transmitter site the decoder would trigger the latching relay which would connect the transmitter to its power source. For increased security, rather than feeding your audio signal via the phone line, you could have a tape deck (which would also be turned on/off by the decoder) as your audio source. To turn off the transmitter you would merely send the decoder another square wave via the phone line. Square waves are made up of overtones, and phone lines are designed to carry speech frequencies (about 300 to 3500 Hz), so if you use this system the fundamental of your square wave should be somewhere around 400Hz.

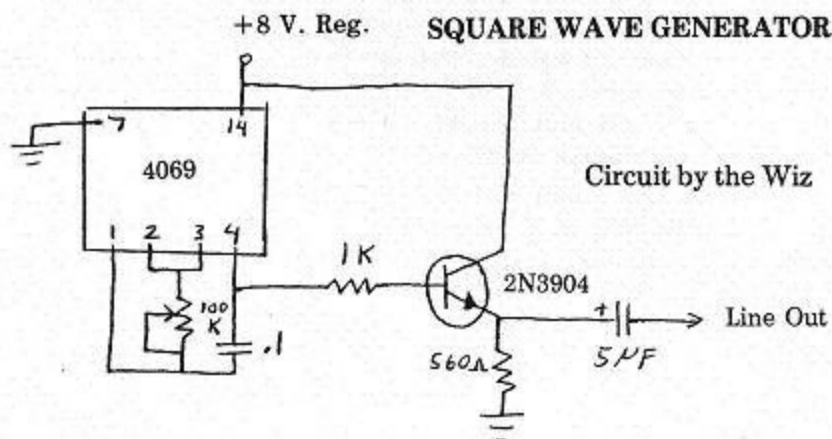

SQUARE WAVE DECODER

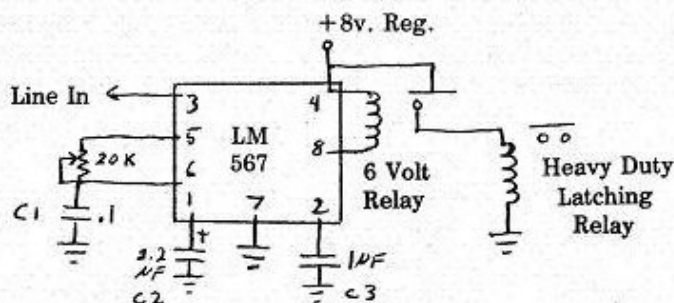

Circuit by the Wiz

$$C3 = 10 \times C1$$

$$\text{Freq.} = 1/R1 \times C1$$

$$C2 = 2 \times C3$$

13) If you don't want to get exotic, but still want to use remote operation from a fixed site, I'd suggest that you buy a timer to turn your equipment on and off. As a safety precaution you might want to buy a fairly elaborate timer which would allow you to set it for varying times days in advance. (For the extra \$15 or \$20 you'd pay over the cost of a simple timer, I think it's worth it.) A further safety precaution would be to observe your transmitter site while it's on the air in order to be sure that the FCC was not on to you. A still further precaution would be to have your transmitter site located in a storage space you had rented under a phony name. (The telephone can be an invaluable tool in obtaining references from "ex-landlords" and "employers"—in reality your friends—for prospective landlords.)

If you follow the preceding advice, you'll greatly reduce your chances of being busted by the FCC.

THE STUDIO

It's relatively easy to build a studio. Chances are that you may already have some of the equipment you need to put one together. A typical studio would contain the following:

- 1) A control board (mixer).
- 2) Two or three turntables.
- 3) Two or three cassette decks.
- 4) Two microphones (one for the jock, one for those being interviewed).
- 5) A telephone and telephone patch (for conducting over-the-phone interviews).

For those who choose to build their own boards, the following design should serve well. It's cheap and easy to build, uses readily available components, will handle up to about a dozen inputs (add FET preamps as needed), and even has a cue channel. Its only drawback is that the chip has a tendency to oscillate—so keep leads short.

(Keep leads short, shield all leads and if necessary add 10 ohm resistors between output coupling capacitors and the load to suppress oscillation.)

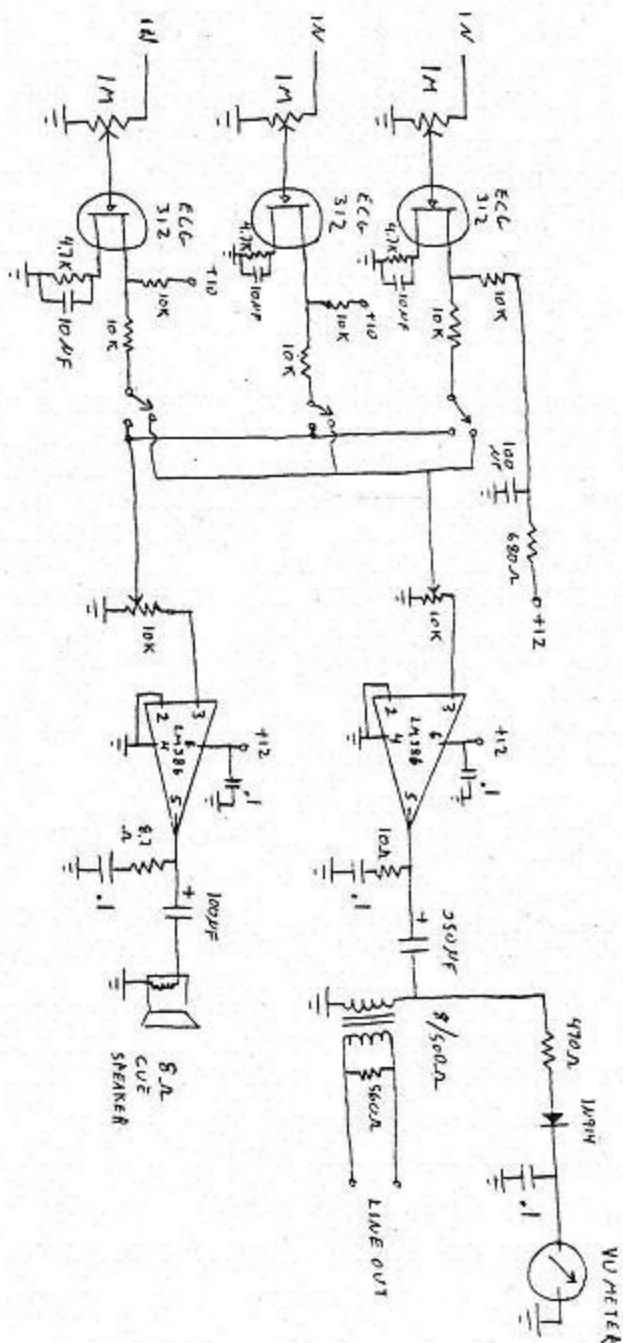

CONTROL BOARD

Circuit by the Wiz

You'll need at least two turntables; don't try to get by with one—it'd be too awkward. If you can get some, get old broadcast turntables. If you can't, use the cheapest manual turntables you can find. Don't use automatic turntables if you can avoid it. Simplicity is a virtue, especially in turntables.

Use cheap cartridges. The life of a stylus tends to be short in studios (due more to operator carelessness than anything else—broadcast engineers, with good reason, often refer to disc jockeys as "monkeys with microphones"), so there's no point in spending more than is absolutely necessary for cartridges.

You'll want to mount toggle switches (wall-type light switches work nicely) in your desk to turn the turntables off and on. This is much more convenient than using the controls on the turntables themselves and will allow you to cue records—just leave the turntable controls in the "on, arm down" position and turn them on and off with the toggle switches.

At least two tape decks are necessary, and three are preferable, in a studio: one or two for playing spots, taped interviews, etc., and one for recording programs. For playing spots, commercial broadcast cart machines are preferable to cassette decks, but cart machines are hard to come by, and cassette decks are a reasonable substitute.

Don't spend a lot of money on microphones. Twenty dollar wholesale house specials will do fine for your purposes. You can get by with one, but if you want to do interviews or have guests you'll need two. Before buying mikes make sure that their impedance and output level matches your preamp/board combo.

The easiest way to record telephone conversations is to use a microphone built for that purpose; these come with built-in suction cups which allow them to be attached directly to the headpiece of a phone. Contact mikes for musical instruments should also be able to be used for this purpose, although audio fidelity might suffer. If you do much over-the-phone work, though, keep one thing in mind: phones can be, and frequently are, tapped. So, if you're concerned about security you might want to avoid this use of the telephone.

You don't need to spend much money on a desk or table for your studio. Hollow wooden doors set on cinder blocks will do just fine.

If you're feeding the output from your board directly into your transmitter (**not recommended**—see section on "Getting Away With It") you'll want to protect your board by feeding its output through a RF choke and/or coupling transformer.

The importance of proper grounding must be emphasized. Very little care is often taken in this area and it leads to hum, ground loop, intermodulation, noise, etc. Large copper strapping going to a physical earth ground (water pipes are generally suitable) is recommended. All equipment should be chassis-connected to the ground buss.

If money is no object, audio patch bays and distribution amps are preferred as is 600 ohm balanced audio. On audio lines, ground the

shield at one end of its run only. Care should be taken with RF shielding if the transmitter is located close to the studio. Attention to AC polarity when plugging gear in will sometimes reduce ground loop and hum. (An AC polarity tester is handy to have.) Keep cables with line-level differences apart, for example, keep AC lines isolated from mike lines. And finally, make sure that your solder connections are good.

When designing a studio you need to keep one thing in mind: operator convenience. Everything should be within easy reach of the operator. A typical design would look something like this:

STUDIO DESIGN

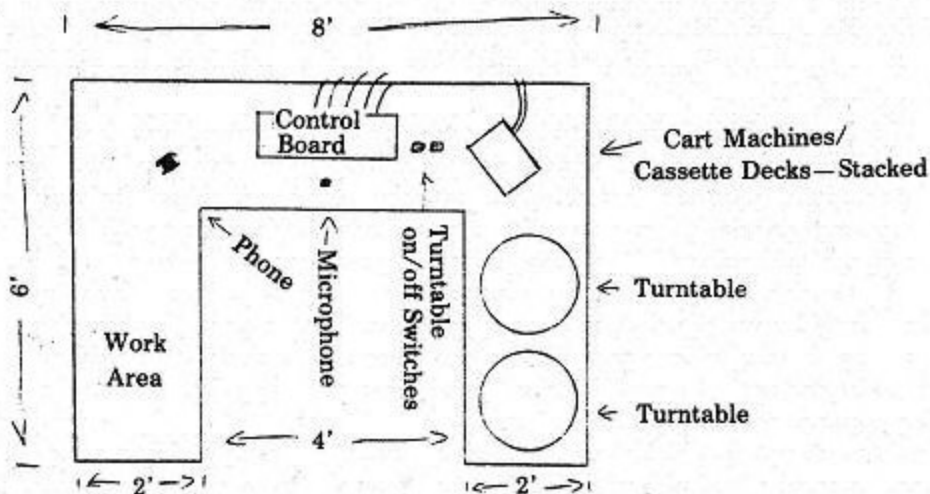

TRANSMITTERS

The three transmitter schematics presented here are all simple. Anyone with electronics construction experience (even building kits) should be able to build any of them.

A schematic for a transistorized transmitter which can be easily modified to work on the AM broadcast band can be found on page 500 of the ARRL's 1972 RAH.

I haven't included any schematics for shortwave transmitters for the simple reason that it would be pointless to do so. There are vast numbers of high quality old ham transmitters available at low cost which can easily be modified to work on several shortwave bands, and can work on others without modification. The cost of parts to build equivalent transmitters from scratch would probably run to two or three times (or even higher) the cost of these widely available, professionally built transmitters.

10 WATT FM TRANSMITTER

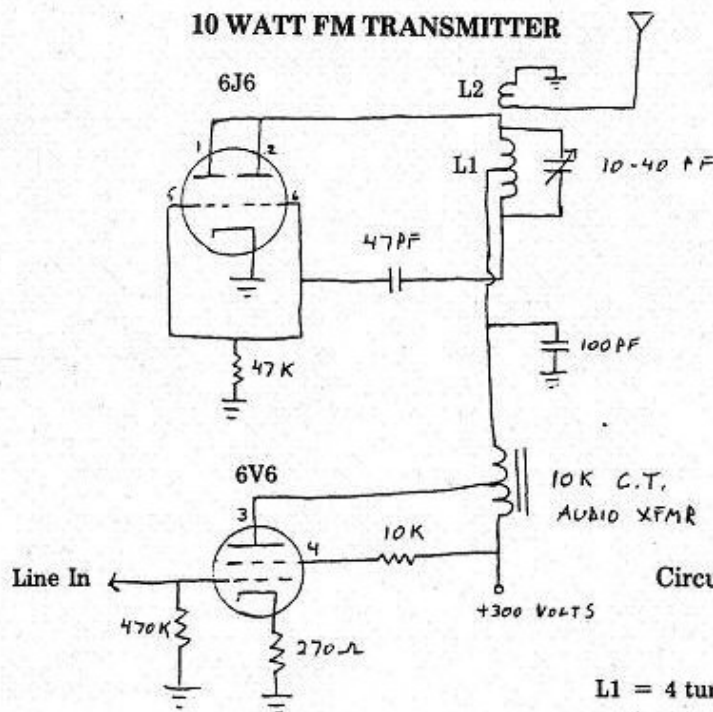

L1 = 4 turns 1" Diam. #18

L2 = 2 Turns 1" Diam. #18

(Be careful about TVI, television interference, especially on channels 2 and 5 with all FM transmitters. Changing frequency will generally take care of any problems.

5 WATT FM TRANSMITTER

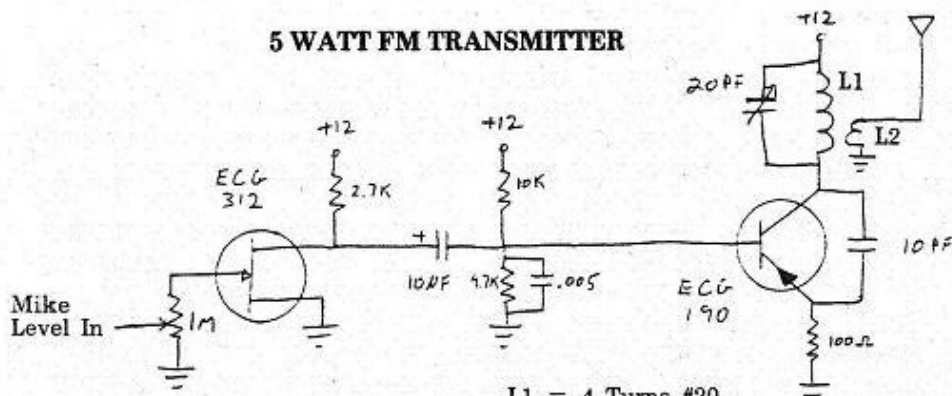

L1 = 4 Turns #20,
 $\frac{1}{2}$ " Diameter or Miller #71 osc.

L2 = 2 Turns #20

Circuit by the Wiz

Whatever you do, though, use coax. It is possible to buy cheap 75 ohm cable ("twin lead"), but line losses are excessive with it.

DIPOLE

The dipole is your bread-and-butter antenna. It's cheap and easy to build, takes reasonably well to being hidden in trees, can be put up and taken down in a short time, and is a practical antenna for virtually any frequency. When using dipoles keep the following in mind: 1) If you're going to string it up in trees for concealment purposes, make it from insulated wire; 2) If you're going to put it up and take it down frequently, make it from stranded wire (#12 or #14 stranded, insulated wire is a good choice); 3) In general, the higher a dipole is above the ground the better it will work; 4) The dipole is moderately directional and most of its radiation will be perpendicular to the direction of its wires—it radiates broadside in other words; 5) At higher frequencies dipoles can be hung from one end to produce the "vertical dipole," a configuration which will produce omnidirectional radiation; 6) If you do use a vertical dipole, make sure that the "hot" lead (center conductor) from your coax goes to the top half of the dipole; 7) Dipoles should be fed with 75 ohm coax.

The "inverted vee" is a variation on the dipole in which the center is higher than the ends. It will produce nearly omnidirectional radiation. About the only point not covered in the above which you'll need to remember if you use an inverted vee is that the angle between the two legs of the antenna should be at least 90 degrees.

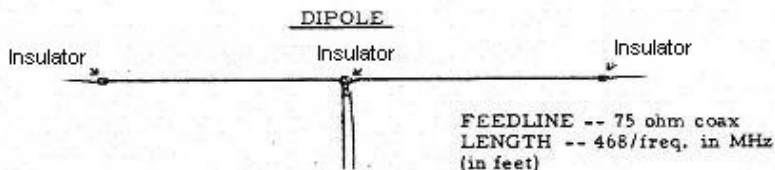

GROUND PLANE

The ground plane is a very useful antenna for frequencies above 15 MHz. Its pattern is omnidirectional and its construction is simplicity itself. It consists of a quarter-wave vertical radiator (often a piece of aluminum conduit, although wire supported by a stick will do) with four quarter-wave radials attached to the braid of the coax transmission line. If you build a ground plane, keep the following in mind: 1) The radials should be about 3 percent longer than the vertical radiator; 2) The radials should be as near to 90 degrees apart from each other as possible; 3) The higher a ground plane is the better it will work; 4) If the radials are flat, or nearly so, you should feed it with 52 ohm coax and use a one-sixth wave (physical length) matching section of 75 ohm coax

between the 52 ohm coax line and the antenna; 5) If the radials are slanted down at approximately a 45 degree angle you can feed the antenna directly with 52 ohm coax.

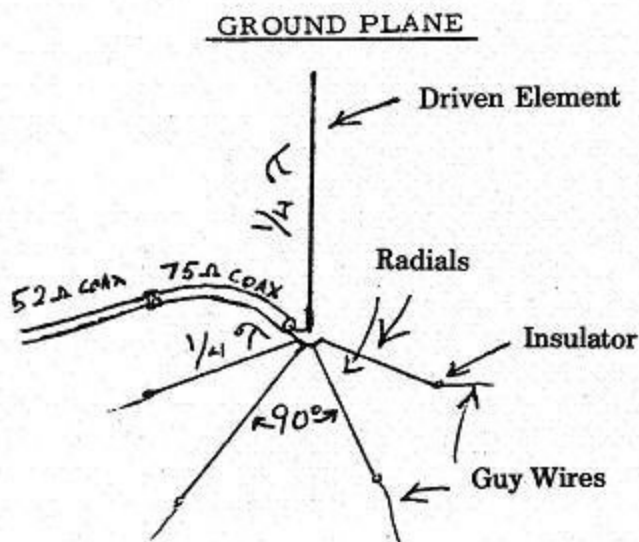

<u>Freq.</u>	<u>Driven Element</u>	<u>Radials</u>	<u>75-ohm Matching Section</u>
15.3	15'5"	15'9"	10'3"
21.5	11'6"	11'9"	7'8"
90.0	2'9"	2'10"	1'10"
100.0	2'6"	2'7"	1'8"

HELICALLY WOUND VERTICAL

The helically wound vertical is a "compromise" antenna—in other words it should be used only where a full-size antenna is not practical. On the negative side, the helically wound vertical is a much less efficient radiator and tends to be more frequency conscious than a full-size antenna. On the positive side, it's easy to construct and takes up comparatively little room. As this antenna is used only because of space reasons, it makes no sense to use it at frequencies above approximately 10 MHz. If you build a helically wound vertical, keep the following things in mind: 1) As this antenna is fairly frequency conscious, build it for the **highest** frequency you'll be using, e.g., 1.6 MHz for the AM band, and put a tapped loading coil at the base if you plan on going much below that frequency; 2) The size of the loading coil isn't terribly important—just make it fairly large; 3) Wind the antenna with insulated wire; 4) Use a good ground system (this is important—a half-inch steel pipe driven three or four feet into the ground with several radials connected to it will do nicely, and chicken wire mesh will do in place of the radials), and in general it's better to have a lot of short radials than a few long ones.

HELICALLY WOUND VERTICAL

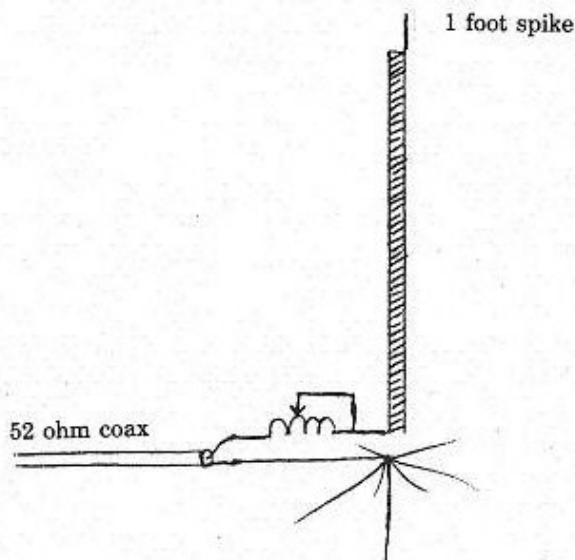

COIL -- 30 turns #14, 3" diameter, 5 turns per inch
 POLE -- 10' to 25' of PVC pipe 2" in diameter
 LENGTH OF WIRE -- 307' for 1.6 MHz; 147' for 3.4 MHz

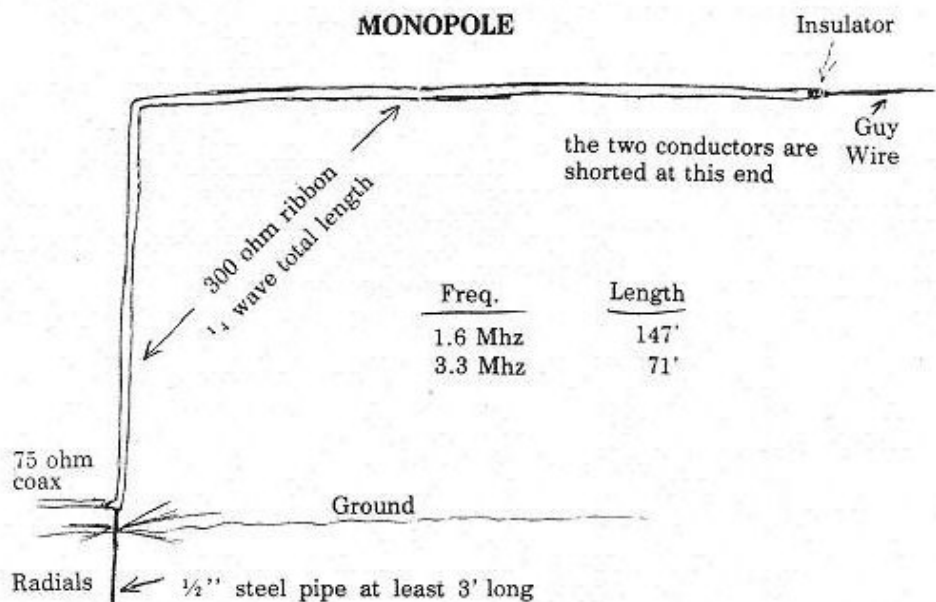

The monopole was originally invented as a limited-space 160 meter ham antenna. It's a good choice for AM and 3.2 to 3.4 MHz operation as it's cheap and easy to build, and is well-adapted to being hidden in trees because of its construction from 300 ohm ribbon. This antenna requires a good ground system. (See the comments regarding the ground system for the helically wound vertical.) The greater the length of the vertical section, the better this antenna will work—but it'll still work reasonably well with a short vertical section and a long horizontal section.

YAGI

The yagi, named after its inventor, is the most common type of directional antenna, and with good reason—its construction is relatively simple and it delivers a relatively high amount of gain. For stationary operation, yagis can be constructed from wire; and for rotatable use can be constructed from aluminum conduit ("plumber's delight" construction—see the section "Rotary Beam Construction" in the **ARRL Antenna Book** for examples of this type of construction). If you're operating on the 15.1 or 21.45 MHz shortwave bands and aiming for a particular country or region, a wire yagi would be an excellent choice. With a yagi on FM you can set up literally miles farther away from your intended audience than you could if you were using a dipole or some type of omnidirectional antenna. (The four element yagi outlined here will deliver approximately 9 db of gain; this is equivalent to multiplying the power output of your transmitter by eight.)

2 ELEMENT YAGI

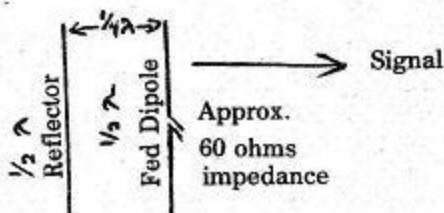

Freq.	Element Lengths	Spacing
15.3	30' 7"	16' 1"
21.5	21' 9"	11' 6"
90.0	5' 2"	2' 9"
100.0	4' 8"	2' 6"

GAIN -- 4.5db

FEEDLINE -- 52 or 75 ohm coax

3 ELEMENT YAGI

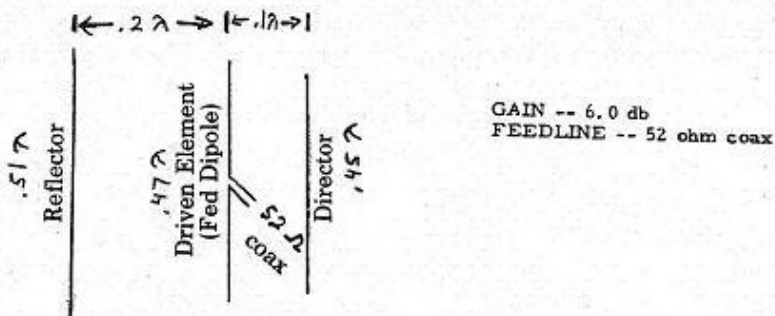

4 ELEMENT YAGI

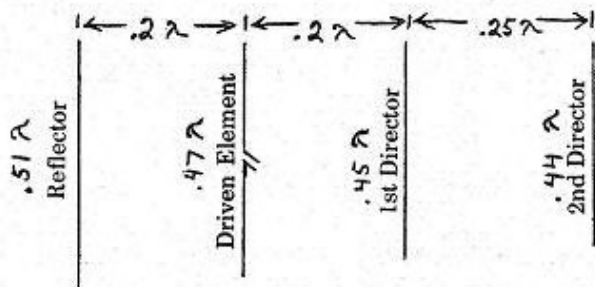

GAIN -- 9.0 db
FEEDLINE -- 52 ohm coax
with a 1/6 wave section of 75
ohm coax (physical size)
inserted between the 52 ohm
coax and the antenna

CUBICAL QUAD

The cubical quad is another type of directional antenna. It's cheap and easy to construct, but bulky and not really practical for pirate use except for the FM band. For the FM band the sides of the quad will only be about two-and-a-half feet long. A two element cubical quad will deliver about as much gain as a three element yagi (about 7 db). There are a few things to bear in mind if you build a quad: 1) The wires making up the loops must be insulated from the supports (TV standoff insulators and bamboo poles will work fine); 2) The two loops should be as nearly parallel as possible; 3) You'll need to tune the rear loop—using the shorting bar on the tuning stub—to maximize gain; an easy way to

do this for quads for the FM band is to set up a FM receiver without an antenna 50 or 100 feet directly in front of the quad, feed a low-level signal to it, adjust its tuning stub (turn off the transmitter while you're making the adjustments) and have a friend watch the signal strength meters or LEDs on the receiver for maximum signal strength.

CUBICAL QUAD

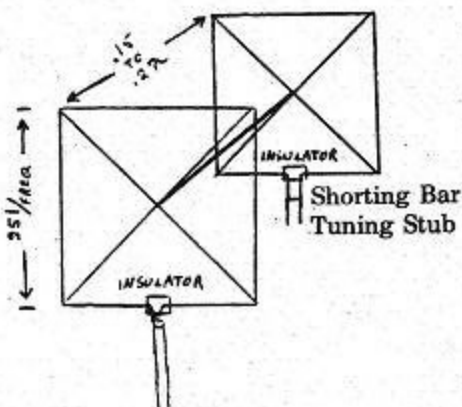

(Loops parallel to each other)

GAIN -- 7 db

FEEDLINE -- 75 ohm coax

SPACING -- .15 to .2 wavelengths between the loops

Freq.	Side	Stub
90	2'9"	6"
100	2'6"	6"

MOBILE OPERATION

Mobile operation is basically pretty simple—it consists of broadcasting from a moving vehicle. That vehicle can be a car, van, truck, or even a bicycle or motorcycle. Because of antenna size considerations, mobile operation is most practical at frequencies above 15 MHz. While mobile operation is possible at lower frequencies, such operation does have drawbacks: 1) Mobile antennas for frequencies below 15 MHz require bulky loading coils which are highly visible; 2) Such antennas are relatively inefficient. Because of these reasons I won't bother to include designs for such antennas. (Those interested in mobile operation on the lower frequencies should consult **The ARRL Antenna Book**.)

Mobile operation on the shortwave bands doesn't make much sense either, for the following reasons: 1) Pirate shortwave operation is relatively low risk; 2) If you're operating on the 15.1 or 21.45 MHz bands you'll in all probability be aiming for a specific region thousands of miles away and will want to use a directional antenna, an impossibility with mobile operation. For those reason, I'd recommend portable or fixed rather than mobile operation on the shortwave bands and the use of two or three element yagis.

That leaves the FM band. Fortunately, mobile operation on FM is easy. If you're using a transistorized transmitter you can, in most cases, run it directly off your car battery (this is the case with all the

transistorized schematics in this pamphlet). If you're using a tube-type transmitter, you'll need a DC/AC inverter. Your best bet is to buy one at an auto parts store.

Your antenna for mobile FM operation is simplicity itself—a quarter-wave vertical radiator with the car (or bike) body acting as ground. This antenna should be fed with 52 ohm coax with a one-sixth wave (physical length) matching section of 75 ohm coax inserted between the 52 ohm line and the antenna. For concealment purposes you can simply adjust your car radio antenna to the proper height for the frequency you're on and feed it. The pattern you'll get from this will not be strictly omnidirectional (your signal will be reflected away to an extent from your car's roof), but this isn't terribly important.

A small portable cassette player will provide a suitable audio source for mobile/portable operation.

Finally, if you do engage in mobile operation, in addition to following the recommendations in the "Getting Away With It" section, you'll probably want to take the additional safety precaution of operating on busy streets during times when there's a fair amount of traffic.

FINDING PARTS

Electronics parts are easy to come by—just open up the yellow pages if you live in an urban area. Radio Shacks generally have a fair supply of the most common parts, but their prices tend to be high. If you live out in the sticks, you can order parts by mail from many sources which advertise in QST, CQ, 73 and other electronics magazines. And the 1985 version of the RAH contains a list of parts suppliers on page 35-28.

A good source for parts such as variable capacitors which cost an arm and a leg if purchased new is the ham swap fest. You can frequently pick up parts at these gatherings for a small fraction of the cost new.

If you're really broke you can get parts free quite often by cannibalizing junked radios, TVs, stereos, and any other type of electronics garbage you can lay your hands on. If you follow this course, you need to be aware that some parts are more affected by use than others. Paper capacitors from junked equipment should not be used unless you have no alternative, and carbon resistors from such equipment should be carefully checked for heat damage. If resistors are heat damaged they'll often take on a shiny appearance, become brittle, show hairline fractures, or simply look burnt. Use of such resistors should be avoided as should use of fixed value capacitors which show signs of leakage (such leakage is pretty obvious). Most other parts from junked equipment will work as well as new parts. All parts should, however, be tested before you attempt to use them.

TEST EQUIPMENT

There are several pieces of test equipment you will find useful. First, you will need a good quality volt-ohm-milliamper meter (VOM). Radio Shack sells a good one for around 30 bucks. Secondly, you'll probably want a standing wave ratio (SWR) bridge for use between your antenna and transmitter, although a SWR bridge isn't really essential for a "cheap and dirty" approach. See page 531 of the 1972 RAH and page 16-32 of the 1982 RAH for schematics as well as any edition of the ARRL Antenna Handbook.

Another useful piece of gear is a field strength meter, which is helpful in adjusting directional antennas. The following field strength meter should work for frequencies from the broadcast band up to around 30 MHz.

FIELD STRENGTH METER

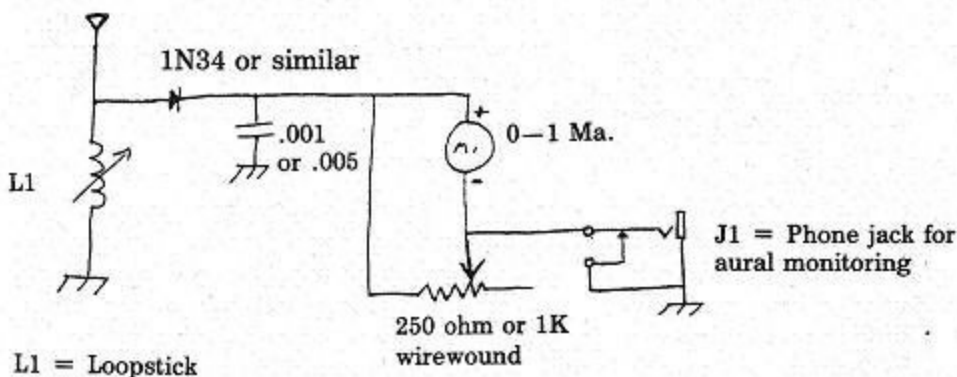

(This circuit should be enclosed in a metal box. Its antenna is a short piece of wire mounted on a feed-through insulator.)

Another very useful piece of equipment is the dip meter, which will let you know the resonant frequency of any tuned circuit or antenna. See page 16-20 of the 1982 RAH for a schematic.

A transistor checker can also be useful, especially if you're using salvaged parts. See page 16-27 of the 1982 RAH for a schematic.

The simple 12 volt supply on page 27-1 of the 1985 RAH will provide all the power any of the transistor circuits in this pamphlet require. Simple designs for high-voltage power supplies can be found in any edition of the RAH.

SAFETY MEASURES

It's extremely important to ground all of your equipment, both at the studio and at your transmitter site.

Avoid the use of solvents for cleaning. Virtually all common solvents (benzene, acetone, xylene, carbon tetrachloride, etc.) are highly toxic and carcinogenic. Alcohol and burnishing tools are all you'll normally need for cleaning purposes. If you do use solvents for cleaning or do much soldering (solder contains a lot of lead) do so in a well ventilated area.

TECHNICAL REFERENCES

The Radio Amateur's Handbook, published yearly by the American Radio Relay League. **YOU NEED THIS BOOK.** This is the single best source of information for pirate operators. It contains straightforward explanations of almost any technical questions you might have, vast amounts of useful technical information (color codes for resistors and capacitors, specs for all common tubes and transistors, etc.) and many schematics which can be used or easily modified for pirate use. This book is updated yearly, so it's actually not a bad idea to own copies from different years—any copy from around the mid'50s on should be of use to you. Be aware that there are other books bearing the title **Radio Amateur's Handbook**; all are vastly inferior to the ARRL's Handbook. Fair Radio Sales, P.O. Box 1105, Lima, Ohio 45802 sometimes has used handbooks available for a few dollars; the price of a new book is now around \$20.

The ARRL Antenna Book. Another fine ARRL publication. It contains all the information you'll probably ever need about antennas.

Seven Steps to Designing Your Own Ham Equipment, by L.B. Cebik, a SAMS publication. This contains a lot of useful information on designing and constructing equipment and is well worth owning.

VHF Projects for Amateur Experimenters, by Wayne Green, TAB Books #608. This contains many circuits which can be modified for use on the FM band.

Engineer's Notebook, by Forrest Mimms. Contains good info on integrated circuits. Available at Radio Shack.

Cienfuegos Anarchist Review #5. Contains step-by-step instructions for the complete novice on putting together a simple FM transmitter.

The Complete Handbook of Radio Transmitters, by Joseph Carr. TAB publication #1224. Contains much much useful information including schematics for amplifiers for the HF and VHF bands.

Simple, Low-Cost Wire Antennas, by Wm. Orr and Stuart Cowan. An excellent introduction to antenna construction for those with no previous experience in this field. Highly recommended.