

# Contents

## A-Z

Owner's Manual  
for Vehicle



The Ultimate  
Driving Machine



# THE BMW 3 SERIES SEDAN.

## OWNER'S MANUAL.

**BMW EfficientDynamics**  
Less emissions. More driving pleasure.



## 3 Series **Owner's Manual for Vehicle**

Thank you for choosing a BMW.

The more familiar you are with your vehicle, the better control you will have on the road. We therefore strongly suggest:

Read this Owner's Manual before starting off in your new BMW. Also use the Integrated Owner's Manual in your vehicle. It contains important information on vehicle operation that will help you make full use of the technical features available in your BMW. The manual also contains information designed to enhance operating reliability and road safety, and to contribute to maintaining the value of your BMW.

Any updates made after the editorial deadline for the printed or Integrated Owner's Manual are located in the appendix of the printed quick reference for the vehicle.

Supplementary information can be found in the additional brochures in the onboard literature.

We wish you a safe and enjoyable drive.

BMW AG

© 2014 Bayerische Motoren Werke  
Aktiengesellschaft  
Munich, Germany  
Reprinting, including excerpts, only with the written  
consent of BMW AG, Munich.  
US English II/14, 03 14 490  
Printed on environmentally friendly paper, bleached  
without chlorine, suitable for recycling.

# Contents

The fastest way to find information on a particular topic or item is by using the index, refer to page [232](#).

[6](#) Notes

## At a glance

[12](#) Cockpit

[16](#) iDrive

[24](#) Voice activation system

[27](#) Integrated Owner's Manual in the vehicle

## Controls

[32](#) Opening and closing

[47](#) Adjusting

[57](#) Transporting children safely

[61](#) Driving

[73](#) Displays

[89](#) Lamps

[94](#) Safety

[114](#) Driving stability control systems

[119](#) Driving comfort

[141](#) Climate control

[148](#) Interior equipment

[156](#) Storage compartments

## Driving tips

[162](#) Things to remember when driving

[165](#) Loading

[168](#) Saving fuel

## Mobility

[178](#) Refueling

[180](#) Fuel

[185](#) Wheels and tires

[196](#) Engine compartment

[198](#) Engine oil

[201](#) Coolant

[202](#) Maintenance

[204](#) Replacing components

[215](#) Breakdown assistance

[221](#) Care

## Reference

[228](#) Technical data

[232](#) Everything from A to Z

# Notes

## Using this Owner's Manual

### Orientation

The fastest way to find information on a particular topic is by using the index.

An initial overview of the vehicle is provided in the first chapter.

### Updates made after the editorial deadline

Any updates made after the editorial deadline for the Owner's Manuals are located in the appendix of the printed quick reference for the vehicle.

### User's manual for Navigation, Entertainment, Communication

The topics of Navigation, Entertainment, Communication and the short commands of the voice activation system are described in a separate user's manual, which is also included with the onboard literature.

### Additional sources of information

The service center will be happy to answer any other questions you may have.

Information on BMW, e.g., on technology, is available on the Internet: [www.bmwusa.com](http://www.bmwusa.com).

## Symbols

 Indicates precautions that must be followed precisely in order to avoid the possibility of personal injury and serious damage to the vehicle.

◀ Marks the end of a specific item of information.

"..." Identifies Control Display texts used to select individual functions.

»...« Verbal instructions to use with the voice activation system.

»...« Identifies the answers generated by the voice activation system.

 Refers to measures that can be taken to help protect the environment.

### Symbols on vehicle components

 Indicates that you should consult the relevant section of this Owner's Manual for information on a particular part or assembly.

## Vehicle equipment

This Owner's Manual describes all models and all standard, country-specific and optional equipment that is offered in the model series. Therefore, in this Owner's Manual, equipment is also described and illustrated that is not available in your vehicle, e.g., because of the selected optional equipment or the country-specific variants.

This also applies for safety-related functions and systems.

For any options and equipment not described in this Owner's Handbook, refer to the Supplementary Owner's Handbooks.

On right-hand drive vehicles, some control elements are arranged differently than shown in the illustrations.

## Status of the Owner's Manual

### Basic information

The manufacturer of your vehicle pursues a policy of constant development that is conceived to ensure that our vehicles continue to embody the highest quality and safety stan-

dards. In rare cases, therefore, the features described in this Owner's Manual may differ from those in your vehicle.

### Updates made after the editorial deadline

Any updates made after the editorial deadline for the Owner's Manuals are located in the appendix of the printed quick reference for the vehicle.

## For your own safety

### Warranty

Your vehicle is technically configured for the operating conditions and registration requirements applying in the country of first delivery - homologation. If your vehicle is to be operated in a different country it might be necessary to adapt your vehicle to potentially differing operating conditions and permit requirements. If your vehicle does not comply with the homologation requirements in a certain country you cannot lodge warranty claims for your vehicle there. Further information can be obtained from your Service Centre.

### Maintenance and repairs

Advanced technology, e.g., the use of modern materials and high-performance electronics, requires suitable maintenance and repair methods.

Therefore, have this work performed only by a BMW center or a workshop that works according to BMW repair procedures with appropriately trained personnel.

If this work is not carried out properly, there is the danger of subsequent damage and related safety hazards.

### Parts and accessories

BMW recommends using parts and accessories approved by BMW for this purpose.

Your BMW center is the right contact for genuine BMW parts and accessories, other products approved by BMW and related qualified advice.

BMW has tested these products for safety and suitability in relation to BMW vehicles.

BMW can assume responsibility for them. However, we cannot assume any responsibility whatsoever for parts and accessories that have not been specifically approved by BMW.

BMW cannot evaluate whether each individual product from another manufacturer can be used with BMW vehicles without presenting a safety hazard. This guarantee is also not applicable when country-specific government approval has been granted. Testing of this kind may fail to embrace the entire range of potential operating conditions to which components might be exposed on BMW vehicles. Such products could conceivably fail to comply with BMW's own stringent quality standards.

### California Proposition 65 Warning

California laws require us to state the following warning:

Engine exhaust and a wide variety of automobile components and parts, including components found in the interior furnishings in a vehicle, contain or emit chemicals known to the State of California to cause cancer and birth defects and reproductive harm. In addition, certain fluids contained in vehicles and certain products of component wear contain or emit chemicals known to the State of California to cause cancer and birth defects or other reproductive harm. Battery posts, terminals and related accessories contain lead and lead compounds. Wash your hands after handling. Used engine oil contains chemicals that have caused cancer in laboratory animals. Always protect your skin by washing thoroughly with soap and water.



## Service and warranty

We recommend that you read this publication thoroughly. Your vehicle is covered by the following warranties:

- ▷ New Vehicle Limited Warranty.
- ▷ Rust Perforation Limited Warranty.
- ▷ Federal Emissions System Defect Warranty.
- ▷ Federal Emissions Performance Warranty.
- ▷ California Emission Control System Limited Warranty.

Detailed information about these warranties is listed in the Service and Warranty Information Booklet for US models or in the Warranty and Service Guide Booklet for Canadian models.

Your vehicle has been specifically adapted and designed to meet the particular operating conditions and homologation requirements in your country and continental region in order to deliver the full driving pleasure while the vehicle is operated under those conditions. If you wish to operate your vehicle in another country or region, you may be required to adapt your vehicle to meet different prevailing operating conditions and homologation requirements. You should also be aware of any applicable warranty limitations or exclusions for such country or region. In such case, please contact Customer Relations for further information.

## Maintenance

Maintain the vehicle regularly to sustain the road safety, operational reliability and the New Vehicle Limited Warranty.

Specifications for required maintenance measures:

- ▷ BMW Maintenance system
- ▷ Service and Warranty Information Booklet for US models
- ▷ Warranty and Service Guide Booklet for Canadian models

If the vehicle is not maintained according to these specifications, this could result in seri-

ous damage to the vehicle. Such damage is not covered by the BMW New Vehicle Limited Warranty.

## Data memory

Many electronic components on your vehicle are equipped with data memories that temporarily or permanently store technical information about the condition of the vehicle, events and faults. This technical information generally documents the state of a component, a module, a system or the environment:

- ▷ Operating states of system components, fill levels for instance.
- ▷ Status messages for the vehicle and from its individual components, e.g., wheel rotation speed/ vehicle speed, deceleration, transverse acceleration.
- ▷ Malfunctions and faults in important system components, e.g., lights and brakes.
- ▷ Responses by the vehicle to special situations, e.g., deployment of an airbag, engagement of stability control systems.
- ▷ Ambient conditions, such as temperature.

This data is purely technical in nature and is used to detect and correct faults and to optimize vehicle functions. Motion profiles over routes traveled cannot be created from this data. When service offerings are used, e.g., repair services, service processes, warranty claims, quality assurance, this technical information can be read out from the event and fault memories by the service personnel, including the manufacturer, using special diagnostic tools. You can obtain further information there if it is needed. After a fault is corrected, the information in the fault memory is deleted or overwritten on a continuous basis.

When the vehicle is in use, situations are conceivable in which it might be possible to associate this technical data with individuals if it is combined with other information, e.g., an accident report, damage to the vehicle, eye wit-



ness accounts — possibly with the assistance of an expert.

Additional functions that are contractually agreed with the customer, such as vehicle locating in an emergency, enable certain vehicle data to be transmitted from the vehicle.

## Event Data Recorder EDR

This vehicle is equipped with an event data recorder EDR. The main purpose of an EDR is to record, in certain crash or near crash-like situations, such as an air bag deployment or hitting a road obstacle, data that will assist in understanding how a vehicle's systems performed. The EDR is designed to record data related to vehicle dynamics and safety systems for a short period of time, typically 30 seconds or less.

The EDR in this vehicle is designed to record such data as:

- ▶ How various systems in your vehicle were operating.
- ▶ Whether or not the driver and passenger safety belts were fastened.
- ▶ How far, if at all, the driver was depressing the accelerator and/or brake pedal.
- ▶ How fast the vehicle was traveling.

These data can help provide a better understanding of the circumstances in which crashes and injuries occur.

EDR data are recorded by your vehicle only if a nontrivial crash situation occurs; no data are recorded by the EDR under normal driving conditions and no personal data, e.g., name, gender, age, and crash location, are recorded.

However, other parties, such as law enforcement, could combine the EDR data with the type of personally identifying data routinely acquired during a crash investigation.

To read data recorded by an EDR, special equipment is required, and access to the vehicle or the EDR is needed. In addition to the ve-

hicle manufacturer, other parties, such as law enforcement, that have the special equipment, can read the information if they have access to the vehicle or the EDR.

## Reporting safety defects

### For US customers

The following only applies to vehicles owned and operated in the US.

If you believe that your vehicle has a defect which could cause a crash or could cause injury or death, you should immediately inform the National Highway Traffic Safety Administration NHTSA, in addition to notifying BMW of North America, LLC, P.O. Box 1227, Westwood, New Jersey 07675-1227, Telephone 1-800-831-1117.

If NHTSA receives similar complaints, it may open an investigation, and if it finds that a safety defect exists in a group of vehicles, it may order a recall and remedy campaign.

However, NHTSA cannot become involved in individual problems between you, your dealer, or BMW of North America, LLC.

To contact NHTSA, you may call the Vehicle Safety Hotline toll-free at 1-888-327-4236 (TTY: 1-800-424-9153); go to <http://www.safercar.gov>; or write to: Administrator, NHTSA, 400 Seventh Street, SW., Washington, DC 20590. You can also obtain other information about motor vehicle safety from <http://www.safercar.gov>.

### For Canadian customers

Canadian customers who wish to report a safety-related defect to Transport Canada, Defect Investigations and Recalls, may telephone the toll-free hotline 1-800-333-0510. You can also obtain other information about motor vehicle safety from <http://www.tc.gc.ca/roadsafety>.



## At a glance

These overviews of buttons, switches and displays are intended to familiarize you with your vehicle. You will also become quickly acquainted with the available control concepts and options.

# Cockpit

## Vehicle equipment

All standard, country-specific and optional equipment that is offered in the model series is described in this chapter. Therefore, equip-

ment is also described that is not available in a vehicle, e. g., because of the selected optional equipment or country variant. This also applies for safety-related functions and systems.

## All around the steering wheel

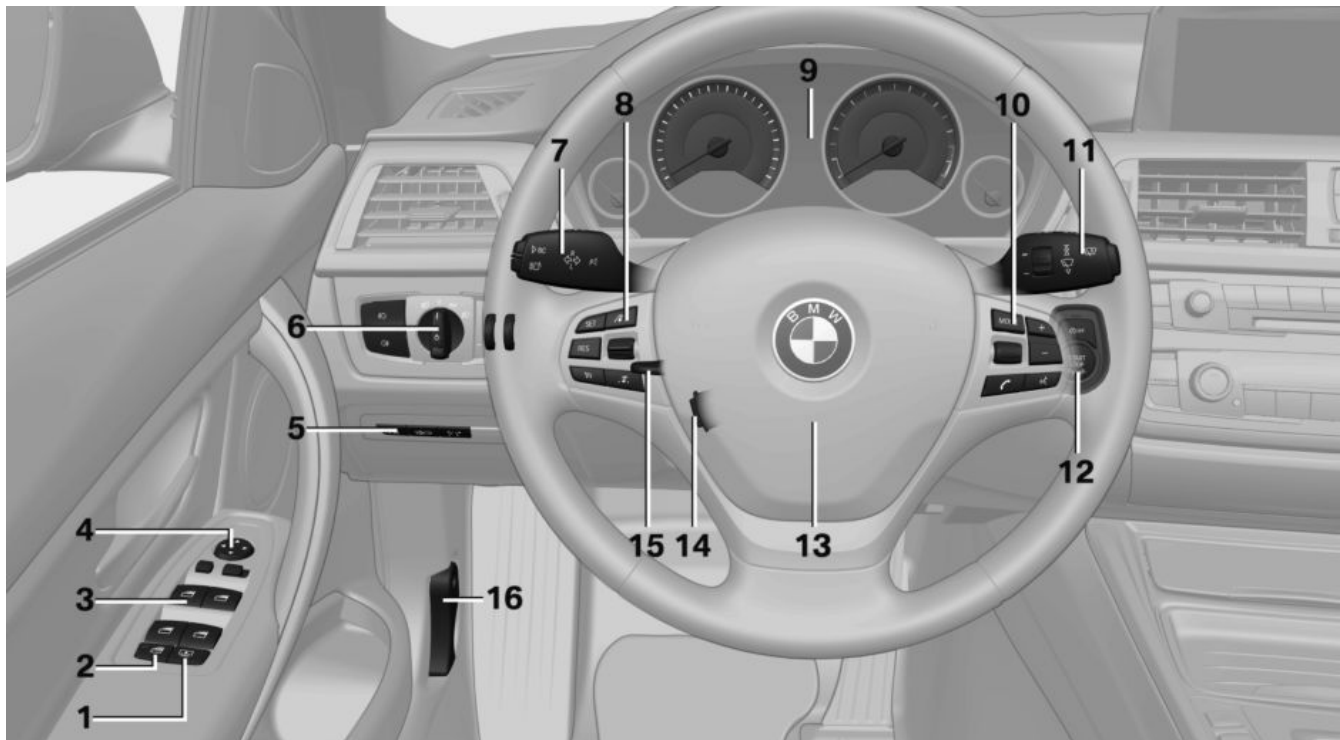

- 1 Roller sunblinds 44
- 2 Rear window safety switch 44
- 3 Power windows 43
- 4 Exterior mirror operation 54
- 5 Glove compartment on the driver's side 156

Driver assistance systems



Active Blind Spot Detection 111



Intelligent Safety 102



Lane departure warning 110

- 6 Lamps



Front fog lamps 92



Parking lamps 89



Low beams 89



Automatic headlamp control 90

Daytime running lights 90

Adaptive Light Control 90

High-beam Assistant 91



Instrument lighting 92

## 7 Steering column stalk, left



Turn signal 65



High beams, headlamp flasher 65



High-beam Assistant 91



Roadside parking lamps 90



Computer 83

## 8 Steering wheel buttons, left



Store speed 125, 119



Resume speed 127, 119



Cruise control on/off, interrupting 126



Active Cruise Control on/off, interrupting 119



Reduce distance 122



Increase distance 122



Cruise control rocker switch 127, 121

## 9 Instrument cluster 73

## 10 Steering wheel buttons, right



Entertainment source



Volume



Voice activation 24



Telephone, see user's manual for Navigation, Entertainment and Communication

Thumbwheel for selection lists 83

## 11 Steering column stalk, right



Windshield wipers 66



Rain sensor 67



Clean the windshields and headlamps 68

## 12 START STOP ENGINE



Auto Start/Stop function 63

## 13 Horn

## 14 Steering wheel heating 56







## 15 Adjust steering wheel 56

## 16 Unlock hood 197

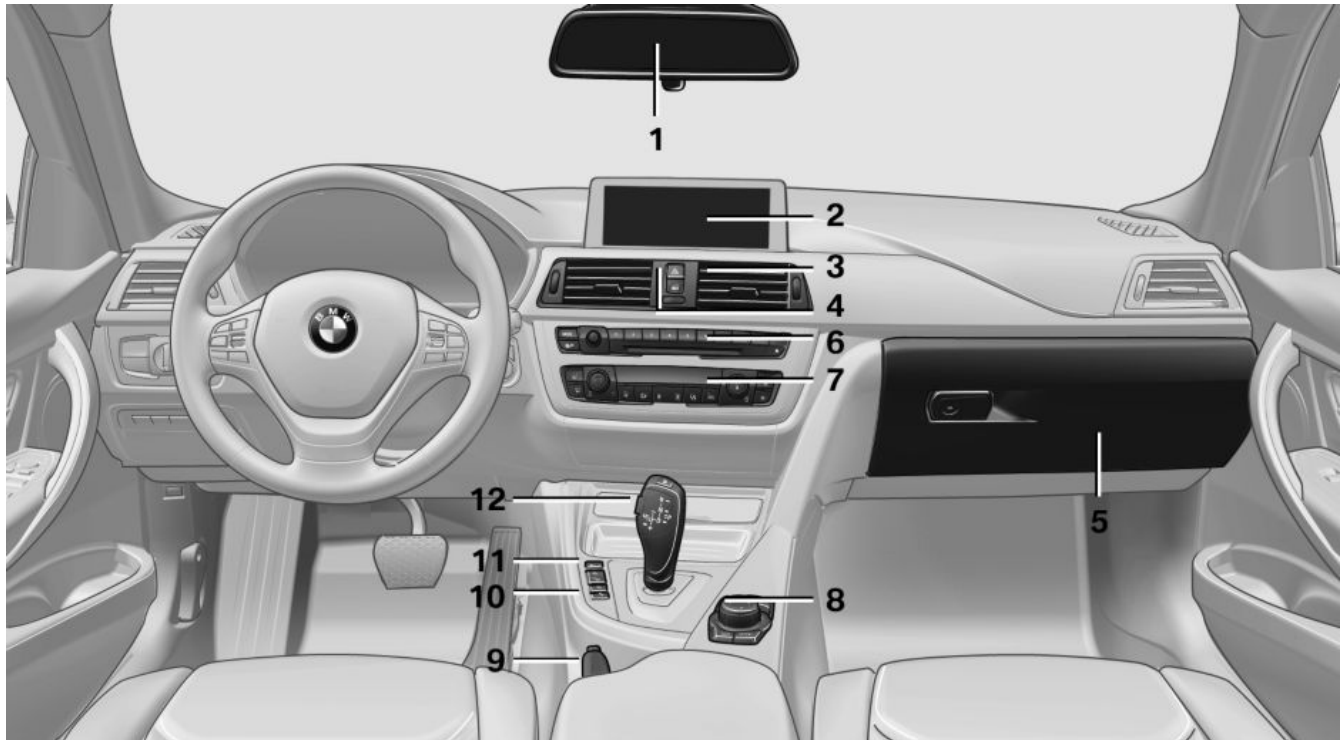





## All around the center console



- 1 Headliner [15](#)
- 2 Control Display [16](#)
- 3 Ventilation [146](#)
- 4  Hazard warning system [215](#)
- 5 Glove compartment [156](#)
- 6 Radio/CD/Multimedia, see user's manual for Navigation, Entertainment and Communication
- 7 Climate control [141](#)
- 8 Controller with buttons [16](#)
- 9 Parking brake [65](#)
- 10  PDC Park Distance Control [128](#)  
Rearview camera [130](#)  
Parking assistant [136](#)  
Surround View [130](#)
- 11  Driving Dynamics Control [116](#)  
DSC Dynamic Stability Control [114](#)
- 12 Automatic transmission selector lever [69](#)  
Manual transmission selector lever [69](#)

## All around the headliner



- |   |   |
|---|---|
| <p><b>1</b>  Intelligent Emergency Request <a href="#">215</a></p>          | <p><b>4</b>  Reading lamps <a href="#">92</a></p>   |
| <p><b>2</b>  Glass sunroof, powered <a href="#">45</a></p>                 | <p><b>5</b>  Interior lamps <a href="#">92</a></p> |
| <p><b>3</b>  Indicator lamp, front passenger airbag <a href="#">96</a></p> |   |



# iDrive

## Vehicle equipment

All standard, country-specific and optional equipment that is offered in the model series is described in this chapter. Therefore, equipment is also described that is not available in a vehicle, e. g., because of the selected optional equipment or country variant. This also applies for safety-related functions and systems.

## The concept

The iDrive combines the functions of a multitude of switches. Thus, these functions can be operated from a central location.

 Using the iDrive during a trip  
To avoid becoming distracted and posing an unnecessary hazard to your vehicle's occupants and to other road users, never attempt to use the controls or enter information unless traffic and road conditions allow this. ◀

## Controls at a glance

### Control elements

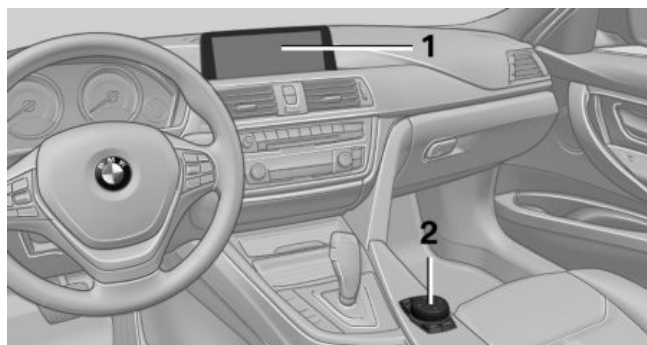

- 1 Control Display
- 2 Controller with buttons and, depending on the equipment version, with touchpad

## Control Display

### Hints

- ▶ To clean the Control Display, follow the care instructions.
- ▶ Do not place objects close to the Control Display; otherwise, the Control Display can be damaged.

### Switching off

1.  Press the button.
2. "Switch off control display"

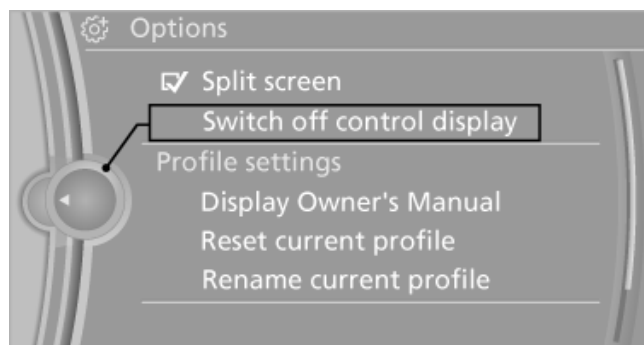

### Switching on

Press the controller again to switch the screen back on.

### Controller with navigation system

The buttons can be used to open the menus directly. The controller can be used to select menu items and create the settings.

Some iDrive functions can be operated using the touchpad on the controller.

## 1. Turn.

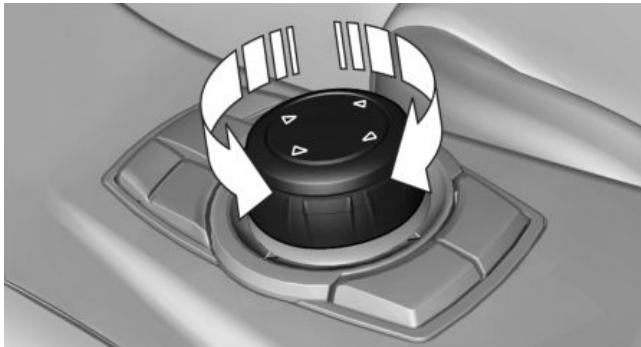

## 2. Press.

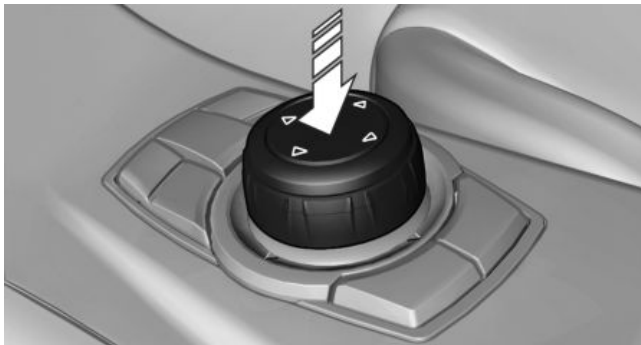

## 3. Move in four directions.

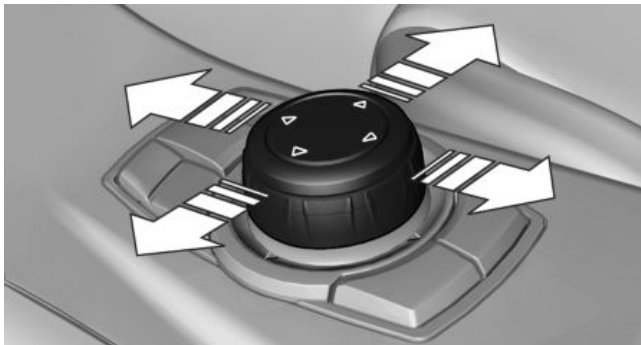

## Buttons on controller

Press the button	Function
MENU	Open the main menu.
RADIO	Opens the Radio menu.
MEDIA	Opens the CD/Multimedia menu.
NAV	Opens the Navigation menu.

Press the button

Function

TEL

Opens the Telephone menu.

BACK

Displays the previous panel.

OPTION

Opens the Options menu.

## Controller without navigation system

The buttons can be used to open the menus directly. The controller can be used to select menu items and create the settings.

## 1. Turn.

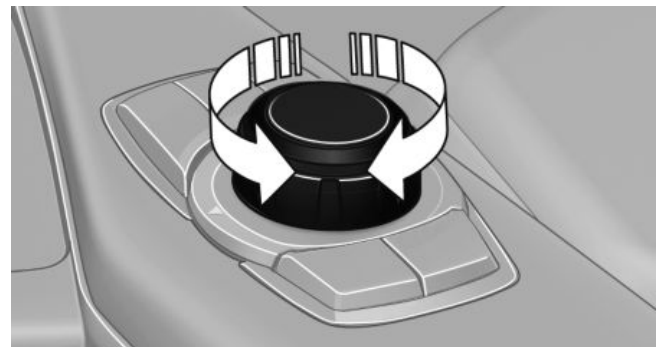

## 2. Press.

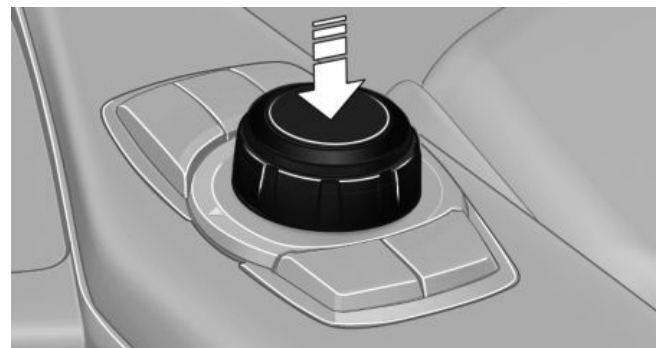

## 3. Move in two directions.

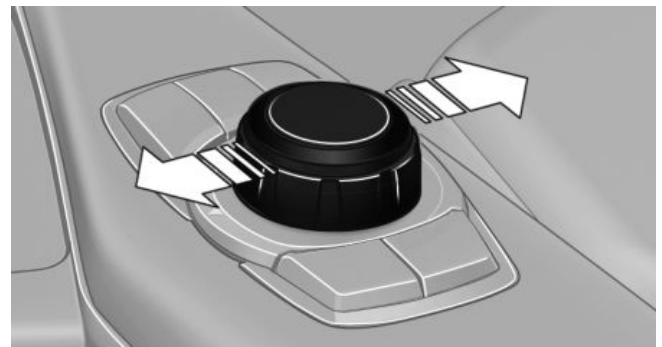

## Buttons on controller

Press the button	Function
MENU	Open the main menu.
Audio	Open audio menu last listened to, switch between audio menus.
TEL	Opens the Telephone menu.
BACK	Open previous panel.
OPTION	Opens the Options menu.

## Operating concept

### Opening the main menu



Press the button.

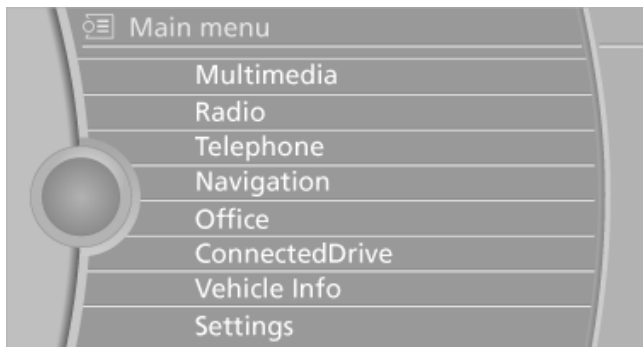

The main menu is displayed.

All iDrive functions can be called up via the main menu.

## Selecting menu items

Highlighted menu items can be selected.

1. Turn the controller until the desired menu item is highlighted.

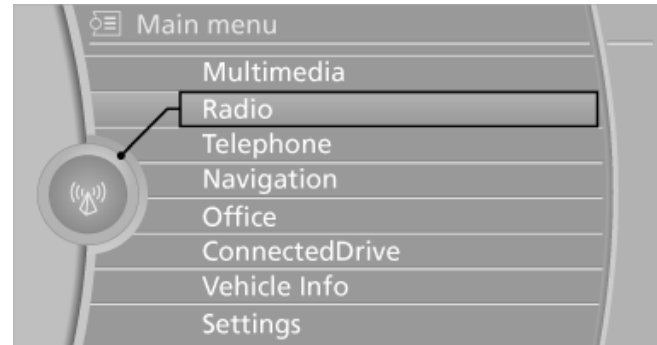

2. Press the controller.

### Menu items in the Owner's Manual

In the Owner's Manual, menu items that can be selected are set in quotation marks, e.g., "Settings".

### Changing between panels

After a menu item is selected, e.g., "Radio", a new panel is displayed. Panels can overlap.

- Move the controller to the left.

The current panel is closed and the previous panel is displayed.

The previous panel is opened again by pressing the BACK button. In this case, the current panel is not closed.

- Move the controller to the right.

A new panel is opened on top of the previous display.

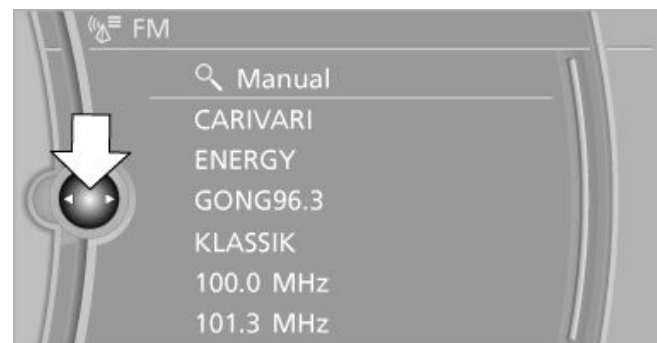

White arrows pointing to the left or right indicate that additional panels can be opened.

### View of an opened menu

When a menu is opened, it generally opens with the panel that was last selected in that menu. To display the first panel of a menu:

- ▶ Move the controller to the left repeatedly until the first panel is displayed.
- ▶ Press the menu button on the controller twice.

### Opening the Options menu



Press the button.

The "Options" menu is displayed.

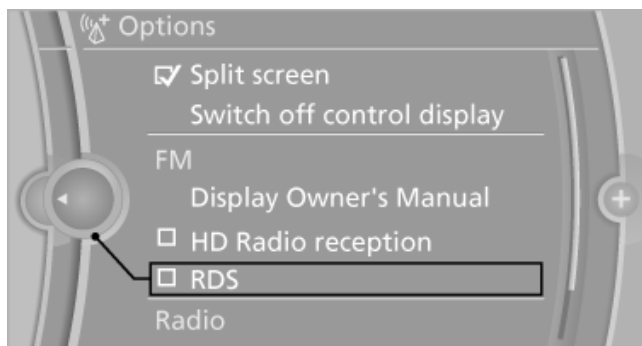

Additional options: move the controller to the right repeatedly until the "Options" menu is displayed.

### Options menu

The "Options" menu consists of various areas:

- ▶ Screen settings, e.g., "Split screen".  
This area remains unchanged.
- ▶ Control options for the selected main menu, e.g., for "Radio".
- ▶ If applicable, further operating options for the selected menu, e.g., "Store station".

### Changing settings

1. Select a field.

2. Turn the controller until the desired setting is displayed.

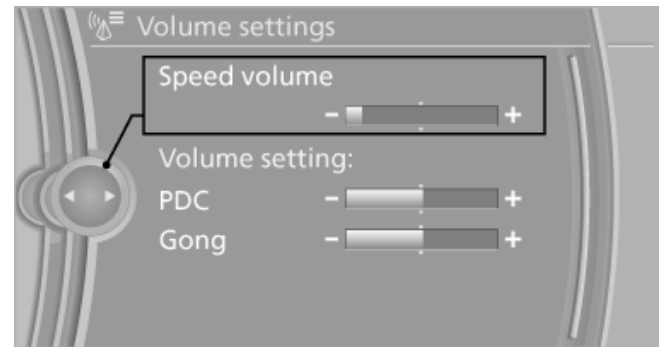

3. Press the controller.

### Activating/deactivating the functions

Several menu items are preceded by a checkbox. It indicates whether the function is activated or deactivated. Selecting the menu item activates or deactivates the function.

The function is activated.

The function is deactivated.

### Touchpad

Some iDrive functions can be operated using the touchpad on the controller:

### Selecting functions

1. "Settings"
2. "Touchpad"
3. Select the desired function.
  - ▶ "Speller": enter letters and numbers.
  - ▶ "Interactive map": operating the interactive map.
  - ▶ "Browser": enter Internet addresses.
  - ▶ "Audio feedback": the entered letters and numbers are announced.

### Entering letters and numbers

The entry of the letters requires some practice at the beginning. In the entry, pay attention to the following:

- ▶ For the input of upper/lower case letters and numbers, it may be necessary to switch via the controller to the corresponding Input mode, refer to page 23, e.g. when the spelling of upper and lower case letters is identical.
- ▶ Enter characters as they are displayed on the Control Display.
- ▶ Always enter accompanying signs, such as accents or periods so that the letter can be clearly recognized. The possibility of input depends on the set language. Where necessary, enter special characters via the controller.
- ▶ To delete a character, slide to the left on the touchpad.
- ▶ To enter a blank space, slide to the right in the center of the touchpad.
- ▶ To enter a hyphen, slide to the right in the upper area of the touchpad.
- ▶ To enter an underscore, slide to the right in the lower area of the touchpad.

### Using interactive map and Internet

The interactive map in the navigation system and Internet sites can be moved via the touchpad.

Function	Controls
Move interactive map or Internet sites.	Slide in the corresponding direction.
Enlarge/shrink interactive map or Internet sites.	Drag inwards or outwards on the touchpad with the fingers.
Display the menu or open a link in the Internet.	Tap once.

### Changing settings

Settings on the control display, such as the volume, can be made via the touchpad. To do this slide to the left or right accordingly.

### Example: setting the clock

#### Setting the clock

1.  Press the button. The main menu is displayed.
2. Turn the controller until "Settings" is highlighted, and then press the controller.

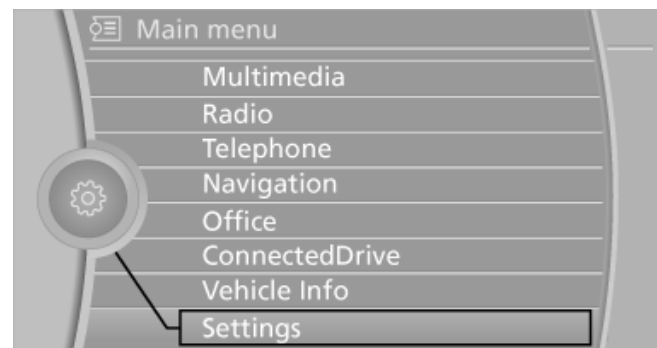

3. If necessary, move the controller to the left to display "Time/Date".
4. Turn the controller until "Time/Date" is highlighted, and then press the controller.



- Turn the controller until "Time:" is highlighted, and then press the controller.



- Turn the controller to set the hours and press the controller.
- Turn the controller to set the minutes and press the controller.

## Status information

### Status field



The following information is displayed in the status field at the top right:

- ▷ Time.
- ▷ Current entertainment source.
- ▷ Sound output, on/off.
- ▷ Wireless network reception strength.
- ▷ Telephone status.
- ▷ Traffic bulletin reception.











### Status field symbols

The symbols are grouped as follows.







#### Radio symbols

Symbol	Meaning
	HD radio station is being received.
	Satellite radio is switched on.

## Telephone symbols

Symbol	Meaning
	Incoming or outgoing call.
	Missed call.
	Wireless network reception strength. Symbol flashes: network search.
	Wireless network is not available.
	Bluetooth is switched on.
	Roaming is active.
	Text message was received.
	Check the SIM card.
	SIM card is blocked.
	SIM card is missing.
	Enter the PIN.

## Entertainment symbols

Symbol	Meaning
	CD/DVD player.
	Music collection.
	Gracenote® database.
	AUX-IN port.
	USB audio interface.
	Mobile phone audio interface.

## Additional symbols

Symbol	Meaning
	Spoken instructions are switched off.



## Split screen

### General information

Additional information can be displayed on the right side of the split screen, e.g., information from the onboard computer.

In the divided screen view, the so-called split screen, this information remains visible even when you change to another menu.

### Switching the split screen on and off

1.  Press the button.
2. "Split screen"

### Selecting the display

1.  Press the button.
2. "Split screen"
3. Move the controller until the split screen is selected.
4. Press the controller or select "Split screen content".
5. Select the desired menu item.

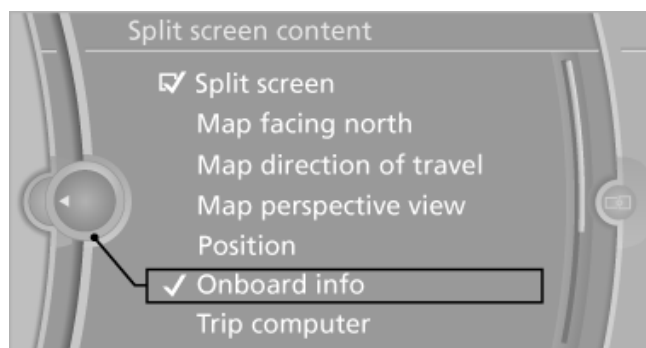

## Programmable memory buttons

### General information

The iDrive functions can be stored on the programmable memory buttons and called up directly, e.g., radio stations, navigation destina-

tions, phone numbers and entry points into the menu.

The settings are stored for the remote control currently in use.

### Without navigation system and telephone

Only radio stations can be stored on the buttons, refer to user's manual for Navigation, Entertainment, Communication.

### Saving a function

1. Highlight the function via the iDrive.
2.  Press the desired button for more than 2 seconds.

### Running a function

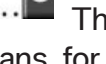
1.  Press the button.
2.  The function will run immediately. This means, for example, that the number is dialed when a phone number is selected.

### Displaying the button assignment

Use a finger to touch the buttons. Do not wear gloves or use objects.

The key assignment is displayed at the top edge of the screen.

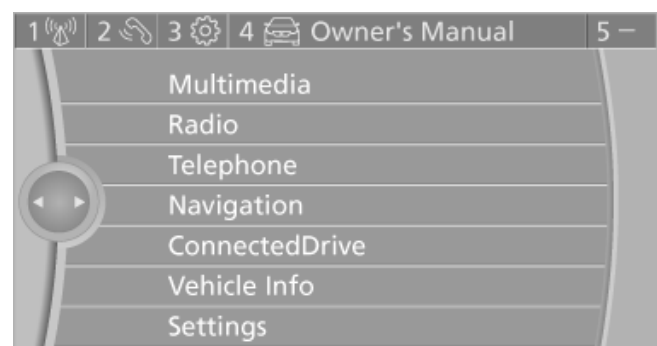

- ▶ To display short information: touch the button.
- ▶ To display detailed information: touch the button for an extended period.





## Deleting the button assignments

1. Press buttons 1 and 8 simultaneously for approx. five seconds.
2. "OK"

## Entering letters and numbers

### General information

1. Turn the controller: select letters or numbers.
2. Select additional letters or numbers if needed.
3. "OK": confirm the entry.

Symbol	Function
	Press the controller: delete the letter or number.
	Press the controller for an extended period: delete all letters or numbers.

### Switching between cases, letters and numbers

Depending on the menu, you can switch between entering upper and lower case, letters and numbers:

Symbol	Function
<b>A<sup>B</sup>C</b>	Enter the letters.
<b>1@+</b>	Enter the numbers.
<b>abc</b> or <b>ABC</b>	Move the controller up.

### Without navigation system

**@<sup>A</sup> A<sup>a</sup> a<sup>@</sup>** Select the symbol.

### Entry comparison

Entry of names and addresses: the selection is narrowed down every time a letter is entered and letters may be added automatically.

The entries are continuously compared to the data stored in the vehicle.

- ▷ Only those letters are offered during the entry for which data is available.
- ▷ Destination search: town/city names can be entered using the spelling of language available on the Control Display.

# Voice activation system

## Vehicle equipment

All standard, country-specific and optional equipment that is offered in the model series is described in this chapter. Therefore, equipment is also described that is not available in a vehicle, e. g., because of the selected optional equipment or country variant. This also applies for safety-related functions and systems.

## The concept

- ▶ Most functions that are displayed on the Control Display can be operated by spoken commands via the voice activation system. The system prompts you to make your entries.
- ▶ Functions that can only be used when the vehicle is stationary cannot be operated using the voice activation system.
- ▶ The system uses a special microphone on the driver's side.
- ▶ ›...‹ Verbal instructions in the Owner's Manual to use with the voice activation system.

## Requirements

Via the Control Display, set a language that is also supported by the voice activation system so that the spoken commands can be identified.

Set the language, refer to page 86.

## Using voice activation

### Activating the voice activation system

1.  Press the button on the steering wheel.
2. Wait for the signal.
3. Say the command.

The command is displayed in the instrument cluster.

 This symbol in the instrument cluster indicates that the voice activation system is active. If no other commands are available, operate the function in this case via iDrive.

### Terminating the voice activation system

 Briefly press the button on the steering wheel or ›End‹.

## Possible commands

Most menu items on the Control Display can be voiced as commands.

The available commands depend on which menu is currently displayed on the Control Display.

Short commands exist for many functions.

Some list entries, e.g., Phone book entries, can also be selected via the voice activation system. Speak these list entries exactly as they are displayed in the respective list.

### Having possible commands read aloud

You can have the available commands read out loud for you: ›commands‹

For example, if the "Settings" menu is displayed, the commands for the settings are read out loud.

## Executing functions using short commands

Functions on the main menu can be performed directly by means of short commands, nearly irrespective of which menu item is currently selected, e.g., ›Vehicle status‹.

List of short commands of the voice activation system, see Navigation, Entertainment, Communication Owner's Manual.

## Help dialog for the voice activation system

Calling up help dialog: ›Help‹

Additional commands for the help dialog:

- ▶ ›Help with examples‹: information about the current operating options and the most important commands for them are announced.
- ▶ ›Help voice activation‹: information about the principle of operation for the voice activation system is announced.

## One example: open the tone settings

### Via the main menu

The commands of the menu items are spoken just as they are selected via the controller.

1. Switch on the Entertainment sound output if necessary.
2.  Press the button on the steering wheel.
3. ›Radio menu‹
4. ›Audio settings‹

### Via short command

The desired radio station can also be started via a short command.

1. Switch on the Entertainment sound output if necessary.

2.  Press the button on the steering wheel.
3. ›Audio settings‹

## Setting the voice dialog

You can set whether the system should use the standard dialog or a shorter version.

In the shorter variant of the voice dialog, the announcements from the system are issued in an abbreviated form.

1. "Settings"
2. "Language/Units"
3. "Speech type:"
4. Select the setting.

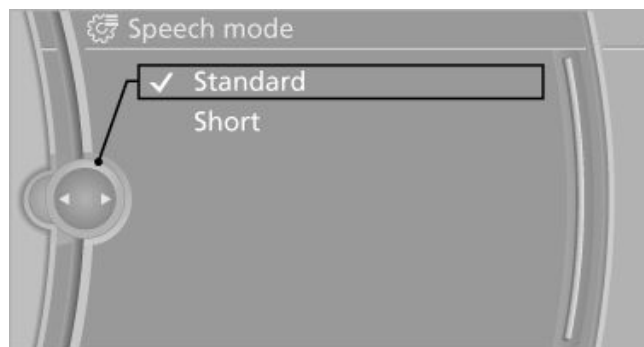

## Adjusting the volume

Turn the volume button while giving an instruction until the desired volume is set.

- ▶ The volume remains constant even if the volume of other audio sources is changed.
- ▶ The volume is stored for the remote control currently in use.

## Hints on Emergency Requests

Do not use the voice activation system to initiate an Emergency Request. In stressful situations, the voice and vocal pitch can change.

This can unnecessarily delay the establishment of a telephone connection.

Instead, use the SOS button, refer to page 215, in the vicinity of the interior mirror.

## Environmental conditions

- ▷ Say the commands, numbers, and letters smoothly and with normal volume, emphasis, and speed.
- ▷ Always say commands in the language of the voice activation system.
- ▷ Keep the doors, windows, and glass sun-roof closed to prevent noise interference.
- ▷ Avoid making other noise in the vehicle while speaking.

# Integrated Owner's Manual in the vehicle

## Vehicle equipment

All standard, country-specific and optional equipment that is offered in the model series is described in this chapter. Therefore, equipment is also described that is not available in a vehicle, e. g., because of the selected optional equipment or country variant. This also applies for safety-related functions and systems.

## Integrated Owner's Manual in the vehicle

The Integrated Owner's Manual can be displayed on the Control Display. The equipment and functions that are in the vehicle are described therein.

### Components of the Integrated Owner's Manual

The Integrated Owner's Manual consists of three parts, which offer various levels of information or access possibilities.

#### Quick Reference Guide

Located in the Quick Reference is important information for the operation of the vehicle, the operation of basic vehicle functions or for what to do in the event of a flat tire. This information can also be displayed during driving.

#### Search by pictures

Information and descriptions based on illustrations can be searched via search by pictures. This is helpful, for example, if the description of an outfitting package that cannot be named is needed.

#### Owner's Manual

Information and descriptions can be searched by direct entry of a search term via the index.

### Select components

1.  Press the button.
2. Turn the controller: open "Vehicle Info".
3. Press the controller.
4. Selecting desired range:
  - ▷ "Quick reference"
  - ▷ "Search by pictures"
  - ▷ "Owner's Manual"

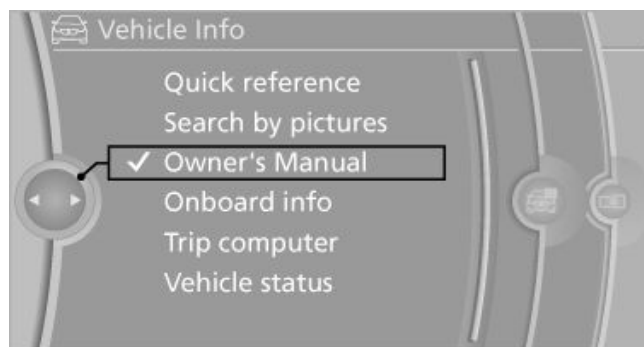

### Leafing through the Owner's Manual

#### Page by page with link access

Turn the controller until the next or previous page is displayed.

#### Page by page without link access

Leaf through the pages directly while skipping the links.

Highlight the symbol once. Now simply press the controller to leaf from page to page.



Leaf back.



Leaf forward.

## Context help - Owner's Manual to the temporarily selected function

The relevant information can be opened directly.

### Opening via the iDrive

To move directly from the application on the Control Display to the options menu:

-  Press the button or move the controller to the right repeatedly until the "Options" menu is displayed.
- "Display Owner's Manual"



### Opening when a Check Control message is displayed

Directly from the Check Control message on the Control Display:

"Display Owner's Manual"

## Changing between a function and the Owner's Manual

To change from a function, e.g., radio, to the Owner's Manual on the Control Display and to switch between the two displays:

-  Press the button or move the controller to the right repeatedly until the "Options" menu is displayed.
- "Display Owner's Manual"
- Select the desired page in the Owner's Manual.
-  Press the button again to return to the function displayed last.
-  Press the button to return to the page of the Owner's Manual displayed last.



To switch back and forth repeatedly between the function displayed last and the page of the Owner's Manual displayed last, repeat steps 4 and 5. This opens a new panel every time.

## Programmable memory buttons



### General information

The Owner's Manual can be stored on the programmable memory buttons and called up directly.

### Storing

- "Owner's Manual" Select via the iDrive.
- ... Press the desired button for more than 2 seconds.

### Executing

- ... Press the button.
- The Owner's Manual is displayed immediately.







## Controls

This chapter is intended to provide you with information that will give you complete control of your vehicle. All features and accessories that are useful for driving and your safety, comfort and convenience are described here.

# Opening and closing

## Vehicle equipment

All standard, country-specific and optional equipment that is offered in the model series is described in this chapter. Therefore, equipment is also described that is not available in a vehicle, e. g., because of the selected optional equipment or country variant. This also applies for safety-related functions and systems.

## Remote control/key

### General information

The vehicle is supplied with two remote controls with integrated keys.

Every remote control contains a replaceable battery.

Depending on the equipment package and country-specific variant, the functions of the keys can be set. Settings, refer to page 41.

For every remote control, personal settings are stored in the vehicle. Personal Profile, refer to page 33.

Information on the required maintenance is stored in the remote controls. Service data in the remote control, refer to page 202.

### At a glance

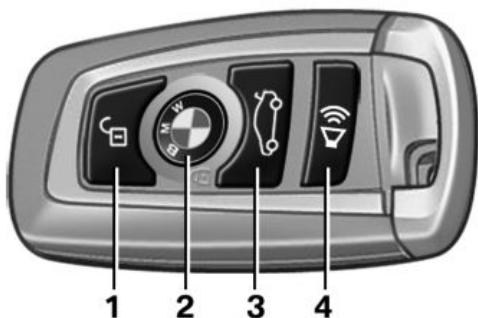

- 1 Unlocking
- 2 Locking

- 3 Opening the trunk lid
- 4 Panic mode in alarm system

### Integrated key

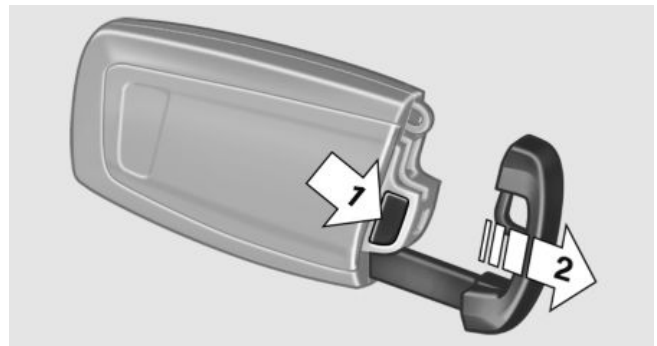

Press the button on the back of the remote control, arrow 1, and pull out the key, arrow 2.

The integrated key fits the following locks:

- ▶ Driver's door.
- ▶ Glove compartment on the front passenger side.

The storage compartment contains a switch for separately securing the trunk lid, refer to page 38.

The front passenger glove compartment contains a switch for separately securing the trunk lid, refer to page 38.

## Replacing the battery

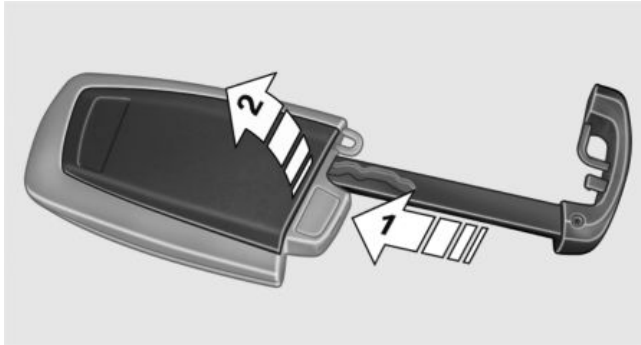

1. Take the integrated key out of the remote control.
2. Push in the catch with the key, arrow 1.
3. Remove the cover of the battery compartment, arrow 2.
4. Insert a battery of the same type with the positive side facing upwards.
5. Press the cover closed.



Take the used battery to a recycling center or to your service center.

## New remote controls

New remote controls are available from the service center.

## Loss of the remote controls

Lost remote controls can be blocked by your service center.

## Emergency detection of remote control

It is possible to switch on the ignition or start the engine in situations such as the following:

- ▷ Interference of radio transmission to remote control by external sources, e.g. by radio masts.
- ▷ Discharged battery in the remote control.
- ▷ Interference of radio transmission by mobile devices in close proximity to the remote control.

- ▷ Interference of radio transmission by charger while charging items such as mobile devices in the vehicle.

A Check Control message is displayed if an attempt is made to switch on the ignition or start the engine.

## Starting the engine with emergency detection of the remote control



Automatic transmission: if a corresponding Check Control message appears, hold the remote control, as shown, against the marked area on the steering column and press the Start/Stop button within 10 seconds while pressing the brake.

Manual transmission: if a corresponding Check Control message appears, hold the remote control, as shown, against the marked area on the steering column and press the Start/Stop button within 10 seconds while pressing the clutch pedal.

## Personal Profile

### The concept

Individual settings in the vehicle are saved in personal profiles. Every remote control is assigned a profile.

Three personal profiles and a guest profile can be created.

- ▷ Changes to the settings are automatically saved in the profile currently activated.

- ▷ During unlocking, the profile stored for the remote control is activated.
- ▷ Your personal settings will be recognized and called up again even if the vehicle has been operated in the meantime with another remote control.

## Adjusting

The following settings are stored in a profile.

- ▷ Radio: stored stations, station listened to last.
- ▷ Assignment of the programmable memory buttons.
- ▷ Tone settings.
- ▷ Audio source listened to last.
- ▷ Unlocking the vehicle: driver door or entire vehicle.
- ▷ Locking the vehicle: if no door is open or after starting off.
- ▷ Welcome lamps: on/off.
- ▷ Triple turn signal activation: on/off.
- ▷ Headlamp courtesy delay feature: time setting.
- ▷ Language on the Control Display.
- ▷ Daytime running lights: on/off.
- ▷ Automatic climate control/Automatic climate control with enhanced features: settings.
- ▷ Navigation: map views, route criteria, voice output on/off.
- ▷ Park Distance Control PDC: adjusting the signal tone volume.
- ▷ Rearview camera: selection of functions and type of display.
- ▷ Side view: display type.
- ▷ Head-up Display: selection, brightness, position and rotation of the display.
- ▷ Driving Dynamics Control: sport program.
- ▷ Exterior mirror position.

- ▷ Driver's seat position: automatically retrieved after unlocking.
- ▷ Collision warning: warning time.
- ▷ Lane departure warning: last setting, on/off.
- ▷ Active Blind Spot Detection: last setting, on/off.

## Profile management

### Opening the profiles

A different profile can be called up than the one associated with the remote control currently in use.

1. "Settings"
2. "Profiles"
3. Select a profile.

Called up profile is assigned to the remote control being used at the time.

### Renaming profiles

1. "Settings"
2. "Profiles"
3. Open "Options".
4. "Rename current profile"

### Resetting profiles

The settings of the active profile are reset to their default values.

1. "Settings"
2. "Profiles"
3. Open "Options".
4. "Reset current profile"

### Exporting profiles

Most settings of the active profile and the saved contacts can be exported.

This can be helpful for securing and retrieving personal settings, before delivering the vehicle to a workshop for example. The saved profiles



can be taken with you to another vehicle equipped with the Personal Profile function.

The following export options are available:

- ▶ BMW Online.
- ▶ Via the USB port to a USB device.  
Popular file systems for USB devices are supported. FAT32 and exFAT are the recommended formats for profile export. Other formats may not support the export.

1. "Settings"
2. "Profiles"
3. "Export profile"
4. BMW Online: "BMW Online"  
USB interface: "USB device"

### Importing profiles

Existing settings and contacts are overwritten with the imported profile.

1. "Settings"
2. "Profiles"
3. "Import profile"
4. BMW Online: "BMW Online"  
USB interface: "USB device"

### Using the guest profile

The guest profile can be used to make individual settings that are saved in none of the three personal profiles.

This can be useful for drivers who are using the vehicle temporarily and do not have their own profile.

1. "Settings"
2. "Profiles"
3. Open "Guest".

The guest profile cannot be renamed. It is not assigned to the current remote control.

### Display profile list during start

The profile list can be displayed during each start for selecting the desired profile.

1. "Settings"
2. "Profiles"
3. Open "Options".
4. "Display user list at startup"

## Using the remote control

### Note



Take the remote control with you

People or animals left unattended in a parked vehicle can lock the doors from the inside. Always take the remote control with you when leaving the vehicle so that the vehicle can then be opened from the outside. ◀

### Unlocking



Press the button on the remote control.

The vehicle is unlocked.

Welcome lamps, interior lamp and courtesy lamps are switched on.

You can set how the vehicle is to be unlocked. Performing settings, refer to page 41.

The alarm system, refer to page 41, is disarmed.

### Convenient opening

The remote control can be used to open the windows and the glass sunroof after unlocking.



Press and hold the button on the remote control.

Releasing the button stops the motion.

### Locking



Press the button on the remote control.



Locking from the outside

Do not lock the vehicle from the outside if there are people in it, as the vehicle cannot be unlocked from inside without special knowledge. ◀

The alarm system, refer to page 41, is armed.

### Switching on interior lamps and courtesy lamps



Press the button on the remote control with the vehicle locked.

If the button is pressed again within 10 seconds of the vehicle being locked, the interior motion sensor and tilt alarm sensor of the anti-theft warning system, refer to page 43, are switched off. After locking, wait 10 seconds before pressing the button again.

### Panic mode

You can trigger the alarm system if you find yourself in a dangerous situation.



Press the button on the remote control for at least 3 seconds.

To switch off the alarm: press any button.

### Opening the trunk lid



Press the button on the remote control for approx. 1 second.

The trunk lid opens, regardless of whether the vehicle was previously locked or unlocked.

During opening, the trunk lid pivots back and up. Ensure that adequate clearance is available before opening.

If the doors were not unlocked, the trunk lid is locked again as soon as it is pushed closed.



Do not place the remote control in the cargo area

Take the remote control with you and do not leave it in the cargo area; otherwise, the re-

mote control is locked inside the vehicle when the trunk lid is closed. ◀

### Malfunction

If the vehicle can no longer be locked or unlocked with the remote control, the battery may be discharged or there may be interference from external sources such as mobile phones, metal objects, overhead power lines, transmission towers, etc.

In this case, lock/unlock the vehicle without the remote control, refer to page 37.

### For US owners only

The transmitter and receiver units comply with part 15 of the FCC/Federal Communication Commission regulations. Operation is governed by the following:

FCC ID:

- ▶ LX8766S.
- ▶ LX8766E.
- ▶ LX8CAS.
- ▶ LX8CAS2.
- ▶ MYTCAS4.

Compliance statement:

This device complies with part 15 of the FCC Rules. Operation is subject to the following two conditions:

- ▶ This device may not cause harmful interference, and
- ▶ this device must accept any interference received, including interference that may cause undesired operation.

Any unauthorized modifications or changes to these devices could void the user's authority to operate this equipment.



## Without remote control

### From the outside



Locking from the outside

Do not lock the vehicle from the outside if there are people in it, as the vehicle cannot be unlocked from inside without special knowledge. ◀



Remove the key before pulling the door handle

Before pulling the outside door handle, remove the key to avoid damaging the paintwork and the key. ◀

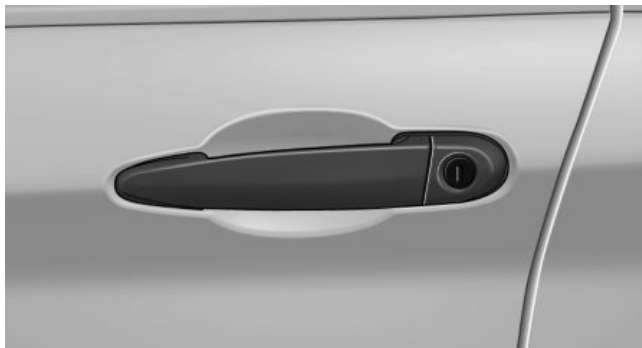

Unlock or lock the driver's door via the door lock using the integrated key. The other doors must be unlocked or locked from the inside.

### Alarm system

The alarm system is not armed if the vehicle is locked with the integrated key.

The alarm system is triggered when the door is opened, if the vehicle was unlocked via the door lock. In order to terminate this alarm, unlock vehicle with the remote control or switch on the ignition, if necessary, by emergency detection of the remote control.

## From the inside

### Locking and unlocking



Pressing the button for the central locking system locks and unlocks the doors and the trunk lid when the front doors are closed, but they are not secured against theft.

The fuel filler flap remains unlocked.

In the event of an accident of corresponding severity, the vehicle is automatically unlocked. The hazard warning system and interior lamps come on.

### Unlocking and opening

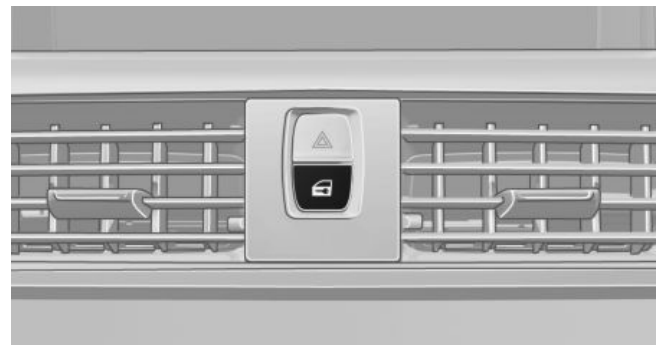

- ▶ Either unlock the doors together using the button for the central locking system and then pull the door handle above the armrest or
- ▶ Pull the door opener twice individually on each door: the first time unlocks the door, the second time opens it.

## Trunk lid

### Opening

During opening, the trunk lid pivots back and up.

Ensure that adequate clearance is available before opening.

### Opening from the outside



- ▷ Press the button on the trunk lid.
- ▷  Press the button on the remote control for approx. 1 second.

The trunk lid opens.

### Opening from the inside

-  With the vehicle stationary, press the button in the driver's footwell.

The trunk lid opens.

### Closing



Recessed grips in the interior trim of the trunk lid make it easier to pull down the lid.



Keep the closing path clear

Make sure that the closing path of the trunk lid is clear; otherwise, injuries may result. ◀



Do not place the remote control in the cargo area

Take the remote control with you and do not leave it in the cargo area; otherwise, the remote control is locked inside the vehicle when the trunk lid is closed. ◀

### Locking separately

The trunk lid can be locked separately with the switch in the front passenger glove compartment.

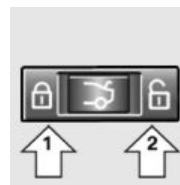

- ▷ Trunk lid secured, arrow 1.
- ▷ Trunk lid not secured, arrow 2.

Slide the switch into the arrow 1 position. This secures the trunk lid and disconnects it from the central locking system.

If the glove compartment on the front passenger side is locked, the trunk lid cannot be opened.

This is beneficial when the vehicle is parked using valet service. The infrared remote control can be handed out without the key.

### Emergency unlocking

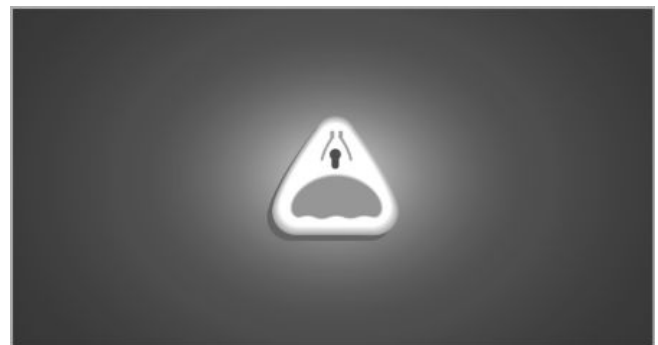

Pull the handle inside the cargo area.

The trunk lid unlocks.

## Comfort Access

### The concept

The vehicle can be accessed without activating the remote control.

All you need to do is to have the remote control with you, such as in your pants pocket.

The vehicle automatically detects the remote control when it is nearby or in the passenger compartment.

Comfort Access supports the following functions:

- ▶ Unlocking/locking of the vehicle.
- ▶ Convenient closing.
- ▶ Open the trunk lid individually.
- ▶ Open trunk lid with no-touch activation
- ▶ Start the engine.

### Functional requirements

- ▶ There are no external sources of interference nearby.
- ▶ To lock the vehicle, the remote control must be located outside of the vehicle.
- ▶ The next unlocking and locking cycle is not possible until after approx. 2 seconds.
- ▶ The engine can only be started if the remote control is in the vehicle.

### Comparison with ordinary remote control

The functions can be controlled by pressing the buttons of the remote control or Comfort Access.

### Unlocking

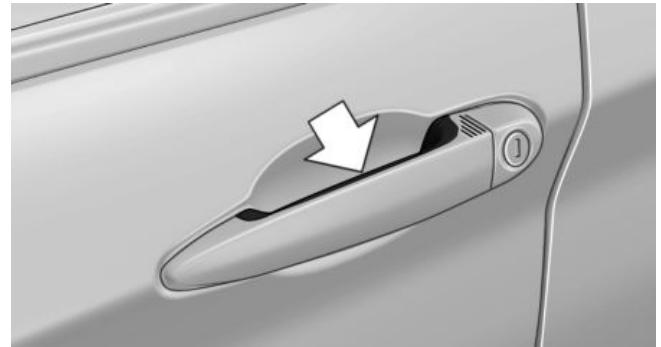

Grasp the door handle on the driver's or front passenger door completely, arrow.

This corresponds to pressing the  button on the remote control.

### Locking

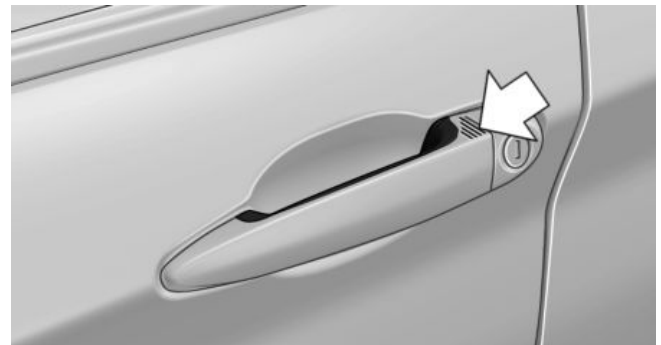

Press the area on the door handle, arrow, with your finger for approx. 1 second without grasping the door handle.

This corresponds to pressing the  button on the remote control.

To save battery power, ensure that the ignition and all electronic systems and/or power consumers are switched off before locking the vehicle.

### Convenient closing

Press the area on the door handle, arrow, with your finger and hold it down.

In addition to locking, the windows and the glass sunroof are closed.



Monitor the closing process

Monitor the closing process to ensure that no one becomes trapped. ◀

### Unlocking the trunk lid separately

Press the button on the exterior of the trunk lid.

This corresponds to pressing the  button on the remote control.



Do not place the remote control in the cargo area

Take the remote control with you and do not leave it in the cargo area; otherwise, the remote control is locked inside the vehicle when the trunk lid is closed. ◀

### Open trunk lid with no-touch activation

With Comfort Access, the trunk lid can be opened with no-touch activation using the remote control you are carrying.

Two sensors detect a forward-directed foot motion in the center of the area at the rear of the car and the trunk lid opens.

### Foot movement to be carried out



Do not touch vehicle

With the foot motion, make sure there is steady stance and do not touch the vehicle; otherwise, there is a danger of injury, e. g. from hot exhaust system parts. ◀

1. Place in the center behind the vehicle, about an arm's length from the vehicle rear.
2. Move a foot in the direction of travel as far under the vehicle as possible and immediately pull it back. With this movement, the

leg must pass through the ranges of both sensors.

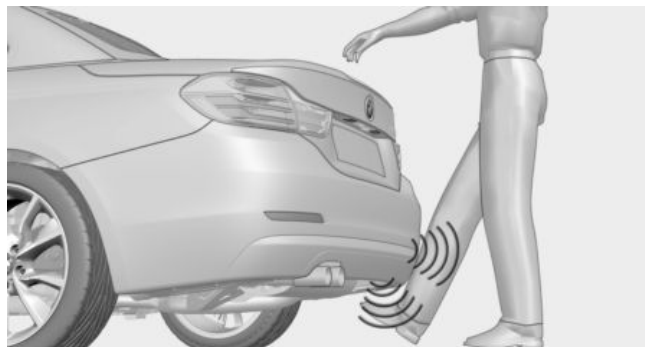

### Opening

The trunk lid opens, regardless of whether it was previously locked or unlocked.

During opening, the trunk lid pivots back and up. Ensure that adequate clearance is available before opening.

Before the opening, the hazard warning system flashes.



Preventing inadvertent opening

In situations where the trunk lid should not be opened with no-touch activation, ensure that the remote control is located beyond the range of the sensor, at least 5 ft/1.50 m from the rear of the car.

Otherwise, the trunk lid may be opened inadvertently, for example by an unintentional or misinterpreted movement of the foot. ◀

### Malfunction

Comfort Access may not function properly if it experiences interference from external sources such as mobile phones, metal objects, overhead power lines, transmission towers, etc.

In this case, open or close the vehicle using the buttons on the remote control or use the integrated key in the door lock.

If there is a malfunction, open the trunk lid with the remote control button or with the button on the trunk lid.

## Adjusting

### Unlocking

The setting is stored for the remote control currently in use.

1. "Settings"
2. "Doors/key"
3.  Select symbol or "Unlock button:"
4. Select the desired function:
  - ▷ "Driver's door only"
 

Only the driver's door and the fuel filler flap are unlocked. Pressing again unlocks the entire vehicle.
  - ▷ "All doors"
 

The entire vehicle is unlocked.

Depending on how the vehicle is equipped or the country-specific variant, you can set whether the doors are also unlocked with the  button on the remote control.

### Confirmation signals from the vehicle

The setting is stored for the remote control currently in use.

1. "Settings"
2. "Doors/key"
3. Deactivate or activate the desired confirmation signals.
  - ▷ "Acoustic sig. lock/unlock"
  - ▷ "Flash when lock/unlock"

### Automatic locking

The setting is stored for the remote control currently in use.

1. "Settings"
2. "Doors/key"
3. Select the desired function:
  - ▷ "Lock if no door is opened"

The vehicle locks automatically after a short period of time if a door is not opened.

- ▷ "Lock after start driving"
 

The vehicle locks automatically after you drive away.

### Retrieving the seat and mirror settings

The driver's seat and exterior mirror positions used last are stored for the remote control currently in use.

When the vehicle is unlocked, these positions are automatically retrieved if this function was activated.



Pinch hazard when moving back the seat  
If this function is used, first make sure that the footwell behind the driver's seat is empty. Otherwise, people can be injured or objects damaged when the seat is moved back. ◀

The adjustment procedure is interrupted:

- ▷ When a seat position switch is pressed.
- ▷ When a button of the seat and mirror memory is pressed.

### Activating the setting

1. "Settings"
2. "Doors/key"
3. "Last seat position autom."

## Alarm system

### The concept

The vehicle alarm system responds to:

- ▷ Opening of a door, the hood or the trunk lid.
- ▷ Movements in the vehicle.
- ▷ Changes in the vehicle tilt, e.g., during attempts to steal a wheel or when towing the car.
- ▷ Interruptions in battery voltage.

The alarm system briefly indicates tampering:

- ▷ By sounding an acoustic alarm.
- ▷ By switching on the hazard warning system.
- ▷ By flashing the daytime running lights.

## Arming and disarming the alarm system

### General information

When you lock or unlock the vehicle, either with the remote control or via the Comfort Access at the door lock, the alarm system is armed or disarmed at the same time.

### Door lock and armed alarm system

The alarm system is triggered when the door is opened, if the vehicle is unlocked via the door lock.

In order to terminate this alarm, unlock vehicle with the remote control or switch on the ignition, if necessary, by emergency detection of the remote control.

### Trunk lid and armed alarm system

The trunk lid can be opened even when the alarm system is armed.

After the trunk lid is closed, it is locked and monitored again if the doors are locked. The hazard warning system flashes once.

### Panic mode

You can trigger the alarm system if you find yourself in a dangerous situation.



Press the button on the remote control for at least 3 seconds.

To switch off the alarm: press any button.

### Switching off the alarm

To terminate the alarm:

- ▷ Unlock the vehicle using the remote control.

- ▷ With Comfort Access: If you are carrying the remote control with you, grasp the driver side or front passenger side door handle completely.

### Indicator lamp on the interior rearview mirror

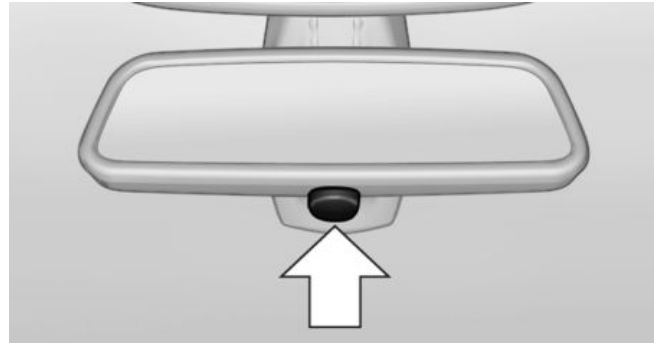

- ▷ The indicator lamp flashes briefly every 2 seconds:  
The system is armed.
- ▷ The indicator lamp flashes after locking:  
The doors, hood or trunk lid is not closed properly, but the rest of the vehicle is secured.  
After 10 seconds, the indicator lamp flashes continuously. Interior motion sensor and tilt alarm sensor are not active.
- ▷ The indicator lamp goes out after unlocking:  
The vehicle has not been tampered with.
- ▷ The indicator lamp flashes after unlocking until the engine ignition is switched on, but no longer than approx. 5 minutes:  
An alarm has been triggered.

### Tilt alarm sensor

The tilt of the vehicle is monitored.

The alarm system responds in situations such as attempts to steal a wheel or when the car is towed.



## Interior motion sensor

The windows and glass sunroof must be closed for the system to function properly.

## Avoiding unintentional alarms

The tilt alarm sensor and interior motion sensor can be switched off together, such as in the following situations:

- ▶ In automatic car washes.
- ▶ In duplex garages.
- ▶ During transport on car-carrying trains, at sea or on a trailer.
- ▶ When animals are to remain in the vehicle.

## Switching off the tilt alarm sensor and interior motion sensor



Press the remote control button again within 10 seconds as soon as the vehicle is locked.

The indicator lamp lights up for approx. 2 seconds and then continues to flash.

The tilt alarm sensor and interior motion sensor are switched off until the vehicle is locked again.

## Power windows

### General information





Take the remote control with you

Take the remote control with you when leaving the vehicle so that children, for example, cannot operate the power windows and injure themselves. ◀



### Opening

- ▶  Press the switch to the resistance point.  
The window opens while the switch is held.
- ▶  Press the switch beyond the resistance point.  
The window opens automatically.

Pressing the switch again stops the motion.



Convenient opening, refer to page 35, via the remote control.

### Closing



Keep the closing path clear

Monitor the closing process and make sure that the closing path of the window is clear; otherwise, injuries may result. ◀

- ▶  Pull the switch to the resistance point.  
The window closes while the switch is held.
- ▶  Pull the switch beyond the resistance point.  
The window closes automatically.  
Pressing the switch stops the motion.  
Closing via Comfort Access, refer to page 39.

## Pinch protection system

If the closing force exceeds a specific value as a window closes, the closing action is interrupted.

The window reopens slightly.

 Danger of pinching even with pinch protection

Even with the pinch protection system, check that the window's closing path is clear; otherwise, the closing action may not stop in certain situations, e.g., if thin objects are present. ◀

 No window accessories  
Do not install any accessories in the range of movement of the windows; otherwise, the pinch protection system will be impaired. ◀

## Closing without the pinch protection system

 Keep the closing path clear  
Monitor the closing process and make sure that the closing path of the window is clear; otherwise, injuries may result. ◀

For example, if there is an external danger or if ice on the windows prevents a window from closing normally, proceed as follows:

1. Pull the switch past the resistance point and hold it there.  
The pinch protection is limited and the window reopens slightly if the closing force exceeds a certain value.
2. Pull the switch past the resistance point again within approx. 4 seconds and hold it there.  
The window closes without pinch protection.

## Safety switch

The safety switch in the driver's door can be used to prevent children, for example, from opening and closing the rear windows using the switches in the rear.

## Switching on and off



Press the button.

The LED lights up if the safety function is switched on.



Safety switch for rear operation

Press the safety switch when transporting children in the rear; otherwise, injury may result if the windows are closed without supervision. ◀

## Roller sunblinds

### Roller sunblind for rear window

#### General information

If you are no longer able to move the roller sunblind for the rear window after having activated it a number of times in a row, the system is blocked for a limited time to prevent overheating. Let the system cool.

The roller sunblind for the rear window cannot be moved at low interior temperatures.

### Extending or retracting roller blind for rear window



Press the button.

### Roller sunblinds for the rear side windows

Pull out the roller sunblind at the loop and hook it onto the bracket.



Do not open the window while the roller sunblind is raised.

Do not open the window while the roller sunblind is raised; otherwise, there is a risk of damage at high speeds that may result in personal injury. ◀

## Glass sunroof, powered

### General information

The glass sunroof is operational when the ignition is switched on.



Keep the closing path clear

Monitor the closing process and make sure that the closing path of the glass sunroof is clear; otherwise, injuries may result. ◀



Take the remote control with you

Take the remote control with you when leaving the vehicle so that children, for example, cannot operate the roof and injure themselves. ◀



### Tilting the glass sunroof

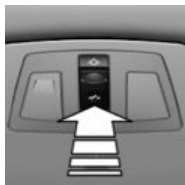

Push switch upward briefly.

- ▷ Closed roof is tilted open.
- ▷ The opened roof closes until it is in its tilted position. The sliding visor stays completely open.

### Opening/closing the glass sunroof and sliding visor together

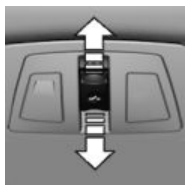

- ▷ Slide switch back to the resistance point and hold. Glass sunroof and sliding visor open together as long as the switch is held down.
- ▷ Press switch back past the resistance point.

The glass sunroof and sliding visor open automatically. Pressing the switch again stops the opening motion.

Analogously, the glass sunroof is closed by sliding the switch forward.

The sliding visor remains open and can be closed by hand.

Convenient operation, refer to page 35, via the remote control.

Convenient closing, refer to page 39, with Comfort Access.

### Comfort position

Stops the roof in the comfort position if the roof is not fully open. This reduces wind noise in the passenger compartment.

If desired, continue the movement by pressing the switch.

### Pinch protection system

If the closing force when closing the glass sunroof exceeds a certain value, the closing movement is stopped, beginning at approximately the middle of the opening in the roof, or from the tilted position during closing.

The glass sunroof opens again slightly.



Danger of pinching even with pinch protection

Despite the pinch protection system, check that the roof's closing path is clear; otherwise, the closing action may not be interrupted in certain extreme situations, such as when thin objects are present. ◀

### Closing from the open position without pinch protection

For example, if there is an external danger, proceed as follows:

1. Press the switch forward beyond the resistance point and hold.

Pinch protection is limited and the roof re-opens slightly if the closing force exceeds a certain value.

2. Press the switch forward again beyond the resistance point and hold until the roof closes without pinch protection. Make sure that the closing area is clear.

### Closing from the raised position without pinch protection

If there is an external danger, push the switch forward past the resistance point and hold it.

The roof closes without pinch protection.

### Initializing after a power failure

After a power failure during the opening or closing process, the roof can only be operated to a limited extent.

### Initializing the system

The system can be initialized when the vehicle is stationary and the engine is running.

During the initialization, the roof closes without pinch protection.



Keep the closing path clear

Monitor the closing process and make sure that the closing path of the glass sunroof is clear; otherwise, injuries may result. ◀



Press the switch up and hold it until the initialization is complete:

- ▶ Initialization begins within 15 seconds and is completed when the sunroof is completely closed.
- ▶ The roof closes without pinch protection.

# Adjusting

## Vehicle equipment

All standard, country-specific and optional equipment that is offered in the model series is described in this chapter. Therefore, equipment is also described that is not available in a vehicle, e. g., because of the selected optional equipment or country variant. This also applies for safety-related functions and systems.

## Sitting safely

The ideal seating position can make a vital contribution to relaxed, fatigue-free driving.

The seating position plays an important role in an accident in combination with:

- ▷ Safety belts, refer to page 50.
- ▷ Head restraints, refer to page 51.
- ▷ Airbags, refer to page 94.

## Seats

### Hints



Do not adjust the seat while driving

Do not adjust the driver's seat while driving, or the seat could respond with unexpected movement and the ensuing loss of vehicle control could lead to an accident. ◀



Do not incline the backrest too far to the rear

Also on the front passenger side, do not incline the backrest on the front passenger side too far to the rear during driving, or there is a risk of slipping under the safety belt in the event of an accident. This would eliminate the protection normally provided by the belt. ◀

## Manually adjustable seats

### At a glance

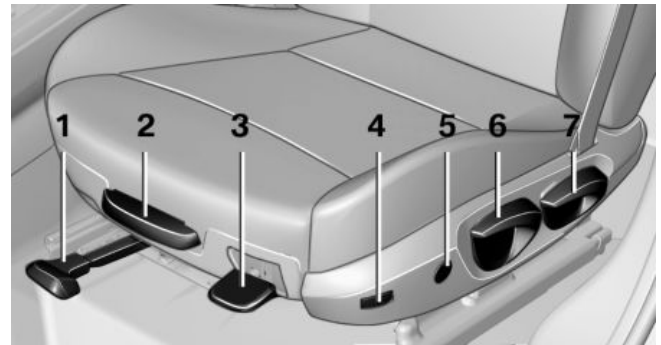

- 1 Forward/backward
- 2 Thigh support
- 3 Seat tilt
- 4 Backrest width
- 5 Lumbar support
- 6 Height
- 7 Backrest tilt

### Forward/backward

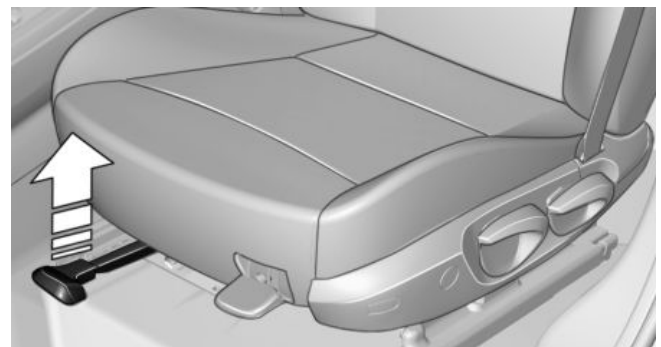

Pull the lever and slide the seat in the desired direction.

After releasing the lever, move the seat forward or back slightly to make sure it engages properly.



## Height

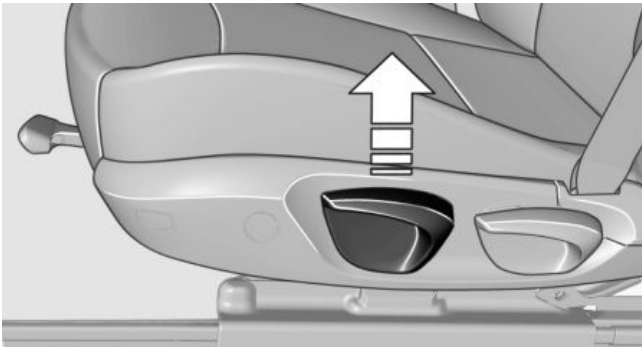

Pull the lever and apply your weight to the seat or lift it off, as necessary.

## Backrest tilt



Pull the lever and apply your weight to the backrest or lift it off, as necessary.

## Seat tilt

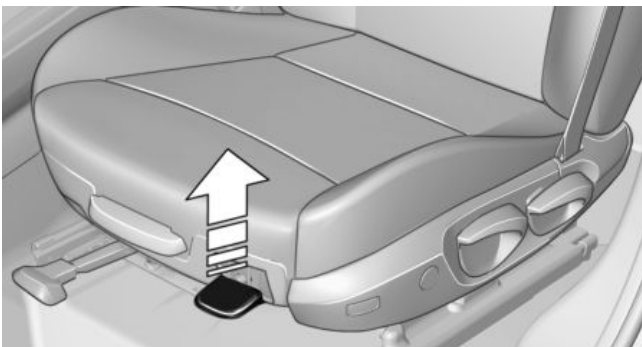

Pull the lever and move the seat to the desired tilt. After releasing the lever, apply your weight to the seat or lift it off to make sure the seat engages properly.

## Electrically adjustable seats

### At a glance

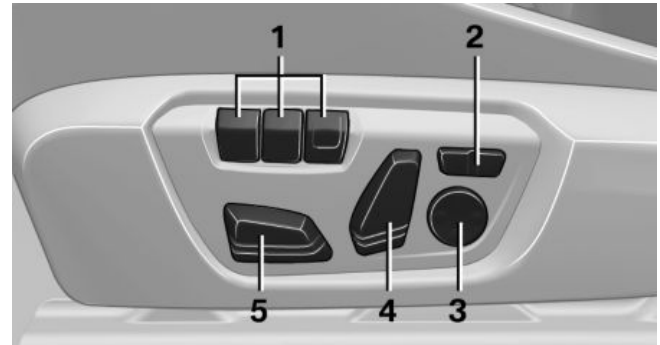

- 1 Seat and mirror memory
- 2 Backrest width
- 3 Lumbar support
- 4 Backrest tilt
- 5 Forward/backward, height, seat tilt

### Note

The seat setting for the driver's seat is stored for the remote control currently in use. When the vehicle is unlocked via the remote control, the position is automatically retrieved if the function, refer to page 41, is activated for this purpose.

### Adjustments in detail

1. Forward/back.

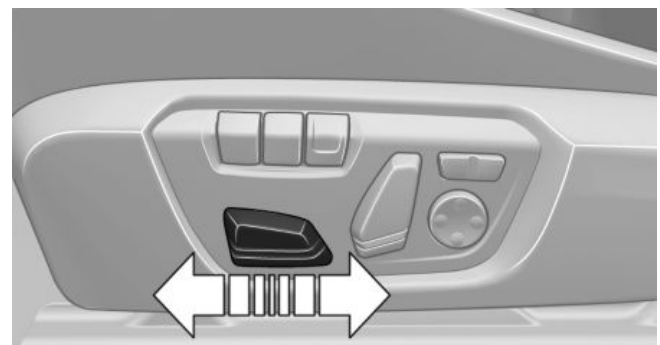



## 2. Height.

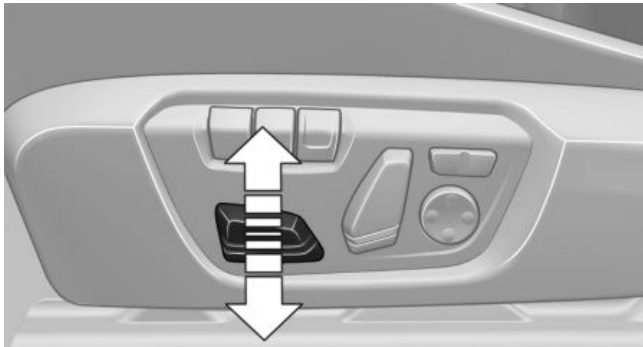

## 3. Seat tilt.

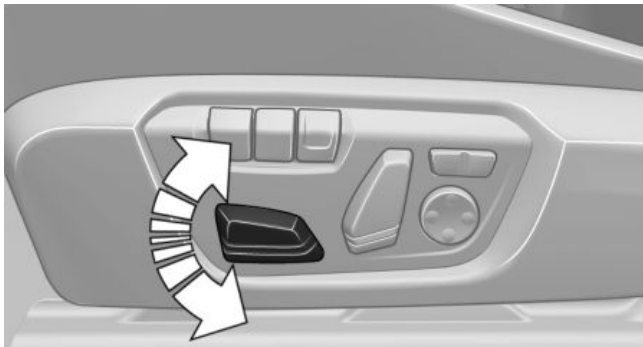

## 4. Backrest tilt.

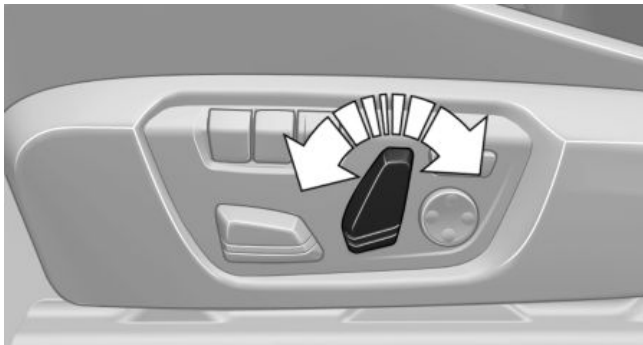

## Thigh support

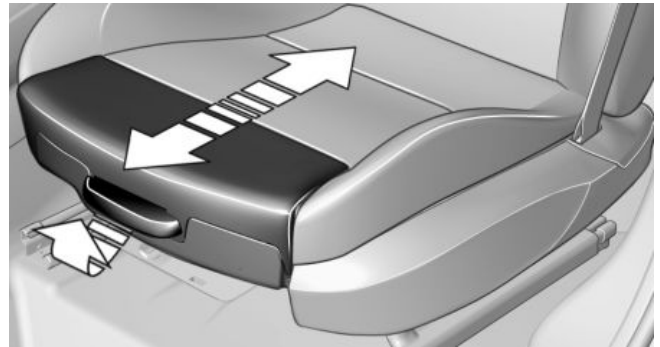

Pull the lever at the front of the seat and adjust the thigh support.

## Lumbar support

The curvature of the seat backrest can be adjusted in such a way that it supports the lumbar region of the spine. The lower back and the spine are supported for upright posture.



- ▷ Press the front/rear section of the switch.  
The curvature is increased/decreased.
- ▷ Press the upper/lower section of the switch.  
The curvature is shifted up/down.

## Backrest width



Change the width of the backrest using the side wings to adjust the lateral support.

## Front seat heating



### Switching on



Press the button once for each temperature level.

The maximum temperature is reached when three LEDs are lit.

If the drive is continued within approx. 15 minutes, the seat heating is activated automatically with the temperature selected last.

When ECO PRO, refer to page 169, is activated, the heater output is reduced.

### Switching off



Press the button longer.  
The LEDs go out.

## Rear seat heating



### Switching on



Press the button once for each temperature level.

The maximum temperature is reached when three LEDs are lit.

If the drive is continued within approx. 15 minutes, the seat heating is activated automatically with the temperature selected last.

When ECO PRO, refer to page 169, is activated, the heater output is reduced.

### Switching off



Press the button longer.  
The LEDs go out.

## Safety belts

### Seats with safety belt

The vehicle has five seats, each of which is equipped with a safety belt.

### Number of safety belts

Your vehicle has been fitted with five safety belts for the safety of you and your passengers. However, they can only offer protection when adjusted correctly.

### Hints

Always make sure that safety belts are being worn by all occupants before driving away.

To protect the occupants, the belt locking triggers early. Slowly guide the belt out of the holder when applying it.

Although airbags enhance safety by providing added protection, they are not a substitute for safety belts.

- ▶ The upper shoulder strap's anchorage point will be correct for adult seat occupants of every build if the seat is correctly adjusted.
- ▶ The two outer safety belt buckles, integrated into the rear seat, are for passengers sitting on the left and right.
- ▶ The center rear seat belt buckle is solely intended for the center passenger.

**One person per safety belt**

Never allow more than one person to wear a single safety belt. Never allow infants or small children to ride on a passenger's lap. ◀

**Putting on the belt**

Lay the belt, without twisting, snugly across the lap and shoulders, as close to the body as possible. Make sure that the belt lies low around the hips in the lap area and does not press on the abdomen. Otherwise, the belt can slip over the hips in the lap area in a frontal impact and injure the abdomen.

The safety belt must not lie across the neck, rub on sharp edges, be routed over breakable objects, or be pinched. ◀

**Reduction of restraining effect**

Avoid wearing bulky clothing, and pull the shoulder belt periodically to readjust the tension. Make sure that the belt is not jammed; otherwise, the belt can be damaged and the restraining effect reduced. ◀

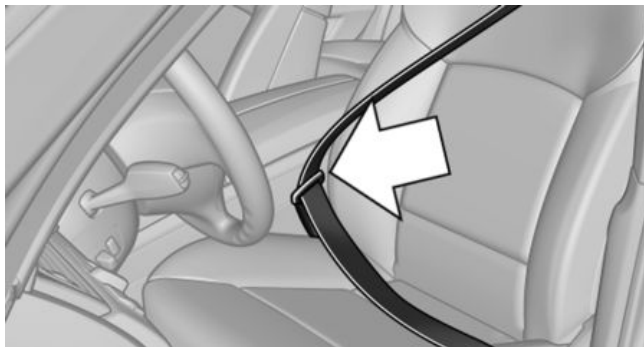
**Buckling the belt**

Make sure you hear the latch plate engage in the belt buckle.

**Unbuckling the belt**

1. Hold the belt firmly.
2. Press the red button in the belt buckle.
3. Guide the belt back into its reel.

**Safety belt reminder for driver's and passenger's seat**

The indicator lamp lights up and a signal sounds. Make sure that the safety belts are positioned correctly. The safety belt reminder is active at speeds above approx. 6 mph/10 km/h. It can also be activated if objects are placed on the front passenger seat.

**Damage to safety belts**

In the case of strain caused by accidents or damage:

Have the safety belts, including the safety belt tensioners, replaced and have the belt anchors checked.

**Checking and replacing safety belts**

Have the work performed only by your service center; otherwise, it cannot be ensured that this safety feature will function properly. ◀

**Front headrests****Correctly adjusted head restraint**

A correctly adjusted head restraint reduces the risk of injury to cervical vertebrae in the event of an accident.

**Adjusting the head restraint**

Correctly adjust the head restraints of all occupied seats; otherwise, there is an increased risk of injury in an accident. ◀

**Height**

Adjust the head restraint so that its center is approximately at ear level.

**Distance**

Adjust the distance so that the head restraint is as close as possible to the back of the head.

If necessary, adjust the distance by adjusting the tilt of the backrest.

## Adjusting the height

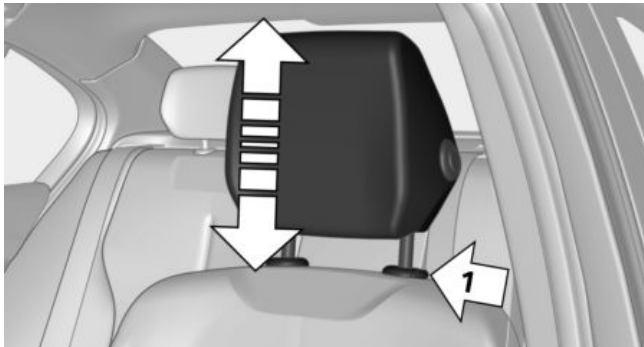

- ▷ To raise: pull.
- ▷ To lower: press the button, arrow 1, and push the head restraint down.

## Tilt

Three different tilt positions are available.

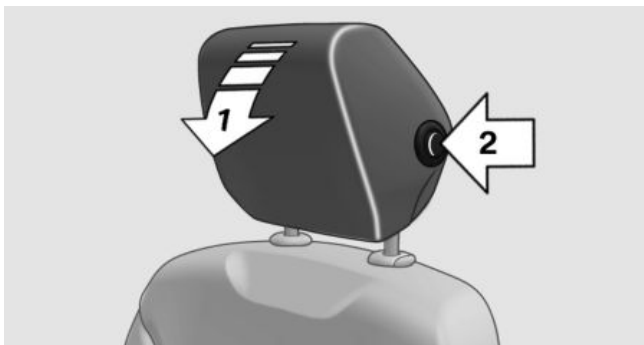

- ▷ Forward: pull the top edge of the head restraint forward, arrow 1.
- ▷ Back: press the button, arrow 2. The head restraint folds as far back as possible.

## Removing

Only remove the head restraint if no one will be sitting in the seat in question.

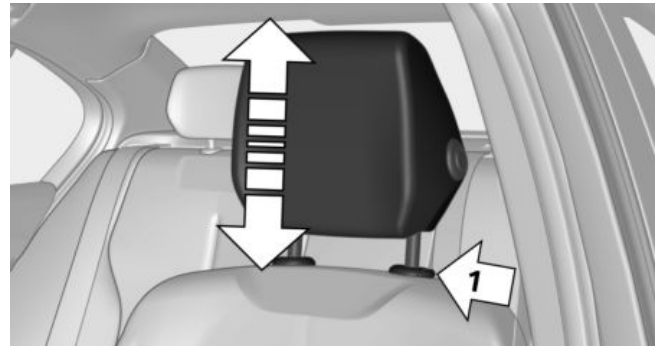

1. Pull the head restraint upward as far as possible.
2. Press the button, arrow 1, and pull the head restraint out completely.



Before transporting passengers

Reinstall the head restraint before transporting anyone in the seat; otherwise, the protective function of the head restraint is unavailable. ◀

## Rear head restraints

### Correctly adjusted head restraint

A correctly adjusted head restraint reduces the risk of injury to cervical vertebrae in the event of an accident.



Adjusting the head restraint

Correctly adjust the head restraints of all occupied seats; otherwise, there is an increased risk of injury in an accident. ◀

### Height

Adjust the head restraint so that its center is approximately at ear level.

## Adjusting the height

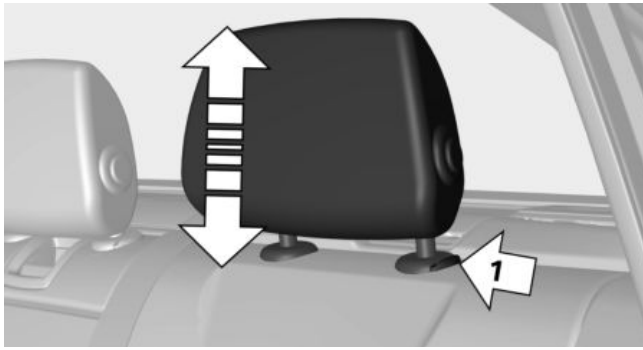

- ▷ To raise: pull.
- ▷ To lower: press the button, arrow 1, and push the head restraint down.

The center head restraint cannot be adjusted in elevation.

## Folding down head restraints

### Extending/retracting head restraint

Only fold down head restraint if no passengers are in the rear. Fold out retracted headrests again if passengers are being carried in the rear; otherwise, there is increased risk of injury in the event of an accident. ◀

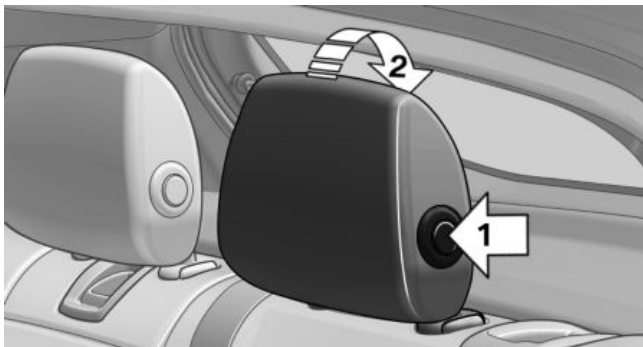

- ▷ To lower flaps: press the button, arrow 1, and press down the head restraint, arrow 2.
- ▷ Fold back up: pull up head restraints.

## Removing

Only remove the head restraint if no one will be sitting in the seat in question.

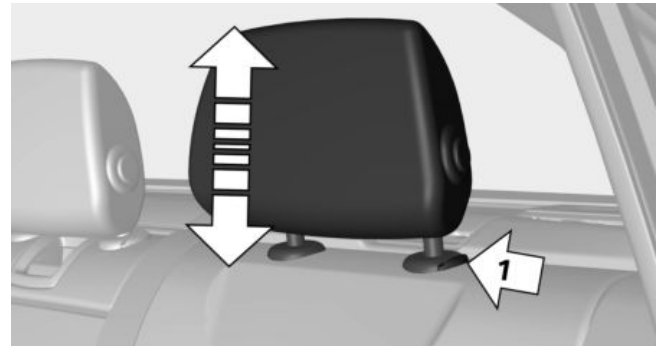





1. Pull the head restraint upward as far as possible.
2. Press the button, arrow 1, and pull the head restraint out completely.

 Before transporting passengers  
Reinstall the head restraint before transporting anyone in the seat; otherwise, the protective function of the head restraint is unavailable. ◀

## Seat and mirror memory

### Hints

-  Do not retrieve the memory while driving
-  Do not retrieve the memory setting while driving, as an unexpected movement of the seat could result in an accident. ◀
-  Keep the movement area unobstructed
-  When changing the seat position, keep the seat's area of movement unobstructed; otherwise, people can be injured or objects damaged. ◀



## General information



Two different driver's seat and exterior mirror positions can be stored and retrieved for each remote control. Settings for the backrest width and lumbar support are not stored in memory.

## Storing

1. Switch on the ignition.
2. Set the desired position.
3.  Press the button. The LED in the button lights up.
4. Press the desired button 1 or 2. The LED goes out.

If the M button is pressed accidentally:

-  Press the button again.  
The LED goes out.

## Calling up settings

### Comfort function

1. Open the driver's door.
2. Switch off the ignition.
3. Briefly press the desired button 1 or 2.

The corresponding seat position is performed automatically.

The procedure stops when a switch for adjusting the seat or one of the buttons is pressed.

### Safety mode

1. Close the driver's door or switch on the ignition.

2. Press and hold the desired button 1 or 2 until the adjustment procedure is completed.

### Calling up of a seat position deactivated

After a brief period, the calling up of stored seat positions is deactivated to save battery power.

To reactivate calling up of a seat position:

- ▶ Open and close the door or trunk lid.
- ▶ Press a button on the remote control.
- ▶ Press the Start/Stop button.

## Mirrors

### Exterior mirrors

#### At a glance



- 1 Adjusting
- 2 Left/right, Automatic Curb Monitor
- 3 Fold in and out

### General information

The mirror on the passenger side is more curved than the driver's side mirror.

-  Estimating distances correctly  
Objects reflected in the mirror are closer than they appear. Do not estimate the distance to the traffic behind you based on what you see in the mirror, as this will increase your risk of an accident. ◀



Depending on how the vehicle is equipped, the mirror setting is stored for the remote control in use. When the vehicle is unlocked via the remote control, the position is automatically retrieved if the setting for this function is active.

### Selecting a mirror



To change over to the other mirror:  
Slide the mirror changeover switch.

### Adjusting electrically



The setting corresponds to the direction in which the button is pressed.

### Saving positions

Seat and mirror memory, refer to page 53

### Adjusting manually

If an electrical malfunction occurs, for example, press the edges of the mirror glass.

### Automatic Curb Monitor

#### The concept

When the reverse gear is engaged, the mirror glass tilts downward slightly on the front passenger side. This improves your view of the curb and other low-lying obstacles when parking, for example.

#### Activating



1. Slide the mirror changeover switch to the driver's side mirror position.
2. Engage selector lever position R.

#### Deactivating

Slide the mirror changeover switch to the passenger side mirror position.

### Fold in and out



Press the button.

Possible up to approx. 15 mph/20 km/h.

For example, this is advantageous

- ▷ In car washes.
- ▷ In narrow streets.
- ▷ For folding back mirrors that were folded away manually.

Mirrors that were folded in are folded out automatically at a speed of approx. 25 mph/40 km/h.



Fold in the mirror in a car wash

Before washing the car in an automatic car wash, fold in the exterior mirrors by hand or with the button; otherwise, the mirrors could be damaged, depending on the width of the vehicle. ◀

### Automatic heating

Both exterior mirrors are automatically heated whenever the engine is running.

### Automatic dimming feature

Both exterior mirrors are automatically dimmed. Photocells are used for control in the interior rear view mirror, refer to page 56.

## Interior rearview mirror, manually dimmable

### Turn knob

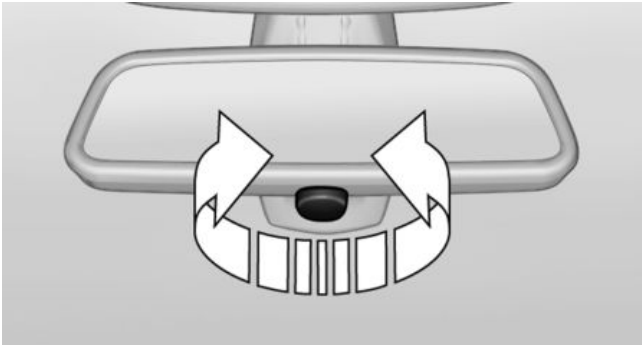

Turn the knob to reduce the blinding effect by the interior mirror.

## Interior rearview mirror, automatic dimming feature

### The concept

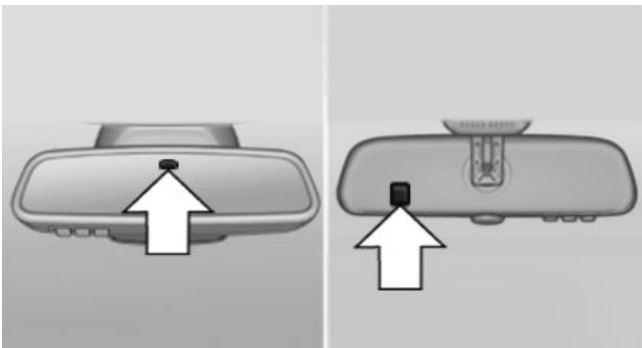

Photocells are used for control:

- ▷ In the mirror glass.
- ▷ On the back of the mirror.

### Functional requirement

For proper operation:

- ▷ Keep the photocells clean.
- ▷ Do not cover the area between the inside rearview mirror and the windshield.

## Steering wheel

### General information



Do not adjust while driving

Do not adjust the steering wheel while driving; otherwise, an unexpected movement could result in an accident. ◀

### Adjusting

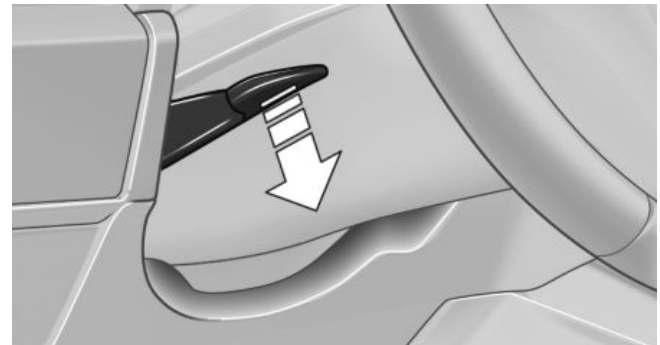

1. Fold the lever down.
2. Move the steering wheel to the preferred height and angle to suit your seating position.
3. Fold the lever back.

## Steering wheel heating



### Switching on/off



Press the button.

- ▷ On: the LED lights up.
- ▷ Off: the LED goes out.

# Transporting children safely

## Vehicle equipment

All standard, country-specific and optional equipment that is offered in the model series is described in this chapter. Therefore, equipment is also described that is not available in a vehicle, e. g., because of the selected optional equipment or country variant. This also applies for safety-related functions and systems.

## The right place for children

### Note



Children in the vehicle

Do not leave children unattended in the vehicle; otherwise, they could endanger themselves and other persons, e.g., by opening the doors. ◀

### Children should always be in the rear

Accident research shows that the safest place for children is in the back seat.



Transporting children in the rear

Only transport children younger than 13 years of age or shorter than 5 ft/150 cm in the rear in child restraint fixing systems provided in accordance with the age, weight and size of the child; otherwise, there is an increased risk of injury in an accident.

Children 13 years of age or older must wear a safety belt as soon as a suitable child restraint fixing system can no longer be used, due to their age, weight and size. ◀

### Children on the front passenger seat

Should it ever be necessary to use a child restraint fixing system in the front passenger seat, make sure that the front, knee and side airbags on the front passenger side are deacti-

vated. Automatic deactivation of front passenger airbags, refer to page 96.

### Note



Deactivated front passenger airbags

If a child restraint fixing system is used in the front passenger seat, the front passenger airbags must be deactivated; otherwise, there is an increased risk of injury to the child when the airbags are triggered, even with a child restraint fixing system. ◀

## Installing child restraint fixing systems

### Before mounting

Before mounting child restraint fixing systems, ensure that the rear seat backrests are locked.

### Hints



Manufacturer's information for child restraint fixing systems

To select, mount and use child restraint fixing systems, observe the information provided by the system manufacturer; otherwise, the protective effect can be impaired. ◀



Ensuring the stability of the child seat

When installing child restraint fixing systems, make sure that the child seat is securely fastened to the backrest of the seat. The angle of the backrest may need to be adjusted and, where necessary, the headrest height may also need to be adjusted, or if possible removed. Make sure that all backrests are securely locked. Otherwise, the stability of the child seat is limited, and there is an increased risk of injury because of unexpected movement of the rear seat backrest. ◀

## On the front passenger seat

### Deactivating airbags

After installing a child restraint fixing system in the front passenger seat, make sure that the front, knee and side airbags on the front passenger side are deactivated.

Deactivate the front passenger airbags automatically, refer to page 96.



Deactivating the front passenger airbags

If a child restraint fixing system is used in the front passenger seat, the front passenger airbags must be deactivated; otherwise, there is an increased risk of injury to the child when the airbags are triggered, even with a child restraint fixing system. ◀

### Seat position and height

Before installing a child restraint fixing system, move the front passenger seat as far back as possible and adjust its height to the highest position to obtain the best possible position for the belt and to offer optimal protection in the event of an accident.

If the upper fixing point of the safety belt is located before the belt guide of the child seat, move the passenger seat carefully forward until the best possible belt guide position is reached.

### Backrest width

Adjustable backrest width: before installing a child restraint fixing system in the front passenger seat, open the backrest width completely. Do not change the backrest width again and do not call up a memory position.

## LATCH child restraint fixing system

LATCH: Lower Anchors and Tether for Children.



Backrest width for the child seat

Before installing a child restraint fixing system in the front passenger seat, the backrest width must be opened completely. Do not change the adjustment after this; otherwise, the stability of the child seat will be reduced. ◀

### Child seat security



The rear safety belts and the front passenger safety belt can be locked against pulling out for mounting the child restraint fixing systems.

### Locking the safety belt

1. Pull out the belt webbing completely.
2. Secure the child restraint fixing system with the belt.
3. Allow the belt webbing to be pulled in and pull it taut against the child restraint fixing system. The safety belt is locked.

### Unlocking the safety belt

1. Unbuckle the belt buckle.
2. Remove the child restraint fixing system.
3. Allow the belt webbing to be pulled in completely.

**Note**

 Follow manufacturer's information for LATCH child restraint fixing systems

To mount and use the LATCH child restraint fixing systems, observe the operating and safety information from the system manufacturer; otherwise, the level of protection may be reduced. ◀

**Mounts for the lower LATCH anchors**

The lower anchors may be used to attach the CRS to the vehicle seat up to a combined child and CRS weight of 65 lb/30 kg when the child is restrained by the internal harnesses.

 Correctly engage the lower LATCH anchors

Make sure that the lower LATCH anchors have properly engaged and that the child restraint fixing system is resting snugly against the backrest; otherwise, the degree of protection offered may be reduced. ◀

Before mounting the LATCH child restraint fixing system, pull the belt away from the child restraint fixing system.

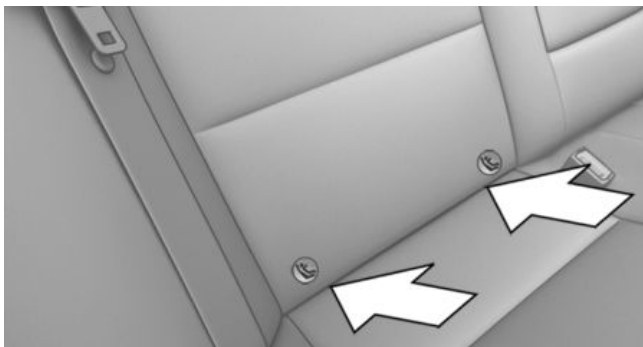
**Without a through-loading system:  
Position**

Mounts for the lower LATCH anchors are located in the gap between the seat and backrest.

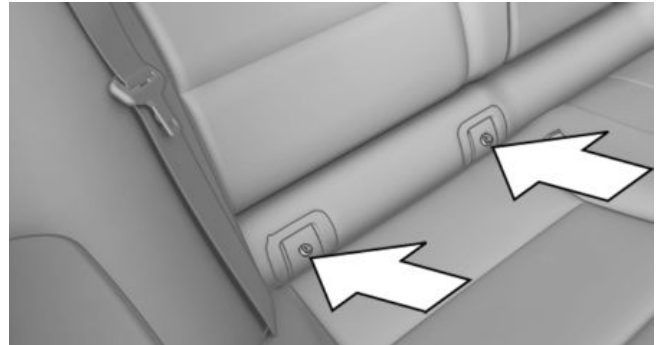
**With a through-loading system:  
Position**

Mounts for the lower LATCH anchors are located behind the indicated covers.

**Mounting ISOFIX child restraint fixing systems**

1. Mount the child restraint fixing system; refer to the user's manual of the system.
2. Ensure that both LATCH anchors are properly connected.

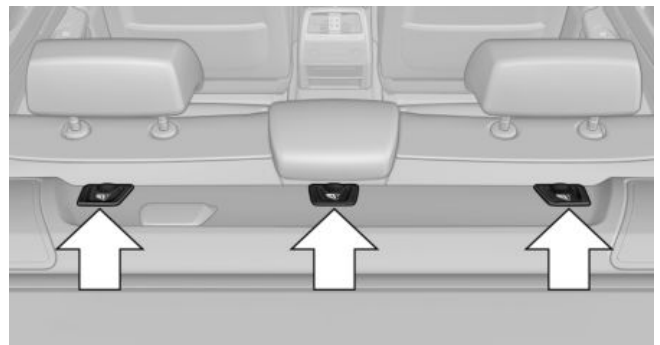
**Child restraint fixing system with a tether strap****Mounting points**

Depending on the vehicle equipment, there are two outer or three mounting points for child restraint fixing systems with a tether strap.



## Note



### Mounting eyes

Only use the mounting eyes for the upper retaining strap to secure child restraint fixing systems; otherwise, the mounting eyes could be damaged. ◀

## Retaining strap guide



### Retaining strap

Make sure that the upper retaining strap is not routed over the head restraints or sharp edges and is free of twisting on its way to the upper mounting point; otherwise, the belt cannot properly secure the child restraint fixing system in an accident. ◀

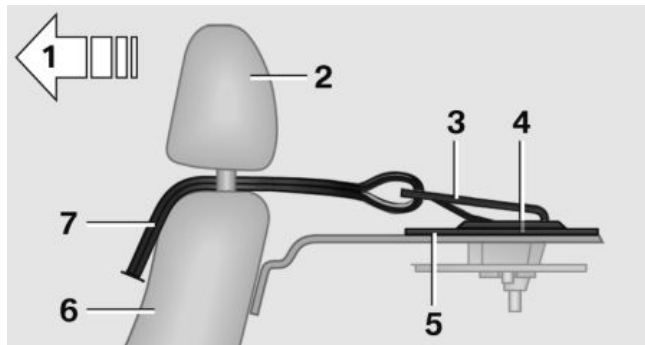

- 1 Direction of travel
- 2 Head restraint.
- 3 Hook for upper retaining strap
- 4 Mounting point/eye
- 5 Rear window shelf
- 6 Seat backrest
- 7 Upper retaining strap

## Attaching the upper retaining strap to the mounting point

1. Remove the mounting point cover.
2. Raise the head restraint.
3. Guide the upper retaining strap between the supports of the head restraint.
4. Attach the hook of the retaining strap to the mounting eye.

5. Tighten the retaining strap by pulling it down.
6. Lower and lock head restraints as needed.

## Locking the doors and windows

### Rear doors

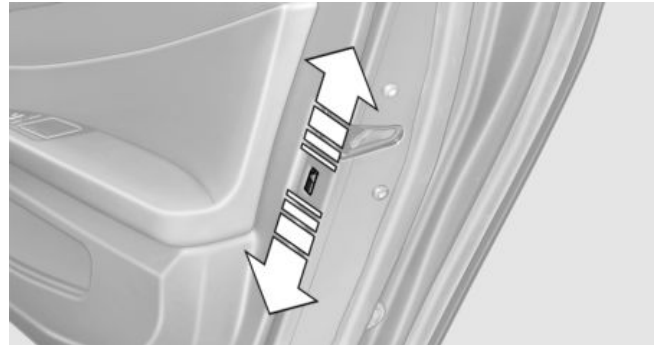

Push the locking lever on the rear doors down. The door can now be opened from the outside only.

### Safety switch for the rear



Press the button on the driver's door if children are being transported in the rear.

This locks various functions so that they cannot be operated from the rear: safety switch, refer to page 44.



# Driving

## Vehicle equipment

All standard, country-specific and optional equipment that is offered in the model series is described in this chapter. Therefore, equipment is also described that is not available in a vehicle, e. g., because of the selected optional equipment or country variant. This also applies for safety-related functions and systems.

## Start/Stop button

### The concept



Pressing the Start/Stop button switches the ignition on or off and starts the engine.

Automatic transmission: The engine starts if the brake is depressed while pressing the Start/Stop button.

Manual transmission: the engine starts if the clutch pedal is depressed when the Start/Stop button is pressed.

### Ignition on

Automatic transmission: Press the Start/Stop button but do not depress the brake.

Manual-shift transmission: press the Start/Stop button, and do not press on the clutch pedal at the same time.

All vehicle systems are ready for operation.

Most of the indicator and warning lamps in the instrument cluster light up for varying lengths of time.

To save battery power when the engine is off, switch off the ignition and any unnecessary electronic systems/power consumers.

### Note

If the engine is switched off and the ignition is switched on, the system automatically switches to the radio ready state when the door is opened if the lights are switched off or the daytime running lights are switched on.

### Ignition off

Automatic transmission: Press the Start/Stop button again, but do not depress the brake.

Manual-shift transmission: press the Start/Stop button again, and do not press on the clutch pedal at the same time.

All indicator lamps in the instrument cluster go out.

To save battery power when the engine is off, switch off the ignition and any unnecessary electronic systems/power consumers.



P when the ignition is switched off

P is engaged automatically when the ignition is switched off. When in an automatic car wash, for example, ensure that the ignition is not switched off accidentally. ◀

The ignition automatically cuts off while the vehicle is stationary and the engine is stopped:

- ▶ When locking the vehicle, and when the low beams are activated.
- ▶ Shortly before the battery is discharged completely, so that the engine can still be started. This function is only available when the low beams are switched off.
- ▶ When opening or closing the driver door, if the driver's seat belt is unbuckled and the low beams are switched off.
- ▶ While the driver's seat belt is unbuckled, if the driver's door is open and the low beams are switched off.

When the ignition is switched off, by opening or closing the driver's door or unbuckling the

driver's seat belt, the radio ready state remains active.

## Radio ready state

Activate radio ready state:

- ▶ When the engine is running: press the Start/Stop button.

Some electronic systems/power consumers remain ready for operation.

The radio ready state switches off automatically:

- ▶ After approx. 8 minutes.
- ▶ When the vehicle is locked using the central locking system.
- ▶ Shortly before the battery is discharged completely, so that the engine can still be started.

## Starting the engine

### Hints



Enclosed areas

Do not let the engine run in enclosed areas, since breathing in exhaust fumes may lead to loss of consciousness and death. The exhaust gases contain carbon monoxide, an odorless and colorless, but highly toxic gas. ◀



Unattended vehicle

Do not leave the vehicle unattended with the engine running; doing so poses a risk of danger.

Before leaving the vehicle with the engine running, set the parking brake and place the transmission in selector lever position P or neutral to prevent the vehicle from moving. ◀



Repeated starting in quick succession

Avoid repeated unsuccessful attempts to start the vehicle or starting the vehicle several times in quick succession. Otherwise, the fuel is not burned or is inadequately burned, posing

a risk of overheating and damage to the catalytic converter. ◀

Do not wait for the engine to warm-up while the vehicle remains stationary. Start driving at moderate engine speeds.

## Diesel engine

If the engine is cold and temperatures are below approx. 32 °F/0 °C, the start process may be delayed somewhat due to automatic pre-heating.

A Check Control message is displayed.

## Automatic transmission

### Starting the engine

1. Depress the brake pedal.
2. Press the Start/Stop button.

The ignition is activated automatically for a certain time and is stopped as soon as the engine starts.

## Manual transmission

### Starting the engine

1. Depress the brake pedal.
2. Press on the clutch pedal and shift to neutral.
3. Press the Start/Stop button.

The ignition is activated automatically for a certain time and is stopped as soon as the engine starts.

## Engine stop

### Hints



Take the remote control with you

Take the remote control with you when leaving the vehicle so that children, for example, cannot start the engine. ◀



Set the parking brake and further secure the vehicle as required

Set the parking brake firmly when parking; otherwise, the vehicle could roll. On steep upward and downward inclines, further secure the vehicle, for example, by turning the steering wheel in the direction of the curb. ◀

## Before driving into a car wash

In order for the vehicle to be able to roll into a car wash, pay attention to the information regarding Washing in automatic car washes, refer to page 221.

## Automatic transmission

### Switching off the engine

1. Engage selector lever position P with the vehicle stopped.
2. Press the Start/Stop button.  
The engine is switched off.  
The radio ready state is switched on.
3. Set the parking brake.

## Manual transmission

### Switching off the engine

1. With the vehicle at a standstill, press the Start/Stop button.
2. Shift into first gear or reverse.
3. Set the parking brake.

## Auto Start/Stop function

### The concept

The Auto Start/Stop function helps save fuel. The system switches off the engine during a stop, e.g., in traffic congestion or at traffic lights. The ignition remains switched on. The engine starts again automatically for driving off.

## Automatic mode

After every start of the engine using the Start/Stop button, the Auto Start/Stop function is in the last selected state, refer to page 64.

When the Auto Start/Stop function is active, it is available when the vehicle is traveling faster than about 3 mph, approx. 5 km/h.

## Engine stop

The engine is switched off automatically during a stop under the following conditions:

Automatic transmission:

- ▶ The selector lever is in selector lever position D.
- ▶ Brake pedal remains depressed while the vehicle is stopped.
- ▶ The driver's safety belt is buckled or the driver's door is closed.

Manual transmission:

- ▶ Neutral is engaged and the clutch pedal is not pressed.
- ▶ The driver's safety belt is buckled or the driver's door is closed.

The air flow of the air conditioner is reduced when the engine is switched off.

## Displays in the instrument cluster



The READY display in the tachometer signals that the Auto Start/Stop function is ready to start the engine automatically.



The display indicates that the conditions for an automatic engine stop have not been satisfied.

## Note

The engine is not switched off automatically in the following situations:

- ▶ External temperature too low.

- ▷ The external temperature is high and automatic climate control is running.
- ▷ The passenger compartment has not yet been heated or cooled to the required level.
- ▷ The engine is not yet at operating temperature.
- ▷ The wheels are at a sharp angle or the steering wheel is being turned.
- ▷ After driving in reverse.
- ▷ Fogging of the windows when the automatic climate control is switched on.
- ▷ Vehicle battery is heavily discharged.
- ▷ The engine compartment lid is unlocked.
- ▷ The parking assistant is activated.
- ▷ Stop-and-go traffic.
- ▷ The selector lever is in position N or M/S.
- ▷ Use of fuel with high ethanol content.

### Starting the engine

The engine starts automatically under the following conditions:

- ▷ Automatic transmission:  
By releasing the brake pedal.
- ▷ Manual transmission:  
The clutch pedal is pressed.

After the engine starts, accelerate as usual.

### Safety mode

After the engine switches off automatically, it will not start again automatically if any one of the following conditions are met.

- ▷ The driver's safety belt is unbuckled and the driver's door is open.
- ▷ The hood was unlocked.

Some indicator lamps light up for varying lengths of time.

The engine can only be started via the Start/Stop button.

### Note

Even if driving away was not intended, the deactivated engine starts up automatically in the following situations:

- ▷ Excessive warming of the passenger compartment when the cooling function is switched on.
- ▷ The steering wheel is turned.
- ▷ Automatic transmission: change from selector lever position D to N, R or M/S.
- ▷ Automatic transmission: change from selector lever position P to N, D, R or M/S.
- ▷ The vehicle begins rolling.
- ▷ Fogging of the windows when the automatic climate control is switched on.
- ▷ Vehicle battery is heavily discharged.
- ▷ Excessive cooling of the passenger compartment when the heating is switched on.
- ▷ Low brake vacuum pressure; this can occur, for example, if the brake pedal is depressed a number of times in succession.

### Activating/deactivating the system manually

#### Using the button



 Press the button.

- ▷ LED comes on: Auto Start Stop function is deactivated.  
The engine is started during an automatic engine stop.

The engine can only be stopped or started via the Start/Stop button.

- ▶ LED goes out: Auto Start Stop function is activated.

### Switching off the vehicle during an automatic engine stop

During an automatic engine stop, the vehicle can be switched off permanently, e.g., when leaving it.

1. Press the Start/Stop button. The ignition is switched off. The Auto Start/Stop function is deactivated.

Selector lever position P is engaged automatically.

2. Set the parking brake.

Engine start as usual via Start/Stop button.

### Automatic deactivation

In certain situations, the Auto Start/Stop function is deactivated automatically for safety reasons, such as when the driver is detected to be absent.

### Malfunction

The Auto Start/Stop function no longer switches of the engine automatically. A Check Control message is displayed. It is possible to continue driving. Have the system checked.

## Parking brake

### Applying

The lever automatically engages after being pulled up.



The indicator lamp lights up red. The parking brake is set.



Lower lamp: indicator lamp in Canadian models

### Releasing

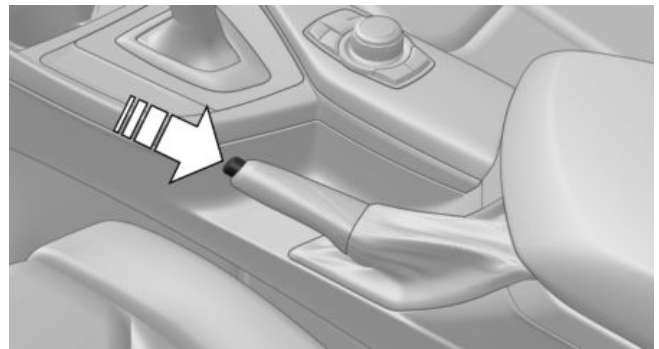

Raise lever slightly, press the button and guide the lever down.

### Hints



Use while driving

If on a rare occasion it is necessary to use the parking brake while driving, do not use excessive force when applying it. When using it, keep the button on the lever depressed.

Otherwise, using excessive force when applying the parking brake may cause the rear wheels to lock, resulting in fishtailing. ◀

To prevent corrosion and braking control on one side only, lightly apply the parking brake periodically while coasting, if traffic conditions permit.

The brake lamps will not light up if the parking brake is engaged.

## Turn signal, high beams, headlamp flasher

### Turn signal



Do not fold in the exterior mirrors

Do not fold in the exterior mirror while driving and when the turn signals/warning flashers are working, or else the additional flasher lights in the exterior mirror will no longer be in the prescribed position and will be difficult to see. ◀



## Using turn signals

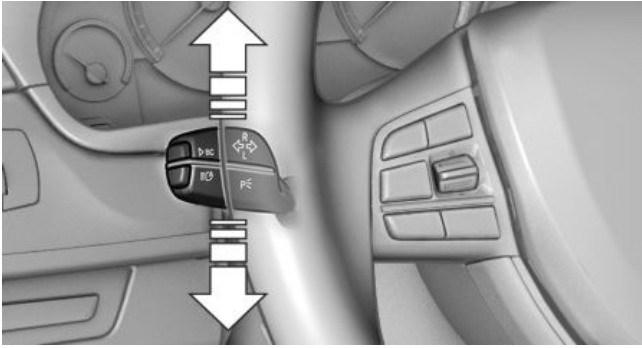

Press the lever beyond the resistance point.  
To switch off manually, press the lever to the resistance point.

Unusually rapid flashing of the indicator lamp indicates that a turn signal bulb has failed.

### Triple turn signal activation

Press the lever to the resistance point.

The turn signal flashes three times.

The function can be activated or deactivated:

1. "Settings"
2. "Lighting"
3. "Triple turn signal"

The setting is stored for the remote control currently in use.

### Signaling briefly

Press the lever to the resistance point and hold it there for as long as you want the turn signal to flash.

## High beams, headlamp flasher

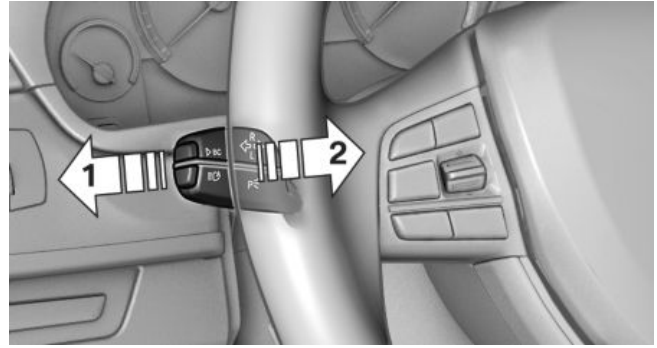

- ▷ High beams, arrow 1.
- ▷ Headlamp flasher, arrow 2.

## Washer/wiper system

### Switching the wipers on/off and brief wipe



Do not switch on the wipers if frozen

Do not switch on the wipers if they are frozen onto the windshield; otherwise, the wiper blades and the windshield wiper motor may be damaged. ◀



No wiper operation on dry windshield

Do not use the windshield wipers if the windshield is dry, as this may damage the wiper blades or cause them to become worn more quickly. ◀



No wiper operation with wipers folded away

Do not switch on the wipers if they are folded away, otherwise the hood or the wipers may be damaged. ◀



## Switching on

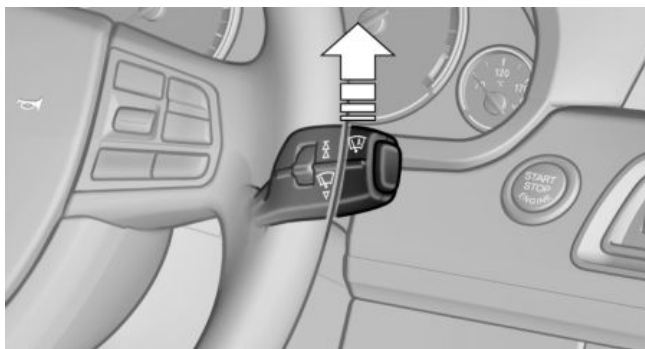

Press the wiper levers up.

The lever automatically returns to its initial position when released.

- ▶ Normal wiping speed: press up once.  
The wipers switch to intermittent operation when the vehicle is stationary.
- ▶ Fast wiping speed: press up twice or press once beyond the resistance point.  
The wipers switch to normal speed when the vehicle is stationary.

## Switching off and brief wipe

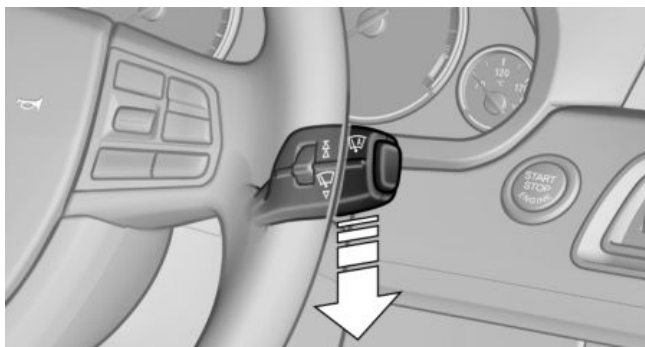

Press the wiper levers down.

The lever automatically returns to its initial position when released.

- ▶ Brief wipe: press down once.
- ▶ To switch off normal wipe: press down once.
- ▶ To switch off fast wipe: press down twice.

## Intermittent operation or rain sensor

### The concept

Without the rain sensor, the frequency of the wiper operation is preset.

The rain sensor automatically controls the time between wipes depending on the intensity of the rainfall. The sensor is located on the windshield, directly behind the interior rearview mirror.

### Activating/deactivating

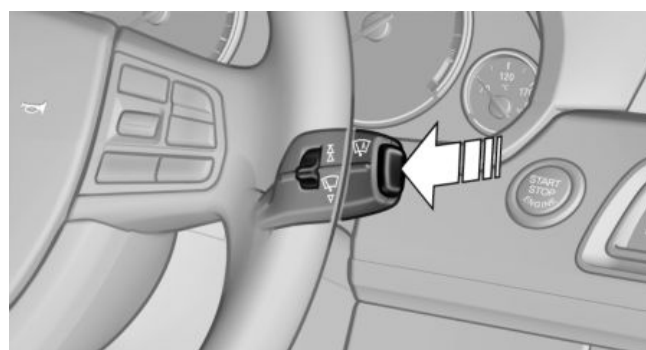

Press the button on the wiper lever.

The LED in the wiper lever lights up and a wiping operation is started. If there is frost, wiper operation is not started.



Deactivate the rain sensor in car washes

Deactivate the rain sensor when passing through an automatic car wash; otherwise, damage could be caused by undesired wiper activation. ◀

## Setting the frequency or sensitivity of the rain sensor

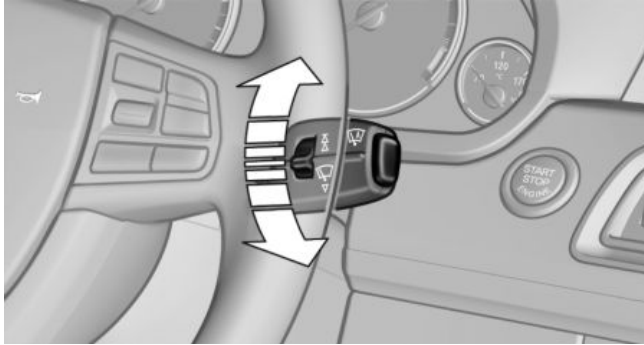

Turn the thumbwheel.

## Clean the windshield, headlamps

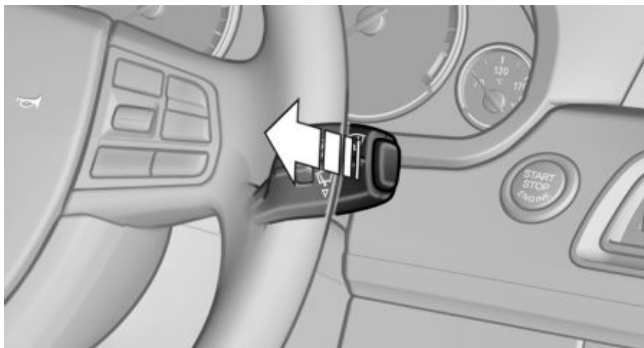

Pull the wiper lever.

The system sprays washer fluid on the windshield and activates the wipers briefly.

In addition, the headlamps are cleaned at regular intervals when the vehicle lights are switched on.

**!** Do not use the washer system at freezing temperatures

Do not use the washers if there is any danger that the fluid will freeze on the windshield; otherwise, your vision could be obscured. For this reason, use antifreeze.

Avoid using the washer when the reservoir is empty; otherwise, you could damage the pump.◀

## Windshield washer nozzles

The windshield washer nozzles are automatically heated while the ignition is switched on.

## Fold-out position of the wipers

Required when changing the wiper blades or under frosty conditions, for example.

1. Switch the ignition on and off again.
2. Under frosty conditions, ensure that the wiper blades are not frozen onto the windshield.
3. Press the wiper lever up beyond the point of resistance and hold it for approx. 3 seconds, until the wiper remains in a nearly vertical position.

After the wipers are folded back down, the wiper system must be reactivated.

**!** Fold the wipers back down  
Before switching the ignition on, fold the wipers back down to the windshield; otherwise, the wipers may become damaged when they are switched on.◀

1. Switch on the ignition.
2. Press the wiper levers down. The wipers move to their resting position and are ready for operation.

## Washer fluid

### General information

**!** Antifreeze for washer fluid  
Antifreeze is flammable and can cause injury if it is used incorrectly.

Therefore, keep it away from sources of ignition.

Only keep it in the closed original container and inaccessible to children.

Follow the notes and instructions on the container.

United States: The washer fluid mixture ratio is regulated by the U.S. EPA and many individual states; do not exceed the allowable washer fluid dilution ratios limits that apply. Follow the usage instructions on the washer fluid con-

tainer. Use BMW's Windshield Washer Concentrate or the equivalent. ◀

### Washer fluid reservoir



#### Adding washer fluid

Only add washer fluid when the engine is cool, and then close the cover completely to avoid contact between the washer fluid and hot engine parts.

Otherwise, there is the danger of fire and a risk to personal safety if the fluid is spilled. ◀



All washer nozzles are supplied from one reservoir.

Fill with a mixture of windshield washer concentrate and tap water and – if required – with a washer antifreeze, according to the manufacturer's recommendations.

Mix the washer fluid before adding to maintain the correct mixing ratio.

Do not add windshield washer concentrate and antifreeze undiluted and do not fill with pure water; this could damage the wiper system.

Do not mix window washer concentrates of different manufacturers, because otherwise it can result in clogging of the windshield washer nozzles.

Recommended minimum fill quantity: 0.2 US gal/1 liter.

## Manual transmission

### Shifting



Shifting into 5th or 6th gear

When shifting into 5th or 6th gear, push the gearshift lever to the right; otherwise inadvertent shifting into the 3rd or 4th gear could lead to engine damage. ◀

### Reverse gear

Select only when the vehicle is stationary.

To overcome the resistance move the selector lever in a dynamic movement to the left and engage the reverse gear.

## Automatic transmission with Steptronic

### Selector lever positions

#### D Drive, automatic position

Gear position for normal vehicle operation. All forward gears are available.

#### R is Reverse

Select only when the vehicle is stationary.

#### N is Neutral

Use in automatic car washes, for example. The vehicle can roll.

When the ignition is switched off, refer to page 61, selector lever position P is engaged automatically.

#### P Park

Select only when the vehicle is stationary. The drive wheels are blocked.

P is engaged automatically:

- ▶ After the engine is switched off when the vehicle is in radio ready state, refer to page 62, or when the ignition is switched

off, refer to page 61, and when position R or D is engaged.

- ▶ With the ignition off, if selector lever position N is engaged.
- ▶ If the safety belt is unbuckled, the driver's door is opened, and the brake pedal is not pressed while the vehicle is stationary and position D or R is engaged.

Before exiting the vehicle, make sure that selector lever position P of the automatic transmission is engaged. Otherwise, the vehicle may begin to roll.

### Kickdown

Kickdown is used to achieve maximum driving performance. Press on the accelerator pedal beyond the resistance point at the full throttle position.

### Engaging selector lever positions

- ▶ It is not possible to shift out of selector lever position P until the engine is running and the brake is applied.
- ▶ With the vehicle stationary, press on the brake pedal before shifting out of P or N; otherwise, the shift command will not be executed: shift lock.



Press on the brake pedal until you start driving

To prevent the vehicle from creeping after you select a gear, maintain pressure on the brake pedal until you are ready to start. ◀

### Engaging D, R and N



Briefly push the selector lever in the desired direction, beyond a resistance point if necessary. After releasing the selector lever, it returns to its center position.



Press unlock button, in order to:

- ▶ Engage R.
- ▶ Shift out of P.

### Engaging P



Press button P.



## Sport program and manual mode

### Activating the sport program



Press the selector lever to the left out of selector lever position D.

The sport program of the transmission is activated.

### Activating the M/S manual mode

1. Press the selector lever to the left out of selector lever position D.
2. Push the selector lever forward or pull it backward.

Manual mode becomes active and the gear is changed.

The engaged gear is displayed in the instrument cluster, e.g., M1.

Once maximum engine speed is attained, M/S manual mode is automatically upshifted as needed.

### Switching to manual mode

- ▶ To shift down: press the selector lever forward.
- ▶ To shift up: pull the selector lever rearwards.

Gears will only be shifted at appropriate engine and road speeds, e.g., downshifting is not possible if the engine speed is too high.

The selected gear is briefly displayed in the instrument cluster, followed by the current gear.

### Sport automatic transmission: prevent automatic upshifting in M/S manual mode

For vehicles with Sport automatic transmissions, automatic shift operations are not performed, at maximum engine speed for example, if one of the following conditions is met:

- ▶ DSC deactivated.
- ▶ TRACTION activated.
- ▶ SPORT+ activated.

In addition, the kickdown is deactivated.

### Ending the sport program/manual mode

Push the selector lever to the right.

D is displayed in the instrument cluster.

### Shift paddles

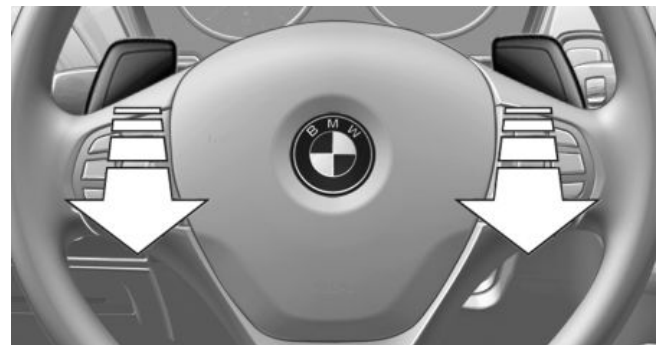

The shift paddles on the steering wheel allow you to shift gears quickly while keeping both hands on the steering wheel.

If the shift paddles on the steering wheel are used to shift gears in automatic mode, the transmission temporarily switches to manual mode.

If the shift paddles are not used and the vehicle is not accelerated for a certain time, the system switches back into automatic mode if the selector lever is in selector lever position D.

- ▶ Shift up: pull right shift paddle.
- ▶ Shift down: pull left shift paddle.

Gears will only be shifted at appropriate engine and road speeds, for example downshifting is not possible if the engine speed is too high.

The selected gear is briefly displayed in the instrument cluster, followed by the current gear.

### Displays in the instrument cluster



The selector lever position is displayed, e.g.: P.

### Sport automatic transmission: Launch Control

#### The concept

Launch Control enables optimum acceleration on surfaces with good traction.

#### Hints



Component wear

Do not use Launch Control too often; otherwise, this may result in premature wear of components due to the high stress placed on the vehicle. ◀

Did not use Launch Control during the break-in, refer to page 162, period.

To increase vehicle stability, activate DSC again as soon as possible.

An experienced driver may be able to achieve better acceleration values in DSC OFF mode.

#### Requirements

Launch Control is available when the engine is warmed up, that is, after uninterrupted driving of at least 6 miles/10 km.

To start with Launch Control do not steer the steering wheel.

### Start with launch control

While the engine is running:

1.  Press button or select with the Driving Dynamics Control Sport+. TRACTION is displayed in the instrument cluster and the indicator lamp for DSC OFF lights up.
2. Engage gear S.
3. With the left foot, forcefully press down on the brake.
4. Press and hold down the accelerator pedal beyond the resistance point at the full throttle position.  
A flag symbol appears in the instrument cluster.
5. The starting engine speed adjusts. Within 3 seconds, release the brake.

Before using Launch Control, allow the transmission to cool down for approx. 5 minutes.

Launch Control adjusts to the surrounding conditions, e.g., wet pavement, when used again.



# Displays

## Vehicle equipment

All standard, country-specific and optional equipment that is offered in the model series is described in this chapter. Therefore, equip-

ment is also described that is not available in a vehicle, e. g., because of the selected optional equipment or country variant. This also applies for safety-related functions and systems.

## Instrument cluster

### Overview, instrument cluster

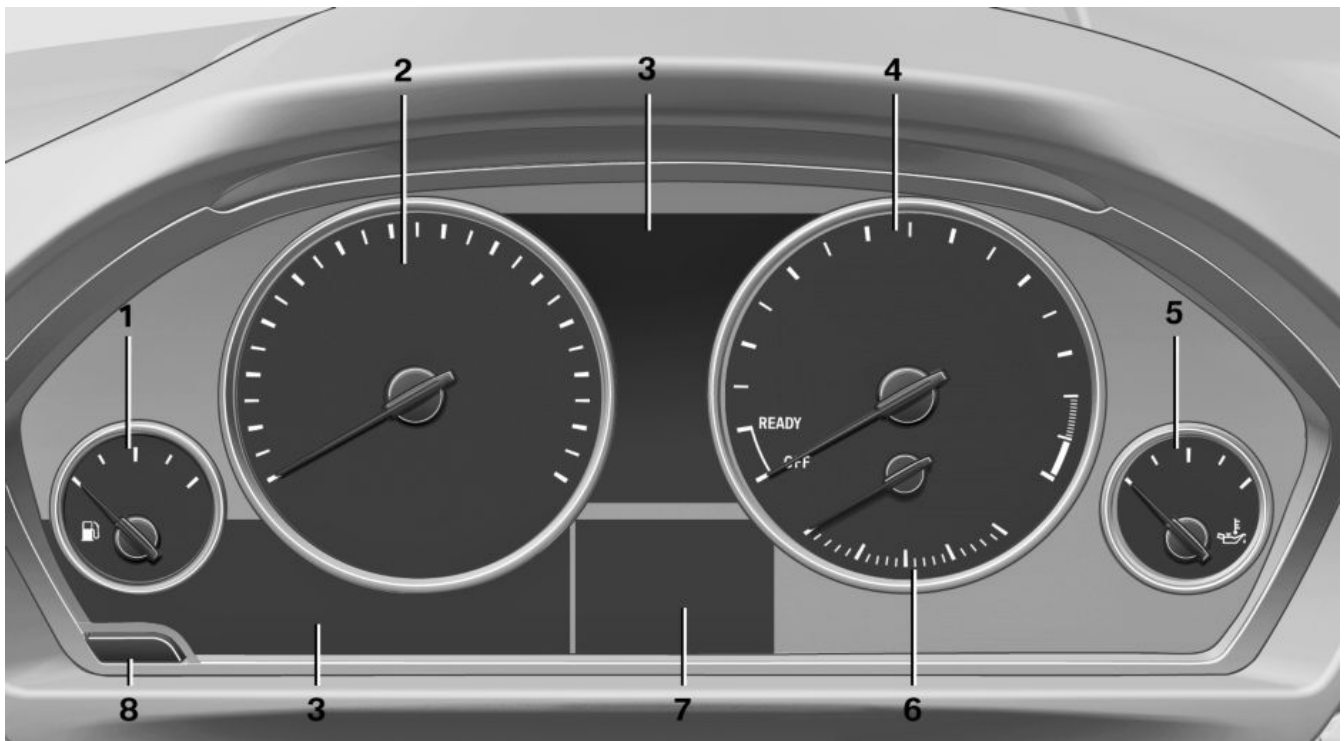

- |  |   |
|--|---|
| 1 Fuel gauge <a href="#">78</a>              | 5 Engine oil temperature <a href="#">78</a>   |
| 2 Speedometer                                | 6 Current fuel consumption <a href="#">80</a> |
| 3 Indicator/warning lamps <a href="#">76</a> | 7 Electronic displays <a href="#">75</a>      |
| 4 Tachometer <a href="#">78</a>              | 8 Display/reset miles <a href="#">79</a>      |

## Overview, instrument cluster with enhanced features

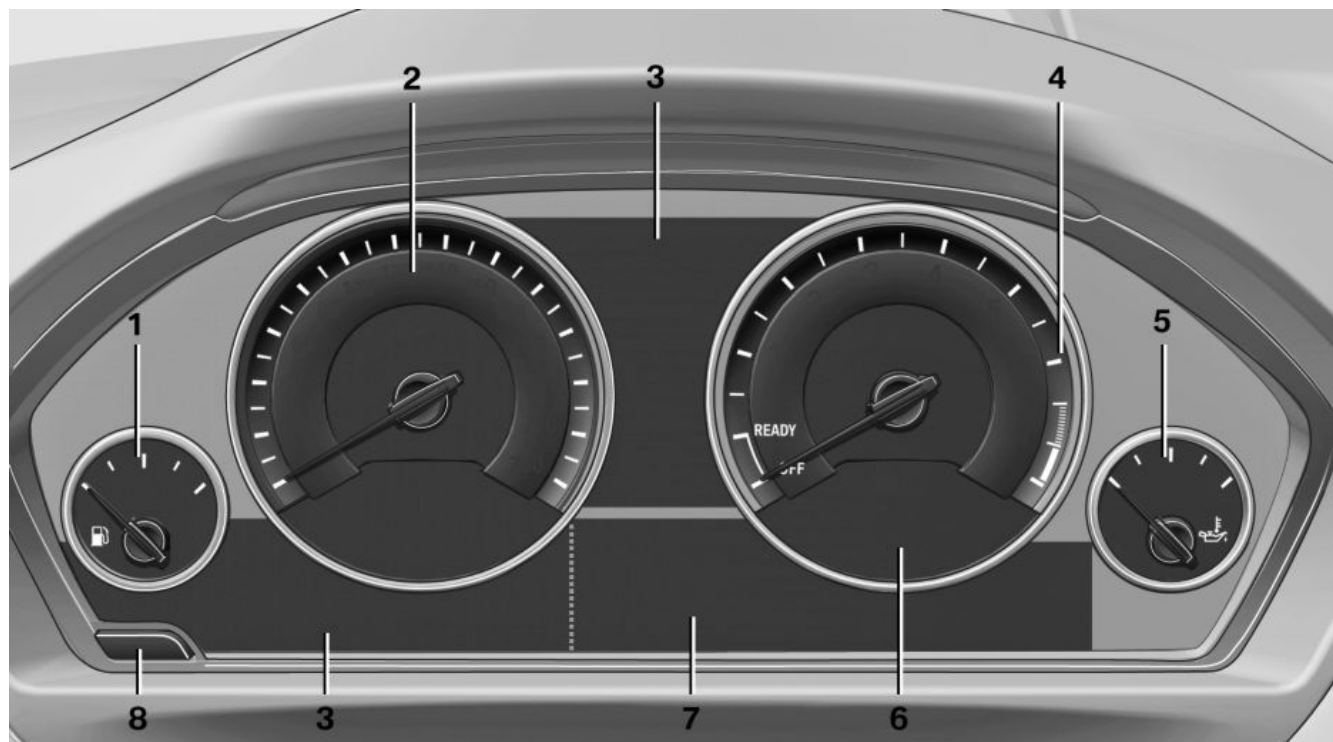

1 Fuel gauge [78](#)

2 Speedometer

3 Indicator/warning lamps [76](#)

4 Tachometer [78](#)

5 Engine oil temperature [78](#)

6 Current fuel consumption [80](#)

7 Electronic displays [75](#)

8 Display/reset miles [79](#)

# Electronic displays

## Overview, instrument cluster

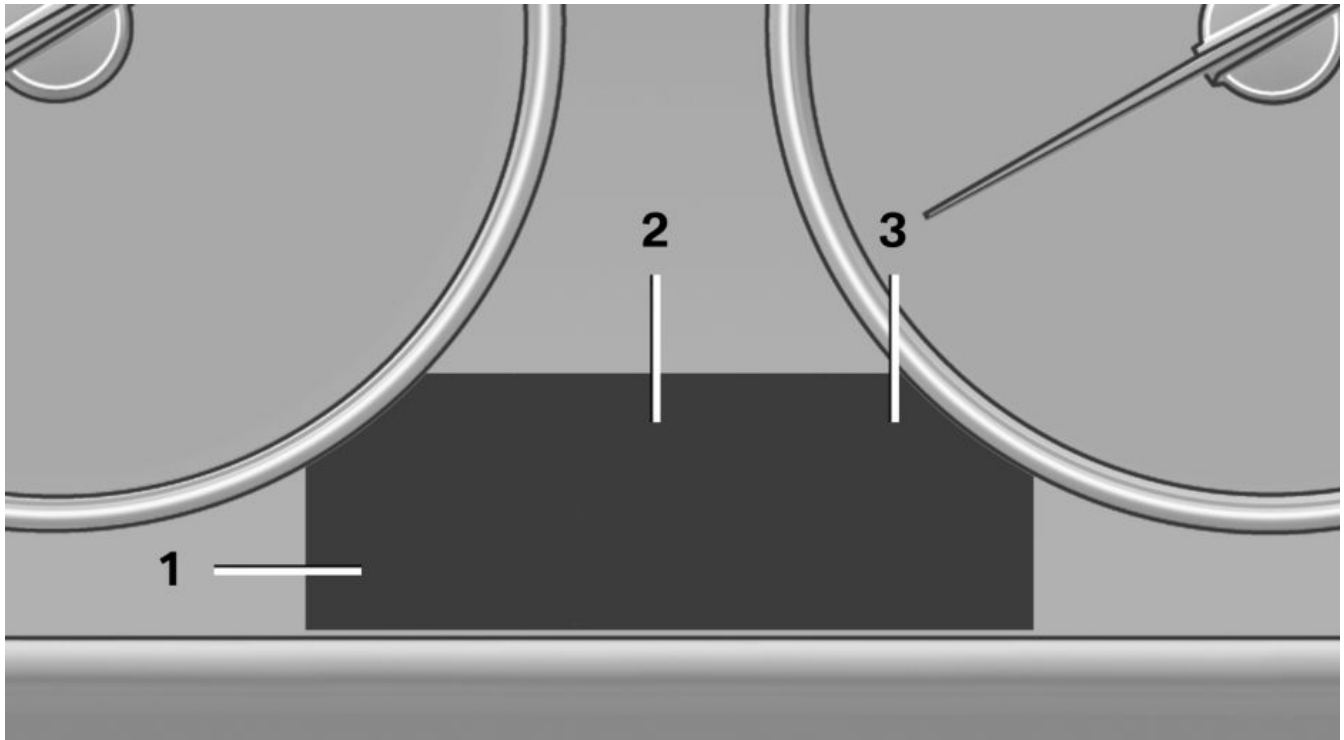

- 1** Messages, e.g., Check Control [76](#)
  - Time [79](#)
  - Date [79](#)
  - External temperature [79](#)
  - Selection lists [83](#)
  - Service requirements [80](#)

- Miles/trip miles [79](#)
- Computer [83](#)
- 2** Transmission display [72](#)
  - Gear shift indicator [81](#)
- 3** Status, Driving Dynamics Control [116](#)

## Overview, instrument cluster with enhanced features

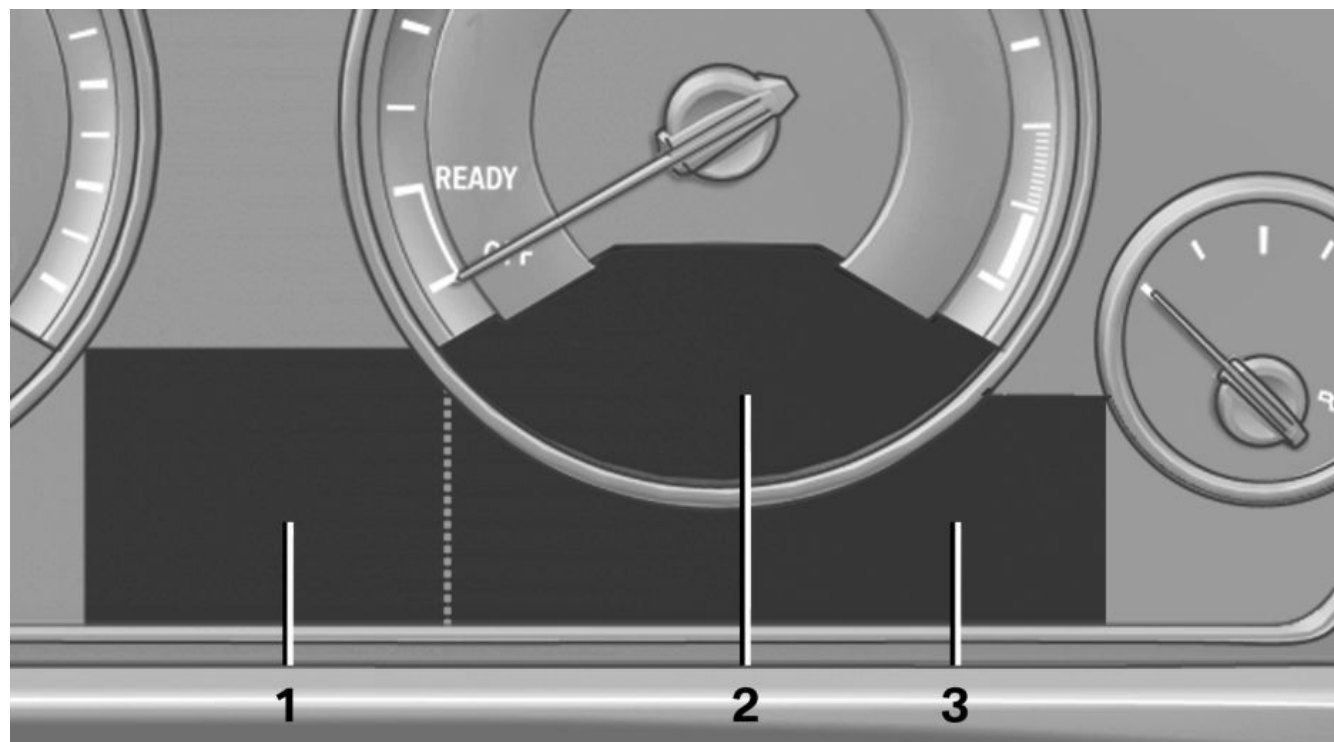

- |   |   |
|---|---|
| <p><b>1</b> Time <a href="#">79</a><br/>         External temperature <a href="#">79</a><br/>         Date <a href="#">79</a><br/>         Selection list, such as for the radio <a href="#">83</a><br/>         Speed limit detection <a href="#">81</a><br/>         Computer <a href="#">83</a><br/>         Miles/trip miles <a href="#">79</a><br/>         Navigation display, see user's manual for Navigation, Entertainment and Communication.</p> | <p>Status, Driving Dynamics Control <a href="#">116</a></p> <p><b>2</b> Energy recovery <a href="#">80</a><br/>         Transmission display <a href="#">72</a><br/>         Current fuel consumption <a href="#">80</a><br/>         ECO PRO <a href="#">169</a></p> <p><b>3</b> Messages, e.g., Check Control <a href="#">76</a><br/>         Service requirements <a href="#">80</a></p> |
|---|---|

## Check Control

### The concept

The Check Control system monitors functions in the vehicle and notifies you of malfunctions in the monitored systems.

A Check Control message is displayed as a combination of indicator or warning lamps and text messages in the instrument cluster and in the Head-up Display.















In addition, an acoustic signal may be output and a text message may appear on the Control Display.









### Indicator/warning lamps

The indicator and warning lamps in the instrument cluster can light up in a variety of combinations and colors.

Several of the lamps are checked for proper functioning and light up temporarily when the engine is started or the ignition is switched on.

## Overview: indicator/warning lamps

Symbol	Function or system
	Turn signal.
	Front fog lamps.
	High beams.
	High-beam Assistant.
	Parking lamps, headlamp control.
	Active Cruise Control.
	Vehicle detection, Active Cruise Control: collision warning.
	Pedestrian warning.
	Cruise control.
	Lane departure warning.
	DSC Dynamic Stability Control.
	DSC Dynamic Stability Control is deactivated or DTC Dynamic Traction Control is activated.
	Tire Pressure Monitor.
	Flat Tire Monitor.
	Safety belts.

Symbol	Function or system
	Airbag system.
	Steering system.
	Engine functions.
	Parking brake. Brake system.
	In Canadian models Parking brake. Brake system.
	ABS Antilock Brake System.
	In Canadian models ABS Antilock Brake System.
	At least one Check Control message is displayed or is stored (symbol in display).

### Text messages

Text messages in combination with a symbol in the instrument cluster explain a Check Control message and the meaning of the indicator and warning lamps.



### Supplementary text messages

Additional information, such as on the cause of a fault or the required action, can be called up via Check Control.

The supplementary text of urgent messages is automatically displayed on the Control Display.

### Symbols

Depending on the Check Control message, the following functions can be selected.

- ▷  "Owner's Manual"  
Display additional information about the Check Control message in the Integrated Owner's Manual.
- ▷  "Service request"  
Contact your service center.
- ▷  "Roadside Assistance"  
Contact Roadside Assistance.

## Hiding Check Control messages

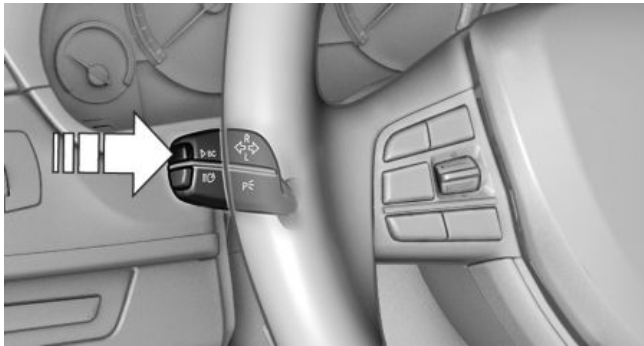

Press the onboard computer button on the turn signal lever.

- ▷ Some Check Control messages are displayed continuously and are not cleared until the malfunction is eliminated. If several malfunctions occur at once, the messages are displayed consecutively. These messages can be hidden for approx. 8 seconds. After this time, they are displayed again automatically.
- ▷ Other Check Control messages are hidden automatically after approx. 20 seconds. They are stored and can be displayed again later.

## Displaying stored Check Control messages

1. "Vehicle Info"
2. "Vehicle status"
3.  "Check Control"
4. Select the text message.

## Messages after trip completion

Special messages that are displayed during driving are displayed again after the ignition is switched off.

## Fuel gauge



The vehicle inclination may cause the display to vary.

US models: the arrow beside the fuel pump symbol shows which side of the vehicle the fuel filler

flap is on.

Hints on refueling, refer to page [178](#).

## Tachometer

Always avoid engine speeds in the red warning field. In this range, the fuel supply is interrupted to protect the engine.

## Engine oil temperature



- ▷ Cold engine: the pointer is at the low temperature end. Drive at moderate engine and vehicle speeds.
- ▷ Normal operating temperature: the pointer is in the middle or in the left half of the temperature display.
- ▷ Hot engine: the pointer is at the high end of the temperature range. A Check Control message is also displayed.

## Coolant temperature

If the coolant along with the engine becomes too hot, a Check Control message is displayed.

Check the coolant level, refer to page [201](#).



## Odometer and trip odometer

### Display

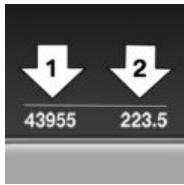

- ▷ Odometer, arrow 1.
- ▷ Trip odometer, arrow 2.

### Show/reset kilometers



Press the knob.

- ▷ When the ignition is switched off, the time, the external temperature and the odometer are displayed.
- ▷ When the ignition is switched on, the trip odometer is reset.

## External temperature

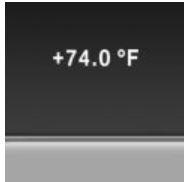

If the indicator drops to +37 °F/+3 °C or lower, a signal sounds.

A Check Control message is displayed.

There is an increased risk of ice on roads.



### Ice on roads

Even at temperatures above +37 °F/+3 °C, there can be a risk of ice on roads.

Therefore, drive carefully on bridges and shaded roads, for example, to avoid the increased risk of an accident. ◀

## Time

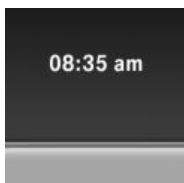

The time is displayed at the bottom of the instrument cluster.

Setting the time and time format, refer to page 86.

## Date

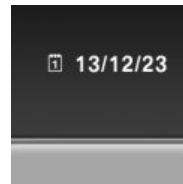

The date is displayed in the computer.

Setting the date and date format, refer to page 86.

## Range

### Display

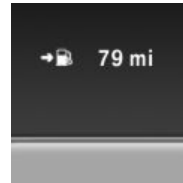

After the reserve range is reached:

- ▷ A Check Control message is displayed briefly.
- ▷ The remaining range is shown on the onboard computer.
- ▷ When a dynamic driving style is used, such as when cornering quickly, operation of the engine is not always ensured.

The Check Control message appears continuously below a range of approx. 30 miles/50 km.



### Refuel promptly

Refuel no later than at a range of 30 miles/50 km, or operation of the engine is not ensured and damage may occur. ◀

## Displaying the cruising range

Depending on the equipment version, the range is displayed in the instrument cluster.

1. "Settings"
2. "Instr. cluster display"
3. "Additional indicators"

## Current fuel consumption

### Instrument cluster

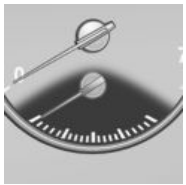

Displays the current fuel consumption. You can check whether you are currently driving in an efficient and environmentally-friendly manner.

### Instrum. cluster with enhanced features



Displays the current fuel consumption. You can check whether you are currently driving in an efficient and environmentally-friendly manner.

### Displaying the current fuel consumption

1. "Settings"
2. "Instr. cluster display"
3. "Additional indicators"

The bar display for the current fuel consumption is displayed in the instrument cluster.

## Energy recovery

### Display



The kinetic energy of the vehicle is converted to electrical energy while coasting. The vehicle battery is partially charged and fuel consumption can be reduced.

## Service requirements

### The concept

The driving distance or the time to the next scheduled maintenance is displayed briefly in

the instrument cluster after the ignition is switched on.

The current service requirements can be read out from the remote control by the service specialist.

### Display



Data regarding the service status or legally mandated inspections of the vehicle are automatically transmitted to your service center before a service due date.

### Detailed information on service requirements

More information on the scope of service required can be displayed on the Control Display.

1. "Vehicle Info"
2. "Vehicle status"
3.  "Service required"  
Required maintenance procedures and legally mandated inspections are displayed.
4. Select an entry to call up detailed information.

### Symbols

Symbols	Description
	No service is currently required.
	The deadline for scheduled maintenance or a legally mandated inspection is approaching.
	The service deadline has already passed.

### Entering appointment dates

Enter the dates for the required inspections.

Ensure that the vehicle date and time are set correctly.

1. "Vehicle Info"
2. "Vehicle status"
3.  "Service required"
4. "§ Vehicle inspection"
5. "Date:"
6. Adjust the settings.
7. Confirm.

The entered date is stored.

### Automatic Service Request

Data regarding the service status or legally mandated inspections of the vehicle are automatically transmitted to your service center before a service due date.

You can check when your service center was notified.

1. "Vehicle Info"
2. "Vehicle status"
3. Open "Options".
4. "Last Service Request"

## Gear shift indicator

### The concept





The system recommends the most fuel efficient gear for the current driving situation.

Depending on how the vehicle is equipped and the country-specific version of the vehicle, the gear shift indicator is active in the manual mode of the automatic transmission and in the manual transmission.



Indicators to shift up or down are displayed in the instrument cluster.

On vehicles without a gear shift indicator, the engaged gear is displayed.

## Manual transmission: displays

Symbol	Description
	Fuel efficient gear is engaged.
	Shift up to fuel efficient gear.
	Shift down to fuel efficient gear.
	Shift into neutral.

## Automatic transmission: displays

Example	Description
	Fuel efficient gear is engaged.
	Shift into fuel efficient gear.

## Speed limit detection with No Passing Information

### The concept

#### Speed limit detection

Speed limit detection uses a symbol in the shape of a traffic sign to display the currently detected speed limit. The camera at the base of the interior rearview mirror detects traffic signs at the edge of the road as well as variable overhead sign posts. Traffic signs with extra symbols for wet road conditions, etc. are also detected and compared with vehicle interior data, such as for the rain sensor, and are displayed depending on the situation. The system takes into account the information stored in

the navigation system and also displays speed limits present on routes without signs.

### No Passing Information

No Passing Information in the instrument cluster displays the beginnings and ends of no passing zones detected by the camera. The system accounts for only the beginnings and ends of No Passing zones marked by signs.

No display is shown:

- ▷ In countries where No Passing zones are primarily identified with road markings.
- ▷ On routes without signage.
- ▷ Where there are railroad crossings, highway markings or other situations where no signage is present, but passing would not be permitted.

### Hints



Personal judgment

The system cannot serve as a substitute for the driver's personal judgment of the traffic situation.

The system assists the driver and does not replace the human eye. ◀

### At a glance

#### Camera

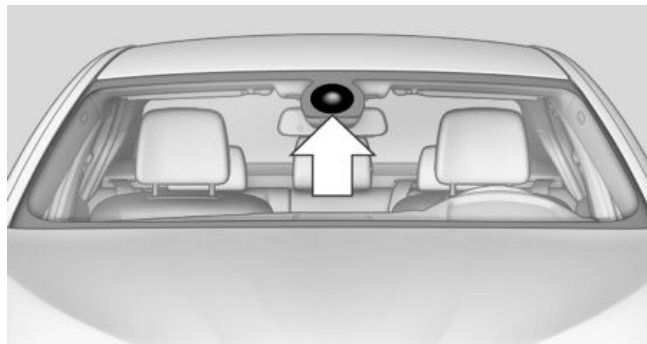

The camera is located near the base of the mirror.

Keep the windshield in the area behind the interior rear view mirror clean and clear.

### Switching on/off

1. "Settings"
2. "Instr. cluster display"
3. "Speed limit information"

If speed limit detection is switched on, it can be displayed on the info display in the instrument cluster via the onboard computer.

No Passing Information is displayed together with the activated speed limit information.

### Display

The following is displayed in the instrument cluster.

#### Speed limit detection

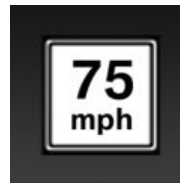

Current speed limit.

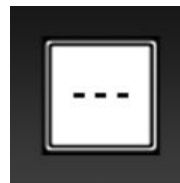

Speed limit detection is not available.

Speed limit detection can also be displayed in the Head-up Display.

#### No Passing Information



- ▷ Start of No Passing zone.
- ▷ End of No Passing zone.
- ▷ No Passing Information not available.

No Passing Information can also be displayed in the Head-up Display.

### System limits

The system may not be fully functional and may provide incorrect information in the following situations:

- ▷ In heavy fog, rain or snowfall.

- ▷ When signs are concealed by objects.
- ▷ When driving very close to the vehicle in front of you.
- ▷ When driving toward bright lights.
- ▷ When the windshield behind the interior rearview mirror is fogged over, dirty or covered by a sticker, etc.
- ▷ In the event of incorrect detection by the camera.
- ▷ If the speed limits stored in the navigation system are incorrect.
- ▷ In areas not covered by the navigation system.
- ▷ When roads differ from the navigation, such as due to changes in the road network.
- ▷ When passing buses or trucks with a speed sticker.
- ▷ If the traffic signs are non-conforming.
- ▷ During calibration of the camera immediately after vehicle shipment.

## Selection lists in the instrument cluster

### The concept

Depending on the equipment version, the following can be displayed or operated using the buttons and the thumbwheel on the steering wheel and the displays in the instrument cluster and the Head-up Display:

- ▷ Current audio source.
- ▷ Redial on telephone.
- ▷ Activation of the voice activation system.

In addition, programs of the Driving Dynamics Control are displayed.

## Display

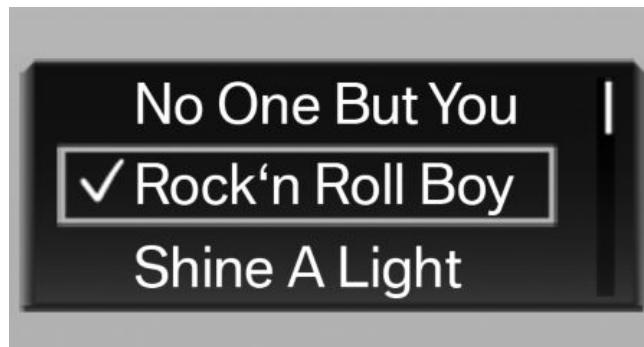

Depending on the equipment version, the list in the instrument cluster can differ from the illustration.

### Activating a list and adjusting the setting

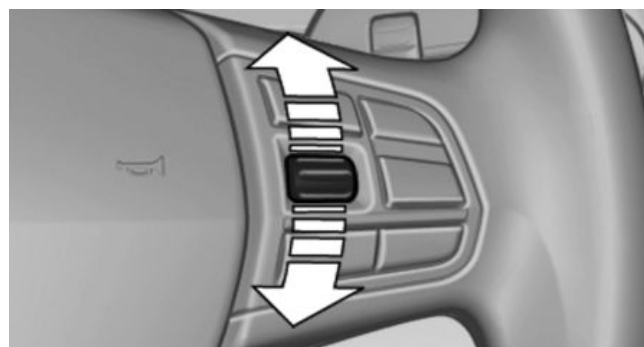

On the right side of the steering wheel, turn the thumbwheel to activate the corresponding list.

Using the thumbwheel, select the desired setting and confirm it by pressing the thumbwheel.

## Computer

### Indication in the info display

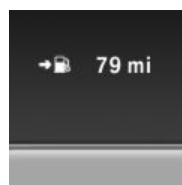

The information from the on-board computer is shown in the info display in the instrument cluster.

## Calling up information on the info display

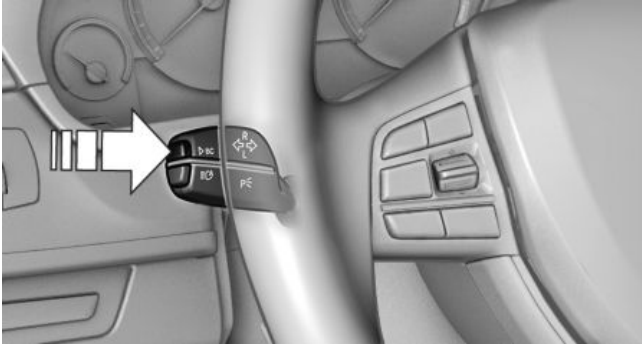

Press the onboard computer button on the turn signal lever.

Information is displayed on the info display of the instrument cluster.

### Information at a glance

Repeatedly pressing the button on the turn signal lever calls up the following information on the info display:

- ▷ Range.
- ▷ Average fuel consumption.
- ▷ Current fuel consumption.
- ▷ Average speed.
- ▷ Date.
- ▷ Speed limit detection.
- ▷ Time of arrival.

When destination guidance is activated in the navigation system.

- ▷ Distance to destination.

When destination guidance is activated in the navigation system.

- ▷ Arrow view of navigation system.

When destination guidance is activated in the navigation system.

When the arrow view in the Head-up Display is inactive.

- ▷ ECO PRO bonus range.

## Adjusting the info display

You can select what information from the on-board computer is to be displayed on the info display of the instrument cluster.

1. "Settings"
2. "Instr. cluster display"
3. Select the desired displays.

### Information in detail

#### Range

Displays the estimated cruising range available with the remaining fuel.

It is calculated based on your driving style over the last 20 miles/30 km.

If there is only enough fuel left for less than 45 miles/80 km, the color of the display changes.

#### Average fuel consumption

The average fuel consumption is calculated for the period during which the engine is running.

The average fuel consumption is calculated for the distance traveled since the last reset by the onboard computer.

#### Average speed

Periods in which the vehicle is parked with the engine manually stopped do not enter into the calculation of the average speed.

#### Resetting average values

Press and hold the computer button on the turn signal lever.

#### Distance to destination

The distance remaining to the destination is displayed if a destination is entered in the navigation system before the trip is started.

The distance to the destination is adopted automatically.



## Time of arrival

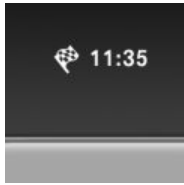

The estimated time of arrival is displayed if a destination is entered in the navigation system before the trip is started.

The time must be correctly set.

## Speed limit detection

Description of the speed limit detection, refer to page 81, function.

## Trip computer

The vehicle features two types of computer.

- ▷ "Onboard info": the values can be reset as often as necessary.
- ▷ "Trip computer": the values provide an overview of the current trip.

## Resetting the trip computer

1. "Vehicle Info"
2. "Trip computer"
3. "Reset": all values are reset.  
"Automatically reset": all values are reset approx. 4 hours after the vehicle comes to a standstill.

## Display on the Control Display

Display the onboard computer or trip computer on the Control Display.

1. "Vehicle Info"
2. "Onboard info" or "Trip computer"

## Resetting the fuel consumption or speed

1. "Vehicle Info"
2. "Onboard info"
3. "Consumpt." or "Speed"
4. "Yes"

## Sport displays

### The concept

In the Control Display, the current values for power and torque can be displayed.

### Displaying sport displays in the Control Display

1. "Vehicle Info"
2. "Sport displays"

## Speed warning

### The concept

Display of a speed limit which, when reached, should cause a warning to be issued.

The warning is repeated if the vehicle speed drops below the set speed limit once by at least 3 mph/5 km/h.

### Displaying, setting or changing the limit

1. "Settings"
2. "Speed"
3. "Warning at:"
4. Turn the controller until the desired limit is displayed.

5. Press the controller.

The speed limit is stored.

### Activating/deactivating the limit

1. "Settings"
2. "Speed"
3. "Warning"
4. Press the controller.

### Setting your current speed as the limit

1. "Settings"
2. "Speed"

3. "Select current speed"
4. Press the controller.  
The current vehicle speed is stored as the limit.

## Settings on the Control Display

### Time

#### Setting the time zone

1. "Settings"
2. "Time/Date"
3. "Time zone"
4. Select the desired time zone.

The time zone is stored.

#### Setting the time

1. "Settings"
2. "Time/Date"
3. "Time:"
4. Turn the controller until the desired hours are displayed.
5. Press the controller.
6. Turn the controller until the desired minutes are displayed.
7. Press the controller.

The time is stored.

#### Setting the time format

1. "Settings"
2. "Time/Date"
3. "Format:"
4. Select the desired format.

The time format is stored.

### Automatic time setting

Depending on the equipment version, the time, date and, if necessary, the time zone are updated automatically.

1. "Settings"
2. "Time/Date"
3. "Auto time set"

### Date

#### Setting the date

1. "Settings"
2. "Time/Date"
3. "Date:"
4. Turn the controller until the desired day is displayed.
5. Press the controller.
6. Make the necessary settings for the month and year.

The date is stored.

#### Setting the date format

1. "Settings"
2. "Time/Date"
3. "Format:"
4. Select the desired format.

The date format is stored.

### Language

#### Setting the language

To set the language on the Control Display:

1. "Settings"
2. "Language/Units"
3. "Language:"
4. Select the desired language.

The setting is stored for the remote control currently in use.

## Setting the voice dialog

Voice dialog for the voice activation system, refer to page 25.

## Units of measure

### Setting the units of measure

To set the units for fuel consumption, route/ distance and temperature:

1. "Settings"
2. "Language/Units"
3. Select the desired menu item.
4. Select the desired unit.

The setting is stored for the remote control currently in use.

## Brightness

### Setting the brightness

To set the brightness of the Control Display:

1. "Settings"
2. "Control display"
3. "Brightness"
4. Turn the controller until the desired brightness is set.
5. Press the controller.

The setting is stored for the remote control currently in use.

Depending on the light conditions, the brightness control may not be clearly visible.

## Assist system information

### Display on the Control Display

Information on the Assist system can be displayed by activating Assist on the Control Display.

1. "Settings"
2. "Control display"
3. "Driver assistance info"

## Head-up Display

### The concept

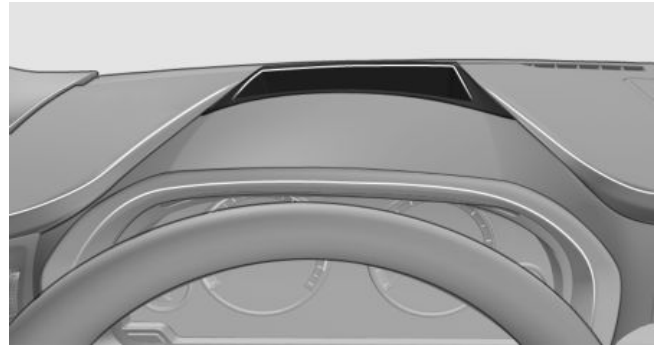

This system projects important information into the driver's field of vision, e.g., the speed.

The driver can get information without averting his or her eyes from the road.

### Display visibility

The visibility of the displays in the Head-up Display is influenced by the following factors:

- ▷ Certain sitting positions.
- ▷ Objects on the cover of the Head-up Display.
- ▷ Sunglasses with certain polarization filters.
- ▷ Wet roads.
- ▷ Unfavorable light conditions.

If the image is distorted, check the basic settings.

### Switching on/off

1. "Settings"
2. "Head-Up Display"
3. "Head-Up Display"

## Display

### Overview

- ▷ Speed.
- ▷ Navigation system.
- ▷ Check Control messages.
- ▷ Selection list from the instrument cluster.

- ▷ Driver assistance systems.

Some of this information is only displayed briefly as needed.

### Selecting displays in the Head-up Display

1. "Settings"
2. "Head-Up Display"
3. "Displayed information"
4. Select the desired displays in the Head-up Display.

The settings are stored for the remote control currently in use.

### Setting the brightness

The brightness is automatically adjusted to the ambient light.

The basic setting can be adjusted manually.

1. "Settings"
2. "Head-Up Display"
3. "Brightness"
4. Turn the controller.

When the low beams are switched on, the brightness of the Head-up Display can be additionally influenced using the instrument lighting.

The setting is stored for the remote control currently in use.

### Adjusting the height

1. "Settings"
2. "Head-Up Display"
3. "Height"
4. Turn the controller.

The setting is stored for the remote control currently in use.

### Setting the rotation

1. "Settings"
2. "Head-Up Display"

3. "Rotation"

4. Turn the controller.

The setting is stored for the remote control currently in use.

### Special windshield

The windshield is part of the system.

The shape of the windshield makes it possible to display a precise image.

A film in the windshield prevents double images from being displayed.

Therefore, have the special windshield replaced by a service center only.

# Lamps

## Vehicle equipment

All standard, country-specific and optional equipment that is offered in the model series is described in this chapter. Therefore, equipment is also described that is not available in a vehicle, e. g., because of the selected optional equipment or country variant. This also applies for safety-related functions and systems.

## At a glance

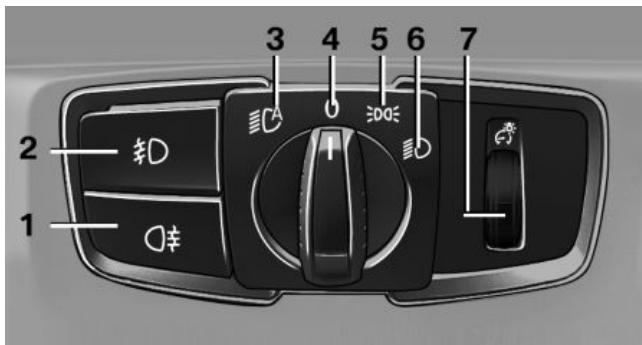

- 1 Rear fog lamps
- 2 Front fog lamps
- 3 Automatic headlamp control, Adaptive Light Control, High-beam Assistant, Welcome lamps, Daytime running lights
- 4 Lamps off, daytime running lights
- 5 Parking lamps, daytime running lights
- 6 Low beams, welcome lamps, High-beam Assistant
- 7 Instrument lighting

## Parking lamps/low beams, headlamp control

### General information

Switch position: 0, , 

If the driver door is opened with the ignition switched off, the exterior lighting is automatically switched off at these switch settings.

### Parking lamps

Switch position  : the vehicle lamps light up on all sides, e.g., for parking.



Do not use the parking lamps for extended periods; otherwise, the vehicle battery may become discharged and it would then be impossible to start the engine.

When parking, it is preferable to switch on the one-sided roadside parking lamps, refer to page 90.

### Low beams

Switch position  with the ignition switched on: the low beams light up.

### Welcome lamps

When the vehicle is parked, leave the switch in position  or  : parking and interior lamps come on briefly when the vehicle is unlocked depending on the ambient light.

### Activating/deactivating

1. "Settings"
2. "Lighting"
3. "Welcome lights"

The setting is stored for the remote control currently in use.

### Headlamp courtesy delay feature

The low beams stay lit for a short while if the headlamp flasher is switched on after the ignition is switched off.

### Setting the duration

1. "Settings"
2. "Lighting"

3. "Pathway lighting:"
4. Set the duration.

The setting is stored for the remote control currently in use.

### Automatic headlamp control

Switch position  : the low beams are switched on and off automatically, e.g., in tunnels, in twilight or if there is precipitation. The indicator lamp in the instrument cluster lights up.

A blue sky with the sun low on the horizon can cause the lights to be switched on.

The low beams always stay on when the fog lamps are switched on.





#### Personal responsibility

The automatic headlamp control cannot serve as a substitute for your personal judgment in determining when the lamps should be switched on in response to ambient lighting conditions.

For example, the sensors are unable to detect fog or hazy weather. To avoid safety risks, you should always switch on the lamps manually under these conditions. ◀

### Daytime running lights

With the ignition switched on, the daytime running lights light up in position 0,  or  . After the ignition is switched off, the parking lamps light up in position  .

### Activating/deactivating

In some countries, daytime running lights are compulsory, so it may not be possible to deactivate the daytime running lights.

1. "Settings"
2. "Lighting"
3. "Daytime running lamps"

The setting is stored for the remote control currently in use.

### Roadside parking lamps

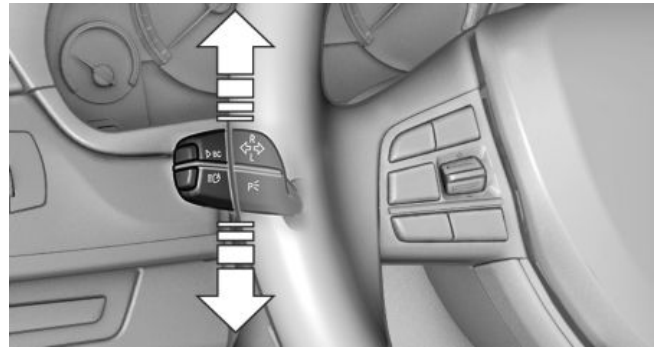

The vehicle can be illuminated on one side.

#### Switching on

With the ignition switched off, press the lever either up or down past the resistance point for approx. 2 seconds.

#### Switching off

Briefly press the lever to the resistance point in the opposite direction.

## Adaptive Light Control

### The concept

Adaptive Light Control is a variable headlamp control system that enables dynamic illumination of the road surface.

Depending on the steering angle and other parameters, the light from the headlamp follows the course of the road.

In tight curves, e.g., on mountainous roads or when turning, one of the two front fog lamps is switched on as a cornering lamp. As a result the inside of the curve is better lighted.

### Activating

Switch position  with the ignition switched on.

The cornering lamps are automatically switched on depending on the steering angle or the use of turn signals.



To avoid blinding oncoming traffic, the Adaptive Light Control does not swivel to the driver's side when the vehicle is at a standstill.

When driving in reverse, only the cornering lamp is active.

### Malfunction

A Check Control message is displayed.

Adaptive light control is malfunctioning or has failed. Have the system checked as soon as possible.

## High-beam Assistant



### The concept

When the low beams are switched on, this system automatically switches the high beams on and off or suppresses the light in the areas that blind oncoming traffic. The procedure is controlled by a sensor on the front of the interior rearview mirror. The assistant ensures that the high beams are switched on whenever the traffic situation allows. The driver can intervene at any time and switch the high beams on and off as usual.

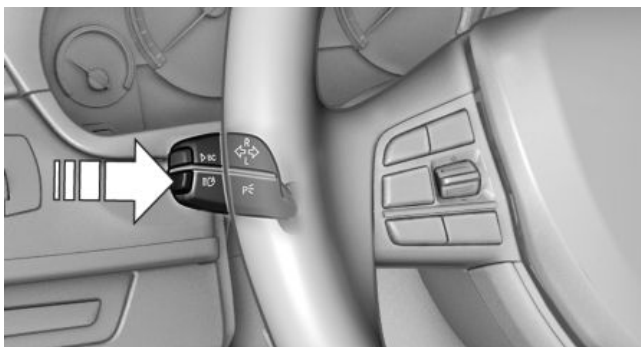
### Activating



The High-beam Assistant can be activated when the low beams are switched on.

1. Turn the light switch to  or .
2. Press the button on the turn signal lever, arrow.



The indicator lamp in the instrument cluster lights up.

When the low beams are on, the lights are automatically brightened or dimmed.

The system responds to light from oncoming traffic and traffic driving ahead of you, and to adequate illumination, e.g., in towns and cities.



The blue indicator lamp in the instrument cluster lights up when the system switches on the high beams. Depending on the version of the system in the vehicle, the high beams may not switch off for oncoming vehicles, but may only be dimmed in the areas that blind oncoming traffic. In this case, the blue indicator light will stay on.

### Switching the high beams on and off manually

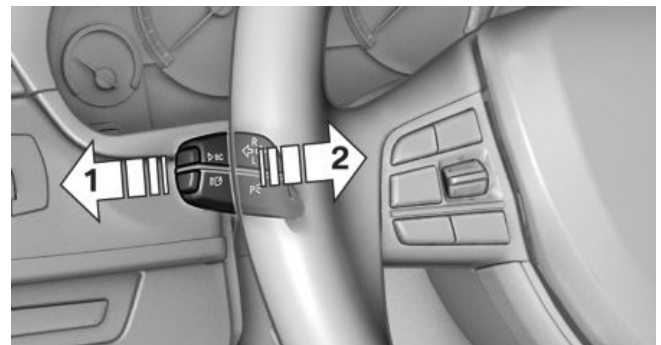

- ▷ High beams on, arrow 1.
- ▷ High beams off/headlamp flasher, arrow 2.

The High-beam Assistant can be switched off when manually adjusting the light. To reactivate the High-beam Assistant, press the button on the turn signal lever.

### System limits



#### Personal responsibility

The high-beam assistant cannot serve as a substitute for the driver's personal judgment of when to use the high beams. Therefore, manually switch off the high beams in situations where this is required to avoid a safety risk. ◀

The system is not fully functional in situations such as the following, and driver intervention may be necessary:

- ▷ In very unfavorable weather conditions, such as fog or heavy precipitation.
- ▷ In detecting poorly-lit road users, such as pedestrians, cyclists, horseback riders and wagons; when driving close to train or ship traffic; and at animal crossings.
- ▷ In tight curves, on hilltops or in depressions, in cross traffic or half-obscured oncoming traffic on freeways.
- ▷ In poorly-lit towns and cities and in the presence of highly reflective signs.
- ▷ At low speeds.
- ▷ When the windshield behind the interior rearview mirror is fogged over, dirty or covered with stickers, etc.

## Camera

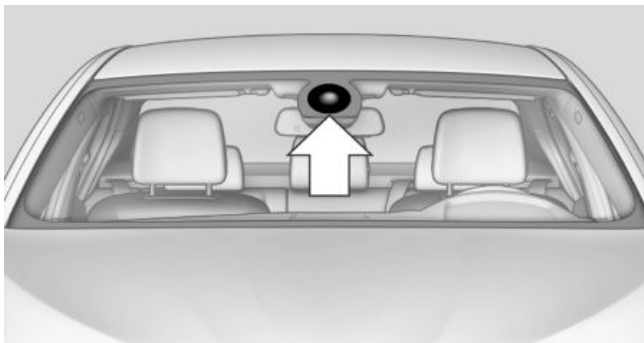

The camera is located near the base of the mirror.

Keep the windshield in the area behind the interior rear view mirror clean and clear.

## Fog lamps

### Front fog lamps

The low beams must be switched on.



Press the button. The green indicator lamp lights up.

If the automatic headlamp control, refer to page 90, is activated, the low beams will come on automatically when you switch on the front fog lamps.

When the high beams or headlamp flasher are activated, the front fog lamps are not switched on.

## Instrument lighting

### Adjusting



The parking lamps or low beams must be switched on to adjust the brightness.

Adjust the brightness using the thumbwheel.

## Interior lamps

### General information

The interior lamps, footwell lamps, entry lamps and courtesy lamps are controlled automatically.

The brightness of some of these lamps is influenced by the thumbwheel for the instrument lighting.



- 1 Interior lamps
- 2 Reading lamp

## Switching the interior lamps on and off



Press the button.

To switch off permanently: press the button for approx. 3 seconds.

Switch back on: press button.

## Reading lamps



Press the button.

Reading lamps are located at the front and rear next to the interior lamps.

## Ambient light

Depending on the equipment, the lighting can be adjusted in the interior for some lights.

## Selecting color scheme

1. "Settings"
2. "Lighting"
3. "Ambient:"
4. Select the desired setting.

If the color scheme of the line is selected and the welcome lamps are activated, the welcome lamps are displayed in the color of the line when the vehicle is unlocked.

## Setting the brightness

The brightness of the ambient light can be adjusted via the thumbwheel for the instrument lighting or on the Control Display.

1. "Settings"
2. "Lighting"
3. "Brightness:"
4. Adjust the brightness.

# Safety

## Vehicle equipment

All standard, country-specific and optional equipment that is offered in the model series is described in this chapter. Therefore, equip-

ment is also described that is not available in a vehicle, e. g., because of the selected optional equipment or country variant. This also applies for safety-related functions and systems.

## Airbags

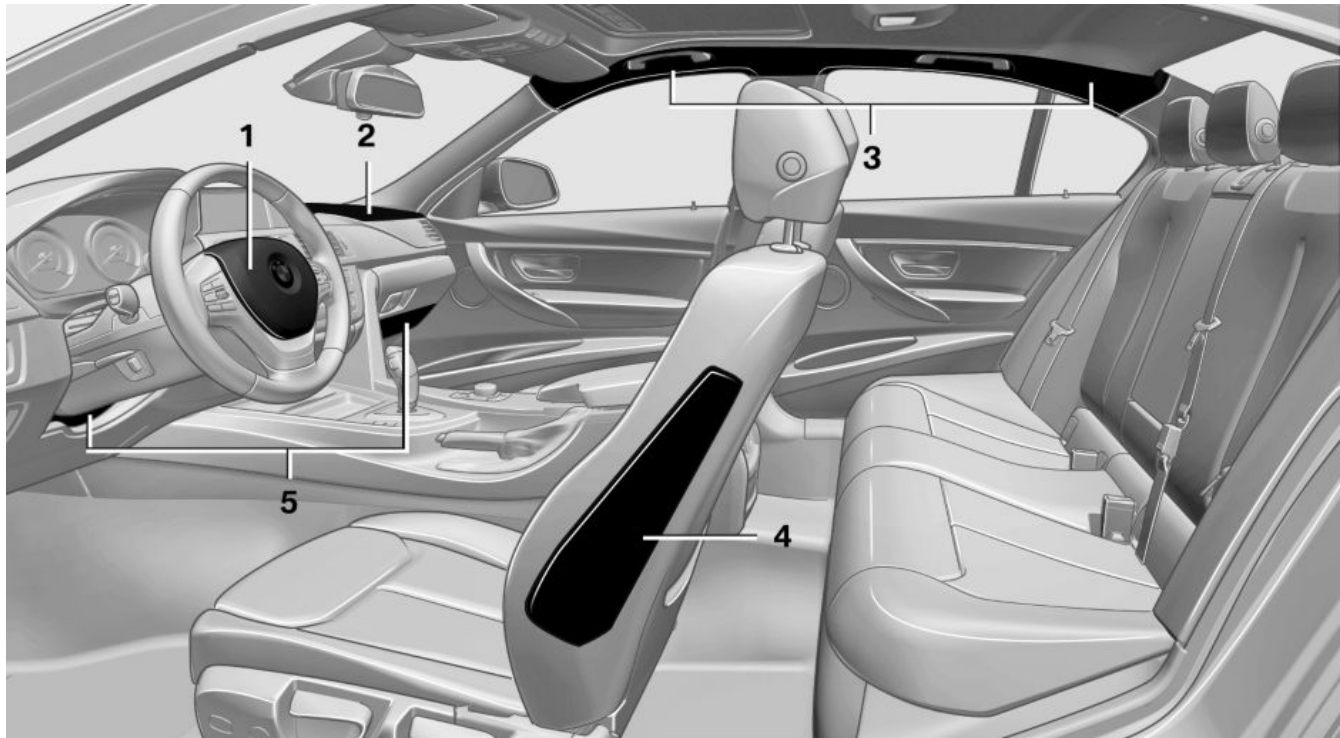

- |                                 |                |
|---------------------------------|----------------|
| 1 Front airbag, driver          | 4 Side airbag  |
| 2 Front airbag, front passenger | 5 Knee airbags |
| 3 Head airbag                   |                |

### Front airbags

Front airbags help protect the driver and front passenger by responding to frontal impacts in which safety belts alone cannot provide adequate restraint.

### Side airbags

In a lateral impact, the side airbag supports the side of the body in the chest and lap area.

### Head airbags

In a lateral impact, the head airbag supports the head.

### Knee airbag

The knee airbag supports the legs in a frontal impact.

## Protective action

Airbags are not triggered in every impact situation, e.g., in less severe accidents or rear-end collisions.



Information on how to ensure the optimal protective effect of the airbags

- ▶ Keep at a distance from the airbags.
- ▶ Always grasp the steering wheel on the steering wheel rim, holding your hands at the 3 o'clock and 9 o'clock positions, to keep the danger of injury to your hands or arms as low as possible if the airbag is triggered.
- ▶ There should be no people, animals, or objects between an airbag and a person.
- ▶ Do not use the cover of the front airbag on the front passenger side as a storage area.
- ▶ Keep the dashboard and window on the front passenger side clear, i.e. do not cover with adhesive labels or coverings, and do not attach holders such as for navigation instruments and mobile phones.
- ▶ Make sure that the front passenger is sitting correctly, i.e., keeps his or her feet and legs in the footwell; otherwise, leg injuries can occur if the front airbag is triggered.
- ▶ Do not place slip covers, seat cushions or other objects on the front passenger seat that are not approved specifically for seats with integrated side airbags.
- ▶ Do not hang pieces of clothing, such as jackets, over the backrests.
- ▶ Make sure that occupants keep their heads away from the side airbag and do not rest against the head airbag; otherwise, injuries can occur if the airbags are triggered.
- ▶ Do not remove the airbag restraint system.
- ▶ Do not remove the steering wheel.
- ▶ Do not apply adhesive materials to the airbag cover panels, cover them or modify them in any way.

- ▶ Never modify either the individual components or the wiring in the airbag system. This also applies to steering wheel covers, the dashboard, the seats, the roof pillars and the sides of the headliner. ◀

Even when all instructions are followed closely, injury from contact with the airbags cannot be ruled out in certain situations.

The ignition and inflation noise may lead to short-term and, in most cases, temporary hearing impairment in sensitive individuals.



In the case of a malfunction, deactivation and after triggering of the airbags

Do not touch the individual components immediately after the system has been triggered; otherwise, there is the danger of burns.

Only have the airbags checked, repaired or dismantled and the airbag generator scrapped by the service center or a workshop that has the necessary authorization for handling explosives.

Non-professional attempts to service the system could lead to failure in an emergency or undesired triggering of the airbag, either of which could result in injury. ◀

Warnings and information on the airbags are also found on the sun visors.

## Functional readiness of the airbag system



When the ignition is switched on, the warning lamp in the instrument cluster lights up briefly and thereby indicates the operational readiness of the entire airbag system and the belt tensioner.

## Airbag system malfunctioning

- ▶ Warning lamp does not come on when the ignition is turned on.
- ▶ The warning lamp lights up continuously.



 When there is a malfunction, have the airbag system checked immediately

When there is a malfunction, have the airbag system checked immediately; otherwise, there is a risk that the system does not function as expected in the event of an accident despite corresponding severity of the accident. ◀

### Automatic deactivation of the front passenger airbags

The system determines whether the front passenger seat is occupied by measuring the resistance of the human body.

The front, knee, and side airbag on the front passenger side are activated or deactivated accordingly.

 Leave feet in the footwell

Make sure that the front passenger keeps his or her feet in the footwell; otherwise, the front passenger airbags may not function properly. ◀

 Child restraint fixing system in the front passenger seat

Before transporting a child on the front passenger seat, refer to the safety notes and instructions under Children on the front passenger seat. ◀

### Malfunction of the automatic deactivation system

When transporting older children and adults, the front passenger airbags may be deactivated in certain sitting positions. In this case, the indicator lamp for the front passenger airbags lights up.

In this case, change the sitting position so that the front passenger airbags are activated and the indicator lamp goes out.

If it is not possible to activate the airbags, have the person sit in the rear.

To make sure that the occupied seat cushion can be evaluated correctly

- ▶ Do not attach covers, cushions, ball mats or other items to the front passenger seat unless they are specifically recommended by the manufacturer of your vehicle.
- ▶ Do not place any electronic devices on the passenger seat if a child restraint system is to be installed on it.
- ▶ Do not place objects under the seat that could press against the seat from below.
- ▶ No moisture in or on the seat.

### Indicator lamp for the front passenger airbags



The indicator lamp for the front passenger airbags indicates the operating state of the front passenger airbags.

The lamp indicates whether the airbags are activated or deactivated.



- ▶ The indicator lamp lights up when a child who is properly seated in a child restraint fixing system intended for that purpose is detected on the seat or the seat is empty. The airbags on the front passenger side are not activated.
- ▶ The indicator lamp does not light up when, for example, a correctly seated person of sufficient size is detected on the seat. The airbags on the front passenger side are activated.



## Detected child seats

The system generally detects children seated in a child seat, especially in the child seats that were required by NHTSA when the vehicle was manufactured. After installing a child seat, make sure that the indicator lamp for the front passenger airbags lights up. This indicates that the child seat has been detected and the front passenger airbags are not activated.

## Strength of the driver's and front passenger airbag

The strength with which the driver's and front passenger airbags are triggered depends on the position of the driver's and front passenger seats.

To maintain the accuracy of this function over the long-term, calibrate the front seats when a corresponding message appears on the Control Display.

## Calibrating the front seats

A corresponding message appears on the Control Display.

1. Move the respective seat forward all the way.
2. Move the respective seat forward again. It moves forward briefly.
3. Readjust the seat to the desired position.

The calibration procedure is completed when the message on the Control Display disappears.

If the message continues to be displayed, repeat the calibration.

If the message does not disappear after a repeat calibration, have the system checked as soon as possible.



Unobstructed area of movement

Ensure that the area of movement of the seats is unobstructed to avoid personal injury or damage to objects. ◀

# Tire Pressure Monitor TPM

## The concept

The system monitors tire pressure in the four mounted tires. The system warns you if there is a significant loss of pressure in one or more tires. For this purpose, sensors in the tire valves measure the tire inflation pressure.

## Hints



Tire damage due to external factors

Sudden tire damage caused by external influences cannot be indicated in advance. ◀

Pay attention to the other information and indications under Tire inflation pressure, refer to page 185, as well when using the system.

## Functional requirements

The system must have been reset with the correct tire inflation pressure; otherwise, reliable signaling of tire pressure loss is not ensured.

Reset the system after each adjustment of the tire inflation pressure and after every tire or wheel change.

Always use wheels with TPM electronics to ensure that the system will operate properly.

## Status display

The current status of the Tire Pressure Monitor TPM can be displayed on the Control Display, e.g., whether or not the TPM is active.

1. "Vehicle Info"
2. "Vehicle status"
3. (⚠) "Tire Pressure Monitor (TPM)"

The status is displayed.

## Status control display

The tire and system status is indicated by the color of the wheels and a text message on the Control Display.

### All wheels green

System is active and will issue a warning relative to the tire inflation pressures stored during the last reset.

### One wheel is yellow

A flat tire or major drop in inflation pressure in the indicated tire.

### All wheels are yellow

A flat tire or major drop in inflation pressure in several tires.

### Wheels, gray

The system cannot detect a flat tire. Reasons for this may be:

- ▷ The system is being reset.
- ▷ Malfunction.

### Carry out reset

Reset the system after each adjustment of the tire inflation pressure and after every tire or wheel change.

1. "Vehicle Info"
2. "Vehicle status"
3.  "Perform reset"
4. Start the engine - do not drive away.
5. Carry out the reset with "Perform reset".
6. Drive away.

The tires are shown in gray and the status is displayed.

After driving faster than 19 mph/30 km/h for a short period, the tire inflation pressures set are accepted as reference values. The reset is completed automatically during driving.

After a successfully completed Reset, the wheels on the Control Display are shown in green and "Tire Pressure Monitor (TPM) active" is displayed.

The trip can be interrupted at any time. If you drive away again, the reset resumes automatically.

### Low tire pressure message



The yellow warning lamp lights up. A Check Control message is displayed.

- ▷ There is a flat tire or a major loss in tire inflation pressure.
- ▷ No reset was performed for the system. The system therefore issues a warning based on the tire inflation pressures before the last reset.
- 1. Reduce your speed and stop cautiously. Avoid sudden braking and steering maneuvers.
- 2. Check whether the vehicle is fitted with regular tires or run-flat tires.

Run-flat tires, refer to page 195, are labeled with a circular symbol containing the letters RSC marked on the tire sidewall.



Do not continue driving without run-flat tires

Do not continue driving if the vehicle is not equipped with run-flat tires; continued driving may result in serious accidents. ◀

When a low inflation pressure is indicated, DSC Dynamic Stability Control is switched on if necessary.

### Actions in the event of a flat tire

#### Normal tires

1. Identify the damaged tire.

Do this by checking the air pressure in all four tires.

If the tire inflation pressure in all four tires is correct, it is possible that a reset was not carried out for the Tire Pressure Monitor. Then perform the reset.

If an identification is not possible, please contact the service center.

2. Fix the flat tire.

## Run-flat tires

### Maximum speed

You can continue driving with a damaged tire at speeds up to 50 mph/80 km/h.

### Continued driving with a flat tire

If continuing to drive with a damaged tire:

1. Avoid sudden braking and steering maneuvers.
2. Do not exceed a speed of 50 mph/80 km/h.
3. Check the air pressure in all four tires at the next opportunity.

If the tire inflation pressure in all four tires is correct, it is possible that a reset was not carried out for the Tire Pressure Monitor. In that case, carry out a reset.

Possible driving distance with complete loss of tire inflation pressure:

The possible driving distance after a loss of tire inflation pressure depends on the cargo load and the driving style and conditions.

For a vehicle containing an average load, the possible driving distance is approx. 50 miles/80 km.

When the vehicle is driven with a damaged tire, its handling characteristics change, e.g., reduced lane stability during braking, a longer braking distance, and altered self-steering properties. Adjust your driving style accordingly. Avoid abrupt steering maneuvers or driving over obstacles, e.g., curbs, potholes, etc.

Because the possible driving distance depends on how the vehicle is used during the trip, the actual distance may be smaller or greater depending on the driving speed, road conditions, external temperature, cargo load, etc.



Continued driving with a flat tire

Drive moderately and do not exceed a speed of 50 mph/80 km/h.

A loss of tire inflation pressure results in a change in the handling characteristics, e.g., reduced lane stability during braking, a longer braking distance and altered self-steering properties. ◀



Final tire failure

Vibrations or loud noises while driving can indicate the final failure of the tire. Reduce speed and stop; otherwise, pieces of the tire could come loose and cause an accident. Do not continue driving, and contact your service center. ◀

### Required inflation pressure check message

A Check Control message is displayed in the following situations

- ▶ The system has detected a wheel change, but no reset was carried out.
- ▶ Inflation was not carried out according to specifications.
- ▶ The tire pressure has fallen below the level of the last confirmation.

In this case:

- ▶ Check the tire pressure and correct as needed.
- ▶ Carry out a reset of the system after a tire change.

### System limits

The system does not function properly if a reset has not been carried out, e.g., a flat tire is reported even though the tire inflation pressures are correct.

The tire pressure depends on the temperature of the tire. If the tire temperature rises, e.g., due to driving or because of the heat of the Sun, the tire inflation pressure increases also. The tire pressure is reduced when the tire

temperature falls again. This behavior may cause a warning to be issued if temperatures fall very sharply.

## Malfunction



The yellow warning lamp flashes and then lights up continuously. A Check Control message is displayed. No flat tire or loss of tire pressure can be detected.

Display in the following situations:

- ▶ A wheel without TPM electronics is fitted: have the service center check it if necessary.
- ▶ Malfunction: have the system checked by your service center.
- ▶ TPM was unable to complete the reset. Reset the system again.
- ▶ Disturbance by systems or devices with the same radio frequency: after leaving the area of the disturbance, the system automatically becomes active again.

## Declaration according to NHTSA/ FMVSS 138 Tire Pressure Monitoring System

Each tire, including the spare (if provided) should be checked monthly when cold and inflated to the inflation pressure recommended by the vehicle manufacturer on the vehicle placard or tire inflation pressure label. (If your vehicle has tires of a different size than the size indicated on the vehicle placard or tire inflation pressure label, you should determine the proper tire inflation pressure for those tires.) As an added safety feature, your vehicle has been equipped with a tire pressure monitoring system (TPMS) that illuminates a low tire pressure telltale when one or more of your tires is significantly under-inflated. Accordingly, when the low tire pressure telltale illuminates, you should stop and check your tires as soon as possible, and inflate them to the proper pressure. Driving on a significantly under-inflated tire causes the tire to overheat and can lead to

tire failure. Under-inflation also reduces fuel efficiency and tire tread life, and may affect the vehicle's handling and stopping ability. Please note that the TPMS is not a substitute for proper tire maintenance, and it is the driver's responsibility to maintain correct tire pressure, even if under-inflation has not reached the level to trigger illumination of the TPMS low tire pressure telltale. Your vehicle has also been equipped with a TPMS malfunction indicator to indicate when the system is not operating properly. The TPMS malfunction indicator is combined with the low tire pressure telltale. When the system detects a malfunction, the telltale will flash for approximately one minute and then remain continuously illuminated. This sequence will continue upon subsequent vehicle start-ups as long as the malfunction exists. When the malfunction indicator is illuminated, the system may not be able to detect or signal low tire pressure as intended. TPMS malfunctions may occur for a variety of reasons, including the installation of replacement or alternate tires or wheels on the vehicle that prevent the TPMS from functioning properly. Always check the TPMS malfunction telltale after replacing one or more tires or wheels on your vehicle to ensure that the replacement or alternate tires and wheels allow the TPMS to continue to function properly.

## FTM Flat Tire Monitor

### The concept

The system detects a pressure loss on the basis of speed differences between the individual wheels while driving.

In the event of a pressure loss, the diameter and therefore the rotational speed of the corresponding wheel change. This is detected and reported as a flat tire.

The system does not measure the actual inflation pressure in the tires.

## Functional requirements

The system must have been initialized when the tire inflation pressure was correct; otherwise, reliable signaling of a flat tire is not ensured. Initialize the system after each correction of the tire inflation pressure and after every tire or wheel change.

## Status display

The current status of the Flat Tire Monitor can be displayed on the Control Display, e.g., whether or not the FTM is active.

1. "Vehicle Info"
2. "Vehicle status"
3.  "Flat Tire Monitor (FTM)"

The status is displayed.

## Initialization

The initialization process adopts the set inflation tire pressures as reference values for the detection of a flat tire. Initialization is started by confirming the inflation pressures.

Do not initialize the system when driving with snow chains.

1. "Vehicle Info"
2. "Vehicle status"
3.  "Perform reset"
4. Start the engine - do not drive away.
5. Start the initialization with "Perform reset".
6. Drive away.

The initialization is completed while driving, which can be interrupted at any time.

The initialization automatically continues when driving resumes.

## Indication of a flat tire



The yellow warning lamp lights up. A Check Control message is displayed.

There is a flat tire or a major loss in tire inflation pressure.

1. Reduce your speed and stop cautiously. Avoid sudden braking and steering maneuvers.
2. Check whether the vehicle is fitted with regular tires or run-flat tires.

Run-flat tires, refer to page 195, are labeled with a circular symbol containing the letters RSC marked on the tire sidewall.



Do not continue driving without run-flat tires

Do not continue driving if the vehicle is not equipped with run-flat tires; continued driving may result in serious accidents. ◀

When a flat tire is indicated, DSC Dynamic Stability Control is switched on if necessary.

## System limits



Sudden tire damage

Sudden serious tire damage caused by external influences cannot be indicated in advance. ◀

A natural, even pressure loss in all four tires cannot be detected. Therefore, check the tire inflation pressure regularly.

The system could be delayed or malfunction in the following situations:

- ▶ When the system has not been initialized.
- ▶ When driving on a snowy or slippery road surface.
- ▶ Sporty driving style: slip in the drive wheels, high lateral acceleration.
- ▶ When driving with snow chains.

## Actions in the event of a flat tire

### Normal tires

1. Identify the damaged tire.

Do this by checking the air pressure in all four tires.



If the tire inflation pressure in all four tires is correct, the Flat Tire Monitor may not have been initialized. In this case, initialize the system.

If an identification is not possible, please contact the service center.

2. Rectify the flat tire.

## Run-flat tires

### Maximum speed

You can continue driving with a damaged tire at speeds up to 50 mph/80 km/h.

### Continued driving with a flat tire

If continuing to drive with a damaged tire:

1. Avoid sudden braking and steering maneuvers.
2. Do not exceed a speed of 50 mph/80 km/h.
3. Check the air pressure in all four tires at the next opportunity.

If the tire inflation pressure in all four tires is correct, the Flat Tire Monitor may not have been initialized. In this case, initialize the system.

Possible driving distance with complete loss of tire inflation pressure:

The possible driving distance after a loss of tire inflation pressure depends on the cargo load and the driving style and conditions.

For a vehicle containing an average load, the possible driving distance is approx. 50 miles/80 km.

When the vehicle is driven with a damaged tire, its handling characteristics change, e.g., reduced lane stability during braking, a longer braking distance, and altered self-steering properties. Adjust your driving style accordingly. Avoid abrupt steering maneuvers or driving over obstacles, e.g., curbs, potholes, etc.

Because the possible driving distance depends on how the vehicle is used during the trip, the actual distance may be smaller or

greater depending on the driving speed, road conditions, external temperature, cargo load, etc.



Continued driving with a flat tire

Drive moderately and do not exceed a speed of 50 mph/80 km/h.

A loss of tire inflation pressure results in a change in the handling characteristics, e.g., reduced lane stability during braking, a longer braking distance and altered self-steering properties. ◀



Final tire failure

Vibrations or loud noises while driving can indicate the final failure of the tire. Reduce speed and stop; otherwise, pieces of the tire could come loose and cause an accident. Do not continue driving, and contact your service center. ◀

## Intelligent Safety

### The concept

Depending on how the vehicle is equipped, Intelligent Safety consists of one or more of the following systems, which can help to avoid an imminent collision. These systems are active automatically every time the engine is started using the Start/Stop button:

- ▶ Collision warning, refer to page 103.
- ▶ Pedestrian warning, refer to page 108.

### Note



Personal responsibility

The system does not serve as a substitute for the driver's personal judgment of the traffic situation.

Be aware of the traffic situation and the vehicle's surroundings at all times, otherwise an accident is still possible despite all warnings. ◀



## At a glance

### Button in the vehicle



Intelligent Safety button

### Camera

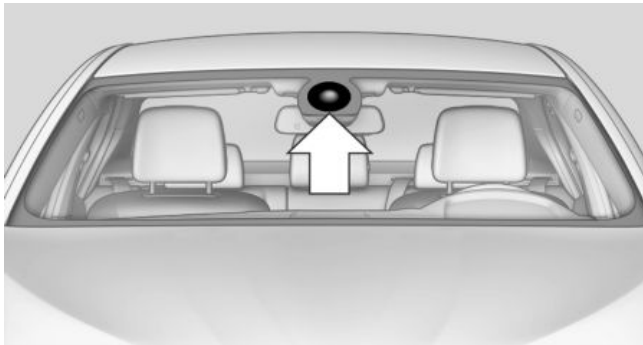

The camera is located near the base of the mirror.

Keep the windshield in the area behind the interior rear view mirror clean and clear.

### Switching on/off

The Intelligent Safety systems are automatically active after each engine start via the start/stop button.



Press the button: the systems are switched off. The LED goes out.

Press the button: the systems are switched on. The LED lights up.

Settings can be made on the Control Display.

## Collision warning

Depending on how the equipment is equipped, the collision warning system consists of one of the two systems:

- ▷ Collision warning with City Braking function, refer to page 103.
- ▷ Collision warning with braking function, refer to page 106

### Collision warning with City Braking function

#### The concept

The system can help to prevent accidents. If an accident cannot be prevented, the system helps to reduce the collision speed.

The system issues a warning if there is imminent danger of a collision and if so brakes independently.

The automatic braking intervention is done with limited force and duration.

The system is controlled via a camera in the base of the mirror.

The collision warning is available even if cruise control has been deactivated.

When the vehicle is intentionally brought close to a vehicle, the collision warning is delayed to avoid false warnings.

#### General information

The system issues a two-phase warning of a danger of collision with vehicles at speeds above approx. 3 mph/5 km/h. The time of these warnings may vary depending on the current driving situation.

Up to approx. 35 mph/60 km/h a braking intervention occurs when appropriate.

## Detection range

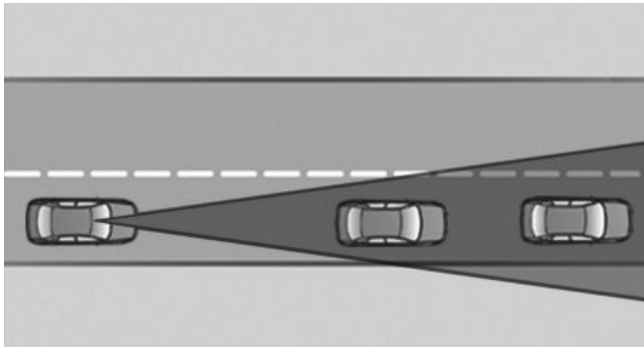

Vehicles are observed when they are traveling in the same direction of movement if they are located within the detection range of the system.

## At a glance

### Button in the vehicle



Intelligent Safety button

## Camera

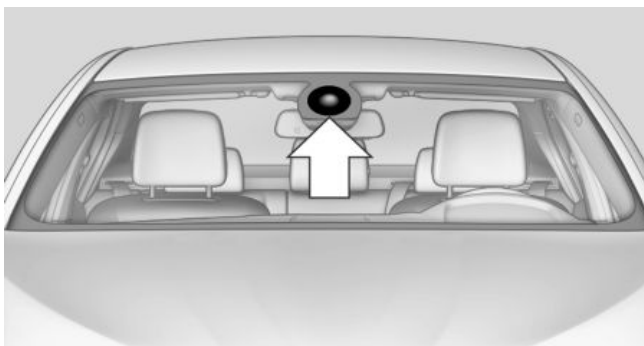

The camera is located near the base of the mirror.

Keep the windshield in the area behind the interior rear view mirror clean and clear.

## Switching on/off

### Switching on automatically

The system is automatically active every time the engine is started using the Start/Stop button.

### Switching off



Press button: the system is switched off. The LED goes out.

Re-press button: the system is switched on. The LED lights up.

### Setting the prewarning time

The prewarning time can be set via iDrive.

1. "Settings"
2. "Frontal Coll. Warning"
3. Activate the desired time on the Control Display.

The selected time is stored for the remote control currently in use.

### Warning with braking function

#### Note



Adapting your speed and driving style

The warning does not relieve the driver of the responsibility to adapt his or her driving speed and style to the traffic conditions. ◀

### Display

If a collision with a vehicle detected in this way is imminent, a warning symbol appears on the instrument cluster and in the Head-up Display.

Symbol	Measure
--------	---------



The vehicle lights up red: prewarning.

Increase braking and distance.



The vehicle flashes red and an acoustic signal sounds: acute warning.

You are requested to intervene by braking or making an evasive maneuver.

### Braking intervention

The warning prompts the driver himself to intervene. During a warning, the maximum braking force is used. A prerequisite for the brake booster is a sufficiently fast and sufficiently strong actuation of the brake pedal. In addition, if there is a risk of collision, the system can assist with a slight braking intervention. The intervention can bring a vehicle traveling at slow speed to a complete stop.

Manual transmission: During a braking intervention up until reaching a complete stop, the engine may be shut down.

The braking intervention is executed only if DSC Dynamic Stability Control is switched on and Dynamic Traction Control DTC is activated.

The braking intervention can be interrupted by pressing on the accelerator pedal or by actively moving the steering wheel.



#### Tow-starting and towing

When tow-starting and towing the vehicle, switch off the Intelligent Safety systems; otherwise, improper behavior of the braking function of individual systems could result in an accident. ◀

### System limits



#### Be alert

Due to system limitations, warnings may not be issued at all, or may be issued late or improperly. Therefore, always be alert and ready to intervene; otherwise, there is the danger of an accident occurring. ◀

### Detection range

The system's detection capabilities are limited. This may result in the warning not being issued or being issued late.

For example, the following situations may not be detected:

- ▷ Slow moving vehicles when you approach them at high speed.
- ▷ Vehicles that suddenly swerve in front of you or sharply decelerating vehicles.
- ▷ Vehicles with an unusual rear appearance.
- ▷ Two-wheeled vehicles ahead of you.
- ▷ Pedestrians.

### Functional limitations

The system may not be fully functional in the following situations:

- ▷ In heavy fog, rain, sprayed water or snowfall.
- ▷ In tight curves.
- ▷ If the driving stability control systems are limited or deactivated, for example, DSC OFF.
- ▷ If the camera in the mirror or the radar sensor is dirty or obscured.
- ▷ During calibration of the camera immediately after vehicle shipment.
- ▷ If there is constant dimming because of oncoming light, for example, from the sun low in the sky.

## Prewarning sensitivity

Depending on the set prewarning time, this may result in increased false warnings.

## Collision warning with braking function

### The concept

The system issues a warning if there is imminent danger of a collision and also includes a braking function.

If the vehicle is equipped with Active Cruise Control with Stop & Go, the collision warning is controlled via the cruise control radar sensor.

The collision warning is available even if cruise control has been deactivated.

When the vehicle is intentionally brought close to a vehicle, the collision warning is delayed to avoid false warnings.

### General information

The system issues a two-phase warning of a possible danger of collision with vehicles at speeds above approx. 3 mph/5 km/h. The time of these warnings may vary depending on the current driving situation.

### Detection range

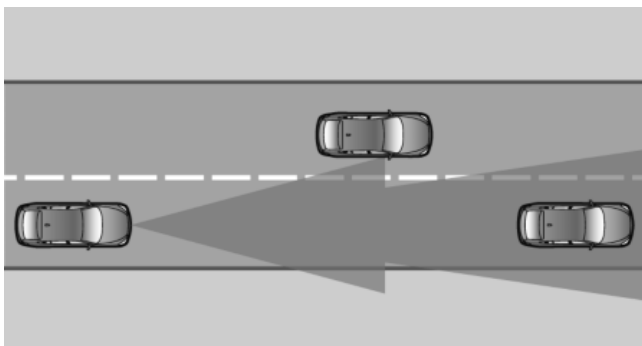

It responds to objects if they are detected by the radar.

## At a glance

### Button in the vehicle



Intelligent Safety button

### Switching on/off

#### Switching on automatically

The system is automatically active every time the engine is started using the Start/Stop button.

#### Switching off



Press button: the system is switched off. The LED goes out.

Re-press button: the system is switched on. The LED lights up.

### Setting the prewarning time

The prewarning time can be set via iDrive.

1. "Settings"
2. "Frontal Coll. Warning"
3. Activate the desired time on the Control Display.

The selected time is stored for the remote control currently in use.

## Display

### Warning stages

#### Prewarning

This warning is issued, for example, when there is the impending danger of a collision or the distance to the vehicle ahead is too small.

#### Acute warning with braking function

Warning of the imminent danger of a collision when the vehicle approaches another object at a relatively high differential speed.

The driver must intervene actively when there is an acute warning. If necessary, the driver is assisted by an automatic braking intervention in a possible risk of collision.

The detection of objects can be influenced by technical system limitations, e. g. pedestrians or stationary objects. Limitations of the detection range and functional restrictions are to be considered.

The braking intervention is executed with limited braking force and for a brief period only.

The intervention can bring the vehicle to a complete stop.

The braking intervention is executed only if DSC Dynamic Stability Control is switched on and Dynamic Traction Control DTC is activated.

Above approx. 130 mph/210 km/h, the braking intervention occurs as a brief braking pressure. No automatic delay occurs.



#### Adapting your speed and driving style

The warning does not relieve the driver of the responsibility to adapt his or her driving speed and style to the traffic conditions. ◀

The braking intervention can be interrupted by pressing on the accelerator pedal or by actively moving the steering wheel.



#### Tow-starting and towing

When tow-starting and towing the vehicle, switch off the Intelligent Safety systems; otherwise, improper behavior of the braking function of individual systems could result in an accident. ◀

### Display in the instrument cluster

The collision warning can be issued in the instrument cluster, in the Head-up Display, and acoustically.

### Warning stages

Symbol	Measure
	The vehicle lights up red: prewarning. Increase distance.
	The vehicle flashes red and an acoustic signal sounds: acute warning. You are requested to intervene by braking or making an evasive maneuver.



The vehicle lights up red: prewarning.

Increase distance.



The vehicle flashes red and an acoustic signal sounds: acute warning.

You are requested to intervene by braking or making an evasive maneuver.



#### Adapting your speed and driving style

The display does not relieve the driver of the responsibility to adapt his or her driving speed and style to the traffic conditions. ◀

### System limits



#### Be alert

Due to system limitations, warnings may be not be issued at all, or may be issued late or improperly. Therefore, always be alert and ready to intervene; otherwise, there is the danger of an accident occurring. ◀

### Detection range

The system's detection capabilities are limited.

This may result in the warning not being issued or being issued late.

For example, the following situations may not be detected:

- ▶ Slow moving vehicles when you approach them at high speed.
- ▶ Vehicles that suddenly swerve in front of you or sharply decelerating vehicles.
- ▶ Vehicles with an unusual rear appearance.
- ▶ Two-wheeled vehicles ahead of you.
- ▶ Pedestrians.
- ▶ Stationary objects.

### Functional limitations

The system may not be fully functional in the following situations:

- ▶ In heavy fog, rain, sprayed water or snowfall.
- ▶ In tight curves.
- ▶ If the driving stability control systems are limited or deactivated, for example, DSC OFF.
- ▶ If the radar sensor is dirty or obscured.

### Prewarning sensitivity

Depending on the set prewarning time, this may result in increased false warnings.

## Pedestrian warning with city braking function

### The concept

The system can help to prevent accidents with pedestrians.

The system issues a warning in the city driving speed area if there is imminent danger of a collision with pedestrians and includes a braking function.

The system is controlled via the camera in the base of the interior mirror.

### General information

The system issues a warning with brightness starting at approx. 6 mph/10 km/h to approx. 35 mph/60 km/h regarding a possible risk of collision with pedestrians and assists with a brake intervention shortly before a collision.

It responds to persons that are within the detection range of the system.

### Detection range

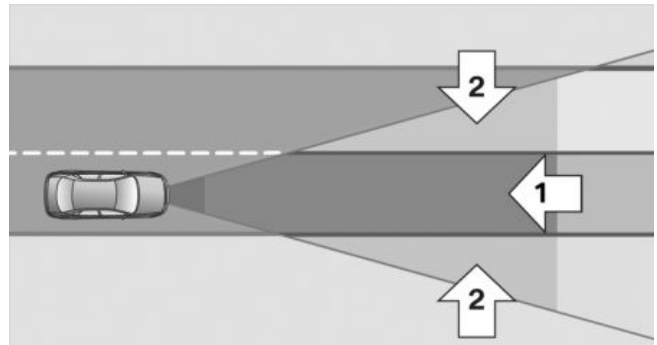

The detection area in front of the vehicle is divided into two areas.

- ▶ Central area, arrow 1, directly in front of the vehicle.
- ▶ Expanded area, arrow 2, to the right and left.

A collision is imminent if pedestrians are located within the central area. A warning is issued about pedestrians who are located within the extended area only if they are moving in the direction of the central area.

### At a glance

#### Button in the vehicle







Intelligent Safety button

## Camera

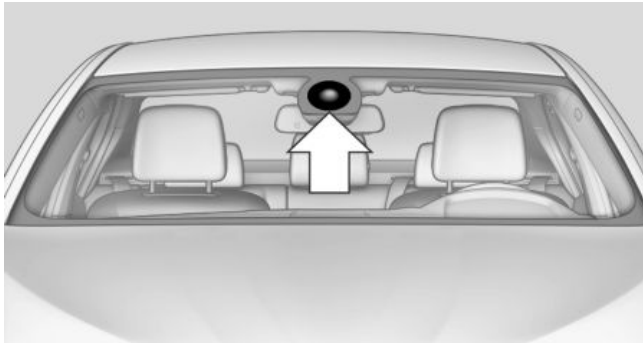

The camera is located near the base of the mirror.

Keep the windshield in the area behind the interior rear view mirror clean and clear.

## Switching on/off

### Switching on automatically

The system is automatically active every time the engine is started using the Start/Stop button.

### Switching off



Press the button: the systems are switched off. The LED goes out.

Press the button: the systems are switched off. The LED lights up.

## Warning with braking function

### Note



Adapting your speed and driving style

The warning does not relieve the driver of the responsibility to adapt his or her driving speed and style to the traffic conditions. ◀

## Display

If a collision with a person detected in this way is imminent, a warning symbol appears on the instrument cluster and in the Head-up Display.



The red symbol is displayed and a signal sounds.

Intervene immediately by braking or making an evasive maneuver.

## Braking intervention

The warning prompts the driver himself to intervene. During a warning, the maximum braking force is used. A prerequisite for the brake booster is a sufficiently fast and sufficiently strong actuation of the brake pedal. In addition, if there is a risk of collision, the system can assist with a slight braking intervention. The intervention can bring a vehicle traveling at slow speed to a complete stop.

Manual transmission: During a braking intervention up until reaching a complete stop, the engine may be shut down.

The braking intervention is executed only if DSC Dynamic Stability Control is switched on and Dynamic Traction Control DTC is activated.

The braking intervention can be interrupted by pressing on the accelerator pedal or by actively moving the steering wheel.



Tow-starting and towing

When tow-starting and towing the vehicle, switch off the Intelligent Safety systems; otherwise, improper behavior of the braking function of individual systems could result in an accident. ◀

## System limits



Be alert

Due to system limitations, warnings may be not be issued at all, or may be issued late or improperly. Therefore, always be alert and

ready to intervene; otherwise, there is the danger of an accident occurring. ◀

### Detection range

The detection capability of the camera is limited.

This may result in the warning not being issued or being issued late.

For example, the following situations may not be detected:

- ▷ Partially covered pedestrians.
- ▷ Pedestrians that are not detected as such because of the viewing angle or contour.
- ▷ Pedestrians outside of the detection range.
- ▷ Pedestrians having a body size less than 32 in/80 cm.

### Functional limitations

The system may not be fully functional or may not be available in the following situations:

- ▷ In heavy fog, rain, sprayed water or snowfall.
- ▷ In tight curves.
- ▷ If the camera view field or the front windshield are dirty or covered.
- ▷ When driving toward bright lights.
- ▷ Up to 10 seconds after the start of the engine, via the Start/Stop knob.
- ▷ During calibration of the camera immediately after vehicle shipment.
- ▷ When it is dark outside.

## Lane departure warning

### The concept

Starting at a specific speed, this system alerts you when the vehicle on streets with lane markings is about to leave the lane. This speed, depending on the country version, is between 35 mph/55 km/h and 45 mph/70 km/h.

When switching on the system below this speed, a message is displayed in the instrument cluster.

The steering wheel begins vibrating gently in the event of warnings. The time of the warning may vary depending on the current driving situation.

The system does not provide a warning if the turn signal is set before leaving the lane.

### Hints



#### Personal responsibility

The system cannot serve as a substitute for the driver's personal judgment of the course of the road and the traffic situation.

In the event of a warning, do not jerk the steering wheel, as you may lose control of the vehicle. ◀

### At a glance

#### Button in the vehicle



Lane departure warning

## Camera

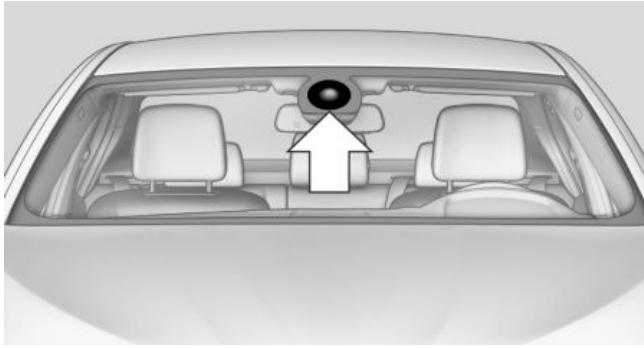

The camera is located near the base of the mirror.

Keep the windshield in the area behind the interior rear view mirror clean and clear.

## Switching on/off



Press the button.

- ▷ On: the LED lights up.
- ▷ Off: the LED goes out.

The setting is stored for the remote control currently in use.

## Display in the instrument cluster



- ▷ Lines: system is activated.
- ▷ Arrows: at least one lane marking was detected and warnings can be issued.

## Issued warning

If you leave the lane and if a lane marking has been detected, the steering wheel begins vibrating.

If the turn signal is set before changing the lane, a warning is not issued.

## End of warning

The warning ends:

- ▷ Automatically after approx. 3 seconds.
- ▷ When returning to your own lane.
- ▷ When braking hard.

- ▷ When using the turn signal.

## System limits

The system may not be fully functional in the following situations:

- ▷ In heavy fog, rain or snowfall.
- ▷ In the event of missing, worn, poorly visible, merging, diverging, or multiple lane markings such as in construction areas.
- ▷ When lane markings are covered in snow, ice, dirt or water.
- ▷ In tight curves or on narrow lanes.
- ▷ When the lane markings are covered by objects.
- ▷ When driving very close to the vehicle in front of you.
- ▷ When driving toward bright lights.
- ▷ When the windshield in front of the interior rearview mirror is fogged over, dirty or covered with stickers, etc.
- ▷ During calibration of the camera immediately after vehicle shipment.

## Active Blind Spot Detection

### The concept

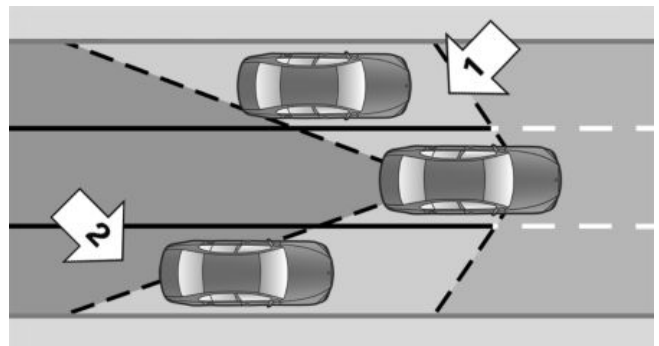

Two radar sensors below the rear bumper monitor the area behind and next to the vehicle at speeds above approx. 30 mph/50 km/h.

The system indicates whether there are vehicles in the blind spot, arrow 1, or approaching from behind on the adjacent lane, arrow 2.

The lamp in the exterior mirror housing lights up dimly.

Before you change lanes after setting the turn signal, the system issues a warning in the situations described above.

The lamp in the housing of the exterior mirror flashes and the steering wheel vibrates.

## Hints



**Personal responsibility**

The system does not serve as a substitute for the driver's personal judgment of the traffic situation.

Be aware of the traffic situation and the vehicle's surroundings at all times, otherwise an accident is still possible despite all warnings. ◀

## At a glance

### Button in the vehicle



Active Blind Spot Detection

## Radar sensors



The radar sensors are located under the rear bumper.

## Switching on/off



Press the button.

- ▷ On: the LED lights up.
- ▷ Off: the LED goes out.

The system can issue warnings at speeds above approx. 30 mph/50 km/h.

The setting is stored for the remote control currently in use.

## Display

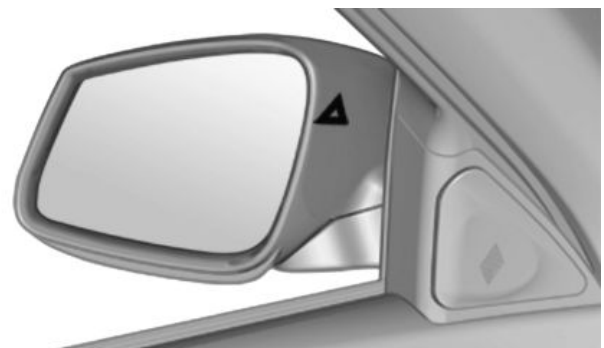

## Information stage

The dimmed lamp in the mirror housing indicates when there are vehicles in the blind spot or approaching from behind.

## Warning

If the turn signal is set while a vehicle is in the critical zone, the steering wheel vibrates briefly

and the lamp in the mirror housing flashes brightly.

The warning stops when the turn signal is switched off, or the other vehicle leaves the critical zone.

### System limits

The system may not be fully functional in the following situations:

- ▶ When a vehicle is approaching at a speed much faster than your own.
- ▶ In heavy fog, rain or snowfall.
- ▶ In tight curves or on narrow lanes.
- ▶ If the bumper is dirty or iced up, or covered with stickers.

A Check Control message is displayed when the system is not fully functional.

### For US owners only

The transmitter and receiver units comply with part 15 of the FCC/Federal Communication Commission regulations. Operation is governed by the following:

FCC ID:

- ▶ NBG009014A.

Compliance statement:

This device complies with part 15 of the FCC Rules. Operation is subject to the following two conditions:

- ▶ This device may not cause harmful interference, and
- ▶ this device must accept any interference received, including interference that may cause undesired operation.

Any unauthorized modifications or changes to these devices could void the user's authority to operate this equipment.

## Brake force display

### The concept



- ▶ During normal brake application, the outer brake lamps light up.
- ▶ During heavy brake application, the inner brake lamps light up in addition.

# Driving stability control systems

## Vehicle equipment

All standard, country-specific and optional equipment that is offered in the model series is described in this chapter. Therefore, equipment is also described that is not available in a vehicle, e. g., because of the selected optional equipment or country variant. This also applies for safety-related functions and systems.

## Antilock Brake System ABS

ABS prevents locking of the wheels during braking.

The vehicle remains steerable even during full brake applications, thus increasing active safety.

ABS is operational every time you start the engine.

## Brake assistant

When you apply the brakes rapidly, this system automatically produces the maximum braking force boost. This then reduces braking distance to a minimum during full braking. This system utilizes all of the benefits provided by ABS.

Do not reduce the pressure on the brake pedal for the duration of the full braking.

## DSC Dynamic Stability Control

### The concept

DSC prevents traction loss in the driving wheels when driving away and accelerating.

DSC also recognizes unstable vehicle conditions, such as fishtailing or nose-diving. Sub-

ject to physical limits, DSC helps to keep the vehicle on a steady course by reducing engine speed and by applying brakes to the individual wheels.



Adjust your driving style to the situation. An appropriate driving style is always the responsibility of the driver.

The laws of physics cannot be repealed, even with DSC.

Therefore, do not reduce the additional safety margin by driving in a risky manner. ◀

### Indicator/warning lamps



The indicator lamp flashes: DSC controls the drive forces and brake forces.

The indicator lamp lights up: DSC has failed.

### Deactivating DSC: DSC OFF

When DSC is deactivated, driving stability is reduced during acceleration and when driving in bends.

To increase vehicle stability, activate DSC again as soon as possible.

### Deactivating DSC



Press and hold the button, but not longer than approx. 10 seconds, until the indicator lamp for DSC OFF lights up in the instrument cluster and DSC OFF is displayed.

The DSC system is switched off.

Steering and, depending on the equipment, the chassis are adjusted for sporty driving.

### Activating DSC



Press the button.



DSC OFF and the DSC OFF indicator lamp go out.

### Indicator/warning lamps

When DSC is deactivated, DSC OFF is displayed in the instrument cluster.



The indicator lamp lights up: DSC is deactivated.

## DTC Dynamic Traction Control

### The concept

The DTC system is a version of the DSC in which forward momentum is optimized.

The system ensures maximum forward momentum on special road conditions, e.g., unplowed snowy roads, but driving stability is limited.

It is therefore necessary to drive with appropriate caution.

You may find it useful to briefly activate DTC under the following special circumstances:

- ▶ When driving in slush or on uncleared, snow-covered roads.
- ▶ When rocking the vehicle or driving off in deep snow or on loose surfaces.
- ▶ When driving with snow chains.

### Deactivating/activating DTC Dynamic Traction Control

Activating the Dynamic Traction Control DTC provides maximum traction on loose ground. Driving stability is limited during acceleration and when driving in bends.

### Activating DTC



Press the button.

TRACTION is displayed in the instrument cluster and the indicator lamp for DSC OFF lights up.

### Deactivating DTC



Press the button again.

TRACTION and the DSC OFF indicator lamp go out.

## xDrive

xDrive is the all-wheel-drive system of your vehicle. Concerted action by the xDrive and DSC further optimize traction and driving dynamics. The xDrive all-wheel-drive system variably distributes the drive forces to the front and rear axles as demanded by the driving situation and road surface.

## Dynamic Damping Control

### The concept

This system reduces undesirable vehicle motion when using a dynamic driving style or traveling on uneven road surfaces.

The system enhances driving dynamics and comfort as required for the road surface and driving style.

### Programs

The system offers several different programs. The programs can be selected via the Driving Dynamics Control, refer to page 116.

### SPORT

Consistently sporty control of the shock absorbers for greater driving agility.

## SPORT+

Consistently sporty control of the shock absorbers for greater driving agility when driving with limited driving stabilization.

## COMFORT/ECO PRO

Balanced control of the vehicle.

## Variable sport steering

The variable sport steering increases the steering angle of the front wheels at large steering wheel angles, e.g., in tight curves or when parking. Steering becomes more direct.

It also varies the force required to turn the wheels in accordance with the vehicle speed.



This results in a sporty steering response. In addition, it becomes easier to steer during parking and maneuvering.

## Driving Dynamics Control

### The concept

The Driving Dynamics Control can be used to adjust the certain characteristics of the vehicle. Various programs can be selected for this purpose. The Driving Dynamics Control and the DSC OFF buttons can each be used to activate a program.

### Operating the programs

Press the button	Program
	DSC OFF TRACTION
	SPORT+ SPORT COMFORT ECO PRO

## Automatic program change

The system automatically switches to COMFORT in the following situations:

- ▶ Failure of DSC Dynamic Stability Control.
- ▶ The vehicle has a flat tire.
- ▶ When activating cruise control in TRACTION or DSC OFF mode.

## DSC OFF

When DSC OFF, refer to page 114, is active, driving stability is limited during acceleration and when driving in bends.

## TRACTION

When TRACTION is active, the vehicle has maximum traction on loose road surfaces. DTC Dynamic Traction Control, refer to page 115, is activated. Driving stability is limited during acceleration and when driving in bends.

## SPORT+

Sporty driving with optimized chassis and adapted engine control with limited driving stabilization.

Dynamic Traction Control is switched on.

The driver handles several of the stabilization tasks.

### Activating SPORT+



Press the button repeatedly until SPORT+ appears in the instrument cluster and the DSC OFF indicator lamp lights up.

## Automatic program change

When activating cruise control, the program automatically switches to SPORT mode.

## Indicator/warning lamps

SPORT+ is displayed in the instrument cluster.



The DSC OFF indicator lamp lights up: Dynamic Traction Control is activated.

## SPORT

Consistently sporty tuning of the suspension and engine control for greater driving agility with maximum driving stabilization.

The program can be configured to individual specifications. The configuration is stored for the remote control currently in use.

### Activating SPORT



Press button repeatedly until SPORT is displayed in the instrument cluster.

### Configuring SPORT

When the display is activated on the Control Display, refer to page 118, the SPORT driving mode can be set to individual specifications.

- ▶ Activating SPORT.
- ▶ "Configure SPORT"
- ▶ Configuring the SPORT driving mode.

SPORT can also be configured before it is activated:

1. "Settings"
2. "Driving mode"
3. "Configure SPORT"
4. Configure driving mode.

This configuration is retrieved when the SPORT driving mode is activated.

## COMFORT

For a balanced tuning with maximum driving stabilization.

### Activating COMFORT



Press button repeatedly until COMFORT is displayed in the instrument cluster.

In certain situations, the system automatically changes to the NORMAL program, automatic program change, refer to page 116.

## ECO PRO

ECO PRO, refer to page 169, provides consistent tuning to minimize fuel consumption for maximum range with maximum driving stabilization.

Comfort functions and the engine controller are adjusted.

The program can be configured to individual specifications.

### Activating ECO PRO



Press button repeatedly until ECO PRO is displayed in the instrument cluster.

### Configuring ECO PRO

1. Activate ECO PRO.
2. "Configure ECO PRO"

Make the desired settings.

### Configuring drive program

Settings can be made for the following driving programs in Driving mode:

- ▶ SPORT, refer to page 117.
- ▶ ECO PRO, refer to page 170.

## Displays

### Program selection

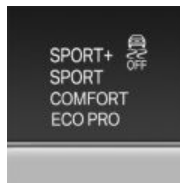

Pressing the button displays a list of the selectable programs.

## Selected program



The selected program is displayed in the instrument cluster.

## Display on the Control Display

Program changes can be displayed on the Control Display.

1. "Settings"
2. "Driving mode"
3. "Driving mode info"

## Drive-off assistant

This system supports driving away on gradients. The parking brake is not required.

1. Hold the vehicle in place with the foot brake.
2. Release the foot brake and drive away without delay.

After the foot brake is released, the vehicle is held in place for approx. 2 seconds.

Depending on the vehicle load or when a trailer is being used, the vehicle may roll back slightly.



### Driving off without delay

After releasing the foot brake, start driving without delay, since the drive-off assistant will not hold the vehicle in place for more than approx. 2 seconds and the vehicle will begin rolling back. ◀

# Driving comfort

## Vehicle equipment

All standard, country-specific and optional equipment that is offered in the model series is described in this chapter. Therefore, equipment is also described that is not available in a vehicle, e. g., because of the selected optional equipment or country variant. This also applies for safety-related functions and systems.

## Active Cruise Control with Stop & Go function, ACC

### The concept

This system can be used to select a desired speed that the vehicle will maintain automatically on clear roads.

To the extent possible, the system automatically adjusts the speed to a slower vehicle ahead of you.

The distance that the vehicle maintains to the vehicle ahead of you can be varied.

For safety reasons, it depends on the speed.

To maintain a certain distance, the system automatically reduces the speed, applies the brakes lightly, or accelerates again if the vehicle ahead begins moving faster.

If the vehicle ahead of you brakes to a halt, the system is able to detect this within the given system limits. If the vehicle ahead of your drives away again from a halt, your vehicle is able to accelerate if operated accordingly.

Even if some time passes before the vehicle ahead of you drives away again, your own vehicle can still be accelerated automatically and simply.

As soon as the road is clear, it accelerates to the desired speed.

The speed is also maintained on downhill gradients, but may not be maintained on uphill slopes if engine power is insufficient.

### General information

Depending on the set driving program, the characteristics of the cruise control can change in certain areas.

### Hints



#### Personal responsibility

Even an active system does not release the driver from personal responsibility for the driving process, especially for lane tracking, adaptation of speed, distance and driving style to the traffic conditions.

Because of technical system limits, the system cannot independently react appropriately in all traffic situations.

Monitor the driving process, the surrounding area and what is occurring in traffic continuously and attentively and actively intervene as required, e.g., by braking, steering or making an evasive maneuver. ◀









#### Unfavorable weather conditions

In the event of unfavorable weather and light conditions, e. g. if there is rain, snowfall, slush, fog or glare, this may result in poorer recognition of vehicles as well as short-term interruptions for vehicles that are already detected. Drive attentively, and react to the current traffic events. Intervene actively when necessary, e.g., by braking, steering or making an evasive maneuver, otherwise, there is danger of an accident. ◀

## At a glance

### Buttons on the steering wheel

Press the button	Function
	System on/off, interrupt, refer to page 120
	Maintaining/storing the speed, refer to page 121
	Resume speed, refer to page 122
	Reduce distance, refer to page 122
	Increase distance, refer to page 122
	Rocker switch: Maintaining/storing the speed, refer to page 121 Changing, maintaining, and storing the speed, refer to page 121

The arrangement of the buttons varies according to the how the vehicle is equipped or country-specific variants.

### Radar sensor

A radar sensor is located in the front bumper for detecting vehicles on the road ahead of the vehicle.

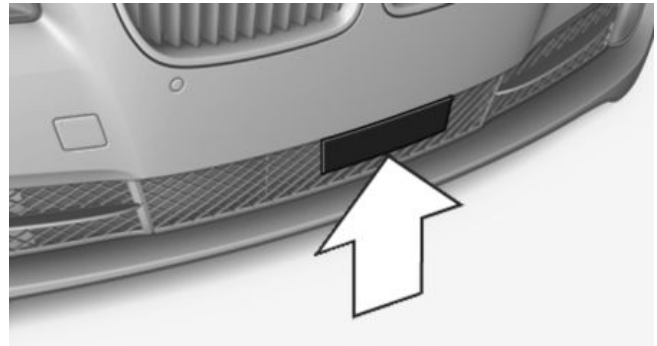

A dirty or covered sensor may hinder the detection of vehicles.

- ▶ If necessary, clean the radar sensor. Remove layers of snow and ice carefully.
- ▶ Do not cover the view field of the radar sensor.

### Switching on/off and interrupting cruise control

#### Switching on

 Press the button on the steering wheel.

The indicator lamps in the instrument cluster light up and the mark in the speedometer is set to the current speed.

Cruise control can be used.

#### Switching off

 Deactivated or interrupted system  
If the system is deactivated or interrupted, actively intervene by braking, steering and, if necessary, with evasive maneuvers; otherwise, there is the danger of an accident occurring. ◀

If switching off the system while stationary, press on the brake pedal at the same time.

 Press the button.

- ▶ If active: press twice.
- ▶ If interrupted: press once.



The displays go out. The stored desired speed and distance are deleted.

## Interrupting



When active, press the button.

If interrupting the system while stationary, press on the brake pedal at the same time.

The system is automatically interrupted in the following situations:

- ▶ When the brakes are applied.
- ▶ When drive mode D is removed.
- ▶ When DTC Dynamic Traction Control is activated or DSC is deactivated.
- ▶ When DSC is actively controlling stability.
- ▶ When SPORT+ is activated with Driving Dynamics Control.
- ▶ If the safety belt and the driver's door are opened when the vehicle is standing still.
- ▶ If the system has not detected objects for an extended period, e.g., on a road with very little traffic without road edge line markings.
- ▶ If the detection range of the radar is disrupted, for example, by dirt or heavy fog.

## Maintaining/storing the speed



Press the button.

Or:

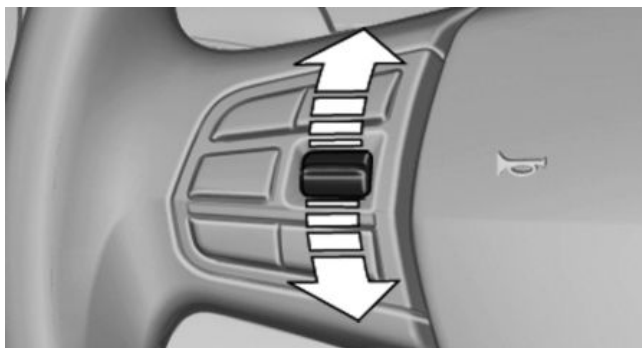

Press the rocker switch while the system is interrupted.

When the system is switched on, the current speed is maintained and stored as the desired speed.

This is displayed, refer to page 123, in the speedometer and briefly in the instrument cluster.

When cruise control is maintained or stored, DSC Dynamic Stability Control is switched on, if necessary.

## Changing, maintaining, and storing the speed

The rocker switch can be pressed while the system is interrupted to maintain and store the current speed. DSC Dynamic Stability Control is switched on, if necessary.



Adapting the desired speed

Adapt the desired speed to the road conditions and be ready to brake at all times; otherwise, there is the danger of an accident occurring. ◀



Speed differences

Large differences in speed relative to vehicles ahead of the vehicle cannot be compensated by the system for example in the following situations:

- ▶ When quickly approaching a slowly moving vehicle.
- ▶ When another vehicle suddenly swerves into the wrong lane. ◀

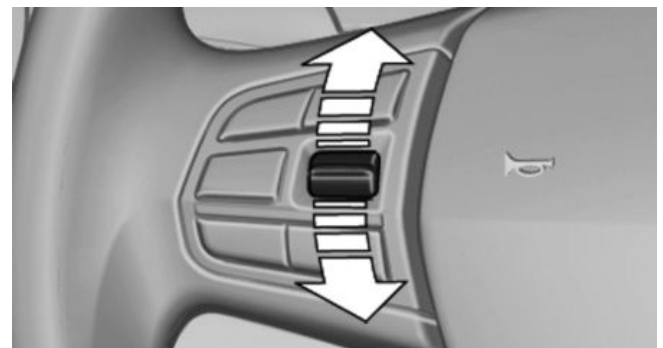

Press the rocker switch up or down repeatedly until the desired speed is set.

If active, the displayed speed is stored and the vehicle reaches the stored speed if the road is clear.

- ▷ Each time the rocker switch is pressed to the point of resistance, the desired speed increases or decreases by approx. 1 mph/1 km/h.
- ▷ Each time the rocker switch is pressed past the point of resistance, the desired speed increases or decreases by a maximum of 5 mph/10 km/h.

Hold the rocker switch in position to repeat the action.

## Distance



Selecting a distance

Adjust the distance according to the traffic and weather conditions; otherwise, there is the danger of an accident occurring. Maintain the prescribed safety distance. ◀

## Reduce distance



Press the button repeatedly until the desired distance is set.

The selected distance, refer to page 123, is displayed in the instrument cluster.

## Increase distance



Press the button repeatedly until the desired distance is set.

The selected distance, refer to page 123, is displayed in the instrument cluster.

## Calling up the desired speed and distance

### While driving



Press the button with the system switched on.

In the following cases, the stored speed value is deleted and cannot be called up again:

- ▷ When the system is switched off.
- ▷ When the ignition is switched off.

### While standing



Before leaving the vehicle, secure it against rolling

Before leaving the vehicle with the engine running, engage position P of the automatic transmission and apply the parking brake. Otherwise, the vehicle may begin to roll. ◀

The system brought the vehicle to a complete standstill.

- ▷ Green marking in the speedometer:  
Your vehicle accelerates automatically as soon as the vehicle in the range of the radar sensor moves off.
- ▷ Marking in the speedometer turns orange:  
no automatic driving away.  
To accelerate to the desired speed automatically, press the accelerator or press the RES or SET button.

Rolling bars in the distance display indicate that the vehicle in the radar sensor detection range has moved off.

Your vehicle was braked to a halt by pressing on the brake pedal and it is standing behind another vehicle:

1.  Press the button to call up a stored desired speed.
2. Release the brake pedal.
3. Press on the accelerator briefly, or press the RES rocker switch when the vehicle ahead of you drives away.

## Displays in the instrument cluster

### Desired speed



- ▶ The marking lights up green: the system is active.
- ▶ The marking lights up orange: the system has been interrupted.
- ▶ The marking does not light up: the system is switched off.

### Brief status display



Selected desired speed.

If --- appears briefly on the display for Check Control messages, it is possible that the system requirements for operation are currently not met.

### Distance to vehicle ahead of you

The selected distance to the vehicle driving ahead of you is shown.

#### Distance display



Distance 1



Distance 2



Distance 3



Distance 4

This value is set after the system is switched on.



The system has been interrupted or distance control is deactivated because the accelerator pedal is being pressed; a vehicle was not detected.

#### Distance display



Distance control is deactivated because the accelerator pedal is being pressed; a vehicle was detected.

Rolling bars: the detected vehicle has driven away.

### Indicator/warning lamps



Personal responsibility

The indicator and warning lamps do not relieve the driver of the responsibility to adapt his or her desired driving speed and style to the traffic conditions. ◀



The vehicle symbol lights up orange: A vehicle has been detected ahead of you.



The vehicle symbol flashes orange: The conditions are not adequate for operating the system.

The system was deactivated but applies the brakes until you actively resume control by pressing on the brake pedal or accelerator pedal.



The vehicle symbol flashes red and an acoustic signal sounds:

You are requested to intervene by braking or making an evasive maneuver.

### System limits

#### Speed range

Best results are achieved when using the system on well-developed roads and highways.

The system is functional at speeds beginning at approx. 20 mph/30 km/h.

The maximum speed that can be set depends on the vehicle.

The system can also be activated when stationary.

Comply with the legal speed limit in every situation when using the system.

### Detection range

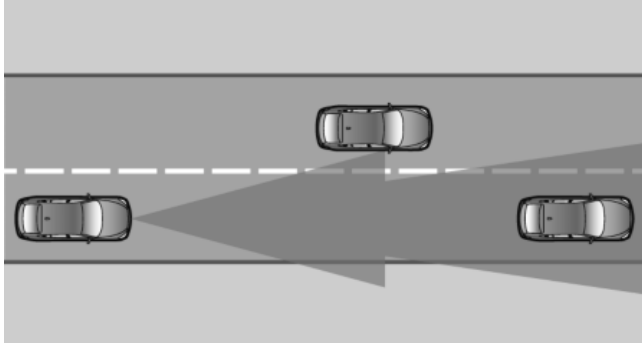

The detection capacity of the system and the automatic braking capacity are limited.

Two-wheeled vehicles driving ahead of you for instance might not be detected.

#### Limited detection capacity

Because of the limits to the detection capacity, you should be alert at all times so that you can intervene if necessary; otherwise, there is the danger of an accident occurring. ◀

### Deceleration

The system does not decelerate when a stationary obstacle is located in the same lane, e.g., a vehicle at a red traffic light or at the end of traffic congestion.

The system also does not respond to:

- ▶ Pedestrians or similar slow-moving road users.
- ▶ Red traffic lights.
- ▶ Stationary objects.
- ▶ Cross traffic.
- ▶ Oncoming traffic.

#### No warnings

A warning may not be issued when approaching a stationary or very slow-moving obstacle. You must react yourself; otherwise, there is the danger of an accident occurring. ◀

### Swerving vehicles

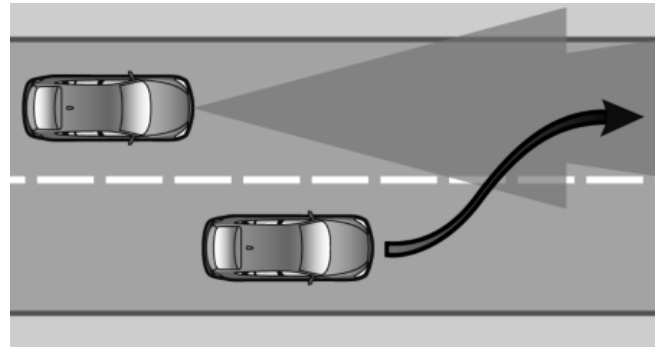

A vehicle driving in front of you is not detected until it is completely within the same lane as your vehicle.

#### Swerving vehicles

If a vehicle driving ahead of you suddenly swerves into your lane, the system may not be able to automatically restore the selected distance. This also applies to major speed differences to vehicles driving ahead of you, e.g., when rapidly approaching a truck. When a vehicle driving ahead of you is reliably detected, the system requests that the driver intervene by braking and carrying out evasive maneuvers, if necessary. You must react yourself; otherwise, there is the danger of an accident occurring. ◀

### Unexpected lane change

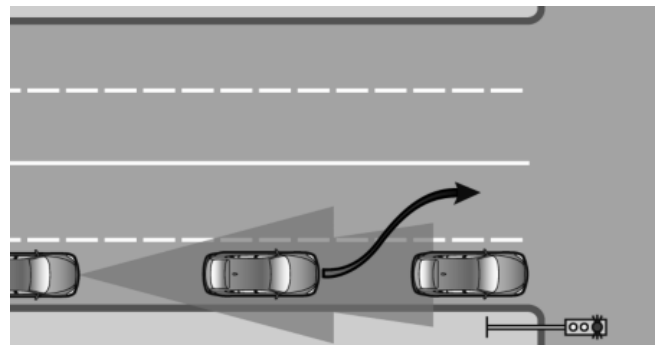

If a vehicle ahead of you unexpectedly moves into another lane from behind a stopped vehicle, you yourself must react, as the system does not react to stopped vehicles.

## Cornering

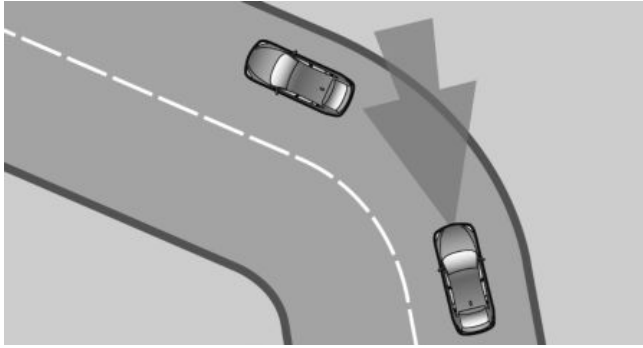

If the desired speed is too high for a curve, the speed is reduced slightly in the curve, although curves cannot be anticipated in advance. Therefore, drive into a curve at an appropriate speed.

In tight curves, situations may result due to the restricted detection range of the system in which a vehicle driving ahead of you may not be detected at all, or not until after a considerable delay.

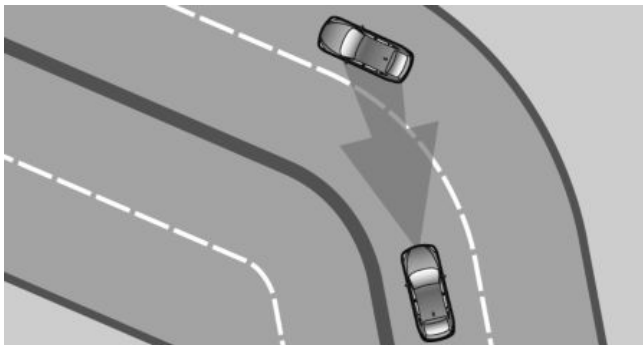

When approaching a curve, the system may react briefly to the vehicles in the next lane due to the bend of the curve. Any deceleration of the vehicle by the system can be compensated for by briefly accelerating. After the accelerator pedal is released, the system becomes active again and independently controls the speed.

## Driving away

In some situations, the vehicle cannot drive away automatically, e.g., on steep inclines or behind bumps in the road.

## Radar sensor

### For US owners only

The transmitter and receiver units comply with part 15 of the FCC/Federal Communication Commission regulations. Operation is governed by the following:

FCC ID:

▷ OAYARS3-A

Compliance statement:

This device complies with part 15 of the FCC Rules. Operation is subject to the following two conditions:

- ▷ This device may not cause harmful interference, and
- ▷ this device must accept any interference received, including interference that may cause undesired operation.

Any unauthorized modifications or changes to these devices could void the user's authority to operate this equipment.

## Malfunction

The system cannot be activated if the radar sensor is not aligned correctly. This may be caused by damage incurred during parking, for example.

A Check Control message is displayed if the system fails.

## Cruise control

### The concept

The system is functional at speeds beginning at approx. 20 mph/30 km/h.

It maintains the speed that was set using the control elements on the steering wheel.

The system brakes on downhill gradients if engine braking action is insufficient.

**Unfavorable conditions**

Do not use the system if unfavorable conditions make it impossible to drive at a constant speed, for instance:

- ▷ On curvy roads.
- ▷ In heavy traffic.
- ▷ On slippery roads, in fog, snow or rain, or on a loose road surface.

Otherwise, you could lose control of the vehicle and cause an accident. ◀

**General information**

Depending on the set driving program, the characteristics of the cruise control can change in certain areas.

**At a glance****Buttons on the steering wheel**

Press the button	Function
	System on/off, interrupt
	Store speed
	Resume speed
	Rocker switch: change, hold, store speed

**Controls****Switching on**

Press the button on the steering wheel.

The marking in the speedometer is set to the current speed.

Cruise control can be used.

**Switching off****Deactivated or interrupted system**

If the system is deactivated or interrupted, actively intervene by braking and, if necessary, with evasive maneuvers; otherwise, there is the danger of an accident occurring. ◀



Press the button.

- ▷ If active: press twice.
- ▷ If interrupted: press once.

The displays go out. The stored desired speed is deleted.

**Interrupting**

When active, press the button.

The system is automatically interrupted if:

- ▷ The brakes are applied.
- ▷ The clutch pedal is depressed for a few seconds or released while a gear is not engaged.
- ▷ The gear engaged is too high for the current speed.
- ▷ Selector lever position D is disengaged.
- ▷ DTC Dynamic Traction Control is activated or DSC is deactivated.
- ▷ DSC is actively controlling stability.
- ▷ When SPORT+ is activated with Driving Dynamics Control.

**Maintaining/storing the current speed**

Press the button.

Or



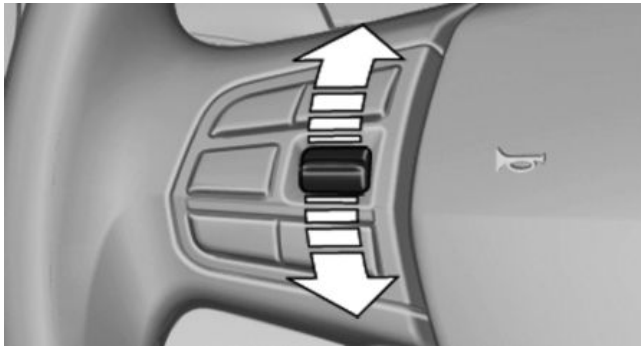

Press the rocker switch while the system is interrupted.

When the system is switched on, the current speed is maintained and stored as the desired speed.

This is displayed, refer to page 127, in the speedometer and briefly in the instrument cluster.

When cruise control is maintained or stored, DSC Dynamic Stability Control is switched on, if necessary.

### Changing/maintaining speed

The rocker switch can be pressed while the system is interrupted in order to maintain and store the current speed.



#### Adapting the desired speed

Adapt the desired speed to the road conditions and be ready to brake at all times; otherwise, there is the danger of an accident occurring. ◀

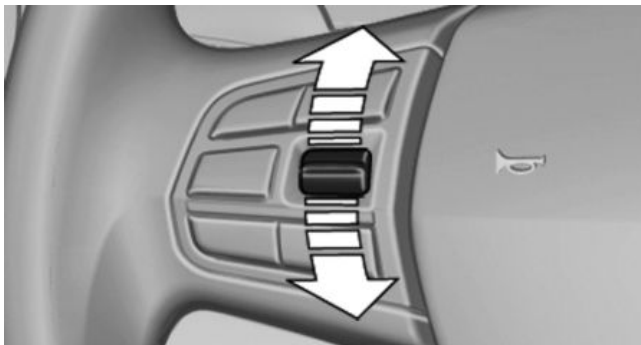

Press the rocker switch up or down repeatedly until the desired speed is set.

If active, the displayed speed is stored and the vehicle reaches the stored speed if the road is clear.

- ▷ Each time the rocker switch is pressed to the point of resistance, the desired speed increases or decreases by approx. 1 mph/1 km/h.
- ▷ Each time the rocker switch is pressed past the point of resistance, the desired speed increases or decreases by a maximum of 5 mph/10 km/h.

The maximum speed that can be set depends on the vehicle.

- ▷ Pressing the rocker switch to the resistance point and holding it accelerates or decelerates the vehicle without requiring pressure on the accelerator pedal. After the rocker switch is released, the vehicle maintains its final speed. Pressing the switch beyond the resistance point causes the vehicle to accelerate more rapidly.

### Resuming the desired speed



Press the button.

The stored speed is reached and maintained.

### Displays in the instrument cluster

#### Indicator lamp



Depending on how the vehicle is equipped, the indicator lamp in the instrument cluster indicates whether the system is switched on.

#### Desired speed



- ▷ The marking lights up green: the system is active.
- ▷ The marking lights up orange: the system has been interrupted.

- ▶ The marking does not light up: the system is switched off.

### Brief status display



Selected desired speed.

If --- appears briefly on the display for Check Control messages, it is possible that the system requirements for operation are currently not met.

## PDC Park Distance Control

### The concept

PDC support when parking. Slowly approaching an object behind or, with the appropriate PDC equipment, also in front of your vehicle is signaled by:

- ▶ Signal tones.
- ▶ Visual display.

### General information

Measurements are made by ultrasound sensors in the bumpers.

The range, depending on the obstacle and environmental conditions, is approx. 6 ft/2 m.

An acoustic warning is first given:

- ▶ By the front sensors and the two rear corner sensors at approx. 24 in/60 cm.
- ▶ By the rear middle sensors at approx. 5 ft/1.50 m.

To ensure full operability:

- ▶ Do not cover sensors, e.g., by stickers, bicycle racks and the like.
- ▶ Keep the sensors clean and free of ice.
- ▶ When using high-pressure washers, do not spray the sensors for long periods and maintain a distance of at least 12 in/30 cm.

### Hints



Personal responsibility

Even an active system does not relieve the driver from personal responsibility for the driving process.

Because of technical system limits, the system cannot independently react appropriately in all traffic situations.

Continuously and attentively monitor the driving process, the area surrounding the vehicle and the traffic situation, and actively intervene when required, otherwise, there is a risk of an accident. ◀



Avoid driving quickly with PDC

Avoid approaching an object quickly.

Avoid driving away quickly while PDC is not yet active.

For technical reasons, the system may otherwise be too late in issuing a warning. ◀

### At a glance

#### With front PDC: button in vehicle



PDC Park Distance Control

### Switching on/off

#### Switching on automatically

With the engine running, engage selector lever position R.

## Automatic deactivation during forward travel

The system switches off when a certain driving distance or speed is exceeded.

Switch the system back on if necessary.

## With front PDC: switching on/off manually



Press the button.

- ▷ On: the LED lights up.
- ▷ Off: the LED goes out.

## Display

### Signal tones

When approaching an object, an intermittent tone is sounded that indicates the position of the object. For example, if an object is detected to the left rear of the vehicle, a signal tone sounds from the left rear speaker.

The shorter the distance to the object becomes, the shorter the intervals.

If the distance to a detected object is less than approx. 10 in/25 cm, a continuous tone is sounded.

With front PDC: if objects are located both in front of and behind the vehicle, an alternating continuous signal is sounded.

The signal tone is switched off:

- ▷ When the vehicle moves away from an object by more than approx. 4 in/10 cm.
- ▷ When selector lever position P is engaged on vehicles with automatic transmission.

### Volume

The volume of the PDC signal tone can be adjusted similar to the tone and volume settings of the radio.

The setting is stored for the remote control currently in use.

## Visual warning

The approach of the vehicle to an object can be shown on the Control Display. Objects that are farther away are displayed on the Control Display before a signal tone sounds.

A display appears as soon as Park Distance Control (PDC) is activated.

The range of the sensors is represented in the colors red, green and yellow.

When the image of the rearview camera is displayed, the switch can be made to PDC:

 "Rear view camera"

## System limits

### Limits of ultrasonic measurement

The detection of objects can reach the physical limits of ultrasonic measurement, e.g., in the following circumstances:

- ▷ For small children and animals.
- ▷ For persons with certain clothing, e.g. coats.
- ▷ If there is an external disturbance of the ultrasound, e.g. from passing vehicles or loud machines.
- ▷ When sensors are dirty, iced over, damaged or out of position.
- ▷ Under certain weather conditions, such as high relative humidity, rain, snowfall extreme heat or strong wind.
- ▷ With tow bars and trailer hitches of other vehicles.
- ▷ With thin or wedge-shaped objects.
- ▷ With moving objects.
- ▷ With elevated, protruding objects such as ledges or cargo.
- ▷ With objects with corners and sharp edges.
- ▷ With objects with a fine surface structure, such as fences.
- ▷ For objects with porous surfaces.

Low objects already displayed, e.g., curbs, can move into the blind area of the sensors before or after a continuous tone sounds.

### False warnings

PDC may issue a warning under the following conditions even though there is no obstacle within the detection range:

- ▷ In heavy rain.
- ▷ When sensors are very dirty or covered in ice.
- ▷ When sensors are covered in snow.
- ▷ On rough road surfaces.
- ▷ On uneven surfaces, such as speed bumps.
- ▷ In large buildings with right angles and smooth walls, e.g., in underground garages.
- ▷ In heavy exhaust.
- ▷ Due to other ultrasound sources, e.g., sweeping machines, high pressure steam cleaners or neon lights.

The malfunction is signaled by a continuous tone alternating between the front and rear speakers. As soon as the malfunction due to other ultrasound sources is no longer present, the system is again fully functional.

### Malfunction

A Check Control message is displayed.

The range of the sensors is shown as a shaded area on the Control Display.

PDC has failed. Have the system checked.

To ensure full operability:

- ▷ Keep the sensors clean and free of ice.
- ▷ Do not adhere any stickers to the sensors.
- ▷ When using high-pressure washers, do not spray the sensors for long periods and maintain a distance of at least 12 in/30 cm.

## Surround View

### The concept

Surround View comprises various camera assistance systems that help the driver when parking, maneuvering, and at complex exits and intersections.

- ▷ Rearview camera, refer to page 130
- ▷ Side View, refer to page 133.
- ▷ Top View, refer to page 134.

## Rearview camera

### The concept

The rearview camera provides assistance in parking and maneuvering backwards. The area behind the vehicle is shown on the Control Display.

### Hints



Check the traffic situation as well

Check the traffic situation around the vehicle with your own eyes. Otherwise, an accident could result from road users or objects located outside the picture area of the backup camera. ◀

### At a glance

### Button in the vehicle



Rearview camera

## Camera

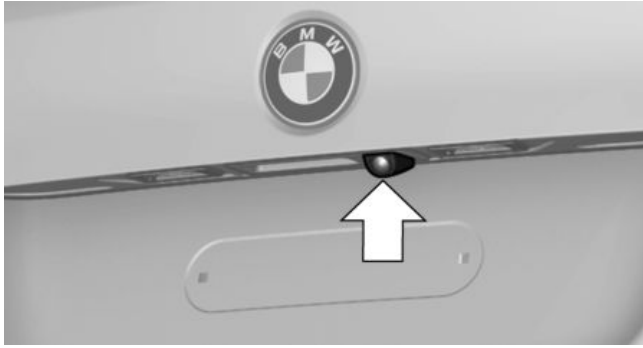

The camera lens is located in the handle of the trunk lid. The image quality may be impaired by dirt.

Clean the lens, refer to page [224](#).

## Switching on/off

### Switching on automatically

With the engine running, engage selector lever position R.

The rearview camera image is displayed if the system was switched on via the iDrive.

### Automatic deactivation during forward travel

The system switches off when a certain driving distance or speed is exceeded.

Switch the system back on if necessary.

### Switching on/off manually



Press the button.

- ▷ On: the LED lights up.
- ▷ Off: the LED goes out.

The PDC is shown on the Control Display.

### Switching on the rearview camera via the iDrive

With PDC activated or Top View switched on:

 "Rear view camera"

The rearview camera image is displayed.



## Display on the Control Display

### Functional requirement

- ▷ The rearview camera is switched on.
- ▷ The trunk lid is fully closed.

### Activating the assistance functions

More than one assistance function can be active at the same time.

- ▷ Parking aid lines
  -  "Parking aid lines"  
Pathway and turning circle lines are displayed.
- ▷ Obstacle marking
  -  "Obstacle marking"  
Spatially-shaped markings are displayed.

### Pathway lines

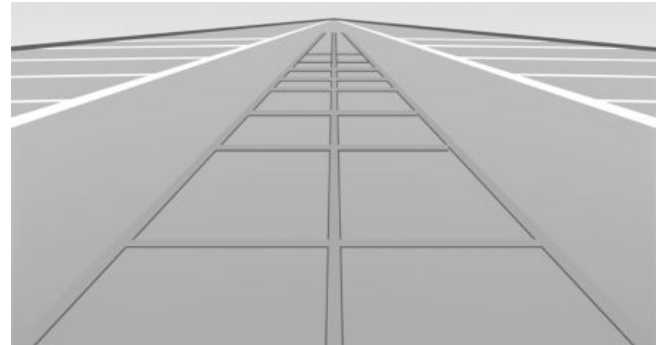

- ▷ Can be shown in the rearview camera image when in selector lever position R.
- ▷ Help you to estimate the space required when parking and maneuvering on level roads.
- ▷ Are dependent on the current steering angle and are continuously adjusted to the steering wheel movements.



## Turning circle lines

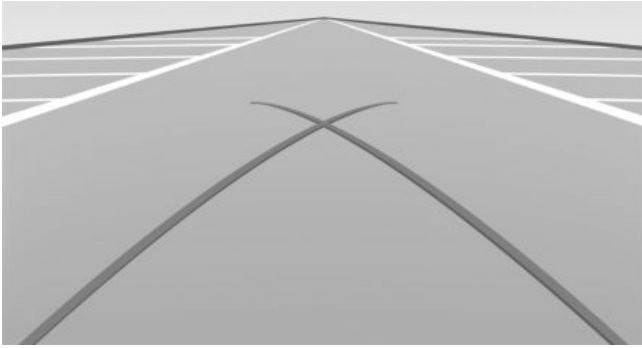

- ▶ Can be shown in the rearview camera image.
- ▶ Show the course of the smallest possible turning circle on a level road.
- ▶ Only one turning circle line is displayed after the steering wheel is turned past a certain angle.

## Obstacle marking

### General information

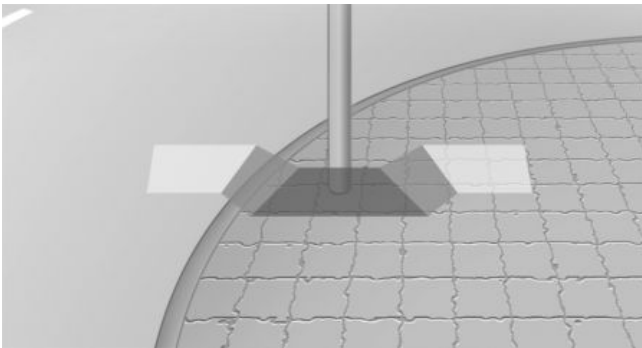

Marks for detected obstacles can be shown in the rearview camera image. Their colored steps match the markings of the PDC. This simplifies estimation of the distance to the object shown.

## Parking using pathway and turning circle lines

1. Position the vehicle so that the turning circle lines lead to within the limits of the parking space.

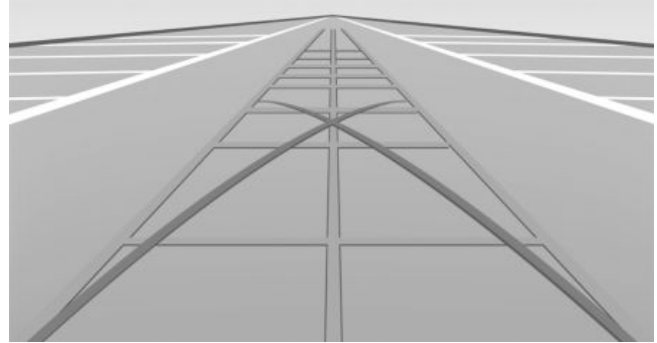

2. Turn the steering wheel to the point where the pathway line covers the corresponding turning circle line.

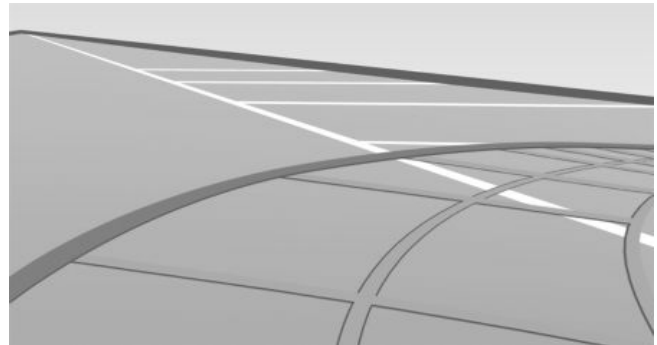

## Display settings

### Brightness

With the rearview camera switched on:

1. ☀ Select the symbol.
2. Turn the controller until the desired setting is reached, and press the controller.

### Contrast

With the rearview camera switched on:

1. ● Select the symbol.
2. Turn the controller until the desired setting is reached, and press the controller.



## System limits

### Detection of objects

Very low obstacles as well as high, protruding objects such as ledges may not be detected by the system.

Assistance functions also take into account data of the PDC.

Follow instructions in the PDC chapter, refer to page 128.

The objects displayed in the Control Display under certain circumstances are closer than they appear. Therefore, do not estimate the distance from the objects on the display.

## Side View

### The concept

Side View provides an early look at cross traffic at blind driveways and intersections. Road users concealed by obstacles to the left and right of the vehicle can only be detected relatively late from the driver's seat. To improve visibility, two cameras in the front of the vehicle record the traffic situation on each side.

### Notes

The images from both cameras are shown simultaneously on the Control Display.



Check the traffic situation as well

Check the traffic situation around the vehicle on blind driveways and intersections with your own eyes. Otherwise, an accident could result from road users or objects located outside the picture area of the Side View cameras. ◀

## At a glance

### Button in the vehicle



Side View

### Cameras

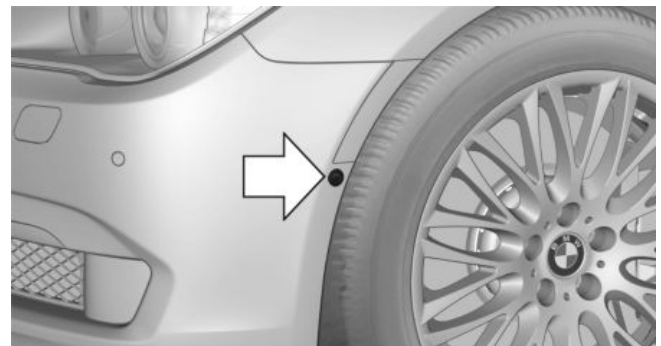

Two cameras integrated in the bumpers capture the image.

The two camera lenses are located on the sides of the bumper.

The image quality may be impaired by dirt. Clean the lens, refer to page 224.

### Switching on/off

#### Switching on/off manually



Press the button.

### Automatic deactivation during forward travel

The system switches off when a certain driving distance or speed is exceeded.

Switch the system back on if necessary.

## Display

The traffic area to the left and right is displayed on the Control Display.

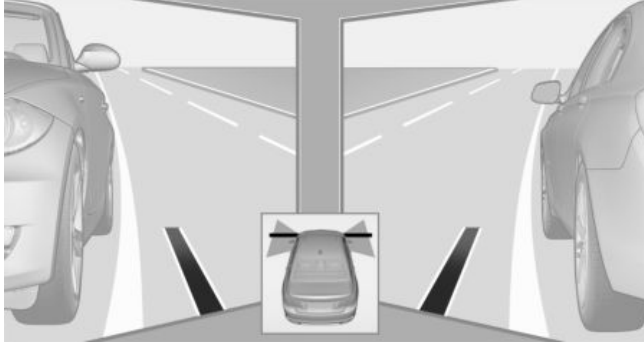

Guidelines at the bottom of the image show the position of the front of the vehicle.

## Brightness

With the Side View switched on:

1. ☀ "Brightness"
2. Turn the controller until the desired setting is reached, and press the controller.

## Contrast

With the Side View switched on:

1. 🌑 "Contrast"
2. Turn the controller until the desired setting is reached, and press the controller.

## System limits

The cameras capture a maximum range of 330 ft/100 m.

## Top View

### The concept

Top View provides assistance in parking and maneuvering. The area around the doors and the road area around the vehicle are shown on the Control Display for this purpose.

## General information

The image is captured by two cameras integrated in the exterior mirrors and by the backup camera.

The range is at least 7 ft/2 m to the side and rear.

In this way, obstacles up to the height of the exterior mirrors are detected early.

## Notes



Check the traffic situation as well

Check the traffic situation around the vehicle with your own eyes. Otherwise, an accident could result from road users or objects located outside the picture area of the cameras. ◀

## At a glance

### Button in the vehicle



Top View

## Cameras

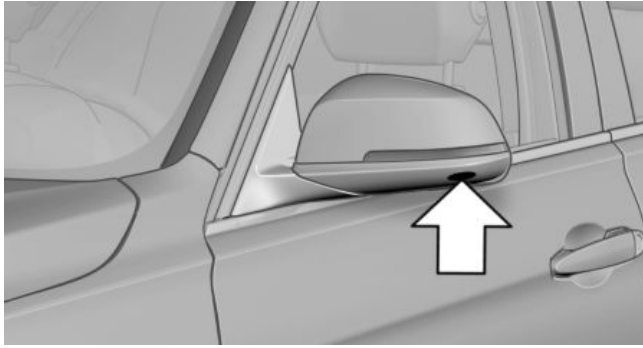

The lenses of the Top View cameras are located at the bottom of the exterior mirror housings. The image quality may be impaired by dirt.

Clean the lens, refer to page [224](#).

## Switching on/off

### Switching on automatically

With the engine running, engage selector lever position R.

The Top View and PDC images are displayed if the system is switched on via iDrive.

### Automatic deactivation during forward travel

The system switches off when a certain driving distance or speed is exceeded.

Switch the system back on if necessary.

### Switching on/off manually



Press the button.

- ▶ On: the LED lights up.
- ▶ Off: the LED goes out.

Top View is displayed.

## Display

### Visual warning

The approach of the vehicle to an object can be shown on the Control Display.

When the distance to an object is small, a red bar is shown in front of the vehicle, as it is in the PDC display.

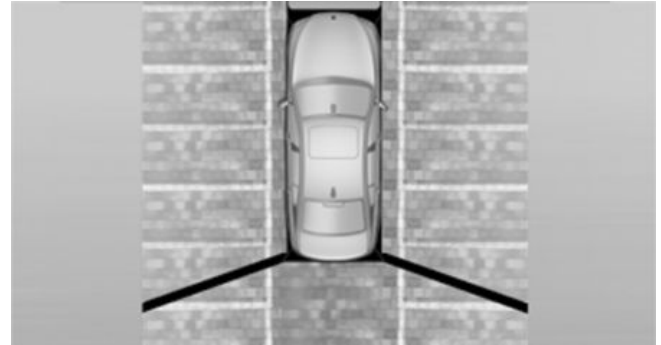

The display appears as soon as Top View is activated.

When the image of the rearview camera is displayed, it is possible to switch to top view:

 "Rear view camera"

## Brightness

With Top View switched on:

1.  Select the symbol.
2. Turn the controller until the desired setting is reached, and press the controller.

## Contrast

With Top View switched on:

1.  Select the symbol.
2. Turn the controller until the desired setting is reached, and press the controller.

## Displaying the turning circle and pathway lines

- ▶ The static, red turning circle line shows the space needed to the side of the vehicle when the steering wheel is turned all the way.
- ▶ The variable, green pathway line assists you in assessing the amount of space actually needed to the side of the vehicle.

The lane line depends on the engaged gear and the current steering angle. The

track line is continuously adjusted for the steering wheel movement.

### "Parking aid lines"

Turning circle and pathway lines are displayed.

## System limits

Top View cannot be used in the following situations:

- ▷ With a door open.
- ▷ With the trunk lid open.
- ▷ With an exterior mirror folded in.
- ▷ In poor light.

A Check Control message is displayed in some of these situations.

## Parking assistant

### The concept

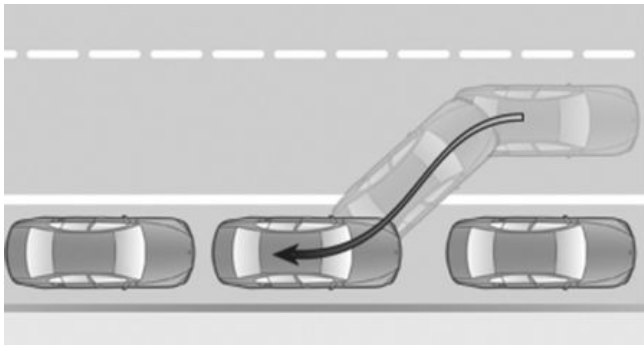

This system assists the driver in parking parallel to the road.

Ultrasound sensors measure parking spaces on both sides of the vehicle.

The parking assistant calculates the best possible parking line and takes control of steering during the parking procedure.

When parking, also take note of the visual and acoustic information and instructions issued by the PDC, the parking assistant and the rear-view camera and react accordingly.

A component of the parking assistant is the PDC Park Distance Control, refer to page [128](#).

## Hints



### Personal responsibility

Even an active system does not relieve the driver from personal responsibility for the driving process.

Because of technical system limits, the system cannot independently react appropriately in all traffic situations.

Continuously and attentively monitor the driving process, the area surrounding the vehicle and the traffic situation, and actively intervene when required, otherwise, there is a risk of an accident. ◀



### Changes to the parking space

Changes to the parking space after it was measured are not taken into account by the system.

Therefore, always be alert and ready to intervene; otherwise, there is the danger of an accident occurring. ◀



### Transporting loads

Loads that extend beyond the perimeter of the vehicle are not taken into account by the system during the parking procedure.

Therefore, always be alert and ready to intervene; otherwise, there is the danger of an accident occurring. ◀



### Curbs

The parking assistant may steer the vehicle over or onto curbs.

Therefore, always be alert and ready to intervene; otherwise, the wheels, tires, or the vehicle may become damaged. ◀

An engine that has been switched off by the Auto Start Stop function is restarted automatically when the parking assistant is activated.

## Requirements

### For measuring parking spaces

- ▷ Maximum speed while driving forward approx. 22 mph/35 km/h.
- ▷ Maximum distance to row of parked vehicles: 5 ft/1.5 m.

### Suitable parking space

- ▷ Gap between two objects with a minimum length of approx. 5 ft/1.5 m.
- ▷ Min. length of gap between two objects: your vehicle's length plus approx. 4 ft/1.2 m.
- ▷ Minimum depth: approx. 5 ft/1.5 m.

### For parking procedure

- ▷ Doors and trunk lid closed.
- ▷ Parking brake released.
- ▷ When parking in parking spaces on the driver's side, the corresponding turn signal must be set where applicable.

## At a glance

### Button in the vehicle



Parking assistant

## Ultrasound sensors

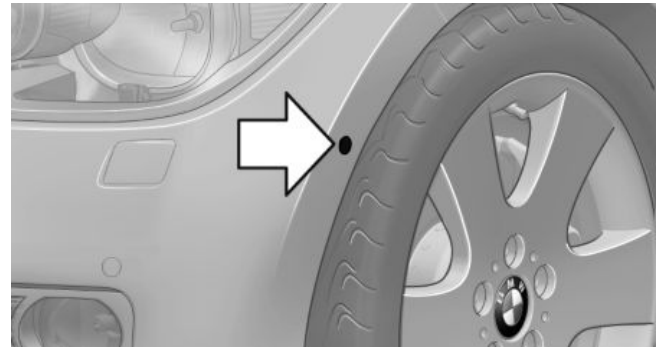

The ultrasound sensors for measuring parking spaces are located on the wheel arches.

To ensure full operability:

- ▷ Keep the sensors clean and free of ice.
- ▷ When using high-pressure washers, do not spray the sensors for long periods and maintain a distance of at least 12 in/30 cm.
- ▷ Do not paste over sensors.

## Switching on/off

### Switching on with the button



Press the button.

The LED lights up.

The current status of the parking space search is indicated on the Control Display.

 Parking assistant is activated automatically.

### Switching on with the reverse gear

Shift into reverse.

The current status of the parking space search is indicated on the Control Display.

To activate:  "Parking Assistant"

## Switching off



The system can be deactivated as follows:

- ▷  Press the button.
- ▷ Switch off the ignition.



## Display on the Control Display

### System activated/deactivated

Symbol	Meaning
	Gray: the system is not available. White: the system is available but not activated.
	The system is activated.

### Status display

Depending on the appointment version, different views of the status display are shown and are described below as View 1, refer to page 138, or View 2, refer to page 138.

#### Status of the system, Display 1

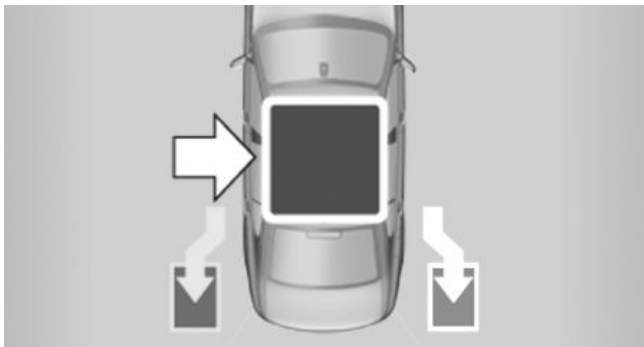

The status is displayed with symbols.



Gray: parking space search.

Blue: the system is activated. A suitable parking space was found.

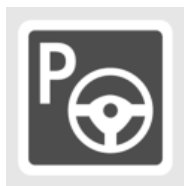

The parking procedure is active.

Steering control has been seized.

#### Status of the parking space search

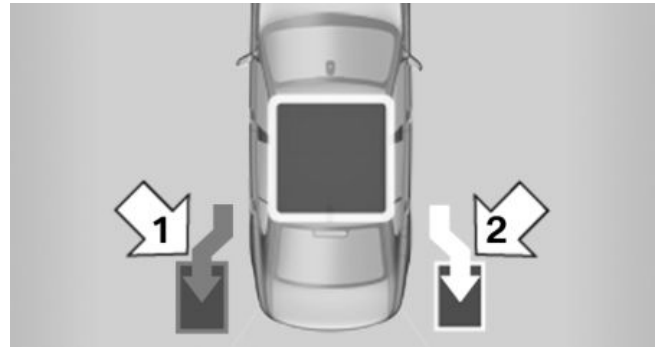

- ▶ Gray, arrow 1: parking space search.
- ▶ Blue, arrow 2: parking space is suitable.  
The vehicle is parked in the parking space if the parking procedure is active.
- ▶ No display: no parking space search.

#### Status of the system, Display 2

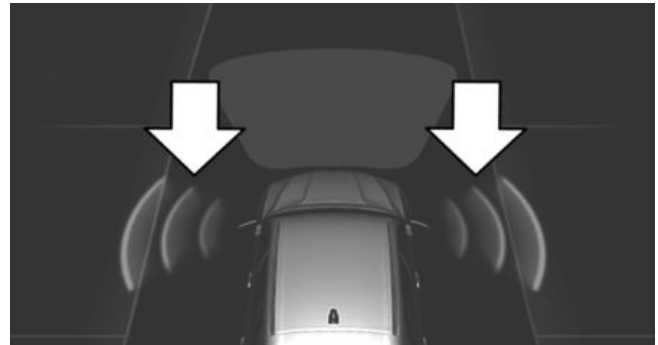

- ▶ Colored symbols, see arrows, on the side of the vehicle representation. Parking assistant is activated and search for parking space active.
- ▶ Suitable parking spaces are displayed next to the vehicle symbol at the edge of the road as on the Control Display. When the parking assistant is active, suitable parking spaces are highlighted.
- ▶  The parking procedure is active. Steering control has been seized.
- ▶ Parking space search is always active whenever the vehicle is moving forwards slow and straight, even if the system is de-



activated. When the system is deactivated, the displays on the Control Display are shown in gray.

## Parking using the parking assistant



Check the traffic situation as well

Loud sounds outside and within the vehicle can drown out the signal tones of the parking assistant and PDC.

Check the traffic situation around the vehicle with your own eyes; otherwise, there is the danger of an accident. ◀

1. Switch on the parking assistant and activate it if necessary.  
The status of the parking space search is indicated on the Control Display.
2. Follow the instructions on the Control Display.  
To achieve the best possible parking position, wait for the automatic steering wheel movement after the gear change when the vehicle is stationary.  
The end of the parking procedure is indicated on the Control Display.
3. Adjust the parking position yourself if necessary.

## Interrupting manually

The parking assistant can be interrupted at any time:

- ▷ "Parking Assistant"
- ▷ Press the button.

## Interrupting automatically

The system is interrupted automatically in the following situations:

- ▷ If the driver grasps the steering wheel or if he takes over steering.
- ▷ If a gear is selected that does not match the instruction on the Control Display.

- ▷ If the vehicle speed exceeds approx. 6 mph/10 km/h.
- ▷ On snow-covered or slippery road surfaces if necessary.
- ▷ If the Park Distance Control PDC displays clearances that are too small.
- ▷ If a maximum number of parking attempts or the time taken for parking is exceeded.
- ▷ When switching to another function on the Control Display.

A Check Control message is displayed.

## Resume

An interrupted parking procedure can be continued if necessary.

Follow the instructions on the Control Display to do this.

## System limits

### No parking assistance

The parking assistant does not offer assistance in the following situations:

- ▷ In tight curves.

### Functional limitations

The system may not be fully functional in the following situations:

- ▷ On bumpy road surfaces such as gravel roads.
- ▷ On slippery ground.
- ▷ When leaves or snow has collected in the parking space.

### Limits of ultrasonic measurement

The detection of objects can reach the physical limits of ultrasonic measurement, e.g., in the following circumstances:

- ▷ For small children and animals.
- ▷ For persons with certain clothing, e.g. coats.

- ▷ If there is an external disturbance of the ultrasound, e.g. from passing vehicles or loud machines.
- ▷ When sensors are dirty, iced over, damaged or out of position.
- ▷ Under certain weather conditions, such as high relative humidity, rain, snowfall extreme heat or strong wind.
- ▷ With tow bars and trailer hitches of other vehicles.
- ▷ With thin or wedge-shaped objects.
- ▷ With moving objects.
- ▷ With elevated, protruding objects such as ledges or cargo.
- ▷ With objects with corners and sharp edges.
- ▷ With objects with a fine surface structure, such as fences.
- ▷ For objects with porous surfaces.

Low objects already displayed, e.g., curbs, can move into the blind area of the sensors before or after a continuous tone sounds.

The parking assistant may identify parking spaces that are not suitable for parking.

## Malfunction

A Check Control message is displayed.

The parking assistant failed. Have the system checked.

# Climate control

## Vehicle equipment

All standard, country-specific and optional equipment that is offered in the model series is described in this chapter. Therefore, equip-

ment is also described that is not available in a vehicle, e. g., because of the selected optional equipment or country variant. This also applies for safety-related functions and systems.

## Automatic climate control

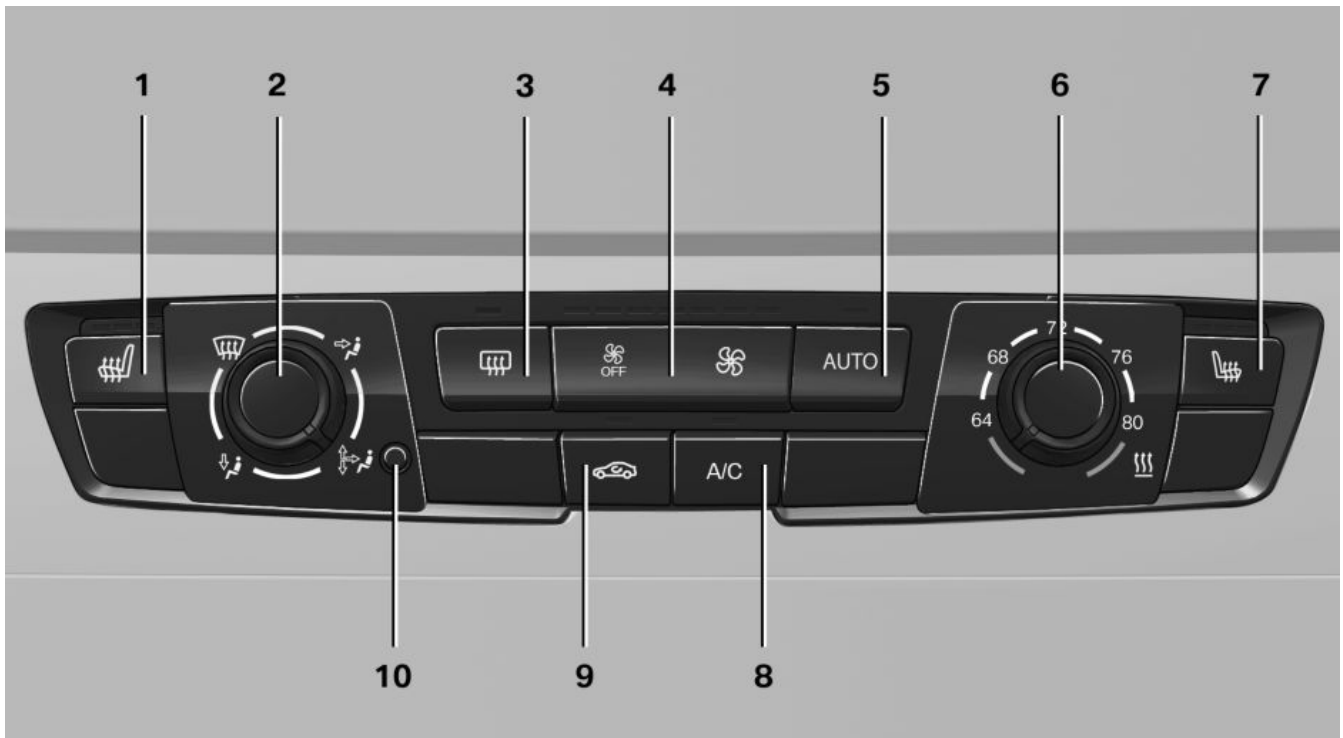

- |   |                       |    |    |                             |
|---|-----------------------|----|----|-----------------------------|
| 1 | Seat heating, left    | 50 | 6  | Temperature                 |
| 2 | Vent settings         |    | 7  | Seat heating, right         |
| 3 | Rear window defroster |    | 8  | Cooling function            |
| 4 | Air flow              |    | 9  | Recirculated-air mode       |
| 5 | AUTO program          |    | 10 | Interior temperature sensor |

## Climate control functions in detail

### Manual air distribution



Turn the wheel to select the desired program or the desired intermediate setting.

- ▷ Windows.
- ▷ Upper body region.
- ▷ Windows, upper body region, and footwell.
- ▷ Footwell.

### Defrosting windows and removing condensation

Direct the air distribution toward windows, increase the air flow and temperature, and, if necessary, use the cooling function.

### Rear window defroster



Press the button.

The rear window defroster switches off automatically after a certain period of time.

### Air flow, manual



Press the left or right side of the button: decrease or increase air flow.

The air flow of the air conditioner may be reduced automatically to save battery power.

### AUTO program



Press the button.

Air flow, air distribution, and temperature are controlled automatically.

Depending on the selected temperature and outside influences, the air is directed to the windshield, side windows, upper body, and into the footwell.

The cooling function, refer to page 142, is switched on automatically with the AUTO program.

### Temperature



Turn the wheel to set the desired temperature.

The automatic climate control reaches this temperature as quickly as possible, if necessary by increasing the cooling or heating output, and then keeps it constant.

Avoid rapidly switching between different temperature settings. Otherwise, the automatic climate control will not have sufficient time to adjust the set temperature.

### Cooling function

The passenger compartment can only be cooled with the engine running.



Press the button.

The air is cooled and dehumidified and, depending on the temperature setting, warmed again.

Depending on the weather, the windshield may fog up briefly when the engine is started.

The cooling function is switched on automatically with the AUTO program.

When using the automatic climate control, condensation water, refer to page 164, develops that exits underneath the vehicle.

### Recirculated-air mode

You can respond to unpleasant odors or pollutants in the immediate environment by temporarily suspending the supply of outside air. The system then recirculates the air currently within the vehicle.



Press the button repeatedly to select an operating mode:

- ▷ LED off: outside air flows in continuously.
- ▷ LED on, recirculated-air mode: the supply of outside air into the vehicle is permanently blocked.

Recirculated air mode switches off automatically at low external temperatures after a certain amount of time in order to window fogging.

If the windows fog over, switch off recirculated-air mode and increase the air flow, if necessary.



#### Continuous recirculated-air mode

The recirculated-air mode should not be used for an extended period of time, as the air quality inside the vehicle deteriorates steadily. ◀

## Switching the system on/off

### Switching off



Press the left button for the minimum speed.

### Switching on

Press any button except

- ▷ Rear window defroster.
- ▷ Seat heating.

### Microfilter

In external and recirculated air mode the microfilter filters dust and pollen out of the air.

This filter should be replaced during scheduled maintenance, refer to page 202, of your vehicle.

## Automatic climate control with enhanced features

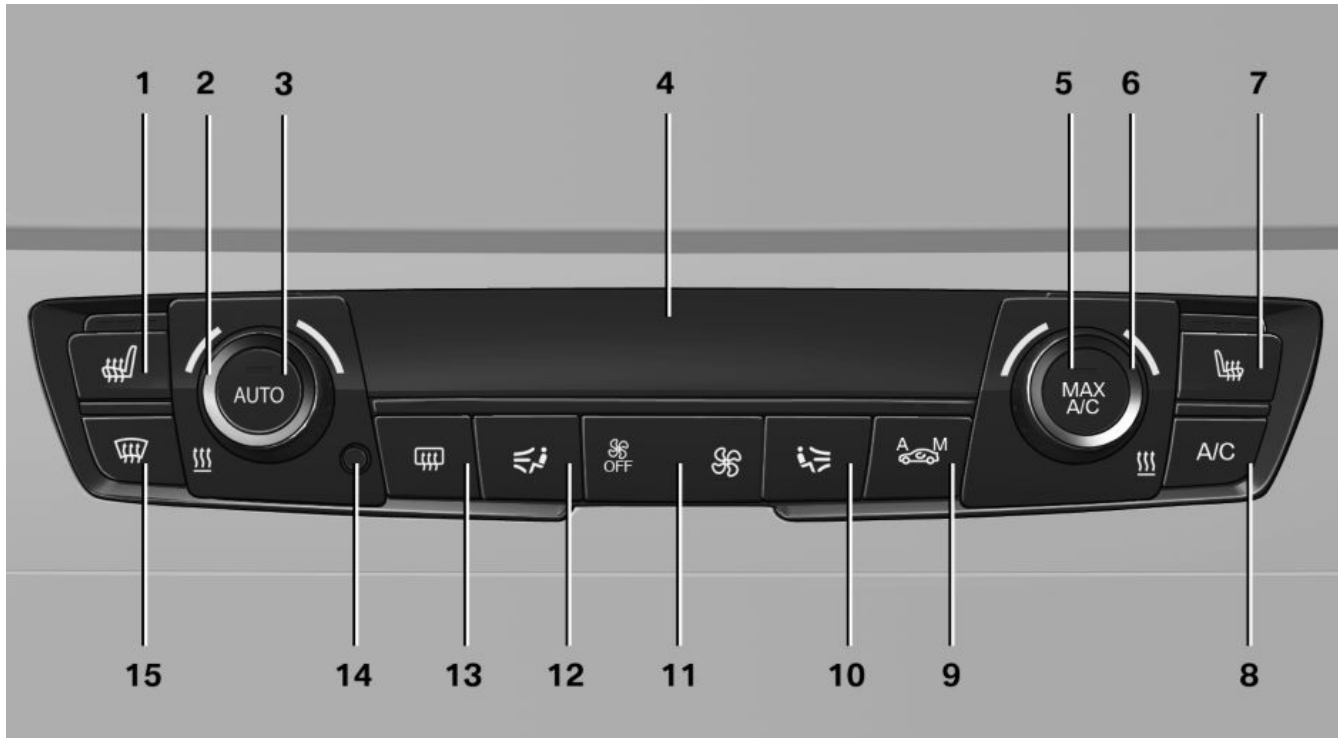

- |    |  |    |
|----|--|----|
| 1  | Seat heating, left                                       | 50 |
| 2  | Temperature, left  |    |
| 3  | AUTO program   |    |
| 4  | Display  |    |
| 5  | Maximum cooling  |    |
| 6  | Temperature, right                                       |    |
| 7  | Seat heating, right                                      | 50 |
| 8  | Cooling function   |    |
| 9  | Automatic recirculated-air control/recirculated-air mode |    |
| 10 | Air distribution, right                                  |    |
| 11 | Air flow, AUTO intensity                                 |    |
| 12 | Air distribution, left                                   |    |
| 13 | Rear window defroster                                    |    |
| 14 | Interior temperature sensor — always keep clear          |    |
| 15 | Defrosting windows and removing condensation             |    |

### Climate control functions in detail

#### Temperature



Turn the wheel to set the desired temperature.

The automatic climate control reaches this temperature as quickly as possible, if neces-

sary by increasing the cooling or heating output, and then keeps it constant.

Avoid rapidly switching between different temperature settings. Otherwise, the automatic climate control will not have sufficient time to adjust the set temperature.

#### AUTO program

 Press the button.



Air flow, air distribution, and temperature are controlled automatically.

Depending on the selected temperature, AUTO intensity program and outside influences, the air is directed to the windshield, side windows, upper body, and into the footwell.

The cooling function, refer to page 145, is switched on automatically with the AUTO program.

At the same time, a condensation sensor controls the program so as to prevent window condensation as much as possible.

### Intensity of the AUTO program

With the AUTO program switched on, automatic control of the air flow and air distribution can be adjusted.



Press the left or right side of the button: decrease or increase the intensity.

The selected intensity is shown on the display of the automatic climate control.

### Maximum cooling



Press the button. The system is set to the lowest temperature, maximum air flow and air circulation mode.

Air flows out of the vents for the upper body region. The vents need to be open for this.

The function is available above an external temperature of approx. 32 °F/0 °C and with the engine running.

The air flow can be adjusted when the program is active.

### Cooling function

The passenger compartment can only be cooled with the engine running.



Press the button.

The air is cooled and dehumidified and, depending on the temperature setting, warmed again.

Depending on the weather, the windshield may fog up briefly when the engine is started.

The cooling function is switched on automatically with the AUTO program.

When using the automatic climate control, condensation water, refer to page 164, develops that exits underneath the vehicle.

### Automatic recirculated-air control/ recirculated-air mode

You can respond to unpleasant odors or pollutants in the immediate environment by temporarily suspending the supply of outside air. The system then recirculates the air currently within the vehicle.



Press the button repeatedly to select an operating mode:

- ▶ LEDs off: outside air flows in continuously.
- ▶ Left LED on, automatic recirculated-air control: a sensor detects pollutants in the outside air and controls the shutoff automatically.
- ▶ Right LED on, recirculated-air mode: the supply of outside air into the vehicle is permanently blocked.

Recirculated air mode switches off automatically at low external temperatures after a certain amount of time in order to window fogging.

If the windows are fogged over, switch off the recirculated-air mode and press the AUTO button to utilize the condensation sensor. Make sure that air can flow onto the windshield.



Continuous recirculated-air mode

The recirculated-air mode should not be used for an extended period of time, as the air quality inside the vehicle deteriorates steadily. ◀

## Manual air distribution



Press the button repeatedly to select a program:

- ▷ Upper body region.
- ▷ Upper body region and footwell.
- ▷ Footwell.
- ▷ Windows and footwell: driver's side only.
- ▷ Windows, upper body region and footwell: driver's side only.

If the windows are fogged over, press the AUTO button to utilize the condensation sensor.

## Air flow, manual

To be able to manually adjust the air flow, switch off the AUTO program first.



Press the left or right side of the button: decrease or increase air flow.

The selected air flow is shown on the display of the automatic climate control.

The air flow of the automatic climate control may be reduced automatically to save battery power.

## Rear window defroster



Press the button.

The rear window defroster switches off automatically after a certain period of time.

## Defrosting windows and removing condensation



Press the button.

Ice and condensation are quickly removed from the windshield and the front side windows.

The air volume can be adjusted when the program is active.

If the windows are fogged over, you can also switch on the cooling function or press the

AUTO button to utilize the condensation sensor.

## Switching the system on/off

### Switching off



Press the left button for the minimum speed.

### Switching on

Press any button except

- ▷ Rear window defroster.
- ▷ Seat heating.

## Microfilter/activated-charcoal filter

In external and recirculated air mode the microfilter/activated charcoal filter filters dust, pollen, and gaseous pollutants out of the air.

This filter should be replaced during scheduled maintenance, refer to page 202, of your vehicle.

## Ventilation

### Front ventilation

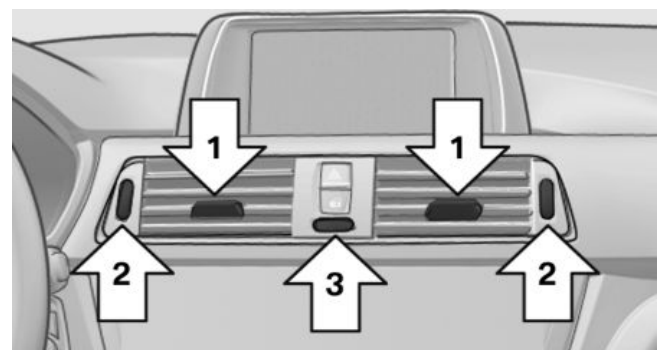

- ▷ Lever for changing the air flow direction, arrow 1.
- ▷ Thumbwheels for opening and closing the vents continuously, arrows 2.
- ▷ Thumbwheel to vary the temperature, arrow 3.  
Toward blue: colder.

Toward red: warmer.

## Adjusting the ventilation

### ▶ Ventilation for cooling:

Adjust the vent to direct the air in your direction, such as if the vehicle interior is hot from the sun.

### ▶ Draft-free ventilation:

Adjust the vent to let the air flow past you.

## Ventilation in the rear

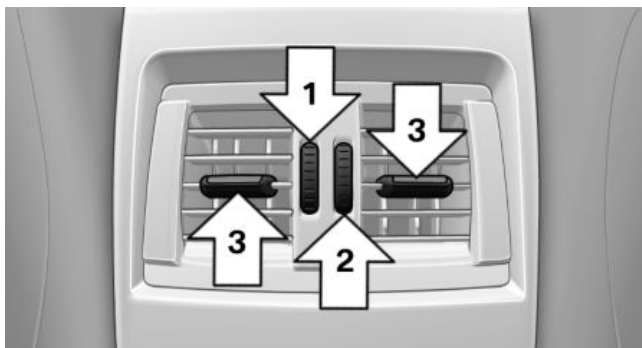

### ▶ Thumbwheel for continuous opening and closing of the vents, arrow 1.

### ▶ Thumbwheel to vary the temperature, arrow 2.

Toward blue: colder.

Toward red: warmer.

### ▶ Lever for changing the air flow direction, arrow 3.

## Parked-car ventilation

### The concept

The parked-car ventilation ventilates the vehicle interior and lowers its temperature, if necessary.

The system can be switched on and off at any external temperature, either directly or by using two preset switch-on times. It remains switched on for 30 minutes.

Open the vents to allow air to flow out.

## Switching on/off directly

1. "Settings"
2. "Climate"
3. "Activate comp. ventilation"

⚙ The symbol on the automatic climate control flashes if the system is switched on.

## Preselecting the switch-on time

1. "Settings"
2. "Climate"
3. "Timer 1:" or "Timer 2:"
4. Set the desired time.

## Activating the switch-on time

1. "Settings"
2. "Climate"
3. "Activate timer 1" or "Activate timer 2"

⚙ The symbol on the automatic climate control lights up when the switch-on time is activated.

⚙ The symbol on the automatic climate control flashes when the system has been switched on.

The system will only be switched on within the next 24 hours. After that, it needs to be reactivated.

# Interior equipment

## Vehicle equipment

All standard, country-specific and optional equipment that is offered in the model series is described in this chapter. Therefore, equipment is also described that is not available in a vehicle, e. g., because of the selected optional equipment or country variant. This also applies for safety-related functions and systems.

## Universal garage door opener

### The concept

The universal garage door opener can operate up to 3 functions of remote-controlled systems such as garage door drives or lighting systems. The universal garage door opener replaces up to 3 different hand-held transmitters. To operate the remote control, the buttons on the interior rearview mirror must be programmed with the desired functions. The hand-held transmitter for the particular system is required in order to program the remote control.



During programming

During programming and before activating a device using the integrated universal remote control, ensure that there are no people, animals, or objects in the range of movement of the remote-controlled device; otherwise, there is a risk of injury or damage.

Also follow the safety instructions of the hand-held transmitter. ◀

Before selling the vehicle, delete the stored functions for the sake of security.

### Compatibility



If this symbol is printed on the packaging or in the instructions of the system to be controlled, the system is gener-

ally compatible with the universal garage door opener.

If you have any questions, please contact:

- ▷ Your service center.
- ▷ [www.homelink.com](http://www.homelink.com) on the Internet.

HomeLink is a registered trademark of Johnson Controls, Inc.

### Controls on the interior rearview mirror

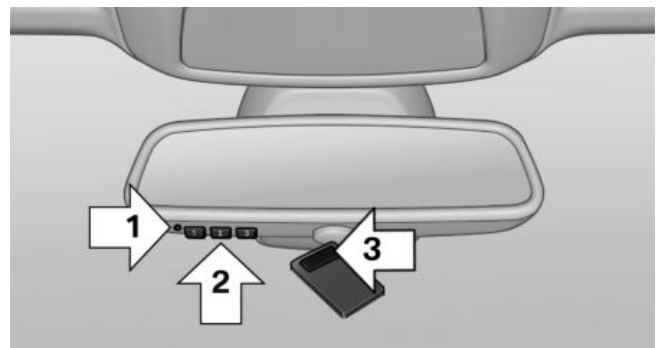

- ▷ LED, arrow 1.
- ▷ Buttons, arrow 2.
- ▷ The hand-held transmitter, arrow 3, is required for programming.

### Programming

#### General information

1. Switch on the ignition.
2. Initial setup:  
Press and hold the left and right button on the interior rearview mirror simultaneously for approximately 20 seconds until the LED on the interior rearview mirror flashes. This erases all programming of the buttons on the interior rearview mirror.
3. Hold the hand-held transmitter for the system to be controlled approx. 1 to 3 in/2.5 to 8 cm away from the buttons on the interior

rearview mirror. The required distance depends on the manual transmitter.

4. Simultaneously press and hold the button of the desired function on the hand-held transmitter and the button to be programmed on the interior rearview mirror. The LED on the interior rearview mirror will begin flashing slowly.
5. Release both buttons as soon as the LED flashes more rapidly. When the LED is flashing faster, this indicates that the button on the interior rearview mirror has been programmed.

If the LED does not flash faster after at least 60 seconds, change the distance between the interior rearview mirror and the hand-held transmitter and repeat the step. Several more attempts at different distances may be necessary. Wait at least 15 seconds between attempts.

Canada: if programming with the hand-held transmitter was interrupted, hold down the interior rearview mirror button and repeatedly press and release the hand-held transmitter button for 2 seconds.

6. To program other functions on other buttons, repeat steps 3 to 5.

The systems can be controlled using the interior rearview mirror buttons.

### Special feature of the alternating-code wireless system

If you are unable to operate the system after repeated programming, please check if the system to be controlled features an alternating-code system.

Read the system's operating manual, or press the programmed button on the interior rearview mirror longer. If the LED on the interior rearview mirror starts flashing rapidly and then stays lit constantly for 2 seconds, the system features an alternating-code system. Flashing

and continuous illumination of the LED will repeat for approximately 20 seconds.

For systems with an alternating-code system, the universal garage door opener and the system also have to be synchronized.

Please read the operating manual of the system being set up for information on how to synchronize the system.

Synchronizing is easier with the aid of a second person.

To synchronize:

1. Park the vehicle within range of the remote-controlled system.
2. Program the relevant button on the interior rearview mirror as described.
3. Locate and press the synchronizing button on the system being programmed. You have approx. 30 seconds for the next step.
4. Hold down the programmed button on the interior rearview mirror for approximately 3 seconds and then release it. If necessary, repeat this work step up to three times in order to finish synchronization. Once synchronization is complete, the programmed function will be carried out.

### Reprogramming individual buttons

1. Switch on the ignition.
2. Press and hold the interior rearview mirror button to be programmed.
3. As soon as the interior rearview mirror LED starts flashing slowly, hold the hand-held transmitter for the system to be controlled approx. 1 to 3 in/2.5 to 8 cm away from the buttons on the interior rearview mirror. The required distance depends on the manual transmitter.
4. Likewise, press and hold the button of the desired function on the hand-held transmitter.
5. Release both buttons as soon as the interior rearview mirror LED flashes more rapidly. When the LED is flashing faster, this



indicates that the button on the interior rearview mirror has been programmed. The system can then be controlled by the button on the interior rearview mirror.

If the LED does not flash faster after at least 60 seconds, change the distance and repeat the step. Several more attempts at different distances may be necessary. Wait at least 15 seconds between attempts.

Canada: if programming with the hand-held transmitter was interrupted, hold down the interior rearview mirror button and repeatedly press and release the hand-held transmitter button for 2 seconds.

## Controls



Before operation

Before operating a system using the integrated universal remote control, ensure that there are no people, animals, or objects within the range of movement of the remote-controlled system; otherwise, there is a risk of injury or damage.

Also follow the safety instructions of the hand-held transmitter. ◀

The system, such as the garage door, can be operated using the button on the interior rearview mirror while the engine is running or when the ignition is started. To do this, hold down the button within receiving range of the system until the function is activated. The interior rearview mirror LED stays lit while the wireless signal is being transmitted.

## Deleting stored functions

Press and hold the left and right button on the interior rearview mirror simultaneously for approximately 20 seconds until the LED flashes rapidly. All stored functions are deleted. The functions cannot be deleted individually.

## Digital compass

### At a glance

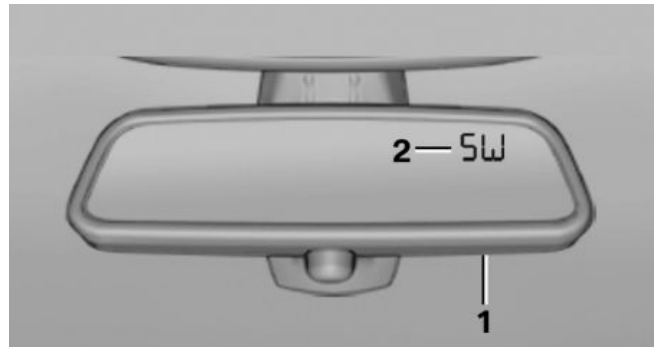

- 1 Control button
- 2 Mirror display

### Mirror display

The point of the compass is displayed in the mirror when driving straight.

### Operating concept

Various functions can be called up by pressing the control button with a pointed object, such as the tip of a ballpoint pen or similar object. The following setting options are displayed in succession, depending on how long the control button is pressed:

- ▶ Pressed briefly: turns display on/off.
- ▶ 3 to 6 seconds: compass zone setting.
- ▶ 6 to 9 seconds: compass calibration.
- ▶ 9 to 12 seconds: left/right-hand steering setting.
- ▶ 12 to 15 seconds: language setting.

### Setting the compass zones

Sets the particular compass zones on the vehicle so that the compass operates correctly; refer to World map with compass zones.



## World map with magnetic zones

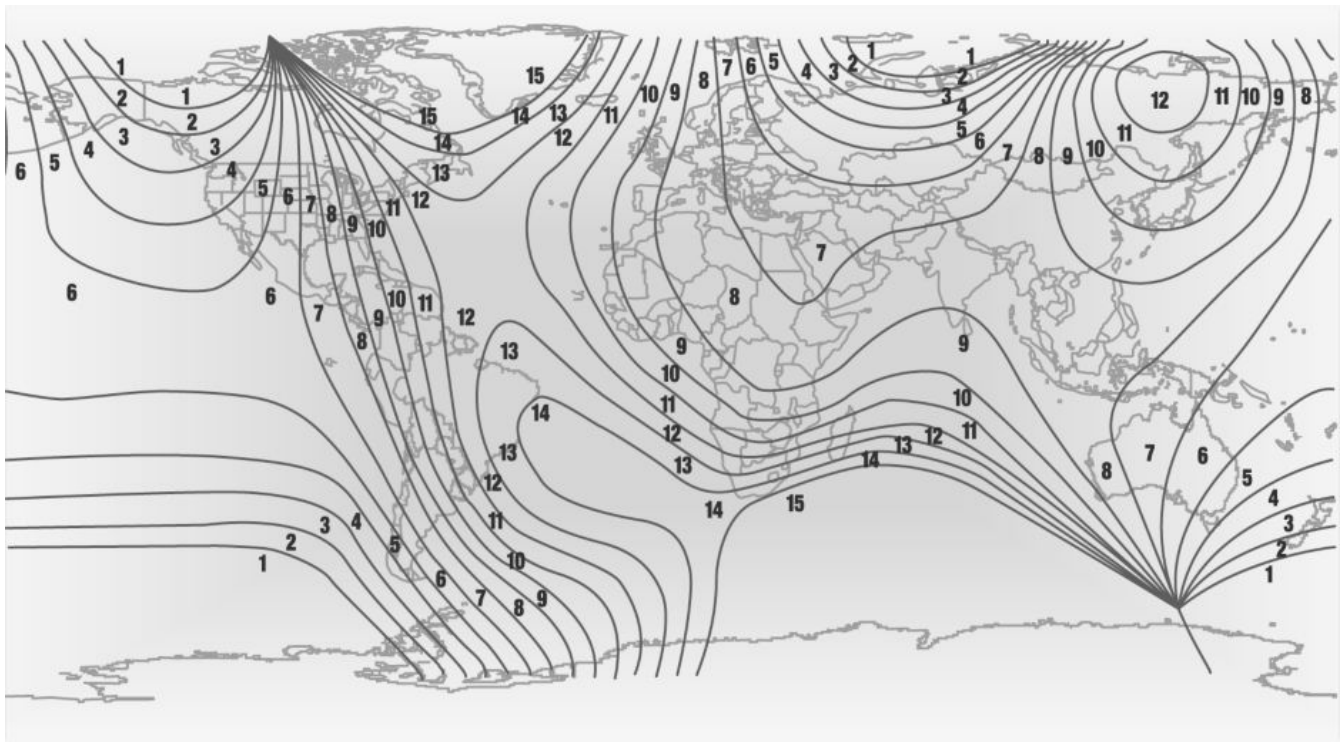

### Procedure

1. Press and hold the control button for approx. 3 to 4 seconds. The number of the set compass zone appears in the mirror.
2. To change the zone setting, press the control button quickly and repeatedly until the number of the compass zone corresponding to your location appears in the mirror.

The set zone is stored automatically. The compass is ready for use again after approximately 10 seconds.

### Calibrating the digital compass

The digital compass must be calibrated in the event of the following:

- ▶ The wrong point of the compass is displayed.
- ▶ The point of the compass displayed does not change despite changing the direction of travel.
- ▶ Not all points of the compass are displayed.

### Procedure

1. Make sure that there are no large metallic objects or overhead power lines near the vehicle and that there is sufficient room to drive around in a circle.
2. Set the currently applicable compass zone.
3. Press and hold the control button for approx. 6 to 7 seconds so that "C" appears on the display. Next, drive in a complete circle at least once at a speed of no more than 4 mph/7 km/h. If calibration is successful, the "C" is replaced by the points of the compass.

### Left/right-hand steering

The digital compass is already set for right or left-hand steering at the factory.

### Setting the language

Press and hold the control button for approx. 12 to 13 seconds. Briefly press the control button again to switch between English "E" and German "O".

The setting is stored automatically after approximately 10 seconds.

## Ashtray/cigarette lighter

### Ashtray

#### Opening



Raise cover.

#### Emptying

Take out the insert.

#### Lighter

 **Danger of burns**  
Only hold the hot lighter by its knob; otherwise, there is the danger of getting burned.

Switch off the ignition and take the remote control with you when leaving the vehicle so that children cannot use the lighter and burn themselves. ◀

 **Replace the cover after use**  
Reinsert the lighter or socket cover after use, otherwise objects may get into the lighter socket or fixture and cause a short circuit. ◀



The lighter is located next to the ashtray.



Push in the lighter.

The lighter can be removed as soon as it pops back out.

## Connecting electrical devices

### Hints

 Do not connect charging devices to the 12 volt socket in the vehicle

Do not connect battery chargers to the factory-installed 12 volt sockets in the vehicle as this may damage the vehicle battery due to an increased power consumption. ◀

 **Replace the cover after use**  
Reinsert the lighter or socket cover after use, otherwise objects may get into the lighter socket or fixture and cause a short circuit. ◀

### Sockets

The lighter socket can be used as a socket for electrical equipment while the engine is running or when the ignition is switched on. The total load of all sockets must not exceed 140 watts at 12 volts.

Do not damage the socket by using unsuitable connectors.

### Front center console

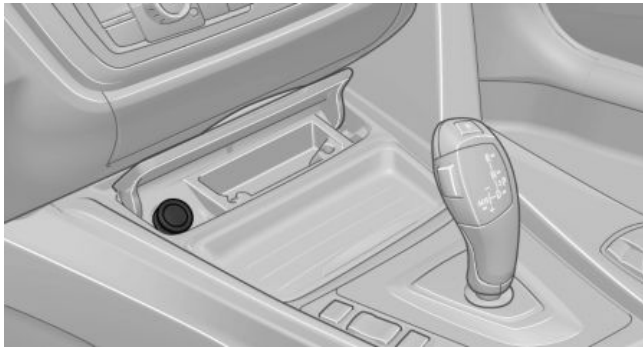

Raise the cap and remove the cover or cigarette lighter.

### In the cargo area

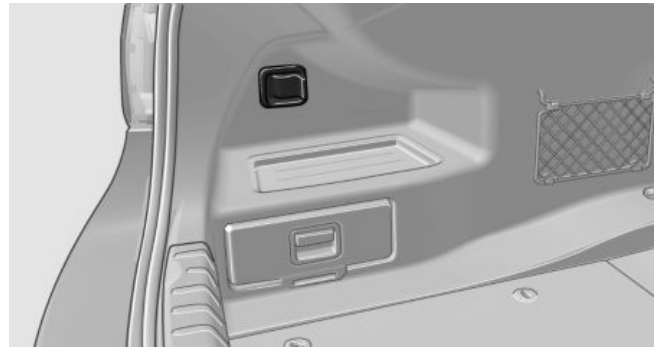

The socket is located on the left side in the cargo area.

### In the front passenger footwell



The socket is located below the glove compartment.

### Rear center console



Remove the cover.

## USB interface for data transfer

### The concept

Connection for importing and exporting data on USB devices, e.g.:

- ▷ Personal Profile settings, refer to page 33.
- ▷ Music collection.
- ▷ Importing Trips.

### Note

For technical reasons, the USB port for data transfer may be located in the glove compartment even in vehicles equipped with a navigation system or TV. If there is a USB port in the glove compartment, it is the USB port intended for transferring data.

## Overview

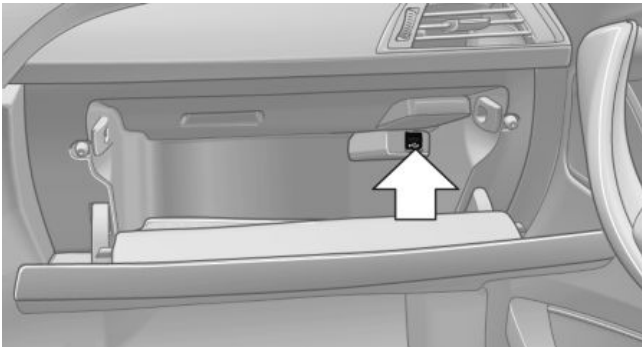

The USB interface is located in the glove compartment.

## Overview

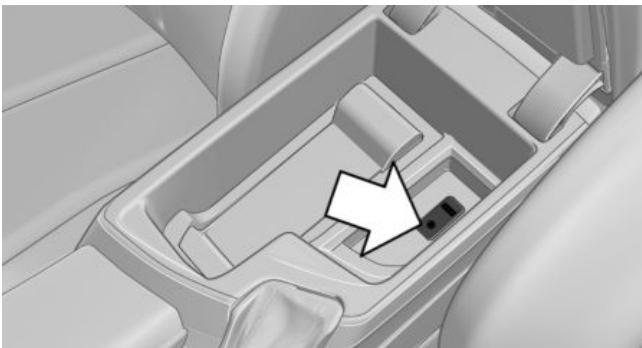

The USB interface is located in the center armrest.

## Notes

Observe the following when connecting:

- ▷ Do not use force when plugging the connector into the USB interface.
- ▷ Do not connect devices such as fans or lamps to the USB interface.
- ▷ Do not connect USB hard drives.
- ▷ Do not use the USB interface to recharge external devices.

## Through-loading system

### The concept

The cargo area can be enlarged by folding down the rear seat backrest.

The rear seat backrest is divided into two parts at a ratio of 60 to 40.

If equipped with through-loading system: the rear seat backrest is divided in the ratio 40–20–40.

The sides can be folded down separately or together.

## Hints



**Danger of pinching**

Before folding down the rear seat backrests, ensure that the area of movement of the backrests is clear. In particular, ensure that no one is located in or reaches into the area of movement of the rear seat backrests when the middle section is folded down. Otherwise, injury or damage may result. ◀



**Ensuring the stability of the child seat**

When installing child restraint fixing systems, make sure that the child seat is securely fastened to the backrest of the seat. The angle of the backrest may need to be adjusted and, where necessary, the headrest height may also need to be adjusted, or if possible removed. Make sure that all backrests are securely locked. Otherwise, the stability of the child seat is limited, and there is an increased risk of injury because of unexpected movement of the rear seat backrest. ◀



**Retract the head restraint if necessary before backrest is folded down**

With folding head restraints, fold in the head restraints before folding down the backrests, or damage may result. ◀



## Opening

1. Unlock the belt lock of the center safety belt in the rear using the latch plate of another safety belt.
2. Insert the latch plate at the end of the belt into the specially designated fixture on the rear window shelf.

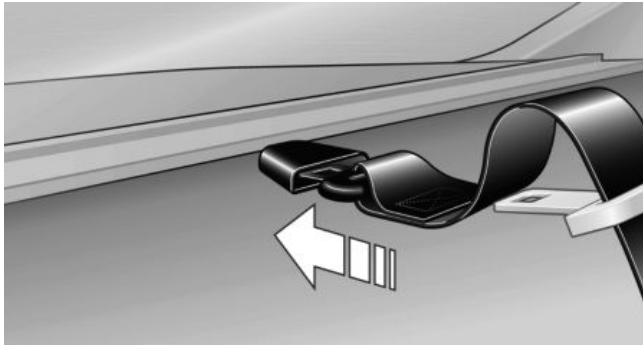

3. Push the corresponding head restraint down as far as it will go.
4. Pull the corresponding lever in the cargo area to release the rear seat backrest.

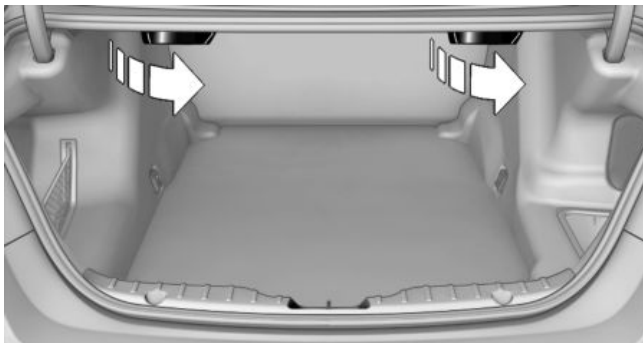

5. The unlocked rear seat backrest moves forward slightly.



6. Fold backrest forward.

## Closing

1. Return the rear seat backrest to the upright seating position and engage it.



Ensure that the lock is securely engaged

Make sure that the lock engages properly when folding back, otherwise transported cargo could enter the passenger compartment during braking or evasive maneuvers and endanger the vehicle occupants. ◀

2. Release the belt tongue from the fixture on the rear window shelf.
3. Insert the belt tongue in the belt lock of the center safety belt. Make sure you hear the latch plate engage.

To secure cargo, refer to page 166, with nets or draw straps, the cargo area is fitted with lashing eyes.

## Folding down the middle section

1. Fold in the middle head restraint.
2. Reach into the recess and pull the middle section forward.

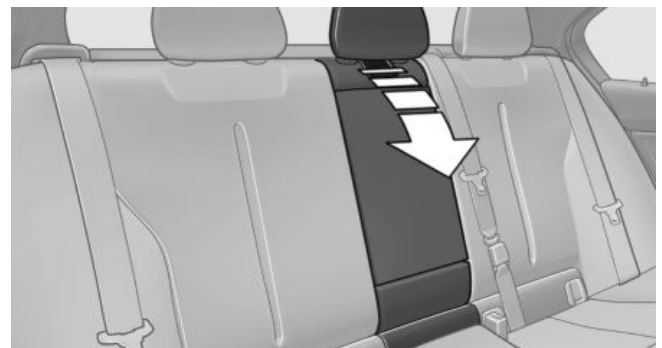

# Storage compartments

## Vehicle equipment

All standard, country-specific and optional equipment that is offered in the model series is described in this chapter. Therefore, equipment is also described that is not available in a vehicle, e. g., because of the selected optional equipment or country variant. This also applies for safety-related functions and systems.

## Notes

 No loose objects in the passenger compartment

Do not stow any objects in the passenger compartment without securing them; otherwise, they may present a danger to occupants for instance during braking and avoidance maneuvers. ◀

 Do not place anti-slip mats on the dashboard

Do not place anti-slip mats on the dashboard. The mat materials could damage the dashboard. ◀

## Storage compartments

The following storage compartments are available in the vehicle interior:

- ▷ Glove compartment on the front passenger side, refer to page 156.
- ▷ Glove compartment on the driver's side, refer to page 157.
- ▷ Without Smoker's package: Front storage compartment, in front of the cupholders, refer to page 157.
- ▷ Storage compartment in the front center armrest, refer to page 157.

- ▷ Compartments in the doors, refer to page 157.
- ▷ Nets on the backrests of the front seats.
- ▷ Storage compartment in the rear center console, refer to page 158.

## Glove compartment

### Front passenger side

#### Note

 Close the glove compartment again immediately

Close the glove compartment immediately after use while driving; otherwise, injury may occur during accidents. ◀

#### Opening



Pull the handle.

The light in the glove compartment switches on.

The net in the glove compartment is provided for stowing the storage tray for the cupholder, refer to page 158.

#### Closing

Fold cover closed.



## Locking

The glove compartment can be locked with an integrated key to separately secure the trunk lid, refer to page 38, for example.

This prevents access to the glove compartment and to the cargo area.

After the glove compartment is locked, the remote control can be handed over, such as at a hotel, without the integrated key.

## Driver's side

### Note



Close the glove compartment again immediately

Close the glove compartment immediately after use while driving; otherwise, injury may occur during accidents. ◀

## Opening



Pull the handle.

## Closing

Fold cover closed.

## Front storage compartment

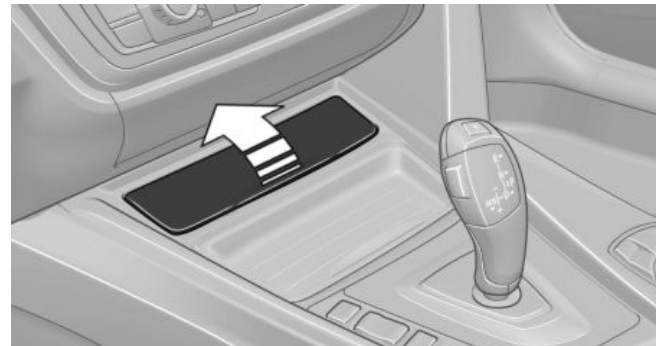

Raise the lid to open it.

## Compartments in the doors



Do not stow any breakable objects

Do not store any breakable objects, e. g. glass bottles, in the compartments, or there is an increased risk of injury in the event of an accident. ◀

## Center armrest

### Front

A storage compartment is located in the center armrest between the front seats.

### Opening

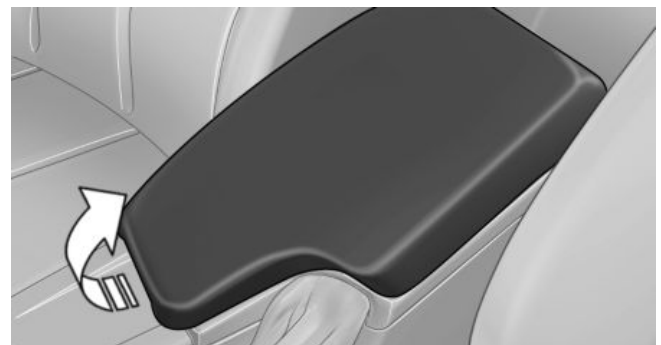

Fold the center armrest up.

### Repositioning

Center armrest can be pushed forwards or backwards. It engages in the end positions.

## Connection for an external audio device



An external audio device, e.g., an MP3 player, can be connected via the AUX-IN port or the USB audio interface in the center armrest.

## Storage compartment in the rear

A storage compartment is located in the center armrest.

## Cupholders

### Hints



Shatter-proof containers and no hot drinks

Use light and shatter-proof containers and do not transport hot drinks. Otherwise, there is the increased danger of injury in an accident. ◀



Unsuitable containers

Do not forcefully push unsuitable containers into the cupholders. This may result in damage. ◀

### Front



## Storage tray for front cupholders

The cupholder with the storage tray can be used for additional storage. To do this, place the storage tray in the cupholder.

Only use the storage tray for small objects, such as keys or the remote control.

When not in use, stow the storage tray in the glove compartment net. Insert the storage tray into the net so that the top surface faces up. Note the trapezoidal shape of the net and tray.

### Rear

In the center armrest.

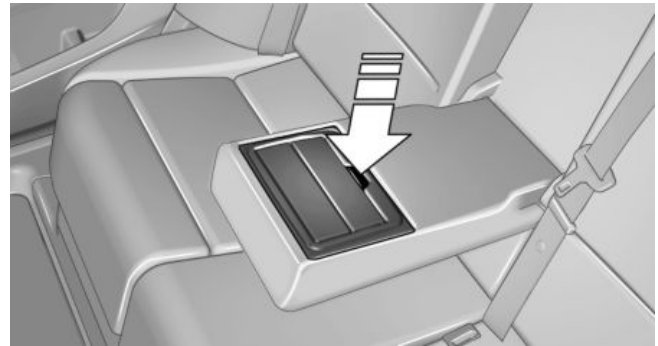

Pull the center armrest forward at the strap.

To open: press the button.

To close: push both covers back in, one after the other.



Pushing back the covers

Push back the covers before folding up the center armrest; otherwise, the cupholder could become damaged. ◀

## Clothes hooks

The clothes hooks are located in the grab handles in the rear.



Do not obstruct view

When suspending clothing from the hooks, ensure that it will not obstruct the driver's vision. ◀



No heavy objects

Do not hang heavy objects from the hooks; otherwise, they may present a danger to passengers during braking and evasive maneuvers. ◀

## Storage compartments in the cargo area

### Storage compartment

A storage compartment is located on the left side.

Located on the right side is a storage compartment for the onboard vehicle tool kit, refer to page 204, and first aid kit, refer to page 216.

### Net

Small objects can be stowed in the net on the left side.

### Hooks/multi-function hook

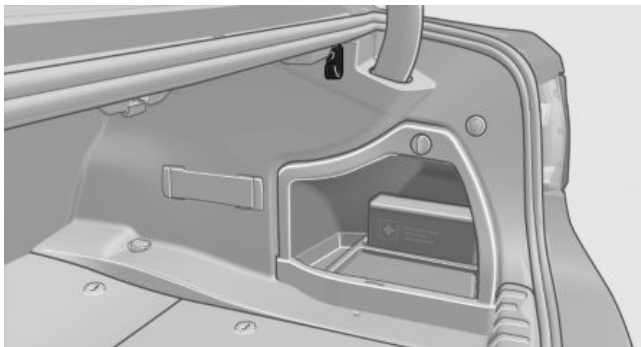

A multi-function hook is located on each side of the cargo area.

The multi-function hooks can be loaded up to a max. of 8.8 lbs/4 kg.



Light and suitable objects only

Only hang light bags or suitable objects from the holders. Otherwise, there is a danger of objects flying about during braking and evasive maneuvers.

Only transport heavy luggage in the trunk if it has been appropriately secured. ◀

### Retaining strap

A retaining strap is available on the right side trim for fastening small objects.

### Lashing eyes in the cargo area

To secure the cargo, refer to page 166, there are four lashing eyes in the cargo area.

### Floor net

The floor net can also be used to Secure the load, refer to page 166, and to store small parts.

### Storage compartment under cargo floor panel



Maximum load

To avoid damage to the vehicle, do not exceed a maximum permitted load of 44 lbs/ 20 kg in the storage compartment under the cargo floor panel. ◀

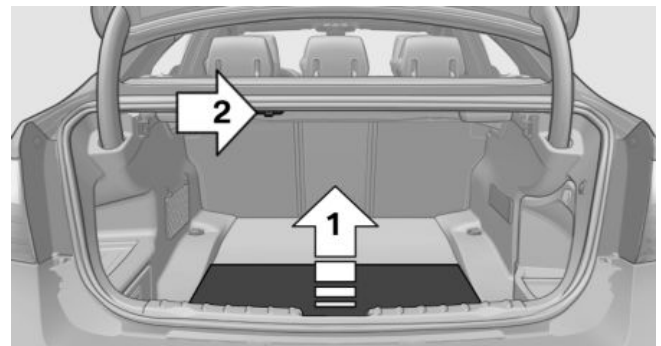

Raise the cargo floor panel, arrow 1, and latch at top, if necessary, arrow 2.

### Partitioning the compartment

The compartment can be divided using an attachable partition.





## Driving tips

This chapter provides you with information useful in dealing with specific driving and operating modes.



# Things to remember when driving

## Vehicle equipment

All standard, country-specific and optional equipment that is offered in the model series is described in this chapter. Therefore, equipment is also described that is not available in a vehicle, e. g., because of the selected optional equipment or country variant. This also applies for safety-related functions and systems.

## Breaking-in period

### General information

Moving parts need to be broken in to adjust to each other.

The following instructions will help achieve a long vehicle life and good economy.

### Engine and differential

Always obey the official speed limit.

### Up to 1,200 miles/2,000 km

Do not exceed the maximum engine and road speed:

- ▶ For gasoline engine 4,500 rpm and 100 mph/160 km/h.
- ▶ For diesel engine 3,500 rpm and 93 mph/150 km/h.

Avoid full load or kickdown under all circumstances.

### From 1,200 miles/2,000 km

The engine and vehicle speed can gradually be increased.

### Tires

Due to technical factors associated with their manufacture, tires do not achieve their full traction potential until after an initial breaking-in period.

Drive conservatively for the first 200 miles/300 km.

### Brake system

Brakes require an initial break-in period of approx. 300 miles/500 km to achieve optimized contact and wear patterns between brake discs and brake pads. Drive moderately during this break-in period.

### Clutch

The function of the clutch reaches its optimal level only after a distance driven of approx. 300 miles/500 km. During this break-in period, engage the clutch gently.

### Following part replacement

The same breaking in procedures should be observed if any of the components mentioned above have to be renewed in the course of the vehicle's operating life.

## General driving notes

### Closing the trunk lid



Drive with the trunk lid closed

Only drive with the tailgate closed; otherwise, in the event of an accident or braking and evasive maneuvers, passengers and other road users may be injured, and the vehicle may be damaged. In addition, exhaust fumes may enter the passenger compartment. ◀

If driving with the tailgate open cannot be avoided:

- ▶ Close all windows and the glass sunroof.
- ▶ Greatly increase the blower speed.
- ▶ Drive moderately.



## Hot exhaust system



### Hot exhaust system

High temperatures are generated in the exhaust system.

Do not remove the heat shields installed and never apply undercoating to them. Make sure that flammable materials, e. g. hay, leaves, grass, etc. do not come in contact with the hot exhaust system during driving, while in idle position mode, or when parked. Such contact could lead to a fire, and with it the risk of serious personal injury as well as property damage.

Do not touch hot exhaust pipes; otherwise, there is the danger of getting burned. ◀

## Diesel particulate filter

The diesel particulate filter collects soot particles and burns them periodically at high temperatures.

During the cleaning time of several minutes, the following may occur:

- ▶ Temporarily, the engine may run less smoothly.
- ▶ Noises and a slight amount of smoke coming from the exhaust until shortly after the engine is shut down.
- ▶ A somewhat higher engine speed is necessary to achieve the accustomed performance.

## Mobile communication devices in the vehicle



### Mobile communication devices in the vehicle

It is advised that you do not use mobile communication devices, e.g., mobile phones, inside the vehicle without connecting them directly to the external antenna. Otherwise, the vehicle electronics and mobile communication devices can interfere with each other. In addition, there is no assurance that the radiation

generated during transmission will be discharged from the vehicle interior. ◀

## Hydroplaning

On wet or slushy roads, a wedge of water can form between the tires and road surface.

This phenomenon is referred to as hydroplaning. It is characterized by a partial or complete loss of contact between the tires and the road surface, ultimately undermining your ability to steer and brake the vehicle.



### Hydroplaning

When driving on wet or slushy roads, reduce your speed to prevent hydroplaning. ◀

## Driving through water



### Adhere to water depth and speed limitations

Do not exceed this water depth and walking speed; otherwise, the vehicle's engine, the electrical systems and the transmission may be damaged. ◀

Drive through calm water only and only if it is not deeper than 9.8 inches/25 cm and at this height, no faster than walking speed, up to 6 mph/10 km/h.

## Braking safely

Your vehicle is equipped with ABS as a standard feature.

Applying the brakes fully is the most effective way of braking in situations when this is necessary.

The vehicle maintains steering responsiveness. You can still avoid any obstacles with a minimum of steering effort.

Pulsation of the brake pedal and sounds from the hydraulic circuits indicate that ABS is in its active mode.

## Objects within the range of movement of the pedals



No objects in the area around the pedals

Keep floor mats, carpets, and any other objects out of the area of motion of the pedals; otherwise, the function of the pedals could be impeded while driving and create the risk of an accident.

Do not place additional floor mats over existing mats or other objects.

Only use floor mats that have been approved for the vehicle and can be properly fixed in place.

Ensure that the floor mats are securely fastened again after they were removed for cleaning, for example. ◀

## Driving in wet conditions

When roads are wet coated with road salt or there is heavy rain, briefly exert gentle pressure on the brake pedal every few miles.

Ensure that this action does not endanger other road users.

The heat generated in this process helps dry the brake discs and pads.

In this way braking efficiency will be available when you need it.

## Hills

Drive long or steep downhill gradients in the gear in which the least braking is required. Otherwise, the brake system may overheat, resulting in a reduction in the brake system efficiency.

You can increase the engine's braking effect by shifting down, going all the way to first gear, if necessary.



Avoid load on the brakes

Avoid placing excessive load on the brake system. Light but consistent brake pressure can lead to high temperatures, brake wear and possibly even brake failure. ◀



Do not drive in neutral

Do not drive in neutral or with the engine stopped, as doing so disables engine braking. In addition, steering and brake assist are unavailable with the engine stopped. ◀

## Brake disc corrosion

The corrosion on the brake discs and the contamination on the brake pads are furthered by:

- ▷ Low mileage.
- ▷ Extended periods when the vehicle is not used at all.
- ▷ Infrequent use of the brakes.

Corrosion occurs when the minimum pressure that must be exerted by the pads during brake applications to clean the discs is not reached.

Should corrosion form on the brake discs, the brakes will tend to respond with a pulsating effect that generally cannot be corrected.

## Condensation under the parked vehicle

When using the automatic climate control, condensation water develops that exits underneath the vehicle.

Traces of water under the vehicle like this are normal.

# Loading

## Vehicle equipment

All standard, country-specific and optional equipment that is offered in the model series is described in this chapter. Therefore, equipment is also described that is not available in a vehicle, e. g., because of the selected optional equipment or country variant. This also applies for safety-related functions and systems.

## Hints



### Overloading the vehicle

To avoid exceeding the approved carrying capacity of the tires, never overload the vehicle. Overloading can lead to overheating and increases the rate at which damage develops inside the tires. This could result in a sudden loss of tire inflation pressure. ◀



### No fluids in the trunk

Make sure that fluids do not leak into the trunk; otherwise, the vehicle may be damaged. ◀



### Heavy and hard objects

Do not stow any heavy and hard objects in the passenger compartment without securing them; otherwise, they may present a danger to occupants, e.g., during braking and evasive maneuvers. ◀

vehicle and unstable driving situations may result.



2. Determine the combined weight of the driver and passengers that will be riding in your vehicle.
3. Subtract the combined weight of the driver and passengers from XXX kilograms or YYY pounds.
4. The resulting figure equals the available amount of cargo and luggage load capacity.  
For example, if the YYY amount equals 1,000 lbs and there will be four 150 lbs passengers in your vehicle, the amount of available cargo and luggage load capacity is 400 lbs: 1,000 lbs minus 600 lbs = 400 lbs.
5. Determine the combined weight of luggage and cargo being loaded on the vehicle. That weight may not safely exceed the available cargo and luggage load capacity calculated in Step 4.

## Determining the load limit

1. Locate the following statement on your vehicle's placard:
  - ▶ The combined weight of occupants and cargo should never exceed XXX kg or YYY lbs. Otherwise, damage to the

## Load

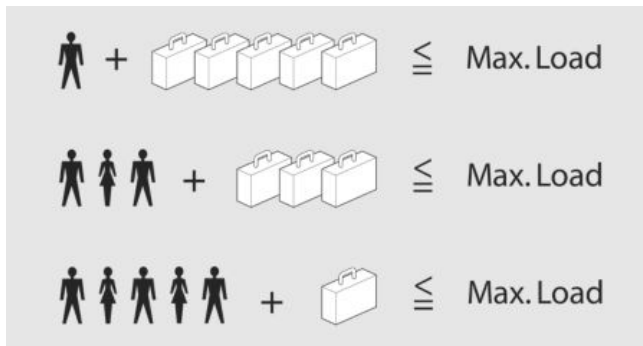

The maximum load is the sum of the weight of the occupants and the cargo.

The greater the weight of the occupants, the less cargo that can be transported.

## Stowing cargo

- ▶ Cover sharp edges and corners on the cargo.
- ▶ Heavy cargo: stow as far forward as possible, directly behind and at the bottom of the rear passenger seat backrests.
- ▶ Very heavy cargo: when the rear seat is not occupied, secure each of the outer safety belts in the opposite buckle.
- ▶ If necessary, fold down the rear backrests to stow cargo.
- ▶ Do not stack cargo above the top edge of the backrests.

## Securing cargo

### Lashing eyes in the cargo area

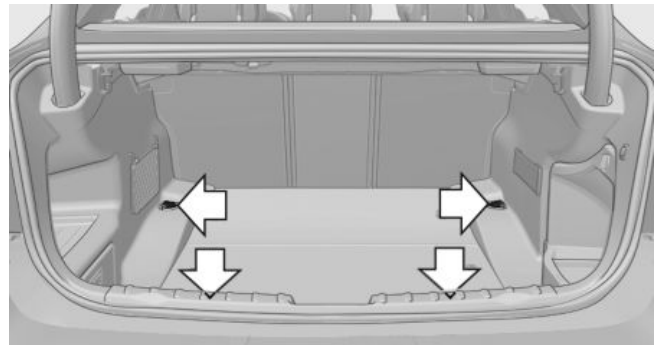

To secure the cargo there are four lashing eyes in the cargo area.

### Floor net

The floor net can also be used to Secure the load and to store small parts.

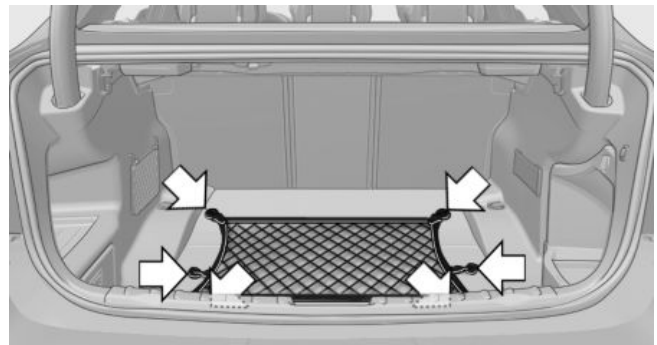

Hook the floor net into the fittings in the cargo area floor.

### Securing cargo

- ▶ Smaller and lighter items: secure with retaining straps or draw straps.
- ▶ Larger and heavy objects: secure with cargo straps.

Attach the cargo straps, retaining straps or draw straps to the lashing eyes in the cargo area.



### Securing cargo

Stow and secure the cargo as described above; otherwise it may present a danger to the occupants, e.g., during braking and avoidance maneuvers. ◀

## Roof-mounted luggage rack

### Note

Roof racks are available as special accessories.

### Securing

Follow the installation instructions of the roof rack.

### Roof drip rail with flaps



The anchorage points are located in the roof drip rail above the doors.

Fold the cover outward.

### Loading

Be sure that adequate clearance is maintained for tilting and opening the glass sunroof.

Because roof racks raise the vehicle's center of gravity when loaded, they have a major effect on vehicle handling and steering response.

Therefore, note the following when loading and driving:

- ▶ Distribute the roof load uniformly.
  - ▶ The roof load should not be too large in area.
  - ▶ Always place the heaviest pieces on the bottom.
  - ▶ Secure the roof luggage firmly, e.g., tie with ratchet straps.
  - ▶ Do not let objects project into the opening path of the trunk lid.
  - ▶ Drive cautiously and avoid sudden acceleration and braking maneuvers. Take corners gently.
- ▶ Do not exceed the approved roof/axle loads and the approved gross vehicle weight.

# Saving fuel

## Vehicle equipment

All standard, country-specific and optional equipment that is offered in the model series is described in this chapter. Therefore, equipment is also described that is not available in a vehicle, e. g., because of the selected optional equipment or country variant. This also applies for safety-related functions and systems.

## General information

Your vehicle contains advanced technology for the reduction of fuel consumption and emissions.

Fuel consumption depends on a number of different factors.

The implementation of certain measures, driving style and regular maintenance can have an influence on fuel consumption and on the environmental impact.

## Remove unnecessary cargo

Additional weight increases fuel consumption.

## Remove attached parts following use

Remove auxiliary mirrors, roof or rear luggage racks which are no longer required following use.

Attached parts on the vehicle impair the aerodynamics and increase the fuel consumption.

## Close the windows and glass sunroof

Driving with the glass sunroof and windows open results in increased air resistance and thereby reduces the range.

## Tires

### General information

Tires can affect fuel consumption values in various ways, for instance fuel consumption can be influenced by the size of the tires.

### Check the tire inflation pressure regularly

Check and, if necessary, correct the tire inflation pressure at least twice a month and before starting on a long trip.

Low tire inflation pressure increases rolling resistance and thus raises fuel consumption and tire wear.

## Drive away immediately

Do not wait for the engine to warm-up while the vehicle remains stationary. Start driving right away, but at moderate engine speeds.

This is the fastest way for the cold engine to reach its operating temperature.

## Look well ahead when driving

Avoid unnecessary acceleration and braking.

By maintaining a suitable distance to the vehicle driving ahead of you.

Driving smoothly and looking ahead reduces fuel consumption.



## Avoid high engine speeds

Use 1st gear to get the vehicle in motion. Beginning with 2nd gear, accelerate rapidly. When accelerating, shift up before reaching high engine speeds.

When you reach the desired speed, shift into the highest applicable gear and drive with the engine speed as low as possible and at a constant speed.

As a rule: driving at low engine speeds lowers fuel consumption and reduces wear.

The gear shift indicator of your vehicle indicates the most fuel efficient gear.

## Use coasting

When approaching a red light, take your foot off the accelerator and let the vehicle coast to a halt.

On a downhill gradient, take your foot off the accelerator and let the vehicle roll.

The flow of fuel is interrupted while coasting.

## Switch off the engine during longer stops

Switch off the engine during longer stops, e.g., at traffic lights, railroad crossings or in traffic congestion.

### Auto Start/Stop function

The Auto Start/Stop function of your vehicle automatically switches off the engine during a stop.

If the engine is switched off and then restarted rather than leaving the engine running constantly, fuel consumption and emissions are reduced. Savings can begin within a few seconds of switching off the engine.

In addition, fuel consumption is also determined by other factors, such as driving style,

road conditions, maintenance or environmental factors.

## Switch off any functions that are not currently needed

Functions such as seat heating and the rear window defroster require a lot of energy and reduce the range, especially in city and stop-and-go traffic.

Therefore, switch off these functions if they are not actually needed.

The ECO PRO driving program supports the energy conserving use of comfort functions. These functions are automatically deactivated partially or completely.

## Have maintenance carried out

Have vehicles maintained regularly to achieve optimal vehicle economy and operating life. The maintenance should be carried out by your service center.

Also note the BMW Maintenance System, refer to page 202.

## ECO PRO

### The concept

ECO PRO supports a driving style that saves on fuel consumption. For this purpose, the engine control and comfort functions, e. g. the climate control output, are adjusted.

Under certain conditions the engine is automatically decoupled from the transmission in the D selector lever position. The vehicle continues traveling with the engine idling to reduce fuel consumption. Selector lever position D remains engaged.

In addition, context-sensitive instructions can be displayed that assist in driving in a manner that optimizes fuel consumption.

In the instrument display, the extension of the range achieved by this can be displayed as a bonus range.

## At a glance

The system includes the following EfficientDynamics functions and displays:

- ▷ ECO PRO bonus range, refer to page 170.
- ▷ ECO PRO tips driving instruction, refer to page 171
- ▷ ECO PRO climate control, refer to page 170.
- ▷ ECO PRO coasting driving status, refer to page 172.
- ▷ ECO PRO driving style analysis, refer to page 173.

## Activate ECO PRO



Press button repeatedly until ECO PRO is displayed in the instrument cluster.

## Configuring ECO PRO

### Via the Driving Dynamics Control

1. Activate ECO PRO.
2. "Configure ECO PRO"
3. Configure the program.

### Via the iDrive

1. "Settings"
2. "ECO PRO mode"

Or

1. "Settings"
2. "Driving mode"
3. "Configure ECO PRO"

Configure the program.

## ECO PRO Tip

- ▷ "Tip at:":  
Set ECO Pro speed at which an ECO PRO Tip is to be displayed.
- ▷ "ECO PRO speed warning":  
A reminder is displayed if the set ECO PRO speed is exceeded.

## Coasting

Fuel-efficiency can be optimized by disengaging the engine and Coasting, refer to page 172, with the engine idling.

This function is only available in ECO PRO mode.

## ECO PRO climate control

"ECO PRO climate control"

The climate control is adjusted to be fuel-efficient.

By making a slight change to the set temperature, or slowly adjusting the rate of heating or cooling of the passenger compartment, fuel consumption can be economized.

The outputs of the seat heater and the exterior mirror heating are also reduced.

The exterior mirror heating is made available when outside temperatures are very cold.

## ECO PRO potential

The percentage of potential savings that can be achieved with the current configuration is displayed.

## Display in the instrument cluster

### ECO PRO bonus range

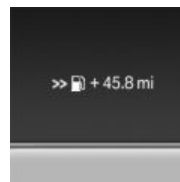

An extension of the range can be achieved by an adjusted driving style.

This may be displayed as the bonus range in the instrument cluster.

The bonus range is shown in the range display. The bonus range is automatically reset every time the vehicle is refueled.

## Driving style

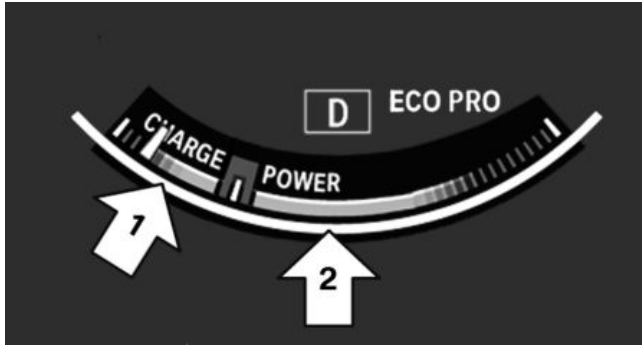

In the tachometer, a mark in the bar display indicates the current efficiency of the driving style.

Mark in the CHARGE area, arrow 1: display for energy recovered by coasting or when braking.

Mark in the POWER area, arrow 2: display when accelerating.

The efficiency of the driving style is shown by the color of the bar:

- ▶ Blue display: efficient driving style as long as the mark moves within the blue range.
- ▶ Gray display: adjust driving style, e. g. by backing off the accelerator pedal.

The display switches to blue as soon as all conditions for fuel-economy-optimized driving are met.

## ECO PRO Tip - driving instruction

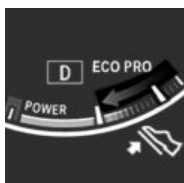

The arrow indicates that the driving style can be adjusted to be more fuel efficient by backing off the accelerator for instance.

## Note

The driving style display and ECO PRO tips in the instrument cluster appear when the ECO PRO display is activated.

Activating driving style and ECO PRO tips:

1. "Settings"
2. "Instr. cluster display"
3. "ECO PRO Info"

## ECO PRO tip - Symbols

An additional symbol and a text instruction are displayed.

Symbol	Measure
	For efficient driving style, back off the accelerator or delay accelerating to allow time to assess road conditions.
	Reduce speed to the selected ECO PRO speed.
	Automatic transmission: switch from M/S to D and avoid manual shift interventions.
	Manual shift transmission: follow shifting instructions.
	Manual shift transmission: engage neutral for engine stop.



## Indications on the Control Display

### EfficientDynamics

Information on fuel consumption and technology can be displayed during driving.

1. "Vehicle Info"
2. "EfficientDynamics"

### Displaying fuel consumption history

The average fuel consumption can be displayed within an adjustable time frame.

Vertical bars show consumption for the selected time frame.

Trip interruptions are represented below the bar on the time axis.

 "Consumption history"

## Adjusting fuel consumption history time frame

 Select the symbol.

## Resetting fuel consumption history

1. Open "Options".
2. "Reset consumption history"

## Displaying EfficientDynamics info

The current efficiency can be displayed.

 "EfficientDynamics info"

The following systems are displayed:

- ▶ Automatic engine Start/Stop function.
- ▶ Energy recovery.
- ▶ Climate control output.
- ▶ Coasting.

## Display ECO PRO tips

 "ECO PRO Tips"

The setting is stored for the profile currently in use.

## Coasting

### The concept

The system helps to conserve fuel.

To do this, under certain conditions the engine is automatically decoupled from the transmission when selector lever position D is engaged. The vehicle continues traveling with the engine idling to reduce fuel consumption. Selector lever position D remains engaged.

This driving condition is referred to as coasting.

As soon as the brake or accelerator pedal is depressed, the engine is automatically coupled to the transmission again.

## Hints

Coasting is a component of the ECO PRO, refer to page 169, driving mode.

Coasting is automatically activated when ECO PRO mode is called via the Driving Dynamics Control.

The function is available in a certain speed range.

A forward-looking driving style helps the driver to use the function as often as possible and supports the fuel-conserving effect of coasting.

## Safety mode

The function is not available if one of the following conditions is satisfied.

- ▶ DSC OFF or TRACTION activated.
- ▶ Driving in the dynamic limit range and on steep uphill or downhill grades.
- ▶ Battery charge status temporarily too low or vehicle electrical system drawing excessive current.
- ▶ Cruise control activated.

## Functional requirements

In ECO PRO mode, this function is available in a speed range from approximately 30 mph, approx. 50 km/h to 100 mph, approx. 160 km/h, if the following conditions are satisfied:

- ▶ Accelerator pedal and brake pedal are not operated.
- ▶ The selector lever is in selector lever position D.
- ▶ Engine and transmission are at operating temperature.

## Display

### Display in the instrument cluster

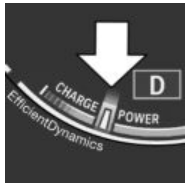

The mark in the bar display below the tachometer is backlit in blue and is located at the zero point. The tachometer approximately indicates idle speed.

The coasting point indicator is illuminated at the zero point during coasting.

### Indications on the Control Display

The Coasting driving condition is displayed in EfficientDynamics Info while this driving mode is active.

The distance traveled in the Coasting driving condition is indicated by a counter.

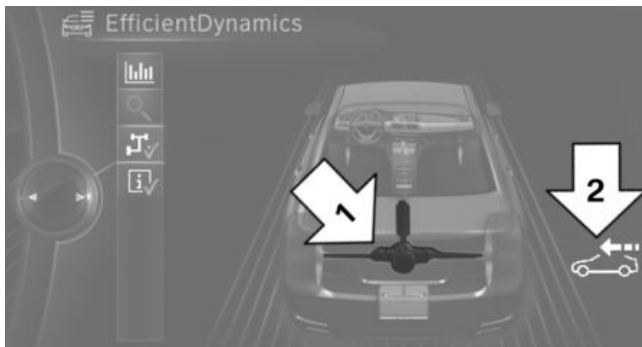

Color code blue, arrow 1, and symbol, arrow 2: driving condition Coasting.

### Displaying EfficientDynamics info

1. "Vehicle Info"
2. "EfficientDynamics"
3.  "EfficientDynamics info"

### Deactivating the system manually

The function can be deactivated in the Configure ECO PRO, refer to page 170, menu, e.g., to use the braking effect of the engine when traveling downhill.

The setting is stored for the profile currently in use.

## ECO PRO driving style analysis

### The concept

The system helps in this situation to develop an especially efficient driving style and to conserve fuel.

For this purpose, the driving style is analyzed. The assessment is done in various categories and is displayed on the Control Display.

Using this indication, the individual driving style can be oriented toward conserving fuel.

The last fifteen minutes of a trip are evaluated.

The range of the vehicle can be extended by an efficient driving style.

This gain in range is displayed as a bonus range in the instrument cluster and on the Control Display.

### Functional requirement

The function is only available in ECO PRO mode.

### Calling up ECO PRO driving style analysis

#### Via the Driving Dynamics Control

1. Activate ECO PRO.
2. "EfficientDynamics"
3.  Select the symbol.

### Display

#### Display on the Control Display

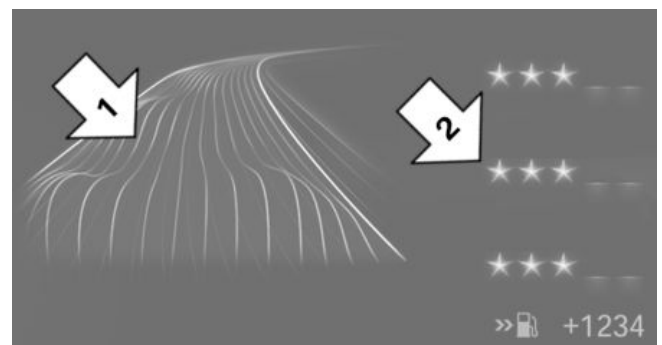

The display of the ECO PRO driving style analysis consists of a symbolized road route and a lookup table.

The road symbolizes the efficiency of the driving style. The more efficient the driving style, the smoother the depicted road route becomes, arrow 1.

The table of values contains stars. The more efficient the driving style, the more stars are included in the table and the faster the bonus range increases, arrow 2.

If, on the other hand, the driving style is inefficient, a wavy road and a reduced number of stars is displayed.

To assist with an efficient driving style, ECO PRO tips are displayed during the drive.

Tips about the energy saving driving style, Conserving fuel, refer to page [168](#).









## Mobility

In order to always ensure your mobility, you will find important information on operating fluids, wheels and tires, maintenance and Roadside Assistance in the following.

# Refueling

## Vehicle equipment

All standard, country-specific and optional equipment that is offered in the model series is described in this chapter. Therefore, equipment is also described that is not available in a vehicle, e. g., because of the selected optional equipment or country variant. This also applies for safety-related functions and systems.

## Hints



Refuel promptly

Refuel no later than at a range of 30 miles/50 km, or operation of the engine is not ensured and damage may occur. ◀

## Diesel engines

The filler neck is designed for refueling at diesel fuel pumps.

## Fuel cap

### Opening

1. Briefly press the rear edge of the fuel filler flap.



2. Turn the fuel cap counterclockwise.

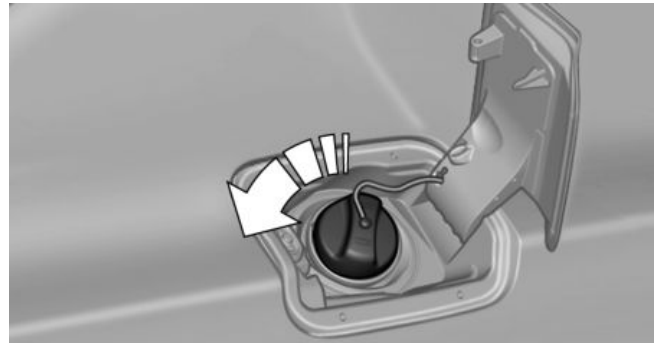

3. Place the fuel cap in the bracket attached to the fuel filler flap.

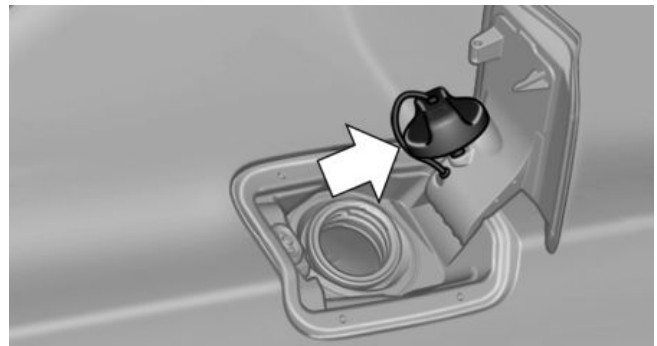

### Closing

1. Fit the cap and turn it clockwise until you clearly hear a click.
2. Close the fuel filler flap.



Do not pinch the retaining strap attached to the cap; otherwise, the cap cannot be closed properly and fuel vapors can escape. ◀

### Manually unlocking fuel filler flap

In the event of an electrical malfunction, for example.

1. Open the cover on the right side trim. To do this, turn the cap.

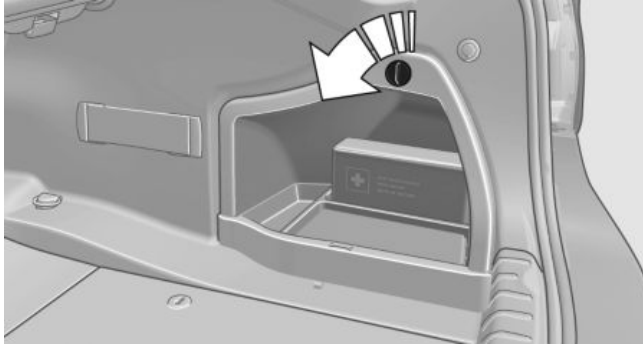

2. Pull the green knob with the fuel pump symbol. This releases the fuel filler flap.

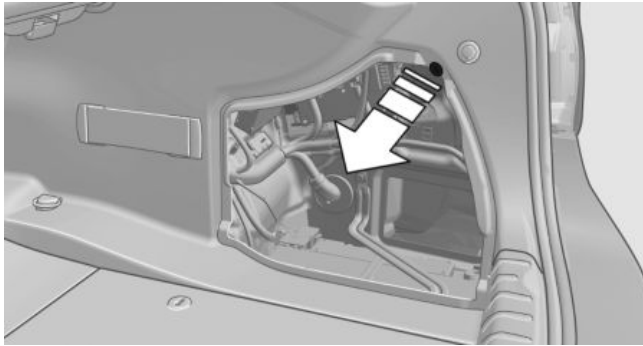

## Observe the following when refueling

The fuel tank is full when the filler nozzle clicks off the first time.



Do not overfill the fuel tank

Do not overfill the fuel tank; otherwise fuel may escape, causing harm to the environment and damaging the vehicle. ◀



Handling fuels

Obey safety regulations posted at the gas station. ◀

# Fuel

## Vehicle equipment

All standard, country-specific and optional equipment that is offered in the model series is described in this chapter. Therefore, equipment is also described that is not available in a vehicle, e. g., because of the selected optional equipment or country variant. This also applies for safety-related functions and systems.

## Fuel recommendation

### Note

 General fuel quality  
Even fuels that conform to the specifications can be of low quality. This may cause engine problems, for instance poor engine starting behavior, poor handling and/or performance. Switch gas stations or use a brand name fuel with a higher octane rating. ◀

### Gasoline

For the best fuel economy, the gasoline should be sulfur-free or very low in sulfur content.

Fuels that are marked on the gas pump as containing metal must not be used.

 Refuel only with unleaded gasoline without metallic additives.

Do not refuel with any leaded gasoline or gasoline with metallic additives, e. g. manganese or iron, or permanent damage to the catalytic converter and other components. ◀

Fuels with a maximum ethanol content of 10 %, i. e., E10, may be used for refueling.

Ethanol should satisfy the following quality standards:

US: ASTM 4806-xx

CAN: CGSB-3.511-xx

xx: comply with the current standard in each case.

 Do not use a fuel with a higher percentage of ethanol

Do not use a fuel with a higher ethanol percentage than recommended or one with other types of alcohol, i.e. no Flex Fuel, otherwise this could damage the engine and fuel supply system. ◀

### Recommended fuel grade

BMW recommends AKI 91.

### Minimum fuel grade

BMW recommends AKI 89.

 Minimum fuel grade  
Do not use any gasoline below the minimum fuel grade as this may impair engine performance. ◀

If you use gasoline with this minimum AKI Rating, the engine may produce knocking sounds when starting at high outside temperatures. This has no effect on the engine life.

 Fuel quality  
The use of poor-quality fuels may result in harmful engine deposits or damage. Additionally, problems relating to drivability, starting and stalling, especially under certain environmental conditions such as high ambient temperature and high altitude, may occur.

If drivability problems are encountered, we recommend switching to a high quality gasoline brand and a higher octane grade — AKI number — for a few tank fills. To avoid harmful engine deposits, it is highly recommended to purchase gasoline from BP or Top Tier retailers.



Failure to comply with these recommendations may result in the need for unscheduled maintenance. ◀

## Diesel

### Low-Sulfur Diesel

The engine of your BMW is designed for diesel with low sulfur content:

Ultra-Low Sulfur Diesel ASTM D 975-xx.

xx: comply with the current standard in each case.



Use only Ultra-Low Sulfur Diesel.

The fraction of biodiesel in the fuel must not exceed 5 %, referred to as B5. Do not use gasoline. If you do fill the tank with the wrong fuel, e.g., gasoline, do not start the engine as this may damage the engine. ◀

After adding the wrong fuel, contact your service center or roadside assistance.

If the fuel pump nozzle does not fit in the filler pipe of your BMW, please check to ensure that you are refueling at a diesel fuel pump that is equipped with a diesel fuel pump nozzle.

In the event the Ultra-Low Sulfur Diesel fuel cannot be fully inserted into the fuel filler neck, please contact BMW Roadside Assistance for instructions on how to add fuel. For more information on BMW Roadside Assistance, refer to page 216.

### Winter diesel

To ensure that the diesel engine remains operational in the winter, use winter diesel.

It is available at gas stations during winter months.

The fuel filter heating system, included as a standard feature, prevents disruption of the fuel supply while driving.



Do not add any diesel additives

Do not add additives, including gasoline; otherwise, engine damage may occur. ◀

BMW recommends BP fuels



## BMW Advanced Diesel

### The concept

BMW Advanced Diesel reduces nitrogen oxides in the diesel emissions by injecting diesel exhaust fluid reducing agent into the exhaust system. A chemical reaction takes place inside the catalytic converter that minimizes nitrogen oxides.

The vehicle has a tank that can be refilled.

To be able to start the engine as usual, there must be an adequate reducing agent.

Reducing agent is added by the service center.

### Warming up the system

In order to warm the engine up to its operating temperature after a cold start, the automatic transmission may subsequently shift up to the next higher gear.

### Displays in the instrument cluster

#### Reserve display

This display in the instrument cluster provides information about the distance that can still be driven with the current reserve level.



The reserve display is shown starting at a remaining range of approx. 1,000 miles/1,600 km.



Refill in good time

The reducing agent must be replenished as soon as the Reserve display appears, otherwise the engine cannot be restarted. ◀

### Diesel exhaust fluid on minimum



The engine will continue to run even when the display shows --, as long as it is not switched off and all other operating conditions are satisfied, sufficient fuel

for example.



Engine does not start

Do not continue driving to the limit of the remaining travel distance. Otherwise, you will not be able to restart the engine after switching it off. ◀

### Misfueling

A Check Control message is displayed when an incorrect fluid is added.

After adding the wrong fluid, contact your service center.

### System defect

A Check Control message is displayed when there is a system defect.

### Have the diesel exhaust fluid replenished

The reducing agent is added by the service center within the context of regular maintenance.

It may be necessary to have the fluid replenished several times under particular circumstances, for example, if the vehicle is driven in a particularly sporty style or if it is driven at high altitudes.

The reducing agent must be replenished as soon as the reserve display appears in the instrument cluster to avoid not being able to restart the engine.

### Diesel exhaust fluid at low temperatures

Due to its physical properties, it is possible that the reducing agent may also need to be replenished between regular maintenance appointments if it is exposed to temperatures under + 23 °F/- 5 °C. In this case, add reducing agent only immediately before starting to drive.

The need to replenish it is indicated by the Reserve display in the instrument cluster.

At temperatures below + 12 °F/- 11 °C the fill level in some cases cannot be measured.

After adding reducing agent, the reserve display is displayed only until the fill level can be measured again.

### Replenishing Diesel exhaust fluid yourself in exceptional cases

You can replenish reducing agent yourself in exceptional cases, e.g., to get to the service center.



Avoid contact with Diesel exhaust fluid

Do not come into contact with the reducing agent. Otherwise, skin or eye irritations may result. ◀



Handling Diesel exhaust fluid

When working with reducing agent in closed spaces, ensure good ventilation. When the bottle or container is opened, acrid smelling fumes may escape. ◀



Keeping Diesel exhaust fluid out of reach of children

Keep reducing agent out of reach of children ◀



Avoid contact with surfaces

Avoid contact of reducing agent with surfaces of the vehicle. Damage could result. ◀

### Suitable Diesel exhaust fluid

▶ Preferred: BMW Diesel Exhaust Fluid. With this bottle and its special adapter, Diesel

exhaust fluid can be replenished simply and safely.

- ▶ Alternative: NOx reduction agent AUS 32 Diesel exhaust fluid can be purchased at your Service Center.

### Refill quantity

When the Reserve display starts, add at least 2 bottles of reducing agent.

This corresponds to approx. 1 gallon.

### Tank for reducing agent

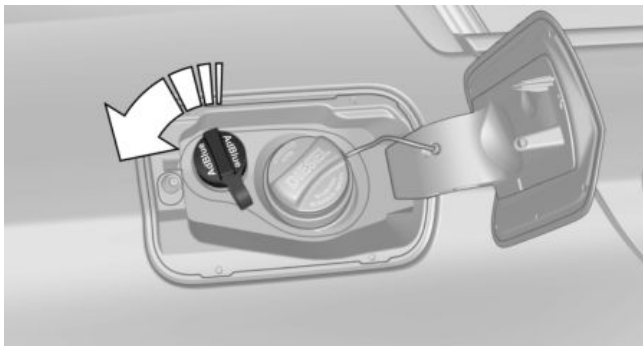

The tank for the reducing agent is located next to the fuel tank.

### Adding the reducing agent

Add the reducing agent when the ignition is switched on.

1. Open the fuel filler flap, refer to page 178.
2. Turn the fuel cap counterclockwise and remove.
3. Place the bottle on it and turn it as far as it will go, see arrow.



4. Press the bottle down, see arrow.

The vehicle tank will be filled.

The tank is full when the fill level in the bottle no longer changes. It is not possible to overfill.



5. Pull back the bottle, see arrow, and unscrew it.



6. Replace the fuel cap and turn it clockwise.
7. Close the fuel filler flap.

### After adding Diesel exhaust fluid

#### Note



**Incorrect fluids**

After filling with incorrect fluids, such as antifreeze for washer water, do not start the engine, otherwise there is risk of fire. ◀

Contact your service center.

### Disposing of bottles



You take your empty Diesel exhaust fluid bottles to your Service Center for disposal.

Do not dispose of empty bottles with household waste unless this is permitted by local regulations.

### Reserve display



The Reserve display will still appear along with the remaining range after refilling.

Engine can be started.

After several minutes of driving, the Reserve indication goes out.

### Diesel exhaust fluid on minimum



After filling, the indication -- is still displayed.

Only after the display goes out can the engine -- be started.

1. Switch on the ignition.  
Display -- goes out after approx. 1 minute.
2. Engine can be started.

# Wheels and tires

## Vehicle equipment

All standard, country-specific and optional equipment that is offered in the model series is described in this chapter. Therefore, equipment is also described that is not available in a vehicle, e. g., because of the selected optional equipment or country variant. This also applies for safety-related functions and systems.

## Tire inflation pressure

### Safety information

The tire characteristics and tire inflation pressure influence the following:

- ▷ The service life of the tires.
- ▷ Road safety.
- ▷ Driving comfort.

### Checking the pressure

Tires have a natural, consistent loss of pressure.



Check the tire inflation pressure regularly

Regularly check the tire inflation pressure, and correct it as needed: at least twice a month and before a long trip. If you fail to observe this precaution, you may be driving on tires with incorrect tire pressures, a condition that may not only compromise your vehicle's driving stability, but also lead to tire damage and the risk of an accident. ◀

Tires heat up during driving, and the tire inflation pressure increases along with the temperature of the tire. The tire inflation pressure specifications relate to cold tires or tires with the ambient temperature.

Only check the tire inflation pressure when the tires are cold. This means after driving no more

than 1.25 miles/2 km or when the vehicle has been parked for at least 2 hours.

The displays of inflation devices may under-read by up to 0.1 bar, 2 psi.

For Flat Tire Monitor: after correcting the tire inflation pressure, reinitialize the Flat Tire Monitor.

For Tire Pressure Monitor: after correcting the tire inflation pressure, reset the Tire Pressure Monitor.

### Pressure specifications

The tire inflation pressure table, refer to page 186, contains all pressure specifications for the specified tire sizes at the ambient temperature. Pressure specifications apply to approved tire sizes and recommended tire brands. This information can be obtained from your service center.

To identify the correct tire inflation pressure, please note the following:

- ▷ Tire sizes of your vehicle.
- ▷ Maximum permitted driving speed.

### Tire inflation pressures up to 100 mph/160 km/h

For speeds of up to 100 mph/160 km/h and for optimum driving comfort, note the pressure values in the tire inflation pressure table, refer to page 186, and adjust as necessary.



These pressure values can also be found on the tire inflation pressure label on the driver's door pillar.

 **Maximum permissible speed**  
Do not exceed 100 mph/160 km/h; otherwise, tire damage and accidents may result. ◀

### Tire inflation pressure values up to 100 mph/160 km/h

#### 320i, 320i xDrive

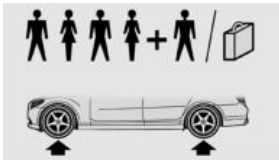
Tire size	Pressure specifications in bar/PSI	
Specifications in bar/PSI with cold tires		
225/50 R 17 94 V M+S A/S RSC	2.2 / 32	2.2 / 32
225/50 R 17 94 H M+S RSC		
225/45 R 18 91 V M+S A/S RSC	2.2 / 32	2.4 / 35
225/45 R 18 91 Y RSC		
225/45 R 18 95 V M+S XL RSC		
Front: 225/50 R 17 94 W RSC	2.2 / 32	-
	-	2.4 / 35
Rear: 255/45 R 17 98 W RSC		

Tire size	Pressure specifications in bar/PSI	
Front: 225/45 R 18 91 Y RSC	2.2 / 32	-
	-	2.2 / 32
Rear: 255/40 R 18 95 Y RSC		
Front: 225/40 R 19 89 Y RSC	2.2 / 32	-
	-	2.4 / 35
Rear: 255/35 R 19 92 Y RSC		
Front: 225/35 R 20 90 Y XL RSC	2.5 / 36	-
	-	3.0 / 44
Rear: 255/30 R 20 92 Y XL RSC		
Compact wheel T 135/80 R 17 102 M	Speed up to a max. of 50 mph / 80 km/h	
	4.2 / 60	

#### 328i, 328d

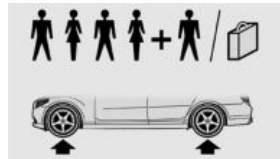
Tire size	Pressure specifications in bar/PSI	
Specifications in bar/PSI with cold tires		
225/50 R 17 94 V M+S A/S RSC	2.2 / 32	2.2 / 32
225/50 R 17 94 H M+S RSC		
225/45 R 18 91 V M+S A/S RSC	2.2 / 32	2.4 / 35
225/45 R 18 91 Y RSC		
225/45 R 18 95 V M+S XL RSC		



Tire size	Pressure specifications in bar/PSI	
Front: 225/50 R 17 94 W RSC	2.2 / 32	-
Rear: 255/45 R 17 98 W RSC	-	2.2 / 32
Front: 225/45 R 18 91 Y RSC	2.2 / 32	-
Rear: 255/40 R 18 95 Y RSC	-	2.2 / 32
Front: 225/40 R 19 89 Y RSC	2.2 / 32	-
Rear: 255/35 R 19 92 Y RSC	-	2.4 / 35
Front: 225/35 R 20 90 Y XL RSC	2.5 / 36	-
Rear: 255/30 R 20 92 Y XL RSC	-	3.0 / 44
Compact wheel T 135/80 R 17 102 M	Speed up to a max. of 50 mph / 80 km/h	
	4.2 / 60	

### 328i xDrive, 328d xDrive

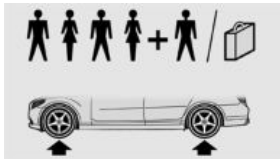
Tire size	Pressure specifications in bar/PSI	
Specifications in bar/PSI with cold tires		
225/50 R 17 94 V M+S A/S RSC	2.2 / 32	2.2 / 32
225/50 R 17 94 H M+S RSC		

Tire size	Pressure specifications in bar/PSI	
225/45 R 18 91 V M+S A/S RSC	2.2 / 32	2.4 / 35
225/45 R 18 91 Y RSC		
225/45 R 18 95 V M+S XL RSC		
Front: 225/50 R 17 94 W RSC	2.2 / 32	-
Rear: 255/45 R 17 98 W RSC	-	2.4 / 35
Front: 225/45 R 18 91 Y RSC	2.2 / 32	-
Rear: 255/40 R 18 95 Y RSC	-	2.2 / 32
Front: 225/40 R 19 89 Y RSC	2.2 / 32	-
Rear: 255/35 R 19 92 Y RSC	-	2.4 / 35
Front: 225/35 R 20 90 Y XL RSC	2.5 / 36	-
Rear: 255/30 R 20 92 Y XL RSC	-	3.0 / 44
Compact wheel T 135/80 R 17 102 M	Speed up to a max. of 50 mph / 80 km/h	
	4.2 / 60	

### 335i, 335i xDrive

Tire size	Pressure specifications in bar/PSI	
Specifications in bar/PSI with cold tires		
225/45 R 18 91 V M+S A/S RSC	2.2 / 32	2.6 / 38
225/45 R 18 91 Y RSC		
225/50 R 17 94 H M+S RSC		
225/45 R 18 95 V M+S XL RSC		
Front: 225/45 R 18 91 Y RSC	2.2 / 32	-
Rear: 255/40 R 18 95 Y RSC	-	2.4 / 35
Front: 225/40 R 19 89 Y RSC	2.4 / 35	-
Rear: 255/35 R 19 92 Y RSC	-	2.6 / 38
Front: 225/35 R 20 90 Y XL RSC	2.6 / 38	-
Rear: 255/30 R 20 92 Y XL RSC	-	3.0 / 44
Compact wheel T 135/80 R 17 102 M	Speed up to a max. of 50 mph / 80 km/h	4.2 / 60

### Tire inflation pressures at max. speeds above 100 mph/160 km/h

 Speeds above 100 mph/160 km/h  
 In order to drive at maximum speeds in excess of 100 mph/160 km/h, please observe, and, if necessary, adjust tire pressures for speeds exceeding 100 mph/160 km/h from the

relevant table on the following pages. Otherwise tire damage and accidents could occur. ◀

### Tire inflation pressure values over 100 mph/160 km/h

#### 320i, 320i xDrive

Without high-speed tuning feature

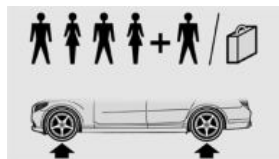
Tire size	Pressure specifications in bar/PSI	
Specifications in bar/PSI with cold tires		
225/50 R 17 94 V M+S A/S RSC	2.2 / 32	2.7 / 39
225/50 R 17 94 H M+S RSC		
225/45 R 18 91 V M+S A/S RSC	2.4 / 35	2.9 / 42
225/45 R 18 91 Y RSC		
225/45 R 18 95 V M+S XL RSC		
Front: 225/50 R 17 94 W RSC	2.2 / 32	-
Rear: 255/45 R 17 98 W RSC	-	2.4 / 35
Front: 225/45 R 18 91 Y RSC	2.4 / 35	-
Rear: 255/40 R 18 95 Y RSC	-	2.4 / 35
Front: 225/40 R 19 89 Y RSC	2.4 / 35	-
Rear: 255/35 R 19 92 Y RSC	-	2.6 / 38

Tire size	Pressure specifications in bar/PSI	
Front: 225/35 R 20 90 Y XL RSC	2.5 / 36	-
Rear: 255/30 R 20 92 Y XL RSC	-	3.0 / 44
Compact wheel T 135/80 R 17 102 M	Speed up to a max. of 50 mph / 80 km/h	
	4.2 / 60	

Tire size	Pressure specifications in bar/PSI	
Front: 225/35 R 20 90 Y XL RSC	2.5 / 36	-
Rear: 255/30 R 20 92 Y XL RSC	-	3.0 / 44
Compact wheel T 135/80 R 17 102 M	Speed up to a max. of 50 mph / 80 km/h	
	4.2 / 60	

## With high-speed tuning feature

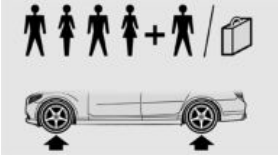
Tire size	Pressure specifications in bar/PSI	
Specifications in bar/PSI with cold tires		
225/50 R 17 94 V M+S A/S RSC	2.2 / 32	2.7 / 39
225/50 R 17 94 H M+S RSC		
225/45 R 18 91 Y RSC	2.4 / 35	2.9 / 42
225/45 R 18 95 V M+S XL RSC		
Front: 225/50 R 17 94 W RSC	2.2 / 32	-
Rear: 255/45 R 17 98 W RSC	-	2.4 / 35
Front: 225/45 R 18 91 Y RSC	2.4 / 35	-
Rear: 255/40 R 18 95 Y RSC	-	2.4 / 35
Front: 225/40 R 19 89 Y RSC	2.4 / 35	-
Rear: 255/35 R 19 92 Y RSC	-	2.6 / 38

## 328i, 328i xDrive, 328d, 328d xDrive

## Without high-speed tuning feature

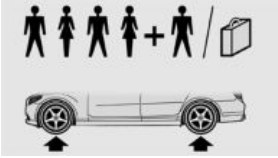
Tire size	Pressure specifications in bar/PSI	
Specifications in bar/PSI with cold tires		
225/50 R 17 94 V M +S A/S RSC	2.4 / 35	2.9 / 42
225/50 R 17 94 H M +S RSC		
225/45 R 18 91 V M +S A/S RSC	2.6 / 38	3.1 / 45
225/45 R 18 91 Y RSC		
225/45 R 18 95 V M +S XL RSC		
Front: 225/50 R 17 94 W RSC	2.4 / 35	-
Rear: 255/45 R 17 98 W RSC	-	2.6 / 38
Front: 225/45 R 18 91 Y RSC	2.6 / 38	-
Rear: 255/40 R 18 95 Y RSC	-	2.6 / 38

Tire size	Pressure specifications in bar/PSI	
Front: 225/40 R 19 89 Y RSC	2.6 / 38	-
Rear: 255/35 R 19 92 Y RSC	-	2.8 / 41
Front: 225/35 R 20 90 Y XL RSC	2.7 / 39	-
Rear: 255/30 R 20 92 Y XL RSC	-	3.2 / 46
Compact wheel T 135/80 R 17 102 M	Speed up to a max. of 50 mph / 80 km/h	
	4.2 / 60	

Tire size	Pressure specifications in bar/PSI	
Front: 225/40 R 19 89 Y RSC	2.6 / 38	-
Rear: 255/35 R 19 92 Y RSC	-	2.8 / 41
Front: 225/35 R 20 90 Y XL RSC	2.7 / 39	-
Rear: 255/30 R 20 92 Y XL RSC	-	3.2 / 46
Compact wheel T 135/80 R 17 102 M	Speed up to a max. of 50 mph / 80 km/h	
	4.2 / 60	

With high-speed tuning feature

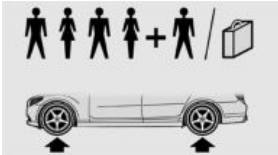
Tire size	Pressure specifications in bar/PSI	
Specifications in bar/PSI with cold tires		
225/50 R 17 94 H M +S RSC	2.4 / 35	2.9 / 42
225/45 R 18 91 Y RSC	2.6 / 38	3.1 / 45
225/45 R 18 95 V M +S XL RSC		
Front: 225/50 R 17 94 W RSC	2.4 / 35	-
Rear: 255/45 R 17 98 W RSC	-	2.6 / 38
Front: 225/45 R 18 91 Y RSC	2.6 / 38	-
Rear: 255/40 R 18 95 Y RSC	-	2.6 / 38

335i, 335i xDrive

Without high-speed tuning feature

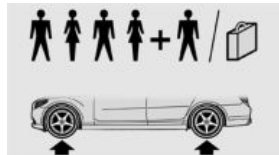
Tire size	Pressure specifications in bar/PSI	
Specifications in bar/PSI with cold tires		
225/45 R 18 91 V M+S A/S RSC	2.7 / 39	3.2 / 46
225/45 R 18 91 Y RSC		
225/50 R 17 94 H M+S RSC		
225/45 R 18 95 V M+S XL RSC		
Front: 225/45 R 18 91 Y RSC	2.7 / 39	-
Rear: 255/40 R 18 95 Y RSC	-	2.8 / 41

Tire size	Pressure specifications in bar/PSI	
Front: 225/40 R 19 89 Y RSC	2.7 / 39	-
Rear: 255/35 R 19 92 Y RSC	-	3.0 / 44
Front: 225/35 R 20 90 Y XL RSC	2.9 / 42	-
Rear: 255/30 R 20 92 Y XL RSC	-	3.4 / 49
Compact wheel T 135/80 R 17 102 M	Speed up to a max. of 50 mph / 80 km/h	
	4.2 / 60	

With high-speed tuning feature

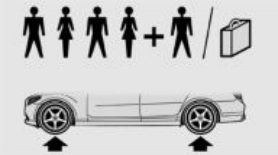
Tire size	Pressure specifications in bar/PSI	
Specifications in bar/PSI with cold tires		
225/45 R 18 91 Y RSC	2.7 / 39	3.2 / 46
225/50 R 17 94 H M+S RSC		
225/45 R 18 95 V M+S XL RSC		
Front: 225/45 R 18 91 Y RSC	2.7 / 39	-
Rear: 255/40 R 18 95 Y RSC	-	2.8 / 41
Front: 225/40 R 19 89 Y RSC	2.7 / 39	-
Rear: 255/35 R 19 92 Y RSC	-	3.0 / 44

Tire size	Pressure specifications in bar/PSI	
Front: 225/35 R 20 90 Y XL RSC	2.9 / 42	-
Rear: 255/30 R 20 92 Y XL RSC	-	3.4 / 49
Compact wheel T 135/80 R 17 102 M	Speed up to a max. of 50 mph / 80 km/h	
	4.2 / 60	

## Tire identification marks

### Tire size

245/45 R 18 96 Y

245: nominal width in mm

45: aspect ratio in %

R: radial tire code

18: rim diameter in inches

96: load rating, not for ZR tires

Y: speed rating, before the R on ZR tires

### Speed letter

Q = up to 100 mph, 160 km/h

R = up to 106 mph, 170 km/h

S = up to 112 mph, 180 km/h

T = up to 118 mph, 190 km/h

H = up to 131 mph, 210 km/h

V = up to 150 mph, 240 km/h

W = up to 167 mph, 270 km/h

Y = up to 186 mph, 300 km/h

### Tire Identification Number

DOT code: DOT xxxx xxx 0814

xxxx: manufacturer code for the tire brand

xxx: tire size and tire design

0814: tire age

Tires with DOT codes meet the guidelines of the U.S. Department of Transportation.

### Tire age

DOT ... 0814: the tire was manufactured in the 8th week of 2014.

### Recommendation

Regardless of wear, replace tires at least every 6 years.

### Uniform Tire Quality Grading

Quality grades can be found where applicable on the tire sidewall between tread shoulder and maximum section width.

For example: Treadwear 200; Traction AA; Temperature A

### DOT Quality Grades

Treadwear

Traction AA A B C

Temperature A B C

All passenger car tires must conform to Federal Safety Requirements in addition to these grades.

### Treadwear

The treadwear grade is a comparative rating based on the wear rate of the tire when tested under controlled conditions on a specified government test course. For example, a tire graded 150 would wear one and one-half, 1 g, times as well on the government course as a tire graded 100. The relative performance of tires depends upon the actual conditions of their use, however, and may depart significantly from the norm due to variations in driving habits, service practices and differences in road characteristics and climate.

### Traction

The traction grades, from highest to lowest, are AA, A, B, and C.

Those grades represent the tire's ability to stop on wet pavement as measured under controlled conditions on specified government test surfaces of asphalt and concrete. A tire marked C may have poor traction performance.

The traction grade assigned to this tire is based on straight-ahead braking traction tests, and does not include acceleration, cornering, hydroplaning, or peak traction characteristics.

### Temperature

The temperature grades are A, the highest, B, and C, representing the tire's resistance to the generation of heat and its ability to dissipate heat when tested under controlled conditions on a specified indoor laboratory test wheel. Sustained high temperature can cause the material of the tire to degenerate and reduce tire life, and excessive temperature can lead to sudden tire failure. The grade C corresponds to a level of performance which all passenger car tires must meet under the Federal Motor Vehicle Safety Standard No. 109. Grades Band A represent higher levels of performance on the laboratory test wheel than the minimum required by law.



Temperature grade for this tire

The temperature grade for this tire is established for a tire that is properly inflated and not overloaded. Excessive speed, underinflation, or excessive loading, either separately or in combination, can cause heat buildup and possible tire failure.

If necessary, have the vehicle towed. ◀

### RSC – Run-flat tires

Run-flat tires, refer to page 195, are labeled with a circular symbol containing the letters RSC marked on the sidewall.

### M+S

Winter and all-season tires with better cold weather performance than summer tires.



## Tire tread

### Summer tires

Do not drive with a tire tread depth of less than 0.12 in/3 mm.

There is an increased danger of hydroplaning if the tread depth is less than 0.12 in/3 mm.

### Winter tires

Do not drive with a tire tread depth of less than 0.16 in/4 mm.

Below a tread depth of 0.16 in/4 mm, tires are less suitable for winter operation.

### Minimum tread depth

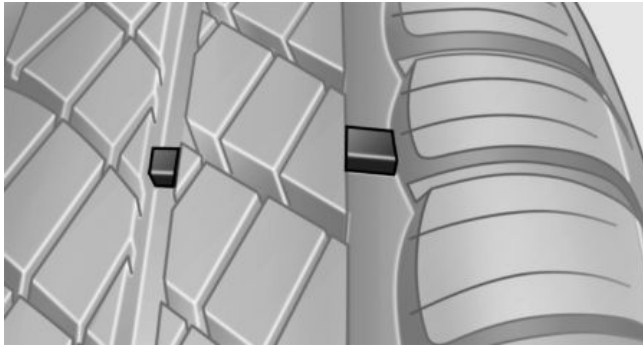

Wear indicators are distributed around the tire's circumference and have the legally required minimum height of 0.063 in/1.6 mm.

They are marked on the side of the tire with TWI, Tread Wear Indicator.

## Tire damage

### General information

Inspect your tires often for damage, foreign objects lodged in the tread, and tread wear.

### Notes

Driving over rough or damaged road surfaces, as well as debris, curbs and other obstacles can cause serious damage to wheels, tires and suspension parts. This is more likely to occur with low-profile tires, which provide less cush-

ioning between the wheel and the road. Be careful to avoid road hazards and reduce your speed, especially if your vehicle is equipped with low-profile tires.

Indications of tire damage or other vehicle defects:

- ▷ Unusual vibrations during driving.
- ▷ Unusual handling such as a strong tendency to pull to the left or right.

Damage can, e. g., be caused by driving over curbs, road damage, or similar things.



#### In case of tire damage

If there are indications of tire damage, reduce your speed immediately and have the wheels and tires checked right away; otherwise, there is the increased risk of an accident.

Drive carefully to the nearest service center. Have the vehicle towed or transported there. Otherwise, tire damage can become life threatening for vehicle occupants and also other road users. ◀



#### Repair of tire damage

For safety reasons, the manufacturer of your vehicle recommends that you do not have damaged tires repaired; they should be replaced. Otherwise, damage can occur as a result. ◀

## Changing wheels and tires

### Mounting



#### Information on mounting tires

Have mounting and balancing performed only by a service center.

If this work is not carried out properly, there is the danger of subsequent damage and related safety hazards. ◀

## Wheel and tire combination

You can ask the service center about the right wheel/tire combination and wheel rim versions for the vehicle.

Incorrect wheel and tire combinations impair the function of a variety of systems such as ABS or DSC.

To maintain good handling and vehicle response, use only tires with a single tread configuration from a single manufacturer.

Following tire damage, have the original wheel and tire combination remounted on the vehicle as soon as possible.

### Approved wheels and tires

You should only use wheels and tires that have been approved by the vehicle manufacturer for your vehicle type; otherwise, for example, despite having the same official size ratings, variations can lead to body contact and with it, the risk of severe accidents

The manufacturer of your vehicle cannot evaluate non-approved wheels and tires to determine if they are suited for use, and therefore cannot ensure the operating safety of the vehicle if they are mounted. ◀

## Recommended tire brands



For each tire size, the manufacturer of your vehicle recommends certain tire brands. These can be identified by a star on the tire sidewall.

With proper use, these tires meet the highest standards for safety and handling.

## New tires

Due to technical factors associated with their manufacture, tires do not achieve their full traction potential until after an initial breaking-in period.

Drive conservatively for the first 200 miles/300 km.

## Retreaded tires

The manufacturer of your vehicle does not recommend the use of retreaded tires.

### Retreaded tires

Possibly substantial variations in the design and age of the tire casing structures can limit service life and have a negative impact on road safety. ◀

## Winter tires

Winter tires are recommended for operating on winter roads.

Although so-called all-season M+S tires do provide better winter traction than summer tires, they do not provide the same level of performance as winter tires.

## Maximum speed of winter tires

If the maximum speed of the vehicle is higher than the permissible speed for the winter tires, then display a corresponding sign in the field of vision. You can obtain this sign from the tire specialist or from your service center.

### Maximum speed for winter tires

Do not exceed the maximum speed for the respective winter tires; otherwise, tire damage and accidents can occur. ◀

## Run-flat tires

If you are already using run-flat tires, for your own safety you should replace them only with the same kind. No spare tire is available in the case of a flat tire. Your service center will be glad to advise you.

## Rotating wheels between axles

Different wear patterns can occur on the front and rear axles depending on individual driving conditions. The tires can be rotated between the axles to achieve even wear. Your service center will be glad to advise you. After rotating, check the tire pressure and correct if necessary.

Rotating the tires is not permissible on vehicles with different tire sizes on the front and rear axles, i.e. when using different types of tires.

## Storage

Store wheels and tires in a cool, dry place with as little exposure to light as possible.

Always protect tires against all contact with oil, grease and fuels.

Do not exceed the maximum tire inflation pressure indicated on the side wall of the tire.

## Run-flat tires

### Label



RSC label on the tire sidewall.

The wheels are composed of special rims and tires that are self-supporting, to a limited degree.

The support of the sidewall allows the tire to remain drivable to a restricted degree in the event of a pressure loss.

FTM: continued driving with a damaged tire, refer to page [102](#).

TPM: continued driving with a damaged tire, refer to page [99](#).

## Changing run-flat tires

For your own safety, only use run-flat tires. No spare tire is available in the case of a flat tire. Your service center will be glad to advise you.

## Snow chains

### Fine-link snow chains

Only certain types of fine-link snow chains have been tested by the manufacturer of the vehicle, classified as road-safe and approved.

Information about the approved snow chains are available from the service center.

### Use

Use only in pairs on the rear wheels, equipped with the tires of the following size:

- ▷ 205/60 R 16.
- ▷ 225/55 R 16.
- ▷ 225/50 R 17.
- ▷ 225/45 R 18.

Follow the chain manufacturer's instructions.

Make sure that the snow chains are always sufficiently tight. Retighten as needed according to the chain manufacturer's instructions.

Do not initialize the Flat Tire Monitor after mounting snow chains, as doing so may result in incorrect readings.

Do not initialize the Tire Pressure Monitor after mounting snow chains, as doing so may result in incorrect readings.

When driving with snow chains, briefly activate Dynamic Traction Control if necessary.

### Maximum speed with snow chains

Do not exceed a speed of 30 mph/50 km/h when using snow chains.

# Engine compartment

## Vehicle equipment

All standard, country-specific and optional equipment that is offered in the model series is described in this chapter. Therefore, equip-

ment is also described that is not available in a vehicle, e. g., because of the selected optional equipment or country variant. This also applies for safety-related functions and systems.

## Important features in the engine compartment

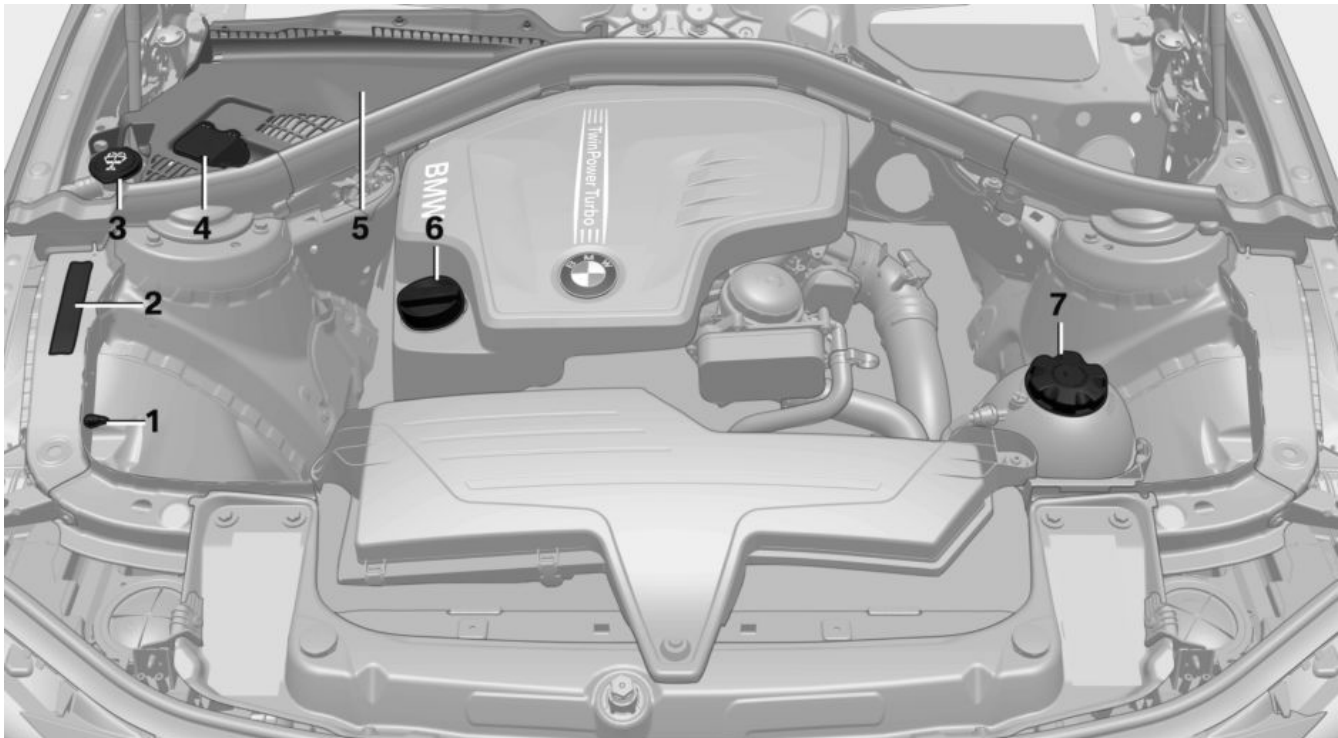

- 1 Jump-starting, negative terminal
- 2 Vehicle identification number
- 3 Washer fluid reservoir
- 4 Jump-starting, positive terminal
- 5 Engine compartment fuse box

- 6 Oil filler neck
- 7 Coolant reservoir

The coolant reservoir for 6-cylinder and diesel engines is located on the opposite side of the engine compartment.

## Hood

### Hints



Working in the engine compartment

Never attempt to perform any service or repair operations on your vehicle without the necessary professional technical training.

If you are unfamiliar with the statutory guidelines, have any work on the vehicle performed only by a service center.

If this work is not carried out properly, there is the danger of subsequent damage and related safety hazards. ◀



Never reach into the engine compartment

Never reach into the intermediate spaces or gaps in the engine compartment. Otherwise, there is risk of injury, e.g., from rotating or hot parts. ◀



Fold down wiper arm

Before opening the hood, ensure that the wiper arms are against the windshield, or this may result in damage. ◀

### Opening the hood

1. Pull lever in the interior:  
Engine is released, arrow 1.



2. After the lever is released, pull the lever again:  
Hood can be opened, arrow 2.

### Indicator/warning lamps

When the hood is opened, a Check Control message is displayed.

### Closing the hood

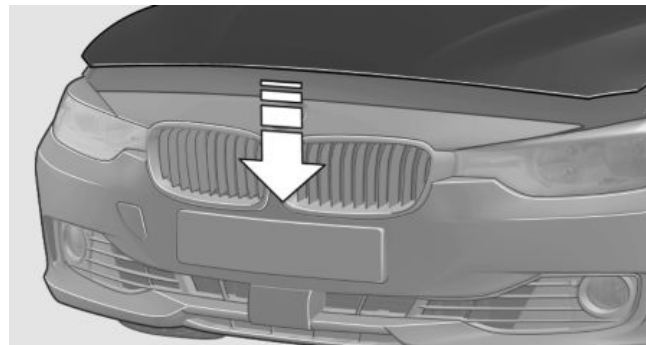

Let the hood drop from a height of approx. 16 in/40 cm and push down on it to lock it fully.

The hood must audibly engage on both sides.



Hood open when driving

If you see any signs that the hood is not completely closed while driving, pull over immediately and close it securely. ◀



Danger of pinching

Make sure that the closing path of the hood is clear; otherwise, injuries may result. ◀



# Engine oil

## Vehicle equipment

All standard, country-specific and optional equipment that is offered in the model series is described in this chapter. Therefore, equipment is also described that is not available in a vehicle, e. g., because of the selected optional equipment or country variant. This also applies for safety-related functions and systems.

## General information

The engine oil consumption is dependent on the driving style and driving conditions. When a sporty driving style is used, the engine oil consumption, for example, is clearly higher.

Therefore, regularly check the engine oil level after refueling.

Depending on its engine, the vehicle is equipped with electronic oil measurement or measuring is done with a dipstick.

The electronic oil measurement has two measuring principles.

- ▷ Status display
- ▷ Detailed measurement

## Checking the oil level electronically

### Status display

#### The concept

The oil level is monitored electronically during driving and shown on the Control Display.

If the oil level reaches the minimum level, a check control message is displayed.

## Requirements

A current measured value is available after approx. 30 minutes of driving. During a shorter trip, the status of the last, sufficiently long trip is displayed.

With frequent short-distance trips, regularly perform a detailed measurement.

## Displaying the oil level

1. "Vehicle Info"
2. "Vehicle status"
3.  "Engine oil level"

## Oil level display messages

Different messages appear on the display depending on the oil level. Pay attention to these messages.

If the engine oil level is too low, within the next 125 miles/200 km Add oil, refer to page 199.



Engine oil level too low

Add oil immediately; otherwise, an insufficient amount of engine oil could result in engine damage. ◀

Take care not to add too much engine oil.



Too much engine oil

Have the vehicle checked immediately; otherwise, surplus oil can lead to engine damage. ◀

## Detailed measurement

### The concept

In the detailed measurement the oil level is checked and displayed via a scale.

During the measurement, the idle speed is increased somewhat.



## General information

A detailed measurement is only possible with certain engines.

## Requirements

- ▶ Vehicle is on level road.
- ▶ Manual transmission: shift lever in neutral position, clutch and accelerator pedals not depressed.
- ▶ Automatic transmission: selector lever in selector lever position N or P and accelerator pedal not depressed.
- ▶ Engine is running and is at operating temperature.

## Performing a detailed measurement

In order to perform a detailed measurement of the engine oil level:

1. "Vehicle Info"
2. "Vehicle status"
3.  "Measure engine oil level"
4. "Start measurement"

The oil level is checked and displayed via a scale.

Duration: approx. 1 minute.

## Adding engine oil

### General information

Switch off the ignition and safely park the vehicle before engine oil is added.

## Filler neck

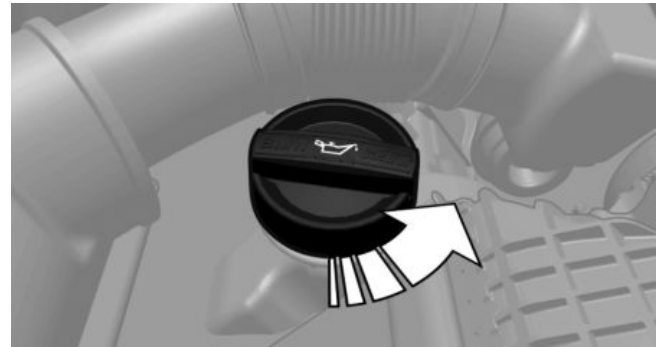

Only add 1 US quart/liter of oil when the message is displayed in the instrument cluster.



Adding oil

Add oil within the next 125 miles/200 km. Otherwise, the engine may be damaged. ◀



Do not add too much engine oil

When too much engine oil is added, immediately have the vehicle checked, otherwise, this may cause engine damage. ◀



Protect children

Keep oil, grease, etc., out of reach of children and heed the warnings on the containers to prevent health risks. ◀

## Oil types for refilling

### Hints



No oil additives

Oil additives may lead to engine damage. ◀



Viscosity grades for engine oils

When selecting an engine oil, ensure that the engine oil belongs to one of the viscosity grades SAE 0W-40, SAE 0W-30, SAE 5W-40, and SAE 5W-30 or malfunctions or engine damage may occur. ◀

The engine oil quality is critical for the life of the engine.

## Approved oil types

You can add oils with the following specifications:

Gasoline engine

BMW Longlife-01.

BMW Longlife-01 FE.

Diesel engine

BMW Longlife-04.

Additional information about the approved types of oils can be requested from the service center.

## Alternative oil types

If the approved engine oils are not available, up to 1 US quart/liter of an oil with the following specification can be added:

Gasoline engine

API SM or superior grade specification.

Diesel engine

API ILSAC GF-5.

## Engine oil change:

The vehicle manufacturer recommends that you let the service center change the motor oil.

**BMW recommends** 

# Coolant

## Vehicle equipment

All standard, country-specific and optional equipment that is offered in the model series is described in this chapter. Therefore, equipment is also described that is not available in a vehicle, e. g., because of the selected optional equipment or country variant. This also applies for safety-related functions and systems.

## Hints



Danger of burns from hot engine

Do not open the cooling system while the engine is hot; otherwise, escaping coolant may cause burns. ◀



Suitable additives

Only use suitable additives; otherwise, engine damage may occur. The additives are harmful to your health. ◀

Coolant consists of water and additives.

Not all commercially available additives are suitable for the vehicle. Information about the suitable additives are available from the service center.

## Coolant level

### General information

Depending on the engine installation, the coolant reservoir may be located on the opposite side of the engine compartment.

### Checking

1. Let the engine cool.
2. The coolant level is correct if it lies between the minimum and maximum marks.

The marks are on the side of the coolant reservoir.

Symbol	Meaning
▽	Maximum
△	Minimum

## Adding

1. Let the engine cool.
2. Turn the cap of the coolant reservoir slightly counterclockwise to allow any excess pressure to dissipate, and then open it.

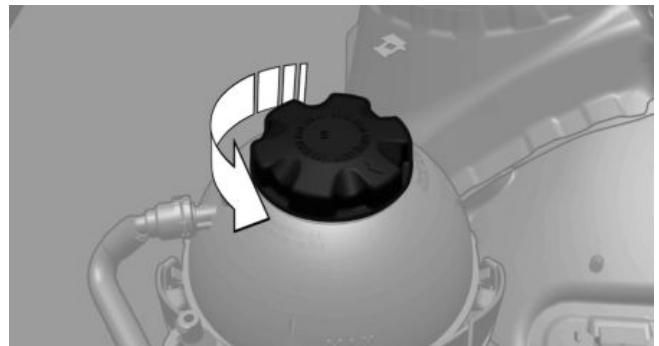

3. If the coolant is low, slowly add coolant up to the specified level; do not overfill.
4. Turn the cap until there is an audible click. The arrows on the coolant reservoir and the cap must point towards one another.
5. Have the cause of the coolant loss eliminated as soon as possible.

## Disposal



Comply with the relevant environmental protection regulations when disposing of coolant and coolant additives.

# Maintenance

## Vehicle equipment

All standard, country-specific and optional equipment that is offered in the model series is described in this chapter. Therefore, equipment is also described that is not available in a vehicle, e. g., because of the selected optional equipment or country variant. This also applies for safety-related functions and systems.

## BMW maintenance system

The maintenance system indicates required maintenance measures, and thereby provides support in maintaining road safety and the operational reliability of the vehicle.

## Condition Based Service CBS

Sensors and special algorithms take into account the driving conditions of your vehicle. Based on this, Condition Based Service determines the maintenance requirements.

The system makes it possible to adapt the amount of maintenance you need to your user profile.

Detailed information on service requirements, refer to page 80, can be displayed on the Control Display.

## Service data in the remote control

Information on the required maintenance is continuously stored in the remote control. Your service center will read out this data and suggest the right array of service procedures for your vehicle.

Therefore, hand your service specialist the remote control with which the vehicle was driven most recently.

## Storage periods

Storage periods during which the vehicle battery was disconnected are not taken into account.

If this occurs, have a service center update the time-dependent maintenance procedures, such as checking brake fluid and, if necessary, changing the engine oil and the microfilter/activated-charcoal filter.

## Service and Warranty Information Booklet for US models and Warranty and Service Guide Booklet for Canadian models

Please consult your Service and Warranty Information Booklet for US models and Warranty and Service Guide Booklet for Canadian models for additional information on service requirements.

Maintenance and repair should be performed by your service center. Make sure to have regular maintenance procedures recorded in the vehicle's Service and Warranty Information Booklet for US models, and in the Warranty and Service Guide Booklet for Canadian models. These entries are proof of regular maintenance.

## Socket for OBD Onboard Diagnosis

### Note



Socket for Onboard Diagnosis

The socket for onboard diagnostics may only be used by the service center or a workshop that operates in accordance with the specifications of the vehicle manufacturer with

correspondingly trained personnel and other authorized persons. Otherwise, use may result in operating problems for the vehicle. ◀

## Position

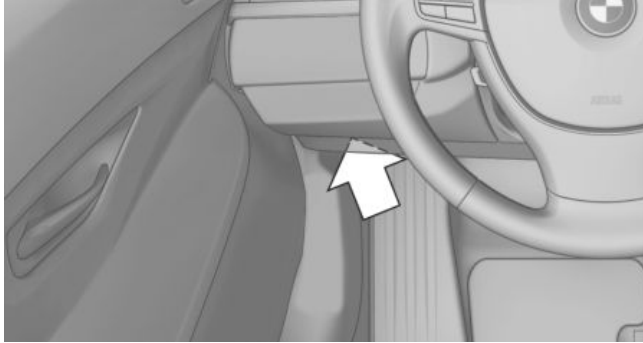

There is an OBD socket on the driver's side for checking the primary components in the vehicle emissions.

## Emissions



- ▶ The warning lamp lights up:  
Emissions are deteriorating. Have the vehicle checked as soon as possible.



Canadian model: warning light indicates the engine symbol.

- ▶ The warning lamp flashes under certain circumstances:  
This indicates that there is excessive misfiring in the engine.  
Reduce the vehicle speed and have the system checked immediately; otherwise, serious engine misfiring within a brief period can seriously damage emission control components, in particular the catalytic converter.

# Replacing components

## Vehicle equipment

All standard, country-specific and optional equipment that is offered in the model series is described in this chapter. Therefore, equipment is also described that is not available in a vehicle, e. g., because of the selected optional equipment or country variant. This also applies for safety-related functions and systems.

## Onboard vehicle tool kit

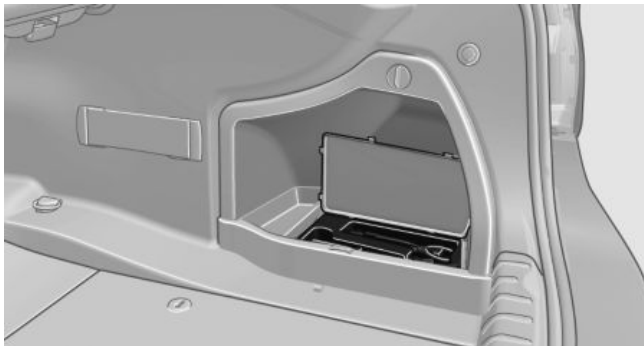

The onboard vehicle tool kit is located on the right side in the cargo area in a storage compartment. Open the cover.

## Wiper blade replacement

### Note



Do not fold down the wipers without wiper blades

Do not fold down the wipers if wiper blades have not been installed; this may damage the windshield. ◀

### Replacing the wiper blades

1. To change the wiper blades, fold up, refer to page 68, the wiper arms.
2. Fold up and hold the wiper arm firmly.

3. Squeeze the retainer spring, arrow 1, and fold up the wiper blade, arrow 2.

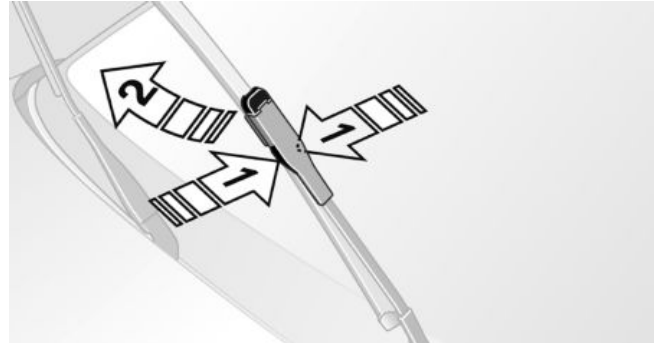

4. Remove the wiper blade forward from the catch.
5. Insert the new wiper blade in reverse order of removal until it locks in place.
6. Fold down the wipers.



Folding down wipers before opening the hood

Before opening the hood, ensure that the wiper arms with the wiper blades are against the windshield to prevent damage. ◀

## Lamp and bulb replacement

### Hints

#### Lamps and bulbs

Lamps and bulbs make an essential contribution to vehicle safety.

The manufacturer of the vehicle recommends that you entrust corresponding procedures to the service center if you are unfamiliar with them or they are not described here.

You can obtain a selection of replacement bulbs at the service center.



**Danger of burns**

Only change bulbs when they are cool; otherwise, there is the danger of getting burned. ◀

**Working on the lighting system**

When working on the lighting system, you should always switch off the lights affected to prevent short circuits.

To avoid possible injury or equipment damage when replacing bulbs, observe any instructions provided by the bulb manufacturer. ◀

**Do not perform work/bulb replacement on xenon headlamps**

Have any work on the xenon lighting system, including bulb replacement, performed only by a service center. Due to the high voltage present in the system, there is the danger of fatal injuries if work is carried out improperly. ◀

**Do not touch the bulbs**

Do not touch the glass of new bulbs with your bare hands, as even minute amounts of contamination will burn into the bulb's surface and reduce its service life.

Use a clean tissue, cloth or something similar, or hold the bulb by its base. ◀

**Light-emitting diodes (LEDs)**

Some items of equipment use light-emitting diodes installed behind a cover as a light source.

These light-emitting diodes, which are related to conventional lasers, are officially designated as Class 1 light-emitting diodes.

**Do not remove the covers**

Do not remove the covers, and never stare into the unfiltered light for several hours; otherwise, irritation of the retina could result. ◀

**Headlamp glass**

Condensation can form on the inside of the external lamps in cool or humid weather. When driving with the light switched on, the condensation evaporates after a short time. The headlamp glasses do not need to be changed.

If the headlamps do not dim despite driving with the light switched on, increasing humidity forms, e. g. water droplets in the light, have the service center check this.

**Headlamp setting**

The headlamp adjustments can be affected by changing lamps and bulbs. Therefore after a change, have the headlamp setting checked and corrected by Service.

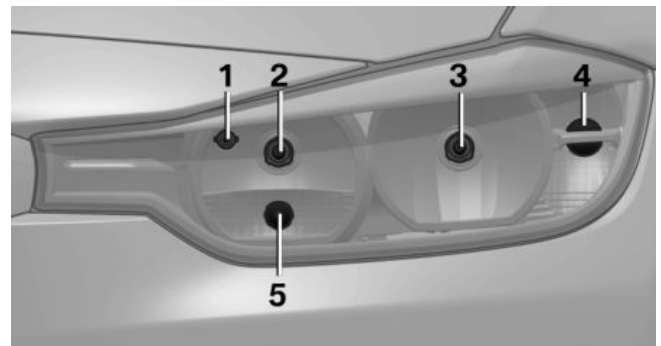
**Front lamps, bulb replacement****Halogen headlamps****Headlamps**

- 1 Parking lamps
- 2 High beams/headlamp flasher
- 3 Low beams
- 4 Turn signal
- 5 Daytime running lights

**Accessing the turn signals and low beams**

Follow general instructions, refer to page 204.

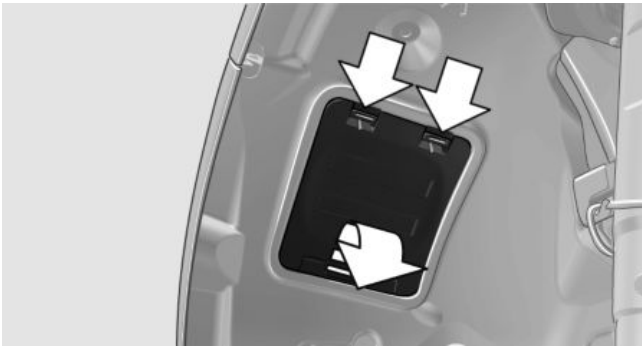

In the wheel house, loosen the two brackets and remove the cover.

### Turn signal

21-watt bulb, PY21W

1. If necessary, pull the inside trim of the wheel house slightly inward. Turn the bulb holder counterclockwise and remove.



2. Press the bulb gently into the socket, turn counterclockwise and remove.
3. Install the new bulb and bulb holder in reverse order of removal.
4. Attach the cover to the wheel house.

### Low beams

55-watt bulb, H7.

1. Turn the cap counterclockwise and remove.

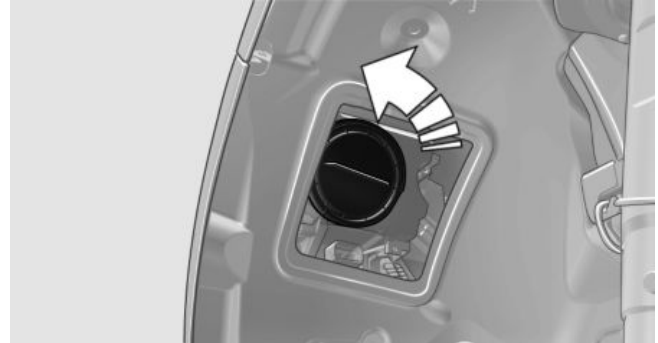

2. Tilt the bulb down and then up to loosen it from the holder and remove.

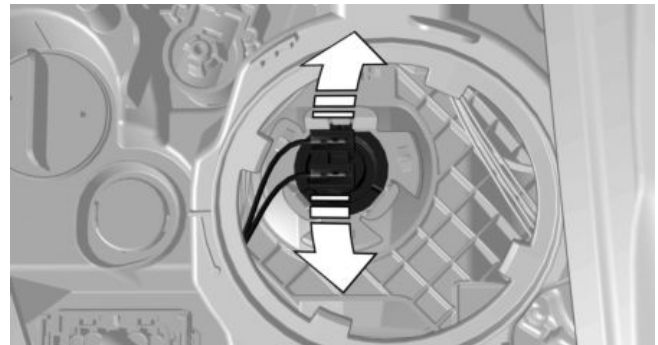

3. Pull the connector off the bulb.
4. Attach the connector to the new bulb.
5. First insert the bulb at the top with the strap, arrow 1, and then press down firmly, arrow 2. Make sure that the bulb snaps into place.

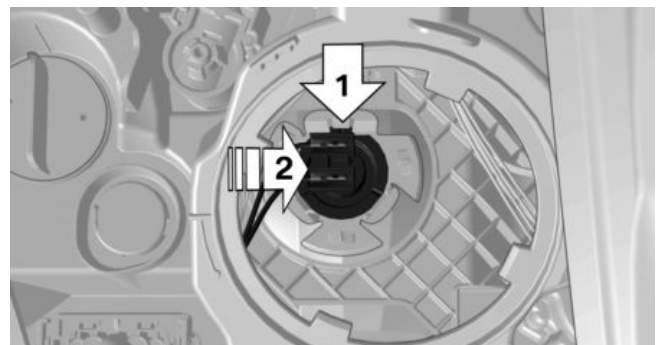

6. Close the headlamp housing with the cap. Make sure that the cap engages.
7. Attach the cover to the wheel house.

### Accessing the daytime running lights, high beams/headlamp flasher and parking lamps

Follow general instructions, refer to page 204.

1. Open the hood, refer to page 197.
2. Turn the cap counterclockwise and remove.

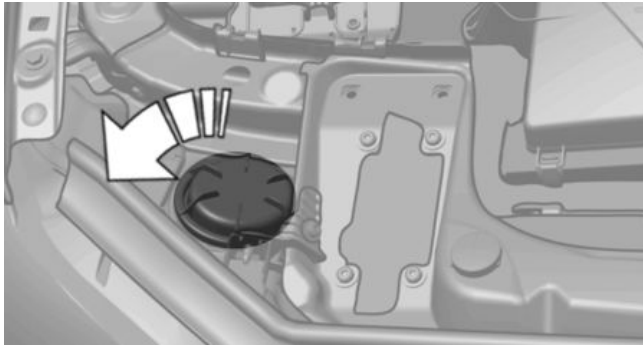

### Parking lamps

6-watt bulb, H6W.

1. Turn the bulb holder counterclockwise and remove.

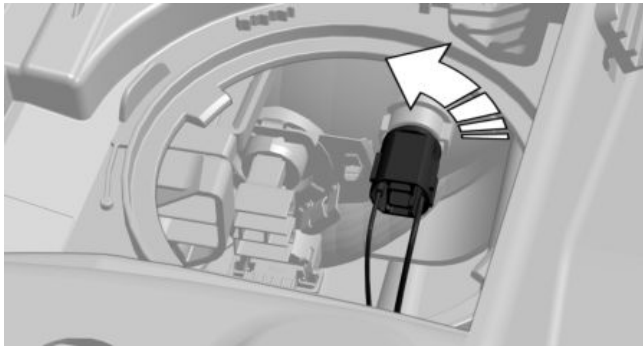

2. Press the bulb gently into the socket, turn counterclockwise and remove.
3. To insert the bulb and bulb holder, proceed in reverse order of removal. Make sure that the bulb holder snaps into place.
4. Close the headlamp housing with the cap. Make sure that the cap engages.

### High beams/headlamp flasher

55-watt bulb, H7.

1. Tilt the bulb down and then up to loosen it from the holder and remove.

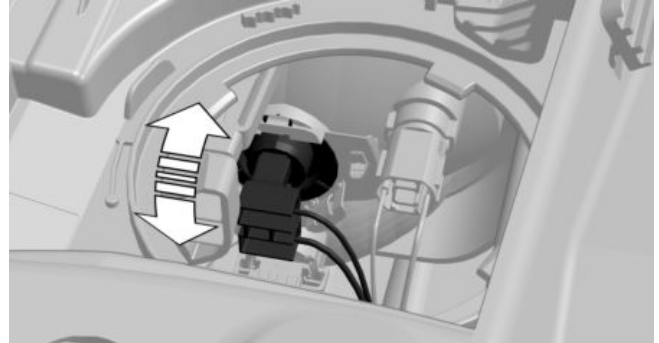

2. Pull the connector off the bulb.
3. Attach the connector to the new bulb.
4. First insert the bulb at the top with the strap, arrow 1, and then press down firmly, arrow 2. Make sure that the bulb snaps into place.

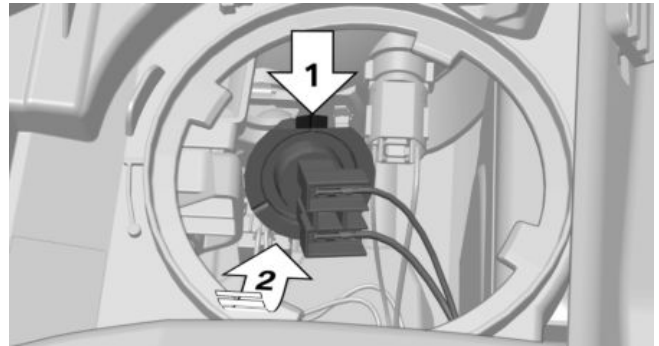

5. Close the headlamp housing with the cap. Make sure that the cap engages.

### Daytime running lights

24-watt bulb, PW24W.

1. If necessary, remove the high beam bulb connector.
2. Remove the bulb holder.

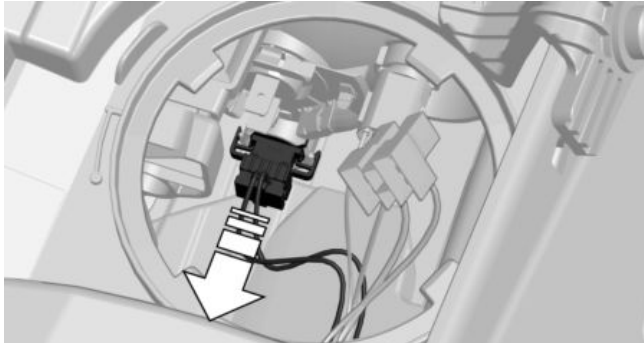

3. Remove the bulb from the bulb holder.
4. To insert the new bulb, proceed in reverse order of removal. During insertion, the bottom of the bulb holder must be facing downward. Make sure that the bulb holder snaps into place.
5. Attach the high beam bulb connector.
6. Close the headlamp housing with the cap. Make sure that the cap engages.

### Xenon headlamps

#### Xenon headlamps

Because of the long life of these bulbs, the likelihood of failure is very low. Switching the lamps on and off frequently shortens their life.

If a bulb fails, switch on the front fog lamps and continue the trip with great care. Comply with local regulations.

 Do not perform work/bulb replacement on xenon headlamps

Have any work on the xenon lighting system, including bulb replacement, performed only by a service center. Due to the high voltage present in the system, there is the danger of fatal injuries if work is carried out improperly. ◀

For checking and adjusting headlamp aim, please contact your BMW center.

### Headlamps

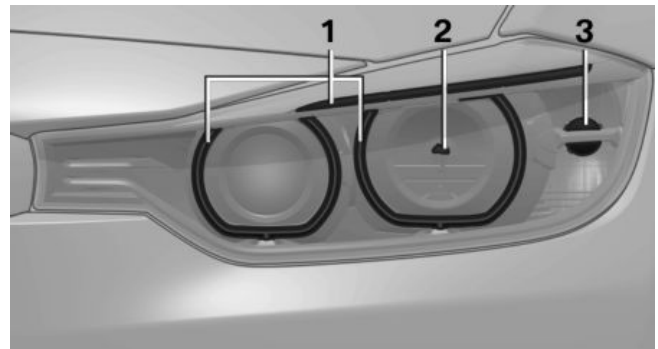

- 1 Parking lamps / daytime running lights
- 2 Low beams/high beams/headlamp flasher
- 3 Turn signal

Low beams and high beams are designed with xenon technology.

The parking lamps and daylight running lights are made using LED technology.

Contact your service center in the event of a malfunction.

#### Turn signal

Follow general instructions, refer to page [204](#).

21-watt bulb, PY21W

1. In the wheel house, loosen the two brackets and remove the cover.

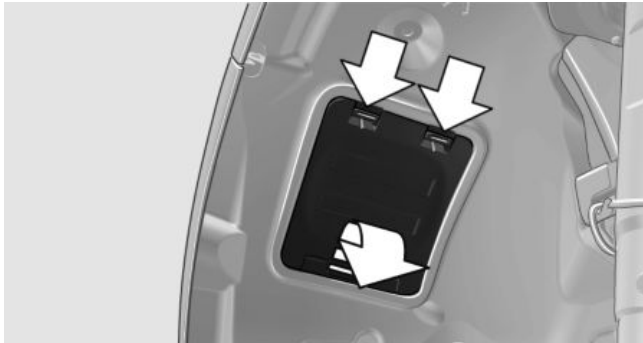

2. If necessary, pull the inside trim of the wheel house slightly inward. Turn the bulb holder counterclockwise and remove.



3. Press the bulb gently into the socket, turn counterclockwise and remove.
4. Install the new bulb and bulb holder in reverse order of removal.
5. Attach the cover to the wheel house.

### Front fog lamps

Follow general instructions, refer to page 204.  
35-watt bulb, H8.

1. Use the handle of the screwdriver from the onboard vehicle tool kit to remove the three wheel house panel screws, arrow 1.

Carefully pull back the wheel house panel, arrow 2.

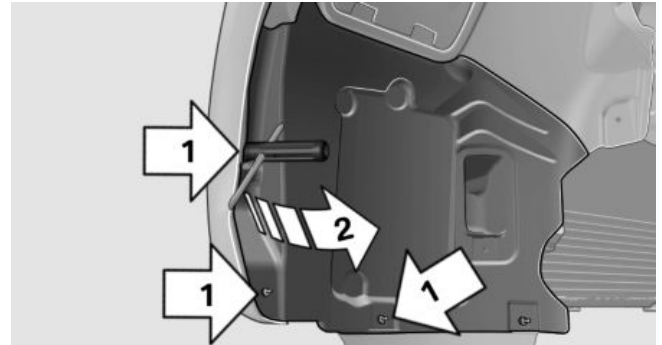

2. Pull off the bulb connector, arrow 1.

Turn the bulb, arrow 2.

Left side of vehicle: turn clockwise.

Right side of vehicle: turn counterclockwise.

Remove the bulb.

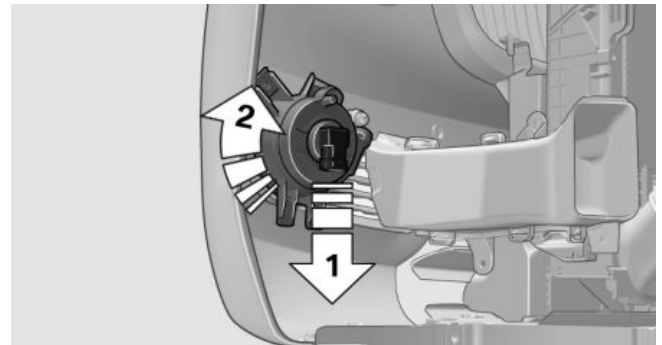

3. Insert the new bulb, connect the connector and screw on the wheel house panel.

### Turn signal in exterior mirror

Follow general instructions, refer to page 204.

The turn signals in the exterior mirrors feature LED technology. Contact your service center in the event of a malfunction.



## Tail lamps, bulb replacement

### At a glance

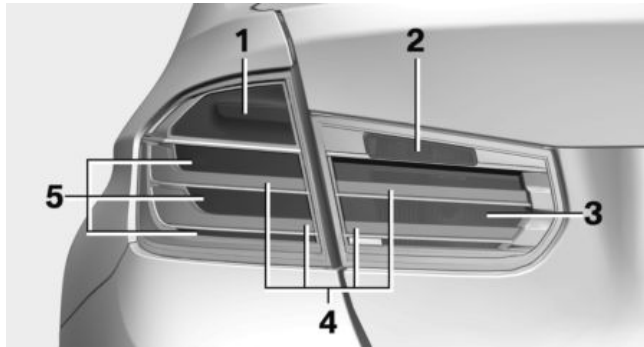

- 1 Turn signal
- 2 Reversing lamp
- 3 Inside brake lamp
- 4 Tail lamps
- 5 Outside brake lamp

### Bulb replacement, exterior tail lamps

#### General information

Follow general instructions, refer to page 204.

Turn signal: 21-watt bulb, P21WLL.

Outer brake lamp: 21-watt bulb, H21W.

The tail lamps feature LED technology. Contact your service center in the event of a malfunction.

-  Use caution when replacing the bulb
- Use caution and proceed one step at a time when replacing the bulbs to prevent damage to the tail lamps or vehicle. ◀

### Removing the exterior tail lamp

1. Open trunk lid.
2. Use the screwdriver from the onboard vehicle tool kit to loosen the screw, arrow 1, and remove the cover, arrow 2.

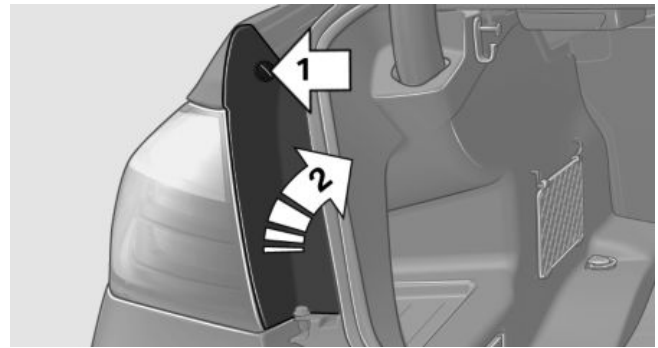

3. Use the screwdriver handle to loosen the two nuts, arrows 1 and 2, and remove. The tail lamp is still attached to a rubber mount on the outside.

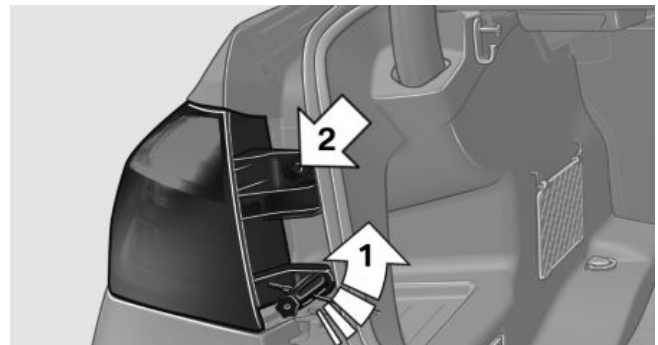

4. Grasp the inner edge of the tail lamp and carefully swing it back and out of the rubber mount, arrow 1. Use your free hand to hold it in place in order to prevent the tail lamp from coming loose suddenly. Make sure that the foam rubber sealing ring is on the centering pin, arrow 2.

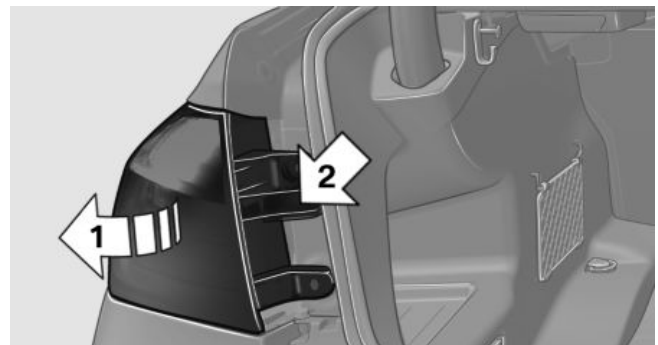



5. Remove the connecting line from the clip on the bulb holder.
6. Release the catch at the top on the connector of the connecting line and remove the connector from the bulb holder.

### Replacing the bulbs

1. Loosen the four fasteners, arrow 1, on the bulb holder and remove the bulb holder from the tail lamp, arrow 2.

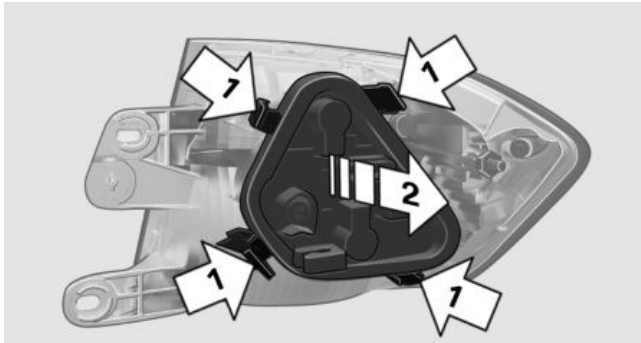

2. Press the defective bulb gently into the socket, turn counterclockwise and remove.
3. Proceed in the reverse order to insert the new bulb and attach the bulb holder. Make sure that the bulb holder engages in all fasteners.

### Installing the tail lamp

1. Connect the connecting line to the tail lamp and secure the bulb holder in the clip.
2. Make sure that the foam rubber sealing ring is on the centering pin, arrow 2, and is not damaged.
3. Position and firmly press the outer part of the tail lamp onto the rubber mount, arrow 1 and the inner part onto the centering

component, arrow 2. Make sure that the tail lamp engages in the rubber mount.

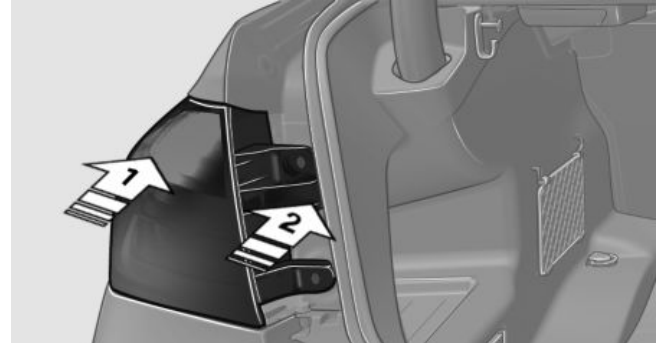

4. Screw the tail lamp on with the two nuts.
5. Insert and secure the cover. Make sure that the tubular seal is not pinched.

### Lamps in the trunk lid

#### General information

Follow general instructions, refer to page 204.

Reversing lamps: 16-watt bulb, PW16W.

Inner brake lamps: 21-watt bulb, H21W

#### Accessing the lamps

1. Use the screwdriver from the onboard vehicle tool kit to loosen and completely remove the six screws on the trim.

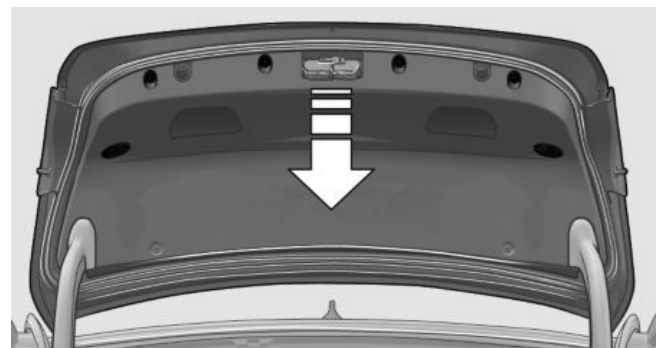

2. Carefully loosen the trim from the trunk lid, starting at the edge and working toward the area around the recessed grips. Make sure that the trim does not become stuck.
3. Carefully swing out the trim.

### Replacing the reversing lamp and inner brake lamp

1. Loosen the two holders, arrow 1 and pull down on the lamp holder to remove, arrow 2.

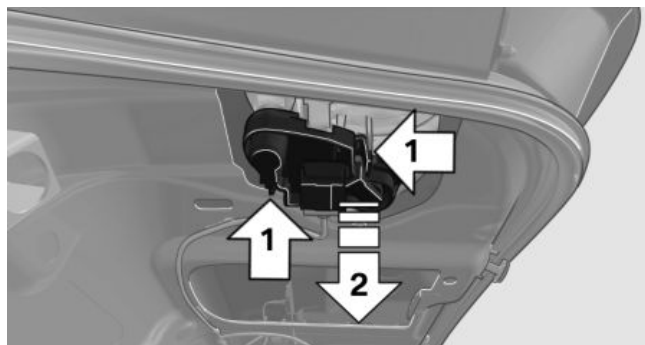

2. Unscrew the defective bulb of the reversing or brake lamp from its socket counter-clockwise.
3. Insert the new bulb.

### Installing the bulb holder

1. Slide the bulb holder onto the two guide pins, arrow 1. Insert the two contacts, arrow 2, into the connections, arrow 3.

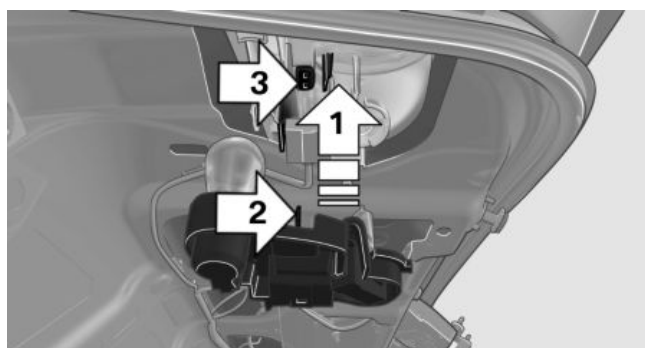

2. Press on the bulb holder. Make sure that the two exterior holders latch into place.
3. Swing the trim back onto the trunk lid and secure.

### Tail lamp, license plate lamp and central brake lamp

Follow general instructions, refer to page 204.

These lamps are made using LED technology. Contact your service center in the event of a malfunction.

## Changing wheels

### Hints

The vehicle equipment does not include a spare tire.

When using run-flat tires or tire sealants, a tire does not need to be changed immediately in the event of pressure loss due to a flat tire.

The tools for changing wheels are available as accessories from your service center.

### Jacking points for the vehicle jack

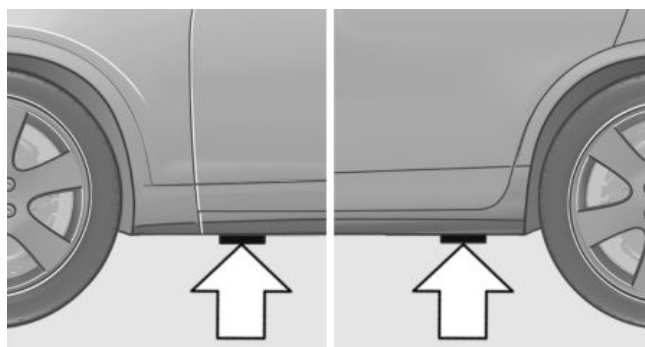

The jacking points for the vehicle jack are located at the positions shown.

## Vehicle battery

### Maintenance

The battery is maintenance-free.

The added amount of acid is sufficient for the service life of the battery.

Your service center will be glad to advise you on questions regarding the battery.

### Battery replacement



Use approved vehicle batteries only

Only use vehicle batteries that have been approved for your vehicle by the manufacturer; otherwise, the vehicle could be damaged and systems or functions may not be fully available. ◀

After a battery replacement, have the battery registered on the vehicle by your service center to ensure that all comfort functions are fully available and that any Check Control messages of these comfort functions are no longer displayed.

## Charging the battery

### Note



Do not connect charging devices to the 12 volt socket in the vehicle

Do not connect battery chargers to the factory-installed 12 volt sockets in the vehicle as this may damage the vehicle battery due to an increased power consumption. ◀

### General information

Make sure that the battery is always sufficiently charged to guarantee that the battery remains usable for its full service life.

The battery may need to be charged in the following cases:

- ▶ When making frequent short-distance drives.
- ▶ If the vehicle is not used for prolonged periods, longer than a month.

### Starting aid terminals

In the vehicle, only charge the battery via the starting aid terminals, refer to page 217, in the engine compartment with the engine off.

### Power failure

After a temporary power loss, some equipment needs to be reinitialized.

Individual settings need to be reprogrammed:

- ▶ Seat and mirror memory: store the positions again.
- ▶ Time: update.
- ▶ Date: update.

- ▶ Navigation system: wait for the operability of the navigation.

### Disposing of old batteries



Have old batteries disposed of by your service center or bring them to a recycling center.

Maintain the battery in an upright position for transport and storage. Secure the battery so that it does not tip over during transport.

## Fuses

### Hints



Replacing fuses

Never attempt to repair a blown fuse and do not replace a defective fuse with a substitute of another color or amperage rating; this could lead to a circuit overload, ultimately resulting in a fire in the vehicle. ◀

Plastic tweezers and information on the fuse types and locations are stored in the fuse box in the cargo area.

### In the engine compartment

1. Use the onboard vehicle tool kit to loosen the three cover screws, arrow 1.

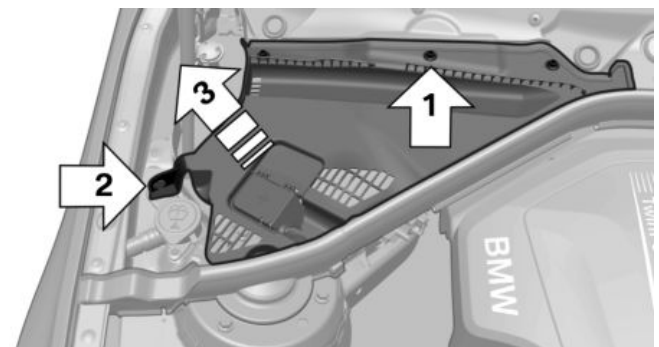

2. Pull up the holder, arrow 2.

3. Remove the cover from one side, arrow 3.
4. Press the four fasteners and remove the cover.

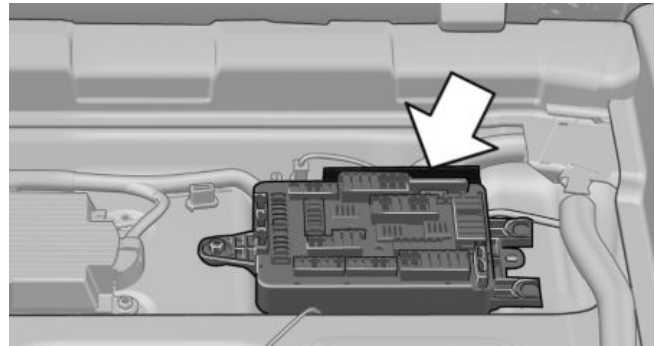
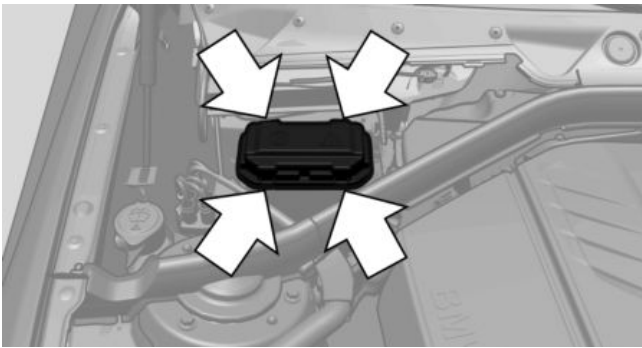

Information on the fuse types and locations is found on a separate sheet.

### Attaching the covers

1. When attaching the cover, make sure that all four fasteners are engaged.
2. Attach the cover under the rubber lip and then thread it between the bars.

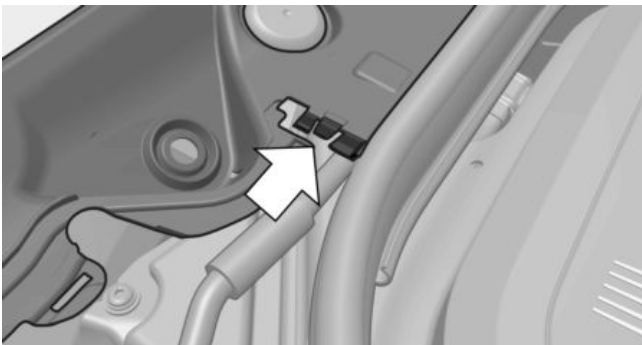

3. Press down on the holder and tighten the three screws.

### In the cargo area

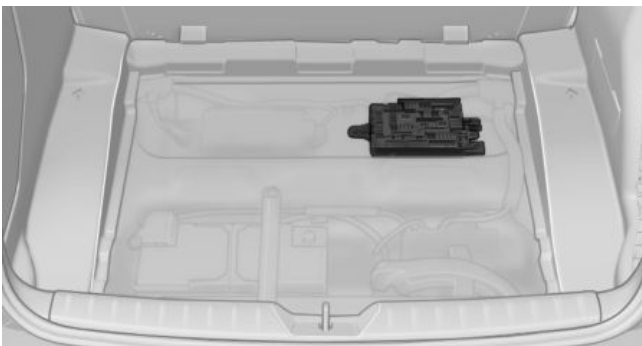

Raise the cargo floor panel.

# Breakdown assistance

## Vehicle equipment

All standard, country-specific and optional equipment that is offered in the model series is described in this chapter. Therefore, equipment is also described that is not available in a vehicle, e. g., because of the selected optional equipment or country variant. This also applies for safety-related functions and systems.

## Hazard warning flashers

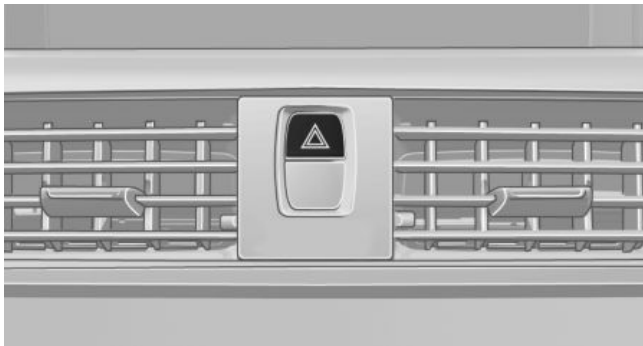

The button is located in the center console.

## Intelligent Emergency Request

### Requirements

- ▶ The radio ready state is switched on.
- ▶ The Assist system is functional.
- ▶ The SIM card integrated in the vehicle has been activated.

### General information

Only press the SOS button in an emergency.

### Hints



Emergency Request not guaranteed

For technical reasons, the Emergency Request cannot be guaranteed under unfavorable conditions. ◀

### Initiating an Emergency Request



1. Press the cover briefly to open it.
2. Press the SOS button until the LED in the button lights up.
  - ▶ The LED lights up: an Emergency Request was initiated.
 

If the situation allows, wait in your vehicle until the voice connection has been established.
  - ▶ The LED flashes when a connection to the BMW Response Center has been established.

When the emergency request is received at the BMW Response Center, the BMW Response Center contacts you and takes further steps to help you.

Even if you are unable to respond, the BMW Response Center can take further steps to help you under certain circumstances.

For this purpose, data that are used to determine the necessary rescue measures, such as the current position of the vehicle



if it can be established, are transmitted to the BMW Response Center.

- ▶ If the LED is flashing, but the BMW Response Center can no longer be heard via the speaker, you can nevertheless still be heard for the BMW Response Center.

### Initiating an Emergency Request automatically

Under certain conditions, an Emergency Request is automatically initiated immediately after a severe accident. Automatic Collision Notification is not affected by pressing the SOS button.

### Warning triangle



The warning triangle is located on the inside of the trunk lid.

To remove, loosen the bracket.

### First aid kit

#### Note

Some of the articles have a limited service life.

Check the expiration dates of the contents regularly and replace any expired items promptly.

### Storage



The first aid kit is located in the cargo area in a storage compartment.

### Roadside Assistance

#### Service availability

Roadside Assistance can be reached around the clock in many countries. You can obtain assistance there in the event of a vehicle breakdown.

#### Roadside Assistance

The Roadside Assistance phone number can be viewed on the iDrive or a connection to Roadside Assistance can be established directly.

For additional information, see user's manual for Navigation, Entertainment and Communication.

### Jump-starting

#### Notes

If the battery is discharged, an engine can be started using the battery of another vehicle and two jumper cables. Only use jumper cables with fully insulated clamp handles.

To prevent personal injury or damage to both vehicles, adhere strictly to the following procedure.



-  Do not touch live parts  
To avoid the risk of potentially fatal injury, always avoid all contact with electrical components while the engine is running. ◀

## Preparation

1. Check whether the battery of the other vehicle has a voltage of 12 volts. This information can be found on the battery.
2. Switch off the engine of the assisting vehicle.
3. Switch off any electronic systems/power consumers in both vehicles.

-  Bodywork contact between vehicles  
Make sure that there is no contact between the bodywork of the two vehicles; otherwise, there is the danger of short circuits. ◀

## Starting aid terminals

-  Connecting order  
Connect the jumper cables in the correct order; otherwise, there is the danger of injury from sparking. ◀

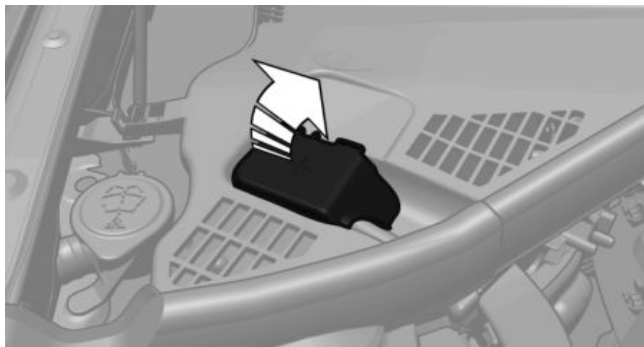

The so-called starting aid terminal in the engine compartment acts as the battery's positive terminal.

Open the cover of the starting aid terminal.

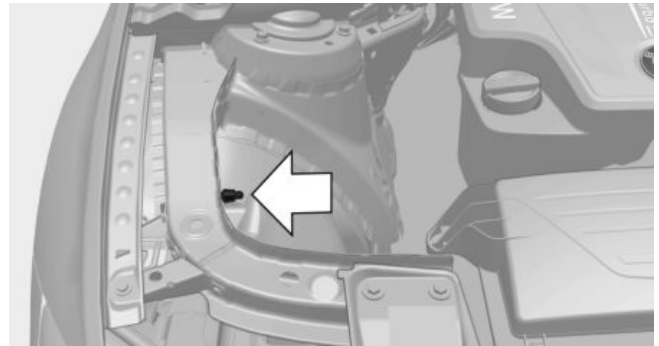

The body ground or a special nut acts as the battery negative terminal.

## Connecting the cables

1. Open the cover of the BMW starting aid terminal.
2. Attach one terminal clamp of the positive jumper cable to the positive terminal of the battery, or to the corresponding starting aid terminal of the vehicle providing assistance.
3. Attach the terminal clamp on the other end of the cable to the positive terminal of the battery, or to the corresponding starting aid terminal of the vehicle to be started.
4. Attach one terminal clamp of the negative jumper cable to the negative terminal of the battery, or to the corresponding engine or body ground of assisting vehicle.
5. Attach the second terminal clamp to the negative terminal of the battery, or to the corresponding engine or body ground of the vehicle to be started.

## Starting the engine

Never use spray fluids to start the engine.

1. Start the engine of the assisting vehicle and let it run for several minutes at an increased idle speed.  
If the vehicle being started has a diesel engine: let the engine of the assisting vehicle run for approx. 10 minutes.
2. Start the engine of the vehicle being started in the usual way.

If the first starting attempt is not successful, wait a few minutes before making another attempt in order to allow the discharged battery to recharge.

3. Let both engines run for several minutes.
4. Disconnect the jumper cables in the reverse order.

Check the battery and recharge if necessary.

## Tow-starting and towing

### Note

 **Tow-starting and towing**  
When tow-starting and towing the vehicle, switch off the Intelligent Safety systems; otherwise, improper behavior of the braking function of individual systems could result in an accident. ◀

Switching off Intelligent Safety systems, refer to page 102.

### Manual transmission

Gearshift lever in neutral position.

### Towing

 Follow the towing instructions  
Follow all towing instructions; otherwise, vehicle damage or accidents may occur. ◀

- ▶ Make sure that the ignition is switched on; otherwise, the low beams, tail lamps, turn signals, and windshield wipers may be unavailable.
- ▶ Do not tow the vehicle with the rear axle tilted, as the front wheels could turn.
- ▶ When the engine is stopped, there is no power assist. Consequently, more force needs to be applied when braking and steering.
- ▶ Larger steering wheel movements are required.

- ▶ The towing vehicle must not be lighter than the vehicle being towed; otherwise, it will not be possible to control the vehicle response.

### Tow truck

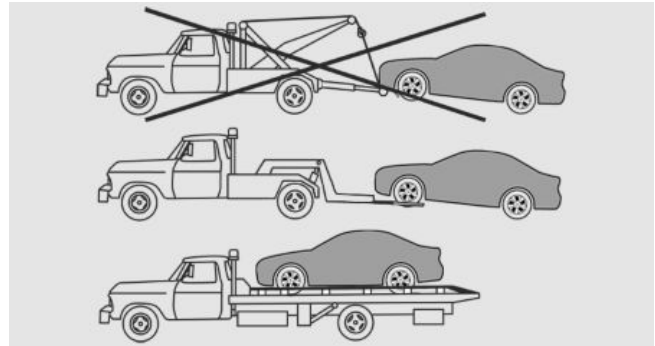

Your vehicle should be transported with a tow truck with a so-called lift bar or on a flat bed.

 Do not lift the vehicle  
Do not lift the vehicle by the tow fitting or body and chassis parts; otherwise, damage may result. ◀

### Automatic transmission: transporting your vehicle

### Note

Your vehicle is not permitted to be towed. Therefore, contact a service center in the event of a breakdown.

 Do not have the vehicle towed  
Have your vehicle transported on a loading platform only; otherwise, damage may occur. ◀

## Tow truck

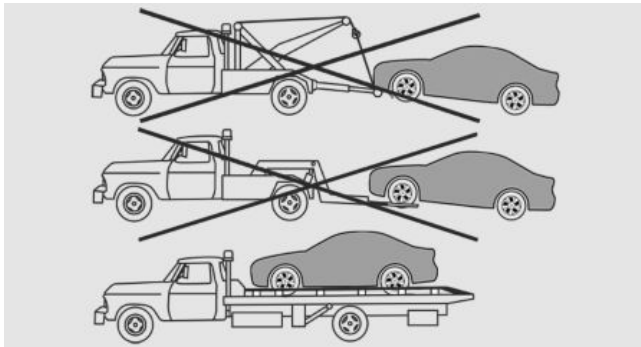

The vehicle should only be transported on a loading platform.



Do not lift the vehicle

Do not lift the vehicle by the tow fitting or body and chassis parts; otherwise, damage may result. ◀

Use the tow fitting screwed in at the front for maneuvering the vehicle only.

## Towing other vehicles

### General information



Light towing vehicle

The towing vehicle must not be lighter than the vehicle being towed; otherwise, it will not be possible to control the vehicle response. ◀



Attaching the tow bar/tow rope correctly

Attach the tow bar or tow rope to the tow fitting; connecting it to other vehicle parts may cause damage. ◀

- ▶ Switch on the hazard warning system, depending on local regulations.
- ▶ If the electrical system has failed, clearly identify the vehicle being towed by placing a sign or a warning triangle in the rear window.

## Tow bar

The tow fittings used should be on the same side on both vehicles.

Should it prove impossible to avoid mounting the tow bar at an offset angle, please observe the following:

- ▶ Maneuvering capability is limited during cornering.
- ▶ The tow bar will generate lateral forces if it is secured with an offset.

## Tow rope

When starting to tow the vehicle, make sure that the tow rope is taut.

To avoid jerking and the associated stresses on the vehicle components when towing, always use nylon ropes or nylon straps.



Attaching the tow rope correctly

Only secure the tow rope on the tow fitting; otherwise, damage can occur when it is secured on other parts of the vehicle. ◀

## Tow fitting

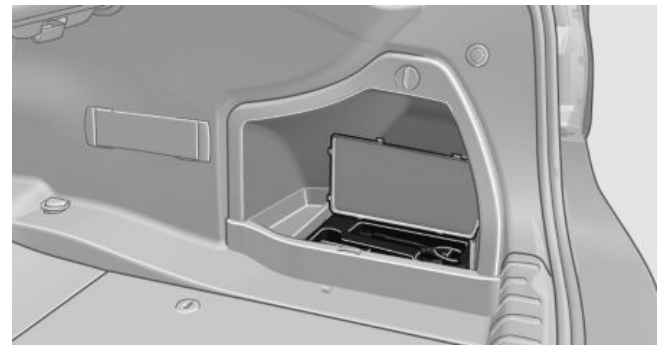

The screw-in tow fitting should always be carried in the vehicle. It can be screwed in at the front or rear of the BMW. It is in the onboard vehicle tool kit located in a storage compartment on the right side in the cargo area. Open the cover.



Tow fitting, information on use

- ▶ Use only the tow fitting provided with the vehicle and screw it all the way in.
- ▶ Use the tow fitting for towing on paved roads only.

- ▶ Avoid lateral loading of the tow fitting, e.g., do not lift the vehicle by the tow fitting.

Otherwise, damage to the tow fitting and the vehicle can occur. ◀

5. Stop at a suitable location, remove the tow bar or rope, and switch off the hazard warning system.
6. Have the vehicle checked.

## Screw thread



Press on the mark on the edge of the cover to push it out.

## Tow-starting

### Automatic transmission

Do not tow-start the vehicle.

Due to the automatic transmission, the engine cannot be started by tow-starting.

Have the cause of the starting difficulties remedied.

### Manual transmission

If possible, do not tow-start the vehicle but start the engine by jump-starting, refer to page 216. If the vehicle is equipped with a catalytic converter, only tow-start while the engine is cold.

1. Switch on the hazard warning system and comply with local regulations.
2. Ignition, refer to page 61, on.
3. Engage third gear.
4. Have the vehicle tow-started with the clutch pedal pressed and slowly release the pedal. After the engine starts, immediately press on the clutch pedal again.

# Care

## Vehicle equipment

All standard, country-specific and optional equipment that is offered in the model series is described in this chapter. Therefore, equipment is also described that is not available in a vehicle, e. g., because of the selected optional equipment or country variant. This also applies for safety-related functions and systems.

## Car washes

### Hints



Steam jets or high-pressure washers

When using steam jets or high-pressure washers, hold them a sufficient distance away and use a maximum temperature of 140 °F/60 °C.

If the vehicle has a glass sunroof, ensure that a distance of at least 31.5 inches/80 cm is maintained. Holding them too close or using excessively high pressures or temperatures can cause damage or preliminary damage that may then lead to long-term damage.

Follow the user's manual for the high-pressure washer. ◀



Cleaning sensors/cameras with high-pressure washers

When using high-pressure washers, do not spray the exterior sensors and cameras, e.g., Park Distance Control, for extended periods of time and only from a distance of at least 12 in/30 cm. ◀

- ▶ Regularly remove foreign items such as leaves in the area below the windshield when the hood is raised.
- ▶ Wash your vehicle frequently, particularly in winter.

Intense soiling and road salt can damage the vehicle.

## Automatic car washes

### Hints

- ▶ Give preference to cloth car washes or those that use soft brushes in order to avoid paint damage.
- ▶ Make sure that the wheels and tires are not damaged by the transport mechanisms.
- ▶ Fold in the exterior mirrors; otherwise, they may be damaged, depending on the width of the vehicle.
- ▶ Deactivate the rain sensor, refer to page 67, to avoid unintentional wiper activation.
- ▶ In some cases, an unintentional alarm can be triggered by the interior motion sensor of the alarm system. Follow the instructions on avoiding an unintentional alarm, refer to page 43.



Guide rails in car washes

Avoid car washes with guide rails higher than 4 in/10 cm; otherwise, the vehicle body could be damaged. ◀

## Before driving into a car wash

In order to ensure that the vehicle can roll in a car wash, take the following steps:

Manual transmission:

1. Drive into the car wash.
2. Shift to neutral.
3. Switch the engine off.
4. Switch on the ignition.

Automatic transmission:

1. Drive into the car wash.



2. Engage selector lever position N.
3. Switch the engine off.

In this way, the ignition remains switched on, and a Check-Control message is displayed.



Do not turn off the ignition in the car wash

Do not turn off the ignition in the car wash; otherwise, selector lever position P is engaged and damages can result. ◀

To start the engine:

1. Depress the brake pedal.
2. Press the Start/Stop button.

Pressing the Start/Stop button without stepping on the brake turns the ignition off.

The vehicle cannot be locked from the outside when in selector lever position N. A signal is sounded when an attempt is made to lock the vehicle.

### Selector lever position

Selector lever position P is engaged automatically:

- ▷ When the ignition is switched off.
- ▷ After approx. 15 minutes.

### Headlamps

- ▷ Do not rub dry and do not use abrasive or caustic cleansers.
- ▷ Soak areas that have been soiled e.g. due to insects, with shampoo and wash off with water.
- ▷ Thaw ice with deicing spray; do not use an ice scraper.

### After washing the vehicle

After washing the vehicle, apply the brakes briefly to dry them; otherwise, braking action can be reduced and corrosion of the brake discs can occur.

Completely remove all residues on the windows, to minimize loss of visibility due to smearing and to reduce wiper noises and wiper blade wear.

## Vehicle care

### Car care products

BMW recommends using cleaning and care products from BMW, since these have been tested and approved.



Car care and cleaning products

Follow the instructions on the container.

When cleaning the interior, open the doors or windows.

Only use products intended for cleaning vehicles.

Cleansers can contain substances that are dangerous and harmful to your health. ◀

### Vehicle paint

Regular care contributes to driving safety and value retention. Environmental influences in areas with elevated air pollution or natural contaminants, such as tree resin or pollen can affect the vehicle's paintwork. Tailor the frequency and extent of your car care to these influences.

Aggressive substances, such as spilled fuel, oil, grease or bird droppings, must be removed immediately to prevent the finish from being altered or discolored.

### Leather care

Remove dust from the leather often, using a cloth or vacuum cleaner.

Otherwise, particles of dust and road grime chafe in pores and folds, and lead to increased wear and premature degradation of the leather surface.



To guard against discoloration, such as from clothing, provide leather care roughly every two months.

Clean light-colored leather more frequently because soiling on such surfaces is substantially more visible.

Use leather care products; otherwise, dirt and grease will gradually break down the protective layer of the leather surface.

Suitable care products are available from the service center.

### Upholstery material care

Vacuum regularly with a vacuum cleaner.

If they are very dirty, e.g., beverage stains, use a soft sponge or microfiber cloth with a suitable interior cleaner.

Clean the upholstery down to the seams using large sweeping motions. Avoid rubbing the material vigorously.



Damage from Velcro® fasteners

Open Velcro® fasteners on pants or other articles of clothing can damage the seat covers. Ensure that any Velcro® fasteners are closed. ◀

### Caring for special components

#### Light-alloy wheels

When cleaning the vehicle, use only neutral wheel cleaners having a pH value from 5 to 9. Do not use abrasive cleaning agents or steam jets above 140 °F/60 °C. Follow the manufacturer's instructions.

Aggressive, acidic or alkaline cleaning agents can destroy the protective layer of adjacent components, such as the brake disk.

#### Chrome surfaces

Carefully clean components such as the radiator grille or door handles with an ample supply of water, possibly with shampoo added, partic-

ularly when they have been exposed to road salt.

### Rubber components

Aside from water, treat only with rubber cleansers.

When cleaning rubber seals, do not use any silicon-containing car care products in order to avoid damage or reduced noise damping.

### Fine wood parts

Clean fine wood facing and fine wood components only with a moist rag. Then dry with a soft cloth.

### Plastic components

These include:

- ▷ Imitation leather surfaces.
- ▷ Headliner.
- ▷ Lamp lenses.
- ▷ Instrument cluster cover.
- ▷ Matte black spray-coated components.
- ▷ Painted parts in the interior.

Clean with a microfiber cloth.

Lightly dampen the cloth with water.

Do not soak the headliner.



Do not use cleansers that contain alcohol or solvents

Do not use cleansers that contain alcohol or solvents, such as lacquer thinners, heavy-duty grease removers, fuel, or such; this could lead to surface damage. ◀

### Safety belts

Dirty belt straps impede the reeling action and thus have a negative impact on safety.



Chemical cleaning

Do not clean chemically; this can destroy the webbing. ◀

Use only a mild soapy solution, with the safety belts clipped into their buckles.

Do not allow the reels to retract the safety belts until they are dry.

### Carpets and floor mats



No objects in the area around the pedals

Keep floor mats, carpets, and any other objects out of the area of motion of the pedals; otherwise, the function of the pedals could be impeded while driving and create the risk of an accident.

Do not place additional floor mats over existing mats or other objects.

Only use floor mats that have been approved for the vehicle and can be properly fixed in place.

Ensure that the floor mats are securely fastened again after they were removed for cleaning, for example. ◀

Floor mats can be removed from the passenger compartment for cleaning.

If the floor carpets are very dirty, clean with a microfiber cloth and water or a textile cleaner. To prevent matting of the carpet, rub back and forth in the direction of travel only.

### Sensors/cameras

To clean sensors and cameras, use a cloth moistened with a small amount of glass cleaner.

### Displays/screens

Clean the displays with an antistatic microfiber cloth.



Cleaning displays

Do not use chemical or household cleansers.

Keep all fluids and moisture away from the unit.

Otherwise, they could affect or damage surfaces or electrical components.

Avoid pressing too hard when cleaning and do not use abrasive materials; otherwise, damage can result. ◀

### Long-term vehicle storage

When the vehicle is shut down for longer than three months, special measures must be taken. Additional information is available from the service center.





## Reference

This chapter contains the technical data and an index that will quickly take you to the information you need.

# Technical data

## Vehicle equipment

All standard, country-specific and optional equipment that is offered in the model series is described in this chapter. Therefore, equip-

ment is also described that is not available in a vehicle, e. g., because of the selected optional equipment or country variant. This also applies for safety-related functions and systems.

## Dimensions

### BMW 3 Series Limousine

Width with mirrors	inches/mm	79.9/2,031
Width without mirrors	inches/mm	71.3/1,811
Height	inches/mm	56.4/1,434
Length	inches/mm	182.2/4,627
Wheel base	inches/mm	110.6/2,810
Smallest turning circle diam.	ft/m	37.1/11.3
Smallest turning circle diameter with xDrive	ft/m	38.4/11.7

## Weights

The values preceding the slash apply to vehicles with manual transmission; the values fol-

lowing the slash apply to vehicles with automatic transmission.

### 320i

Approved gross vehicle weight	lbs	4,300/4,340
	kg	1,950/1,969
Load	lbs/kg	900/408
Approved front axle load	lbs/kg	1,985/900
Approved rear axle load	lbs/kg	2,480/1,125
Approved roof load capacity	lbs/kg	165/75
Cargo area capacity	cu ft/l	16.9/480



**328i**

Approved gross vehicle weight	lbs	4,365/4,420
	kg	1,980/2,005
Load	lbs/kg	900/408
Approved front axle load	lbs/kg	2,015/914
Approved rear axle load	lbs/kg	2,510/1,139
Approved roof load capacity	lbs/kg	165/75
Cargo area capacity	cu ft/l	16.9/480

**335i**

Approved gross vehicle weight	lbs	4,540/4,565
	kg	2,059/2,071
Load	lbs/kg	900/408
Approved front axle load	lbs/kg	2,140/971
Approved rear axle load	lbs/kg	2,535/1,150
Approved roof load capacity	lbs/kg	165/75
Cargo area capacity	cu ft/l	16.9/480

**320i xDrive**

Approved gross vehicle weight	lbs	4,465/4,505
	kg	2,025/2,043
Load	lbs/kg	900/408
Approved front axle load	lbs/kg	2,125/964
Approved rear axle load	lbs/kg	2,510/1,139
Approved roof load capacity	lbs/kg	165/75
Cargo area capacity	cu ft/l	16.9/480

**328i xDrive**

Approved gross vehicle weight	lbs/kg	4,585/2,080
Load	lbs/kg	900/408
Approved front axle load	lbs/kg	2,160/980
Approved rear axle load	lbs/kg	2,555/1,159
Approved roof load capacity	lbs/kg	165/75
Cargo area capacity	cu ft/l	16.9/480

**335i xDrive**

Approved gross vehicle weight	lbs kg	4,675/4,695 2,121/2,130
Load	lbs/kg	900/408
Approved front axle load	lbs/kg	2,280/1,034
Approved rear axle load	lbs/kg	2,560/1,161
Approved roof load capacity	lbs/kg	165/75
Cargo area capacity	cu ft/l	16.9/480

**328d**

Approved gross vehicle weight	lbs/kg	4,365/1,980
Load	lbs/kg	900/408
Approved front axle load	lbs/kg	1,995/905
Approved rear axle load	lbs/kg	2,490/1,129
Approved roof load capacity	lbs/kg	165/75
Cargo area capacity	cu ft/l	16.9/480

**328d xDrive**

Approved gross vehicle weight	lbs/kg	4,540/2,059
Load	lbs/kg	900/408
Approved front axle load	lbs/kg	2,160/980

**328d xDrive**

Approved rear axle load	lbs/kg	2,525/1,145
Approved roof load capacity	lbs/kg	165/75
Cargo area capacity	cu ft/l	16.9/480

## Capacities

	US gal/liters	Notes
Fuel tank	Gasoline: 15.8/60 Diesel: 15/57	Fuel quality, refer to page <a href="#">180</a>

# Everything from A to Z

## Index

### A

- ABS, Antilock Brake System 114
- ACC, Active Cruise Control with Stop & Go 119
- Acceleration Assistant, refer to Launch Control 72
- Accessories and parts 7
- Activated-charcoal filter 146
- Active Blind Spot Detection 111
- Active Cruise Control with Stop & Go, ACC 119
- Adaptive brake lights, refer to Brake force display 113
- Adaptive Light Control 90
- Additives, oil 199
- Adjustments, seats/head restraints 47
- After washing vehicle 222
- Airbags 94
- Airbags, indicator/warning light 95
- Air circulation, refer to Recirculated-air mode 142, 145
- Air, dehumidifying, refer to Cooling function 142, 145
- Air distribution, manual 142, 146
- Air flow, air conditioner 142
- Air flow, automatic climate control 146
- Air pressure, tires 185
- Air vents, refer to Ventilation 146
- Alarm system 41
- Alarm, unintentional 43
- All around the center console 14
- All around the headliner 15
- All around the steering wheel 12
- All-season tires, refer to Winter tires 194
- All-wheel-drive 115
- Alternating-code hand-held transmitter 149
- Alternative oil types 200
- Antifreeze, washer fluid 68
- Antilock Brake System, ABS 114
- Anti-slip control, refer to DSC 114
- Approved axle load 228
- Approved engine oils 200
- Arrival time 85
- Ash tray 152
- Assistance, Roadside Assistance 216
- Assistance when driving off 118
- Assist system information, on Control Display 87
- AUTO intensity 145
- Automatic car wash 221
- Automatic climate control 141
- Automatic climate control with enhanced features 144
- Automatic Cruise Control with Stop & Go 119
- Automatic Curb Monitor 55
- Automatic deactivation, front passenger airbags 96
- Automatic headlamp control 90
- Automatic locking 41
- Automatic recirculated-air control 145
- Automatic transmission with Steptronic 69
- AUTO program, automatic climate control 144
- AUTO program, climate control 142
- AUTO program, intensity 145
- Auto Start/Stop function 63
- Average fuel consumption 84
- Average speed 84
- Axle loads, weights 228

### B

- Backrest curvature, refer to Lumbar support 49
- Backrest, width 49
- Band-aids, refer to First aid kit 216
- Bar for tow-starting/towing 219
- Battery replacement, vehicle battery 212
- Battery replacement, vehicle remote control 33
- Battery, vehicle 212
- Belts, safety belts 50
- Beverage holder, cupholder 158
- Blinds, sun protection 44
- BMW Advanced Diesel 181
- BMW Assist, see user's manual for Navigation, Entertainment and Communication
- BMW Homepage 6
- BMW Internet page 6
- BMW maintenance system 202
- Bonus range, ECO PRO 170
- Bottle holder, refer to Cupholder 158
- Brake assistant 114

Brake discs, breaking in [162](#)  
 Brake force display [113](#)  
 Brake lamps, brake force display [113](#)  
 Brake lights, adaptive [113](#)  
 Brake pads, breaking in [162](#)  
 Braking, hints [163](#)  
 Breakdown assistance [215](#), [216](#)  
 Breaking in [162](#)  
 Brightness of Control Display [87](#)  
 Bulb replacement [204](#)  
 Bulb replacement, front [205](#)  
 Bulb replacement, halogen headlamps [205](#)  
 Bulb replacement, rear [210](#)  
 Bulb replacement, xenon headlamps [208](#)  
 Bulbs and lamps [204](#)  
 Button, RES [122](#)  
 Button, Start/Stop [61](#)  
 Bypassing, refer to Jump-starting [216](#)

## C

California Proposition 65 Warning [7](#)  
 Camera, care [224](#)  
 Camera, rearview camera [131](#)  
 Camera, Side View [133](#)  
 Camera, Top View [135](#)  
 Can holder, refer to Cupholder [158](#)  
 Car battery [212](#)  
 Car care products [222](#)  
 Care, displays [224](#)  
 Care, vehicle [222](#)  
 Cargo [165](#)  
 Cargo area, enlarging [154](#)  
 Cargo area, storage compartments [159](#)  
 Cargo, securing [166](#)  
 Cargo straps, securing cargo [166](#)  
 Car key, refer to Remote control [32](#)  
 Carpet, care [224](#)  
 Car wash [221](#)  
 Catalytic converter, refer to Hot exhaust system [163](#)  
 CBS Condition Based Service [202](#)  
 CD/Multimedia, see user's manual for Navigation, Entertainment and Communication  
 Center armrest [157](#)  
 Center console [14](#)  
 Central locking system [37](#)  
 Central screen, refer to Control Display [16](#)  
 Changes, technical, refer to Safety [7](#)  
 Changing parts [204](#)  
 Changing wheels [212](#)  
 Changing wheels/tires [193](#)  
 Check Control [76](#)  
 Checking the oil level electronically [198](#)  
 Children, seating position [57](#)  
 Children, transporting safely [57](#)  
 Child restraint fixing system [57](#)  
 Child restraint fixing system LATCH [58](#)  
 Child restraint fixing systems, mounting [57](#)  
 Child safety locks [60](#)  
 Child seat, mounting [57](#)  
 Child seats [57](#)  
 Chrome parts, care [223](#)  
 Cigarette lighter [152](#)  
 Cleaning, displays [224](#)  
 Climate control [141](#), [144](#)  
 Clock [79](#)  
 Closing/opening via door lock [37](#)  
 Closing/opening with remote control [35](#)  
 Clothes hooks [158](#)  
 Coasting [172](#)  
 Coasting with engine decoupled, coasting [172](#)  
 Coasting with idling engine [172](#)  
 Cockpit [12](#)  
 Cold starting, refer to Starting the engine [62](#)  
 Collision warning with braking function [106](#)  
 Collision warning with City Braking function [103](#)  
 Combination switch, refer to Turn signals [65](#)  
 Combination switch, refer to Wiper system [66](#)  
 Comfort Access [39](#)  
 COMFORT program, Dynamic Driving Control [117](#)  
 Compartments in the doors [157](#)  
 Compass [150](#)  
 Computer [83](#)  
 Condensation on windows [146](#)  
 Condensation under the vehicle [164](#)  
 Condition Based Service CBS [202](#)  
 Configuring drive program [117](#)  
 Confirmation signal [41](#)  
 ConnectedDrive, see user's manual for Navigation, Entertainment and Communication  
 ConnectedDrive Services  
 Connecting electrical devices [152](#)  
 Control Display [16](#)  
 Control Display, settings [86](#)  
 Controller [16](#), [17](#)

Control systems, driving stability 114  
Convenient opening 35  
Coolant 201  
Coolant temperature 78  
Cooling function 142, 145  
Cooling, maximum 145  
Cooling system 201  
Corrosion on brake discs 164  
Cruise control 125  
Cruise control, active with Stop & Go 119  
Cruising range 79  
Cupholder 158  
Current fuel consumption 80

## D

Damage, tires 193  
Damping control, dynamic 115  
Data, technical 228  
Date 79  
Daytime running lights 90  
Defrosting, refer to defrosting the windows 142  
Defrosting, refer to Windows, defrosting 146  
Defrosting the windows 142  
Dehumidifying, air 142, 145  
Destination distance 84  
Diesel exhaust fluid, at low temperatures 182  
Diesel exhaust fluid, having refilled 182  
Diesel exhaust fluid, on minimum 182  
Diesel exhaust fluid, replenishing yourself 182  
Diesel particulate filter 163  
Digital clock 79  
Digital compass 150  
Dimensions 228  
Dimmable exterior mirrors 55  
Dimmable interior rearview mirror 56  
Direction indicator, refer to Turn signals 65  
Display, electronic, instrument cluster 75  
Display in windshield 87  
Display lighting, refer to Instrument lighting 92  
Displays 73  
Displays, cleaning 224  
Disposal, coolant 201  
Disposal, vehicle battery 213  
Distance control, refer to PDC 128  
Distance to destination 84  
Divided screen view, split screen 22  
Door lock 37  
Door lock, refer to Remote control 32  
Drive-off assistant 118  
Drive-off assistant, refer to DSC 114  
Driver assistance, refer to Intelligent Safety 102  
Driving Assistant, refer to Intelligent Safety 102  
Driving Dynamics Control 116  
Driving instructions, breaking in 162  
Driving mode 116  
Driving notes, general 162  
Driving stability control systems 114  
Driving style analysis 173  
Driving tips 162  
DSC Dynamic Stability Control 114  
DTC Dynamic Traction Control 115  
Dynamic Damping Control 115  
Dynamic Stability Control DSC 114  
Dynamic Traction Control DTC 115

## E

ECO PRO 169  
ECO PRO, bonus range 170  
ECO PRO display 169  
ECO PRO driving mode 169  
ECO PRO driving style analysis 173  
ECO PRO mode 169  
ECO PRO Tip - driving instruction 171  
EfficientDynamics 171  
Electronic displays, instrument cluster 75  
Electronic Stability Program ESP, refer to DSC 114  
Emergency detection, remote control 33  
Emergency release, fuel filler flap 178  
Emergency Request 215  
Emergency service, refer to Roadside Assistance 216  
Emergency start function, engine start 33  
Emergency unlocking, trunk lid 38  
Energy Control 80  
Energy recovery 80  
Engine, automatic Start/Stop function 63  
Engine, automatic switch-off 63  
Engine compartment 196  
Engine compartment, working in 197  
Engine coolant 201  
Engine idling when driving, coasting 172  
Engine oil 198  
Engine oil, adding 199  
Engine oil additives 199  
Engine oil change 200  
Engine oil filler neck 199  
Engine oil temperature 78



Engine oil types, alternative [200](#)  
 Engine oil types, approved [200](#)  
 Engine start during malfunction [33](#)  
 Engine start, jump-starting [216](#)  
 Engine start, refer to Starting the engine [62](#)  
 Engine stop [62](#)  
 Engine temperature [78](#)  
 Entering a car wash [221](#)  
 Equipment, interior [148](#)  
 ESP Electronic Stability Program, refer to DSC [114](#)  
 Exchanging wheels/tires [193](#)  
 Exhaust system [163](#)  
 Exterior mirror, automatic dimming feature [55](#)  
 Exterior mirrors [54](#)  
 External start [216](#)  
 External temperature display [79](#)  
 External temperature warning [79](#)  
 Eyes for securing cargo [166](#)

## F

Failure message, refer to Check Control [76](#)  
 False alarm, refer to Unintentional alarm [43](#)  
 Fan, refer to Air flow [142](#), [146](#)  
 Fault displays, refer to Check Control [76](#)  
 Filler neck for engine oil [199](#)  
 Fine wood, care [223](#)  
 First aid kit [216](#)  
 Fitting for towing, refer to Tow fitting [219](#)  
 Flat tire, changing wheels [212](#)  
 Flat Tire Monitor FTM [100](#)

Flat tire, Tire Pressure Monitor TPM [97](#)  
 Flat tire, warning lamp [98](#), [101](#)  
 Flooding [163](#)  
 Floor carpet, care [224](#)  
 Floor mats, care [224](#)  
 Fogged up windows [142](#)  
 Fold down the rear seat backrest, see Though-loading system [154](#)  
 Fold-out position, windshield wipers [68](#)  
 Foot brake [163](#)  
 Front airbags [94](#)  
 Front fog lamps [92](#)  
 Front fog lamps, bulb replacement [209](#)  
 Front lamps [205](#)  
 Front passenger airbags, automatic deactivation [96](#)  
 Front passenger airbags, indicator lamp [96](#)  
 FTM Flat Tire Monitor [100](#)  
 Fuel [180](#)  
 Fuel cap [178](#)  
 Fuel consumption, current [80](#)  
 Fuel consumption, refer to Average fuel consumption [84](#)  
 Fuel filler flap [178](#)  
 Fuel gauge [78](#)  
 Fuel quality [180](#)  
 Fuel recommendation [180](#)  
 Fuel, tank capacity [231](#)  
 Fuse [213](#)

## G

Garage door opener, refer to Universal garage door opener [148](#)  
 Gasoline [180](#)  
 Gear change, automatic transmission [70](#)  
 Gear shift indicator [81](#)

General driving notes [162](#)  
 Glass sunroof, powered [45](#)  
 Glove compartment [156](#)  
 Gross vehicle weight, approved [228](#)

## H

Handbrake, refer to parking brake [65](#)  
 Hand-held transmitter, alternating code [149](#)  
 Hazard warning flashers [215](#)  
 Head airbags [94](#)  
 Headlamp control, automatic [90](#)  
 Headlamp courtesy delay feature [89](#)  
 Headlamp flasher [66](#)  
 Headlamp glass [205](#)  
 Headlamps [205](#)  
 Headlamps, care [222](#)  
 Headlamp washer system [66](#)  
 Headliner [15](#)  
 Head restraints [47](#)  
 Head restraints, front [51](#)  
 Head restraints, rear [52](#)  
 Head-up Display [87](#)  
 Head-up Display, care [224](#)  
 Heavy cargo, stowing [166](#)  
 Height, vehicle [228](#)  
 High-beam Assistant [91](#)  
 High beams [66](#)  
 High beams/low beams, refer to High-beam Assistant [91](#)  
 Hills [164](#)  
 Hill start assistant, refer to Drive-off assistant [118](#)  
 Hints [6](#)  
 Holder for beverages [158](#)  
 Homepage [6](#)  
 Hood [197](#)  
 Horn [12](#)  
 Hotel function, trunk lid [38](#)  
 Hot exhaust system [163](#)  
 HUD Head-up Display [87](#)

Hydroplaning [163](#)

## I

Ice warning, see External temperature warning [79](#)

Icy roads, see External temperature warning [79](#)

Identification marks, tires [191](#)

Identification number, refer to Important features in the engine compartment [196](#)

iDrive [16](#)

Ignition key, refer to Remote control [32](#)

Ignition off [61](#)

Ignition on [61](#)

Indication of a flat tire [98](#), [101](#)

Indicator and warning lamps [76](#)

Individual air distribution [142](#), [146](#)

Individual settings, refer to Personal Profile [33](#)

Inflation pressure, tires [185](#)

Inflation pressure warning FTM, tires [100](#)

Info display, refer to Computer [83](#)

Initialize, Tire Pressure Monitor TPM [98](#)

Initializing, Flat Tire Monitor FTM [101](#)

Instrument cluster [73](#)

Instrument cluster, electronic displays [75](#)

Instrument lighting [92](#)

Integrated key [32](#)

Integrated Owner's Manual in the vehicle [27](#)

Intelligent Emergency Request [215](#)

Intelligent Safety [102](#)

Intensity, AUTO program [145](#)

Interior equipment [148](#)

Interior lamps [92](#)

Interior lamps via remote control [36](#)

Interior motion sensor [43](#)

Interior rearview mirror, automatic dimming feature [56](#)

Interior rearview mirror, compass [150](#)

Interior rearview mirror, manually dimmable [56](#)

Internet page [6](#)

Interval display, service requirements [80](#)

## J

Jacking points for the vehicle jack [212](#)

Joystick, automatic transmission [70](#)

Jump-starting [216](#)

## K

Key/remote control [32](#)

Keyless Go, refer to Comfort Access [39](#)

Key Memory, refer to Personal Profile [33](#)

Kickdown, automatic transmission [70](#)

Knee airbag [94](#)

## L

Lamp replacement [204](#)

Lamp replacement, front [205](#)

Lamp replacement, rear [210](#)

Lamps [89](#)

Lamps and bulbs [204](#)

Lane departure warning [110](#)

Lane margin, warning [110](#)

Language on Control Display [86](#)

Lashing eyes, securing cargo [166](#)

LATCH child restraint fixing system [58](#)

Launch Control [72](#)

Leather, care [222](#)

LEDs, light-emitting diodes [205](#)

Length, vehicle [228](#)

Letters and numbers, entering [23](#)

Light alloy wheels, care [223](#)

Light control [90](#)

Light-emitting diodes, LEDs [205](#)

Lighter [152](#)

Lighting [89](#)

Lighting via remote control [36](#)

Light switch [89](#)

Load [166](#)

Loading [165](#)

Lock, door [37](#)

Locking/unlocking via door lock [37](#)

Locking/unlocking with remote control [35](#)

Locking, automatic [41](#)

Locking, settings [41](#)

Lock, power window [44](#)

Locks, doors, and windows [60](#)

Low beams [89](#)

Low beams, automatic, refer to High-beam Assistant [91](#)

Lower back support [49](#)

Low-Sulfur Diesel [181](#)

Luggage rack, refer to Roof-mounted luggage rack [167](#)

Lumbar support [49](#)

## M

Maintenance [202](#)

Maintenance requirements [202](#)

Maintenance, service requirements [80](#)

- Maintenance system,  
BMW 202
- Malfunction displays, refer to  
Check Control 76
- Manual air distribu-  
tion 142, 146
- Manual air flow 142, 146
- Manual mode, transmis-  
sion 71
- Manual operation, door  
lock 37
- Manual operation, exterior  
mirrors 55
- Manual operation, fuel filler  
flap 178
- Manual operation, Park Dis-  
tance Control PDC 129
- Manual operation, rearview  
camera 131
- Manual operation, Side  
View 133
- Manual operation, Top  
View 135
- Manual transmission 69
- Marking on approved  
tires 194
- Marking, run-flat tires 195
- Master key, refer to Remote  
control 32
- Maximum cooling 145
- Maximum speed, display 81
- Maximum speed, winter  
tires 194
- Measure, units of 87
- Medical kit 216
- Memory, seat, mirror 53
- Menu, EfficientDynamics 171
- Menu in instrument clus-  
ter 83
- Menus, operating, iDrive 16
- Menus, refer to iDrive operat-  
ing concept 18
- Messages, refer to Check  
Control 76
- Microfilter 143, 146
- Minimum tread, tires 193
- Mirror 54
- Mirror memory 53
- Mobile communication devi-  
ces in the vehicle 163
- Modifications, technical, refer  
to Safety 7
- Moisture in headlamp 205
- Monitor, refer to Control Dis-  
play 16
- Mounting of child restraint fix-  
ing systems 57
- Multifunction steering wheel,  
buttons 12
- ## N
- Navigation, see user's manual  
for Navigation, Entertain-  
ment and Communication
- Neck restraints, front, refer to  
Head restraints 51
- Neck restraints, rear, refer to  
Head restraints 52
- Neutral cleaner, see wheel  
cleaner 223
- New wheels and tires 193
- No Passing Information 81
- Nylon rope for tow-starting/  
towing 219
- ## O
- OBD Onboard Diagnosis 202
- OBD, see OBD Onboard Di-  
agnosis 202
- Obstacle marking, rearview  
camera 132
- Octane rating, refer to Rec-  
ommended fuel grade 180
- Odometer 79
- Office, see user's manual for  
Navigation, Entertainment  
and Communication
- Oil 198
- Oil, adding 199
- Oil additives 199
- Oil change 200
- Oil change interval, service  
requirements 80
- Oil filler neck 199
- Oil types, alternative 200
- Oil types, approved 200
- Old batteries, disposal 213
- Onboard monitor, refer to  
Control Display 16
- Onboard vehicle tool kit 204
- Opening/closing via door  
lock 37
- Opening and closing 32
- Opening and closing, without  
remote control 37
- Opening and closing, with re-  
mote control 35
- Operating concept, iDrive 16
- Optional equipment, standard  
equipment 6
- Outside air, refer to Auto-  
matic recirculated-air con-  
trol 145
- Overheating of engine, refer  
to Coolant temperature 78
- ## P
- Paint, vehicle 222
- Parallel parking assistant 136
- Park Distance Control  
PDC 128
- Parked-car ventilation 147
- Parked vehicle, condensa-  
tion 164
- Parking aid, refer to PDC 128
- Parking assistant 136
- Parking brake 65
- Parking lamps 89
- Particulate filter 163
- Parts and accessories 7
- Passenger side mirror, tilting  
downward 55
- Pathway lines, rearview cam-  
era 131

PDC Park Distance Control [128](#)  
Pedestrian warning with city braking function [108](#)  
Personal Profile [33](#)  
Personal Profile, exporting profiles [34](#)  
Personal Profile, importing profiles [35](#)  
Pinch protection system, glass sunroof [45](#)  
Pinch protection system, windows [44](#)  
Plastic, care [223](#)  
Power failure [213](#)  
Power sunroof, glass [45](#)  
Power windows [43](#)  
Pressure, tire air pressure [185](#)  
Pressure warning FTM, tires [100](#)  
Profile, refer to Personal Profile [33](#)  
Programmable memory buttons, iDrive [22](#)  
Protective function, glass sunroof [45](#)  
Protective function, windows [44](#)  
Push-and-turn switch, refer to Controller [16](#), [17](#)

## R

Radiator fluid [201](#)  
Radio-operated key, refer to Remote control [32](#)  
Radio ready state [62](#)  
Radio, see user's manual for Navigation, Entertainment and Communication  
Rain sensor [67](#)  
Rear socket [153](#)  
Rear turn signal, bulb replacement [210](#)  
Rearview camera [130](#)

Rearview mirror [54](#)  
Rear window defroster [142](#), [146](#)  
Recirculated-air filter [146](#)  
Recirculated-air mode [142](#), [145](#)  
Recommended fuel grade [180](#)  
Recommended tire brands [194](#)  
Refueling [178](#)  
Remaining range [79](#)  
Remote control/key [32](#)  
Remote control, malfunction [36](#)  
Remote control, universal [148](#)  
Replacement fuse [213](#)  
Replacing parts [204](#)  
Replacing wheels/tires [193](#)  
Reporting safety defects [9](#)  
RES button [122](#)  
Reserve warning, refer to Range [79](#)  
Reset, Tire Pressure Monitor TPM [98](#)  
Retaining straps, securing cargo [166](#)  
Retreaded tires [194](#)  
Roadside parking lamps [90](#)  
Roller sunblinds [44](#)  
RON recommended fuel grade [180](#)  
Roof load capacity [228](#)  
Roof-mounted luggage rack [167](#)  
Rope for tow-starting/towing [219](#)  
RSC Run Flat System Component, refer to Run-flat tires [195](#)  
Rubber components, care [223](#)  
Run-flat tires [195](#)

## S

Safe braking [163](#)  
Safety [7](#)  
Safety belt reminder for driver's seat and front passenger seat [51](#)  
Safety belts [50](#)  
Safety belts, care [223](#)  
Safety switch, windows [44](#)  
Safety systems, airbags [94](#)  
Saving fuel [168](#)  
Screen, refer to Control Display [16](#)  
Screwdriver, see Onboard vehicle tool kit [204](#)  
Screw thread for tow fitting [220](#)  
Seat and mirror memory [53](#)  
Seat belts, refer to Safety belts [50](#)  
Seat heating, front [50](#)  
Seat heating, rear [50](#)  
Seating position for children [57](#)  
Seats [47](#)  
Selection list in instrument cluster [83](#)  
Selector lever, automatic transmission [70](#)  
Sensors, care [224](#)  
Service and warranty [8](#)  
Service requirements, Condition Based Service CBS [202](#)  
Service requirements, display [80](#)  
Service, Roadside Assistance [216](#)  
Services, ConnectedDrive Settings, locking/unlocking [41](#)  
Settings on Control Display [86](#)  
Settings, storing for seat, mirror [53](#)

- Shifting, automatic transmission [69](#)
- Shifting, manual transmission [69](#)
- Shift paddles on steering wheel [71](#)
- Side airbags [94](#)
- Side View [133](#)
- Signaling, horn [12](#)
- Signals when unlocking [41](#)
- Sitting safely [47](#)
- Size [228](#)
- Slide/tilt glass roof [45](#)
- Smallest turning circle [228](#)
- Snow chains [195](#)
- Socket [152](#)
- Socket, OBD Onboard Diagnostics [202](#)
- Soot particulate filter [163](#)
- SOS button [215](#)
- Spare fuse [213](#)
- Specified engine oil types [200](#)
- Speed, average [84](#)
- Speed limit detection, on-board computer [85](#)
- Speed limiter, display [81](#)
- Speed Limit Information [81](#)
- Speed warning [85](#)
- Split screen [22](#)
- SPORT+ - program, Dynamic Driving Control [116](#)
- Sport automatic transmission [71](#)
- Sport displays, torque display, performance display [85](#)
- SPORT program, Dynamic Driving Control [117](#)
- Sport program, transmission [71](#)
- Sport steering, variable [116](#)
- Stability control systems [114](#)
- Start/stop, automatic function [63](#)
- Start/Stop button [61](#)
- Start function during malfunction [33](#)
- Starting the engine [62](#)
- Status control display, tires [97](#)
- Status information, iDrive [21](#)
- Status of Owner's Manual [6](#)
- Steering wheel, adjusting [56](#)
- Steering wheel heating [56](#)
- Steptronic, automatic transmission [69](#)
- Stopping the engine [62](#)
- Storage compartment in the rear [158](#)
- Storage compartments [156](#)
- Storage compartments, locations [156](#)
- Storage, tires [195](#)
- Storing the vehicle [224](#)
- Summer tires, tread [193](#)
- Supplementary text message [77](#)
- Surround View [130](#)
- Switch for Dynamic Driving [116](#)
- Switch-on times, parked-car ventilation [147](#)
- Switch, refer to Cockpit [12](#)
- Symbols [6](#)
- Symbols in the status field [21](#)
- ## T
- Tachometer [78](#)
- Tail lamp [210](#)
- Tail lamps [210](#), [212](#)
- Technical changes, refer to Safety [7](#)
- Technical data [228](#)
- Telephone, see user's manual for Navigation, Entertainment and Communication
- Temperature, automatic climate control [142](#), [144](#)
- Temperature display for external temperature [79](#)
- Temperature, engine oil [78](#)
- Tempomat, refer to Active Cruise Control [119](#)
- Terminal, starting aid [217](#)
- Text message, supplementary [77](#)
- Theft alarm system, refer to Alarm system [41](#)
- Thigh support [49](#)
- Through-loading system [154](#)
- Tilt alarm sensor [42](#)
- Time of arrival [85](#)
- Tire damage [193](#)
- Tire identification marks [191](#)
- Tire inflation pressure [185](#)
- Tire inflation pressure monitor, refer to FTM [100](#)
- Tire Pressure Monitor TPM [97](#)
- Tires, changing [193](#)
- Tires, everything on wheels and tires [185](#)
- Tires, run-flat tires [195](#)
- Tire tread [193](#)
- Tone, see user's manual for Navigation, Entertainment and Communication
- Tool [204](#)
- Top View [134](#)
- Total vehicle weight [228](#)
- Touchpad [19](#)
- Tow fitting [219](#)
- Towing [218](#)
- Tow-starting [218](#)
- Tow truck [218](#)
- TPM Tire Pressure Monitor [97](#)
- Traction control [115](#)
- TRACTION program, Dynamic Driving Control [115](#)
- Transmission, automatic [69](#)
- Transmission, manual [69](#)
- Transporting children safely [57](#)
- Tread, tires [193](#)
- Trip computer [85](#)



Triple turn signal activation [66](#)  
Trip odometer [79](#)  
Truck for tow-starting/  
towing [218](#)  
Trunk lid closing [38](#)  
Trunk lid, emergency unlock-  
ing [38](#)  
Trunk lid, hotel function [38](#)  
Trunk lid opening [38](#)  
Trunk lid via remote con-  
trol [36](#)  
Turning circle [228](#)  
Turning circle lines, rearview  
camera [132](#)  
Turn signals, operation [65](#)

## U

Unintentional alarm [43](#)  
Units of measure [87](#)  
Universal remote control [148](#)  
Unlock button, automatic  
transmission [70](#)  
Unlocking/locking via door  
lock [37](#)  
Unlocking/locking with re-  
mote control [35](#)  
Unlocking, settings [41](#)  
Updates made after the edito-  
rial deadline [6](#)  
Upholstery care [223](#)  
USB interface [153](#)

## V

Variable sport steering [116](#)  
Vehicle battery [212](#)  
Vehicle battery, replac-  
ing [212](#)  
Vehicle, breaking in [162](#)  
Vehicle care [222](#)  
Vehicle equipment [6](#)  
Vehicle identification number,  
refer to Identification num-

ber in the engine compart-  
ment [196](#)  
Vehicle jack [212](#)  
Vehicle paint [222](#)  
Vehicle storage [224](#)  
Vehicle wash [221](#)  
Ventilation [146](#)  
Ventilation, refer to Parked-  
car ventilation [147](#)  
Voice activation system [24](#)

## W

Warning indicators [76](#)  
Warning lamps [76](#)  
Warning messages, refer to  
Check Control [76](#)  
Warning triangle [216](#)  
Washer fluid [68](#)  
Washer nozzles, wind-  
shield [68](#)  
Washer system [66](#)  
Washing, vehicle [221](#)  
Water on roads [163](#)  
Weights [228](#)  
Welcome lamps [89](#)  
Wheel base, vehicle [228](#)  
Wheel cleaner [223](#)  
Wheels, changing [193](#)  
Wheels, everything on wheels  
and tires [185](#)  
Wheels, Flat Tire Monitor  
FTM [100](#)  
Wheels, Tire Pressure Moni-  
tor TPM [97](#)  
Width, vehicle [228](#)  
Window defroster,  
rear [142](#), [146](#)  
Windows, powered [43](#)  
Windshield washer fluid [68](#)  
Windshield washer noz-  
zles [68](#)  
Windshield washer sys-  
tem [66](#)  
Windshield wiper [66](#)

Windshield wipers, fold-out  
position [68](#)  
Winter diesel [181](#)  
Winter storage, care [224](#)  
Winter tires, suitable  
tires [194](#)  
Winter tires, tread [193](#)  
Wiper blades, replacing [204](#)  
Wiper fluid [68](#)  
Wiper system [66](#)  
Wood, care [223](#)  
Word match concept, naviga-  
tion [23](#)  
Wrench, see Onboard vehicle  
tool kit [204](#)

## X

xDrive [115](#)  
Xenon headlamps, bulb re-  
placement [208](#)





More about BMW

bmwusa.com



The Ultimate  
Driving Machine

01 40 2 925 743 ue

