

Avengers Compound

1

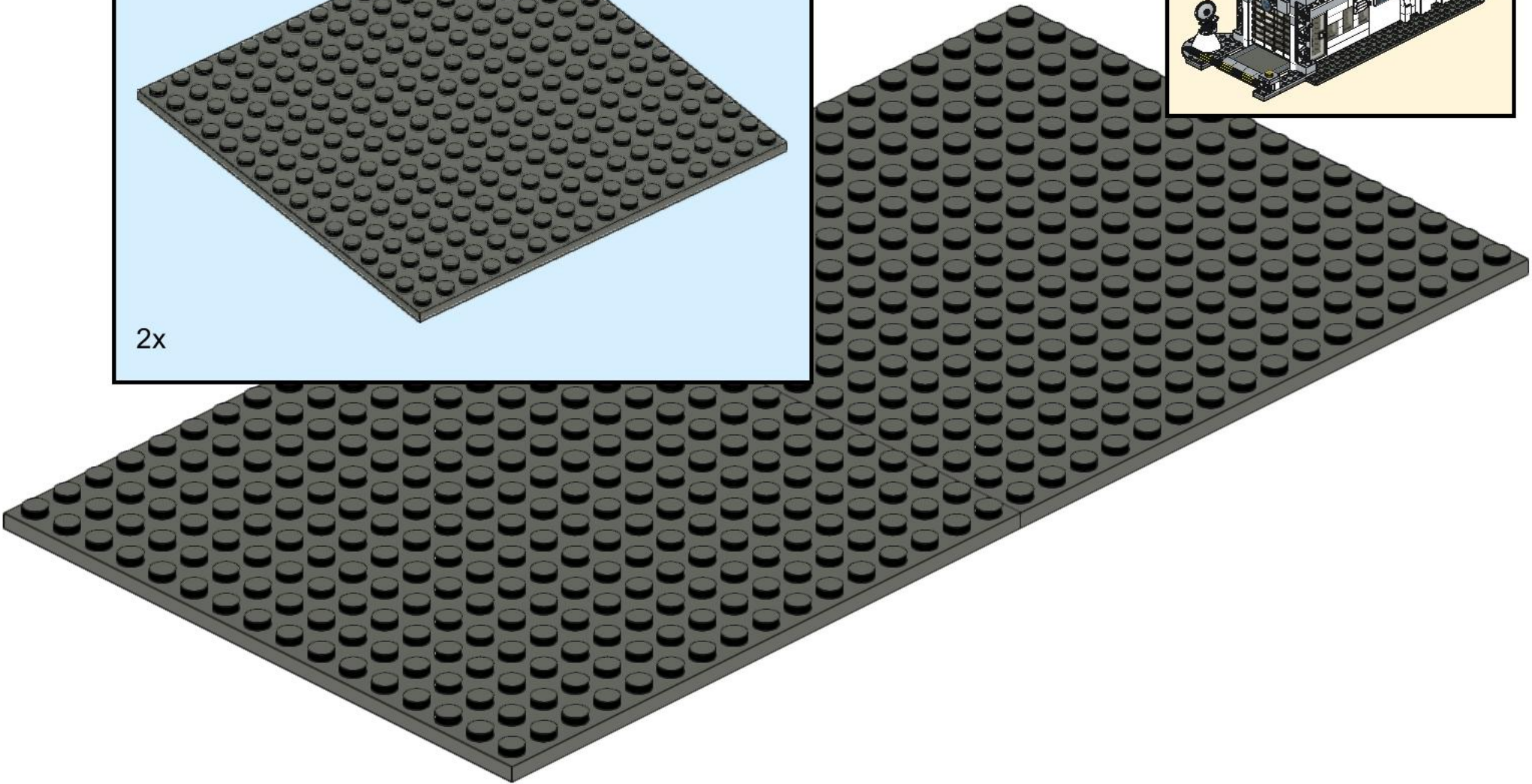

2

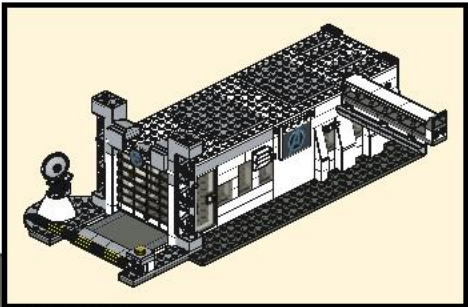
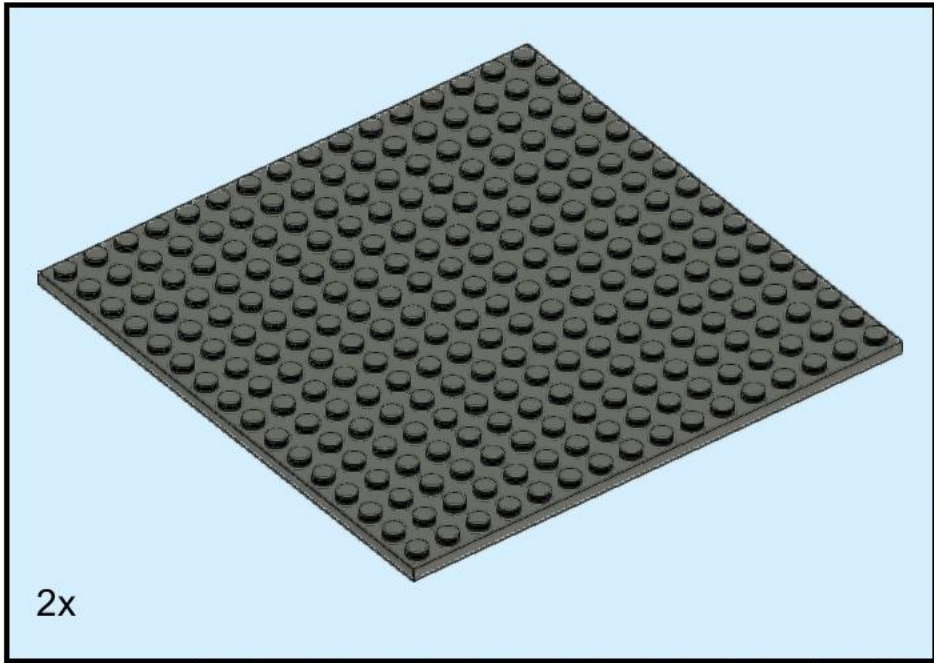
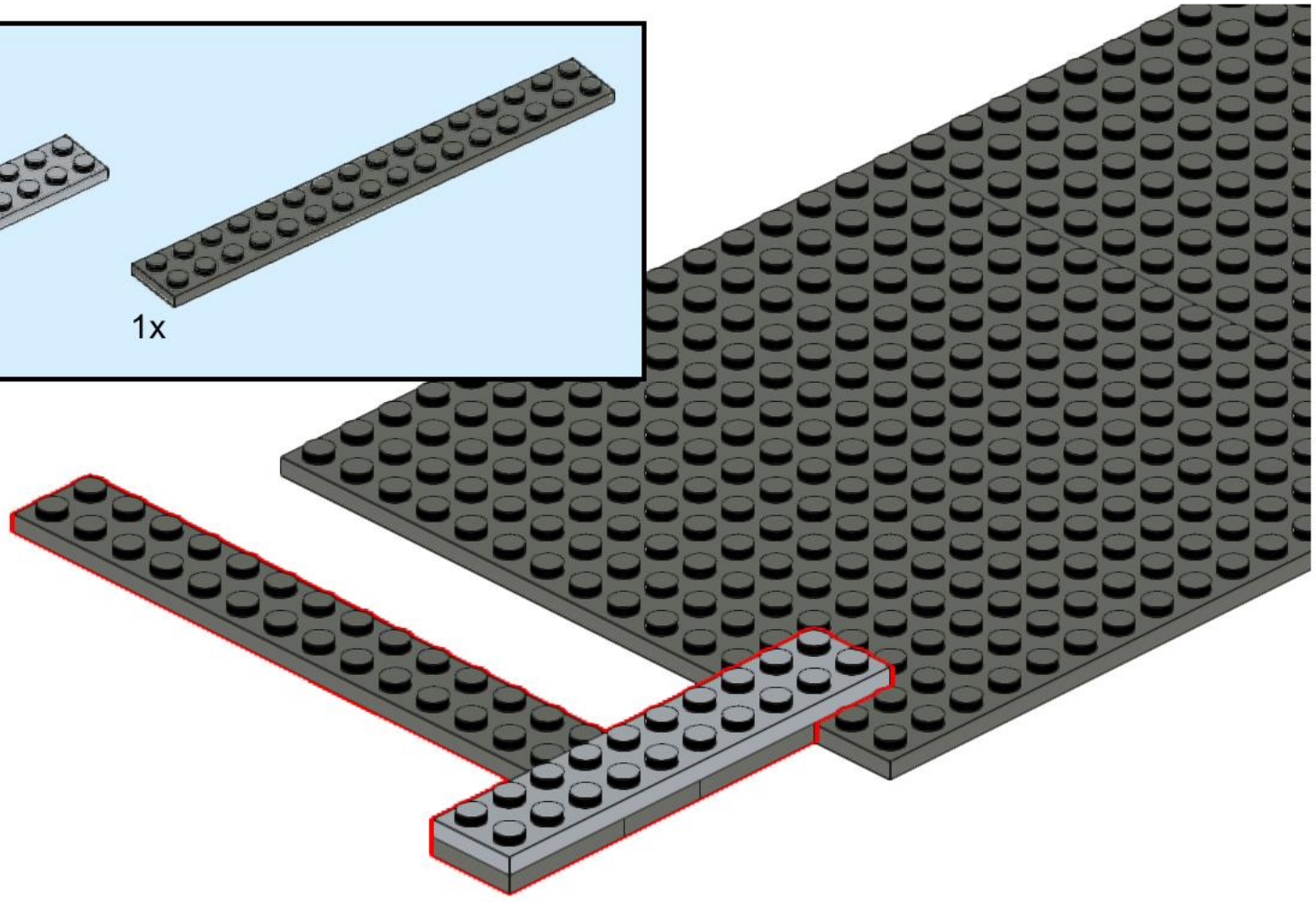
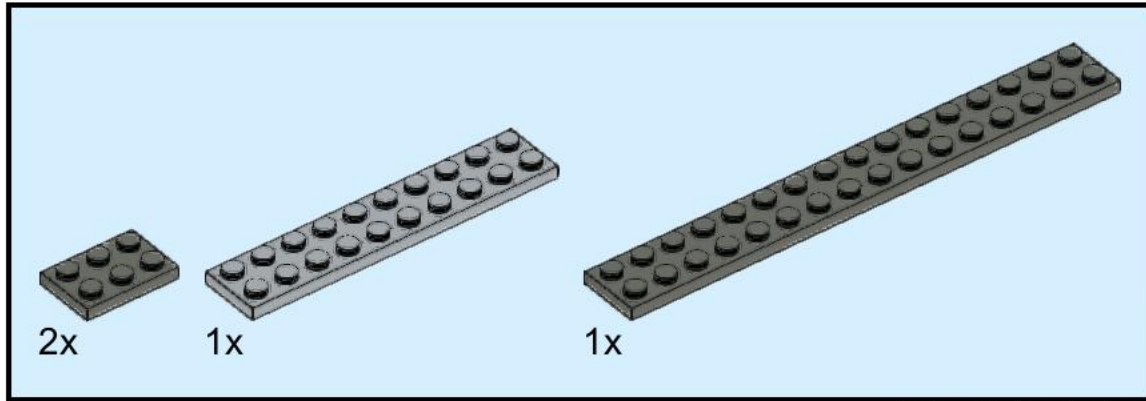

3

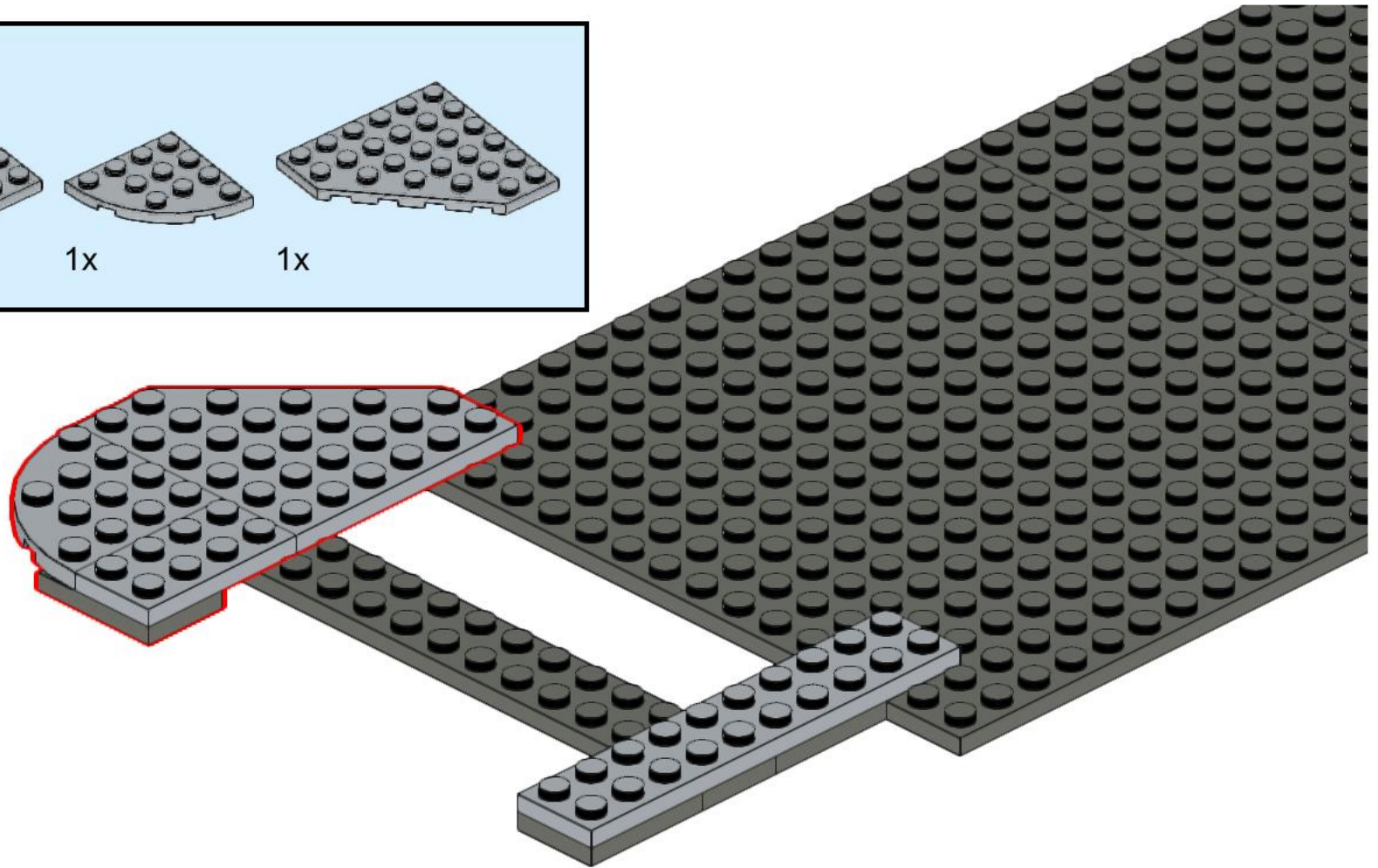
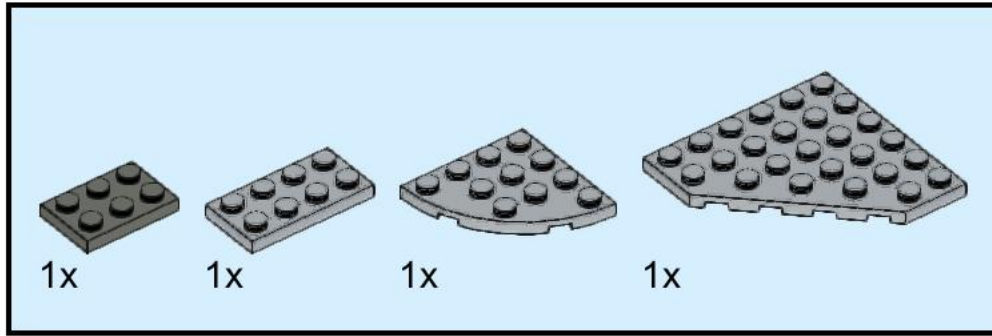

4

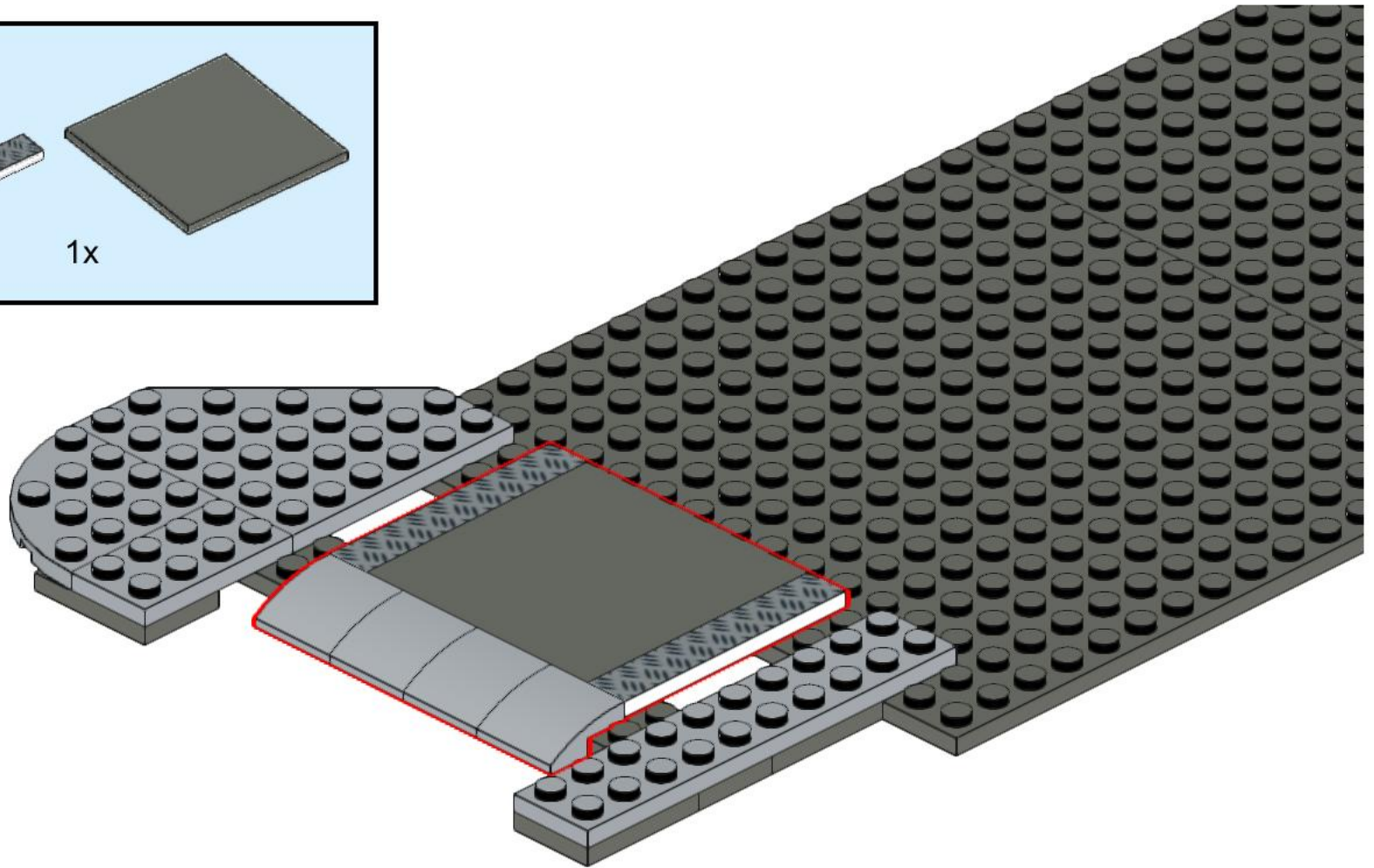
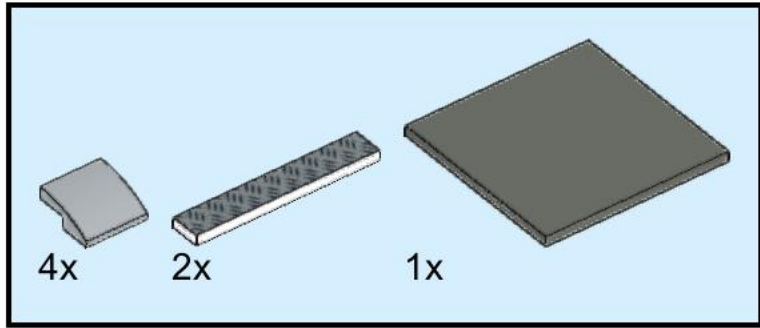

5

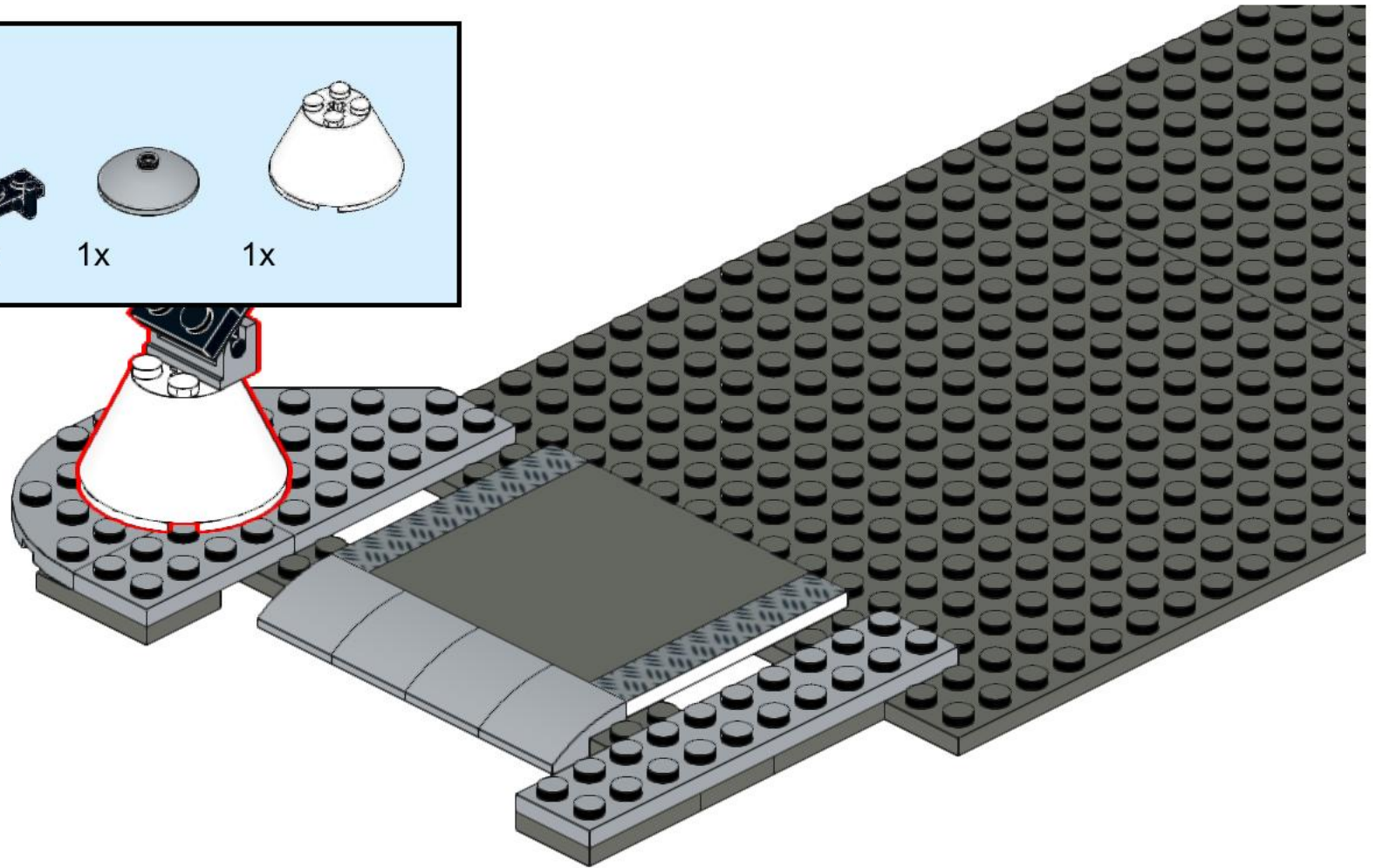
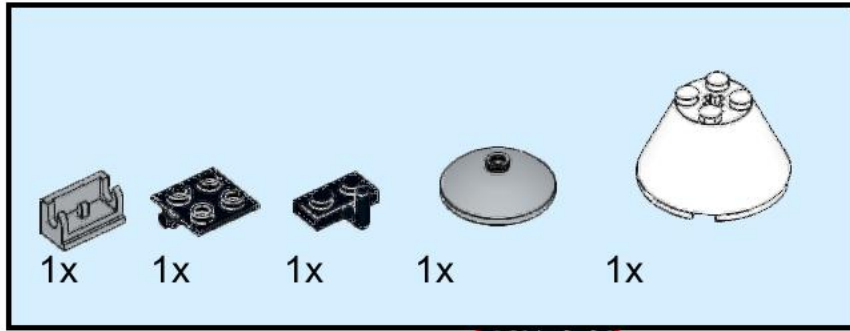

6

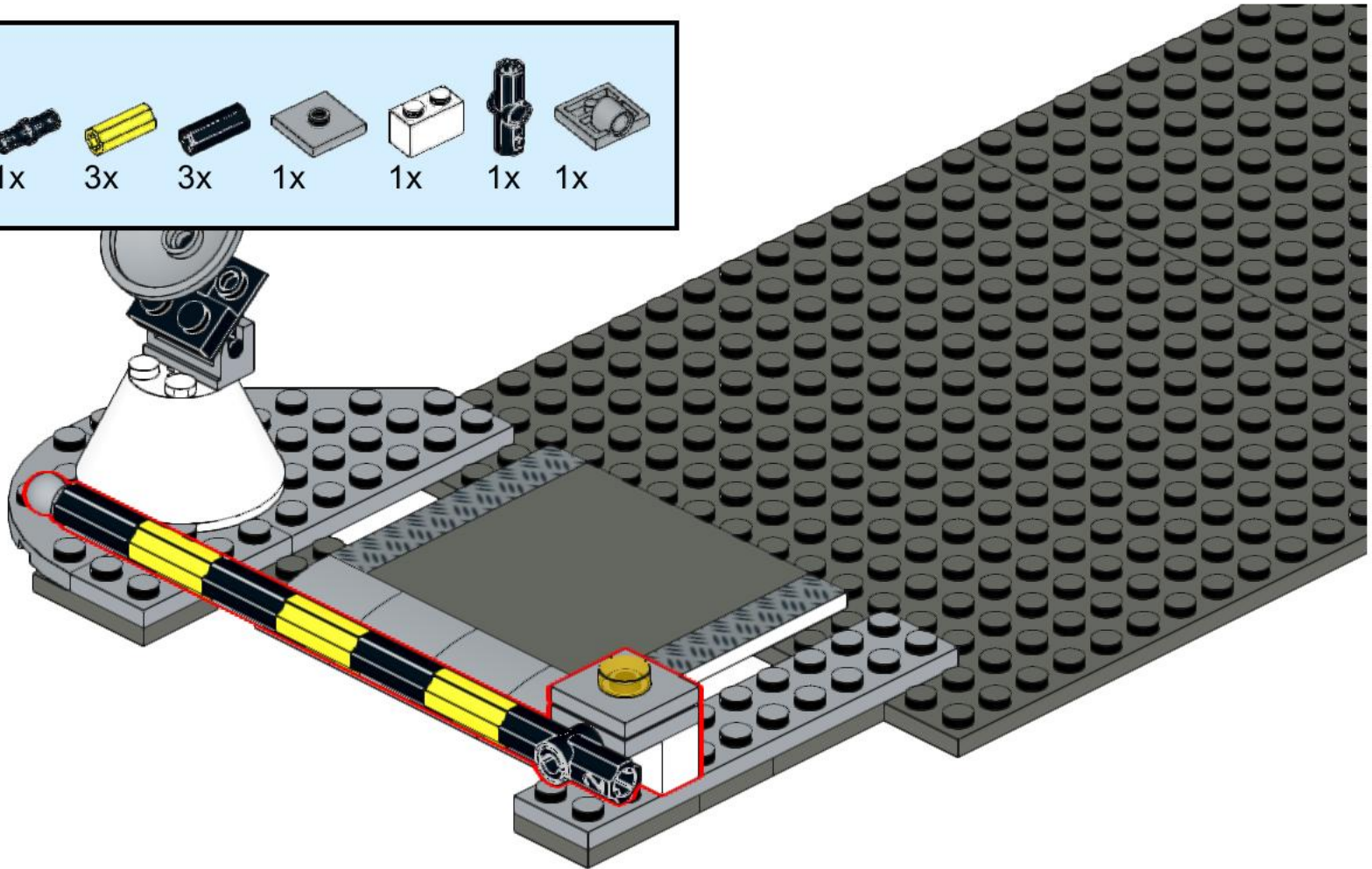
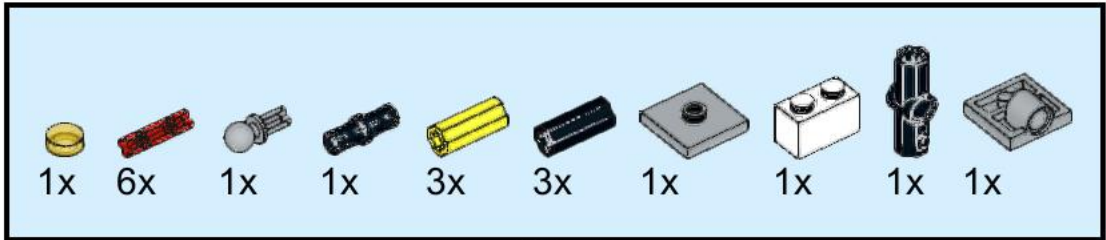

7

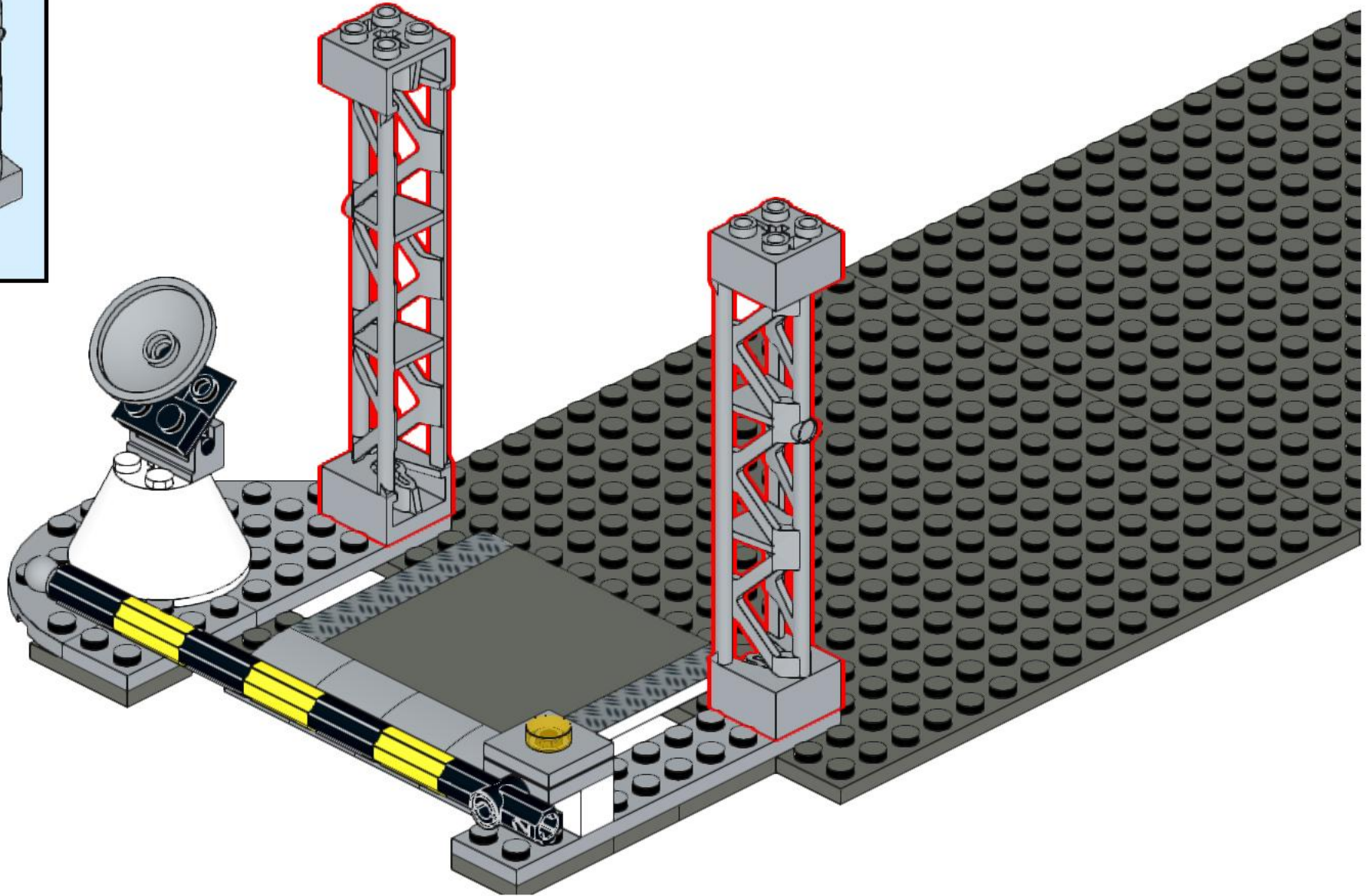
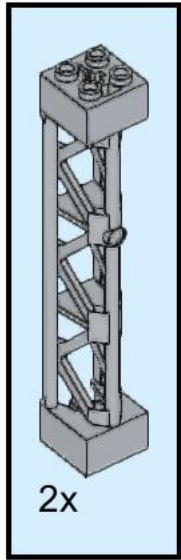

8

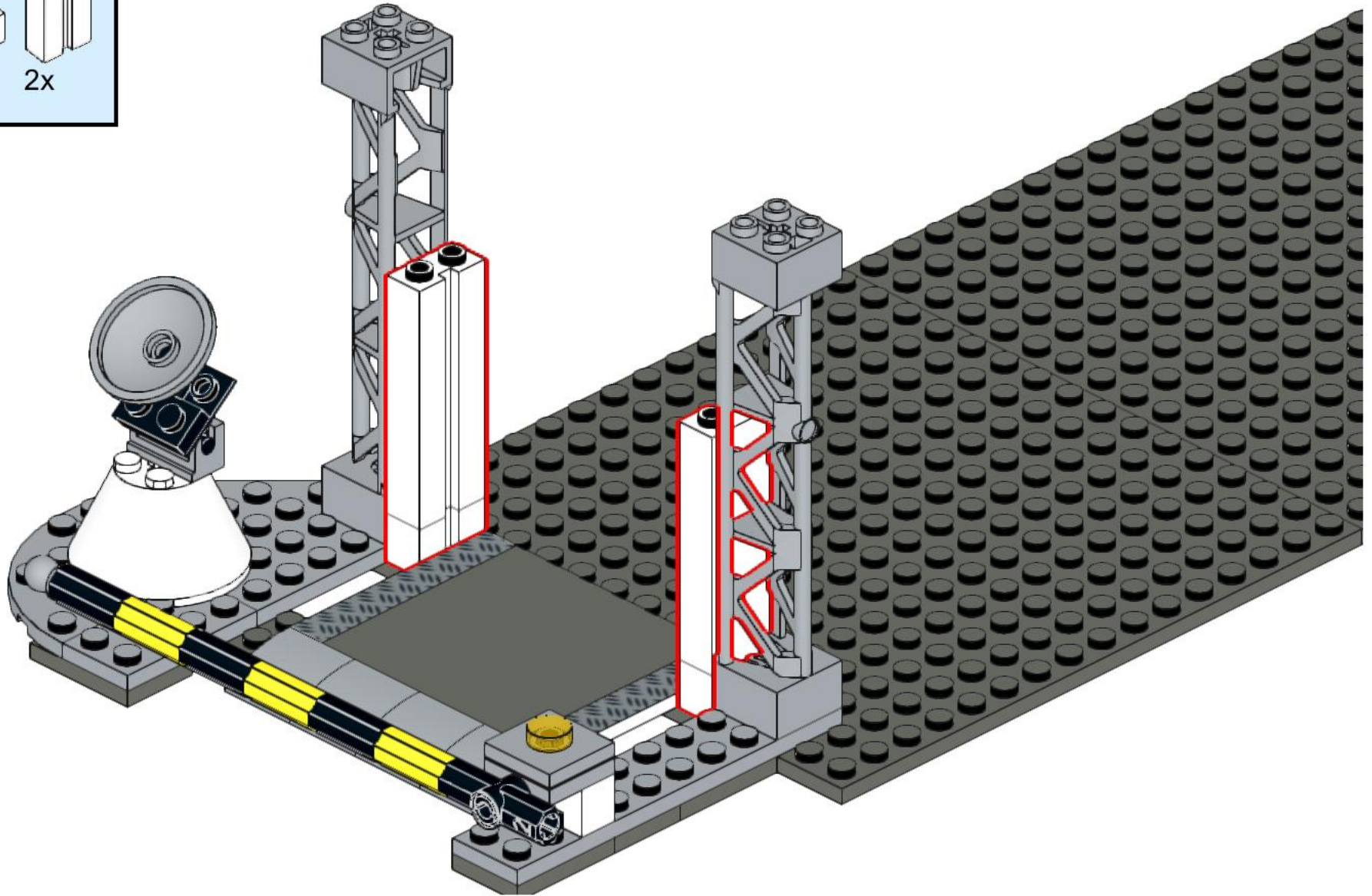
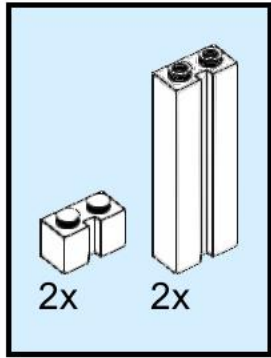

9

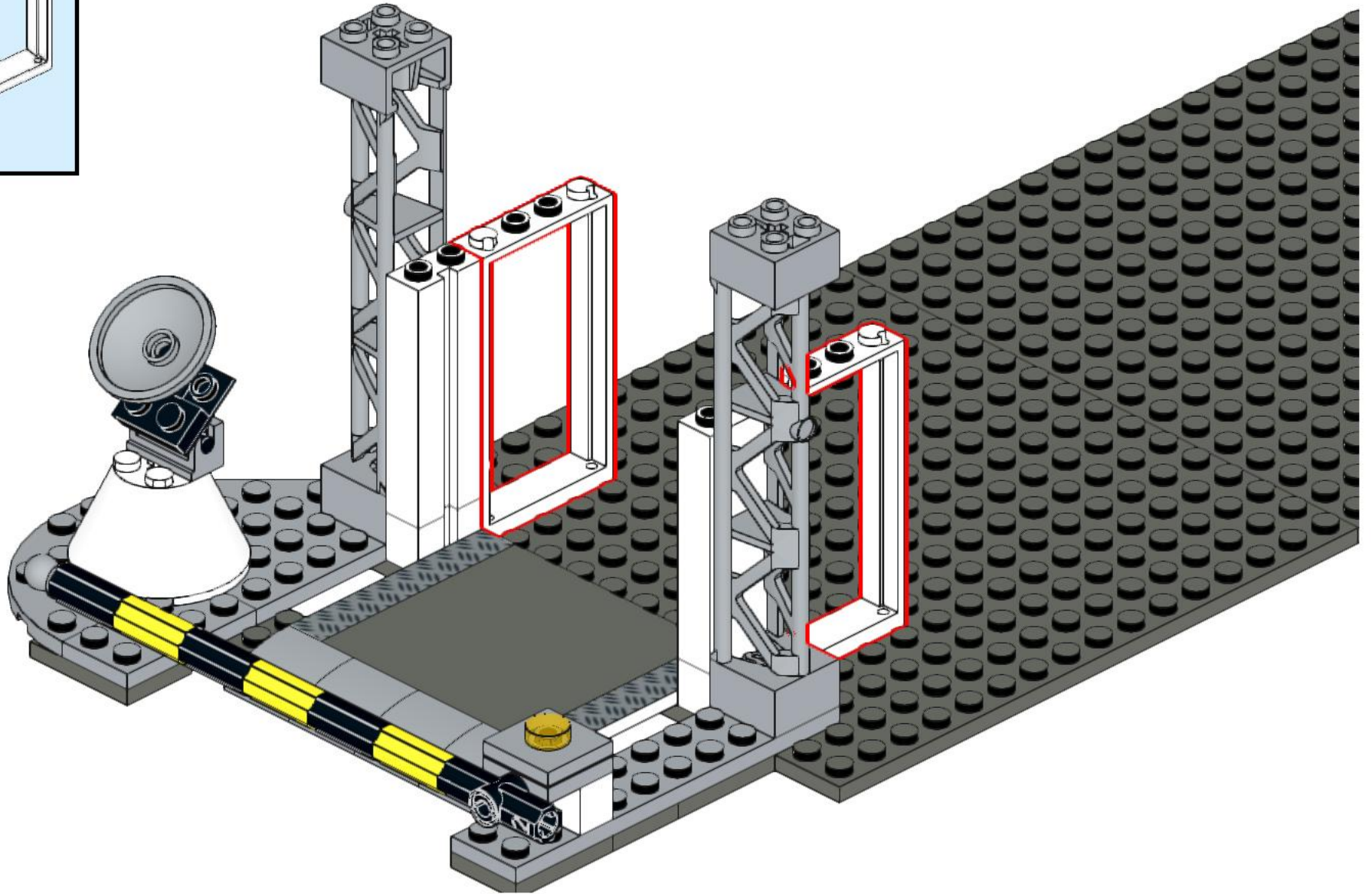
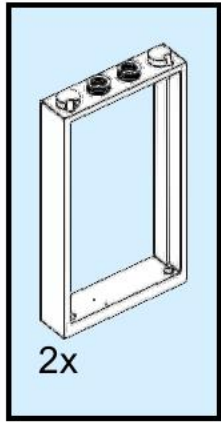

10

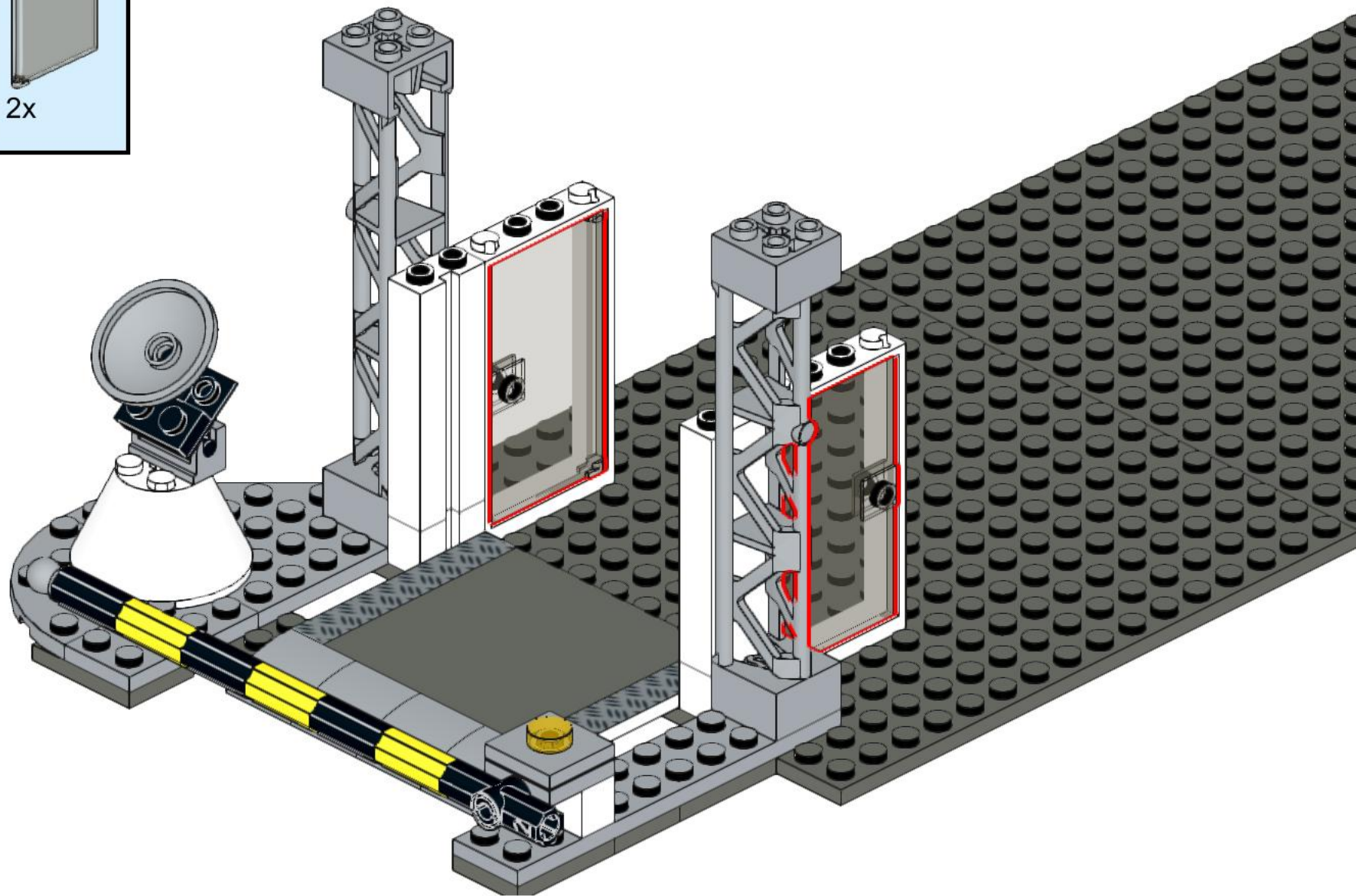
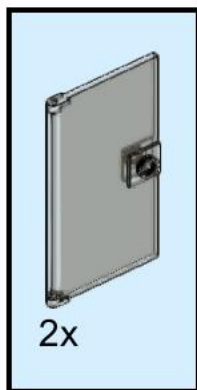

11

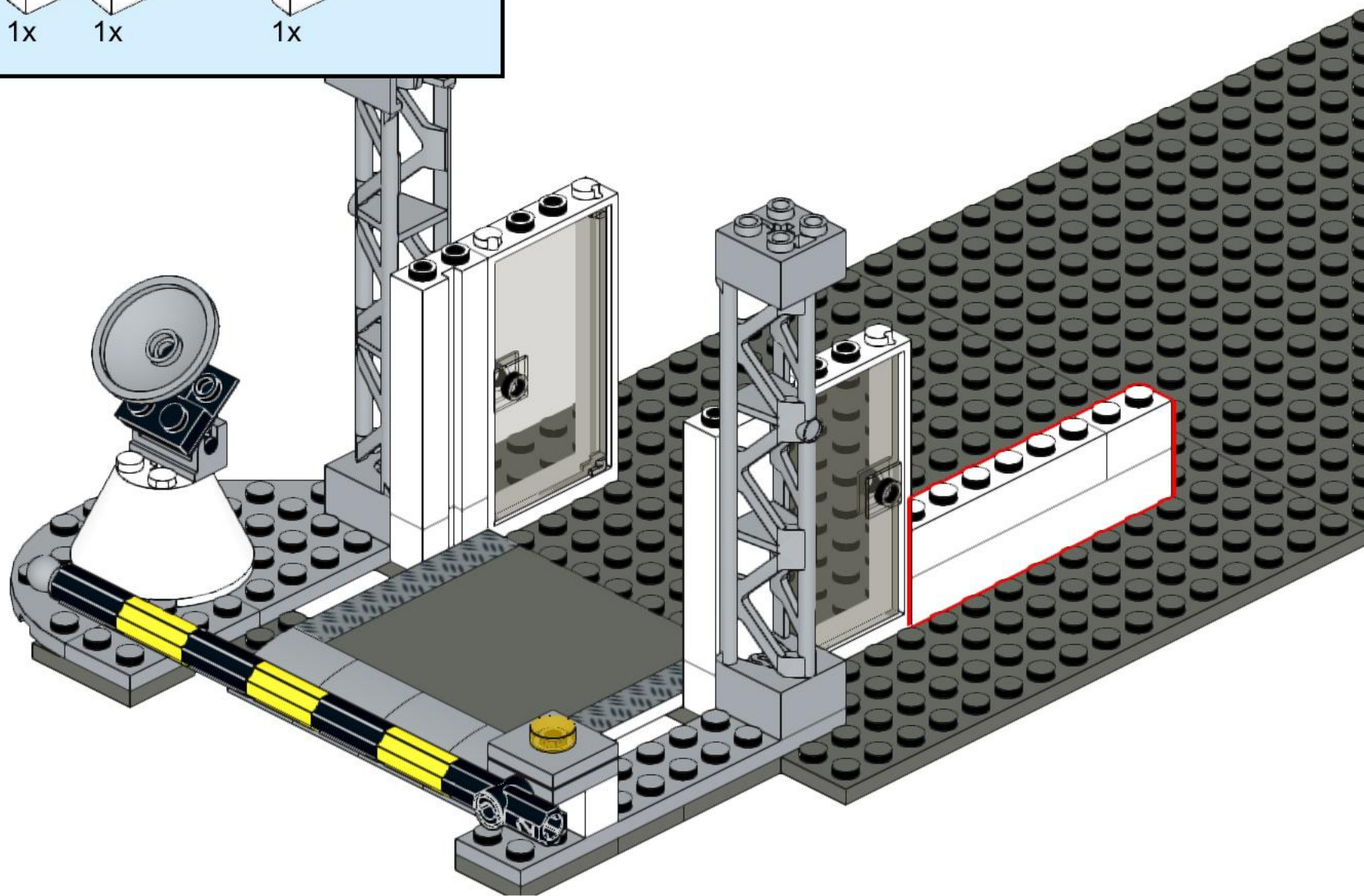
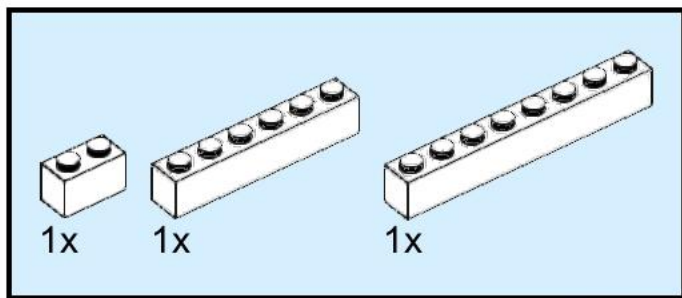

12

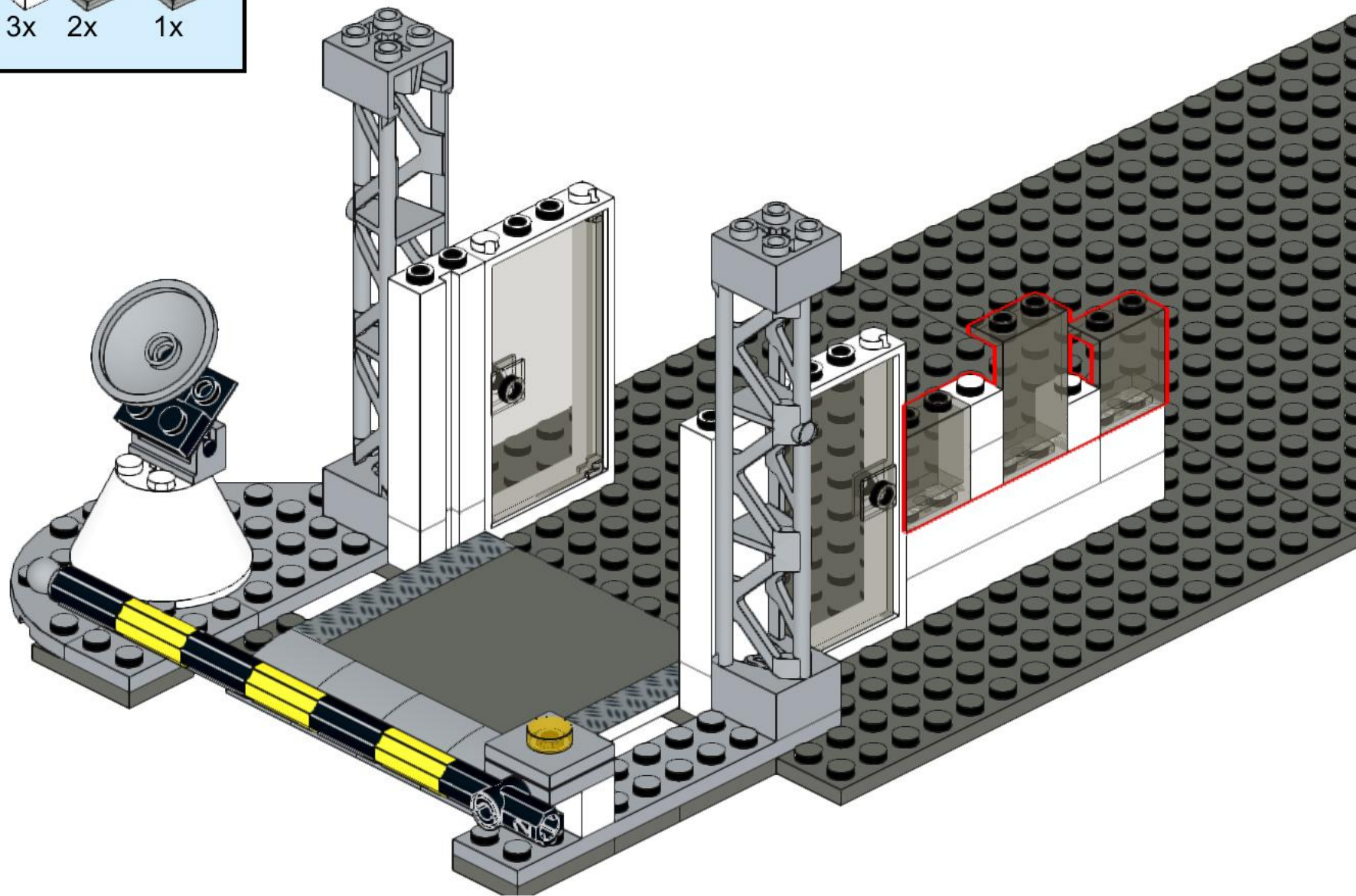
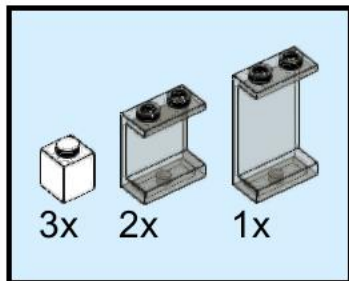

13

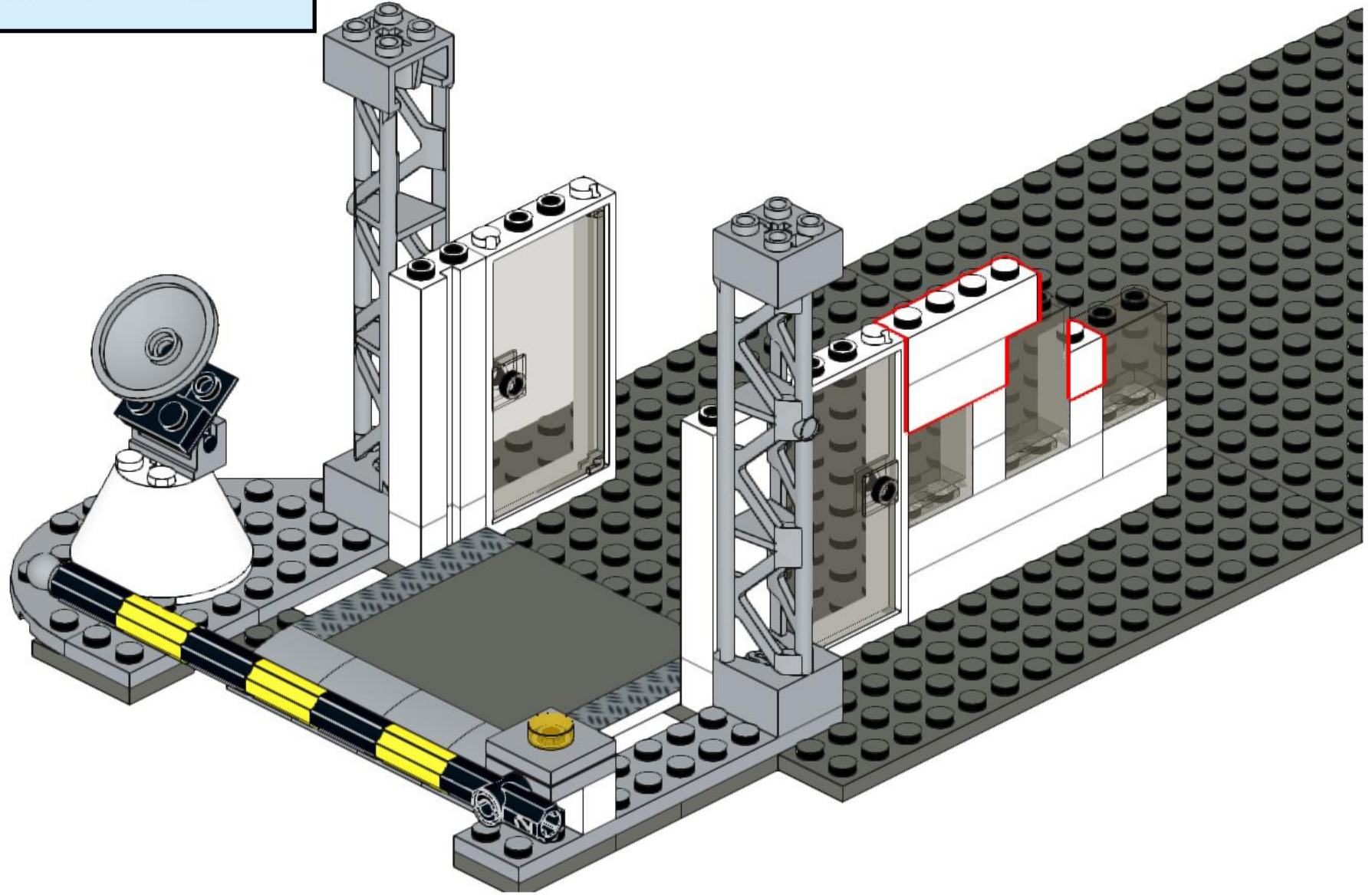
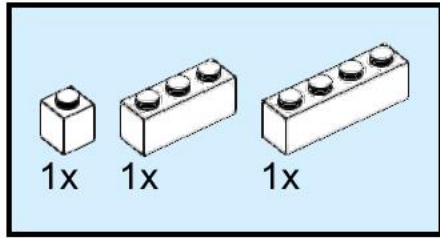

14

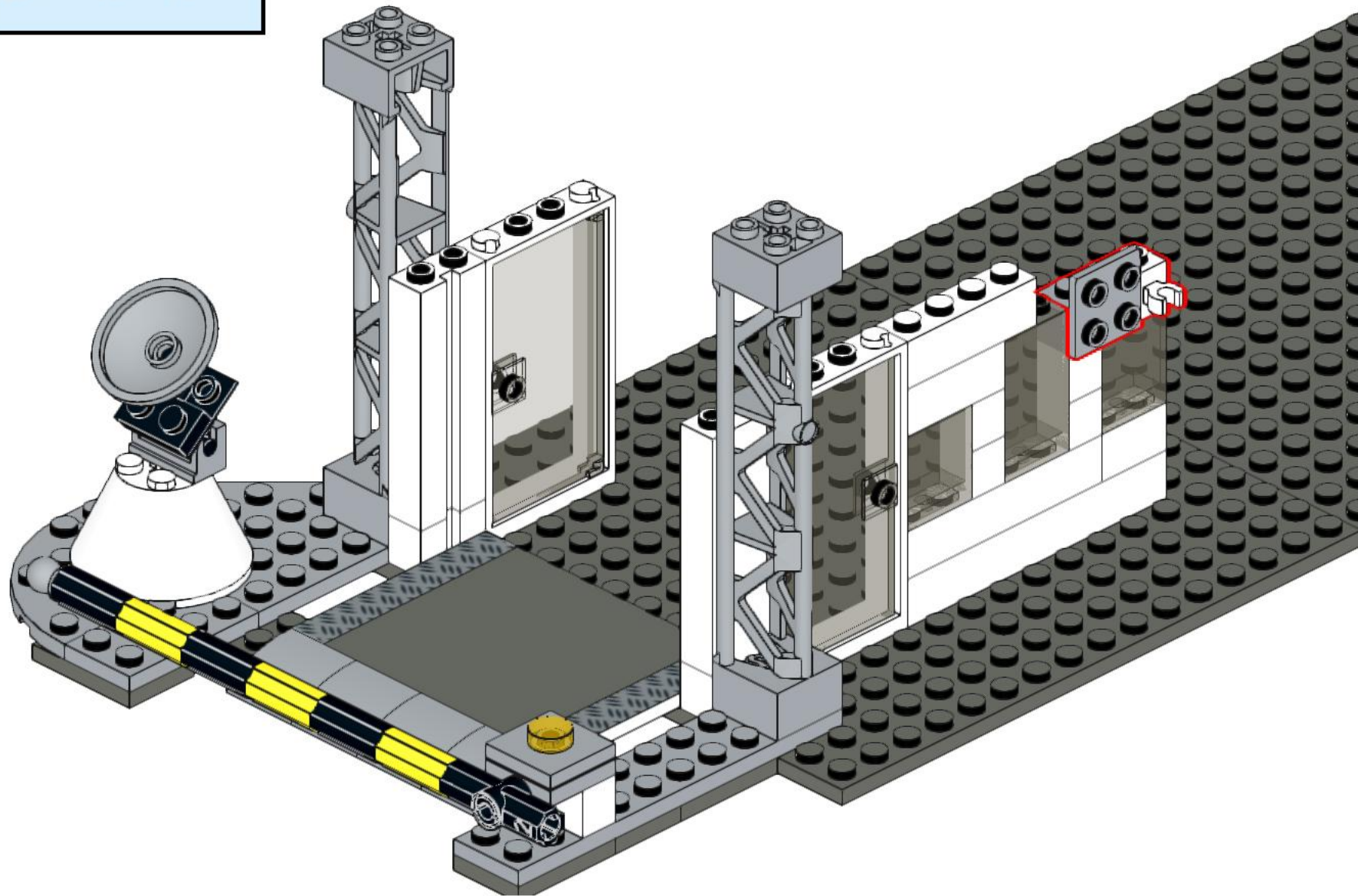
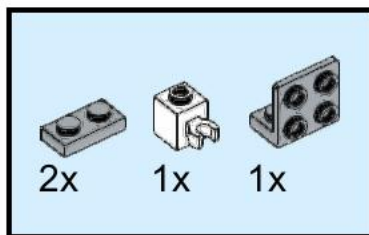

15

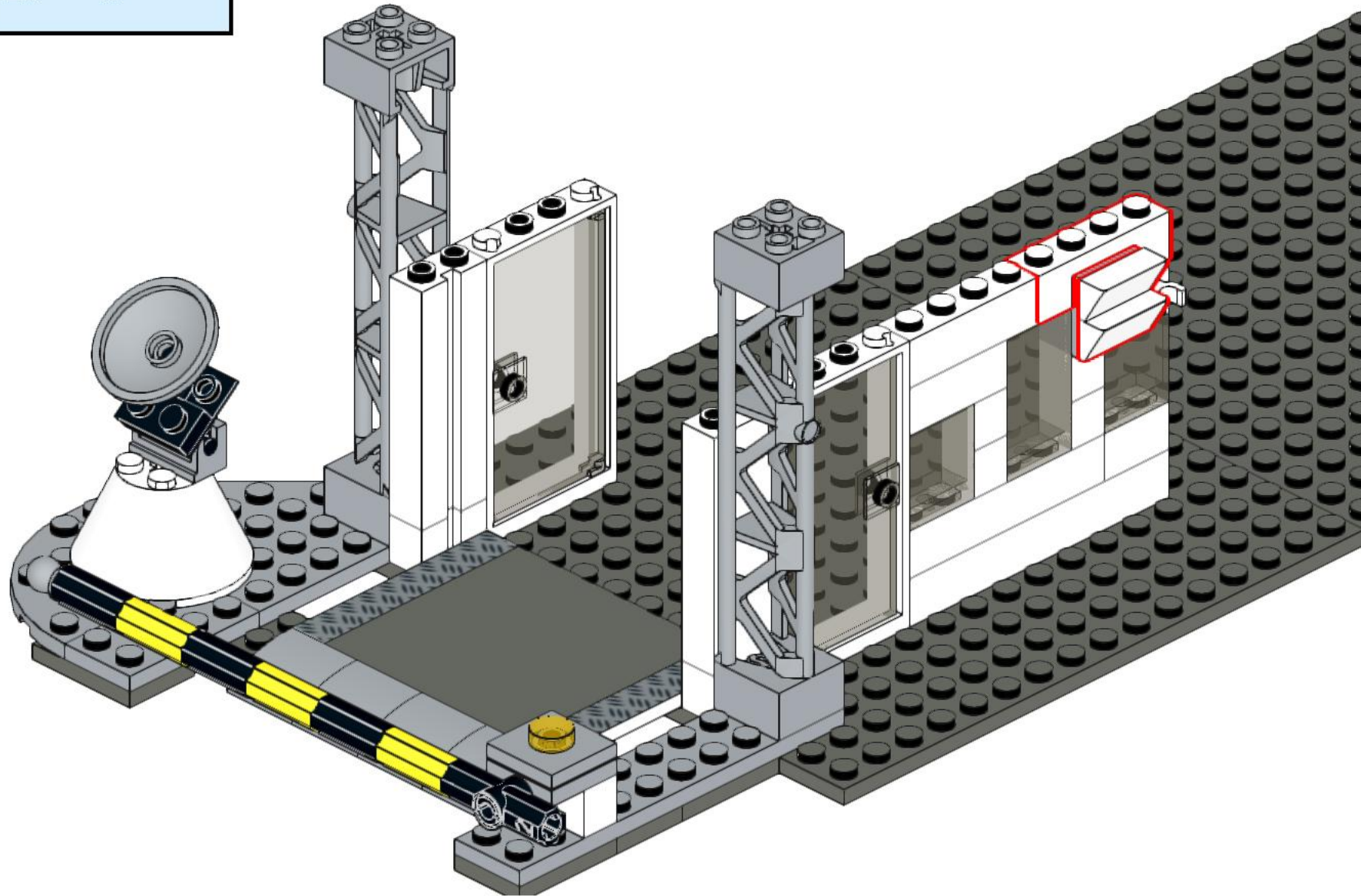
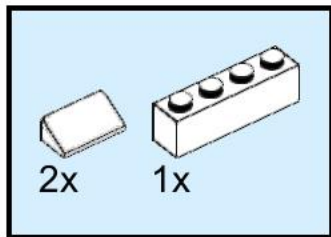

16

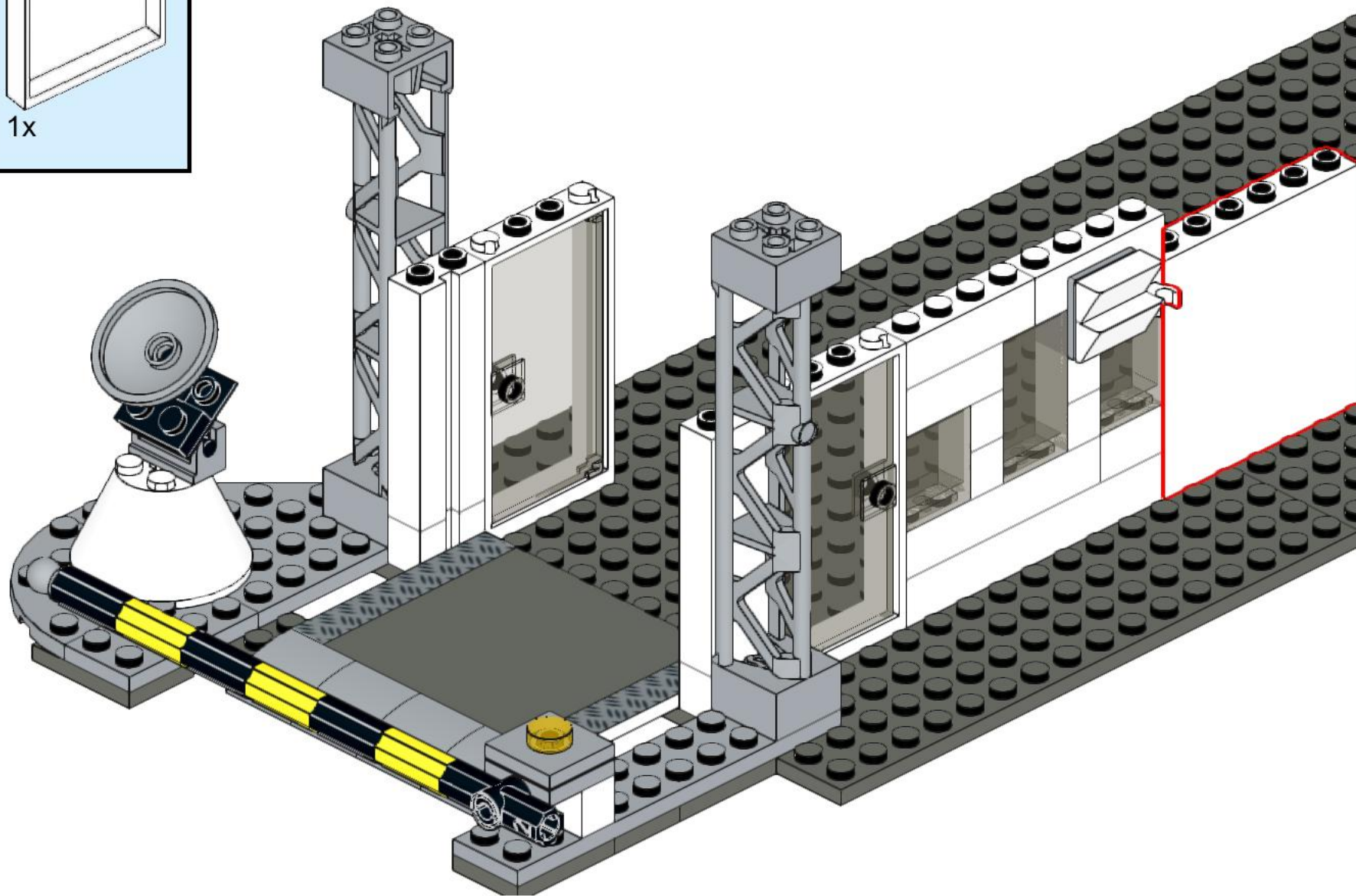
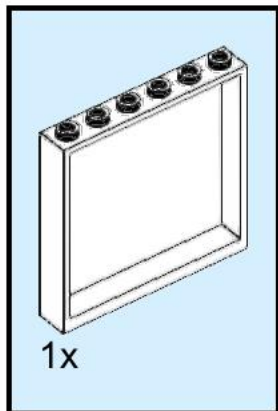

17

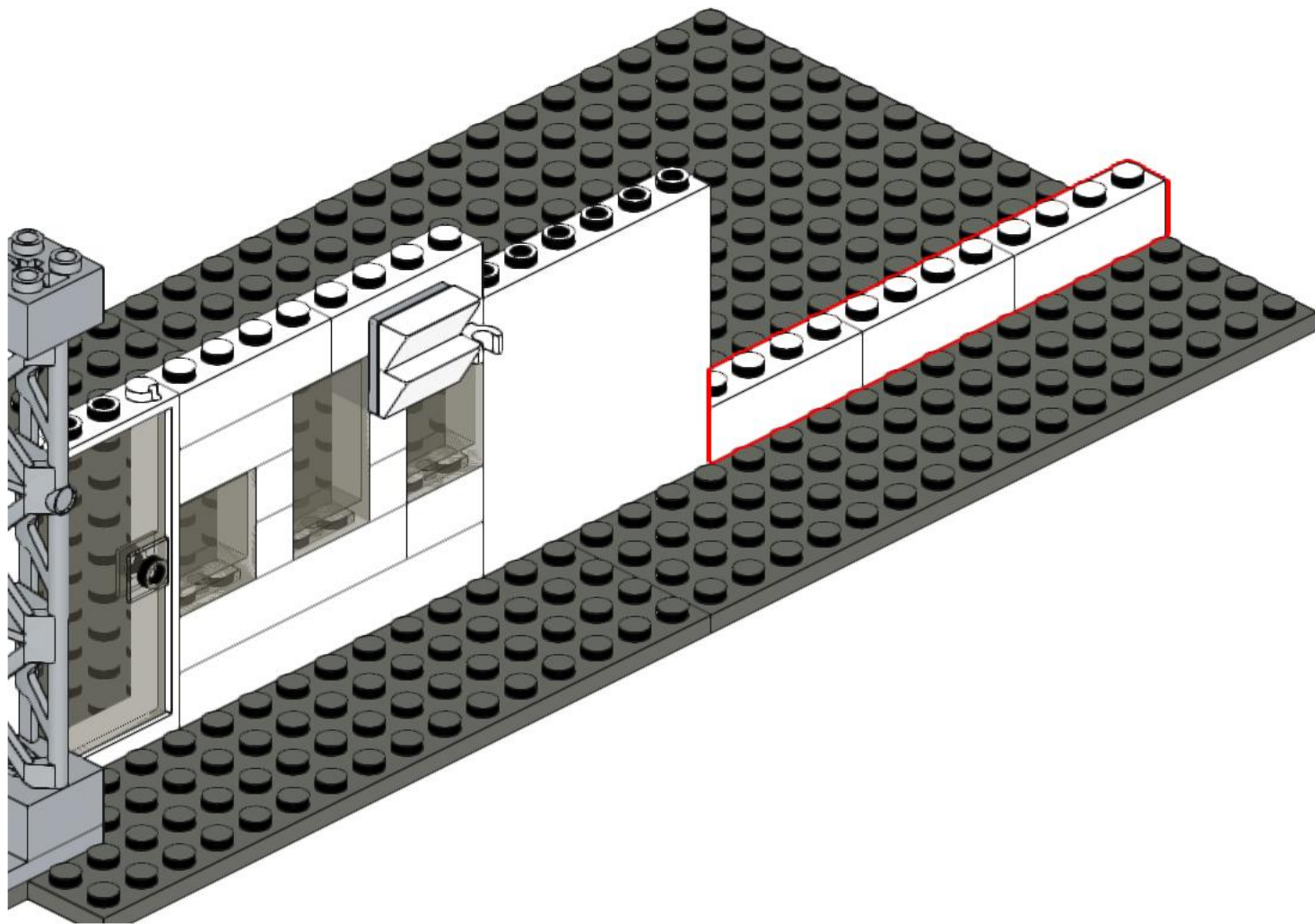
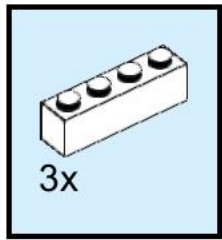

18

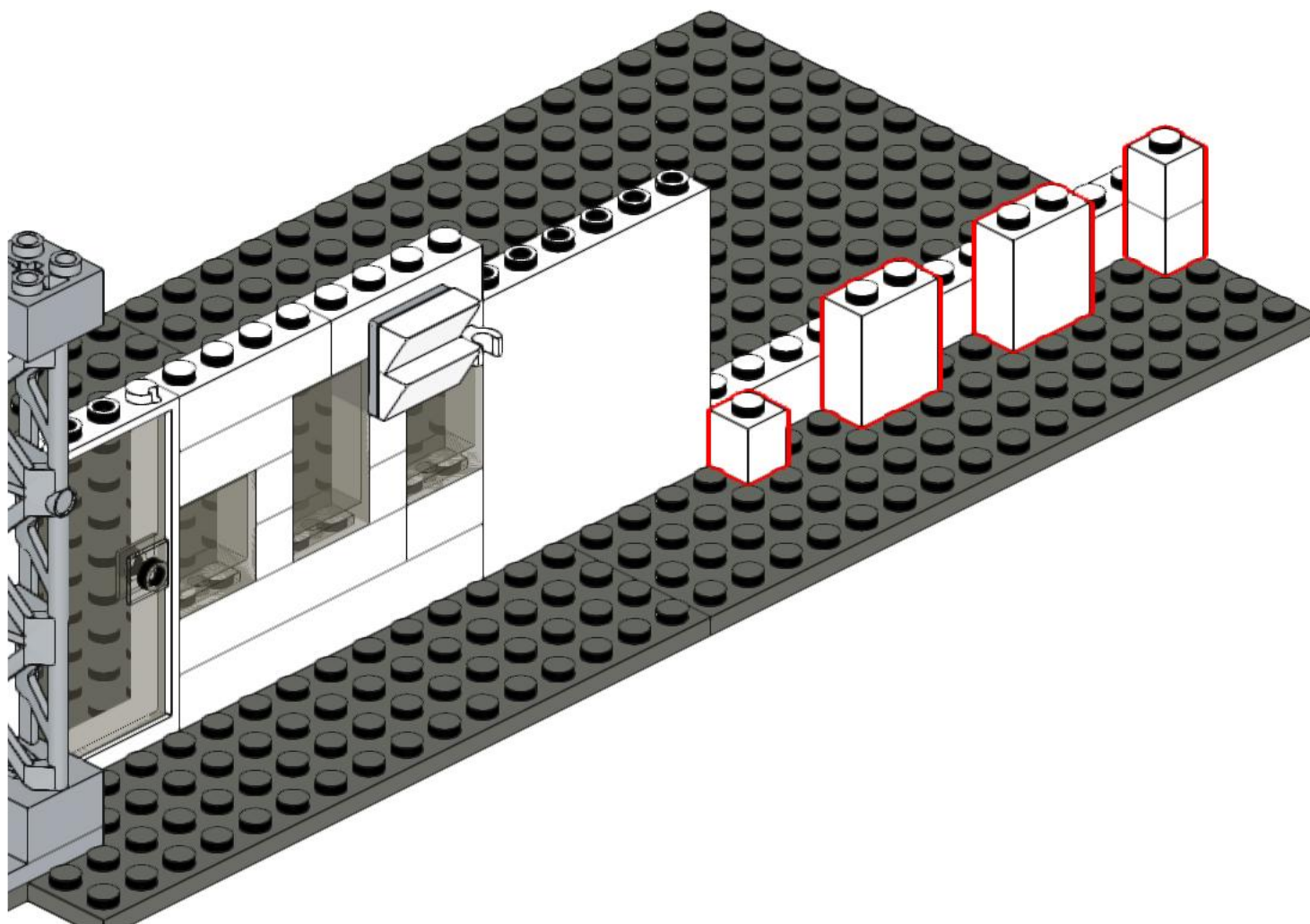
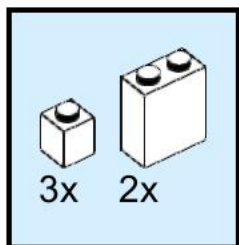

19

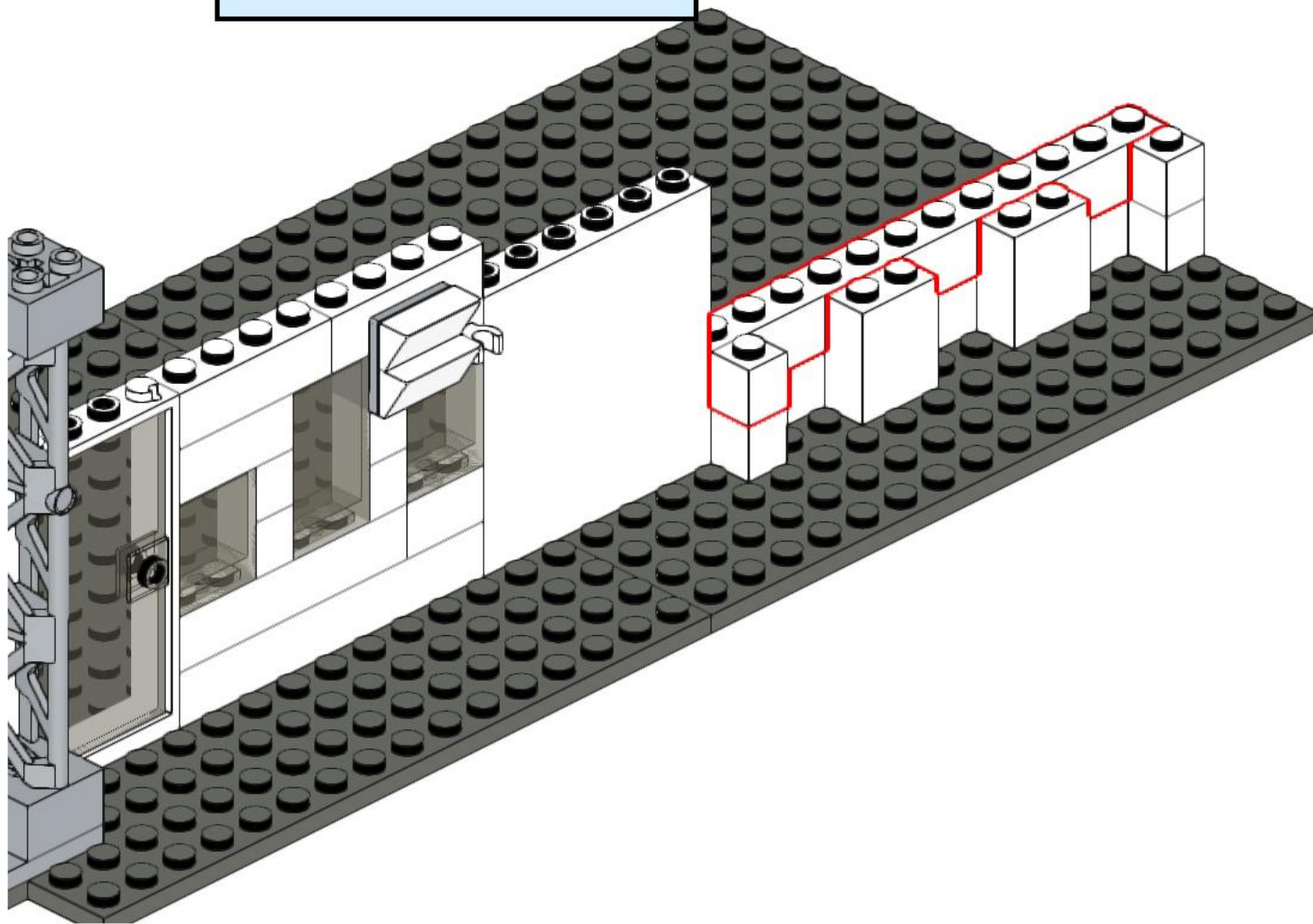
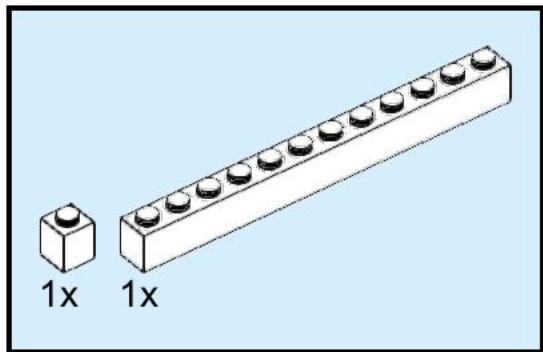

20

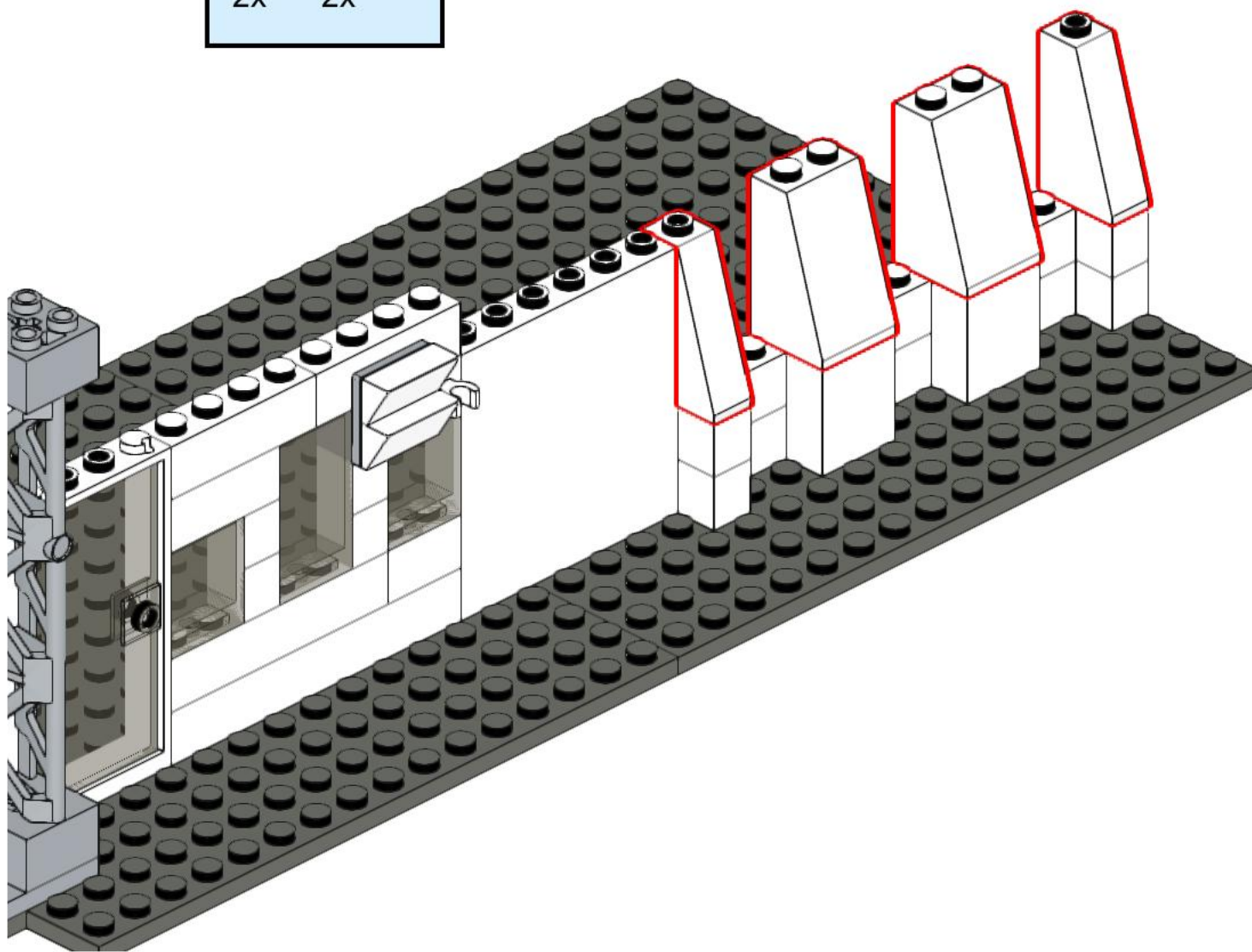
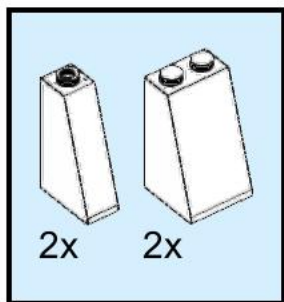

21

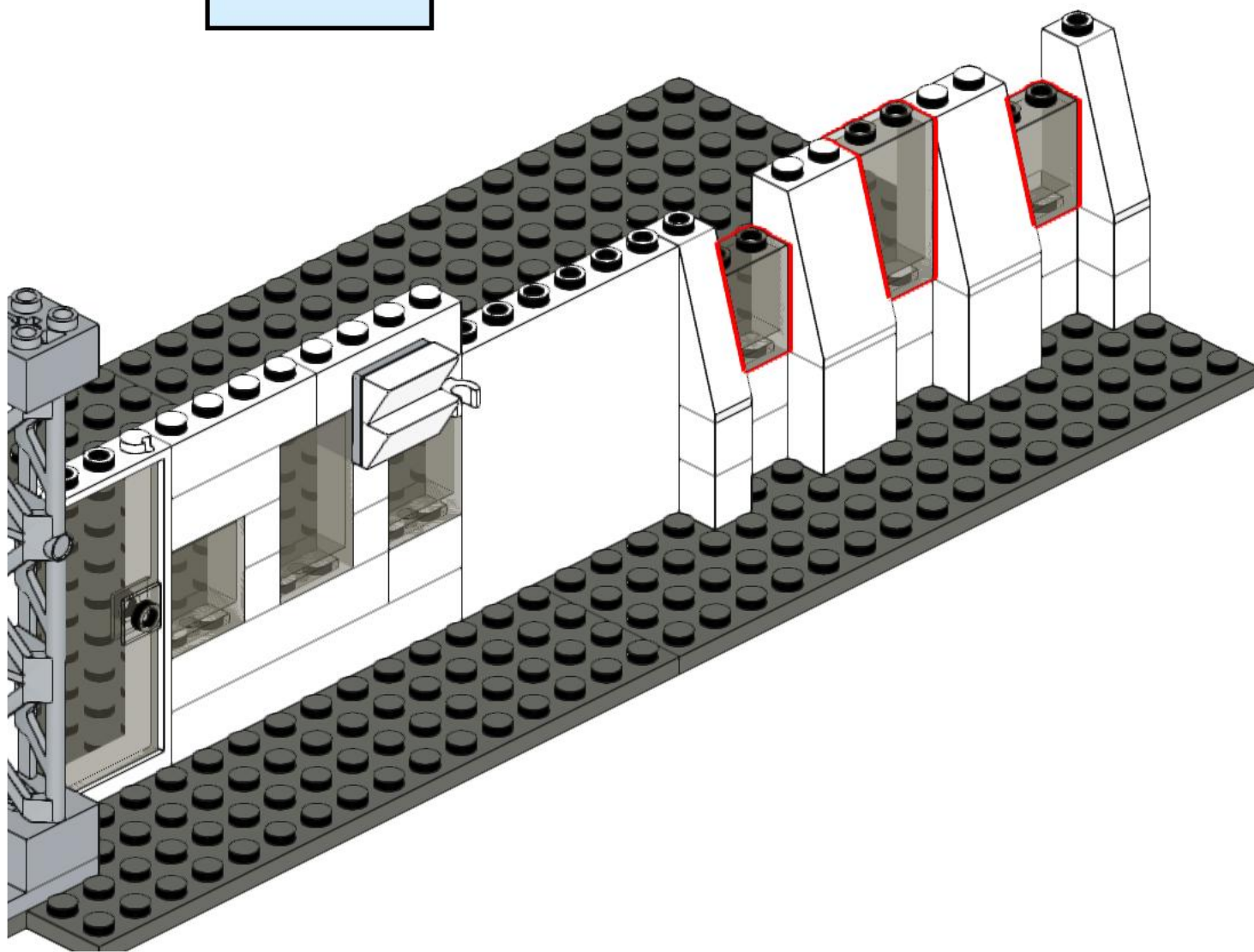
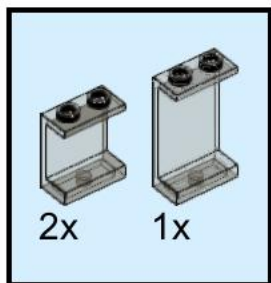

22

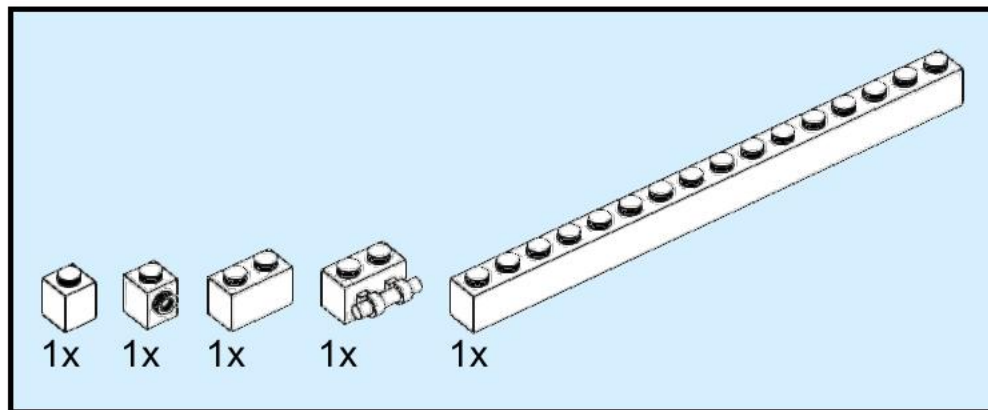
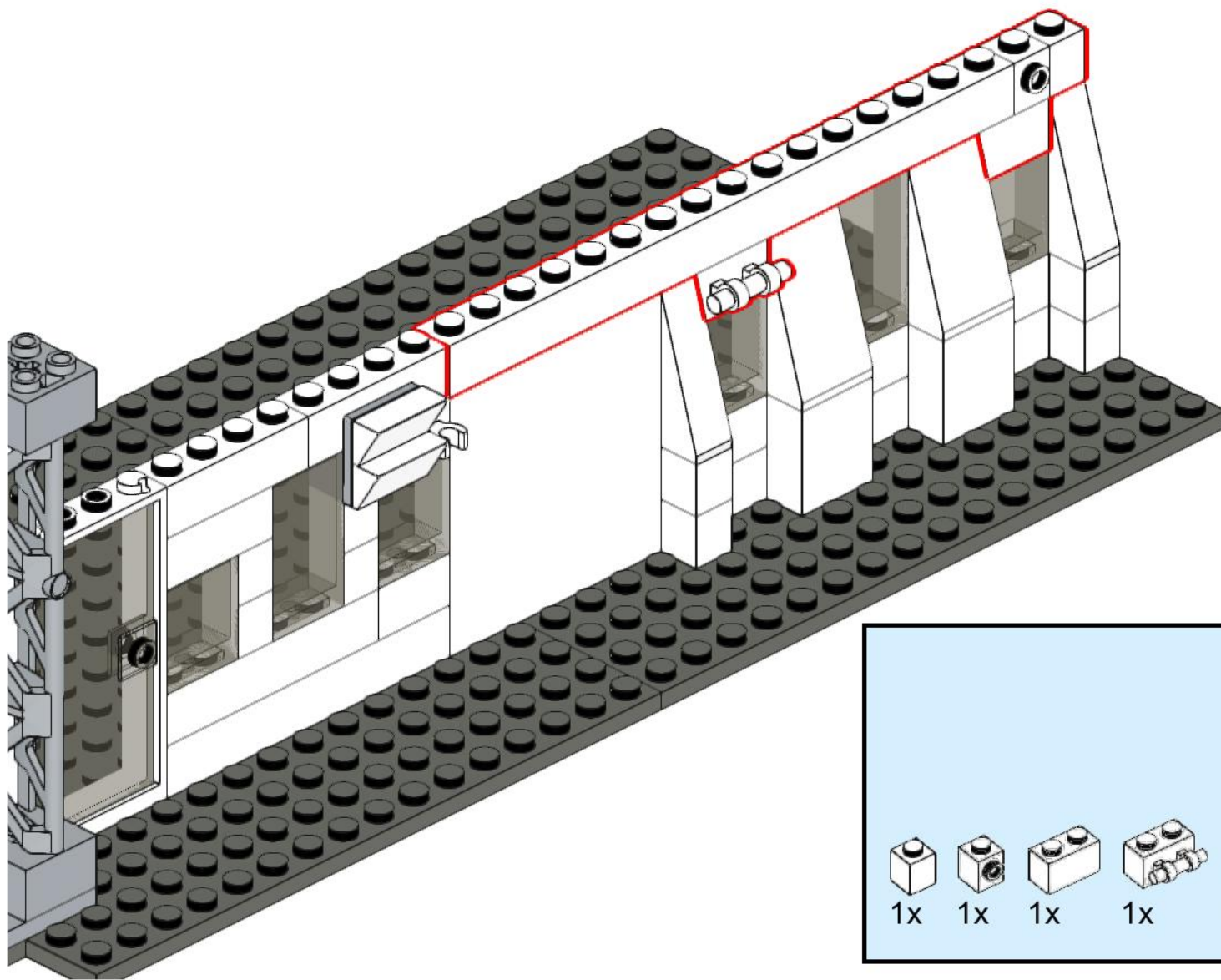

23

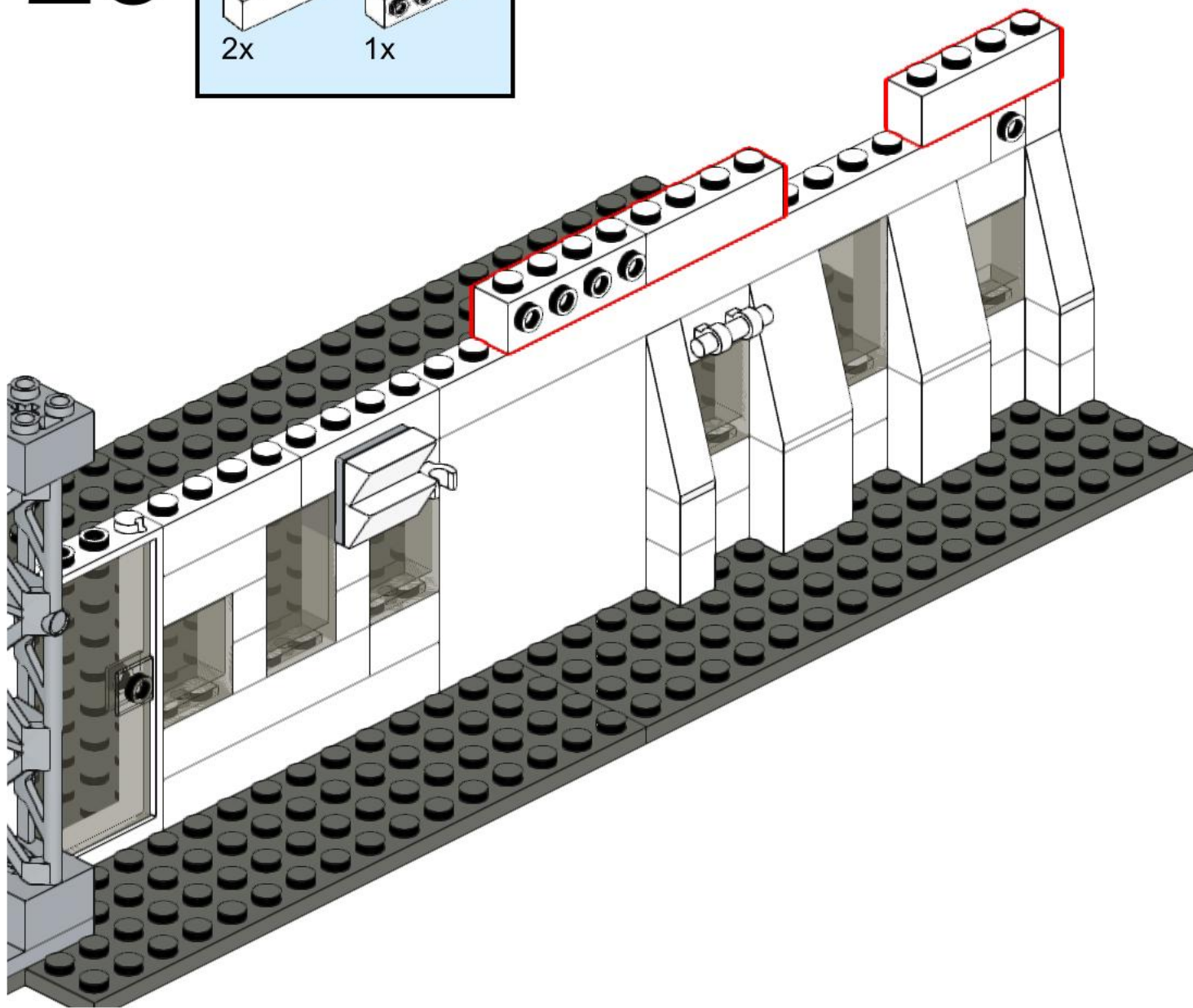
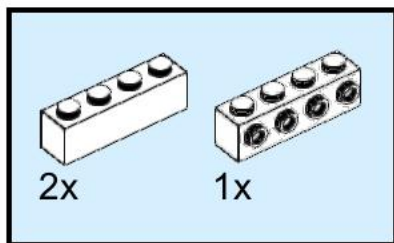

24

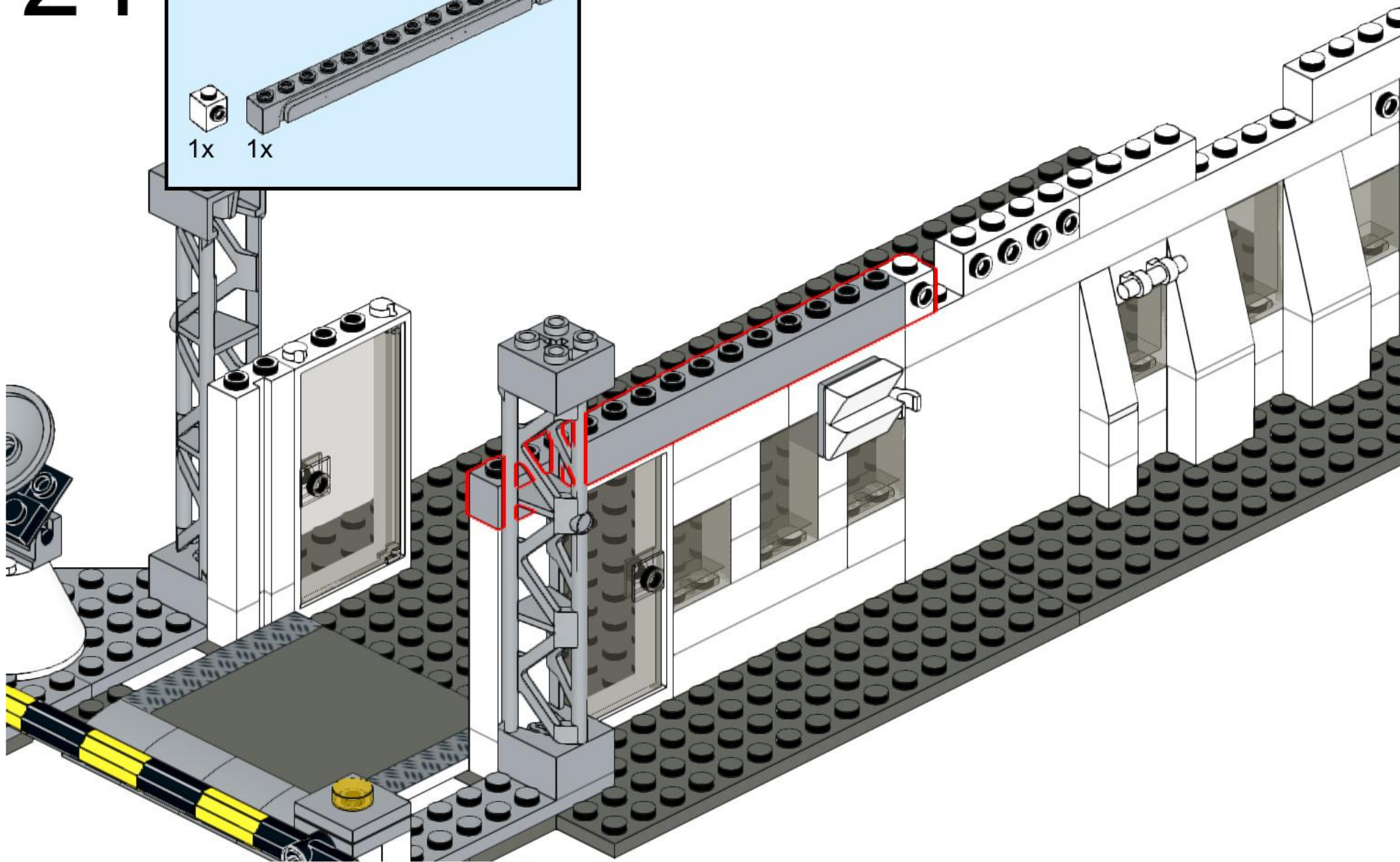
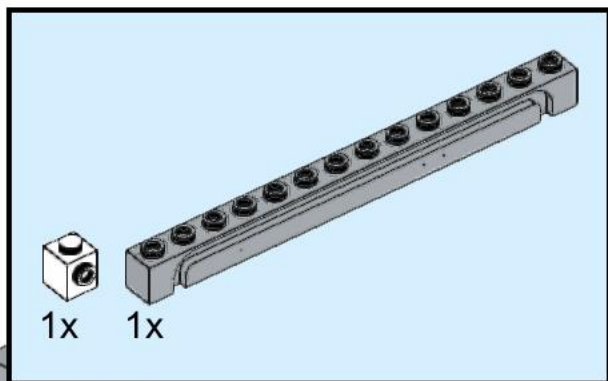

25

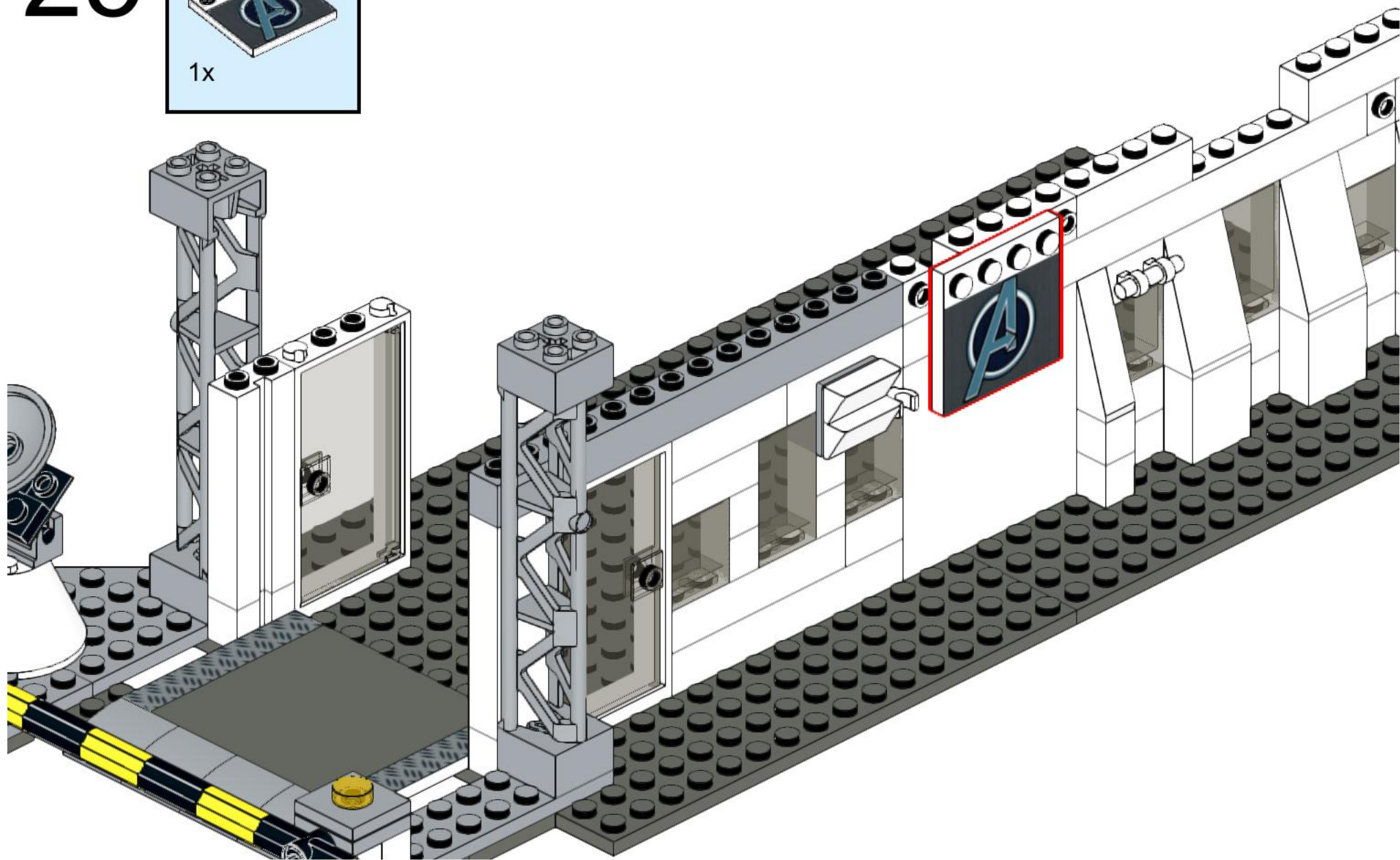
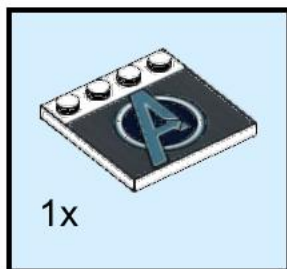

26

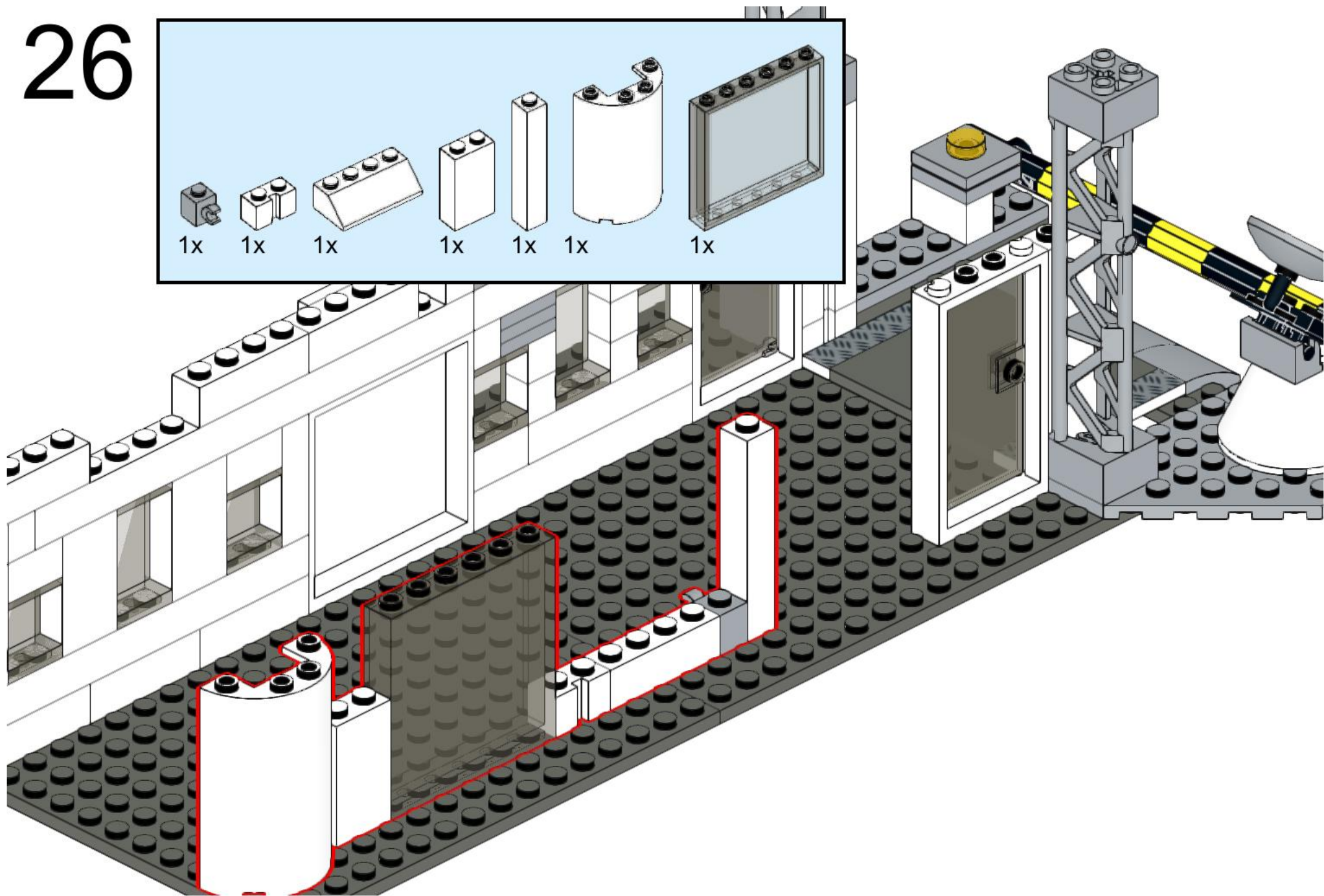
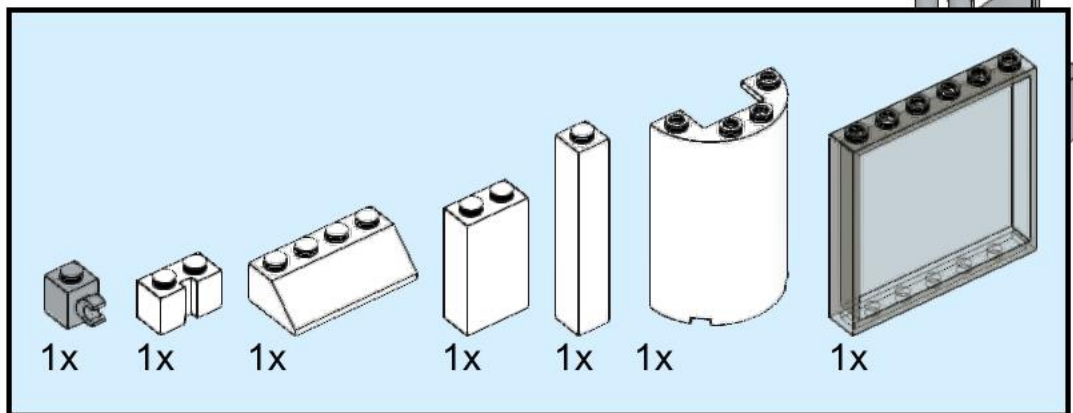

27

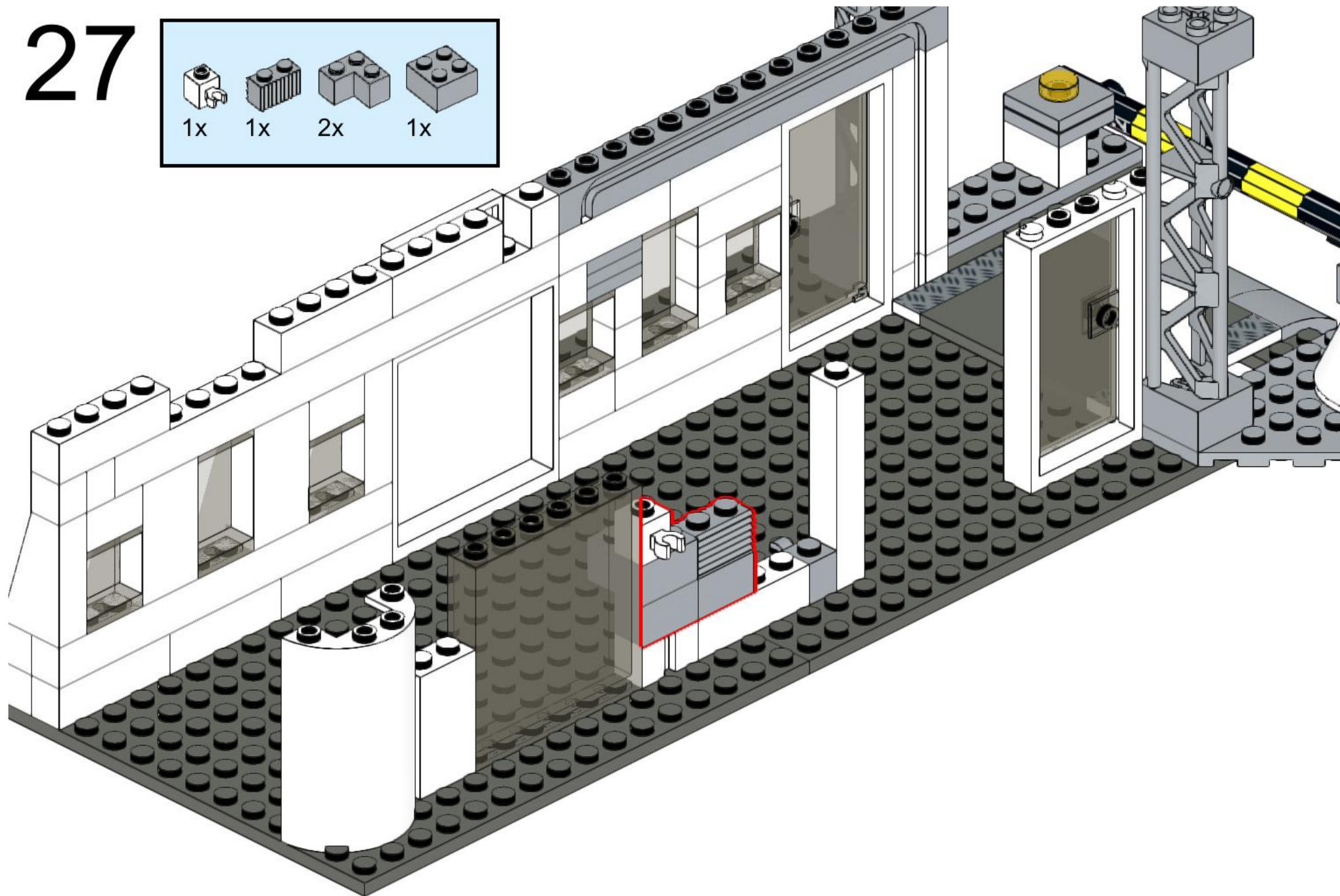
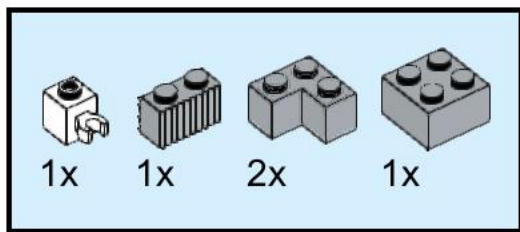

28

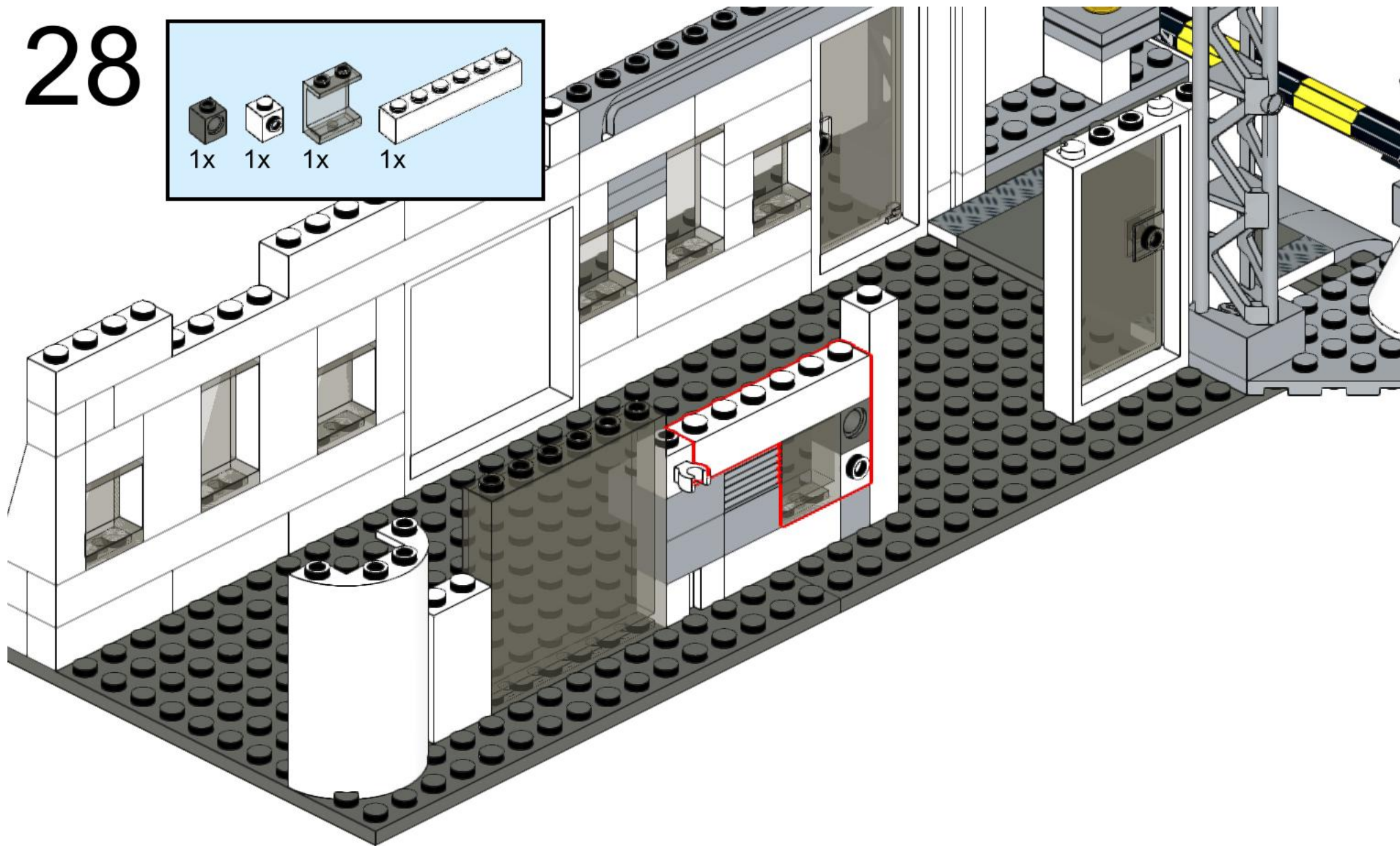
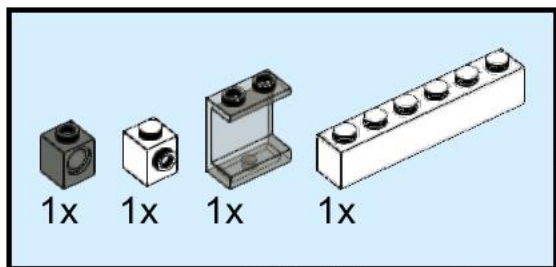

29

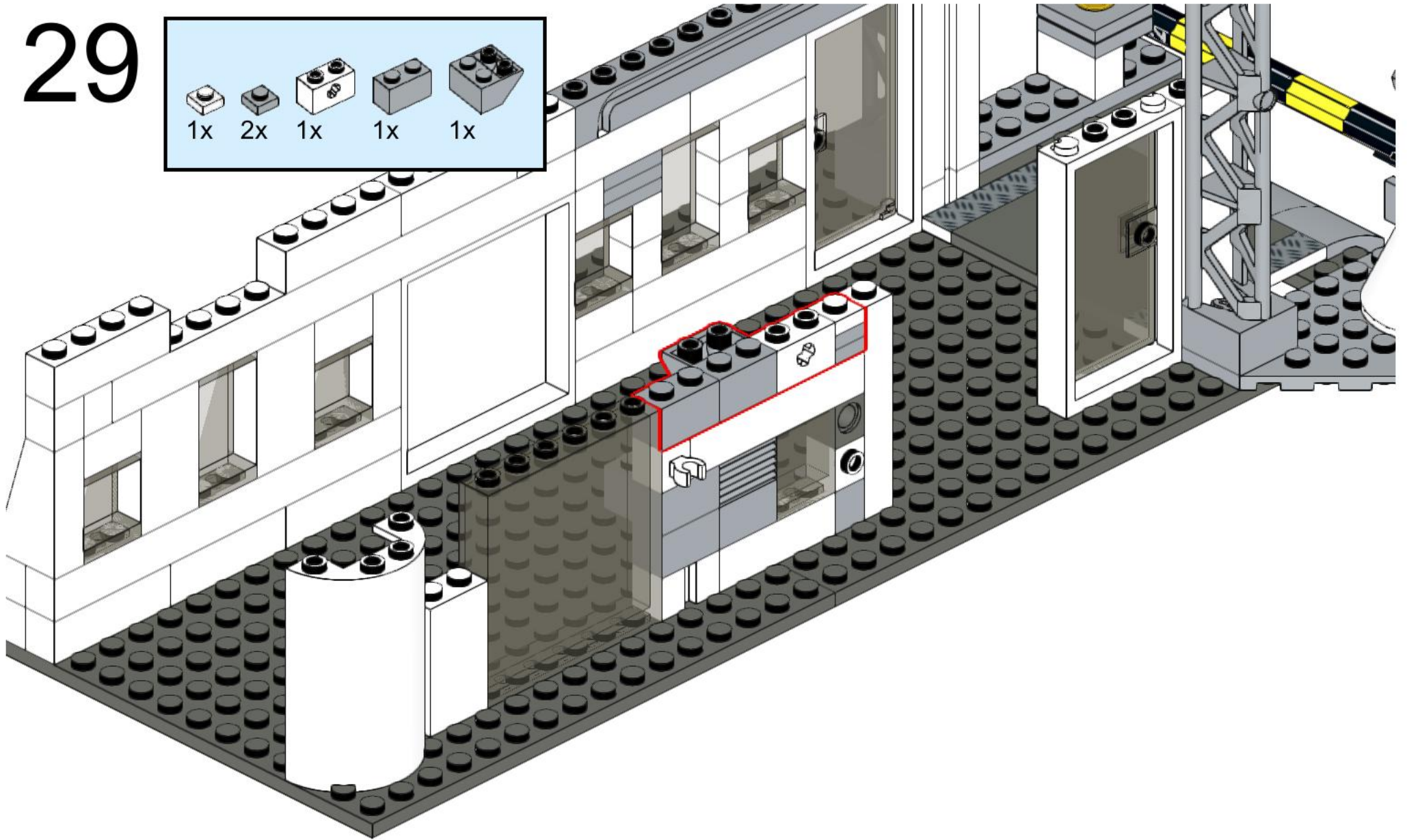
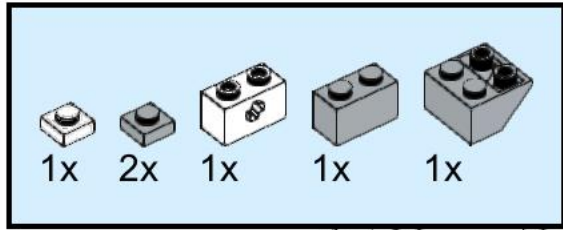

30

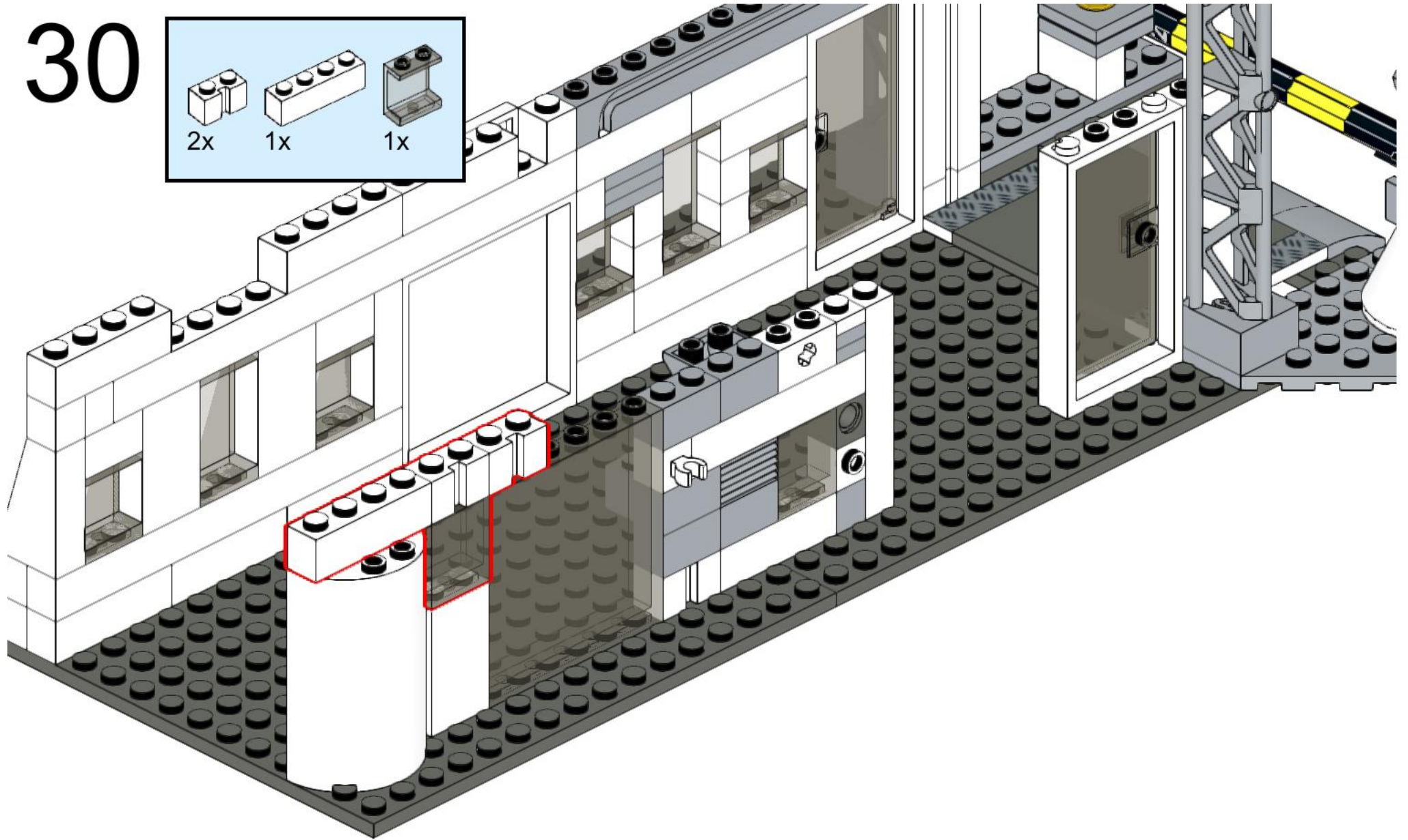
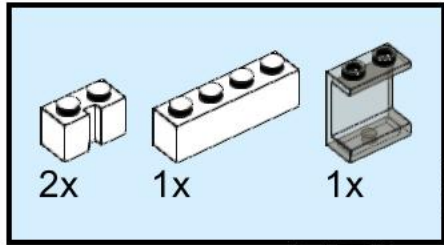

31

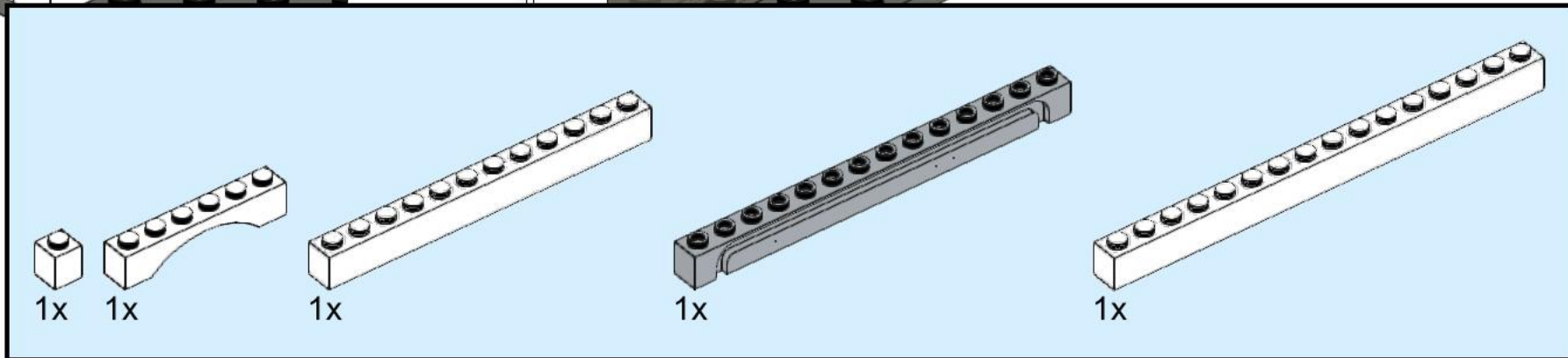
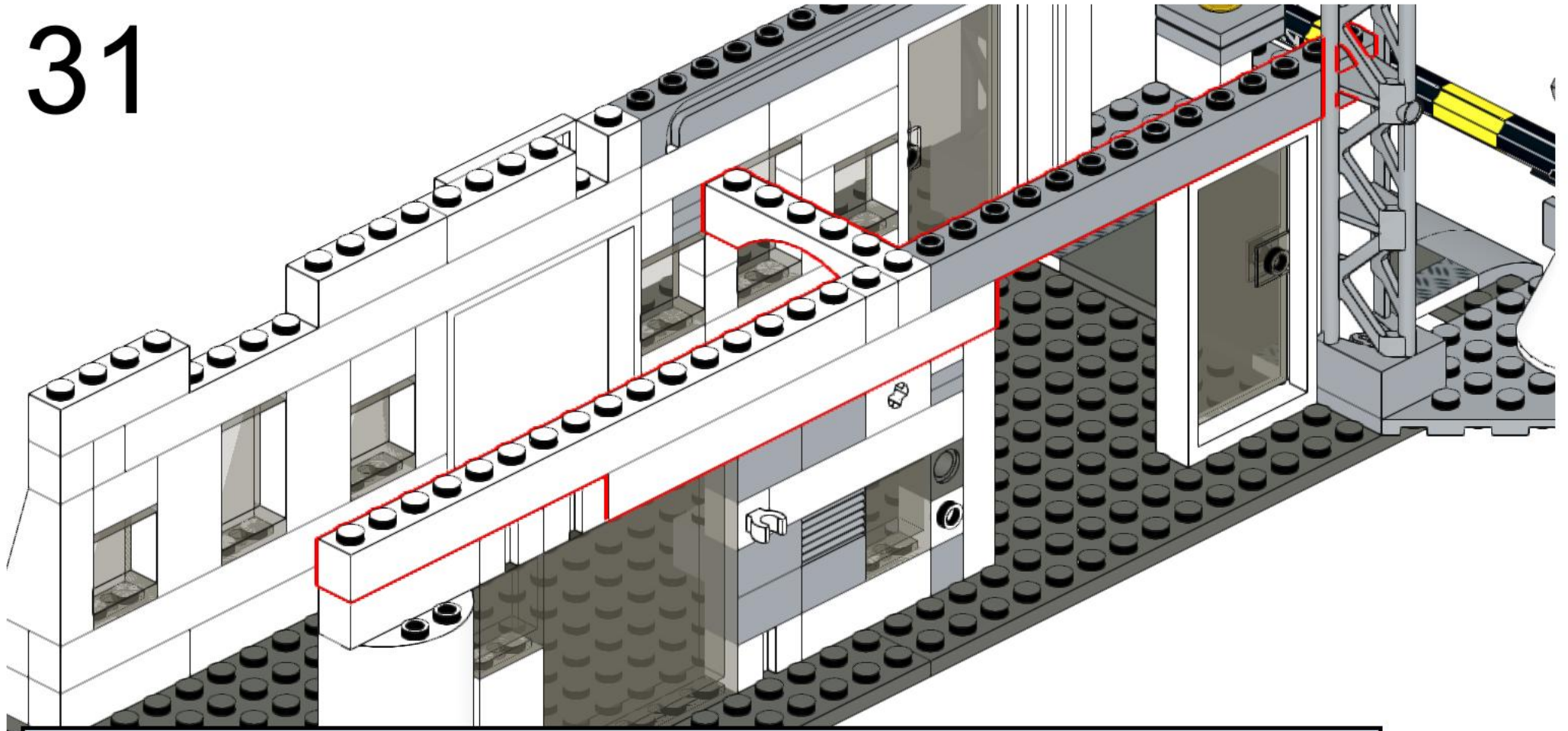

32

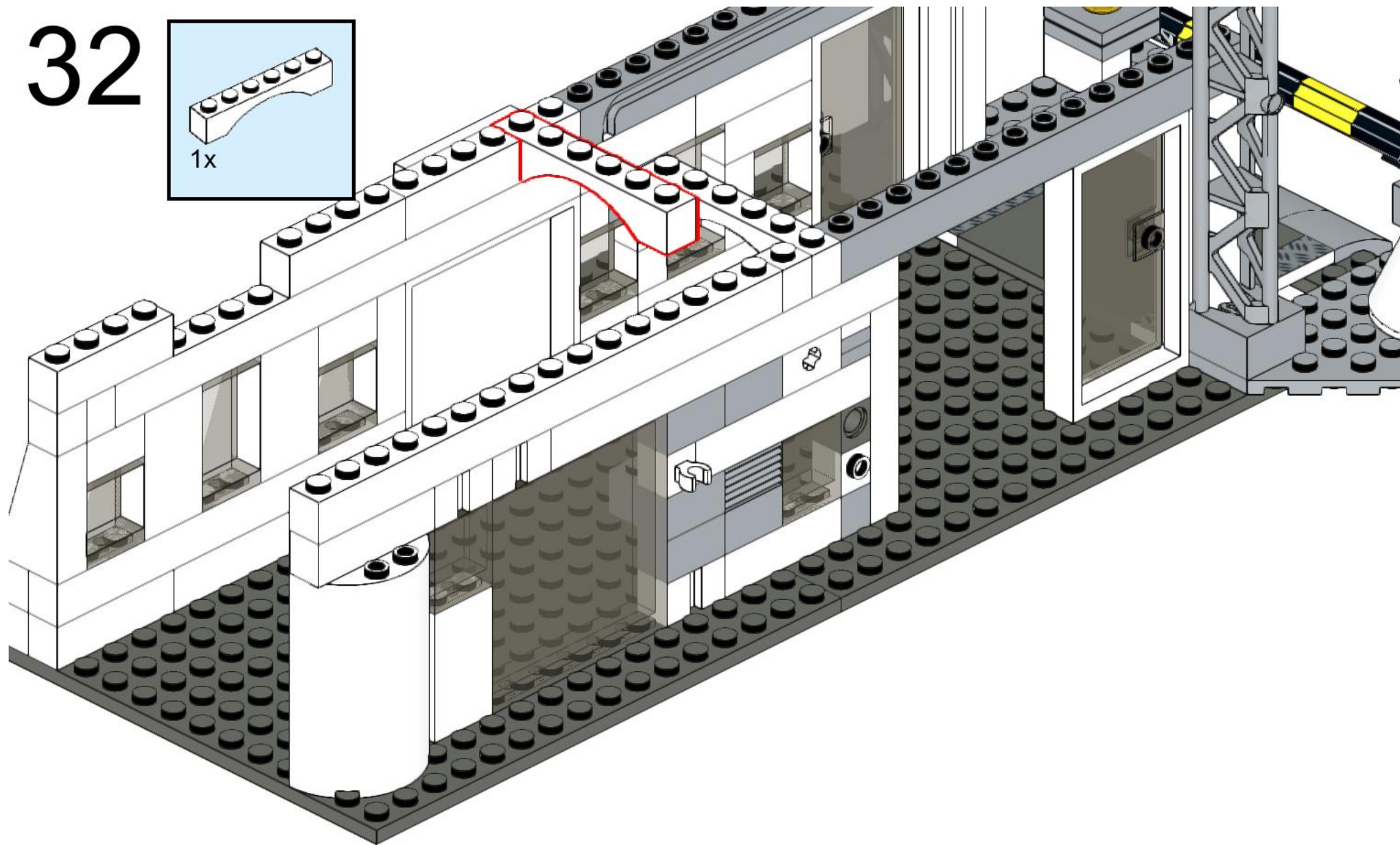
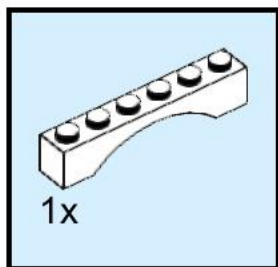

33

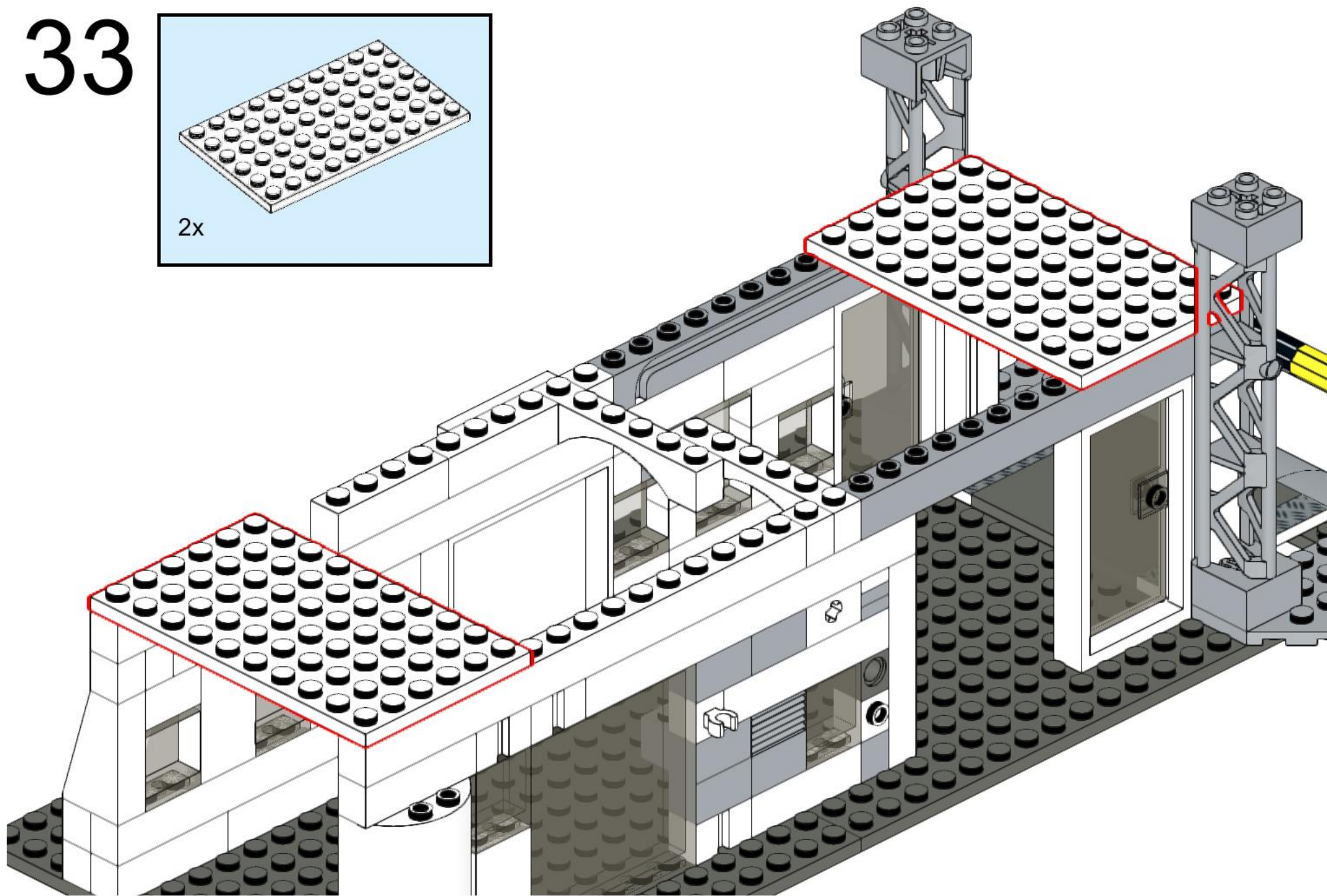
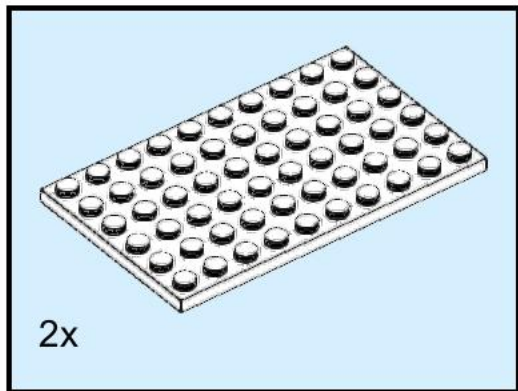

34

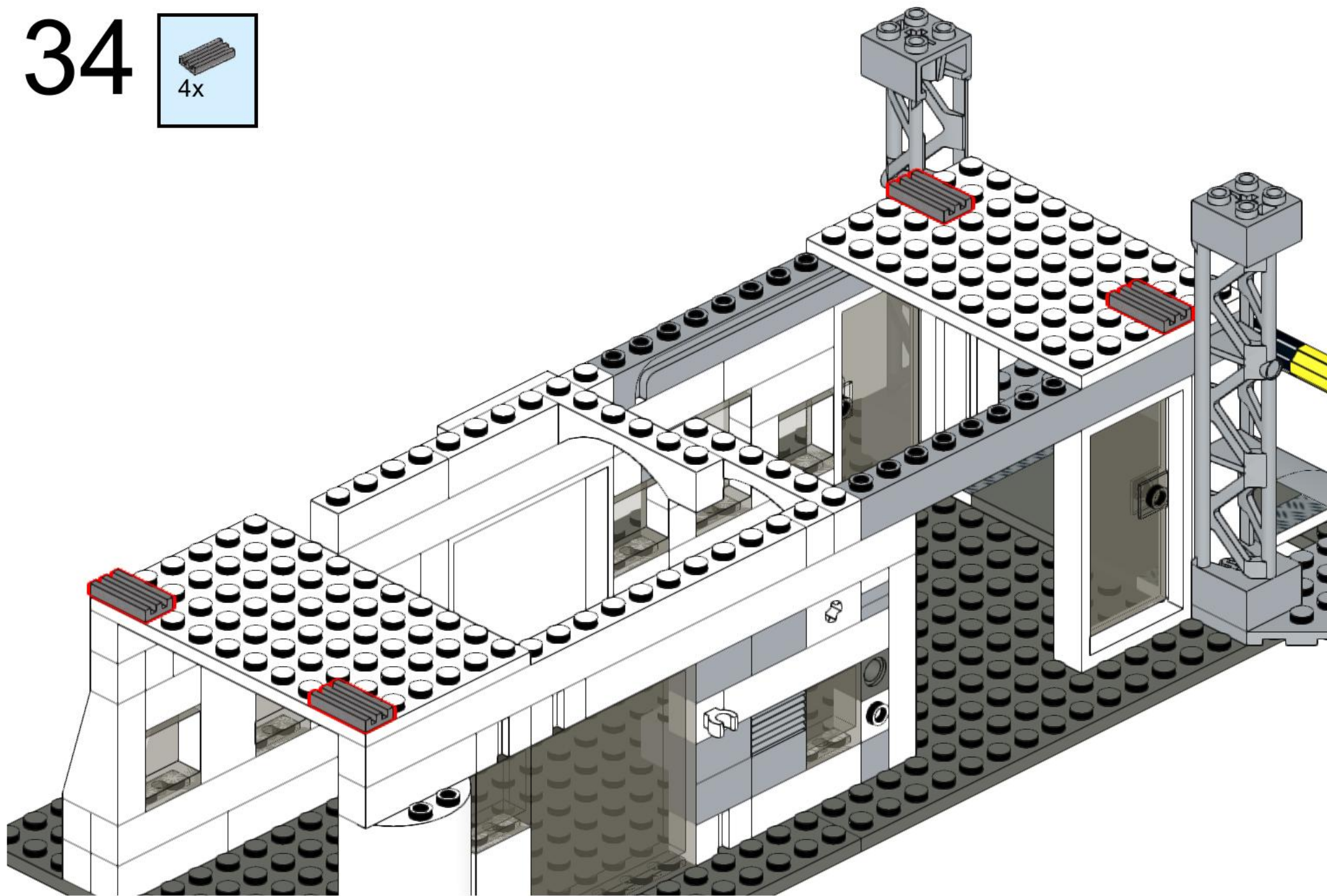
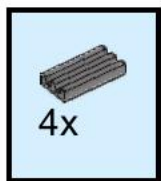

35

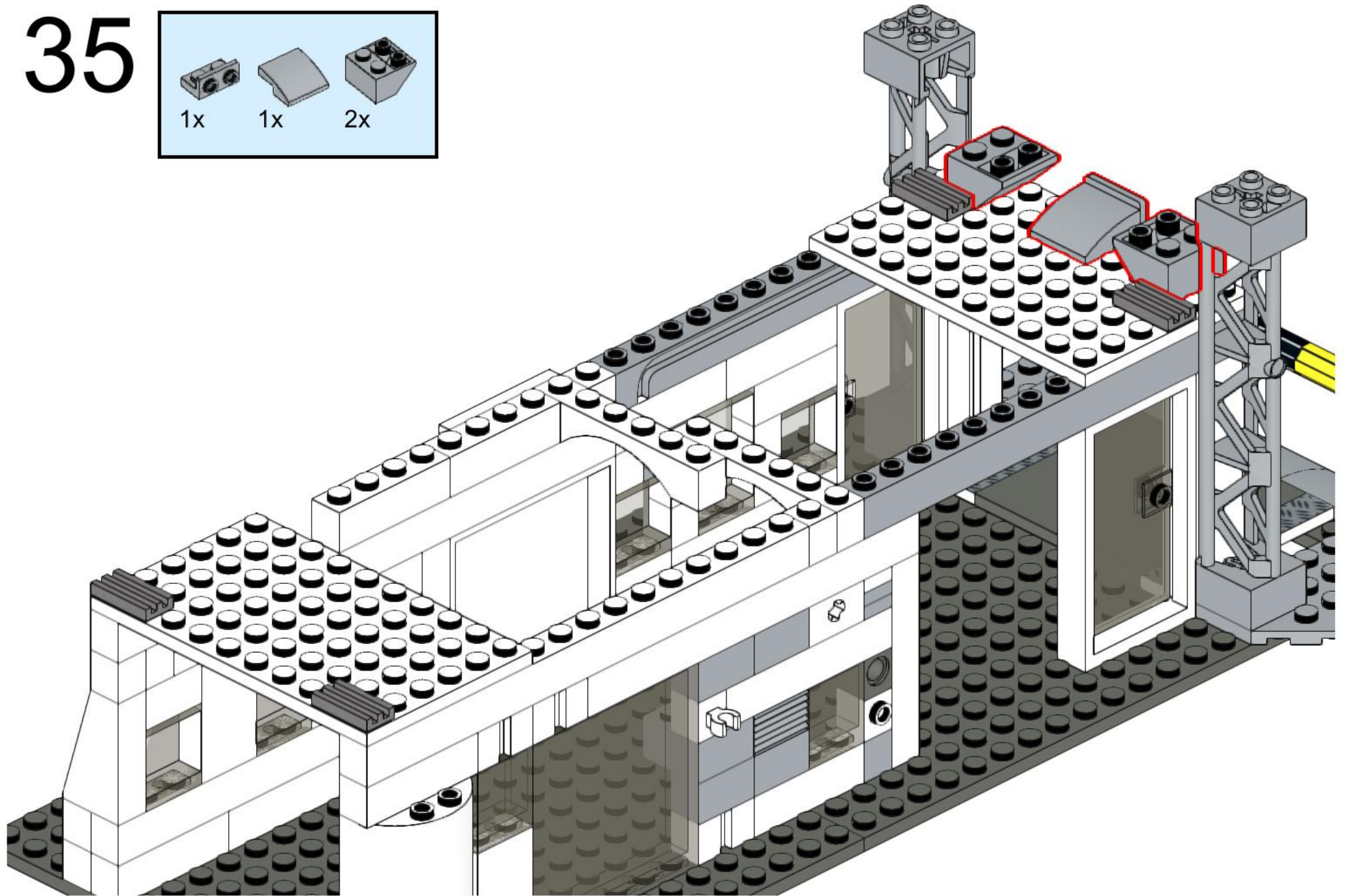
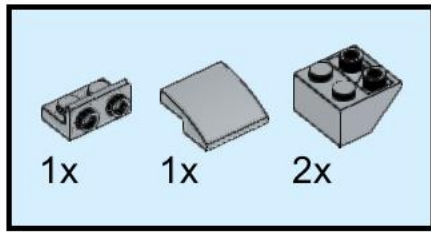

36

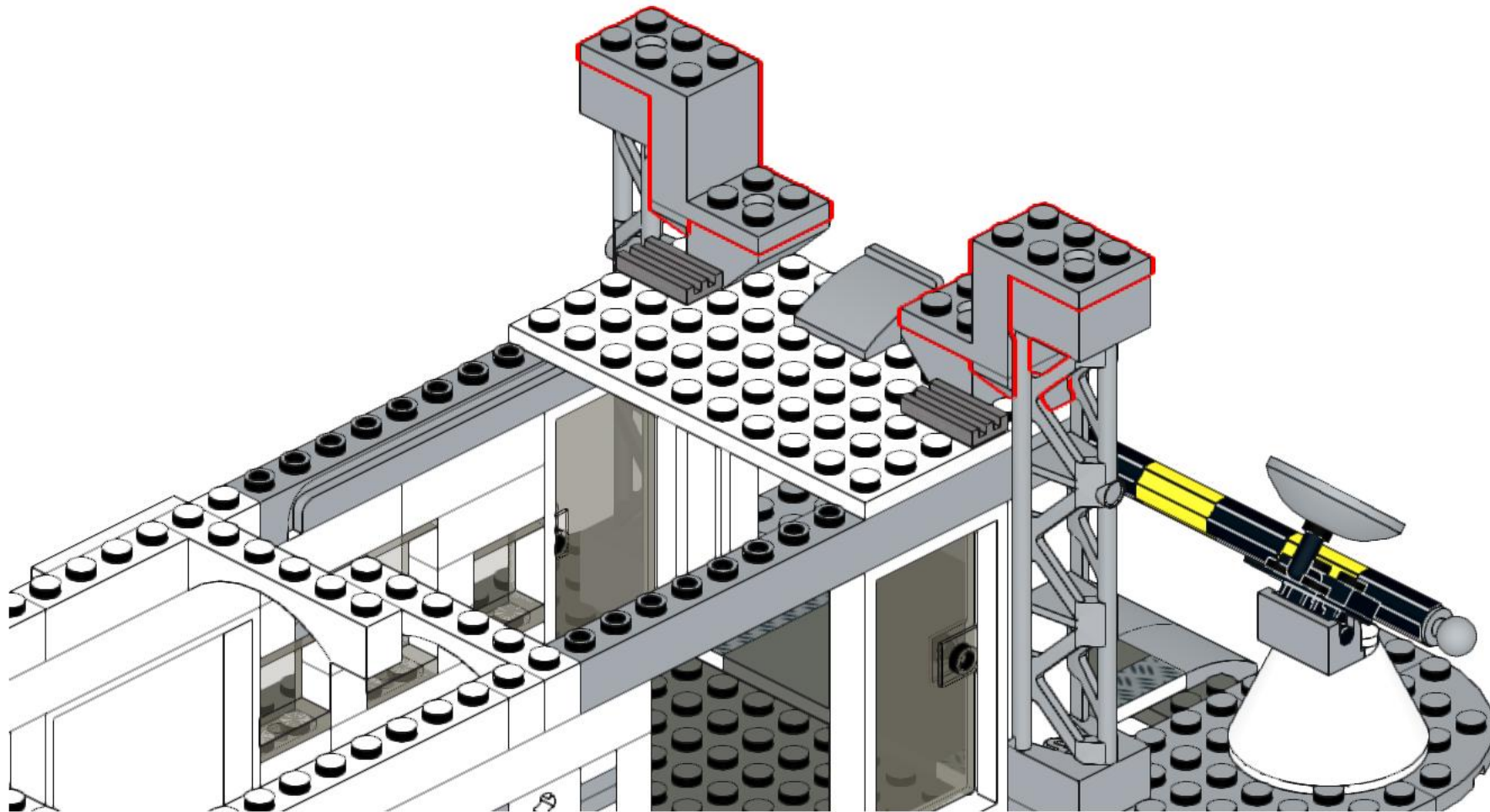
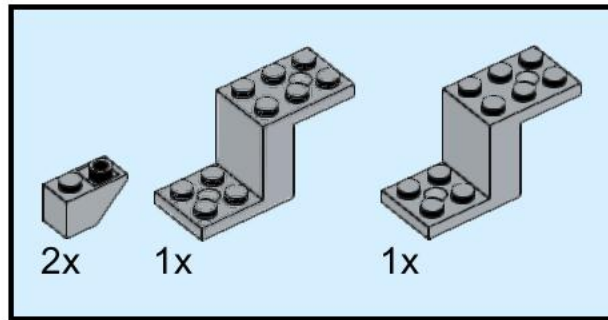

37

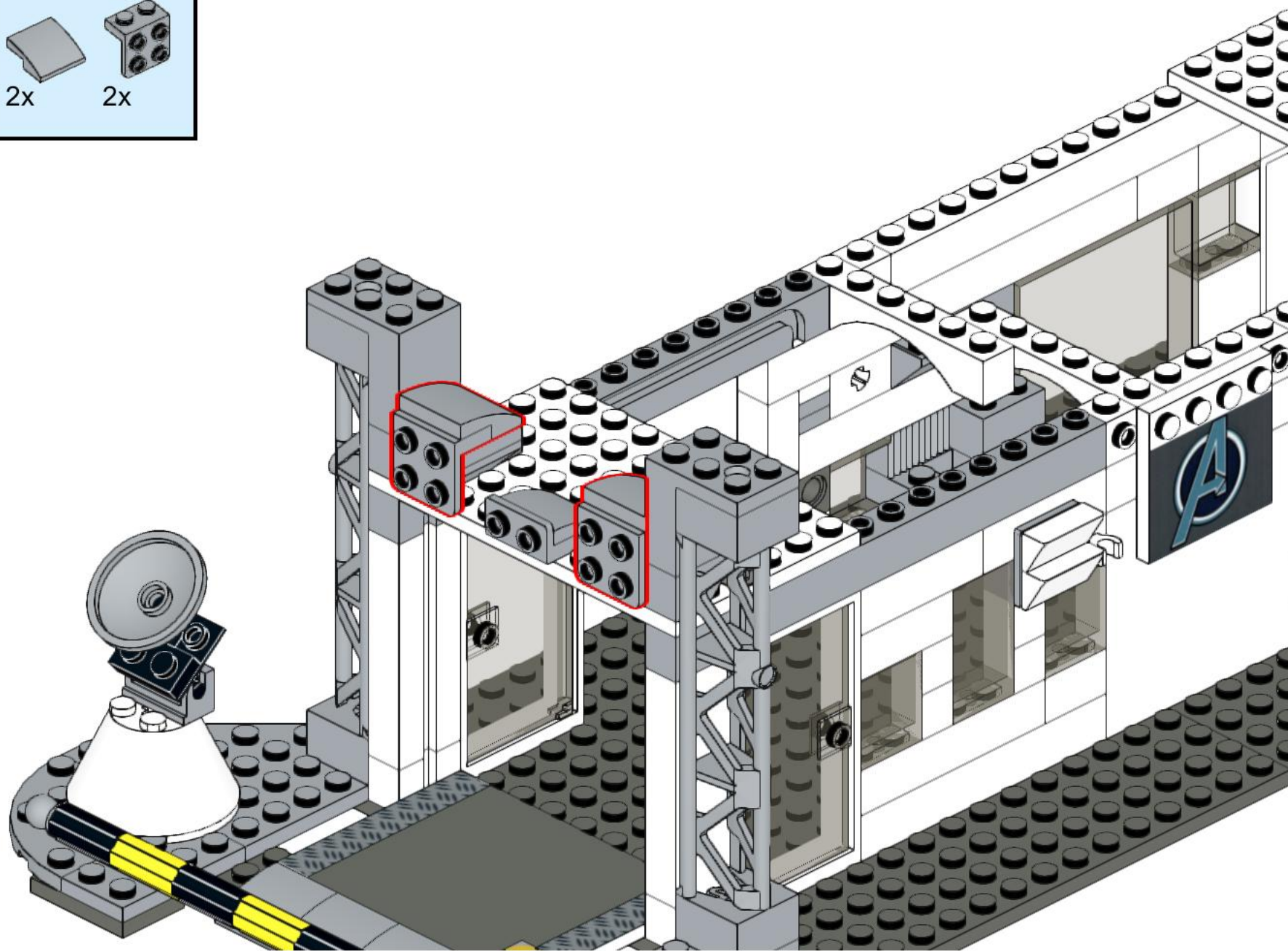
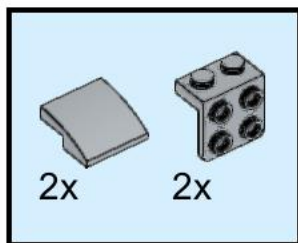

38

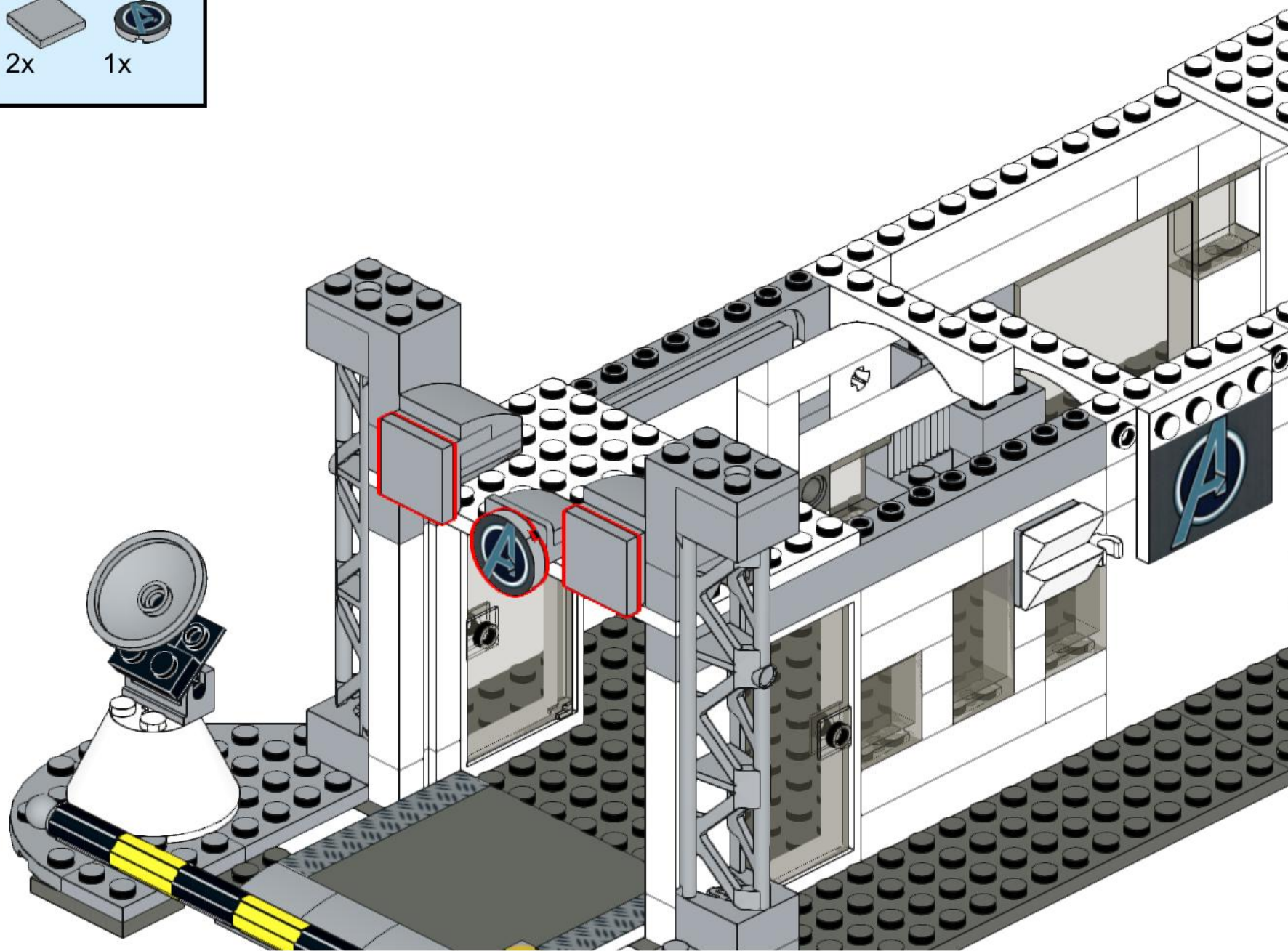
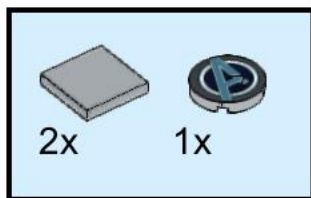

39

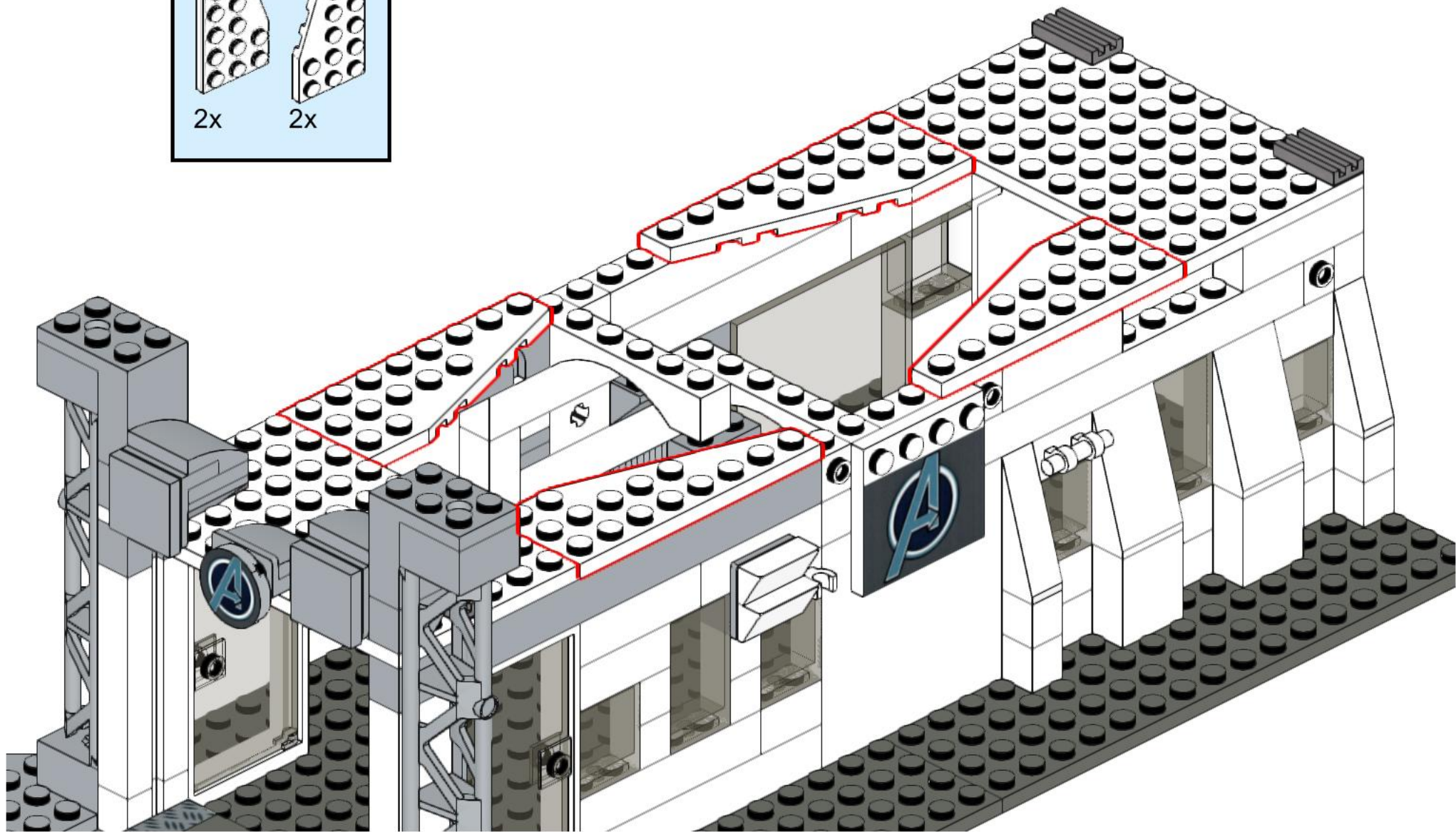
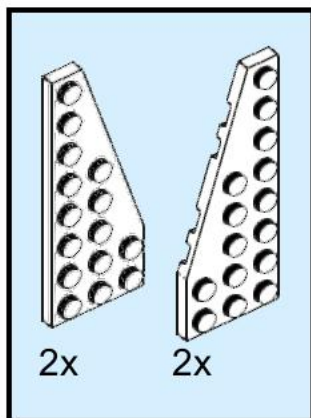

40

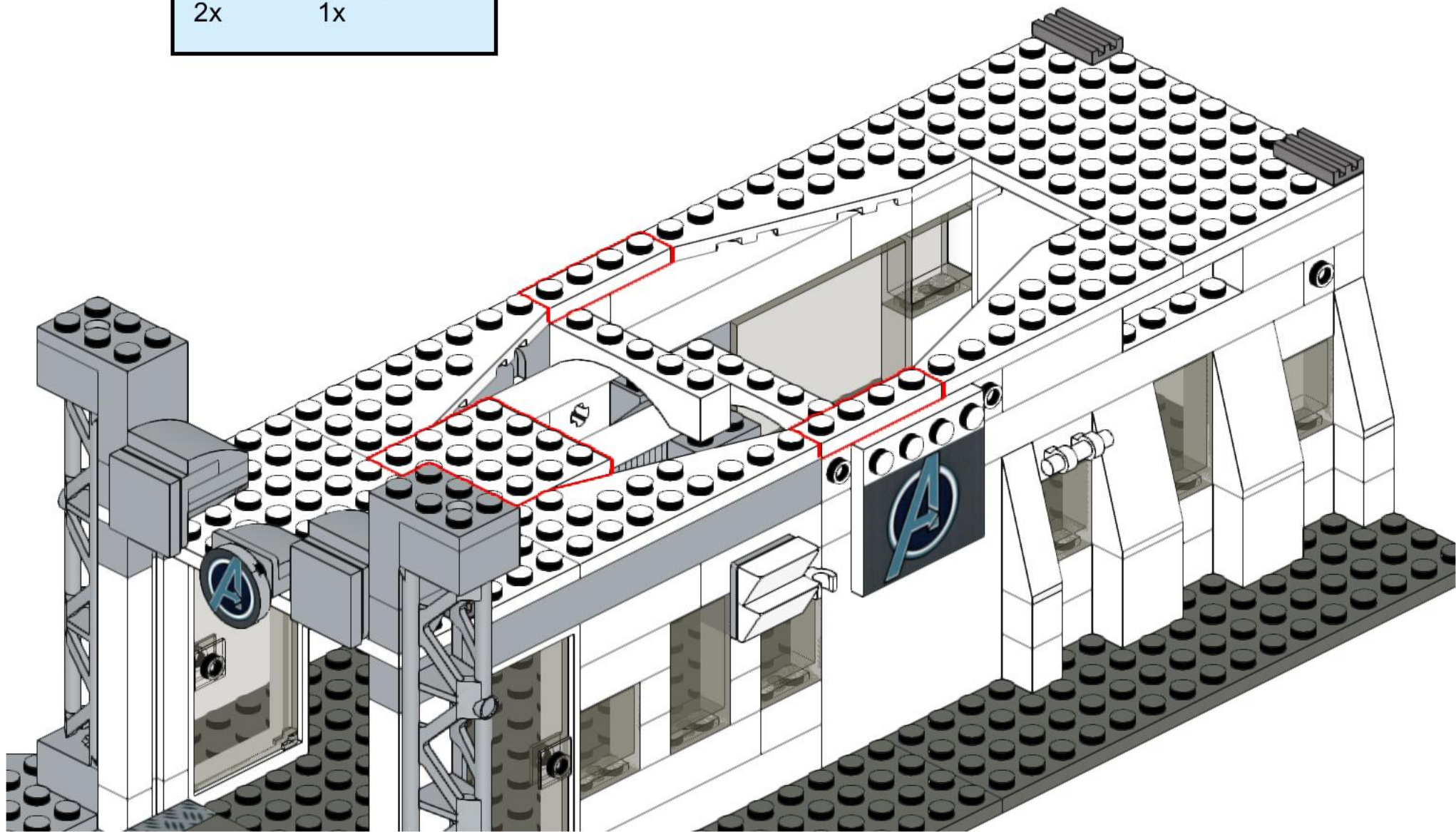
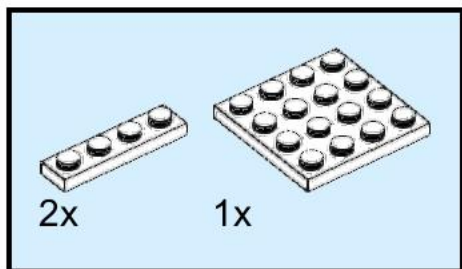

41

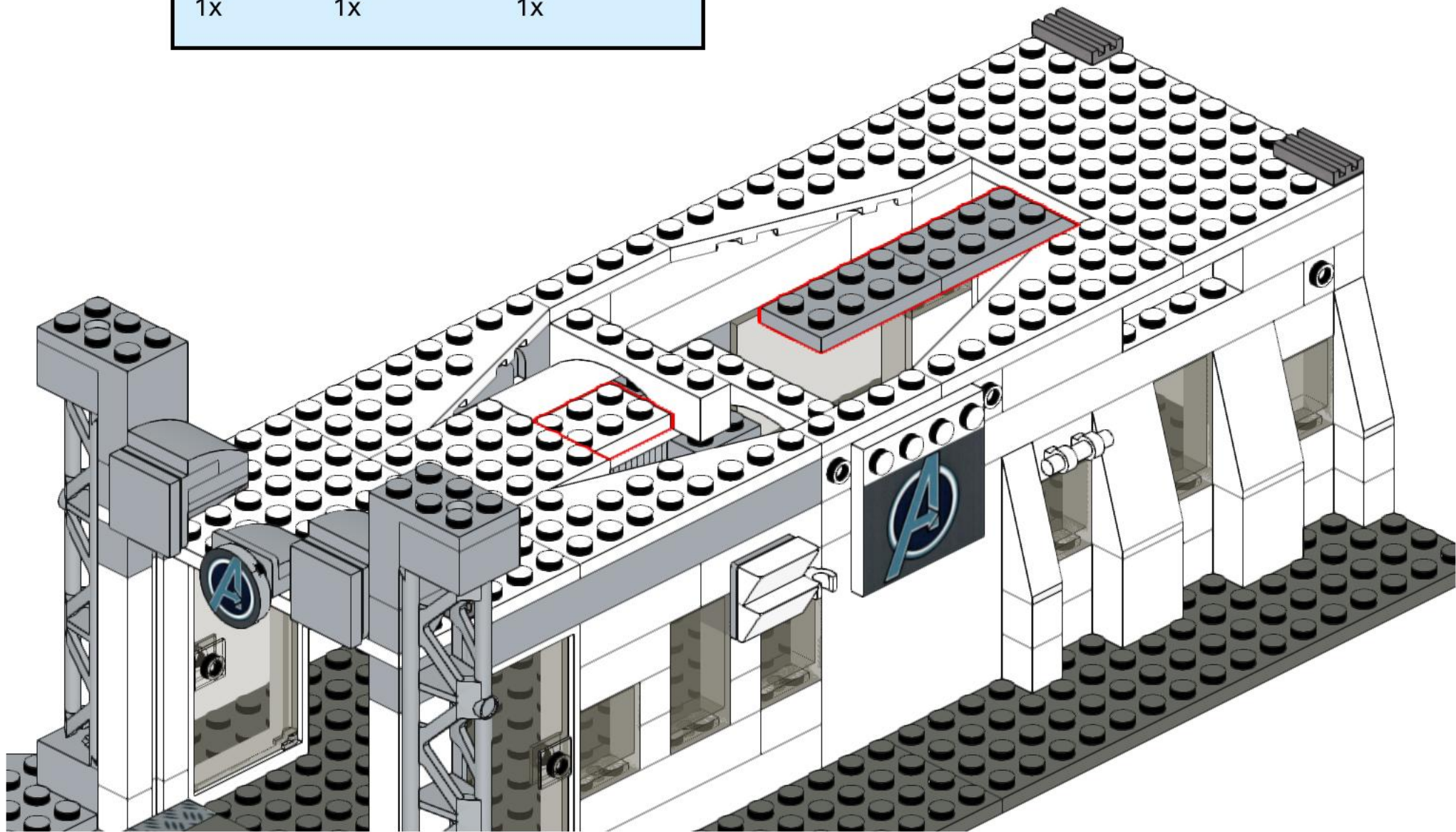
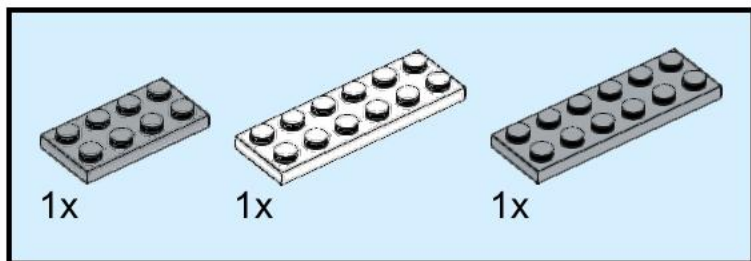

42

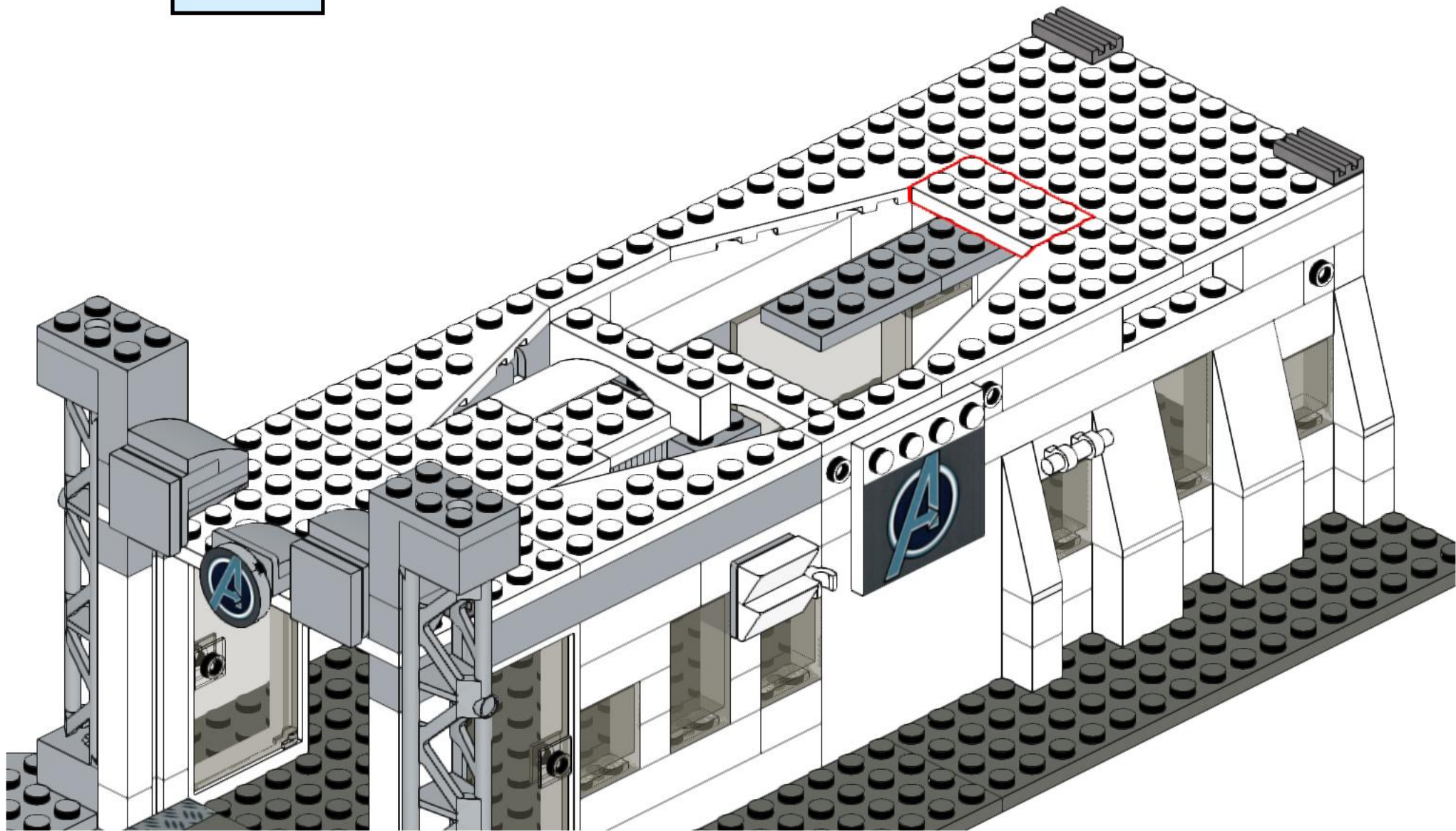
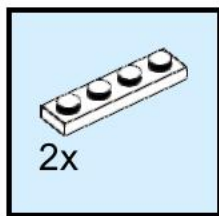

43

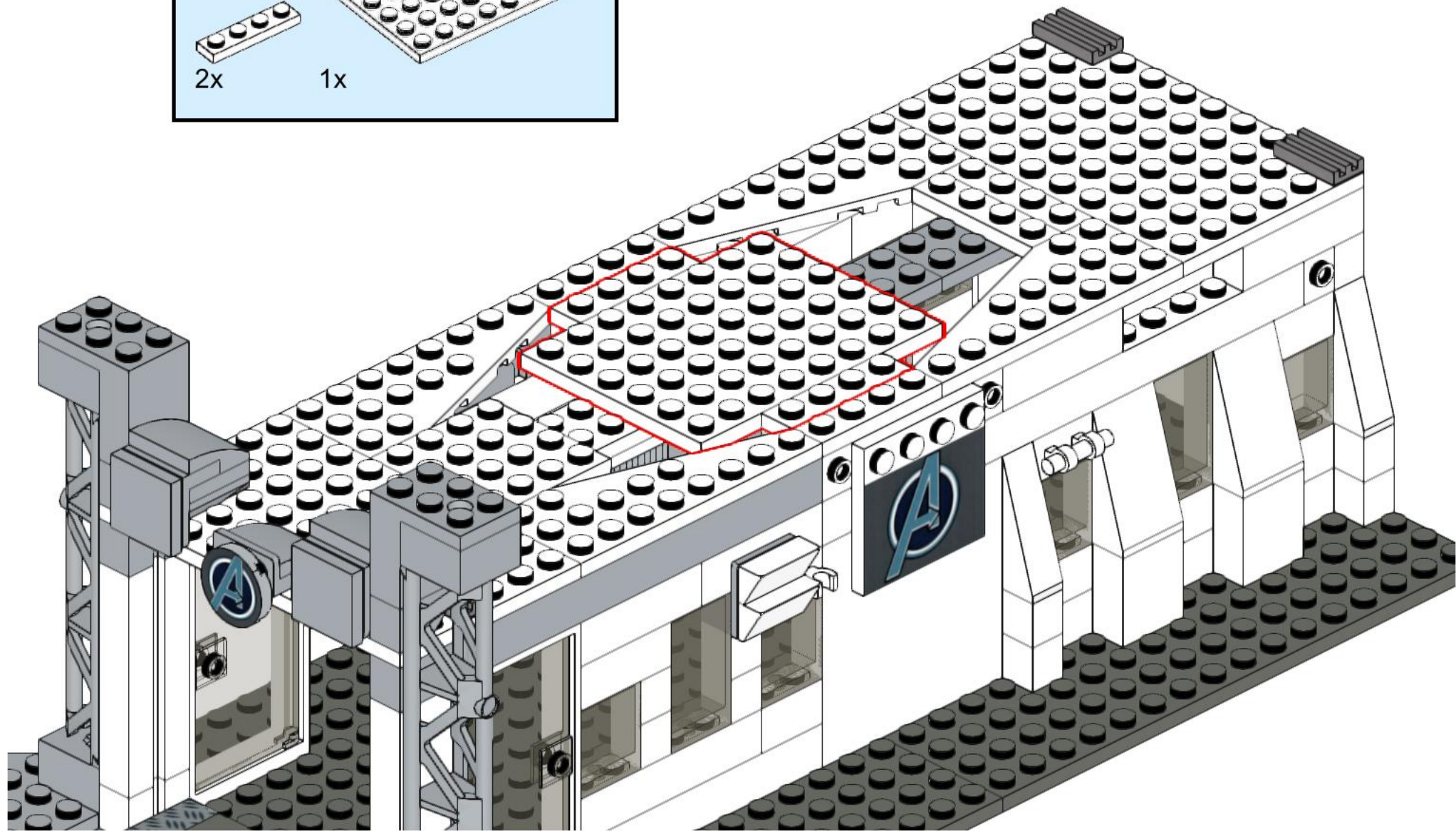
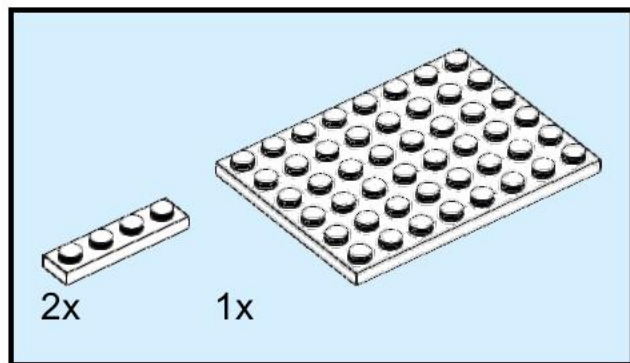

44

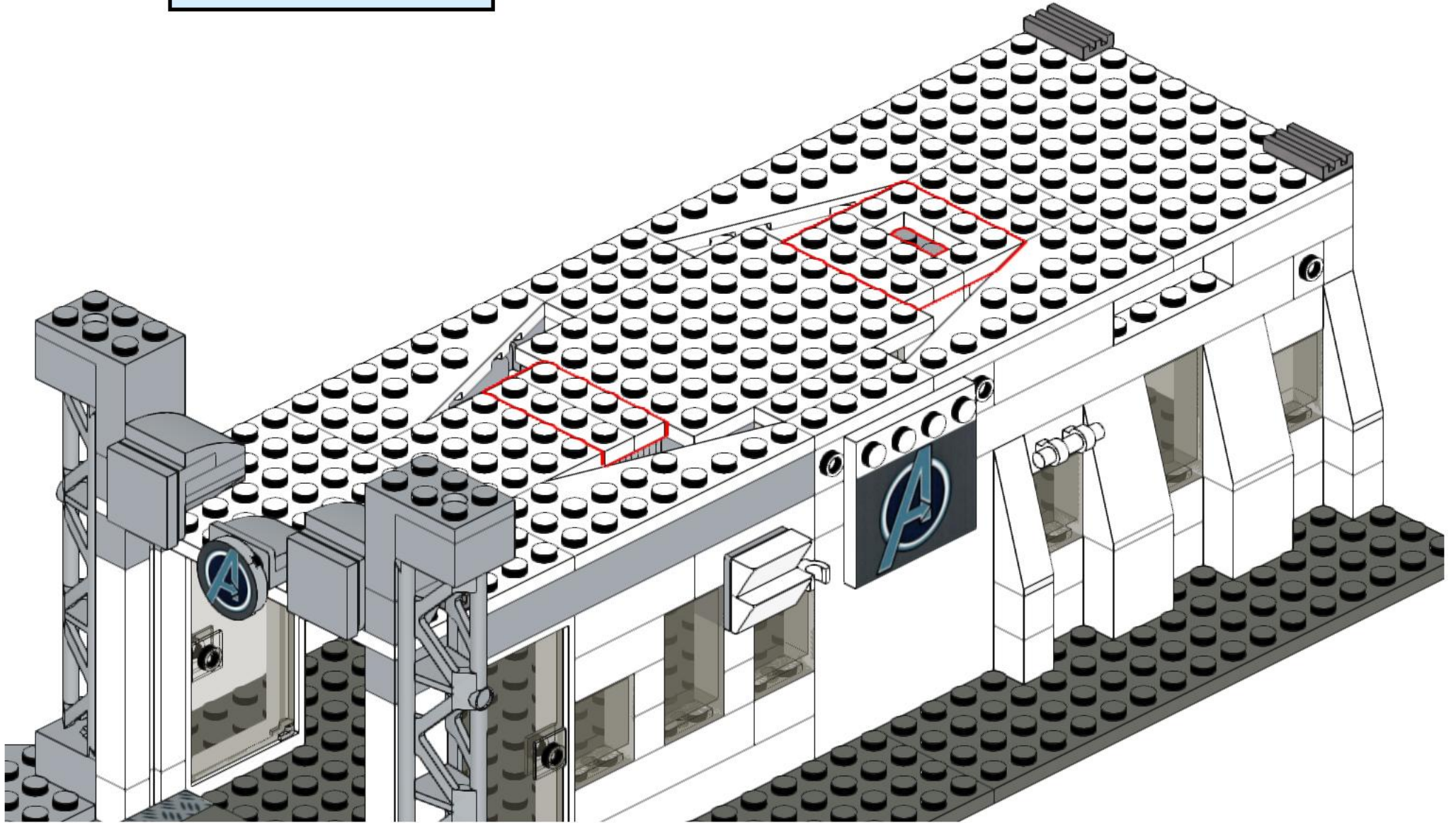
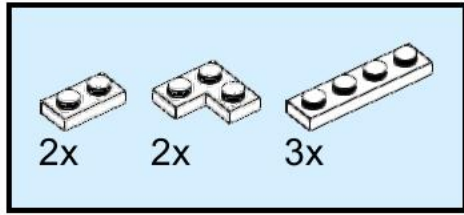

45

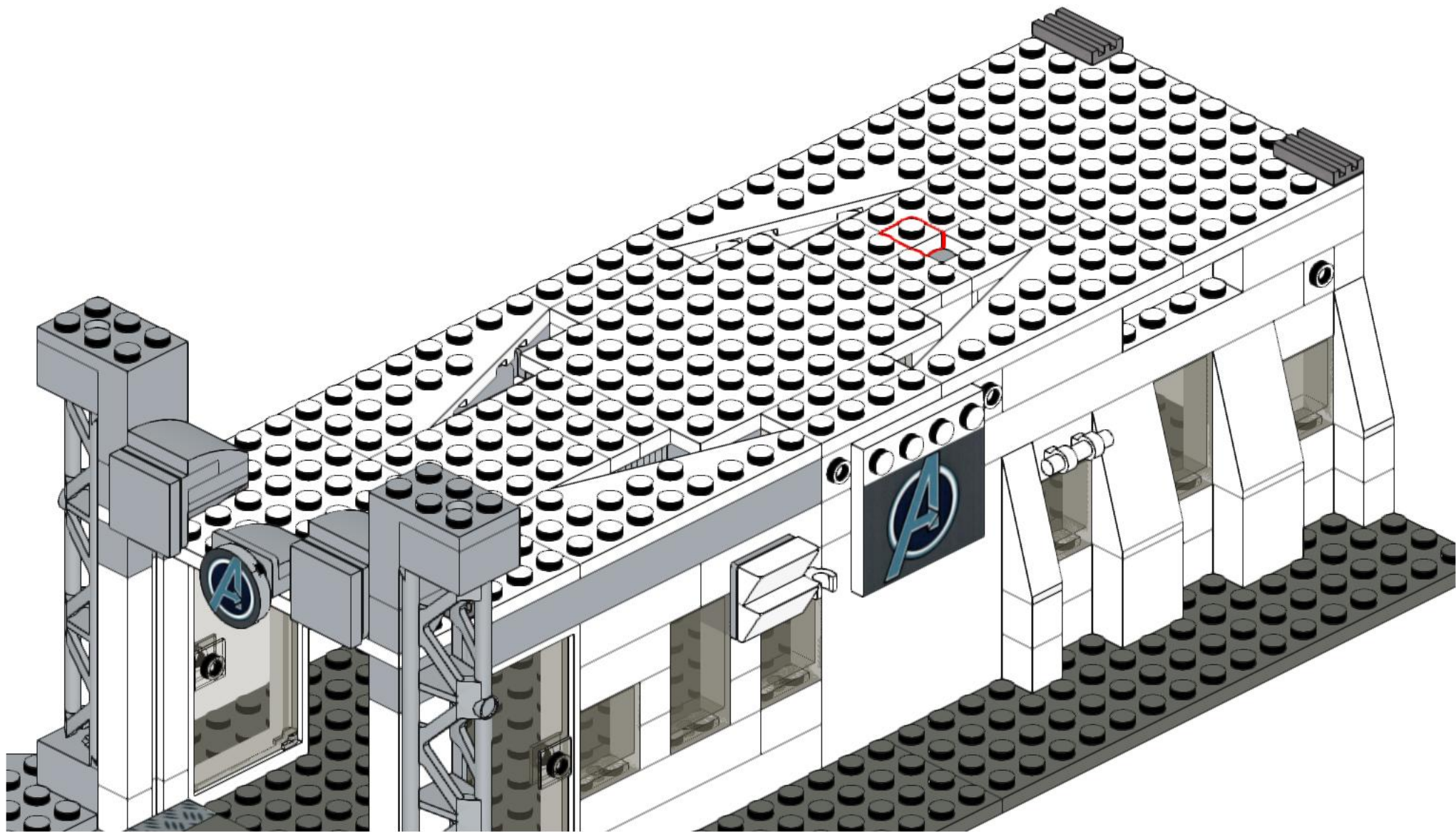
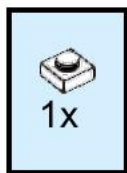

46

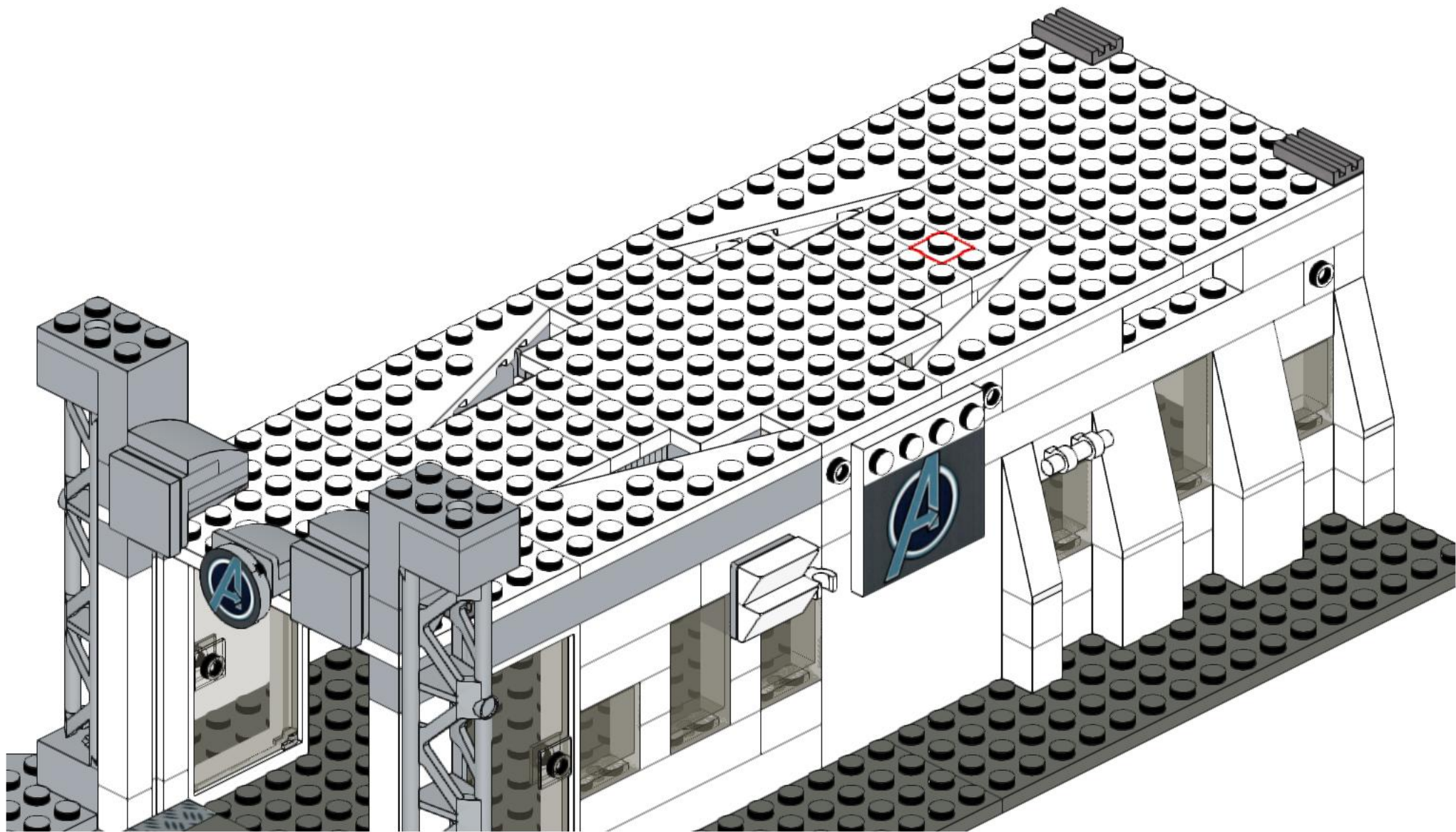
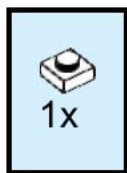

47

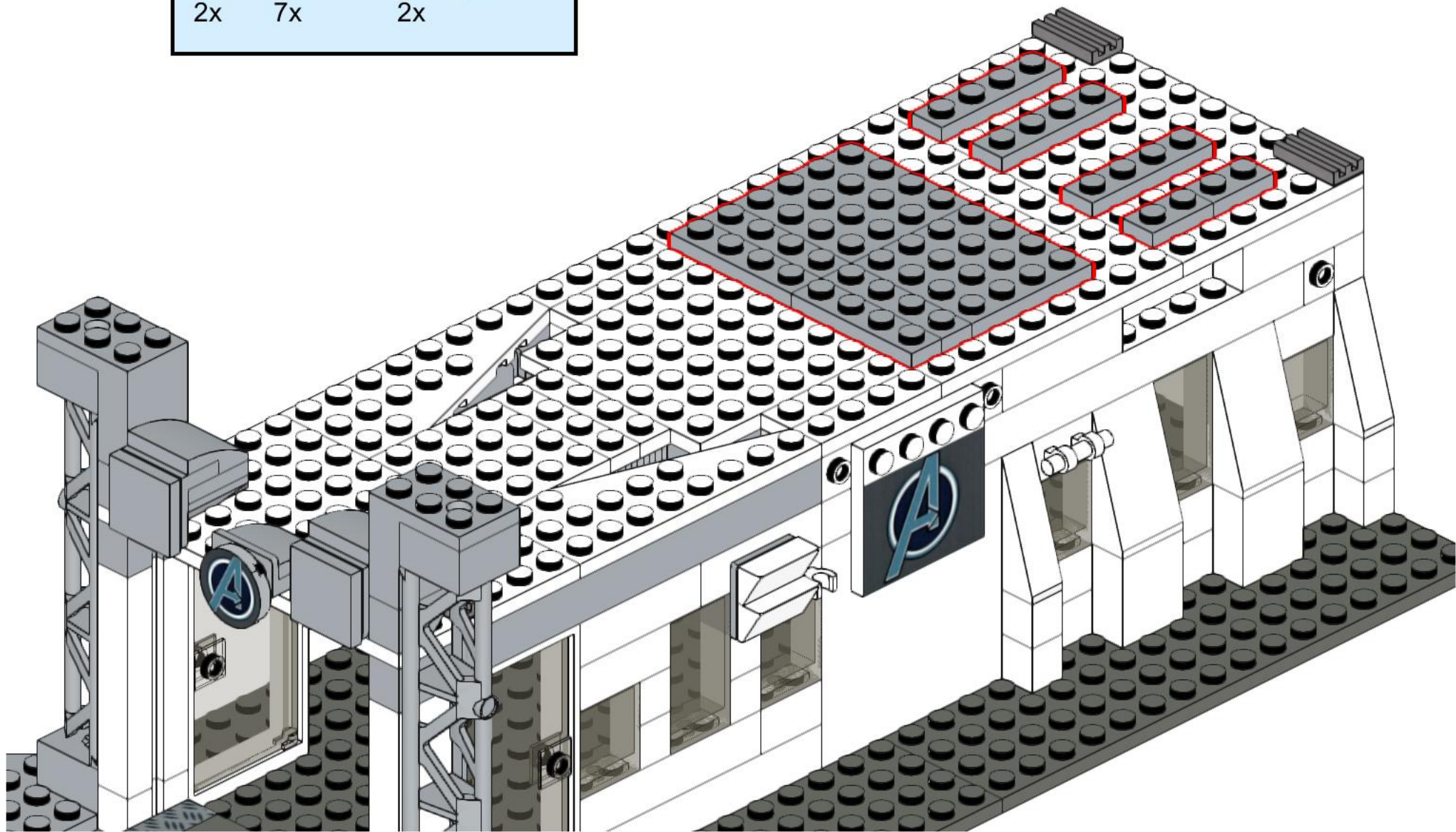
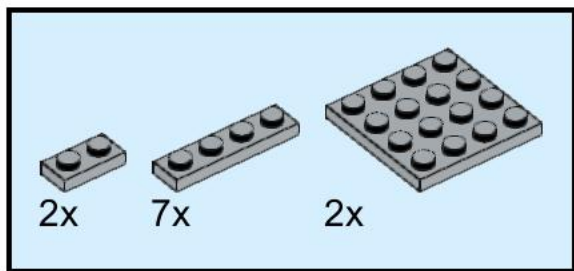

48

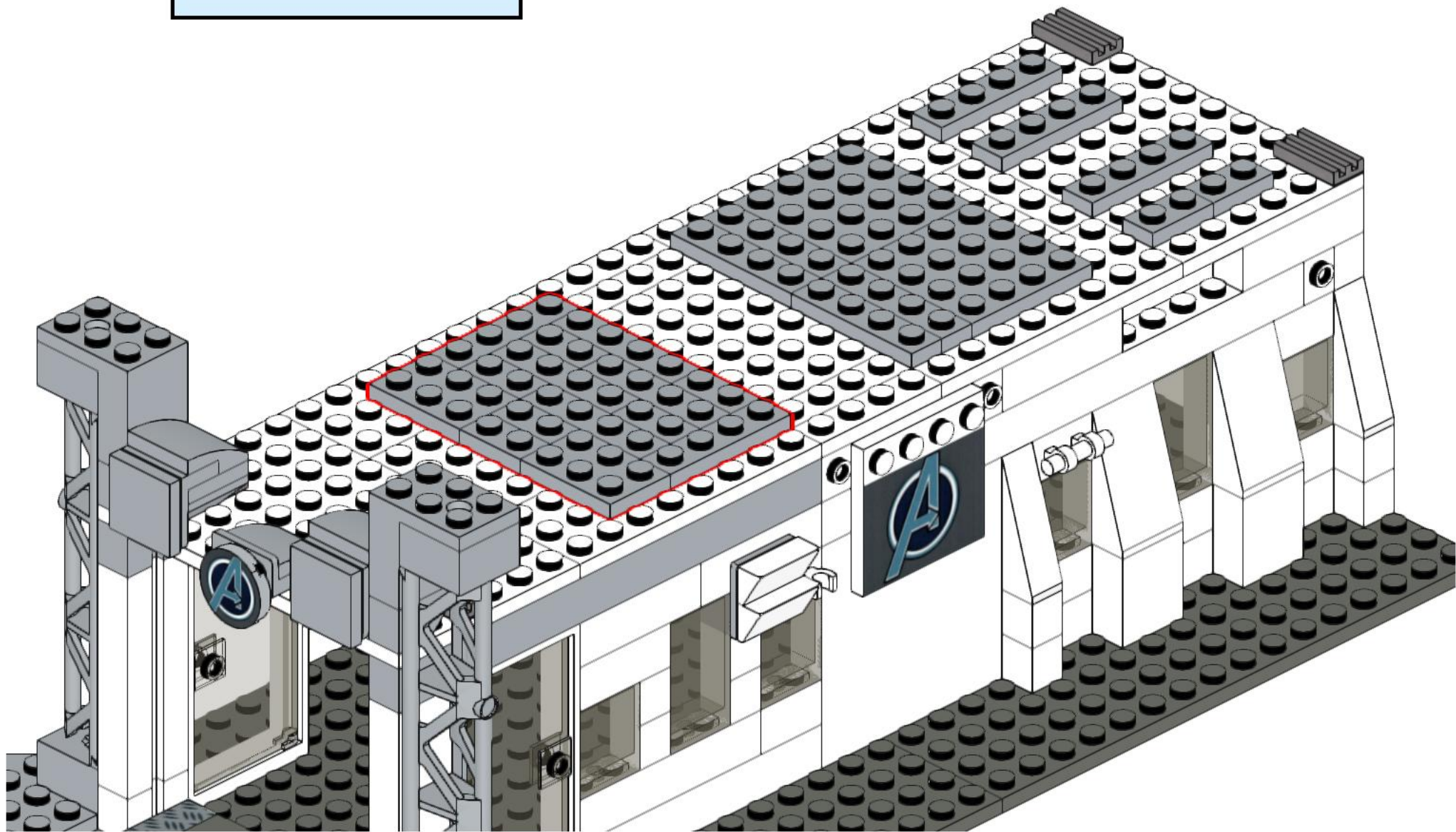
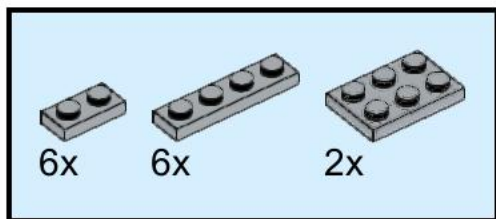

49

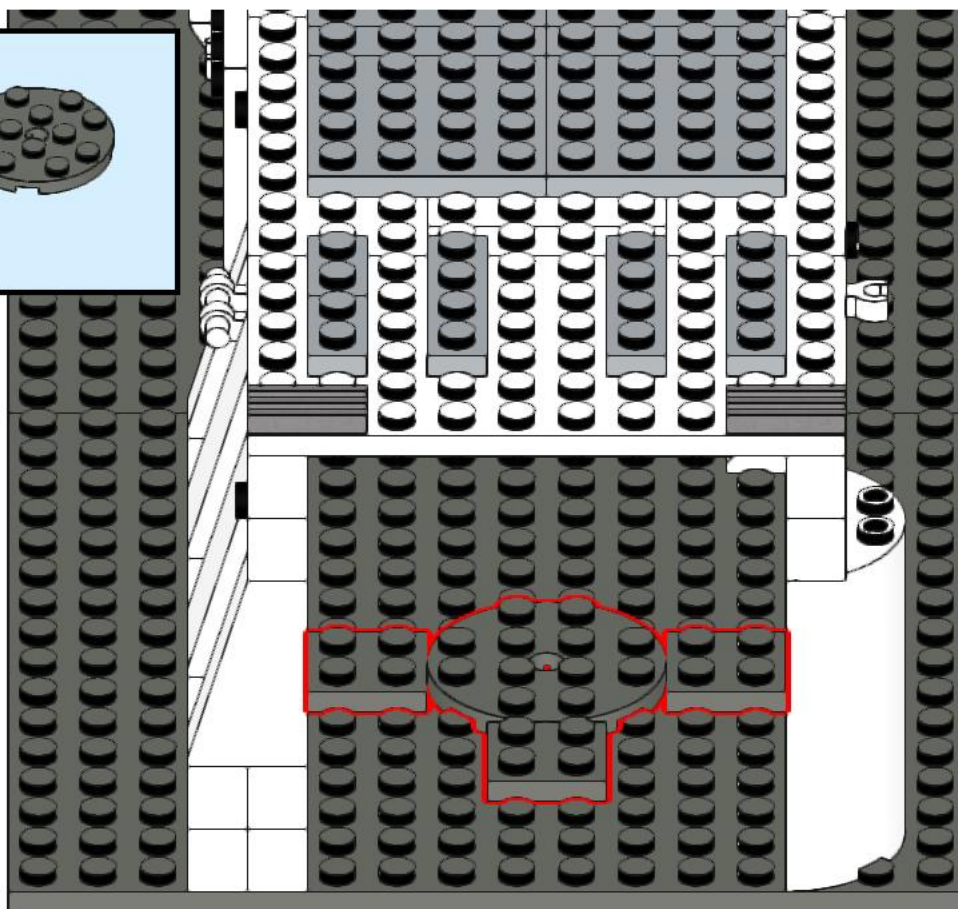
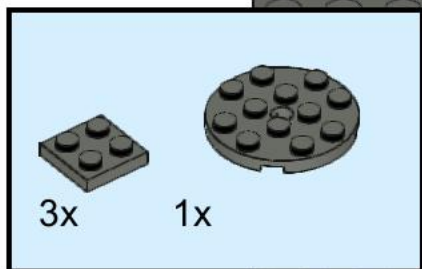

50

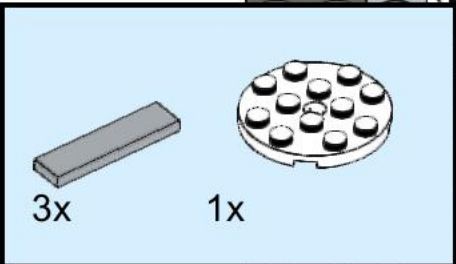

3x

1x

This inset box shows the parts required for step 50: three grey 1x3 Technic Technaxs Technic Bricks and one white 1x4 Technic Technaxs Technic Plate with 4 holes.

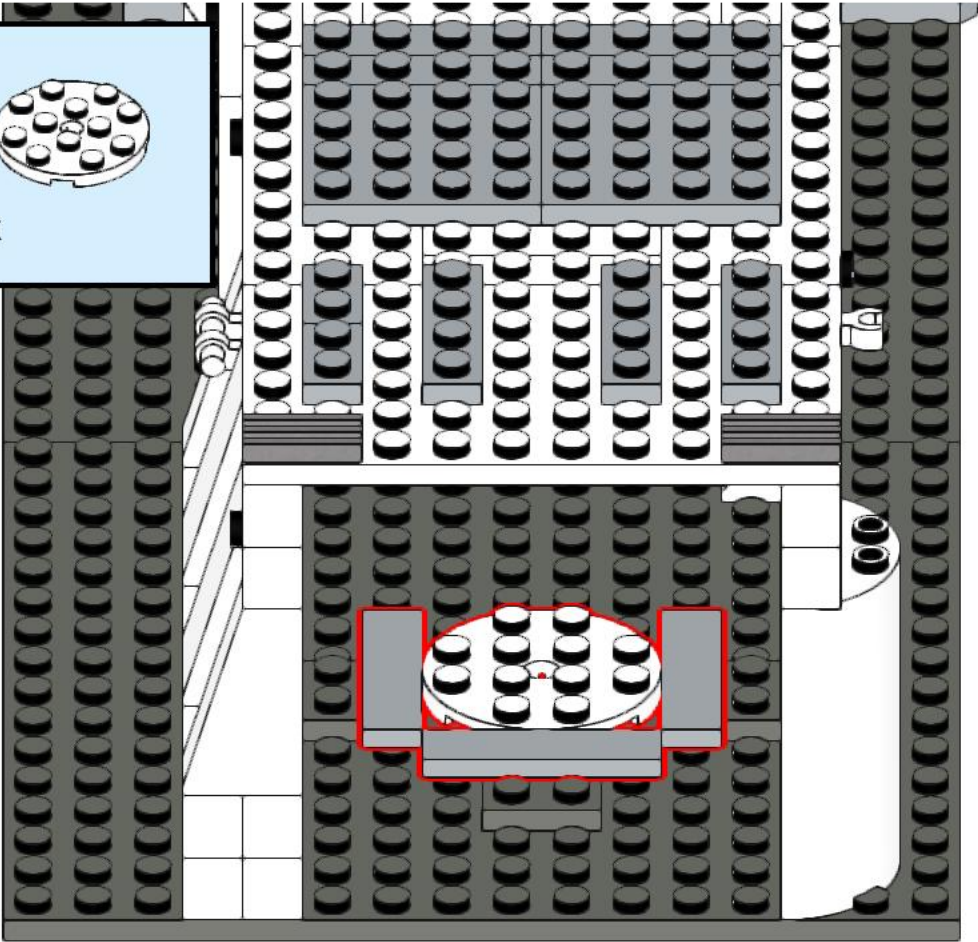

51

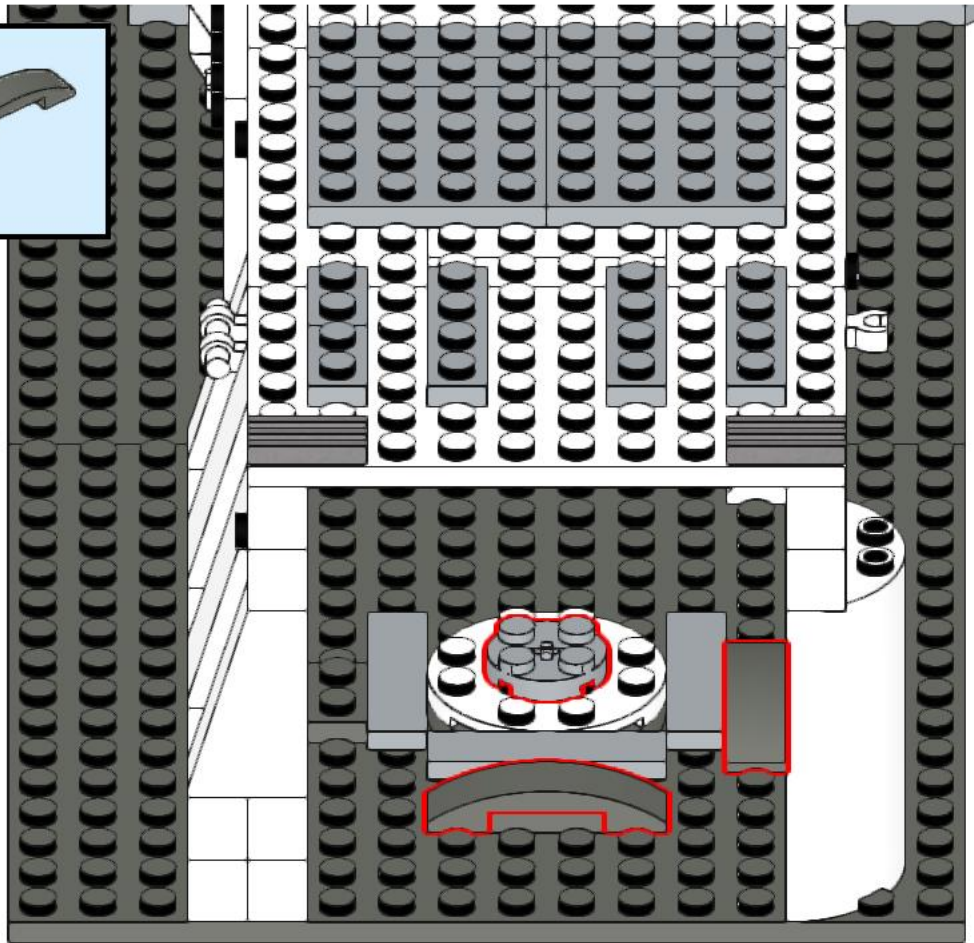
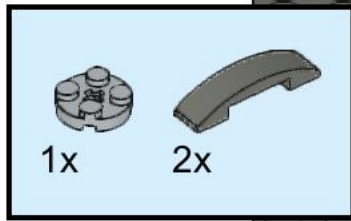

52

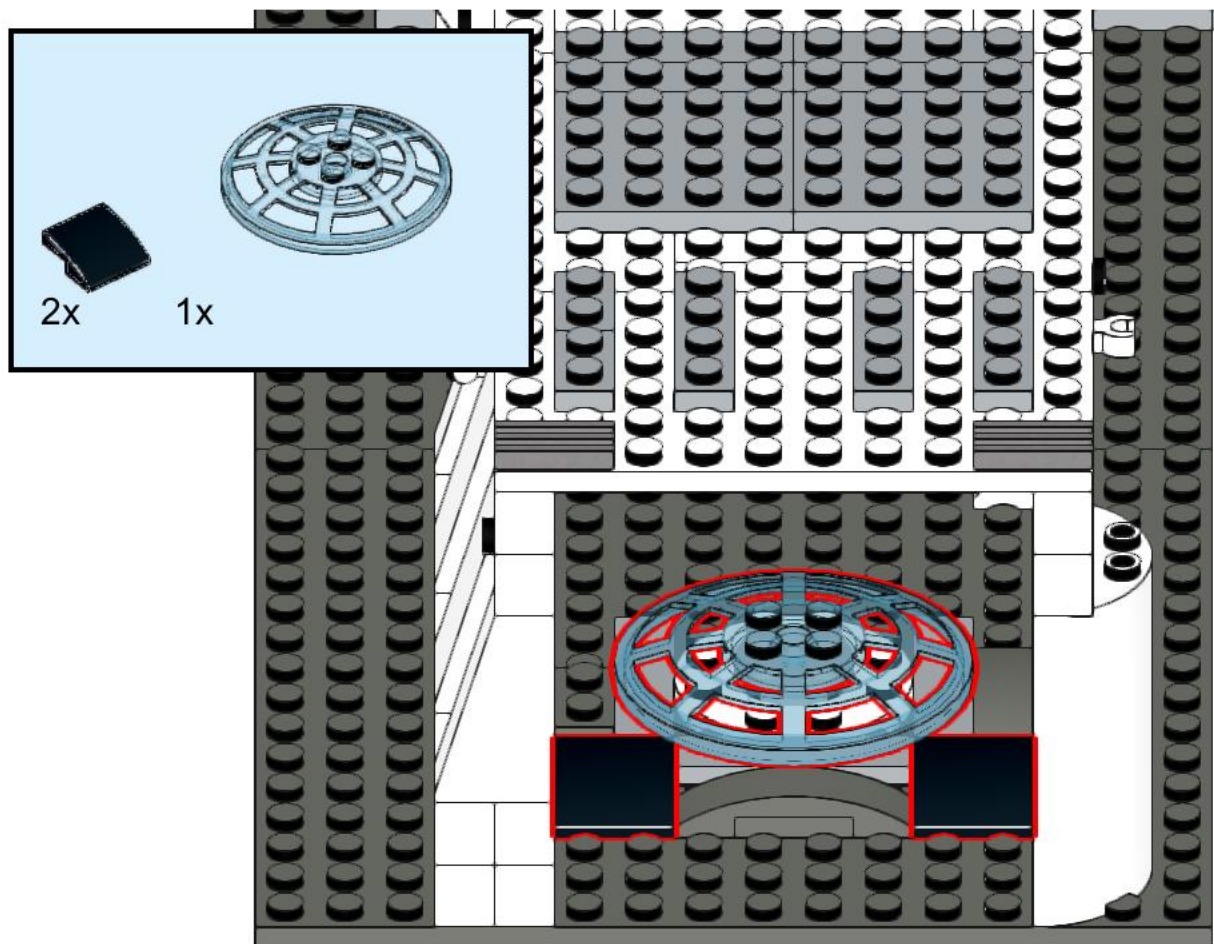

53

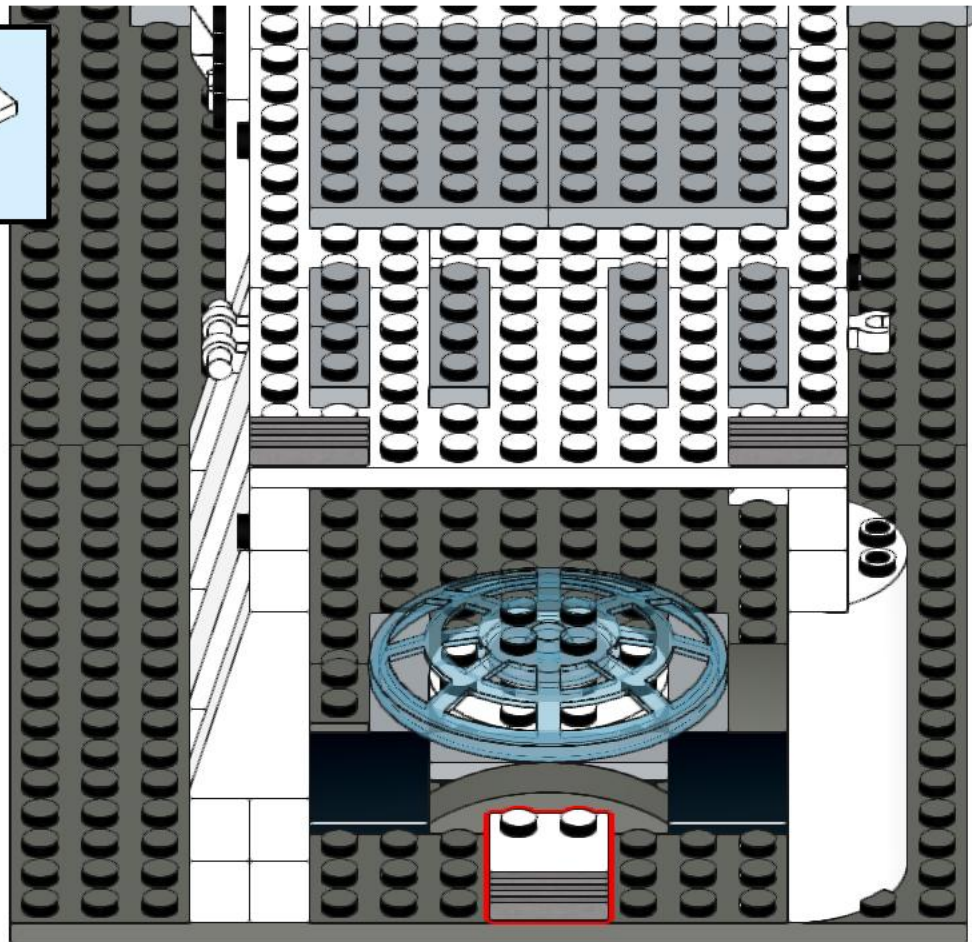
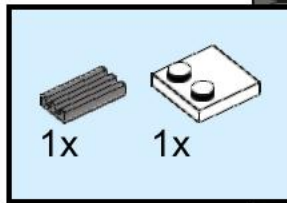

54

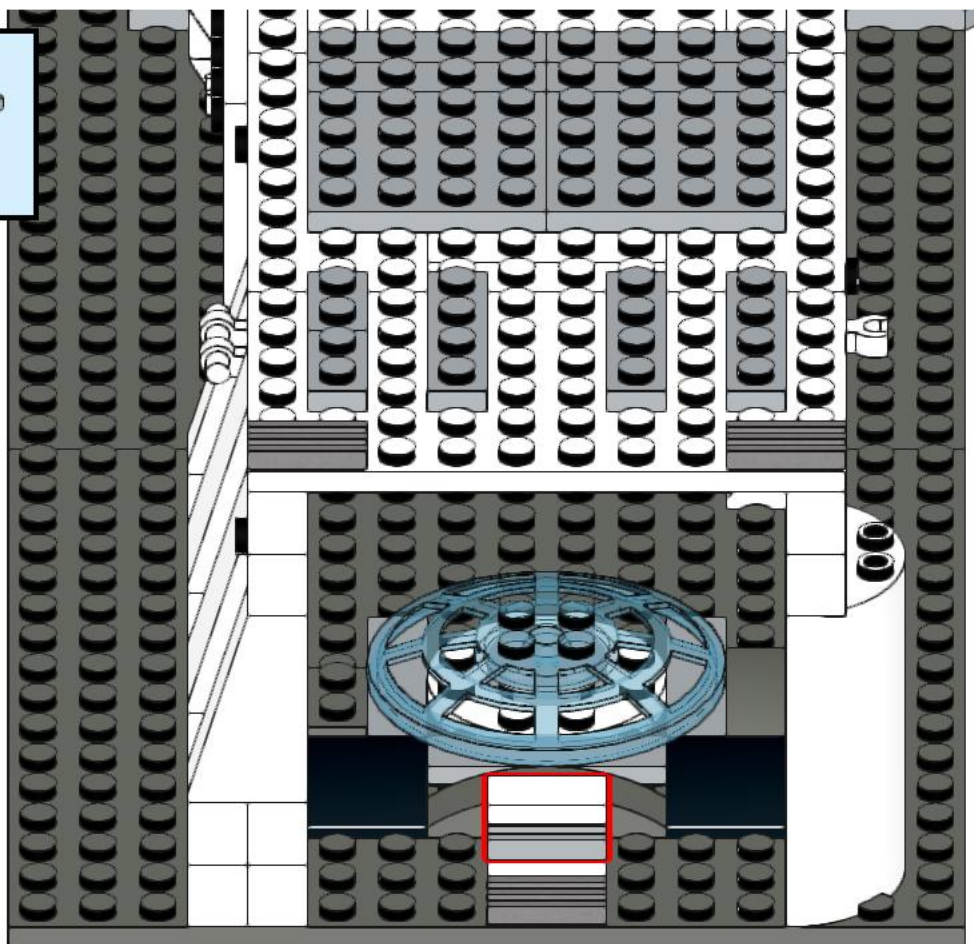
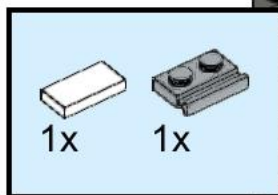

55

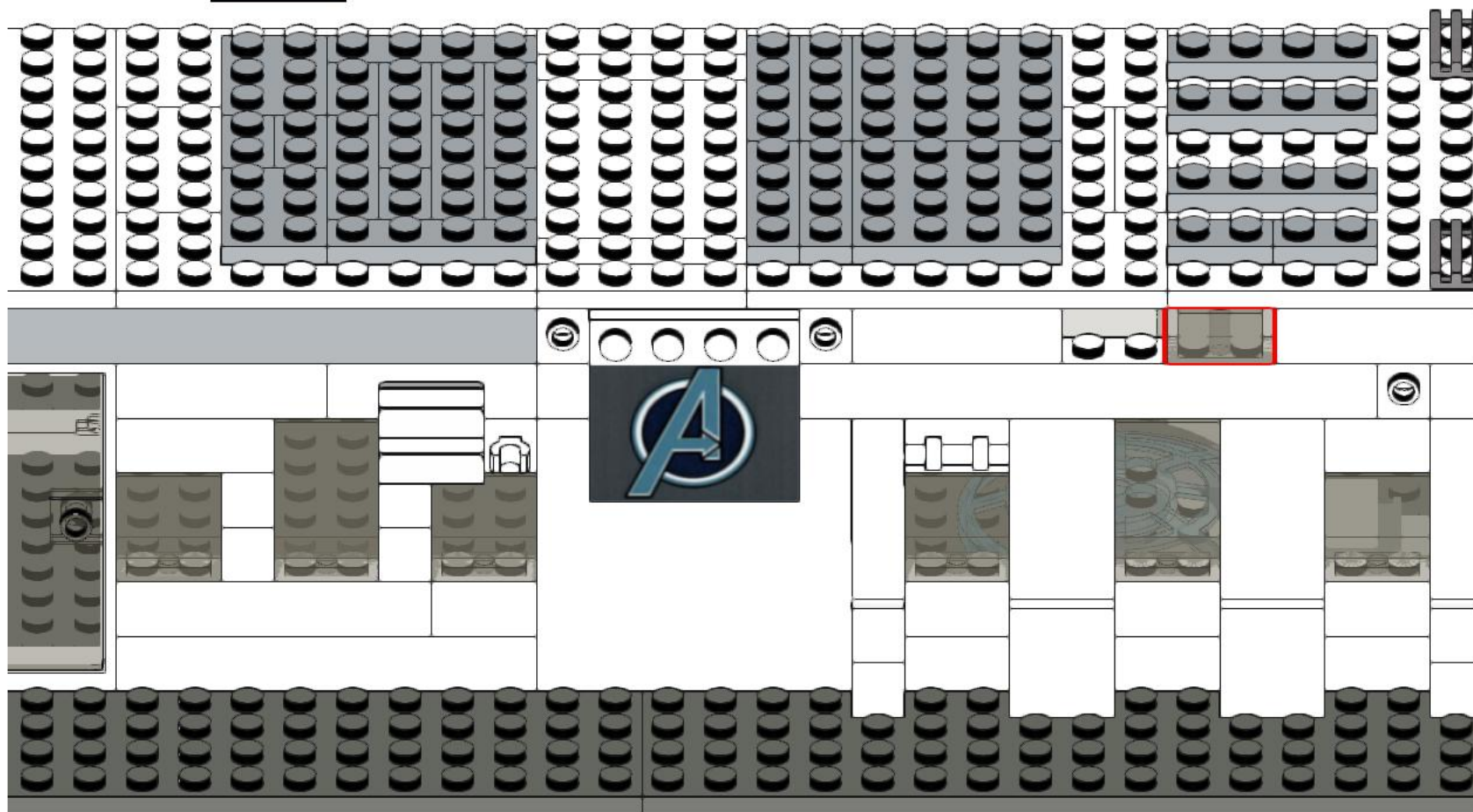
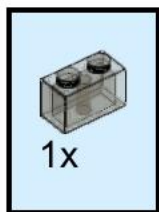

56

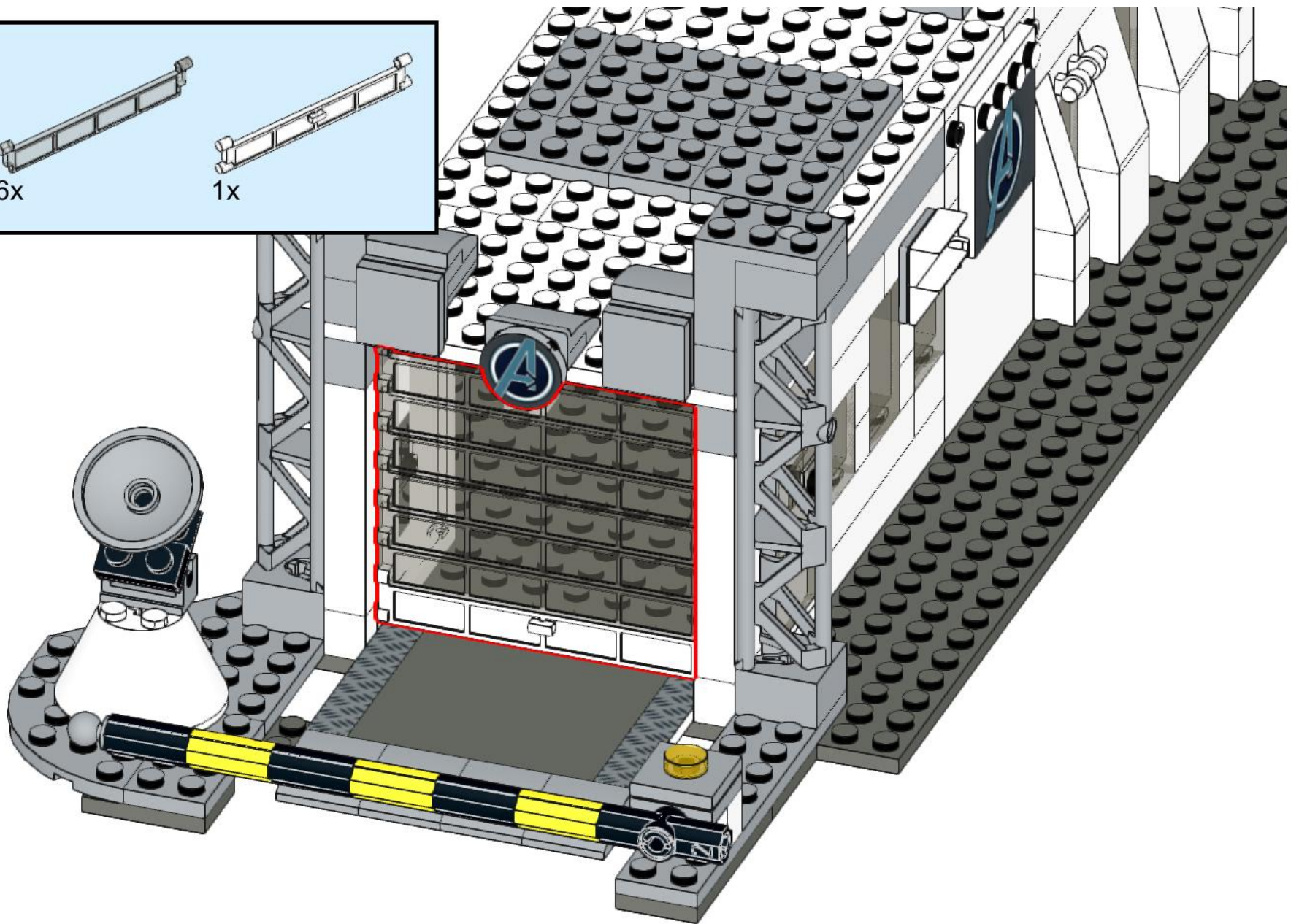
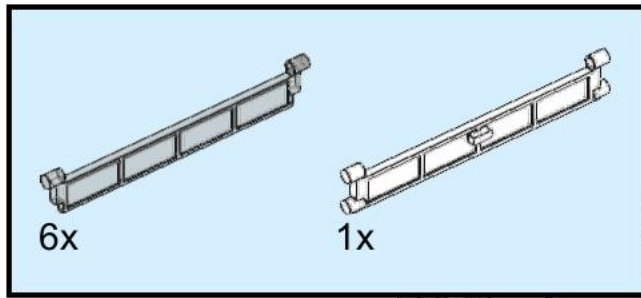

57

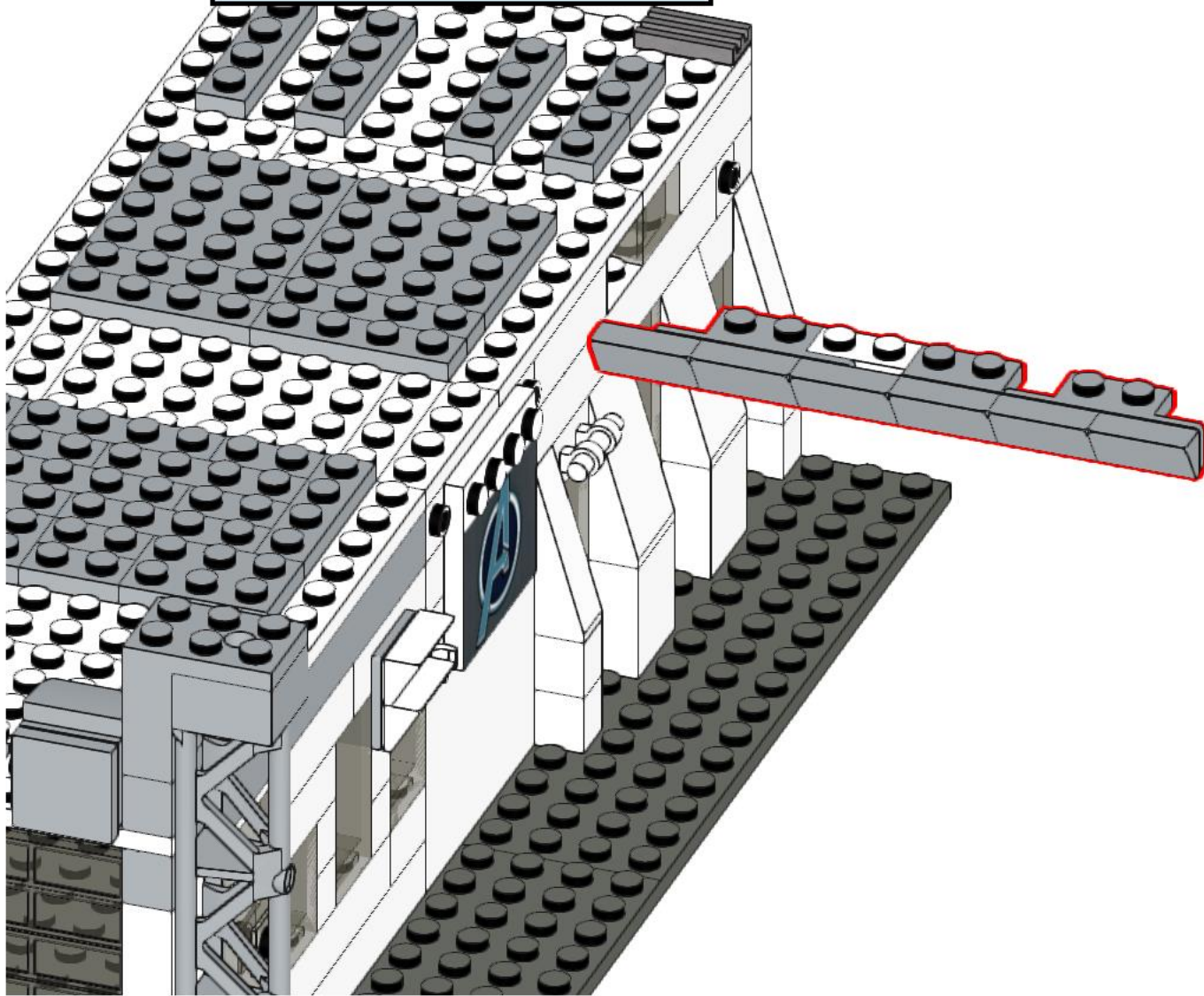
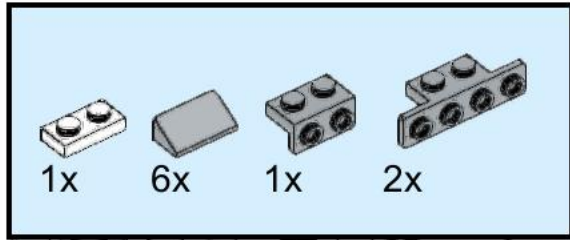

58

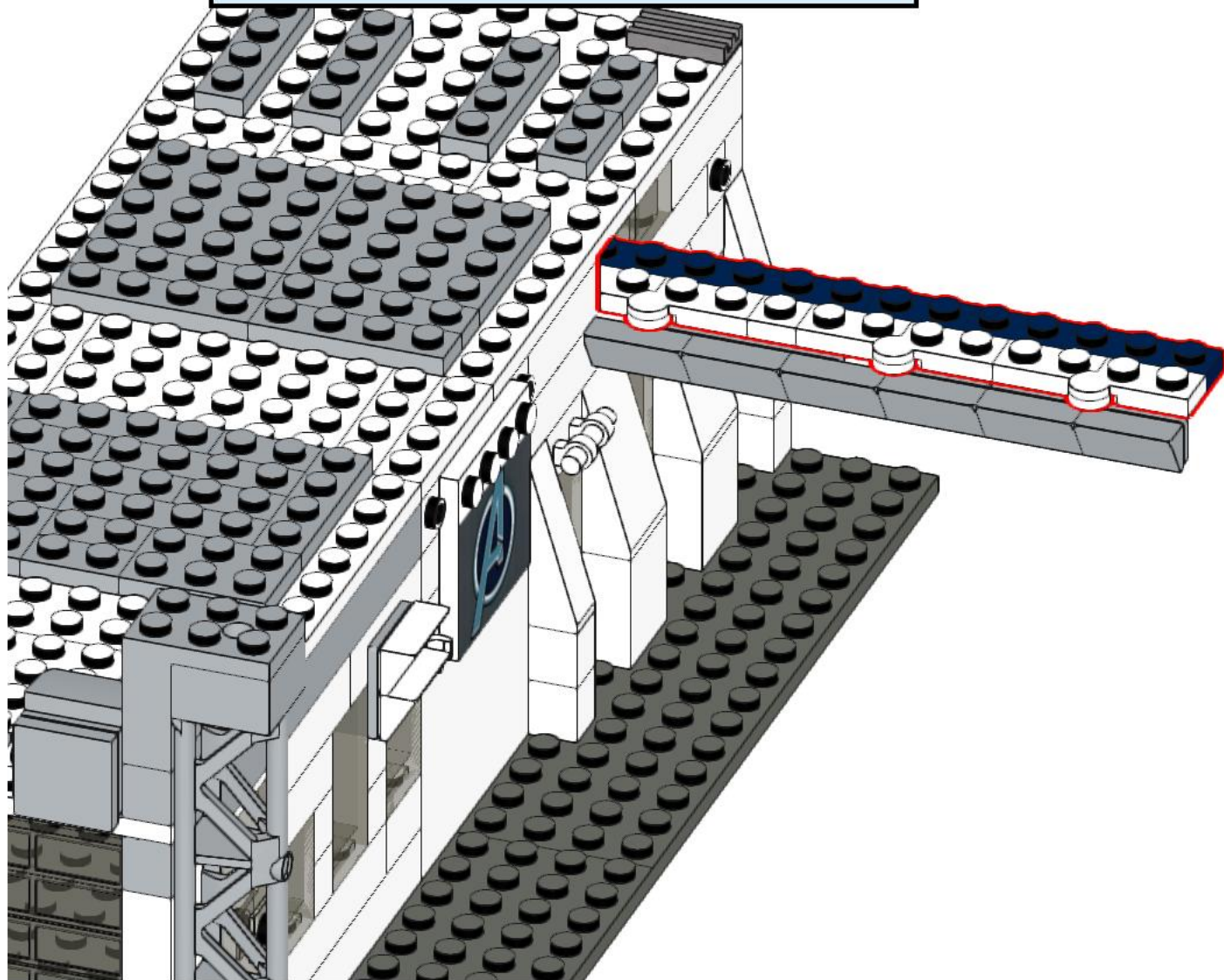
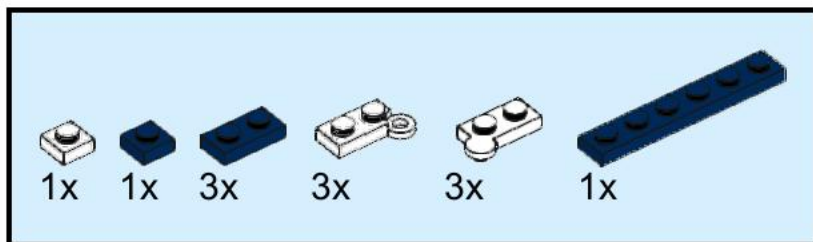

59

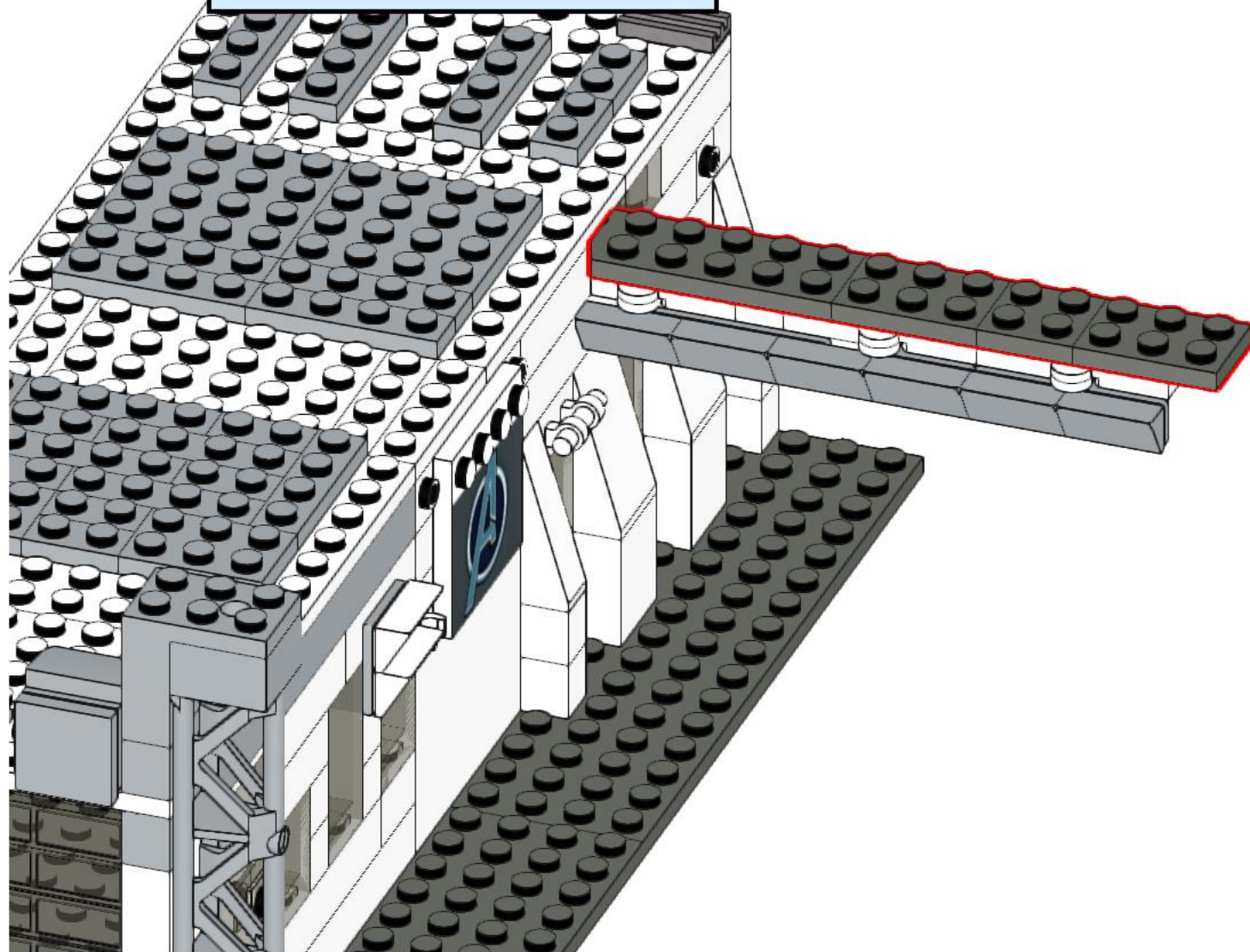
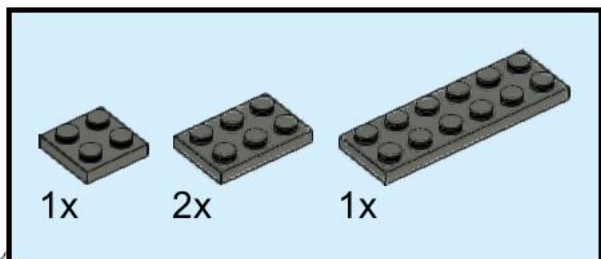

60

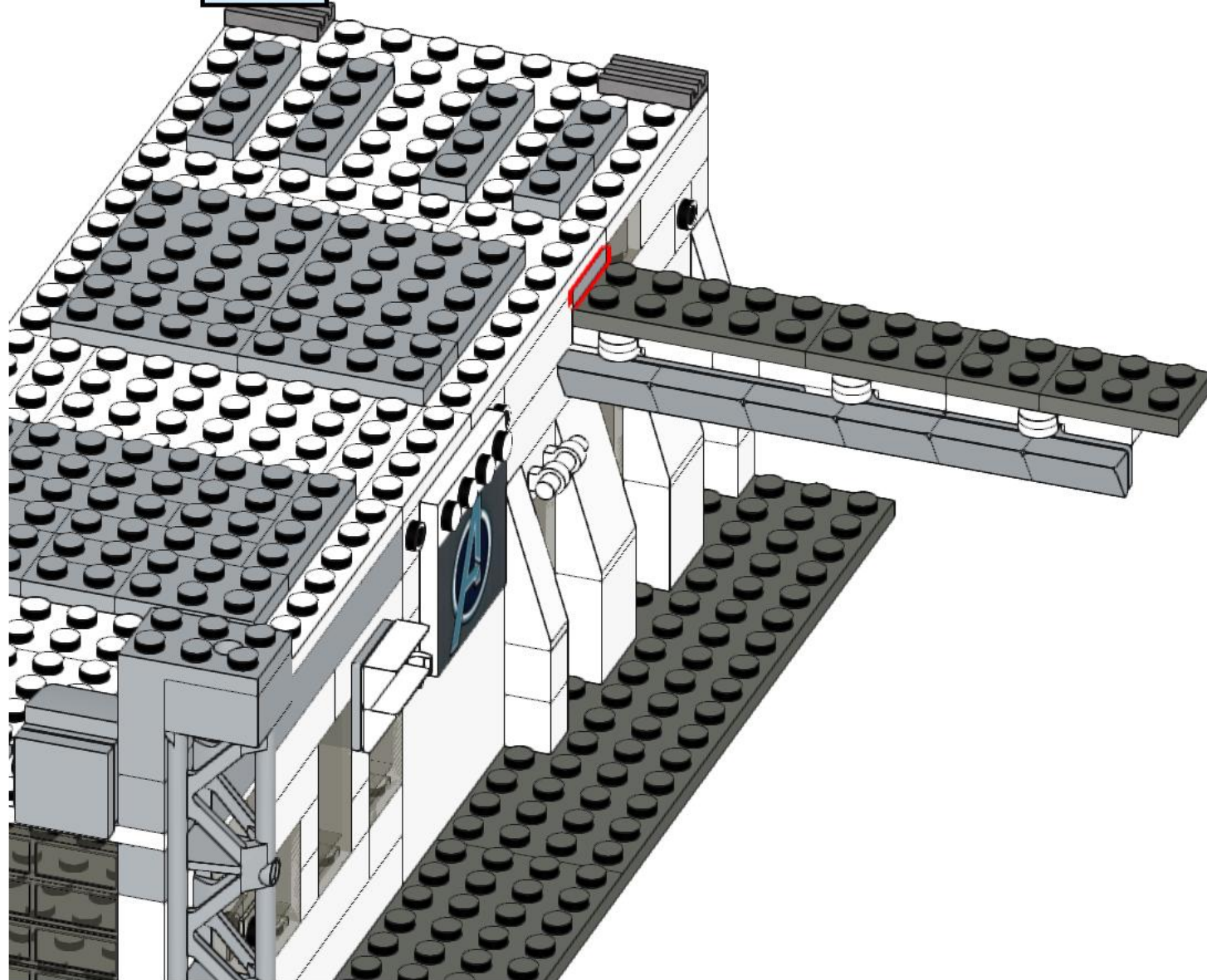
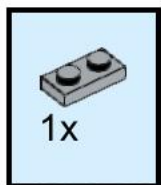

61

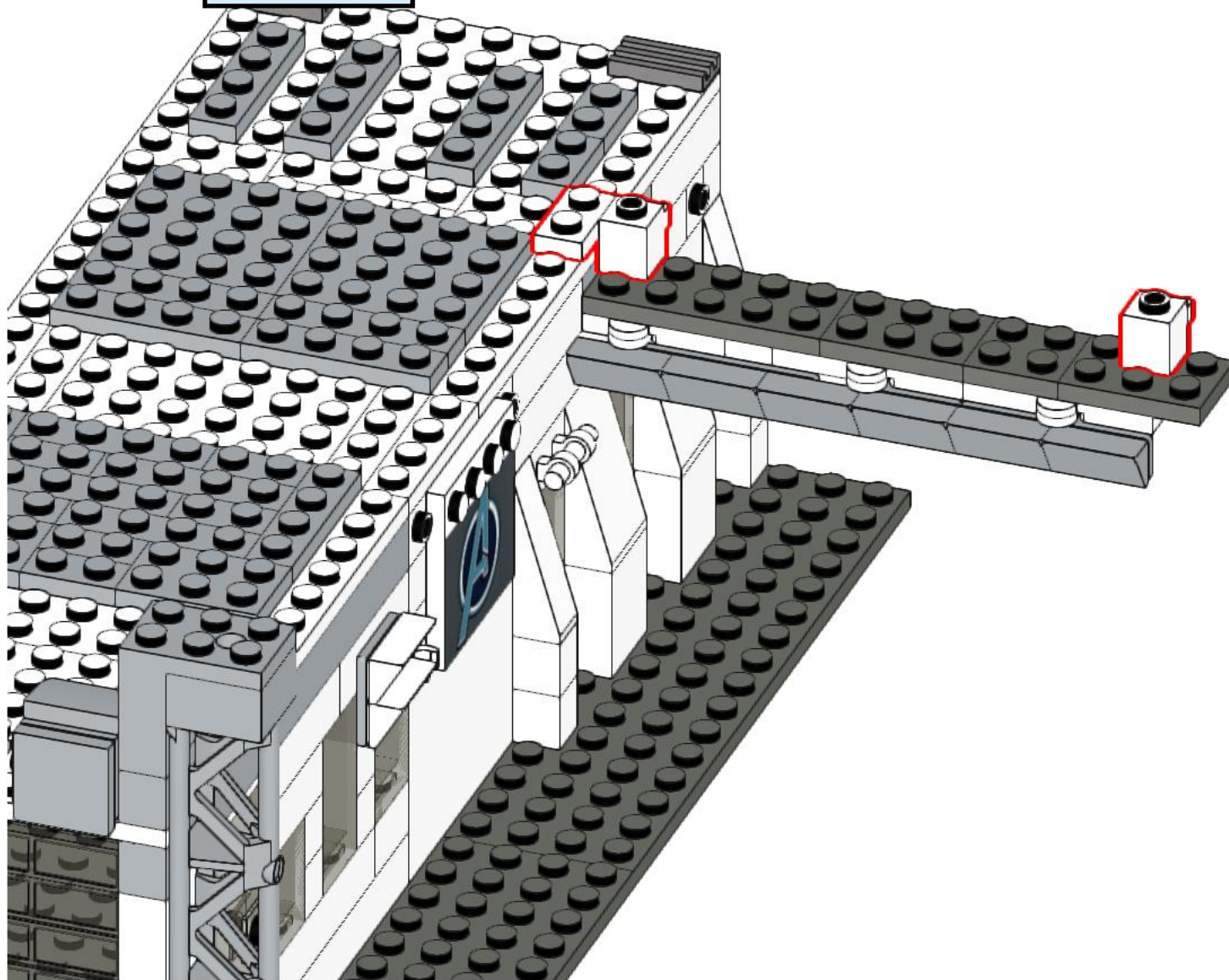
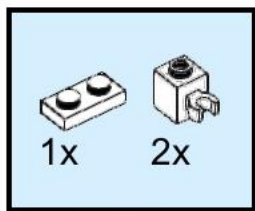

62

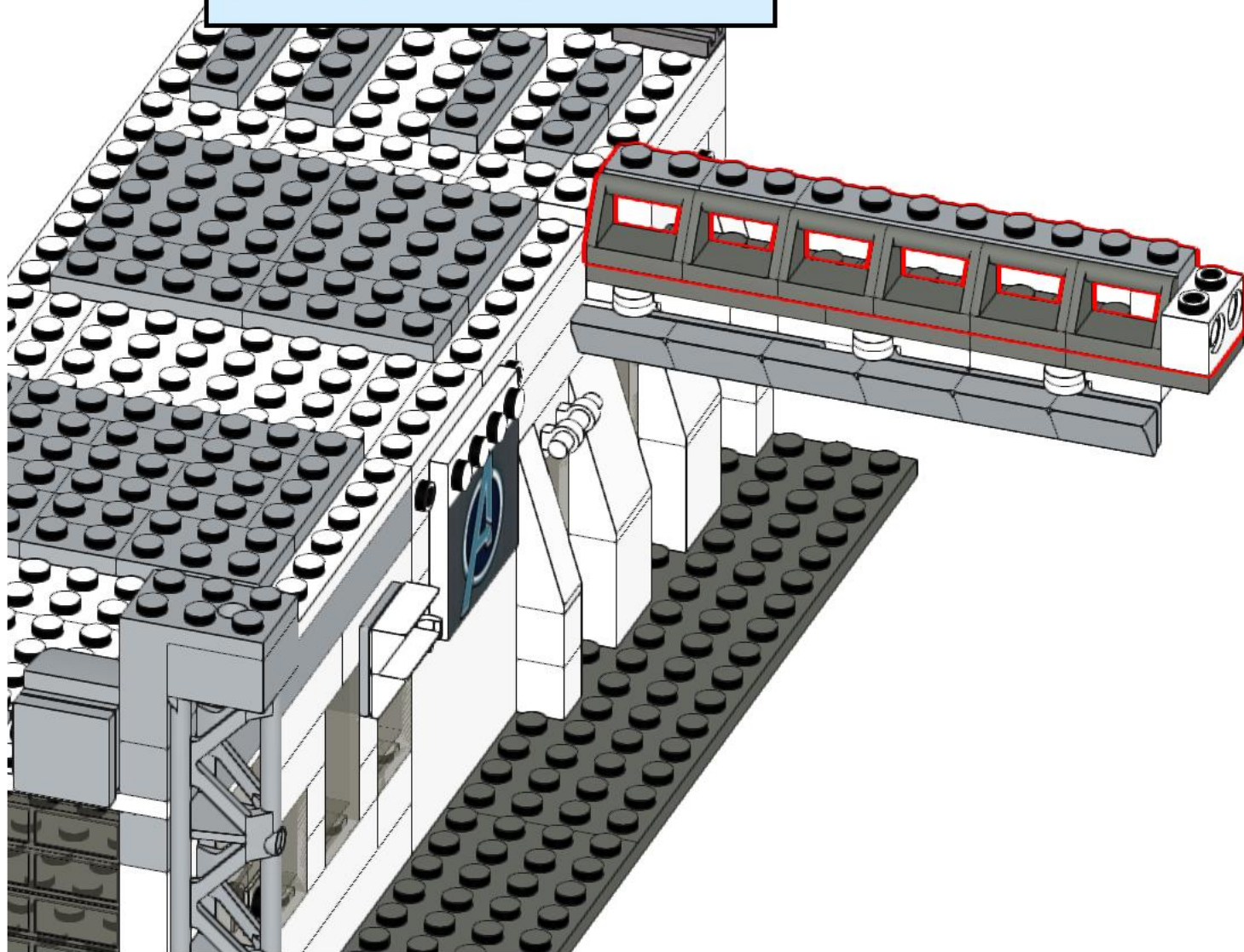
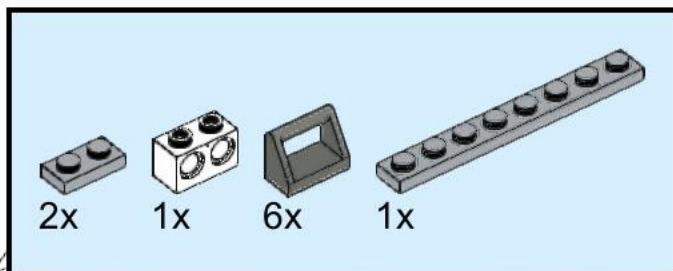

63

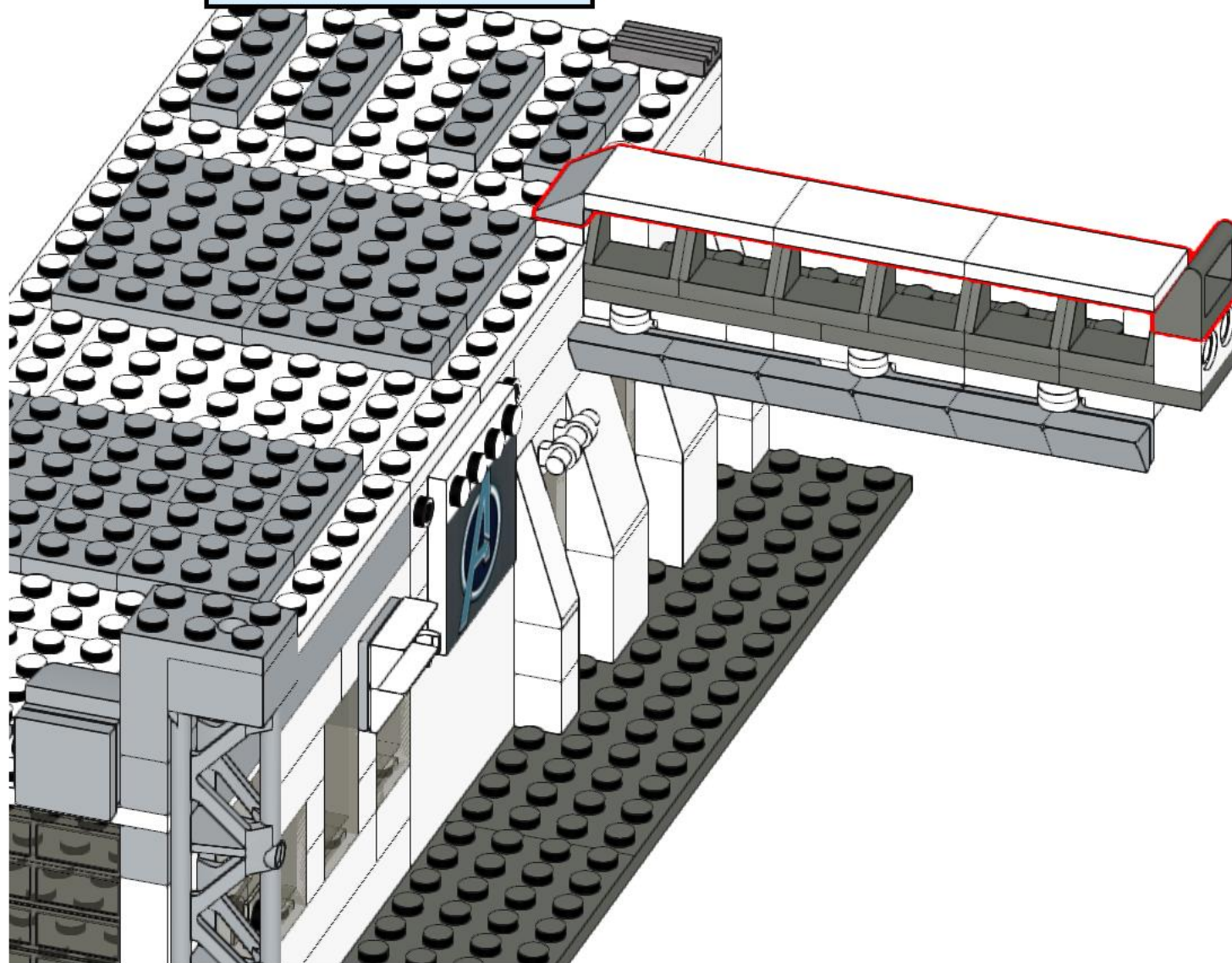
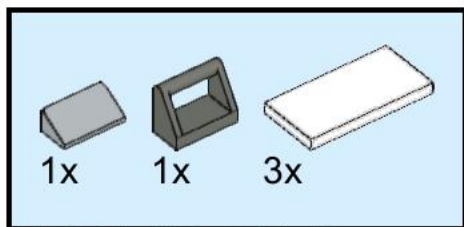

64

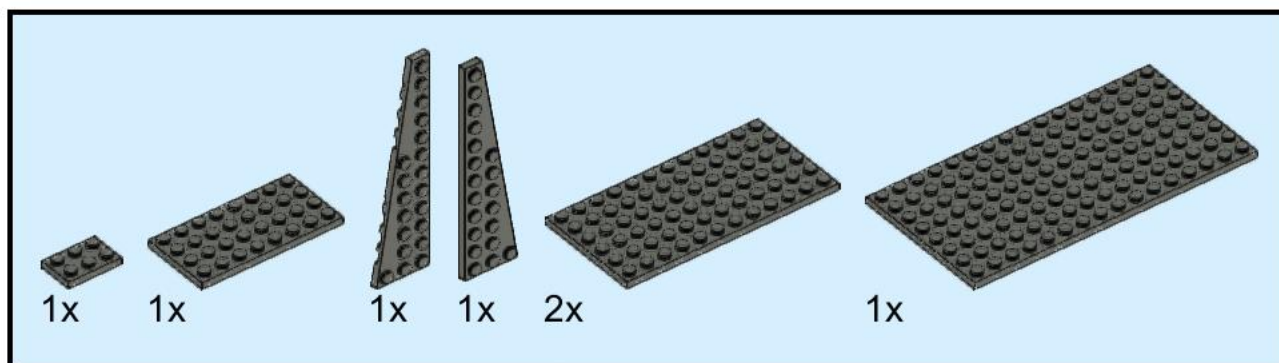
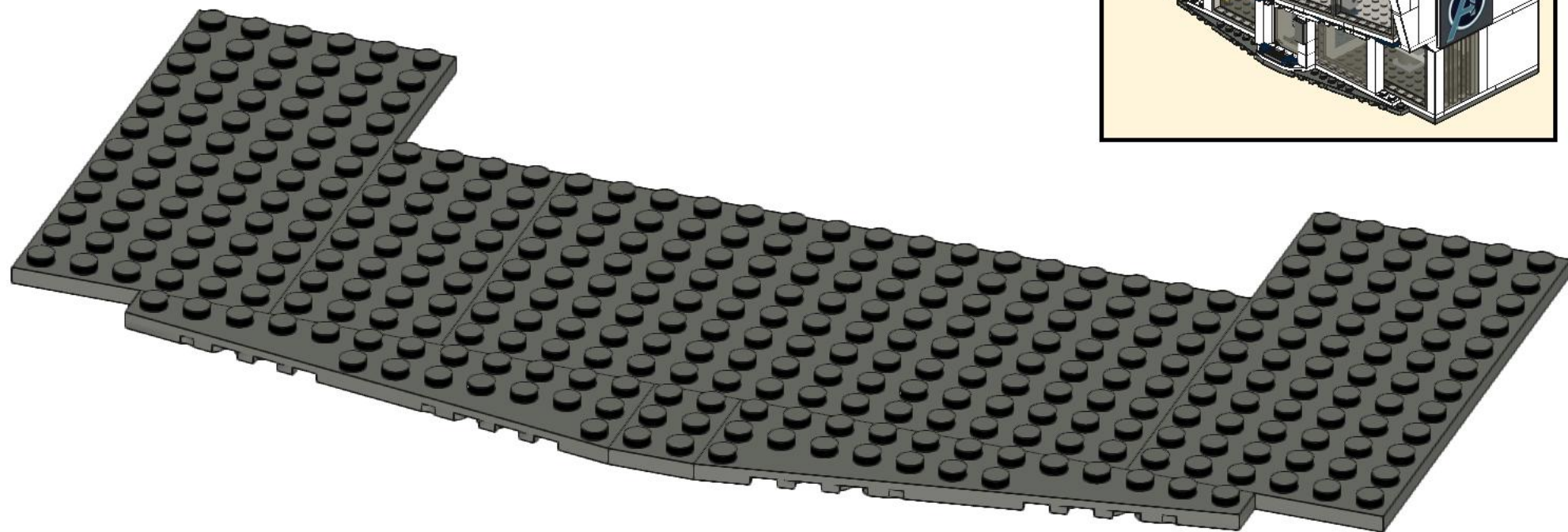
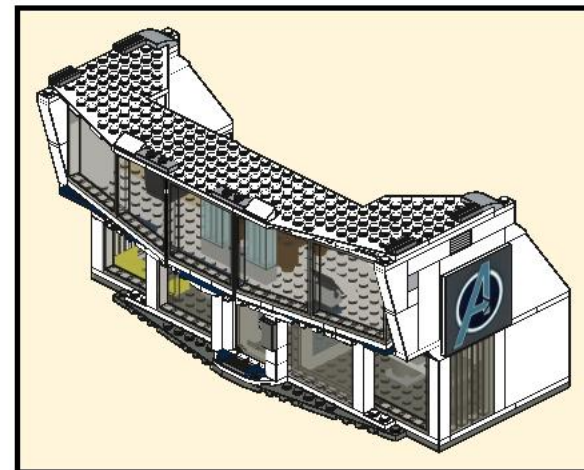

65

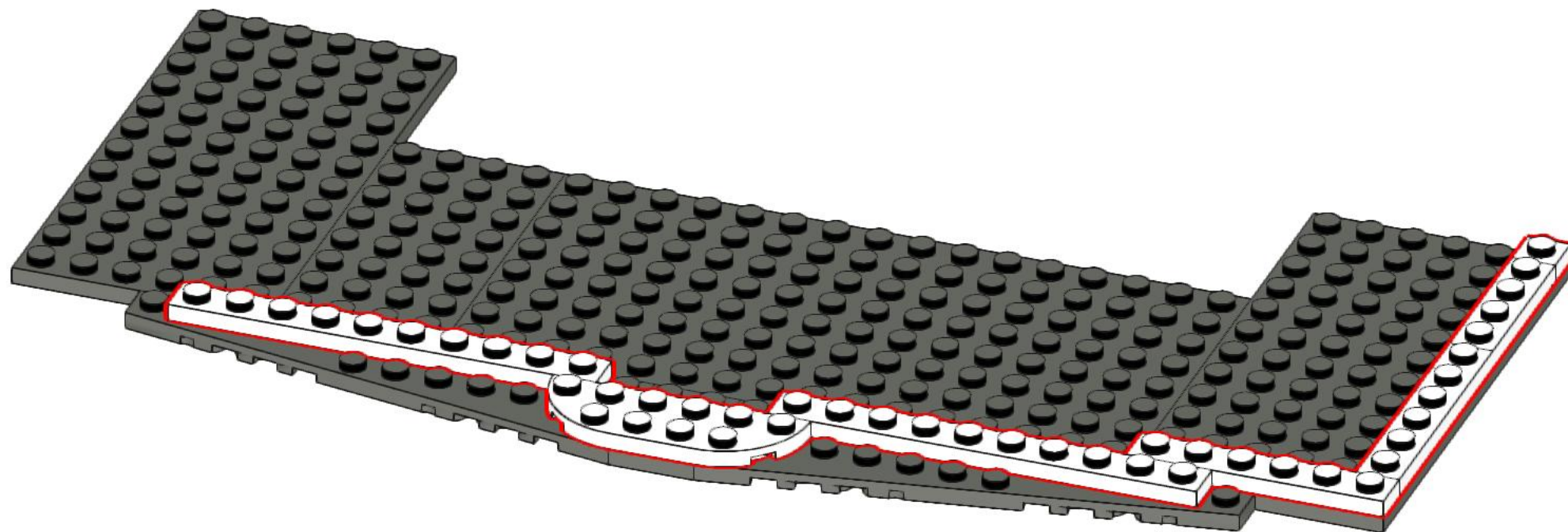
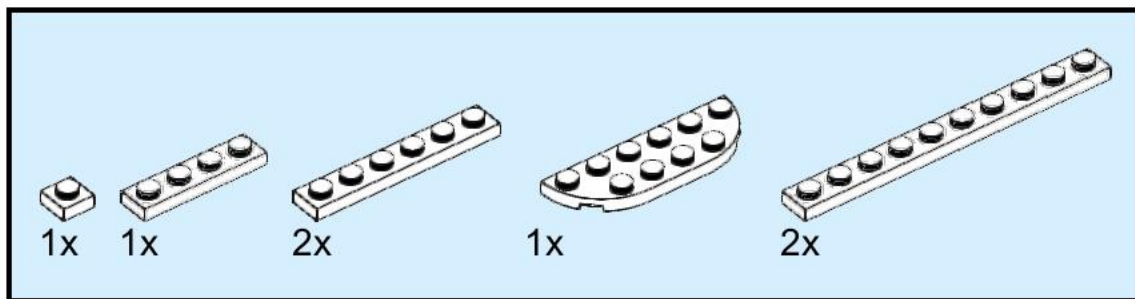

66

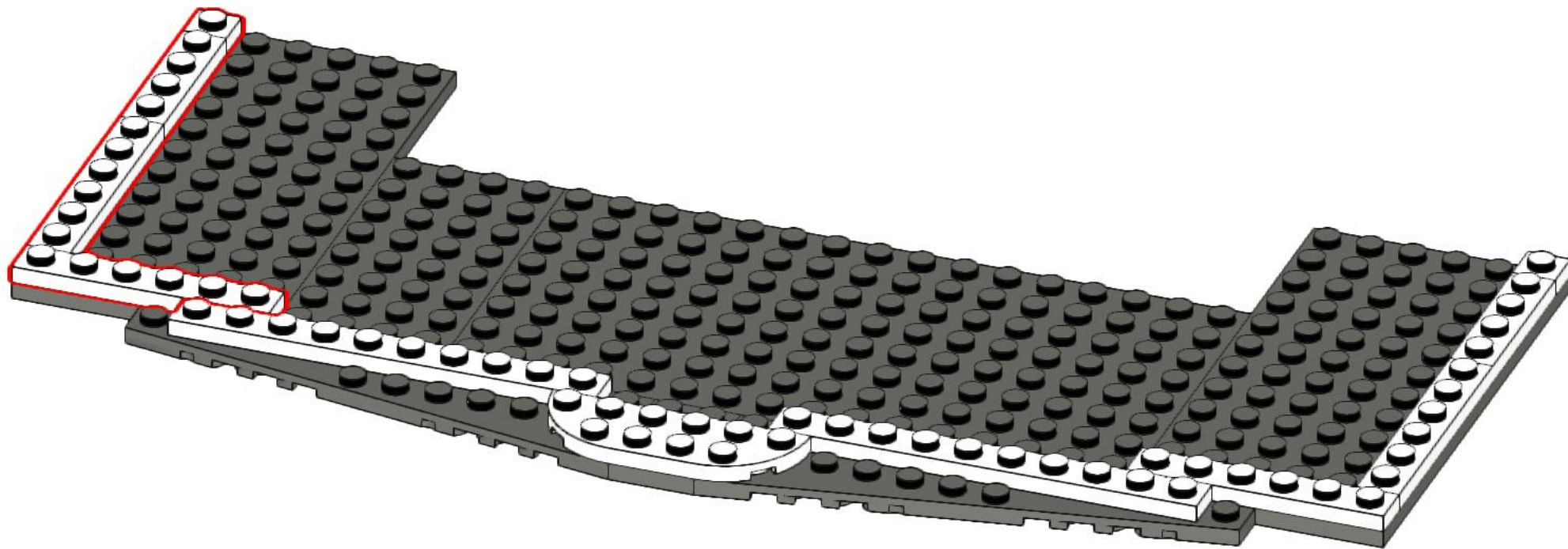
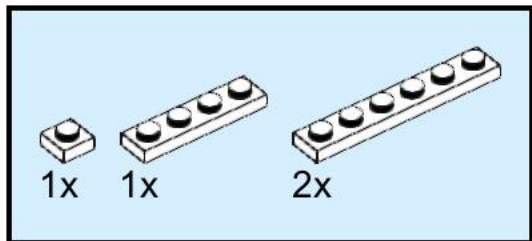

67

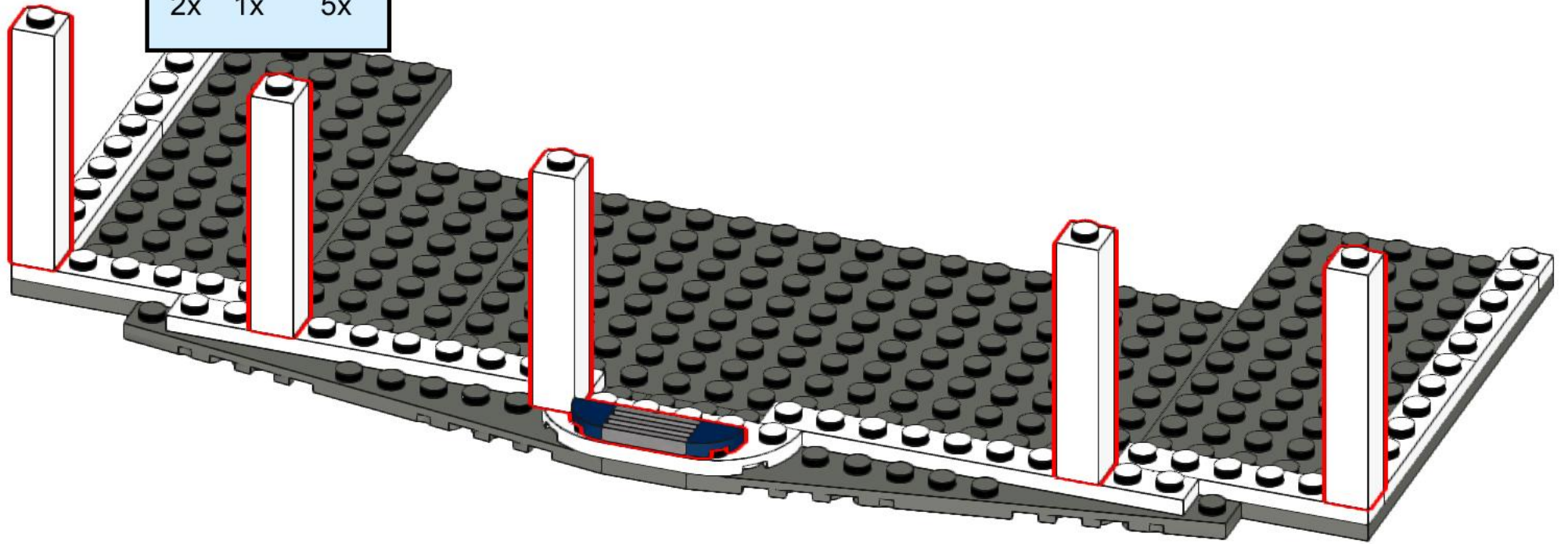
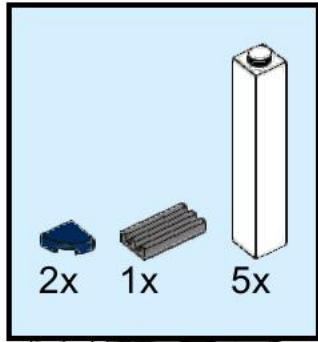

68

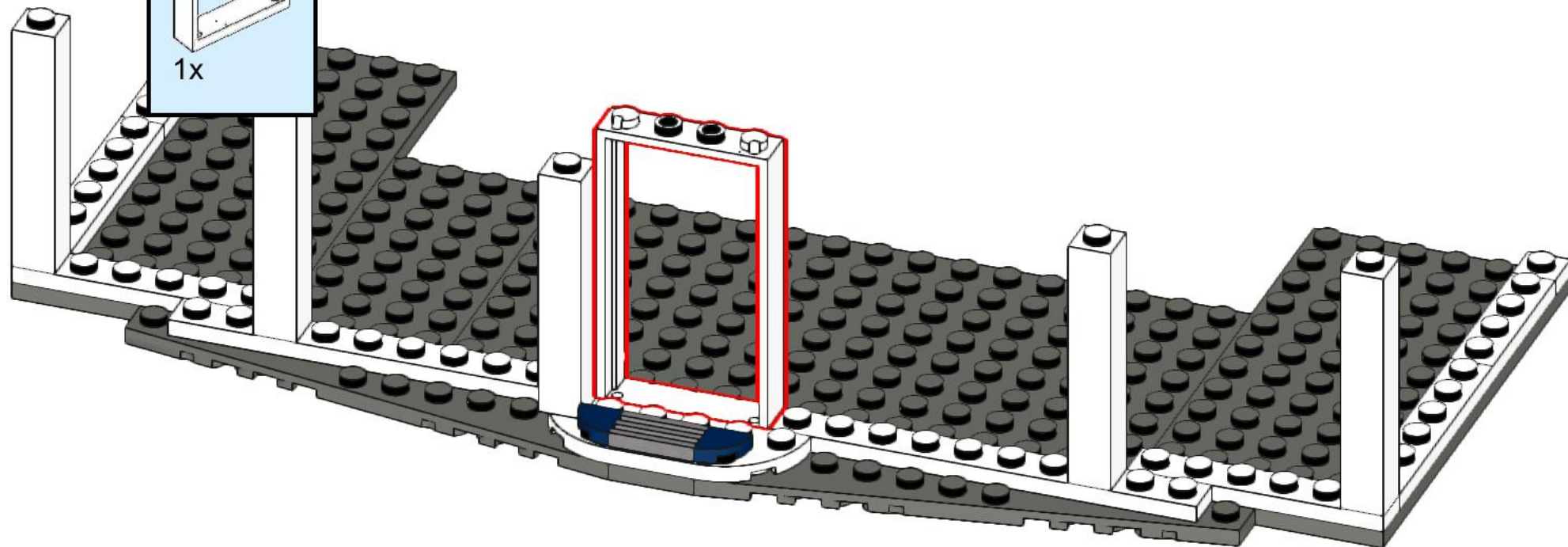
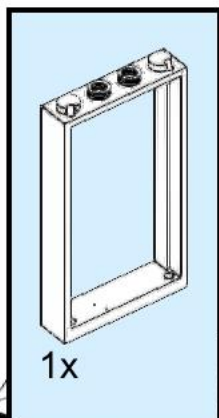

69

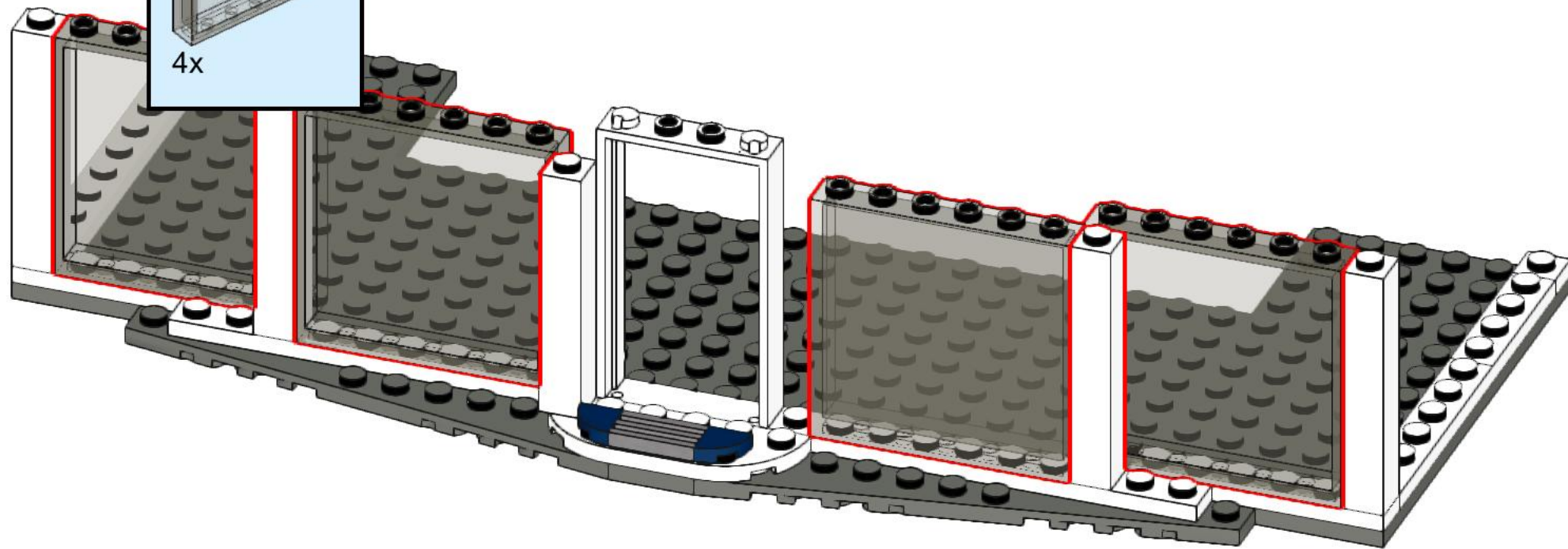
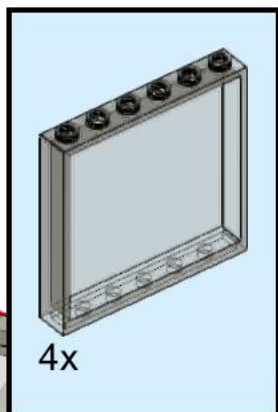

70

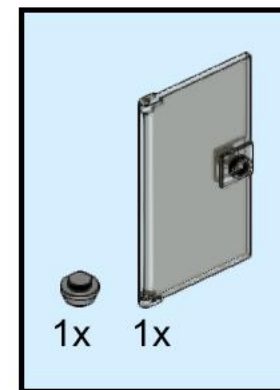
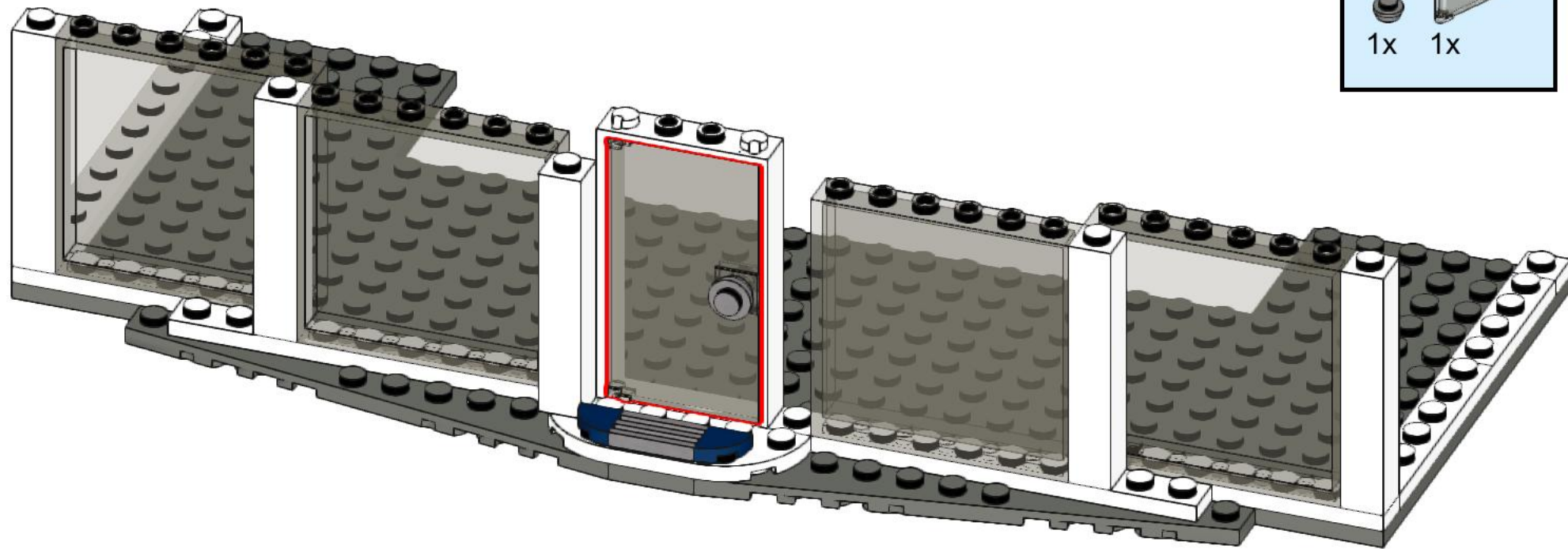

71

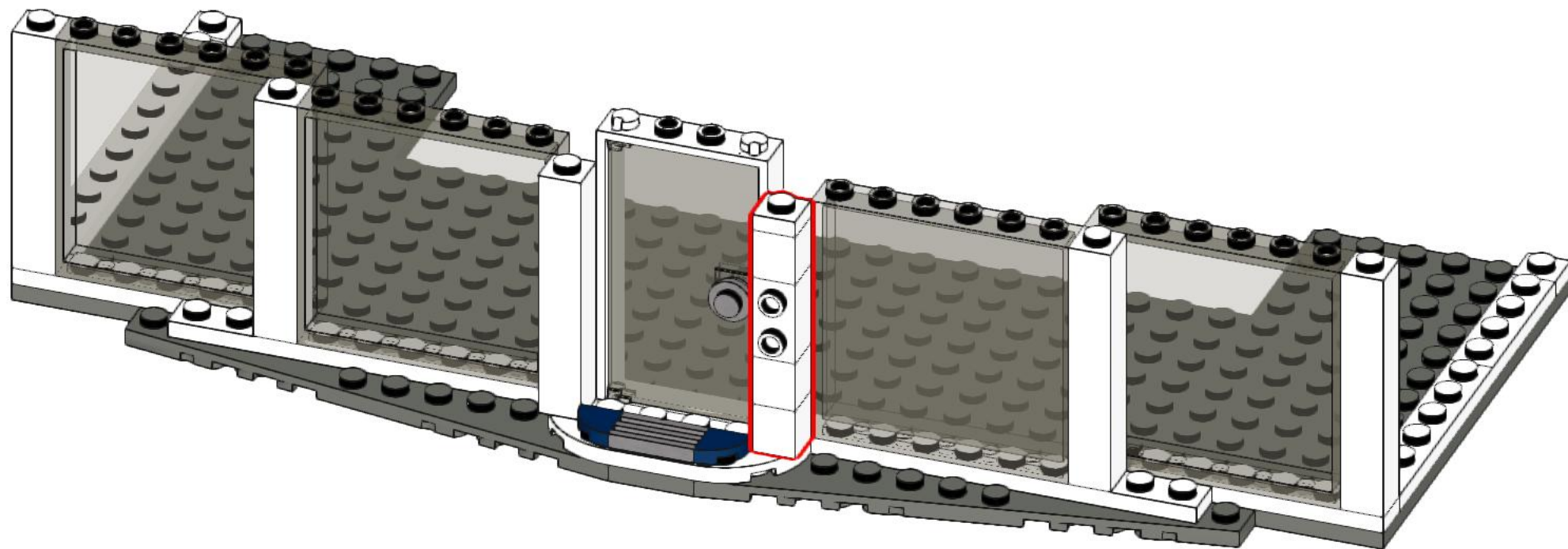
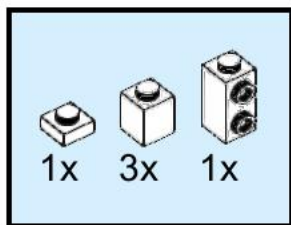

72

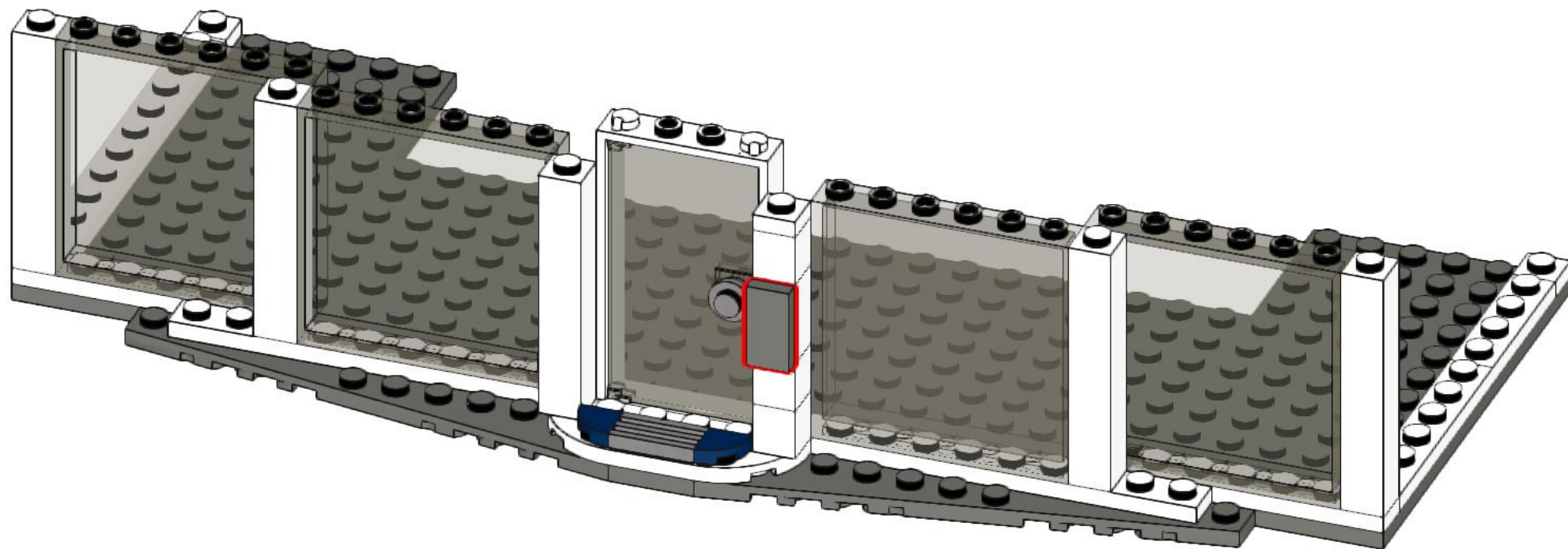
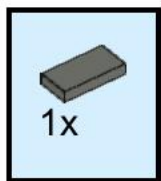

73

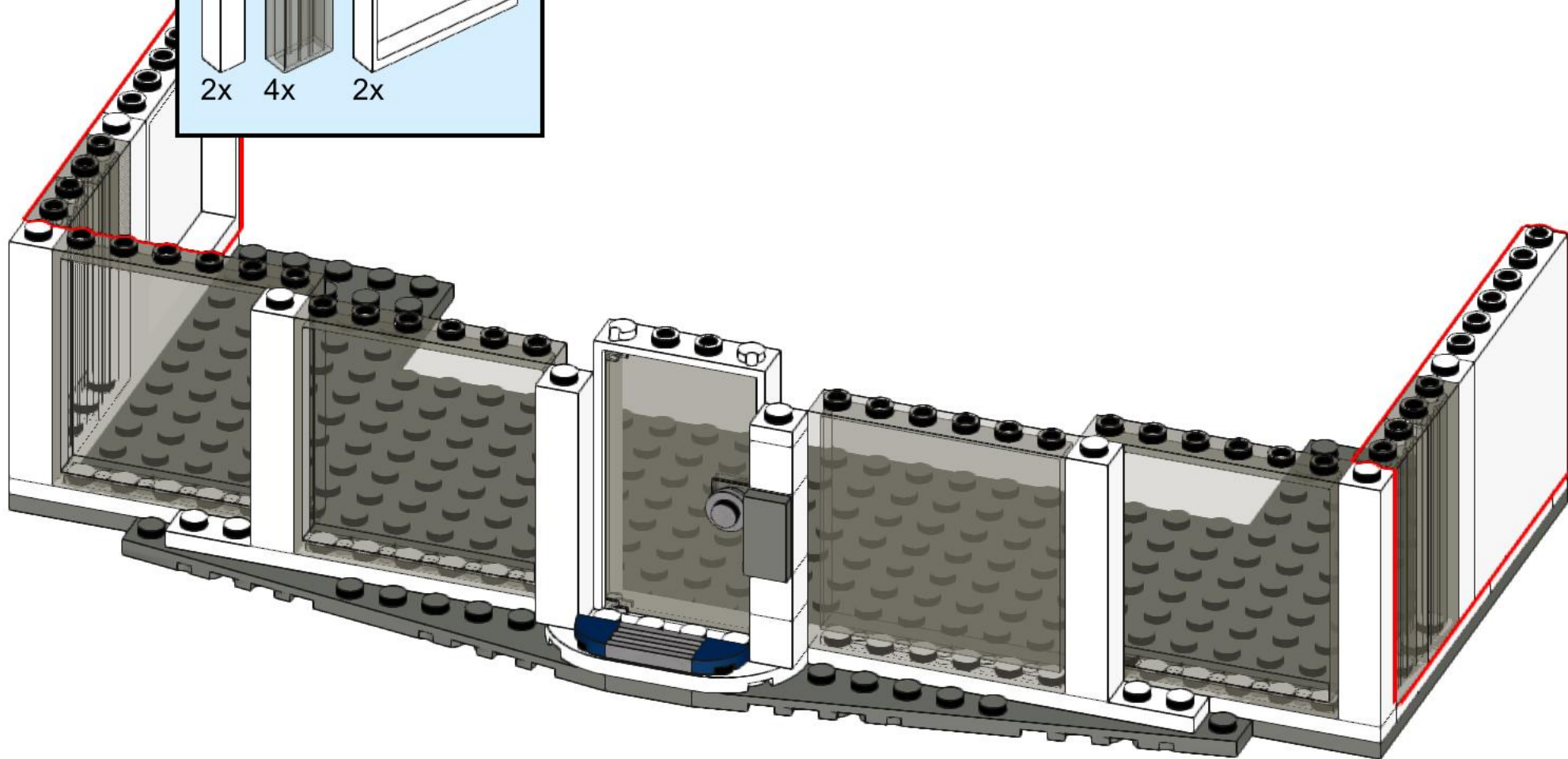
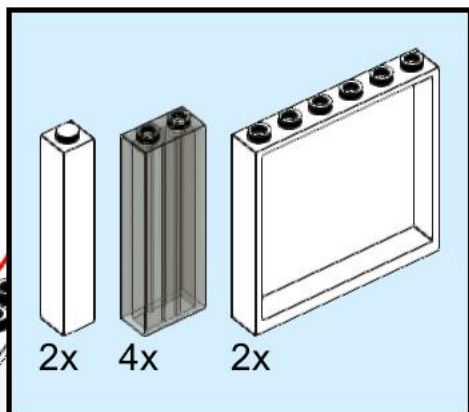

74

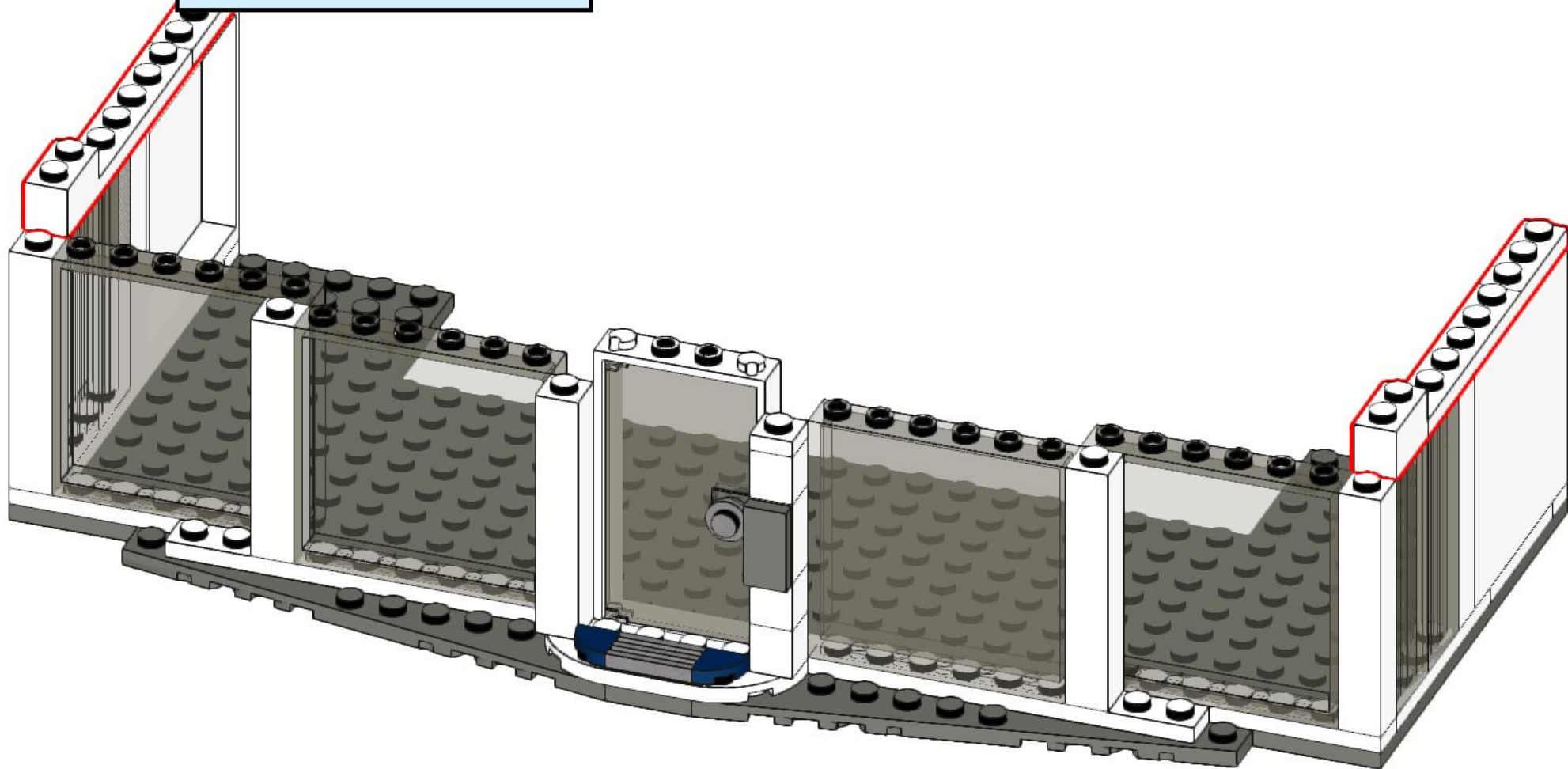
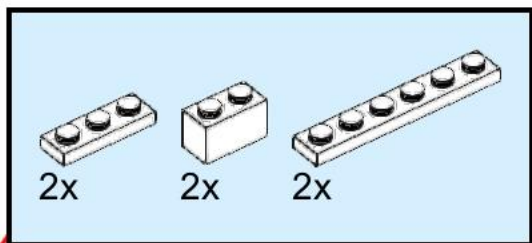

75

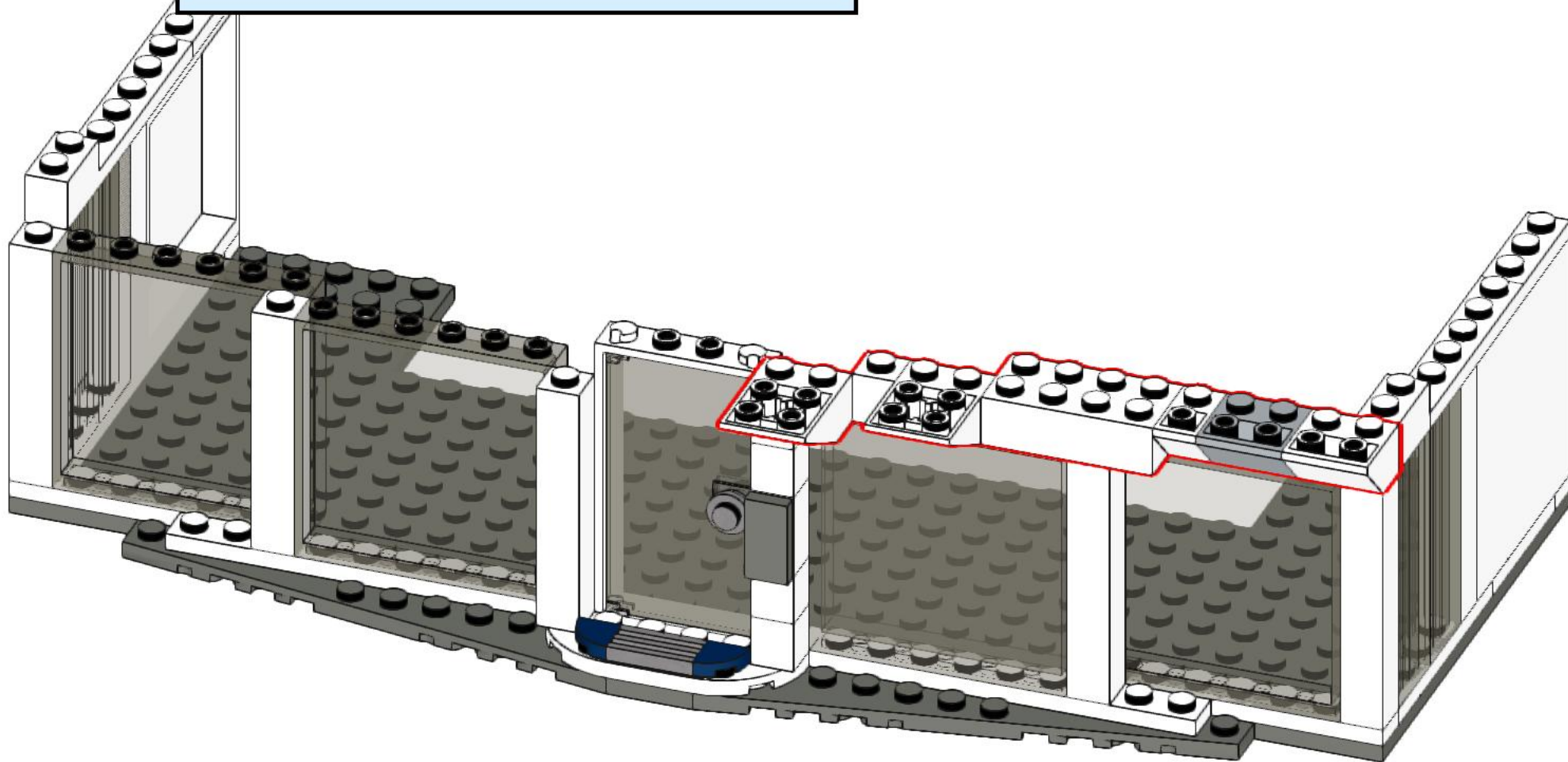
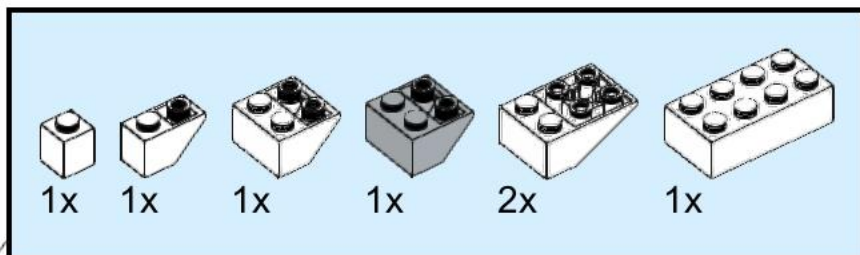

76

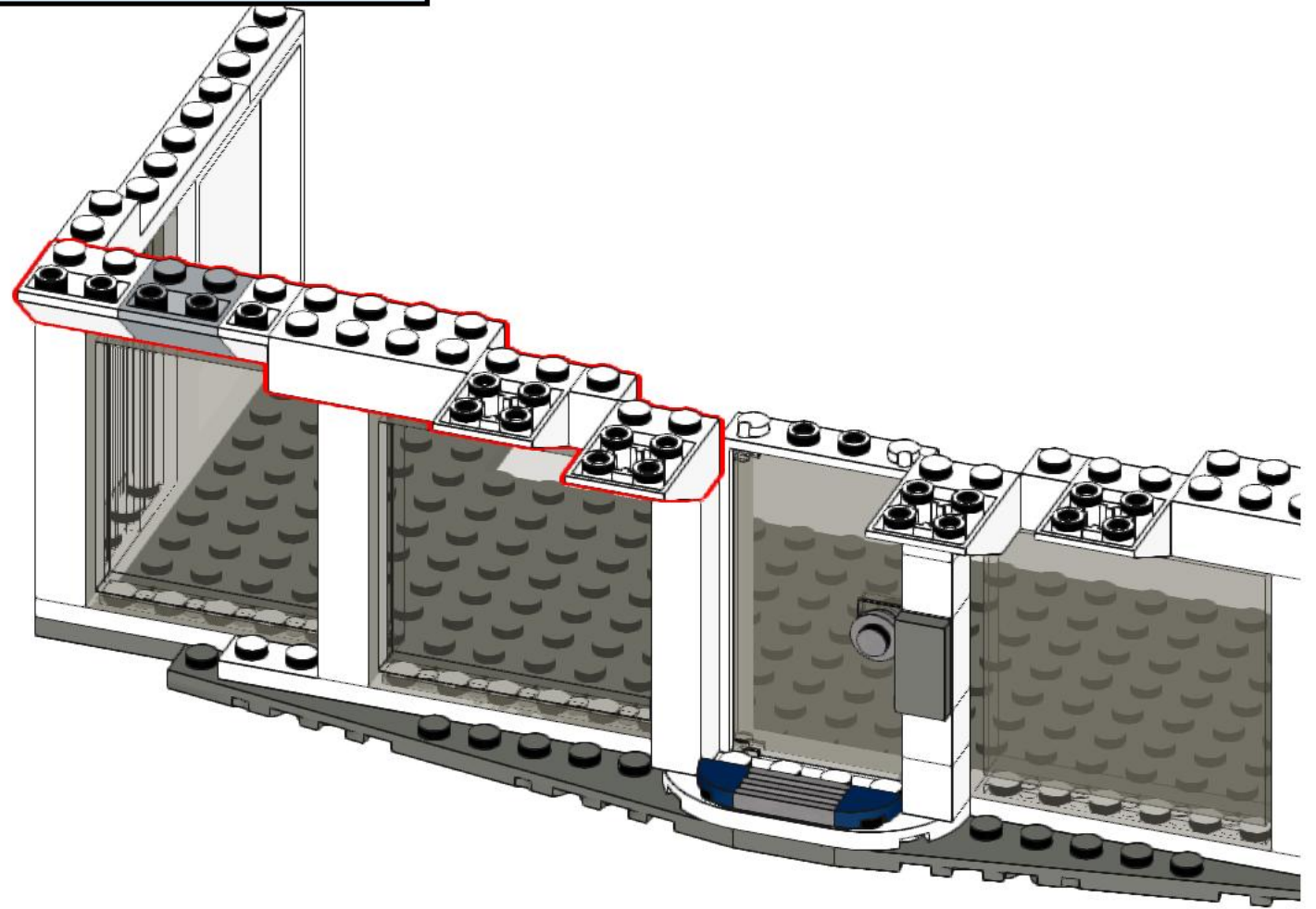
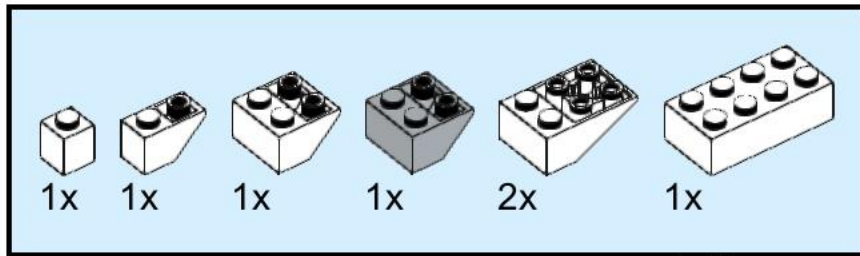

77

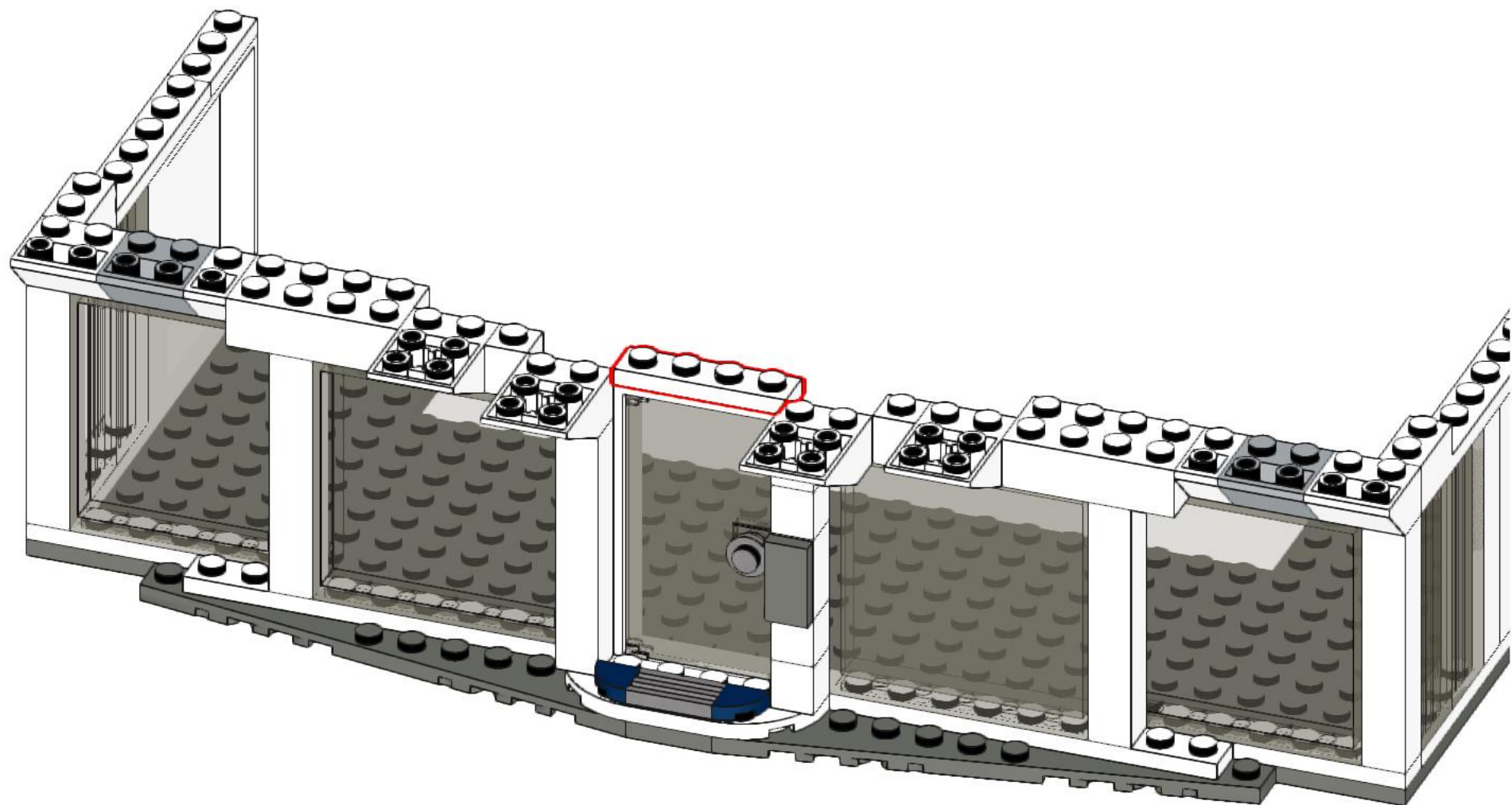
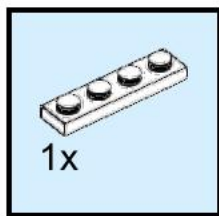

78

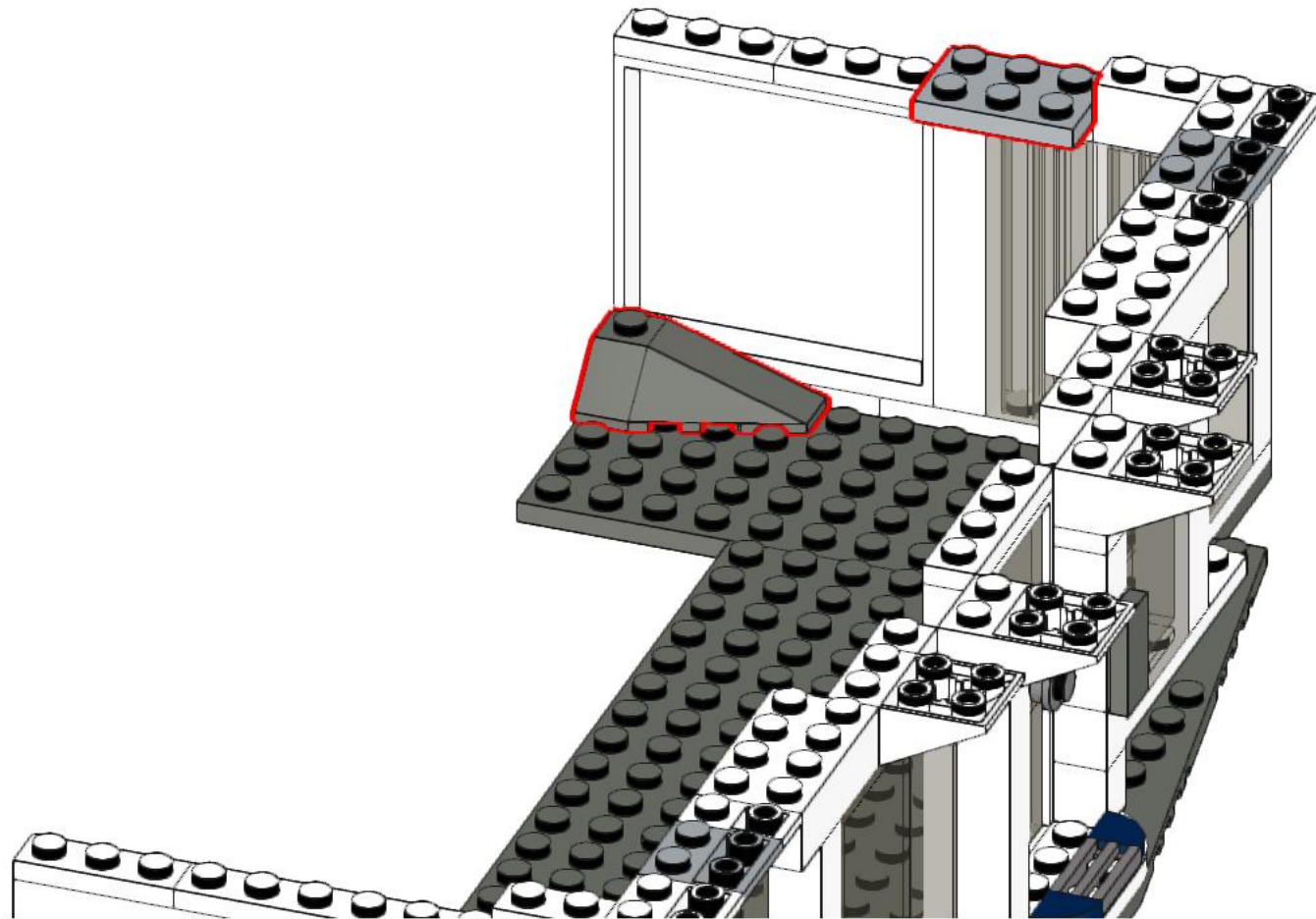
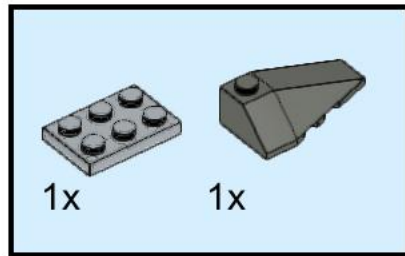

79

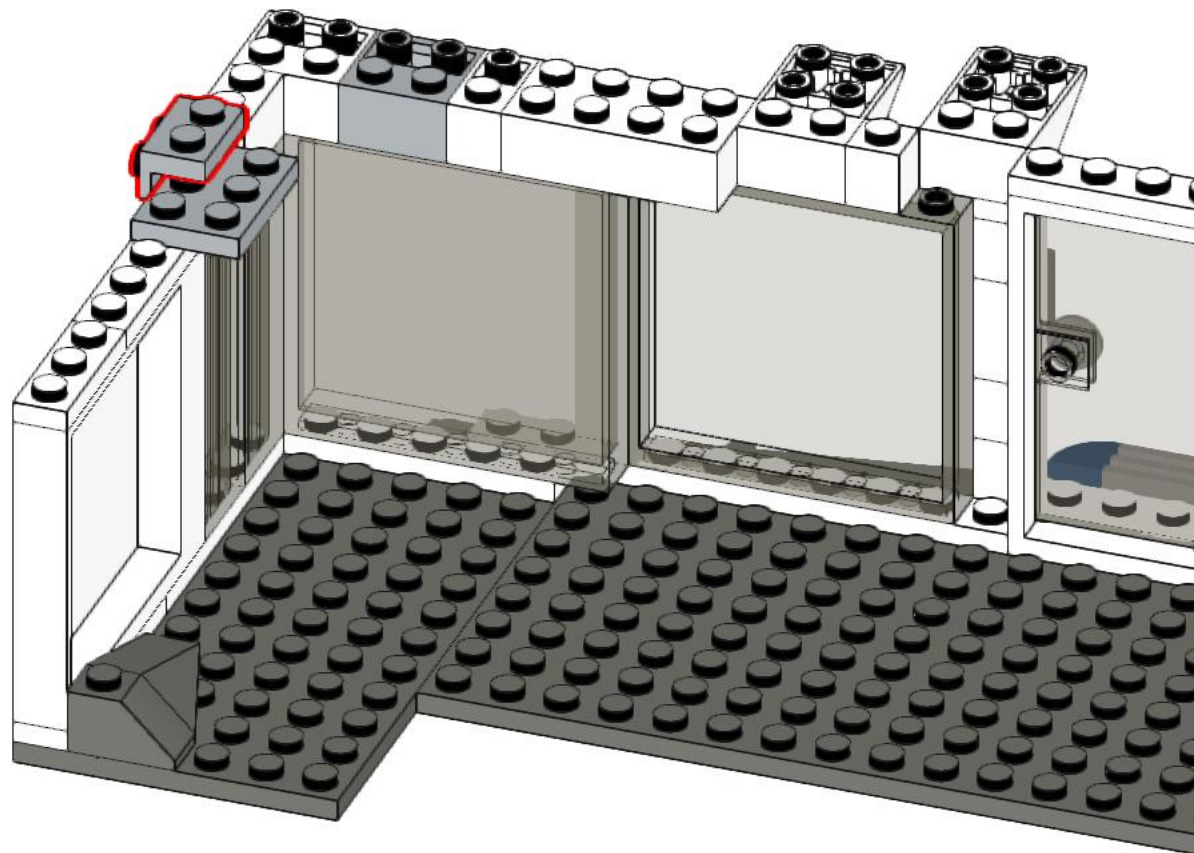
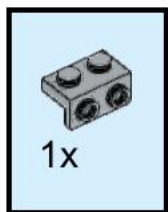

80

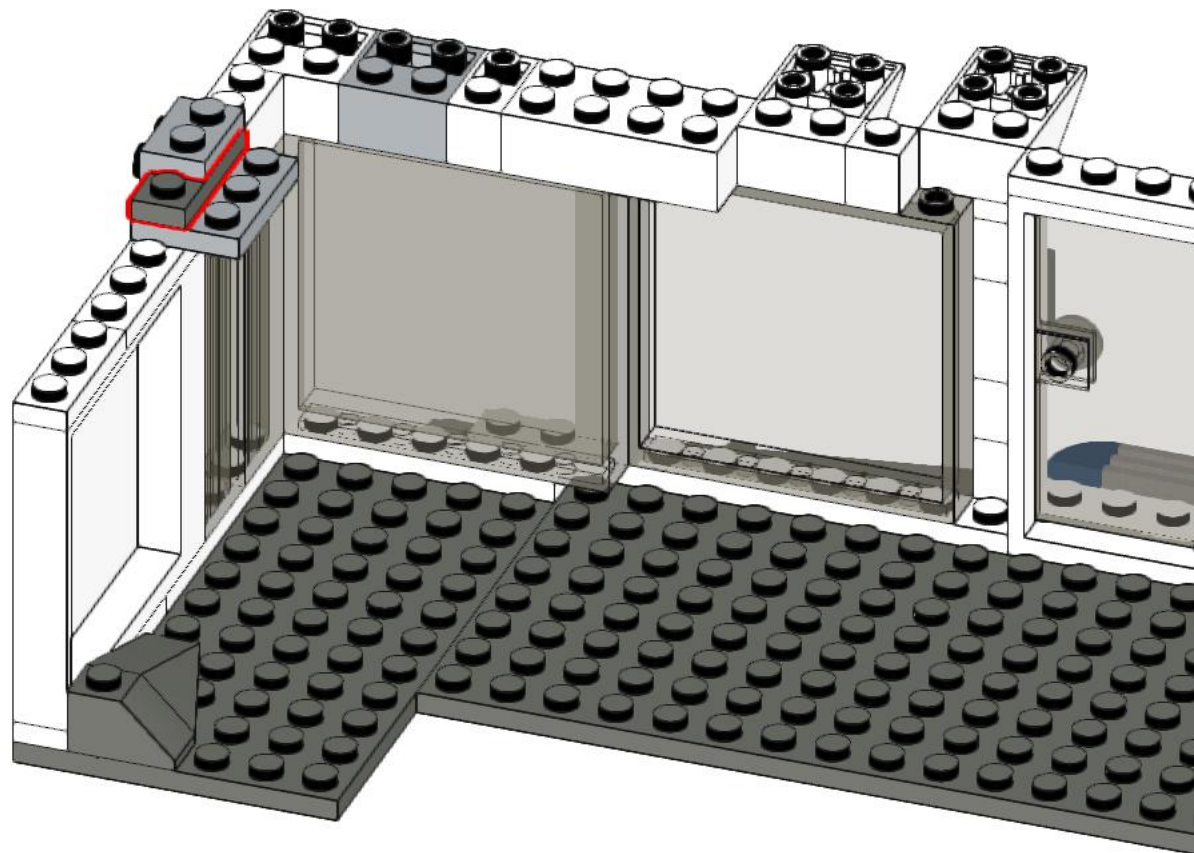
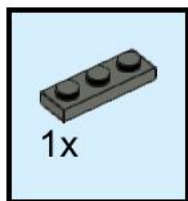

81

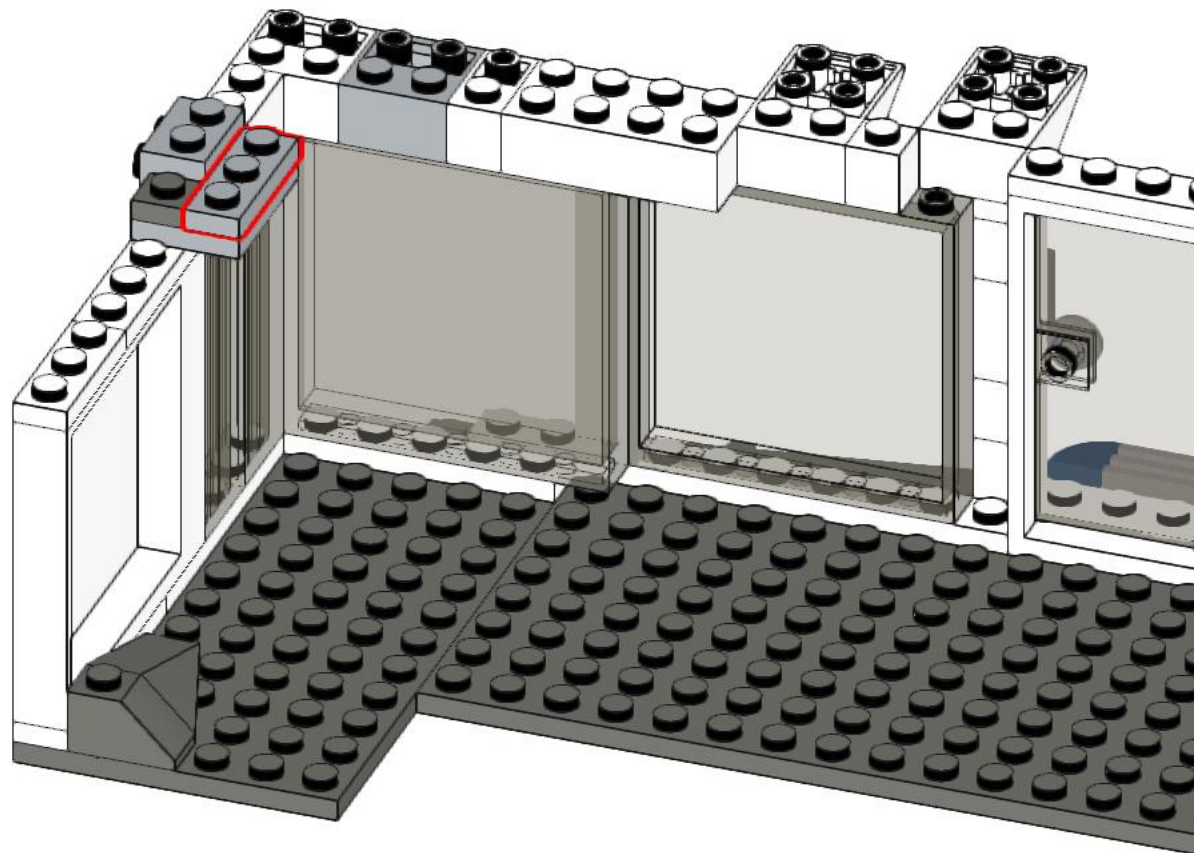
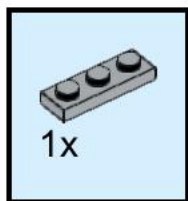

82

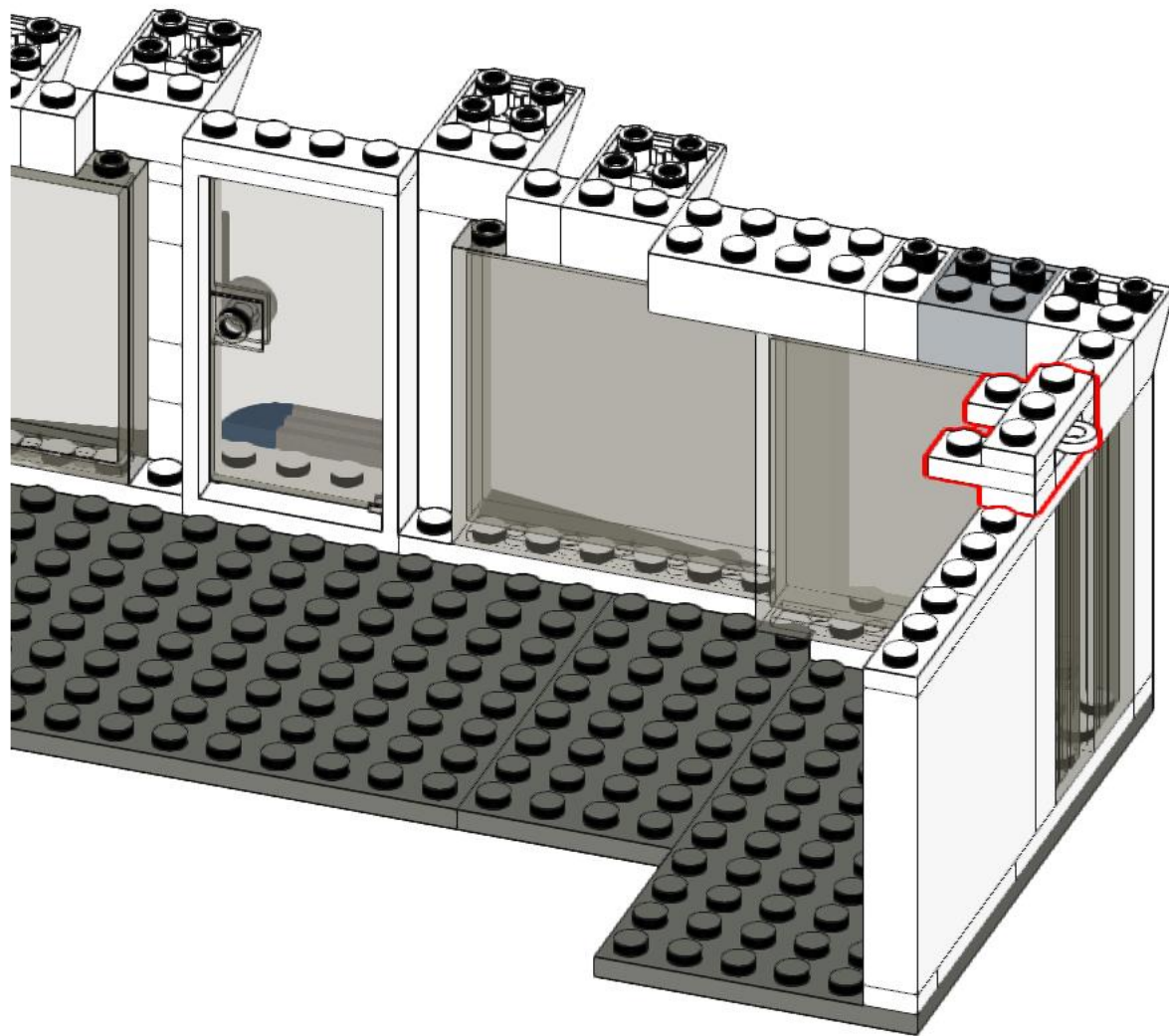
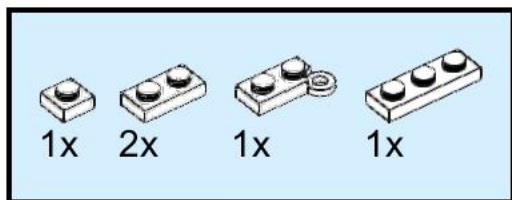

83

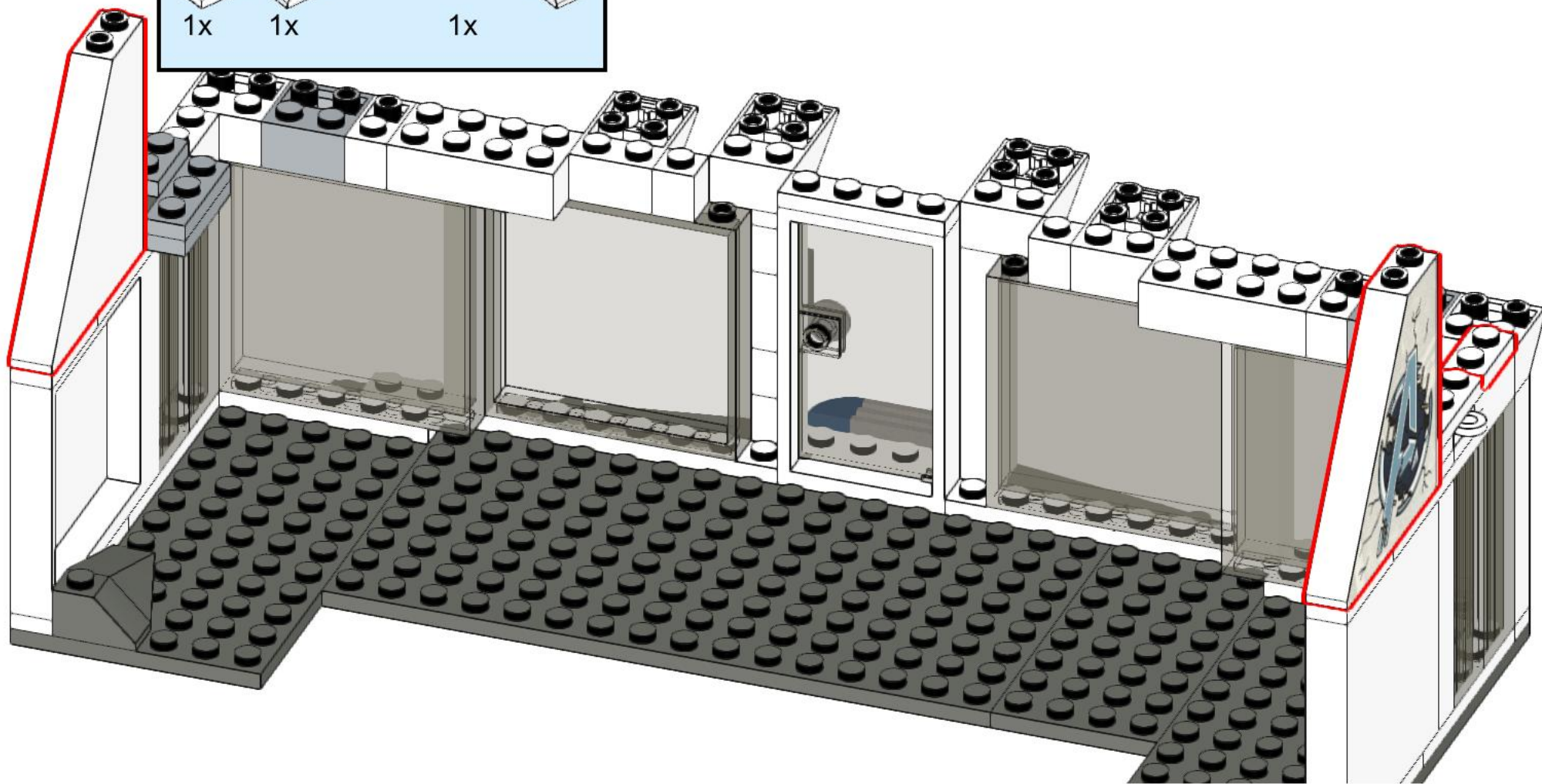
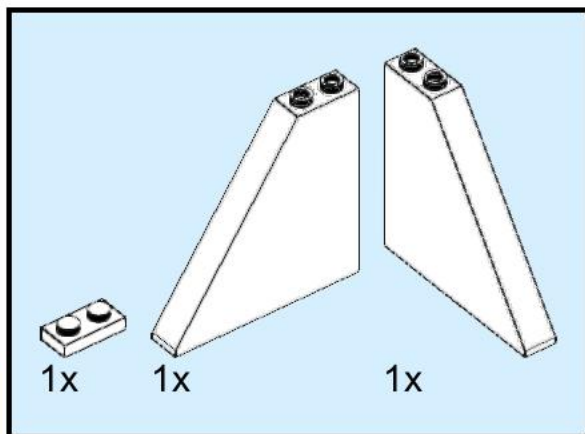

84

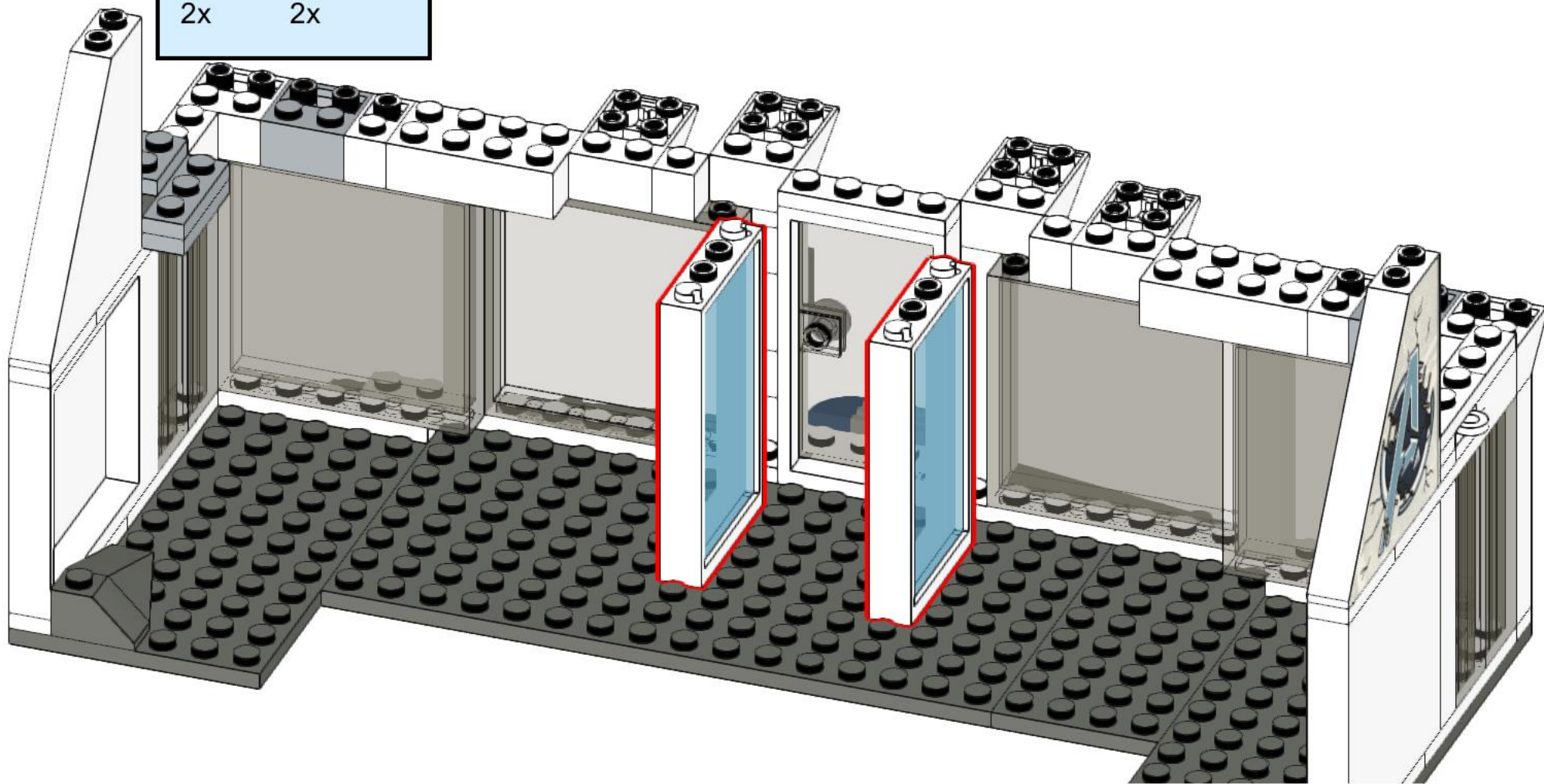
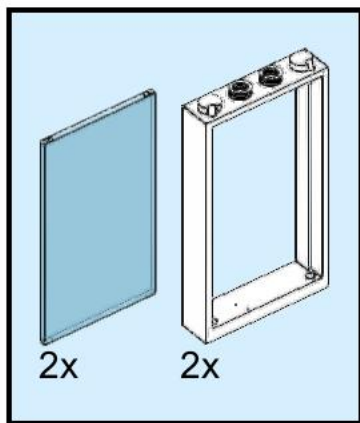

85

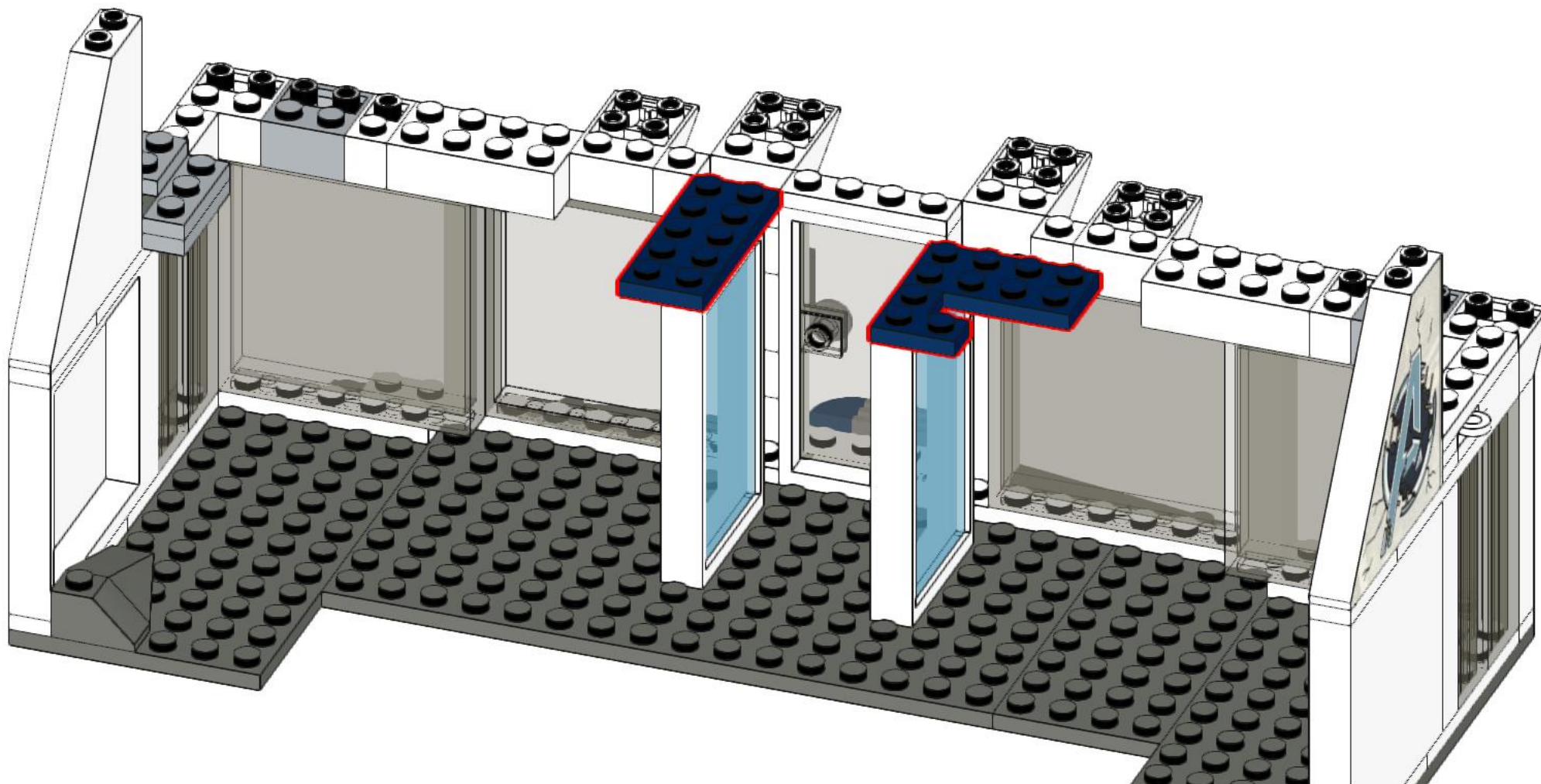
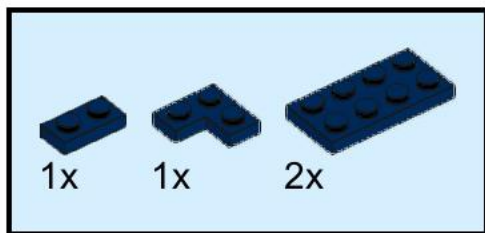

86

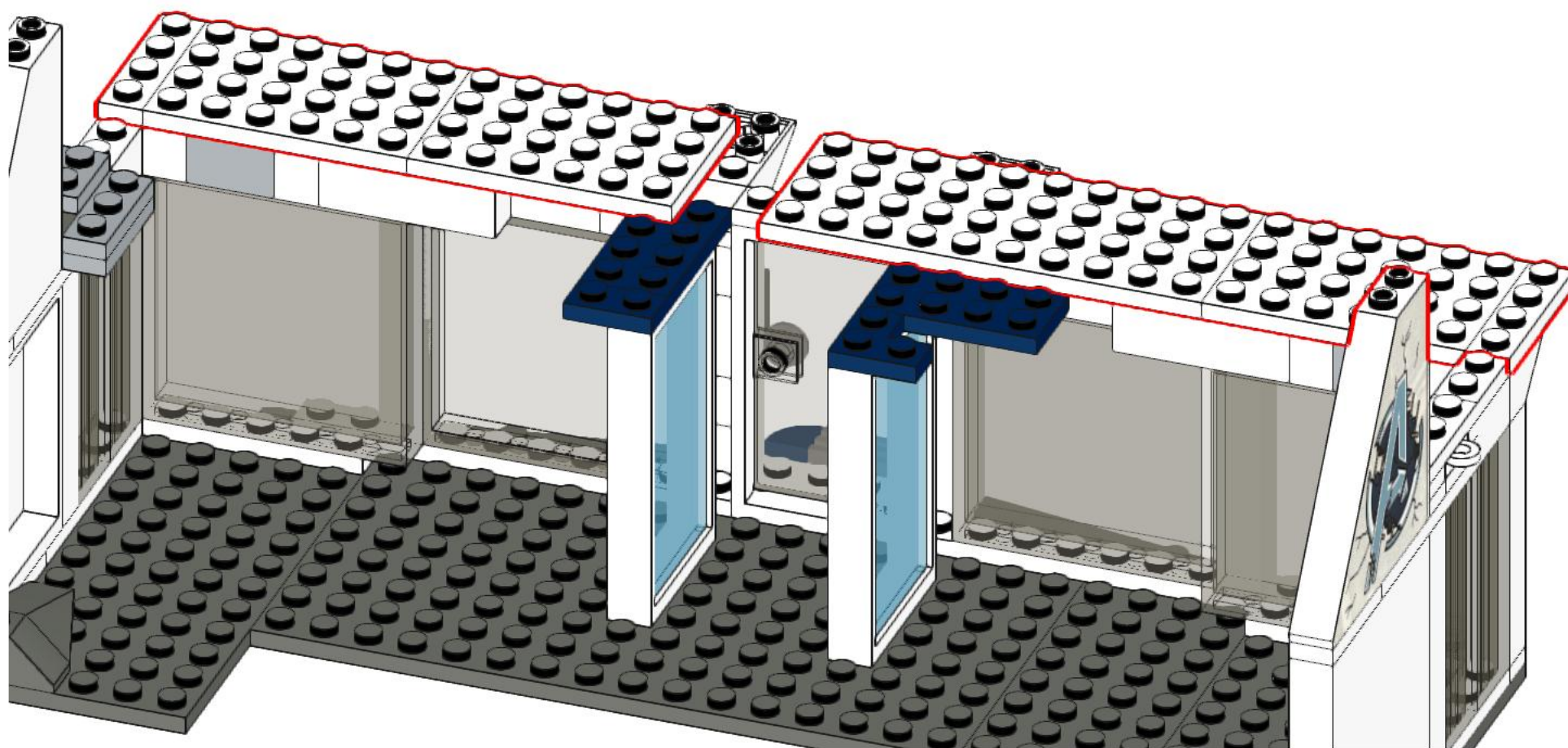
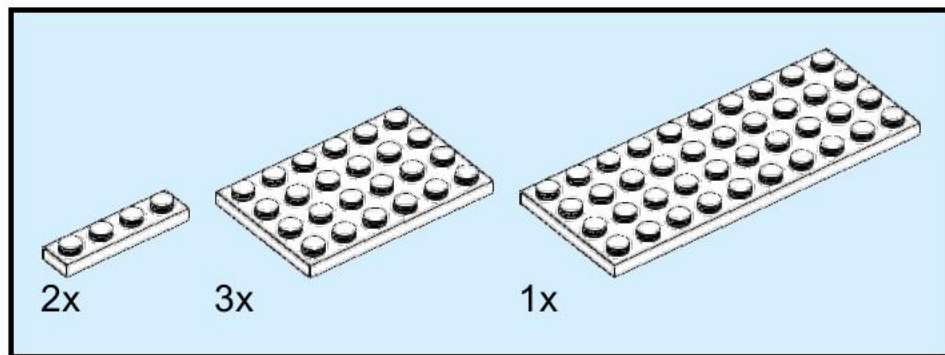

87

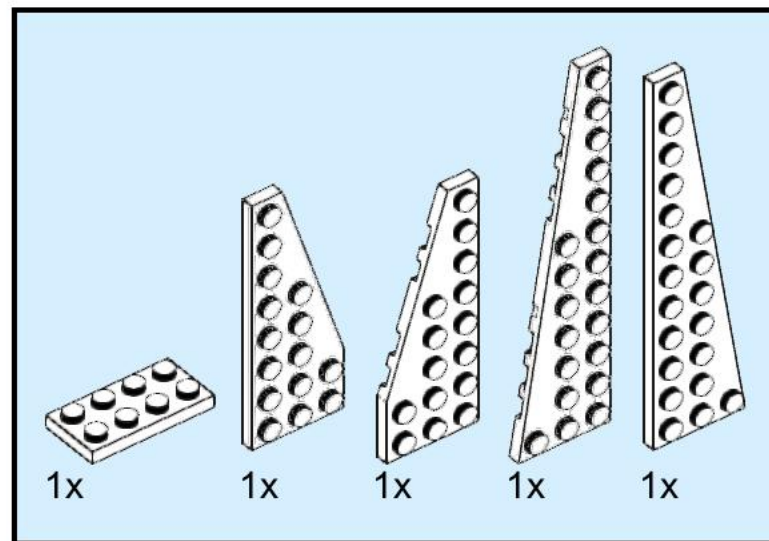
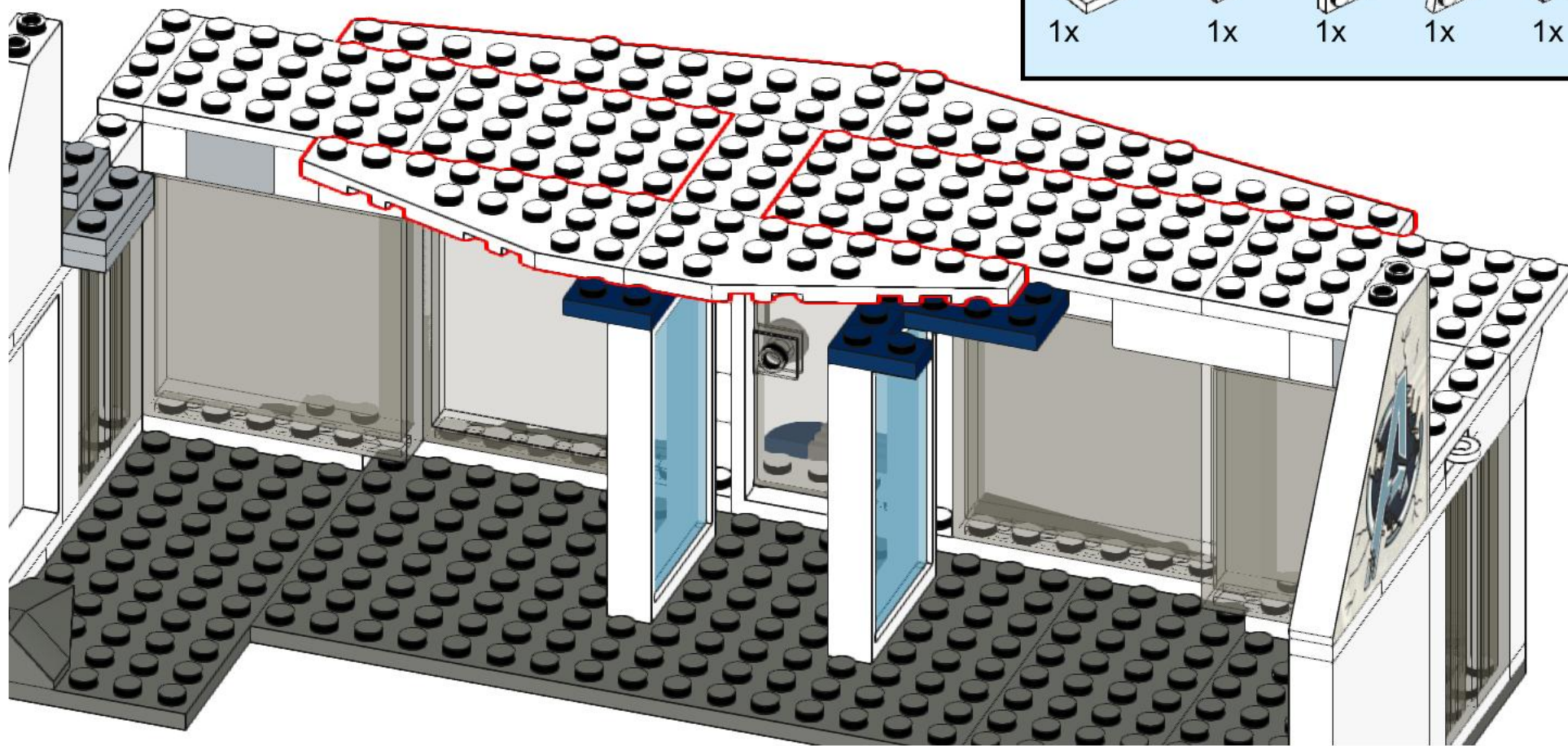

88

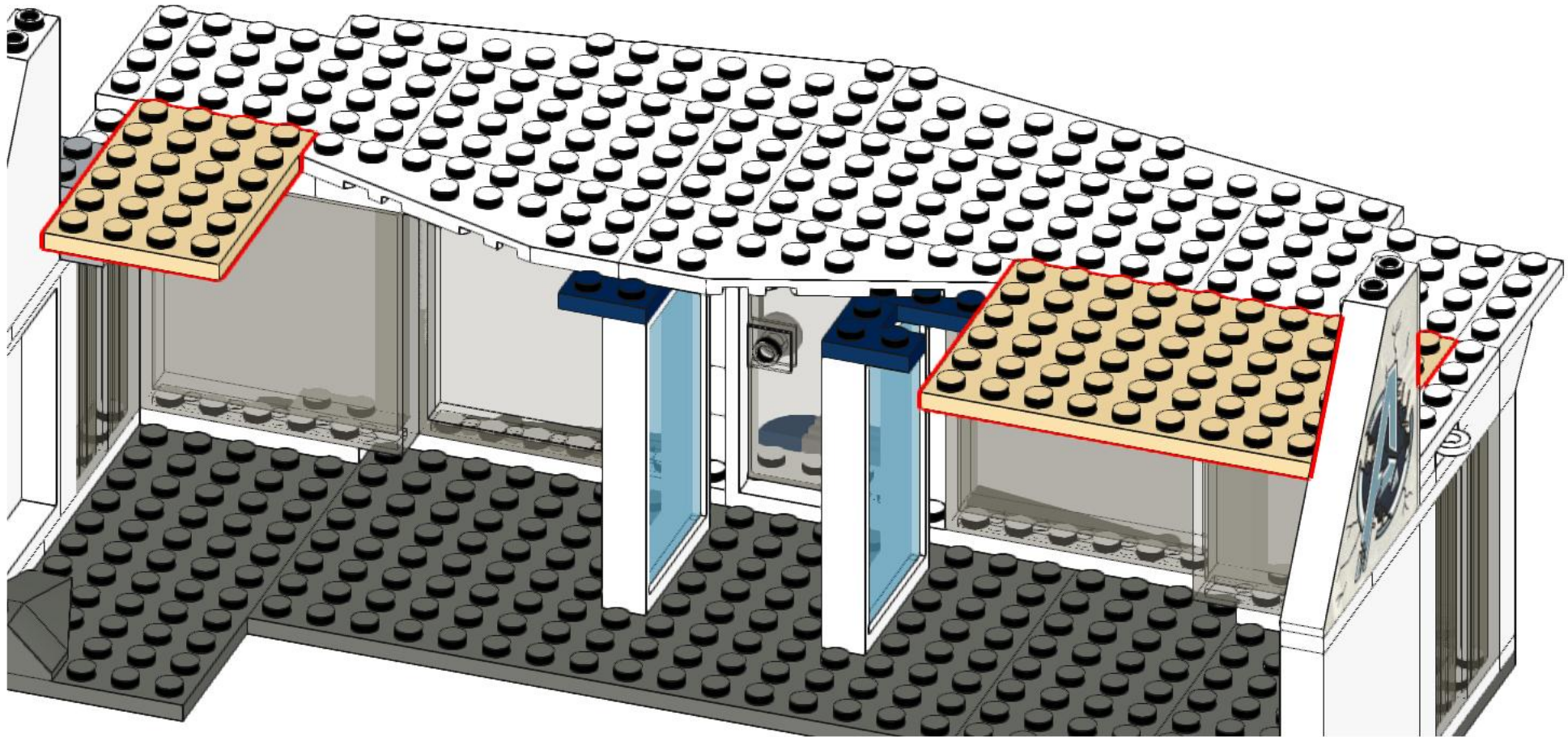
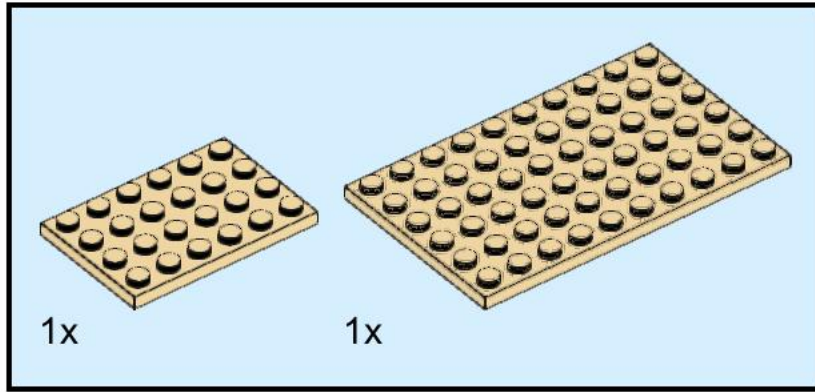

89

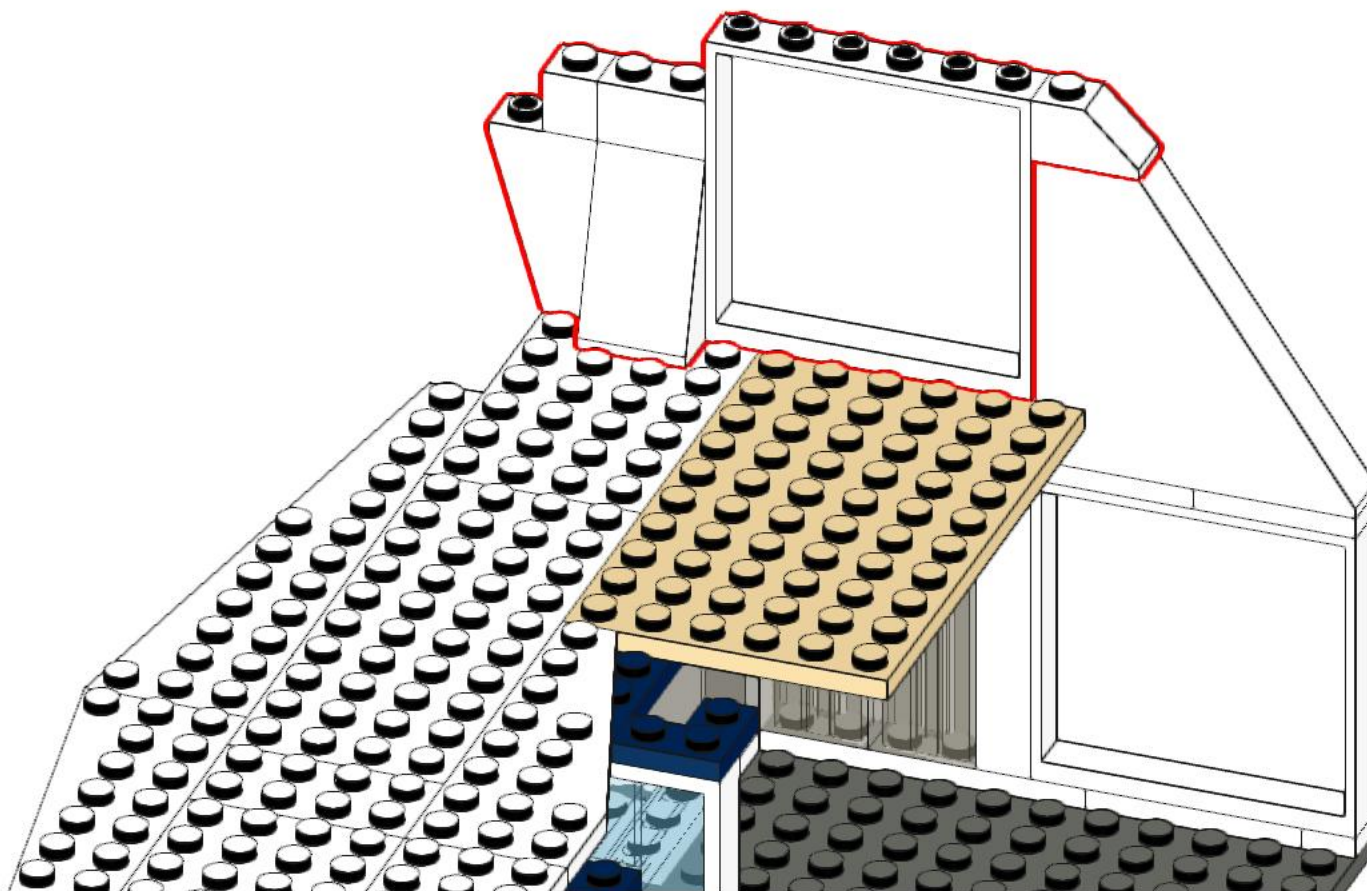
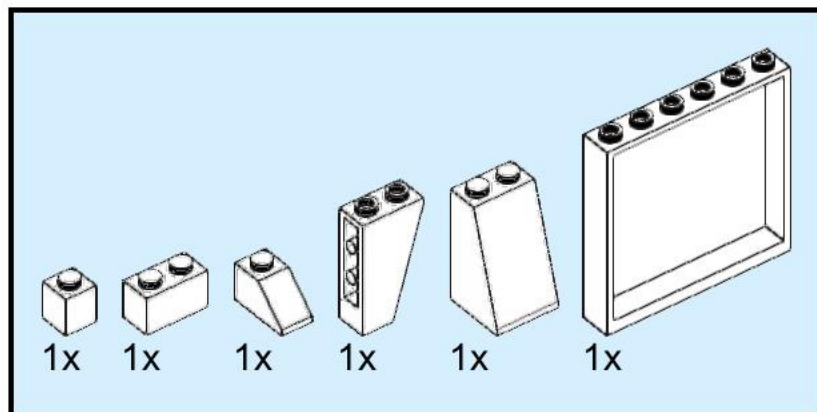

90

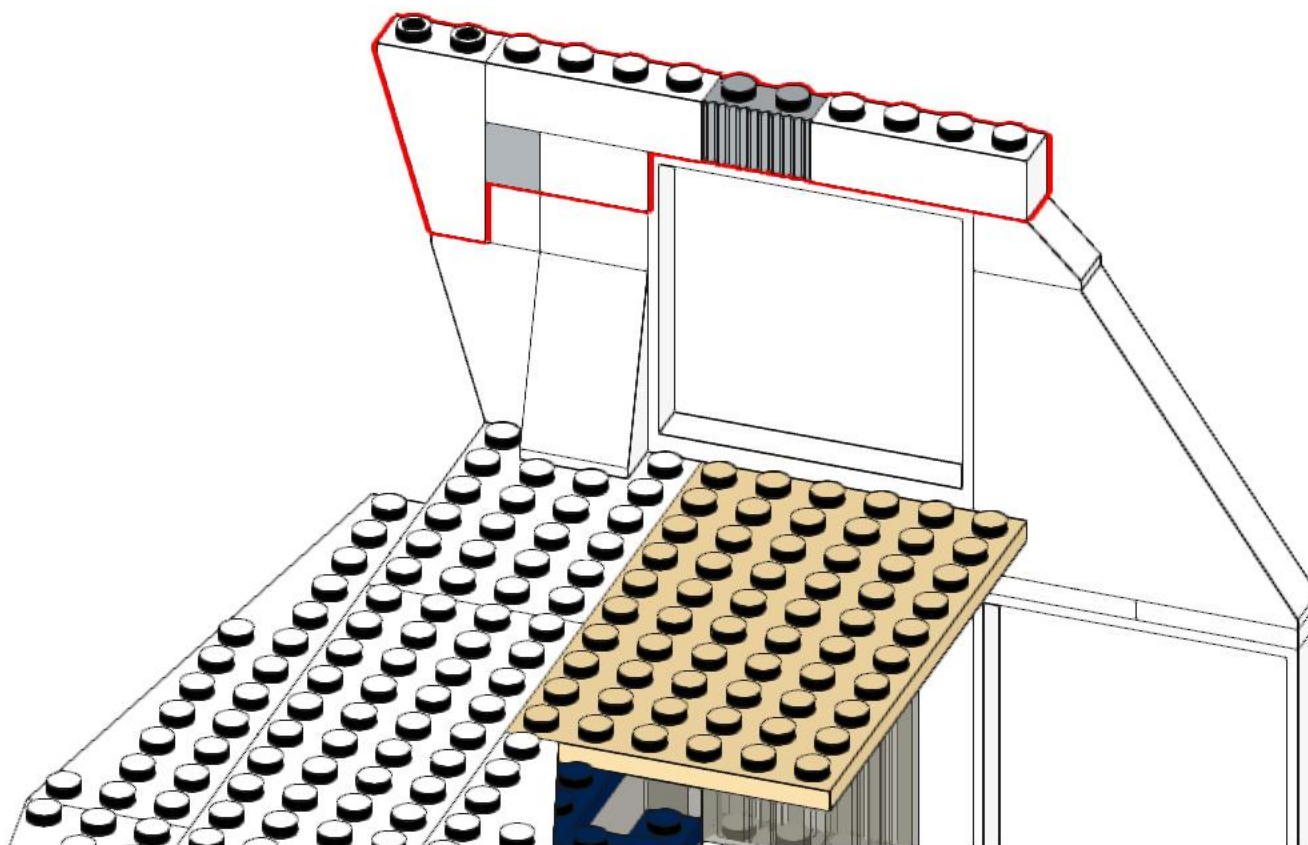
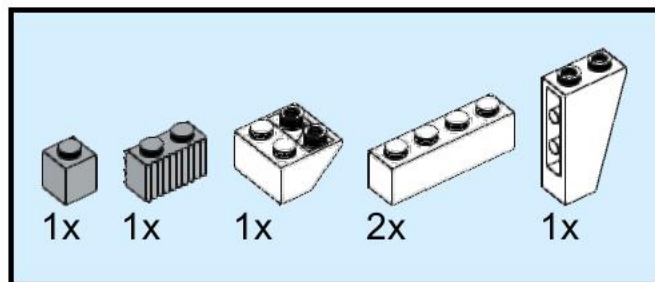

91

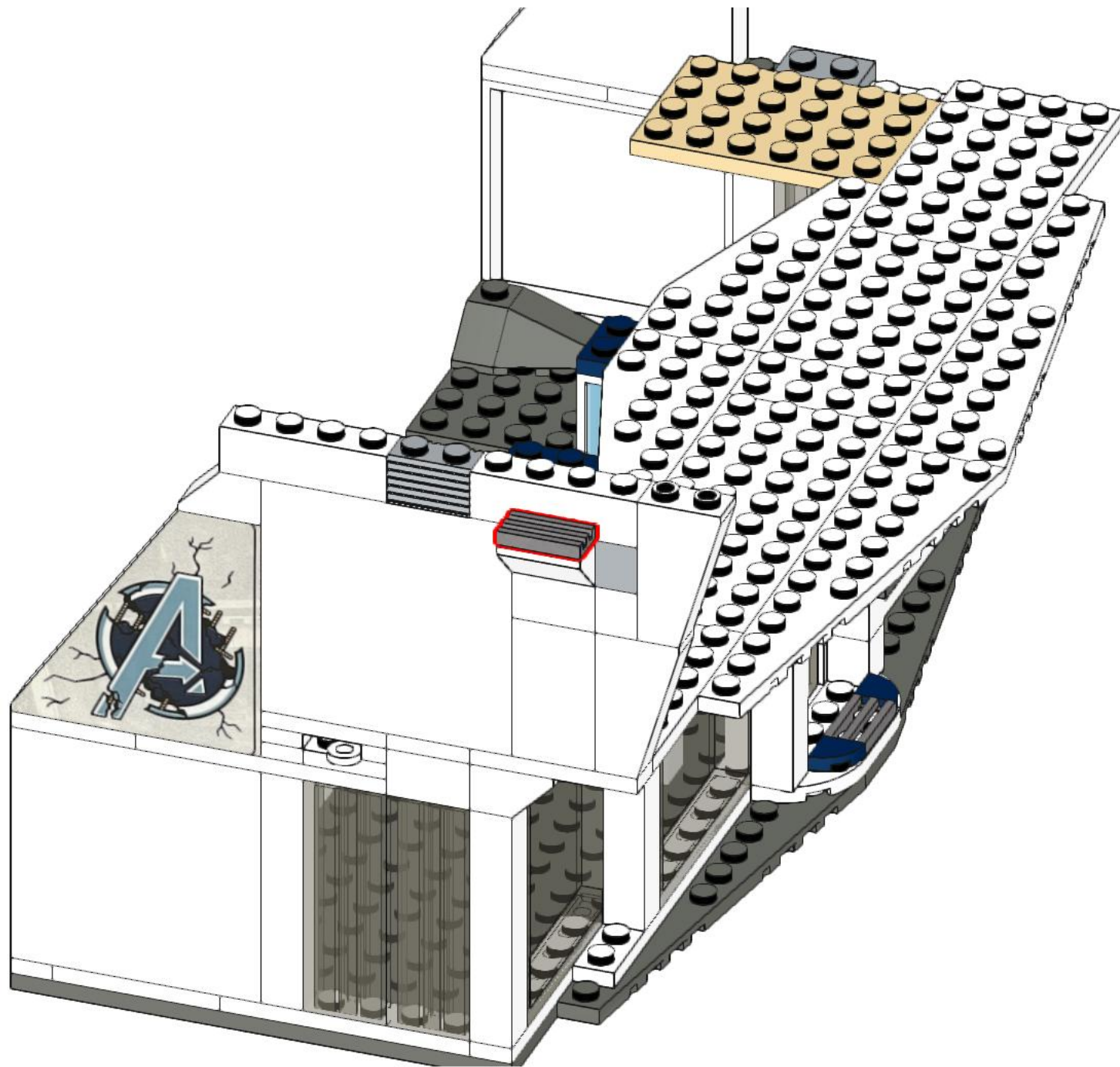
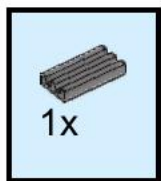

92

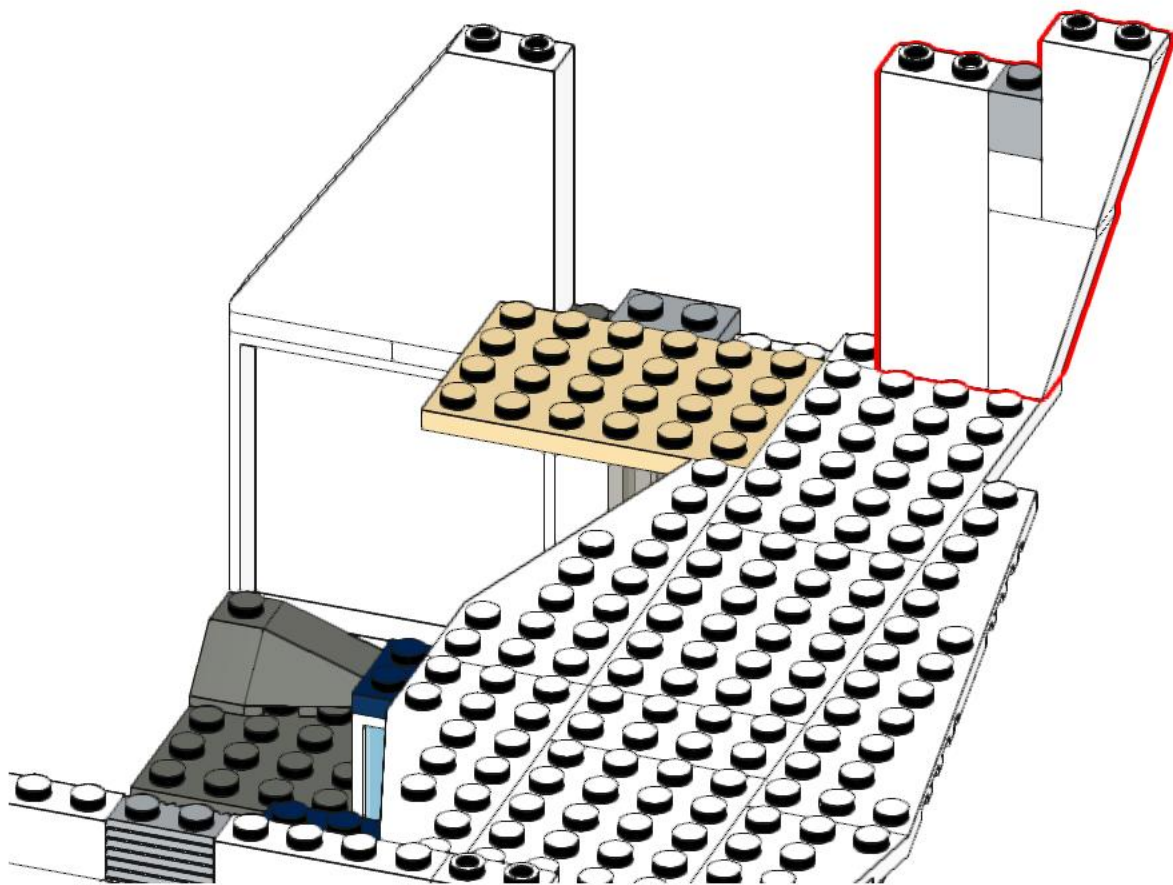
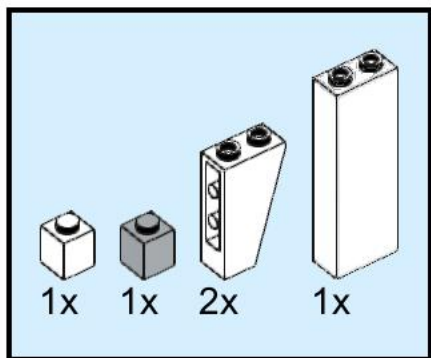

93

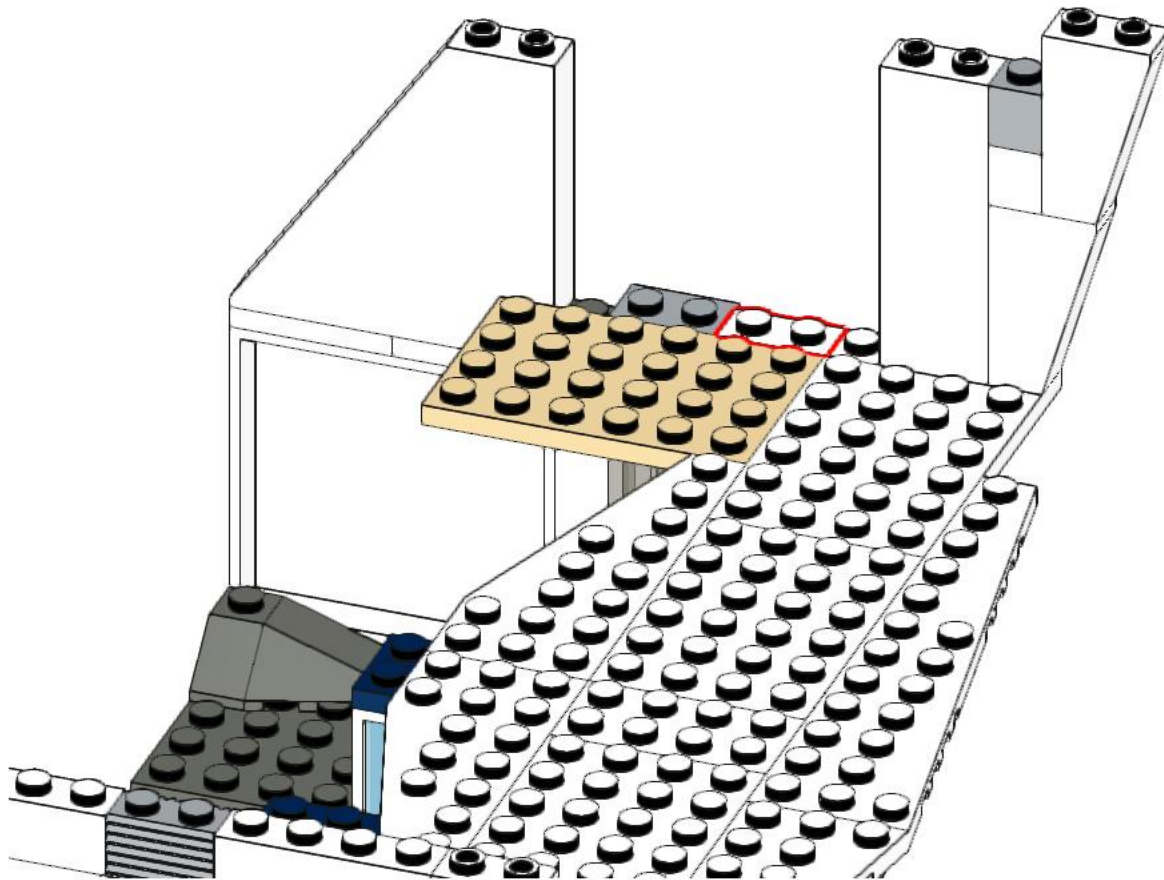
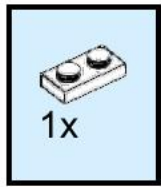

94

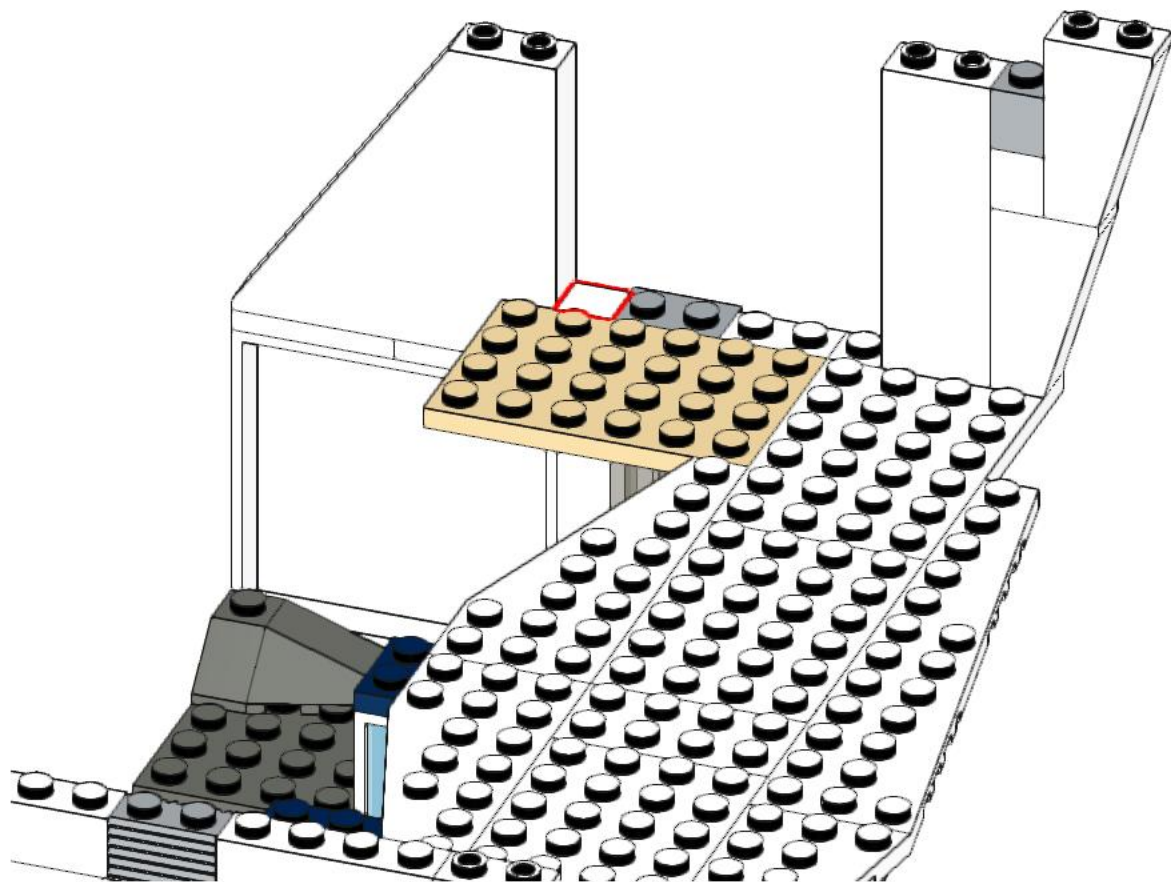
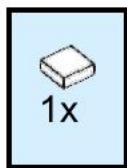

95

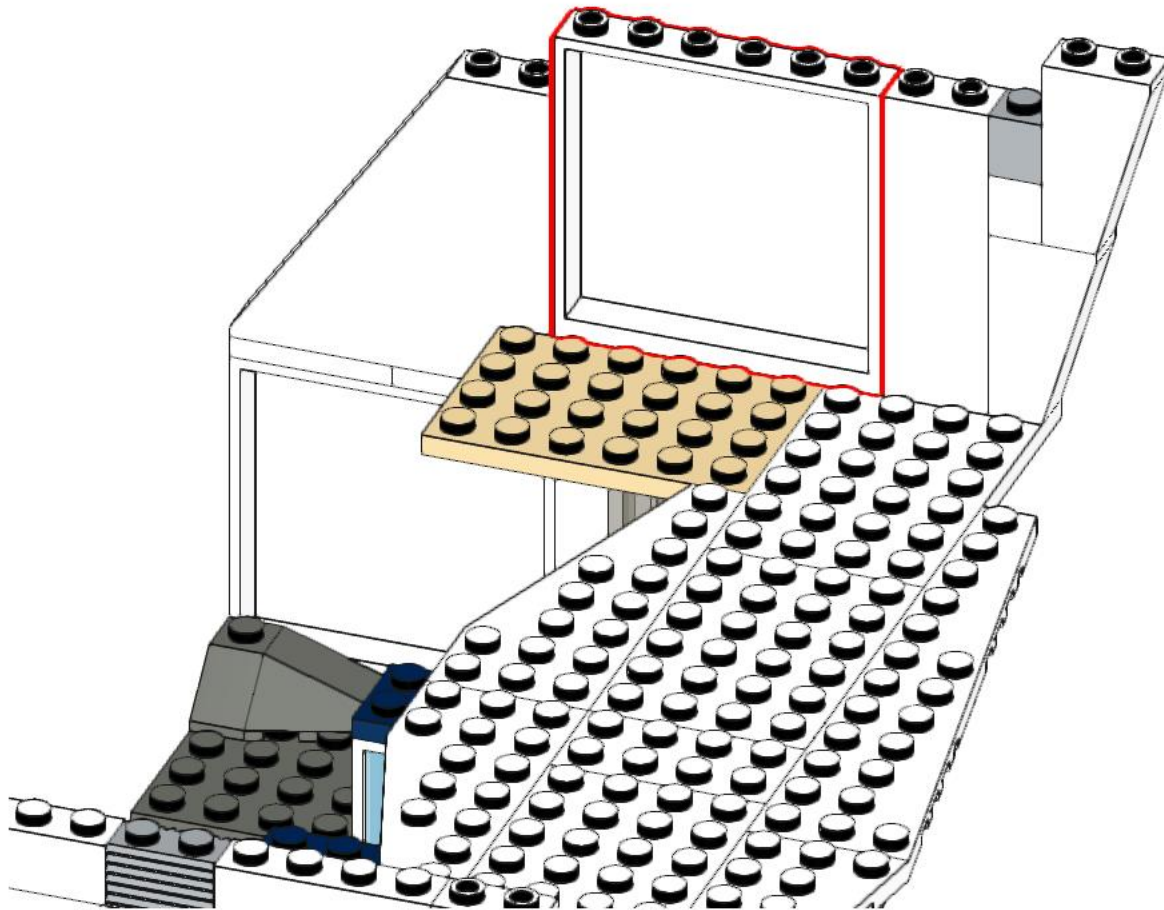
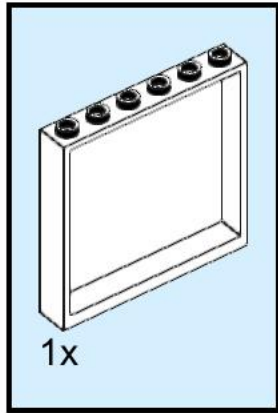

96

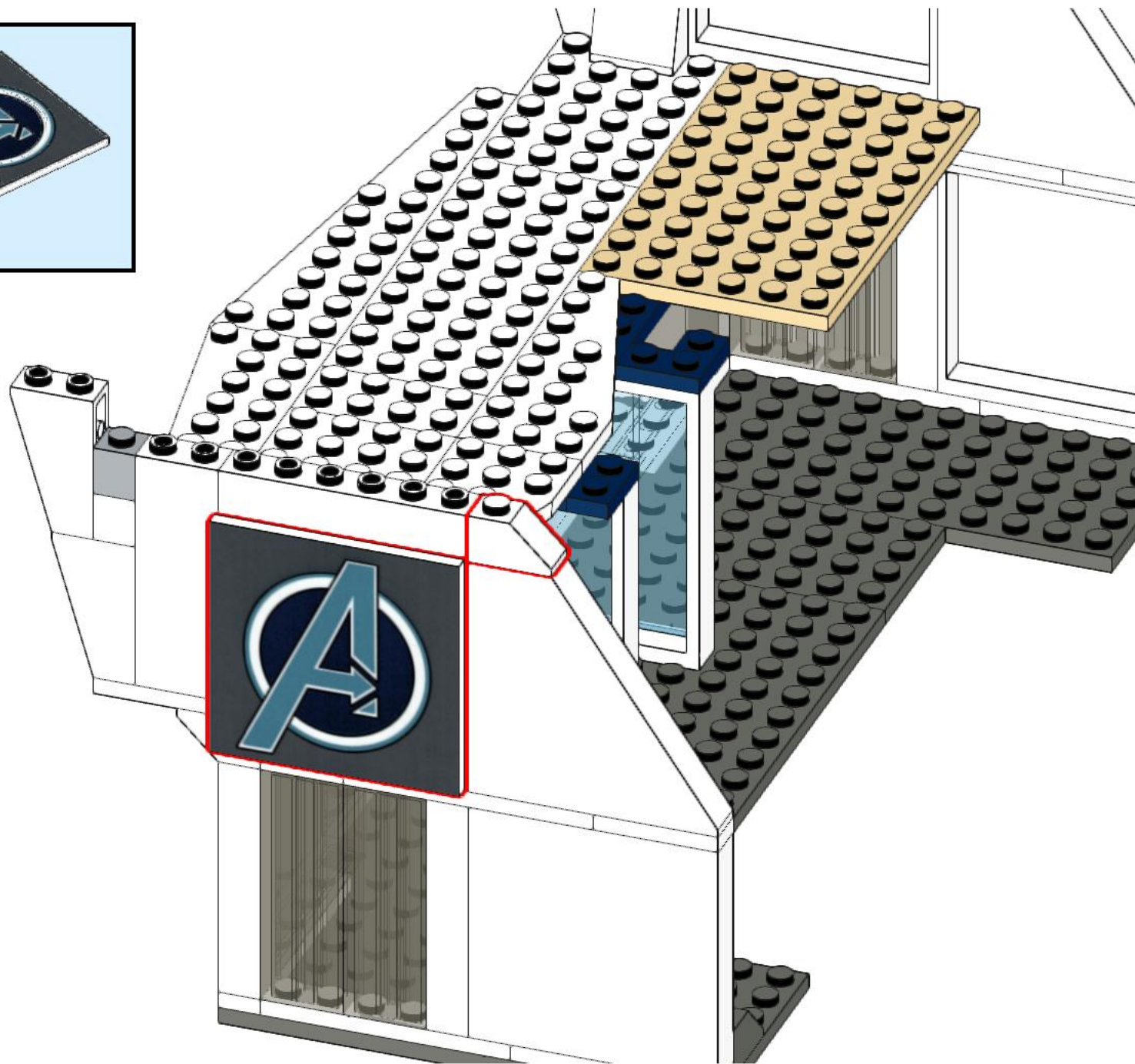
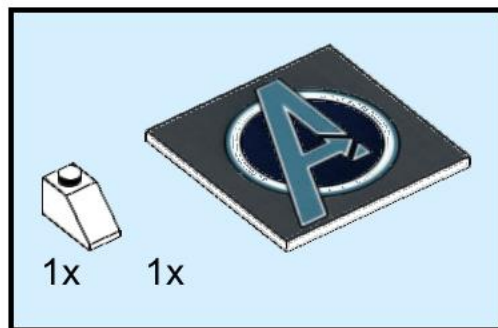

97

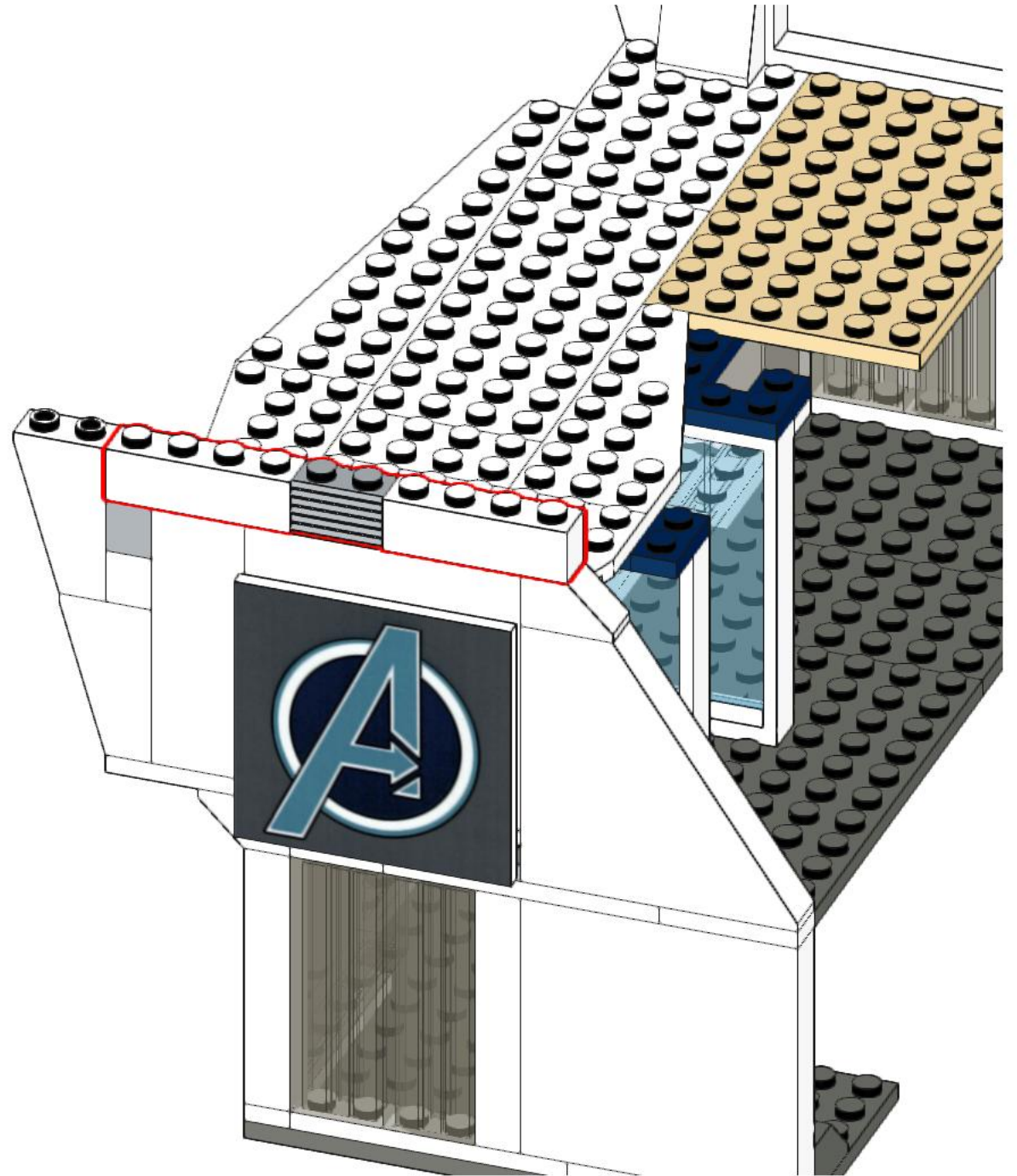
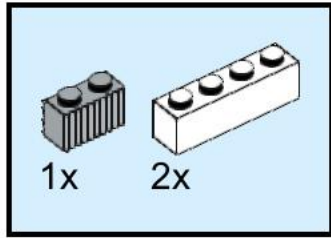

98

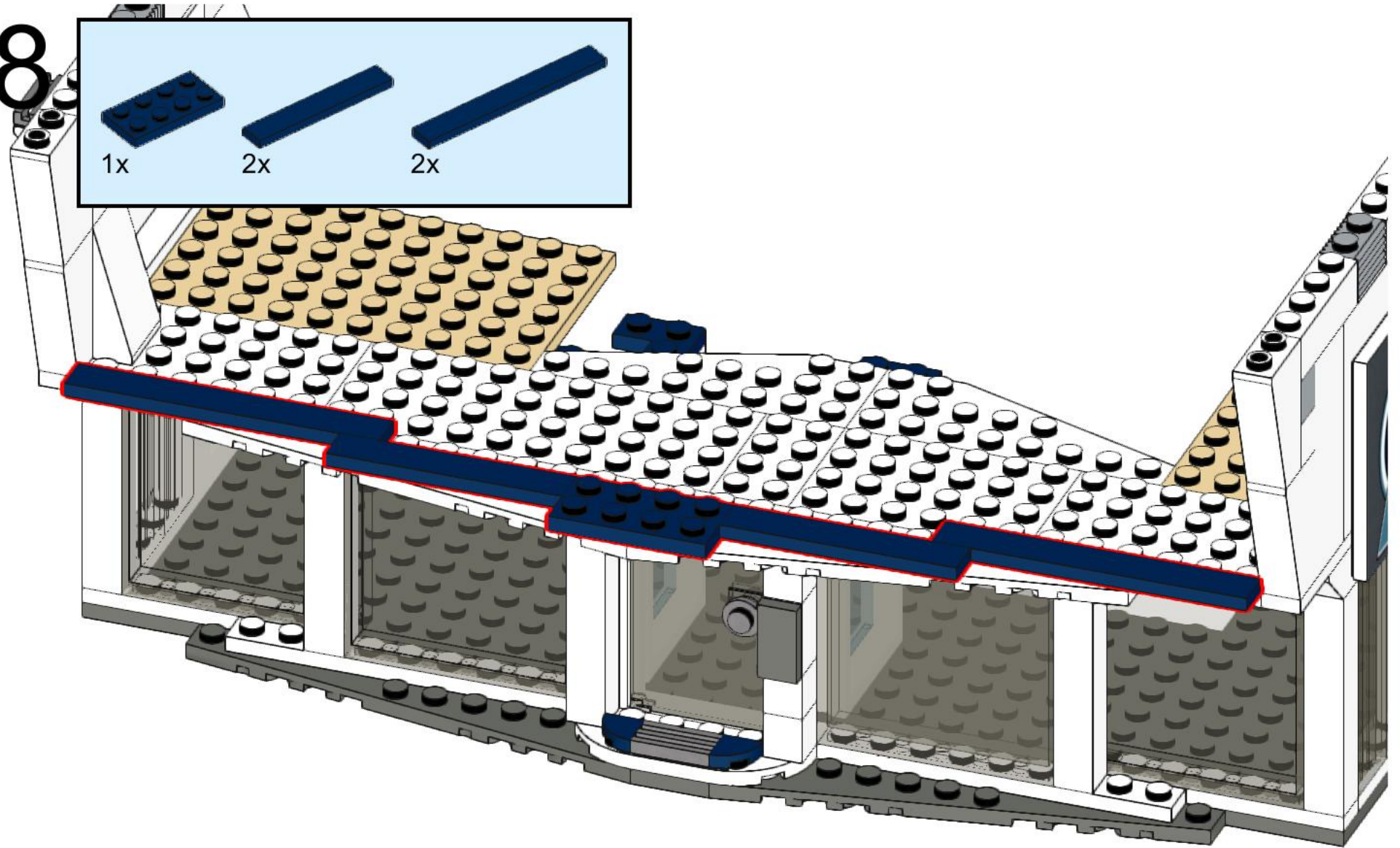
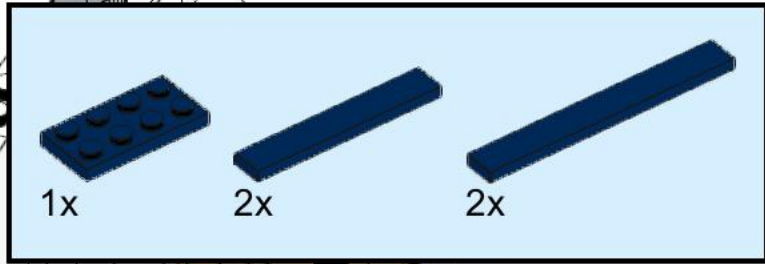

99

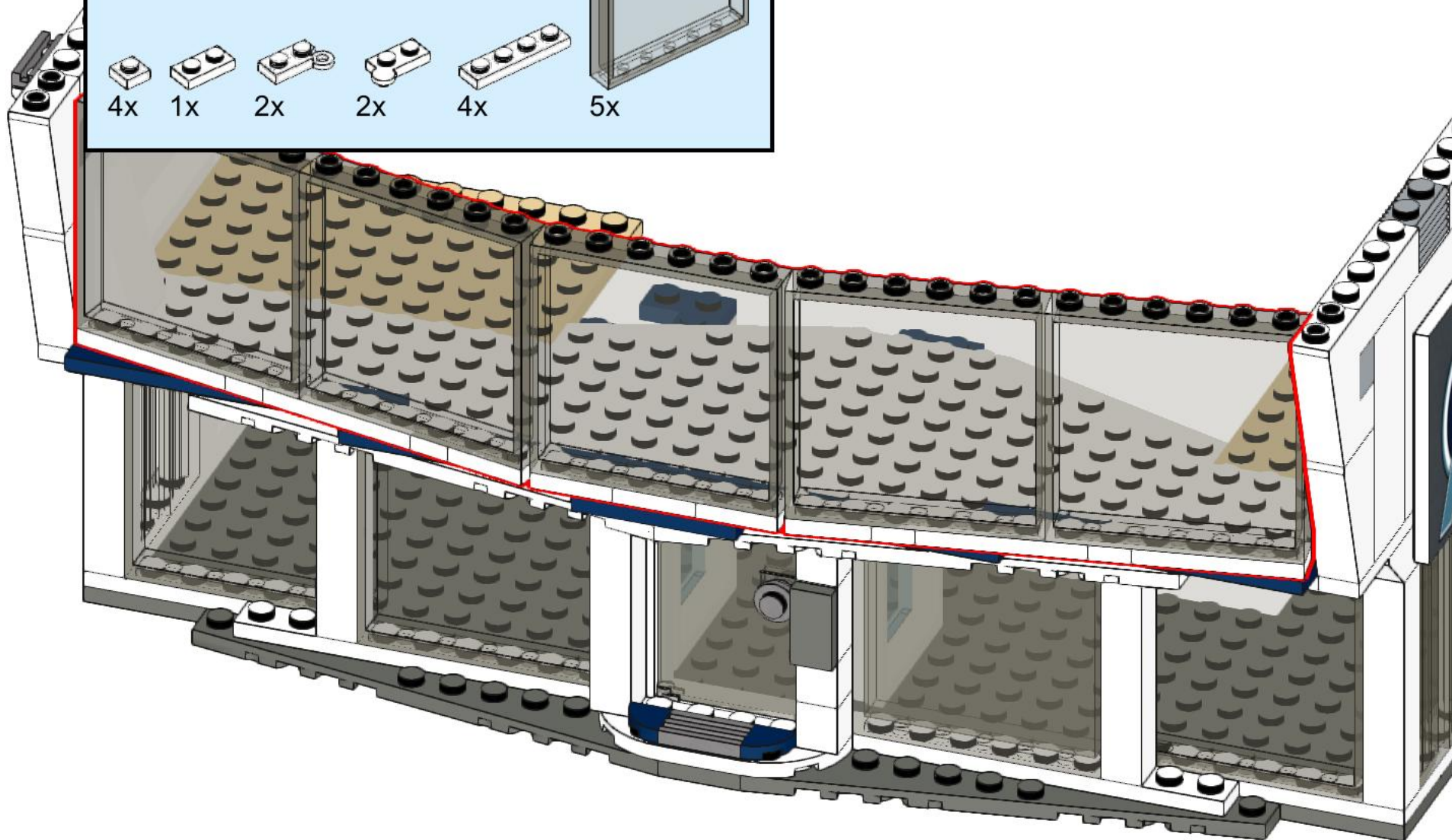
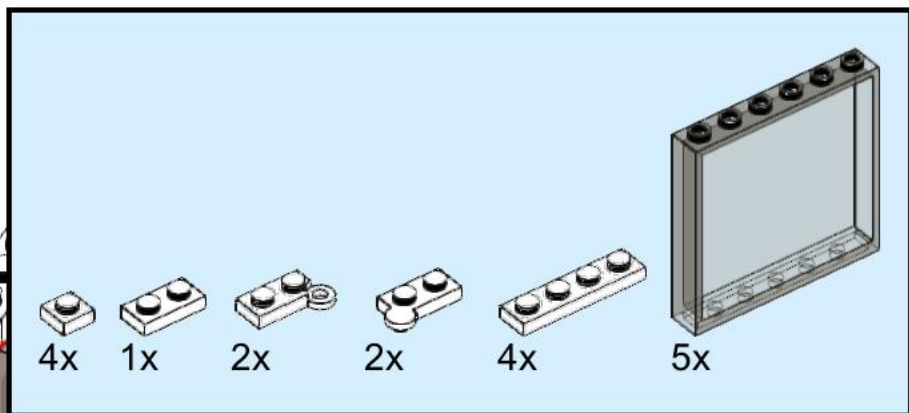

100

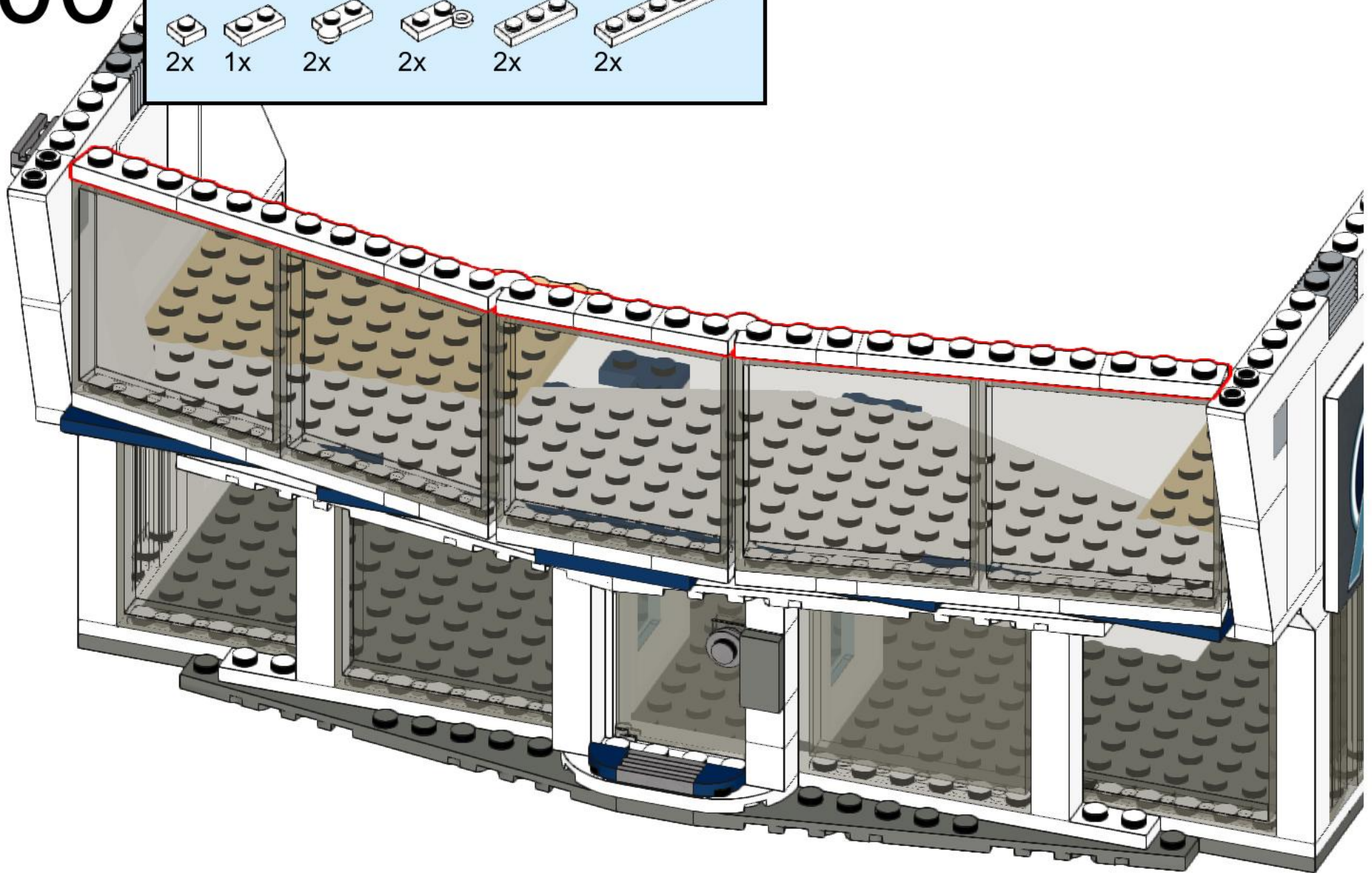
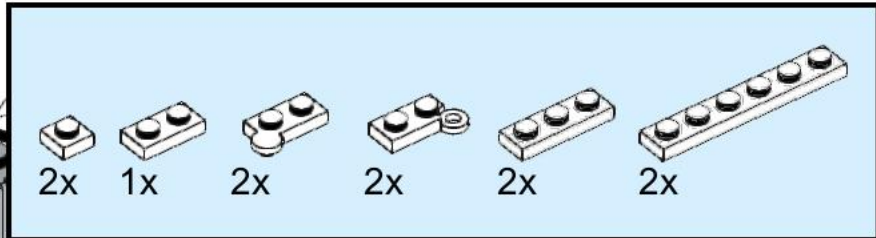

101

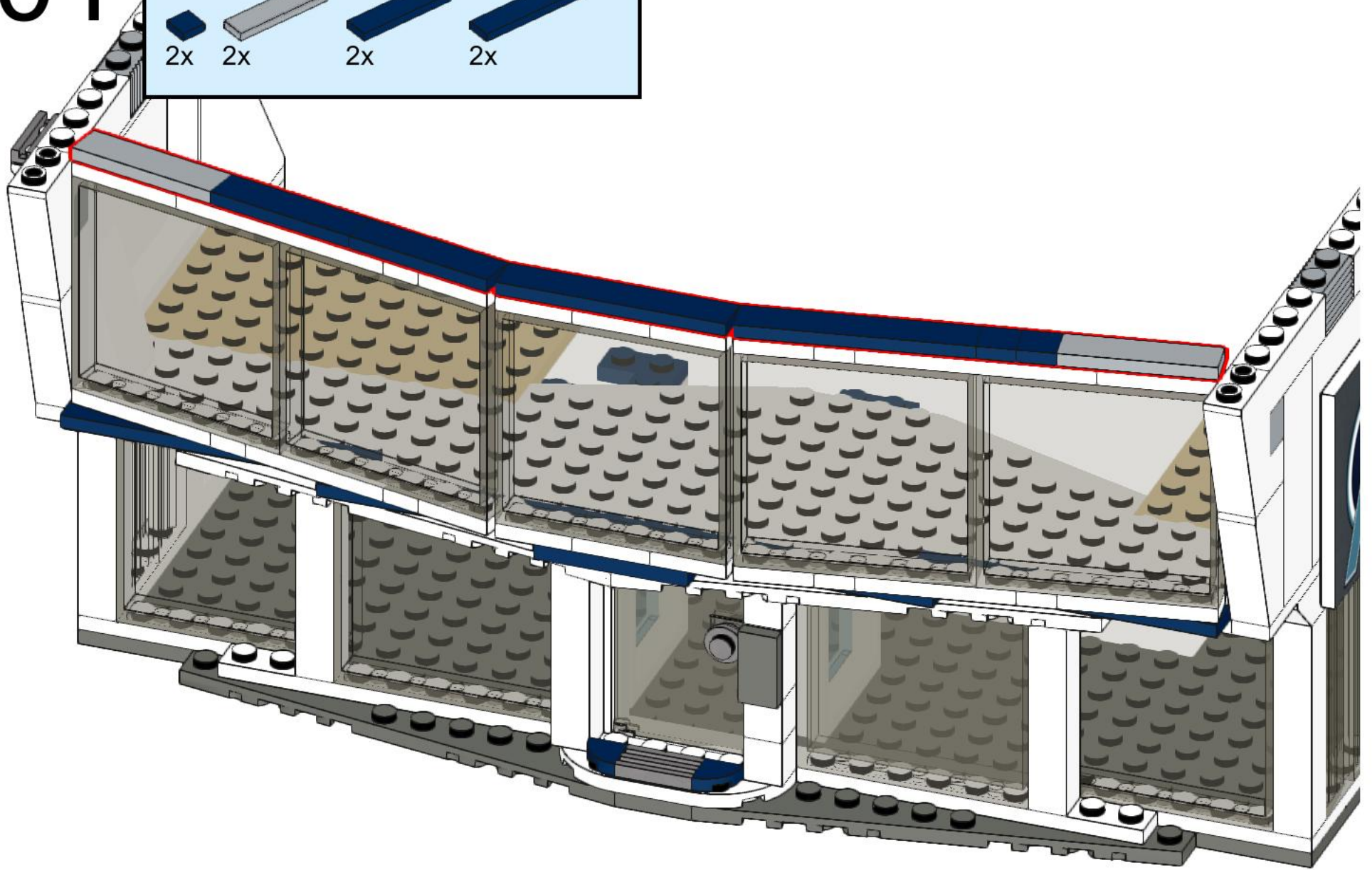
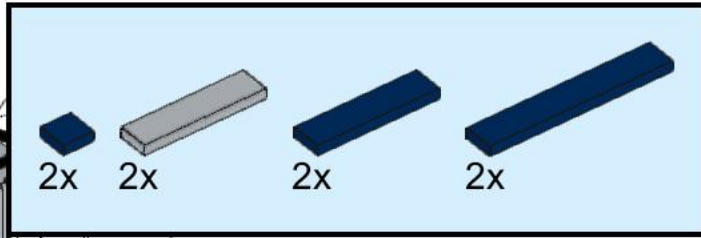

102

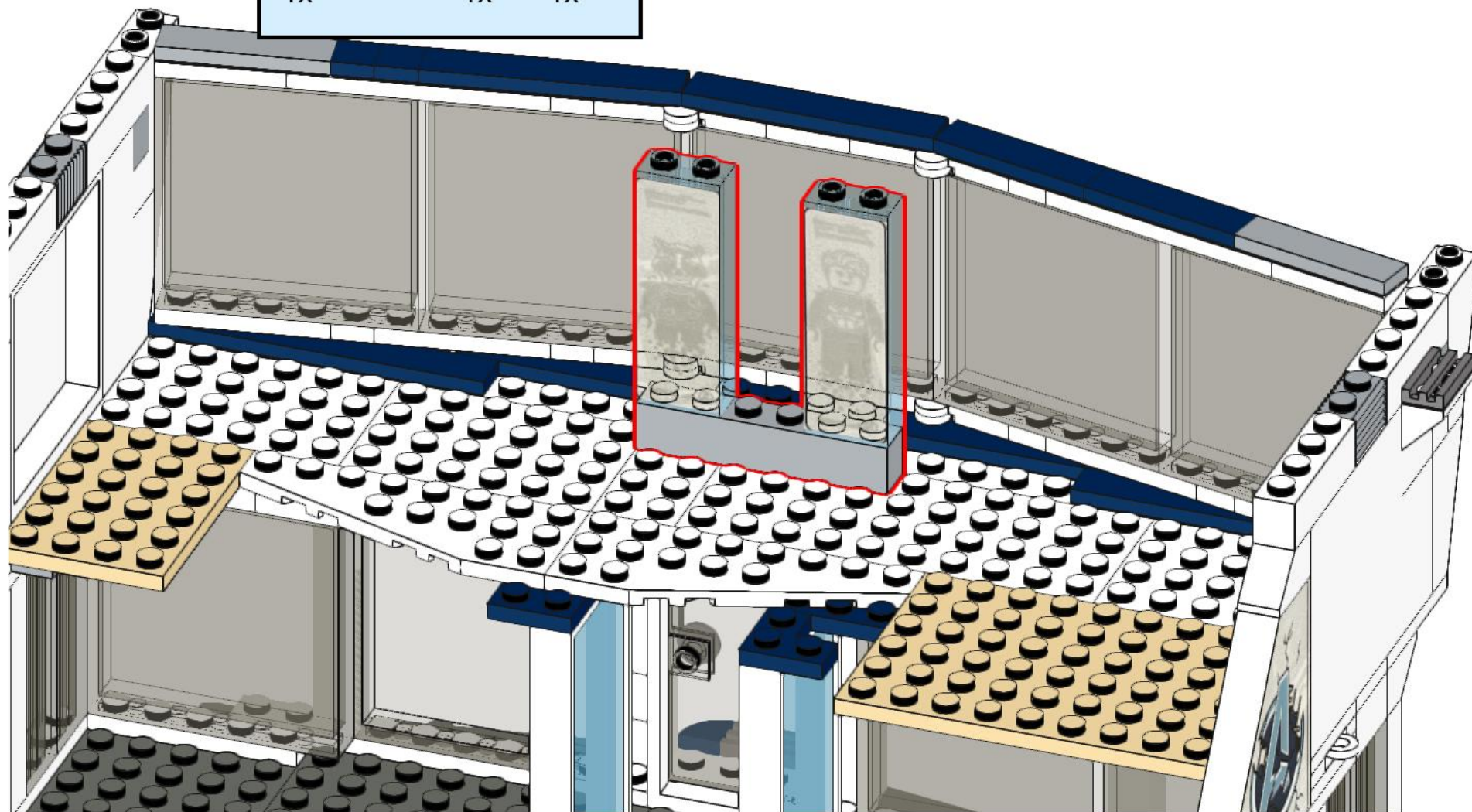
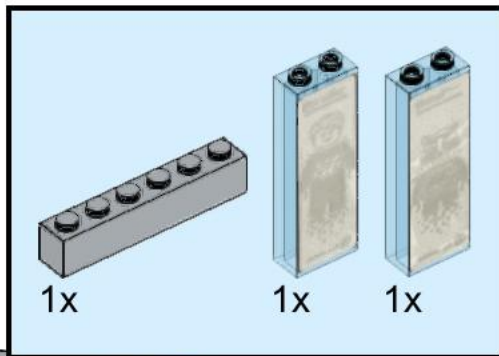

103

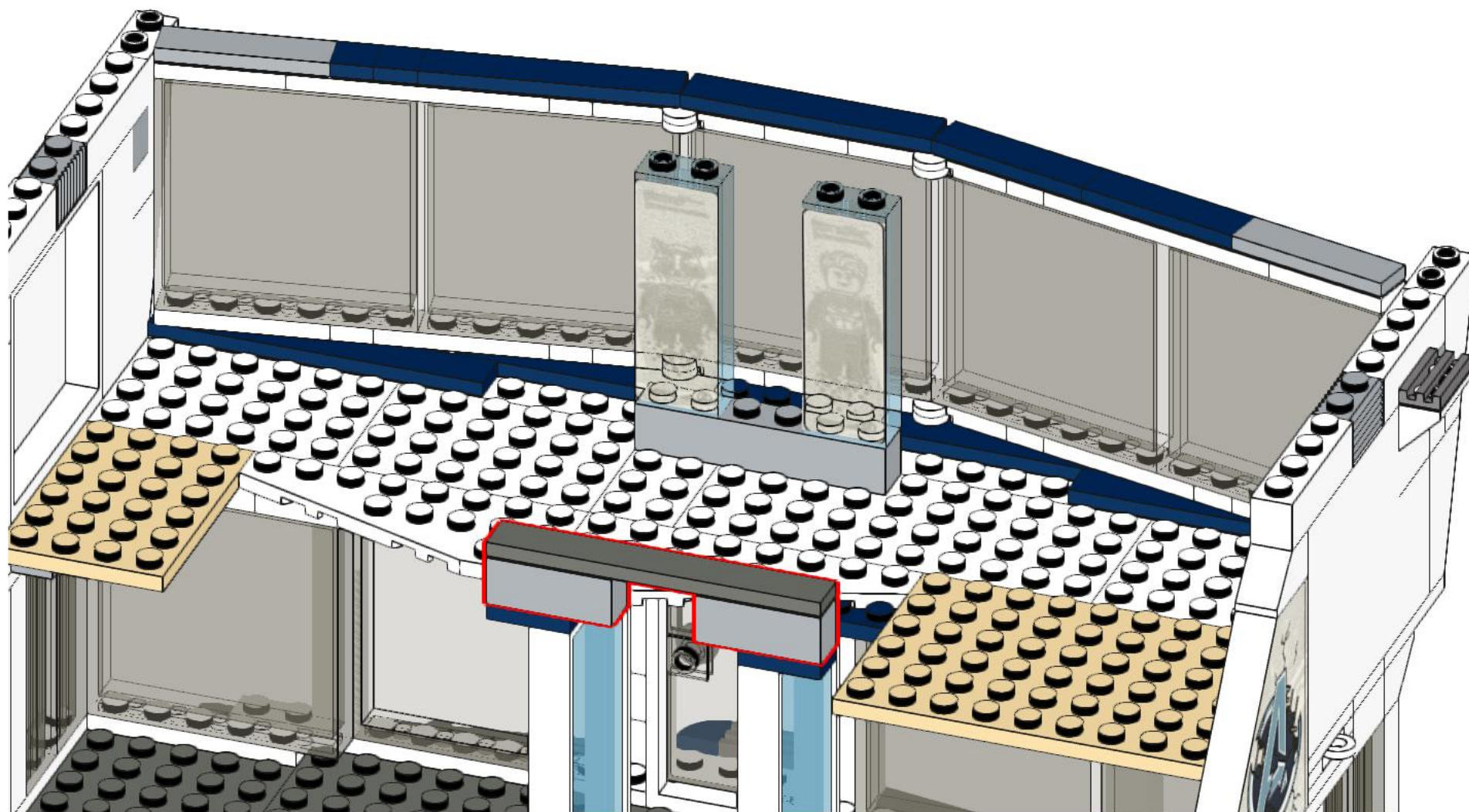
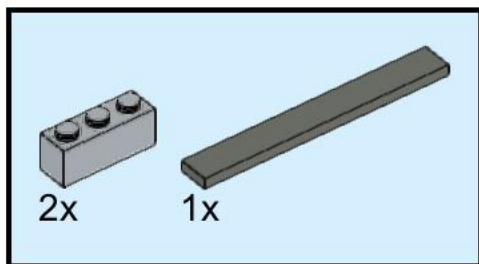

104

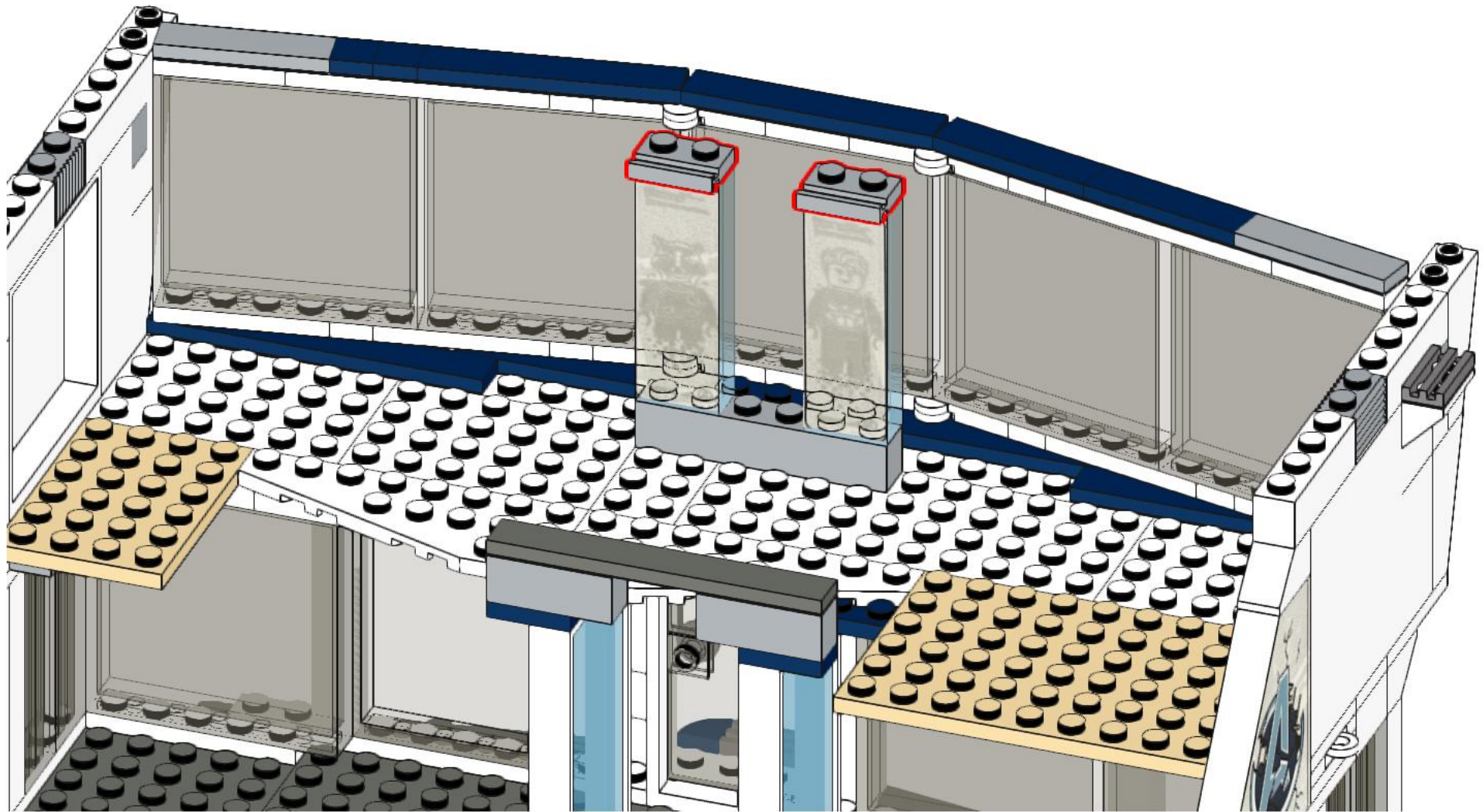
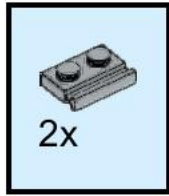

105

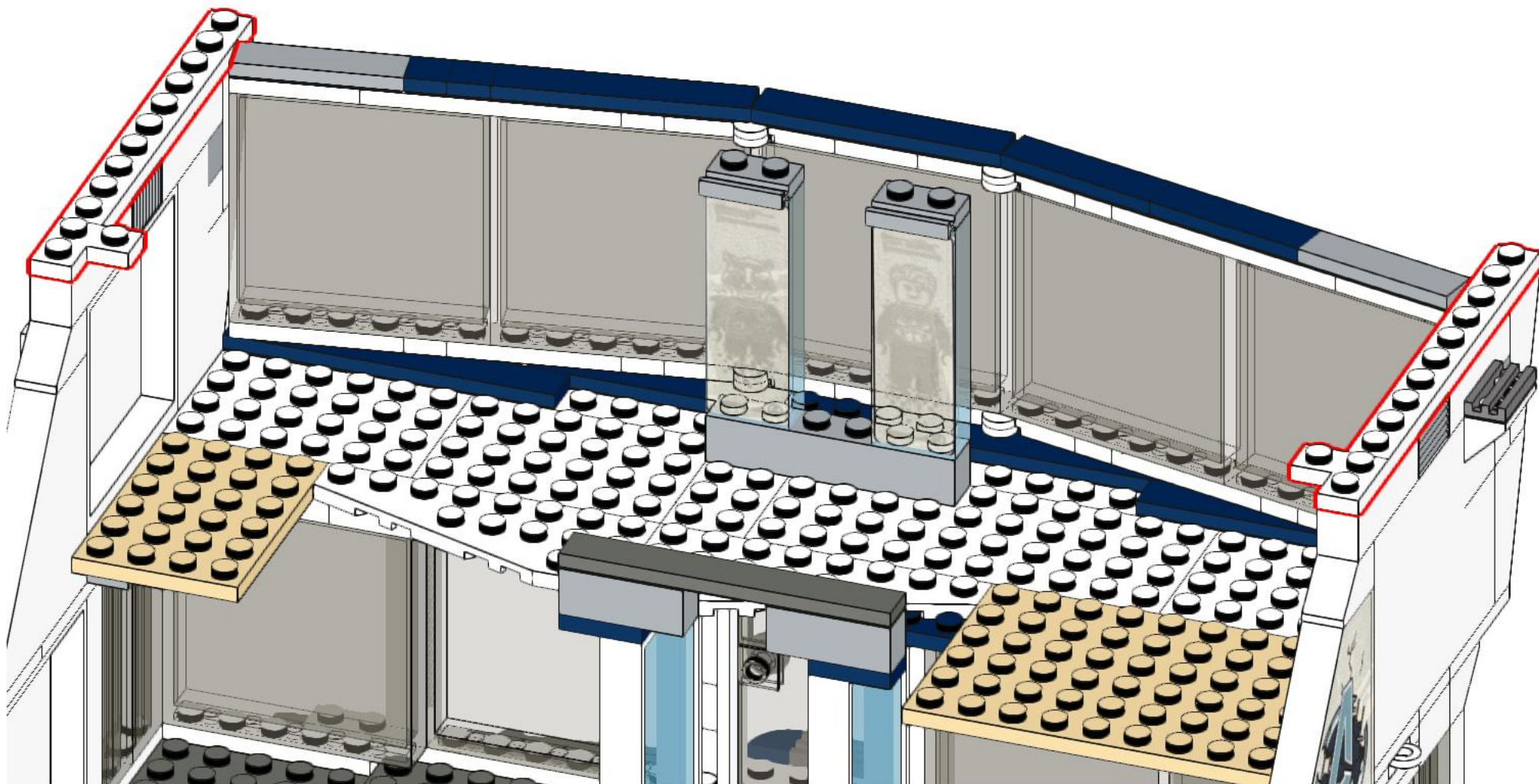
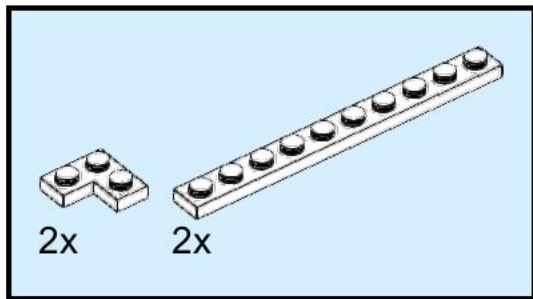

106

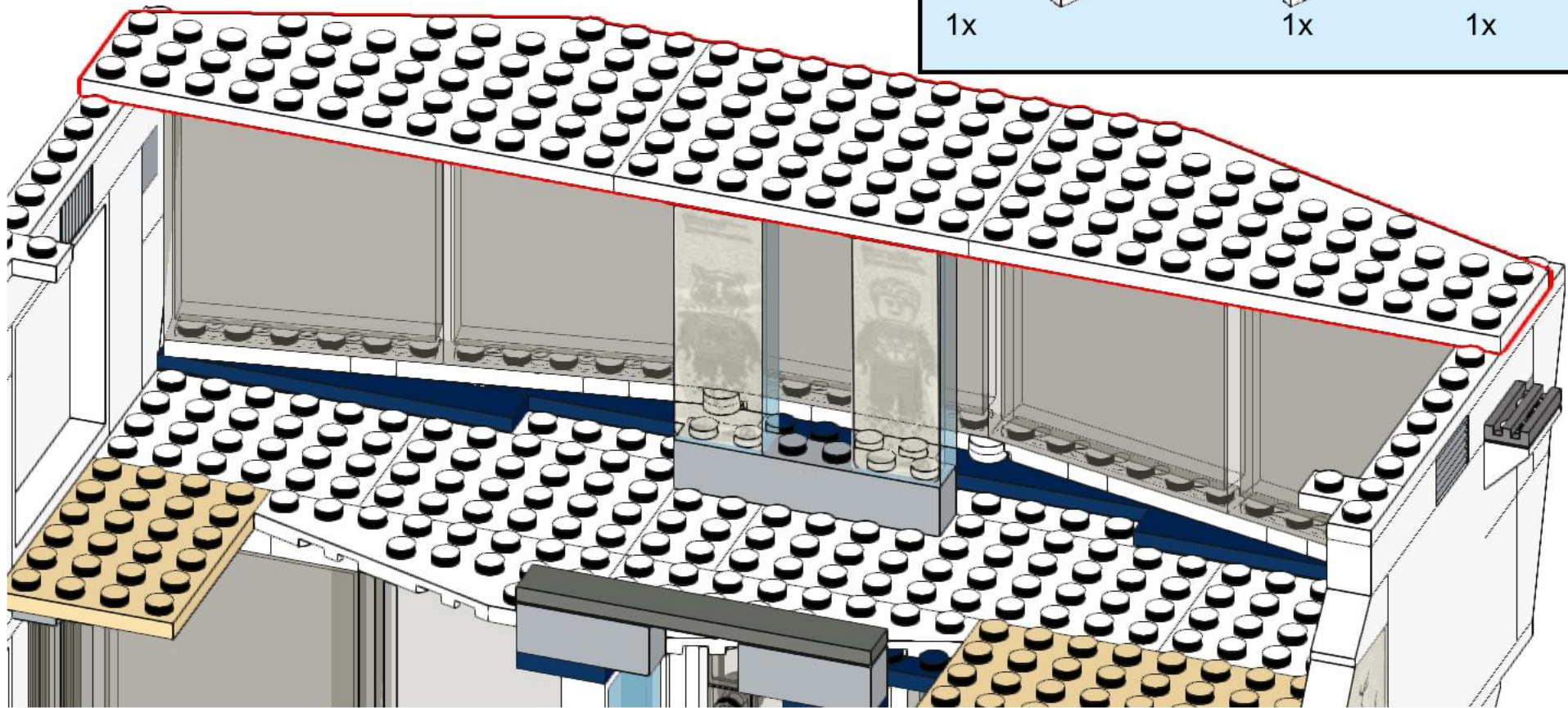
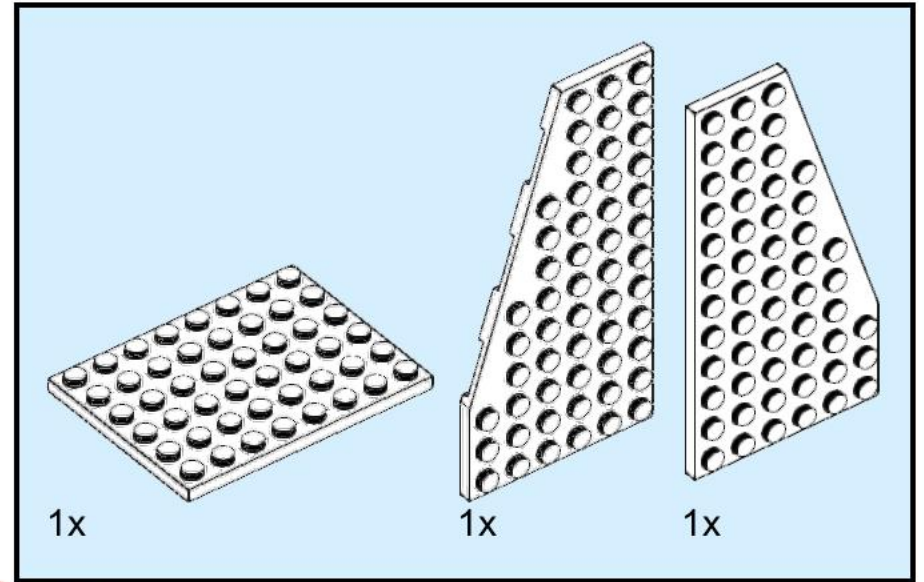

107

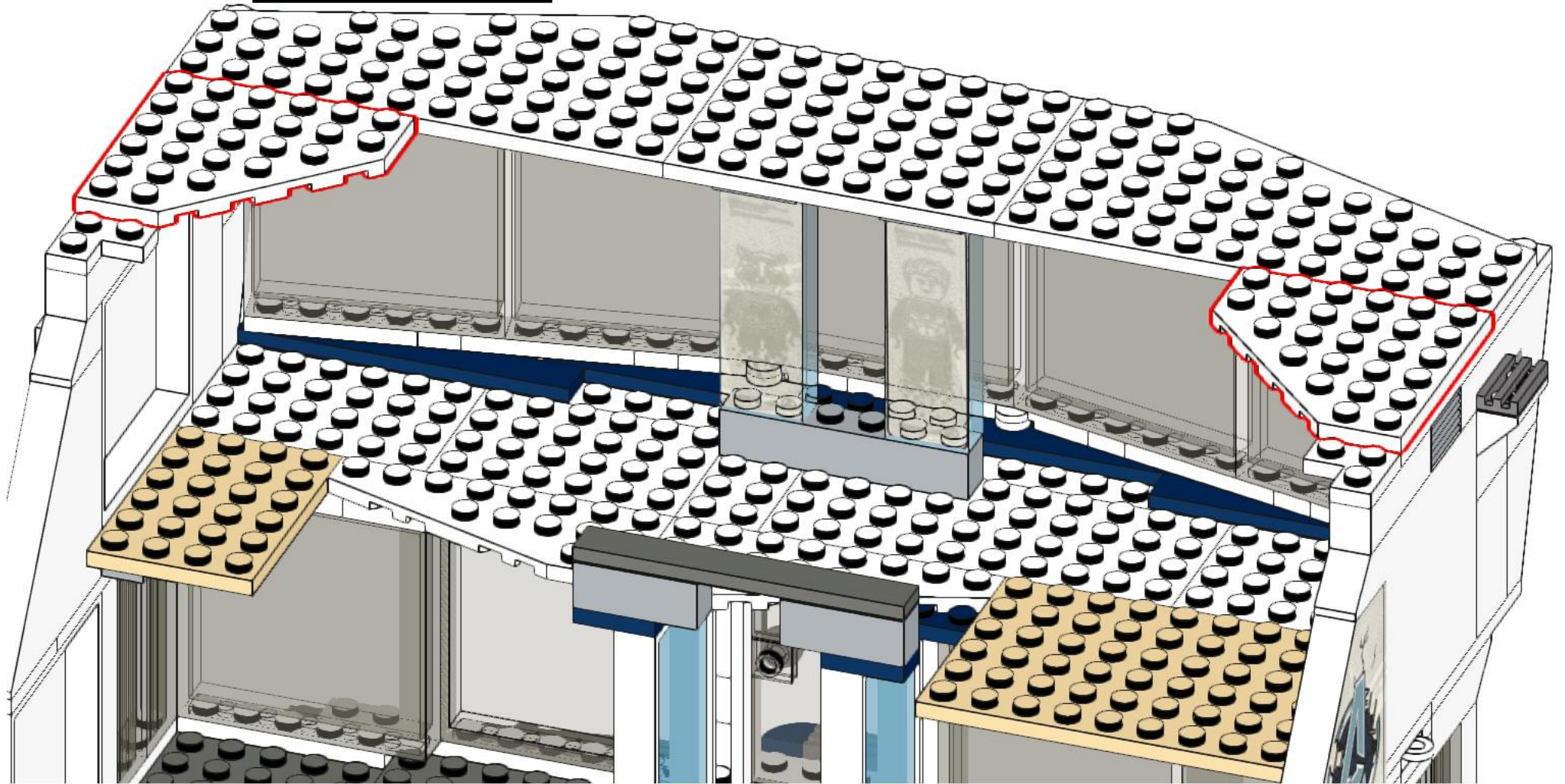
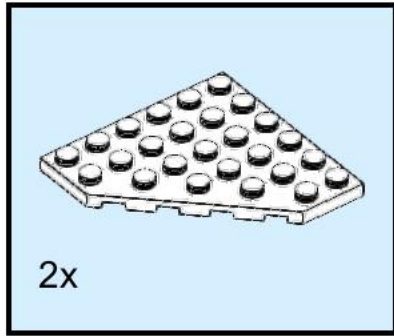

108

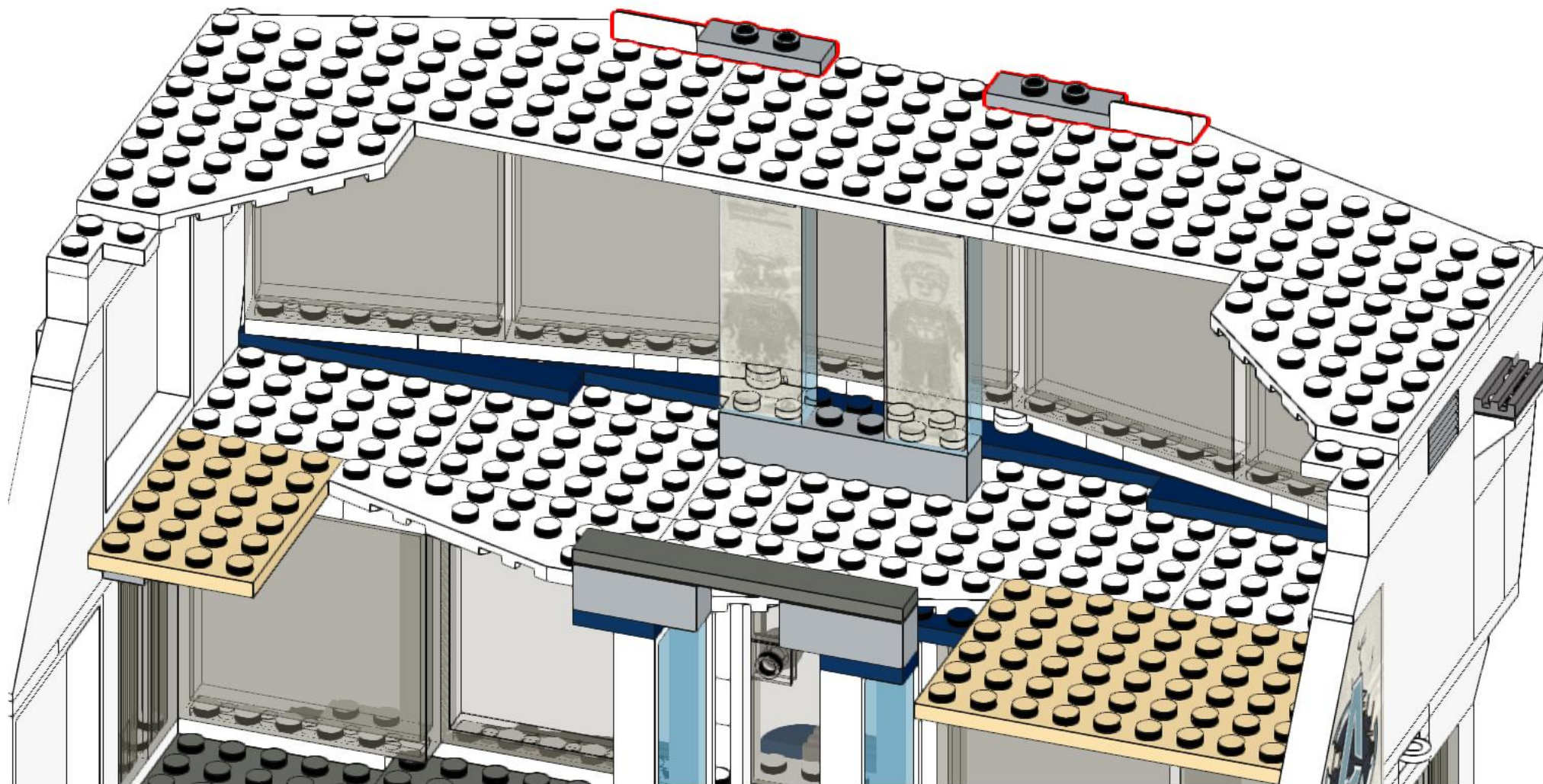
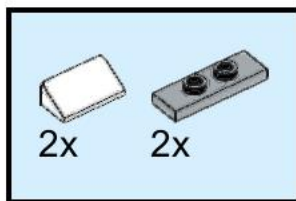

109

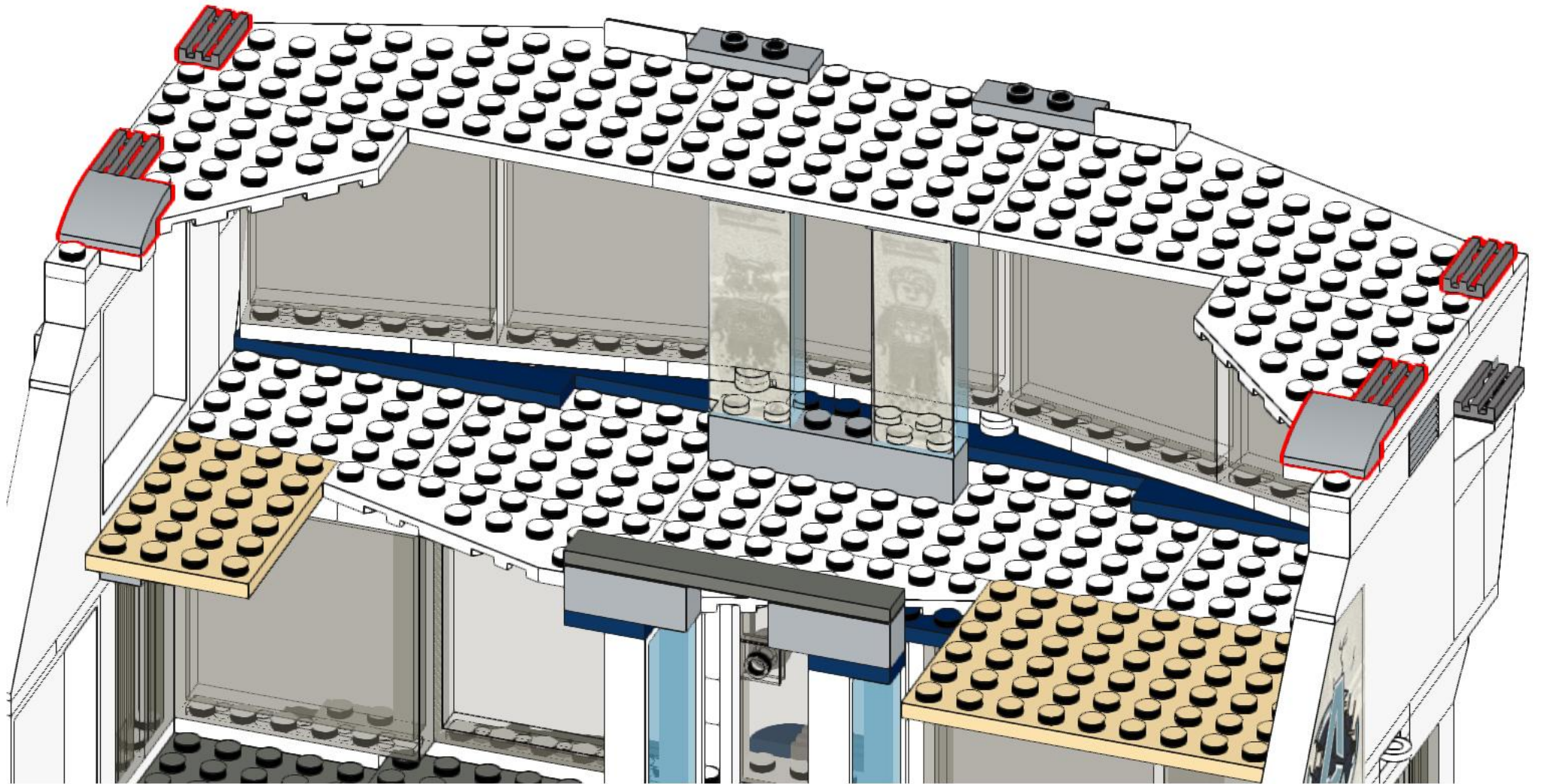
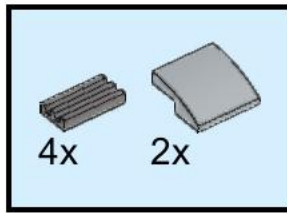

110

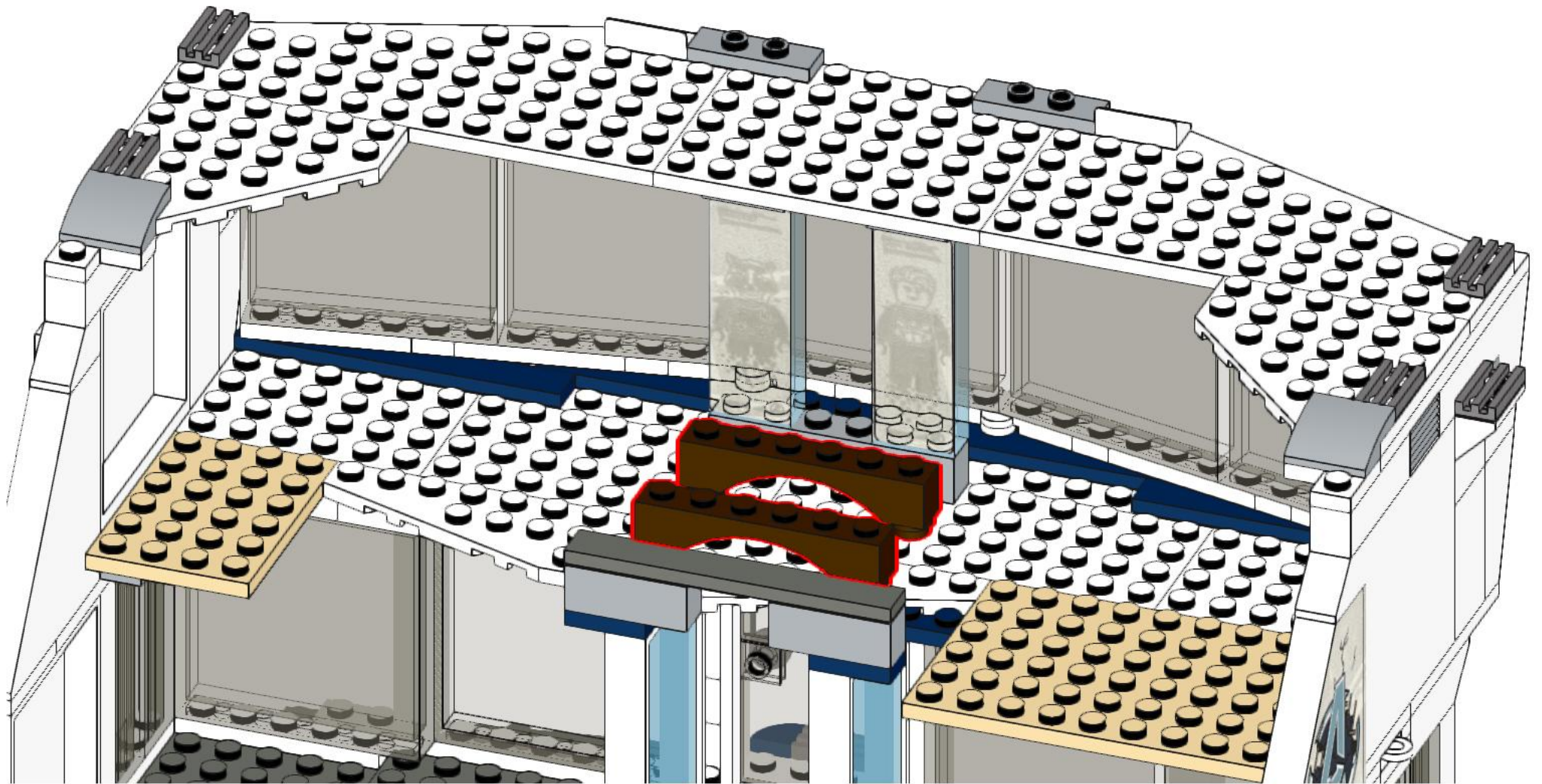
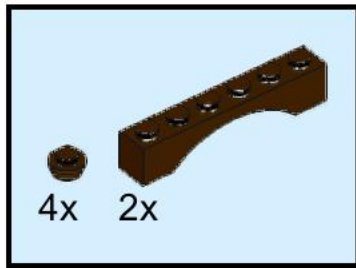

111

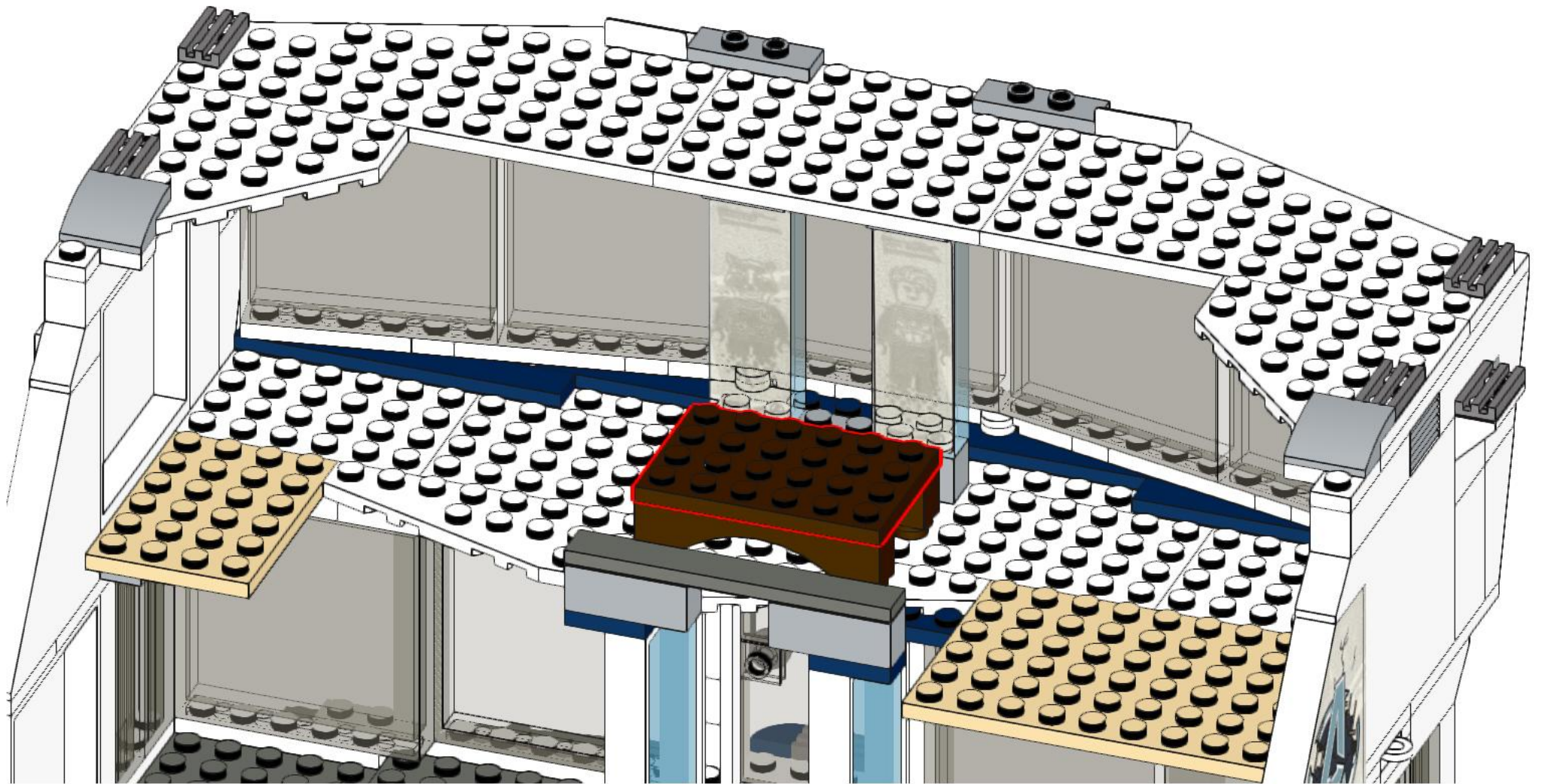
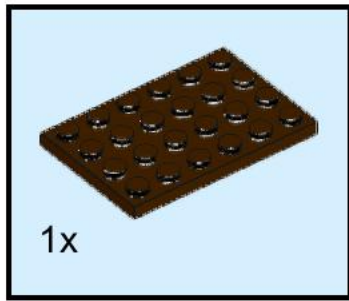

112

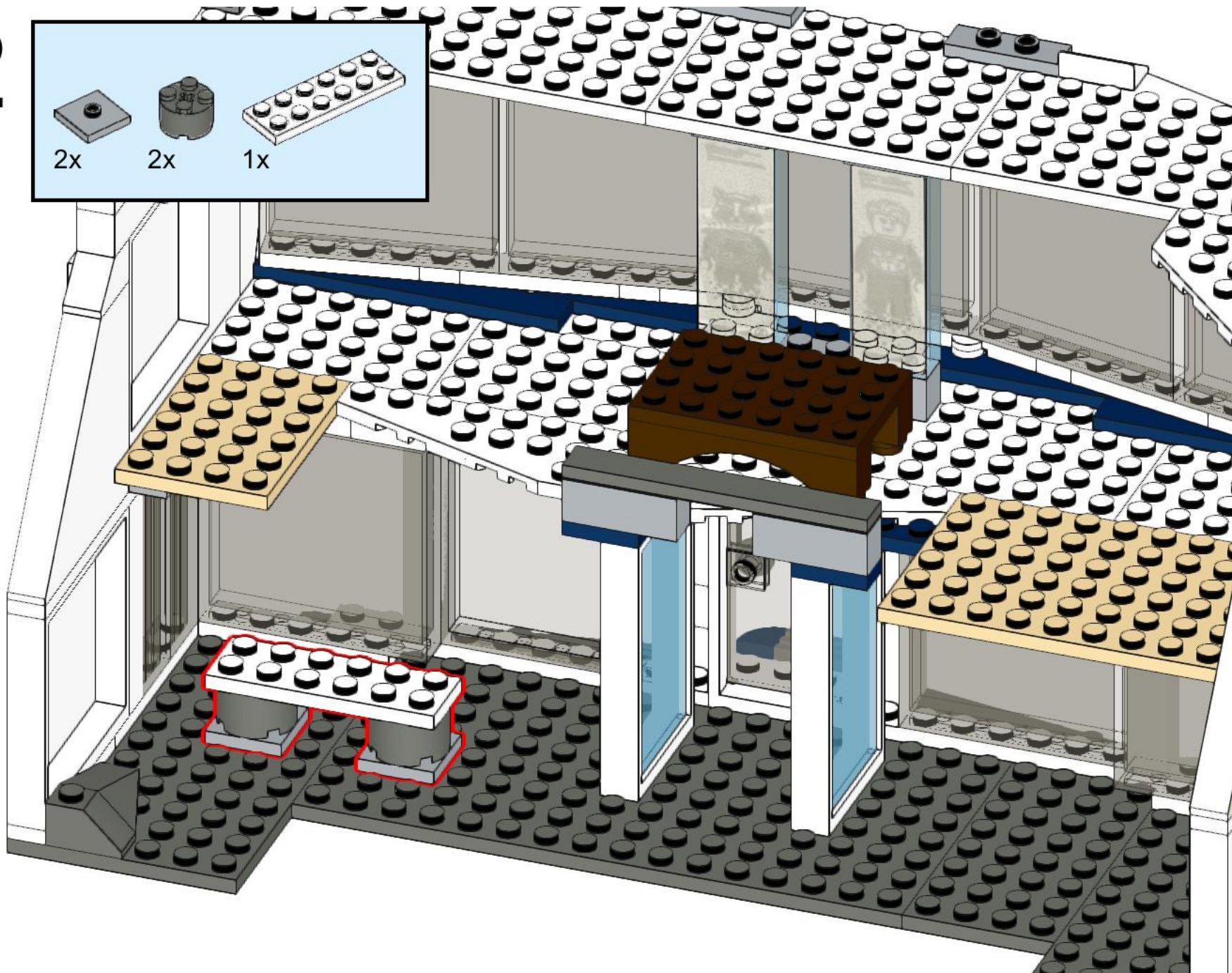

113

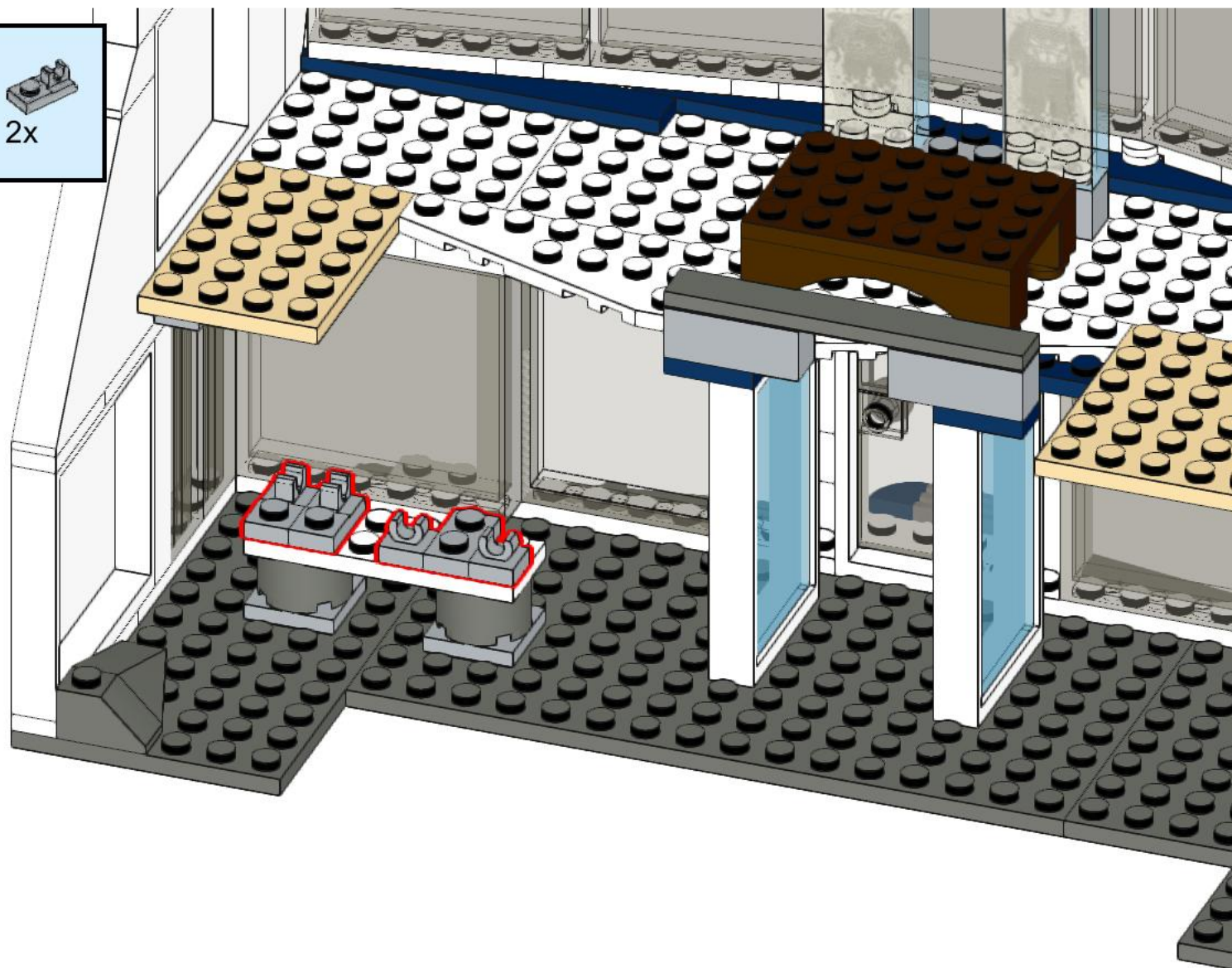
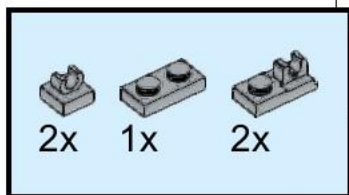

114

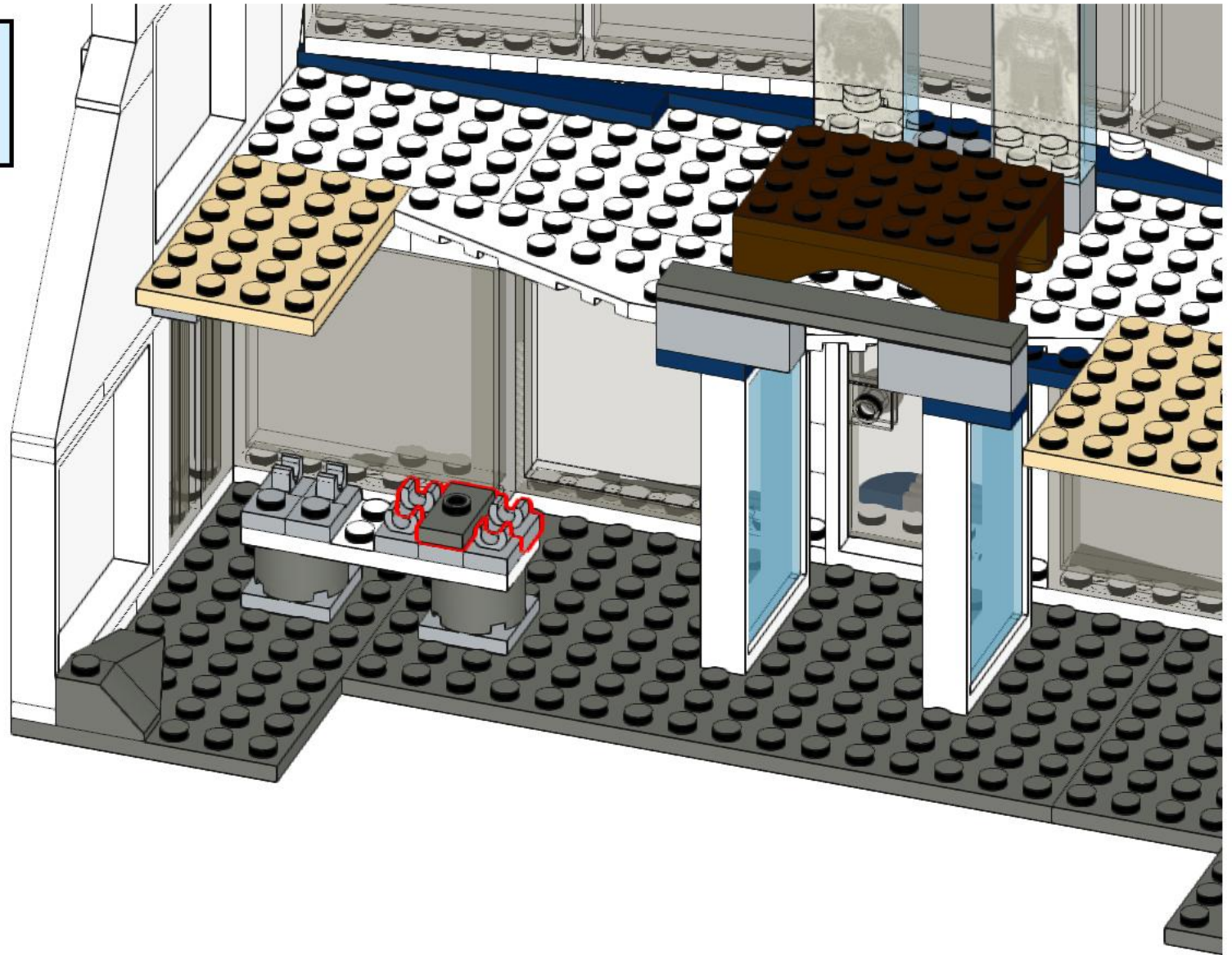
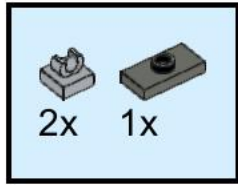

115

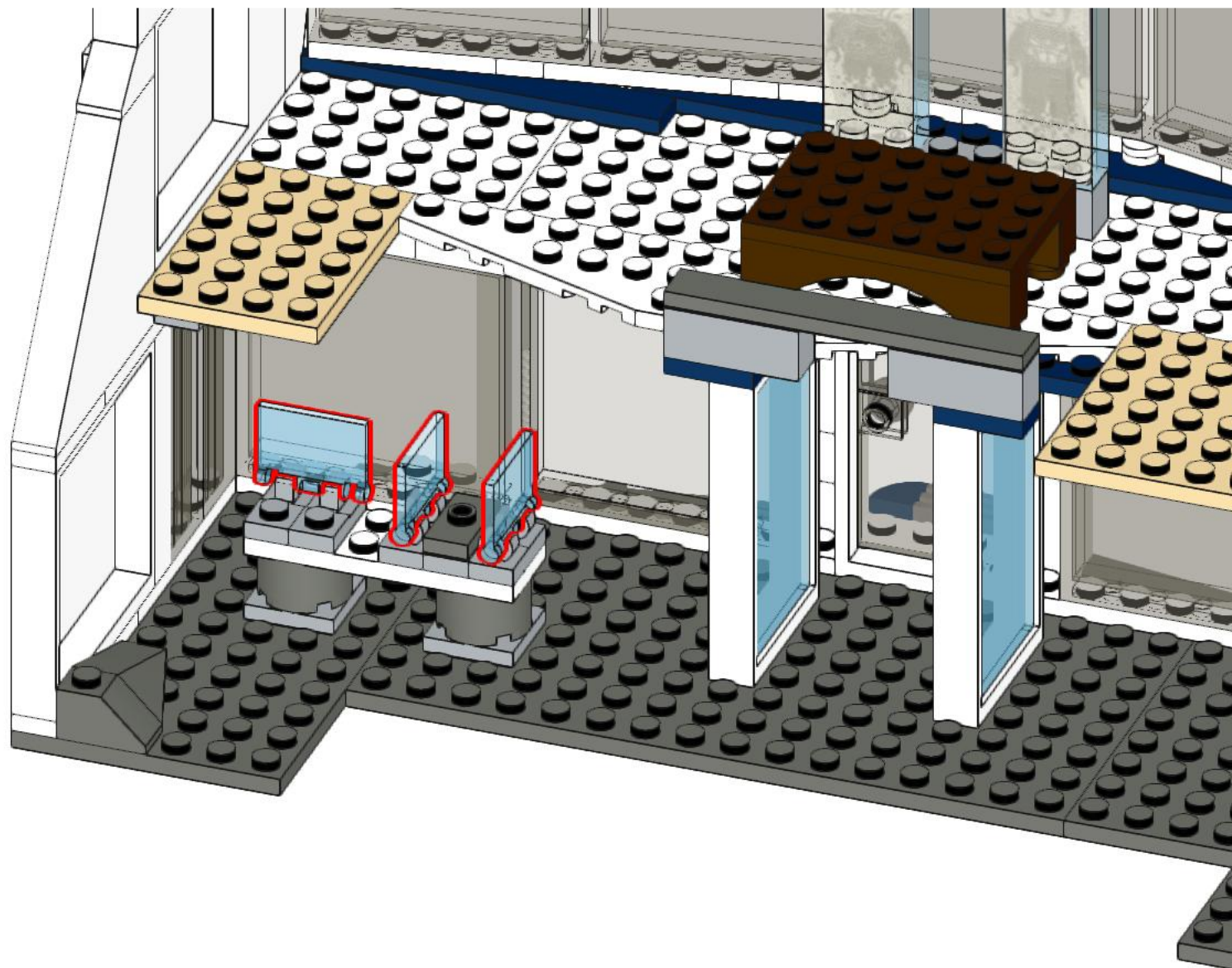
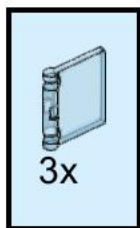

116

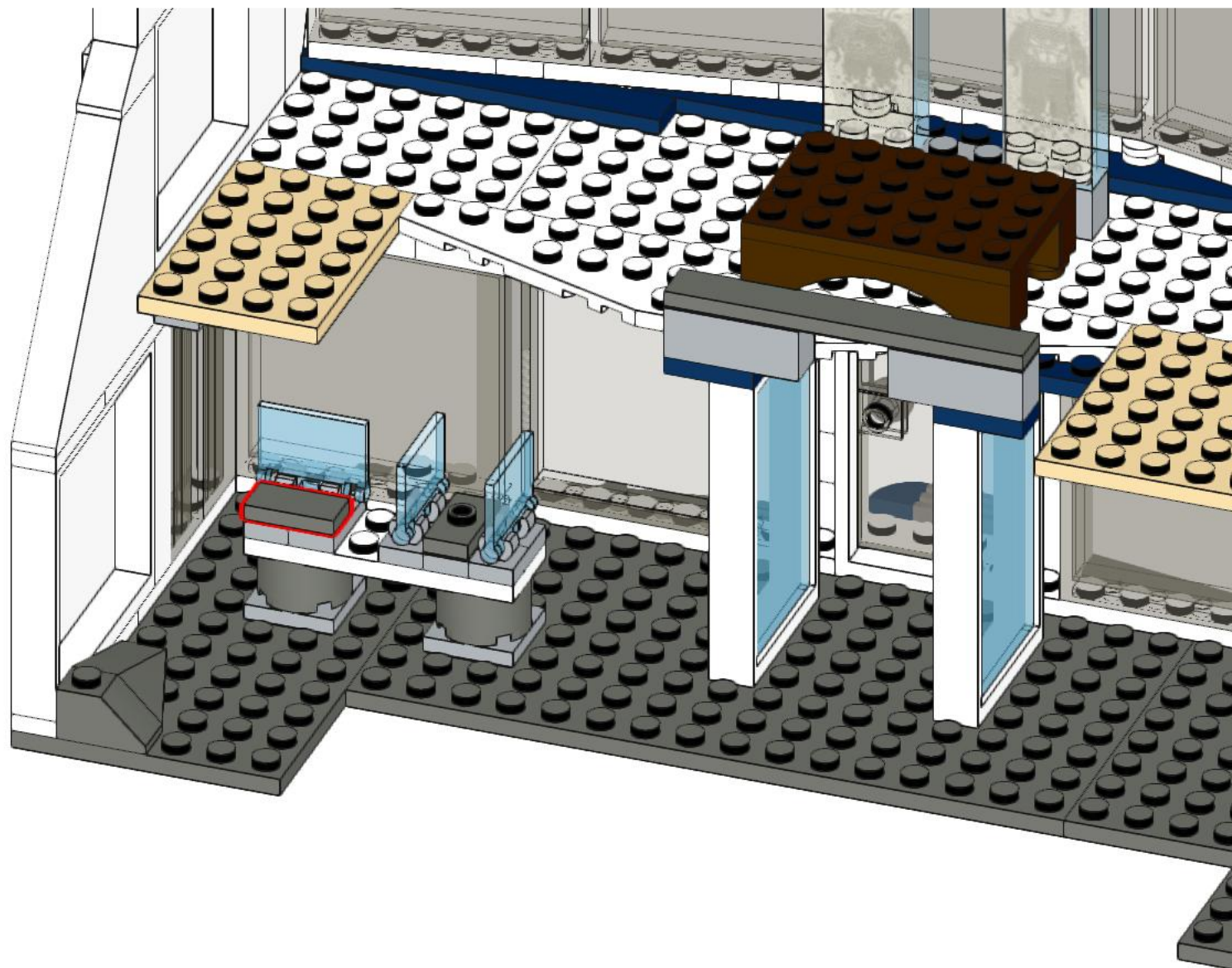
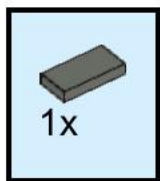

117

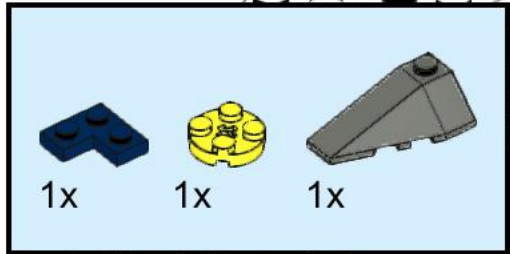

1x 1x 1x

This inset box lists the parts required for step 117: one dark blue 1x2 Technic brick with a hole, one yellow 1x2 Technic axle connector, and one grey 1x2 Technic slope.

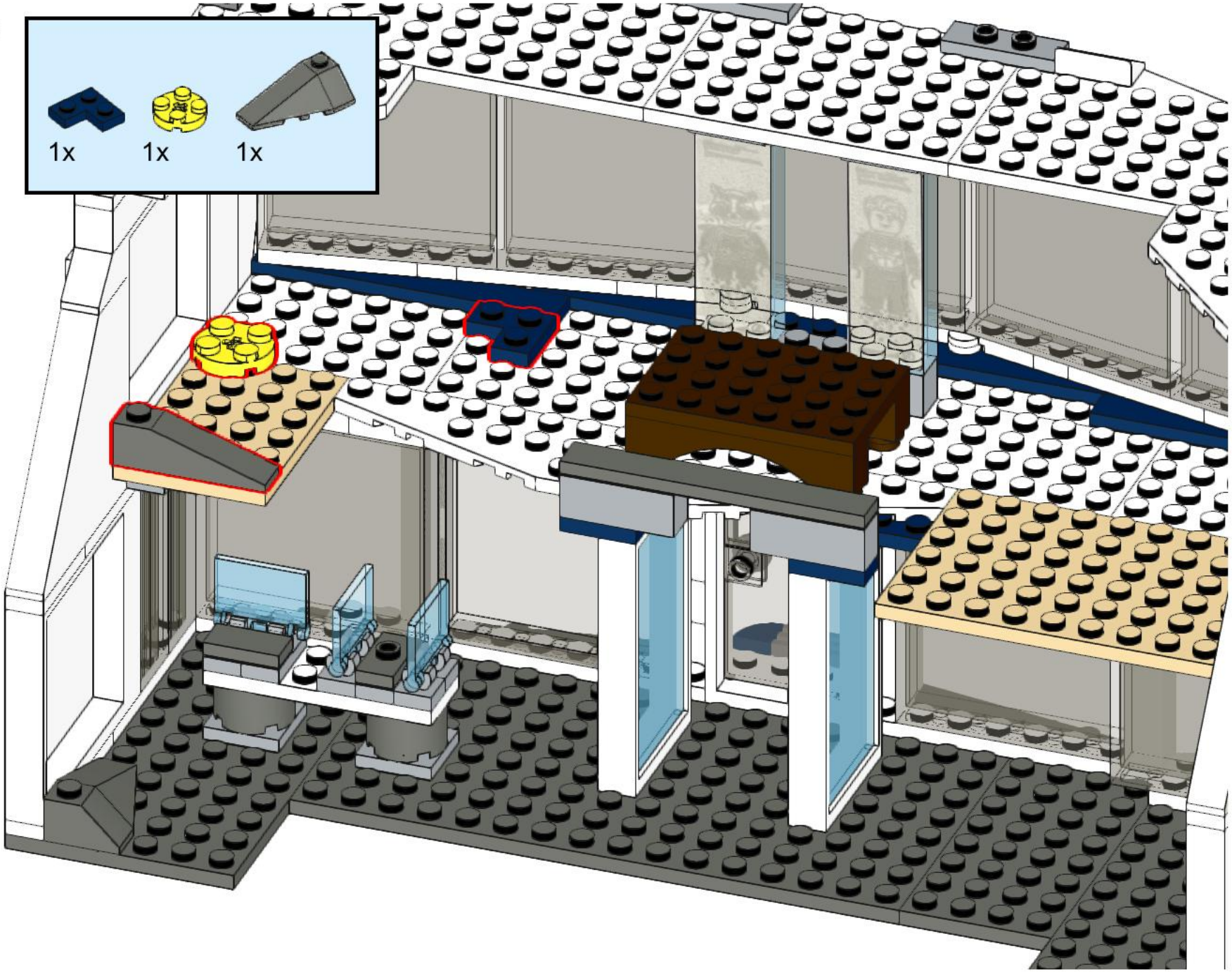

118

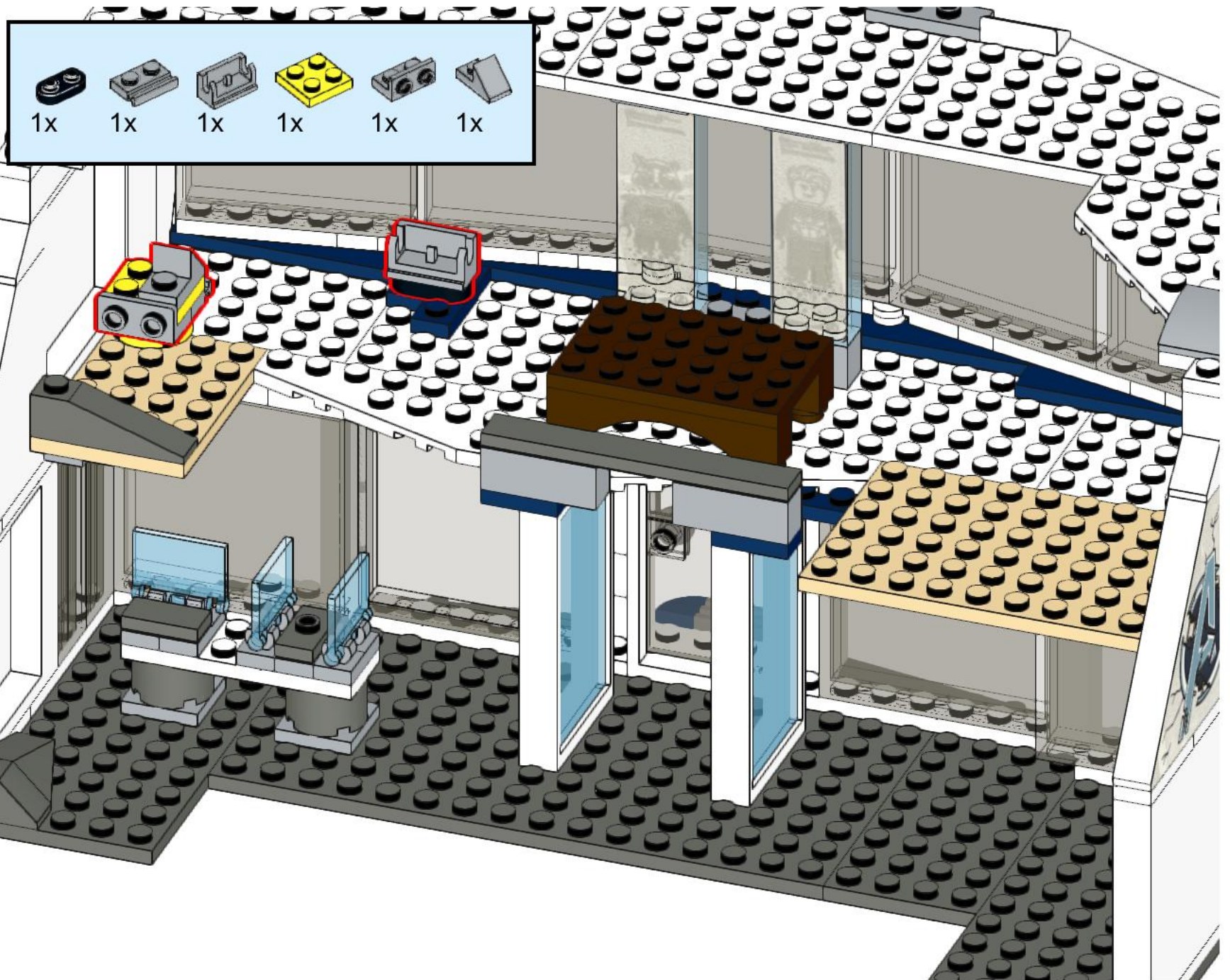

119

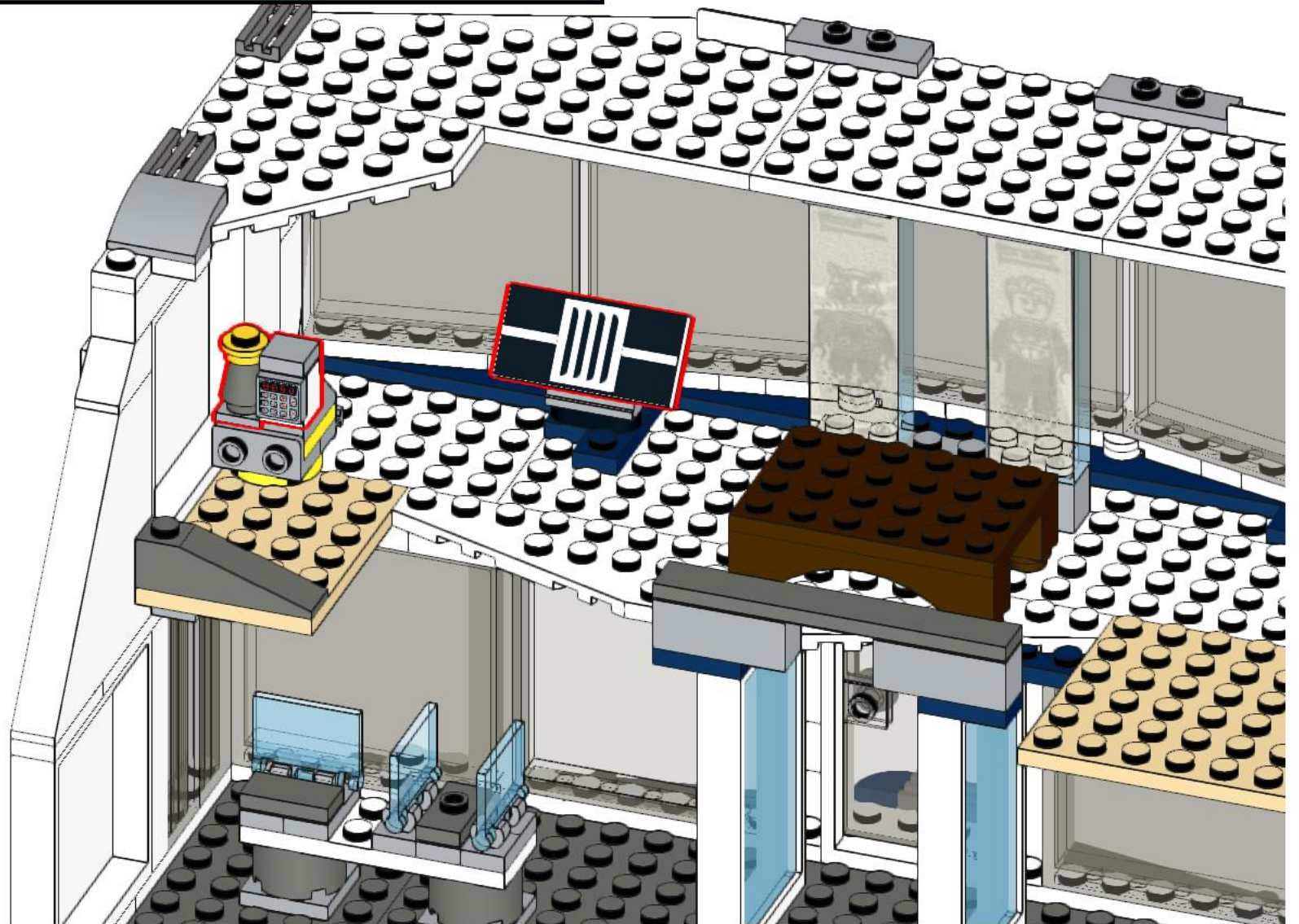
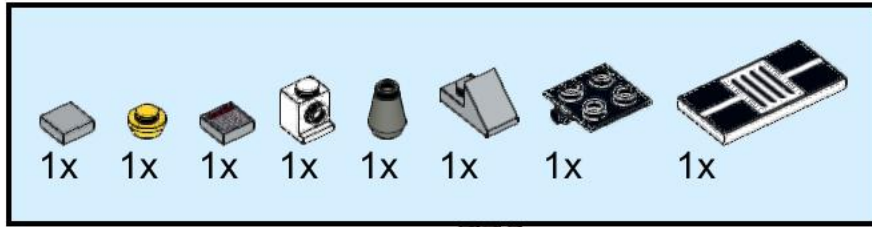

120

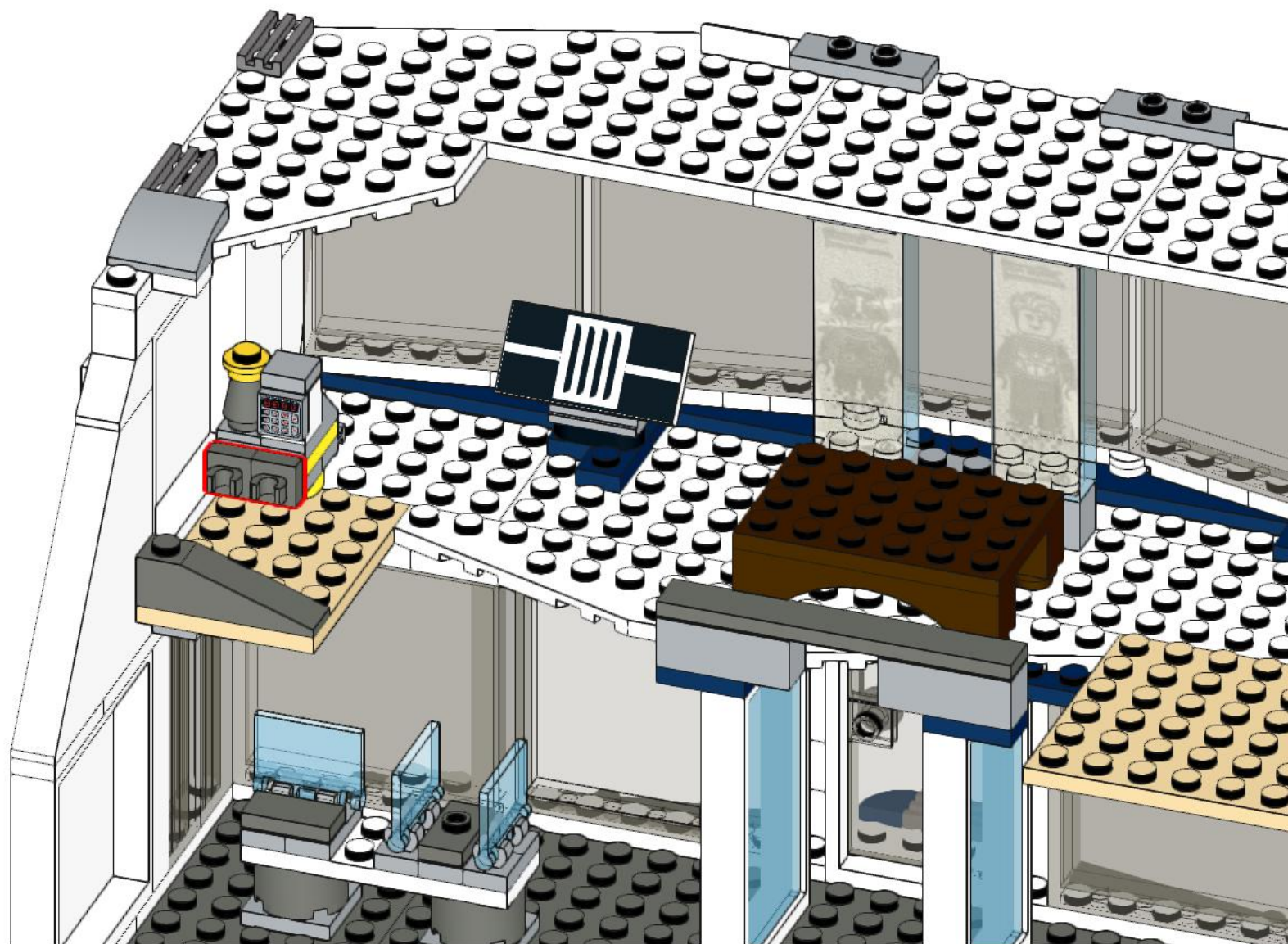
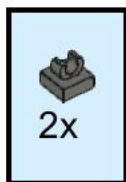

121

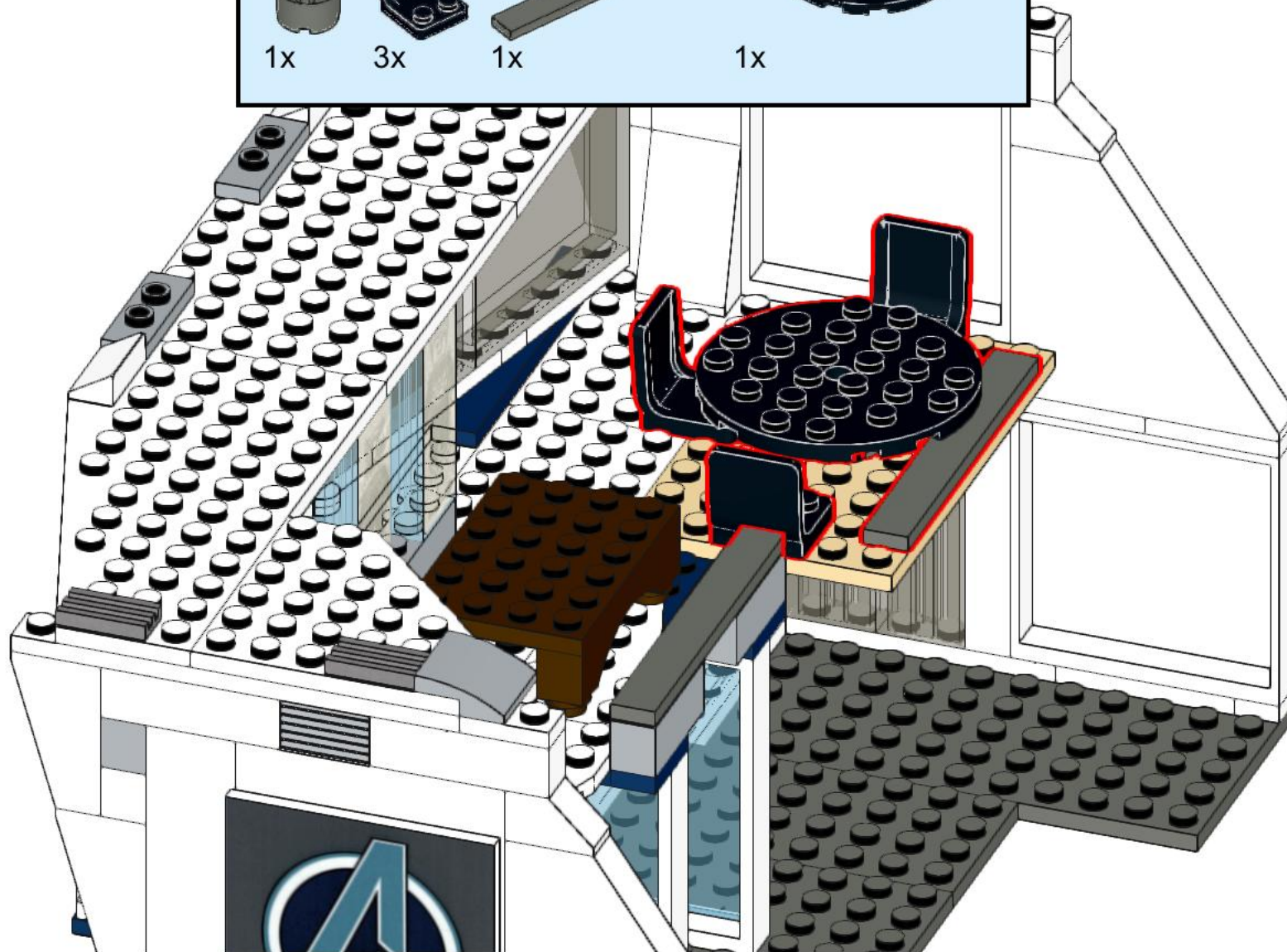
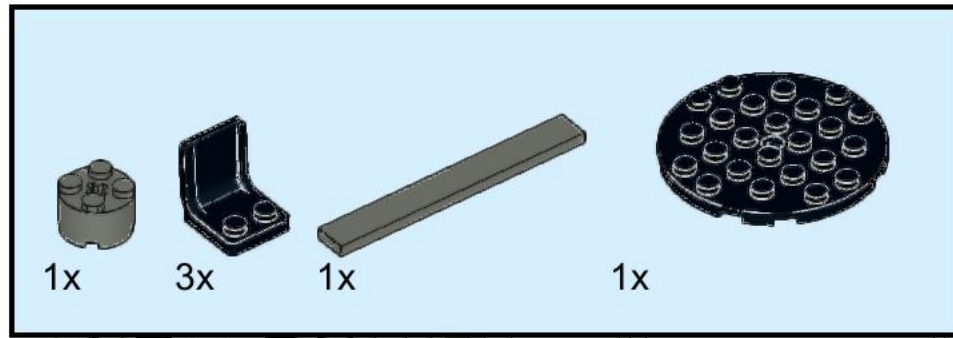

122

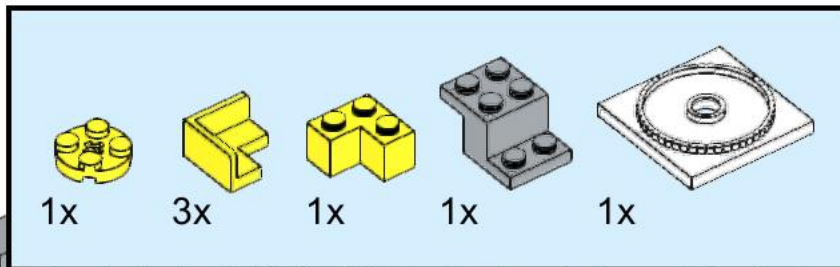

124

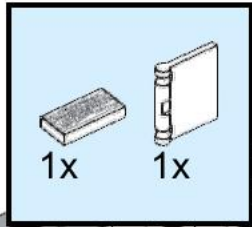

125

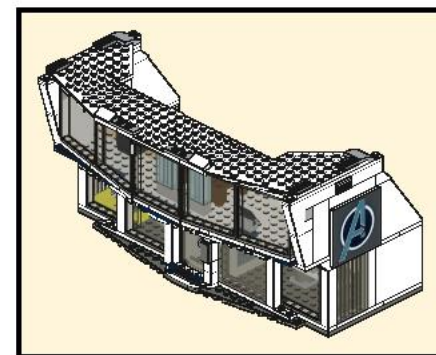
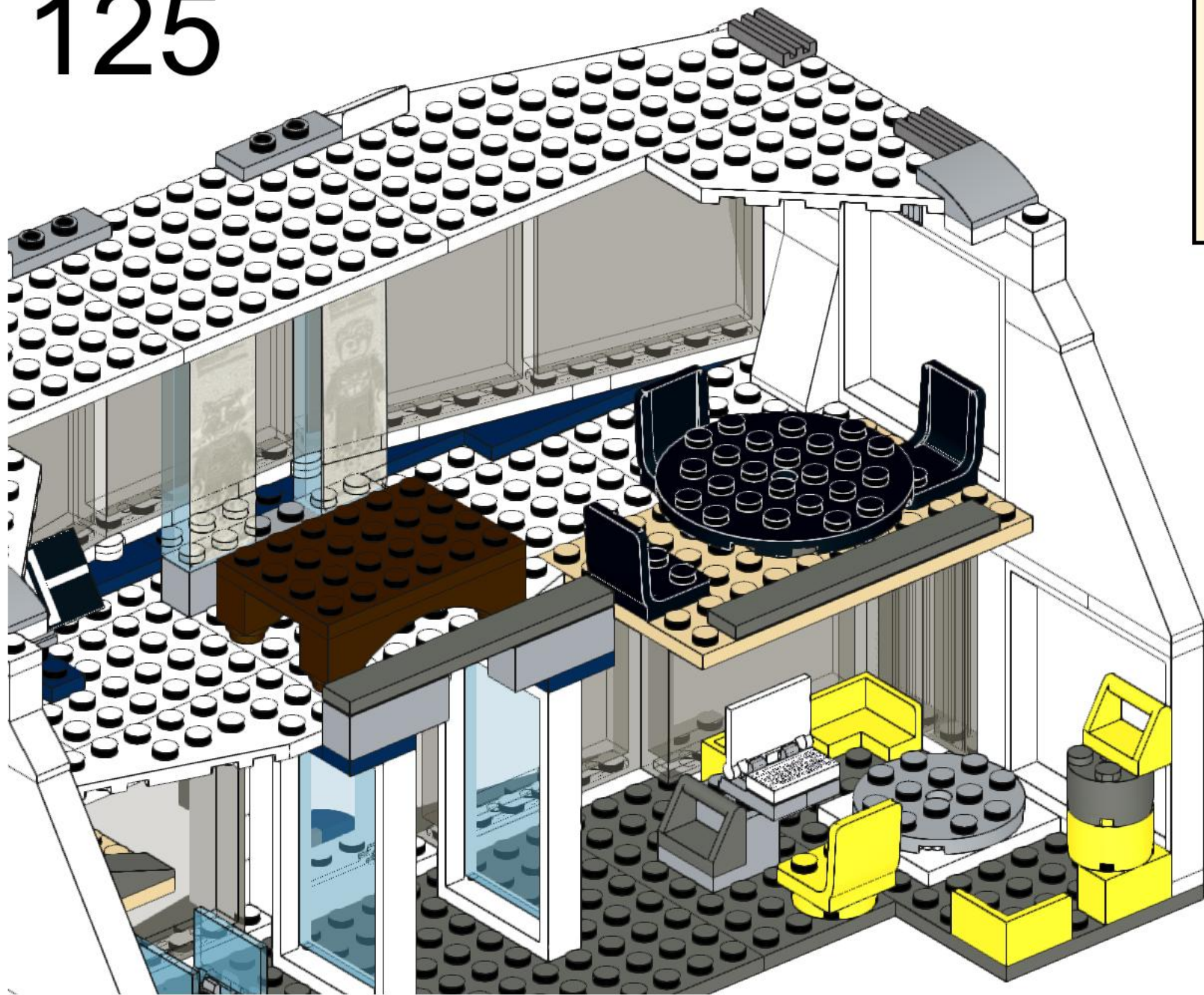

126

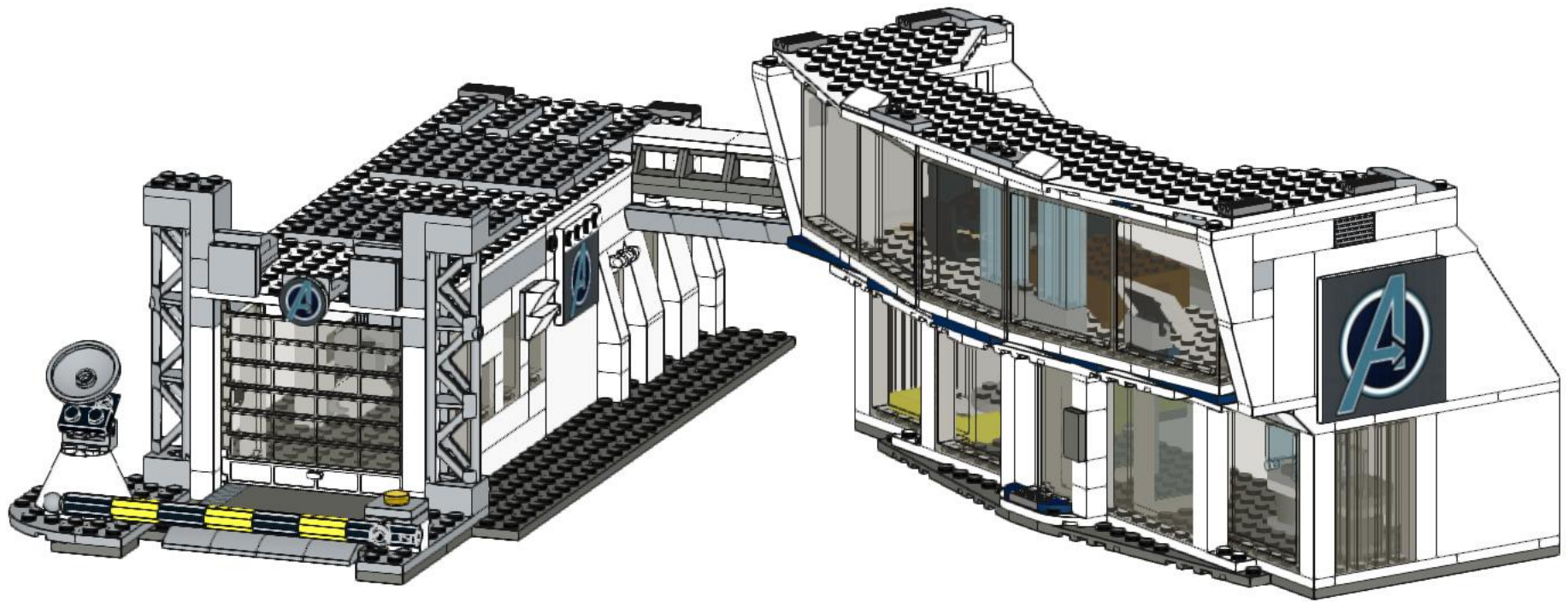

127

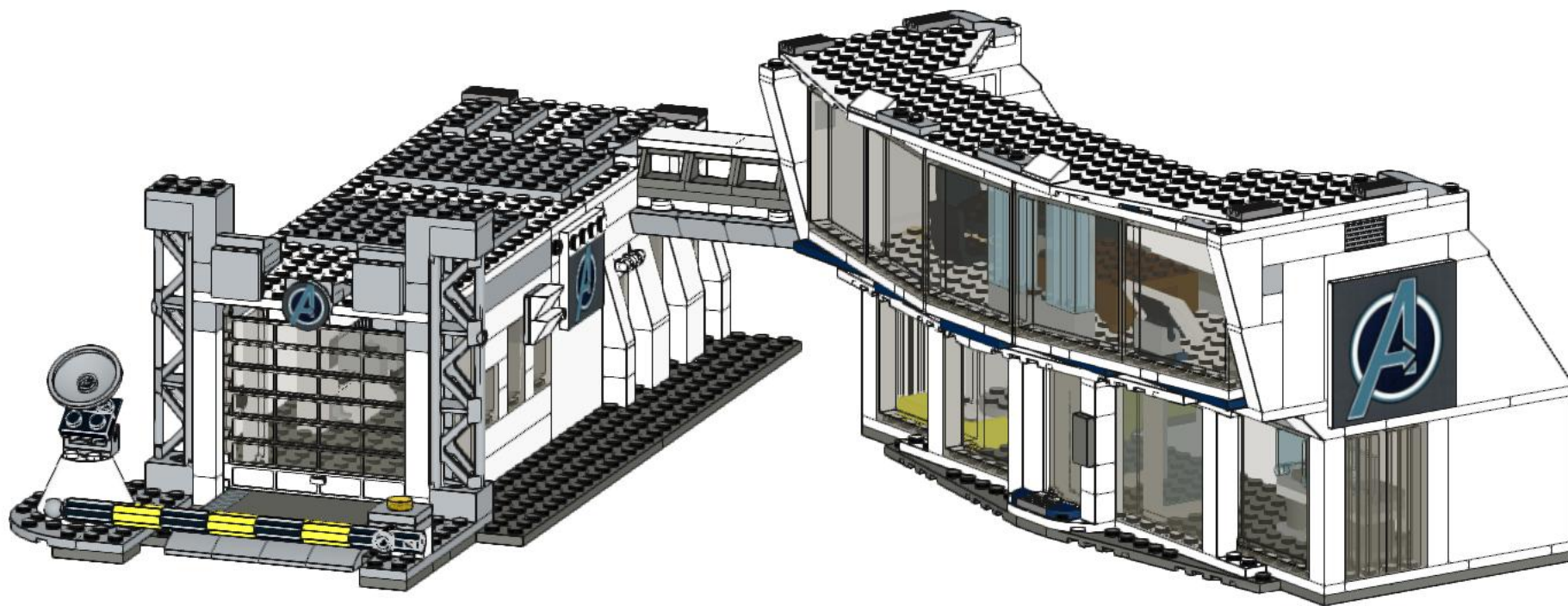
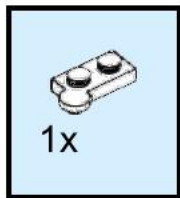

128

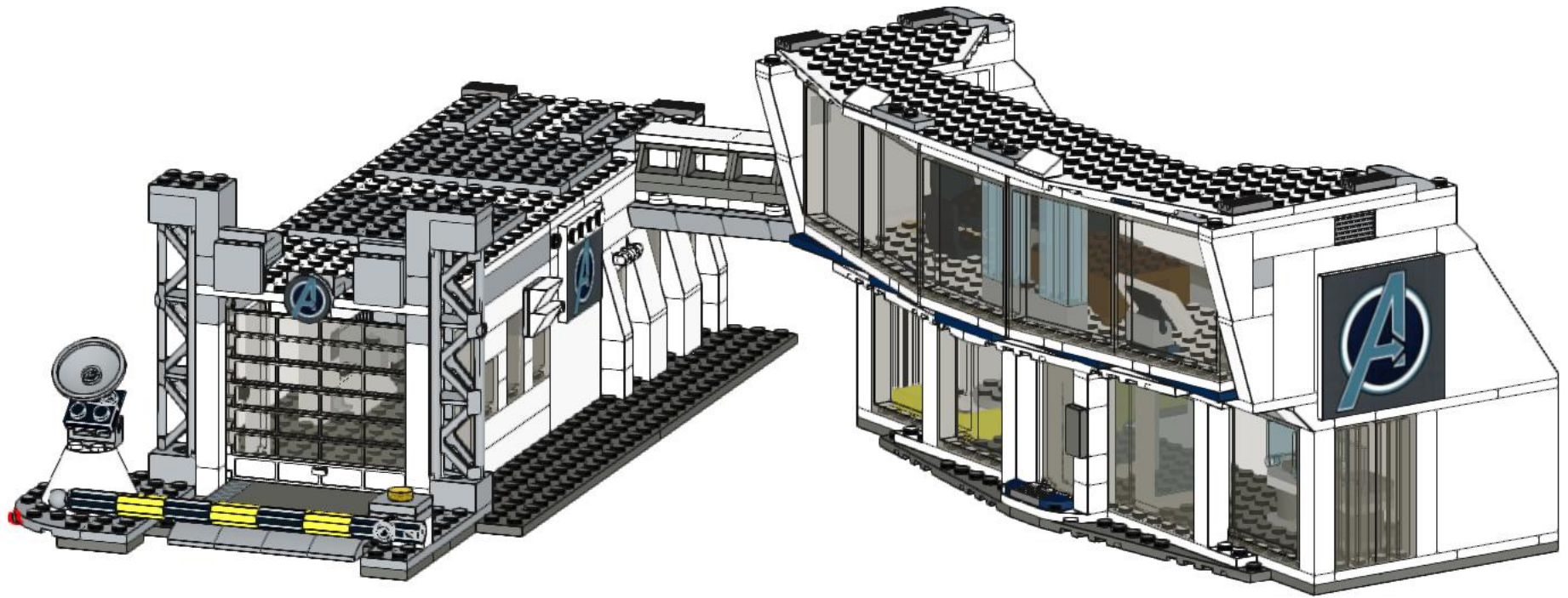
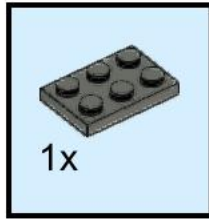

129

