

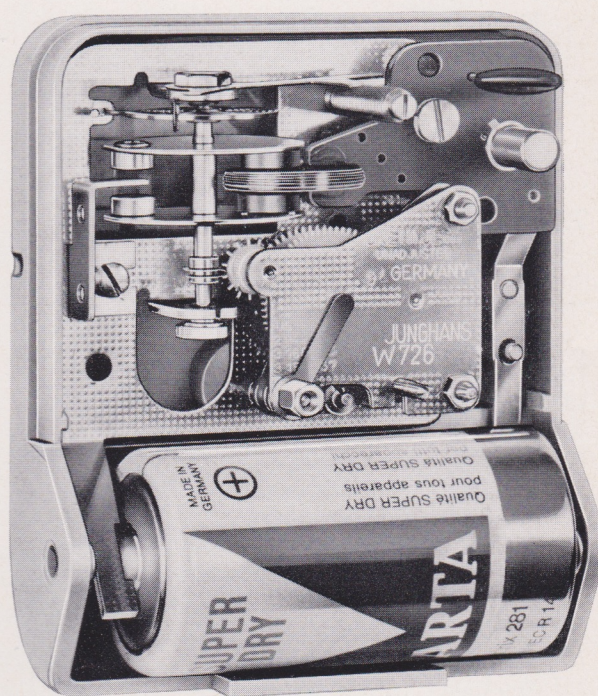

**JUNGHANS-electronic
Transistor-Werk 726**



Werk 726

Technische Daten

Mechanisch Gangregler	Schlagzahl	18 000/h
	Schwingungsdauer	0,4 S
	Amplitude	260° bei 1,6 V
Spirale	Qualität CGS	< 2 s/d °C 1600
Elektrisch Batterie	Monozelle Leakproof 1,5 V 25 Ø x 47 mm	IEC: R 14 z. B. Varta 281

Werkübersicht

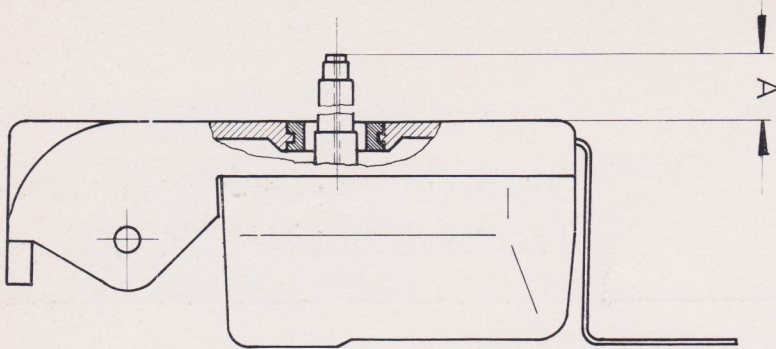

Werk-Abart	Maß A	Zeigerstellung	Steinezahl
726.02	16 mm	—	1
726.03	16 mm	hinten	1
726.08	10 mm	hinten	1
726.06	21,4 mm	hinten	1

726.03

Ref. Nr.	Benennung
707.00-0002	Friktionsfeder
707.00-0006	Wirbelstrombremse
707.00-1203	Exzenterbolzen
707.00-1300	Sperrfeder
707.00-2300	Stundenrad
707.00-2900	Elektronikblock
707.14-3100	Rückwand grau
707.20-1500	mittlere Werkplatte
707.26-0001	hintere Werkplatte
707.26-0003	Rücker
707.26-0006	Wechselrad
707.26-0008	Zwischenrohr
707.26-1000	Werkplatte vorn
707.26-1100	Minutenrad
707.26-1300	Lagerschraube unten
707.26-1400	Lagerschraube oben
707.26-1500	Unruh
707.26-1700	Spirale
707.26-2000	Kleinbodenrad
707.26-2100	Zentrum-Sekundenrad
707.26-2200	Weichenrad
707.26-2300	Gehäuseteil - grau
707.27-1000	Zeigerstellwelle
42 387-0334	Mutter für Werkplatte
42 387-0336	Mutter für Werkbefestigung
42 387-0436	Mutter H. 4,4 mm für Werkplatte
42 503-0369	Richtknopf - gelb
42 546-1139	Sicherungsscheibe für Zeigerstellwelle
42 569-2076	Schraube für Elektronikblock
42 569-2442	Schraube für Rückwand
42 569-9262	Schraube für Wirbelstrombremse
42 596-0582	Spiralversteckstift

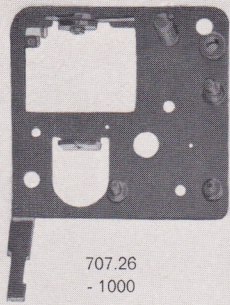

707.26
- 1000



707.20
- 1500



707.00
- 1300



707.00
- 1203



707.26
- 0008

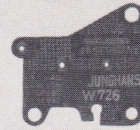

707.26
- 0001



42 387
- 0334



707.26
- 1100



707.26
- 2000



707.26
- 2100



707.26
- 2200

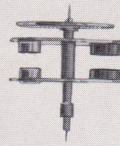

707.26
- 1500



707.26
- 1300



707.26
- 1400

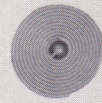

707.26
- 1700



42 596
- 0582



707.26
- 0003



707.00
- 0006



42 569
- 9262



707.26
- 0006

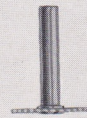

707.00
- 2300

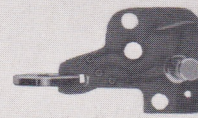

707.00
- 2900



42 569
- 2076



707.00
- 0002



42 387
- 0436

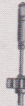

707.27
- 1000



42 546
- 1139



42 503
- 0369

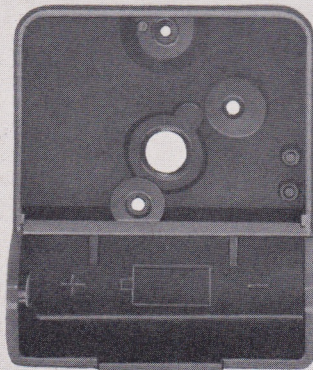

707.26
- 2300



42 387
- 0336



42 569
- 2442

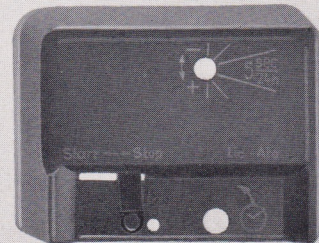

707.14
- 3100

726.02

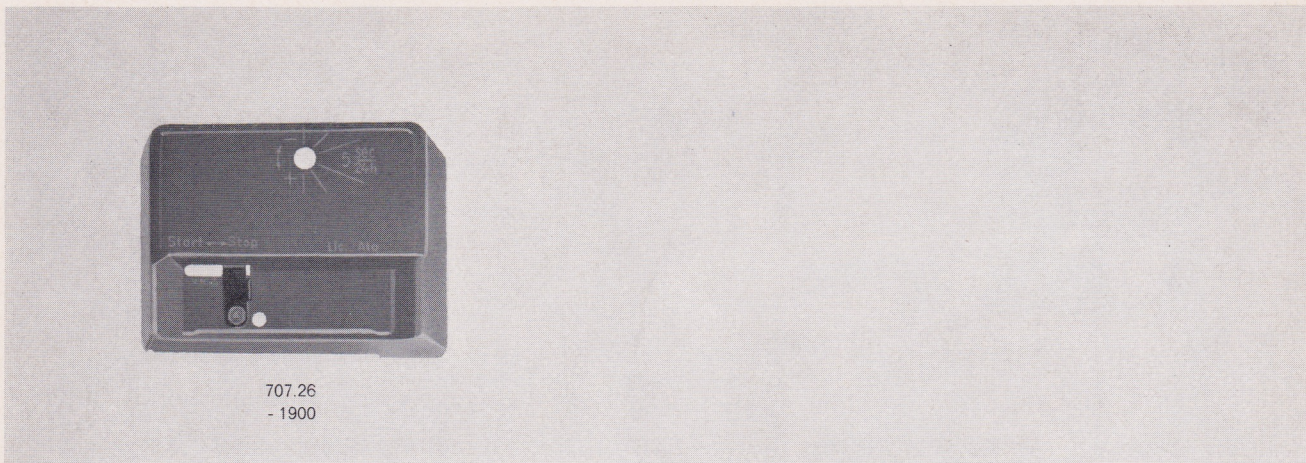

707.26
- 1900

707.26 – 1900 Rückwand

Alle nicht aufgeführten Teile = 726.03

726.08

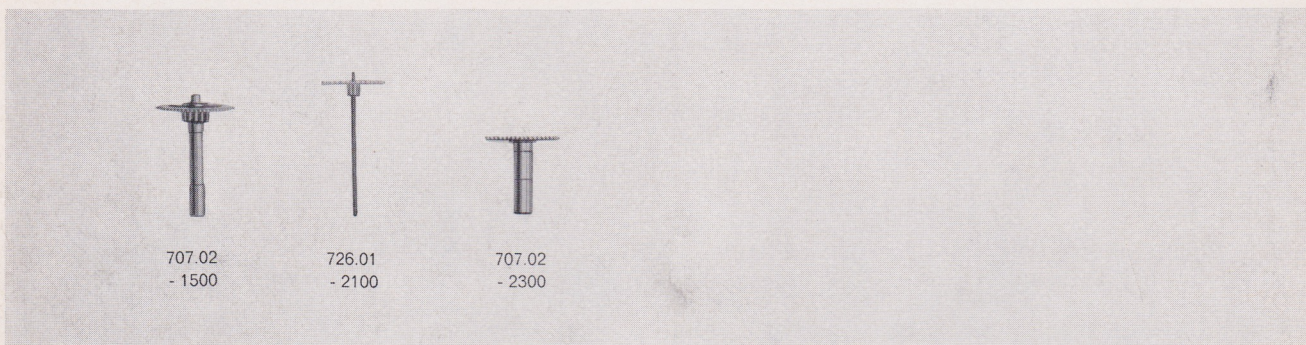

707.02
- 1500

726.01
- 2100

707.02
- 2300

707.02 – 1500 Minutenrad
707.02 – 2300 Stundenrad
726.01 – 2100 Sekundenrad

Alle nicht aufgeführten Teile = 726.03

726.06

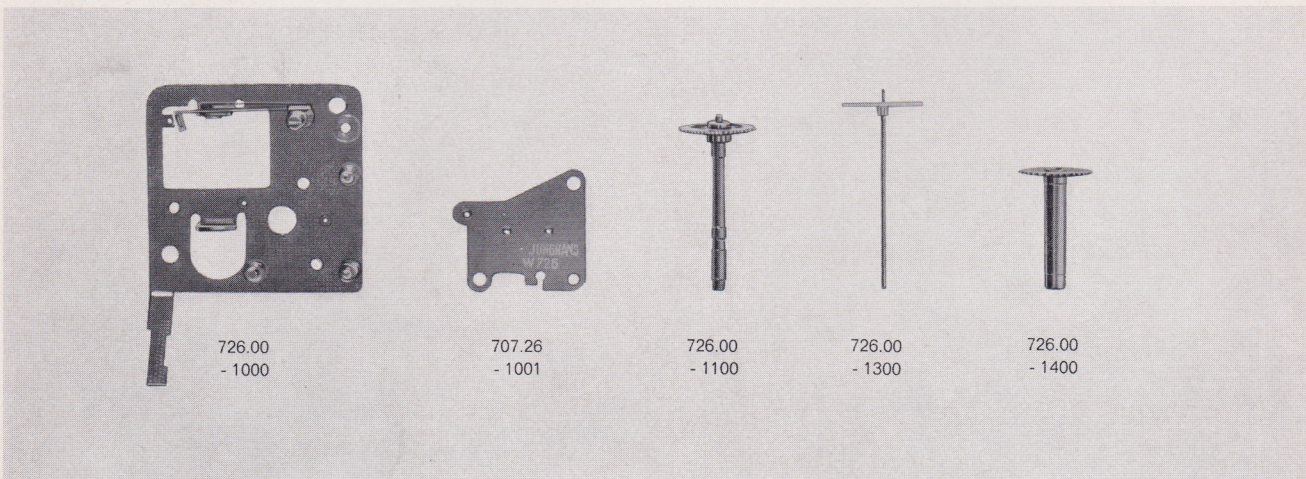

726.00
- 1000

707.26
- 1001

726.00
- 1100

726.00
- 1300

726.00
- 1400

707.26 – 1001 hintere Werkplatte
726.00 – 1000 vordere Werkplatte
726.00 – 1100 Minutenrad
726.00 – 1300 Sekundenrad
726.00 – 1400 Stundenrad

Alle nicht aufgeführten Teile = 726.03



Gebr. Junghans GmbH
Uhrenfabriken
7230 Schramberg