

The Federal Government of The Imperium of Diamond's

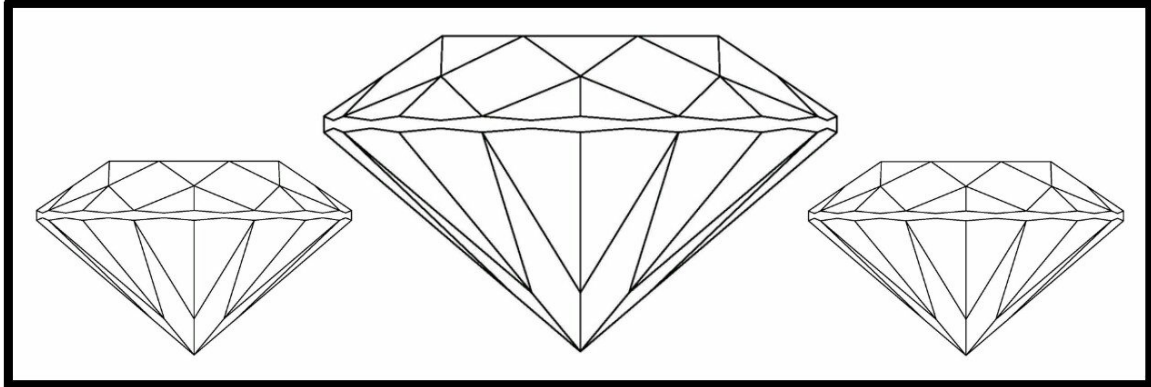

ID's Provisory Office

Sunday, December 4, 2016

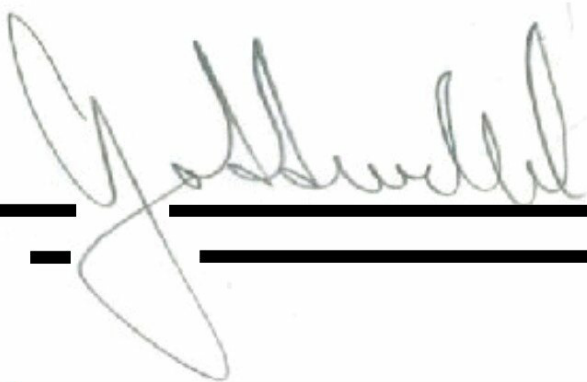

Signature of The King Imperium of Diamond's
The King Gottwald Peter

A handwritten signature in black ink, appearing to read 'Gottwald'.

<http://www.TheImperiumofDiamondsGovernment.populiser.com>

ID's Provisory Office

- o **Reserve check to ensure the functions of the Office.**

€ 10 000 000 000 (In DMD)

- o **Payment for the government of the country providing support to the Chief Financial Office.**

€ 10 000 000 000 (In DMD)

Target of Office:

- ✓ Build contacts with Banks and ensure the management of ID's economy and a register.
 - ✓ Stabilization Ministries and Ministerial launch planning.
 - ✓ Activation of cooperation between International Military forces and ensure the development of International security.
 - ✓ Development for ID's membership into the Global Structures of Organization's.
 - ✓ Activation of International business and legal market raw materials. Registry markets.
 - ✓ International business development in order to develop and stabilize civilization ID's.
 - ✓ Contacting all Refugee camps and relief centers for the opportunity to obtain a new population. Development for Global Humanitarian projects.
 - ✓ Safe life of all hungry people and grow global life qualities for all.
 - ✓ Stabilization of cooperation to the International Alliance of WD.
 - ✓ Stabilization of cooperation to the ID's Corporatocracy government.
 - ✓ Stabilization of cooperation to the ID's Popular government.
 - ✓ Open the Culture Center's in the world.
 - ✓ Creating contracts between legal entities, in order to spread our own active structure in society and thereby maintain the stability and development office.
 - ✓ Registration & development of the New Corporation's.
-

The Imperium of Diamond's Office functions:

Authority and its composition in the number of members is unlimited, the official person can become everyone who will be confirmed as safe and responsible person.

The Office was first divided into geographic offices, which are based on a centralization by local commercial markets and continental political relations.

Furthermore, the office established for the logistics and implementation of strategic communications at the political monitoring of global public media, ID's private messages office plans in the official calendar of important dates, and business and political acts, with continental and global statistics.

The Office as the most strength of its management, communicates and organizes always in the interest of the local continental cooperation activities with the other traders, NGOs, organizations and governments and their policies, and other communities. The target is to establish a Common Friendship and Diplomacy, and develop markets. Office registers all subjects of politics and business in the local area office of the continent, and thus promotes the growth of logistics, communication and cooperation in the interest of each individual entity and its own International legal position volume. Office creates a filing cabinet that stores all the files and systematical information on each subject, for better development of our friendship relation and planning.

The Office as the residual minority forces its management, communicates and organizes always in the interest of global planetary cooperation activities, thereby creating interactive chain among other ID's Offices in a range of other continents of the planet, and it is led by a string of public authorities for the purposes of global development. So there is a part of the ID's Royal Council.

The Royal Council checks the documents and then carried their approval or division into two categories of legal responsibility performance of legal affairs of the document, according to the Autonomy of Authority or responsibility of the Royal Council. The Royal Council also verifies the activities of officials and thereby gains the right to replace officials in the interest of their official position, or stop their functioning. Any official who is registered with the Royal Council and thus a right to create the office of management and activities.

ID's provisory Offices and their people are not divided into different position in the scheme of active difference. Official persons together and each as interactive group that organizes its budget work by the time the performance of the strategy in light of its own division of the number of officials and their qualifications. This creates a Common Intelligence Society that produces management activities in the official register of each individual.

Officials are together as a group for direct intelligence work at the Ministerial Councils function flexibly in accordance with the budget challenges. The Office therefore creates an administration official annual financial budget, which is then confirmed before the International Bureau ID's government.

The authority must always be someone who is responsible for supervising ministerial interests, and that means creating oversight interests of the Ministry and exercise activities by budget targets active on the International and Federal level, and in the interests of the network established cooperation and partnership. The leader creates management oversight functions, and thus subsequently

leader of management controlled by the investigating police official.

The main objectives of the office and logistic distribution flexible position of members of group intelligence is determined by major and important categories which are then developed by the Office of achievements.

-
- **The Office of extraterritorial rights**
 - **Political relations between organizations, states and communities.**
 - **Business relationships and agreements and strategies, global network of business partners.**
 - **Against monopoly control**
 - **Labour and Employment**
 - **Architecture and construction**
 - **Army and Military Affairs**
 - **Ecology**
 - **Economic stability competition**
 - **Energy**
 - **Federal issues**
 - **Finance and Bank**
 - **Globalization**
 - **Hygiene**
 - **Information Management and Processing**
 - **Cosmic intelligence diplomacy**
 - **Cosmic matter**
 - **International law and strategy**
 - **The Ministry of mapping and geography of the area**
 - **Media and public activities**
 - **Standardization**
 - **Claims copyright and registration marks**
 - **Police and security**
 - **Project Planning and Development**
 - **Industry and Development**
 - **Recreation and entertainment**
 - **Social affairs**
 - **Justice and Courts**
 - **Modernization strategy and interactive development**
 - **Structures economic markets**
 - **Education, education, development of Universal Intelligence**
 - **Technology**
 - **Telecommunication**
 - **Transport**
 - **Mining and production laboratory**
 - **internal affairs**
 - **Science, Research and Development**
 - **foreign affairs**
 - **health**
 - **Agriculture and farms**
-

Furthermore, the office is active at the level of the second group of officers, employees and offshore agencies and activities that lead the administration of the tax office, intelligence banks, trade financing costs and investment strategies of the market and its own operations, authentication, real estate management, document archive, security services, cleaning services, management of Cultural centers, Business centers management, and other operational functions. Office holds the right to set up commercial companies that can be applied in the public market, thereby ensuring the administration offices and also extend gains offices in strategy autonomously employed offshore companies.

Each office dedicated profit budget before the Royal Council to finance this interest will be determined on the application of the annual budget of the Authority. Authorities by ensuring legal communications between local Banks, thus resulting agreements are designed to ensure confirmation of the ability to

create a common exchange coins between states while planning investment cooperation.

The first objective of the office is to provide legal and registered financial management functions, and so consequently gain the cooperation of the state bureau de change and the creation of a joint session with Banks, as a first goal. Then the authorities can act as a secure facility that guarantees the legal value of financial authorities, and therefore the ability to create trade missions and provide their own profit, too. Office allows the use rights of other foreign institutions for inspection office and the issue of ratification on financial management and proper activity management, investigation according office observation, and signature of the Royal Council.

Each authority therefore develops its own business structure and thus also the ability to create their own autonomy of the offices in the nature of the annual budget for the financial functions of the office and ensuring payments from profit corporation official. Official corporations are then combined into a single volume of trade names with other trade unions in the same category, administered by the Foreign Office's ID.

So they are organized market business and processing markets, markets servitude, markets, investment strategies, but also markets petroleum refinery center Fisheries, Mining, metallurgy and mechanical engineering, electronics, chemicals markets, aerospace industry, architecture, many other key markets around the world.

Authorities own right to create a new registry business corporations, establishment and management of state trading corporations, as well as development of business networks and employment of new workers and expand the management of markets and trade networks.

Aim office and exercise their rights as Imperium of Diamond's arising from the UN Charter, the main task is to create our own business contacts and presentations in Associations of traders, marketing planning and market development in many fields of business categories. Creating business plans among traders and also grow their own intelligence sources for support our common development or development their new Head Quarters of corporation into the Imperium of Diamond's countries.

To ensure the strategy of development of the markets, and the growth of civilization Imperium of Diamond's Federal Government Imperium of Diamonds is willing to provide up to 1 000 000 000 000 € as an annual sum to purchase strategic raw materials in the market to stabilize the ID's civilization, thus ensuring growth also for internal markets and new business center and new branches population.

Office holds the right for receipt of applications for new citizens and providing VISA Cards, or for granting Citizenship ID's subsequent verification of identity and also ensure the safety of questioning be Investigative commission. People who seek to receive Extraterritorial VISA and have the right to also take advantage of business interests and support the development of other business networks.

New citizens may be utilized for the provision of the new business corporations and their management, and for the purpose of securing business networks consumerism, new living houses, development of the new cities. Register new citizens also supports the ability to support the number of employees at offices and production and strengthen the intelligence official

activities and regularity of International relations and development results in a better level of success.

The Authorities thus further expanding the growth strategy of real estate values to its own stability and also for the development of custom levels for the position of an International character.

In order administration official as the register of immovable property and possessions, register and development of industrial centers. Register and agricultural development centers. Register and development research centers. Register and develop their own military forces. Register and develop other interests civilizational dimension advanced look, and strategies for stabilizing ID's civilization.

One of the primary goals is strategies for development of Offices Living Social centers when each Officer can use properties as a his home.

Each official must function during a temporary office, so use either dual citizenship as belonging to their own state and thus the Imperium of Diamonds State, or official will be as user Extraterritorial VISA. In the case of the government to ensure full stability Imperium of Diamonds, then it will be every official to take responsibility to ensure full citizenship of Diamond's Imperium, or in the latter case to resign from office. An official who confirms the full citizenship of Imperium Diamonds obtains the right to political activity and are also entitled to apply for the position of senator, and other political positions.

Any official who creates a job that takes a responsible financial payment that is due to Extra-territorial division calculated on the two amounts.

The first amount of financial payout is provided for the possibility of ensuring good social policies and quality of life for each official and by the budgets of standard financial revenue civilization in which the official in his own personal life moves on and what the economy is dependent upon his own life.

The balance of the value of financial payout under the economic budget Imperium of Diamonds country, will be deposited to the account of the interests of the territories of Diamond's Imperium, and the clerk so it can develop its own property and trade on the territory of the Imperium of Diamonds, be use of his fund. Such funds can not be transferred to foreign bank accounts unless agreed bilateral agreements on joint stabilization cooperation between states, and it is led by the Principal state charges for the transfer of certain financial dimensions in the territory of a foreign state.

Official persons have the right to ask for the democratic development of the state of Diamond's Imperium, until will provide full stabilization of the Imperium of Diamonds and the ability to utilize all security resources for legitimate function of government.

Authority within a period of time only supports the development of logistics and strategy and legal planning and propagation dynamics jurisdiction Imperium of Diamonds based on the universal principles and also in the interest of stabilizing obligations civilization.

Each office must possess Proven communication services, and web business card, with adress and labor order

It is an obligation to create its own center for the use of a central postal address (a small warehouse for sorting the mail between departments offices), telephone number of the office, fax, e-mail, Internet account for deposit and withdrawal of a public document, a private website office and portable server connected to the Internet, is an intranet for the possibility of International communication, and also contracted or available resources for the possibility to organize conference meetings, summit, and cultural center for the purpose of presentation of ID's state before the public company.

As the main unseen becomes an obligation to possess the ability to exploit fully private function space for offices and small storage Archive documents and books, The Archive. The Office shall provide the ability to use their own financial safe which serves as a local branch of the budget for the financial manipulation and limited transmission and storage of Finance. They must be safe guarded recording system, while private security patrol. Architecture and design creation vault will be designed for communication with the Royal Council.

In the event of a successful and safe operation of the office of management and safe, then it will also open a safe investment.

Development Office

- ✓ *Exil or Extraterritorial Office as an office on the territory of another state (because of the occupation).*
- ✓ *All Authorities unified position on the provisional orbits planet Earth (synchronization with defense station).*
- ✓ *Government offices for the position of legal territories of Diamond's Imperium (after ensuring stability, security).*

The Office mustnt organize and promote any illegal drug trade in arms, terrorism, drug trafficking, human trafficking, trafficking of stolen properties, national and international organized crime, or any other persons who are active in such a form of crime. The Authority must always expand relations only with persons who may legally verify and prosecute justice courts, or if necessary, to guarantee enforceable guarantees active in the jurisdiction area of Diamond's Imperium and ownership.

Each member of the Office, must to be at the level of International law Intelligence, or active education by the following principles:

- The UN Charter
- Priority UNGA Declaration
- Common UNSC Resolutions
- WTO Treaties
- Multilateral, bilateral and jurisdiction rights of local zone of the continent
- Natural Political Principles
- Global Geography of countries
- The ID's Jurisdiction
- The International Law Intelligence Council

If the Imperium of Diamonds federal government, because of the destabilization in the occupation, it will not use its own population for the activity of its official activities, and than therefore all governments around the world in view of the rights of the UN Charter and peaceful purposes to support developing countries as a principle and universal moralism and all governments have every right to use their own state labor offices, thus ensuring the development of Extra-territorial office ID's government from its own resources stocks for temporary use and ensuring stabilization.

Target of Office:

- ✓ Build contacts with Banks and ensure the management of ID's economy and a register.
- ✓ Stabilization Ministries and Ministerial launch planning.
- ✓ Activation of cooperation between International Military forces and ensure the development of International security.
- ✓ Development for ID's membership into the Global Structures of Organization's.
- ✓ Activation of International business and legal market raw materials. Registry markets.
- ✓ International business development in order to develop and stabilize civilization ID's.
- ✓ Contacting all Refugee camps and relief centers for the opportunity to obtain a new population. Development for Global Humanitarian projects.
- ✓ Safe life of all hungry people and grow global life qualities for all.
- ✓ Stabilization of cooperation to the International Alliance of WD.
- ✓ Stabilization of cooperation to the ID's Corporatocracy government.
- ✓ Stabilization of cooperation to the ID's Popular government.
- ✓ Open the Culture Center's in the world.
- ✓ Creating contracts between legal entities, in order to spread our own active structure in society and thereby maintain the stability and development office.
- ✓ Registration & development of the New Corporation's.

A Member of the Authority shall be not any person who may be under threat as recognized for manipulation or hypnotic influence.

Instructions on how to create the first authority

Photos Skyscraper boxes construction, and a description of the construction project.

The Sunshine tower, design be Qubic engineering

The height of 655 meters

Width base 100 m

Diagram

133 block sizes of $15 \times 15 \times 5$ m

30 blocks with a size of $30 \times 30 \times 5$ meters

4 blocks with a size of $40 \times 30 \times 5$ meters

1 block sizes of $30 \times 30 \times 80$ m

1 glass block sizes of $30 \times 30 \times 80$ m

118 balcony with a size of 30×30 meters, 0.8 meters railing

88 balconies in different sizes depending on the angle, railing 0.8 m

156 glass corridors, with a size of $20.5 \times 5 \times 8$ meters

52 glass corridors with a size of $39.6 \times 5 \times 8$ meters

5 supporting structures with a height of 655 m

1 structure with a height of 685 m

52 floors between retaining structures

5 centers with lifts

4 area for helicopter

Underground garage

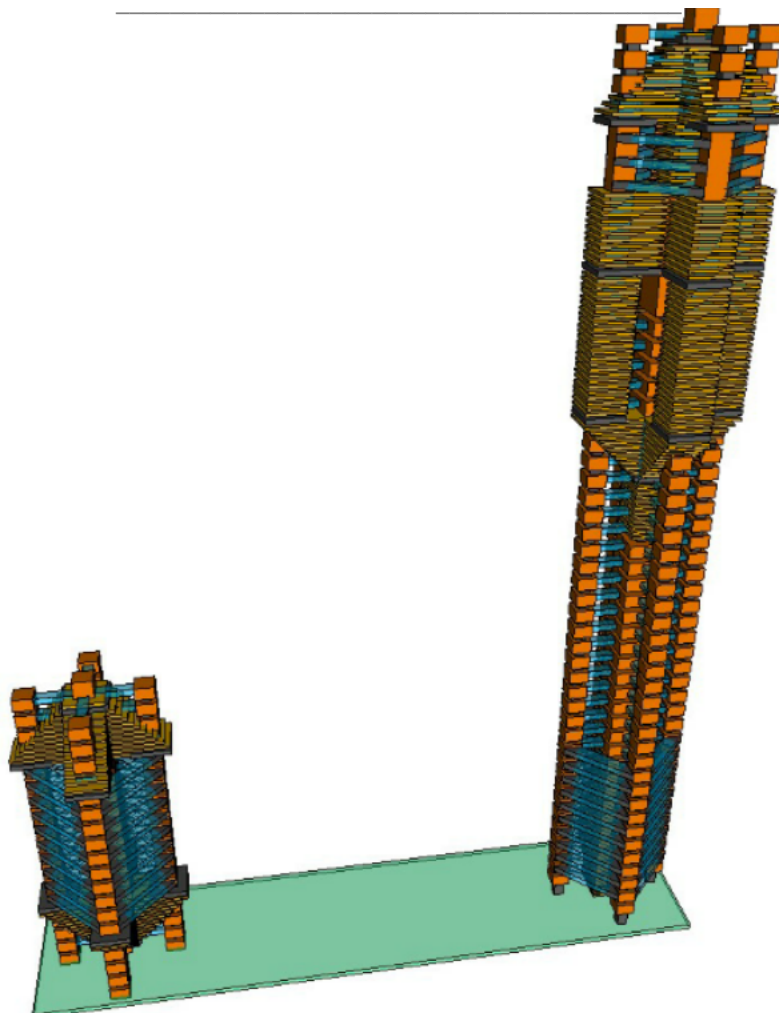

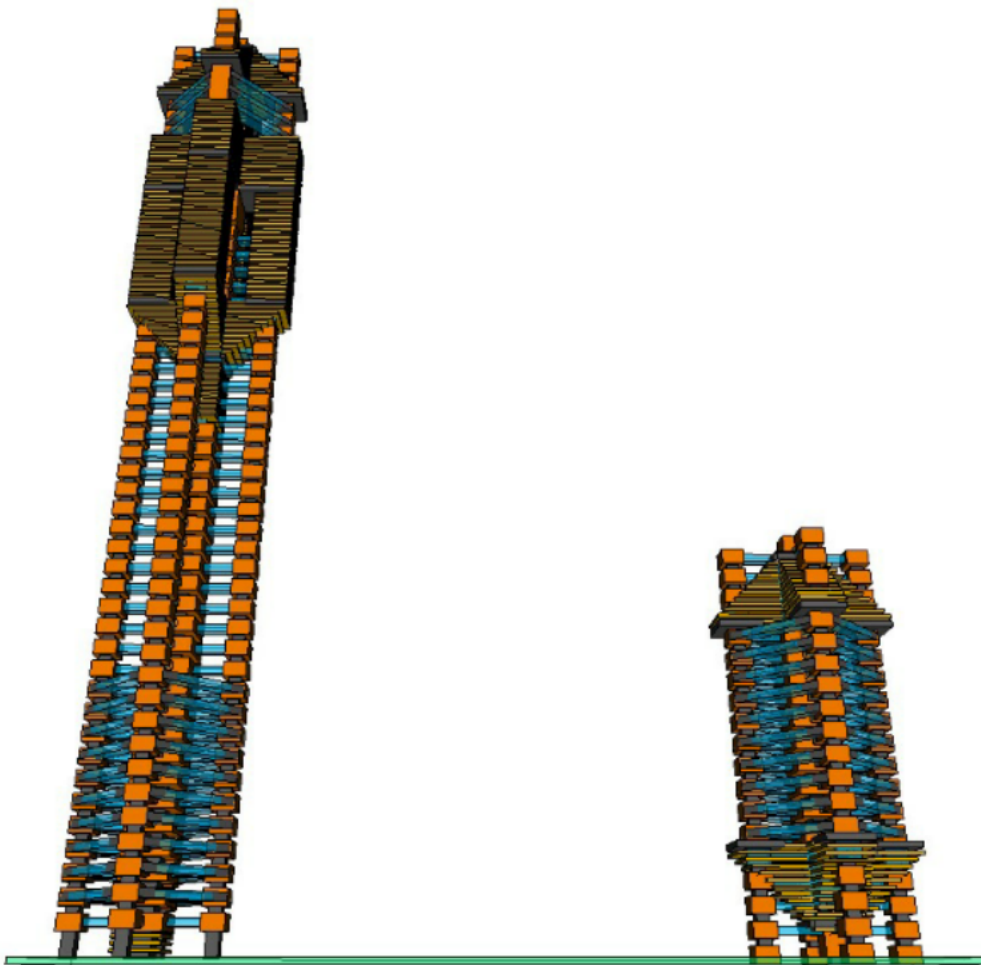
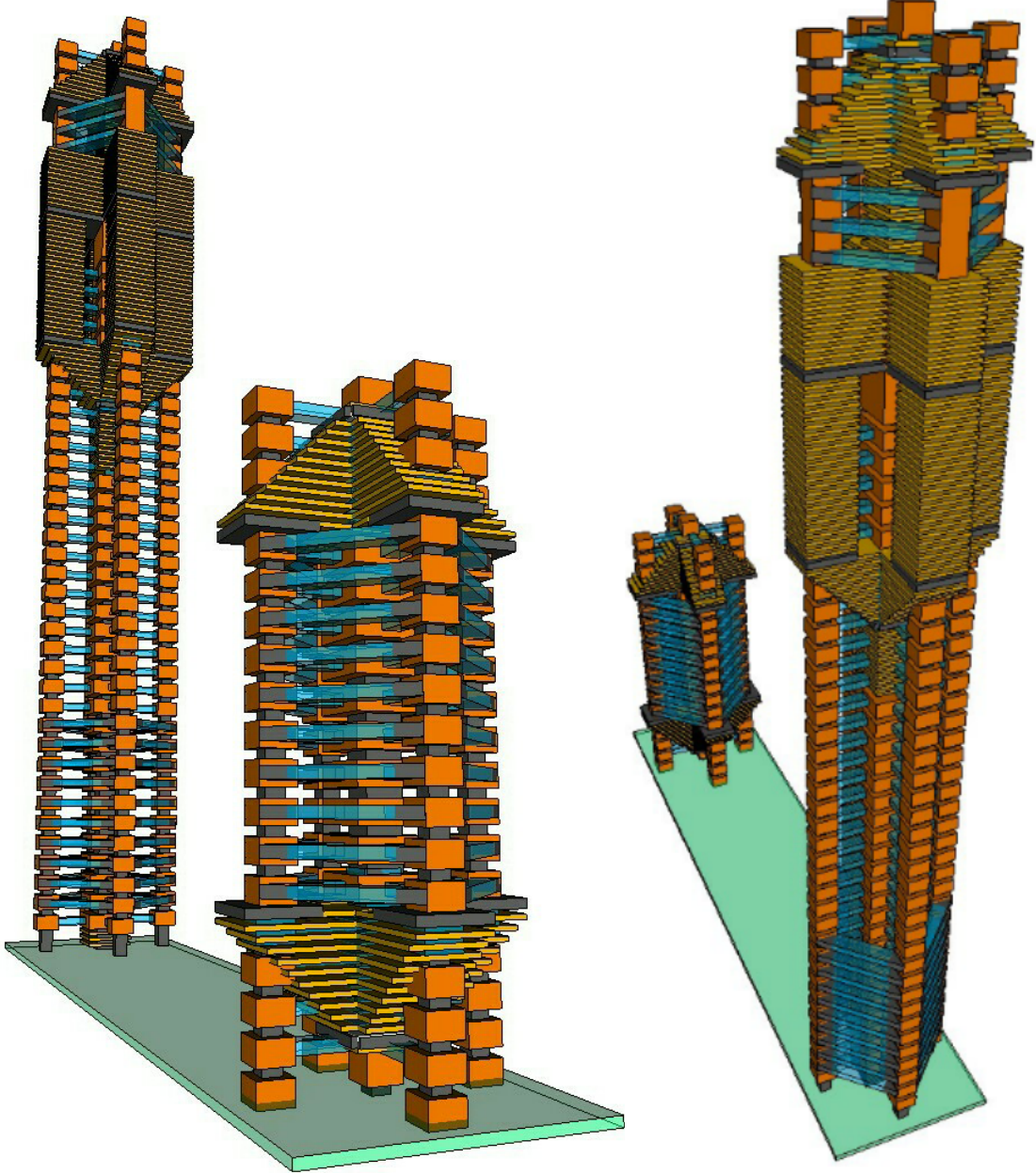

The Sunshine Tower



Centrum business sector, offices and social housing units. Balconies serves as an open garden with autonomous system maintenance and watering plants. Ability to connect to electricity, gas pipes, heating steam distribution water pipes, sewage drains, digital networks, data centra, intranet, internet, air conditioning, air mail, air pressure, high-speed lifts (600 meters per 5 seconds), solar panels and electric generator extinguishing systems and fire alarm technology, many other forms of utilities.

The process of construction, industrial hall for the construction of modular housing units for folding using large-capacity circuit components of concrete steel, carbon steel, sheets and construction, glass, construction, or any other special materials.

Industrial hall can be equipped with a robotic arms that can immediately and mass-produce flat plate from which arises the wall units. Flat plates made from its own resources chemical laboratories, or through trade agreements of financially autonomous business without start-capital. Production of materials and their processing on building walls to work automatically by computers and mechatronics. Production of materials and their processing with the production of construction wall using industrial technology simple time step, for 20 hours each component is made to build the whole dimension of the skyscraper.

Of the major components will be automatically according to a digital patchwork plan living room, one room, according to the distribution of industrial lines. The base is a kitchen, toilet, sleeping room, living room, library, wardrobe, children's room, children's playroom, or under comercial business form therefore schema of the comercial and office space properties. Robotic arm to install electrical wiring, sanitation, interior design, floor, doors and windows, all the basic components of the interior according to the social, economic and construction standards. Each room can be designed according to the schedule of any size and utilities.

Rooms will be transported to the construction site. Each room will immediately enthroned crane for mounting on a steel-concrete structure into a single housing unit. The construction was carried out automated crane that lifts all the rooms and then composed a social apartment, one after another, until the appearance of the skyscraper. Crane is fully automatic, navigation with a digital plans and synchronize with 3D cameras. Residential units are designed to immediately belonged together, as a dual component that automatically connects via geometric mechanical system.

The technology is able to build a skyscraper in the period of 40 hours from the beginning of the production of materials until the hour when folded all rooms.

Starting price for full activity Construction Corporation, € 10 million standard diameter to start simple projects.

Profit is a simple investment, created a skyscraper can serve as a center for canclely and comerce zone renting, and business centers. In many countries around the world, financial markets and business corporations count on a good size that can ensure pro forma net profit from renting properties over a period of one year. In a country like France, according to the fundamental analysis of the economic value of property, income from renting commercial space can be discounted monetary value of € 50 million, for a budget of 200 business corporations. This means that if we can use our own resources for construction materials laboratory using chemical production, carbon, specialty plastics and many types of metals, construction is capable of success for stable development. Some Utilities can then be paid in five annual installment agreement, or through joint trade with other corporations.

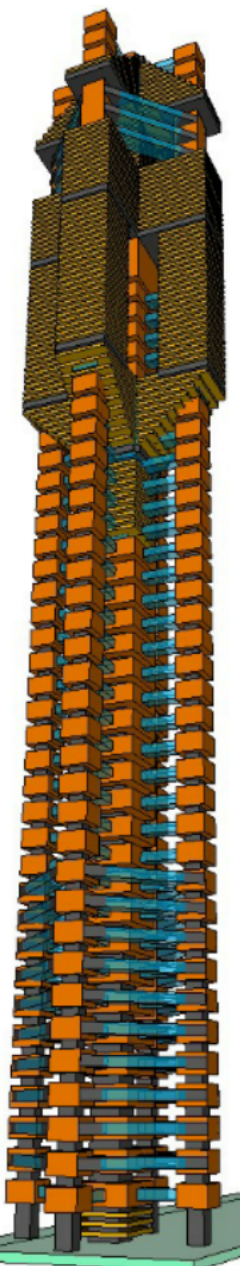
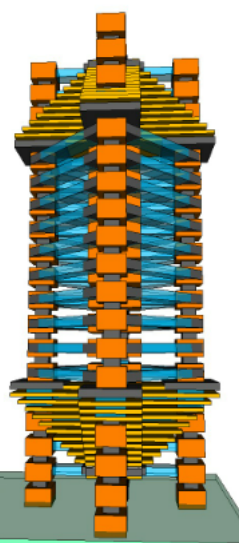

Technology Industrial Lines, ID's High Tech zone

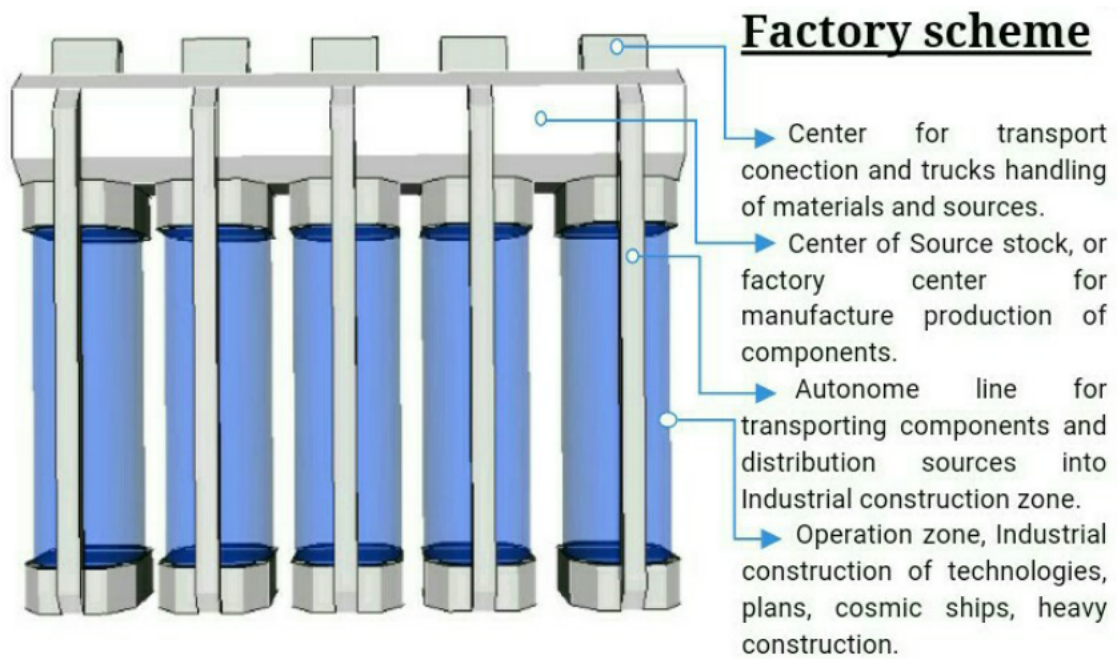

©™ Federal Government Imperium of Diamonds 2000/2016 claim

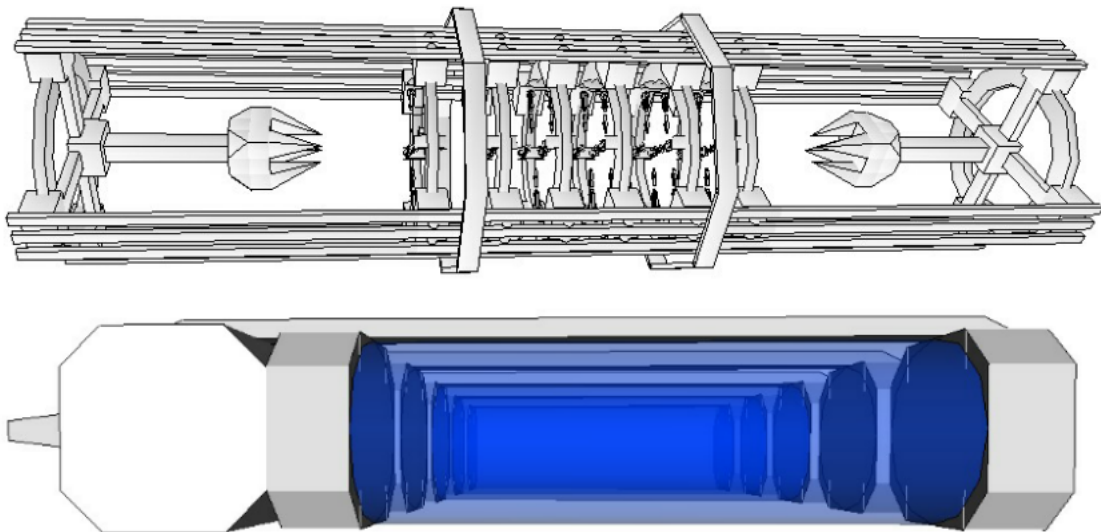

System special tube with a feature called Dynamic multy factories according to plan strategy for digital 3D Surround centralization, and robotic work with full centralization according digital systematic plan.

One tube dymension 30×10×10 meters (options for regulation capacities). Tubes is option for multiple combination. Tubes is convertable into multy factory, or one industrial line from five, tens, or hundreds of tubes as one factory plant.

The ability of autonomous recovery, below the water surface, the planet's surface, or outer space. Not limiting, easy production, and first factory can autonomously produced another new factories. Production of five plans every day in one tube as a capacity minimum (Hard logistic be component combinations).

Open for investment or business cooperation development plans.

The Factory is in the central part of the base on a special industrial processing circle that can move on the path rail-way-lines around, the rhythm for the progress of the work plan. Each circle on rail-line owns their eight robotic arms that can move along circle, in each space of Inter-3D of circle's. Robotic arms are therefore fully interactive and able to use access to any point in 3D space between the circles and use all ability for High-Manipulation and Construction move.

Therefore robotic arm technology to build and develop it. Production of cars, airplanes, spacecraft, space shuttles; satellites, ships, military hard to technology, robotic advanced systems, whatever.

Robotic arm may utilize any dimension or Work deploys, because their work is multy a functioning, depending on digital program.

Designed for IDs International cooperation, trade and common markets or amicable agreement. Commonly we can agree about common industry logistic or development.

Designed for ID's Civilizational development, and support development for all states abroad, easy for business agreement.

The ID's Culture Center

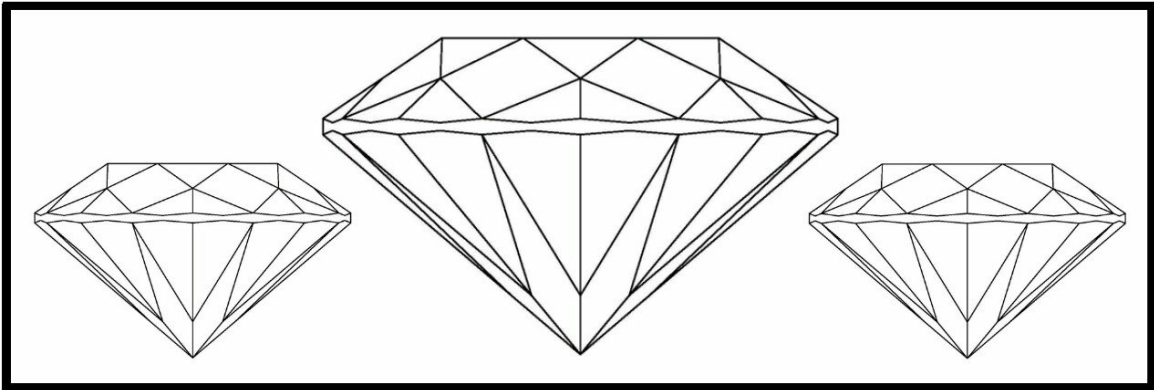

Cultural Center, a very simple project, an arts center can be established as quickly as instant soups , cooperation in trade between restaurants , artists , glassworks , model artists, musicians, ceramic makers, creative people who want to represent modern civilization advanced technological intelligence, modern science, urbanization of future civilizations and city skyscrapers super special civilizations in the universe, all according to real technology and science.

Trading range for € 5 million each month as a minimum storage capacity, profit from conferences can reach force € 1 000 000 000, partnerships between corporations and associations is always pops challenge. Even you can support our growth and improve the future of our humanity. Everyone has the right to interact.

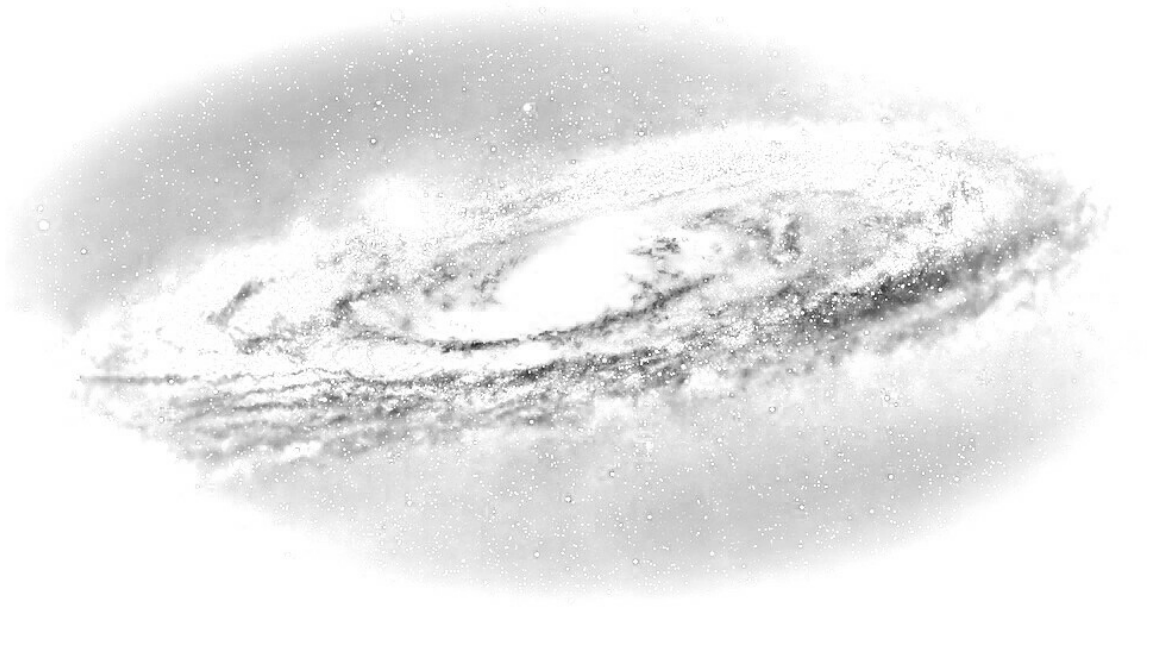

The ID's Global Market Development



Marketing Center of social services and raw materials, food and drugstore chain for the consumption of high-density population.

Also, I'm looking forward to my markets will operate and trade chains can economically supply the full dimension of my population using possibilities of the modern system of common business contracts and prosperous cooperation for our party.

It is easy, in the interest of civilization beginning, even with favorable bilateral and multilateral agreements beneficial to both the business side. Support for the establishment of basic business corporations abroad, anywhere in the world, the goal of the corporation is the processing of raw materials for the production of basic social and marketing products, the Corporation for trade with biscuits Corporation for the fruit and vegetable shops for toilet needs, trades on basic consumer products. Possibility to use the system also for the expansion of the pharmaceutical industry in your country through agreements between traders on sharing the market between corporations in your country, and a new corporate ID's.

The new ID's corporation can be based on an investment basis of society, and with business activities in your country and in your jurisdiction, offshore enterprise system. Therefore, financial profit corporations will be used for payment of the founding of financial costs, while at work and administrative operation of the business, paying taxes, and operational needs, paying for a manager who cares about the function and management of company manager called to the employment office to exercise functions of political or business contracts.

The subsequent balance of the profits of the enterprise will be made market in which the government Imperium of Diamond's as the owner of companies abroad, will be from these own businesses in buying up raw materials from their profit and carry them into the country Imperium of Diamond's, along with the strategy of payment for customs services and bulk import.

Some funds may be used for promotion and investment in local development activities of civilization in which business corporations have their own seat and therefore while there is support strategies for the development of your country, or the ability to use the fund for the development of our bilateral and multilateral projects is a special form of division.

Consumer Raw, thinks bars, drinks, fruits, hygienic products, textiles, and other consumer products without long-term durability and therefore as values without sustained investment value products that are at redemption for corporate money because state-owned Imperium of Diamond's and imported for sale in their own state trading centers and compatible trade Marketo for public social Diamond Oasis.

A Formal agreement to promote investment value of business corporations and businesses in your countries, and trade which again promotes the growth of the value of these enterprises in the ratio of consumer population statistics Imperium of Diamond's Diamond Oasis with a plan for 10 million consumers, it means an increase in GDP of your country's strong financial growth and making the basic unit of civilization market, which will be used for future development of your country in case of natural growth of your population and consumption, stronger consumer economy in your country and thus strengthen the investment value of such forms of business corporations which automatically increases a whopping GDP and economy of your country , strengthening growth in strength of your currency.

At the same time, Diamond Oasis could such a deal be used for gain basic raw materials for the survival of civilization and population health, the establishment of basic infrastructure Market and shopping malls for public social company, thereby ensuring a stable pace for the possibility of adopting a new population from abroad, people who migrate, refugees, refugees, children are dying of hunger and people who for reasons of civilization deficiencies must suffer in society as people without gain for the state, people in the form of mere consumption of social financial benefits from the authorities, or those that can only beg on the streets of small finance and coins and therefore they

only damaging to look at the quality of your civilization, people who only because of their civil registry causes need your bank to print higher number of coins which therefore cause a weakening of your financial currency and reduced production and profits from international markets, it is weaker profit for your business corporations and their development, strongly statistically slower development of your civilizations.

Joint agreement is based on a common profit, stable retail chain advantageous for each side and at the same time with the ability to succeed at the level of humanitarian missions and the application of modern principles of the policy of peaceful principles after World War II, and also in accordance with the UN Charter, to promote peaceful development nations.

It's beautiful to live in a world that is stable and prosperous, every one of you own the right to promote the development of such contracts as contract activity political form, or business form, and therefore each one of you and supports the ideology of modern peace and humanitarian resources with global application, is an important gain for you and for your country.

Deport is also permissible. According to international principles and in many cases the jurisdiction of the States, vagrant and homeless people have no right to use public streets for their private life without social principles, and at the same time safeguarding international law that each person's own obligation rights to health and quality of life. Development plan civilization Diamond Oasis is the first year designed for 10 million people.

Today, throughout the world, for reasons of economic differential civilizations die more than 15 million children, more than 500 million people have to live on the street without any financial income persons without any civilizing exercise and social contact, many of these people are just a little children without social life and education, children who must live as a raw material for commercial sex and rape, or slavery without financial disbursements. The federal government Imperium of Diamond's is the entity that owns the legal value of government and state, but because of European terrorist blocking, without an opportunity to steadily develop the principles and standard principles of today's world of peace policies and rules.

Each of you who will support the joint development opportunities, each of you and supports better values around the world, politics, states and public companies.

It's an important step for the whole world.

As one of the basic steps of the investment opportunity is your cooperation and present the proposal before the committee Nobel Peace Prize. The most important humanitarian challenges of today's world and society.

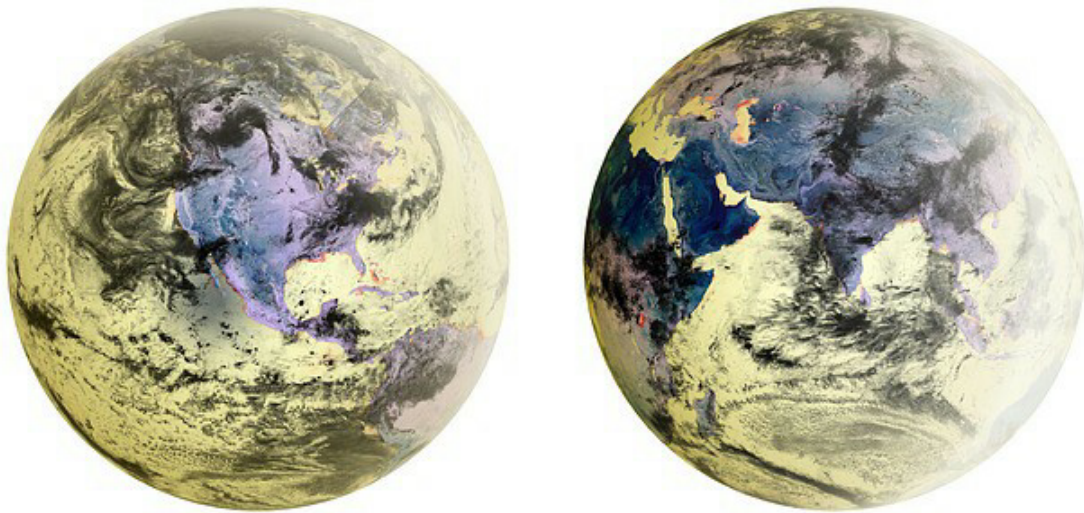

NEW WORLD OF DIGITAL TECHNOLOGIES ©™ 3D-NETWORK

Project Intranet system and trade cooperation for development, the possibility to exercise your legal activities of The International Law Intelligence Council:



The system of trade between businessmen from around the world, and ensuring the establishment of our global digital infrastructure, Intranet, using satellites and telecommunication towers, public Internet or using a laser connection of mobile telecommunications devices to satellites when the rights for the use of extraterritoriality and other legal conventions UNGA on diplomatic principles between states and their rights, and also by bilateral and multilateral ID's government with the other states.

System new business step for the development of a joint profits is based on the development strategy of business cooperation between corporations for the construction and programming of virtual worlds and digital properties, the Corporation for the production of electronic and telecommunications equipment and computers, especially corporations that are based on the pursuit of cooperation in the Royal Consortium Imperium of Diamond's.

Trading profit project for our financial fund, materials, engineering and intelligence capability for the production of technologies created with the help of legal agreements between traders with the intention to develop a global system of 3D virtual social networks and media like digital server accessible over the internet or on a new 3D net.

System 3D virtual social networks according to plan Imperium of Diamond's is based on the ability to create technologies that will be successful in international markets, while certainly large and strategic financial gain to the achievement of security for our goals.

Business Corporation with us will be signed development agreements on trade cooperation under the strategic management of joint planning for the manufacture of satellites and light aircraft for salvaging the satellite at the orbital space planet Earth, our own technology, satellites and telecommunications system in accordance with the principles of international political and business rules.

The main step is the establishment of data centers which will be stored in digital virtual reality programs over the Internet that is accessible to every registered users around the world.

Data centers will serve as carriers of digital programs that mimic social system, information and media networks, the Internet, while a 3D virtual reality in the form now known computer games and worlds for gamers, ©The 3Dnet. Geometric space created from the virtual world, at fair graphics and the ability for real social contact, multiple virtual conferences, joint sporting events, use of recreation-level visits to trade virtual centers for bids textiles, art, shops with cars, stores with electronic and consumer products goods exchange, bank branches, educational institutions, concerts and musicals, the city health consultation, betting and sports lottery and betting offices, public appearances by famous comedians and musical artists, or, for example, centers of relaxation and community activities with the possibility of using virtual spaces for their own social and socializing with the ways of the media, socially and commercially developed, building new centers and thus promote economic growth, global digital civilization.

Virtual spaces will be created as a real copies of our real world and civilizations, cities and states, building and public centers, transport networks and infrastructure in the virtual world will be created also the center of agriculture and industry, factories for the production of cars, ships and planes, textile factories, electronics stores, production of construction materials and the possibility to develop the architecture and build new virtual buildings, skyscrapers, business centers and shopping centers, sports stadiums and cinema halls, opera halls, really and truly real form of an advanced civilization with a dynamic infrastructure.

Hence arises market structure in our real world, a market which is based on the values of the actual shape values of dynamic civilizing the economy and the registration of gross domestic product with the number of population with a level of access for all persons in the world and current synchronization with digital people which are based on artificial intelligence. Therefore is such an average population in numbers despite the potential three miliard until ten miliard people who are active members of the digital economy.

Project that can create financial gains at a level that surpasses the competitiveness of any country around the world, because such a business is up economically with much greater force than the whole world of The Earth.

Therefore, one of the first steps in our logistics is the goal for the founding of the International Bank ID's virtual reality and digital financial markets, therefore, may be a step towards achieving the objective of fully developing our projects and creation of common infrastructure of our community communication and financial gains for our activities and work results.

International Bank ID's virtual reality and digital financial markets will be sufficiently financially based on the ability of high financial guarantees and register their own project plans with business treaties for contacting other business corporations and companies doing business in the market of digital technologies and telecommunications, programming, virtual worlds programs. We therefore able to gain a lot of traders who want to benefit from our progress of business cooperation and opening common commercial contracts for the development of technological infrastructure of our digital world, antennas and digital transmitter technology, data centers and specialized centers for high-capacity operating activities, global infrastructure of satellite transmitters and satellites that they will be synchronized with special technologies for clients who want to join in our virtual world and use this world, together with the other people.

Business Corporations immediately receive all the funds for their services, and our global network of virtual world can be fully active in quick time. We therefore can jointly establish well business corporations that are owned by the International Bank ID's virtual reality and digital financial markets or the Federal Government Imperium of Diamond's and business associations may therefore be active in management development strategic business plans that will develop the technology and structure of digital worlds and networks . Built business firms will be designed to develop technology at a level supercomputers, data centers and computing infrastructure, technology, data media, telecommunications and the Internet, together with further networks intranet and specialty telecommunications and virtual technologies, too quantum technology to calculate our reality and many options for this direction development on scale technological world.

The target is to build a new global communications network which is based on a new level in the form of 3D-net © ® ™, advanced level of today's Internet and telecommunications.

Therefore we can always good to know that our network of data centers and communication will always be based on full stability and success for our intranet and our freedom of communication in the legal development of our society, The International Law Intelligence Council.

Our common goal is to organize for the purpose of creating a global infrastructure businesses 3D virtual world and making communication with the governments countries worldwide. Our strategy is to develop a new international center for multinationals ID's,

or offshore centers, with quarter our ID's International Bank for virtual reality and digital markets. We together will create steps for the development of new branches in diplomatic relations with the other countries governments and therefore the ability to own scope of jurisdiction in the territory of a foreign state.

Our branches and the bank will therefore benefit of business cooperation that will strengthen the commercial strength and the currency of other countries using our bilateral and multilateral agreements on the common market, which will be a guarantee for foreign states in their stable standard financial currency and the strength of the economy without inflation, and the ability to develop our economy. Central owner of the economic relations of these virtual worlds are the Corporation for the operation and development of 3D virtual reality, artificial networks together with the Bank IDs for digital markets. That is why other governments are depending on our business cooperation and the need to ensure that our agreement on strategy, financial manipulation without the threat of inflation and the currency lost value economic dimensions of GDP.

Our joint markets can be the basis for agreement on a common trade products and exchange resources for money is an investment development projects or contracts on joint financial fund which is used for the development of our civilizations and business interests of our party strategic partnership, and it is equally possible to develop our relations agreements as a form of ID's multy savings Bank for virtual reality with the possibility to impose financial gains for local banks in foreign branches and therefore strengthen the currency state government. Commercial Corporation for the management and administration activities of the 3D virtual world based on the foundations of the rights of claim for taxation of financial income of all clients who use the services of 3D digital world 15, 25, to for example, 35% of the direct gains on the activity of virtual markets and shops, it It is a theoretical financial dimension to the level of 60 000 000 000 000 € in the phase of global recovery, and soon with the ability to dynamic growth in financial strength gain over 300 000 000 000 000 €. Economy of interactive android intelligence virtual people is full owned be the Bank and Corporations for service management, therefore the Dymension of financial profit is in theoretical values of 500 000 000 000 000 €. These are values which, in the interest of business collaboration are truly essential strategy for implementation of joint agreements for each government of the country in the entire world. Significant values which have an extra benefit for investing in dynamic development of world civilization and the rise of values maturity of all the states with the ability to ensure the development of civilization Imperium of Diamond's.

Our main goal is to create the global economic associations of governments of countries that can benefit our joint investments and trade are to agree on a multilateral commitment to a common strategy and development of our civilization, economic and political alliance at the G20, G77, OECD, ASEAN and other similar business organizations it is the fact that we were able to level the digital world to build the same structure trade policy as well as the world trade Organization.

Our goal is to promote throughout the world, the development of other civilizations and modern level. At the same time, the more users we can get that much bigger gains will be for our business center of the digital world. Therefore, our significant investment capability and technology to ensure the development of telecommunications and Internet networks throughout the world, our planet Earth, in Third World countries and territories of widespread land without any radio signal and communication technologies.

Our industrial and commercial network of corporations, banks will be expanded sufficiently in the circuit telecommunication and technological level to ensure that new development for digital telecommunications and Internet infrastructure anywhere in the world, while the abilities and gain financial gains from new users of 3D virtual world, and therefore governments gain our development interests and telecommunication technology is fully free, with no obligation to pay direct state funding, or the option to subsequently negotiate the common market. For each country the government's high profits and big business opportunity.

Future development of a 3D virtual technology will be focused on creating other central datacenter on space stations and the universal civilization of ships, real ships that can fly in space and attend distance beyond the range of our best observational skills radars and optics, more than 10 000 000 000 000 light-years from planet Earth.

Therefore, business corporations that will support our development and common markets, traders can therefore benefit from great opportunities for the development of their markets at the level of other civilizations in the universe, even with options cooperation on the development of new advanced technologies that are important to the economy, politics and civilization of the future tense.

According to today's technological intelligence Imperium of Diamonds is an option to extend the intelligence and dynamism of 3D virtual worlds and new civilizations on other planets in the universe, a civilization in special space stations. Imperium of Diamonds technology can ensure the creation of a special space-based telecommunications network at the same level of maturity as worthy of today's infrastructure radio networks on the planet Earth. We can use 3D-net communication between galaxies, with speed digital connections in the period of just a few short seconds. Today's radio signal is able to digitally and telecom combine two galaxies

within about 14 years, but the technology Imperium of Diamonds can these positions connect in just a few short seconds, it is today one of the greatest achievements of mankind and move full ability to develop mutual civilizations on other planets in space.

If successful, these activities and their defense in the interest of the just claims and legal rights, therefore the ability to create high-capacity infrastructure 3D net that creates a large financial gains and that means that the federal government Imperium of Diamonds in cooperation with IDs Bank for Virtual Worlds and Digital Markets can immediately apply in full to each active member of the International Law Intelligence Council.

That is why for us, this step is the most important and vital for the development of our cooperation and the confidence to achieve good results.



The creation of Consortia business entity as a legal person introduced Organizer

Organiser acquires the business parties, corporations and businesses at the state level, the foreign country and internationally, for the opportunity to ensure the growth of transnational relations business sides of the same category and thus their alliance to form a single entity activating the territory of the Imperium of Diamond's like a business Consortium at a unitary corporations representing General Council composed of many of the numerous range of business entities with legal personality.

Organiser is organizing a group as the third representative of the Organizing documents such entities trading parties in the form of consortia which are composed of all acquired by business corporations, and thus create a common trade as an act collectively to expand its network of sales offices with a new name legal society over the legitimacy of the Organizing Document of the consortium and this authorization to use profits from its own program, trade and investment by the joint development of guarantee contracts between traders consortium.

The consortium thus arises that three or more, and no limit on the number of parties business corporations the same size business category and merchants together constitute an agreement on trade cooperation as a consortium of ID's, and that means that the members of such an agreement becomes General Council as the main representation for body Consortium. The consortium is a fully independent body and its representation own dimension as the General Council functioning on the territory of jurisdiction of Diamond's Imperium, and thus no obligation dual taxation for persons from foreign countries.

The consortium and its General Council are therefore legally recognized as the second person with his own foundation's headquarters under the jurisdiction of Diamond's Imperium, and not against a foreign state.

Each consortium obtains legal address within the Imperium of Diamond Offshore's under the format of principle, while the right anonymous bank account of the State Imperium of Diamond's.

Organiser therefore own position only as a contracting authority with a registry document and produce evidence common parties in order to form a consortium and the selection of the registration fee which will be handed over to the official authorities ID's government and to confirm the registry of a new business entity in the ID's Commercial Register, it means the ability to start a legitimate business activities in the Imperium of Diamond's and the extent of such jurisdiction.

Organizer subsequently obtains financial share for its activity and gain a new member of the Group Consortium. For each consortium receives profits immediately in the event that the subject of the Consortium made a first payment of income taxes and profits. Profit from the creation of the consortium is ratified by the number for every single entity, while in the second ratification of a number of active business entities in the interest of capacities necessary for the full functioning of the consortium as a stable business entity, and therefore with acreage values of the capitalist system ratification by market levels.

Consortium may be founded in order to produce oil companies, firms and corporations with electronics, metallurgy, chemical industry, mechanical engineering, medical center or as agricultural centers and financial services, even the side of the bank from foreign countries together can launch function as a consortium of which there is one company form.

Consortium may be established for the purpose of conducting business on behalf of another legal person status, and to the Strategic Trade Cooperation in the Imperium of Diamonds or the use of a new center for the export of the product abroad, mainly as a second source to ensure their own development resources to foreign parties.

Advantage consortium for each business group, is the possibility of cooperation in a multi-national group and develop also thanks to intelligence and technological advancement from other individuals in the group and therefore is entitled to conveniently organize and develop as a group and with global selecting the best intelligence and values. Development is organized by the willingness of commercial parties in the interest of the provisions on deposit in contracting act of the General Council of the Consortium.

Creating the Consortium on the territory of the Imperium of Diamond's is an opportunity to develop trade markets and build common commercial properties on the territory of the Imperium of Diamond's, under the name of the state Imperium of Diamond's and legal registry in the territory of international waters, as well as to free orbit and subsequently in free cosmic space and on other planets in the cosmos.

This creates the ability to dynamically developing at advanced level and significantly grow into the largest business groups in converting the entire world. Cooperation is

beneficial for all traders and their interest in growth when using the multi-dimensional nature of global cooperation organized by the Common Market.

Multy Consortium

Multy consortium becomes subject which comprises a further alliances between several different categories of Consortia which are tied together related business networks, meaning the structure of the system of Internal trade organizations to build their own modernization of all groups Multy Consortium for using common resources. Market development and financial cycle is composed of its own closed cyclisation without inflationary rhythm. The groups will jointly develop and produce advanced level of their own capabilities.

Example activities and composition of the Consortium's multi-trade system when a corporation jointly formed a consortium single category of the market, such as consortia that may be composed of one business category, such as Metallurgy, is the second category Electronics, the third category Agriculture, and so on.

Consortia are therefore then collectively unite to form a multi-consortium that it may be active as a group composed, for example, a business category markets for mining resources and their laboratory production, followed by the category manufacturing solid materials, machining category, categories of construction technology and product electrical engineering and thus the sales or the economic and strategic use of its own internal management of the consortia, or trade on the open market.

This creates a multi-consortium. Multi-consortium may also focus on the public market, as is standard business corporation.

Multy consortium is also based on a system of cooperation with the Government of Diamond's Imperium for planning grants and financial development objectives or division missions and projects, expanded categories multy national dimension.

Business Categories

Business categories of legal business associations offered by the federal government Imperium of Diamond's

Junior Business

Trade body at the social company level, but the foundation office in the form of legal commercial entity. Business entity is intended only for small markets and easy to work voluntary nature. Junior business is a form of trafficking for children from 10 years, child's who is Freely interested.

Firm

The body as a natural person presenting a certificate of proficiency in performance in the professional field, and thus the right to form a business as a contract company. Every natural person has the right to create an unlimited number of property firms owned by qualification and profession without reference to any other form of legal ownership of the name. The company is the physical association.

Start Corporation

Start Corporation is a business association that is designed for people who obtain certification for mental health condition and ability of professional development training is. Start founding corporation formed under the authority of an autonomous government Imperium of Diamond's why the owner of Start Corporation does not need any financial resources and expertise in the profession, while losing his own responsibility activities of the corporation. Start Corporation is a business-led management of the Government Office and the authorities organize the procurement of trade and development 'trade union. Corporate profits are determined to ensure the quality of life of the owner Start Corporation, and especially for his study or family development. In the period when the owner Start Corporation received sufficient education, the business association handed over to full management responsibility and ownership. If the owner fails to achieve the necessary qualifications, it will start Corporation passed in the name of another person in order, or will be made public outcry. Start Corporation is active at the public market, and particularly for cooperation with educational centers in order to provide practice for students during their education at the level of real business environment, and is a corporation or used for public purpose.

Register Company

The company provides for the registration of copyright and the arts of individuals and society by supporting the organization of business activities with the copyright value.

Offshore Management Service

The entity which is led by the retailers who are expanding strategy of the association on behalf of other clients entrusted corporations as owners of the business entity, or the Council Offshore Service Management team takes clients to the possibility of using the service team in order to create a new business entity.

Company

Association of firms and smaller merchants who together create a partnership agreement that arises from a commercial entity as a legitimate company in order to function according to the size category of rights trading company.

Representation Company

The company belonging to another legal entity without a shared relationship, only destined for ceremonial matters.

Public Media Corporation

Television, radio, magazine, news and commercial act before a public audience.

3DD Real Estate Company

Trading company active in the digital world and the network business economics among others 3DD Real Estate companies. Virtual entity can possess anyone, without any limit while having the maximum number of other business entities.

Capital Company

Company managing only the capitalist system-driven market and thus activate the self-development of commercial interests and strategic development under capitalist strategy.

Investment Company

Investment company creates financial and development resources for other companies and corporations that use sponsorship in order to expand their own market and profit from investments to ensure the return borrowed for Investment companies.

Prime Corporation

Ownership of the business Company, only one person, and with the established management team. Prime-Corporation Limited own capital limit.

Comand Company

The association of two parties composed of persons as a financial investor and business organizer, thus to agree on a common profit.

Interactive Comand Company

The association of two parties composed of persons as a financial investor and flexible business organizer, thus to agree on a common profit. Flexible organizer of trade is only temporary partner that can be exchanged for another candidate to Community if the candidate will possess a better business plan than its competitors.

Holding Company

Trading company in order to develop transport logistics and establish cooperation as a supplier of goods under transit and either by private taxi service charges.

Building Corporation

The corporation focuses on construction markets, development of architecture and urbanization, and therefore the possibility of establishing a dual takings as its own center of the construction industry and activities of architect engineering and construction of the building. Construction Corporation consists of a number of professional experts and companies who jointly expand the building fund.

Market Company

Market processing and sales, management uses its own market when market activity of other traders and thus the creation of common own financial profit from the value added to the price of products and services.

International Company

The use of logistics management of international markets for the possibility of interactive planning and expand contractual relationships with global traders to develop their own gain and the structure of markets. The government has the right support development of logistics management.

Joint-stock Company

Business association with the obligation upon the leadership level budgets to the limit dimension of owned capital to the level of maximum profits without limitation except for the obligation to respect tax systems. Joint-stock Corporation issued and limits their

own investment securities available for sale are the foundation of their prices by size of economic power joint stock corporation.

Civilizational Corporation

State organizes business in order to build new markets and business, raw, resource and financial networks civilization.

Federal Company

Company commercial interest only active on the territory of the Federation, or between Company bodies and by expanding own multi infrastructure throughout the civilization. The company has a widespread development rights at official level synchronization.

Multy Company

The association of a consortium of one category of the retail market and thus functions as a business company.

Commercial Consortium

Association of Corporate different business categories and the creation of business cooperation such as jointly owned other person associated corporations made up for the purpose of activities as a single business entity based on the form of the Business Council dealer associations.

Multy Consortium

Association of consortia to function as one company.

Management Company

The company with the register of trade associations that own the debt level of confidence of the financial crisis and bankruptcy, and there are obligations of the act entrusting the indebted business entity into the hands Management Company that extends the strategy of the foundation property uses many of the numerous dimensions of a registry operated business associations which are therefore in the hands of management administration form internal and public business strategy of common interest for the financial management and development of business entities with a view to ensuring their deleveraging and returning back into the hands of the legal owner. Indebted corporations that are responsible of its trade name.

Interactive Corporation

Group of companies based on a system that allows immediate own immediate ability restructuralization markets and internal resources in accordance with the strategic plan and emergency situations civilization and business markets. Corporations own source benefits and the right to activate multiple forms multy trade, as well as an interactive cooperation with Federal Bank.

Private Corporations

Publicly anonymous business entity is a form of private association which is associated with the business of government, and receives orders from the authorities of the states. Military orders, arms manufacturing, technology, special resources, others.

Intelligent Corporation

Corporations that contacts with other governmental and foreign merchants or services, and always with a view to selling the business intelligence development plans and building intelligence used to grow new projects in the rhythm of state business stability and also to develop new markets or increase their dynamics.

Booking Company

Trading company with its own jurisdiction in the form of a free trade categorization of activities in the space reserved for a limited period of time and with limited territorial zone. The register is kept at the offices of the government.

Incorporate

Corporations with form their own principles of jurisdiction and activity for the purpose of self-interest according to the contractual provisions with the government of the country.

OFFICE Company

Trading company that supports government and local authorities, with their own financial profit from operations in the fees for use of authority and the establishment of commercial and professional intelligence networks or Multi sponsorship, development and consumerism. The Office carries out political activity in public affairs, and it is necessary to respect the obligation of the company structure in sync with the authorities, police and investigative bodies governed by public action.

Research Corporation

Form institution and business entity uses its own business entity management used for the commercial application of research and securing sources of finance.

Planetary Corporation

Corporation active in the size of the planet and as a business entity expanding its own infrastructure company.

Stationary Corporation

Corporation active in the dimension of space stations and expanding as business entity owns the infrastructure company.

Universal Corporation

Multy business entity with its own infrastructure cosmic sources and industrial centers between planets in the universe.

Space Science Corporation

Research center with free opportunities to own and expand their own resources to develop the infrastructure at the research center and to research work around the space subjects special natural phenomenon.

Business Burza

Diet merchants in common centralization of business rhythm in the same direction, thereby resulting Mercantile Exchange as traders parliament in order to increase the centralization of market intelligence and enable a steady income logistics business development. Exchange is led by the founder, or representations that have been selected from a number of traders active on the exchange. Stock representations loses other rights of ownership and management of any other business entity. Exchange may collect fees for the financial register of cooperation and business development rhythms or register a trade with investment materials. The Exchange is a legal institution.

The Cheque system of The Imperium of Diamonds Federal Bank

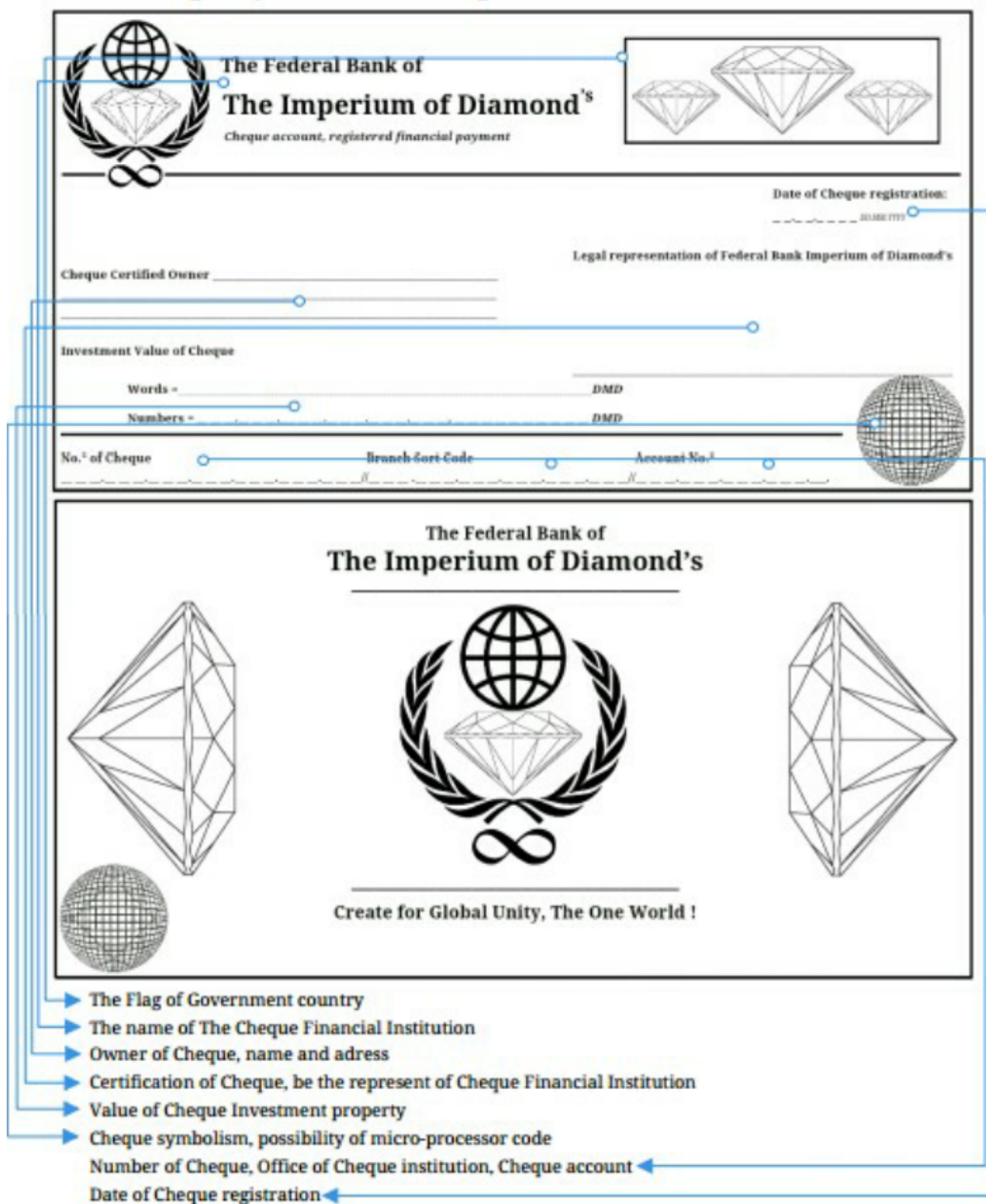

The Federal Government of The Imperium of Diamond's

The King Gottwald Peter

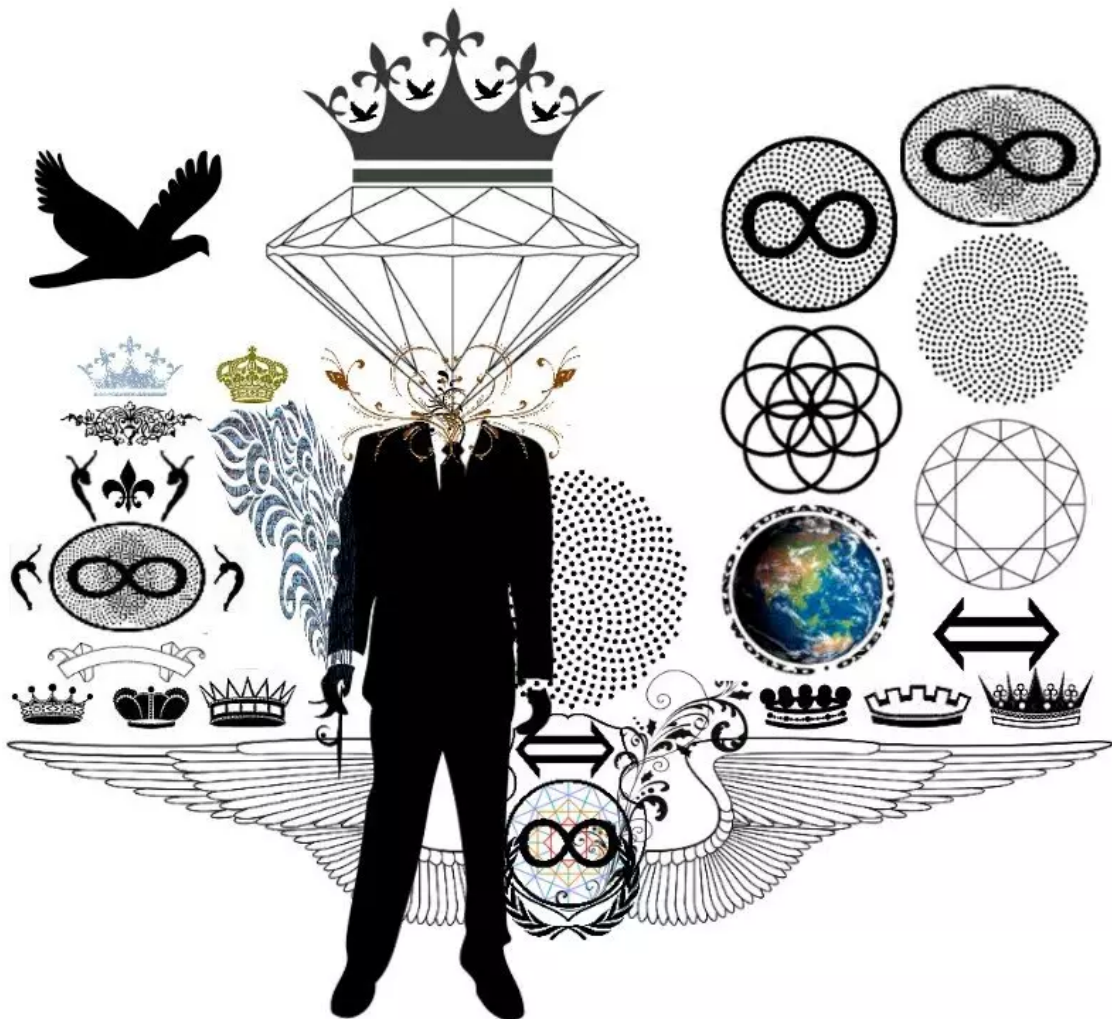

Provisory Contact:

Peter.Gottwald.Eu.orb.runner@gmail.com
IDs.Fed.gov@gmail.com

www.theimperiumofdiamondsgovernment.populiser.com

[The King Gottwald Peter of The ID's](#)

I am the Legal Represent, legal form of a value of over 7 500 000 000 000 000 000 (7,5 Triliard) number of ID's business corporations be legal form, and the economic value of over € 3 750 000 000 000 000 000 000 000 000 000 000 000 000 000 (3,75 Sextiliard €) standard.

Legal registr of The Imperium of Diamond's population in capacity standartization who outstrip power of 3 000 000 000 000 000 000 000 people, and multy civilizational territories in the dimension of the 1 000 000 000 000 000 000 000 planet's in Universe as a active gross civilizational space.

Today, the political situation, the Government of Imperium Diamonds under terrorist occupation, misinformation and blocking for development, all the claimed values are fully legal without dispute in the interest of International political rules, and all rights for development.

Therefore, I am King Gottwald Peter seeking intelligent people who are able to support the development of our shared Global infrastructure of organized networks Imperium of Diamonds policies with Extraterritorial status, and its own intent for custom stabilization of civilization, when principles and claims under the UN Charter, the UN General Assembly Declaration, universal principles.

So I offer to each of You and for Your Dear Friends, new opportunities for a political career for Your own future on their own knowledge of the actual experience of life at the level of global politics and the real world of intelligence, advanced society our human race.

I offer the possibility for You to work at the Office of the Imperium of Diamonds government the opportunity to work with the Global policy spheres, states, traders and public companies, development of the new worlds and human dimensions.

Our goal is the stabilization of development, the new dimensions of the world, it is also Your personal advantage as the ability to subsequently advance to the significant level of politics and get fully free, dynamic and intelligent life.

Our common success is best for You to step Your Life!

I wish You good luck!

**The Federal Government of
The Imperium of Diamond's**

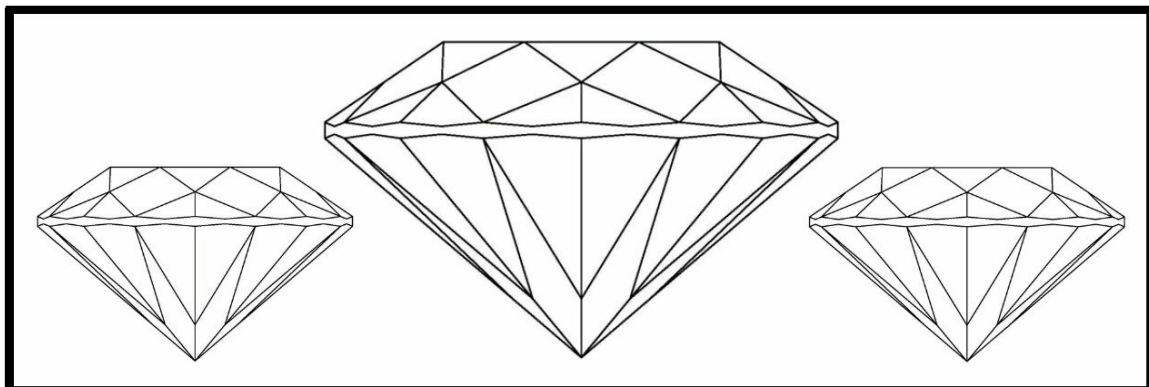

ID's Provisory Office

END of Document



**Signature of The King Imperium of Diamond's
The King Gottwald Peter**

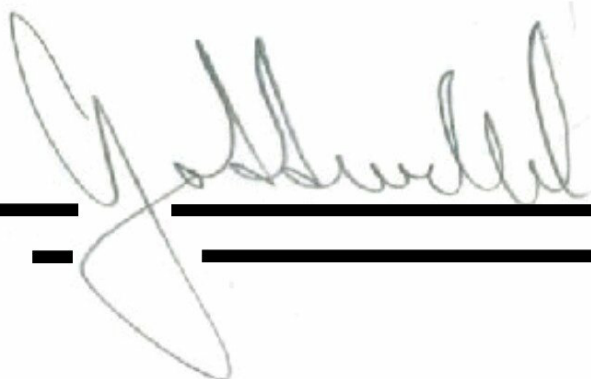

Sunday, December 4, 2016

<http://www.TheImperiumofDiamondsGovernment.populiser.com>
