

BAČVA INOX
INOX Kegs

Bačva - Kegs
 Rezervni dijelovi Bačva - Spare parts Tanks
 Bačva za dezinfekciju - Cleaning Tanks
 Priključne igle za bačve - Extractor tube
 Ključ za priključne igle - Tools for extractor tube
 Glava za pranje sistema - Rinsing heads

Konzole za istakanje
mesing-inox
Tower in Brass and steel

Konzola za istakanje mesing - Brass towers
 Konzola za istakanje inox - Stainless Steel towers
 Konzola za istakanje za vodu - Water dispenser
 Konzola za istakanje od keramike - Ceramic towers
 Konzola za istakanje od drva - Wooden towers
 Imitacija vinske bačve - Cask head in wood
 Konzola Post-Mix - Pre-Mix - Pre-mix end Post-mix tower

Dijelovi konzola za istakanje
Accessories for towers

Reklamna keramika - Plate holders
 Kit prsteni - Kit rings
 Ovalni prsteni - Elliptical rings
 Montažni kit - Assembling system for ceramic tower
 Optok za hlađenje - Recirculation tube for tower

Slavine za PIVO -Taps

Slavina za pivo - Beer taps
 Slavina za pivo DSI - DSI beer taps
 Slavina za pivo ALUMASC - ALUMASC beer taps
 Slavina Pre-Mix CMB - CMB Pre-Mix taps

Pištalj - Bar Valve

Pištalj Post-Mix - Bar Valve Post-Mix
 Pištalj Pre-Mix - Bar Valve Pre-Mix
 Pištalj seltz - Bar Valve soda

Slavina post-Mix - Post-Mix Valve

Ventil Post-Mix - Post-Mix Valve

Pult za točenje
Cabinet / Wooden counters

Rashladni pult bačva - Refrigeration cabinet
 Dijelovi rashladnog pulta - Pare parts for cabinet
 Pult Unibar - Bar counter
 Moduli rashladnog pulta - Modular cellar box
 Mini rashladni sistem hladna bačva - Party beer cooler
 Drveni pult - Wooden counters

Rezervni dijelovi - Accessories

Drveni modeli - Wooden cases
 Konzole za čaše - Glass holder
 Miješalo Co2/ N2 - Carbomix
 Generator N2 - Nitrogen generator
 Regulatorni i volumetrijski brojači - Flow controller
 Fob stop pivo - Fob Detector Fob Shurflo
 Pripreme za pranje - Drip trays base
 Pripreme za pranje čaša - Glass rinsers
 Sabirnici - Drip trays

Rezervni dijelovi
Accessories / Spare parts

Karbonatori - *Carbonators*

Filteri H2o Everpure - *Everpure H2o Filter*

Pumpa Shurflo - *Shurflo pumps*

Motori pumpe H2o/ Pompe H2o - *Motors for Carb / H2o pumps*

Termostati / Kontrola nivoja - *Thermostat / Level Control*

Pumpe optoka / Mješala - *Recirculation pumps / Agitators*

Elektroventilatori - *Fan motors*

Kompresori - *Compressors*

Reduktor pritiska Co2 / N2 - *Co2 / N2 Pressur regulators*

Priklop glava pivo / Sokovi - *Kegs heads / Quick disconnect*

Zavojnice inox - *Stainless Steel coils*

Sitni materijal
Miscellaneous

Spojni elementi inox - *Stainless Steel fittings*

Spojni elementi mesing - *Brass fittings*

Spojni elementi PVC - *Plastic fittings*

Brtve - *Gasket / OR*

Spojni elementi J.G - *Quick Joints*

Stezajke inox - *Hoseclip*

Alati različiti - *Tools*

Python CEV
Python & Tube

Python MDP - *MDP Python*

Python EVA - *EVA Python*

Python MD PLUS - *MD PLUS Python*

Python lupulus - *LUPULUS Python*

Python WET- WET *Python*

Python WATER UP - *WATER UP Python*

Crijevo MDP - *MDP Tube*

Crijevo EVA - *EVA Tube*

Crijevo MD PLUS - *MD PLUS Tube*

Crijevo LUPULUS - *LUPULUS Tube*

Crijevo FLEXPLUS - *FLEXPLUSTube*

Izolacijska cijev - *Insulation Tube*

Rashladni agregati
Coolers

Grupa rashladnih uređaja- Pivo - *Beer Coolers*

Grupa rashladnih uređaja-Pre-Mix -Vino - *Pre-mix Coolers*

Grupa rashladnih uređaja-Post-Mix / SC - *Post-Mix Coolers*

BAČVE KEGS

Inox Kegs

BAČVE COCA-COLA
coca cola tanks

BAČVE R JOLLY
R jolly tanks

BAČVE NC
NC tanks
BAČVE VINO
wine tanks

BAČVE PIVO
beer tanks

BAČVE ZA PRANJE
cleaning tanks

BAČVE DIJELOVI
spare parts tanks

PRIKLJUČNE IGLE
extractor tube

KLJUČEVI ZA PRIKLJUČNE IGLE

Tools for extractor tubes

GLAVE ZA PRANJE

Rinsing heads

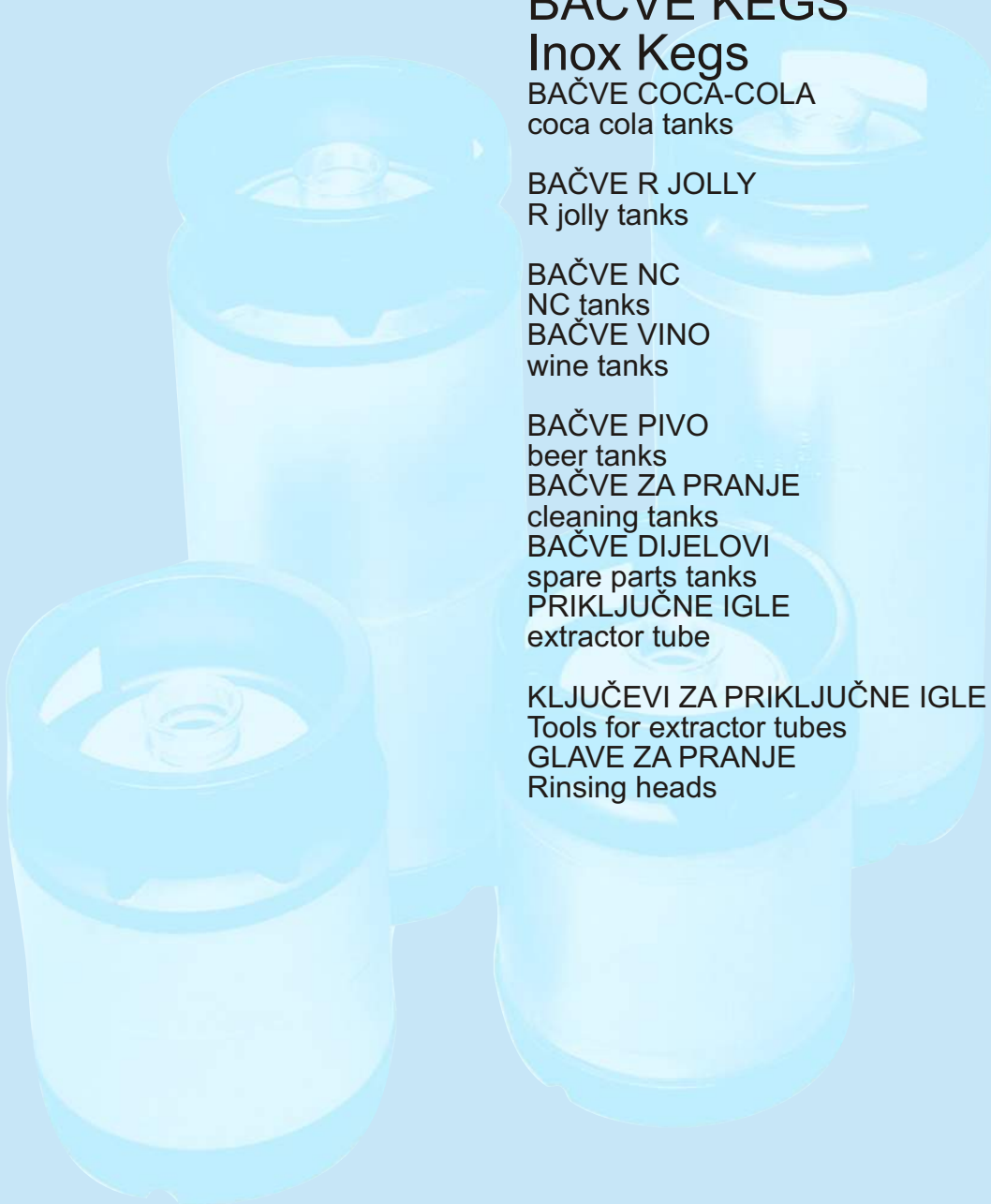

BAČVA R COCA COLA-JOLLY

KOD <i>CODE</i>	OPIS ARTIKLA <i>DESCRIPTION</i>	
1003-I	Bačva 9LT "R" C.C.	
1003-VS	Bačva 9LT "R" C.C.VS	
1000-I	Bačva 18LT "R" C.C.	
1002-VS	Bačva 18LT "R" C.C. VS	
1000-I	Bačva 18LT "R" C.C.	
1002-VS	Bačva 18LT "R" C.C. VS	
1009-I	Bačva 9LT "R" Jolly	
1009-VS	Bačva 9LT "R" Jolly VS	
1008-I	Bačva 18LT "R" Jolly	
1008-VS	Bačva 18LT "R" Jolly con VS	



BAČVE JOLLY

1011-VS	Bačva 9LT Jolly VS	
1010-VS	Bačva 18LT Jolly VS	
040192	Bačva 9LT Jolly VS brez ventila	
040193	Bačva 18LT Jolly VS brez ventila	



BAČVE NC

1027-VS	Bačva 3 galloni NC VS	
1025-VS	Bačva 5 galloni NC VS	
1028-VS	Bačva 2,5 galloni NC VS	



BAČVE PIVO-VINO

1015-V	Bačva 20L vino 3PZ	
1020-B2S	Bačva 10L piva 2PZ sic.	
1016-B2	Bačva 20L piva 2PZ	
1020-B2	Bačva 10L piva 2PZ	
1016-B2S	Bačva 20L piva 2PZ sic.	
1029-3V	Bačva 25L vino vino 3PZ	
1021-V	Bačva 30L vino vino 3PZ	





Model Type Typ	Volumen Capacity Capacité Inhalt Litri-Litres-Liter	Ukupna visina Total height Hauteur total Höhe Gesamt mm ± 2	Promjer Outside diameter Diametre extérieur Außendurchmesser Gesamt mm ± 2	Tip priklop ventila Valve type Type de soupape Ventiltyp	Težina - Weight - Poids - Gewicht		Kod, Code number Numéro de code Artikel Nr.
					Standard kg. ± 0,1	Bez vrhnje gume Without rubber cover Sans revêtements en gomme srl la tete Ohne Aufvulkanisierten Kragen kg. ± 0,1	
«R»	18	563,5	232	Coca Cola	4,4	3,35	1001
«R JOLLY»	18	563,5	232	Jolly	4,4	3,35	1008
«MINI R»	9	340	232	Coca Cola	3,65	2,6	1003
«MINI R JOLLY»	9	340	232	Jolly	3,65	2,6	1009



Cod. 3333
 Tip «R»
 Type «R» Foreign Standard
 Type «R» Standard Etrangé
 Containerdeckel Typ «R» Standard Export



Cod. 3331
 Tip «R» Italia
 Type «R» Italy Standard
 Type «R» Standard Italie
 Containerdeckel Typ «R» Standard Italien



Cod. 3332
 Tip «R» sigurnosni ventil
 (detta valvola NON sostituisce la valvola di sicurezza)
 Type «R» with Stated Relief Valve
 (this valve does not replace equipment SAFETY VALVES)
 Type «R» avec Soupape de décharge
 (cette sorte de soupape ne remplace pas la soupape de sureté)
 Containerdeckel Typ «R» mit Entlüftungsventil
 (Kein Sicherheitsventil)



Ventil - Valve Soupape - Ventil	CO ₂		Tekučina- Product Produit - Getränk	
	RE	Cod. N. - Art. Nr.	RE	Cod. N. - Art. Nr.
Coca Cola	1	3261	2	3262
Jolly	3	3063	4	3064



Model Type Typ	Volumen Capacity capacité Inhalt Litri-Litres-Liter	Volumen Capacity capacité Inhalt US Gallon	Ukupna visina Total height Hauteur total Höhe Gesamt mm ± 2	Promjer Outside diameter Diametre extérieur Außendurchmesser Gesamt mm ± 2	Tip ventila Valve type Type de soupape Ventiltyp	Težina Weight Poids Gewicht kg ± 0,1	Kod Code number Numéro de code Artikel Nr.
NC.	18	5	633	215	NC.	4,15	1025/V5
MINI NC.	9	2,5	403	215	NC.	3,32	1026/VS



Cod. 3330
 Tip «R»
 Type «R» Foreign Standard
 Type «R» Standard Etrangé
 Containerdeckel Typ «R» Standard Export



Cod. 3328
 Tip «R» Italia
 Type «R» Italy Standard
 Type «R» Standard Italie
 Containerdeckel Typ «R» Standard Italien



Cod. 3329
 Tip «R» varnostni ventil
 (detta valvola NON sostituisce la valvola di sicurezza)
 Type «R» with Stated Relief Valve
 (this valve does not replace equipment SAFETY VALVES)
 Type «R» avec Soupape de décharge
 (cette sorte de soupape ne remplace pas la soupape de sureté)
 Containerdeckel Typ «R» mit Entlüftungsventil
 (Kein Sicherheitsventil)



Ventil - Valve Soupape - Ventil	CO ₂		Tekučina - Product Produit - Getränk	
	RE	Cod. N. - Art. Nr.	RE	Cod. N. - Art. Nr.
NC.	1	3263	2	3264



BAČVA INOX 10,20 lt Pivo-Vino

Dijelovi presvučeni s hladnom vulkaniziranom gumom. Materijal INOX AISI 304

Fusto tipo KEG da 10 e 20 lt. Per Birra e Vino in acciaio INOX. Materiale ASTM A 240 tipo AISI 304. Testa e fondo rivestiti in gomma naturale vulcanizzata a caldo

*10 and 20 lt. stainless KEG for Beer and Wine. Material ASTM A 240 type AISI 304
Top and bottom are covered with hot vulcanized natural rubber*

*10 und 20 lt. Edelstahl-KEG für Bier und Wein. Material nach DIN 1.3401
Ober und-Unterteil mit heissvulkanisiertem Naturgummi überzogen*

*FUTde 10 et 20 lt. pour Biere et Vin en acier inoxydable. Material ASTM A 240 type AISI 304
Tête et fond revetus en gomme naturelle vulcanisée a chaud*

*CONTENEDOR de 10 y 20 lt. para Cerveza y Vino en acero inoxidable. Material ASTM A 240 tipo AISI 304
Parte superior y inferior recubierta en goma natural vulcanizada por calor*

Priklopni vrat sesalne igle
je standard 2" W 14
ali po naročilu.

Necks are available with
standard 2" W 14 threading
or a different one on request.

Füllstutzen 2" W 14
Standardgewinde oder
anderes auf Wunsch.

Goulotte avec filetage
standard de 2" W 14
ou autre sur demande.

Manguito con conexión
roscada standard de 2" W 14
u otra según pedido.



Model Type Typ	10 LB	20 L	20 LB/3	10 LB/2
Volumen u litrama Capacity Litres Inhalt Liter	10,3 +0,4	20,0 +/- 0,4	20,3 +/- 0,4	20,3 +/- 0,4
D 1 +/- 2 mm.	239	239	239	239
D 2 +/- 2 mm.	234	234	234	234
H 1 +/- 2 mm.	338	559	568	568
HF +/- 2 mm.	302	523	532	532
H3 +/- 2 mm.	273	494	503	503
Tezina bez priklju. igle Weight without fitting Gewicht ohne fitting Kg +/- 4%	3,15	4,15	4,25	4,60
Coda Code number Artikel Nr.	1020	1015/V	1015/B	1016

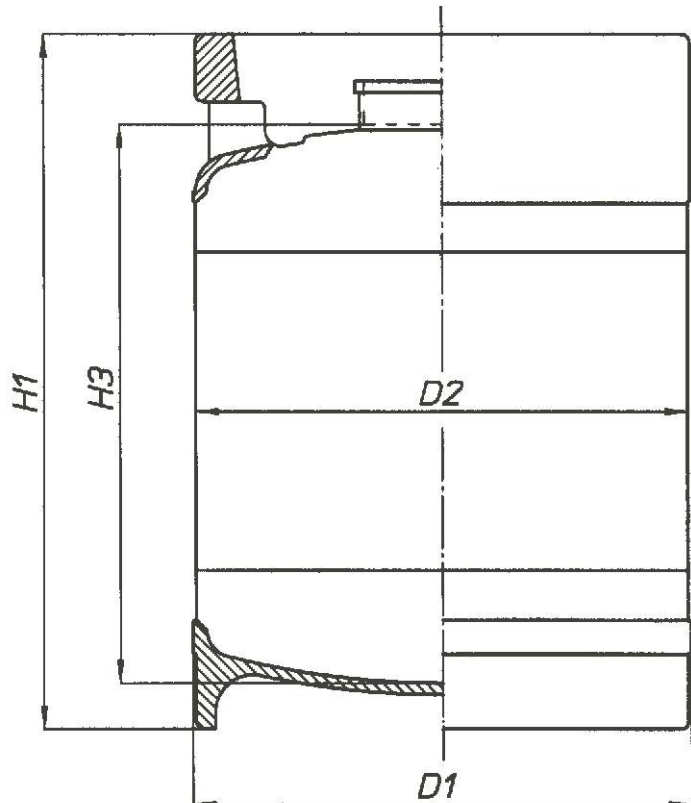



BAČVA INOX 25,30 lt Pivo - Vino

Dijelovi presvučeni s hladnom vulkaniziranom gumom. Materijal INOX AISI 304

*Fusto tipo KEG da 25 e 30 lt. Per Birra e Vino in acciaio INOX. Materiale ASTM A 240 tipo AISI 304.
Testa e fondo rivestiti in gomma naturale vulcanizzata a caldo*

*25 and 30 lt. stainless KEG for Beer and Wine. Material ASTM A 240 type AISI 304
Top and bottom are covered with hot vulcanized natural rubber*

*25 und 30 lt. Edelstahl-KEG für Bier und Wein. Material nach DIN 1.3401
Ober und-Unterteil mit heissvulkanisiertem Naturgummi überzogen*

*FUTde 25 et 30 lt. pour Biere et Vin en acier inoxydable. Material ASTM A 240 type AISI 304
Tete et fond revetus en gomme naturelle vulcanisée a chaud*

*CONTENEDOR de 25 y 30 lt. para Cerveza y Vino en acero inoxidable. Material ASTM A 240 tipo AISI 304
Parte superior y inferior recubierta en goma natural vulcanizada por calor*

Preklopni vrat priključne igle
je standard 2" W 14
ili po narudžbi.
Necks are available with
standard 2" W 14 threading
or a different one on request.

Füllstutzen 2" W 14
Standardgewinde oder
anderes auf Wunsch.

Goulotte avec filetage
standard de 2" W 14
ou autre sur demande.

Manguito con conexión
roscada standard de 2" W 14
u otra según pedido.



Model Type Typ	25 L	30 LB
Volumen u litrama Capacity Litres Inhalt Liter	25 +/- 0,2	30 +/- 0,2
D 1 +/- 2 mm.	286	286
D 2 +/- 2 mm.	280	280
H 1 +/- 2 mm.	510	591
H3 +/- 2 mm.	455	536
Težina bez priklj.igle Weight without fitting Gewicht ohne fitting Kg +/- 4%	6,150	6,750
Kod Code number Artikel Nr.	1029	1021

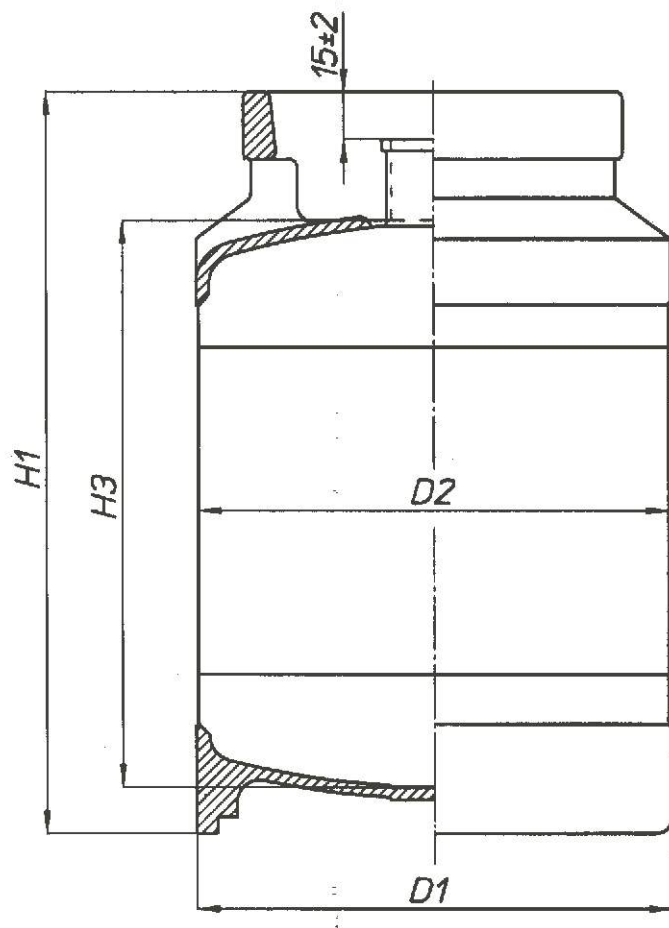



BAČVA INOX 25,30 lt Pivo-Vino

Dijelovi presvučeni sa hladnom vulkaniziranom gumom. Materijal INOX AISI 304

Fusto tipo KEG da 25 e 30 lt. Per Birra e Vino in acciaio INOX. Materiale ASTM A 240 tipo AISI 304. Testa e fondo rivestiti in gomma naturale vulcanizzata a caldo

*25 and 30 lt. stainless KEG for Beer and Wine. Material ASTM A 240 type AISI 304
Top and bottom are covered with hot vulcanized natural rubber*

*25 und 30 lt. Edlsthäl-KEG für Bier und Wein. Material nach DIN 1.3401
Ober und-Unterteil mit heissvulkanisiertem Naturgummi überzogen*

*FUTde 25 et 30 lt. pour Biere et Vin en acier inoxydable. Material ASTM A 240 type AISI 304
Tete et fond revetus en gomme naturelle vulcanisée a chaud*

*CONTENEDOR de 25 y 30 lt. para Cerveza y Vino en acero inoxidable. Material ASTM A 240 tipo AISI 304
Parte superior y inferior recubierta en goma natural vulcanizada por calor*

Priklucni vrat prikljucne igle
je standart 2" W 14
ili po narocilu.

Necks are available with
standard 2" W 14 threading
or a different one on request.

Füllstutzen 2" W 14
Standardgewinde oder
anderes auf Wunsch.

Goulotte avec filetage
standard de 2" W 14
ou autre sur demande.

Manguito con conexión
roscada standard de 2" W 14
u otra según pedido.



Model Type Typ	20 L	20 LB	25 L	25 LB
Volumen u litrama Capacity Litres Inhalt Liter	20 +/- 0,2	20,4 +/- 0,2	25 +/- 0,2	25,4 +/- 0,2
D 1 +/- 2 mm.	269	269	269	269
D 2 +/- 2 mm.	260	260	260	260
H1 +/- 2 mm.	488	495	584	591
H3 +/- 2 mm.	431	438	529	536
Težina bez priklj.igle Weight without fitting Gewicht ohne fitting Kg +/- 4%	6,250	6,380	6,850	6,980
Kod Code number Artikel Nr.	1017/V	1017/B	1018/V	1018/B

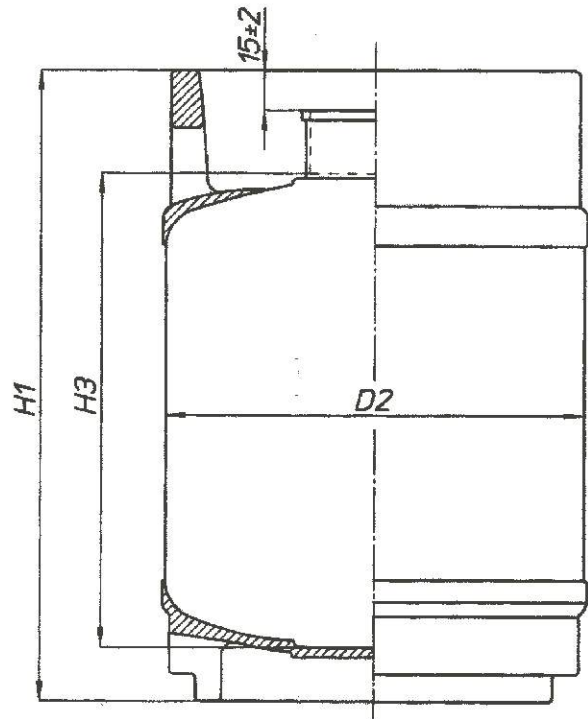



BAČVA INOX Pivo-Vino *Materijal ASTM A240 tip AISI 304*

Fusto per Birra e Vino in acciaio INOX. Materiale ASTM A 240 tipo AISI 304.

Stainless steel TANK for Beer and Wine. Material ASTM A 240 type AISI 304.

KEG aus rostfreiem Edlsthah für Bier und Wein. Das Material: ASTM A 240 Typ AISI 304.

FUTpour Biere et Vin en acier inoxydable. Matériau ASTM A 240 type AISI 304.

CONTENEDOR para Cerveza y Vino en acero inoxidable. Material ASTM A 240 tipo AISI 304.

Priključni vrat priključne igle
je standard 2" W 14
ili po narudžbi.

Necks are available with
standard 2" W 14 threading
or a different one on request.

Füllstutzen 2" W 14
Standardgewinde oder
anderes auf Wunsch.

Goulotte avec filetage
standard de 2" W 14
ou autre sur demande.

Manguito con conexión
roscada standard de 2" W 14
u otra según pedido.



Model Type Typ	10	15	20 V	20 B
Volumen u litrama Capacity Litres Inhalt Liter	10,4 +/-0,2	15,4 +/- 0,2	20,0 +/- 0,2	20,4 +/- 0,2
D 1 / D 3	237+/-1	237+/-1	237+/-1	237+/-1
D 2	237,4+/-1	237,4+/-1	237,4+/-1	237,4+/-1
H 1	338+/-2	452+/-2	560+/-2	568+/-2
H2	28+/-2	28+/-2	28+/-2	28+/-2
H3	272+/-2	386+/-2	494+/-2	501+/-2
Težina Weight Gewicht Kg +/- 4%	3,9	4,65	5,3	5,5
Kod Code number Artikel Nr.				

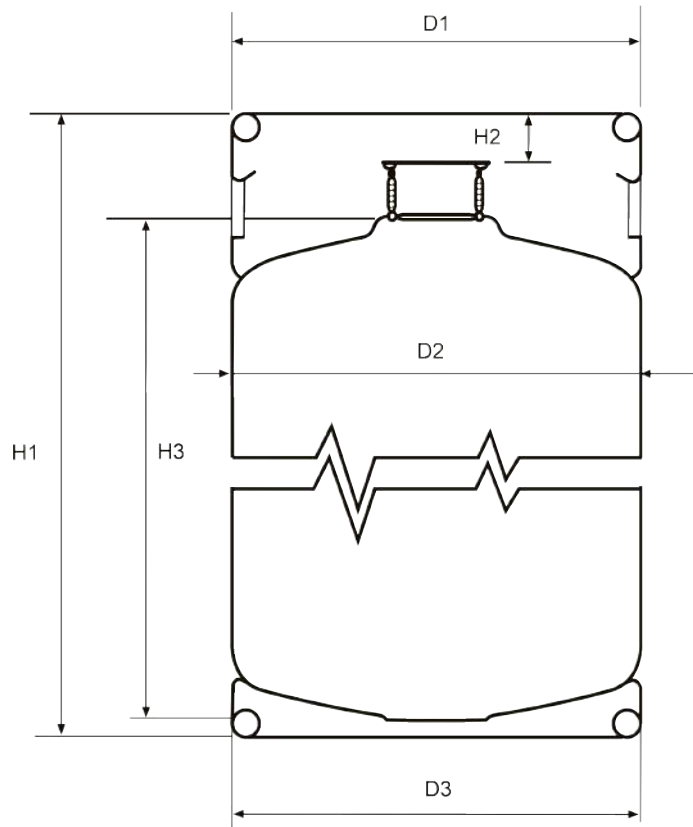

BAČVA ZA DEZINFEKCIJU

KOD CODE	OPIS ARTIKLA DESCRIPTION
1030-VS	1Keg 1Jolly IN 1Jolly OUT
1034-VS	2Keg 1Jolly IN 1Jolly OUT
1038-VS	3Keg 1Jolly IN 1Jolly OUT
1050-VS	1Keg 1CC IN 1CC OUT
1054-VS	2Keg 1CC IN 1CC OUT
1058-VS	3Keg 1CC IN 1CC OUT
1071-4B	4Keg 1CC IN 1CC OUT
1061-VS	1 KEG
1090-VS	2 KEG
1091-VS	3 KEG
1089-VS	4 KEG
1092-VS	5 KEG
1042-VS	4 Jolly OUT 1 Jolly IN
040156	5 Jolly OUT 1 Jolly IN
1079-VS	6 Jolly OUT 1 Jolly IN
1087	7 Jolly OUT 1 Jolly IN
040170	4 CC OUT 1 CC IN
1062	5 CC OUT 1 CC IN
1046-VS	6 CC OUT 1 CC IN
1041	7 CC OUT 1 CC IN
1088	8 CC OUT 1 CC IN
9700	Sredstvo za čišćenje (12 KG)
3263	Ventil NC IN
3264	Ventil NC OUT
3063	Ventil Jolly IN
3064	Ventil Jolly OUT
3261	Ventil CC IN
3262	Ventil CC OUT
3351	Tijelo ispusnog ventila
2221	Spojnicica ispusnog ventila
3015	OR ventila Jolly - NC
3010	OR ventila CC
3329	Poklopac VS
2142-FC	Poklopac VS + ventil CC
2142-FJ	Poklopac VS + ventil jolly
3350	Sigurnosni ventil
3324	OR- brtva komplet
3310	Cijev prod.bačva 9LT
3307	Cijev prod.bačva 18LT
3323	OR Cijevi 9/18LT
3463	Ventil priključne igle - model SI
3464	Brtva priključne igle
3341	Poklopac protiv prašine priključne igle



PRIKLJUČNE IGLE 9lt-sanitacija

KOD CODE	OPIS ARTIKLA DESCRIPTION
275965-L100	Priključna igla mod -S-
275855-L100	Priključna igla mod -G-
275850-L100	Priključna igla mod -A-
201-206	Priključna igla mod -U-
201-204	Priključna igla mod -S.mig.-
201-207	Priključna igla Combi-M-



PRIKLJUČNE IGLE KEG 10lt pivo L260

275965-L260	Priključna igla mod -S-
276200-L260	Priključna igla mod -S-osiguralo
275850-L260	Priključna igla mod -A-
276085-L260	Priključna igla mod -A-osiguralo
275855-L260	Priključna igla mod -G-
276295-L260	Priključna igla mod -G-osiguralo

PRIKLJUČNE IGLE KEG 20lt pivo L490

275965-L490	Priključna igla mod -S-
276200-L490	Priključna igla mod -S-osiguralo
275850-L490	Priključna igla mod -A-
276085-L490	Priključna igla mod -A-osiguralo
275855-L490	Priključna igla mod -G-
276295-L490	Priključna igla mod -G-osiguralo



PRIKLJUČNE IGLE KEG 20lt vino L480

275965-L480	Priključna igla mod -S-
276200-L480	Priključna igla mod -S-osiguralo
275850-L480	Priključna igla mod -A-
276085-L480	Priključna igla mod -A-osiguralo
275855-L480	Priključna igla mod -G-
276295-L480	Priključna igla mod -G-osiguralo

PRIKLJUČNE IGLE KEG 25lt vino L517

275965-L517	Priključna igla mod -S-
276200-L517	Priključna igla mod -S-osiguralo
275850-L517	Priključna igla mod -A-
276085-L517	Priključna igla mod -A-osiguralo
275855-L517	Priključna igla mod -G-
276295-L517	Priključna igla mod -G-osiguralo

PRIKLJUČNE IGLE KEG 25lt vino L444

275965-L444	Priključna igla mod -S-
276200-L444	Priključna igla mod -S-osiguralo
275850-L444	Priključna igla mod -A-
276085-L444	Priključna igla mod -A-osiguralo
275855-L444	Priključna igla mod -G-
276295-L444	Priključna igla mod -G-osiguralo



PRIKLJUČNE IGLE KEG 30lt vino L528

275965-L528	Priključna igla mod -S-
276200-L528	Priključna igla mod -S-osiguralo
275850-L528	Priključna igla mod -A-
276085-L528	Priključna igla mod -A-osiguralo
275855-L528	Priključna igla mod -G-
276295-L528	Priključna igla mod -G-osiguralo

KLJUČ ZA PRIKLJUČNE IGLE

KOD
CODE

OPIS ARTIKLA
DESCRIPTION

9380 Kjuč za priključne igle - model S
9381 Ključ za priključne igle - model A
9382 Ključ za priključne igle - model G
9384 Ključ za ventil CC - Jolly



GLAVE ZA PRANJE

9394 Glava za pranje - model S 3/8
9395 Glava za pranje - model A 3/8
9396 Glav za pranje - model G 3/8



9351 Glave za pranje- model S
9352 Glave za pranje - model M



9397 Glave za pranje preklop GUINNES JG 3/8

35,070



9398 Glave za pranje Coca Cola 3/8
9399 Glave za pranje Jolly 3/8

20,500

20,500





KONZOLE ZA ISTAKANJE- DIJELOVI Tower - accessories

KONZOLE ZA ISTAKANJE MESING
brass tower

KONZOLE ZA ISTAKANJE INOX
stainless steel tower

KONZOLE ZA ISTAKANJE VODE
water dispenser

KONZOLE ZA ISTAKANJE OD KERAMIKE
ceramic tower

KONZOLE ZA ISTAKANJE OD DRVETA
wooden tower

IMITACIJA DRVENE BAČVE
cask head in wood

KONZOLE ZA ISTAKANJE-MIX - PRE-MIX
pre-mix - post-mix tower

REKLAMNA KERAMIKA
plate holders

OBLIKOVANI PRSTENI
kit rings

OVALNI PRSTENI
elliptical rings

MONTAŽNI KIT
assembling system for ceramic tower

RECIRKULACIJA
recirculation tube for tower

Konzole za istakanje-pivo

Beer tower



FLORIDA 1 GLAVA

KOD CODE	OPIS ARTIKLA DESCRIPTION
5726	Konzola FLORIDA Pozla 1G 5/8 +recirkulacija
5727	Konzola FLORIDA Crom 1G 5/8 +recirkulacija
5728	Konzola FLORIDA Pulira 1G 5/8 +recirkulacija
5729	Konzola FLORIDA Mesin 1G 5/8 +recirkulacija
5730	Konzola FLORIDA Bakar 1G 5/8 +recirkulacija



FLORIDA 2 GLAVE

5751	Konzola FLORIDA Pozla 2G 5/8 +recirkulacija
5752	Konzola FLORIDA Crom 2G 5/8 +recirkulacija
5753	Konzola FLORIDA Pulira 2G 5/8 +recirkulacija
5754	Konzola FLORIDA Mesin 2G 5/8 +recirkulacija
5755	Konzola FLORIDA Bakar 2G 5/8 +recirkulacija



FLORIDA 3/4 GLAVE

5772	Konzola FLORIDA Pozla 3G 5/8 +recirkulacija
5773	Konzola FLORIDA Crom 3G 5/8 +recirkulacija
5774	Konzola FLORIDA Pulira 3G 5/8 +recirkulacija
5775	Konzola FLORIDA Mesin 3G 5/8 +recirkulacija
5777	Konzola FLORIDA Bakar 3G 5/8 +recirkulacija
5776	Konzola FLORIDA Crom 4G 5/8 +recirkulacija
5778	Konzola FLORIDA Pozla 3G 5/8 +recirkulacija



FALKON 1 GLAVA

KOD CODE	OPIS ARTIKLA DESCRIPTION
5841	Konzola FALKON Pozla 1G 5/8 +recirkulacija
5842	Konzola FALKON Crom 1G 5/8 +recirkulacija
5839	Konzola FALKON Pulira 1G 5/8 +recirkulacija
5840	Konzola FALKON Mesin 1G 5/8 +recirkulacija

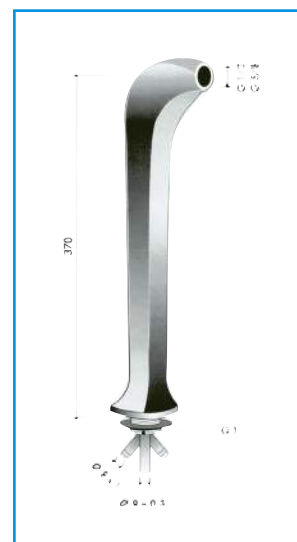

FALKON 2 GLAVE

5845	Konzola FALKON Pozla 2G 5/8 +recirkulacija
5846	Konzola FALKON Crom 2G 5/8 +recirkulacija
5843	Konzola FALKON Pulira 2G 5/8 +recirkulacija
5844	Konzola FALKON Mesin 2G 5/8 +recirkulacija



FALKON 3 GLAVE

5849	Konzola FALKON Pozla 3G 5/8 +recirkulacija
5850	Konzola FALKON Crom 3G 5/8 +recirkulacija
5847	Konzola FALKON Pulira 3G 5/8 +recirkulacija
5848	Konzola FALKON Mesin 3G 5/8 +recirkulacija



FLORIDA MINI 1G

KOD CODE	OPIS ARTIKLA DESCRIPTION
5788	Konzola FLORIDA MINI Pozla 1G 1/2 +rec.
5789	Konzola FLORIDA MINI Crom 1G 1/2 +rec.
5792	Konzola FLORIDA MINI Pozla 1G 5/8 +rec.
5794	Konzola FLORIDA MINI Crom 1G 5/8 +rec.

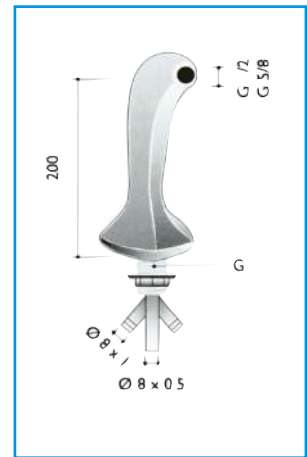

PANAMA 1G

5809	Konzola PANAMA Pozla 1G 5/8 +rec.
5810	Konzola PANAMA Crom 1G 5/8 +rec



DUPIN 1G

5797	Konzola DUPIN Pozla 1G 5/8 +recirkulacija
5798	Konzola DUPIN Crom 1G 5/8 +recirkulacija



BRIDGE TOWER 1 MONTAŽNI

KOD CODE	OPIS ARTIKLA DESCRIPTION
5629 5630 5631 5632 5633	<p>Konzola - Inox puliran Premjer cevi 114mm (Ostale dimenzije po narudzbi)</p> <p>Bridge Tower 3G 740mm Bridge Tower 4G 865mm Bridge Tower 5G 990mm Bridge Tower 6G 1.115mm Bridge Tower 7G 1,240mm</p>

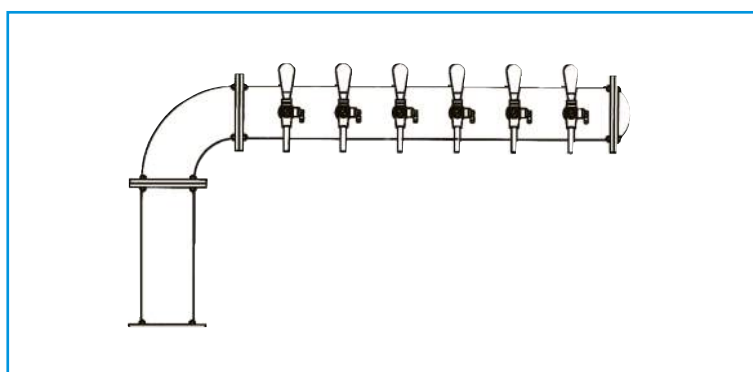

BRIDGE TOWER 2 MONTAŽNI

KOD CODE	OPIS ARTIKLA DESCRIPTION
5639 5640 5641 5642 5643 5644	<p>Konzola - Inox puliran Promjer cijevi 114mm (Ostale dimenzije po narudzbi)</p> <p>Bridge Tower 3G 960mm Bridge Tower 4G 1.085mm Bridge Tower 5G 1.210mm Bridge Tower 6G 1.335mm Bridge Tower 7G 1.460mm Bridge Tower 8G 1.585mm</p>

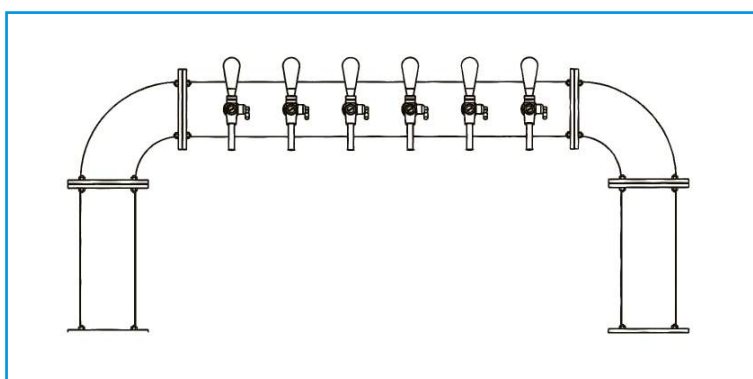

BRIDGE TOWER T-Y

KOD CODE	OPIS ARTIKLA DESCRIPTION
	<p>Konzole se mogu naručiti u INOX puliran i INOX pjeskan u verzijama 1/2 i 5/8 G Promjer konzole 114mm</p>
5647	Bridge Tower 3+3G 1.275mm
5648	Bridge Tower 4+4G 1.525mm
5650	Bridge Tower 5+5G 1.775mm

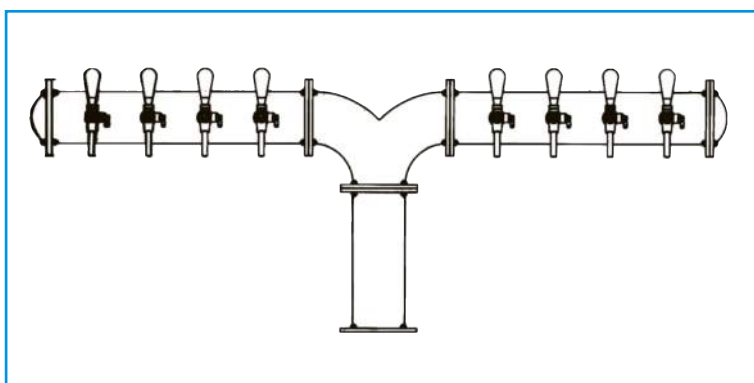

CRIJEVA ZA KONZOLE

KOD CODE	OPIS ARTIKLA DESCRIPTION
	<p>Materijal crijeva AISI.316L - MDP</p>
8530	Crijevo inox 8 mm nipl 1/2 L 1600 mm
8531	Crijevo inox 8 mm nipl 1/2 L 1200 mm
8513	Crijevo inox 8 mm nipl 5/8 L 1600 mm
8514	Crijevo inox 8 mm nipl 5/8 L 1200 mm
8517	Crijevo MDP 8 mm 5/16 nipl 5/8 L 1200 mm
8516	Crijevo MDP 9,5 mm 3/8 nipl 5/8 L 1200 mm



CANADA 3G

KOD CODE	OPIS ARTIKLA DESCRIPTION
	Konzola pozlačena - crom + komplet cirjeva Inox 8mm H 428 mm
5455	Canada 3G pozl 5/8 L 443 mm
5456	Canada 3G crom 5/8 L 443 mm
5459	Canada 3G pozl 1/2 L 443 mm
5460	Canada 3G crom 1/2 L 443 mm

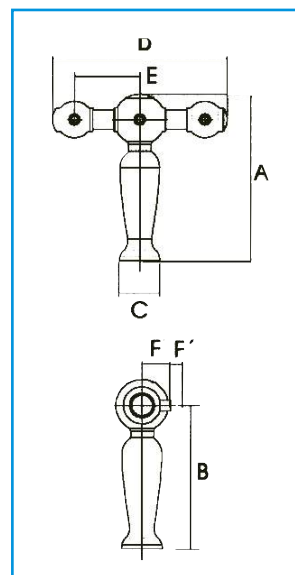

A	428 mm
B	368 mm
C	105 mm
D	443 mm
E	165 mm
F	70 mm
F'	F + 37 mm FLARE

CANADA 5G

Konzola pozlačena - crom + komplet crijeva inox 8mm H 428 mm	
5457	Canada 5G pozl 5/8 L 699 mm
5458	Canada 5G crom 5/8 L 699 mm
5461	Canada 5G pozl 1/2 L 699 mm
5462	Canada 5G crom 1/2 L 699 mm

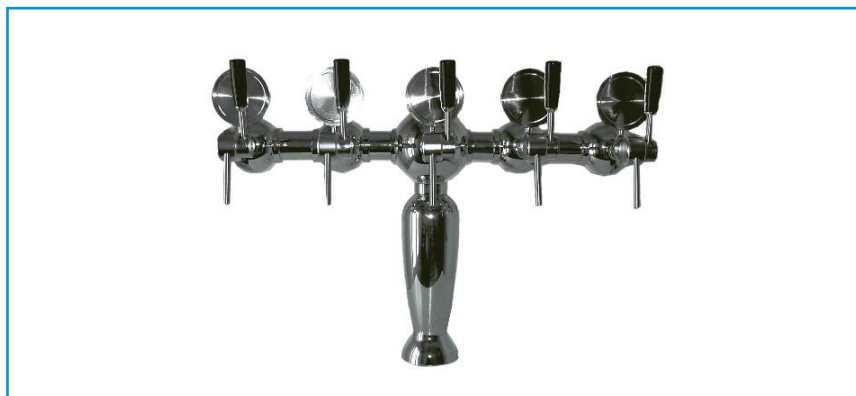
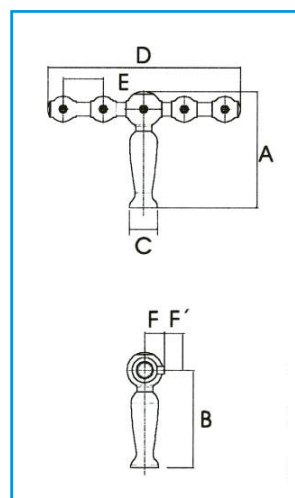

A	428 mm
B	368 mm
C	105 mm
D	699 mm
E	147 mm
F	70 mm
F'	F + 37 mm FLARE

IBIZA 4-5-6G

KOD <i>CODE</i>	OPIS ARTIKLA <i>DESCRIPTION</i>	
	Konzola INOX 4-5-6P H570mm	
5661	Ibiza 4P 5/8 INOX L 680mm	
5662	Ibiza 5P 5/8 INOX L 680mm	
5663	Ibiza 6P 5/8 INOX L 680mm	
8513	Cev inox 1600mm 5/8	
8514	Cev inox 1200mm 5/8	
8517	Cev MDP 8mm 5/16 1400 cod. 5/8	
8516	Cev MDP 9,5mm 3/8 1400 cod. 5/8	

**MALAGA 4-5-6G**

	Konzola INOX 4-5-6P H570mm	
5664	Malaga 4P 5/8 INOX L 757mm	
5665	Malaga 5P 5/8 INOX L 757mm	
5666	Malaga 6P 5/8 INOX L 822mm	
8513	Cijev inox 1600mm 5/8	
8514	Cijev inox 1200mm 5/8	
8517	Cijev MDP 8mm 5/16 1400 cod. 5/8	
8516	Cijev MDP 9,5mm 3/8 1400 cod. 5/8	



TUDOR BEER TOWER 1-2G

KOD <i>CODE</i>	OPIS ARTIKLA <i>DESCRIPTION</i>
5680 5681	Konzola INOX 1-2P H600mm diam. 89mm TUDOR inox 1P 5/8 600mm TUDOR inox 2P 5/8 600mm (Komplet s cijevima za recirkulaciju)



TEE BEER TOWER 3-4-5G

5683 5684 5685	Konzola TEE INOX 4-5-6 H530mm Konzola TEE inox 3P 5/8 L 290 mm Konzola TEE inox 4P 5/8 L 378 mm Konzola TEE inox 5P 5/8 L 470 mm (komplet za recirkulaciju)
----------------------	---



OLD PUB TOWER 1G

5803 7228 6390 6392	Konzola 1G montirano preko vijaka H550 Old Pub 1G ott Slavina .FB mesing BI 60mm Ručica bijela Ručica drvo
------------------------------	--



HIDRA 3G		
KOD CODE	OPIS ARTIKLA DESCRIPTION	
5710	Konzola koja omogućava do 3 vode HIDRA 3G	
BISTRA 3G		
5713 5713K	Konzola koja nama omoguca do 3 vode (Upravljanje prek elektroventilov) BISTRA 3G Kit elektroventilov	
BUNAR 3G		
5711 5712 5712K	Nosilec ki nam zagotavlja dotok 3 vod (Krmiljenje prek elektroventilov) IZVIR mini 3P IZVIR plus 3P Kit elektroventili	



KERAMIKA mod MADRID 130mm		
KOD CODE	OPIS ARTIKLA DESCRIPTION	
5672 5673	Keramika bijela prsten zlat. KeramiKa bijela prsten plat.	
KERAMIKA mod PRAGA 130mm		
5674 5675	Keramika bijela prsten zlat. KeramiKa bijela prsten plat.	
KERAMIKA mod ATENE 130mm		
5552 5553	Keramika bijela prsten zlat. KeramiKa bijela prsten plat.	
KONZOLA OD DRVETA		
5671 5670 5678	Konzola od drva boja hrast Konzola od drva boja orah Maska drvene bačve	
REKLAMNA KERAMIKA		
6017 6018	Reklamna keramika bijela Reklamna leča 3D	

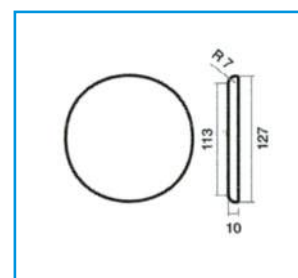
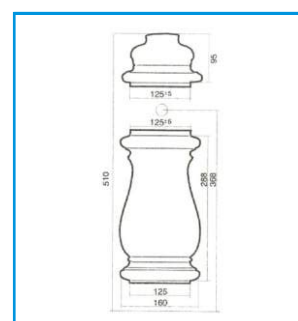
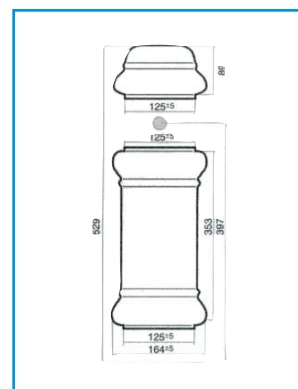
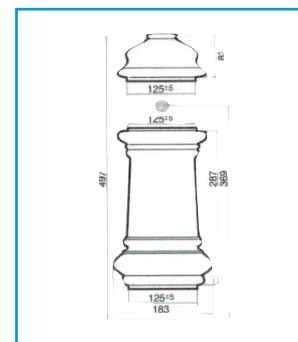
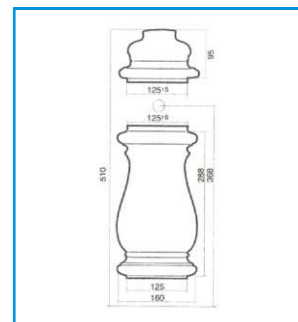

Dispense fonts

Dispense fonts

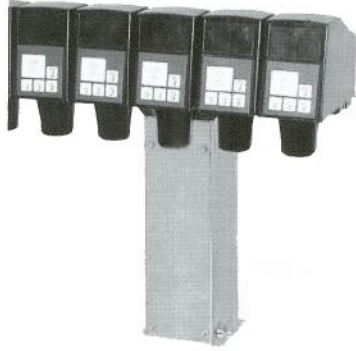
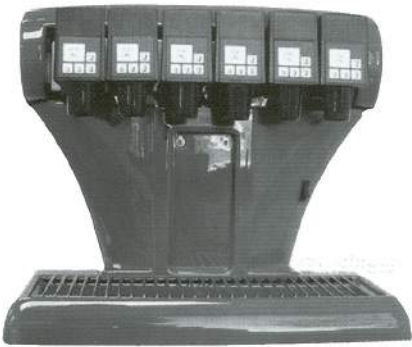

ODSTOJNICI

CODA <i>CODE</i>	OPIS ARTIKLA <i>DESCRIPTION</i>
6151	Pozlačen 23 mm
6152	Crom 23 mm
6153	Puliran 23 mm
6154	Mesing 23 mm
6195	Podaljšek poz.
6197	Podaljšek crom.
6196	Podaljšek.mesing



REKLAMNE MEDALJE OKRUGLI/OVAL

REKLAMNE MEDALJE OKRUGLI/OVAL	
	Reklamni medaljon z distančnikom
6158	Pozlačen okr. 1P
6161	Crom okr. 1P
6164	Puliran okr. 1P
6170	Mesing okr. 1P
6161H	Crom okr. (clip)
6159	Pozlačen oval. vert.1P
6162	Crom oval. Vert. 1P
6165	Puliran oval. Vert. 1P



REKLAMNI MEDALJONI

REKLAMNI MEDALJONI	
	Reklamni medaljon s nastavkom 6mm
6100	R.M.mesing okr.jednostruki
6101	R.M.mesing oval.vert.jednostruki
6103	R.M.krom okr.jednostruki
6104	R.M.krom oval.vert.jednostruki
6106	R.M.mesing okr.dvostruki
6107	R.M.mesing oval.vert.dvostruki
6109	R.M.krom okr.dvostruki
6110	R.M.krom oval.vert.dvostruki
6112	R.M.mesing okr.trostruki
6113	R.M.mesing oval vert.trostruki
6115	R.M.krom okr.trostruki
6116	R.M.krom oval vert.trostruki



KIT DIM.120-DIM.130-DIM.150

KOD <i>CODE</i>	OPIS ARTIKLA <i>DESCRIPTION</i>
6500	Kit inox pozl dim.120 1F
6501	Kit inox pozl dim.120 2F
6502	Kit inox dim.120 1F
6503	Kit inox dim.120 2F
6510	Kit inox pozl. dim.130 1F
6511	Kit inox pozl. dim.130 2F
6509	Kit inox pozl. dim.130 3F
6512	Kit inox dim.130 1F
6513	Kit inox dim.130 2F
6514	Kit inox dim.130 3F
6521	Kit inox pozl. dim.150 2F
6522	Kit inox pozl. dim.150 3F
6523	Kit inox dim.150 1F
6524	Kit inox dim.150 2F
6525	Kit inox dim.150 3F



KIT KONZOLA 320mm-450mm-650mm

6587	Kit Inox dim.130/320mm
6588	Kit Inox pozl. dim.130/320mm
6590	Kit Inox dim 130/450mm
6591	Kit Inox pozl. dim 130/450mm
6593	Kit Inox dim 130/650mm
6594	Kit Inox pozl. dim 130/650mm



MONTAŽNI KIT PVC

6597	Montažni kit dim 120
6598	Montažni kit dim 130/150





SLAVINE ZA TOČENJE Taps

SLAVINE ZA PIVO
beer taps

SLAVINE ZA PIVO DSI
dsi beer taps

SLAVINE ZA PIVO ALUMASC
alumasc beer taps
SLAVINE PRE-MIX CMB
cmb pre-mix taps

PIŠTOLJ WUNDER BAR
bar valve wunder bar

PIŠTOLJ SELTZ
bar valve soda

VENTILI POST-MIX
post-mix valve

KIT KONZOLA 320mm-450mm-650mm

CODA <i>CODE</i>	OPIS ARTIKLA <i>DESCRIPTION</i>
6488	Canotto ottone G1 L150
6490	Canotto ottone G1-1/2 L130



RICIRKULACIJA-CEVI

8500	Ric.5/8 dir 40mm
8501	Ric.5/8 90° 40mm
8502	Ric.5/8 90° 610mm
8506	Ric.inox 2x10mm 1x7mm
8507	Ric.inox diam.8-650mm
8508	Ric.inox diam.7- 40mm
8509	Ric.inox diam.10-40mm
8518	Ric.MDP 8mm (5/16) L1200mm
8519	Ric.MDP 9,5mm (3/8) L1200mm
8510	Ric. Pvc 10mm
PIUB16S	Ric.JG diam. 3/8 9,5
8513	Cev inox 8mm cod 5/8 L1600mm
8514	Cev inox 8mm cod 5/8 L1200mm
8515	Cev inox 6mm cod 5/8 L1600mm
8517	Cev MDP 8mm (5/16) cod 5/8 L1200mm
8516	Cev MDP 9,5mm (3/8) cod 5/8 L1200mm



SLAVINA FB INOX-COMPENSATOR

CODA
CODE

OPIS ARTIKLA
DESCRIPTION

7200	F.B Inox mesing B.I.5/8
7201	F.B Inox mesing B.P.5/8
7202	F.B Inox puliran B.I.5/8
7203	F.B Inox puliran B.P.5/8
7205	F.B Inox puliran WHT



SLAVINA FB -COMPENSATOR

KOD
CODE

OPIS ARTIKLA
DESCRIPTION

7230	F.B pozlačen I.Inox. 5/8 35mm
7232	F.B pozlačen I.Plas. 5/8 35mm
7229	F.B pozlačen I.Inox. 5/8 47mm
7234	F.B pozlačen I.Plas. 5/8 47mm
7228	F.B pozlačen I.Inox. 5/8 60mm
7235	F.B pozlačen I.Plas. 5/8 60mm
7220	F.B pozlačen I.Inox. 1/2 35mm

7376 F.B mesing I.Inox. 5/8 35mm

7251	F.B krom I.Inox. 5/8 35mm
7253	F.B krom I.Plas. 5/8 35mm
7257	F.B krom I.Inox. 5/8 47mm
7255	F.B krom I.Plas. 5/8 47mm
7258	F.B krom I.Inox. 5/8 60mm
7256	F.B krom I.Plas. 5/8 60mm
7221	F.B krom I.Inox. 1/2 35mm

7260 F.B Plast. KROM. I.Plas 5/8 35mm

7261 F.B Plast. Pozlač. I.Inox 5/8 35mm

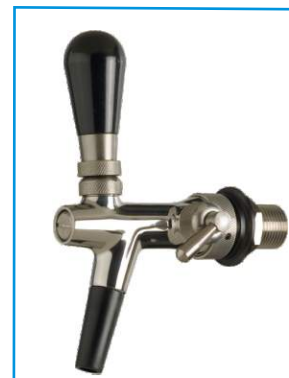

SLAVINA BEZ KOMPENZATORA

KOD CODE	OPIS ARTIKLA DESCRIPTION
7231	F.B Pozl. I.Inox. 5/8 35mm
7233	F.B Pozl. I.Plas. 5/8 35mm
7252	F.B Krom I.Inox. 5/8 35mm
7254	F.B Krom I.Plas. 5/8 35mm



SLAVINA NC- DIREKT -Spherix

7366	Spherix krom 1/2 I.Inox. 11mm
7367	Spherix pozl. 1/2 I.Inox. 11mm
7370	Spherix krom 5/8 I.Inox. 35mm
7371	Spherix pozl. 5/8 I.Inox. 35mm
7368	Spherix krom 5/8 I.Inox. 11mm
7369	Spherix pozl. 5/8 I.Inox. 11mm
7363	Spherix krom 5/8 I.Inox. 10mm
7364	Spherix pozl. 5/8 I.Inox. 10mm



SLAVINA - STOUT

7386	FB STOUT Krom. 35mm 5/8
7387	FB STOUT Pozlačeno 35mm 5/8
7388	FB STOUT Krom. 35mm 1/2
7389	FB STOUT Pozlačeno 35mm 1/2



DIJELOVI SLAVINA FB

7358	Kit OR EPDM za slavinu PIVO NC
7365	Kit OR silikon za slavinu INOX
7355	Kit OR EPDM za slavinu PIVO
7308	Istočnik inox 1,754
7309	Istočnik plastika
7360	Sistem za čišćenje FB
6349	Ručka Faggio 39x131
6330	Ručka Faggio 32x150



SLAVINA mod.BT 1051 DSI**KOD**
*CODE***OPIS ARTIKLA**
*DESCRIPTION*7281
7282BT Krom. 5/8 35mm
BT Krom. 5/8 55mm7283
7284BT Mesing 5/8 35mm
BT Mesing 5/8 55mm**SLAVINA mod.BT 1052 DSI**7265
7266BT Krom. 5/8 35mm
BT Krom. 5/8 55mm7267
7268BT Mesing 5/8 35mm
BT Mesing 5/8 55mm**SLAVINA mod.B.O. BT DSI**7269
7270BO Krom. 5/8 35mm
BO Mesing 5/8 35mm

SLAVINA ALUMASC PLASTIK

KOD CODE	OPIS ARTIKLA DESCRIPTION
7298	BEZ KOMPENZATORA MK3 QAVF 5/8 35mm
7299	MK6 QAVF 1/2 25mm
7240	MK4 QAVF 1/2 15mm JG 3/8 (STOUT)
7296	BEZ KOMPENZATORA MK3 QA 5/8 25mm
7297	MK3 QA 1/2 25mm
7239	MK4 QA 1/2 15mm JG 3/8 (STOUT)



SLAVINA ALUMASC MESING

7241	BEZ KOMPENZATORA MK6 QA ott 5/8 25mm
7292	MK6 QA ott 1/2 25mm
7242	MK6 QA crom 5/8 25mm
7293	MK6 QA crom 1/2 25mm



SLAVINA ALUMASC INOX

7287	BEZ KOMPENZATORA MK6 QA SS Creamer Tap 1/2(STOUT)
------	--



NADOMESTNI DELI TOČ.PIP ALUMASC

6372	Rocka les. P149
6398	Rocka les. P95
9371	Distančnik rocke crom.
9372	Distančnik rocke mesing.



SLAVINA PRE-MIX 24V SK 215-18

KOD
CODE

OPIS ARTIKLA
DESCRIPTION

7277
7278

Premix PX100A1
Premix PX100A2



SLAVINA CMB

7244
7245

CMB crno 7/16
CMB crvena 1/2

7250

CMB crno 7/16



7390
7391

CMB SPEEDY s komp. 5/8
CMB SPEEDY s komp. 1/2

7390/18

OR crveni



BAR VENTIL WUNDER BAR PRE MIX

KOD <i>CODE</i>	OPIS ARTIKLA <i>DESCRIPTION</i>
5050	Pre-Mix 5P
5048	Pre-Mix 6P
5046	Pre-Mix 7P

**BAR VENTIL WUNDER BAR VINO**

5016	Pre-Mix za vino 4P
------	--------------------

**BAR VENTIL WUNDER BAR POST MIX**

5049	Post-Mix 8P WBM841
5034	Post-Mix 8P WBM841 120cm
5035	Post-Mix CC crvena 8P con Flow control
5032	Post-Mix PC modra 8P za Flow control
9324	Kit za popravak Wunder Bar
9810	Separator dos za Wunder Bar
9601	Svijetleća podloga WB (Coca Cola/Pepsi Cola)

**PIŠTOLJ SELTZ**

5047	Pištolj SELTZ
------	---------------



POST-MIX VENTIL FLOMATIC

KOD CODE	OPIS ARTIKLA DESCRIPTION
5041	Flomatic 424-CF-E35-1521 3,0oz(24V)
5040	Flomatic 424-CF-P35-1500 3,0oz(PC)
5033	Flomatic 424-CF-1521 3,0oz (Man)
5038	Montažni blok
5036	Konzola S+Vite
5037	Električni kablei
5039 4,290	Spojница 7mm
9809	Brix Kit Flomatic



POST-MIX VENTIL LANCER

5025	Lancer 24V+soda 3,0 oz/sec
5029	Konzola S+viljci
5026	Električni kablei
5027	Spojница inox dir. 4,4mm
5028	Spojница 90° 7mm
9813	Separator soka



REZERVNI DIJELOVI SUSTAVA ZA PIVO

Beer Accessories

PULTOVI ZA TOČENJE HLADNA BAČVA
refrigeration cabinet

DIJELOVI PULTOVA ZA TOČENJE ZA PIVO
refrigeration unit

DIJELOVI PULTOVA ZA TOČENJE
components for cabinet

PULTOVI ZA TOČENJE UNIBAR
bar counter

KOMORA ZA HLAĐENJE - MULTISYSTEM
modular cellar box

AGREGATI ZA HLAĐENJE - PIVO
party beer coolers

DRVENI PULTOVI ZA TOČENJE
wooden counters

DRVENE PODSTAVE
wooden cases

DRŽALA ZA ČAŠE
glass holder

MIJEŠALO CO2-N2
carbomix

GENERATOR N2
nitrogen generator

REGULATORI PROTOKA
flow controller

FOBSTOP PIVO
fob detector - fob shurflo

SISTEMI ZA PRANJE
sink driptrays base

SISTEMI ZA PRANJE ČAŠA
glass washer - glass rinser

SABIRNICI
Driptrays

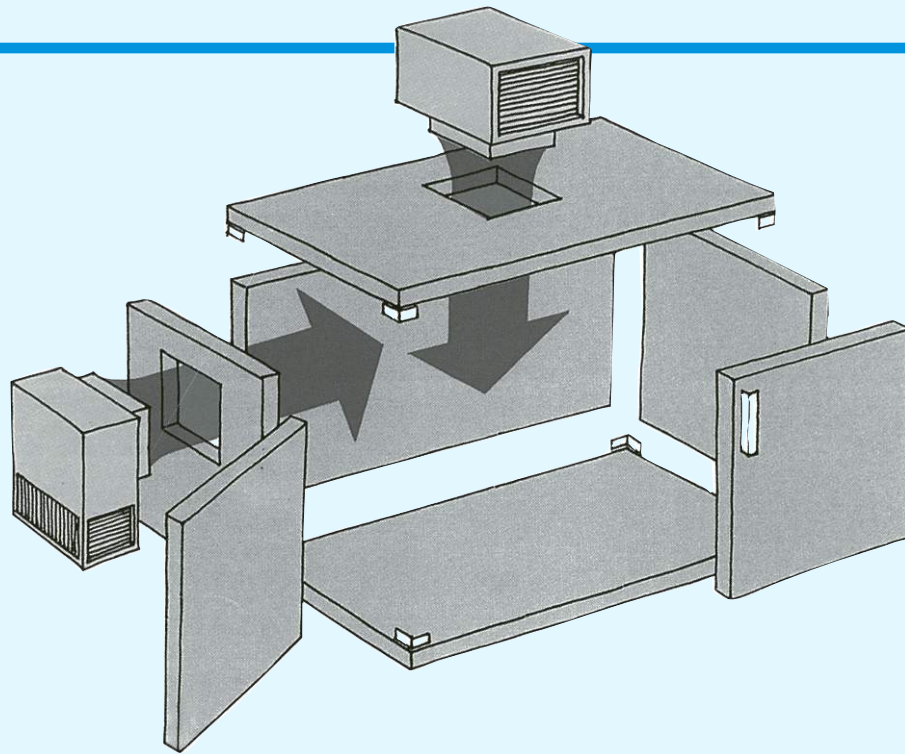

TIPO/TYP TYPE/TYP	400 FKV-FKE 2/2	660 FKV-FKE 4/4	570 FKV-FKE 3/3	945 FKV-FKE 6/6	750 FKV-FKE 4/4 linea	1235 FKV-FKE 8/8	1480 FKV-FKE 10/10
Vanjski(mm) External Exterieur Aussen +300 mm gruppo frig. + Chiller 300 mm + Groupe frig. 300 mm + Aggregat 300 mm	1075x595x1020	1075x965x1020	1465x635x1020	1465x965x1020	1885x635x1020	1885x965x1020	2215x965x1020
Unutarnji (mm) Internal Interieur Innen	945x470x835	945x840x835	1335x510x835	1335x840x835	1755x510x835	1755x840x835	2085x840x835
Litri / Liter Litres / Liter	400	660	570	945	750	1235	1485
50 L Euro KEG	2	4	3	6	4	8	10
50 L DIN KEG	2	4	3	6	4	8	10
Vrata/ Doors Portinos / Tueren	2	2	2	2	2	2	2
Noge / Feet Pieds / Verstellb. Füße	4	4	6	6	6	6	8
Unutarnji Internal Interieur Innen	ABS - Acciaio - Lamiera zincata ABS - Steel - Galvanizedl ABS - Acier - Toile zinguée ABS - Stahl - Verzinkt	ABS - Acciaio - Lamiera zincata ABS - Steel - Galvanizedl ABS - Acier - Toile zinguée ABS - Stahl - Verzinkt	ABS - Acciaio - Lamiera zincata ABS - Steel - Galvanizedl ABS - Acier - Toile zinguée ABS - Stahl - Verzinkt	ABS - Acciaio - Lamiera zincata ABS - Steel - Galvanizedl ABS - Acier - Toile zinguée ABS - Stahl - Verzinkt	ABS - Acciaio - Lamiera zincata ABS - Steel - Galvanizedl ABS - Acier - Toile zinguée ABS - Stahl - Verzinkt	ABS - Acciaio - Lamiera zincata ABS - Steel - Galvanizedl ABS - Acier - Toile zinguée ABS - Stahl - Verzinkt	ABS - Acciaio - Lamiera zincata ABS - Steel - Galvanizedl ABS - Acier - Toile zinguée ABS - Stahl - Verzinkt
Polica unutarnja Internal floor Planchet nterieur Boden innen	acciaio steel acier Stahl	acciaio steel acier Stahl	acciaio steel acier Stahl	acciaio steel acier Stahl	acciaio steel acier Stahl	acciaio steel acier Stahl	acciaio steel acier Stahl
Izolacija poliretan Polyurethane insulation Isolation polyuréthane Pu-Isolierung	42 mm.	42 mm.	42 mm.	42 mm.	42 mm.	42 mm.	42 mm.
Jačina kompresora Refrig. unit power Puissance Groupe frig. Leistung Aggregat	1/4 HP	1/4 HP	1/4 HP	1/4 HP	1/4 HP	1/4 HP	1/4 HP

FKV - Fasskühler Rapid Verzinkt - Galvanized refrigerant cabinet - Refrigerateur pour la biere en toile zinguée - Pult za točenje piva pocinkana
FKE - Fasskühler Rapid Edelstahl - Steel refrigerant cabinet - Refrigerateur pour la biere en acier - Banco birra in acciaio

KOMORA ZA HLAĐENJE

KOD CODE	OPIS ARTIKLA DESCRIPTION
	Paneli za slaganje za hladne komore Za bačve - pivo
7651-S	FKV 2/2 IN LINEA
7666-S	FKV 3/3 IN LINEA
7666-F	FKV 3/3 H975
7652-S	FKV 4/4
7653-S	FKV 4/4 IN LINEA
7654-S	FKV 6/6
7656-S	FKV 8/8
7656-F	FKV 8/8 H975
7657-S	FKV 10/10

KOMORA ZA HLAĐENJE

	Paneli za slaganje za hladne komore Za bačve - pivo
7651V	FKV 2/2 IN LINEA
7666V	FKV 3/3 IN LINEA
7652V	FKV 4/4
7653V	FKV 4/4 IN LINEA
7654V	FKV 6/6
7656V	FKV 8/8
7657V	FKV 10/10



RASHLADNI AGREGATI BIBE -obtok

KOD <i>CODE</i>	OPIS ARTIKLA <i>DESCRIPTION</i>	
7677-BR	Seriya "BIBE" vodni bazen 30LT optočna pumpa 7,5MT BIBE 1/3HP + RIC	1 275 945
7677-BRWC	BIBE 1/3HP WATER COND. + RIC	
7677-BR-R	BIBE 1/3HP SPLIT	



RAZHILADNI AGREGAT FK horizontalni

	Seriya "UMTO" horizontalan (N razpolaganju +15<>+18)	
7645	UMTO 08/45 1/3HP	
7646	UMTO 10/45 3/8HP	
7646-WC	UMTO 10/45 3/8HP WATER COND.	
7646-R	UMTO 10/45 3/8HP SPLIT	

RASHLADNI AGREGAT FK vertikalni

	Seriya " UMTL" vertikaln	
7645V	UMTL 08/45 1/3HP	
7646V	UMTL 10/45 3/8HP	
7646-VWC	UMTL 10/45 3/8HP WATER COND	
7646-VR	UMTL 10/45 3/8HP SPLIT	



REZERVNI DIJELOVI

	Rezervni dijelovi pulta FKV / UMTO-L / BIBE	
7720	Zatvarač	
7721	Gumica od vrata	
7722	Spojnik unutarnji	
7723	Podešavajuća konzola	
7740-SX	Vrata lijeva	
7740-DX	Vrata desna	
7733	Ventilator uzdužni .180mm	
7734	Ventilator uzdužni .240mm	
7811	Term.RANCO K50H2005	
7814	Term.RANCO K50P1115	
7730	Timer za otopljanje	
7731	Valjasta tuljava	
7732	Blocco Finder	
7736	Rele BIBE	
7103	Optočna pumpa MT8 (BIBE)	
8684	Elektroventilator 10W	

PULTEVI ZA HLAĐENJE mod.UNIBAR

KOD <i>CODE</i>	OPIS ARTIKLA <i>DESCRIPTION</i>
	KOMORE ZA HLAĐENJE TEM.SEKTOR +2/+8°C INOX- STAKLENA VRATA
R015402DXG RO21403DX RO27404DX	UNIBAR 1540x540x910/960 373L UNIBAR 2140x540x910/960 573L UNIBAR 2740x540x910/960 772L
	MOD. DIJELOVI SKLOPOVA TERMOSTAT VENTIL
SG12002DXG SG18003DXG SG24004DXG	UNIBAR 1200x540x910/960 373L UNIBAR 1800x540x910/960 573L UNIBAR 2400x540x910/960 772L
7760	JEDINICA ZA KONDENZATOR
7755	JEDINICA ZA 2 LADICE

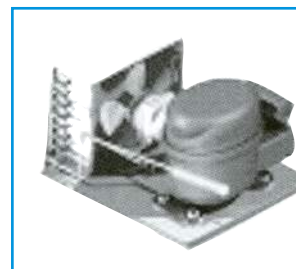

KOMORA ZA HLAĐENJE MULTI SYSTEM po mjeri

KOD
CODE

OPIS ARTIKLA
DESCRIPTION

Tehničke karakteristike standard:

Dimenzija min 1350x1350mm

Dimenzija max 8630x8630mm

Sastavne ploče lim - bijela barva

3 Visina standard 2030-2230-2430mm

3 Debljina 60-80-100mm

Limeno pojačanje

Profili utor.

Vrata standard 950x1800mm obrubljena DX

Dodaci:

Termička vrata 80x80-80x120-80x180-80x200

120x120-120x160-120x200

Kit rasvjete 1x36W- 2x36W-

Polica 600x1200L

Agregati za hlađenje:

Montažni blok Min. 1/2HP 6mc

Max. 4HP 56mc

7751
7750

MULTI SYSTEM po mjeri
Izgrađen iz jednog dijela po narudžbi



PIVO BAR 20 L

KOD <i>CODE</i>	OPIS ARTIKLA <i>DESCRIPTION</i>	
	Kapacitet: 2 soda 20 L Dimenzije zun: 600x615x835mm	
	Mobilni pult -pocin.ploča Radna ploča INOX- AISI 304 Temperatura +3<>+12°C	
5390	PIVO Bar 2F 20L	
5727	Florida krom 1P	
7251	Slavina krom. 5/8 . 35mm	
6161	Reklamni medaljon krom.	
6602	Sabirnik, inox 400x220	
8400	Priklop ventil not. 7Mmm	
7430	Reduc. Ventil. Co2 1P	



PULT ZA TOČENJE KEGGY SYSTEM

KOD <i>CODE</i>	OPIS ARTIKLA <i>DESCRIPTION</i>	
5275	Napetost: 230 V 50Hz Kompresor: 1/3 HP R134A 1/2 HP R/134 A Radna temperatura: M1 (-1-+15°C) Keggy system	



PULT ZA HLADENJE - HLADNA BAČVA

KOD <i>CODE</i>	OPIS ARTIKLA <i>DESCRIPTION</i>	
7600	Izgrađen od masivnog drva Radni pult obložen-inox Dvojna radna vrata Pod presvučen u alum.ploču Pripravljen za domontažu kolica	
7601	1000 x 700 x 1080H	
7603	1400 x 700 x 1080H	
7603	1800 x 700 x 1080H	



PULT ZA HLAĐENJE-PIVO-HLADNA BAČVA

KOD <i>CODE</i>	OPIS ARTIKLA <i>DESCRIPTION</i>	
	Izgrađen od masivnog drva Radni pult obložen-inox Dvojna radna vrata Pod presvučen u alum.ploču Pripravljen za domontazu kolica	
7604	1000 x 750 x 1080H	
7605	1400 x 750 x 1080H	
5359	Agregat za hlađenje H35 1/5HP	
7030	1° spir mt 15	
7031	2° spir mt 13	
7027	3° spir mt 12	



DRVENE PODSTAVE

KOD <i>CODE</i>	OPIS ARTIKLA <i>DESCRIPTION</i>
9313 9314	Mohagonij L450 P180 H220mm Orah L450 P180 H220mm
9309 9310	Mohagonij L600 P180 H220mm Orah L 600 P180 H220mm
9311 9312	Mohagonij L750 P180 H220mm Orah L750 P180 H220mm
9316 9321	Mohagonij L1000 P180 H220mm Orah L1000 P180 H220mm
9315 9322	Mohagonij L450 P180 H400mm Orah L450 P180 H400mm
9369 9370	Mohagonij L600 P180 H400mm Orah L600 P180 H400mm
9364 9365	Mohagonij L750 P180 H400mm Orah L750 P180 H400mm
9366 9367	Mohagonij L1000 P180 H400mm Orah L1000 P180 H400mm

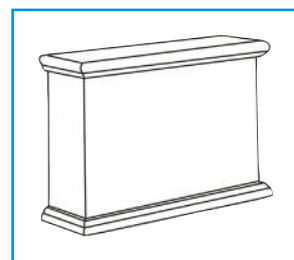
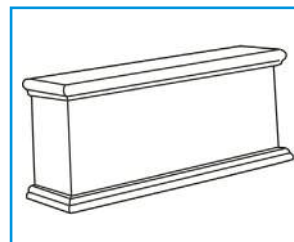

DRŽAČI ZA ČAŠE

KOD CODE	OPIS ARTIKLA DESCRIPTION
7620	Mesing 700mm
7621	Krom 700mm
7622	Mesing 700mm bez nastavka
7623	Krom 700mm bez nastavka
7624	Mesing 1250mm
7625	Krom 1250mm
7626	Mesing 1250mm bez nastavka
7627	Krom 1250mm bez nastavka
7628	Mesing 1650mm
7629	Krom 1650mm
7630	Mesing 1650mm brez pal
7631	Krom 1650mm brez pal
7637	Držači za čaše krom
7638	Držači za čaše mesing

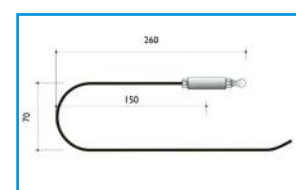
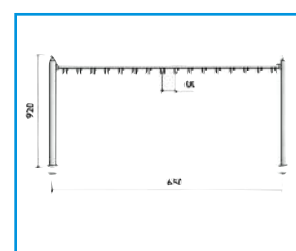
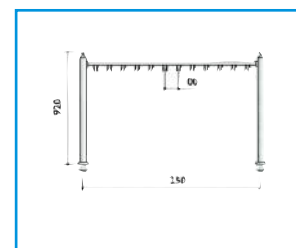
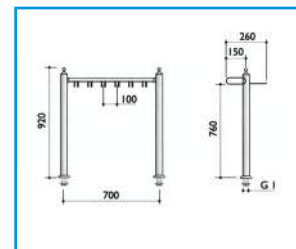

KOD CODE	OPIS ARTIKLA DESCRIPTION
	<p>TEHNIČKE KARAKTERISTIKE Dimenzije 480x380x940H Teža KG 75 Tlak max. 10BAR v rezervoar 250L Direktni tlak max. 7BAR Priključna napetost 230 Vac /50Hz Moč/apsorbiranja 600W - 4,9° Čistoća N2 (% na volumen) 99,9%</p> <p>DODATNI DIJELOVI Visokotlačni rezervoar komplet s cijevima Sigurnosni ventil manometer Pripravljeno za priključenje MICRO MIX90. Volumen rezervoara 250L (tlak 3BAR (g) 1750L za 3 h djelovanja (tlak max.a 10BAR(g) Zgotovljena čistoća (99,5%)</p>
5971	Generator MICRO MIX 90
5972	Rezervoar 250L
5973	Maint kit 1
5974	Maint kit 2



REGULATOR PROTOKA DIGMESA

KOD <i>CODE</i>	OPIS ARTIKLA <i>DESCRIPTION</i>
5968	Volumetrijski brojač +turbina 3/8
5965	Turbina FFB2
5967	Turbina FFB4 pin 3/8
5966	FC REGULATOR PROTOKA DIGMESA
5969	Volumetrijski brojač CONTROLLER 4 x 4 pin
5967	FC Programmer DIGMESA



MIJEŠALO N2-CO2

5970	<p>Miješalo 2 ulaza 70/30-50/50</p> <p>Miješalo CO2-N2</p>
------	--



REGULATOR PROTOKA

KOD <i>CODE</i>	OPIS ARTIKLA <i>DESCRIPTION</i>
5483	Regulator protoka 803097KS2 3/8x8/8 JG
5482	Regulator protoka 802860KS2 3/8x5/16 JG
5484	Regulator protoka 802482KS2 5/16x5/16 JG

**FOB DETECTOR**

5951	SOLENT FOB DETECTOR 3/8 JG
5059	Nadomjesno tijelo za FOB
5060	Zatvorna kugla od FOB
5080	Nadomjesni obroč FOB

**FOB STOP SHURFLO**

5952	FOB STOP PIVO 1/2
5955	FOB STOP PIVO 5/8
5953	FOB STOP PRE-MIX 7/16
5954	FOB STOP PRE-MIX 1/2



KORITA INOX**KOD**
*CODE***OPIS ARTIKLA**
DESCRIPTION

Na raspolaganju H50mm H45mm

6751
6752
6753
675480x50 2 korita centr
100x50 2 korita sx
100x50 2 korita dx
100x50 2 korita centr**INOX KORITO ZA PRANJE ČAŠA**

Na raspolaganju H50mm H45mm

6777
6779
6698
9150Korito inox 500x300x50
Korito inox 500x300x45
Kit optok G1/2
PVC za optok 1/2-16mm**DIJELOVI**6765
6790
6767Optok kombiniran PVC
Pipa kromirana
Uvijek pun nivo PVC6770
6750Cijedilo inox
Lopata inox

DIJELOVI ZA PRANJE

KOD <i>CODE</i>	OPIS ARTIKLA <i>DESCRIPTION</i>
6769	Spulboy Twin-Go T
6778	Spulboy Neptun T2000
6766	Četka tripla (18-18-18)
6766-S	Četka tripla (18-25-18)
6766-T	Četka tripla (25-25-25)
6711	Mrežica za drenažu čaša
9704	Tablete (192dosi)
9705	Deterđent KG 1
9830	Četka KEG 80mm
9831	Četka KEG 40mm

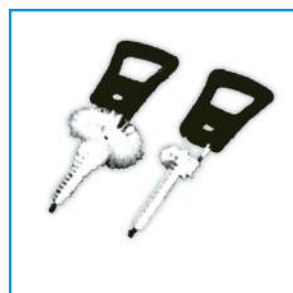
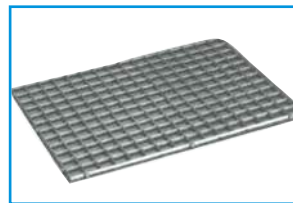

KIT ZA HLAĐENJE ČAŠA

KOD CODE	OPIS ARTIKLA DESCRIPTION
6699	(Kit za hlađenje čaša s optokom) Kit za hlađenje čaša ABS belo
6699/T	Kit za hlađenje čaša - križ
6696	Kit za hlađenje čaša PVC
6698 9150	Kit optok G 1/2 Spojnica PVC za istakanje 1/2 16mm



DODACI ZA KONZOLE ZA TOČENJE

6898	Dodatak STD s cjedilom za točenje
------	-----------------------------------



SABIRNIK P40

KOD <i>CODE</i>	OPIS ARTIKLA <i>DESCRIPTION</i>
6740	40x40x4 inox + hlađenje čaša
6743	50x40x4 inox + hlađenje čaša
6742	60x40x4 inox + hlađenje čaša
6748	70x40x4 inox + hlađenje čaša
6741	38,5x40,5X5 inox + hlađenje čaša
6729	40x40x4 inox
6730	60x40x4 inox
6737	80x40x4 inox
6744	40x40x4 mesing+hlađenje čaša
6746	60x40x4 mesing+hlađenje čaša
6749	80x40x4 mesing+hlađenje čaša
6727	40x40x4 mesing
6728	60x40x4 mesing
6738	80x40x4 mesing

**SABIRNIK P50**

Na raspolaganju H50mm H45mm	
6725	60x50 inox+hlađenje čaša
6780	80x50 inox+hlađenje čaša
6781	100x50 inox+hlađenje čaša
6731	60x50 inox
6733	80x50 inox
6735	100x50 inox
6726	60x50x5 mesing+hlađenje čaša
6786	80x50x5 mesing+hlađenje čaša
6787	100x50x5 mesing+hlađenje čaša
6732	60x50x5 mesing
6734	80x50x5 mesing
6736	100x50x5 mesing

**SABIRNIK PX50I**

Na raspolaganju H50mm H45mm	
6796	50x50x5 inox
6771	80x50x5 inox
6772	100x50x5 inox



SABIRNIK PLUS 150X220

CODA CODE	OPIS ARTIKLA DESCRIPTION
6600	Inox 150x220
6640	Inox 150x220+H.kozarcev
6612	Mesing. 150x220



SABIRNIK PLUS 400X220

6601	Inox 400x220
6613	Mesing. 400x220
6618	Inox 400x220 + hlađenje čaša
6630	Mesing. 400x220 + hlađenje čaša
6603	Inox 400x220 d.130
6604	Inox 400x220 d.150
6615	Mesing. 400x220 d.130
6616	Mesing. 400x220 d.150
6646	Mesing. 400x220 d.170
6620	Inox 400x220 d.130 + hlađenje čaša
6621	Inox 400x220 d.150 + hlađenje čaša
6628	Mesing. 400x220 d.130 + hlađenje čaša
6631	Mesing. 400x220 d.150 + hlađenje čaša

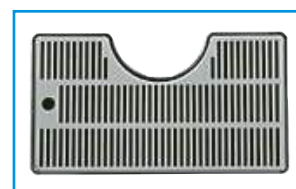
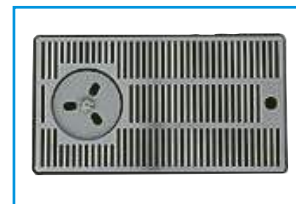

SABIRNIK 500X250

	(Na raspolaganju D. 180 / 250)
6605	Inox 500x250 d.210
6617	Mesing. 500x250 d.210
6622	Inox 500x250 d.210 + hlađenje čaša
6632	Mesing. 500x250 d.210 + hlađenje čaša

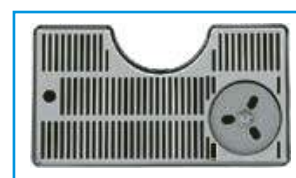

SABIRNIK PLUS 600X220

KOD <i>CODE</i>	OPIS ARTIKLA <i>DESCRIPTION</i>
6602	Inox 600x220
6614	Mesing. 600x220
6619	Inox 600x220 + hlađenje čaša
6629	Mesing. 600x220 + hlađenje čaša
6633	Inox 600x220 +hlađenje čaša dim 130
6634	Mesing. 600x220 +hlađenje čaša dim 130

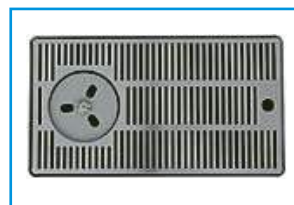
**SABIRNIK PLUS 800X220**

6635	Mesing. 800x220 + hlađenje čaša
6636	Inox 800x220 + hlađenje čaša
6637	Mesing. 800x220
6638	Inox 800x220

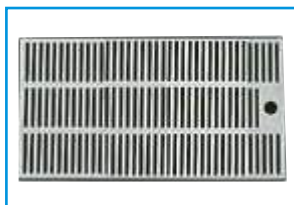
**SABIRNIK PLUS 1.000X220**

6686	Inox 1.000x220
6687	Inox 1.000x220 + hlađenje čaša
6689	Mesing 1.000x220
6688	Mesing 1.000x220 + hlađenje čaša

SABIRNIK PLUS 1.200X220

6832	Inox 1.200x220
6830	Inox 1.200x220 + hlađenje čaša
6833	Mesing 1.200x220
6831	Mesing 1.200x220 + hlađenje čaša

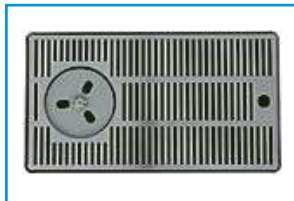

SABIRNIK S RUBOM

KOD CODE	OPIS ARTIKLA DESCRIPTION
6670	Inox 400x220 s optokom
6672	Inox 400x220 hlađenje čaša + optok
6671	Inox 600x220 s optokom
6673	Inox 600x220 hlađenje čaša + optok
6681	Inox 800x220 s optokom
6682	Inox 800x220 H.kozarcev + optok
6649	Inox 1000x220 s optokom
6650	Inox 1000x220 hlađenje čaša + optok
6647	Inox 1200x220 s optokom
6648	Inox 1200x220 hlađenje čaša + optok
6664	Inox 300x220 hlađenje čaša
6663	Inox 750x220 hlađenje čaša

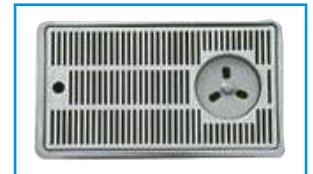
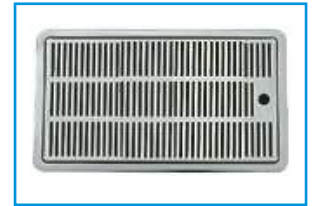

SABIRNIK STD

6651	Inox 300x180
6654	Inox 300x180 + hlađenje čaša centr.
6657	Mesing. 300x180
6660	Mesing. 300x180 + hlađenje čaša centr.
6652	Inox 500x180
6655	Inox 500x180 + hlađenje čaša centr.
6658	Mesing. 500x180
6661	Mesing. 500x180 + hlađenje čaša centr.
6653	Inox 750x180
6656	Inox 750x180 + hlađenje čaša centr.
6659	Mesing. 750x180
6662	Mesing. 750x180 + hlađenje čaša centr.



REZERVNI DIJELOVI

Accessories

KARBONATORI
carbonators

FILTRI H²O
everpure filters H²O

PUMPE CO² - ELEKTRIČNE PUMPE SHURFLO
shurflo pumps

ELEKTROMOTORI ZA PUMPE H²O
motors pumps for carb

TERMOSTATI - KONTROLA RAZINE
thermostats - level control

OPTOČNE PUMPE
recirculation pumps

MIJEŠALA
Agitators

ELEKTROVENTILATORI
fan motors

KOMPRESORI
compressors

REDUKTOR PRITISKA CO² - N₂
CO² - N₂ pressure reducers

DIJELOVI REDUKTORA PRITISKA
accessories for reducers

PRIKLJUČNE GLAVE
kegs head - quick disconnect

SPIRALE INOX
stainless steel coils



KARBONATORI

KOD CODE	OPIS ARTIKLA DESCRIPTION
5056	Motor 1/4 HP pumpa 300 LT Kontrola nivoa + taimer Karbonator - topao Dim. 25x25x35H
5053	Karbonator - hlađen Dim. 25x25x35H
5051	Kompresor 1/10 HP Kcal/H160 Pumpa H ² O 30 LT Temperatura nastavljiva H ² O prirodna - gazirana Karbonator hlađen Dim. 25x35x40H



SATORATORI

5090	Satorator 400cc
5090-TP	Satorator 400cc
5091	Satorator 650cc
5092	Satorator 1050cc
5093	Satorator 2500cc
9136	Nepovratni ventil PL 3/8
5098	Nepovratni ventil inox jednostruki
5099	Nepovratni ventil inox dvostruki
5089	Nepovratni ventil PL 7/16
3350	Ispustni ventil
5094	Sonda duga
5095	Sonda kratka



GLAVA FILTERA EVERPURE

KOD CODE	OPIS ARTIKLA DESCRIPTION
8009	QL 2
8012	QL 3
8013	QL 3B



FILTERI EVERPURE

8003	Vložek 4CB5
8000	Vložek AC
8001	Vložek 4C
8002	Vložek MC
8010	Vložek 4C razkužilo



KIT-FILTERI 4C+UV

8020	Kit sastavljen QL2 - 4C - UV
802	Kit filter 4c + uv Nadomjesna UV svjetiljka



DIJELOVI FILTERA

8051	Redukcijski ventil H ₂ O 3/8
8052	Manometer H ² O
8053	Mjerač vode digitalni 3/8 x 3/8
9136	VNR 3/8 x 3/8
9215	T- 2 x 3/8 F 1 x 3/8 M
9216	T- 3 x 3/8 F
9219	Spojnica 2 x 3/8 M
7504	Zatvorni ventil 3/8 MF
9218	Spojnica 90° 3/8 MF
9222	Spojnica 90° 3/8 M



PUMPE CO₂ - SHURFLO

KOD CODE	OPIS ARTIKLA DESCRIPTION
8220	Shurflo BLU 166-296-28
8221	Shurflo C.C 166-296-25
8216	Shurflo Brix 94-260-03
8217	Shurflo Pivo 166-257-39
8215	Shurflo W.B.SUK 0123
8226	Shurflo Juice 94-360-13
8258	Scambia BIB 94-350-08
8218	Spojnicica inox 90°-26 94-178-07
8228	Spojnicica PL 90°-9,5 94-178-01
8229	Spojnicica PL 90°-265 94-178-02
8219	Prigušivač 94-057-00
8222	T x Co2-265 VNR 94-178-17
8231	Spojnicica 90°Co2 VNR 94-178-16
9526	Kit brtve SHURFLO Co2
8223	Montažna ploča 2P 22-109-00
8225	Montažna ploča 3P 22-121-00
8270	Track system 3P 22-243-03
8271	Track system 4P 22-243-04



KIT VINO-VAKUM VENTIL

8242	Kit vino 1P
8243	Kit vino 2P
8240	Vakum ventil - mikro
9359	Montažna ploča 1 - 2 pumpe kit vino



PUMPE - SHURFLO električne

KOD CODE	OPIS ARTIKLA DESCRIPTION
8253	SHURFLO -TIMER 94-050-01
8260	SHURFLO W.B. 8090-902-278
8257	SHURFLO W.B. 8095-951-269
8214	SHURFLO carb.crp. 8095-911-269
8227	Vezni element PL 7mm
8230	Vezni element PL JG 3/8

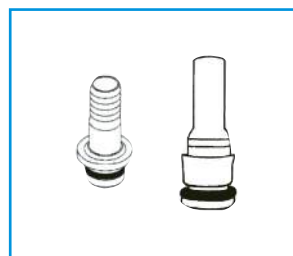
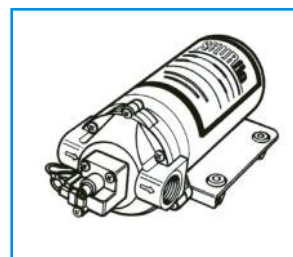

WATER BOOSTER

8280	Mini Water Booster SHURFLO 230V 0,9LT 804-021
8281	Midi Water Booster SHURFLO 230V 7,5LT 804-004
8282	Water Booster SHURFLO Gas PUMP 3,75LT 804-062

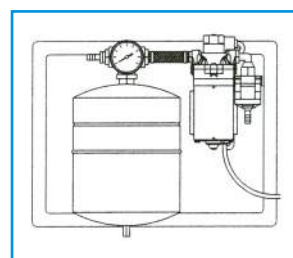
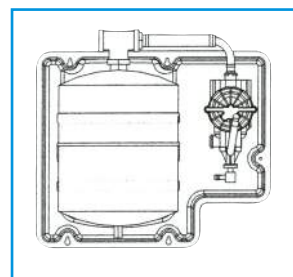
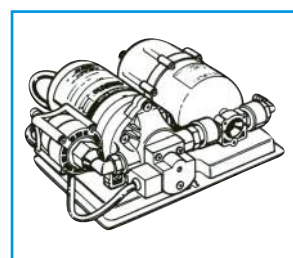

ELEKTROMOTORI PUMPE H2O

KOD CODE	OPIS ARTIKLA DESCRIPTION
8600 8601	Motor H2o 180W 1/4HP(ULKA) Motor H2o 130W 1/8HP(ULKA)
8655 8656	Kondenzator 12,5 mF Kondenzator 4,0 mF



PUMPE H2O

8200 8202	300 LT inox Fluid-o-Tech 300 LT inox Procon
8201 8203	300 LT mesing. Fluid-o-Tech 300 LT mesing. Procon
8204 8205	200 LT mesing. Fluid-o-Tech 200 LT mesing. Procon
8207	500 LT mesing. Fluid-o-Tech
9340 9320	Kućište inox za motorne pumpe Izolacijsko kućište za pumpe



TERMOSTATI KONTROLA RAZINE

Kod <i>CODE</i>	OPIS ARTIKLA <i>DESCRIPTION</i>
7811 7814	Termostat Ranco K50H2005 Termostat Ranco K50P1115
7800 7801 7803 7827	Termostat elektronski AL101 Termostat elektronski AL100 Kontrola razine - temp Kontrola razine - temp Gicar
7851 7852 7853	Montažna ploča za ter. RANCO Montažna ploča za ter. IBC Termostat Elektronski IBC



OPTOČNE PUMPE

KOD <i>CODE</i>	OPIS ARTIKLA <i>DESCRIPTION</i>
7100	PUMPA mt 8
7112	PUMPA. POL. 8 mt (Priključak Feller)
8651	El.kondenzator 2.mf
7124	PUMPA ric. HC-MN 3mt
7125	PUMPA ric. HB-4 6mt
7103C	PUMPA ric. BIR-P 8 Montažna ploča- Univ.
7103S	PUMPA ric. BIR-P 8 (Feller) Montažna ploča- STD
7103	PUMPA ric. BIR-P 8(Feller) Montažna ploča- Univ.
7126	PUMPA ric. BIR-8
7127	PUMPA ric. BIR-13
7129	PUMPA ric. BIR-18
7132	Potopna PUMPA MT1,5



MIJEŠALA

KOD CODE	OPIS ARTIKLA DESCRIPTION
7114	Miješalo VMC rot DX
7115	Miješalo VMC rot SX
7120	Miješalo Coprel P20



ELEKTROMOTOR VENTILATORA

8670	Elco 5W
8670V	Elipsa 200mm 28°
8671	Elco 10W
8671V	Elipsa 254mm 22°
8680	Euromotors 5W
8684	Euromotors 10W
8688	Euromotors 16W
8675	Coprel VA 13
8676	Motor ventilatora 15W asp. 107mm
7733	Tangencialen TRF 180/30
7734	Tangencialen TRF 240/30



KOMPRESORI ASPERA

KOD CODE	OPIS ARTIKLA DESCRIPTION
9404	Aspera 1/5HP T6144Z
9440	Rele 1/5
9420	Uključna sklopka 1/5
9430	Kondenzator 1/5
9406	Aspera 1/4HP T6170Z
9441	Rele 1/4
9421	Uključna sklopka 1/4
9430	Kondenzator 1/4
9403	Aspera 1/3HP T6187Z
9442	Rele 1/3
9422	Uključna sklopka 1/3
9431	Kondenzator 1/3
9407	Aspera 1/2HP T6213Z
9443	Rele 1/2
9423	Uključna sklopka 1/2
9432	Kondenzator 1/2
9402	Aspera 3/4 T-6215Z
9443	Rele 3/4
9425	Uključna sklopka 3/4
9435	Kondenzator 3/4
9408	Aspera 1/1HP J-6226Z
9444	Rele 1/1
9424	Uključna sklopka 1/1
9434	Kondenzator 1/1



KOMPRESORI DANFOSS

9409	Danfoss 1/5 FR7,5G
9410	Rele 1/5
9412	Danfoss 1/4 FR10G
9413	Rele 1/4
9415	Danfoss 1/3 SC12G
9416	Rele 1/3
9418	Danfoss 1/2 SC15GH
9419	Rele 1/2
9411	Kondenzator 80mf



KOMPRESORI ELECTROLUX

9450	Electrolux 1/4 GL90TB
9453	Rele 1/4
9451	Uključna sklopka 1/4
9455	Kondenzator 47/56mF
9452	Electrolux 1/3HP GP12TB
9453	Rele 1/3
9454	Uključna sklopka 1/3
9455	Kondenzator 1/3 47/56 mF



REDUKTOR PRITISKA S Co2 priključak boca		
KOD CODE	OPIS ARTIKLA DESCRIPTION	
7430	S 1 izlazom ODL	
7431	S 2 izlaza ODL	
7432	S 3 izlaza ODL	
7433	S 4 izlaza ODL	100,270
RED. PRITISKA S Co2 1-8bar visokotlačna cijev		
7470	S 1 izlazom ODL	
7471	S 2 izlaza ODL	
7472	S 3 izlaza ODL	
7473	S 4 izlaza ODL	
7474	S 5 izlaza ODL	
RED. PRITISKA S Co2 izh.1/4 visokotlačna cijev		
7481	S 1 izlazom ODL	
7482	S 2 izlaza ODL	
7483	S 3 izlaza ODL	
7484	S 4 izlaza ODL	
7485	S 5 izlaza ODL	
RED. PRITISKA Co2 ODL primarni		
7464	Primarni 1P ODL	81 052
RED. VENTIL Co2 ODL mod. SA B.P.		
7440	S 1 izlazom ODL	
RED. VENTIL N2 ODL mod. SA		
7435	S 1 izlazom	
7436	S 2 izlaza	



NADOMESTNI DELI RED.VENTIL

CODA CODE	OPIS ARTIKLA DESCRIPTION
7530	Manometer AP Co2
7531	Manometer AP N2
7532	Manometer BP 10 bar
7533	Manometer BP 6 bar
7538	Kit deli Red.ventila ODL
7539	Kit deli Red.ventila STD
7540	Kit deli Ried.ventila PRIMARNI
7561	Komplet membrana za red.vent ODL
7575	Ventil AP ODL
7576	Tesnila ventila AP
9507	Tesnilo.N2
9508	Tesnilo.Co2
9509	OR spojnice
9518	OR spojnice PARKER



FIKSIRNI SKLOPOVI

7551	Montažna ploča Red.Ventila 1 izh.
7552	Montažna ploča Red.Ventila 2-3-4 izh.
7553	Zaštitnik Red.Ventila 1 izh.
7556	Ploča inox L1000xH450mm
7554	Konzola boce CO2-N2
9386	Ključ 30mm
9387	Ključ 28mm



DIFUZORI I VENTILI

KOD CODE	OPIS ARTIKLA DESCRIPTION
7503	Zatvorni ventil 1/4-M/F
7500	Razdvajač Y 1/4
7501	Zatvorni ventil OR/7/16 ODL
7511	Difuzor 1P 1/4-7mm VNR
7512	Difuzor 1P 1/4-7/16 VNR
7513	Difuzor 1P OR - 7/16 VNR
7520	Adapter SA-S
7514	Difuzor 2P 7/16 ODL
7515	Difuzor 2P 7/16 OR ODL
7516	Difuzor 3P 7/16ODL
7517	Difuzor 3P 7/16 ORODL
7518	Difuzor 4P 7/16ODL
7519	Difuzor 4P 7/16 ORODL



NADOMJESNI DIJELOVI

7537-180	Cijev VT 300BAR 1/4 1800mm
7537	Cijev VT 300BAR 1/4 1200mm
7424	Cijev VT 200BAR 1/4 1200mm
7536	Cijev VT Co2 21,8MF s maticom
7528	Cijev VT N2 21,8 MF s maticom
7529	Cijev VT Co2 s ručnom maticom
7525	Matica + trn Co2
7570	Završni dio 1/4-21,7mm Co2
7526	Matica + trn N2
7573	Završni dio 1/4M 21,7F
7578	Racc. 1/4-1/4 L 30mm
7579	Racc 1/4-1/4 L 40mm
7580	Racc 1/4-1/4 con.
7585	Tappo 1/4
9513	Guarnizione alluminio
7582	Spojka 1/4 OG 8mm
7583	Spojka OG 8x8mm
7594	Spojka muro OG 8mm
7581	Spojka 3/8 8mm 3/8 tubo



PRIKLJUČNE GLAVE

KOD CODE	OPIS ARTIKLA DESCRIPTION
8400	Priključna glava not. 7mm ODL S system
8401	Priključna glava not. 7/16 ODL S system
8430	Priključna glava not. JG 3/8 ODL S system
8402	Kit brtva ODL
8400-VSH	Priključna glava not.VSH S system
9510	Brtva unutarnja
9511	Brtva vanjska
9512	VNR silokonsko ODL
9521	OR 130
8403	Priključna glava trik. 7mm ODL G system
8404	Priključna glava trik. 7/16 ODL G system
9520	Brtva mod.trik ODL
8406	Priključna glava okr. 7mm ODL A system
8407	Priključna glava okr. 7/16 ODL A system
8431	Priključna glava okr. JG 3/8 A system
9520	Brtva mod.okr. ODL



PRIKLJUČNA GLAVA -MICRO MATIC

8444	Priključna glava not.S system 7mm
8432	Priključna glava M system (Veltins) 7mm
8443	Priključna glava trik.G system 7mm
8442	Priključna glava okr.A system
8440	Priključna glava U system (Guinnes)
8444-3	VNR Co2
8444-5	VNR proizvod
8444-4	OR unutarnji



PRIKLJUČNA GLAVA-CMB

8453	Priključna glava.Jolly gas CMB 7/16
8454	Priključna glava.Jolly prod CMB 7/16
5086	VNR 7/16
8415	Priključna glava C.C. gas CMB 1/2
8416	Priključna glava C.C. prod CMB.1/2
5087	VNR1/2
8420	Priključna glava C.C. B.I.B.CMB



SPIRALE ZA HLAĐENJE AISI 316

KOD CODE	OPIS ARTIKLA DESCRIPTION
	Spirale za hlađenje AISI 316 L (H 220 mm)
7090	mt 3,8 dim.7x8mm
7091	mt 6,5 dim.7x8mm
7091-7	mt 6,5 dim.6X7mm22,000
7094	mt 9,0 dim.5x6 mm 7/16
(Druge dimenzije po narudžbi)	

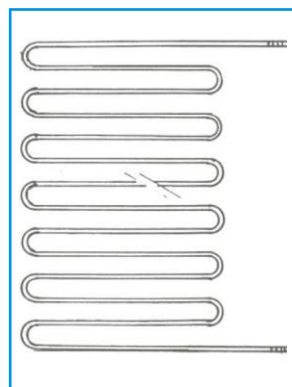

SPIRALE ZA HLAĐENJE AISI 316 mod 35-50-100

	Spirale za hlađenje AISI 316 L Dim.unutar. 120x120xH220mm Dim.vanj. 220x220xH200mm
7028	mt 17 8mm 1°/100
7029	mt 17 8mm 1°/50 2°/100
7030	mt 15 8mm 2°/50 3°/100
7031	mt 13 8mm 3°/50 4°/100
7027	mt 12 8mm 4°/50 5°/100
7072	mt 20 8mm 1°/100
7073	mt 20 8mm 1°/50 2°/100
7074	mt 20 8mm 2°/50 3°/100

SPIRALE ZA HLAĐENJE AISI 316 mod 200-400

	Spirale za hlađenje AISI 316 L Dim.unut. 170x170xH300mm Dim.vanj. 270x270xH320mm
7070	mt 20 dim 8mm 1° V 200
7071	mt 20 dim 8mm 2° V 200
7072	mt 20 dim 8mm 3° V200 1° V 100
7073	mt 20 dim 8mm 4° V 200 2° V 100
7074	mt 20 dim 8mm 5° V 200 3° V 100
7075	mt 20 dim 8mm 6° V 200
7066	mt 12+12 dim 6mm 6° V 200
7067	mt 8+8+8 dim 6mm 6° V 200

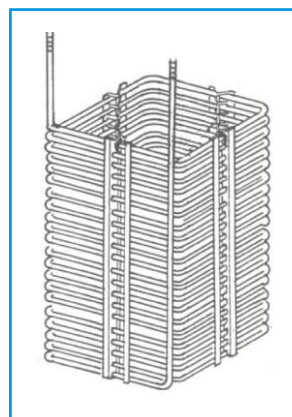



PRIKLJUČCI - ALAT

Fittings-tools

MATICE ŠESTEROKUTNE MESING
nuts

RAZNE BRTVE
washers

SPOJNICE INOX - MESING
fittings

SPOJNI ELEMENTI INOX X.T
fittings

SPOJNI ELEMENTI MESING
brass fittings

SPOJNI ELEMENTI PVC
plastic fittings

STEZALJKA INOX
hoseclips

BRZA SPOJKA
quick joints

RAZNI ALATI
tools

MATICE

KOD CODE	OPIS ARTIKLA DESCRIPTION	
9000	Matica šesterokutna 7/16	0
9001	Matica šesterokutna 1/2	0
9009	Matica šesterokutna 1/2 x 10mm	0
9004	Matica šesterokutna 7/16 slepa	0
9005	Matica šesterokutna 1/2 slepa	0
9006	Matica šesterokutna 5/8	7
9008	Matica šesterokutna 1/2	5
9007	Matica nazupčana 5/8	3
9003	Matica nazupčana 3/4	7
9002	Matica šesterokutna 3/4	8



BRTVE

9500	Brтва con.bijela	0
9501	Brтва con.crvena	0
9505	Brтва meka 5/8 20x13x2	0
9503	Brтва tvrda 5/8 20x13x2	0
9504	Brтва tvrda 5/8 20x09x2	0



SPOJNICE INOX

9010	7/16x4mm inox	5
9011	7/16x7mm inox	0
9012	1/2 x4mm inox	0
9013	1/2 x7mm inox	0
9014	1/2 x10mm inox	0



SPOJNICE MESING

9051	Priključna spojnica ravna+glava 7mm	0
9052	Priključna spojnica ravna+glava(ravna)7mm	0
9053	Priključna spojnica ravna+glava.4,4mm	0
9054	Priključna spojnica ravna+glava(ravna)4,4mm	0
9055	Priključna spojnica 90°+glava 7mm	0
9056	Priključna spojnica 90°+glava(ravna)7mm	0
9057	Priključna spojnica 90°+glava.4,4mm	0
9058	Priključna spojnica 90°+glava(ravna)4,4mm	0
9059	Priključna spojnica 90°+glava 9,5mm	0



SPOJNICE INOX

9061	Priključna spojnica ravna+glava.8mm	0
9062	Priključna spojnica ravna+glava(ravna).8mm	0
9063	Priključna spojnica 90°+glava.8mm	0
9064	Priključna spojnica 90°+glava(ravna).8mm	1,



SPOJNI ELEMENTI INOX

KOD CODE	OPIS ARTIKLA DESCRIPTION
9204	Spojni elem. inox. 7x 7mm
9205	Spojni elem. inox. 4x 7mm
9206	Spojni elem. inox. 4x 4mm
9207	Spojni elem. inox. 7x10mm
9208	Spojni elem. Inox. 10x10mm



SPOJNI ELEMENTI INOX-T

9295	Spojni elem. inox.T.3x4,4mm
9296	Spojni elem. inox.T.2x4,4 1x7mm
9297	Spojni elem. inox.T.3x7mm
9298	Spojni elem. inox.T.2x10 1x7mm
9299	Spojni elem. Inox.T.3x10mm



SPOJNI ELEMENTI INOX-X

9290	Spojni elem. inox.X. 4,4mm
9291	Spojni elem. Inox.X. 7mm



PRIKLJUČNI ELEMENTI MESING

9210	Priključni elem. mesing. 3/8x7mm
9211	Priključni elem. mesing. 3/8x10mm
9212	Priključni elem. mesing. 1/4x7mm
9213	Priključni elem. mesing. 3/8x7/16
9226	Priključni elem. Mesing. 3/8x9/16



SPOJNI ELEMENTI MESING 3/8

9216	Spojni elem.mesing -T- 3 x 3/8 F
9215	Spojni elem. mesing-T- 2 x 3/8 F 1x 3/8 M
9217	Čep mesing 3/8 M
9220	Čep mesing 3/8 F
9219	Spojница mesing 3/8
9218	Spojница mesing 90°3/8 MF
9222	Spojница mesing 90° 3/8 M
7504	Zatvorni ventil 3/8 MF



STEZALJKE INOX 10R

KOD <i>CODE</i>	OPIS ARTIKLA <i>DESCRIPTION</i>
9020	Stežaljka dim. 8,7
9021	Stežaljka dim.10,5
9022	Stežaljka dim.11,0
9023	Stežaljka dim.12,3
9018	Stežaljka dim.12,8
9024	Stežaljka dim.13,3
9026	Stežaljka dim.14,0
9027	Stežaljka dim.14,5
9019	Stežaljka dim.15,5
9025	Stežaljka dim.16,0
9028	Stežaljka dim.17,5
9029	Stežaljka dim.19,5

**STEZALJKE INOX ANTIGRINZA**

9040	Stežaljka antig. dim. 8,7
9041	Stežaljka antig. dim.10,5
9038	Stežaljka antig. dim.10,9
9042	Stežaljka antig. dim.11,3
9043	Stežaljka antig. dim.12,3
9044	Stežaljka antig. dim.13,3
9039	Stežaljka antig. dim.13,8
9045	Stežaljka antig. dim.14,0
9046	Stežaljka antig. dim.14,5
9050	Stežaljka antig. dim:15,3
9037	Stežaljka antig.dim:15,7
9047	Stežaljka antig. dim.17,5
9049	Stežaljka antig. dim 18,8
9048	Stežaljka antig. Dim.19,2









**STEZALJKE UNEX -vijak**

9060	Stežaljka vijak UNEX 14 / 9,6
9065	Stežaljka vljak UNEX 12 / 9,0
9066	Stežaljka vijak UNEX 17/12

**KLIJEŠTA ZA STEZALJKE**

9390	Kliješta OETIKER za stezanje
------	------------------------------



SPOJNI ELEMENT - X		
CODA CODE	OPIS ARTIKLA DESCRIPTION	
9100	Spojni elem.PVC-X- 4x4,4mm	
9101	Spojni elem.PVC-X- 4x7mm	
SPOJNI ELEMENT - T		
9105	Spojni elem.PVC-T- 3x4,4mm	
9106	Spojni elem.PVC-T- 3x7mm	
9107	Spojni elem.PVC-T- 3x10mm	
SPOJNI ELEMENT - RAVNI		
9110	Spojni elem.PVC 7x7mm	
9111	Spojni elem.PVC 10x10mm	
9112	Spojni elem.PVC 4,4x7mm	
9113	Spojni elem.PVC 7x10mm	
SPOJNI ELEMENT - vijak		
9115	Spojni elem.PVC 3/8 7mm	
9116	Spojni elem.PVC 3/8 10mm	
9119	Spojni elem.PVC 3/8 7/16	
9118	Spojni elem.PVC 7/16 10mm	
9117	Spojni elem.PVC 7/16 7mm	
SPOJNI ELEMENT - 90		
9126	Spojni elem.PVC 90° 7/16x7/16	
SPOJNI ELEMENT - T vijak		
9124	Spojni.elem.PVC-T- 3x7/16	
SPOJNI ELEMENT - vijak		
9124	Spojni elem.PVC-T- 3x7/16	
SPOJNI ELEMENT 3/8 - vijak		
9135	Spojnica PVC. 3/8 MM	
9125	Čep PVC 3/8 M	
9131	Spojni elem.PVC 90° 3/8 M	

SERIJA 01 BSP-BSPT

KOD CODE	OPIS ARTIKLA DESCRIPTION	
PM010823S	5/16-1/4 BSPT	:0
PM010803S	5/16-3/8 BSPT	:0
PI011202S	3/8-1/4 BSPT	0
PI011203S	3/8-3/8 BSPT	:0
PI011603S	1/2-3/8 BSPT	:0
PI011604S	1/2.-1/2 BSPT	:0
PI011212S	3/8-1/4 BSP	:0
PI010823S	1/4-3/8 MPT F	:0



SERIJA 02 spojnik-T-

PM0204S	5/32	0
PI0206S	3/16	0
PI0208S	1/4.	0
PM0208S	5/16	0
PI 0212S	3/8	0
PI 0216S	1/2.	0



SERIJA 03 spojnik 90

PM0304S	5/32	0
PI 0306	3/16	0
PI 0308S	1/4	0
PM0308S	5/16	0
PI 0312S	3/8	0
PI 0316S	1/2.	0



SERIJA 04 spojnik ravni

PM0404S	5/32	0
PI0406S	3/16	0
PI 0408S	1/4.	0
PM0408S	5/16	0
PI 0412S	3/8	0
PI 0416S	1/2.	0



SERIJA 06 redukcija

PI 061008S	5/16-1/4.	0
PI 061210S	3/8-5/16	0
PI 061612S	1/2-3/8	0
PI 061206S	3/8-3/16	0
PI 061208S	3/8-1/4	0

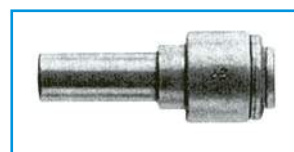

SERIJA 08 čep

PI 0808S	1/4	0
PM0808S	5/16	0
PI 0812S	3/8	0
PI 0816S	1/2	0



SERIJA 12 spojnik vijak

KOD CODE	OPIS ARTIKLA DESCRIPTION
PI1212S PI1216S	3/8 1/2



SERIA 20 spojnik redukcija

PI200806S	1/4-3/16
PI201006S	5/16-3/16
PI 201008S	5/16-1/4
PI 201206S	3/8-3/16
PI 201208S	3/8-1/4
PI 201210S	3/8-5/16
PI 201610S	1/2-5/16
PI 201612S	1/2-3/8



SERIJA 21 spojnik redukcija 90

PI 211006S	5/16-3/16
PI 211008S	5/16-1/4
PI 211206S	3/8-3/16
PI 211208S	3/8-1/4
PI 211210S	3/8-5/16
PI 211612S	1/2-3/8
PI 211610S	1/2-5/16



SERIJA 22 spojnik redukcija

PM 220404S	5/32-5/32
PI220606S	3/16-3/16
PI 220808S	1/4-1/4
PM220808S	5/16-5/16
PI 221210S	3/8-5/16
PI 221212S	3/8-3/8
PI 221616S	1/2 -1/2
PI 221206S	3/8-3/16
PI 221208S	3/8-1/4

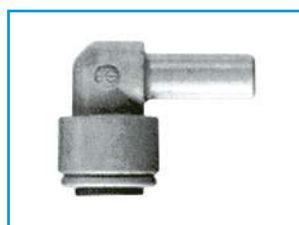

SERIJA 20 spojnik Y

PI 2308S	5/16
PI 2312S	3/8
PI 241210S	3/8-5/16



SERIJA 25 spojnik redukcija		
KOD CODE	OPIS ARTIKLA DESCRIPTION	
PI 251210S	3/8-5/16	
PI 251208S	3/8-1/4	
PI 251212	3/8-3/8	
PI 251612S	1/2 -3/8	
PI 251616S	1/2-1/2	
SERIJA 29 spojnik redukcija 90		
PI 291008S	5/16-1/4	
PI 291208S	3/8-1/4	
PI 291210S	3/8-5/16	
SERIJA 45 spojnik redukcija		
PI4512F4S	3/8-7/16	
PI4512C5S	3/8-1/2 (COCA-COLA)	
PI451215FS	3/8-5/8	
PI451214FS	3/8-1/2	
PI451222S	3/8-1/4 NPTF	
CI3208U7S	1/4-7/1624UNS	
AFAUF06716VM	6-7/16	
AFAUF08716VM	8-7/16	
SERIJA 47 spojnik X		
PI 4712S	3/8	
VEZNI ELEMENT ZA OPTOK		
PIUB16S	1/2	
AUB0606W	3/8	
AUB0505W	5/16	
FIKSATOR KRIVULJE		
PM 2610S	3/8	
PM 2608S	5/16	

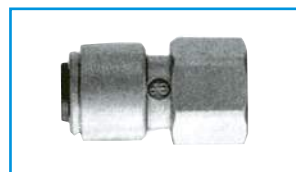

SPOJNIK SUPERSEAL ravni

KOD CODE	OPIS ARTIKLA DESCRIPTION
SM410808E	5/16 S-5/16 S

SPOJNIK SUPERSEAL SPEED ravni

SM040808S SI041012S	5/16.S -5/16 5/16.S - 3/8
------------------------	------------------------------



SPOJNIK SUPERSEAL SPEED 90

SM030808S SI 031012S	5/16.S -5/16 5/16.S -3/8
-------------------------	-----------------------------

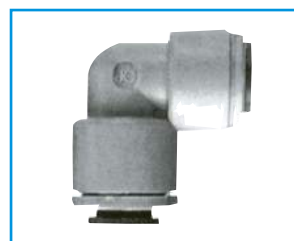

SPOJNIK SUPERSEAL 90

SM400808S	5/16.S -5/16
-----------	--------------



SPOJNIK KRIVULJA SUPERSEAL

SM420808S SI 421012S	5/16.S -5/16 5/16.S- 3/8
-------------------------	-----------------------------



SPOJNIK SUPERSEAL ravni

SM010812S	5/16.S-1/4 BSP
-----------	----------------



OSIGURAČ

KOD CODE	OPIS ARTIKLA DESCRIPTION
PIC1812R	Osigurač 3/8-1/2
PIC1808R	Osigurač 1/4-5/16
ALC05	Osigurač 5/16
ALC06	Osigurač 3/8
ALC08	Osigurač 1/2



KIT KLJUČ J.G.

ICLT/2	KIT ključ J.G.
--------	----------------



ZATVORNI VENTIL

PPSV041212W	Zatvorni ventil 3/8
-------------	---------------------



NEPOVRATNI VENTIL

3/8SCV	Nepovratni ventil 3/8
--------	-----------------------



REGULATOR PROTOKA

ACUC0606M	Regulator protoka not. 6 mm
ACUC0606	Regulator protoka not. 3/8



MONTAŽNI OSIGURAČ

SVM-10	Montažni osigurač
--------	-------------------



POMAGALA ZA REZANJE CIJEVI

KOD CODE	OPIS ARTIKLA DESCRIPTION
9389	Kliješta za rezanje cijevi Mod.Velike
9389P	Kliješta za rezanje cijevi Mod.Male
9383	Rezač cijevi STD in PL.
9356	Kliješta za rezanje pitona



POMAGALA ZA OBRADU INOX CIJEVI

9391	Feder za savijanje cijevi dim. 8/10mm
9355	Priprava za rezanje cijevi Baker/Inox 3-30mm



RAZNA POMAGALA

9385	Zupčasti ključ 15-35mm
9390	Kliješta bočna
ICLT/2	KIT ključ J.G.



RAZNA POMAGALA

9385	Zupčasti ključ 15-35mm
9390	Kliješta bočna
ICLT/2	KIT ključ J.G.



PYTON CRIJEVO

Pyton tube

PROIZVODI ZA PREHRANU
approved products

FDA / EEC SI N°3145
NSF STANDARD 51

SK 082-006
SK 292-001
SK 292-002
SK 292-005
SK 292-011
SK 292-009
SK 292-016
SK 292-014

COCA COLA APPROVAL

PITON MDP IZOLACIJA 13mm
python mdp insulation 13mm

PITON MDP IZOLACIJA 15mm-19mm
python mdp insulation 15mm-19mm

PITON HYPABREW
python hypabrew

PITON MD PLUS
python md plus

PITON BREWFLEX
python brewflex

CIJEV	MDP - EVA - MD PLUS - LUPULUS
tube	BREWFLEX - PVC - AISI 316 L
	mdp - eva - md plus - hypabrew
	brewflex - pvc - aisi 316 l

PYTON 13mm

KOD
CODE

OPIS ARTIKLA
DESCRIPTION

Cijev proizvod 6,7 x 9,5 (3/8)
Cijev recirkulacija 9,5 x 12,7 (1/2)
Električna žica /conf 50 mt
Izolacija 13mm ARMAFLEX (clasa A)

8801	2+2 MD Poly električna žica 2x0,5mm
8860	2+2 MD Poly
8803	3+2 MD Poly električna žica 2x0,5mm
8861	3+2 MD Poly
8805	4+2 MD Poly električna žica 2x0,5mm
8862	4+2 MD Poly
8846	4+2 MD Poly cijev proizvod 5,5x7,9
8807	5+2 MD Poly električna žica 2x0,5mm
8863	5+2 MD Poly
8809	6+2 MD Poly električna žica 2x0,5mm
8859	6+2 MD Poly
8812	8+2 HG EVA električna žica 6x1mm
8821	8+2 MD Poly električna žica 2x0,5mm
8845	8+2 MD Poly cijev proizvod 5,5x7,9
8815	10+2 MD Poly električna žica 2x0,5mm
8823	10+4 MD Poly električna žica 5x0,5mm
8824	12+2 MD Poly električna žica 6x1,5mm
8825	12+4 MD Poly električna žica 6x1,5mm
8788	15+2 MD Poly 2 električne žice
8789	15+4 MD Poly 2 električne žice
8790	16+2 MD Poly 2 električne žice



PYTON 15mm

Cijev proizvod 6,7 x 9,5 MD Poly (3/8)
Cijev recirkulacija 9,5 x 12,7 MD Poly (1/2)
Elek.žic 4 x 1,5mm 4 x 0,5mm conf 50 mt
Izolacija 15mm ARMAFLEX (clasa A)

8757	5+2 MD Poly
8758	6+2 MD Poly
8756	6+3 MD Poly
8760	8+2 MD Poly
8759	8+3 MD Poly
8765	8+4 MD Poly
8761	10+3 MD Poly
8762	12+3 MD Poly
8764	12+4 MD Poly
8780	12+6 MD Poly



PITON LUPULUS

KOD CODE	OPIS ARTIKLA DESCRIPTION
	Cijev proizvod 7,0 x 9,5 8 (3/8), Cijev recirkulacija 9,5 x 12,7 (1/2) Kolut 50 mt Izolacija 13mm ARMAFLEX (clasa A)
8769	2+2 HYB
8770	4+2 HYB
8771	6+2 HYB



PITON AISI 316 L

	Cijev proizvod Aisi 316 L 8mm Cijev recirkulacija MD Poly 9,5 x 12,7 (1/2) Kolut 50 mt Izolacija 13mm ARMAFLEX (clasa A)
8880	2+2 inox
8881	3+2 inox
8882	4+2 inox
8876	5+2 inox
8877	6+2 inox

PITON MDPLUS SK292-014

	Cijev proizvod MDPLUS 6,7x9,5 (3/8) Cijev recirkulacija MDP 9,5x12,7 (1/2) Kolut 50 mt Izolacija 13mm ARMAFLEX (clasa A)
8830	2+2 MDPLUS 7,393
8831	3+2 MDPLUS 8,370
8832	4+2 MDPLUS 9,047
8833	5+2 MDPLUS 9,374
8834	6+2 MDPLUS 10,526



PITON BREWFLEX SK 292-016

	Cijev proizvod SGEVA/MDPLUS 6,7x12,7 (1/2) Cijev recirkulacija MDP 9,5x12,7 (1/2) Kolut 50 mt Izolacija 13mm ARMAFLEX (clasa A)
8892-C	2+2 EVA/MDPLUS
8895-C	3+2 EVA/MDPLUS
8896-C	4+2 EVA/MDPLUS
8893-C	5+2 EVA/MDPLUS
8894-C	6+2 EVA/MDPLUS



MONTAŽNA STEZALJKA ZA PITON

9470	MONTAŽNA STEZALJKA ZA PITON
------	-----------------------------

CIJEV POLYETHYLENE SK292-001

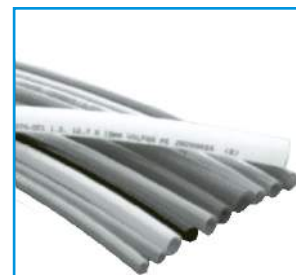

KOD CODE	OPIS ARTIKLA DESCRIPTION
	CEV Polyethylene (LD-MD)
8907	MDP 2,9x4,8mm 0,117x3/16
8951	MDP 4x8mm 5/32x5/16
8951-G.MIX	MDP 4x8mm 5/16 crna
8951-Co2	MDP 4x8mm 5/16 siva
8998	MDP 0,170x1/4
8955	MDP 4x6mm
8958	MDP 6x8mm
8954	MDP 8x10mm
8952	MDP 6,7x9,5mm 0,265x3/8
8905	MDP 6,7x9,5mm 0,265x3/8 rdeca
8957	MDP 6,7x10,5mm
8953	MDP 6,7x12,5mm
8906	MDP 9,5x12,7mm 3/8x1/2 modra
8956	MDP 12,7x16mm

CIJEV MDPLUS (Antibakterijska)

CIJEV MDP Medium Density Polyethylene (Antibakterijske)	
8944	MDPLUS 6,7x9,5mm 3/8
8945	MDPLUS 9,5x12,7mm 1
8947	MDPLUS 4x6mm
8946	MDPLUS 0,170x1/4
8950	MDPLUS 6x8mm
8943	MDPLUS 2x4mm

CIJEV E.V.A. SK292-002

CIJEV EVA (Ethylene Vinyl Acetate)	
8970	HG EVA 4x8mm
8971	HG EVA 6,7x9,5mm
8972	HG EVA 6,7x12,5mm
8974	HG EVA 9,5x12,7mm
8976	SG EVA 4x8mm
8967	SG EVA 5x9mm
8977	SG EVA 6,7x 9,5mm
8978	SG EVA 6,7x12,5mm
8988	SG EVA 6x11mm
8979	SG EVA 9,5x12,7mm
8992	MG EVA 6,7x9,5mm 3/8
8993	MG EVA 9,5x12,5mm



CRIJEVO VAM-Lupulus

KOD CODE	OPIS ARTIKLA DESCRIPTION
8996	CRIJEVO HYB zun. MDP not. NYLON 11-FDA HYB 7,0x9,5mm
8997	HYB 6,7x9,5mm



CRIJEVO VAM-B.FLEX

8989	CRIJEVO B-FLEX zun.SG EVA not. MDPLUS (Antibakterijske) B.FLEX 4x8mm
8994	B.FLEX 5x9mm
8995	B.FLEX 6,7x12,7mm
8991	B.FLEX 6x10mm

CRIJEVO FQ PVC VT/717-1

8990	FQ PVC 9,5x16.5mm
8960	FQ PVC 4x8mm
8961	FQ PVC 5x9mm
8962	FQ PVC 6x12mm
8963	Twin CRIJEVO dvoj.x ric 8x11mm
8964	FPV CRY30 18x24 (za priklj.iglu-bačva za pranje)



CIJEV AISI 316 L

7001	CIJEV AISI 316L IN kolut. 200MT CIJEV AISI 316L 7x8mm
------	--

TRAKA TEROSTAT-TERMO

8900	Traka TERMO 3mmx50mmx10MT
8900-MT5	Traka TERMO 3mmx50mmx5MT
8901	Traka Termo 5mmx50mmx10MT
8902	Traka PVC 75mmx100MT
8903	Traka PVC 19mmx25MT



IZOLACIJSKA CIJEV

IZOLACIJSKA CIJEV Dim.pakiranja cm 210x40x26	
8910	Izol. 6x10mm m/cart 280
8911	Izol. 9x12mm m/cart 170
8912	Izol. 9x14mm m/cart 160
8913	Izol. 9x28mm m/cart 80
8914	Izol. 9x35mm m/cart 60
8920	Izol. 13x28mm m/cart 54
8921	Izol. 13x35mm m/cart 40
8922	Izol. 13x42mm m/cart 32
8923	Izol. 13x48mm m/cart 30
8930	Izol. 19x28mm m/cart 34
8931	Izol. 19x35mm m/cart 30
8932	Izol. 19x42mm m/cart 24
8933	Izol. 19x48mm m/cart 22



Comparative Data

Features

- MDP – Nylon FDA
- Bio-film Reducing Additive
- SK approved
- Compiles with:
 - UK SI 3145/1192
 - EEC Directive 90/128
- Working Pressure:
 - Minimum 7 bar @ 20 deg C
- Dimensions:
 - 4 x 8 mm
 - 6.7 x 9.5 mm
 - 7 x 9.5 mm
 - 7 x 12.7 mm
 - 9.5 x 12.7 mm
 - 10 x 12.7 mm

Advantages

- Smooth Nylon Bore
- MDP or EVA/Outer surface
- Anti-Bacterial and Antifungal
- Prevents build up of Bio-film
- Non migratory – Does not wash away with use

Benefits

- Adhesive layer stops risk of layer separation
- Visual analysis gives high degree of confidence in product integrity

- ### Advantages
- Anti-Bacterial and Antifungal
 - Prevent build-up of Bio-film
 - Non migratory – does not wash away with use
 - increased flexibility
 - longer cleaning-cycle
 - High degree of transparency
 - Long Life
 - Tubing can be striped for identification

Persistence (chart 1):

This bar chart shows how PE Film impregnated (red bar) with the Anti-Microbial additive compares to standard PE Film (blue bar).

An initial Microbe population is created (blue bar) and is placed on both the standard and impregnated samples of film.

After 24 hours the number of microbes left on each sample is compared. It can be seen that in each case the impregnated film has virtually no microbes left (99.9 % reduction). The same test was repeated on the SAME impregnated sample and it showed the same level of reduction at 8 years as the original test.

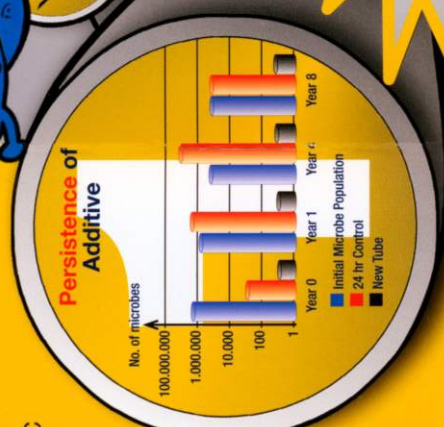

Anti-Bacterial Activity (chart 2):

This bar chart shows how well Anti-Microbial tubing performs after liquid was continually passed through it for 3 months. The test is the same as before, and it can be seen that both tubes have the same ability to reduce antibacterial activity. This gives confidence for our type of application.

Adhesion of Yeast and Bacteria (Test Material Beer)

Cell Count

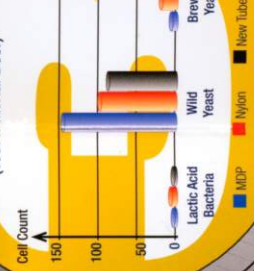

Adhesion (chart 3):

This bar chart compares the adhesion of 3 types of bacteria and yeast to the inside surface of our tubing. It can be seen that the test material compares favourably to Nylon.

This test was conducted over a period of 5 days.

Anti-Bacterial Activity of tube samples vs E-Coil

Log viable bacterial count

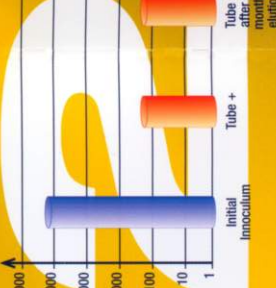

The new cleanliness

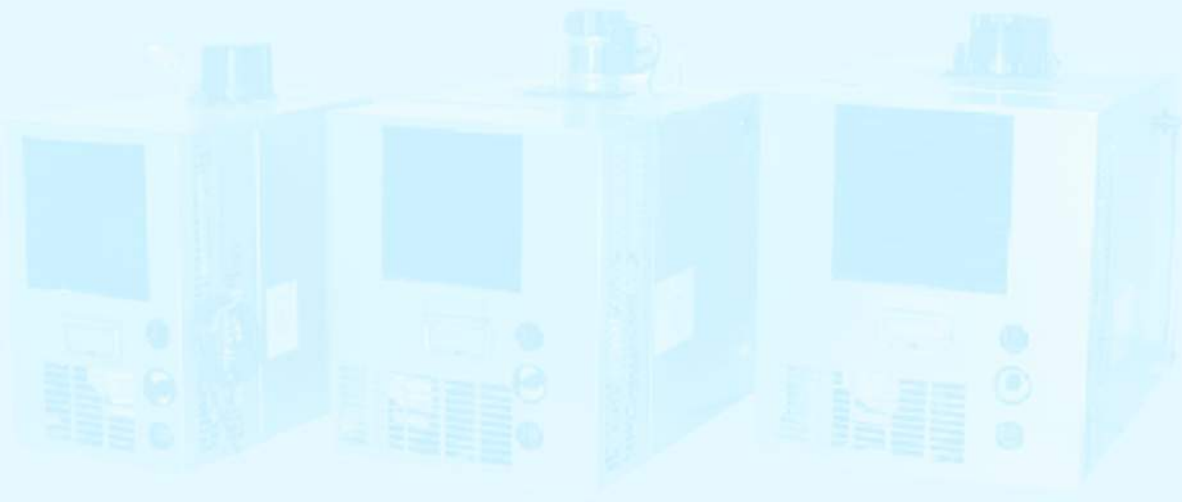

AGREGATI ZA HLADENJE - PIVO
beer coolers

AGREGATI ZA HLADENJE - PRE-MIX
pre-mix coolers

AGREGATI ZA HLADENJE - VINO
wine coolers

AGREGATI ZA HLADENJE - POST-MIX
post-mix coolers

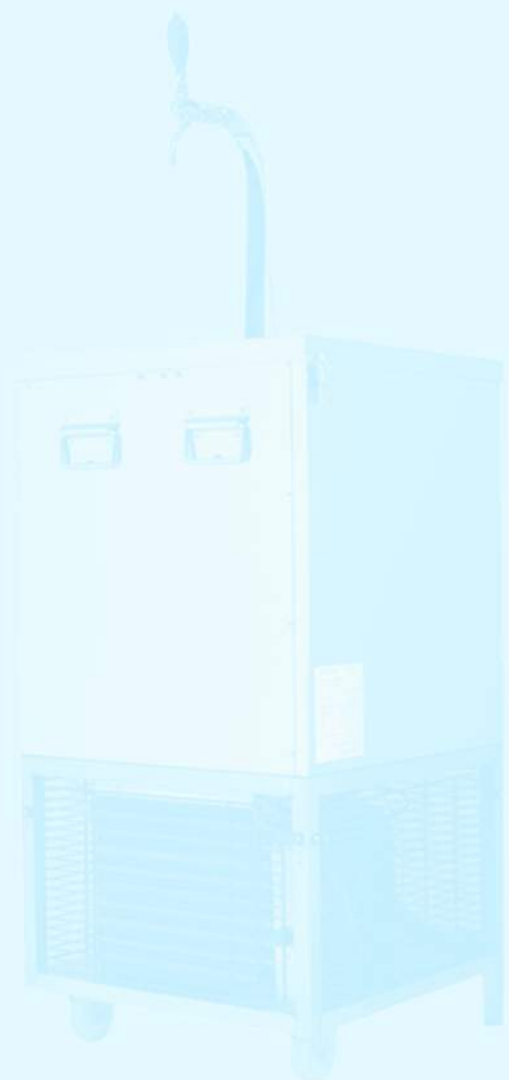

Agregati za hlađenje - pivo - ESTA

Napon. 230 V 50Hz
Kompresor: 1/5HP R134-a
Kapaciteta hlađenja 313W 1120 kJ/h
Kontinuirano istakanje 30 L
Zaliha leda: 3,5KG =1172 kJ
Kapaciteta istakanja na 1.sat 61 L
Volumen kupke 15 L
Dimenzije: d.500mm š.320mm v.425mm
Težina: kg 29

KOD
CODE

OPIS ARTIKLA
DESCRIPTION

50053
7031
7027

H20 1/5 HP
1° spirala za hlađenje mt 13
2° spirala za hlađenje mt 12



Agregati za hlađenje - pivo - ICE 7

Napon. 230 V 50Hz
Kompresor: 1/4HP R134-a
Kapaciteta hlađenja 381 W 1360 kJ/h
Kontinuirano istakanje 36 L
Zaliha leda: 7KG =2344 kJ
Kapaciteta istakanja na 1.sat 98 L
Volumen kupke 15 L
Dimenzije: d.570mm š.370mm v.430mm
Težina: kg 34

COD
CODE

OPIS ARTIKLA
DESCRIPTION

50056

ICE 7

7029

1° spirala za hlađenje mt 17

7030

2° spirala za hlađenje mt 15

7031

3° spirala za hlađenje mt 13



Agregati za hlađenje - pivo - ICE 13

Napon. 230 V 50Hz
Kompresor: 1/3HP R134-a
Kapaciteta hlađenja 501 W 1789 kJ/h
Kontinuirano istakanje 47 L
Zaliha leda: 13KG =4356 kJ
Kapaciteta istakanja na 1.sat 162 L
Volumen kupke 31 L
Dimenzije: d.570mm š.370mm v.540mm
Težina: kg 39

COD
CODE

OPIS ARTIKLA
DESCRIPTION

50065

ICE 13

7028

1° spirala za hlađenje mt 17

7029

2° spirala za hlađenje mt 17

7030

3° spirala za hlađenje mt 15

7031

4° spirala za hlađenje mt 13



Agregati za hlađenje - NB 45

Napon. 230 V 50Hz
Kompresor: 1/3HP R134-a
Kapaciteta hlađenja 501 W 1789 kJ/h
Kontinuirano istakanje 47 L
Zaliha leda: 8KG =2679 kJ
Kapaciteta istakanja na 1.sat 118 L
Volumen kupke 20,5 L
Dimenzije: d.535mm š.320mm v.510mm
Težina: kg 38

COD
CODE

OPIS ARTIKLA
DESCRIPTION

50070

NB 45

7070

1°spirala za hlađenje mt 20x8mm

7071

2°spirala za hlađenje mt 20x8mm

7072

3°spirala za hlađenja mt 20x8mm



Agregati za hlađenje - ICE 23

Napon. 230 V 50Hz
Kompresor: 1/2HP R134-a
Kapaciteta hlađenja 870 W 3107 kJ/h
Kontinuirano istakanje 82 L
Zaliha leda: 23KG =7702 kJ
Kapaciteta istakanja na 1.sat 286 L
Volumen kupke 53 L
Dimenzije: d.720mm š.500mm v.540mm
Težina: kg 39

COD
CODE

OPIS ARTIKLA
DESCRIPTION

50090

ICE 23

7028

1° spirala za hlađenje mt 17

7029

2° spirala za hlađenje mt 17

7030

3° spirala za hlađenje mt 15

7031

4° spirala za hlađenje mt 13



Agregati za hlađenje - SIRIO

Napon: 220 V 50Hz
Kompresor: 1/3HP Kcal/h 396
 1/4HP Kcal/h 275
Obtočna pumpa: pumpa 8 mt
Termostat: Ranco K50
Zaliha leda: Sirio 50 10kg 38mm
 Sirio 100 16kg 42mm
Volumen kupke: Sirio 50 26 Lt
 Sirio 100 42 Lt
Kućište: Plastifi.lim
Dimenzije: Sirio V50: D.380mm S.380mm V.580mm 28kg
 Sirio V100: D.430mm S.430mm V.630mm 34kg

COD
CODE

OPIS ARTIKLA
DESCRIPTION

5328
5330

Sirio V50 2 spirale za hlađenje mt 18
Sirio V100 4 spirale za hlađenje mt 18



Agregati za hlađenje - pivo - NORD

Napon. 230 V 50Hz
Kompresor: 3/4HP R134-a
Kapaciteta hlađenja 960 W 3430 kJ/h
Kontinuirano istakanje 92 L
Zaliha leda: 30KG =10047 kJ
Kapaciteta istakanja na 1.sat 358 L
Volumen kupke 61,5 L
Dimenzije: d.575mm š.620mm v.980mm
Težina: kg 38

COD
CODE

OPIS ARTIKLA
DESCRIPTION

5373

NORD 120

7071

1°spirala za hlađenje

7072

2°spirala za hlađenje

7073

3°spirala za hlađenje

7074

4°spirala za hlađenje

7031

5°spirala za hlađenje

7027

6°spirala za hlađenje



Agregati za hlađenje - EASY KEG X 50

Napon. 230 V 50Hz
Kompresor: 1/5HP R134-a
Kapaciteta hlađenja 313W 1120 kJ/h
Kontinuirano istakanje 30 L
Zaliha leda: 3,5KG =1172 kJ
Kapaciteta istakanja na 1.sat 61 L
Volumen kupke 10 L
Dimenzije: d.500mm š.500mm v.1000mm(bez konzole)
Težina: kg 68

COD
CODE

OPIS ARTIKLA
DESCRIPTION

60050

EASY KEG X 50



Agregati za hlađenje - EASY KEG V 60

Napon. 230 V 50Hz
Kompresor: 1/5HP R134-a
Kapaciteta hlađenja 313W 1120 kJ/h
Kontinuirano istakanje 30 L
Zaliha leda: 3,5KG =1172 kJ
Kapaciteta istakanja na 1.sat 61 L
Volumen kupke 15 L
Dimenzije: d.500mm š.500mm v.1000mm (bez konzole)
Težina: kg 70

COD
CODE

60060

OPIS ARTIKLA
DESCRIPTION

EASY KEG 2V



Agregati za hlađenje - Nb600

Napon. 230 V 50Hz
Kompresor: 5/8HP R134-a
Kapaciteta hlađenja 1012 W 3614 kJ/h
Kontinuirano istakanje 95 L
Zaliha leda: 33KG =10047 kJ
Kapaciteta istakanja na 1.sat 447 L
Volumen kupke 70 L
Dimenzije: d.545mm š.540mm v.1020mm(bez konzole)
Težina: kg 66,5

COD
CODE
50310

OPIS ARTIKLA
DESCRIPTION
NB 600 VG MOBI



Agregati za hlađenje - pivo - ESTA

Napon. 230 V 50Hz
Kompresor: 3/4HP R134-a
Kapaciteta hlađenja 960 W 3430 kJ/h
Kontinuirano istakanje 92 L
Zaliha leda: 30KG =10047 kJ
Kapaciteta istakanja na 1.sat 358 L
Volumen kupke 61,5 L
Dimenzije: d.575mm š.620mm v.980mm
Težina: kg 38

COD
CODE

OPIS ARTIKLA
DESCRIPTION

5394	Fiesta V/200
7070	1°hladilna spirala mt 20
7071	2°hladiln spirali mt 20
7072	3°hladilne spirale mt 20
7073	4°hladilne spirale mt 20



Agregati za hlađenje - NB 45 MOBI

Napon. 230 V 50Hz
Kompresor: 1/3HP R134-a
Kapaciteta hlađenja 501 W 1789 kJ/h
Kontinuirano istakanje 47 L
Zaliha leda: 8KG =2679 kJ
Kapaciteta istakanja na 1.sat 118 L
Volumen kupke 20,5 L
Dimenzije: d.535mm š.320mm v.510mm (bez slavina)
Težina: kg 38

COD
CODE

OPIS ARTIKLA
DESCRIPTION

50071

NB 45 MOBI 2X



Agregati za hlađenje - CASTOR

Napot: 230 V 50Hz
Kompresor: 1/5HP Kcal/H 182
Termostat: Ranco K50
Zaliha leda: Kg 16- 54mm
Volumenkupke: 16 Lt
kućište: INOX 304
Dimenzije: D600 S291 V500
Težina: 34 kg

COD
CODE

OPIS ARTIKLA
DESCRIPTION

5356

Castor 18L 1P



Agregati za hlađenje - pivo - ESTA MOBI

Napon. 230 V 50Hz
Kompresor: 1/5HP R134-a
Kapaciteta hlađenja 313W 1120 kJ/h
Kontinuirano istakanje 30 L
Zaliha leda: 3,5KG =1172 kJ
Kapaciteta istakanja na 1.sat 61 L
Volumen kupke 15 L
Dimenzije: d.500mm š.320mm v.425mm (bez slavina)
Težina: kg 29

COD
CODE

OPIS ARTIKLA
DESCRIPTION

50150

ESTA MOBI 20 2X



Agregati za hlađenje - NBD MOBI

Napon. 230 V 50Hz
Kompresor: 1/2HP R134-a
Kapaciteta hlađenja 870 W 3107 kJ/h
Kontinuirano istakanje 82 L
Zaliha leda: 17KG =5693 kJ
Kapaciteta istakanja na 1.sat 233 L
Volumen kupke 46 L
Dimenzije: d.650mm š.425mm v.570mm (bez slavina)
Težina: kg 51,5

COD
CODE

5270

OPIS ARTIKLA
DESCRIPTION

NBD 520 2X



Agregati za hlađenje - pivo - BERG MINI vino

Napon. 230 V 50Hz
Kompresor: 1/7HP R134-a
Kapaciteta hlađenja 185 W 660 kJ/h
Kontinuirano istakanje 18 L
Zaliha leda: 2KG =670 kJ
Kapaciteta istakanja na 1.sat 36 L
Volumen kupke 6 L
Dimenzije: d.565mm š.250mm v.468mm (bez slavina)
Težina: kg 38

COD
CODE

OPIS ARTIKLA
DESCRIPTION

50552

BERG MINI nadpultni - vino 2X



Agregati za hlađenje - MEDITERAN

Post - Mix nadpultni 5S Flomatic
Stranice reklamno osvetljene
Napon: 198/242 V 50Hz
Kompresor: 1/4 HP 278 Kcal/h
Mjesalo: VMC 1350 RPM
Termostat: Elektronski AL-100
Iztočni ventili: Flomatic
Zaliha leda: 7,0 KG
Volumen kupke: 30 Lt
Dimenzije: D505mm S 660mm V500mm
Težina: 45 Kg

COD
CODE

5220

OPIS ARTIKLA
DESCRIPTION

Mediteran 5P Flomatic



Agregati za hlađenje - POST MIX P/C 250

Napon. 230 V 50Hz
Kompresor: 5/8HP R134-a
Kapaciteta hlađenja 1012 W 3614 kJ/h
Kontinuirano istakanje 45 L
Zaliha leda: 24KG =8037 kJ
Kapaciteta istakanja na 1.sat 146 L
Volumen kupke 54 L
Dimenzije: d.900mm š.545mm v.600mm
Težina: kg 78

COD
CODE

OPIS ARTIKLA
DESCRIPTION

50522

POST MIX P/C 250



Agregati za hlađenje - POST MIX ORION

Napon: 198/242 V 50Hz
Transformator: 220/24V 150W
Kompresor: 1/2HP R134-585 Kcal/h
Obtočna pumpa: pumpa 8 mt
Termostat: elektronski
Zalihaa leda: 25,5 kg
Volumen kupke: 86 Lt
Kučište: AISI 304U
Dimenzije: D878 S495 V582mm
Teža: 77 Kg

COD
CODE

5215

OPIS ARTIKLA
DESCRIPTION

ORION H200 6P SC

