

AUTOSPORT

CHINESE GP

www.autosport.com • APRIL 16 2015 • £3.70

HAMILTON BACK ON TOP



...But Rosberg row reignites



haymarket

9 770269 946265

16

C\$8.99

PLUS

AUDI STRIKES BACK
Porsche defeated in close finish





Porsche recommends Mobil 1 and MICHELIN

**Over 30,000 trophies would be in other hands.
If we didn't believe in our ideas.**

Mission: Future Sportscar

The Porsche 919 Hybrid at the FIA World Endurance Championship:

porsche.com/FutureSportscar





PORSCHE

AUTOSPORT **GRAND PRIX PREDICTOR**

ARE YOU ON THE GRID YET?

**NEW
LOOK
FOR
2015**

**REGISTER TODAY AND PICK YOUR
TOP 10 FINISHERS FOR THE
2015 AUSTRALIAN GRAND PRIX!**



- **Win A PlayStation 4 Drive Club Bundle!**
- Compete against your mates in private mini-leagues!
- It's free and easy to play for great prizes every race!

**PLAY NOW AT
GPPREDICTOR.COM**

POLE POSITION

What Rosberg's China complaints really meant

NICO ROSBERG'S CRITICISM OF LEWIS HAMILTON AFTER the Chinese Grand Prix is significant not because of what he said, but instead the fact that he said it. Why? Because it reflects just how much pressure Rosberg is under thanks to the level Hamilton is operating at this season.

Ever since the pair clashed in last year's Belgian GP, Hamilton has been on a roll. At the back end of last season, he consistently won races from losing positions – just as Rosberg lost races from winning ones – and that form has carried into 2015.

Last year, Rosberg very effectively destabilised Hamilton and got the upper hand for a significant slice of the championship. It would only have required turning a couple of winning positions into 25 points late on, and then no mechanical problems in Abu Dhabi, to win the title. It seems that after three weekends being the second-best Mercedes driver, he's trying very hard to repeat that trick.

Rosberg is a classy driver and a shrewd operator. But the Hamilton we have seen during the past eight months has been mighty. The chinks in the armour probably aren't there for Rosberg to exploit anymore.

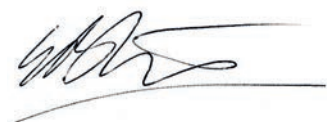

EDD STRAW EDITOR
 edd.straw@haymarket.com
 @eddstrawF1

COVER STORY

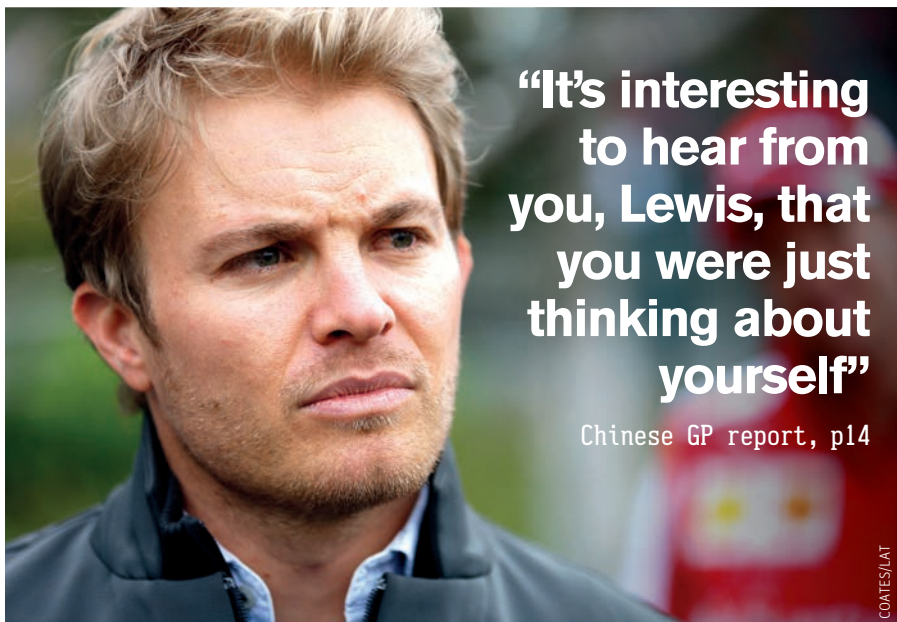

FIND US ON



Cover image: Charniaux/XPB Images; Lee/Getty

PIT & PADDOCK

- 8 THIS WEEK IN F1
- 11 IN THE PADDOCK: BEN ANDERSON
- 12 THIS WEEK IN MOTORSPORT

FEATURES & REPORTS



- 14 CHINESE GRAND PRIX REPORT
- 30 WILL MERCEDES USE TEAM ORDERS?

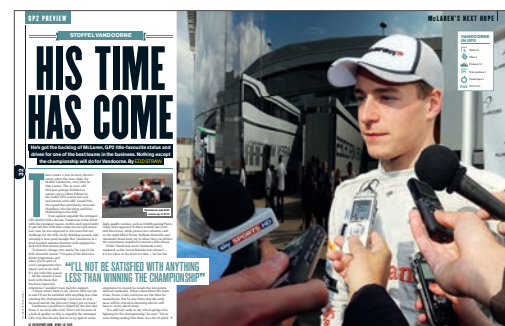

- 32 GP2 PREVIEW: STOFFEL VANDOORNE
- 36 WEC SILVERSTONE
- 44 EUROPEAN F3 SILVERSTONE
- 46 BLANCPAIN ENDURANCE MONZA
- 51 TCR INTERNATIONAL, RENAULT NEC
- 52 INDYCAR NOLA
- 54 ELMS SILVERSTONE
- 57 NASCAR, FORMULA RENAULT ALPS
- 58 INTERNATIONAL RESULTS ROUND-UP



- 60 LOST TALENTS: HOTTINGER AND BURGER
- CLUB AUTOSPORT**
- 79 CARLIN APPEALS NORRIS EXCLUSION
- 80 MIDDLEHURST TO RETURN TO FF1600
- 83 GINETTA LMP3 FOR BRITCAR 24 HOURS

SUBSCRIPTION OFFER

82 GET AUTOSPORT DELIVERED TO YOU

- THE BACK STRAIGHT**
- 90 THIS WEEK
- 92 FROM THE SOFA
- 94 MICHAEL KRUMM IN CHAMP CAR



THE BIG PICTURE

Sparks were always going to fly at Scuderia Toro Rosso in 2015 with its all-rookie line-up. But here Carlos Sainz Jr lights up Shanghai International Circuit in a positive way

Photographer XPB Images



This week in F1

PALMER GETS FIRST GP OUTING

GP2 champion Jolyon Palmer made his Formula 1 race-weekend debut last Friday when he appeared for Lotus in free practice at Shanghai.

The Briton recovered from an early spin to end his first run 15th on the timesheets, just 0.6s off team-mate Pastor Maldonado.

Although his focus this year is on doing as well as he can as third driver for the Enstone-based outfit, he has admitted he is eager to keep racing if possible.

"If I get a good offer to do something that would be a good career move for me then I'd like to race," he told AUTOSPORT.

"It's about keeping sharp. It's the one thing I'm missing this year. I'm enjoying working with Lotus and being in F1, but I'd love to be

REMEMBER WHEN



Palmer's appearance in China was the first time the family name had taken part in an F1 weekend since his father Jonathan failed to qualify for the 1989 Australian Grand Prix.

racing as well, so if I get a good offer I'd take it."

Palmer is set to drive again in Bahrain tomorrow (Friday).



RED BULL OWNER MATESCHITZ REITERATES F1 QUIT THREAT

Red Bull owner Dietrich Mateschitz is adamant that he is ready to pull his teams out of Formula 1 following a difficult start to the season.

Speaking to Austrian media at the Shanghai track over the Chinese Grand Prix weekend, he indicated that the Red Bull and Toro Rosso teams' futures were not guaranteed.

"We'll only stay in Formula 1 if we have a competitive team, and we need a competitive power unit for that," Mateschitz was quoted as saying by the Austria Press Agency.

"If we don't have one, we can

race with the best car and the best drivers and still have no chance of competing for victory."

Mateschitz says that it is not just Red Bull's future that is in doubt, because he thinks Renault itself should quit if it cannot make adequate progress.

"Of course Renault can also weigh its options, including a pull-out," he said. "As a manufacturer, it's your task to deliver a competitive power unit.

"If you can do that, it's great. If, for whatever reason, you can't do that, you should pull out. Then the consequences for us would be clear too."

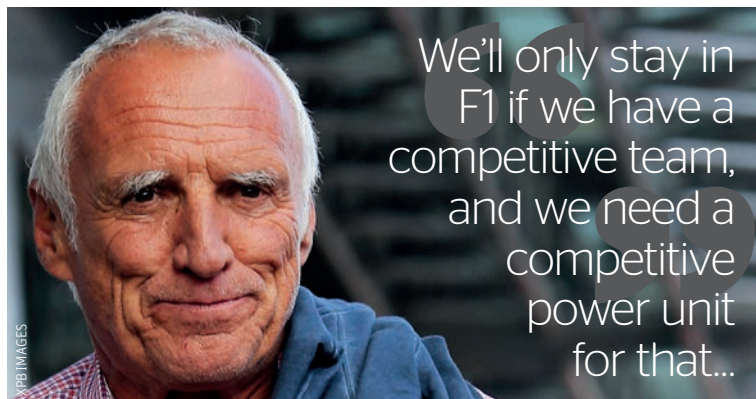

We'll only stay in F1 if we have a competitive team, and we need a competitive power unit for that...

For all the breaking news, visit AUTOSPORT.COM

Early-season podium record

Formula 1 achieved an unenviable hat-trick at last weekend's Chinese Grand Prix.

For the first time in history, the podium at the first three races has been filled with the same three drivers: Lewis Hamilton, Nico Rosberg and Sebastian Vettel.



Australia



Malaysia



China



TEAMS MUST HELP BOOST F1

Teams must help race promoters more to try to boost ticket sales, according to Toro Rosso team boss Franz Tost.

The demise of the German Grand Prix for 2015 and concern about Formula 1's falling popularity should act as a spur for competitors to change their approach, says Tost.

"We need to show the people a fantastic race with fights on track and overtaking moves," he told AUTOSPORT.

"We must also support the promoters with their requests because the races must be promoted in advance and the race weekends must have more entertainment.

"It means more [support] races and maybe concerts. It must be a fantastic event because Formula 1 is only once in every country.

"If this is promoted enough, the people will have the feeling to go there as it's the highlight of the year. This is how I see it."

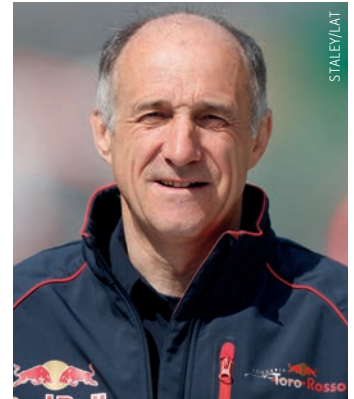

STALEY/LAT

China tightens track security

Shanghai circuit officials were forced to tighten security at the Chinese Grand Prix after a spectator ran across the circuit during second practice.

The man climbed the trackside fence on the main straight and sprinted across to the pitwall. He is then believed to have run to the Ferrari garage with his ticket and demanded a drive in its car.

It is not the first time spectators have breached security at F1 events. At the 2003 British GP a protestor ran onto the Silverstone track during the race, while in 2000 a disgruntled Mercedes employee walked onto the Hockenheim circuit during the German GP.



COATES/LAT

If Ferrari win the championship at the end of the year, maybe I'll have a different opinion; if they finish second or third, I think I'm happy with the decision [to join McLaren]



Fernando Alonso insists there are no regrets about his decision to leave Ferrari at the end of 2014



STALEY/LAT

Gasly earns Toro Rosso test

Red Bull development driver Pierre Gasly will drive a Formula 1 car for the first time when he tests for Toro Rosso after the Spanish Grand Prix.

The Frenchman, who is racing in GP2 this year, will drive on one of the two days at the Barcelona test.

Toro Rosso has not yet confirmed who will drive on the other days.



LEICESTER/GP2



BY APPOINTMENT TO
HER MAJESTY THE QUEEN
SUPPLIER OF CAR CARE PRODUCTS
AUTOGLYM, LETCHWORTH, ENGLAND



BY APPOINTMENT TO
H.R.H. THE PRINCE OF WALES
SUPPLIER OF CAR CARE PRODUCTS
AUTOGLYM, LETCHWORTH, ENGLAND

THE OLDER WE GET, THE BETTER YOU LOOK.

Born to shine, since 1965.



With age comes wisdom and one thing we've learnt in our 50 years is that perfection can only be achieved when you strive to be the best. Product innovation is at the heart of everything we do and Autoglym products are regarded by experts as being of the finest quality. They're also easy to use if you're new to car care and, for the more devoted, our expert advice can help transform you and your car into automotive heroes. We think that's something worth celebrating and hope you do too. *That's the Autoglym way, always has been.*

Join in the 50th anniversary celebrations and win special edition products, visit: facebook.com/autoglym



Made in Great Britain

Pas5ion
for PERFECTION





Ben Anderson

From the paddock

Two big names in Formula 1 are fighting to recover lost form, but there's a gulf between them in how they're reacting to adversity

Red Bull and McLaren are two of Formula 1's best teams, but both are going through a tough period. Having dominated the sport for four consecutive seasons from 2010 to '13, Red Bull and its engine partner Renault have hit a rocky patch. Their alliance managed three wins and finished second in the constructors' championship last year, but efforts to close the gap to Mercedes over the winter have backfired and now they are struggling even to finish in the top six, let alone trouble the podium.

McLaren has been in the doldrums for two seasons now. Its last victory came in the final race of the 2012 season in Brazil. Last Sunday's Chinese Grand Prix marked 41 starts since it last topped the podium – its longest losing streak since it went 49 races without a win from 1994 to the first race of '97.

Having renewed an old alliance with Honda – the engine manufacturer that powered its most successful period in Formula 1 in the late-'80s and early-'90s – McLaren is further off the pace than at any point since 2012.

What both teams have in common is the fact that their respective partners are struggling to produce powerful engines that don't break down. Teams are only permitted four engines per car this season, but Red Bull's Daniel Ricciardo and Daniil Kvyat are both already on their third heading into round four in Bahrain this weekend. Meanwhile, McLaren spent

something similar more recently (witness team chief Christian Horner and Renault boss Cyril Abiteboul jointly speaking to the media in China), but unfortunately their true feelings are already out in the open...

On the face of it McLaren and its world champion drivers should be seething with rage. We've had three races this season and so far neither MP4-30 has escaped the first part of qualifying, while Jenson Button's twice-lapped 11th place (last) in the Australian Grand Prix remains McLaren's best result.

It's not good for fans of McLaren, nor for F1 in general, to have two of the sport's top drivers (and one of its top teams) driving around at the back of the field. The pressure of expectation on McLaren-Honda – given the history and the resources at play – is enormous.

Yet the atmosphere at the team is relaxed and jovial. Brows are rarely furrowed among staff, the drivers are smiling, and there have been few – if any – of the 'our-car-is-mega-but-the-engine-is-holding-it-back' statements so regularly heard further along the pitlane.

"As senior management we have to lead by example," McLaren racing director Eric Boullier told me. "We have to be joined at our level – me, [Honda chief Yasuhisa] Arai, and Ron [Dennis, McLaren chairman] – to make sure that people understand where we want to go.

"Once you establish the leadership, it's much easier to make sure that every level of the organisation –

“McLaren and Honda are focused on the bigger picture – short-term pain for long-term gain”

most of pre-season testing in the garage as it struggled to make its Honda engine run cleanly, and now it's got things going the package is woefully off the pace.

The present situation is arguably more frustrating for Red Bull, given that Renault has been racing in this new V6 hybrid turbo formula for a year already, while Honda is new to the game. But the contrast in attitude between the two teams is stark.

Where Red Bull has entered into a public slanging match with its engine partner (and threatened to quit the sport altogether if things don't improve), McLaren has kept quiet when it comes to the inadequacies of a Honda operation that clearly underestimated the challenge of returning to F1 under the current regulations.

Instead of hauling its engine partner over the coals for failing to quickly develop a reliable ERS system, McLaren has supported its Japanese ally and presented a united front to the world. In fairness to Red Bull and Renault, they have tried to do

or both organisations – is working well together.”

That doesn't mean McLaren and Honda are just sitting back and swallowing defeat, but this pairing is focused on the bigger picture, essentially accepting some short-term pain for the long-term gain that a partnership such as this should yield if it's protected and nurtured properly.

Mercedes is enjoying the fruits of that already, while Ferrari is getting there after a season of pain in 2014.

Both Red Bull and Renault have spoken at length about the need to move from a customer/supplier basis to an integrated 'works' relationship in order to return to the front (this is also easier said than done when certain ways of working are already established), but it seems McLaren-Honda is already living that ideal.

The Woking/Sakura alliance is undoubtedly way behind Milton Keynes/Viry on the circuit right now, but in terms of a productive working relationship it already looks streets ahead. ❧

This week in motorsport

SPEED LIMITS IMPOSED FOR NORDSCHLEIFE GT3



Performance restrictions – including speed limits – have been imposed on GT3 cars to allow them to return to the Nurburgring Nordschleife, meaning that they will be able to contest the track's flagship 24 Hours on May 16-17.

The German motorsport federation, the DMSB, has lifted the ban on GT3 machinery and a range of other cars

that followed the death of a spectator when Jann Mardenborough's Nissan cleared the debris fencing in last month's VLN series opener. It has opted to slow the cars as well as imposing speed limits at critical locations around the track.

Engine performance has been cut by five per cent across the board in the affected classes.

A limit of 200km/h (124mph), to be policed by GPS, will be imposed at the Flugplatz, Schwedenkreuz and Antoniusbuche sections, with a 250km/h (155mph) maximum on the Dottinger Hohe straight.

The move came in time to allow GT3 cars to contest the six-hour qualifying race for the 24 Hours last weekend.



Hyundai scraps three-door plan

Hyundai has binned plans to run a three-door i20 WRC in the World Rally Championship and has directed its effort into an all-new five-door model, which tested in Spain recently (above).

Homologation of the three-door model was not possible after South Korea failed to produce enough road cars. The team will not replace the current car this year.

Corsica U-turn on long stages

Tour of Corsica organisers have toned down the radical itinerary originally planned for their first World Rally Championship round since 2008.

Plans for a five-stage event starting with a 45-mile Friday night test have been shelved. Instead, the October rally runs three stages (shortest is the powerstage at nine miles, longest is also on the final day at 28 miles) on each of three days based from a service park at Corte airport with three separate overnight locations: Ajaccio, Bastia and Porto-Vecchio.

12

Danielsson to contest WRX

Swede Alx Danielsson is the latest racing driver to switch codes to the World Rallycross Championship, and will contest the opening three rounds in a Munnich Motorsport Audi S3.

Danielsson, who will partner team boss Rene Munnich, therefore continues an odyssey that has taken him from single-seaters via touring cars, Porsches and even a NASCAR road-course race.

"Everybody in Sweden who is into cars likes rallying and rallycross," said Danielsson. "I've driven pretty much everything else there is to drive, so this lies in the mix somewhere."

Also in WRX, Timur Timerzyanov has switched from the Peugeot-Hansen team to join Andreas Bakkerud and Reinis Nitiss at the OlsbergsMSE Ford team. Peugeot-Hansen promotes Davy Jeanney to its squad alongside Timmy Hansen.



REMEMBER WHEN

Alx Danielsson's biggest success in motorsport came with his Formula Renault 3.5 title with Comtec Racing, beating a field that included Pastor Maldonado, Alvaro Parente, Davide Valsecchi and Mikhail Aleshin. Sebastian Vettel also made a cameo appearance that season.



SOLBERG JOINS UP WITH DORAN

World Rallycross champion Petter Solberg is teaming up with Briton Liam Doran for 2015. The pair, who both drive Citroen DS3s, will work together on events although will continue to prepare their own cars.

For all the breaking news, visit **AUTOSPORT.COM**



S. BLOKHAM/GP3

PALOU PIPS ART STARS

GP3 newcomer Alex Palou stole the headlines from ART Grand Prix's heavy hitters in last week's two-day pre-season test at Valencia.

The Spaniard, a race winner in Euroformula Open last season, took his Campos Racing machine (above) to the fastest time, narrowly heading ART's duo of Marvin Kirchhofer and

European Formula 3 champion Esteban Ocon. Kevin Korjus, deputising for Lotus F1 development driver Adderly Fong with Koiranen GP, was fourth fastest.

Palou topped two of the four sessions, with Kirchhofer ahead in one and the final half-day going to category veteran Pal Varhaug.

Indy aero kits are beefed up

IndyCar mandated changes to strengthen the manufacturer-designed aero kits on the eve of last weekend's race at NOLA Motorsports Park.

The reinforcements were introduced off the back of a debris-laden season opener in St Petersburg, and are aimed at limiting the amount of bodywork damage caused by car-to-car contact.

IndyCar president of competition and operations Derrick Walker said: "We applaud both Honda and Chevrolet for their efforts to implement these changes. We'll continue this collaboration and expect additional improvements in the future."



ABBOTT/LAT

In brief



LEVITT/LAT

ESTRE'S SPA PORSCHE

McLaren factory driver Kevin Estre will race for Porsche in the Spa World Endurance Championship round next month. The Frenchman (above) has been drafted in to race the #92 Manthey-run 911 RSR with Porsche junior Sven Muller. Frederic Makowiecki and Richard Lietz will team up in the other GTE Pro entry as part of a reshuffle resulting from the clashing Laguna Seca United SportsCar round. USC regulars Nick Tandy and Earl Bamber will be on duty at Spa in the third 919 Hybrid LMP1.

JUNCADELLA IN SLS

Mercedes DTM driver Daniel Juncadella will contest selected rounds of the Blancpain Endurance Series around an attack on the Spa 24 Hours in July. The Spaniard, who was reserve and test driver for Force India in Formula 1 last year, made his sportscar debut driving a Mercedes SLS AMG for the German Rowe Racing squad in last weekend's series opener at Monza.

SUPERCUP NEW BOYS

Briton Cameron Twynham has switched disciplines from single-seaters to race in the Porsche Supercup this season with the MOMO-Megatron team. Also new to the Supercup are Italian Carrera Cup champion Matteo Cairoli, who succeeds Earl Bamber as the winner of Porsche's scholarship and will race with the Project 1 squad, and Australian Spike Goddard, with the European Formula 3 graduate joining up with MRS.

PENALTY FOR CHILTON

Tom Chilton will take a grid penalty for this weekend's World Touring Car counter at Marrakech after ROAL Motorsport elected to fit an upgraded engine to his Chevrolet Cruze.

JIANG RETURNS IN TCR

Ex-A1GP Team China racer Tengyi Jiang raced in TCR International at Shanghai last weekend, finishing ninth in a Target Competition SEAT.

GINETTA EYES LMP2 MARKET

British sportscar constructor Ginetta is evaluating an entry into the LMP2 market when new regulations come into force for the category in 2017.

Ginetta boss Lawrence Tomlinson, whose new Nissan-engined LMP3 made its debut in last weekend's European Le Mans Series opener at Silverstone, has revealed that he attended the most-recent P2 rules meeting. He stated that he has an interest in making a bid to become one of the four constructors to be granted licences to produce LMP2 cars in 2017-20.

Tomlinson said: "It is a really exciting concept and we have the technical and financial ability to do it. So why wouldn't we do it?"

"We've already proved that we can deliver a car to a price with LMP3 and plan to make an expression of interest."



Schmitz for WTCC at Nurburgring

Germany's 'Queen of the Ring' Sabine Schmitz will contest the World Touring Car round on the Nurburgring Nordschleife in a Munnich Motorsport Chevrolet. The 45-year-old has twice won the 24 Hours.

HILDEBRAND GETS CFH SEAT FOR THE 500



LEVITT/LAT

JR Hildebrand, the nearly-man of the 2011 Indianapolis 500, will return to the IndyCar field next month after signing on to drive a third CFH Racing entry at the Indy road course race and the 500.

The 27-year-old, who crashed while leading on the final lap four years ago, drove a second car for the team's previous

incarnation, Ed Carpenter Racing, at the 500 last year, where he finished 10th. This year's race will be his fifth appearance on the Speedway, although he has never raced on the road course.

Hildebrand has been out of a full-time ride since he parted with Panther Racing in the first half of 2013.

HAMILTON'S CRUISE, ROSBERG'S BRUISE

The world champion dominated practice, qualifying and the race for his third Shanghai win, while his team-mate felt aggrieved over what he felt were delaying tactics. **BEN ANDERSON** relays the key facts







THE RACE 14:00, 12.04.2015



Three races into last year's Formula 1 World Championship, Nico Rosberg and Lewis Hamilton fell out over the tactics each employed during their duel for victory in the Bahrain Grand Prix.

Hamilton won that race, but his Mercedes teammate — who had dropped behind at the start — was unhappy with the way Hamilton had rebuffed his repeated attempts to repass for the lead. Conversely, Hamilton was angered by the superior engine settings Rosberg had used to come back at him.

Three races into the 2015 season these two were at loggerheads again, as Rosberg complained Hamilton drove “unnecessarily” slowly to win the Chinese Grand Prix, and thus exposed Mercedes' second car to the threat of a resurgent Ferrari.

This post-race spat between last year's two principal title protagonists — the sort of personal tension that bolsters any great sporting rivalry — enlivened an otherwise processional grand prix at the front of the field.

Regardless of the pre-race warnings coming from the Mercedes garage, Ferrari was not as competitive here as it was in Malaysia, and Mercedes looked to have a big margin over the rest from the moment the cars first turned wheels on Friday.

But Sebastian Vettel's shock win at Sepang a fortnight prior had the Stuttgart/Brackley/Brixworth alliance rattled. Mercedes shouldn't have lost that race, given it began with the advantage of track position and two cars in the fight compared

to Ferrari's one. But the Scuderia's superior tyre management over longer runs in the Malaysian heat helped it beat a team that has got used to running its own race at the front.

Mercedes simply had to ensure there was no repeat in China. Theoretically, the Shanghai International Circuit shouldn't have presented anything like the same tyre-life conundrum to Mercedes as Sepang did. The circuit layout switches the emphasis of tyre management from the rear of the car to the front, the conditions were much cooler than in Malaysia (helping to protect the rubber), and the upgraded W06 was further ahead on pure pace.

Nevertheless, Mercedes entered the Chinese GP with a certain degree of paranoia about the challenge

it might face from its new nearest rival, so it held pace in reserve on Sunday, principally because it feared the W06 would eat its Pirelli tyres too greedily again, and hand Ferrari another victory on a silver platter.

So Hamilton drove slowly. Fast enough to maintain a lead, but far slower than he could have driven had he wanted to. The first stint (14 laps on a used set of soft rubber) went off without a hitch, Hamilton reporting “these tyres have lasted really well” over team radio. He began his second stint (on new softs) lapping at a similar pace. In the early stages of that second stint Rosberg grew impatient. “Get him to speed up!” he cried on the radio, with Vettel tracking less than two seconds behind.



Hamilton looked after his rubber, controlling the race from the front



Hamilton heads Rosberg, Vettel and fast-starting Bottas



Williams didn't threaten the Ferraris this time

MASON/GETTY



Vettel led challenge to Mercedes again

XPB IMAGES

Mercedes explained to Hamilton that Rosberg was concerned he would destroy his own tyres faster if he got any closer, and asked Hamilton to up the ante (which he could do easily).

Lewis suddenly began lapping in the 1m43s; Rosberg responded in kind; the Ferraris continued to match the Mercs (or lap fractionally faster).

By lap 25 Mercedes was warning Hamilton it would have to hand Rosberg the advantage of an earlier second stop if he didn't start going more quickly. Lewis upped his pace again (into the low 1m43s this time), but Rosberg couldn't match him, complaining: "my left front has become a problem". He was 1.8s behind on lap 25, then Hamilton pumped in the following sequence:

HAMILTON FIVE-LAP SEQUENCE

1m43.508s	
1m43.647s	
1m43.644s	
1m43.239s	
1m43.008s	

ROSBERG'S BEST

The best Rosberg managed during that time was a 1m43.5s on lap 30, before making his second stop one lap later. The rest were 1m43.6-8s. As Rosberg pitted, Hamilton unleashed his withheld extra pace, pumped in two consecutive low 1m42s laps to protect his advantage, then made his own second stop on lap 33.

For the rest of the race (with both cars running the

Hamilton: "I wasn't controlling his race, I was controlling mine. My goal was to look after my car. I had no threat from Nico"

slower medium tyre), Hamilton maintained a comfortable gap to his closest rival, which fluctuated only slightly. He had the lead out to 8.6s with three laps to go, before the safety-car finish necessitated by the comically slow recovery of Max Verstappen's stranded Toro Rosso.

Throughout the first two stints of the race Hamilton was holding back, which allowed Vettel to stay close and made Rosberg very uncomfortable. When asked whether he was aware that Rosberg was getting backed up into the Ferrari, Hamilton replied: "I wasn't controlling his race, I was controlling my race. Going into the race we thought it would be a lot closer. We knew the Ferraris were very good with their long-run pace and also looking after their tyres, so today the real goal was to manage the tyres.

"My goal was to look after my car. I had no real threat from Nico so I just managed it. Generally, it was a much smoother weekend than we had in the last race. We had the full practice sessions, on my side of the garage at least, and that made a real big difference to the balance of the car."

Rosberg responded by questioning the selfishness of Hamilton's tactics.

"It's interesting to hear from you Lewis that you were just thinking about yourself with the pace at the front. Unnecessarily, that was compromising my race because driving slower at the beginning of stints meant Sebastian was very close to me, and it cost me a lot of race time as I had to cover him [strategically] and my tyres died at the end because my [last] stint was so much longer.

"I'm unhappy about that. Other than that, there is not much to say."

Vettel did make his first two stops earlier than Rosberg, in a vain attempt to get the jump on the second Merc, but he was not really quick enough to threaten and ultimately fell away during the latter part of the race as a result. And, as Hamilton indicated afterwards, "if Nico wanted to get by he could try, but he didn't."

"It's not my job to look after Nico's race; my job is to bring the car home as healthy and fast as possible, and that is what I did," he continued. "I didn't do anything intentionally to slow any of the cars up.

"I'm out there driving as hard as I can, but within the constraints of the tyres. The team kept coming on the radio asking me to pick up the pace, but I'm trying to manage these tyres.

"It's like you have £100 and you have to spend it wisely over your stint. I was trying to make my stint go as long as possible. I was hopefully still wealthy at the end of it..." ▶

ISITITENE/GETTY



One happy Merc driver;
one with a lot to discuss

► It's easy to dismiss Rosberg's rant as the sour grapes of a driver who desperately needs to beat a rival who appears to have all bases covered at the moment. The question is whether Mercedes could have been more aggressive in this race and still protected itself from the Ferrari challenge, thus avoiding the situation that created fresh tension between its two drivers.

Team chief Toto Wolff ultimately felt it wasn't a risk worth taking. "We thought we might run into trouble with the option [soft tyre] but it was actually holding on much better than expected, and much better than Ferrari," he explained.

"With Malaysia still being in the back of our mind, we decided to change the car in various aspects to make it last on the tyres. We didn't know when the point was coming or how sudden the drop would be if the tyre would go over the cliff; this is why it was learning by doing at that stage.

"We wanted to cover Ferrari with the option, so we put the option on [at the first stop]. Lewis needed to take the option longer than expected, so he was controlling his pace – from his point of view, completely understandable.

"Nico was really running into trouble; he was bunched up behind Lewis, he couldn't go anywhere near, so he asked for a two-second gap to Lewis to protect the tyres a bit, which he did, and at the same time Sebastian was increasing the pace behind him. So it was understandable between both of them."

Wolff dismissed any suggestion that Hamilton

was deliberately trying to back Rosberg into the Ferrari drivers "in order to make him finish third or worse" and argued Mercedes had intervened as far as it could in asking Hamilton to up his pace, given its policy of equality between the drivers and not splitting strategies under ordinary circumstances.

Hamilton can argue (as he did) that Rosberg should simply have driven faster; Rosberg can argue Hamilton could have gone faster than he did while still protecting the team's one-two

result from Ferrari's eager clutches.

Mercedes is caught in the delicate balancing act of looking after its collective interest, managing the ruthless individual hunger that is a prerequisite for elite racing drivers, and allowing them to race freely.

As three-time world champion and Mercedes non-executive chairman Niki Lauda explained after the race: "Sure, he [Hamilton] will drive selfish. These guys... I call them egocentric bastards, let's say, and this is the only way to



Vettel stopped before Rosberg both times but couldn't get ahead

QUALIFYING



Tiny details often make the difference in Formula 1. And although Lewis Hamilton continued his relentless 2015 qualifying form and notched up the 40th pole position of his career in China, it could so easily have turned out very differently.

Nico Rosberg came within an agonising 0.042s of denying Hamilton – closer than he has managed at any other point this year – but the qualifying specialist of last year remains frustrated by the “exceptional” (Mercedes team chief Toto Wolff’s description) efforts of the new-and-improved double world champion.

A conventional circuit, with the most straight-line sections on the calendar yet, and the coolest conditions we’ve seen since pre-season testing, was likely to turn this session into an all-Mercedes battle. Malaysian winner Sebastian Vettel hauled his Ferrari within a second of the silver cars, but they were well and truly in a league – or planet, as Williams’s Rob Smedley alleged – of their own.

So it was a contest between Hamilton and Rosberg for pole. Hamilton ultimately won it but, having been comprehensively defeated by his team-mate in rounds one and two, Rosberg made a much better fist of the fight here.

If you compare their best sector times Rosberg was actually four hundredths faster than Hamilton in the final one (incorporating Turns 11 and 12, the long, banked right-hander at 13, the long back straight, the Turn 14 hairpin, and the final left at 15), while Hamilton held an identical edge through the twists of sector two (Turns 6-10 and the short straight before the left at 11). Crucially, Hamilton was also fractionally faster through the first sector, which includes the long, looping right-hander(s) at 1-2, plus the tight left-hander at 3.

Hamilton “didn’t make the most of the tyres” on his second Q3 run, so his first effort stood as pole. Rosberg thought he was going to grab it on his final push, but dropped 0.014s compared to his earlier best in sector two and was understandably frustrated to fall short.

“It was a really good lap, it was 99.5 but not 100 per cent,” he rued. “Four hundredths is the blink of an eye. So that’s it. I was convinced at the time that it was enough, but it wasn’t.”

How to translate four hundredths of a second into something tangible? It’s almost impossible: a tiny amount of extra steering lock through that first right-hander? Holding the brake pedal a mite too long at Turn 2? Not running quite enough speed into the downhill left at 3? Or too much? Or being fractionally too greedy with the throttle pedal on exit?

Tiny details...

Hamilton grabbed his 40th F1 pole

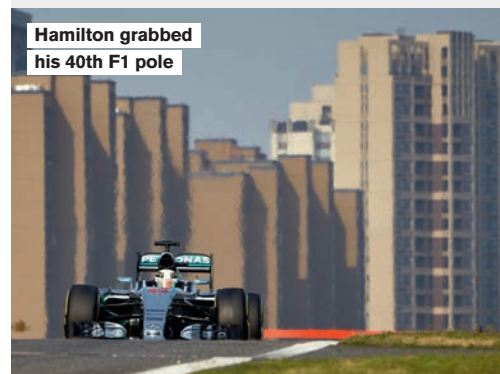

ETHERINGTON/LAT



Renault blowout for Verstappen...

COAT S/LAT



...brings out safety car – all the way to the chequered flag

win a championship. It’s the oldest thing.

“Nico tried hard all the way, you could see this from his lap times. He had Vettel behind, which was a worry at some stage, and he had to fight hard, hard, hard to catch up to Lewis and beat him, but Lewis was better in the end.

“For sure it hurts. When I was being beaten by [Alain] Prost all the time in the old days I was not happy. On the other hand, Nico is a guy who comes back quickly, so thank God there is only one week to the next race so the bullshit will stop quickly when they start driving again.”

Whatever tensions needed defusing afterwards, Mercedes ultimately achieved the right result in this race, and it’s easy to say with hindsight that it should have taken a different tack and run its race faster simply to avoid uncomfortable conversations.

Mercedes was clearly genuinely concerned that if it went too quickly it risked losing out to Ferrari. This was based on the fact that Kimi Raikkonen had been only fractionally slower over long runs on the medium tyre in practice, but gone on for longer.

In addition, Mercedes feared it couldn’t make the soft tyre last long enough to complete the race on two stops, so was actually considering using the unfancied medium twice during the race. Pirelli predicted two soft-tyre stints for everyone and Mercedes’ own soft-tyre Friday runs were comfortably faster than Ferrari’s, but with some concerning ‘drop-off’ towards the end of the run.

Lauda: “Sure Hamilton will drive selfish. These guys... I call them egocentric bastards. It’s the only way to win a championship”

“If we are not driven by scepticism about our own performance and expecting the worst from our main competitor, we will lose out at some stage and Malaysia might happen again,” argued Wolff.

“So in everything we do in how we tackle the race, it was always expecting surprise pace [from Ferrari]. This is why there is no such thing as being overcautious. If you go into a race weekend overconfident, with such an overconfidence you can get caught out.”

Ultimately, the hindsight of Malaysia engendered a necessary degree of caution on the Mercedes pitwall, which in turn led to a closer race than might otherwise have been necessary with Ferrari, which led to a tense situation between its drivers that might otherwise have been avoided.

But that’s not Hamilton’s problem. His job was to do what the late, great Juan Manuel Fangio always said was the aim: win the race at the slowest possible speed. Hamilton did that. What Rosberg needs to do is find a way to beat a driver who is absolutely on top of his game right now. ❧

HOW THE RACE WAS WON

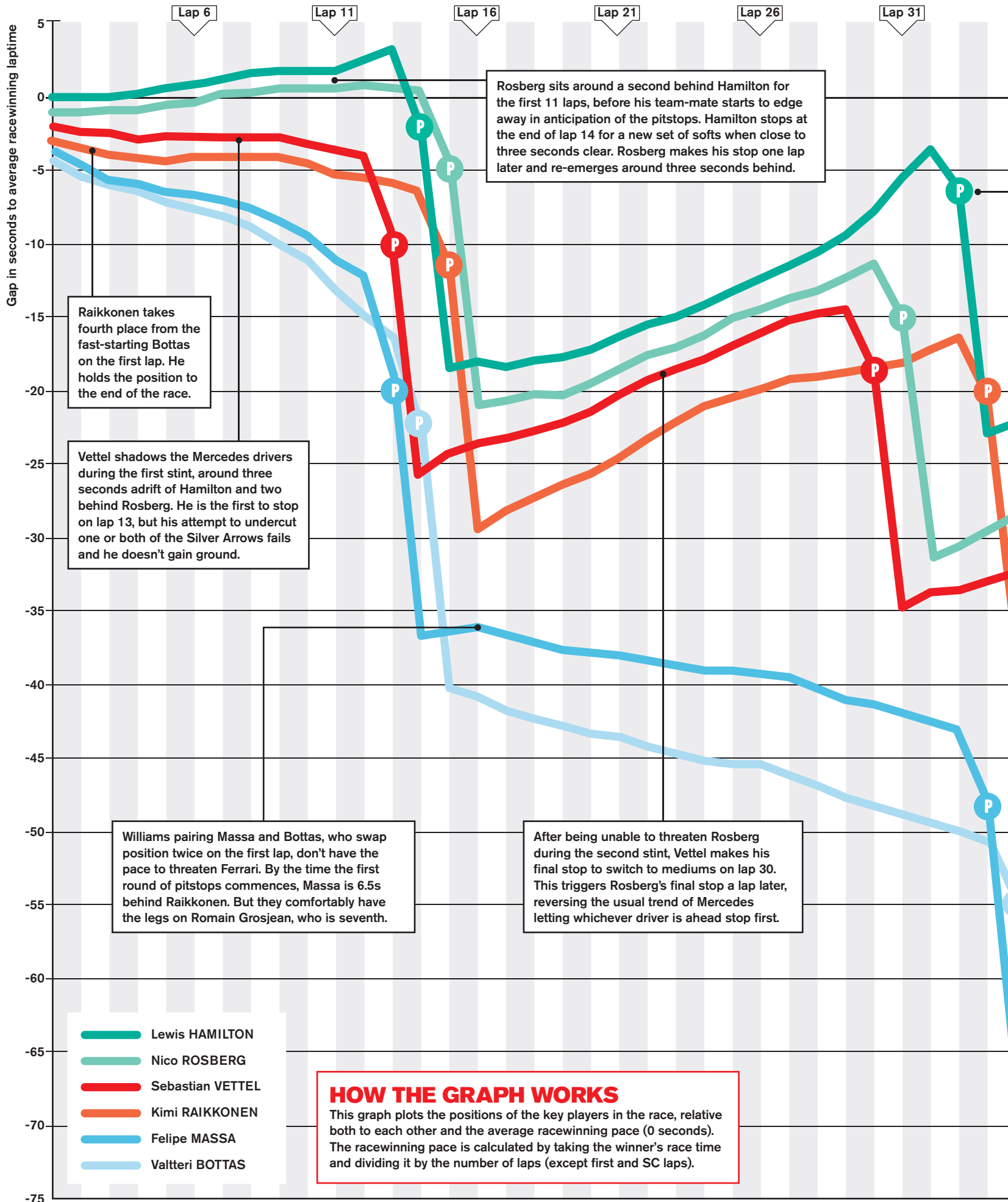

Raikkonen takes fourth place from the fast-starting Bottas on the first lap. He holds the position to the end of the race.

Vettel shadows the Mercedes drivers during the first stint, around three seconds adrift of Hamilton and two behind Rosberg. He is the first to stop on lap 13, but his attempt to undercut one or both of the Silver Arrows fails and he doesn't gain ground.

Rosberg sits around a second behind Hamilton for the first 11 laps, before his team-mate starts to edge away in anticipation of the pitstops. Hamilton stops at the end of lap 14 for a new set of softs when close to three seconds clear. Rosberg makes his stop one lap later and re-emerges around three seconds behind.

Williams pairing Massa and Bottas, who swap position twice on the first lap, don't have the pace to threaten Ferrari. By the time the first round of pitstops commences, Massa is 6.5s behind Raikkonen. But they comfortably have the legs on Romain Grosjean, who is seventh.

After being unable to threaten Rosberg during the second stint, Vettel makes his final stop to switch to mediums on lap 30. This triggers Rosberg's final stop a lap later, reversing the usual trend of Mercedes letting whichever driver is ahead stop first.

HOW THE GRAPH WORKS
 This graph plots the positions of the key players in the race, relative both to each other and the average race-winning pace (0 seconds). The race-winning pace is calculated by taking the winner's race time and dividing it by the number of laps (except first and SC laps).

- Lewis HAMILTON
- Nico ROSBERG
- Sebastian VETTEL
- Kimi RAIKKONEN
- Felipe MASSA
- Valtteri BOTTAS

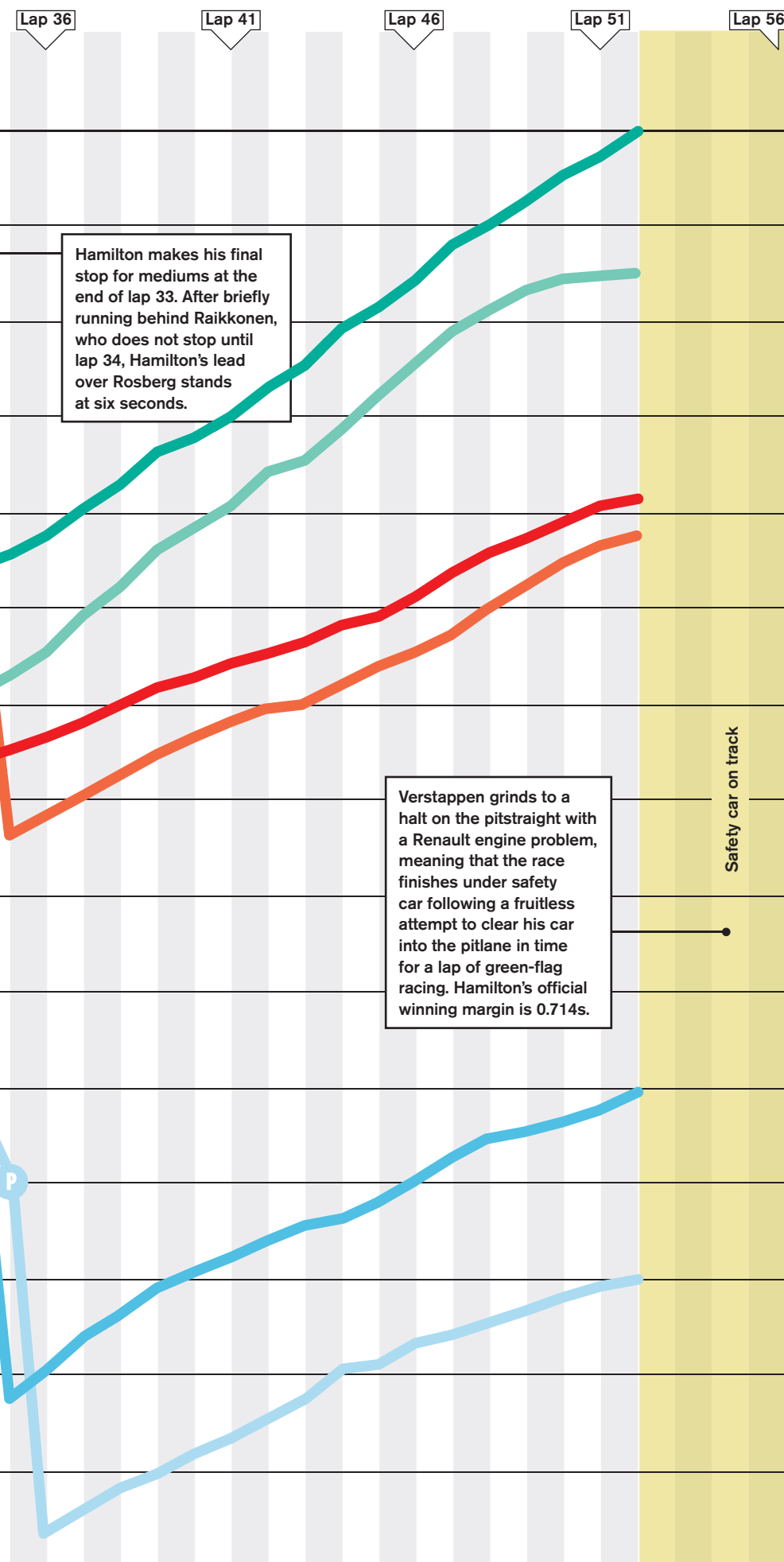

TRACKSIDE VIEW

BEN ANDERSON
F1 ASSISTANT EDITOR

ben.anderson@haymarket.com

@BenAndersonAuto

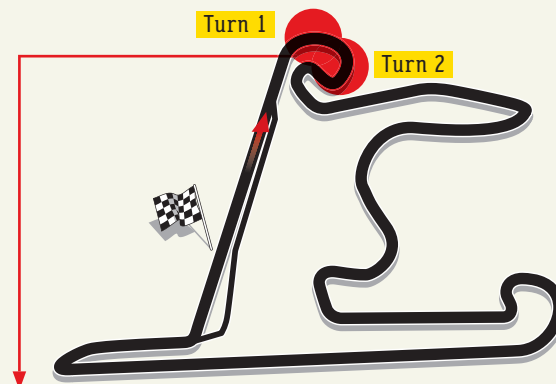

Watching from the inside of the Shanghai International Circuit's first cornering challenge gives a clear indication of the haves and have-nots in Formula 1's perpetual downforce quest.

Lewis Hamilton's updated Mercedes W06 looks mighty through this section, turning in on full throttle, sticking to the first apex like glue, and able to manage the challenge of braking while turning for Turn 2 without difficulty.

Hamilton is mighty around this place and clearly looks at home straight away in first free practice. "You barrel as much speed in as you allow yourself mentally and deal with it as you go through," he says of the cornering challenge. "It's a very, very long corner and the front-left tyre overheats as you go on. There are lots of lines – sometimes wide doesn't lose time, sometimes tight. There is no specific way; you just try to go as quick as possible."

Easier said than done Lewis! For Nico Hulkenberg – a highly capable driver whose Force India lacks the capabilities of Hamilton's Mercedes – the corner is surprisingly uncomplicated.

"You barrel as much speed in as you allow yourself and deal with it"

"It's quite simple – we just enter slower!" he says. "There's no magic to it. If you hit it nicely you get it done in one go, without getting back on throttle. We're off throttle at turn-in, or just before, and then you roll the car in more or less. If you're too slow, or have a moment, you go back on throttle, but usually that means it wasn't a good line at the entry!"

Rookie Max Verstappen lacks Hulkenberg's experience here, so this part of the circuit is more of an eye-opener.

"It's very tricky. It's difficult to find the right line, because it's a long corner," he says. "You try turning in a bit earlier or later, and feel what the best line is, but it's not perfect so you have to compromise a little bit." But not if your name is Lewis...



No specific way, says Hamilton

STORIES OF THE RACE

Red Bull's woeful season continues

Red Bull suffered another difficult race as new reliability concerns plagued engine supplier Renault in China.

Daniel Ricciardo required a precautionary engine change between qualifying and the race, taking him onto his third of 2015 already, while Red Bull team-mate Daniil Kvyat (right) and Toro Rosso's Max Verstappen retired from the race with Renault failures.

Renault has admitted the reliability problems that hit Red Bull and Toro Rosso in the Chinese GP may well strike again in this weekend's Bahrain event.

Renault F1 chief Cyril Abiteboul admitted his company had taken reliability gambles in pushing for more performance this season, and said the problems that struck in China were not a surprise.

"We knew that the first engine we built had some reliability weaknesses, so there was a plan in place," he said. "We need to make sure the plan is good enough for the size of the issues we had, and whether it can be addressed fairly quickly.

"I'm not sure from a logistical perspective that it could

be addressed for Bahrain, but certainly our aim is to have absolutely no reliability issues by Monaco.

"A problem with reliability is bad for PR and when you have to address reliability you're not necessarily in a position to address power, which is also still missing. The plan is to make sure that the future engine we will be building has absolutely no reliability issues."

Red Bull team boss Christian Horner said that while problems had been anticipated, the extent of them was a surprise.

"I don't think anybody expected us to be on engine three at race three in any of our scenarios," he said. "We accept that sometimes to find performance you've got to take some risks. Calculated risks are what Red Bull has always bought into, but the frustrating thing for both parties is that we're in this situation with three of the allotted four engines in use going into race four."

Asked by AUTOSPORT how that would affect Red Bull's approach to Bahrain, Horner replied: "You've just got to go for it and hope for the best."



RED BULL 2015 v 2014		
AFTER THREE RACES		
2015	YEAR	2014
13	POINTS	35
5th	CONSTRUCTORS' CHAMPIONSHIP POSITION	4th
0	PODIUMS	1
6th	BEST FINISH	3rd
7th	BEST QUALIFYING	2nd



Ferrari expected China defeat

Ferrari admitted after the Chinese Grand Prix that its defeat at the hands of Mercedes came as no surprise.

Although Malaysian GP winner Sebastian Vettel appeared capable of threatening Lewis Hamilton and Nico Rosberg at times at Shanghai, in the end he was unable to do better than third.

Team principal Maurizio Arrivabene said his outfit had gone into the race fully expecting Mercedes to dominate, because Ferrari's long-run pace in practice was not as strong as in Malaysia. "Here we were expecting exactly what happened," he said. "On Friday when we tried the long run we were sure about our performance. So in the first part of the race we were attacking, in the second defending, a simple strategy."

Vettel said putting Mercedes under pressure, in the hope of it making a mistake, was the best they could do. "We tried everything we could," he said. "I think it was very close, especially the first pitstop. I didn't expect it to be that close, so maybe I should have pushed a bit harder on the out-lap. Towards the end they were just too quick. They were pulling away."

More tyre struggles for Williams

Williams needs to understand why it has struggled to make the soft Pirelli tyre work if it is to challenge Mercedes and Ferrari, says performance chief Rob Smedley.

Felipe Massa and Valtteri Bottas finished fifth and sixth in China, but were unable to keep pace with race winner Lewis Hamilton, his team-mate Nico Rosberg, or the two Ferraris.

While both Mercedes and Ferrari ran the soft tyre for a second successive stint in the race, Williams's data showed it could not make the

compound last long enough. As a result, Williams used the slower medium tyre for the middle stint, where Massa and Bottas lost most of the time.

"We have to go away and look at the philosophy of our weekend and understand why we couldn't run the option," said Smedley.

Bottas said Williams also struggled on the medium tyre. "Even when we tried everything to reduce the temperatures for the race, for the tyres it was not enough," he explained.

"We need to improve on that."



HOW WILLIAMS FADED AWAY

GAP FROM MASSA TO RAIKKONEN

LAP 16	+6.845s	████████████████████
LAP 20	+12.339s	████████████████████
LAP 25	+18.613s	████████████████████
LAP 30	+22.766s	████████████████████
LAP 33	+26.590s	████████████████████





Button penalised for Maldonado clash

McLaren's Jenson Button received a licence points penalty and was demoted to 14th place in China for a collision with Lotus driver Pastor Maldonado.

A five-second penalty dropped Button – who called the incident a “misjudgement” – from 13th to 14th behind Carlos Sainz Jr in the final results.

Button and Maldonado had the biggest scrap of the race, exchanging 13th place over several fraught laps. It came to a head on lap 48, when Button made contact with the rear of the Lotus into Turn 1, spinning Maldonado while the McLaren ran wide and damaged its front wing.

“I thought there was room on the inside,” said Button. “An incident you never want to happen, but just a misjudgement I guess.”

Lotus head of trackside operations Alan Permane played down the incident. “I know it is frustrating when you're not used to racing at the back,” he said. “These things happen so it's no drama.”

Grosjean scores breakthrough points

Romain Grosjean kick-started Lotus's season by finishing seventh in the Chinese Grand Prix, the team's best finish since the United States GP of 2013.

Grosjean qualified eighth, but gained a place thanks to Daniel Ricciardo's poor start. He trailed team-mate Pastor Maldonado through the second stint, but stayed clear of the Saubers and Max Verstappen's Toro Rosso through the closing stages.

Lotus struggled for long-run pace during practice on Friday, but head of trackside operations Alan Permane said “significant” set-up changes overnight

put the team back on track.

“We had too much understeer, and with a front-limited circuit like this it kills your pace and degradation,” he explained. “So we made some significant changes overnight, really improved the car and we were very confident [for the race].”

“It looks like in the race we are the fourth quickest car. If we can keep finishing in those positions and really have a good stab at getting fourth in the championship, I think everyone here will be very, very happy.”

Q&A

ROMAIN GROSJEAN

BROUGHT LOTUS ITS BEST FINISH SINCE 2013

This must feel like a breakthrough result after a terrible 2014...

Yes. We've been trying to forget last year and move on to this year – especially me! For all of us it's important to see on the board that finally you've scored points.

You had a clean race with no problems. Did this make all the difference?

No issues. In the second stint I struggled a little bit with my rear tyres, but we made a small adjustment on the last set, which made the car much better.

Your long runs on Friday were terrible, so were you concerned about the cars behind?

Yeah, we made some big changes overnight, but then you don't have the chance to try them over a

long run, so it's pleasing that it went good in the first stint and last stint, but we need to understand the second stint.

The aim is to beat Williams, so how will you close that gap?

Since day one we know exactly what we can improve on the car. There are two areas, which are clear. They were clear in Barcelona, they were clear in Melbourne, clear in Sepang and they are the same here. I'm sure there is some good work in the factory, in the windtunnel, trying to improve that and hopefully in Bahrain we can test a few things.

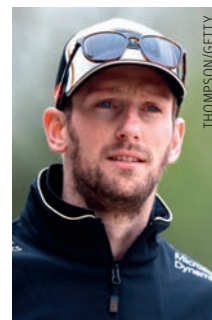

THOMPSON/GETTY

STORIES OF THE RACE

Engine failure denies superb Verstappen points finish

Toro Rosso rookie Max Verstappen looked on course to record his second consecutive points finish in Formula 1 until a late-race engine failure caused his car to become stranded on the pit straight.

The Dutch teenager started 13th, but gained two places on the opening lap and also passed both

Saubers with late-braking moves into the Turn 14 hairpin during the first half of the race.

Verstappen was on course to finish eighth before his Renault engine failed exiting the last corner on his 52nd lap. "I was enjoying the race a lot," he told AUTOSPORT. "I think I had some good moves, so I was enjoying that.

The car was performing well, especially under braking, and the tyres were holding on quite well too.

"Of course on the straights we are nowhere at the moment, so that's what we have to work on. I think the team did a good job. Unfortunately we couldn't finish it."



"I had some good moves, so I was really enjoying the race. The car was performing and the tyres held on

24

McLaren promises better performance

McLaren-Honda will begin ramping up performance after showing good reliability in the Chinese Grand Prix, according to racing director Eric Boullier.

The team secured its first double finish of 2015, although Fernando Alonso and Jenson Button finished out of the points in 12th and 14th.

Although McLaren-Honda again failed to escape Q1 or to score a point, Boullier said getting two cars to the finish represented an important milestone.

"We've made some progress and it's actually a good achievement because we had a reliable package here and it's good to

see we ran the race absolutely trouble-free," Boullier told AUTOSPORT.

"Now we can power up a little bit and we know there's a lot of potential coming from this point.

"We have some new specs coming. In terms of chassis as well, we are bringing parts to Bahrain [this weekend]. We have a good package coming in Barcelona [next month] so we're ramping up. As we said – it's not tenths by tenths but half a second by half a second.

"So as Fernando said, we started from too far behind but we are catching up. Now we are just behind the midfield pack so hopefully in a few races we will be in front."

McLAREN'S IMPROVING RELIABILITY

TOTAL McLAREN LAPS AT EACH EVENT

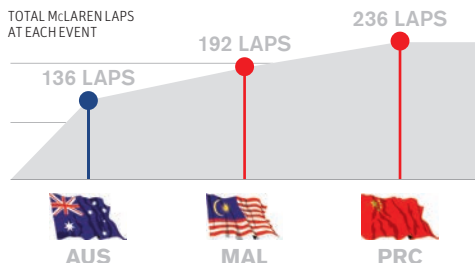

McLaren has completed an increasing amount of laps during each grand prix weekend in 2015

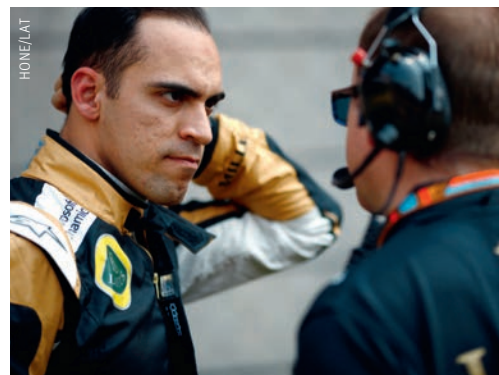

Entry lock-up costs Maldonado points

Pastor Maldonado looked set to score his first points of the season in China, but his race unravelled when he lost control of his Lotus E23 entering the pitlane for his second stop on lap 33.

The Venezuelan ran as high as seventh, but lost around 20 seconds reversing back onto the road and his comeback was delayed further by another spin on track, before a late clash with Jenson Button's McLaren and a subsequent brake failure ended his race.

"It started to go wrong in the pit entry. I completely lost my race there," he admitted. "I had a big lock-up, especially on the inside wheel, in the entry. We need to see what happened. It was very easy to lock – I was not expecting to have this."

DRAWING BOARD

by Craig Scarborough

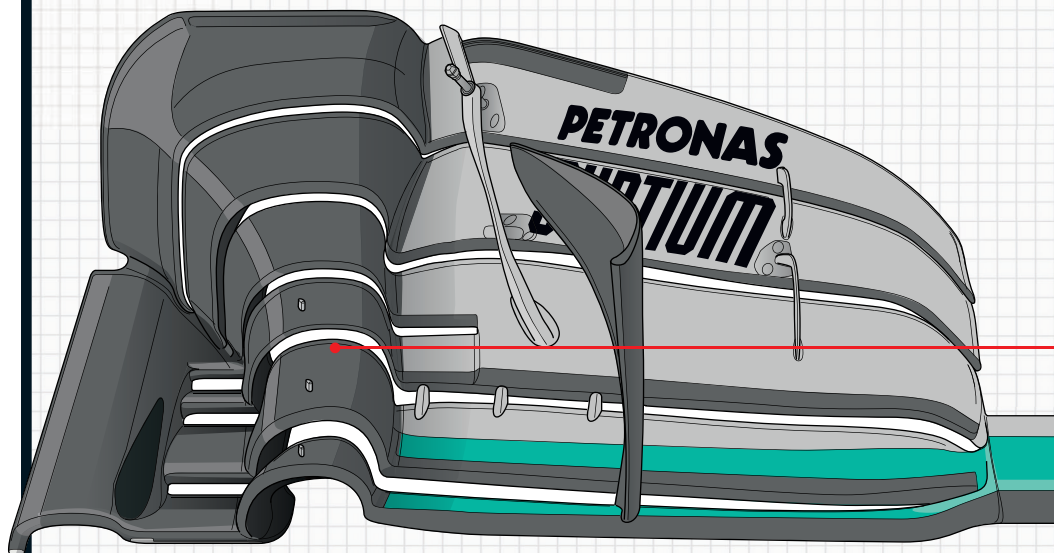

MERCEDES WING-TIP TWEAK HELPS AERO

The new Mercedes front wing features a unique 'arched' section near the wing tip. It has split the wing into distinct inner and outer sections. The inner span is a conventional four-element design. But the area ahead of the front tyre steps up from the inner-wing level with a square-edged arch shape.

In bare black carbonfibre, this outer section is worked harder, creating a powerful spiralling vortex flow that is thrown outboard of the front wheel to keep the spinning front tyre's turbulence away from the rear of the car.

This helps the aero both front and rear, as the diffuser sits in a cleaner airflow.

McLAREN ADDS FIN TO DUCT FENCE

In pre-season testing McLaren updated its front brake-duct fences with an unusual organic-looking fairing. This fence protrudes forwards to the tyre's front perimeter. These fences are usually flatter and help guide the front-wing wake around the inside of the wheel and have little to do with any form of brake cooling. McLaren's more-rounded design sits inside the 120mm area allowed for brake-duct 'bodywork'.

In China, this fence was updated with a small horizontal fin. This is an aerodynamic feature for twisting the airflow off the front wing to the area behind the front tyre.

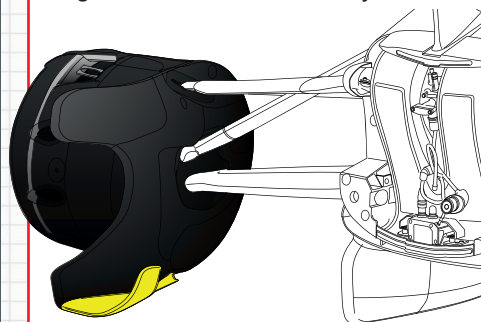

RED BULL'S SUBTLE OUTER-WING UPDATE

There was a subtle but fundamental change to Red Bull's front wing in China. Denoted by the different vane on the endplate, with its angled trailing edge and lack of cutaway section beneath, it was actually the outer section of wing hidden beneath the cascade

winglets that was new.

The wing is narrow at the front and the wing tips sweep outwards as they near the front tyre. This creates an outwash effect to reduce the impact of the front-tyre wake on the back of the car.

SAUBER UPDATES USE NEW FLOW STRUCTURE

Brought forward from its planned Spanish Grand Prix debut, Sauber has finally updated its well-used front-wing design. The inboard area of wing that is distinctly new is the extra vane near the cascade winglet.

This area creates a flow structure known as the Y250 vortex (as it is 250mm from the car's centreline). This airflow curves outwards behind the front tyre, separating the messy tyre airflow from the car's central bodywork. Now the new wing works this area harder in a more conventional way, by extending the wing flaps to nearly meet the inner joint of the wing. The arched shape formed below these flaps helps create the swirling vortex effect.

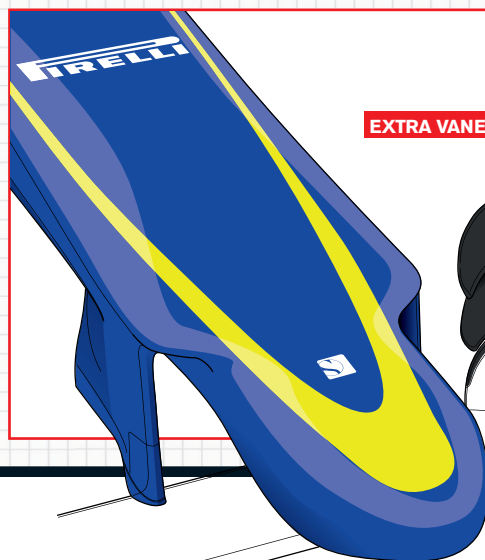

EXTRA VANE HERE

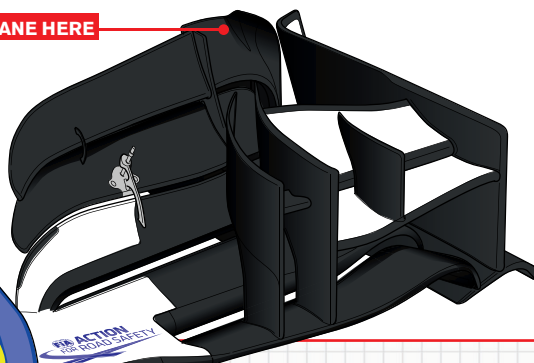

DRIVER RATINGS

MERCEDES



7

NICO ROSBERG 

Admitted to being disappointed by his first two races of this season, but was stronger here. Came within “the blink of an eye” of denying Hamilton pole for the first time this year and those four hundredths of a second proved crucial. Was annoyed by his team-mate’s ‘go-slow’ approach to the race, but that’s the price you pay for being second best.



10

LEWIS HAMILTON 

Reckoned the significance of Ferrari’s shock win in Malaysia was blown out of proportion, but Mercedes’ strategists clearly begged to differ. Finally enjoyed a clean run through practice and topped every session (though almost lost pole to Rosberg by not improving on his second Q3 run). Drove only as fast as necessary on Sunday, to protect his tyres and record his 35th victory.

RED BULL



8

DANIEL RICCIARDO 

Red Bull reverted to Brembo brakes after disaster of Malaysia and, combined with improved driveability, the RB11 looked a more competitive proposition. Qualified as high as could reasonably be expected, given Renault’s power deficit, but poor start cost him. Arguably should have been fighting the Williams duo, but ended up battling Ericsson’s Sauber...



6

DANIIL KVYAT 

Was set back by rear-brake failure on Friday, followed by engine woes that hampered qualifying. Started his race on the medium tyre, which made the early laps challenging. Got involved in contact on the first lap and remained in the fight long enough to make his team-mate’s life unnecessarily difficult, before his second engine of the season went bang on lap 16.

WILLIAMS



9

FELIPE MASSA 

Crunched the FW37’s new front wing after the rear one stalled under braking for Turn 14 on Friday, but turned his weekend around with an excellent performance on Saturday, qualifying fourth with a “perfect” lap. Lost ground at the first corner to Raikkonen and Bottas in the race, but repassed his team-mate at Turn 6 and edged away. Couldn’t have finished any higher.



7

VALTTERI BOTTAS 

Overheated his tyres in qualifying and ended up almost two tenths adrift of Massa. Made a valiant effort to pass both his team-mate and Raikkonen’s Ferrari round the outside of Turn 1 after the start, but eventually got shuffled back at Turn 6. Struggled with the tyres again thereafter. Just not quite on Massa’s level this weekend, as Williams again trailed Ferrari.

TORO ROSSO



9

MAX VERSTAPPEN 

Looked super-strong over longer runs on the medium tyre through free practice, but wasn’t entirely comfortable with his car. Should probably have qualified one place higher but for a mistake under braking on his best lap. Drove an excellent race, pulling off demon late-braking moves on the Saubers to lie eighth before cruel engine failure three laps from home.



6

CARLOS SAINZ JR 

Not as impressive here as in his first two GPs. Qualified 0.145s adrift of his team-mate and endured a difficult race. Felt there was “no grip” starting on the medium and spun at Turn 2 while battling Perez on lap two. Was more comfortable on the softs, but lost 43.5s resetting his car when it lost drive. Even without these dramas he likely wouldn’t have scored.

“GROSJEAN PUT IN A FINE DRIVE TO SCORE HIS FIRST POINTS SINCE MONACO LAST YEAR”



BEN ANDERSON reviews and rates each driver's grand prix weekend performance out of 10

FERRARI



SEBASTIAN VETTEL

Another strong performance from the four-time champion, who got the best possible result for Ferrari. A bit disjointed on Friday, but pulled it together on Saturday to qualify third. Put Rosberg under pressure early in the race, but struggled slightly on the medium tyre later on, and fell into Raikkonen's clutches before the safety car saved the day.



KIMI RAIKKONEN

Lacked Vettel's pace on Saturday, but should have been on row two at least. Delivered another poor lap in qualifying, which put him behind the Williams drivers. Recovered with an excellent start and a feisty first lap in the race. Displayed the excellent tyre-management skills that rattled Merc on Friday and was closing on Vettel late on, before the safety car spoiled his party.

McLAREN



FERNANDO ALONSO

Has a strong record at this track and came to China bolstered by reliability modifications to the engine after his Malaysia retirement. Suffered more problems in free practice, but was in better shape come qualifying and the race. Qualified fractionally slower than Button, but got ahead at the start and stayed out of trouble on an alternative strategy for first McLaren-Honda finish.



JENSON BUTTON

Looked stronger than his team-mate in free practice, but had fewer reliability problems. Had benefit of a newer specification of floor for qualifying, but this was counteracted by effect on chassis balance. A bit weaker than Alonso early in the race, but came alive for brilliant late battle with Maldonado's Lotus. Was penalised for clattering into him at Turn 1, so dropped a place after the flag.

FORCE INDIA

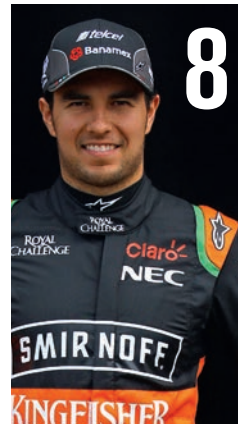

SERGIO PEREZ

Admitted to frustration at team trailing rivals while B-spec car is finished. Will need to keep that frustration in check for a while longer yet. Looked weaker than his team-mate through practice, but came good in qualifying to beat Hulkenberg into Q2. Executed an alternative three-stop strategy to rise to 11th and remain ahead of the McLarens. His best race yet in 2015.



NICO HULKENBERG

Looked in good shape through free practice, but dropped out in Q1 with what the team described as a "poor" third sector on his fastest lap. Even if he'd strung it all together he would have qualified fractionally slower than his team-mate. Made up for all that with an excellent first lap in the race, but only lasted eight more before a suspected engine problem stopped him in his tracks.

LOTUS

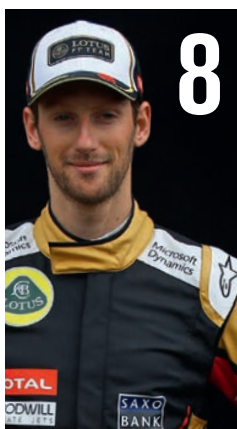

ROMAIN GROSJEAN

Stymied by an engine-sensor failure and wrong cooling configuration in Malaysia, so reckoned points would be on the cards with a clean event and was proved correct. Superb again on Saturday to qualify eighth. Helped by Ricciardo's poor race start, and was slower than team-mate Maldonado in the middle stint, but a fine drive – his first points since Monaco last year.



PASTOR MALDONADO

Not happy with his E23's balance on Friday but missed out on Q3 by just 0.007s on Saturday. Drove an excellent first two thirds of the race, and was on course to beat his team-mate, but ruined it by outbraking himself at the pit entry. Spun trying to recover the lost time and then got punted off during battle with Button's McLaren. Eventually retired with a rear brake problem.

SAUBER



MARCUS ERICSSON

Keen to follow up on his "breakthrough" weekend in Malaysia, Ericsson had a good Chinese GP but was shaded by team-mate Nasr. Made Q3 for the second successive race, qualifying less than a tenth behind his team-mate, but struggled to get his front tyres working in the race. Slipped back as it wore on and was outmanoeuvred in late battle with Ricciardo's Red Bull.



FELIPE NASR

Putting the disaster of Malaysia behind him, made use of a new front wing and revised rear suspension to show more of the quality we saw during his star debut in Melbourne. Converted his best qualifying position yet into another points finish. Was outfumbled by Max Verstappen's Toro Rosso in wheel-to-wheel combat, but couldn't really have finished any higher.

MANOR

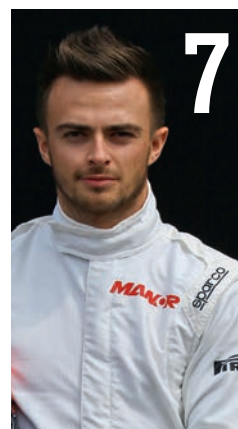

WILL STEVENS

Lost a chunk of practice to an electrical problem on Friday, but the car ran cleanly on Saturday, which allowed him to qualify for the first time this season. Team felt he "clicked" with the circuit and showed pace comparable with Jules Bianchi in last year's Marussia here. His first start of the year didn't go well, but he repassed team-mate Merhi early on and never looked back.



ROBERTO MERHI

Was desperate for his team-mate to make the start, in order to avoid a "boring" grand prix driving around on his own. Reckoned 0.751s deficit to Stevens in qualifying was down to missing FP3 due to a fuel-pump control problem and carrying extra weight compared with his team-mate. Was more competitive in the race, but still trailed Stevens by 0.25s per lap.

RESULTS

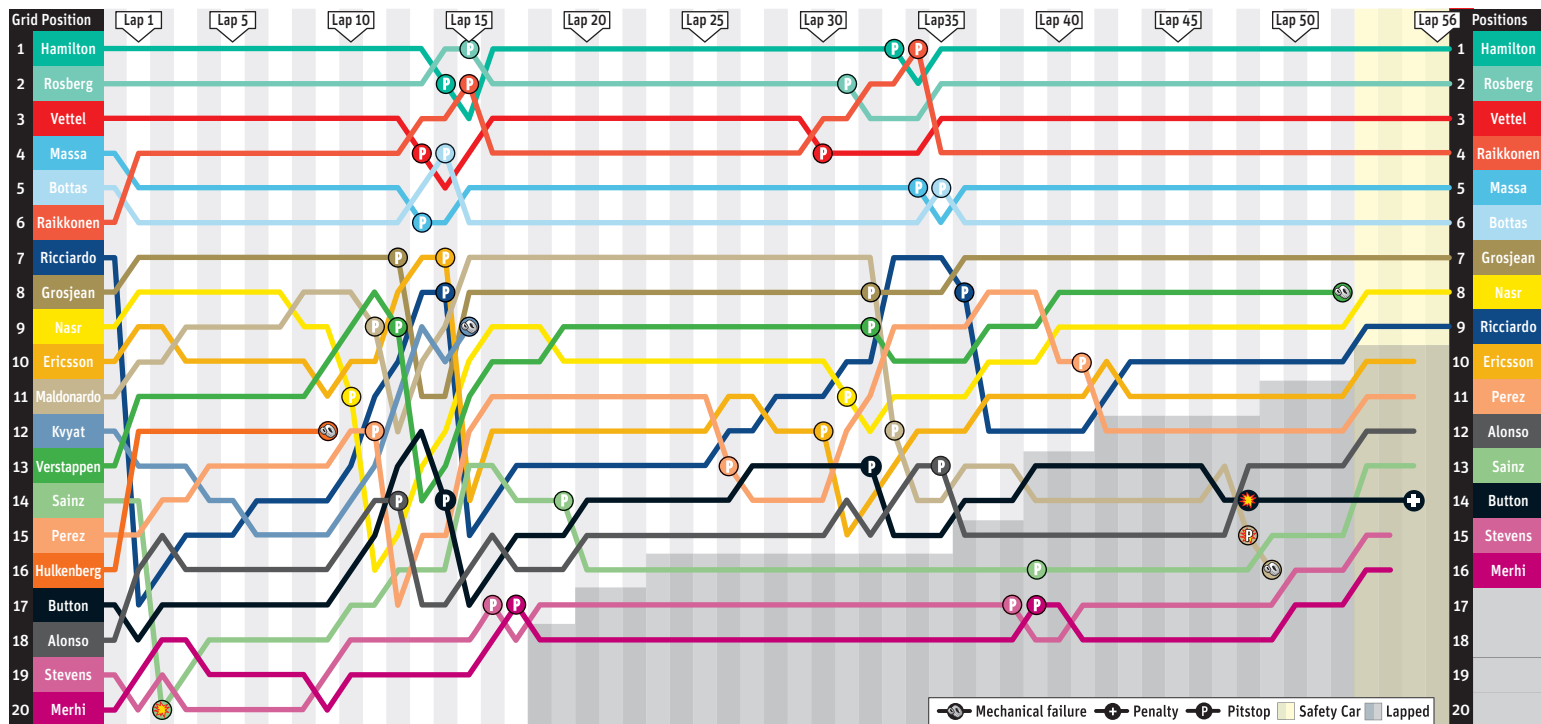

PRACTICE 1: Friday

POS	DRIVER	TIME
1	HAMILTON	1m39.033s
2	ROSBERG	1m39.574s
3	VETTEL	1m40.157s
4	RAIKKONEN	1m40.661s
5	NASR	1m41.012s
6	RICCIARDO	1m41.029s
7	KVYAT	1m41.097s
8	SAINZ	1m41.112s
9	BOTTAS	1m41.303s
10	MASSA	1m41.304s
11	MALDONADO	1m41.335s
12	VERSTAPPEN	1m41.575s
13	BUTTON	1m41.845s
14	ERICSSON	1m41.918s
15	PALMER	1m41.967s
16	PEREZ	1m42.141s
17	ALONSO	1m42.161s
18	HULKENBERG	1m42.184s
19	STEVENS	1m45.379s
20	MERHI	1m46.443s

Weather: 20C, sunny



PRACTICE 2: Friday

POS	DRIVER	TIME
1	HAMILTON	1m37.219s
2	RAIKKONEN	1m37.662s
3	RICCIARDO	1m38.311s
4	VETTEL	1m38.339s
5	ROSBERG	1m38.399s
6	KVYAT	1m38.737s
7	BOTTAS	1m38.850s
8	NASR	1m39.032s
9	GROSJEAN	1m39.142s
10	BUTTON	1m39.275s
11	MALDONADO	1m39.444s
12	ALONSO	1m39.743s
13	ERICSSON	1m39.751s
14	VERSTAPPEN	1m39.894s
15	SAINZ	1m39.971s
16	HULKENBERG	1m40.151s
17	MASSA	1m40.423s
18	PEREZ	1m40.868s
19	MERHI	1m42.973s
20	STEVENS	1m44.564s

Weather: 20C, sunny



PRACTICE 3: Saturday

POS	DRIVER	TIME
1	HAMILTON	1m37.615s
2	ROSBERG	1m37.841s
3	VETTEL	1m38.313s
4	RAIKKONEN	1m38.512s
5	RICCIARDO	1m39.020s
6	KVYAT	1m39.106s
7	SAINZ	1m39.113s
8	BOTTAS	1m39.243s
9	VERSTAPPEN	1m39.274s
10	GROSJEAN	1m39.405s
11	MASSA	1m39.410s
12	HULKENBERG	1m39.513s
13	ERICSSON	1m39.559s
14	NASR	1m39.591s
15	BUTTON	1m39.694s
16	MALDONADO	1m39.766s
17	PEREZ	1m39.781s
18	STEVENS	1m42.928s
19	MERHI	1m44.956s
20	ALONSO	no time

Weather: 19C, sunny



FRIDAY TESTERS

POS	DRIVER	TIME
1	PALMER	1m41.967s



QUALIFYING TIMES

POS	DRIVER	QUALIFYING 1	QUALIFYING 2	QUALIFYING 3
1	HAMILTON	1m38.285s (5)	1m36.423s (1)	1m35.782s
2	ROSBERG	1m38.496s (8)	1m36.747s (2)	1m35.824s
3	VETTEL	1m37.502s (1)	1m36.957s (3)	1m36.687s
4	MASSA	1m38.433s (7)	1m37.357s (5)	1m36.954s
5	BOTTAS	1m38.014s (3)	1m37.763s (6)	1m37.143s
6	RAIKKONEN	1m37.790s (2)	1m37.109s (4)	1m37.232s
7	RICCIARDO	1m38.534s (10)	1m37.939s (7)	1m37.540s
8	GROSJEAN	1m38.209s (4)	1m38.063s (9)	1m37.905s
9	NASR	1m38.521s (9)	1m38.017s (8)	1m38.067s
10	ERICSSON	1m38.941s (14)	1m38.127s (10)	1m38.158s
11	MALDONADO	1m38.563s (11)	1m38.134s	-
12	KVYAT	1m39.051s (15)	1m38.209s	-
13	VERSTAPPEN	1m38.387s (6)	1m38.393s	-
14	SAINZ	1m38.622s (12)	1m38.538s	-
15	PEREZ	1m38.903s (13)	1m39.290s	-
16	HULKENBERG	1m39.216s	-	-
17	BUTTON	1m39.276s	-	-
18	ALONSO	1m39.280s	-	-
19	STEVENS	1m42.091s	-	-
20	MERHI	1m42.842s	-	-

Weather: 18C, sunny

QUALIFYING STATISTICS

HEAD TO HEAD		
ROSBERG	0	3 HAMILTON
RICCIARDO	3	0 KVYAT
MASSA	3	0 BOTTAS
VETTEL	3	0 RAIKKONEN
ALONSO/MAGNUSSEN	0	3 BUTTON
PEREZ	1	2 HULKENBERG
SAINZ	1	2 VERSTAPPEN
GROSJEAN	3	0 MALDONADO
ERICSSON	1	2 NASR
STEVENS	1	0 MERHI



POLE POSITION TROPHY

HAMILTON		
AUS	WAL	PRC 3



RACE: 56 LAPS - 189.559 MILES

POS	DRIVER	TEAM	LAPS	TOTAL TIME	FASTEST LAP	PITSTOPS	TIME IN PITS	GRID
1	LEWIS HAMILTON	MERCEDES	56	1h39m42.008s	1m42.208s	2	44.880s	1
2	NICO ROSBERG	MERCEDES	56	+0.714s	1m42.565s	2	45.312s	2
3	SEBASTIAN VETTEL	FERRARI	56	+2.988s	1m43.018s	2	44.932s	3
4	KIMI RAIKKONEN	FERRARI	56	+3.835s	1m43.026s	2	45.271s	6
5	FELIPE MASSA	WILLIAMS-MERCEDES	56	+8.544s	1m42.734s	2	46.462s	4
6	VALTTERI BOTTAS	WILLIAMS-MERCEDES	56	+9.885s	1m43.051s	2	46.666s	5
7	ROMAIN GROSJEAN	LOTUS-MERCEDES	56	+19.008s	1m43.134s	2	47.026s	8
8	FELIPE NASR	SAUBER-FERRARI	56	+22.625s	1m43.692s	2	47.141s	9
9	DANIEL RICCIARDO	RED BULL-RENAULT	56	+32.117s	1m43.245s	2	45.532s	7
10	MARCUS ERICSSON	SAUBER-FERRARI	55	-1 lap	1m44.204s	2	48.435s	10
11	SERGIO PEREZ	FORCE INDIA-MERCEDES	55	-1 lap	1m43.512s	3	1m09.311s	15
12	FERNANDO ALONSO	McLAREN-HONDA	55	-1 lap	1m43.728s	2	46.583s	18
13	CARLOS SAINZ	TORO ROSSO-RENAULT	55	-1 lap	1m42.652s	2	47.219s	14
14	JENSON BUTTON	McLAREN-HONDA	55	-1 lap	1m44.991s	2	47.209s	17
15	WILL STEVENS	MARUSSIA-FERRARI	54	-2 laps	1m45.414s	2	48.186s	19
16	ROBERTO MERHI	MARUSSIA-FERRARI	54	-2 laps	1m45.963s	2	50.026s	20
17	MAX VERSTAPPEN	TORO ROSSO-RENAULT	52	engine	1m43.880s	2	47.514s	13
R	PASTOR MALDONADO	LOTUS-MERCEDES	49	collision	1m43.686s	2	1m03.281s	11
R	DANIL KVYAT	RED BULL-RENAULT	15	engine	1m46.291s	-	-	12
R	NICO HULKENBERG	FORCE INDIA-MERCEDES	9	gearbox	1m45.844s	-	-	16

Weather: 20C, sunny. Winner's average speed: 114.078mph. Fastest lap: Hamilton 1m42.208s (119.301mph) on lap 31. Lap leader: 1-13 Hamilton, 14-15 Rosberg, 16-33 Hamilton, 34 Raikkonen, 35-56 Hamilton.

TYRE CHOICE

STINT 1	STINT 2	STINT 3	STINT 4
Soft u	Soft N	Medium N	
Soft u	Soft N	Medium N	
Soft u	Soft N	Medium N	
Soft u	Soft N	Medium N	
Soft u	Medium N	Medium u	
Soft u	Medium N	Medium u	
Soft u	Medium N	Medium N	
Soft u	Medium N	Medium N	
Soft u	Soft u	Medium N	
Soft u	Soft u	Medium N	
Soft N	Soft N	Soft u	Medium N
Soft N	Medium N	Soft u	
Medium N	Soft N	Soft u	
Soft N	Soft N	Medium N	
Soft N	Medium N	Soft N	
Soft N	Medium N	Soft N	
Soft N	Medium N	Medium N	
Soft N	Medium N	Medium N	
Medium N			
Soft N			

N - new; U - used

DRIVERS' STANDINGS

POS	DRIVER	PTS	AUS	MAL	PRC	BRN	E	MC	CDN	A	GB	H	B	I	SGP	J	RUS	USA	MEX	BR	UAE
1	HAMILTON	68	1st	2nd	1st	-	-	-	-	-	-	-	-	-	-	-	-	-	-	-	-
2	VETTEL	55	3rd	1st	3rd	-	-	-	-	-	-	-	-	-	-	-	-	-	-	-	-
3	ROSBERG	51	2nd	3rd	2nd	-	-	-	-	-	-	-	-	-	-	-	-	-	-	-	-
4	MASSA	30	4th	6th	5th	-	-	-	-	-	-	-	-	-	-	-	-	-	-	-	-
5	RAIKKONEN	24	ret	4th	4th	-	-	-	-	-	-	-	-	-	-	-	-	-	-	-	-
6	BOTTAS	18	DNS	5th	6th	-	-	-	-	-	-	-	-	-	-	-	-	-	-	-	-
7	NASR	14	5th	12th	8th	-	-	-	-	-	-	-	-	-	-	-	-	-	-	-	-
8	RICCIARDO	11	6th	10th	9th	-	-	-	-	-	-	-	-	-	-	-	-	-	-	-	-
9	GROSJEAN	6	ret	11th	7th	-	-	-	-	-	-	-	-	-	-	-	-	-	-	-	-
10	HULKENBERG	6	7th	14th	ret	-	-	-	-	-	-	-	-	-	-	-	-	-	-	-	-
11	VERSTAPPEN	6	ret	7th	17th	-	-	-	-	-	-	-	-	-	-	-	-	-	-	-	-
12	SAINZ	6	9th	8th	13th	-	-	-	-	-	-	-	-	-	-	-	-	-	-	-	-
13	ERICSSON	5	8th	ret	10th	-	-	-	-	-	-	-	-	-	-	-	-	-	-	-	-
14	KVYAT	2	DNS	9th	ret	-	-	-	-	-	-	-	-	-	-	-	-	-	-	-	-
15	PEREZ	1	10th	13th	11th	-	-	-	-	-	-	-	-	-	-	-	-	-	-	-	-
16	BUTTON	0	11th	ret	14th	-	-	-	-	-	-	-	-	-	-	-	-	-	-	-	-
17	ALONSO	0	-	ret	12th	-	-	-	-	-	-	-	-	-	-	-	-	-	-	-	-
18	MERHI	0	DNS	15th	16th	-	-	-	-	-	-	-	-	-	-	-	-	-	-	-	-
19	STEVENS	0	DNS	DNS	15th	-	-	-	-	-	-	-	-	-	-	-	-	-	-	-	-
20	MALDONADO	0	ret	ret	ret	-	-	-	-	-	-	-	-	-	-	-	-	-	-	-	-
21	MAGNUSSEN	0	DNS	-	-	-	-	-	-	-	-	-	-	-	-	-	-	-	-	-	-



CONSTRUCTORS' STANDINGS

POS	CONSTRUCTOR	PTS	AUS	MAL	PRC	BRN	E	MC	CDN	A	GB	H	B	I	SGP	J	RUS	USA	MEX	BR	UAE
1	MERCEDES	119	43	33	43	-	-	-	-	-	-	-	-	-	-	-	-	-	-	-	-
2	FERRARI	79	15	37	27	-	-	-	-	-	-	-	-	-	-	-	-	-	-	-	-
3	WILLIAMS	48	12	18	18	-	-	-	-	-	-	-	-	-	-	-	-	-	-	-	-
4	SAUBER	19	14	0	5	-	-	-	-	-	-	-	-	-	-	-	-	-	-	-	-
5	RED BULL	13	8	3	2	-	-	-	-	-	-	-	-	-	-	-	-	-	-	-	-
6	TORO ROSSO	12	2	10	0	-	-	-	-	-	-	-	-	-	-	-	-	-	-	-	-
7	FORCE INDIA	7	7	0	0	-	-	-	-	-	-	-	-	-	-	-	-	-	-	-	-
8	LOTUS	6	0	0	6	-	-	-	-	-	-	-	-	-	-	-	-	-	-	-	-
9	McLAREN	0	0	0	0	-	-	-	-	-	-	-	-	-	-	-	-	-	-	-	-
10	MARUSSIA	0	0	0	0	-	-	-	-	-	-	-	-	-	-	-	-	-	-	-	-

SPEED TRAP FOR EACH CONSTRUCTOR (QUALIFYING)

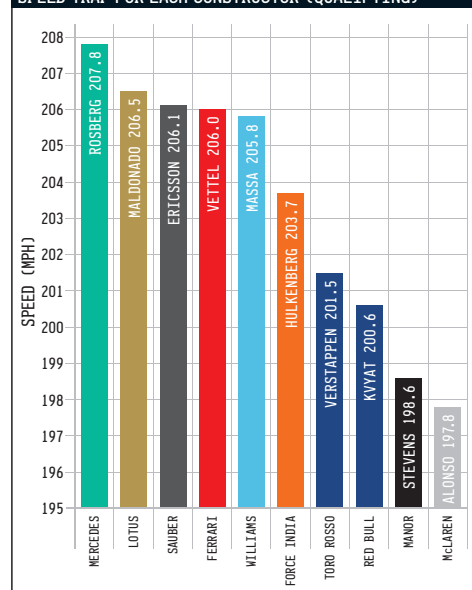

FOR IN-DEPTH RESULTS
forix.autosport.com



Tempers are frayed after three defeats for Rosberg...



MASON/GETTY

30

Will Mercedes have to resort to team orders?

With a resurgent Ferrari on its tail and Nico Rosberg unhappy with Lewis Hamilton's driving, Mercedes faces the possibility of its pitwall strategists intervening. By **LAWRENCE BARRETTO**

For the second race in succession, the actions of a Mercedes driver were called into question when Nico Rosberg accused team-mate Lewis Hamilton of deliberately trying to back him up into Ferrari's Sebastian Vettel during last weekend's Chinese Grand Prix.

After a relatively harmonious start to Mercedes' 2015 campaign, memories of the pair's fractious relationship during their title battle last season resurfaced,

with Rosberg clearly furious during his post-race interviews while Hamilton shrugged it off.

It followed Rosberg's denial that he blocked Hamilton during qualifying at the previous race weekend in Malaysia. In both instances, Mercedes team boss Toto Wolff came to the defence of the accused, saying Rosberg did nothing wrong at Sepang while defending Hamilton's actions at Shanghai.

And in both instances, Hamilton, who ultimately finished ahead of

Rosberg after the incidents in question, moved to play things down. In Malaysia, he said he didn't feel he was blocked, while in China he said: "There shouldn't be too much aggro really."

Mercedes non-executive chairman Niki Lauda seemed nonplussed by the furore, saying there was no need to "quarrel" and he expected Hamilton and Rosberg to drive "selfishly" during grands prix in the future because "this is the only way

to win a championship".

While Mercedes could perhaps afford the odd mistake or clash last year because of its clear pace advantage over the rest of the field, that is no longer a luxury it enjoys. Ferrari showed at Sepang that not only is it closer on pace, but also ready to capitalise on any Mercedes mistakes as Sebastian Vettel took victory. In China, Vettel and Kimi Raikkonen kept pace with the Mercedes in the opening two stints before fading in the closing stages.

WHEN TEAM ORDERS ARE BAD FOR FORMULA 1

Since returning to the sport in 2010 Mercedes has been keen to avoid using team orders with boss Toto Wolff saying last year that employing them would damage the Formula 1 brand. Here are three cases of when team orders grabbed the headlines.



AUSTRIAN GRAND PRIX 2002

Ferrari was comfortably leading the drivers' standings with Michael Schumacher, but such was its desire to ensure success that it asked Rubens Barrichello to relinquish the lead to the German at the A1 Ring, something he did just before the finish line. The move went down badly with fans, who jeered the drivers during the podium ceremony. An FIA-directed ban on team orders followed.

GERMAN GRAND PRIX 2010

Ferrari caused controversy again when Felipe Massa was given the coded team order "Fernando is faster than you" to let team-mate Fernando Alonso through into the lead at Hockenheim. Ferrari insisted it was a driver decision and, although the result stood, the team was fined \$100,000 for breaching sporting regulations. The FIA subsequently lifted the team-order ban.



MALAYSIAN GRAND PRIX 2013

Mark Webber was fuming when Red Bull team-mate Sebastian Vettel ignored an instruction to hold position – known as 'multi 21' – from the team to steal victory from the Australian at Sepang. Webber said the team had decided to turn down the engines until the end of the race to protect the one-two but Vettel had "made his own decision" when he fought his way past with 13 laps to go.



...and looming threat from Ferrari means Merc is now wary

"We would split the strategies if it was not clear to us which one is the better one"

TOTO WOLFF

So that leaves Mercedes with some thinking to do. The Brackley-based team has always been against team orders, suggesting they are bad for Formula 1, and has thus let its drivers race. "What we always tried to do last year was be very fair and square for the drivers, and stayed as much as possible neutral so they do not argue at the end of the race," said Wolff.

In the wake of the incident in China, Wolff said he understood why teams used team orders in

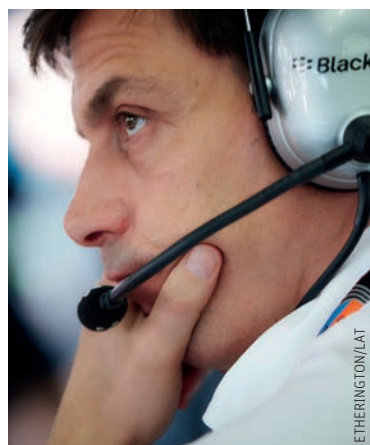

the past – "because they were under threat of losing a championship" – but he said his team has not been in that position yet and that ultimately he would prefer to better manage the drivers. While an honourable policy to have, it is one that will be tested as the season continues and the challenge from rivals increases.

There is also the question of splitting strategies. It has always been the team's policy not to vary the number of pitstops its drivers

make. The one exception last year came in Hungary, but that was done as a precaution when the safety car came out. So a decision to tweak its current policy would mark a significant change in approach.

Wolff intimated in China that the team has to consider putting its drivers on different strategies when required to cover off the threat from its rivals in the future, particularly in light of its defeat on strategy in Malaysia. "Probably we need to reflect the increased competition with our strategy calls," he said.

"You don't want to repeat what you did in Sepang. Probably there could have been a different call and will be a different call for the future. We would split the strategies if it is not clear which one is the better one and if we need to mirror the other team, at least with one of the cars, which we didn't do in Sepang."

The problem with split strategies is that one driver will likely be compromised, as Wolff pointed out, while it can also lead to friction between the drivers involved, with last year's race in Hungary a prime example.

Mercedes asked Hamilton to let

Rosberg past because the German had one more stop to make and would benefit from clear air, but Hamilton replied: "I'm not slowing down for Nico. If he gets close enough to overtake, he can overtake me."

While Rosberg questioned why Hamilton was not moving across at the time, he refused to discuss it publicly after the race. Hamilton, meanwhile, said he was "very, very shocked" to be asked to let Rosberg by. It was one of many flashpoints between the pair during the season.

While the team has said it will continue to be fair to both drivers, there were hints in China that Mercedes realises it needs to adjust its policy if it is to succeed in its aim of winning the drivers' and constructors' championships for the second successive season.

Whether that means going as far as direct team orders is unclear, and at this early stage unlikely, but Rosberg will know he needs to start beating Hamilton – something he has yet to do this year – sooner rather than later to avoid the possibility of being on the wrong end of a Mercedes policy tweak. ❧

STOFFEL VANDOORNE

HIS TIME HAS COME

He's got the backing of McLaren, GP2 title-favourite status and drives for one of the best teams in the business. Nothing except the championship will do for Vandoorne. By **EDD STRAW**

32

There comes a year in every driver's career when the stars align. For Stoffel Vandoorne, 2015 *must* be that season. The 23-year-old McLaren protege finished as runner-up to Jolyon Palmer in his rookie GP2 season last year and returns with ART Grand Prix, the squad that previously ran Lewis Hamilton, Nico Rosberg and Nico Hulkenberg to the title.

Even against arguably the strongest GP2 field in half a decade, Vandoorne is the driver with the strongest means, motive and opportunity to prevail. But with that comes its own pressures. Last year, he was expected to win races but not challenge for the title. So by finishing second, only winning is now good enough. But Vandoorne is a level-headed, mature character well equipped to deal with that intense pressure.

"It doesn't change very much," he says of his title-favourite status. "I'm part of the McLaren driver programme and when you're part of such a programme they expect you to do well. It's not only this season – all the seasons I have been with them that has been expected, otherwise I wouldn't have had the support.

"I know what I have to do, I know what my job is and I'll not be satisfied with anything less than winning the championship. I just have to stay focused and do the job every time I get on track."

Vandoorne's position is helped by the fact that there is no clear title rival. That's not because of a lack of quality, as this is arguably the strongest GP2 crop this decade. But he is up against some



Vandoorne was GP2 runner-up in 2014

high-quality rookies, such as DAMS pairing Pierre Gasly (who appeared in three rounds last year) and Alex Lynn, while proven race winners such as the rapid Mitch Evans, Raffaele Marciello and Alexander Rossi have yet to show they can deliver the consistency required to mount a title threat.

While Vandoorne won't dominate every weekend, as the recent Bahrain test showed – it's too close at the front for that – he has the

"I'LL NOT BE SATISFIED WITH ANYTHING LESS THAN WINNING THE CHAMPIONSHIP"

experience to ensure he avoids the low points and bad weekends. When asked about his main rivals, Evans, Gasly and Lynn are the three he namechecks. But he also hints that the early races will be crucial in dictating who he will have to worry about most.

"It's still very early to say who is going to be fighting for the championship," he says. "We've seen during testing that there are a lot of quick ▶

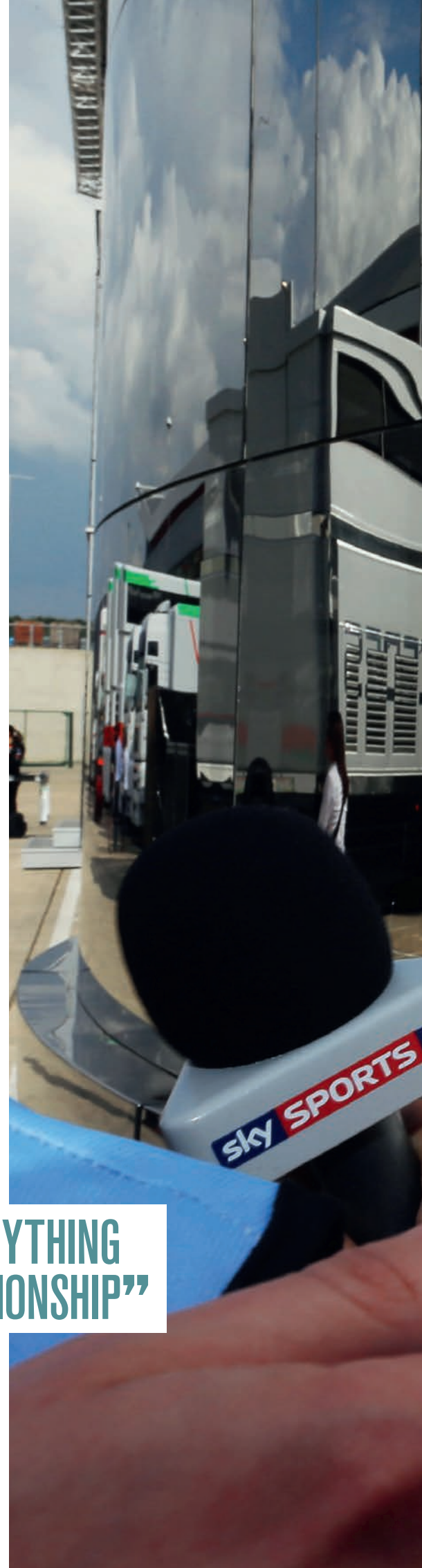

VANDOORNE IN GP2

S Starts 22

 Wins 4

 Podiums 10

P1 Pole positions 4

 Fastest laps 3

POS 2014 2nd



► drivers. But being quick is one thing – putting a championship together is different.”

This is an area where Vandoorne should be the best equipped. Last season he won on his debut in Bahrain, a victory that made his subsequent early-season struggles look like underachievement. But he has always been quick to highlight that he wasn't the fastest out there in Bahrain in 2014 and that the early win skewed expectations. But by mid-season he was on it, and a run of four consecutive pole positions proves he can be at the front week-in, week-out.

The ART team also had some rebuilding to do. Qualifying had become a weakness before that strong run, while there were still moments where, operationally, the sharpness wasn't there. A case in point: during the Sochi feature race last year, it was clear there would be a safety car but the team failed to call him in while leading. So both team and driver should now be on the money.

“Last season I made some mistakes during the first part of the season that I probably wouldn't have made if I had more experience,” he says. “But I also showed that as a rookie it's still possible to get very good results. It's my second season and over the winter we worked really hard with ART to get rid of all the mistakes from my side and the team's side as well.”

There was a point last year when it wasn't



McLaren backing raises expectations

BATCHLOR/APB

clear whether Vandoorne would continue with ART, McLaren considering switching him to the DAMS team that's run three of the past four drivers' champions. But while you have to look all the way back to 2009 for ART's last title victory, he and his backers kept the faith.

“Both teams are very successful and wherever I went would have been good,” says the Belgian. “But we finished the season really strongly with ART and there wasn't really a reason to change. I didn't put in so much work over the season with the team to get where we were, get those

poles, get those victories, and throw everything we learned away. It's definitely an advantage for me staying on with ART.”

So the driver is right, the team is right and the path is clear for Vandoorne to win the championship. But he is fully aware that the real work will be done during the races, and that history is littered with title favourites who failed. With competition for opportunities in F1 so limited – “There's no guarantee that if you win GP2 you'll make it to F1,” he says – it's up to Vandoorne not just to win, but to win well.

GP2 RUNNERS & RIDERS

MP MOTORSPORT



DRIVERS

- 16 VITTORIO GHIRELLI (I)*
- 17 DANIEL DE JONG (NL)

Marco Sorensen's good run of form last year, culminating in sprint-race victory at Sochi, shows the team is capable of turning out a good car. De Jong, whose father owns the team, has one seventh place to show for two and a half years in GP2. Sergio Canamasas was still in the running for the other seat as AUTOSPORT closed for press, but Vittorio Ghirelli was also a contender.

DAMS



DRIVERS

- 1 PIERRE GASLY (F)
- 2 ALEX LYNN (GB)

Three of the past four GP2 titles have been won by DAMS drivers. Now it's effectively fielding two rookies, Red Bull junior Gasly having three weekends with the ailing Caterham Racing (since taken over by Status) last year. Both have been fast in testing and will surely win races, but need to hit the ground running and score consistently from the start to stay in the title hunt. Intra-team battle will be fascinating.

RAPAX



DRIVERS

- 18 SERGEY SIROTKIN (RUS)
- 19 ROBERT VISIOIU (RO)

Eighteen months ago, Rapax looked well set to run a second consecutive driver to the GP2 crown after Pastor Maldonado, only for Stefano Coletti to develop a spectacular aversion to scoring points. Things didn't pick up last year and, with a pair of GP2 rookies in 2015, it could be a tough season. Both drivers have shown flashes of form in their careers, but neither has strung together consistent results.

CARLIN



DRIVERS

- 3 JULIAN LEAL (CO)
- 4 MARCO SORENSON (DK)

Carlin is an established race-winning force in GP2, although there remain doubts over whether it can achieve the same consistency as DAMS and ART. Leal is the more experienced driver, but too erratic to be a title threat. Instead, look to Sorensen as the man with the potential to lead Carlin after some decent showings for MP Motorsport last year, even though a title tilt would probably be a stretch.

ARDEN INTERNATIONAL



DRIVERS

- 20 ANDRE NEGRAO (BR)
- 21 NORMAN NATO (F)

It's difficult to get too excited about Arden, which has race-winning form in GP2 but, for the second successive season, has a driver line-up best described as adequate rather than inspiring. Negrao did come through as a regular points scorer late last season, while Nato has won races in Formula Renault 3.5, but in this company the best the team can really hope for is nabbing the odd sprint-race victory.

ART GRAND PRIX



DRIVERS

- 5 STOFFEL VANDOORNE (B)
- 6 NOBUHARU MATSUSHITA (J)

When it comes to declaring Vandoorne title favourite, the only doubt – and it's a very small one – is the fact that ART wasn't always as sharp on the pitwall last year as it should have been. The McLaren junior should still run away with it. Honda-backed Matsushita can only approach this as a learning year, but the Japanese F3 champion is a genuine prospect so should emerge as a consistent points scorer.

STATUS GRAND PRIX



DRIVERS

- 22 MARLON STOCKINGER (RP)
- 23 RICHIE STANAWAY (NZ)*

*First round only confirmed

Status is a new name in GP2, but familiar thanks to its race-winning exploits in GP3. Over the winter the team acquired the Caterham Racing GP2 squad for its expansion into the category. Stockinger is solid enough, although he needs to carry his qualifying pace into race situations more often. Stanaway will at least contest the first round, and certainly has the speed to score points.

DRS READY FOR GP2 DEBUT

Since being introduced to Formula 1 in 2011, the drag-reduction system has proved controversial. Some accept that it's a necessary evil if you're going to make it possible for cars to overtake; others hate it for its 'artificial' nature. Either way, it's here to stay.

In 2015 it's in GP2 as well. Unlike the DRS adopted in the rival Formula Renault 3.5 category in 2012, which is usable freely for a set amount of time during a race, the GP2 version matches F1 directly. It will employ the same detection and activation points as F1, although the technology is different and has been developed in association with electronics company EM Motorsport.

Inevitably, some have questioned the wisdom of introducing technology designed to make overtaking easier to a category that has usually produced excellent racing. But that was never the motivation. As series boss Bruno Michel has pointed out, the DRS has been introduced because of GP2's "mission



Critics claim GP2 has no need for DRS



Tech differs from F1, but procedure is identical

statement", which is to prepare drivers for F1.

The system is simple: a green light appears on the dash to let the driver know that the DRS is available in the following zone, and the wing is 'opened' by using a paddle mounted on the steering wheel.

"It's about a tenth of a second between it being closed and fully open," explains Alex Lynn, who conducted testing on the system as well as using it during the regular pre-season running. "In Bahrain, we were looking at a 20-22km/h difference. If you're within a second, you'll get past on the main straight."

RACING ENGINEERING



DRIVERS

- 7 JORDAN KING (GB)
- 8 ALEXANDER ROSSI (USA)

Last year was trying for the Spanish squad, which ran Fabio Leimer to the 2013 title. In Rossi, it has a driver with ambitions to fight for the championship and with a proven ability to win races, but consistency has eluded him at this level. King has made a decent impression in testing, although is likely to be bottom-half-of-the-top-10 fodder.

RUSSIAN TIME



DRIVERS

- 9 MITCH EVANS (NZ)
- 10 ARTEM MARKELOV (RUS)

There have been significant changes over the winter, with iSport no longer running the cars and British-based Virtuosi Racing taking over. Testing has looked very promising and Evans has the speed and experience to win races; the question is whether he and the team will have the consistency to challenge for the title. In the second car, don't expect much from Markelov, on average the worst qualifier in GP2 last year.

TRIDENT



DRIVERS

- 11 RAFFAELE MARCIELLO (I)
- 12 RENE BINDER (A)

In Marciello, Trident has a driver who should be regarded as a championship threat even though his rookie season last year with Racing Engineering was patchy. Marciello himself is adamant the team is good enough for a title run, even though historically it has lagged behind GP2's leading squads. He should at least be a clear lead driver, with teammate Binder having spent 50 races in GP2 largely making up the numbers.

CAMPOS RACING



DRIVERS

- 14 ARTHUR PIC (F)
- 15 RIO HARYANTO (RI)

The Campos name returned to GP2 last year after taking over the Addax operation and settled back in well. Pic is a quick driver and, on his day, can win races, although he needs to take a step if he's to figure among the title contenders. Haryanto has his moments, but don't expect him to venture far beyond the midfield, except perhaps in the tricky conditions in which he excels.

HILMER MOTORSPORT



DRIVERS

- 24 SERGIO CANAMASAS (E)**
- 25 NIGEL MELKER (NL)**

**Unconfirmed at time of going to press

Franz Hilmer's team has certainly had big ambitions, winning races in each of its two seasons in GP2. But its uncertain preparation for the season, with neither driver confirmed as AUTOSPORT closed for press, means there are serious doubts about its prospects. Canamasas has tested solidly for the team, while Melker is a driver whose career momentum has suffered since a strong season in GP3 in 2011.

VENEZUELA GP LAZARUS



DRIVERS

- 26 NATHANAEL BERTHON (F)
- 27 ZOEL AMBERG (CH)

The Italian squad has achieved little in GP2, so don't hold your breath for anything different this year. Berthon is in his fourth year in the category and has the ability to score points regularly, but didn't manage to do so in Lazarus equipment in 2014 so probably won't this year. Series rookie Amberg brings plenty of experience from a similar level in Formula Renault 3.5, but not much pace.

BAHRAIN



CALENDAR

DATE	LOCATION	DATE	LOCATION
April 18-19	Bahrain	August 22-23	Spa
May 9-10	Barcelona	September 5-6	Monza
May 22-23	Monte Carlo	October 10-11	Sochi
June 20-21	Red Bull Ring	November 28-29	Yas Marina
July 4-5	Silverstone		
July 25-26	Hungaroring		

GP2 is currently assessing whether to add an 11th round to replace the races that were due to support the cancelled German GP



EBREY/LAT

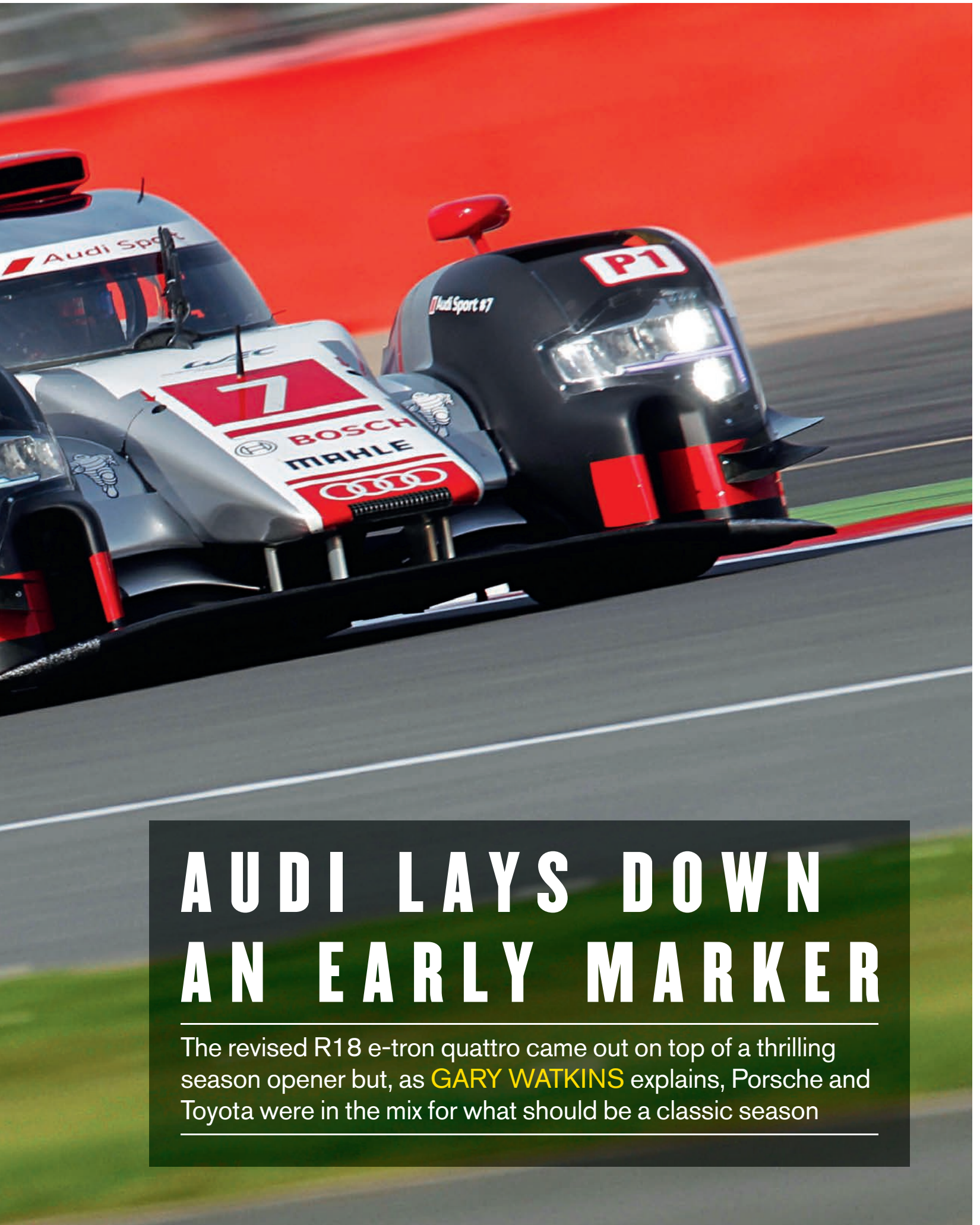

AUDI LAYS DOWN AN EARLY MARKER

The revised R18 e-tron quattro came out on top of a thrilling season opener but, as **GARY WATKINS** explains, Porsche and Toyota were in the mix for what should be a classic season

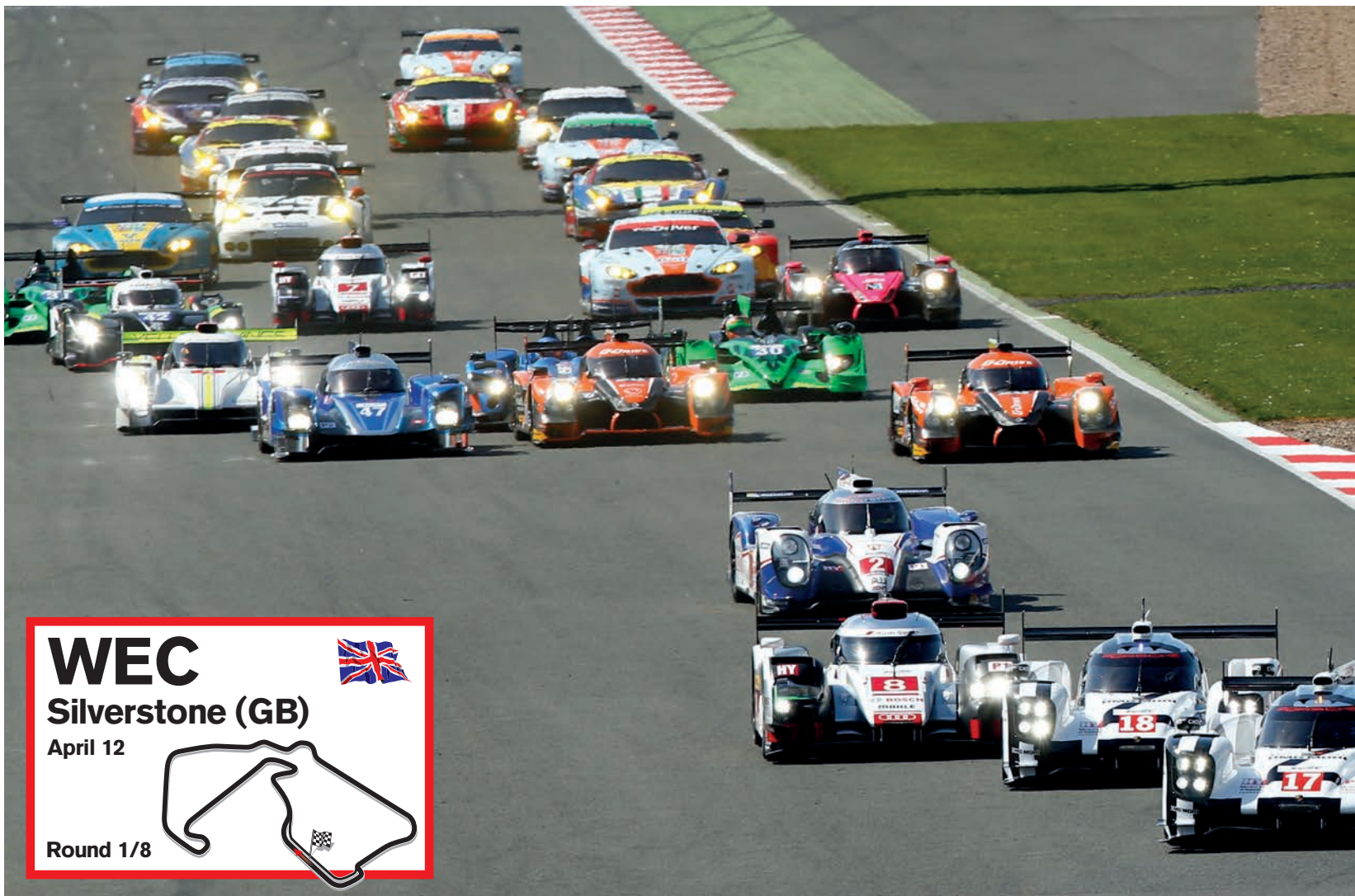

WEC

Silverstone (GB)

April 12



Round 1/8



AUDI'S HEAVILY REVISED R18 E-TRON QUATTRO was the fastest thing around Silverstone last weekend. But if it was going to win the opening round of the 2015 World Endurance Championship, it needed a clear track to exploit its advantage. Which is why Andre Lotterer's move on Porsche driver Romain Dumas four laps into his first stint was the turning point in a race that yielded Audi's first WEC victory since Austin last September.

Marcel Fassler, sharing as usual with Lotterer and Benoit Treluyer, had been bottled up behind the Porsche for the best part of a stint that straddled the two-hour mark. He repeatedly passed Neel Jani around the outside of Village, or between the right-hander and The Loop, only to be outdragged by the fast-accelerating 919 Hybrid down the Wellington Straight.

When Lotterer took over shortly after half distance he knew he had to get past, get past quick and then make it stick. Dumas was on his first flying lap after taking over from Jani when Lotterer dived down the inside into Village. The inside line was crucial, because he was then able to run his rival out onto the kerbs.

That forced Dumas off the gas and gave the Audi driver the breathing space he needed. Lotterer was just ahead by the time they got to Brooklands and still in front at the end of the old start-finish straight. And by the time they got beyond the Maggotts/Becketts/Chapel sweepers, he was gone and on the way to victory.

"I knew I had to surprise him, otherwise I was going to play the same game as Marcel for the whole stint," said Lotterer, who got his name on the historic Royal Automobile Club Tourist Trophy along with his team-mates' for his efforts.

"It was a kind of block pass: I knew I had to put him in a difficult position so I could get away. That was an important moment for us."

It was no good for an Audi to be bottled up behind the Porsches, which had blocked out the front row in qualifying, at Silverstone. That prevented it from exploiting its advantage in the corners, not only the high-speed stuff where Audi has been so strong since last year, but also in the slow turns in which drivers from other manufacturers also suggested it had an advantage.

The Porsche was in the ascendent on the straights courtesy of its greater hybrid punch out of the corners and lower downforce level. That explained Fassler's problem behind Jani. Time after time he got ahead, only to be blown away down the straight.

The differences between the two German cars produced a fascinating battle around the 3.67-mile Silverstone Grand Prix Circuit that had a decent crowd – put at 45,000 for the three days – on the

edge of their seats. And the drivers enjoyed it too!

"I think that was one of the best fights I have had in my whole career; honestly it was really exciting in the car," reckoned Fassler. "We were pretty fair with each other, but it was annoying when Neel kept passing me on the straight."

Lotterer's pass of Dumas – cheeky would be a better description than forceful – was actually for third place, because both Toyotas were ahead at this point late in the third hour. Lotterer quickly caught and passed Mike Conway in the second-placed TSo40 HYBRID and then chased down Anthony Davidson in the #1 Toyota. By the time the cars started pitting, he was eight seconds up on the reigning champion and, more importantly, a further dozen ahead of the Porsche that Dumas and Jani shared with Marc Lieb.

Lotterer subsequently double-stinted a set of Michelin tyres, a tactic Porsche opted against. Its strategy was to go further on the fuel to avoid the final splash-and-dash stop its rivals would need.

Fassler struggled to make move stick on Jani (18)

LEE/GETTY



Mark Webber leads the field from pole at the start, but Porsche #17 would fail

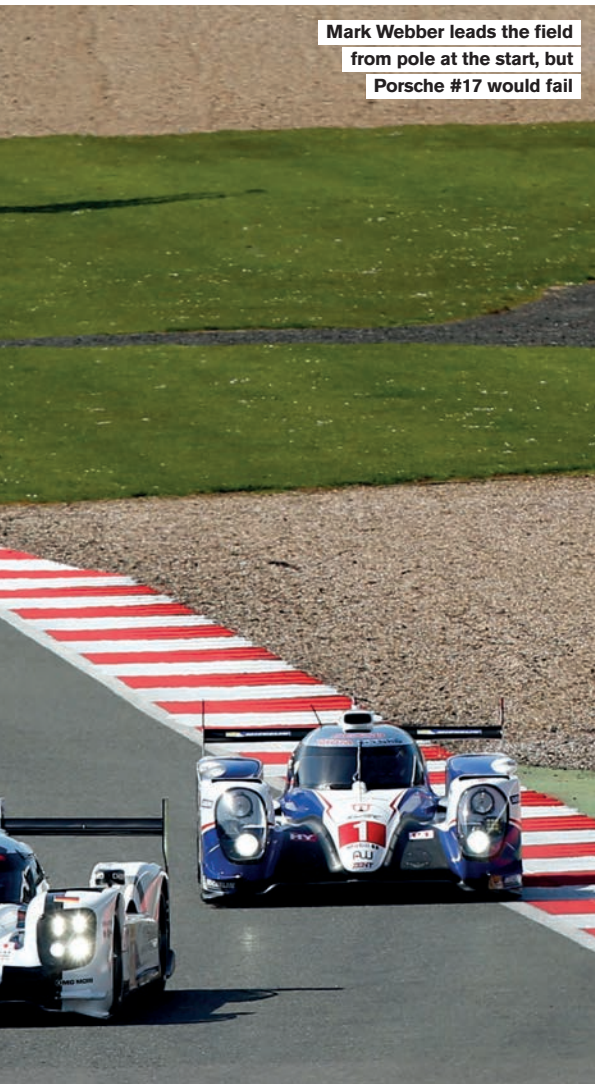

The plan ultimately yielded second place ahead of the TSO40 that Davidson shared with fellow world champ Sebastien Buemi and new team-mate Kazuki Nakajima. One final twist in an exciting race almost gave Porsche a second consecutive WEC win after its Interlagos triumph in last year's finale.

Fassler, who got back in the winning Audi after a triple stint from Lotterer, was awarded a stop-go penalty in the final half hour for overtaking a GTE car beyond the track limits on the exit of Club Corner. The race would finish for the #7 Audi as it began, with a delay: Treluyer had failed to get away cleanly at the start after struggling to change gear, though he quickly made up the lost time.

The Swiss driver held a lead of 1m12s over the Porsche when he ducked into the pits for his splash with 15 minutes to go. That came down to 37s before he came straight back in to take the penalty. The lead was suddenly down to under 10s.

The smart money was still on an Audi victory because it had already proved it could pull off a double stint on the tyres. New rules that limit each P1 entry to six sets for qualifying and race mean that every car has to do one double, though Porsche opted for a less conventional strategy.

Lieb had to do one of his stints with two already-raced tyres, which meant two fresh Michelins were held back for Jani's final stint. These went on the left-hand side of the car for the run to the flag.

Rather than dropping time to the leader and coming under pressure from Buemi, who had made his final fuel stop four laps before Fassler, Jani was able to chip away at Fassler's advantage.

"In the beginning, especially in my stint, I'd been struggling a bit with brake temperatures," said Jani. "But at the end the car got better and better and ▶

AF Corse Ferraris took first and third



GTE

Slick strategy wins it for AF Ferrari

GIANMARIA BRUNI AND TONI VILANDER DIDN'T look like potential GTE Pro winners a lap into the race on Sunday — their AF Corse Ferrari 458 Italia was dead last. Yet six hours later they sealed a 10-second victory thanks to a tactical masterclass from the factory AF squad and another superlative driving performance from the reigning class champions.

Bruni had to take to the grass in The Loop in avoidance of a spinning LMP2, which left him 14s off the front of field. Two pitstops during Full-Course Yellow periods either side of the one-hour mark allowed Bruni to get back on terms and enter into a battle with the sister car of Davide Rigon and James Calado and the best of the factory Manthey Porsche 911 RSRs shared by Richard Lietz and Michael Christensen that ebbed and flowed through the race.

Vilander got the car into the lead ahead of the other AF Ferrari in the penultimate hour, but the Porsche was coming up fast. A new refuelling system for this season has given Manthey an advantage in the pits that AF was worried might leapfrog the German car into the lead. Bruni's and Vilander's six-stop strategy meant the Italian car would have a shorter run to the flag than its rivals, so it opted to save vital seconds by changing only the left-side tyres when Bruni got back in for the dash to the finish.

That gave him a 14s lead over Christensen,

who was sent out of the pits just ahead of Rigon. Bruni was able to maintain his advantage before backing off over the final laps.

"The team made an excellent call and got us back in it," said Bruni. "I knew we had a chance when I was able to catch the sister car in the second hour, but it was always going to be close."

Lietz and Christensen reckoned they might have won had they been on the same strategy as the Ferrari. Manthey opted to split its strategies at the first FCY, bringing in Patrick Pilet, who was behind because he'd been involved in the same fracas as Bruni, and leaving Lietz out to run a conventional five-stopper. Its misfortune was that Pilet's and Frederic Makowiecki's chances disappeared with a damper problem in the fourth hour that left them seventh and last after a 3m30s change of the offending item.

Aston Martin Racing might have blocked out the top three positions in qualifying, but none of its Pro class Vantage GTEs made it onto the podium. Nicki Thiim led the first stint in the Danish-crewed car that he and Marco Sorensen had qualified on pole, but their bid for victory together with Christoffer Nygaard started to unravel at the first round of pitstops.

A slow first stop resulted in the car dropping to fourth, which set the tone for the remainder of the race. The #95 car never managed to get in and out of the pits in less than 1m30s, whereas the super-quick Manthey team was able to get under the 1m20s mark.

The Danes were actually only a minute behind at the flag, despite being classified a lap down, which wasn't that much more than they had lost in the pits.

Pedro Lamy, Mathias Lauda and Paul Dalla Lana salvaged something for AMR with victory in the GTE Am class. Lamy was another to lose out in the first-lap confusion, but he and his team-mates were quickly back in the mix and able to take a 13s victory over the AF Ferrari shared by Emmanuel Collard, Rui Aguas and Francois Perrodo.



Bruni/Vilander took stunning back-to-front victory for Ferrari

AUTOSPORT

fantasy league GP

STILL SPACE ON THE GRID!

DON'T MISS OUT
IT'S NOT TOO LATE TO ENTER A TEAM..



\$100M BUDGET - LIVE SCORING
VARIOUS COMPETITIONS
FANTASTIC PRIZES - PRIVATE LEAGUES

**BUILD YOUR ULTIMATE GP TEAM AT
AUTOSPORT.FANTASYLEAGUEGP.COM**



The Davidson/Buemi/
Nakajima Toyota took P3

► we were able to pick up the pace. The race, unfortunately, was too short for us.”

Jani got the gap down to just 4.6s after six hours of frenetic racing, while extending an initial advantage of eight seconds over Buemi to 14s by the chequered flag. The Toyota squad had expected to come back at the Porsche, but technical director Pascal Vasselon suggested that his driver had been unlucky in traffic in the closing laps.

Davidson reckoned he was happy with a podium in a race that hasn't traditionally favoured Toyota. The difficulty retrieving the full amount of megajoules with its fully-kinetic hybrid system on such a fast track without a proliferation of heavy braking zones was at least part of the reason.

Buemi had lost time in his second stint when Toyota unsuccessfully tried a different compound of Michelin tyre – believed to be softer – but Davidson had been able to make up the lost ground as Jani and Fassler battled ahead of him. Double-stinting the tyres allowed him to move into the lead but, once it became apparent that Audi could do the same, Toyota never looked like winning.

The second TSO40 HYBRID finished fourth and a lap down in the hands of Conway, Alex Wurz and Stephane Sarrazin. It hadn't been on a par with the #1 car in qualifying and nor was it in the race for reasons that Toyota either didn't fully understand or wasn't prepared to reveal.

The second Audi ended up four laps down in fifth position in the hands of Lucas di Grassi, Loic Duval and Oliver Jarvis. The car lost a lap to rear-bodywork repairs after di Grassi made contact with a GTE car early in the race and more time later on with a nose-fixation problem.

The Porsche 919 Hybrid that Mark Webber and Brendon Hartley had qualified on pole by six tenths from the sister car in the 20-minute aggregate qualifying session (now based on the fastest lap of each driver rather than their fastest two) led through the opening stint in the Australian's hands. On fresh rubber he was able to pull a gap on Dumas, who started on tyres used in qualifying, and was 10s up the road after the first pitstops when he pitted with gearbox problems that could not be resolved for it to return to the track. ❏

FOR FULL RESULTS, PAGE 58



First blood to Audi, thanks to Treluyer, Fassler and Lotterer



Bird/Canal/Rusinov Ligier cleaned up en route to LMP2 victory...

LMP2

G-Drive snares an easy one-two

THE G-DRIVE RACING LIGIER SQUAD STARTED its LMP2 campaign with a victory, just as it had done at Silverstone in 2014. Twelve months ago it had to fight back from lengthy delays, but this time its pair of Nissan-engined Ligier JSP2 coupes dominated on the way to a one-two.

The OAK-run cars had a clear advantage over the opposition and the winning Ligier shared by Sam Bird, Roman Rusinov and Julien Canal had the edge over team-mates Pipo Derani, Gustavo Yacaman and Ricardo Gonzalez. The triumphant trio were ahead nearly all the way, though the final winning margin of more than a lap came only as a result of late-race problems for the chasing sister car.

The G-Drive squad was only headed at the very beginning of the race when Nick Tandy vaulted ahead of them in KCMG's new ORECA-Nissan 05 coupe. The Briton kept Bird behind for five laps and Derani for three more, after which the P2 battle became an all-Ligier affair.

Bird was faster than Derani and finished his opening double stint half a minute up the road, but much of his advantage was won during the two Full Course Yellows, the virtual safety-car procedure during which the cars have to slow to 80km/h. Rusinov was able to extend the lead to over a minute when he went up against silver-rated Gonzalez, before the roles were reversed and Yacaman came back at the winning line-up's silver driver, Canal.



...that the trio celebrated later

The gap was down to 20s when Bird and Derani climbed back aboard for the run to the flag, but a handling issue on the chasing car ensured the leader never came under pressure. Derani changed tyres twice during his double stint in an unsuccessful attempt to resolve the problem, which was later traced to the steering.

KCMG's bid for a podium disappeared as early as the second hour with a radiator failure that left Tandy, Richard Bradley and Matt Howson 18 laps behind at the finish and down in fifth. That became fourth when the third-placed Extreme Speed Motorsports HPD-Honda ARX-03b of Ryan Dalziel, Scott Sharp and David Heinemeier Hansson was excluded because its underfloor skid plank was worn beyond the prescribed limits, which promoted the debuting Strakka Dome-Nissan S103 driven by Danny Watts, Jonny Kane and Nick Leventis to a distant third.



Briton Nick Tandy's KCMG ORECA led the early running

QUALITY MOTORSPORT LOOMS *FROM A PROVEN MOTORSPORT MANUFACTURER*

- Looms manufactured to Tyco System 25 and IPC-620 standards
- Fully automated CNC and semi auto tooling
- ISO9000, ISO:14001 and OHSAS:18001 approved

*Quality is key to our success
- and yours!*



scan for more info

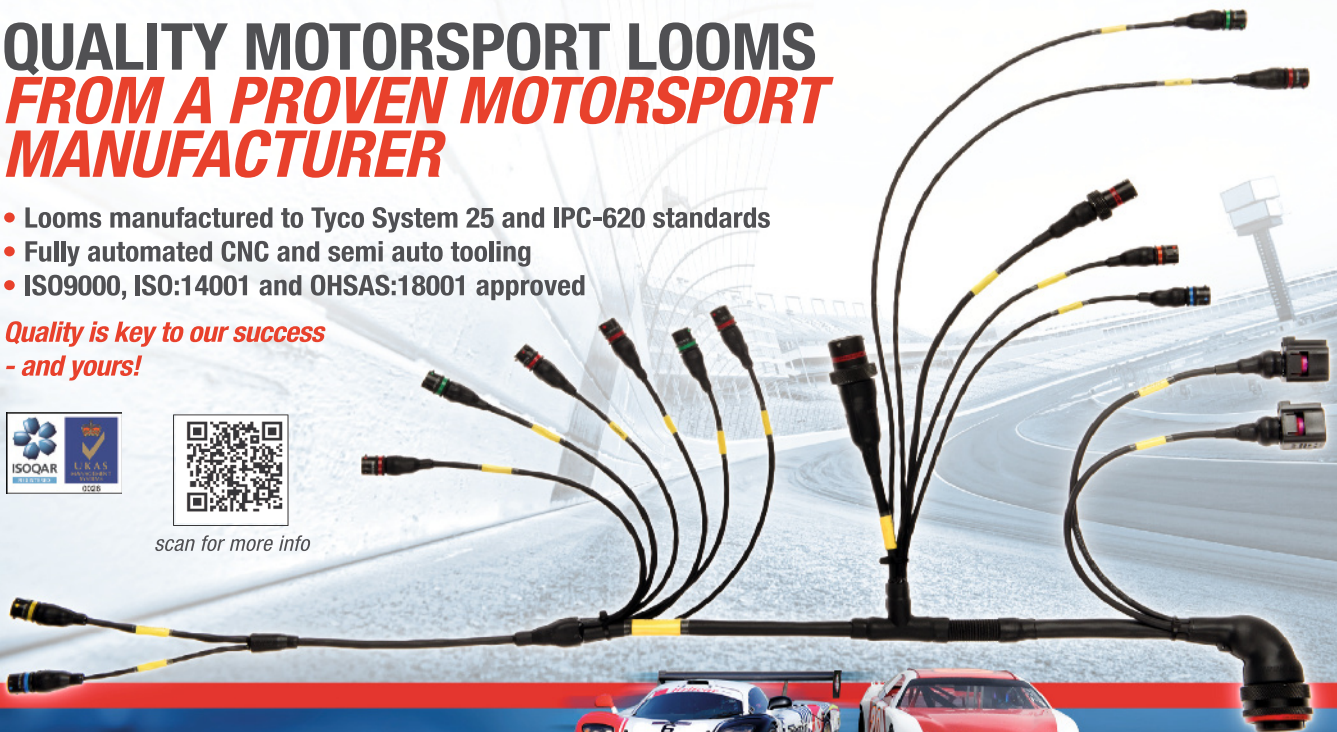

Contact us now with your requirements.

UNIT 14 MOUNT PLEASANT INDUSTRIAL PARK,
SOUTHAMPTON, SO14 0SP, ENGLAND

TEL: +44 23 8022 7636

EMAIL: sales@st-cross-electronics.co.uk

St. Cross Electronics

Established 30 Years 1983 - 2013



GRAND PRIX BREAKAWAYS



EUROPEAN FORMULA 1 AND LE MANS TRAVEL PACKAGES



No Overnight Travel - Client Focused Friendly Travel

Multiple on Route Pickup Points - Le Mans 24hr Specialists

Luxury VIP Mini Coach - Competitively Priced Holiday Packages

Grand Prix Breakaways is a family run business with comprehensive knowledge and personal experience of the European Grand Prix circuits. Our VIP Executive coaches are equipped with "Captain Style" reclining leather seats situated around tables and fitted with: seat belts for your safety, air-conditioning for your comfort and media entertainment for your enjoyment whilst travelling.

www.grandprixbreakaways.co.uk

enquiries@grandprixbreakaways.co.uk +44 (0) 114 287 5201

IN THE PADDOCK

GARY WATKINS
CONTRIBUTOR

@gazzasportscars



AUDI ENDED ITS WINNING DROUGHT at Silverstone, Porsche easily qualified on pole and the Toyota looked after its tyres well. But we could probably have predicted those things before last weekend. So what did we really learn from the WEC opener as we look forward to the rest of the season?

The answer is probably not a lot.

Audi has a car that as well as being mega in the high-speed corners also has impressive mechanical grip that appears to have given it an advantage in the slow corners. Those suspension tweaks also appear to have overcome its problems getting its tyres into their operating window (it was pretty chilly at the weekend).

Porsche's performance provided conflicting evidence about whether the redesign of the 919 Hybrid has overcome the mid-corner understeer that resulted in an unhealthy appetite for its tyres last season. It didn't double-stint a whole set, which backed up concerns it was happy to voice. And Silverstone isn't a particularly hard circuit on tyres. But then Neel Jani's final short stint with only two new Michelins suggested big advances have been made.

What we truly learned at Silverstone is that all three manufacturers with their new or nearly-new 2015 P1 contenders are in the game. Audi Sport Team Joest boss Ralf Juttner probably summed it up best with the words: "We now know that it is going to be a very tight season, but not a lot else."



SARD Morand in 24H reprieve

TEAM SARD MORAND HAS BEEN granted an extension to confirm its entries for the Le Mans 24 Hours after missing the Silverstone WEC round.

The Swiss team was forced to withdraw its pair of Morgan-Judd/BMW EVOs after a buyout deal with data-encryption specialist Kairos Technologies was not completed in time. The failure of the deal to go through meant that it was also unable to pay the final instalment of its Le Mans entry on the closing date last week.

Kairos is still going through the due-diligence process to complete the sale, which was agreed in late March.



Ligier will face fewer LMP2 chassis rivals

ACO confirms LMP2 build limit

PLANS TO LIMIT THE NUMBER OF constructors that can build cars for the LMP2 prototype category have been confirmed by the rulemakers.

The Automobile Club de l'Ouest, which writes the rules for the category together with the FIA, will offer a fixed number of licences to produce P2 cars from 2017. It has yet to confirm that the

plan calls for that number to be four, with one spot to be reserved for a North American company.

A statement from the ACO said that the move would create "a more sustainable business case" for constructors, at the same time as allowing for a reduction in the running costs.

Nissan targets extra mileage

NISSAN WAS FOCUSING ON

endurance running on the resumption of testing with its GT-R LM NISMO LMP1 prototype ahead of its race debut in the Le Mans 24 Hours in June.

The GT-R LM, which was last month withdrawn from the opening two rounds of the World Endurance Championship at Silverstone and Spa, started the four-day test at Chevrolet test track Bowling Green in Kentucky on Monday. The plan is to increase the mileage on the car after its specification was fixed at its most recent test at the same venue.

Nissan global motorsport boss Darren Cox said: "Up to this point, the focus has been on development and trying to drive performance out of the car. The next six days we have planned are about putting mileage on the car."

Nissan believes it made significant advances with the front-engined, front-wheel-drive GT-R LM during the previous test.

Marc Gene, who will share the #23 Nissan with Max Chilton and Jann Mardenborough, said: "Up to Sebring [where it tested in early March] we were struggling to get the laps, but we made a big step two weeks ago. Now we are able to do long runs, which we couldn't before."

Olivier Pla, who will drive the other full-season WEC entry with Harry Tincknell and Michael Krumm at Le Mans, suggested significant progress had been made in terms of tyre wear.

"Over two stints [on the tyres] the car was very consistent, which is quite promising," he said.



Nissan's radical GT-R LM will rack up more miles before its Le Mans debut



KLIEN DRAFTED IN...

Christian Klien, who briefly drove for ByKolles boss Colin Kolles at the HRT Formula 1 team in 2009, was brought in to share the CLM with Tonio Liuzzi and Simon Trummer after the latter arrived late at the circuit due to the French air-traffic control strike. Klien was in the UK because he had been scheduled to race for Team SARD Morand.

...FOR '14-SPEC CLM

The ByKolles squad's CLM-AER P1/01 ran in 2014 trim with only minor upgrades at Silverstone. The revised car, with new aero and an Xtrac gearbox, is due to appear at Spa, although no shakedown date has been released by the team. The old car retired with engine problems, possibly the result of a water leak, having already undergone repairs to the floor after Liuzzi was forced over a kerb early in the race.

NO REBELLION AT SPA

Silverstone absentee Rebellion Racing will also miss the Spa round next month. The revised AER-engined Rebellion R-One LMP1 is due to be homologated on May 11.

NEW NAME FOR TOYOTA

The Toyota TS040 HYBRIDS will carry affiliation to the Japanese marque's Gazoo Racing philosophy from Spa next month. A rebranding exercise will follow for 2016 when all its motorsport programmes, including its WRC team from 2017, will run under the Toyota Gazoo Racing banner. Gazoo, the baby of Toyota boss Akio Toyoda, is aimed at invigorating the marque's fanbase.

BRABHAM RETURNS

Sportscar veteran David Brabham made a return to the Extreme Speed Motorsports squad at Silverstone. The 2009 Le Mans winner was called up to drive with Jon Fogarty and Ed Brown as Johannes van Overbeek was ruled out with a rib injury.

CAR SWAP FOR KCMG

Chinese entrant KCMG could swap its second Le Mans entry from an ORECA-Nissan 03R to its second ORECA 05 coupe should it move up from second place on the reserve list. Team boss Paul Ip said he was talking to a large number of drivers in case the entry is confirmed.

Russell led fellow rookie Leclerc to race-two win

Euro F3 Silverstone (GB)

April 11-12

Round 1/11

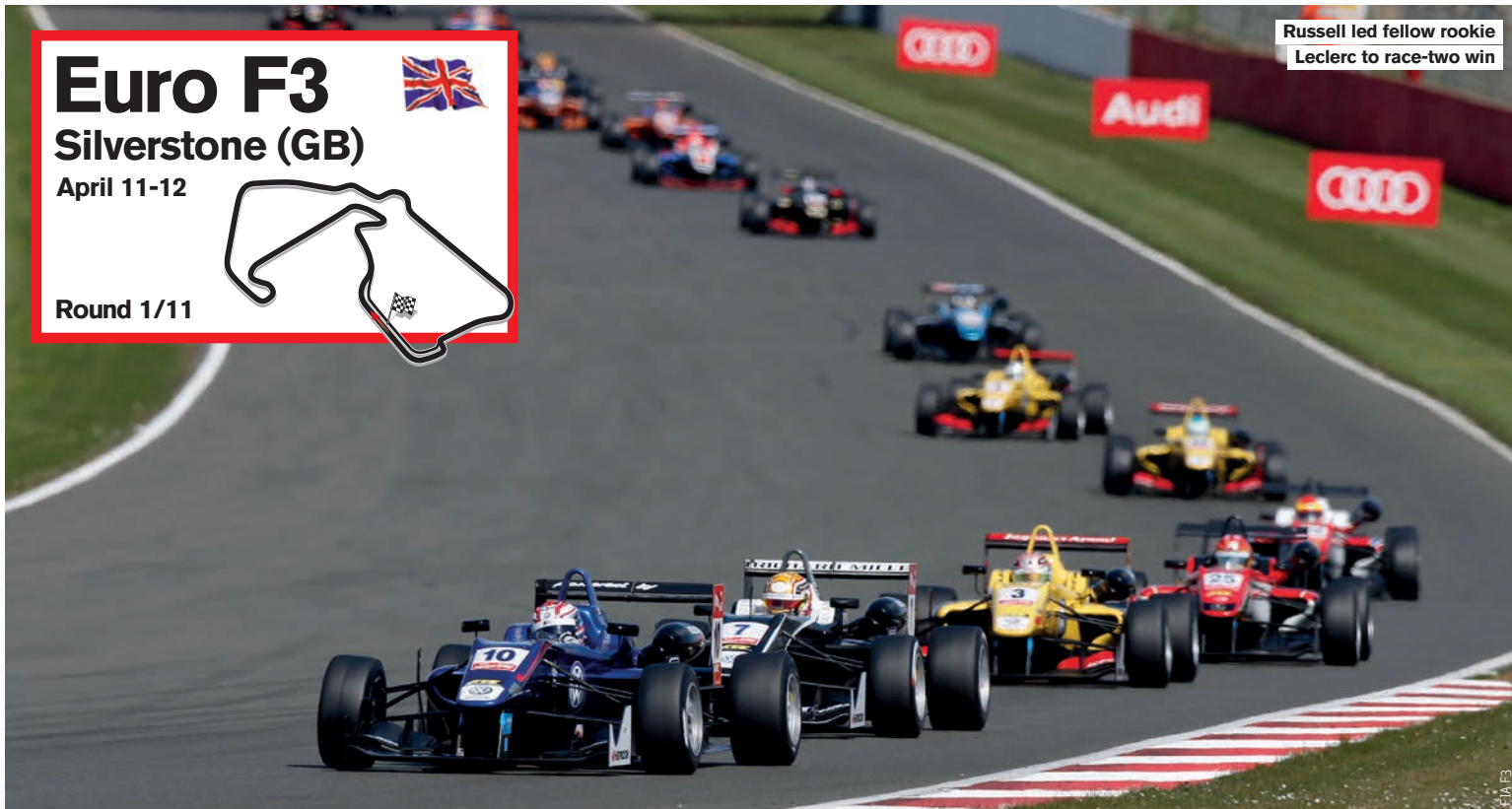

Rookies take fight to the old hands

MOST EXPECTED FELIX ROSENQVIST AND ANTONIO

Giovinazzi to be the two experienced hands fighting out this year's Formula 3 European Championship, and for George Russell and Charles Leclerc to be the two rookies giving them the hardest time. Sure enough, at Silverstone opener last weekend it was a win apiece for Rosenqvist, Russell and Leclerc, while a hat-trick of podiums has propelled Giovinazzi into the championship lead.

Beyond that, we didn't get many clues as to who will be fighting out the title come October, unless it's all four of them...

Sensational driving had taken Leclerc to a fastest-ever F3 lap of Silverstone in Tuesday's test, while Prema Powerteam's Euro F3 new boys Lance Stroll and Brandon Maisano had topped free practice. But first qualifying at Friday lunchtime brought experience to the fore, and from then on Macau Grand Prix winner Rosenqvist was the fastest man on his first competition outing with Prema.

Not only did 35 cars on track mean that it was tough to find a clear space to set a time, but the rubber laid down from the sportscar sessions meant the Hankook F3 tyres provided just one lap of peak performance. Rosenqvist slammed in a time a quarter of a second clear on his first hot lap, with Giovinazzi and Jake Dennis — who ran

in tandem just behind the Swede — a further quarter of a second clear of top rookies Russell and Leclerc.

Interestingly, outside the top three it was only Leclerc who set his quickest time on his first flier, and that was despite his having to defend at the beginning of the lap from an attempted re-overtake. It's always tough for newcomers to F3 to nail that crucial lap straight away when the pressure's on in qualifying, and the data from Silverstone suggests that this was exaggerated by the tyre situation.

So, in a stop-start race that began behind the safety car on a damp-ish track (with all on slicks), there was little to prevent Rosenqvist cruising to the season's first 25-point haul, with Giovinazzi second and Dennis shaking off a challenge from Alex Albon to take third.

Russell and Leclerc? They'd been eliminated from contention when the safety car set the field free, Leclerc slithering down the inside of the Briton at Club on the wet line and thumping into him, and poor Maisano spinning out with nowhere to go. Stunning recoveries brought Russell (with a bent wishbone) to eighth and Leclerc (after a pitstop behind the safety car for a new front wing) to 12th.

The tyres had a much longer peak in the second session, yet still Rosenqvist prevailed, until the scrutineers had their say (see column, right) and he was dumped to the back of the grid for races two and three, elevating the Van Amersfoort Racing car of Leclerc to two poles.

Russell made it an all-rookie front row, albeit three tenths adrift of Leclerc, and both he and Carlin team-mate Giovinazzi made better starts than the Monegasque poleman. Giovinazzi tried to squeeze through the middle, but contact with Russell bent the Jagonya Ayam protege's steering and the Italian — who did not use any of his allocation of four fresh tyres in this race — fell back to keep Stroll at arm's length on his run to third.



Leclerc leads Giovinazzi in the third race

Up front, McLaren AUTOSPORT BRDC Award winner Russell put in a superbly judged drive under constant pressure from Leclerc — a driver he knows well from karts and Formula Renault ALPS — to take the win. Leclerc got the gap down to about seven tenths, but as he did this he lost downforce and the front tyres started graining.

His time would come in Sunday morning's race. This time Leclerc fought off a race-long challenge from Giovinazzi, including a side-by-side sprint down the Wellington Straight at half-distance after Leclerc made a small mistake at the same time as his engine alarm spelt jangling nerves in the cockpit.

A low-key race for Russell was caused, he felt, by the change in wind direction having a drastic effect on his relatively high-downforce set-up. He couldn't switch the tyres on soon enough and struggled on the straights, yet when the car came to him he passed Albon in the battle for fifth.

Are Russell and Leclerc the new Ocon and Verstappen? For championship interest, yes. But as far as outdoing the experienced guys, the ominous form of Rosenqvist and Giovinazzi (who doesn't rate Silverstone as one of his better tracks) suggest that question is far from being answered.



Points lead for Giovinazzi (left); win for Russell

FOR FULL RESULTS, PAGE 58

IN THE PADDOCK

MARCUS SIMMONS
DEPUTY EDITOR

@marcussimmons54



A NEW SEASON OFTEN BRINGS fresh controversies, but there was a lot of sympathy for Prema Powerteam in the Silverstone paddock on Saturday morning.

After second qualifying, Felix Rosenqvist's times were deleted when it was found that the bodywork on his Dallara-Mercedes was outside the prescribed dimensions. Prema team manager Rene Rosin explained that it was because a screw coming loose had caused a front-wing endplate to flex just wide enough to break the rules.

It was heartening – in a sportsmanship kind of way – that leading rival teams felt it was a harsh penalty, especially as it could have been caused by something as innocuous as Rosenqvist hitting a kerb.

Even so, Prema played the game, saying that it was an oversight in preparation and that the fault lay with the team.



Rosenqvist lost his qualifying advantage

Still, every cloud has a silver lining, because now we'd get to see Rosenqvist charging from 35th on the grid. Twice! In the first race, he picked his way through a massive midfield scrum to take seventh. In the second he 'only' made it to 12th, struggling to get the tyres to work early in the race and then losing ground – and

positions – on a late restart when he lost downforce and went off the track.

After four years at Mucke Motorsport, Prema represents a new way of working for Rosenqvist. "It's very new, very different for me," he said. "I had all my success with Mucke, and they have very strong sides and Prema have very strong sides. Everyone

here is very happy – it's a bit of a family feeling really and that's what it's all about."

His form bodes very well. Not only were there three 'poles' and one win, but in race two – using four old tyres – he was just 0.005s off the fastest lap.

"I feel quite confident the way we are going," he concluded. That's ominous!

Albon puts in a Signature performance

ALEX ALBON WAS THE ONLY F3 rookie to take a hat-trick of top-six finishes over the weekend, as the Signature team begins its first full season in the category since 2011.

Neither the Thai nor fellow Lotus F1

Junior Dorian Boccocacci figured in Tuesday's test, but made big strides forward when it counted.

"People think, 'Oh this is Signature, they're a top team,' but they don't realise it's all new engineers," said Albon. "It just takes

time to find the balance of the car – we're an inexperienced team. But they did a great job and really transformed it since the test."

Albon's best result was fourth, after a fight with Jake Dennis in race one.



Albon settled in well at returning Signature team

BIG NUMBER
0.011

Median average gap in seconds between Carlin team-mates George Russell and Antonio Giovinazzi over six Silverstone sessions of testing, free practice and qualifying. The closest was in free practice two: 0.001 to Russell.

Dennis steps up in qualifying

JAKE DENNIS BEGAN HIS SEASON with something he never managed last year: a qualifying position in the top four.

The Racing Steps-backed Briton switched to Prema Powerteam over the winter, and the Italian squad has been focusing on his one-lap pace, a weak spot from last year. First time out he took third on the grid for the opening race, although brake problems dropped him back in the second session.

Dennis scored two podiums, but he needed luck for the second. Carlin runner



Dennis nailed one-lap-pace bugbear at Silverstone

Gustavo Menezes had scorched from eighth on the grid to third at the beginning of the final race, but a late fuel-pump glitch cost the Californian pace. "I nearly rammed straight up the back of him!" said Dennis.

POMMER ON PACE

The Motopark team returned to European F3 for the first time since 2011, with Markus Pommer taking two strong finishes in the points, and a best of fifth in race one. A clash with Red Bull junior Callum Iott in the second race caused a non-finish, but both were outside the points anyway.

MACLEOD'S PENALTY

Sam MacLeod had a very tough weekend on his Euro F3 debut with Motopark. The Scot started the weekend with a trio of 10-place grid penalties due to replacing a Volkswagen engine after a failure in last month's Valencia test, then lost track time in free practice with an electronics issue.

SCHILLER IN SPARE

Team West-Tec driver Fabian Schiller raced with a spare Dallara tub borrowed from Double R Racing after damage caused by an off at Becketts in Tuesday's test. The German rookie ran strongly in sixth place in race two, before understeer shuffled him back and a last-corner collision with Jake Dennis dropped him outside the points. Team-mate Raoul Hyman struggled for speed in qualifying, but set a top-10 fastest lap in the third race.

POINTS FOR FITTIPALDI

Pietro Fittipaldi scored points on his F3 debut for Fortec Motorsport with an eighth place in race two. The Brazilian-American forced his way past Schiller to earn the spot after emerging from a frantic early battle. A spin in race three forced him out and caused a safety car.

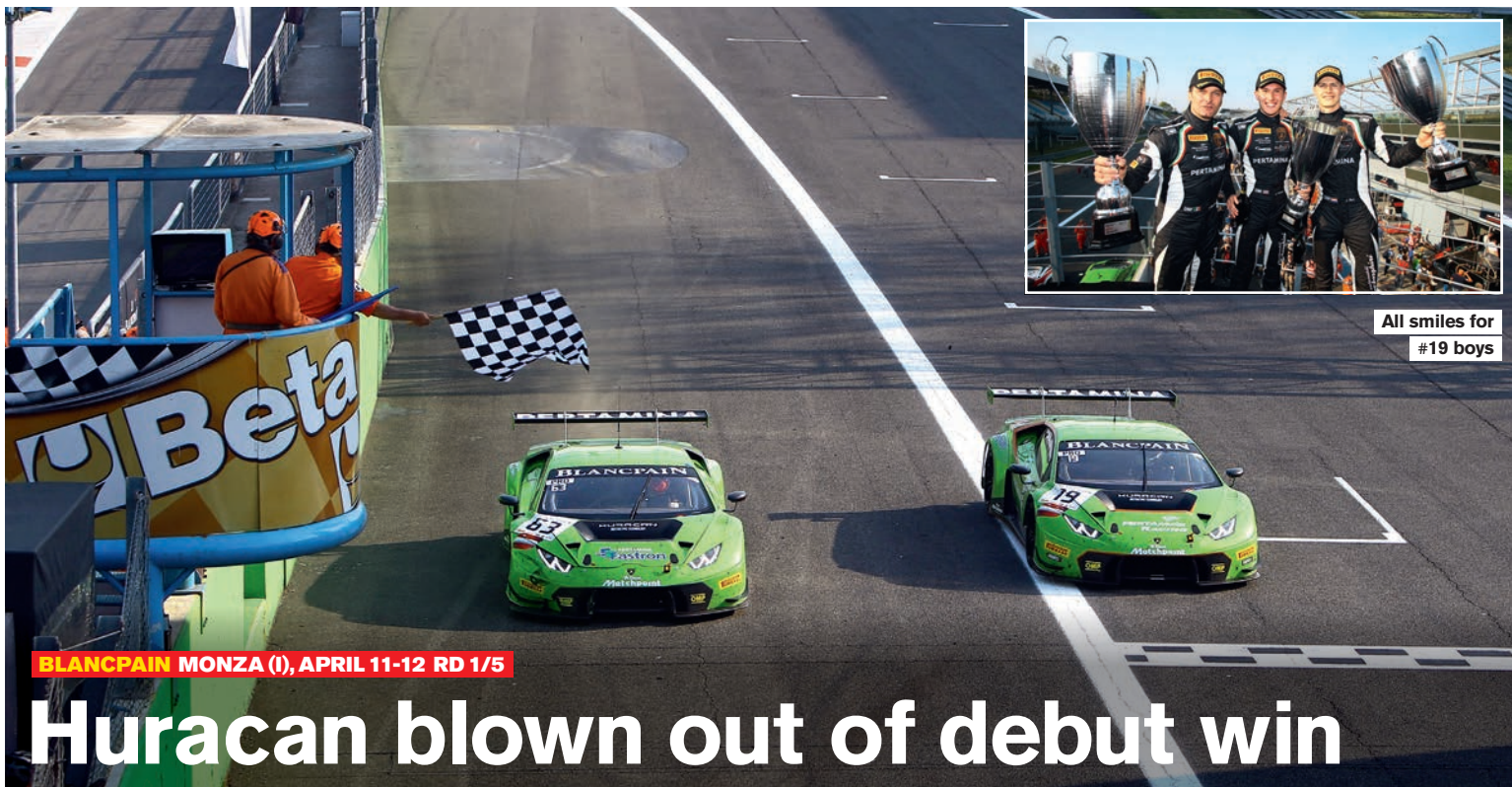

All smiles for #19 boys

BLANCPAIN MONZA (I), APRIL 11-12 RD 1/5

Huracan blown out of debut win

LAMBORGHINI'S NEW HURACAN GT3 machine made a sensational debut as GRT Grasser's #19 car led virtually the entire Blancpain Endurance Series opener at Monza, only to be disqualified for breaching refuelling restrictor rules.

Several hours after the race finish the stewards announced they had excluded the #19 from the meeting but GRT Grasser appealed against that decision and the race results were still provisional as AUTOSPORT closed for press.

Another Italian marque had dominated qualifying – a kind Balance of Performance ruling leaving the Ferraris very rapid in a straight line and meaning six 458 Italias lined up in the top six on the grid, with the #333 Rinaldi car of Rinat Salikhov and Norbert Siedler taking pole position.

But the #333 could only finish in second place on the road, 37 seconds behind Fabio Babini, Andrew Palmer and Jeroen Mul.

"There is always some luck involved in racing, and when we managed to keep the lead in the second stint, we started to believe we might get a good overall result as well," said Salikhov.

"I pushed hard in the final stint and thanks to the good work of the team we got this great result."

Reigning Blancpain Endurance champion Laurens Vanthoor had to settle for third in the best of WRT's Audis, alongside Robin Frijns and Jean-Karl Vernay. "This podium finish is a good way to start my title defence," said Vanthoor. "If we can be consistent, to finish on the podium every time, we should be able to have a shot at the title."

A packed field of 58 cars started the race and though they all managed to get through the first chicane unscathed – with Pierre Kaffer in the #66 Black Pearl Racing Ferrari seizing the lead from polesitter Salikhov – there were casualties at Curva Grande.

The #78 BMW of Leo Matchitski and the #12 BMW of Eric Dermont ended up in the barriers and gravel trap respectively after Dermont was punted into a spin and Matchitski tried to avoid the carnage.

The safety car appeared as the two BMWs were recovered but it came in again after just one lap which caused large gaps to appear among the field as several drivers failed to notice the green flags coming back out.

As Kaffer subsequently escaped up the road in first, Salikhov surrendered second place to Babini when the Russian driver outbraked himself into Turn 1 at the start of the seventh lap.

Kaffer pitted the #66 Ferrari on lap 19 and Babini inherited a lead that the #19 Lamborghini team would never lose, other than momentarily in the next two pitstops. The #66 Ferrari dropped down thereafter, coming home 22nd.

The Lamborghini's lead then stabilised at around 20 seconds for most of the race, the advantage swiftly rebuilt after a safety car period so debris could be retrieved from the track.

With 45 minutes left to run the safety car was called out again after Ronnie Volani in the #54 McLaren suffered a huge accident at the Parabolica when he lost the car under braking while fighting the #84 Bentley of Mike Parisy and slammed into the barrier on the inside of the track.

It took 15 minutes to clear the debris that had been strewn across the track, and the #19 Lamborghini then had a clear run to the finish.

Alessandro Bonacini in the #11 Kessel Ferrari looked like he was going to take second place from the #333 Ferrari but he fell away with mechanical gremlins, allowing the WRT Audi through.

Duncan Cameron in the #51 AF Corse Ferrari came home fourth ahead of the #7 M-Sport Bentley. The #2 WRT Audi finished in sixth place ahead of Bonacini, with the #23 RJN Nissan in eighth and the #35 Audi in ninth. The #53 AF Corse Ferrari completed the top 10.

The Mercedes had been able to



Awesome sight, 58 lined up ready

stretch their fuel efficiency further than the other manufacturers in the first phase but they did not have the pace to make that advantage work in their favour. The #99 Rowe Mercedes machine was the best placed, coming home eleventh.

RESULTS

- 1 Andrew Palmer/Fabio Babini/Jeroen Mul (Lamborghini Huracan)**, 93 laps in 3h01m48.550s;
2 Norbert Siedler/Rinat Salikhov (Ferrari 458 Italia GT3), +37.007s; **3 Jean-Karl Vernay/Robin Frijns/Laurens Vanthoor (Audi R8 LMS ultra)**;
4 Duncan Cameron/Matt Griffin (Ferrari);
5 Guy Smith/Andy Meyrick/Steven Kane (Bentley Continental GT3); **6 Frank Stippler/Stephane Ortelli/Nico Muller (Audi)**;
7 Michael Lyons/Alessandro Bonacini/Michal Broniszewski (Ferrari);
8 Katsumasa Chiyo/Wolfgang Reip/Alex Buncombe (Nissan GT-R Nismo GT3);
9 Edward Sandstrom/Edoardo Mortara/Gregory Guilvert (Audi);
10 Piergiuseppe Perazzini/Marco Cioci/Enzo Potolicchio (Ferrari).
Points 1 Palmer/Babini/Mul, 25; **2 Vernay/Frijns/Vanthoor, 18**; **3 Smith/Meyrick/Kane, 15**;
4 Stippler/Ortelli/Muller, 12; **5 Chiyo/Reip/Buncombe, 10**; **6 Sandstrom/Mortara/Guilvert, 8**.
Pro-Am 1 Siedler/Salikhov, 25; **2 Cameron/Griffin, 18**; **3 Lyons/Bonacini/Broniszewski, 15**.

#333 dominated quali, second in race



Don't Miss - Book Now

Le Mans 24 Hour | 6 Coach Tours departing UK | Tours from £155
Circuit Camping Packages | Hotels: Arrive by Air | Eurostar | Self Drive
HISTORIC TOURS: Mille Miglia Goodwood Festival of Speed and Revival

**FREE
BROCHURE**

FORMULA ONE TOURS

Executive Coach Tours with our UK Travel team

- ▶ No overnight Travel
- ▶ Circuit pit lane walkabout
- ▶ Spain Holiday Tour 8 nights Half Board £595*
- ▶ Monaco Holiday Tour 7 nights £525*
- ▶ Austria Holiday Tour 8 nights £679*
- ▶ Hungary 'Imperial Cities' Tour 9 nights £679*
- ▶ Belgium Coach Tours options 5 nights £408* - 4 nights £382* - 3 nights £299*
- ▶ Italian Holiday Tour, Black Forest, Alps, Lake Como 8 nights £625*

By Air Tours All Events

- ▶ Flexible nights stay
 - ▶ Airport Meet and Greet
 - ▶ Circuit Transfers
- With our UK travel team

VIP travel package options

*Prices do not include race tickets



F1 Abu Dhabi Grand Prix - Season Final - Join us and party with the drivers

Formula One • Le Mans 24hr • MotoGP • Superbikes • Historic

LE MANS 24 HOUR

- Tickets & Hospitality
- Circuit Camping

Travel packages

- Coach Tours
- By Air options
- Self drive packages



FORMULA ONE GRAND PRIX

Flexible Travel Packages ALL Events

Arrive by : Air | Coach | Train | Self Drive

Race tickets and hospitality

HISTORIC

- ▶ Monaco
- ▶ Le Mans Classic
- ▶ Mille Miglia
- ▶ Goodwood Festival
- ▶ Goodwood Revival



Like us on Facebook



Follow us on Twitter



UK TRAVEL TEAM: +44 (0) 1451 833 721

BOOK ONLINE: enquiry@selectmotorracing.com



FORMULA RENAULT 2.0 ALPS

FORMULA RENAULT 2.0 ALPS 2015 // ROUND 1+2 // IMO



Imola again hosted the opening round of the Formula Renault 2.0 ALPS series, which this time saw Antoine Hubert impress in his Tech 1 Racing-prepared car. The Frenchman took pole and victory for the first race, closely followed home by Koiranen GP's Jack Aitken and the other Tech 1 Frenchman Simon Gachet, who also made it to the Imola podium last year. Fortec Motorsport's Ben Barnicoat finished fourth, having battled up from seventh – passing both Hugo de Sadeleer and Matevos Isaakyan, who were having their own duel resulting in them both dropping back. Austrian Stefan Riener (Koiranen GP) came in fifth ahead of Martin Kodric (Fortec), Brazilian Thiago Vivacqua and Isaakyan, both JD Motorsport.

Jack Aitken grabbed pole for the second race from Antoine Hubert, and was immediately able to pull away during the opening laps. His Koiranen GP machine, undoubtedly the strongest contender of last year, took him all the way to his first victory in the Formula Renault 2.0 ALPS series. Team-mate Jake Hughes started fifth but got the jump on Stefan Riener at the start, also passing Croatian Martin Kodric later on to finish third. Kodric came home fourth, his Fortec team-mate Ben Barnicoat following him home in fifth. Behind them Stefan Riener (Koiranen GP), Vasily Romanov (Cram Motorsport) and Danyilo Pronenko (BVM Racing) completed the top eight. Cram Motorsport's rookie Matteo Ferrer did well to run higher than JD Motorsport's Matevos Isaakyan, though he was suffering with a temperature and unable to put up much of a fight.



Next Race // Pau, France // 16-17 May 2015 // www.renaultsport.com
// Facebook www.facebook.com/fast.lane.pr

PS 2015

LA, ITALY

FORMULA RENAULT



ALPS



The prestigious, picturesque Imola circuit was the perfect place to start the 2015 Formula Renault 2.0 ALPS championship – the series witnessing two great races. It was a two-day event, which will also be the case at Pau, Spa, Misano and Jerez later in the year – with the rounds at Monza in Italy and the Red Bull Ring in Austria running three races, over three days – an exciting new format for 2015.

A very healthy grid saw title holders Koiranen GP enter five cars for the season-opener – driven by the two Brits Jack Aitken and Jake Hughes, the Austrian Stefan Riener and the two rookies Bruno Baptista and Philip Hamprecht. JD Motorsport’s Russian Matevos Isaakyan stays with them for another year, joined this time by the Brazilian Thiago Vivacqua.

Cram Motorsport and GSK Grand Prix both field three cars – Vasily Romanov and two rookies Matteo Ferrer and Travis Jordan Fischer for Cram, the two Italians Daniele Cazzaniga and Andrea Russo and Russian Denis Bulatov for GSK. BVM Racing lines up with the Ukrainian Danyilo Pronenko, while Technorace ‘s single-driver line-up is Italian – Alex Perullo.

The strong grid is completed by Tech 1 Racing, Arta Engineering (one car for Australian James Allen) and Fortec Motorsport.

DRIVER	TEAM	PTS
Jack Aitken	Koiranen GP	50
Stefan Riener	Koiranen GP	33
Jake Hughes	Koiranen GP	18
Matevos Isaakyan	JD Motorsport	18
Thiago Vivacqua	JD Motorsport	15
Matteo Ferrer	Cram Motorsport	14
Philip Hamprecht	Koiranen GP	14
Danyilo Pronenko	BVM Racing	14
Vasily Romanov	Cram Motorsport	12
Andrea Russo	GSK Grand Prix	8

italia.it // Twitter @flp_renault
omotion



SUBSCRIBE TO AUTOSPORT FOR ONLY £6 EVERY 6 ISSUES

PLUS FREE DIGITAL EDITION &
UNLIMITED ACCESS TO AUTOSPORT.COM



SUBSCRIBER BENEFITS...

- ✓ **JUST £6** for your first 6 issues, thereafter pay only £34.99 every 13 issues
- ✓ **NEVER** miss an issue
- ✓ **FREE** delivery direct to your door
- ✓ **UNLIMITED** access to news and views from the paddock
- ✓ **ACCESS TO** subscriber-only offers and discounts

CALL 08448 488 817 AND QUOTE **ASPO15** OR VISIT
www.themagazineshop.com/taspo/asp015

Terms & Conditions: This offer is open to UK residents only. If you require any assistance following the purchase of your subscription, then you can speak to a member of our customer service team on 01795 592 974, calls are charged at local rate. Overseas rates are available on +44 (0) 1795 592 974. Please allow 35 days for delivery of your first issue. To activate your Autosport online account visit <https://secure.autosport.com/subs/activate.php> and enter your activation code (your personal magazine subscriber number which will be included in your welcome email/letter) along with your email address to access your extra Autosport content. Price is £6 for your first 6 issues then continuous Direct Debit payments of £34.99 every 13 issues unless you cancel. Direct Debit rates are fixed for 12 months after which they may be subject to change, should prices change you will be informed in writing. Details of the Direct Debit guarantee are available on request. Should you wish to cancel the subscription thereafter it will be cancelled on expiry of your current term. Savings are based on the standard UK cover price of £3.70. Offer ends 31st January 2016.

**The best drivers are using simulators....
...why aren't you?**

#1 UK Supplier to Professional Driver Development Facilities



Get your own Advanced Force Feedback Steering System
From: £2400 (exc.VAT)

- Test Drives Available at Silverstone -

Leo Bodnar Electronics Ltd
Units 7-8 New Rookery Farm, Little London
Silverstone, UK, NN12 8UP
Tel: +44(0)1327 850666 | E-mail: support@leobodnar.com

www.simsteering.com

DUNLOP MSA

BRITISH TOURING CAR CHAMPIONSHIP

**SATURDAY 18TH
- SUNDAY 19TH
APRIL 2015
AT DONINGTON PARK**

**SAVE 25% WHEN BUYING
YOUR TICKET IN ADVANCE**

VISIT WWW.DONINGTON-PARK.CO.UK
OR CALL 0844 873 7343

(calls cost 6p per minute plus your phone company's access charge to order over the phone)



#LOVECARS
#LOVEDONINGTON



www.donington-park.co.uk

Official Donington Park Racing @DoningtonParkUK @DoningtonPark



Morbidelli leads the field at Shanghai



APB IMAGES

TCR INTERNATIONAL SHANGHAI (PRC), APRIL 11-12 RD 2/11

Victory gives Morbidelli points lead

THE NEW HONDA CIVIC TCR ONLY RAN for the first time two months ago, yet on just its second weekend of racing the car not only claimed its first win, but locked out the podium of a grand prix support race.

While this was a victory for a new car in a new championship, it had a familiar feel, for it was Gianni Morbidelli, a veteran of nearly two decades of tin-top racing, taking victory in a car built by long-time Honda touring car specialist JAS Motorsport and run by crack Swedish squad West Coast Racing. Morbidelli's run to victory in the

first race from pole position was straightforward given the drama that unfolded behind him. A clash between SEAT driver Pepe Oriola and the Honda of Rene Munnich on the first lap not only eliminated the Spaniard, but secured a one-two finish for the West Coast team.

Honda's podium sweep wasn't secured until the very last lap, with Kevin Gleason prevailing in a tight scrap for third place against Stefano Comini in the strongest of the SEATs that had dominated the first round, but carried an extra 30kg of ballast at Shanghai.

In race two, Comini and Target Competition team-mate Andrea Belicchi claimed revenge for SEAT with a one-two finish. But while Belicchi led at the start and finish, he was shuffled as low as third at one stage.

Both Comini and Morbidelli took stints in the lead, with Morbidelli looking well placed for a double victory, only for his engine to cut out briefly with just over two laps remaining, allowing Belicchi and Comini to pass him.

Belicchi eventually saw off Comini's challenge, with the Swiss

having to re-pass Morbidelli at the penultimate corner on the last lap to secure second.

RESULTS

Race 1 1 Gianni Morbidelli (Honda Civic TCR), 10 laps in 23m18.758s; 2 Rene Munnich (Honda), +0.851s; 3 Kevin Gleason (Honda); 4 Stefano Comini (SEAT Leon Racer); 5 Andrea Belicchi (SEAT); 6 Franz Engstler (Audi TT).

Race 2 1 Belicchi, 10 laps in 23m19.292s; 2 Comini, +1.252s; 3 Morbidelli; 4 Pepe Oriola (SEAT); 5 Michel Nykjaer (SEAT); 6 Gleason.

Points 1 Morbidelli, 72; 2 Comini, 70; 3 Belicchi, 59; 4 Oriola, 49; 5 Gleason, 45; 6 Jordi Gene, 38.

EUROFORMULA OPEN JEREZ (E), APRIL 11-12 RD 1/8

Rovera scores in first race

ALESSIO ROVERA AND KONSTANTIN Tereschenko shared the wins in a lively opening weekend.

DAV Racing-run Rovera mastered changeable conditions on Saturday. With a heavy shower instants before the start the Italian gambled on slicks and picked his way through the early carnage to move clear at two-thirds distance. Brazilian Vitor Baptista claimed a strong second ahead of Tanart Sathienthirakul, Team West-Tec's Thai driver having led much of the race before fading.

Sunshine on Sunday provided a more processional race, with Campos Racing's Tereschenko



FOTOSPEEDY

converting pole position into a well-controlled victory. Title favourites Yu Kanamaru and Yarin Stern completed the podium, with neither driver able to really challenge Russian Tereschenko.

● Ben Evans

RESULTS

Race 1 1 Alessio Rovera, 19 laps in 35m44.453s; 2 Vitor Baptista, +7.473s; 3 Tanart Sathienthirakul; 4 Yu Kanamaru; 5 William Barbosa; 6 Konstantin Tereschenko.

Race 2 1 Tereschenko, 18 laps in 30m13.729s; 2 Kanamaru, +2.505s; 3 Yarin Stern; 4 Dzhon Simonyan; 5 Baptista; 6 Rovera. **Points** 1 Tereschenko, 35; 2 Rovera, 33; 3 Kanamaru, 30; 4 Baptista, 29; 5 Sathienthirakul, 19; 6 Stern, 16.

FORMULA RENAULT NEC MONZA (I), APRIL 11-12 RD 1/7

Deletraz sins then wins

LOUIS DELETRAZ ATONED FOR A blunder in the opening race by taking victory on Sunday.

The Swiss stalled at the red lights for the opener, triggering an extra green-flag lap. Deletraz should have started at the rear of the grid, but instead took up his pole position slot, earning a drive-through penalty.

That left Josef Kaufmann Racing team-mate Kevin Jorg ahead of ART Junior Team's Ukyo Sasahara, the Japanese having a one-off outing before his Eurocup campaign. But when the two touched on the penultimate lap, leader Jorg suffered a rear puncture and

Sasahara ran out the winner from Ignazio D'Agosto (Manor MP Motorsport) and top rookie Max Defourny (Strakka Racing).

Deletraz made amends in race two once he had wrested the lead from Sasahara, while Valentin Hasse-Clot became the second Strakka driver to take a podium. He defended third from Jorg, who was then clouted by Callan O'Keeffe at the first chicane and dropped to ninth.

Of the Britons, Alex Gill fared best with a fifth in race two, with Colin Noble ninth in race one.

● David Addison

RESULTS

Race 1 1 Ukyo Sasahara, 12 laps in 22m10.576s; 2 Ignazio D'Agosto, +5.081s; 3 Max Defourny; 4 Darius Oskoui; 5 Callan O'Keeffe; 6 Dries Vanthoor. **Race 2** 1 Louis Deletraz, 14 laps in 25m39.337s; 2 Sasahara, +2.909s; 3 Valentin Hasse-Clot; 4 Jehan Daruvala; 5 Alex Gill; 6 Dennis Olsen. **Points** 1 Sasahara, 54; 2 Deletraz, 37; 3 Defourny, 33; 4 Daruvala, 30; 5 Olsen, 29; 6 Hasse-Clot, 28.



INDYCAR

NOLA (USA)

April 12

Round 2/15

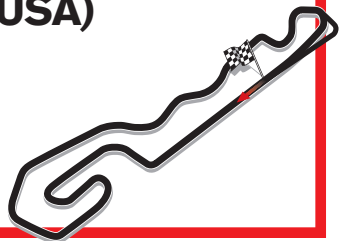

WEIRD THINGS HAPPEN IN NEW ORLEANS. IT'S been that way for centuries; a reputation built upon a foundation that includes voodoo, and that lives on today as the after-effects of one too many purple cocktails at a bar on Bourbon Street.

It's a place built upon folklore: a city where it was long considered bad luck to leave a building by any door other than the one you came in by; a city that is home to the mythical Rougarou, a sort of Cajun equivalent to a werewolf.

Another local tradition held that it was good luck to tie the wings of a butterfly to your right leg. That probably wasn't part of James Hinchcliffe's pre-race preparations ahead of last Sunday's inaugural IndyCar event at NOLA, but it might as well have been. It was a strange weekend that delivered a lot of strange outcomes. Helio Castroneves summed it up best. "Sometimes," he mused, "it's better to be lucky than good."

Any old voodoo charms relating to mastery of a race car on a wet track have been lost to the mists of time, but there was enough bald good fortune on display to suggest that some sort of supernatural powers were at work.

Hinchcliffe delivering a win for Schmidt in just his second race with the team after moving across from Andretti was the first surprise, not least because the Canadian had spent a good bit of the early part of the weekend spinning off the track. This will be a defining year for Hinchcliffe one way or the other: after an apprenticeship at Newman/Haas and a three-year spell at Andretti, his arrival at Schmidt heralds his elevation to a position of team leadership.

Schmidt is no match for the likes of Penske when it comes to resources, which makes the standard set by Hinchcliffe's predecessor Simon Pagenaud all the more daunting: in his three years with the team, the Frenchman never finished lower than fifth in the championship. Hinchcliffe is yet to finish higher than eighth in the standings, and there's a case to be made that he still has something to prove.

His win on Sunday was the fourth in his career, and if it wasn't the sort of drive that looks like an obvious precursor to a tilt at the championship, it

Hinchcliffe misjudges it to perfection

Canadian James Hinchcliffe won on just his second appearance with Schmidt thanks to a huge slice of Louisiana luck. By MARK GLENDENNING



was a just reward for a well-executed strategy.

Qualifying had been rained out, leaving the grid to be set by entrant points. Hinchcliffe's rough weekend at St Pete a fortnight ago left him starting 16th, and a rash of early yellows prompted the Schmidt team to start thinking creatively. They kept Hinchcliffe out during an early caution, pitted him on lap 13 to ditch the wet tyres he'd started on in favour of some soft-compound slicks – and then left him out there until the end of the race. On most days, this wouldn't have worked: if fuel mileage didn't get him, 34 laps on the soft tyres would.

But this wasn't most days. This was a day so incident-laden that the Louisiana fans who had come to experience IndyCar for the first time saw barely more than half an hour of green-flag time. As everyone around him made their later stops, Hinchcliffe kept cycling further and further towards the front of the pack. He emerged as race leader when the frontrunners on the more conventional strategies made their final visits to

the pits, and then produced a blinding restart to make sure he stayed there. A final late caution that prompted a finish under yellows afforded him the luxury of an easy coast to the flag.

Hindsight makes Hinchcliffe's one-stopper look like a masterstroke, but it was actually the product of a miscalculation. The race had started wet, and Hinchcliffe's crew was gambling on it staying that way for the afternoon. Instead, cars were changing to slicks after just a few laps.

"At first we did [the one-stopper] for weather, but the weather held off," Hinchcliffe said.

"At the end of the day it was actually yellows that saved us. At first I was cursing the yellows that were coming out because we needed green to get the gap to have a better shot at it when we did stop. But a one-stop strategy... who thought that was going to play out?"

If Hinchcliffe rode his luck a little in getting a break with the yellows, then Castroneves took the 'lucky rather than good' ethos to another level again to finish second. He'd been running up front with the rest of the Penskes early on before he had what he described as "some issues with a backmarker".

Pumping driver-speak into Google Translate converts that into 'I tried to pass Francesco Dragone on a restart and tore half of my front wing off'. Castroneves was forced to pit for repairs just a couple of laps after he'd made a scheduled stop, which threw him off-sequence and dropped him from third to 21st. But as with Hinchcliffe, the butterfly wings were working their magic: Castroneves had somehow stumbled upon a strategy that, with a bit of massaging, would keep him ahead of the earlier race leaders once they rejoined from their final servicing.

"In a very competitive field, when you go from third to 21st ... in normal conditions it's extremely difficult to come back," he said. "But

Simona de Silvestro equalled her best finish with fourth



ABBOTT/LAT



Hinchcliffe leads
Castroneves and Jakes
to yellow-flag finish

“It was yellows that saved us. A one-stop strategy... who thought that was going to play out?”

JAMES HINCHCLIFFE

with so many variables, we were back in the game with strategy and timing and yellows and things like that. Things that happen outside of our control. If you went with a prediction, [third] wouldn't be the way we would be finishing.”

It took a similar bit of freakish good fortune to get James Jakes onto the final podium spot, giving the SPM team a 1-3. The Brit, who returned to the series this year after a season on the sidelines, had started towards the back and was running in the lower midfield when he spun at the final corner on a restart and was forced to pit. As luck would have it, that forced move off-sequence was the biggest factor in his result.

“The guys in front had to stop one last time before the end of the race,” he said. “We didn't.”

It would be easy to look at all of this, consider the fact that Juan Pablo Montoya had comfortably controlled the first three-quarters of the race, and then wonder whether he felt short-changed at having nothing more than a fifth to show for it. But there was some New Orleans mojo at work there, too: 24 hours earlier he [and Castroneves] had been facing the prospect of starting from near the back after being shock casualties of the



Qualifying was rained off... but race did run

first elimination round in qualifying, only for qualifying to be binned altogether just a few minutes later due to the threat of lightning strikes. The average duration of a lightning bolt is 30 microseconds, and in that time, Montoya was propelled from the back few rows of the grid up to pole. The yellows might have conspired against him come race day, but he wasn't complaining.

“We did everything right,” he said. “We executed. We pushed when we needed to push. We took good points. We'll probably still lead in the championship, so it's good.”

One of sport's great clichés is that you make your own luck, and most of the time, the adage is intended as a testament to hard work. Montoya's good fortune in qualifying badly and then being handed pole anyway could be seen as a textbook example: it was the payoff for his great performance in St Pete. But in Sunday's race, the podium finishers earned their results by misreading the weather, crashing into a lapped car, and spinning on a restart. New Orleans is replete with ghost stories, and if they're even a tiny bit true, the spirits were clearly in a playful mood. ☼



Bourdais was wiped out in late shunt

BOURDAIS' CAR CRACKED

Sebastien Bourdais suffered a cracked tub in the three-car accident that eliminated the Frenchman along with Simon Pagenaud and Ryan Hunter-Reay. “It's a shame, because that was going to be my Indy 500 car,” Bourdais said.

HONDA AHEAD OF CHEVROLET

Honda leads Chevrolet 187 to 8 in the manufacturer standings, despite Chevrolet's early dominance of the timesheets. Chevrolet started the NOLA weekend with a negative score after being docked 220 points for engine repairs after St Petersburg.

DE SILVESTRO BACK TO FRONT

Simona de Silvestro capitalised on a similar pit strategy to James Jakes to climb from the rear of the grid to fourth place on Sunday. The Swiss driver is currently the only Andretti driver inside the top 10 in the points, although she is not currently scheduled to race again until the Indy 500.

KARAM'S HARSH LESSON

Ganassi development driver Sage Karam vowed to learn from a New Orleans race that was marred by several spins and mistakes. “I hate it for the team and my guys,” he said. “I learned a lot today and will go back and talk everything over with the team to get a game plan together on how we can improve.”

DOUBLE BLOW FOR FOYT DUO

NOLA was not a happy hunting ground for the AJ Foyt Racing team, whose drivers Jack Hawksworth and Takuma Sato were eliminated through accidents. Hawksworth hit the wall while trying to avoid the spinning James Jakes, and Sato suffered a broken wiring loom when he was hit by another car.

KANAAN CAPITALISES

The theme of drivers turning misfortune into results at NOLA extended down to Tony Kanaan's sixth place. The Brazilian was one of the first drivers to switch from wets to slicks but spun almost immediately on the wet track, forcing him to go off-sequence.



Kanaan (10) had a dramatic run to sixth

FOR FULL RESULTS, PAGE 58

ELMS

Silverstone (GB)

April 10-11

Round 1/5



Lancaster won by
just four tenths

Lancaster bombs his way to win

Some forceful driving that wasn't appreciated by a few of his fellow prototype runners gave Jon Lancaster his first sportscar win for the Greaves squad. **EDD STRAW** watched the action

TRISTAN GOMMENDY'S MISERABLE DEMEANOUR IN the post-race press conference said it all. Driving the red-and-black TDS Racing ORECA-Nissan 05 – the coupe LMP2 machine making its racing debut – he held the lead of the Silverstone 4 Hours with six minutes remaining. But there was a problem, for he had only taken left-side tyres at his final pitstop to preserve his lead and was under attack from Jon Lancaster, driving Greaves Motorsport's Gibson (the new name for Zytek)-Nissan 015S.

Gommendy lost momentum passing Aaron Scott's LM GTE-class Ferrari 458 Italia on the inside of The Loop, the slow left-hander leading to the curved-entry to the Wellington Straight. Lancaster, who had gone around the outside, carried more momentum and moved to the inside of Gommendy as they came through

the flat-out Aintree left-hander. Gommendy took the normal line and the front-right of Lancaster's Gibson glanced the rear of the ORECA, sending it into a spin. Lancaster lost momentum, but escaped with the lead, while Gommendy rejoined in third.

"It's a place where it is just impossible to overtake," said Gommendy. "It's not the spirit of endurance, and it's not my spirit. I was young like him, a few years ago. I won in F3, I won Macau, I did a pole position in Champ Car so I think I can drive quite fast but I never did that. If you are a good driver, you don't have to do that."

Lancaster was unrepentant. Given that it was the closing stages and victory was at stake, you can't blame him and, thanks to the television director bafflingly cutting away from the lead battle, it's difficult to make a definitive judgment on the move. But the bottom line is that the stewards looked at it and took no action.

"The rules now, as far as I am aware, in an FIA championship is if the car gets alongside even by the back wheel you have to leave a car's width, you can't take the apex," said Lancaster. "As we came out of the hairpin, we had just passed the GT car and he had a slow exit anyway with a lot of wheelspin, leaving two black lines on the track, and I had a really good exit.

"It was either back off and lose momentum or pull alongside. I got halfway down, he left a little bit of room but it wasn't enough and I grazed the red humps in the kerb. I literally grazed the back of him, it was that light a touch. It was an avoidable incident on his part and if he'd

It was an avoidable incident. If he'd left more room, we'd have gone down the straight side by side

JON LANCASTER

left a little bit more room, I wouldn't have gone past and we'd have gone down the next straight side by side."

Gommendy wasn't the only one with some harsh words for Lancaster. Harry Tincknell, who moved up to second after the incident and harried Lancaster to the finish, ending up just 0.370s behind at the chequered flag, was also unimpressed.

Tincknell had been in the thick of the battle for victory as he dived for second with Lancaster while both reeled in Gommendy, only to spin at Becketts with just under 13 minutes remaining. The Jota Sport Gibson-Nissan driver had, a lap earlier, taken second place around the outside of Lancaster, who had been blocked by a pair of GT cars at The Loop. But with Gommendy just a few car lengths ahead, Tincknell encountered Adam Carroll in the GTE LM class-winning Porsche 911

The TDS Racing
ORECA leads





Lancaster celebrates first sports car win



TDS Racing BMW prevailed in GTC



Unimpressed Tincknell and Gommendy flank the winners



The Gulf Porsche took LM GTE victory

RSR at Copse. Tincknell had to check, which allowed Lancaster to have a run.

Lancaster had the outside line into the right-hander at Becketts, and was just ahead. Tincknell attempted to hang on on the inside line, but clobbered the kerb and spun. But that wasn't the incident he was annoyed about – instead, it was an earlier clash with Lancaster.

“We were catching Tristan pretty fast and I managed to make a nice move around the outside of Jon at the new complex,” said Tincknell. “When I spun, the GT car was slower than I expected parked on the apex, which meant Jon got the run. I ended up spinning and that was fairly fair. But [earlier] going around Turn 1 I was shoved wide. I think the boos on the podium sort of summed up

the feeling [towards Lancaster].”

But while Lancaster was unpopular with both the second and third-placed crews, his performance level was impressive. Having taken pole position, he was key to Greaves Motorsport taking its first victory since the ELMS round at Silverstone in September 2011. Silver-rated driver Gary Hirsch took the start and did a superb job during his double stint, leading before being passed by Filipe Albuquerque in the Jota car. Bjorn Wirdheim took over and consolidated the team's position, extending its lead over the Jota Gibson while Simon Dolan was at the wheel. But a caution period with 90 minutes remaining set up the grandstand finish, with all three of the frontrunning teams having their fastest drivers



Robertson/Hoy won inaugural LMP3 race

LMP3

Baby prototypes make their debut

NISSAN-BACKED CHRIS HOY'S MAIDEN VICTORY IN motorsport inevitably grabbed the headlines, but in the grander scheme of things the debut of the new baby prototype LMP3 class is potentially more significant than the success of the cycling legend-turned-racer.

The new category is an open-chassis formula, with all cars powered by the NISMO-prepped five-litre Nissan VK50VE powerplant and using an ORECA gearbox. But at Silverstone, the five entries were all for the new Ginetta thanks to a Herculean effort by Lawrence Tomlinson's Yorkshire-based manufacturer to build up the new cars, several of which were only delivered on the eve of the Silverstone weekend.

Considering how undercooked the cars were, the pace was promising. Charlie Robertson, sharing with Hoy, claimed class pole with a lap 11.140s off Jon Lancaster's LMP2 fastest qualifying time. This was just enough to put it ahead of the leading LM GTE car by 0.259s.

Impressively, four of the five cars were classified finishers, with only the Lanar Racing

example driven by Alex Craven, Joey Foster, and Charlie Hollings, which was delivered on the eve of the event, not making the finish.

Robertson laid the foundations for the #3 Team LNT-run car's victory over the sister machine driven by Michael Simpson and Gaetan Paletou, the latest winner of the European Nissan GT Academy, with his strong stints early in the race. Hoy was not as quick, as you would expect for the cycling legend who is still early in his racing career, but he was quick enough despite a couple of spins to allow Robertson to close out victory.

“It ran faultlessly all weekend,” said Robertson of the car, which had just two days of testing under its belt. “There's still some work to be done like with any new project, but it was just brilliant. To do a constant four hours without any long-run testing is just fantastic.”

With more cars on the horizon – and not just from Ginetta, as Ligier's machine is set to arrive later in the season – it will be fascinating to see how the class grows over the next 12 months.

in the car for the run-in, the TDS car having remained in contention thanks to a good opening stint from Pierre Thiriet and Ludo Badey's solid middle stint (despite a spin).

Fourth place was taken by the Krohn Racing squad's Ligier-Judd JSP2, making its European debut with Tracy Krohn, Nic Jonsson and Oswald Negri Jr – contesting his first race in the UK since contesting the 1992 British Formula 3 Championship. But this was only after the AF Corse ORECA 03 – the previous-specification, open-topped machine – ended up in the gravel with a puncture with 20 minutes remaining with Maurizio Mediani at the wheel.

With Charlie Robertson and Chris Hoy taking victory in the new LMP3 class (see above), the Gulf Racing Porsche of Carroll, Phil Keen and Mike Wainwright won LM GTE. After a strong start by Keen, the car moved into the lead of the class when Rui Aguas's AF Corse Ferrari went off after a collision with the Krohn Ligier and stayed there. There was a dicey moment under the safety car when Wainwright's lead was cut to almost nothing, only for him to be waved past and handed a 90-second lead.

In the poorly supported GTC class for GT3-spec machinery, Franck Perera, Dino Lunardi and Eric Dermont won for TDS Racing in their BMW Z4 GT3. Only five cars contested the race thanks to Thomas Flohr spinning his Ferrari out of the race at the rolling start.

FOR FULL RESULTS, PAGE 58



25 – 28 JUNE

For the latest event news follow us on [facebook](#) and [twitter](#) 

Admission strictly by advance ticket only • For hospitality or tickets please call: +44 (0)1243 755055 or visit

www.goodwood.com/tickets



Johnson took his second win of season

NASCAR SPRINT CUP TEXAS MOTOR SPEEDWAY (USA), APRIL 11 RD 7/36

Johnson relights his fire with Texas win

COMING OFF THE BACK OF A VERY disappointing race at Martinsville, where he has eight wins, multiple champ Jimmie Johnson rebounded perfectly to take a brilliant victory at Texas Motor Speedway.

It was a return to some sort of normality at Fort Worth, where both the Hendrick Motorsports Chevrolet team and Johnson have performed brilliantly in the past.

Johnson took the lead at the halfway point and managed to hold onto it consistently, until a few late shake-ups, coupled with a final caution during which multiple drivers gambled on saving time by taking just two tyres at the pitstops.

Coming off the final caution it came down to a three-way tussle, as

Johnson, Kevin Harvick and Dale Earnhardt Jr – with fresh rubber all round – made their way past the two-new-tyre cars and to the front. It was Johnson who made a break for the lead, while Harvick spent a few costly laps battling with Earnhardt.

Once Harvick had shaken off NASCAR's prodigal son, he began to close down the leading car of Johnson in the last five laps, but to no avail as he ended up scraping the wall, and only narrowly holding off Earnhardt to finish second.

Earnhardt had enjoyed one of the quickest cars all day, despite missing out on the second segment of qualifying on Friday, lining up 25th. A loose wheel early on forced him to pit twice and dropped him to

the back of the pack, but his car was strong enough to fight back through the field.

RESULTS

1 Jimmie Johnson (Chevrolet SS), 334 laps in 3h33m57s; 2 Kevin Harvick (Chevy), +1.107s; 3 Dale Earnhardt Jr (Chevy); 4 Joey Logano (Ford Fusion); 5 Brad Keselowski (Ford); 6 Jamie McMurray (Chevy); 7 Jeff Gordon (Chevy); 8 Kasey Kahne (Chevy); 9 Martin Truex Jr (Chevy); 10 Carl Edwards (Toyota Camry).

Chase grid 1 Harvick, 2 wins/306 points: 2 Johnson, 2/216; 3 Logano, 1/280; 4 Keselowski, 1/246; 5 Denny Hamlin, 1/205; 6 Truex, 0/266; 7 Kahne, 0/230; 8 Earnhardt, 0/213; 9 Aric Almirola, 0/195; 10 David Ragan, 0/194; 11 McMurray, 0/193; 12 Matt Kenseth, 0/189; 13 Gordon, 0/186; 14 Edwards, 0/182; 15 Casey Mears, 0/178; 16 Paul Menard, 0/177.

**FORMULA RENAULT ALPS
IMOLA (I), APRIL 11-12 RD 1/7**

Aitken off to a flying start in ALPS

JACK AITKEN COULDN'T QUITE PROVE a match for Anthoine Hubert in the first race at Imola, but he managed to turn the tables in the second.

Frenchman Hubert was only contesting this round as a 'wildcard' warm-up for the Formula Renault Eurocup. He planted his Tech 1 Racing car on pole position, and in the race proved just out of reach of Koiranen GP's two British hopes, Aitken and Jake Hughes.

It looked as though the race had settled, but with just a few laps remaining Hughes got a wheel on the kerb at Acque Minerali and spun into the gravel, promoting another Tech 1 Frenchman, Simon Gachet, into the final podium place.

Ben Barnicoat, also contesting this event as a wildcard, had a quiet start to the race in seventh place behind the duelling Hugo de



Aitken (right) holds off Hubert at start

Sadeleer. This scrap proved rather fraught and both de Sadeleer and Isaakyan dropped back as a result, with Barnicoat slicing his way through to fourth in his Fortec Motorsport machine.

Aitken grabbed pole for the second race from Hubert, and this proved decisive as he was able to pull away during the opening laps to open his ALPS winning account.

Hughes qualified a disappointed fifth, but he was able to jump ahead of Stefan Riener at the start before hunting down Fortec-run Croatian Martin Kodric, who had qualified third. The Brummie finally made it through with an outside lunge into

Tamburello, by which time the leading duo were too far ahead.

Kodric took fourth, with reigning Renault NEC champion Barnicoat reaching the flag in fifth and Riener taking sixth – good enough to give the German second in the points.

RESULTS

Race 1 1 Anthoine Hubert, 16 laps in 27m34.409s; 2 Jack Aitken, +1.930s; 3 Simon Gachet; 4 Ben Barnicoat; 5 Stefan Riener; 6 Martin Kodric. **Race 2 1 Aitken**, 16 laps in 27m34.029s; 2 Hubert, +3.892s; 3 Jake Hughes; 4 Kodric; 5 Barnicoat; 6 Riener. **Points 1 Aitken, 50**; 2 Riener, 33; 3 Hughes, 18; 4 Matevos Isaakyan, 18; 5 Thiago Vivacqua, 15; 6 Matteo Ferrer, 14.



NURBURGRING 24 HOUR QUALIFICATION RACE

The Schubert BMW team took honours after the Haribo Mercedes of Maxi Gotz stopped with front-axle failure with 15 minutes of the six-hour race remaining. That left the BMW Z4 of Dominik Baumann, Claudia Hurlgen, Jens Klingmann and Martin Tomczyk to take the win from the Manthey Porsche of Porsche juniors Sven Muller and Matteo Cairoli, with Christoph Breuer.

PRO MAZDA

Uruguayan ex-GP3 racer Santiago Urrutia made light of treacherous conditions early on Sunday morning at NOLA Motorsports Park to win a race that was delayed from a day earlier due to thunderstorms in his Team Pelfrey car. Malaysian Weiron Tan shadowed him home in second. Race two was cancelled due to worsening weather.

USF2000

Frenchman Nico Jamin won the first race at NOLA Motorsports Park, held in dry conditions on Saturday. On Sunday in the wet, the Cape Motorsports with Wayne Taylor Racing driver chased home Brazilian Victor Franzoni (Afterburner Autosport). Jake Eidson still leads the championship after a pair of thirds.

NZ SUPERTOURERS

Simon Evans, older brother of GP2 race winner Mitch, has won New Zealand's SuperTourers championship twice over. The cancellation of the scheduled final round at Pukekohe officially made the points leader champion, and when some decided to race anyway he scored enough extra points in his Holden Commodore to be unofficial champion too.

NASCAR XFINITY

Teenager Erik Jones scored his first win in NASCAR's second-tier series when his Joe Gibbs Toyota held off the duelling Brad Keselowski and Dale Earnhardt Jr at Texas Motor Speedway. Fourth place went to Regan Smith ahead of Austin Dillon.

ASIAN CARRERA CUP

Craig Baird pipped fellow Kiwi Chris van der Drift and Martin Ragginger in the first of the Chinese GP support races. Ho-Pin Tung triumphed in race two from Rodolfo Avila and Austrian Ragginger.

LAMBO SUPER TROFEO

Patrick Kujala made a successful switch from GP3 to sportscars, the Finn taking a double win at Monza. He won the first race from Italian pair Fabrizio Crestani and Sergio Campana, while the runner-up spot in race two went to Daniel Zampieri and Roman Mavlanov.

RESULTS ROUND-UP

WORLD ENDURANCE CHAMPIONSHIP

ROUND 1/8, SILVERSTONE, APRIL 12 (201 LAPS – 737.008 MILES)

Pos	Driver	Time
1	Benoit Treluyer (F)/Marcel Fassler (CH)/Andre Lotterer (D) Audi Sport Team Joest Audi R18 e-tron quattro (LMP1)	6h00m30.876s
2	Romain Dumas (F)/Neel Jani (CH)/Marc Lieb (D) Porsche Team Porsche 919 Hybrid (LMP1)	+4.610s
3	Sebastien Buemi (CH)/Anthony Davidson (GB)/Kazuki Nakajima (J) Toyota Racing TSO40 HYBRID (LMP1)	+14.816s
4	Alexander Wurz (A)/Stephane Sarrazin (F)/Mike Conway (GB) Toyota Racing TSO40 HYBRID (LMP1)	-1 lap
5	Lucas di Grassi (BR)/Loic Duval (F)/Oliver Jarvis (GB) Audi Sport Team Joest Audi R18 e-tron quattro (LMP1)	-4 laps
6	Sam Bird (GB)/Roman Rusinov (RUS)/Julien Canal (F) G-Drive Racing (OAK) Ligier-Nissan JSP2 (LMP2)	-16 laps
7	Pipo Derani (BR)/Gustavo Yacamán (CO)/Ricardo Gonzalez (MEX) G-Drive Racing (OAK) Ligier-Nissan JSP2 (LMP2)	-17 laps
8	Danny Watts (GB)/Nick Leventis (GB)/Jonny Kane (GB) Strakka Racing Dome-Nissan S103 (LMP2)	-23 laps
9	Gianmaria Bruni (I)/Toni Vilander (FIN) AF Corse Ferrari 458 Italia (GTE Pro)	-29 laps
10	Richard Lietz (A)/Michael Christensen (DK) Porsche Team Manthey Porsche 911 RSR (GTE Pro)	-29 laps
11	James Calado (GB)/Davide Rigon (I) AF Corse Ferrari 458 Italia (GTE Pro)	-29 laps
12	Nicki Thiim (DK)/Christoffer Nygaard (DK)/Marco Sorensen (DK) Aston Martin Racing Aston Martin Vantage V8 (GTE Pro)	-30 laps
13	Darren Turner (GB)/Stefan Mucke (D) Aston Martin Racing Aston Martin Vantage V8 (GTE Pro)	-30 laps
14	Richie Stanaway (NZ)/Alex MacDowall (GB)/Fernando Rees (BR) Aston Martin Racing Aston Martin Vantage V8 (GTE Pro)	-30 laps
15	Patrick Pilet (F)/Frederic Makowiecki (F) Porsche Team Manthey Porsche 911 RSR (GTE Pro)	-31 laps
16	Pedro Lamy (P)/Paul dalla Lana (CDN)/Mathias Lauda (A) Aston Martin Racing Aston Martin Vantage V8 (GTE Am)	-33 laps
17	Emmanuel Collard (F)/Francois Perrodo (F)/Rui Aguas (P) AF Corse Ferrari 458 Italia (GTE Am)	-33 laps
18	Viktor Shaitar (RUS)/Andrea Bertolini (I)/Alexey Basov (RUS) SMP Racing (AF) Ferrari 458 Italia (GTE Am)	-33 laps
19	Mark Tandy (GB)/Matt Howson (GB)/Richard Bradley (GB) KCMG ORECA-Nissan 05 (LMP2)	-34 laps
20	Stuart Hall (GB)/Francesco Castellacci (I)/Roald Goethe (D) Aston Martin Racing Aston Martin Vantage V8 (GTE Am)	-35 laps
21	Klaus Bachler (A)/Christian Ried (D)/Khaled Al Qubaisi (UAE) Abu Dhabi-Proton Racing Porsche 911 RSR (GTE Am)	-35 laps
22	Jacques Nicolet (F)/Jean-Marc Merlin (F)/Erik Maris (F) OAK Racing Ligier-Nissan JSP2 (LMP2)	-36 laps
23	Patrick Long (USA)/Patrick Dempsey (USA)/Marco Seefried (D) Dempsey Racing-Proton Porsche 911 RSR (GTE Am)	-36 laps
24	Jon Fogarty (USA)/Ed Brown (USA)/David Brabham (AUS) Extreme Speed Motorsports HPD-Honda ARX-03b (LMP2)	-36 laps
25	Paolo Ruberti (I)/Gianluca Roda (I)/Kristian Poulsen (DK) Larber Competition Chevrolet Corvette C7.R (GTE Am)	-41 laps
R	Vitantonio Iuizzi (I)/Simon Trummer (CH)/Christian Klien (A) Team ByKolles CLM-AER P1/01 (LMP1)	116 laps-water leak/engine
R	Mark Webber (AUS)/Timo Bernhard (D)/Brendon Hartley (NZ) Porsche Team Porsche 919 Hybrid (LMP1)	44 laps-gearbox
R	Paul-Loup Chatin (F)/Nelson Panciatici (F)/Vincent Capillaire (F) Signatech Alpine ORECA-Nissan 03R (LMP2)	20 laps-lost wheel/accident
EX	Ryan Dalziel (GB)/Scott Sharp (USA)/David Heinemeier Hansson (DK) Extreme Speed Motorsports HPD-Honda ARX-03b (LMP2)	-18 laps

In each car, first-named driver started the race.

Winners' average speed 122.659mph

Fastest lap Treluyer, 1m40.836s, 130.907mph.

LMP2 Bird, 1m50.045s, 119.952mph.

GTE Pro Thiim, 2m01.054s, 109.043mph.

GTE Am Lamy, 2m02.026s, 108.175mph.

QUALIFYING

Pos	Driver	Time	Pos	Driver	Time
1	Hartley	1m39.534s	Webber	1m39.908s	1m39.721s
2	Jani	1m39.974s	Dumas	1m40.706s	1m40.340s
3	di Grassi	1m40.180s	Jarvis	1m40.525s	1m40.352s
4	Nakajima	1m40.361s	Davidson	1m40.403s	1m40.382s
5	Lotterer	1m40.201s	Fassler	1m42.105s	1m41.153s
6	Conway	1m41.399s	Sarrazin	1m41.990s	1m41.694s
7	Derani	1m47.090s	Gonzalez	1m48.952s	1m48.021s
8	Bird	1m47.337s	Canal	1m48.829s	1m48.083s
9	Tandy	1m49.086s	Howson	1m49.692s	1m49.389s
10	Chatin	1m48.438s	Capillaire	1m50.559s	1m49.498s
11	Iuizzi	1m49.967s	Trummer	1m51.278s	1m50.622s
12	Dalziel	1m51.481s	H Hansson	1m51.622s	1m51.551s
13	Watts	1m49.814s	Leventis	1m54.755s	1m52.284s
14	Nicolet	1m53.167s	Merlin	1m53.748s	1m53.457s
15	Fogarty	1m50.692s	Brown	2m00.290s	1m55.491s
16	Thiim	1m59.861s	Sorensen	2m00.079s	1m59.970s
17	Rees	2m00.019s	Stanaway	2m00.332s	2m00.175s
18	Turner	2m00.268s	Mucke	2m00.398s	2m00.333s
19	Lietz	2m00.390s	Christensen	2m00.913s	2m00.651s
20	Bruni	2m00.237s	Vilander	2m01.166s	2m00.701s
21	Makowiecki	2m01.502s	Pilet	2m01.681s	2m01.591s
22	Lamy	2m00.956s	dalla Lana	2m03.041s	2m01.998s
23	Rigon	2m01.402s	Calado	2m02.911s	2m02.156s
24	Ruberti	2m02.529s	Roda	2m03.346s	2m02.937s
25	Bachler	2m01.125s	Al Qubaisi	2m05.144s	2m03.134s
26	Collard	2m01.451s	Perrodo	2m05.513s	2m03.482s
27	Shaitar	2m02.246s	Basov	2m05.982s	2m04.114s
28	Hall	2m01.569s	Goethe	2m08.532s	2m05.050s
29	Long	2m02.231s	Dempsey	2m09.552s	2m06.024s

In each car, the two qualifying drivers are listed with their times, followed by their grid-deciding average.

CHAMPIONSHIP

LMP drivers 1 Lotterer/Treluyer/Fassler, 25; 2 Lieb/Jani/Dumas, 18; 3 Davidson/Nakajima/Buemi, 15; 4 Wurz/Conway/Sarrazin, 12; 5 di Grassi/Duval/Jarvis, 10; 6 Canal/Rusinov/Bird, 8. **LMP manufacturers** 1 Audi, 35; 2 Toyota, 27; 3 Porsche, 19. **LMP2 drivers** 1 Rusinov/Canal/Bird, 25; 2 Yacamán/Derani/Gonzalez, 19; 3 Sharp/Dalziel/Heinemeier Hansson, 15; 4 Watts/Kane/Leventis, 12. **GTE drivers** 1 Bruni/Vilander, 25; 2 Christensen/Lietz, 18; 3 Rigon/Calado, 15; 4 Nygaard/Sorensen/Thiim, 13; 5 Turner/Mucke, 10; 6 MacDowall/Rees/Stanaway, 8. **GTE manufacturers** 1 Ferrari, 40; 2 Porsche, 24; 3 Aston Martin, 23. **GTE Am drivers** 1 Lamy/Lauda/dalla Lana, 26; 2 Collard/Perrodo/Aguas, 18; 3 Bertolini/Basov/Shaitar, 15; 4 Castellacci/Hall/Goethe, 12.



ROBERTSON/GETTY

EUROPEAN LE MANS SERIES

ROUND 1/5, SILVERSTONE, APRIL 11

118 LAPS – 432.671 MILES

Pos	Driver	Time
1	Gary Hirsch (CH)/Bjorn Wirdheim (S)/Jon Lancaster (GB) Greaves Motorsport Gibson-Nissan 015S (LMP2)	4h01m15.279s
2	Filipe Albuquerque (P)/Simon Dolan (GB)/Harry Tincknell (GB) Jota Sport Gibson-Nissan 015S (LMP2)	+0.370s
3	Pierre Thiriet (F)/Ludovic Badey (F)/Tristan Gommendy (F) Thiriet by TDS Racing ORECA-Nissan 05 (LMP2)	+20.063s
4	Oswaldo Negri (BR)/Tracy Krohn (USA)/Nic Jonsson (S) Krohn Racing Ligier-Judd JSP2 (LMP2)	-1 lap
5	Pieter de Bruijn (NL)/Pu Jun Jin (PRC) Eurasia Motorsport ORECA-Nissan 03R (LMP2)	-2 laps
6	Nicolas Minassian (F)/Maurizio Mediani (I)/David Markozov (RUS) AF Corse ORECA-Nissan 03 (LMP2)	-4 laps
7	Ivan Bellarosa (I)/Pierre Perret (F)/Jose Ibanez (F) Ibanez Racing ORECA-Nissan 03 (LMP2)	-4 laps
8	Phil Keen (GB)/Michael Wainwright (GB)/Adam Carroll (GB) Gulf Racing UK Porsche 911 RSR (GTE)	-8 laps
9	Rob Smith (GB)/George Richardson (GB)/Sam Tordoff (GB) JMW Motorsport Ferrari 458 Italia (GTE)	-9 laps
10	Aaron Scott (GB)/Duncan Cameron (GB)/Matt Griffin (IRL) AF Corse Ferrari 458 Italia (GTE)	-9 laps
11	Henry Hassid (F)/Andy Priaulx (GB)/Jesse Krohn (FIN) BMW Team MRC VDS BMW Z4 (GTE)	-9 laps
12	Christian Ried (D)/Klaus Bachler (A)/Khaled Al Qubaisi (UAE) Proton Competition Porsche 911 RSR (GTE)	-9 laps
13	Johnny Laursen (DK)/Mikkel Mac (DK)/Andrea Rizzoli (I) Formula Racing Ferrari 458 Italia (GTE)	-9 laps
14	Eric Dermont (F)/Franck Perera (F)/Dino Lunardi (F) TDS Racing BMW Z4 GT3 (GTC)	-10 laps
15	Alexander Talkanitsa Jr (BY)/Alexander Talkanitsa (BY)/Alessandro Pier Guidi (I) AT Racing Ferrari 458 Italia (GTE)	-11 laps
16	Charlie Robertson (GB)/Chris Hoy (GB) Team LNT Ginetta-Nissan (LMP3)	-11 laps
17	Mike Simpson (GB)/Gaetan Paletou (F) Team LNT Ginetta-Nissan (LMP3)	-12 laps
18	Mads Rasmussen (DK)/Felipe Barreiros (P)/Francisco Guedes (P) AF Corse Ferrari 458 Italia GT3 (GTC)	-12 laps
19	Kirill Ladygin (RUS)/Mikhail Aleshin (RUS)/Anton Ladygin (RUS) AF Corse ORECA-Nissan 03 (LMP2)	-13 laps
20	Rob Garofall (GB)/Jens Petersen (D) University of Bolton Ginetta-Nissan (LMP3)	-13 laps
21	Konstantins Calko (LV)/Jesús Fuster (E)/Dainius Matijaisaitis (LT) SVK by Speed Factory Ginetta-Nissan (LMP3)	-16 laps
22	Dan Brown (GB)/Roald Goethe (D)/Archie Hamilton (GB) Gulf Racing UK Lamborghini Gallardo LP560 GT3 (GTC)	-26 laps
R	Michele la Rosa (I)/Yutaka Yamagishi (I) Ibanez Racing ORECA-Nissan 03 (LMP2)	99 laps-brakes/accident
R	Michael Lyons (GB)/Nathanael Berthon (F)/Mark Patterson (USA) Murphy Prototypes ORECA-Nissan 03R (LMP2)	83 laps-electrical
R	Ilya Melnikov (RUS)/Giorgio Roda (I)/Marco Cioci (I) AF Corse Ferrari 458 Italia GT3 (GTC)	67 laps-accident damage
R	Casper Elgaard (DK)/Simon Moller (DK)/Kristian Poulsen (DK) Massive Motorsport Aston Martin Vantage GT3 (GTC)	65 laps-accident
R	Jonathan Coleman (GB)/Leo Roussel (F)/David Cheng (PRC) Pegasus Racing Morgan-Nissan (LMP2)	64 laps-accident damage
R	Charlie Hollings (GB)/Alex Craven (GB)/Joey Foster (GB) Lanan Racing Ginetta-Nissan (LMP3)	52 laps-engine
R	Matteo Cressoni (I)/Peter Mann (USA)/Raffaele Giammaria (I) AF Corse Ferrari 458 Italia (GTE)	35 laps-collision
R	Rui Aguas (P)/Steve Wyatt (AUS)/Michele Rugolo (I) AF Corse Ferrari 458 Italia (GTE)	32 laps-collision
R	Thomas Flohr (CH)/Francesco Castellacci (I)/Stuart Hall (GB) AF Corse Ferrari 458 Italia GT3 (GTC)	0 laps-spin

In each car, first-named driver started the race.

Winners' average speed 107.605mph.

FASTEST LAP Tincknell, 1m50.405s, 119.561mph; **LMP3** Robertson, 2m01.214s, 108.899mph; **GTE** Griffin, 2m01.772s, 108.400mph; **GTC** Perera, 2m03.594s, 106.802mph.

GRID 1 Lancaster, 1m48.752s; 2 Tincknell, 1m49.212s; 3 Gommendy, 1m49.353s; 4 Aleshin, 1m49.486s; 5 Berthon, 1m49.681s; 6 de Bruijn, 1m50.216s; 7 Roussel, 1m50.757s; 8 Bellarosa, 1m51.418s; 9 Minassian, 1m52.020s; 10 la Rosa, 1m53.096s; 11 T Krohn, 1m55.589s; 12 Rugolo, 2m00.051s; 13 Bachler, 2m00.269s; 14 Pier Guidi, 2m00.478s; 15 Priaulx, 2m00.480s; 16 Carroll, 2m00.641s; 17 Tordoff, 2m00.997s; 18 Griffin, 2m01.110s; 19 Giammaria, 2m01.336s; 20 Mac, 2m01.437s; 21 Perera, 2m01.939s; 22 Foster, 2m02.045s; 23 Garofall, 2m02.686s; 24 Cioci, 2m03.002s; 25 Castellacci, 2m03.298s; 26 Guedes, 2m03.564s; 27 Elgaard, 2m04.046s; 28 Brown, 2m04.596s; 29 Calko, 2m06.697s; 30 Simpson, 2m00.457s; 31 Robertson, 1m59.892s*. * = excluded from qualifying. In each car, the driver setting the fastest qualifying time is listed.

CHAMPIONSHIP

LMP2 1 Wirdheim/Lancaster/Hirsch, 26; 2 Tincknell/Dolan/Albuquerque, 18; 3 Gommendy/Badey/Thiriet, 15; 4 Negri/Krohn/Jonsson, 12; 5 de Bruijn/Pu, 10; 6 Markozov/Mediani/Minassian, 8. **LMP3** 1 Hoy/Robertson, 25; 2 Paletou/Simpson, 18; 3 Garofall/Petersen, 15. **GTE** 1 Keen/Carroll/Wainwright, 25; 2 Richardson/Smith/Tordoff, 18; 3 Cameron/Griffin/Scott, 15. **GTC** 1 Perera/Lunardi/Dermont, 26; 2 Rasmussen/Barreiros/Guedes, 18; 3 Hamilton/Brown/Goethe, 15.

Menezes (back), Iltot and co do F3 battle



Hinchcliffe celebrates his IndyCar success



RESULTS BY FORIX

FORMULA 3 EUROPEAN CHAMPIONSHIP

ROUND 1/11 SILVERSTONE, APRIL 11-12
RACE 1 (15 LAPS – 55.001 MILES)

- 1 **Felix Rosenqvist** (S) Prema Powerteam Dallara-Mercedes F315 **36m44.906s** +0.938s
 - 2 Antonio Giovinazzi (I) Carlin Dallara-VW F315 +2.681s
 - 3 Jake Dennis (GB) Prema Powerteam Dallara-Mercedes F315 +4.767s
 - 4 Alexander Albon (T) Signature Dallara-VW F315 +5.229s
 - 5 Markus Pommer (D) Motopark Dallara-VW F315 +6.175s
 - 6 Lance Stroll (CDN) Prema Powerteam Dallara-Mercedes F315 +6.934s
 - 7 Gustavo Menezes (USA) Carlin Dallara-VW F312 +7.470s
 - 8 George Russell (GB) Carlin Dallara-VW F312 +7.897s
 - 9 Maximilian Gunther (D) Mücke Motorsport Dallara-Mercedes F312 +8.531s
 - 10 Callum Iltott (GB) Carlin Dallara-VW F312 +9.886s
 - 11 Pietro Fittipaldi (BR) Fortec Motorsport Dallara-Mercedes F312 +10.282s
 - 12 Charles Leclerc (MC) Van Amersfoort Racing Dallara-VW F314 +12.464s
 - 13 Mikkel Jensen (DK) Mücke Motorsport Dallara-Mercedes F312 +13.147s
 - 14 Nicolas Beer (DK) EuroInternational Dallara-Mercedes F312 +14.060s
 - 15 Nabil Jeffri (MAL) Motopark Dallara-VW F314 +14.915s
 - 16 Fabian Schiller (D) Team West-Tec Dallara-Mercedes F312 +15.486s
 - 17 Sergio Sette Camara (BR) Motopark Dallara-VW F314 +15.884s
 - 18 Santino Ferrucci (USA) Mücke Motorsport Dallara-Mercedes F312 +17.549s
 - 19 Raoul Hyman (ZA) Team West-Tec Dallara-Mercedes F314 +17.939s
 - 20 Tatiana Calderon (CO) Carlin Dallara-VW F312 +18.687s
 - 21 Dorian Boccia (F) Signature Dallara-VW F314 +19.510s
 - 22 Sam MacLeod (GB) Motopark Dallara-VW F315 +20.021s
 - 23 Cao Hong Wei (PRC) Fortec Motorsport Dallara-Mercedes F312 +20.304s
 - 24 Michele Beretta (I) Mücke Motorsport Dallara-Mercedes F312 +22.949s
 - 25 Matt Solomon (PRC) Double R Racing Dallara-Mercedes F313 +28.887s
 - 26 Mahaveer Raghunathan (IND) Motopark Dallara-VW F314 +30.780s
 - 27 Nicolas Pohler (D) Double R Racing Dallara-Mercedes F313 +33.168s
 - 28 Julio Moreno (EC) T-Sport Dallara-NBE F312 -4 laps
 - NC Kang Ling (PRC) Mücke Motorsport Dallara-Mercedes F312 -5 laps
 - NC Li Zhi Cong (PRC) Fortec Motorsport Dallara-Mercedes F312 8 laps-off in gravel
 - R Arjun Maini (IND) Van Amersfoort Racing Dallara-VW F312 6 laps-acc damage
 - R Ryan Tveiter (USA) Carlin Dallara-VW F312 5 laps-acc damage
 - R Brandon Maisano (F) Prema Powerteam Dallara-Mercedes F312 1 lap-spun
 - R Matt Rao (GB) Fortec Motorsport Dallara-Mercedes F313 1 lap-accident
- Winner's average speed** 89.801mph
Fastest lap Rosenqvist, 1m52.372s, 117.468mph.

- QUALIFYING 1** 1 Rosenqvist, 1m51.007s; 2 Giovinazzi, 1m51.274s; 3 Dennis, 1m51.332s; 4 Russell, 1m51.652s; 5 Leclerc, 1m51.685s; 6 Maisano, 1m51.768s; 7 Albon, 1m51.792s; 8 Stroll, 1m52.066s; 9 Pommer, 1m52.113s; 10 Iltott, 1m52.113s; 11 Gunther, 1m52.294s; 12 Tveiter, 1m52.309s; 13 Menezes, 1m52.324s; 14 Beer, 1m52.352s; 15 Jeffri, 1m52.374s; 16 Maini, 1m52.426s; 17 Fittipaldi, 1m52.443s; 18 Sette Camara, 1m52.446s; 19 Schiller, 1m52.486s; 20 Boccia, 1m52.490s; 21 Lorandi, 1m52.496s; 22 Hyman, 1m52.543s; 23 Jensen, 1m52.543s; 24 Calderon, 1m52.798s; 25 Ferrucci, 1m52.849s; 26 Cao, 1m52.901s; 27 Moreno, 1m52.938s; 28 Solomon, 1m53.039s; 29 Beretta, 1m53.073s; 30 Ling, 1m53.198s; 31 Rao, 1m53.251s; 32 Li, 1m53.305s; 33 Pohler, 1m53.705s; 34 Raghunathan, 1m53.874s; 35 MacLeod, 1m52.879s*.
* = grid penalty.

RACE 2 (18 LAPS – 66.001 MILES)

- 1 **Russell**, 36m33.460s; 2 Leclerc, +1.723s; 3 Giovinazzi, +5.412s; 4 Stroll, +6.332s; 5 Maisano, +13.630s; 6 Albon, +15.005s; 7 Rosenqvist, +22.178s; 8 Fittipaldi, +36.821s; 9 Ferrucci, +42.445s; 10 Jensen, +43.404s; 11 Schiller, +44.052s; 12 Gunther, +44.849s; 13 Jeffri, +45.599s; 14 Maini, +45.928s; 15 Tveiter, +46.420s; 16 Lorandi, +46.592s; 17 Cao, +50.542s; 18 Menezes, +50.935s; 19 Iltott, +52.882s; 20 Beer, +55.323s; 21 Ling, +56.477s; 22 Rao, +1m02.028s; 23 Moreno, +1m03.680s; 24 Pohler, +1m05.301s; 25 Raghunathan, +1m12.137s; 26 Solomon, -1 lap; 27 Hyman, -1 lap; R Dennis, 17 laps-accident; R Pommer, 17 laps-accident damage; R Boccia, 16 laps-accident damage; R Beretta, 0 laps-accident; R Calderon, 0 laps-accident; R Sette Camara, 0 laps-accident; R MacLeod, 0 laps-accident.
- Winner's average speed** 108.323mph
Fastest lap Leclerc, 1m51.670s, 118.207mph.

- QUALIFYING 2** 1 Leclerc, 1m51.148s; 2 Russell, 1m51.448s; 3 Giovinazzi, 1m51.458s; 4 Albon, 1m51.550s; 5 Maisano, 1m51.755s; 6 Dennis, 1m51.781s; 7 Stroll, 1m51.808s; 8 Menezes, 1m51.982s; 9 Tveiter, 1m52.042s; 10 Iltott, 1m52.061s; 11 Jensen, 1m52.165s; 12 Pommer, 1m52.189s; 13 Schiller, 1m52.317s; 14 Boccia, 1m52.347s; 15 Fittipaldi, 1m52.367s; 16 Gunther, 1m52.376s; 17 Maini, 1m52.402s; 18 Ferrucci, 1m52.411s; 19 Beretta, 1m52.474s; 20 Beer, 1m52.506s; 21 Lorandi, 1m52.506s; 22 Jeffri, 1m52.564s; 23 Calderon, 1m52.677s; 24 Moreno, 1m52.755s; 25 Hyman, 1m52.769s; 26 Sette Camara, 1m52.904s; 27 Solomon, 1m52.909s; 28 Rao, 1m53.332s; 29 Ling, 1m53.354s; 30 Cao, 1m53.409s; 31 Raghunathan, 1m53.468s; 32 Li, 1m53.488s; 33 Pohler, 1m53.954s; 34 MacLeod, 1m53.460s*; 35 Rosenqvist, 1m51.087s**.
* = grid penalty; ** = excluded from qualifying.

RACE 3 (18 LAPS – 66.001 MILES)

- 1 **Leclerc**, 35m56.649s; 2 Giovinazzi, +0.440s; 3 Dennis, +3.255s; 4 Menezes, +4.242s; 5 Russell, +4.626s; 6 Albon, +6.345s; 7 Pommer, +7.185s; 8 Maisano, +8.447s; 9 Iltott, +9.098s; 10 Jensen, +9.551s; 11 Tveiter, +10.269s; 12 Rosenqvist, +10.984s; 13 Ferrucci, +11.622s; 14 Lorandi, +12.379s; 15 Jeffri, +12.942s; 16 Maini, +13.969s; 17 Boccia, +14.485s; 18 Beer, +14.820s; 19 Beretta, +15.877s; 20 Sette Camara, +16.074s; 21 Gunther, +17.417s; 22 Calderon, +18.216s; 23 Cao, +19.958s; 24 Solomon, +20.622s; 25 Schiller, +21.249s; 26 Pohler, +21.600s; 27 Li, +22.071s; 28 Hyman, +22.561s; 29 Raghunathan, +23.113s; 30 Moreno, -1 lap; R MacLeod, 17 laps-accident; R Rao, 17 laps-accident; R Ling, 16 laps-accident damage; R Fittipaldi, 14 laps-spun; R Stroll, 0 laps-spun.
- Winner's average speed** 110.172mph
Fastest lap Leclerc, 1m51.498s, 118.389mph.

GRID FOR RACE 3

- 1 Leclerc; 2 Giovinazzi; 3 Russell; 4 Albon; 5 Maisano; 6 Dennis; 7 Stroll; 8 Menezes; 9 Iltott; 10 Pommer; 11 Jensen; 12 Boccia; 13 Tveiter; 14 Lorandi; 15 Fittipaldi; 16 Jeffri; 17 Beer; 18 Ferrucci; 19 Maini; 20 Gunther; 21 Calderon; 22 Beretta; 23 Schiller; 24 Moreno; 25 Hyman; 26 Solomon; 27 Sette Camara; 28 Rao; 29 Ling; 30 Cao; 31 Li; 32 Raghunathan; 33 Pohler; 34 MacLeod*; 35 Rosenqvist**.
* = grid penalty; ** = excluded from qualifying.

CHAMPIONSHIP

- 1 Giovinazzi, 51; 2 Leclerc, 43; 3 Russell, 39; 4 Rosenqvist, 31; 5 Dennis, 30; 6 Albon, 28; 7 Stroll, 20; 8 Menezes, 18; 9 Pommer, 16; 10 Maisano, 14.

INDYCAR SERIES

ROUND 2/15, NOLA MOTORSPORTS PARK, APRIL 12
47 LAPS – 128.78 MILES

- 1 **James Hinchcliffe** (CDN) Schmidt Peterson Motorsports Dallara-Honda **1h47m19.4896s**
 - 2 Helio Castroneves (BR) Team Penske Dallara-Chevrolet +0.4279s
 - 3 James Jakes (GB)-Schmidt Peterson Motorsports Dallara-Honda +0.8452s
 - 4 Simona de Silvestro (CH) Andretti Autosport Dallara-Honda +1.2924s
 - 5 Juan Pablo Montoya (CO) Team Penske Dallara-Chevrolet +1.7564s
 - 6 Tony Kanaan (BR) Chip Ganassi Racing Dallara-Chevrolet +2.2638s
 - 7 Will Power (AUS) Team Penske Dallara-Chevrolet +3.0958s
 - 8 Graham Rahal (USA) Rahal Letterman Lanigan Racing Dallara-Honda +3.3495s
 - 9 Josef Newgarden (USA) CFH Racing Dallara-Chevrolet +5.7352s
 - 10 Luca Filippi (I) CFH Racing Dallara-Chevrolet +7.2115s
 - 11 Scott Dixon (NZ) Chip Ganassi Racing Dallara-Chevrolet +7.8421s
 - 12 Carlos Munoz (CO) Andretti Autosport Dallara-Honda +9.0899s
 - 13 Marco Andretti (USA) Andretti Autosport Dallara-Honda +9.7817s
 - 14 Charlie Kimball (USA) Chip Ganassi Racing Dallara-Chevrolet +15.7221s
 - 15 Gabby Chaves (CO)-Bryan Herta Autosport Dallara-Honda -1 lap
 - 16 Carlos Huertas (CO) Dale Coyne Racing Dallara-Honda -1 lap
 - 17 Stefano Coletti (MC) KV Racing Dallara-Chevrolet -3 laps
 - 18 Sage Karam (USA) Chip Ganassi Racing Dallara-Chevrolet -3 laps
 - 19 Ryan Hunter-Reay (USA) Andretti Autosport Dallara-Honda 43 laps-accident
 - 20 Simon Pagenaud (F) Team Penske Dallara-Chevrolet 43 laps-accident
 - 21 Sebastien Bourdais (F) KVSH Racing Dallara-Chevrolet 43 laps-accident
 - 22 Takuma Sato (J) AJ Foyt Racing Dallara-Honda 39 laps-wiring loom
 - 23 Francesco Dracone (I) Dale Coyne Racing Dallara-Honda 23 laps-accident
 - 24 Jack Hawksworth (GB) AJ Foyt Racing Dallara-Honda 19 laps-accident
- Winner's average speed** 71.995mph
Fastest lap Dixon, 1m28.5583s, 111.384mph.

GRID

- 1 **Montoya**; 2 Power; 3 Kanaan; 4 Castroneves; 5 Pagenaud; 6 Bourdais; 7 Hunter-Reay; 8 Hawksworth; 9 Filippi; 10 Andretti; 11 Rahal; 12 Newgarden; 13 Sato; 14 Munoz; 15 Dixon; 16 Hinchcliffe; 17 Chaves; 18 de Silvestro; 19 Karam; 20 Coletti; 21 Kimball; 22 Jakes; 23 Dracone; 24 Huertas.
- Grid decided on points after rain forced cancellation of qualifying after Q1.

- Q1 – GROUP 1** 1 Kanaan, 1m38.3668s; 2 Pagenaud, 1m38.4420s; 3 Munoz, 1m38.5526s; 4 Power, 1m38.5766s; 5 Jakes, 1m39.1614s; 6 Hinchcliffe, 1m39.7898s; 7 Montoya, 1m39.8157s; 8 Huertas, 1m40.1864s; 9 Castroneves, 1m40.2080s; 10 de Silvestro, 1m40.2154s; 11 Dracone, 1m40.6653s; 12 Bourdais, 1m41.7573s.

- Q1 – GROUP 2** 1 Newgarden, 1m43.8783s; 2 Hunter-Reay, 1m46.7627s; 3 Dixon, 1m47.1617s; 4 Kimball, 1m47.4779s; 5 Andretti, 1m48.0192s; 6 Karam, 1m49.1470s; 7 Sato, 1m49.6570s; 8 Coletti, 1m50.7773s; 9 Filippi, 1m51.7934s; 10 Chaves, 1m52.6481s; 11 Rahal, 1m54.7272s; 12 Hawksworth, 1m55.9685s.

- CHAMPIONSHIP** 1 Montoya, 84; 2 Castroneves, 74; 3 Power, 70; 4 Hinchcliffe, 65; 5 Kanaan, 63; 6 de Silvestro, 44; 7 Jakes, 43; 8 Rahal, 43; 9 Filippi, 42; 10 Pagenaud, 41.

THE LOST STARS OF

Markus Hottinger and Hans-Georg Burger died during the '80 European F2 season. **ADAM COOPER** explains



Hottinger (#6) with
Burger alongside, 1979
Hockenheim DRM race

1980

why they shouldn't be forgotten



“BOTH WERE SUPPORTED BY BMW WITH A VIEW TO A GRADUATION TO FORMULA 1”

THIRTY-FIVE YEARS AGO THE EUROPEAN Formula 2 Championship was struck twice by tragedy. In April Austrian Markus Hottinger was killed at Hockenheim, and just three months later German Hans-Georg Burger lost his life following an accident at Zandvoort.

Given that they died just 13 weeks apart – and both in freak incidents that involved head and neck injuries – it's inevitable that the names of Hottinger and Burger are usually mentioned in tandem. In fact the links are much stronger. Close friends, they both emerged from the hurly-burly of Renault 5 racing, attracted support from BMW, and caught the eye by taking on established Formula 1 stars in the M1 Procar series. Both were then channelled into F2 by the Munich manufacturer with a view to an eventual graduation to grand prix racing. Sadly it was not to be, and BMW lost its two brightest proteges in one year.

“Markus was very good and a nice guy,” recalls his friend Niki Lauda. “He slept in my hotel room once. He couldn't pay for his room and I made him sleep in on my floor! And then unfortunately Hockenheim came...”

Hottinger (pronounced ‘Hurtinger’ with the umlaut) was born in May 1956, four years after Burger. That he made it to the international stage first perhaps reflects the fact that he came from a more affluent background, and had the opportunity to go racing at an earlier age. Indeed, he was still a student when motorsport took over from skiing as his main passion.

“Markus was running a Renault 5 in the Austrian or German championship,” recalls Dr Helmut Marko. “He was just a young guy from Burgenland, which is the smallest state in Austria. He was working on the cars himself in the beginning, just with a friend of his. And then I think we did some sort of cooperation in the European championship. So from then on I was following him or guiding him through the various categories.”

The Renault 5 scene was fiercely competitive – future F1 driver Mauro Baldi was the big star in Europe at the time – and Hottinger caught the eye when he won the support event at the 1977 Italian GP. Marko helped to galvanise support from BMW competition boss Jochen Neerpasch, which led to an appearance at the Kyalami 1000Km at the end of that year, alongside veteran Harald Grohs in a 320. It was a huge step up for the 21-year-old R5 racer, but the pair finished third.

Hottinger was contracted to BMW for 1978, and the heart of his busy programme was the popular German Group 5 series, or DRM. Given a seat with the GS Tuning team, he immediately impressed,

winning several races and finishing the year second in Division 2, and fourth overall.

He also contested some endurance races, partnering the Hans Stuck, Dieter Quester and Giorgio Francia, and he even found time to win an ETCC race at the Osterreichring with the crack Luigi team.

“I did the deals with him,” says Marko. “But it was a sort of friendship relationship. He was a very intelligent guy, with a sort of philosophical humour. Everything developed very well, his personality, his speed. It was going in the right direction.

“I taught him to be professional and so on. He was good-looking, and I had to stop him coming home at 4am on Sunday morning from the ▶

WHO THEY WERE...

Markus Hottinger



Born

May 28 1956

Died

April 13 1980

1976

■ Renault 5

1977

■ Renault 5 1st Austrian championship
■ Kyalami 1000Km 3rd in Faltz Alpina BMW 320

1978

■ DRM 4th overall in GS Tuning BMW 320
■ Nurburgring 1000Km, Watkins Glen 6Hrs, Misano 6Hrs, Vallelunga 6Hrs Various teams, BMW 320

1979

■ Procar 4th with GS Tuning
■ DRM 8th overall with GS Tuning BMW 320
■ Osterreichring ETCC 1st with Luigi BMW CSL
■ F2 Five starts with Bob Salisbury/Jagermeister March 792
■ Kyalami 1000Km Marko BMW M1

1980

■ F2 Two starts with Maurer MM80

Hans-Georg Burger



Born

April 1 1952

Died

July 22 1980

1977

■ Renault 5

1978

■ German F3 5th with Bertram Schafer Ralt RT 1
■ European Super Vee Ralt RT 1
■ DRM One start with GS Tuning BMW 320

1979

■ German F3 2nd with Bertram Schafer Ralt RT 1
■ DRM GS Tuning BMW 320
■ Hockenheim Procar 3rd with factory
■ Nurburgring and Kyalami 1000Km GS Tuning BMW M1

1980

■ F2 Five starts with Tiga F280
■ Procar GS Tuning
■ Le Mans Lacaud BMW M1
■ Nurburgring 1000Km GS Tuning BMW M1
■ Monaco F3 GP 6th with Zimmermann Ralt RT3

► disco and things like that! That was his lifestyle, a typical easygoing student. He pretty soon realised that it can't go on like that, and he understood what is necessary. He put a lot of effort in."

"He was a very friendly chap, and well brought up," says close friend Christian Danner. "Unusually for the time he was very into fitness, running around in shorts, and he had these strange eating attitudes. He made a big fuss about ham if it had the slightest bit of fat on it, and he was into nuts and things like that. I found it quite interesting!"

Hottinger's 1979 season was to be even busier. As well as the DRM he faced a steep learning curve when he contested five F2 races in a Bob Salisbury-prepared March 792, earning three seventh places. Most significantly Marko fielded him in the new Procar series, where the competition included Lauda, Alan Jones, Carlos Reutemann, Mario Andretti and Nelson Piquet.

It was the perfect opportunity for a young gun to shine, and Hottinger made the most of it. He regularly mixed it with the big names, earning second behind Jacques Laffite on home ground in Austria, and thirds at Zolder, Silverstone and Monza. He finished fourth in the championship behind Lauda, Stuck and Clay Regazzoni.

"His performance in the Procar really opened up his future," says Marko. "Especially with BMW. Neerpasch noticed his talent and helped a lot."

Hottinger's career developed in parallel with that of Burger. The pair had got to know each other when they were competing in Renault 5s together, and Burger was picked up by Neerpasch and BMW a year later than Hottinger. He ran in German Formula 3 in 1978 before enjoying his first DRM drives in a 320 at the end that year. He was helped on his way by top journalist Rainer Braun and by wheeler-dealer Werner Heinz, who would later look after Nick Heidfeld and Nico Hulkenberg.

Burger really began to make his mark in 1979, finishing second in the F3 series and fourth in the DRM's Division 2, as team-mate to Hottinger at GS Tuning. He also made a huge impression when he earned third on his Procar debut at Hockenheim in a spare works car. At the end of '79 Burger and Hottinger shared a Marko-entered M1 in the Kyalami 1000Km, underlining their shared roles as BMW's men of the future.

"They were close friends, but on the other hand opposition," says Marko.

"I think the more natural talent was clearly Burger," says Danner. "Markus however was extremely clever. He immediately twigged that with some brains you could improve your game

dramatically in those days. He was struggling a little bit when he went to single-seaters. It took him a while, but he got on top of it because he was smart and willing to learn.

"He was like a gypsy. He'd just turn up without any spare clothes, and he was very happy to rely on people like me or my girlfriend for lunch or dinner. Hans-Georg was very different, because he was married and he already had a child. I think he was a mechanic and had no proper school education."

Meanwhile there was much going on back in Munich in the winter of 1979-80. BMW had quietly been working a new F1 turbo project, and indeed Hottinger had helped to develop it in 1.4-litre DRM form. Neerpasch had even tried to engineer a deal for BMW to join forces with McLaren and Lauda, but that didn't fly with the board. He then announced that he was leaving to join Talbot, and that his gameplan was for the French company to take over the BMW F1 engine project.

But the man he recommended as his successor, Dieter Stappert, was determined to see BMW competing in F1 in its own right. The Austrian tried to block the Talbot deal and, while BMW's F1 future was far from settled as 1980 began, he saw a bigger picture. He wanted the company's proteges to be part of it.

Having run the Procar series, he knew Hottinger and Burger well, and he placed them in F2 drives with works engine deals to help further their education. Burger signed to drive the new Tiga F280, run by former F1 racers Howden Ganley and Tim Schenken.

"I can't remember if we approached Dieter, or he approached us," recalls Schenken. "Hans-Georg had works engines and some sponsorship from Winnebago. He was a lovely bloke, and a racer as well. He fitted in very well, and got on well with the mechanics. We could have a good laugh together, and there was no clash of cultures. He was obviously a good driver, but to try to evaluate him was difficult because the car was a one-off."

Meanwhile Hottinger joined Maurer. The German outfit had got off to a shaky start in 1979, but had some good people on board, including designer Gustav Brunner.

"The plan was to be successful in F2, and then move on," Marko explains. "And Stappert was a

"HANS-GEORG WAS A LOVELY BLOKE. HE FITTED IN WELL AND GOT ON WITH THE MECHANICS. WE HAD A LAUGH"

TIM SCHENKEN BURGER'S TEAM BOSS



Burger confers with Tim Schenken, Hockenheim '80

big fan of Hottinger, so it was obvious that there were possibilities. Markus was, from BMW's side, the guy they wanted."

"He came along as BMW's new kid on the block," says Maurer team-mate Eje Elgh. "He'd done some touring cars and done very well and he was a future star, basically. He turned out to be a really nice guy. His feet were completely on the ground, always very happy, very social, and I got on very well with him. Some guys you don't know at all from the start, but with him you joked and you laughed. He was a good-looking kid, and he was full of life."

Sadly it was to be an all-too-short relationship. Hottinger endured a difficult first weekend at Thruxton, where he was hampered by a series of niggling problems, and he qualified midfield at Hockenheim the following weekend.

In the race Andrea de Cesaris and Manfred Winkelhock tangled at Turn 1 at the start of the third lap. Then a lap later Derek Warwick spun off on the dirty track surface and hit the barrier on the right. One of his rear wheels flew back across the track and, by a stroke of fate, struck Hottinger's



Both shone in Procar; this is Burger's 1979 Hockenheim star turn

helmet. Its driver unconscious, the Maurer spun to a halt and was hit by the following Bernard Devaney.

Medical staff worked on Hottinger at trackside. There were faint signs of life, but it wasn't until some 27 of the 30 laps had been run that the race was red-flagged so that a helicopter could land on the track. He was transferred to Heidelberg, but nothing could be done to save him. He was just 23 years old.

"It was very tragic because he was a young kid," says Elgh. "I was staying in a hotel in Speyer, as that's where the workshop was. After breakfast on Monday I went over and there was Markus's car. There was hardly any damage, but the rollhoop was flattened."

"He was the first guy I supported who was killed," says Marko. "So that was a big shock. At some stage I was really, 'Should I do this any more?' It's a big responsibility you take if you have a young driver. So it was not an easy time."

Just 11 days after Hottinger's death BMW announced that it would be joining forces with Bernie Ecclestone and Brabham from 1981. ▶



Thrxuton one of five F2 races contested by Hottinger in hectic '79

LAT

STUDENT PROFILE

FACTFILE

Student's name: Dan East

Course: Foundation Degree (Engineering) in
Motorsports: Performance and Automotive Technology

Location: Banbury and Bicester College
- Bicester campus

Year: Second

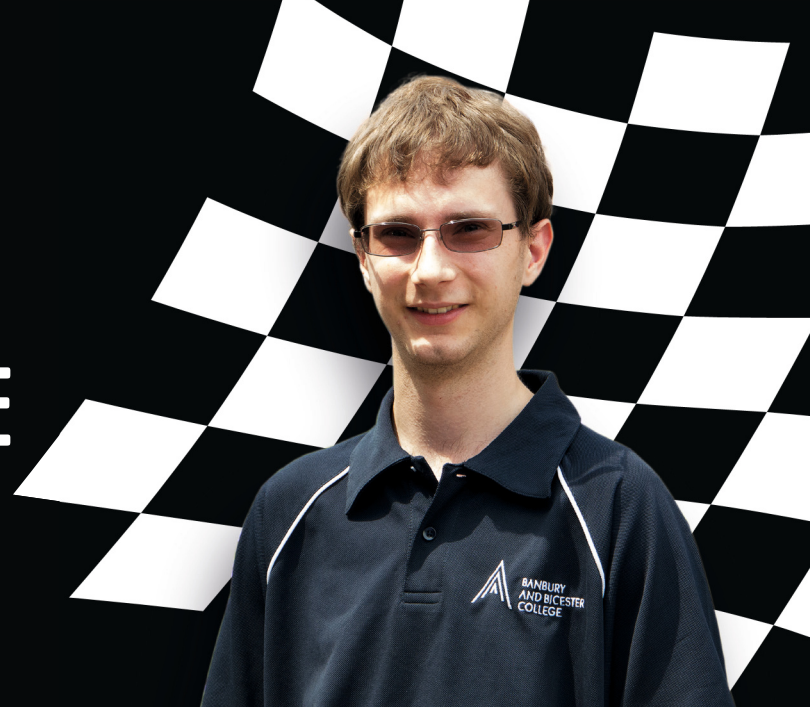

» What are your career plans for when you have completed your study at college?

I plan to do the BEng course at Oxford Brookes to achieve the full honours degree. I then want to do an MSc before going on to work with a firm such as Williams as a race engineer. I want to be able to work in a hands-on role, but then use my qualifications to make the move into management later on.

» How has being at college changed your life?

The course is helping to make my dreams come true – it is making everything I have planned for possible. It is also giving me the knowledge and excuse to build my own rally car, which forms part of the course assessment.

» What made you choose to study at an Activate Learning college, rather than somewhere else?

I had completed part of my GCSEs at Banbury and Bicester College, taking part in a day release scheme from school to achieve a Level 1 Diploma in Engineering. While I was at the college I got to know the staff and students and made up my mind that I wanted to come back and do the foundation degree.

» Why did you select this programme of study?

I have known that I wanted a career in the motorsports industry since the age of about eight and I have carefully planned my route through. I have been part of Thame Motorsports Club for the last three years and want to progress to become an F1 race engineer. This programme suits my style of learning, because it is very practical, and combines my skills in engineering with my love of motorsports.

» What do you enjoy about studying for this particular programme?

You do 150 hours of work experience during the programme and my first placement has been with Williams F1. Prior to the work experience placement I completed a one-week composites course (one of the course modules) which meant I could work in their composites department and be trusted to get on with the job. I felt part of the team and the experience has confirmed that this is the right career path for me. The college has excellent links with employers – it seems like they know everyone in the industry – so that really helps when it comes to building real experience.

» What skills do you seek that will help you in your chosen career?

The Level 1 engineering course taught me about basic brakes and suspension systems on road cars, but this course is preparing me to work with F1 cars. We cover race preparation and aerodynamics and you can develop your composite skills using the on-campus facilities. The skills are completely aligned to working in the industry.



Are you ready to transform your future? We'll help you go further than education. Come along to our next Open Event – on Saturday 25 April (10am-1pm).

Register at: www.banbury-bicester.ac.uk/events

**Or contact us:
0808 1686 626 - enquiries@banbury-bicester.ac.uk**

Remember - we provide a range of Motorsport and Engineering courses, so even if a Foundation Degree isn't for you right now, we can get you there with Level 2 Certificates, Level 3 Diplomas and Level 3 Extended Diplomas.

► The Talbot deal pushed by Neerpasch had been canned, and Stappert had got his way. There was now a clear path to F1 for a talented BMW protege, if not with Brabham then perhaps with another future customer.

BMW's focus moved to Burger, who was getting to grips with the unproven Tiga. At the Nurburgring he qualified a sensational second despite missing practice mileage as he was commuting to and from a Procar event at Donington. In the race he ran second to Teo Fabi before dropping to third behind Winkelhock, who subsequently performed his infamous televised flip at the Flugplatz. The Tiga guys were convinced that Burger could have caught and passed Fabi and won the race, but a broken gear linkage – the result of an unauthorised modification by a mechanic – stopped him.

A busy BMW programme ensured that he didn't do all the F2 races, and he continued to shine in a BASF-liveried GS Tuning Procar. He also shared an M1 with Stuck on his Le Mans debut.

He was back on F2 duty at Zandvoort in July as the small Tiga team began to make progress. Alas, in the Sunday morning warm-up he ploughed off the road at the fifth-gear Scheivlak corner.

"It was just raining lightly," recalls Ganley. "He'd stopped the lap before and said, 'This car's got so much grip.' I guess he was planning on doing that corner flat-out, and it was just a bit too slippery. It seemed fairly innocent initially, just sliding into a catch fence. But about an hour later Tim came back and said, 'This is not sounding very good...'"

In fact a fence post had struck and split Burger's helmet. He was transferred to Amsterdam with head, neck and throat injuries, to which he succumbed on the Monday evening. He left a wife, Anni, and a young son Thomas.

Stappert didn't give up on his plan to promote home-grown talent, and Procar racer Danner was fast-tracked into a works March F2 drive to help fill the void. Meanwhile BMW still had one long-time junior driver in Winkelhock, who hadn't been widely regarded as F1 material. But his 'arms-and-elbows' style was much admired by engine wizard Paul Rosche, and in 1982 he was helped into an ATS F1 seat. Two years later Gerhard Berger was given a similar opportunity with the same team. Stefan Bellof also had some BMW support at Maurer in F2, although he was a Porsche man by the time he graduated to F1.

Neerpasch would later find a German-speaking superstar in Michael Schumacher – and Marko would find another in Sebastian Vettel. We'll never know how Hottinger and Burger would have fared had they lived, but those who knew them rated both men highly.

"For sure Markus would have been competitive in F1," Marko insists. "Just from his speed and his intelligence. Hans-Georg didn't have the straightforward approach that Markus had, but he was one of the best Germans at that time."

"Whatever happened to Manfred and Gerhard with ATS, that would have been the route," says Danner. "Markus had the right personality, and was very disciplined. Burger just relied on his talent. But he was absolutely amazing in a racing car." ❧

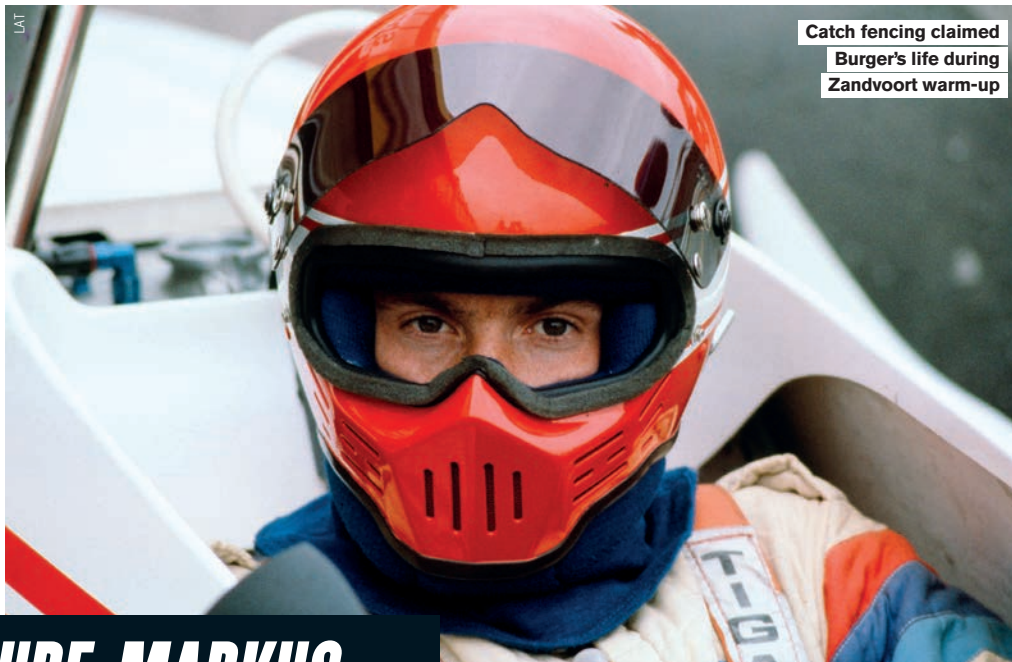

Catch fencing claimed
Burger's life during
Zandvoort warm-up

**"FOR SURE MARKUS
WOULD HAVE BEEN
COMPETITIVE IN F1,
JUST FROM HIS SPEED
AND INTELLIGENCE"**

HELMUT MARKO HOTTINGER'S FRIEND



Hottinger died in freak
accident at Hockenheim

WEB DIRECTORY

CAR BROKERAGE

RACING CARS FOR SALE
 ALAN CORNOCK FCS
 BUYING - SELLING - BROKERAGE
www.racingcarsforsale.co.uk
 TEL: 01480 891212

ENGINES

Precision machining and engineering
 Leading brand replacement & performance engine parts
www.gosnays.co.uk
 Tel: 01708 748320



EXHAUSTS

Inconel & Stainless Steel Specialists
SIMPSON
 Race Exhausts
 Tel: 01753 532222
www.simpsonraceexhausts.com



GEARBOXES

Gearboxman.com
 COMPETITION TRANSMISSION SERVICES
 Gearboxes & Axles for Road, Race, Rally and more
 Telephone: 01582 840008 Fax: 01582 840007

HELMET GRAPHICS

visit: www.liquidcolourdesign.com
 Studio: +44 028 93378525
 Mob: +44 0770 9442894



liquidcolourdesign
 Helmet Paint | Design | Airbrush | Custom Paint

Mike Fairholme Designs
 Sole approved painter of Arai helmets.
 Silver Birches, Corby Birkholme, Nr Grantham, Lincs NG33 4LE.
 Tel: 01476 550630. Fax: 01476 550029.
 email: fairholmedesigns@btconnect.com
www.fairholmedesigns.co.uk

MEMORABILIA

Speed King.cc
 EXCLUSIVE MOTORSPORT MEMORABILIA
 EST. 1996
We Buy Your Teamgear!

FINAL LAP
 For Everything Formula One
www.finallap.net **WE BUY AND SELL**
 +44 (0) 1245 287588 / 07771 920345

MOTOR RACING LEGAL ADVICE

Motor Sport Legal Advice
 Tudor Alexander, LI.B Solicitor
tudor@fletcherday.co.uk
 07887 713512

RACE PARTS

ARE DRY SUMP SYSTEMS
 ARMSTRONG RACE ENGINEERING INC.
WWW.DRYSUMP.COM (916) 652-5282

CARTEK
 MOTORSPORT ELECTRONICS



info@cartekmotorsport.com
 023 80 457747
WWW.CARTEKMOTORSPORT.COM

JJC) race and rally
 PASSIONATE ABOUT MOTORSPORT
www.jjcraceandrally.com

RACE PRODUCTS

PORSCHE SHOP
 10% off with website
 voucher code AUTOTEN
 Or Call: 0121 585 6088

Pit to Car Autotel
 Radio solutions **Digital Race Radio**
 0044(0)1508 528837
www.raceradio.co.uk

demon tweeks
 PROFESSIONAL MOTORSPORT EQUIPMENT
www.demon-tweeks.co.uk

RACEWEAR

AUTHORISED DISTRIBUTOR
OMP YBRACING
 MOTORSPORT & PERFORMANCE
WWW.YBRACING.COM

MANUFACTURERS OF SPORTS PROTOTYPE RACING CARS
 NEW & SECOND HAND MCR'S FOR SALE
 ARRIVE & DRIVE PACKAGES

MCR RACE CARS

TURATELLO RIMORCHI 40 years excellence
www.turatello.com/en/

TRAILERS

BRIAN JAMES TRAILERS
 » Connected to you
www.brianjames.co.uk

PRG TRAILERS
www.prgtrailers.co.uk
 Phone no: +44 (0) 1270 812402

WORKSHOP EQUIPMENT

Image® Manufacturers of bespoke split rim alloy wheels
www.imagewheels.co.uk
 IMAGE WHEELS INTERNATIONAL LTD.

AUTOSPORT

TO ADVERTISE IN THE WEB DIRECTORY
 PLEASE CALL 020 8267 5271
 OR EMAIL: autosportads@haymarket.com

BRIAN JAMES TRAILERS

»» Connected to you



www.brianjames.co.uk

Form follows function

A combination of style, aerodynamic efficiency and construction using the latest in GRP manufacturing technology means that our Race Shuttle and Transporter range is the choice for quality.

These capable enclosed trailers transport vehicles from classics to LMP sports car prototypes with safety and comfort.

Photographed (above), Race Shuttle 3 tilt-bed with optional style B1 12" alloy wheels.

Race Shuttle range from £ 5,189 (excl. VAT).

To find your nearest dealer visit:
www.brianjames.co.uk/dealer



T +44 (0)1327 308 833

For more information and details on the Brian James Trailers range, please contact our head office.

CAR TRANSPORTER

TRAILERS & TRANSPORTERS



www.**WOODFORDTRAILERS**.com

HIGH QUALITY TRAILERS FOR CLUB, PRIVATE AND PRO MOTORSPORTS



Email: sales@woodfordtrailers.com

CALL US NOW **01327 263 384**

TRAILERS & TRANSPORTERS

FUN MOVER FOR SALE

£64500



2009 Fun Mover "A" Class Motorhome and race transporter. 34', Long Range LPG system. Twin slide-outs, Rear ramp, electric bed, 6 berth, satellite dish & 2 x TV's, Generator, leveling jacks, leather trim, full body paint etc. All usual RV creature comforts...and lots more!! Only 16000 miles. Superb!



See our website for more info at www.justrvs.co.uk.

Tel: (Main): **01522 246222** or

Mobiles: **07756 721257** or **07704 570044**

A colour-matched Brian James Tri-Axle Race Shuttle trailer is available with this RV, by separate negotiation

SCANIA TRACTOR UNIT AND RACE TRAILER FOR 3 RACE CARS WITH TWIN POP OUT PODS.

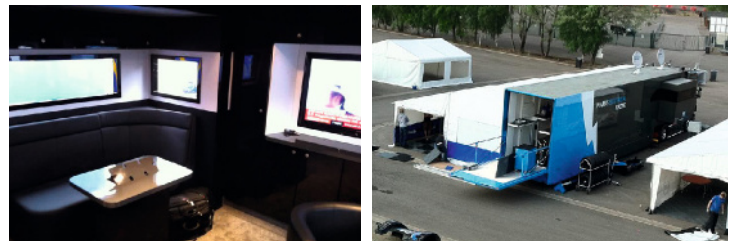

This bespoke race trailer has been owned from new since 2010 and has been maintained fastidiously with no expense spared. It has an internet connection (Via dish) and also sky tv (Via another dish), along with a 6m radio mast. All these are electrically controlled from ground level. Both pods come out on hydraulic rams and are operated electrically. The lounge area has a 46" Samsung LED tv, twin data tables, sink unit, Miele appliances, including a dishwasher, fridge and wine fridge It has a 20kw generator, awning and all the relevant poles etc.

This is probably the best race trailer available for sale in the UK.
To have this built would take nearly 12 months.

(07970) 709685 • mark@markselectrical.co.uk

TRAILERS & TRANSPORTERS

Media / Hospitality / Mobile Office



Built in 2011, this incredible vehicle was built with a view to multi-purpose use - Mobile Office, Media Office, Hospitality & Exhibitions. The vehicle was totally built from the ground up; false floor deck that rolls out, interior stairs to roof deck that can hold 20 people, interior shower, kitchen. The slide-out creates a large working area for up to 8 people whilst the rear separate office benefits private meetings. 2 x Interior Samsung TV's, Satellite for internet use, surround sound system, lockers throughout body, water tanks and built in silenced Honda Generator.



This vehicle is incredible. It's built to the highest spec and most importantly can be driven to an event and set up by one person in less than an hour.



I'd consider swapping / part-exchanging for any (within reason) vehicle, car, truck motorhome etc.

You can contact me on matt@e22sports.com or on **07855 420654**. www.e22sports.com

PRG TRAILERS

Finest Built British Trailers.



PRG Trailers | Cheshire | UK | Tel: +44 (0) 1270812402
Web: www.prgtrailers.co.uk | Email: info@prgtrailers.co.uk

D.A.F LF 45 race truck, large rear workshop which includes compressor, generator, tool cabinet, work bench etc. Front living area with cooker, microwave, sink, couch/bed, tv, toilet. Customised metallic paint.



Phone
Neil **00353872658933**

Price
€22,950

Over 100 new and used trailers in stock

FIELDFARE TRAILER CENTRE



Sold to Competitors by Competitors !

Fieldfare Trailer Centre, Salisbury.

With over 15 years of experience in dealing with trailers, we know a thing or two about them.

Our expert and professional advice will help you find the right trailer for your requirements.

People come from all over the country to see our extensive range for a number of different uses.

- * Sales
- * Trailer Hire
- * Servicing
- * Repairs
- * Parts

Selection of used Brian James Trailers for sale

1. A-Max, 5.0m x 1.96m, 2.6t GVW, £1800 + vat
2. A-Max, 4.3m x 1.96m, 2.6t GVW, £1850 + vat
3. A-Max, 4.3m x 1.96m, 2.6t GVW, £2000 + vat
4. TT Tiltbed, 5.0m x 2.02m, 3.5t GVW, £2500 + vat
5. Covered A-Max, 4.24m x 1.94 x 1.52m high, 2.0t GVW, £3,495 no vat.



BRIAN JAMES TRAILERS

Tel: 01980 611853 info@fieldfaretrailers.co.uk www.fieldfaretrailers.co.uk

The Trailer Warehouse, Ford Farm, Old Malthouse Lane, Ford, Salisbury, Wiltshire, SP4 6DR.



PREMIUM CLASS IN THE WORLD OF MOTORSPORTS!

GERMAN ENGINEERING ON BOARD



TRAILERS & TRANSPORTERS

living quarters

workshop facilities

technical office



BISCHOFF SCHECK AG

WWW.BISCHOFF-SCHECK.COM

RACE & RALLY CARS

CAR FOR SALE



Formula Renault 2.0 – 2007

Formula Renault 2.0 complete with 2007 onwards bodywork, numerous race wins, engine has 3,000kms left before rebuild required maintained to a very high specification includes 3 sets of wheels and some spares **Price £19,250 + VAT**



1978 March Toyota F3 car

March Toyota 783 Ex Nigel Mansell, Fully rebuilt prior to Historique Monaco 2014, including rebuilt engine and gearbox including a new maincase, new fuel cell, new dampers, rebuilt calipers and new discs, new master cylinders, new brake discs new bearings and suspension joints, new springs, new HTP papers May 2014, 2 new sets of wheel rims and some spare bodywork. **£60,000**

Tel: 01327 879999

Email: trevor.foster@fortecmotorsport.com



DRIVES AVAILABLE

2015 F3 Cup Drives Available



★Dallara F305-7 F3 cars for rent
Fully maintained, cars ready to race or test
Full or partial season with testing to suit your budget

★Full preparation and maintenance package for *your* car including the new for 2015 Dallara F308 - F311 cars

★Exciting new 3 race format in the fastest UK single seater championship

Omicron Motorsport

2014 & 2012 F3 Cup Teams Champions

Contact Tristan Cliffe on: 01508 570351

racing@omicronmotorsport.co.uk

www.omicronmotorsport.co.uk

PORSCHE



Porsche 997 GT3R 2015 FIA Specification

Car 1 (Engine 35 hours Gear box 25 hours)

Car 2 (Engine 30 hours Gear box 20 hours)

2 sets of wheels per car , lots of additional spares available on request.

Both cars used in British GT3 Series up to the end of 2014 season.

Phone 01483 225878 | Email : info@trackspeed.net

PEUGEOT



Peugeot 205 For Sale

Mid engine rear wheel drive Peugeot 205 built from 1987 205 Gti. Guy Croft 1840cc Fiat twin cam engine, GC cams ground from blank, 11.2:1 CR, Titan dry sump pump, Ark Racing flywheel and starter, Tilton twin plate race clutch with hydraulic release bearing, Hewland Mk9 gearbox with Mk5 ratios and LSD, EWP80 electric water pump, 45 DHLAs on GC manifold, Megajolt ignition, Mocal remote filter, engine bay fully heat managed, dyno'd during running in produced 180bhp at 6500rpm. (Peak power is @ 7500rpm)

Bilstein Prodrive Impreza coilover rear suspension, fully adjustable Combrake wishbones all round, eccentric top mounts all round, Wilwood Midlite 4 pot front calipers, Powerlite HB 4 pot rear calipers.

Wilwood bias adjustable pedal box and master cylinders, Momo suede steering wheel, 2.7 quickrack, Cobra Monaco seats, D2 5 point 3" FIA belts, Fabricage multi-point rollcage, 11 gallon custom fabricated alloy baffled fuel tank, Facet Red Top, heated laminated windscreen, 4mm polycarbonate windows all round, Smiths stepper-motor rev counter, Vapor speedometer, Lumenition air-fuel ratio meter, comprehensively switched, fused and relayed, Lifeline plumbed-in extinguisher and passenger floor mounted hand-held extinguisher, Avanti map light.

Fully road legal, logbooked, correct engine number and type recorded in logbook, engineers report supplied. Has competed in special stage rallying in 2010-2011. No longer eligible. A fast and stunning car, would be competitive in Modified saloon racing, hillclimb or rallycross. And obviously lots of fun on a track day.

Selling at a fraction of build cost due to present financial commitments.

Price **£12,000** • Contact **Robert 07914696479**

RACE PRODUCTS

Elite Carbon Fibre

Carbon fibre race car component manufacturer

EliteCarbonFibre Ltd.
Units 20-22 Norwich Road Ind. Est.
Watton, Thetford, Norfolk IP25 6DR

Contact – Dave Greenwood 07809390316
Email – davecarbonelite@googlemail.com
Website – elitecarbonfibre.co.uk



Carbon Composite Wings, Bodywork & Repairs

RACE & RALLY CARS / MARKETPLACE

THE NATIONAL KIT CAR MOTOR SHOW 2015

STONELEIGH

» **BANK HOLIDAY WEEKEND** Sunday 3rd & Monday 4th May 2015 «



The **BIGGEST** kit car show in the **WORLD!**

THE ANNUAL MECCA FOR KIT CAR ENTHUSIASTS

SAT NAV CV8 2LZ

MANUFACTURERS' NEW LAUNCHES

400 Trade Stands in 5 Exhibition Halls plus 300 Outside Trade & Club Stands in over 5 Acres!



HALL 2 FEATURE DISPLAYS

WSCC IN MOTORSPORT

750 MC CLUB

MASSIVE CLUB DISPLAY

PLUS: LIVE ACTION HAVE A GO!



WESTFIELD TEST CIRCUIT

It's the one and only **WORLD FAMOUS** kit car show



THE DAKAR 4X4 EXPERIENCE

4000 KIT CARS ON DISPLAY

complete **KITCAR** night out
MUSIC NIGHT SUNDAY LIVE BAND

CAMP ON SITE

Camping & caravanning available from midday Saturday 2nd May.
Book now: www.nationalkitcarshow.co.uk

FREE » **SHOW GUIDE**
» **ENTRY FOR KIT CAR DRIVERS***
*(For drivers arriving in their kit cars on the day)

complete **KITCAR** show sponsor

at **STONELEIGH PARK**
ROYAL SHOWGROUND,
STONELEIGH,
Nr. KENILWORTH,
WARWICKSHIRE
CV8 2LZ

GATES OPEN EACH DAY

9.30am – 5.00pm

BE THERE!

DIRECTIONS

From London M40:

Exit J15. A46 to A452. B4113

From M6 or M69: Exit M6 J2 to join A46. M69 to A46. Exit A46 to join B4113.

From M1 Northbound: Exit J21, M69, A46, Exit A46 to join B4113.

TICKETS

Advance Tickets: £12*

Available until 20th April

Accompanied children (under 16) FREE

Tickets on the Door £15

Accompanied children (under 16) FREE

FREE Show Guide

FREE Parking

ALL ENQUIRIES TELEPHONE

01406 372600

01406 372601

*Credit and Debit Card bookings are subject to a 50p booking fee per transaction.

Organised by: **Grosvenor Shows Ltd.**

www.nationalkitcarshow.co.uk

MARKETPLACE

FLOORING

Kiwi Tiles

Interlocking Plastic Floor Tiles, as used by leading race teams throughout Europe.

- Easy installation & removal
- Many colours
- Lightweight
- Strong and durable
- Compact & easy to store
- Top quality
- Value for money

Stock Colours:
Red, Blue, Green,
Yellow, Silver, Orange,
Grey, Black, White,
Dayglo Red

Ralt Engineering

Tel: 01865 883354 Fax: 01865 883789
Email: enquiries@kiwitiles.com
www.kiwitiles.com

MEMORABILIA

F1 COLLECTORS .COM



#1 FOR F1 MEMORABILIA & AUTOGRAPHS

We buy and sell F1 items
AYRTON SENNA specialists

Call CHRIS GRINT

01763 274448

email:- sales@f1collectors.com

RACE PRODUCTS

CARTEK

MOTORSPORT ELECTRONICS

NEW

Power Control Panels

Shift Lights

Battery Isolators

Coolant Level Alarms

FIA Rain Lights

Power Distribution Modules

Wireless Steering Wheel Controls

Suppliers to:

- Porsche
- HWA AMG
- Ford
- KTM X-Bow
- Mini Challenge (UK)
- Kamaz
- V8 Super Cars
- Rage Motorsport

www.CARTEKMOTORSPORT.com
CARTEK AUTOMOTIVE ELECTRONICS Ltd
+44 (0)2380 457747 New number
info@cartekmotorsport.com

TYRES

FOR ALL YOUR



RACING TYRES

Inc. ACB 10 Formula Ford
Contact

BMTR LTD

Tel: 0121 331 1122

Fax: 0121 331 1144

email: sales@bmtr.co.uk

see our new website at www.bmtr.co.uk

AUTOSPORT

IF YOU'D LIKE TO
ADVERTISE YOUR
PRODUCTS AND
SERVICES IN THE
MARKETPLACE CALL:

0208 267 5271

HOSPITALITY TICKETS

Formula One Grand Prix Weekends

Great Value
from only
£399
pp

4 & 5-day breaks
available...

...by coach

Belgian (21 Aug) Monaco (21 May)

Spanish (7 May) Austrian (18 Jun)

...by air†

Book your own flights and we'll do the rest. We even take care of your airport transfers.

Spanish (8 May) Italian (4 Sep)

Monaco (22 May)

Plus... 24 Hour Le Mans and
German Classic Motor Show

CALL OR CLICK TODAY!

Just look
what's included:

- ✓ Entry ticket to the qualifying session* and race day
- ✓ Transfers to the race circuit each day*
- ✓ 3 or 4 nights' hotel with breakfast
- ✓ Travel by executive coach from a choice of more than 500 regional joining points†
- ✓ Return Channel crossings†

Leger 0843 178 3736 ABTA
Holidays leger.f1-weekends.co.uk ABTA No.V3582

All holidays are subject to availability. Terms and conditions apply. *Entry ticket and transfers to the Monaco Grand Prix qualifying session are extra. †Only available on coach holidays. ††Flights not included.

016260

RACE PRODUCTS

• EXPERT ADVICE • MASSIVE STOCK • RAPID DELIVERY •

PROFESSIONAL MOTORSPORT EQUIPMENT

alpinestars

MEDIA CODE: NZ252A

0844 375 2196
www.demon-tweeks.co.uk

LOW CALL RATE
CALLS MAY BE
RECORDED
FOR TRAINING
PURPOSES

Light Up The Night

LED 6000 Lumens
400 watts (Halogen)
60 watts consumption
96mm Diameter

£205 + vat

clearwaterlights.co.uk 01480 498640

MARKETPLACE

HOSPITALITY



MOTORSPORT EVENT
CATERERS

www.smokingdog.co.uk

Starters

SMOKING DOG HAVE BEEN CATERING FOR MOTORSPORTS TEAMS FOR MANY YEARS, GAINING EXTENSIVE EXPERIENCE IN LOOKING AFTER THE WHOLE TEAM. FROM OFFERING MEALS FOR THE MECHANICS IN THE PITS TO THE VIP TREATMENT OF TEAM SPONSORS.

Mains

WE HAVE DIFFERENT SIZED UNITS THAT CAN SEAT 40 TO 220. COMPLETE WITH LOUNGE AND ROUND DINING TABLES, YOUR GUESTS WILL BE GREETED IN A RECEPTION AREA AND IF SUNNY THEY CAN ENJOY THE PADDOCK ATMOSPHERE OUTSIDE IN THE GARDEN AREA.

Sides

WE ARE HAPPY TO PROVIDE OUR SERVICE AT YOUR OWN FACILITY. IF NEEDED WE HAVE EQUIPMENT AVAILABLE FOR HIRE. WITH SMOKING DOG, OPTIONS ARE ENDLESS AND WE LOOK FORWARD TO DISCUSSING ANY REQUIREMENTS YOU HAVE.

Dessert

THE SMOKING DOG TEAM OF TALENTED CHEFS USE ONLY QUALITY FRESH PRODUCE IN PREPARING YOUR MENU. OUR DELICIOUS FOOD IS COMPLEMENTED BY OUR EXPERIENCED AND PROFESSIONAL WAITING STAFF, TOGETHER CREATING THE SMOKING DOG EXPERIENCE.

info@smokingdog.co.uk +44 1428 288023

RACE PRODUCTS



Walkers Garage Ltd.
Northallerton DL7 9HT
0044(0)1609 777221
www.walkersgarage.co.uk
www.teknofibra-racing.co.uk
www.walkers-radiators.co.uk
www.tecno2.co.uk
www.energa-batteries.co.uk

Heat resistant material
to 1000 °C



Bespoke radiator
manufacture

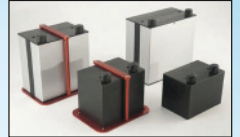

Up to 5 years life
expectancy

360 cranking amps – 1.28 kg.
600 Cranking amps – 2.25 kg.

- Importers & Manufacturers
- Teknofibra heat resistant materials
- Lightweight Lithium Batteries
- Walkers Competition Radiators
- Tecno2 Performance Products
- Competition wheel studs & nuts



COMPETITION DIFFERENTIALS

WIN 316 HORSES WITH A MOUSE



WIN YOUR DREAM CAR
FREE £5 WHEN YOU SIGN UP
GUARANTEED WINNER EVERY WEEK

ENTER NOW AT BOTB.COM/AUTOSPORT



KOBKUL SINEY
BMW 435i M-SPORT



JAMES MCLAUGHLIN
AUDI RS4 AVANT
+ £10K CASH



BOTB.COM
WIN YOUR DREAM CAR

Tel: +44 (0)20 7371 8866
Email: info@botb.com

MARKETPLACE

AWNINGS



Weatherweave
Awnings & Tarpaulins

» WORKING WITH YOU

ESSENTIAL FOR MOTORSPORT TEAMS & COMPETITORS

MAKE TRANSPORTING AND STORING EASY WITH A WEATHERWEAVE CONVERTED TRAILER

Weatherweave is the UK's leading specialist in bespoke awnings and trailer conversions. Featuring high specification PVC covers in a wide range of colours with artwork of your choice. Simple to use, durable, long-lasting and fire retardant to a British Standard, with an anti fungal lacquered finish. Our customer base spans from the general public, to international race teams and multi-global firms giving us experience second to none.

call us on: +44 (0) 1268 774 141 or visit: www.weatherweave.co.uk

MEMORABILIA

FINALLAP
Revealed:
The history of Formula One

Senna
Rindt
Prost
Villeneuve
Mansell
Pangio
Hawthorn
Ascari
Clark
Hamilton
Button
Pittipaldi
Piquet
Taruffi

FI Collectables • Team Memorabilia • Clothing
Buy • Sell • Evaluations
One of Europe's largest collections
+44 (0)1245 287588 • +44(0) 7771 920345 • sales@finallap.net
www.finallap.net

FINALLAP
For Everything Formula 1

Genuine Senna Memorabilia

RACE PRODUCTS



UK Distributor / Warehouse

Tel: +44 (0)1784 493 555

Fax: +44 (0)1784 493 222

Email: sales@glencoeltd.co.uk

Made in the USA

"Fuel Pumps for the Professionals":-
Original Equipment
Formula One
Race Teams
Rally Teams
Military



FAST ROAD

'IN TANK PUMP'
UPGRADES

From £56.08

Pump kits..... £60.40

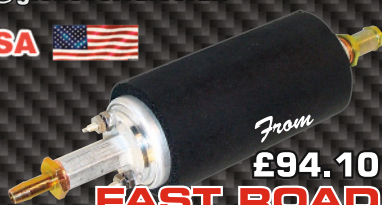

From £94.10
FAST ROAD
'OUT OF TANK'
(3 BAR) REPLACEMENT PUMPS

**400
450** LITRES/HR

EXTREME FUEL

For
EXTREME POWER

2 YEAR WARRANTY

**190
255** LITRES/HR

MOTORSPORT

'IN TANK PUMP' From £65.80

350 BHP From £74.64

500 BHP From £75.90



325 LITRES/HR
MOTORSPORT
'OUT OF TANK'

325 LTR / HR
5 BAR FUEL PUMP
(180 LTR / HR @ 3 BAR)

From £99.50

**MOTORSPORT
400 LTR/HR**

Upto 600 BHP

Pt.No. GST400 (PUMP ONLY)

GST400K (PUMP KIT)

From £92.40

**MOTORSPORT
450 LTR/HR**

Upto 750 BHP

Pt.No. GST450 (PUMP ONLY)

GST450K (PUMP KIT)

From £112.00

Prices exclude VAT @ 20%

www.glencoeltd.co.uk

BRITAIN'S FIRST ONLINE MOTORSPORT ENGINEERING DEGREE



Mosler GT. Winner
GT Cup, GTO Class
Championship

Learn Online and On-track with one of our Race Teams

College/School leavers – earn while you learn & gain practical motorsport experience

Mature Students – A second chance for a Motorsport Career, study flexibly alongside work & family

Foundation Degree (FdSc) Motorsport Engineering

BSc (Hons) Motorsport Engineering



Awarded by Staffordshire University (subject to validation). The National Motorsport Academy, in partnership with Staffordshire University, is pleased to launch Britain's first online Motorsport Engineering degrees. In this competitive, global industry, Motorsport Engineers must have the broad range of skills demanded by the top teams. Working closely with the industry, we have designed our courses specifically to meet their requirements. Not only will our graduates be qualified Motorsport Engineers with practical experience, they will also be innovative, resourceful and commercially-focused. Making them highly sought after graduates.

Why study with us?

- Low Tuition Fees £5,500 per year/level
- Entry from 100 points
- Mature students welcome
- EARN while you LEARN
- Choose your own start date
- Your own personal tutor
- Unlimited tutor support, 5 days a week,
- Stimulating, interactive, course content
- Online forum to meet other students
- Student loans available
- Free Autocad & industry software, NUS card
- Guaranteed work experience placement

How to apply

Final university validation is expected by June 2015. Please register your interest on our website motorsport.nda.ac.uk & we will keep you informed of progress.

What you will study

- Mathematics for Motorsport
- Race Car Design & Preparation
- R & D Simulation and Analysis
- Fundamentals of Motorsport Technology
- Fluid Mechanics & Thermodynamics
- Engine Design, Development & Simulation
- Vehicle Dynamics, Physics & Data Acquisition
- Work Experience & Research Study
- Advanced Engine Development
- Aerodynamics
- Hybrid & Electric Vehicle
- Final Project



New for 2015 Lotus GTE (Le Mans). Over 30 races planned.

MOTORSPORT JOBS

AUTOSPORT

Want to advertise a motorsport job?

If you are recruiting in motorsport and wish to advertise with Autosport in print and online please contact Jonathan.Whitehead@haymarket.com by email or call 020 8267 5908.

For all current vacancies advertised please visit our website www.autosport.com

NO.1 RACE MECHANIC

Arden International is seeking a No.1 race mechanic to join their team. The role involves responsibility for the preparation of the racing car, its associated parts & equipment.

The individual will have GP2, World series by Renault or F3 experience, be self motivated and flexible with the many hours during short periods and travel involved.

To apply please email your covering letter and CV to: arden@arden-motorsport.com



At McLaren we are totally committed to one objective..... To Win.

Within the inspirational McLaren Technology Centre we are constantly striving to develop a high performance culture. This focus and passion to encourage innovation, and the uncompromising commitment to achieve extraordinary things has enabled us to create one of the most successful and prestigious race teams in world motorsport.

We currently have the following exciting opportunities:

RRQ 31 RIDE MODELLING & ANALYSIS ENGINEER
 RRQ 35 AERODYNAMICIST (CFD)
 RRQ 40 VEHICLE DYNAMICS ENGINEER
 RRQ 1901 R&D ENGINEER
 RRQ 2521 GARAGE SUPPORT TECHNICIAN
 RRQ 3161 GARAGE SUPPORT ELECTRICIAN
 RRQ 3221 SIMULATOR DESIGN ENGINEER
 RRQ 3481 DESIGN ENGINEER - SUSPENSION
 RRQ 3981 MECHANIC - CAR SUPPORT

In our Operations and Manufacturing facility we currently have multi-axis machine tool opportunities:

RRQ 22/ 24/26/30 CNC MACHINE TOOL PROGRAMMER/ SETTER/OPERATOR

To apply please visit <http://www.mclaren-jobs.com/> quoting Autosport.



HONDA (FORMULA 1) IS SEEKING TO FILL A NUMBER OF POSITIONS IN MILTON KEYNES BOTH IMMEDIATELY AND IN THE FUTURE.

ERS Systems Engineer x2 - The purpose of this role is factory & race operation as an Energy Recovery System Engineer to support power unit development on Engines.

Knowledge, Skills & Experience:

- Strong Energy Recovery System (ERS) exposure
- Advanced user of datalogging systems and analysis packages
- Advanced ERS / Battery analysis, monitor and development experience
- ERS testing methodologies

Dyno Operator - The purpose of this role is Dyno Test operation as Dyno Operator at Factory to support power unit development on Engines.

Knowledge, Skills & Experience:

- Strong Dyno operation knowledge
- Power Unit testing methodologies
- AVL Puma system experience (preferred)
- ATLAS/System Monitor experience (preferred)
- Fault finding and diagnostic abilities

Trackside Mechanic - The purpose of this role is Factory and Race operation as Mechanic at Factory and Track side to support power unit development on Engines.

- Power Unit Mechanic at Trackside & Factory.
- Strong Engine build knowledge
- Fault finding and diagnostic abilities
- Excellent document presentational skills
- An adept communicator, be able to build good relationships across all cultures both internally and externally

It is a prerequisite that overseas travel will be required.

Honda (Formula 1) require candidates to have the following personal competencies: Engineering enthusiasm, Analytical, Self-motivated and competitive, Excellent communication skills, High integrity, Problem solving and decision making skills.

All applicants must have the right to work in UK on applying.

To apply please send your CV to

Nick Gerrell - nickg@gahl.co.uk



The Power of Dreams

THE OFFICIAL
FORMULA 1[®]
SEASON REVIEW 2014

**AVAILABLE FROM
ALL GOOD
BOOKSELLERS**

THE 2014 YEARBOOK
GIVES A UNIQUE,
ACCESS-ALL-AREAS PASS
BEHIND THE SCENES OF
ONE OF THE MOST
THRILLING F1 SEASONS
OF RECENT YEARS



WWW.F1YEARBOOK.COM

CLUB AUTOSPORT

NATIONAL RACING • HISTORICS • RALLYCROSS • HILLCLIMB • TRACK TESTS



Norris (right) lost win for illegal pass on Leist (left)

ROB LADBROOK
GROUP NATIONAL EDITOR



robert.ladbroke@haymarket.com
@LaddersMN

Norris excluded from opener

Erstwhile MSA Formula points leader loses second Brands Hatch win

LANDO NORRIS HAS LOST HIS MSA Formula points lead after being excluded from victory in the final race of the opening weekend at Brands Hatch on April 5.

The 15-year-old, who won the opening race at Brands earlier this month, took victory in race three on the road but was subsequently excluded for passing rival Matheus Leist under yellow flags during a safety car period.

Norris's Carlin squad has appealed the exclusion and stewards will meet to review the incident at the Donington Park round this weekend. James Pull, who finished second on the road, has been awarded victory, while the decision also knocked Norris off the top of the points standings.

Daniel Ticktum now leads the title race, with Norris 22 points

behind in fifth place.

"I'm disappointed in the exclusion," said Norris.

"But I'm now focusing my attentions on this weekend and ensuring that I'm scoring consistent top-three finishes.

"Regular podiums and wins are important to make sure that I'm in contention for the title. Leist has been a bit of a surprise but he has a good amount of racing experience from Brazilian F3 Light last year.

"He's gone from a quicker car into a slower one so the racing is more natural to him."

Norris's team boss, Trevor Carlin, criticised the decision, claiming that the race officials had misinterpreted a brief mix-up as a misdemeanour.

"Drivers have organisational radios and ear pieces," said Carlin. "We're not allowed radios ourselves

— it's just for race control to tell the drivers what's going on.

"At the safety car, race control told the drivers, 'safety car'. Lando came around Clearways just following Pull. Leist comes barrelling past at 200mph because he probably didn't understand what was being said.

"Officials were just getting around to putting the safety car board out. Leist then realised what was going on, pulled to the left and let Lando past. All the race director saw was that. He said the safety car board wasn't out until the line.

"But the rules state it's when the SC board or flag are out or 'by any other means' [including the radio call from race control]."

Carlin also questioned the delay in the appeal being heard.

"I have already appealed it and this is typical British motor racing: they can't be arsed to hear it until Donington," he added.

"All the drivers were brilliant — Leist, Lando and Pull — and they went on and had a great race."

Responding to Carlin's point about the appeal, MSA Formula promoter Sam Roach said: "This is in the hands of the clerk of the course and MSA stewards, and we await their decision.

"The stewards were unable to hear the appeal at the time and will hold their review at Donington."



Norris appeal will be heard at Donington

ENGINEERING HAS ALWAYS

been one of Britain's strong points, and nowhere was that more evident last weekend than at Silverstone.

The show was stolen on Sunday by the World Endurance Championship but Saturday marked the start of a new era for international motorsport, and it was spearheaded by British marques.

Five cars lined up for the inaugural LMP3 class within the European Le Mans Series grid — all designed, built and supplied by Ginetta-Juno.

Lawrence Tomlinson's Leeds-based Ginetta firm and the Juno team — led by founder Ewan Baldry — deserve a huge amount of credit for their work in getting the machines to the grid. When the LMP3 project was announced, three manufacturers released plans for projects, but only Ginetta has made it a reality.

It's a fantastic testament to the dedication of the engineers involved in the project, all of which worked around the clock to get the carbon-tubbed machines ready in such a short lead-time. The last car turned up at the track having rolled off the assembly line that morning and all sailed through morning scrutineering. Four of the five also completed the full four-hour race distance without any major issue, and virtually zero prior testing.

Yes, most of the mechanical components in the cars are already proven, such as the five-litre Nissan V8 engine and the Xtrac gearbox, but it's the human skill that binds all of the components together in harmony that's so impressive in this case.

Ginetta-Juno has proven that British engineering is still the most efficient in the world. The car's next outing? Just the small matter of the Britcar 24 Hours at Silverstone. It'll be more of a public test, but one that should prove the car's potential as a thoroughbred endurance racing stepping-stone.



LMP3 will return to Silverstone



**Middlehurst is
back in FF1600**

Formula Ford 1600

Andy Middlehurst in FF1600 race return

HISTORIC RACING ACE ANDY

Middlehurst will return to Formula Ford 1600 this Saturday at Oulton Park after a 32-year absence from the category.

The 51-year-old former British Touring Car Championship racer will drive the Mygale GV15K campaigned by son Chris for Geva Racing in the National Formula Ford 1600 Championship.

He is planning further outings in Champion of Oulton rounds, and could also contest the Walter Hayes Trophy and Formula Ford Festival.

"I'm probably going to do most of the Champion of Oulton rounds, partly to keep my hand in for historic racing and because it's a bit of a challenge," said Middlehurst. "At the end of the year, there's a possibility that I might do the

Festival and the Walter Hayes with Chris. We might get a second car and do those against each other!"

Middlehurst, a frontrunner in FF1600 in 1982 and '83, will test on the Oulton Park Fosters circuit on Friday ahead of Saturday's double-header. "I'm aiming for a podium finish this weekend but I like to think I'm still competitive and able to win," he said.

"I've tested for one session at Donington and I was half a second slower than Chris after a short stint so I think I'll be on it."

The Middlehurst Mygale made its first racing appearance of the season in the National FF1600 opener at Silverstone two weeks ago with Middlehurst Jr. Engine damage restricted him to eighth and ninth-place finishes.

Italian Clio Cup

Files turns his back on UK drive for Italian job in Clios

FORMER RENAULT UK AND

European Clio Cup champion Josh Files will contest the Italian Clio Cup with title-winning squad Rangoni Corse.

The 24-year-old, who won both the UK and European titles in 2012, raced a part-campaign last season but will now compete for the Italian squad having been offered a fully-paid drive.

He was supposed to be a Racing for Heroes driver in the Porsche Carrera Cup GB this year but the scheme failed to raise the required funding.

"Rangoni approached me at the end of January," said Files, who won the second race of last weekend's opening Clio round at Imola. "The Eurocup was the plan but the team couldn't get a newly built car in time. I was then offered the Italian drive.

"The set-up of the car is different than I'm used to. It behaves very differently into and out of corners. I have to brake harder and longer than before.

"There are past champions returning and my team-mate, Simone Iacone, finished second last year. Plus I've only raced at two of the circuits on the calendar."



GT Cup

Oulton Park GT Cup debut for BTCC racer Ingram

BRITISH TOURING CAR

Championship racer Tom Ingram will contest the opening GT Cup round at Donington Park later this month in a Ferrari 458 Challenge racer.

The 21-year-old, who is competing in his second BTCC season in a Speedworks Motorsport Toyota Avensis, will partner Marcus Hoggarth at the April 25-26 event.

Hoggarth, who was Ingram's team-mate in the Ginetta GT Supercup in 2012 and '13, will



campaign a full GT Cup season, while Ingram is hopeful of entering all GT Cup rounds this year which do not clash with his BTCC commitments.

"I'm looking forward to entering the GT Cup this year," Ingram said. "Marcus wanted someone to partner him and I jumped at the chance.

"It will be the first proper bit of GT racing I have done. The most powerful GT car I've driven is the G55 so hopefully this will open up another avenue of racing for me."

Comprehensive motorsport insurance products to keep you on track;

- 🚗 Worldwide On Track
- 🚗 Personal Accident
- 🚗 Storage and transit
- 🚗 Track day
- 🚗 Liability
- 🚗 Commercial

Please complete an online quote request form at – www.ryanmi.com

Email – info@ryanmi.com Tel – +44 (0)1799 524202

Ryan Motorsport Insurance Limited is an appointed representative (557405) of Independent Broking Solutions Limited who are authorised and regulated by the Financial Services Authority, registration number 312026

RYAN
MOTORSPORT INSURANCE

Silverstone Classic

Wrathall to make racing comeback in Super Touring

BRITISH TOURING CAR RACE

winner Frank Wrathall will return to competition in the Silverstone Classic, but a BTCC comeback is not a target.

Wrathall won the 2012 BTCC Brands Hatch finale in his family run Dynojet Toyota Avensis before finishing 16th in the standings the following season. He then served time in prison after a fatal road-traffic accident.



Wrathall has raced Cavalier

Wrathall will make his racing return at the Super Touring races at the Classic on July 24-26. He previously raced a Vauxhall Cavalier and recently tested series boss David Jarman's Nissan Primera, but his car for the event has yet to be confirmed.

"I was a bit nervous beforehand, but as soon as I got my helmet on it all came back very quickly," said the 28-year-old. "Ideally we would race in [co-organiser] Jonny Westbrook's Audi A4 or Volvo S40, but they're not going to be ready."

Wrathall did not rule out further historic outings in future, but he believes a BTCC return is unlikely as the family team sold its entire equipment following the 2013 season.

"It would have to be the right opportunity and I'm not desperate to do a full-time programme," he added.

HUMBLE PYE

The voice of club racing



Ex-Minardi racer Barilla will drive 1981 Williams

"LE MANS WINNER BARILLA JOINS HISTORIC F1 FIELD"

At almost 54, Paolo Barilla has ticked most boxes on aspiring racers' wish lists. While never equipped to be a Formula 1 great, the Milanese pasta magnate served his apprenticeship in F3, F2 and F3000 and competed in F1 in 1990 for Minardi. He won Le Mans en route to the top of the single-seater ladder too, sharing a Joest Racing Porsche 956 with Germans Klaus Ludwig and 'John Winter' in '85.

That big success came 30 years ago, yet the Italian still loves racing – not with the all-consuming passion of compatriot Emanuele Pirro, but who does? – to the extent that he won last year's Monaco GP Historique F3 race in a Chevron B34. This weekend, the 1975 national 100cc karting champion saddles a 1981 Williams FW07C in the opening round of the FIA Masters Historic F1 championship at Barcelona.

Although comprising essentially amateurs, it's a sensational 33-strong field that gathers on the Spanish GP circuit. Four Williams 'wing cars' (two more FW07Cs and an FW08), Brabham BT49C, Lotus 79 and 91 and Ligier JS11/15 are as good as the era gets, but such is the diversity of driving talent that one of the Arrows A4s, an Ensign N180, a later Ligier or a Tyrrell 010 could win from the Head division.

Fresh from his searing Thruxton HSCC demo over Easter, Michael Lyons (Hesketh 308E) certainly has ideas of winning, as does Fittipaldi-

class rival Katsu Kubota (March 761), while double Thoroughbred GP champion Martin Stretton – winner of the best Historic F1 race I've seen at last year's Silverstone Classic – and Andy Wolfe, in Tyrrell 012 and 011 respectively, can do it from the Lauda split.

Former International SuperSports Cup titlist Wolfe hasn't raced in the arena for 15 years, yet was setting competitive lap times out of the box last month in the flat-bottomed chassis acquired from Nick Mason. Andy brings with him past FIA Lurani Trophy champ Jason Wright, who has acquired a gorgeous Shadow DN8 for his graduation, having impressed in a Lola T70 sportscar of similar power last year.

What delights (and amazes) me is the number of competitors making the jump. Never before has there been such an influx of new drivers to Historic F1. With short-stroke Cosworth DFV engines at £100k a pop, business is clearly very healthy somewhere.

Marcus Pye

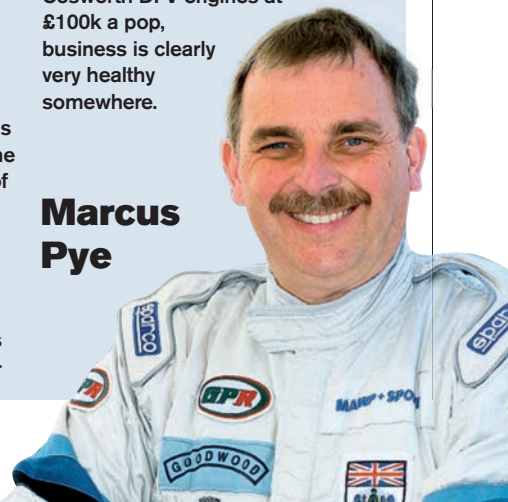

First public F4 run for Schumacher

Michael Schumacher's son Mick's ADAC Formula 4 preparation continued last week with his first public run. The single-seater rookie took part in the collective test at Oschersleben ahead of the first round of the new series at the same track on April 25-26. Schumacher will drive for Van Amersfoort Racing in his first year out of karting.

MSA Formula

MSA Formula grid swells

OLLIE PIDGLEY WILL MAKE HIS

MSA Formula debut with the Richardson Racing squad at the second round at Donington Park this weekend.

Pidgley moves into single-seaters after spending his first season in cars in the Clio Cup Series last year, finishing sixth.

The 17-year-old will line up alongside Louise Richardson, who took part in the opening event at Brands Hatch. Pidgley had completed winter testing with fellow MSA Formula squad Team Pyro but did not compete at the opening rounds in Kent earlier this month.

Richardson's brother Andrew, who wants to run three cars, said: "We saw

Ollie wasn't racing, so we worked with him to try to make sure he could."

He will be one of two additions to the grid this weekend, as JTR's Ameya Vaidyanathan joins having missed Brands Hatch due to a clash with his concurrent BRDC Formula 4 campaign.



Vaidyanathan has tested with Pyro

SUBSCRIBE TO **AUTOSPORT** AND GET...

★★ TEAM JENSON ★★

★★ TEAM ALONSO ★★

A FREE McLAREN-HONDA CAP



+PLUS+

**FREE DIGITAL EDITION
SUBSCRIPTION & UNLIMITED
ACCESS TO AUTOSPORT.COM**



FREE GIFTS

- ✓ **FREE McLAREN HONDA CAP**
Choose from either Team Jenson or Team Alonso as this month's free gift. The cap comes with unique driver number on the front and embroidered signature on the back.
- ✓ **FREE SUBSCRIPTION TO THE AUTOSPORT DIGITAL EDITION** and unlimited access to **AUTOSPORT.com**

SUBSCRIBE NOW!



- ✓ Save 27% on the cover price
- ✓ Pay just £34.99 every 13 issues by Direct Debit

Visit: www.themagazineshop.com/taspo/m0315p

08448 488 817

Or call and quote **M0315P**
Please have your bank details ready.

Offer ends April 23 2015.

themagazineshop.com

THE BENEFITS OF SUBSCRIBING!

- ✓ Never miss an issue
- ✓ Free delivery direct to your door
- ✓ Unlimited access to news and views from the paddock
- ✓ Access to subscriber-only analysis and comment

TERMS AND CONDITIONS This offer is open to UK residents only. If you require any assistance following the purchase of your subscription, then you can speak to a member of our customer service team on 01795 592 974; calls are charged at local rate. Overseas rates are available on +44 (0) 1795592 974. Please allow 35 days for delivery of your gift and first issue. The gift will be sent under separate cover from the magazine. Should we run out of gifts, you may be offered an alternative gift – there is no cash alternative. To activate your AUTOSPORT online account visit <https://secure.autosport.com/subs/activate.php> and enter your activation code (your personal magazine subscriber number which will be included in your welcome email/letter) along with your email address to access your extra AUTOSPORT content. Direct Debit rates are valid for one year after which they are subject to change – should prices change we will inform you in writing. We ask that you enter into a Direct Debit agreement with the intention that your subscription will continue for a minimum period of 12 months, even if the frequency of payment is for a shorter period, however, you will still have the right to cancel your Direct Debit in accordance with Direct Debit Guarantee. Should you wish to cancel your subscription it will be cancelled on expiry of the current term which will not be refundable, other than in exceptional circumstances. If a gift is included as part of the subscription offer we reserve the right to request the return of the gift. Details of the Direct Debit Guarantee are available on request. Savings are based on the standard UK cover price of £3.70. Offer ends April 23 2015. Haymarket Media Group Ltd uses a best-practice layered Privacy Policy to provide you with details about how we would like to use your personal information. To read the full privacy policy please visit our website www.haymarket.com/privacy or call us on 08448 482 800. Please ask if you have any questions as submitting your personal information indicates your consent, for the time being, that we and our partners may contact you about products and services that will be of interest to you via post, phone, email and SMS. You can opt out at ANY time by emailing datacontroller@haymarket.com or calling 08448 482 800.



New prototype will contest 24-hour race

Britcar

Ginetta LMP3 to Britcar 24H

GINETTA WILL ENTER ITS brand-new LMP3 prototype in next week's Britcar 24 Hours at Silverstone. The Team LNT car made its debut in the European Le Mans Series opener at the track last weekend and will be driven in the April 25-26 event on the Grand Prix circuit by Mike Simpson, Charlie Robertson and marque

boss Lawrence Tomlinson. Robertson and Olympic cycling legend Chris Hoy scored class victory in last Saturday's race but Simpson, who finished second alongside Hoy's Nissan stablemate Gaetan Paletou, said there was a large amount of work to be done. "We're already out testing again since the weekend, working on optimising the

braking," he added. "We want to push the car like hell. As the manufacturer, we need to be ahead of the customers. "With 5000 kilometres [more than 3000 miles] next weekend, the data we will gather will be invaluable. "It's more of an engineering exercise to see if the car can cope with the strains of proper endurance competition."



In brief

Ayres in Juniors plan
Karter Anthony Ayres will graduate to car racing later this season in the Ginetta Junior Championship with the Mectech Motorsport squad. The 15-year-old has a three-year association with the Essex squad and plans to race in a number of rounds towards the end of this season before mounting a Winter Series campaign.

Brands Hatch app
Brands Hatch spectators will now be able to follow race events on an app launched by the circuit's owner, MotorSport Vision. Brands Hatch LIVE! Xtra, designed for iPhone and iPad, shows the top 20 drivers and the position of vehicles on track. There are plans for an Android version and to expand to other MSVR circuits.

FF1600 Cadwell return
FF1600 guru James Beckett is "aiming for at least 15 cars" for his Super Series Formula Ford contest at the Champion of Cadwell this weekend, which brings contemporary FF1600 racing back to the circuit for the first time in 10 years. The Super Series began with just a nine-car field at Oulton Park at Easter.

ERAs for anniversary
A trio of ERAs head the entry for the VSCC's 30th Patrick Lindsay Memorial race at Silverstone this weekend. Nick Topliss (R4A), Julian Wilton (R7A) and Terry Crabb (R12C) will join James Baxter (in Mac Hulbert's R4D) and Duncan Ricketts (E-type GP1) in the inaugural Premier Cru Pre-1941 race. Calum Lockie will drive Sean Danaher's ex-'Raph' Maserati 6CM.

Lane breaks leg
X-rays have confirmed that Mike Lane, who had a miraculous escape from an enormous crash in his Classic Clubmans Mallock at Thruxton on Easter Sunday, has broken a bone in his lower leg.



Combe FF1600

Moyers bolsters Combe field

MICHAEL MOYERS IS CONTESTING a full championship for the first time in 10 years this season as he joins a growing Castle Combe Formula Ford 1600 field with Kevin Mills Racing.

The 30-year-old ex-BRDC Single Seater and Formula BMW racer has largely restricted his racing to the Walter Hayes Trophy in recent years, but has extended a KMR deal that began with last year's Combe Carnival and WHT.

Moyers joins regular race winners Roger Orgee and Nathan Ward in the KMR line-up. The Combe field has been further bolstered with Fisher brothers Josh (the 2008 champion) and Felix keen to contest their first full seasons in recent years, opening-round winner Jonathan Hoad and reigning double champion Adam Higgins returning, and Luke Cooper aiming for more regular appearances.

THE WINNER OF THE RENAULT UK Clio Cup from this season onwards will be awarded the trophy handed to Barrie Williams after winning the Renault Alpine V6 Turbo Europa Cup support race to the 1985 European Grand Prix at Brands Hatch. 'Whizzo' Williams, a star of British tin-top racing for at least three

decades, has a strong association with Renault UK that encompasses winning the 5 GT Turbo crown in 1987. He has donated the trophy to Renault as part of the newly crowned champion's prize. "Renault has always been good to me down the years so I wanted to give something back," said Williams.



Radical European Masters

Debut Euro win for new Radical Spyder

STUART MOSELEY AND JAAP Bartels gave the new Radical Spyder its first win at the Radical European Masters round at Jerez. James Swift won the first race, his first in a Radical for three years, with ex-Formula 3 racer Victor Correa sharing

the second-placed SR8 with Jon Harrison. Jamie Patterson was also back out for the first time in five years, sharing his SR8 with Alex Kapadia. They looked set to win race two but picked up a late penalty for a short pitstop, dropping them to third behind Terrence Woodward/

Ross Kaiser and Harrison/Correa. Both Harrison/Correa and Swift led race three, but when Swift made his stop Moseley took charge. In the SR3 class, reigning champions Andy Cummings and Bradley Ellis won all three races.



SWINGING 60s SNETTERTON, APRIL 12 CSCC

Ginetta is class of giant grid

WITH ALL CLASSES OF THE EVER-popular Swinging Sixties series running as a combined grid on the Snetterton 300, a total of 43 cars took part in qualifying – just two below the circuit limit. It made for a frenetic race.

Despite the quality and quantity of the field, there only ever looked like one team that was going to win it, as the pairing of Mark Halstead and Stuart McPherson guided their rapid Ginetta G4 to an impressive victory. Halstead took the first stint, pulling almost half a minute clear before peeling into the pits to hand over to his team-mate. Once the dust had settled after the mid-race stops, McPherson was able to ease clear to secure the win.

The closest challenger almost throughout was the powerful Camaro of Raymond Barrow, who (pitstops aside) kept the gap to the leader at 10 seconds or less for almost all of the race. “Very pleased with that,” he said. “I thought I was in with a chance after the driver changes, but I couldn’t catch that Ginetta.”

Half a minute further back, proven Swinging 60s frontrunner Mark Campbell claimed third place at the flag and the final podium spot. It was an impressive comeback for Campbell, who had spent much of the previous year focusing almost exclusively on racing and time trialling from the seat of a bicycle rather than working the wheel of



Near-capacity field at the start

his nimble Triumph. Campbell could have been forgiven if he had appeared a little ring rusty on his return to the series, but there was none of it. Instead he

guided his TR5 to a creditable, if lonely, third place.

“I’m over the moon” confirmed a satisfied Campbell, acknowledging that the Ginetta was just too quick

Mensley keeps his Focus to win after Tongue slips back

A GREAT START FOR PAUL Mensley propelled his Ford Focus into the lead of the combined **Tin Tops and Puma Cup** field ahead of pole-man Nigel Tongue’s Peugeot. Despite tumbling to fifth by the end of lap one, Tongue recovered to take runner-up spot. A late safety car period bunched up



the field, but Mensley kept his cool on the re-start to seal victory.

The **Morgan Challenge** started 2015 with strong grids for its season-opening double-header. Despite the best efforts of young charger William Plant in both races, reigning champion Keith Ahlers had enough of an edge to secure the 74th and 75th wins of his Morgan Challenge career.

Despite wet conditions limiting Tim Davis’ Tuscan to seventh on the grid for the **New Millennium** field, he bounced back in the bone-dry race, surging to the lead past pole-man Chris Randall’s Lotus Europa within a lap. But once Randall handed over to co-driver Fabio Randaccio it was only a matter of time before the latter reeled him in, and built a lead.

Sam Clarke Jr was the man to beat in the opening skirmishes of this year’s **Jaguar Saloons/GTs** championship, securing a brace of wins. He pulled away from last year’s runner-up James Ramm to dominate race one, while the ever-rapid David Howard recovered from a disappointing qualifying to secure third. Clarke Jr led throughout again in race two.

An early safety car period proved one of the defining moments of the **Sports v Saloons** pitstop race as it tempted in some of the front-runners for an early stop. While some lost out, Simon Smith’s Caterham pitted with minimal delay and went on to claim an impressive win.

Having claimed victory in the Swinging Sixties race earlier in the

day in a Ginetta G4, Mark Halstead and Stuart McPherson switched to a Lotus Elan to win the hour-long **Classic K** enduro. While the duo dominated up front, a battle developed behind for runner-up spot, with Fabio Randaccio overtaking Tom Skinner in the closing stages.

Martyn Adams (Triumph TR7), Nicholas Olson (Lotus Esprit), Matthew Wurr (Marcos Mantula) and Mark Chilton (Porsche 928) were among the pace-setters in the **Future Classics**. Sadly Chilton retired on lap two, and Wurr’s charge through the field was scuppered when he mistakenly pitted thinking he’d been given a penalty. A determined Adams powered onto Olson’s rear to snatch the win.

Ginetta controlled
Swinging 60s race



ALL PICS: RICHARDSTYLES

Owen and Smith share Sevens wins

STEVE OWEN CONVERTED pole to victory in the Group 1 Magnificent Sevens race, but had to overcome some frantic scraps in the opening laps.

The trio of Owen, Neil Palmer and Oliver Clarke briefly ran three abreast as they jostled for position on the first lap before they spread out, allowing Owen to pull away in the closing laps.

It could still have gone wrong for him though, as Owen mistakenly assumed a lapped backmarker he encountered was on the same lap.

The pair enjoyed a brief battle until the chequered flag thankfully brought the race to a conclusion with Owen securing



Owen took
Magnificent Sevens
victory in Group 1

a comfortable win. An inspired Daniel Williamson (enjoying his first race weekend) snatched second ahead of Wayne Crabtree.

In the faster Group 2 race, Danny Winstanley looked to have the race in his control, pulling out a lead over his rivals in the early stages. But having dropped back after making his pitstop relatively early,

Winstanley quickly returned to the pits and retired.

In his absence, first reigning champion Peter Ratcliff and then Tom Eden enjoyed spells in the lead, an inspired Simon Smith, closed in on both of them before moving ahead and securing the winner's trophy by less than a second.

and his car is not yet quite as good as it used to be.

Jon Wolfe's TVR Tuscan took fourth place ahead of Fabio Randaccio's nimble Lotus Elan. In an impressive stint, the rapid Randaccio surged from midfield to claim a fifth-placed finish.

However, not all the frontrunners had a smooth run. David McDonald (Triumph TR6) had chased after the leaders almost throughout, moving up to fifth in the opening laps and making similar progress after his mandatory pitstop. Sadly his charge fell flat when an overheating issue forced him to coast into retirement on the infield section just four laps from home.

● Oliver Timson



Mather/Spencer
won Modern Classics

The **Modern Classics** thrash looked set for a dramatic finish, as the BMW M3s of race-long rivals Mark Smith/James Moulton-Smith and Paul Mather/Lee Spencer remained locked together at the front almost throughout. But just as the climax neared Moulton-Smith's machine ground to a halt on the exit of Riches, handing Spencer a decisive advantage.

RESULTS

SWINGING 60S (18 LAPS) 1 Mark Halstead/Stuart McPherson (Ginetta G4) 41m17.695s (77.64mph); 2 Raymond Barrow (Chevrolet Camaro) +14.651s; 3 Mark Campbell (Triumph TR5); 4 Jon Wolfe (TVR Tuscan V8); 5 Nicholas Randall/Fabio Randaccio (Lotus Elan); 6 Ben Gough/Iain Daniels (Marcos). **CW** Barrow; Campbell; Dave Bailey (Triumph TR4); Adam Cunningham (Austin Healey Sprite); Thomas Pead (BMW BMW 1600Ti); Stuart Daburn (Triumph TR6); Jon Sandilands (MGB Roadster); Roger Bowman (Jaguar Mk1 Saloon). **FL** McPherson 2m12.121s (80.89mph).

MAGNIFICENT SEVENS - GROUP 1 (18 LAPS) 1 Steve Owen (Caterham 7 Blackbird) 41m35.575s (77.09mph); 2 Daniel Williamson (Caterham Supersport) +21.670s; 3 Oliver Clarke/Wayne Crabtree (Caterham Sigma); 4 Fraser Greenshields (Caterham Supersport); 5 Alex Saunders/John Saunders (Caterham Supersport); 6 Michael Jordan/Robert West (Caterham Supersport). **CW** Williamson; Ian Payne (Caterham Roadsport A). **FL** Philip Horne (Caterham Blackbird) 2m10.672s (81.79mph).

MAGNIFICENT SEVENS - GROUP 2 (18 LAPS) 1 Simon Smith (Caterham CSR) 40m30.380s (79.15mph); 2 Tom Eden (CSR) +0.972s; 3 Peter Ratcliff (Caterham C400); 4 Jonathan Gibbs (C400); 5 Christian Pittard (Caterham 7); 6 Gary Bate (C400). **CW** Gibbs; Pascal Green/Richard Green (C400); Graham Charman (Caterham Superlight R400); Peter French (Superlight). **FL** Smith 2m01.954s (87.64mph).

TIN TOPS & PUMA CUP (15 LAPS) 1 Paul Mensley (Ford Focus) 40m02.012s (66.74mph); 2 Nigel Tongue (Peugeot 306) +2.691s; 3 Russell Hird (Honda Integra); 4 Kester Cook (Ford Fiesta Zetec); 5 Carl Chambers (Peugeot 306 Rallye); 6 Colin Simpson/Steven Simpson (Peugeot 206 RC). **CW** Cook; Toby Harris/Lisa Selby (Ford Puma);

Ray Honeybone (Renault Clio); William Hardy (Vauxhall Nova GTE); Chris Boardman/James Moulton-Smith (BMW 318ti); Luke Johnson (Ford Puma). **FL** Tongue 2m12.521s (80.65mph).

MORGAN CHALLENGE (10 LAPS) 1 Keith Ahlers (Plus 8) 21m33.028s (82.65mph); 2 William Plant (Plus 8) +3.794s; 3 Jeremy Plant (Plus 8); 4 Jonathan Edwards (Plus 8); 5 Tony Lees (Plus 8); 6 Richard Plant (Plus 8). **CW** Edwards; Christian McCarty (Roadster); John Milbank (4/4); Tim Ayres (Plus 8). **FL** W Plant 2m07.547s (83.79mph).

RACE 2 (9 LAPS) 1 Ahlers 19m16.020s (83.21mph); 2 W Plant +2.884s; 3 Jeremy Knight (Plus 8); 4 Lees; 5 Andrew Thompson (Plus Four Baby Doll); 6 Edwards. **CW** Lees; McCarty; Ayres; Henry Williams (4/4 Sport); Michele Bailey (Plus 4). **FL** W Plant 2m06.656s (84.38mph).

NEW MILLENNIUM (19 LAPS) 1 Chris Randall/Fabio Randaccio (Lotus Europa) 41m02.685s (82.46mph); 2 Tim Davis (TVR Tuscan) +51.457s; 3 Darren Johnson (Renault Clio Cup); 4 Dan Ludlow (Honda Civic Type R) 5 Bruce White (Renault Clio Cup); 6 Bob Hosier/Nick Barton (Seat Leon). **CW** Davis; Johnson; Barton; Hosier; Dennis Hays/James Grange (Ford Mondeo). **FL** Randaccio 2m02.482s (87.26mph).

JAGUAR SALOONS & GTS (9 LAPS) 1 Sam Clarke Jr (XJS) 20m39.392s (77.61mph); 2 James Ramm (XJS) +18.252s; 3 David Howard (XJ12); 4 Guy Connew (XJ6); 5 Colin Philpott (XJS); 6 Ian Drage (XJS). **CW** Howard; Connew; Alasdair McGregor (X300). **FL** Clarke Jr 2m16.556s (78.26mph). **RACE 2 (9 LAPS) 1 Clarke Jr 20m40.173s (77.56mph);** 2 Howard +16.927s; 3 Ramm; 4 Philpott; 5 Rodney Frost (XJS); 6 Connew. **CW** Howard; Frost; McGregor. **FL** Clarke Jr 2m17.025s (78.00mph).

SPORTS SALOONS (15 LAPS) 1 Simon Smith (Caterham CSR) 35m36.679s (75.03mph); 2 Gary Bate (Caterham C400) +14.819s; 3 Pascal Green (Caterham C400); 4 Chris Randall/Fabio Randaccio (Lotus Europa); 5 Darren Johnson (Renault Clio Cup); 6 Tom Eden (Caterham CSR). **CW** Ian Towers (RAW Striker); Michael Jordan/

Robert West (Caterham Supersport); David Grover (Porsche 968); Steven Chaplin/Adam Chaplin (MG Midget). **FL** Randaccio 2m00.757s (88.50mph).

CLASSIC K (26 LAPS) 1 Mark Halstead/Stuart McPherson (Lotus Elan S2) 1h01m33.957s (75.22mph); 2 Nicholas Randall/Fabio Randaccio (Lotus Elan) +1m06.303s; 3 David Garrett (Lotus Elan 26R); 4 Richard Skinner/Tom Skinner (Marcos 1800 GT); 5 Michael Gray/Kallum Gray (Jaguar E Type); 6 Brian Lambert (MGB Roadster). **CW** Gray/Gray; Lambert; Nigel Adams/Lyndon Griffin (Lotus Elan S1); Richard McKoen (Triumph TR4A); David Thompson/Chris Conoley (TVR Grantura MkIII); Mark Dunn (Austin Healey 3000). **FL** Randaccio 2m16.182s (78.48mph).

FUTURE CLASSICS (17 LAPS) 1 Marty Adams (Triumph TR7 V8) 40m04.680s (75.55mph); 2 Nicholas Owen (Lotus Esprit S3) +3.930s; 3 Matthew Lewis (Marcos Mantula); 4 Stuart Jefcoate (Porsche 911 Carrera); 5 James Neal/Neil Harvey (Porsche 964 Carrera 2); 6 Josh Sadler/Mark Henderson (Porsche 911ST). **CW** Olson; Lewis; David Bryant (Toyota MR2 MkII); Jamie McHugh (Porsche 944 S2); Jack Sandle-Brownlie/Kevin O'Brien (Rover 216 GTI); Sam Polley (MGB). **FL** Matthew Wurr (Morgan Plus 8 R) 2m13.566s (80.02mph).

MODERN CLASSICS (18 LAPS) 1 Paul Mather/Lee Spencer (BMW E36 M3) 40m45.490s (78.66mph); 2 Peter Morris (Porsche 996) +52.328s; 3 Barry O'Neill/Andrew Szymanski (BMW E36 M3); 4 Bryan Bransom (BMW E36); 5 Martin Johnston/Andy Woods-Dean (BMW M3); 6 Edward Leigh (BMW E36). **CW** Gerry Taylor/Paul Stephens (Porsche Boxster); Paul Livesey (Porsche 968CS); JM Littman (Porsche Boxster 986); Andy Napier (Lotus S1 Elise); Rob Baker (Smart Brabus Turbo); Richard Senter/Karen Phillips (Subaru WRX). **FL** Mather 2m10.330s (82.00mph).



Herbert took two wins...

CLIO CUP SERIES ROCKINGHAM, APRIL 11-12 BARC

Last-lap move denies Herbert hat-trick

WESTBOURNE MOTORSPORT'S LUKE

Herbert took two wins from the opening three rounds to open a substantial 22-point lead at the top of the championship, while privateer Paul Streater enjoyed his maiden Clio win in race three.

It was Herbert's team-mate Sam Randon who led the way in the wet

qualifying session to secure pole position for round one but, after making a good start to the opener, Randon was caught out on some fluid at the exit of Pif Paf.

As the erstwhile leader slid wide and out of contention, Herbert motored past and went on to win by four seconds from Finesse

Motorsport's Andy Jordan – up from sixth on the grid – and 20Ten Racing's Brett Lidsey.

Herbert did the double in round two, but only after immense pressure from Streater dissipated on the last lap at Deene when he had a spin trying to avoid contact as the duo battled for the lead.

Instead, Randon took second and Lidsey again rounded out the podium with a strong third. Streater recovered to fifth behind Jordan.

In round three, Streater finally took the race victory he threatened in his debut season last year and also set fastest lap. Having to battle his way through from sixth on the grid, the privateer produced a fantastic drive and managed to pass Herbert at Deene on the last lap to



claim a memorable triumph.

Jordan had been in contention for victory, but a puncture ruined his chances, so Randon completed the podium in third to cap a strong season-opener.

Ben Davis, driving the Racing for Heroes Academy Clio, started on only his second weekend in car racing with all three Sport Class wins. He also took best overall finishes of fourth in races one and three.

Luke Pinder utterly dominated the Michelin Clio Cup Road Series, taking all three victories and bonus points for fastest lap in each race, having also locked out pole position for each contest. Racking up a perfect points tally for the weekend, he also posted a new lap record for the converted roadcars.

Pinder's Jade Developments team-mate Jake Honour sealed a hat-trick of second-place results to get his year off to a strong start, while Nic Harrison finished third with 20Ten in the first two contests. Championship newcomer Matt Fincham bagged his first podium in round three.

● Marc Orme



... but Streater nicked the finale

Driven Wells dominates Bimmer opener

POLE-POSITION QUALIFIER COLIN

Wells got his Kumho BMW Championship season off to a sparkling start, taking two very comfortable wins in the Class A contests in his BMW M3 CSL.

He also posted fastest lap in each outing for good measure.

In race one he trounced the opposition with a near 18-second margin after 14 laps. E-While his advantage in the second encounter wasn't quite as substantial, he was still 10 seconds to the good at the chequered flag. BMW E46 M3 drivers Richard Bacon and James MacIntyre-Ure took a second- and third-place finish apiece.

Closer action came courtesy of the B, C & D Class races and the second of the encounters was the undoubted highlight. Thomas

Hibbert impressively scythed his way through from dead last on the grid – 23rd position – to win by almost six seconds. Mounting a tremendous drive, Hibbert more than made amends for retirement from race one.

Pole starter Richard Marsh was second with Dave Heasman bagging third, the latter just holding off Paul Travers and Ian Crisp. In the earlier race, Marsh converted pole position into a 3.6-second win over Travers, while Domenic Surdi completed the podium.



Well was untouchable

Colburn's saloon double heads a batch of braces

BEN COLBURN STARTED HIS Junior Saloon Car Championship season with a perfect winning double, first taking a near eight-second win over Brad Hutchinson in race one and then increasing his advantage to 13 seconds over Hutchinson in race two.

Former club Autograss racer Katie Milner was unable to make the start of the first race after crunching the front of her Saxo against the concrete wall at the exit of Turn 1 in qualifying.

Milner did race in the second encounter, ending the contest in 11th position.

Another double victory went the way of Rob Horsfield in the **Nippon Challenge** at the wheel of his Toyota MR2 Speedster. Just seeing off James Janicki's powerful Nissan Skyline by a mere 0.3 seconds in race one, after Janicki had stormed up the order from 21st on the grid, Horsfield controlled the second encounter by eight seconds. Danny Cassar and Nerijus Zabolka also visited the podium.

Two very strong **Toyota MR2 Series** grids delivered some terrific action but nobody was able to deny Aaron Pullan a brace of successes. Race one was unbelievably close, Nathan Harrison mounting a fantastic challenge and close to victory himself after moving into the lead on the penultimate tour. Pullan hit back, though, to win the drag race to the line by 0.089s.



Colburn attacks en route to double

Joe Spencer stormed away from the rest of the field in his Locosaki during both of the **CNC Heads Sports** and Saloons races, squashing the opposition with a 35-second winning margin in the first contest and by half a minute in the second.

Russell Thomson and Simon James enjoyed a great battle at the front during the first half of the opening **Tricolore Trophy and Coupe Cup** race but, after taking the lead at mid-distance, James steered his Citroen Saxo VTS to

a three-second victory. In race two, James again headed home Thomson's Renault Clio. Andrew Mitchell was a distant third in both encounters.

In the **Lancaster Insurance MG Owners Club**, pole qualifier Andrew Rogerson took the spoils in both races at the wheel of his ZR160 – race two was red flagged and ended with four minutes to run after Simon Kendrick became beached in the Gracelands gravel.

● Marc Orme



Rogerson won twice in MG

RESULTS

CLIO CUP RACE AND ROAD SERIES (12 LAPS) 1 Luke Herbert (Westbourne Motorsport) 18m36.411s (75.06mph); 2 Andy Jordan +4.087s; 3 Brett Lidsey; 4 Ben Davis; 5 Tom Barley; 6 Adam Hatfield. **Pole** Randon. **Starters** 15. **Class winners** Davis; Pinder; Tyler Lidsey. **Fastest Lap** Jordan 1m31.144s (76.62mph). **RACE 2 (12 LAPS)** 1 Herbert 18m36.448s (75.06mph); 2 Randon +1.222s; 3 Brett Lidsey; 4 Jordan; 5 Paul Streather (Privateer); 6 Barley. **P** Lidsey. **S** 16. **CW** Davis; Pinder; Tyler Lidsey. **FL** Streather 1m31.292s (76.50mph). **RACE 3 (12 LAPS)** 1 Streather 18m44.409s (74.53mph); 2 Herbert +0.323s; 3 Randon; 4 Davis; 5 Barley; 6 Bennett. **P** Herbert. **S** 16. **CW** Davis; Pinder; Tyler Lidsey. **FL** Streather 1m31.840s (76.04mph). **KUMHO BMW CHAMPIONSHIP, CLASS B/C/D (13 LAPS)** 1 Richard Marsh (BMW E36 M3) 20m41.331s (73.14mph); 2 Paul Travers (BMW 328i Coupe) +3.677s; 3 Domenic Surdi (BMW M3); 4 Dave Heasman (BMW 328i Saloon); 5 David Griffin (BMW E36 M3); 6 Ian Crisp (BMW E36 M3). **CW** Travers; Greg Marking (BMW 318is); Rob Bennett (BMW 318is). **FL** Thomas Hibbert (BMW E36 M3) 1m33.471s

(74.71mph). **P** Marsh. **S** 23. **RACE 2 (13 LAPS)** 1 Hibbert 20m45.611s (72.88mph); 2 Marsh +5.834s; 3 Heasman; 4 Travers; 5 Crisp; 6 Griffin. **CW** Heasman; Marking; Bennett. **FL** Hibbert 1m34.160s (74.17mph). **P** Marsh. **S** 23. **KUMHO BMW CHAMPIONSHIP, CLASS A (14 LAPS)** 1 Colin Wells (BMW M3 CSL) 20m59.708s (77.61mph); 2 Richard Bacon (BMW E46 M3) +17.650s; 3 James MacIntyre-Ure (BMW E46 M3); 4 Darren Fielding (VMW E46 M3 CSL); 5 Matthew Fielding (BMW E36 M3 Evo); 6 Kal Ezzat (BMW M3). **FL** Wells 1m28.353s (79.04mph). **P** Wells. **S** 12. **RACE 2 (14 LAPS)** 1 Wells 21m02.295s (77.45mph); 2 MacIntyre-Ure +9.558s; 3 Bacon; 4 Card; 5 Matthew Fielding; 6 Darren Fielding. **FL** Wells 1m28.477s (78.93mph). **P** Wells. **S** 12. **JUNIOR SALOON CAR CHAMPIONSHIP (10 LAPS)** 1 Ben Colburn 17m33.270s (66.30mph); 2 Brad Hutchinson +7.827s; 3 Charlie Kennedy; 4 Matteo Zanetti; 5 Edward Moore; 6 Scott Mitchell. **FL** Mitchell 1m44.111s (67.08mph). **P** Mitchell. **S** 14. **RACE 2 (10 LAPS)** 1 Colburn 17m43.557s (65.66mph); 2 Hutchinson +13.169s; 3 Kennedy; 4 Moore; 5 Alex Day; 6 Stockton. **FL** Hutchinson 1m44.869s (66.59mph). **P** Mitchell. **S** 15. **NIPPON CHALLENGE (10 LAPS)** 1 Rob Horsfield

(Toyota MR2 Speedster) 16m23.685s (70.99mph); 2 James Janicki (Nissan Skyline R32) +0.334s; 3 Danny Cassar (Honda Integra); 4 Philip Collard (Mazda RX7); 5 Nerijus Zabolka (Subaru Impreza); 6 Andrew Roberts (Honda Civic EK). **CW** Cassar; Zabolka; Roberts; Paul Calloway (Toyota MR2 Mk1). **FL** Janicki 1m35.080s (73.45mph). **P** Vic Hope (Honda Civic Type R) 1m53.966s (61.28mph). **S** 27. **RACE 2 (9 LAPS)** 1 Horsfield 16m29.144s (63.54mph); 2 Janicki +7.678s; 3 Zabolka; 4 Cassar; 5 Hope; 6 Stratton. **CW** Zabolka; Cassar; Stratton; Craig Rankine (Toyota MR2 Mk1). **FL** Horsfield 1m35.713s (72.96mph). **P** Horsfield. **S** 26. **MR2 SERIES (9 LAPS)** 1 Aaron Pullan 15m40.978s (66.79mph); 2 Nathan Harrison +0.089s; 3 Paul Corbridge; 4 Craig Rankine; 5 Neale Hurren; 6 Kevin Molineaux. **FL** Corbridge 1m42.659s (68.03mph). **P** Pullan. **S** 27. **RACE 2 (9 LAPS)** 1 Pullan 15m43.643s (66.60mph); 2 Rankine +5.510s; 3 Farmer; 4 Highton; 5 Hurren; 6 Molineaux. **FL** Harrison 1m42.657s (68.03mph). **P** Pullan. **S** 24. **CNC HEADS SPORTS AND SALOONS (15 LAPS)** 1 Joe Spencer (Stuart Taylor Locosaki) 22m03.286s (79.16mph); 2 Ilsa Cox (SEAT Leon Cupra) +34.761s; 3 Dave Harvey (Stuart Taylor Locosaki); 4 Luke Armiger (Vauxhall Tigra); 5 Danny Keenan (MK Indy RR); 6 Stuart Pearson (Ginetta G20). **CW** Cox; Armiger; Pearson; Chris Grimes (Ford Escort XR3i). **FL** Spencer 1m26.187s (81.03mph). **P** Cox. **S** 19. **RACE 2 (15 LAPS)** 1 Spencer 21m57.746s (79.49mph); 2 Harvey +31.074s; 3 Keenan; 4 Cox; 5 Pearson; 6 Hurst. **CW** Cox; Pearson; Kirk; Grimes. **FL** Spencer 1m26.088s (81.12mph). **P** Spencer. **S** 16. **TRICOLETTE TROPHY & COUPE CUP (9 LAPS)** 1 Simon James (Citroen Saxo VTS)



Marsh and Hibbert fight

14m33.481s (71.96mph); 2 Russell Thomson (Renault Clio) +2.940s; 3 Andrew Mitchell (Peugeot 205 GTI); 4 Kevin Jones (Renault Clio 200); 5 Gareth Nutley (Peugeot 206); 6 Sonny Hardy (Renault Clio). **CW** Mitchell; Simon Miles (Hyundai Coupe); Paul Clothier (Renault Clio); Tony Hunter (Peugeot 106); Kevin Jones (Renault 5T). **FL** James 1m34.717s (73.73mph). **P** Miles. **S** 27. **RACE 2 (9 LAPS)** 1 James 15m05.165s (69.44mph); 2 Thomson +2.108s; 3 Mitchell; 4 Kevin Jones (Renault Clio); 5 Hardy; 6 Miles. **CW** Mitchell; Miles; Hunter; Jeff McCall (Peugeot 206 GTI); Kevin Jones (Renault 5T). **FL** Thomson 1m34.747s (73.71mph). **P** James. **S** 26. **MGOC CHAMPIONSHIP (9 LAPS)** 1 Andrew Rogerson (MG ZR160) 15m01.668s (69.71mph); 2 Martin Wills (MG ZR) +3.697s; 3 Mark Baker (MGF); 4 Adam Jackson (MG ZR); 5 David Mellor (MG F); 6 Simon Kendrick (MGF VVC). **CW** Baker; Henry Sharpe (MG ZR 160); Chris Pollard (MG B Roadster). **FL** Rogerson 1m39.125s (70.45mph). **P** Rogerson. **S** 22. **RACE 2 (5 LAPS)** 1 Rogerson 8m29.162s (68.58mph); 2 Jackson +4.854s; 3 Baker; 4 Mellor; 5 Wills; 6 Wisbey. **CW** Baker; Will Sharpe (MG Midget). **FL** Rogerson 1m39.724s (70.03mph). **P** Rogerson. **S** 19.



Pullan dominated packed MR2 field

Butler and Birley take Brands wins

MOTORSPORT NEWS SALOON

Championship honours were shared between surprised winner Ian Butler and one who was fully expected to succeed, Rod Birley.

A wet qualifying session produced a topsy-turvy grid, although polesitter Birley's four-wheel-drive Ford Escort WRC revelled in the conditions, as did some of the smaller, front-wheel-drive cars.

But much of the larger machinery found the going tough and had to start much further back than expected. Nevertheless, Marcus Bicknell's Mustang was a welcome newcomer to the series.

Changes to the technical specs for this year's series effectively ruled out the only real opposition to Birley and so the local racer was expected to have things all his own way. But after leading the opening laps of Saturday's race his Escort suddenly slowed and Butler raced past to win in his Ford Focus.



Butler (30) and Birley (44) at Clearways

ALL PICS: GARY HAWKINS

"It started to cut out on me," explained the former chairman of the BARC SE Centre. Subsequent examination identified a problem with the plenum chamber, which

was fixed overnight.

The opening laps of the race were complete mayhem and most of it had to be run under the safety car after Gavin Thomson and Malcolm Wise collided along the Cooper Straight while Dave Charlton and Glen Rossiter were involved in a high-speed crash on the approach to Druids. The force of the impact meant that the barriers required lengthy repairs. The shunts eliminated four of the most successful cars, which is why Craig Shepherd's little Fiesta was able to claim third place overall.

Paul Nevill's Escort Mk1 spent much of the race in fourth place, but towards the end he was overhauled by Stephen Dann's Golf and Andy Banham's Subaru. Class D winner Nick Proudlock (Escort Mk1)

finished seventh overall.

On Sunday none of the damaged cars was able to take part, but normal service was resumed for Birley, who seized the lead and began to pull away from Butler and Shepherd.

But then Shepherd's Fiesta suddenly slowed and he pulled off with a broken differential. Birley raced on to a clear-cut victory with a six-second margin over Butler. Shepherd's woes allowed Jamie Liptrott's BMW to claim the final podium position ahead of Dann.

After a slow start Daniel Palmer's Mitsubishi hunted down Banham's Subaru and went on to finish sixth. This time Andy Pipe's Escort Mk1 took Class E honours while Perry Winch (Clio) won Class D.

● Kerry Dunlop



Birley leads the field

RESULTS

MOTORSPORT NEWS SALOON CAR

CHAMPIONSHIP (12 LAPS) 1 Ian Butler (Ford Focus) 15m32.401s (55.96mph); 2 Rod Birley (Ford Escort WRC) +1.030s; 3 Craig Shepherd (Ford Fiesta); 4 Stephen Dann (Volkswagen Golf); 5 Andy Banham (Subaru Impreza); 6 Paul Nevill (Ford Escort RS2000). **Class winners** Birley; Shepherd; Nevill; Nick Proudlock (Ford Escort Mk1). **Fastest lap** Butler 53.722s (80.94mph). **Pole** Birley. **Starters** 22. **RACE 2 (17 LAPS) 1 Birley 15m17.804s (80.54mph);** 2 Butler +6.720s; 3 Jamie Liptrott (BMW E36); 4 Dann; 5 Matthew Turner (BMW E36); 6 Daniel Palmer (Mitsubishi Evo). **CW** Butler; Liptrott; Andy Pipe (Ford Escort Mk1); Perry Winch (Renault Clio). **FL** Birley 52.901s (82.20mph). **P** Butler. **S** 17. **BRITISH TRUCK RACING CHAMPIONSHIP (16 LAPS) 1 Ryan Smith (MAN TGA)**

16m29.573s (70.31mph); 2 David Jenkins (MAN TGX) +0.335s; 3 Stuart Oliver (Volvo RH13); 4 Steve Thomas (MAN TGX); 5 Matt Summerfield (MAN TGS); 6 Simon Reid (MAN TGX). **CW** Steven Powell (Foden Alfa). **FL** Jenkins 1m00.034s (72.43mph). **P** Smith. **S** 20. **RACE 2 (9 LAPS) 1 Adam Bint (Volvo White) 9m50.784s (66.24mph);** 2 Powell +5.676s; 3 Summerfield; 4 Jenkins; 5 Oliver; 6 Brian Burt (Volvo White). **CW** Summerfield. **FL** Jenkins 1m00.164s (72.27mph). **P** Bint. **S** 20. **RACE 3 (11 LAPS) 1 Jenkins 11m52.782s (67.10mph);** 2 Smith +1.094s; 3 Oliver; 4 Thomas; 5 Ray Coleman (Renault); 6 Summerfield. **CW** Powell. **FL** Smith 59.687s (72.85mph). **P** Wayne Eason (Iveco Stralis). **S** 18. **RACE 4 (15 LAPS) 1 Jenkins 16m06.735s (67.47mph);** 2 Summerfield +0.424s; 3 Thomas; 4 Smith; 5 Bint; 6 Powell. **CW** Bint. **FL** Jenkins 1m00.412s (71.98mph). **P** Eason. **S** 18.

RACE 5 (16 LAPS) 1 Oliver 16m42.456s (69.40mph); 2 Summerfield +7.258s; 3 Smith; 4 Reid; 5 Jenkins; 6 Luke Taylor (Renault Premium). **CW** Powell. **FL** Summerfield 1m00.327s (72.08mph). **P** Eason. **S** 14. **LEGENDS CARS CHAMPIONSHIP (10 LAPS) 1 Euan McKay 11m21.987s (63.76mph);** 2 Jack Parker +0.177s; 3 Daniel McKay; 4 Ben Power; 5 Paul O'Brien; 6 John Mickel. **FL** Power 1m05.512s (66.37mph). **P** Paul McKay. **S** 26. **RACE 2 (10 LAPS) 1 Power 9m25.921s (76.84mph);** 2 Henry King +0.753s; 3 Nathan Anthony; 4 Mickel; 5 Parker; 6 Thomas Grainger. **FL** Mickel 55.271s (78.67mph). **P** Power. **S** 26. **RACE 3 (12 LAPS) 1 James Holman 11m20.313s (76.70mph);** 2 Steve Whitelegg +0.144s; 3 Mickel; 4 Power; 5 John Paterson; 6 Will Gibson. **FL** Power 55.139s (78.86mph) equals lap record. **P** Gibson. **S** 26. **RACE 4 (10 LAPS) 1 Mickel 9m24.511s (77.03mph);** 2 H King

+0.125s; 3 Robert King; 4 Power; 5 Holman; 6 Connor Mills. **FL** Holman 55.176s (78.81mph). **P** R King. **S** 27. **RACE 5 (10 LAPS) 1 Power 9m24.947s (76.97mph);** 2 Holman +0.125s; 3 H King; 4 Mickel; 5 E McKay; 6 Whitelegg. **FL** Mickel 55.175s (78.81mph). **P** Mick Mercer. **S** 27. **RACE 6 (14 LAPS) 1 Power 14m50.315s (68.38mph);** 2 Mickel +0.341s; 3 Matthew Pape; 4 D McKay; 5 E McKay; 6 Whitelegg. **FL** E McKay 55.236s (78.72mph). **P** Grainger. **S** 27. **CATERHAM GRADUATES - CLASSIC & SUPER (23 LAPS) 1 Toby Briant 21m07.301s (78.92mph);** 2 Martin Collier +0.360s; 3 Charles Elliott; 4 Martin Kay; 5 Gareth Cordey; 6 Tony Barson. **CW** Graham Smith. **FL** Kay 54.175s (80.26mph). **P** Collier. **S** 25. **RACE 2 (20 LAPS) 1 Briant 21m08.650s (68.55mph);** 2 Chris Rome +7.822s; 3 Kay; 4 Collier; 5 Elliott; 6 Andy Molsom. **CW** Smith. **FL** Kay 54.135s (80.32mph). **P** Briant. **S** 25.

Power bids to fill void in Legends

WITH RECENT LEGENDS

champions Lawrence Davey and Dean Brace no longer contesting the series, it was left to Ben Power to assert himself as the best contender at Brands with a hat-trick of wins from six sizzling races.

Euan McKay, James Holman and John Mickel were the remaining winners, and it was Mickel who performed the most consistently in all the races.

Some determined and decisive passes on backmarkers gave Toby Briant the edge in both hotly-contested **Caterham Super** races. In the first race Martin Collier drew alongside twice at Paddock Bend, but each time he was forced



Power won half the Legends races

to drop back again.

Next time out it was Martin Kay who provided the strongest opposition, but in the closing stages he was baulked by backmarkers and then a quick spin at Druids let Chris Rome through to second place. In each race Graham Smith was the best of the Classic competitors.

Oliver Gibson, Glenn Burtenshaw and Andy Skinner fought ferociously throughout the two **Caterham Mega** races with never more than a length or two between them. But there

could only be two winners: Gibson and Skinner. Andrew Outterside was outstanding as he won the **Sigma** category each time.

Neil Shinner proved just too good for Dylan Stanley and Scott Lawrence in the two **Caterham Sigma** races. "I made a great start from the second row and just got turned in ahead of them" he said.

The **2CV Citroens** are always great fun and in the first race they slithered around the circuit together like a sinuous serpent. The colours

and pattern on its back changed constantly, but at its head Pete Sparrow led Philip Myatt and Alec Graham all the way. Kris Tovey eventually came out on top in a six-car squabble for fourth place.

On Sunday Sparrow handed his car over to Jon Davis, who led from the start but then ran wide and dropped out of contention. Phil Myatt and Matt Lambert battled mightily for the lead until they were caught by Kris Tovey. Then, with less than a minute to go, Myatt's car expired so Tovey was gifted the win.

Two tremendous **Pickup** races allowed leading contenders Mark Willis, David O'Regan and Paul Jones to battle hard throughout.

O'Regan pipped Willis to victory by just two tenths in the first race, and then just as Willis seemed set for victory in race two he was passed right at the end by Jones. Young Freddie Lee showed well and looks a great prospect.

Jenkins at the double in ex-Hahn MAN

DAVE JENKINS AND HIS MAN, recently acquired from European champion Jochen Hahn, notched up a double victory as well as a hatful of leaderboard places, which made him by far the most successful of the Truck championship contenders at Brands Hatch.



Smith claimed spoils in opener

But it was Ryan Smith, 33, who eclipsed his rivals on his Division 1 debut when he and another ex-Hahn MAN claimed pole position for Saturday's opening event. The reigning Division 2 vice-champion then fought off a strong challenge from Jenkins to lead all the way. "He was always going to be good," said the runner-up. "I drew alongside him once, but he squeezed me out. Mind you, I'd have done exactly the same thing."

But Smith's dream start turned into a nightmare next time out. As they thundered away from the start three or four of the big trucks needed the same piece of track at

the same time and the race-one winner found himself buried in the ballast at the top of Paddock Hill. It took a while to extricate his truck but at least he was able to take the restart.

The Division 2 trucks seized the advantage from the reversed grid as Adam Bint led Steven Powell, but on the last lap, just as they were about to be swallowed up by their bigger brethren, the race was red-flagged as Jim Bennett, Stuart Oliver and Andrew Lovenberry slid into the gravel at Paddock. Current champion Matt Summerfield was the first Division 1 driver home in third.

Jenkins turned the tables on



Behemoths had five races on tight circuit

Smith with a fine win in race three and then successfully appealed a five-second penalty to take a narrow win over Summerfield in race four. But the reigning champion fought back with a beautiful pass on Smith to claim second place behind fast-starting Stuart Oliver in the last race of the afternoon.

CATERHAM GRADUATES - SIGMA & MEGA

(23 LAPS) 1 Oliver Gibson 21m02.216s (79.23mph); 2 Andy Skinner +0.094s; 3 Glenn Burtenshaw; 4 Declan Dolan; 5 James Batchelor; 6 Simon Longman. **CW** Andrew Outterside. **FL** Gibson 53.817s (80.80mph). **P** Gibson. **S** 24. **RACE 2 (21 LAPS)** 1 Skinner 20m52.888s (72.88mph); 2 Burtenshaw +0.998s; 3 Gibson; 4 Batchelor; 5 Martin Kay; 6 Dolan. **CW** Outterside. **FL** Kay 53.984s (80.68mph). **P** Burtenshaw. **S** 25.

CATERHAM GRADUATES - SIGMAX (24 LAPS)

1 Neil Shinner 21m40.204s (80.26mph); 2 Scott Lawrence +2.455s; 3 Dylan Stanley; 4 Mick Whitehead; 5 Martin Jeffs; 6 Ray Gilliland. **FL** Shinner 52.841s (82.29mph). **P** Lawrence. **S** 18. **RACE 2 (24 LAPS)** 1 Shinner 21m31.128s (80.83mph); 2 Stanley +0.225s; 3 Lawrence; 4 Whitehead; 5 Simon Oliphant; 6 Zoltan Csabai. **FL** Whitehead 52.855s (82.27mph).

P Lawrence. **S** 18.

CITROEN 2CV (18 LAPS)

1 Pete Sparrow 20m47.158s (62.76mph); 2 Philip Myatt +5.282s; 3 Alec Graham; 4 Kris Tovey; 5 Nick Crispin; 6 Paul Taylor. **FL** Sparrow 1m08.065s (63.88mph). **P** Sparrow. **S** 22. **RACE 2 (18 LAPS)** 1 Tovey 20m55.206s (62.36mph); 2 Matt Lambert +3.872s; 3 Mick Storey; 4 Graham; 5 Crispin; 6 Louis Tyson. **FL** Tovey 1m07.821s (64.11mph). **P** Myatt. **S** 22.

PICKUP TRUCK RACING CHAMPIONSHIP (18 LAPS)

1 David O'Regan 15m52.823s (82.15mph); 2 Mark Willis +0.286s; 3 Paul Jones; 4 Freddie Lee; 5 David Longhurst; 6 Paul Tompkins. **FL** Michael Smith 51.851s (83.86mph). **P** Tompkins. **S** 13. **RACE 2 (18 LAPS)** 1 Jones 15m56.492s (81.83mph); 2 Willis +0.434s; 3 Anthony Hawkins; 4 Smith; 5 Gavin Murray; 6 Longhurst. **FL** Shane Brereton 52.272s (83.19mph). **P** Willis. **S** 13.



O'Regan led first Pickup encounter



Teddington Studios, Broom Road, Teddington, Middlesex TW11 9BE, UK.
Tel: +44 (0) 20 8267 5804 Fax: +44 (0) 20 8267 5922
E-mail: autosport@haymarket.com Website: www.autosport.com

EDITOR
Edd Straw ext.5889
edd.straw@haymarket.com

DEPUTY EDITOR
Marcus Simmons ext.5807
marcus.simmons@haymarket.com

GROUP F1 EDITOR
Jonathan Noble ext.5810
jonathan.noble@haymarket.com

GRAND PRIX EDITOR
Ben Anderson ext.5425
ben.anderson@haymarket.com

F1 REPORTER
Lawrence Barretto ext.5887
lawrence.barretto@haymarket.com

FEATURES EDITOR
Scott Mitchell ext.5370
scott.mitchell@haymarket.com

EDITOR AUTOSPORT.COM
Glenn Freeman ext.5309
glenn.freeman@haymarket.com

DEPUTY EDITOR AUTOSPORT.COM
Matt Beer ext.5811
matt.beer@haymarket.com

INTERNATIONAL EDITOR
Mitchell Adam ext.5432
mitchell.adam@haymarket.com

MANAGING EDITOR
Peter Hodges ext.5903
peter.hodges@haymarket.com

EXECUTIVE EDITOR
Stuart Codling ext.5835
stuart.codling@haymarket.com

GROUP NATIONAL EDITOR
Rob Ladbroke ext.5209
robert.ladbroke@haymarket.com

RALLIES EDITOR
David Evans
david.evans@haymarket.com

ART EDITOR
Lydney Row ext.5914
lydney.row@haymarket.com

SENIOR DESIGNER
Michael Cavalli ext.5381
michael.cavalli@haymarket.com

PHOTOGRAPHS
LAT Photographic, XPB Images

GROUP PICTURE EDITOR
Peter Mills ext.5918
peter.mills@haymarket.com

AUTOSPORT.COM TECHNICAL TEAM LEADER
Geoff Creighton
geoff.creighton@haymarket.com

AUTOSPORT.COM DEVELOPER
Tomasz Trznadel
tomasz.trznadel@haymarket.com

OFFICE MANAGER
Joanne Grove ext.5804
joanne.grove@haymarket.com

SPECIAL CONTRIBUTORS
Gary Watkins Mark Glendenning Alan Eldridge
Henry Hope-Frost Dieter Rencken
Marcus Pye Gary Anderson

CORRESPONDENTS

ARGENTINA
Tony Watson

AUSTRALIA
Phil Brangan

AUSTRIA
Gerhard Kuntschik

BELGIUM
Gordon McKay

BRAZIL
Lito Cavalcanti

FINLAND
Esa Illinen

GERMANY
Rene de Boer

GREECE
Dimitris Papadopoulos

ITALY
Roberto Chinchero

JAPAN
Hiro Takahashi, Len Clarke

NEW ZEALAND
Bernard Carpinter

RUSSIA
Gregory Golyshov

SOUTH AFRICA
Richard Asher

SPAIN
Raimon Duran

SWEDEN
Tege Tornvall

USA
Jonathan Ingram, David Phillips, Robin Miller, Jeremy Shaw

UK & EIRE
Jack Bonyon, Jonathan Crawford, Dan Cross, Kerry Dunlop, Tom Errington, Leanne Fahy, Paul Healy, Linda Keen, Alex Kalmauskas, Mark Libbeter, Stephen Lickorish, Marc Orme, Graham Read, Hal Ridge, Peter Scherer, Ian Sowaan, Oliver Timson, Ian Tilchmarsh, Matt Upton, Eddie Walder, Richard Young

ADVERTISING
Tel: +44 (0) 20 8267 5389
Fax: +44 (0) 20 8267 5850
E-mail: autosport.ads@haymarket.com

CLASSIFIED ADVERTISING
James Hunter ext.5367
james.hunter@haymarket.com

DISPLAY ADVERTISING
Gary Lee Hoebeck ext.5376
garylee.hoebeck@haymarket.com

SALES MANAGER
Don Rupal ext.5244
don.rupal@haymarket.com

CLASSIFIED SALES MANAGER
Jonathan Whitehead ext.5908
jonathan.whitehead@haymarket.com

ONLINE ADVERTISING
Leah Mimms ext.5846
leah.mimms@haymarket.com

SUBSCRIPTIONS
UK 0844 8488817
OVERSEAS +44 (0)1795 592 974
EMAIL autosport@servicehelpline.co.uk

BACK ISSUES
Tel: 0844 8488817

DIRECT MARKETING EXECUTIVE
Katie Chanter ext.5622
katie.chanter@haymarket.com

LICENSING AND SYNDICATION LICENSING DIRECTOR
Alistair Lewis

MANAGEMENT GROUP DIRECTOR
Tim Bulley
GROUP PUBLISHER
Stuart Williams
GROUP EDITOR
Anthony Rowlinson
GROUP COMMERCIAL DIRECTOR
Ben Guyan

PUBLISHING MANAGER
Samantha Jemson
SPECIAL EVENTS MANAGER
Laura Coppin
DIGITAL SPECIAL PROJECT MANAGER
Simon Strang, ext. 5093
simon.strang@haymarket.com
DIGITAL PRODUCT MANAGER
Simon Grayson, ext. 5346
simon.grayson@haymarket.com

CIRCULATION TRADE ENQUIRIES
Frontline Ltd, Park House, 117 Park Road, Peterborough, Cambs, PE21 2TS.
Tel: +44 (0) 1733 55161. Printed in England by Wyndeham Peterborough Ltd.
ISSN 0269-946X. AUTOSPORT, incorporating Autosport, is published weekly by Haymarket Consumer Media, Teddington Studios, Broom Road, Teddington, TW11 9BE, UK.

© 2015, HAYMARKET MEDIA GROUP LTD
Publishing, trade and further subscription details on www.autosport.com. While due care is taken to ensure the contents of AUTOSPORT are accurate, the publishers and printers cannot accept liability for errors and omissions. Advertisements are accepted for publication in AUTOSPORT only upon Haymarket Media Group Ltd's Standard Terms of Acceptance of Advertising, copies of which are available from the Advertising Sales Department of AUTOSPORT.

EDITORIAL DIRECTOR
Mark Payton
CREATIVE DIRECTOR
Paul Haypin
STRATEGY AND PLANNING DIRECTOR
Bob McDowell

PUBLISHING DIRECTOR
Patrick Fuller
MANAGING DIRECTOR
David Prasher
CHIEF EXECUTIVE
Kevin Costello



Haymarket is certified by BSI to environmental standard ISO14001

THIS WEEK

LETTERS • ON TRACK • TV PICKS • FROM THE WEB • AUTOSPORT.COM

What you think of the motorsport news of the past week



Nice try, but we need more opposite lock

F1 just needs to look fast

Ben Anderson's review of the possibilities for change in F1 was OK (April 9), but far too reserved, as evidenced by his early categorisation of aerodynamics as an 'untouchable' – his justification being the need for outright speed.

It is not the quantity of speed that is required, it's the impression of speed. Downforce leads to cars cornering as if on rails, taking away much of the concept

of speed. With reduced downforce the racing would be closer and the variety of cornering angles would make for gripping viewing (sorry about the pun). Doubtless development costs would be significantly reduced into the bargain.

Make the cars more interesting and competitive in the corners; that will capture the audience's attention.

Steve Cobbold, Portknockie

Having taken my two children (six and five) to Silverstone for the WEC, I feel I have to say well done to the track and championship for organising the event in such a family friendly way.

From the constant bus shuttles to the free funfair to the open paddock and fan area, the event was fun and great value for money. My kids were never bored and the racing was good entertainment for me too! If this is indicative of the new regime at Silverstone, it certainly has my approval.

Neil Wooding
By email

We want tyres that degrade to make races interesting, but Pirelli wants to preserve its brand. Its tyres are 'hard' or 'soft', but the teams talk 'prime' and 'option' for no apparent reason.

A simple solution: refer to the tyres as 'sprint' and 'endurance'. No one would question a 'sprint' tyre that only lasted

5-10 laps at qualifying pace, so Pirelli can give us varied strategies with no loss of reputation.

Steve Morris
Walthamstow

You found space for Frances

Stewart (April 9) to tell us of her "Pavlovian" reaction to a German driver winning in a Ferrari, and that "Vettel is a very different man from Schumacher". But how much time has she actually spent with either? Her letter suggests to me that she had also spent too much of her youth reading interminable nonsense in the media – not least AUTOSPORT's old *Fifth Column* – and believing it...

David Cole
Rutland

When I first suggested in AUTOSPORT that certain GPs be designated 'Grand Slam' events,

I suggested traditional venues such as Monaco, Spa, Monza, etc.

This would allow drivers of different eras to be compared, would strengthen the negotiating position of these traditional events and would cost nothing.

However I now hear from Dieter Rencken that the titles could go to the highest bidders! We can all guess which circuits these will be. How naive I was.

Peter O'Donnell
Epsom, Surrey

Bernie said that after 50 years'

work he will not let F1 destroy itself. Yet again he has conveniently forgotten that he started the process himself by selling the rights on and letting the sport be bled dry. The heart of the problems lies at his door and it's time he realised that he's not the right person to fix it.

Richard Hargrave
Hitchin

BIG NUMBER

8 Gordon Shedden has eight BTCC race victories at Donington Park in just 24 starts there. None of his rivals can match that tally at the venue

MILESTONE

550 Matt Neal starts his 550th BTCC race at Donington this weekend. He made his debut at Silverstone in 1991. He's pictured here back in 1997



WHAT'S ON TRACK IN THE UK



VSCC

STYLES

ROCKINGHAM 360MRC

April 18
The new-for-2015 Endurance Racing Series headlines the 360MRC's 2015 opener.

SNETTERTON 300 BRSCC

April 18-19
Caterham and Fiesta racing will be the focus as the BRSCC heads to Snetterton.

MONDELLO PARK MRC

April 18-19
Single-seaters and saloons make up a bumper weekend as the Irish Touring Car Championship visits Mondello.

BRSCC

MICK WALKER



SILVERSTONE NATIONAL VSCC

April 18
The club's Spring Start meeting includes its traditional GP Itala Trophy races among plenty of pre-war action.

CADWELL PARK MSVR

April 18-19
MSVR's first Cadwell meeting of the season takes place this weekend as contemporary FF1600 returns to the track for the first time in 10 years.

OULTON PARK FOSTERS BRSCC

April 18
The one-day event features the Toyo Porsche Championship as well as two doses of both Mighty Minis and Formula Ford.



Collard went from winner to spinner in Brands opener

EVENT OF THE WEEK

DONINGTON PARK BTCC

April 18-19
The BTCC circus heads to Donington Park for its second round after a particularly wild and wide-open Brands curtain-

raiser. Matt Neal and Jack Goff lead the standings after three very different races in Kent, where Honda secured two wins with its new Civic Type R. BMR's hotly-tipped 'superteam' and star returnee Andy Priaulx will

be out to make amends after leaving Brands with little to show for their pace. In the regular support pack, it's all eyes on-track and off it as Lando Norris fights back from his MSA Formula exclusion.

WHAT'S ON TRACK AROUND THE WORLD

BAHRAIN GP

Formula 1 World Championship
Rd 4/19
Bahrain International Circuit
April 19
f1.com

GP2 SERIES

Rd 1/10
Bahrain International Circuit
April 18-19
gp2series.com



GP2



F1

TEE/LAT

Bahrain hosts a floodlit F1 fest

INDYCAR SERIES

Rd 3/15
Long Beach, California, USA
April 19
indycar.com

INDY LIGHTS

Rd 2/10
Long Beach, California, USA
April 19
indycar.com/RoadToIndy



INDY

LEVIT/LAT

WORLD TOURING CARS

Rd 2/12
Marrakech, Morocco
April 19
fiawtcc.com



WTCC

NASCAR SPRINT CUP

Rd 8/36
Bristol, Tennessee, USA
April 19
nascar.com

SUPER FORMULA

Rd 1/7
Suzuka, Japan
April 19
superformula.net

FROM THE SOFA

WHAT'S ON TELEVISION

Q&A

ANDREW COLEY WORLD RX COMMENTATOR

@Andrew_Coley

AUTOSPORT: As a competitor, do you find commentating frustrating?

Andrew Coley: Not at all. I've finally sold my rally car, but that's not to say I'm not hoping to compete again – it's just my weekends are a bit busy right now. Having competed, I have a bit of an idea about what the car might be doing in some of the corners, which can help. But every time I walk the track with one of the World RX drivers and listen to the perspective from inside a car with 600bhp and four-wheel drive, it's usually a case of: "Wow! I hadn't thought of that..."

AS: How did you make the transition from competing?

AC: I was doing some driver tuition and some of the manufacturers I was working with asked me to do driver briefings or voiceover videos. The feedback from them was really positive, so I thought I'd have a go at taking it a step further.

AS: So I guess public speaking doesn't bother you at all?

AC: Quite the opposite actually. I still get really nervous at having to do that kind of thing. It's the same when I'm getting ready to commentate on a race; I'm usually jumping around all over the place, full of nervous energy. I think that's a good thing, though. The minute you don't get those kind of feelings about going live, maybe it's time to move on.

AS: What was the first event you commentated on?

AC: The 2009 Azores Rally. I'd gone to Eurosport and asked if they needed any help with rally commentary, that's how it all started. I can remember the first thing I talked about: Kris Meeke's damper test on his Peugeot 207. I was unbelievably nervous!

AS: Have you ever taken advice on commentating?

AC: Yes, from Murray Walker – he's a real hero! I commentated at the



Coley with RX sidekick Jordan

Goodwood Festival of Speed in 2013 and I was talking to him at the press day before the event. I told him I was going to rallycross and, as he'd commentated so well on that side of the sport, I asked if he had any advice. He told me to make sure I know my stuff and not to stop talking.

AS: And you haven't stopped since...

AC: I do talk a lot, don't I?! Watching some of the races back, I surprise myself with some of the stuff I come out with – where did that come from?

I'm really lucky to have had Andrew Jordan as a co-commentator. He and I get



MCKLEIN

on like a house on fire and we can talk about just about anything on the screen.

We have a two-hour world feed which means two hours of non-stop commentating – even when the racing stops, we have to keep talking. I'd like to think Andrew and I sound like a couple of blokes having a good chat about a sport we love – the same way two mates might be doing sitting at home on the sofa – it's just a step further.

AS: What's been your highlight?

AC: I think it was the World RX race in Argentina last year. It kind of really dawned on me that I was part of a world championship and something really cool. Working with guys like Petter Solberg is fantastic and Argentina last year really underlined for me that I have the best job in the world!

Andrew Coley was talking to David Evans

TV pick of

Edited by Jack Cozens



BAHRAIN GRAND PRIX FULL UK LISTINGS

Sky Sports F1 - LIVE

Practice 1: Friday 1145-1350

Practice 2: Friday 1545-1755

Practice 3: Saturday 1245-1415

Qualifying: Saturday 1500-1745

Race: Sunday 1430-1830

BBC - LIVE

Practice 1: Friday 1155-1335

(Red Button)

Practice 2: Friday 1600-1740 (BBC2)

Practice 3: Saturday 1255-1405 (BBC2)

Qualifying: Saturday 1530-1705 (BBC1)

Race: Sunday 1500-1805 (BBC1)



INDYCAR LONG BEACH - LIVE BT Sport 2

Sunday 2100-2330

Fresh from hosting Formula E, the Long Beach circuit returns to its longer Grand Prix layout for IndyCar's visit, as BT Sport picks up NBCSN's coverage of the third round of the championship.

There's little chance of the rain that marred last week's inaugural NOLA event in California, but the tight confines of the circuit will be a tough test for the recently toughened-up new aero kits. After wins for Mike Conway of Ed Carpenter Racing and Takuma Sato of AJ Foyt Racing in 2014 and '13, will there be another underdog triumph?

GET AUTOSPORT ON THE MOVE

ON SALE ALL OVER THE WORLD
DOWNLOAD IT NOW FROM AUTOSPORT.COM



ONLINE

Top stories on AUTOSPORT.com in the last week

RED BULL CHIEF REITERATES QUIT THREAT

Ahead of what became another tough weekend for both of his Renault-powered teams, Red Bull owner Dietrich Mateschitz once again threatened to pull out of F1

BUTTON NOT EXCITED BY Q2 OR Q3 CHANCE

After Fernando Alonso drummed up hopes of McLaren getting a car into Q2 last weekend, team-mate Jenson Button said the team wasn't aiming so low

WOLFF: HAMILTON WASN'T UNDERHAND

Following the post-race storm created by Nico Rosberg's comments about Lewis Hamilton in the Chinese GP, Mercedes chief Toto Wolff played the matter down

RENAULT FEARS MORE PROBLEMS IN BAHRAIN

Renault F1 chief Cyril Abiteboul warned that his firm's engines could be in trouble again in this weekend's Bahrain Grand Prix while it works on further fixes



ROSBERG SLAMS HAMILTON'S TACTICS

Another Mercedes one-two was overshadowed by Nico Rosberg's attack on Lewis Hamilton's go-slow approach to tyre management in the Chinese GP

NEW MONTOYA IS THE REAL DEAL IN INDYCAR

Juan Pablo Montoya tops the points after two rounds. Our US correspondent Mark Glendenning says he's a legitimate contender and should be taken seriously

the week



BTCC DONINGTON - LIVE

ITV4
Sunday 1030-1800
 After the thrills of the opening weekend at Brands Hatch, ITV4's bumper coverage of the British Touring Car Championship resumes as Donington Park plays host to the second round of the season.

Honda heads to the Leicestershire circuit as the surprise championship frontrunner after Gordon Shedden and Matt Neal both won in the new Civic Type-Rs, but the chasing pack of West Surrey Racing, Triple Eight and Team BMR will be keen to recover after mixed starts to their 2015 campaigns.



GP2 BAHRAIN - LIVE

Sky Sports F1
Sat 1105-1235, Sun 1210-1325
 Last season's GP2 runner-up Stoffel Vandoorne starts 2015 as clear favourite, but with strong competition from DAMS duo Pierre Gasly and Alex Lynn plus returning threats of Mitch Evans, Alexander Rossi and Raffaele Marciello, the McLaren development driver faces stiff competition for the crown. Sky's F1 channel continues its coverage, but times relative to the grand prix sessions differ from the European rounds due to Bahrain's night-leaning F1 schedule.



NASCAR BRISTOL - LIVE

Premier Sports
Sunday 1800-2130
 It's back to the bruising short tracks for a second time in three Sprint Cup rounds as NASCAR heads to Tennessee's popular half-mile Bristol Motor Speedway.

Kevin Harvick and Jimmie Johnson are the leading Chase contenders so far with two wins each, Penske pair Brad Keselowski and Joey Logano are in the title hunt too, but Harvick's Stewart-Haas team-mate Kurt Busch has little to show for the speed that has brought two poles in the last three races. Keep an eye on the resurgent, but yet to win, Furniture Row team and Martin Truex Jr too.



WTCC MARRAKECH - LIVE

Eurosport
Sunday 1600-1800
 Last season's curtain-raiser, the Circuit Moulay el Hassan street track hosts round two in 2015. Citroen's opposition will be hoping that they can close the gap to the 2014 champion team, which dominated the opening round of the season with Jose Maria Lopez and Sebastien Loeb both easing to victory in Argentina.

There's normally plenty of destructive chaos at the Marrakech venue, which could open the door for a surprise or two. And will it be the intriguing new Lada that springs it?

HOT ON THE WEB THIS WEEK

YouTube NASCAR'S DREADED COMMITMENT CONE VIOLATION

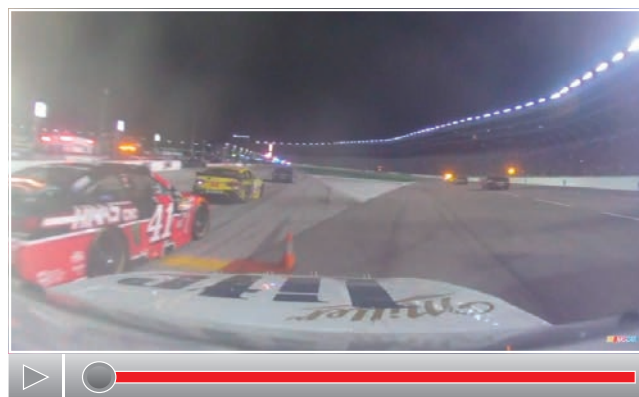

SEARCH FOR: Kez hits the commitment cone
 NASCAR likes to keep things low-tech – it's a formula that's served the series well for decades. So when Brad Keselowski bailed from the pitlane approach at Texas Motor Speedway, he knew he was in trouble the moment he hit a humble traffic cone.

AUTOSPORT'S TWEETERS

- Autosport**
@autosport
- Ben Anderson**
@BenAndersonAuto
- Gary Watkins**
@gazzasportscars
- Edd Straw**
@eddstrawF1
- Mark Glendenning**
@m_glendenning
- Glenn Freeman**
@glenn_autosport
- Stuart Codling**
@CoddorsF1
- Mitchell Adam**
@DrMitchellAdam
- Marcus Simmons**
@MarcusSimmons54
- David Evans**
@daveevansrally
- Henry Hope-Frost**
@henryhopetrost
- Jonathan Noble**
@NobleF1
- Scott Mitchell**
@ScottMitchell89
- Lawrence Barretto**
@lawrobarretto

HAVE-A-GO HERO

When drivers crop up in unexpected places



Krumm's Stateside career back in 2001 didn't last very long...

Krumm's US adventure

German Michael Krumm jumped at a chance to race in CART in 2001, despite very little testing. He now wishes he'd had a proper crack at it

Michael Krumm had already established himself as a great multi-disciplinarian, finishing second in Formula Nippon in 2000 while also contesting SuperGT for Nismo, when he received a tentative offer to race in Champ Car for 2001. The call came from Christian Danner, who together with Andreas Leberle had been trying to get a team off the ground for several years.

"They had some German sponsors that unfortunately never came through," recalls Krumm. "But it was a chance to race in CART, so I said, 'Sure, I'm up for that.' It wasn't a risky thing for me career-wise because I could still race in Japan.

"Andreas was full of passion, and no matter how bad the situation was he just wanted to make it happen."

A January 2001 edition of AUTOSPORT carried a prophetic image of Krumm testing a sponsor-free Reynard at Laguna Seca.

"Sadly they did not take the water



...but the all-rounder enjoyed the experience

out of the engine for the drive to Laguna," he says. "It froze and broke the engine before the car arrived. I got one afternoon's testing."

Project Racing merged with fellow minnow Dale Coyne Racing shortly before the start of the season in March. There was just enough backing for Krumm to run two races in Coyne's Lola: the season-opener in Monterey and then Long Beach.

"I had to prepare physically," he says, "and without testing it was

going to be really difficult. I'd done a lot of training over the winter.

"The cars had no power steering and a sequential seven-speed 'box. I wish I'd done left-foot braking then, because I was doing heel-and-toe. It was busy! And the downforce was huge. You had all this grip and 900bhp. It was completely mad."

To add to the difficulties, the brand-new track was completed late and, at first, the 'green' surface offered very little grip.

"It was like driving on ice. The top guys were doing one lap in practice and then pitting — waiting for me to clean the track! The first time there was some grip was in qualifying. I qualified P-nowhere.

"But in the race, the car was very well-balanced. I kept out of the craziness of the first laps, and step by step I got up to speed. And the grip kept increasing. I got quicker and the forces got more brutal."

Having pitted for new tyres and fuel, Krumm found the forces even

more onerous. He began to wonder if he would make it to the end. But, since he was now running in ninth place, there was no question of wimping out quietly.

"I was breathing like a horse," he says, "but the car felt competitive. Finishing in the points in my first race would be awesome. We calculated I could have been sixth.

"After my last pitstop, when the grip came in, I just couldn't turn the wheel any more. Thank God the engine blew up — although I didn't say that at the time! Another lap and I would have hit the wall."

The second and final race, at Long Beach, proved less satisfying even though Krumm made it to the finish. A diff failure left him unable to put the power down and he took 15th place. The cash-strapped team shut its doors thereafter.

"As brutal as it was," says Krumm, "I enjoyed it. I would have loved to race there again." ❧

Stuart Codling

NEXT WEEK F1 hots up in Bahrain

Plus: the BTCC heads to Donington Park

LYDDENHILL

AS SEEN ON
TOP GEAR



**MOTORSPORT NEWS
WORLD RX OF GREAT BRITAIN
R4: 23 - 24 MAY
LYDDEN HILL, CANTERBURY, KENT**



SAVE 15+% ADVANCED TICKETS NOW AVAILABLE
LYDDENHILL.CO.UK

TICKETS FROM £25 ACCOMPANIED U12s FREE
0844 871 8819

*(CALLS COST 6P PER MINUTE PLUS NETWORK EXTRAS)



**READY FOR
THE BEST PERFORMANCE!**



NFERA SUI NFERA RUI



NEXEN TYRE

Driving Tomorrow

NEXEN TYRE Global Homepage - www.nexentire.com
NEXEN TYRE U K Homepage - www.nexentyres.co.uk