

AUTOSPORT

ALL-TIME CLASSIC HUNGARIAN GP

www.autosport.com • JULY 31 2014

RICCIARDO'S RIPPER RACE



STORIES OF AN EPIC BATTLE

Mercedes new team orders row >>

Alonso second "feels like win"

Button suffers strategy disaster



ADAM FIRTH
 MICHELIN Pilot Sport Challenge
 in Spa-Francorchamps, 951 points
 and a reference time of 03:26:70

ALEXANDRE SCHONT
 Coach and MICHELIN expert

PORSCHE 911 GT2
 462 HP at 6,250 rpm

MICHELIN Pilot Sport Cup 2
 Over 50% more laps and faster*
 due to technologies from endurance racing

**PERFORMING BEYOND YOUR
 LIMITS IS THE ONLY VICTORY
 THAT COUNTS.**

FOR MORE INFORMATION ON
 THE MICHELIN PILOT SPORT CHALLENGE GO TO:
PILOTSPORTEXPERIENCE.MICHELIN.CO.UK

Adam Firth, 41, set a personal best in his Porsche GT2 at the MICHELIN Pilot Sport Challenge in Spa-Francorchamps.

Becoming a better driver isn't about what you can achieve in just one lap of the race track – it's about being able to replicate the performance over several laps. Michelin understands this very well – and that's why they're offering drivers all the benefits of their expertise, lap after lap. Thanks to Michelin, competitors in the MICHELIN Pilot Sport Challenge have two formidable weapons to call upon. Firstly,

they've got the advantage of having their own MICHELIN coach to provide technical support. Secondly, their cars are fitted with MICHELIN Pilot Sport tyres such as the MICHELIN Pilot Sport Cup 2 – which can help achieve up to 50% more laps of the track, faster and with greater consistency*. That's because MICHELIN Total Performance delivers more all round performance in one tyre.



MICHELIN Pilot Sport Cup 2 - approved for the road, designed for the race track.



*Compared to its predecessor, Michelin Pilot Sport Cup+. Internal tests 2013.



Cover images:
Staley & Etherington/LAT

POLE POSITION

Ricciardo shows he can be F1's next megastar

WHAT A CLASSIC GRAND PRIX THAT WAS! CULMINATING in that three-way dice for the lead (a party that early leader Nico Rosberg arrived a little late for), the tyre-life situation of the top trio set up a perfect scenario for a frantic race to the finish line as Fernando Alonso (worn-out softs), Lewis Hamilton (worn-out mediums) and Daniel Ricciardo (fresh-ish softs) went to battle.

For the second time in his career, Ricciardo had a chance to win a grand prix and snatched it with glee, this time passing Hamilton around the outside (it was Sergio Perez in Canada) and then nailing a pass on a hobbled leader in the closing moments. Then we had the Mercedes pair warring hard over the final podium position, this following the sideshow of the earlier team-orders instruction that Hamilton (quite rightly) chose to dismiss.

"Bubbly out of the car, Ricciardo is showing true mettle behind the wheel"

Ricciardo has been a breath of fresh air for F1 this year, grabbing his big chance to shine, and it underlines the fact that the drivers should always be the stars of the Formula 1 show. Bubbly out of the car, Ricciardo is showing true mettle behind the wheel – not many drivers can say they've passed Hamilton the long way round!

He not only overtook Alonso for the win on Sunday, he's pulling away from him in the non-Mercedes world championship standings too. It seems Red Bull has a new smiling assassin, and one with whom his four-time world champion team-mate Sebastian Vettel knows he's got a fight on his hands when F1 reconvenes after the summer break if he's to remain top dog at the team.

● On a far more sombre note, it came as a real shock to hear of the tragic accident that claimed the life of Denis Welch in a Lotus at the Silverstone Classic on Sunday. I'll fondly recall the gusto with which he used to drive his beloved Austin-Healeys over the years. Our condolences to his family and friends in what has been such a sad year for historic and vintage racing alike.

● Sally Bamber, the widow of our former ace cartoonist Jim, has asked me to thank everyone who took the time to write about him over the past few weeks since he passed away. The Bamber family has been overwhelmed by all the kind messages and tributes to Jim on social media, and in the many cards and letters they've received, and it has been a comfort to them to know that Jim was so well liked and admired.



Charles Bradley

CHARLES BRADLEY EDITOR
charles.bradley@haymarket.com
@Autosport_Ed

FIND US ON



PIT & PADDOCK

- 6 **THIS WEEK IN F1**
- 9 **JONATHAN NOBLE: F1 NEWSHOUND**
- 10 **THIS WEEK IN MOTORSPORT**
- 15 **DARREN TURNER: INSIDE LINE**

GRAND PRIX REPORT

16 **HUNGARIAN GRAND PRIX**
Well, that was rather entertaining... Full story of how Daniel Ricciardo proved his emergence as a top-liner by fully grasping an opportunity given him by circumstances. Plus the many other narratives of an enthralling race, the stories behind the scenes, team by team, technical updates and full results

DEBRIEF

- 32 **MERC BIDS TO RAMP UP RELIABILITY**
Dominant team wants fair fight between its stars
- 34 **MAGNUSSEN ON THE UP AT McLAREN**
How F1 rookie is staking his claim as a long-termer

FEATURES

- 37 **15 QUESTIONS: JEAN-ERIC VERGNE**
Toro Rosso's man on karting, food... And acting
- 38 **JOTA SPORT'S RISE TO THE TOP**
Decade-long story behind the LMP2 Le Mans winners
- 40 **JOLYON PALMER INTERVIEW**
He's Britain's boy making headway towards GP2 title

RACE CENTRE

- 42 **GP2 HUNGARORING**
Just like F1! Well-timed safety car gives Pic his chance
- 45 **GP3 HUNGARORING**
Just like F1! Epic finish; bloke from Down Under wins
- 46 **USC; NASCAR; FORMULA RENAULT NEC**
- 53 **BRITISH F3 SPA**
Jones on top as Merhi puts in stunning performance
- 54 **SPA 24 HOURS**
Audi heads BMW in tight – and dramatic – enduro
- 58 **SILVERSTONE CLASSIC**
Early-1980s F1 cars. Check. High-tech Super Tourers. Check. Pretty F3 cars. Check. Read our bumper report

CLUB AUTOSPORT

- 75 **TRAGEDY AT SILVERSTONE CLASSIC**
Historic ace Denis Welch succumbs to injuries
- 76 **FORMULA RENAULT UK IS BACK**
National series returns for 2015 after three-year break
- 80 **NATIONAL REPORTS**
Brands Hatch BARC; Pembrey rallycross; Cadwell Park BARC; Anglesey 750MC; Kirkistown 500 MRCI; Wiscombe Park hillclimb

SUBSCRIPTION OFFER

88 **FREE BOLLE SUNGLASSES**
Subscribe for a great free gift and digital package

THE BACK STRAIGHT

- 90 **THIS WEEK**
Readers' letters; best pictures; product reviews
- 92 **WHAT'S ON**
The best track and TV action in the coming week
- 94 **RACE OF MY LIFE: ALAN MINSHAW**



THE BIG PICTURE

Ex-Formula 1 driver and Le Mans 24 winner Jackie Oliver presses on in his newly acquired Ford Mustang at the Silverstone Classic event last weekend. [Full report, p58](#)



This week in F1

MEXICO BACK ON F1 CALENDAR

Mexico will return to the F1 calendar next season after a 23-year absence.

The event will take place at the 2.747-mile Mexico City circuit.

The final track layout has yet to be defined, but organisers have said the pits, paddock and spectator areas will be revamped.

The race featured on a provisional

calendar for this season, but failed to get track updates ready in time to secure the slot.

Tavo Hellmund, who played a key role in taking F1 to Austin, has pushed efforts to get Mexico back on the calendar. Mexico would likely become a back-to-back event with the US GP.

Meanwhile, Azerbaijan will host the European Grand Prix in 2016 after event organisers confirmed a one-year delay to original plans for a race on the streets of Baku. The race will take place on a new circuit designed by Hermann Tilke, with the pits and start/finish straight based around its iconic Azadliq Square.

I am 100 per cent sure that we will go to Mexico next year. Everything was confirmed last year, but it was very difficult due to the time we had to build the circuit. Now there is no doubt.

FORCE INDIA'S MEXICAN RACER SERGIO PEREZ

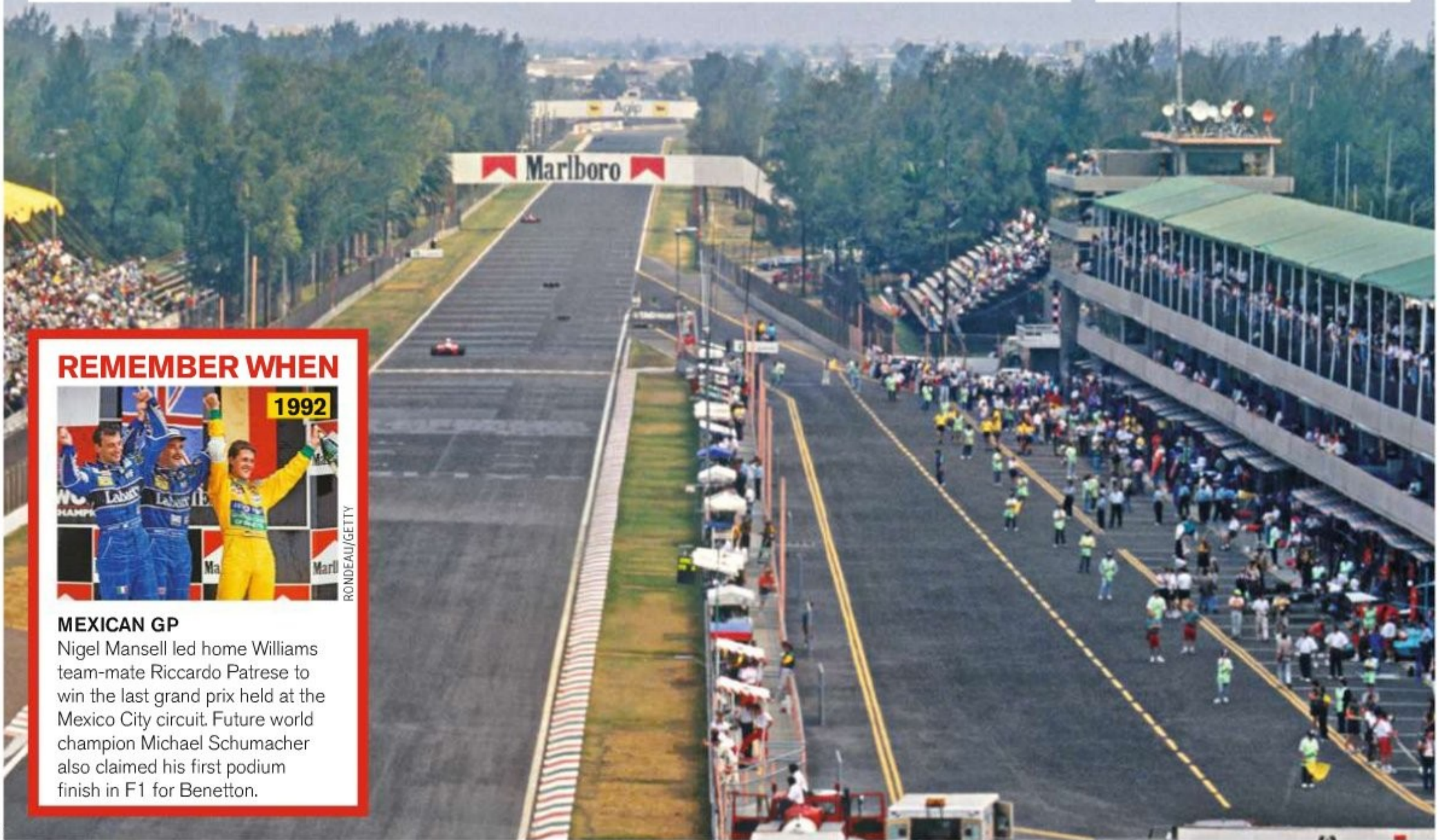

REMEMBER WHEN

1992

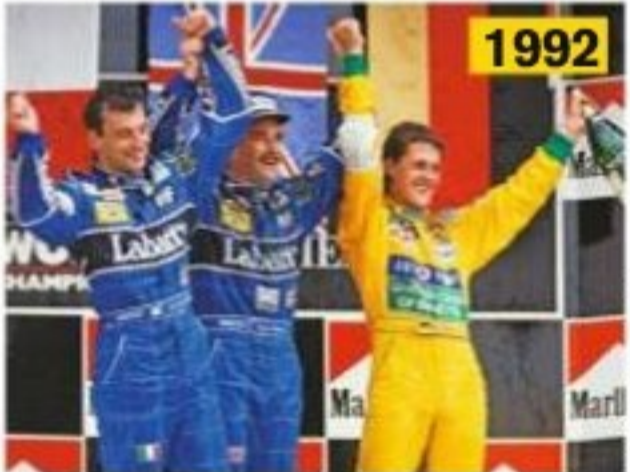

MEXICAN GP

Nigel Mansell led home Williams team-mate Riccardo Patrese to win the last grand prix held at the Mexico City circuit. Future world champion Michael Schumacher also claimed his first podium finish in F1 for Benetton.

HAMILTON DISMISSES VETTEL-MERC RUMOURS

Lewis Hamilton insists he is not concerned for his long-term future at Mercedes, despite speculation linking Sebastian Vettel with the team.

Red Bull's motorsport advisor Helmut Marko suggested in German media that Mercedes is trying to lure Vettel for 2016, after Hamilton's current contract runs out.

"You never know what's going to happen in the future, but I can't particularly see myself anywhere else," Hamilton said. "But if they happen to want someone else then I'm not going to whinge about it. There are places [on the grid] for everyone."



"I don't think it is fair and I don't think we should have done it."



Mercedes boss Toto Wolff admits the folly of F1's double points finale

For all the breaking news, visit **AUTOSPORT.COM**

S.BLOXHAM/LAT



ROSSI JOINS MARUSSIA

Former Caterham tester Alexander Rossi has joined the Marussia F1 team as reserve driver for the rest of the 2014 season. Rossi confirmed there are "plans" for him to appear in Friday morning practice for Marussia later in the season. Meanwhile, Auto GP racer Kevin Giovesi has joined Nathanael Berthon on Caterham's 'new' F1 driver development programme.

Capelli behind Monza rescue

Ex-Formula 1 driver Ivan Capelli is behind a fresh push to keep the Italian Grand Prix at Monza, following Bernie Ecclestone's threat to drop the race. Capelli, who raced in 93 grands prix between 1985 and 1993, has just won election to the board of directors of the

Automobile Club of Milan – the organisation that effectively manages the Monza circuit. "Monza is historically one of the oldest GPs and we would like to continue after 2015, knowing that Bernie is always pushing everybody in his direction," Capelli told AUTOSPORT.



F1's MOST USED TRACKS

CIRCUIT	NUMBER OF GPs*
Monza	63
Monaco	61
Silverstone	48
Spa	46
Nurburgring	40
Montreal	35

* World championship GPs only

COATES/LAT

Sutil insists his seat is safe

Adrian Sutil says his future with Sauber is secure, despite speculation the Swiss squad may replace him with reserve driver Giedo van der Garde. Sauber is known to have suffered financial difficulties in recent seasons, but Sutil denied the presence of well-funded reserve drivers puts his own position under threat: "Since I am in F1 I had this situation. I think for half of my career people have said 'Adrian is out', but I am still here."



DUNBAR/LAT

Caterham faces legal challenge

The Caterham team's new owners are facing legal action from around 40 of its former staff, after they were axed in the wake of its recent takeover.

As well as taking legal action over the matter they want the FIA to look into the team's conduct.

A statement issued on behalf of the group of former staff said: "The

summary dismissal of employees from Caterham was done without warning or consultation and will result in significant compensation claims against the team.

"Caterham has also reneged on promises that employees would at least be paid in July. Lawyers for the group will take immediate action."

COATES/LAT



7

BIG NUMBER

120

The number of GPs Adrian Sutil has started in his career, a record for a driver without a podium finish to his name.

RENAULT CONSIDERS SPLIT MERC-STYLE TURBO FOR '15

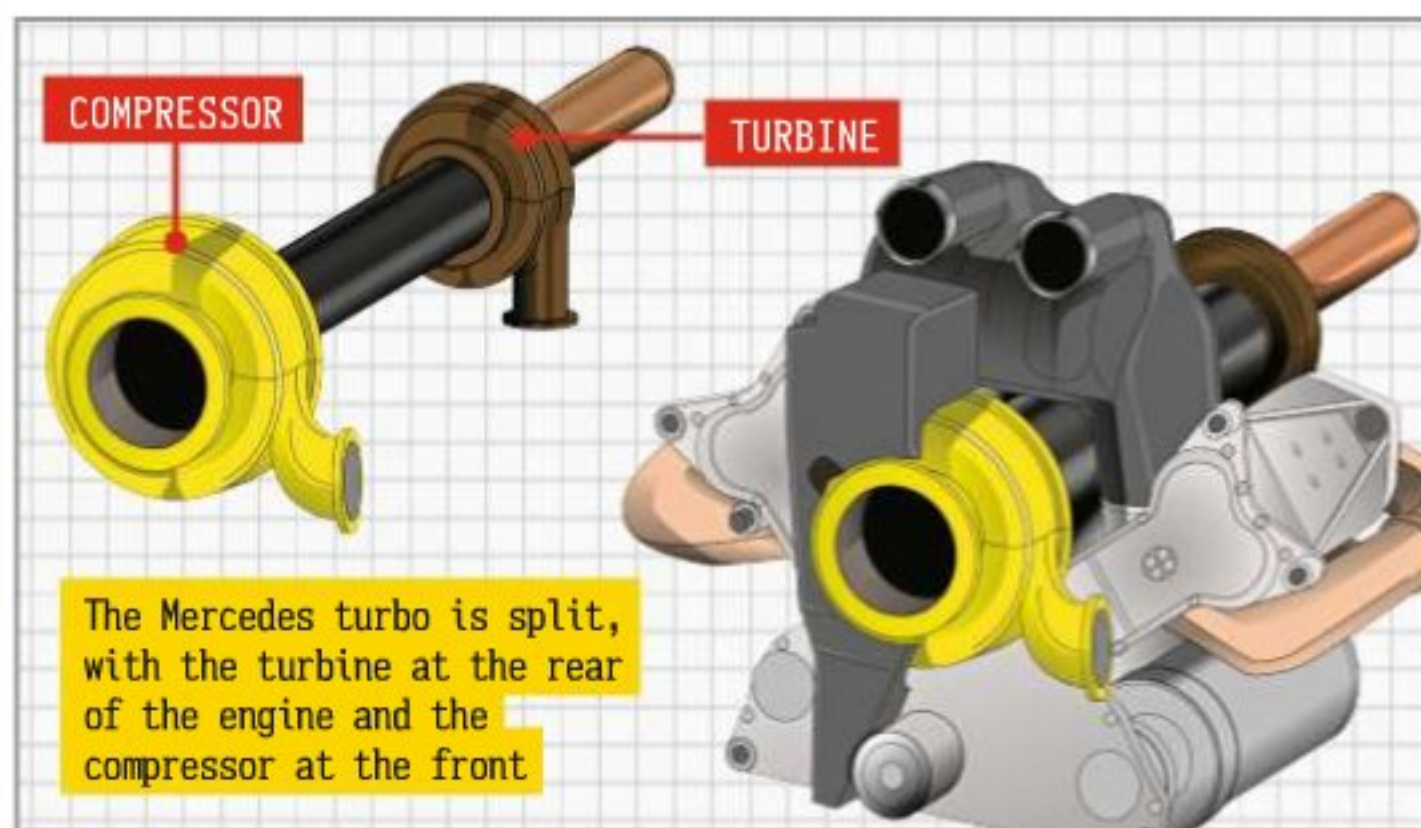

The Mercedes turbo is split, with the turbine at the rear of the engine and the compressor at the front

Renault is considering adopting the Mercedes split concept on its turbo for next season, as it works to overhaul its current F1 engine. One of the factors believed to have boosted Mercedes' form this year is

a design in which its air compressor and turbine are on separate ends of the powerplant. It is said to reduce turbo lag for improved efficiency, as well as assist with the car's aerodynamic packaging.



Briatore to help F1 popularity

Ex-Formula 1 team boss Flavio Briatore will be part of a new working group set up by Bernie Ecclestone to look at ways of making the sport more popular amid declining TV audiences. Ecclestone met with team principals at the Hungarian GP and informed them he plans to host a summit meeting over the next few weeks with a few outfits, plus Briatore, to consider ideas. Briatore has not been involved in F1 since stepping down at Renault in 2009 due to his part in fixing the 2008 Singapore GP.

RHYS/GETTY

COME AND SEE WHAT 'SERIOUS FUN' REALLY MEANS WITH ATOM CUP!

We are running a 'taster' day for
MSA Licence holders at Silverstone,
Friday 8th August in the 245bhp,
540kgs Ariel Atom.

Advice on the day from BRDC
Rising Star **Jake Hill**, 4 time
Atom Cup Race Winner.

Fantastic Packages to join the
Championship as an Owner-
Driver or on an Arrive and Drive
hire basis still available at our
remaining races at Brands GP
(August 16/17), Silverstone
(September 6) & Snetterton
(October 25/26) and for 2015.

www.atomcup.co.uk

For more information please contact **Simon Hill**
E: simon.hill@live.co.uk M: 07811 348681



DUNLOP MSA BRITISH TOURING CAR CHAMPIONSHIP

BTCC



SNETTERTON

SAT 2/SUN 3 AUGUST



SAVE
UP TO £6*
BOOK IN ADVANCE
KIDS UNDER 13 GO FREE!

WITH THE MAGNIFICENT
SEVEN CHAMPIONS

Adult advance admission
tickets from £26.
See online for details.
*Admission tickets available until midday
Wednesday 31 July 2014. Booking fee applies.

0843 453 9000
snetterton.co.uk



Snetterton



Jonathan Noble

F1's newshound

If F1 is to understand why its audience figures at the track and on TV continue to fall, it needs to ask the people who watch it – the fans

Formula 1 appears to have had a bit of an Einstein moment. Sadly, it's not something truly genius that's going to help the sport suddenly find a solution to turn around what many believe is a popularity crisis. Instead, I'm talking about one of (allegedly) Einstein's most famous quotes: "Insanity is doing the same thing over and over again and expecting different results."

That is in effect what F1 has done in creating a new working group with some teams, Bernie Ecclestone and Flavio Briatore to look at ways to make the sport more popular. You don't have to be too clever to realise that asking the very same team bosses who backed a hugely detested idea like double points to solve F1's current ills is unlikely to generate anything of much note.

If the teams are the right people to come up with the answers, then why haven't they done so already through F1's Strategy Group?

Why is Ecclestone the man to come up with the solution? He has openly poured scorn on social media, which is perhaps the biggest single route to opening up fresh ways to engage with a younger and wider audience.

And then we have, more controversially, Briatore's involvement. While there is benefit in having input from someone without a vested team interest, should F1 be embracing a man who was banished from the sport for his involvement in fixing the 2008 Singapore Grand Prix?

So if it's not the teams, Ecclestone or Briatore who have the answer to F1's falling audience figures, then who should



thing you do if you are worried that the punters are going to be upset about the noise is to ask them. It doesn't cost very much; if 98 per cent of the people who went to Silverstone said it was a disaster because it was so quiet, well, then you need to think.

"Then you can go off and increase the noise. But nobody knows for definite, because nobody has ever asked them. Just because Bernie and Luca think it should be noisy, and a few of the old hands do, doesn't mean it should.

"You're trying to get the 18-to-20-year-olds interested, not the 80-to-90-year-olds."

F1 has spent too much time in recent months trying to find answers for problems that don't exist – like double

"F1 must be the only major world activity where nobody understands about market research"

it be? Well, they are sitting right in front of every single person on the pitwall: it's the fans.

One of the key elements for any successful business in the world is to understand its customers – if you know what they want, it's much easier to give it to them. F1 is astonishingly guilty of not only failing to give fans what they want but not even knowing what they are after. It's remarkable that F1 has entirely failed to do a widescale market research campaign of its followers – both in the grandstands and those that watch on TV – to try to understand what it should be delivering.

I caught up recently with former FIA president Max Mosley, and he stated that it was incredibly frustrating that F1 didn't know what its fans really wanted. "What irritates me about the commercial side of F1 is that they all blow off about the noise, Bernie [Ecclestone], Luca [di Montezemolo] etc, but nobody does any market research," he said.

"It must be the only major world activity where nobody understands about market research. For example, the first

points and standing restarts – and doing nothing in areas where things have to change: like a coherent social media policy to bring F1 to a new generation of fans.

And ultimately the problems are more of where F1's culture has taken it – because what happens between the lights going out and the chequered flag is far from a problem. How can anyone not be excited by what was delivered on track in Hungary last Sunday?

F1's failures relate more to a lack of a coherent marketing strategy to promote the sport. It needs to improve fan interaction, make drivers true stars again, ramp up the characters and controversy that fuels the passion – and makes every young boy and girl want to be a part of the sport and follow it religiously.

But until F1 wakes up to the fact that it needs to go out there and ask those who watch it – and even those who don't – for their opinion on what they really want, it can't hope to come up with the solutions that are needed.

To think otherwise is insanity. ☹

This week in motorsport

PORSCHE STEPS IN TO SAVE KYALAMI

The chances of racing returning to the famous Kyalami circuit in South Africa have taken a big step forward after the country's Porsche importer bought the facility at auction.

Porsche South Africa put in the winning bid of 205 million rand (£11.4m), and company CEO Toby Venter – an ex-competitor – wants to preserve it as a racing venue.

Kyalami hosted the South African Grand Prix from 1967-85, and again on a redesigned track in 1992-93. Its most recent international fixture was A1GP (pictured) in 2009.

Venter told South African website *Wheels24*: "It would have been a tragedy if the racetrack was lost. We all have a role to play and every single motorsport enthusiast needs to know the track is saved."



REMEMBER WHEN



Porsches had a run of wins in Kyalami's international sportscar race in the 1980s, starting when Jochen Mass and Reinhold Joest took victory in '81 in Joest's 936 (here chasing the sister 908).

10

Ostberg wins Helsinki Battle



Citroën's Mads Ostberg defeated rally stars of past and present to win Saturday's Helsinki Battle.

The event, which ran through the city streets in celebration of 20 years of Neste Oils' Rally Finland sponsorship, pitched the Norwegian and his current World Rally colleagues against Finnish legends such as Marcus Gronholm, Markku Alen, Juha Kankkunen and Tommi Makinen. Ostberg beat Gronholm (driving a Hyundai i20 WRC) in the final.

"It's great to get my first win for Citroën and this is the perfect warm-up for Rally Finland," said Ostberg.



Audi: no change on R18 concept

Audi looks certain to continue racing its R18 e-tron quattro with only one hybrid system in next year's World Endurance Championship.

Audi Sport boss Wolfgang Ullrich told *AUTOSPORT* that there would be no major changes to the concept of the R18 in the planned development drive to increase the LMP1 car's

level of energy-retrieval for 2015.

Asked if that meant there would be no second system to supplement the 2014 R18's front-axle braking system, he said: "We will try to do what is possible in a short period of time. We must be more competitive, but we must be reliable. There will not be big concept steps."

Motopark back into Euro F3



Top German Formula 3 Cup team Motopark Academy is to return to the category's top echelon: the F3 European Championship.

Motopark aims to have two brand-new Dallara-Volkswagens on the grid for this season's final two Euro F3 rounds, at Imola and Hockenheim in October, and is also bidding for a Macau Grand Prix entry. The team raced in the F3 Euro Series in 2009-11.

GP2 veteran Tom Dillmann, who competed for the Motopark-run Russian Time squad in 2013, will be the development driver for the project.

For all the breaking news, visit **AUTOSPORT.COM**

Lowndes gets Le Mans bug



V8 Supercar stars Craig Lowndes and Shane van Gisbergen are both targeting competing in the Le Mans 24 Hours after taking part in last weekend's Spa twice-around-the-clock classic.

Lowndes, who was third in the Pro-Am class in an AF Corse Ferrari (above), said: "I'd like to do more endurance racing in Europe and I definitely want to do Le Mans. It's a bit of a bucket-list thing, but it's also about reconnecting with the European racing scene."

Van Gisbergen, who also participated in this year's Daytona 24 Hours, said he was looking to take part in all the major enduros, including Le Mans, the Nurburgring 24 Hours and Petit Le Mans at Road Atlanta.

P54 SPA 24 HOURS ACTION

PIQUET PLUGS IN FOR E TEST

Nelson Piquet Jr closed on joining the growing list of ex-Formula 1 drivers in the all-electric Formula E Championship when he tested the Spark-Renault at Donington Park last week.

Piquet squeezed in the test, with Campos-run China Racing, in between back-to-back events in the US-based Global Rallycross series, which he leads.

"It's good to get back in a single-seater, and I'm really interested in the Formula E concept and technology and what the car's like," said Piquet.

"It's been a while since I've driven at Donington but it was a track I loved back in F3 days."

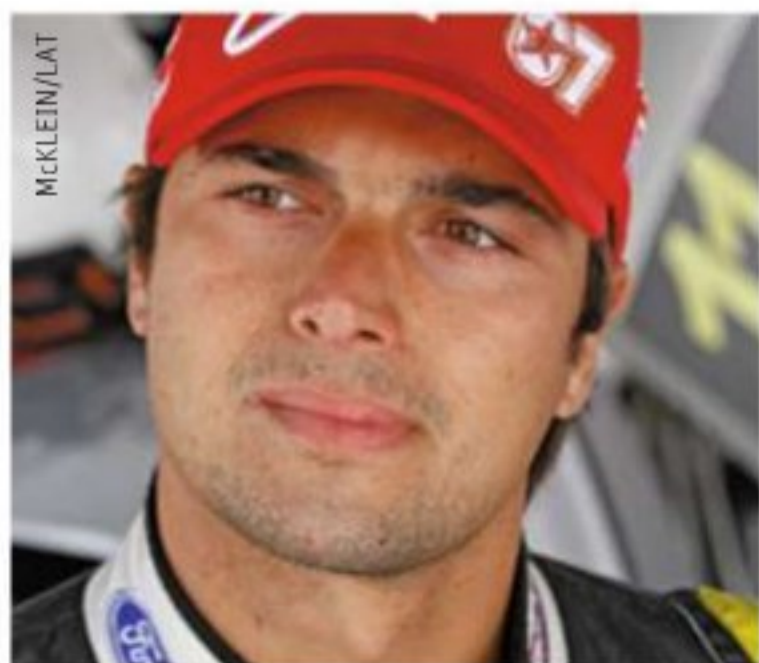

Ford Fiesta's Finnish facelift

M-Sport will bring its Ford Fiesta RS WRC up to date with the launch of its facelifted car at this week's Rally Finland. The launch was delayed by two months while the team conducted more testing.

In 29 years of doing F3, I think what Roberto did in race two - to hold off a car that had much more power - is the best drive I've ever seen. I'm totally amazed.



Double R team boss Anthony 'Boyo' Hieatt on Roberto Merhi's F3 return at Spa.

P53 BRITISH F3 REPORT

Brit alliance for GT Nissan

British single-seater teams Comtec Racing and Virtuosi UK are joining forces in Blancpain GT Sprint.

The Norfolk neighbours, which race in Formula Renault 3.5 and Auto GP respectively, aim to put a Nissan GT-R NISMO on the grid before the end of this season.

They have tested Norwegian GP3 racer Pal Varhaug, Russian FR3.5 podium finisher Nikolay Martsenko, Australian Nathan Antunes and South African Liam Venter.



DTM DROPS CHINESE TRIP

The DTM has abandoned plans to race in China this year, and will instead stage its penultimate round at Zandvoort (pictured).

The series was set to race on a brand-new street circuit in Guangzhou on the last weekend on September, but has now confirmed that the trip east will not be going ahead. The Zandvoort event that takes its place will be held on the same date.

ITR chairman Hans Werner Aufrecht said: "We have to be able to also guarantee the DTM standard when it comes to racing in foreign countries."

"When it comes to China, this year, all this couldn't be realised on the necessary level."

The return to Zandvoort will not feature on the European Formula 3 calendar - which traditionally supports the DTM - according to FIA sources.

In brief

EDWARDS OUT OF RFR

NASCAR Sprint Cup team Roush Fenway Racing has finally come clean on its split at the end of 2014 with former series runner-up Carl Edwards. Rival team boss Joe Gibbs, who is expected to sign Edwards, said: "We don't have anything right now to announce. I'm not sure exactly what the time line is."

INDYCAR FINES

IndyCar teams Rahal Letterman Lanigan Racing and AJ Foyt Racing have been penalised for rule breaches last time out at Toronto. RLL was fined \$5000 because Luca Filippi's car was underweight in race one; Foyt was hit for \$1000 due to a rear-underwing breach in qualifying on Takuma Sato's car.

GT86 TO BREAK COVER

Former world champion Isolde Holdereid will drive this Toyota GT86 CS-R3 as a zero car on next month's Rally Germany. This will be the second time in three years Holdereid has given a new Toyota its debut in Trier - she also drove the Yaris R1 in 2012.



Palmer accuses GP2 'crier' Nasr

GP2 points leader Jolyon Palmer has accused title rival Felipe Nasr of "crying about it" when he twice passed the Brazilian during last weekend's races at the Hungaroring.

Nasr claimed he was forced off the track by the British driver in both races. Although stewards investigated the second incident, they decided that Palmer was not at fault.

"I passed a few people fairly but unfortunately Felipe was the most aggressive," said Palmer. "I went up the inside and he squeezed me in the braking zone all the way to the inside so I understeered."

Nasr countered: "I expected better driving standards from him. This is the kind of driving that is not very fair when you're fighting for the title."

marcvds
racing team



Car #77: 2nd Place by 7077 seconds after 24 hours of racing
With thanks to all our sponsors and fans



randstad

Castrol EDGE

LeasePlan



CHAMPAGNE
JEEP

HEROCK
WWW.HEROCKWORKWEAR.COM

PCL

CHASSISIM
The Winner's Edge

OPTIMUM
vehicle dynamics solutions

GT wins by
LePlan
DIRK VERMEERSCH

M. PALTALA
D. WERNER
L. LUHR
77
marcvds
BMW Z4 GT3

24 HOURS
SPA

LeasePlan



www.marcvds.com



FAST CARS. CHALLENGING CIRCUITS. GREAT RACING.

INVITING DRIVERS TO THE MRF CHALLENGE 2014.

Arthur Pic, Harry Tincknell, Rupert Cook, Sam Dejonghe and Tio Ellinas were some of the international drivers who participated in the closely contested MRF Challenge 2013. The 2014 MRF Challenge should be even more exciting. We are inviting drivers with a passion for speed to be crowned 2014 Champions. We are offering a very competitive all-inclusive "arrive & drive" pricing of USD 50,000 for the chance to race in one of India's premier Formula Championship Racing Series. Are you fast enough to grab this opportunity?

FEATURES

- Carbon-fibre F3 safety standard chassis from Dallara
- 3 weekends – 12 races
- 5 sets of MRF tyres per round
- Round 1 will take place in Qatar
- Round 2 is a support race for FIA WEC in Bahrain
- USD 100,000 (INR 64 lakhs) prize – fund for the top 3 finishers
- All-inclusive "arrive & drive" pricing including flights and hotels*
- Top European race engineers and mechanics
- On-board cameras on all cars

SCHEDULE

- Round 1 – October 17-18, 2014 - Losail International Circuit, Qatar (night race)
- Round 2 – November 14-15, 2014 - Bahrain International Circuit, Bahrain
- Round 3 – January 24-25, 2015 - MMRT, Chennai, India

*Flights from Heathrow to the venue or equivalent thereof



**LEAVE
EVERYTHING
BEHIND**



For more details:

UK contact: David Hayle, Personal No: 0044(0)7768662384
Office No: 0044(0)858561, Email: davidhayle3@hotmail.co.uk
India contact: Phone No: +91 93819 21113
Email: ja@jamotorsport.com, Visit us at www.mrfacing.in



Darren Turner

The Inside Line

The Aston Martin Racing stalwart reflects on a decade of sportscar success and how he still relishes the role's variety



Aston Martin Racing reaching 10 years is a real milestone. It doesn't feel like that long has already passed since we did the first shakedown with the DBR9 at Donington Park in 2004.

I wouldn't call it a rollercoaster, it's been very successful. The only real negative was the AMR-One prototype. We've managed to win some big races and it's been great to have been part of the development of the cars, race in the American Le Mans Series, the World Endurance Championship, at Le Mans and lots of other places.

One of the highlights has to be the first race with the GT1 DBR9, at Sebring in 2005. We didn't expect to win – it was a shakedown really – but we got quicker and quicker as the track rubbered-in over the weekend. Winning GT1 at Le Mans in 2007 and 2008 are also highlights, not just of my time with AMR but of my whole career.

AMR is a small team and punches well above its weight. We're always there or thereabouts and to have a chance to challenge for wins is what you want as a racing driver.

I never had the funding to make it up the single-seater ladder; there was no way I was going to get a Formula 3000 seat. The opportunity to switch came off the back of the McLaren AUTOSPORT BRDC Award, getting the McLaren F1 test and McLaren putting me in touch with Mercedes to do the DTM. McLaren's Martin Whitmarsh opened doors for me – it wasn't a big decision, I was just thankful of the opportunity. I needed to be a professional driver and that gave me the chance.

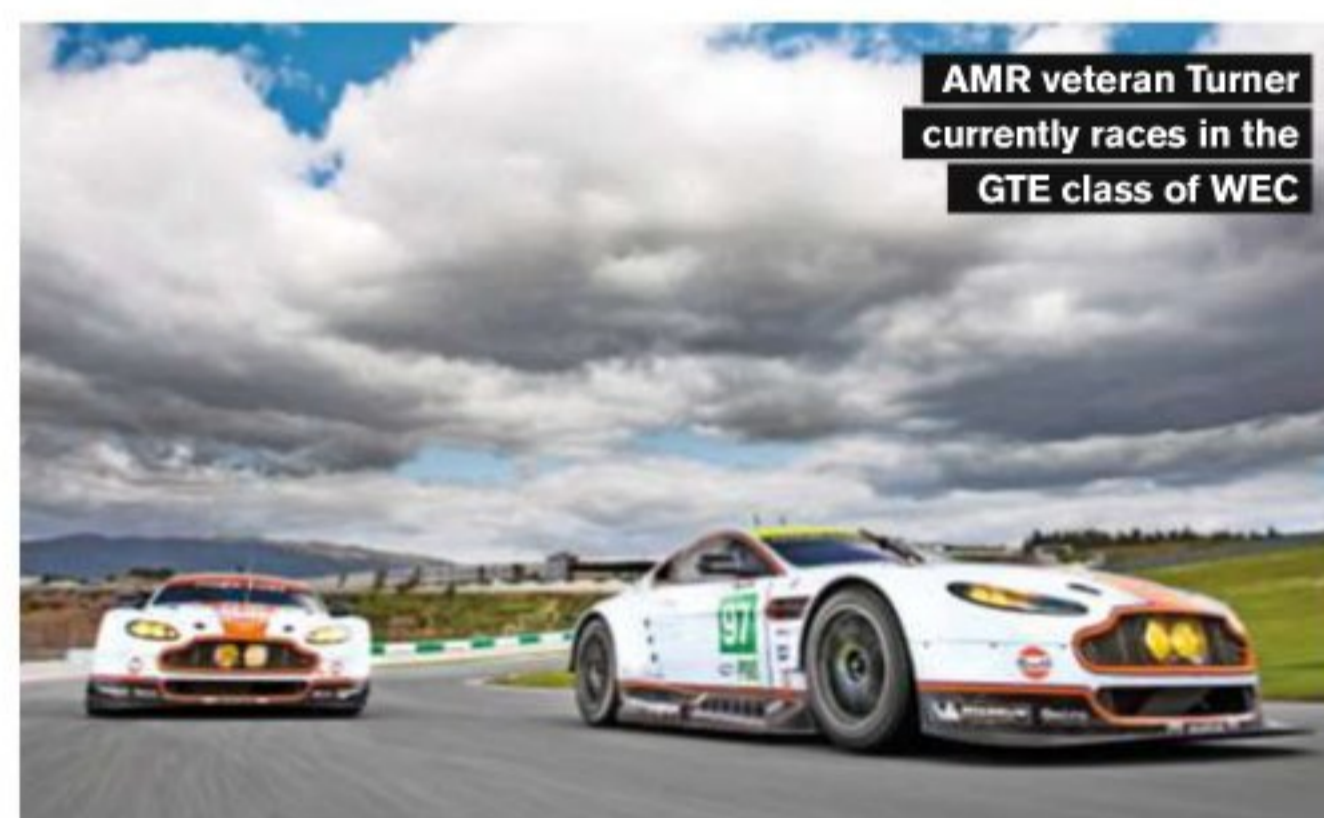

There have been ideas to bring GTE and GT3 together, but if it's not broken, don't fix it. There are manufacturers who just want to build GT3. Anyone can come along and, with the Balance of Performance, be competitive. You still need good teams and drivers, but you can do it. Maybe in time there will be one type of car, but at the moment I enjoy jumping between the two.

GTE has more downforce and the overall package is more refined, the cars are more special to drive. They have a little less power but no ABS. It's more like an F3 car, less power and more cornering ability.

I really enjoyed the LMP1 prototypes – I loved the

“As a works driver I get loaned out to customer teams. I get to see things from a different angle”

I totally understand why young guys are coming off the single-seater ladder earlier and earlier to get drives in touring cars or sportscars. It's a sign of the times; F1 has gone so far it's become about technology and money.

It's good to have great guys coming over, but I've not yet seen one who has jumped in and moved the goalposts in terms of performance – it just raises the level. The level is high and it shows it's not some second-tier competition.

Racing with AMR is varied, too. Last weekend I was driving with MP Motorsport at Spa and the week before it was TF at Silverstone [winning in the International GT Open]. As a works driver I get loaned out to customer teams, which is good because you see things from a different angle and how a private outfit operates.

You look at those teams and they are clever people. We might have come up with a solution three or four years ago, but they come to it with fresh eyes and sometimes have different solutions. It's not a one-way street from factory to customer; you never stop learning.

Lola-Aston [in 2009-2010]. The AMR-One project [in 2011] got the green light really late and didn't have the budget for a programme like that. It was massively brave.

We didn't do many laps in the car, but there was one point through the Porsche Curves at Le Mans where I saw a Peugeot coming up behind and thought it would blow past, but it dropped further back. It was a very small section of track, but it showed the car had some real potential, if we'd had more time with it. Ultimately though, it was the right decision to can the project and focus on something Aston can do so well.

I had a really good chance with Toyota when they came into LMP1, but my contract with Aston stopped me doing it. I can't imagine Aston going down the prototype route again, but you never know. If something came along and was possible I'd consider it. I just enjoy driving.

As long as you do a good job, you should still get drives. Maybe there's a role for me at AMR after I've stopped, but I think I've got a few more good years in me yet. ☺

HUNGARIAN GP

THE RACE REPORT

QUALIFYING • TRACKSIDE VIEW • RACE HISTORY • TEAM BY TEAM • RESULTS

Luck only had a little to do with it

Daniel Ricciardo needed a well-timed safety car to get into victory contention, but **EDD STRAW** explains how he drove an inspired race to take a victory that cements him as an F1 superstar



AT A GLANCE



"We had to overtake to win the race – we had fresher tyres but I knew it would be an exciting finish" **DANIEL RICCIARDO**

HUNGARIAN GP
Hungaroring

ROUND 11/19

LAPS 70

WINNER
Daniel Ricciardo
1h53m05.058s

POLE POSITION
Nico Rosberg
1m22.715s

FASTEST LAP
Nico Rosberg
1m25.724s

RACE RATING
★★★★★ An absolute classic that will be remembered for years as Ricciardo stormed to victory

DRIVERS' STANDINGS

1 Nico Rosberg	202pts
2 Lewis Hamilton	191pts
3 Daniel Ricciardo	131pts





Hamilton walks away from his smouldering Mercedes

QUALIFYING 14:00, 26.07.2014

18

With Lewis Hamilton's charred Mercedes eliminated just five minutes into qualifying thanks to a fuel leak, the way was clear for the Nico Rosberg to cruise effortlessly to an unopposed pole position. But rain at the start of Q3 meant it was far from easy.

Rosberg was ideally placed as first car on the road, but with the rain at its worst in the vicinity of Turn 1, locked up and went straight on. "I took it easy under braking because I could see it was wet," said Rosberg. "And I took it just easy enough not to hit the tyres. It could have been the last shot with slick tyres, so I had to take a little bit of risk. It was just completely unpredictable."

Rosberg only rued his error for a moment. Kevin Magnussen, second on the road, then locked up at the same point and smacked into the barriers, bringing out the red flag. Given that Jenson Button also slid off, Rosberg's

overshoot was entirely excusable.

When things got back underway, it all came down to the second runs. Rosberg had been fastest on the first runs, but Sebastian Vettel's late effort bumped him down to second. Rosberg had to respond, which he did brilliantly, stringing together the three fastest sector times of anyone to reclaim pole position by almost half-a-second.

Yes, Hamilton was absent, but the pair had been separated by just 47-thousandths on their Saturday morning qualifying simulations and Rosberg's final lap was excellent, so a Hamilton pole was not guaranteed.

Vettel, happier with the handling of his Red Bull than at any point in the season, was an excellent second. But the real star of qualifying was Valtteri Bottas, not just for his fine third on the grid in a Williams less well-suited to the tight confines of the Hungaroring, but for his pace in the still-slippery first

sector after the red flag. On his first flying lap, he was almost a second faster than anyone else. It wasn't his fastest, so was ultimately irrelevant, but it was a reminder of his class and bravery.

Daniel Ricciardo, who lost his 'monkey seat' wing during Q3 (later confirming "I think the monkey's dead, his tambourines got pretty messed up as well"), was fourth ahead of Fernando Alonso. The Spaniard was frustrated at Ferrari's timing, which meant he finished his flier with 14s remaining, missing optimum conditions.

But he wasn't as frustrated as teammate Kimi Raikkonen. The Finn was eliminated early on after Ferrari underestimated the potential for improvement by Jules Bianchi. While Raikkonen sat in the pits after completing just one run on the slower medium-compound Pirellis, the Marussia driver knocked him down to 17th in the closing moments of Q1.



Rosberg romped to another pole once rain passed

P30 FULL RESULTS & POINTS

THE GRID

1 ROSBERG MERCEDES 1m22.715s Intermediate	2 VETTEL RED BULL 1m23.201s Intermediate
3 BOTTAS WILLIAMS 1m23.354s Intermediate	4 RICCIARDO RED BULL 1m23.391s Intermediate
5 ALONSO FERRARI 1m23.909s Intermediate	6 MASSA WILLIAMS 1m24.223s Intermediate
7 BUTTON McLAREN 1m24.294s Intermediate	8 VERGNE TORO ROSSO 1m24.720s Intermediate
9 HULKENBERG FORCE INDIA 1m24.775s Intermediate	10 KVYAT TORO ROSSO 1m24.706s Intermediate
11 SUTIL SAUBER 1m25.136s Intermediate	12 PEREZ FORCE INDIA 1m25.211s Intermediate
13 GUTIERREZ SAUBER 1m25.260s Intermediate	14 GROSJEAN LOTUS 1m25.337s Intermediate
15 BIANCHI MARUSSIA 1m27.419s Intermediate	16 RAIKKONEN FERRARI 1m26.792s Intermediate
17 KOBAYASHI CATERHAM 1m27.139s Intermediate	18 CHILTON MARUSSIA 1m27.819s Intermediate
19 ERICSSON CATERHAM 1m28.643s Intermediate	20 MALDONADO LOTUS no time Intermediate
21 MAGNUSSEN McLAREN no time Intermediate	22 HAMILTON MERCEDES no time Intermediate

KEY
+5 5-place grid penalty
P Started from pitlane



Rosberg left pack in his wake in opening stages on wet track

RACE 14:00, 27.07.2014



Daniel Ricciardo had one slice of luck on his way to Hungarian Grand Prix victory. That came

when Marcus Ericsson launched his Caterham into the wall too late for the top four cars to make it into the pits.

The Australian, who spent the early stages of the race running sixth, had dropped five seconds behind Nico Rosberg, Valtteri Bottas, Sebastian Vettel and Fernando Alonso thanks to being stuck behind Jenson Button's McLaren. It was enough of a delay to mean that he was able to make a late dive into the pits when Ericsson's crash made a safety car inevitable.

This provided a vital leg-up in terms of track position, but still with a lot of work to do to seal what proved to be a spectacular victory. Luck had a little to do with it, but this was a win made possible by the virtuosity of a driver who is looking less and less of an

interloper among the elite, and increasingly an established part of it.

PHASE ONE ROSBERG IN CONTROL

Prior to Ericsson's shunt, Rosberg ran away with it. Having held the lead from pole position, he set about building a lead. Thanks to Bottas getting around the outside of Vettel at Turn 1, Rosberg had a helpful Williams roadblock backing up the leading Red Bull.

By the time the safety car was deployed on lap eight, Rosberg's Mercedes was long past the pit entry. The bulk of the field pitted at the end of that lap, leaving only the four unfortunate stopouts to trudge around for another lap before heading in.

"We knew it was going to be a safety car, so told both boys to box," said Red Bull team principal Christian Horner. "Seb was halfway around the

last turn. Daniel managed to make the pitlane. The first four cars didn't make it in, so the group behind were in the pound seats."

Of the four early frontrunners, it was only Bottas who was eliminated from podium contention thanks to a tardy 5.2s pitstop that relegated him to 11th. This round of pitstops also broke Button's race. He lost what was to become the lead to Ricciardo, having peeled into the pits in front of him, and still rejoined in second, but he was the only driver to take another set of intermediate tyres for the drying track.

It was a costly call by a team that placed too much confidence in what its weather service claimed. He did pass Ricciardo for the lead at the restart, but it was a pyrrhic victory given that his intermediates were shot after just two laps, and he dropped to the back after pitting for slicks.

With Bottas and Button relegated to supporting acts, Rosberg, Vettel and Alonso were at least still in it, running fourth, seventh and eighth respectively.

PHASE TWO BETWEEN THE SAFETY CARS

Things were already looking very good for Ricciardo. Like most, he was on the soft rubber and able to start building a lead over Felipe Massa's Williams, with an almighty battle raging for third involving Alonso, Jean-Eric Vergne, Rosberg, Vettel and Hamilton.

Yes, that would be the same Hamilton who had started from the pits

'After the first safety car, Hamilton passed Gutierrez, Bottas, Perez & Hulkenberg'

and then spun at Turn 2 on the opening lap, grazing the barrier with his left front. This was a needless error, the consequence of failing to account for cold brakes, having not been able to complete a warm-up lap. But in what was effectively a new car, built up around a spare chassis after his qualifying blaze, Hamilton had climbed to 13th by the time Ericsson crashed.

On the first lap after the green-flag, Hamilton found his way past Esteban Gutierrez, Bottas, Sergio Perez and Nico Hulkenberg to run ninth. That became seventh when Button and Kevin Magnussen both pitted their McLarens for slicks.

By the time Perez lost the rear of his Force India on the damp exit kerbing at the final corner and speared heavily into the concrete pitwall, Ricciardo had built up a five-second lead over Massa.

After only nine and a half green-flag laps, and 15 in total on his soft Pirellis, Ricciardo had just crept into the Red Bull pit window, the distance into a stint where it is calculated as logical to pit in the event of a safety car. With 47 laps remaining, this divided the rest of the race into two stints on softs, and the team was surprised that so few rivals ▶

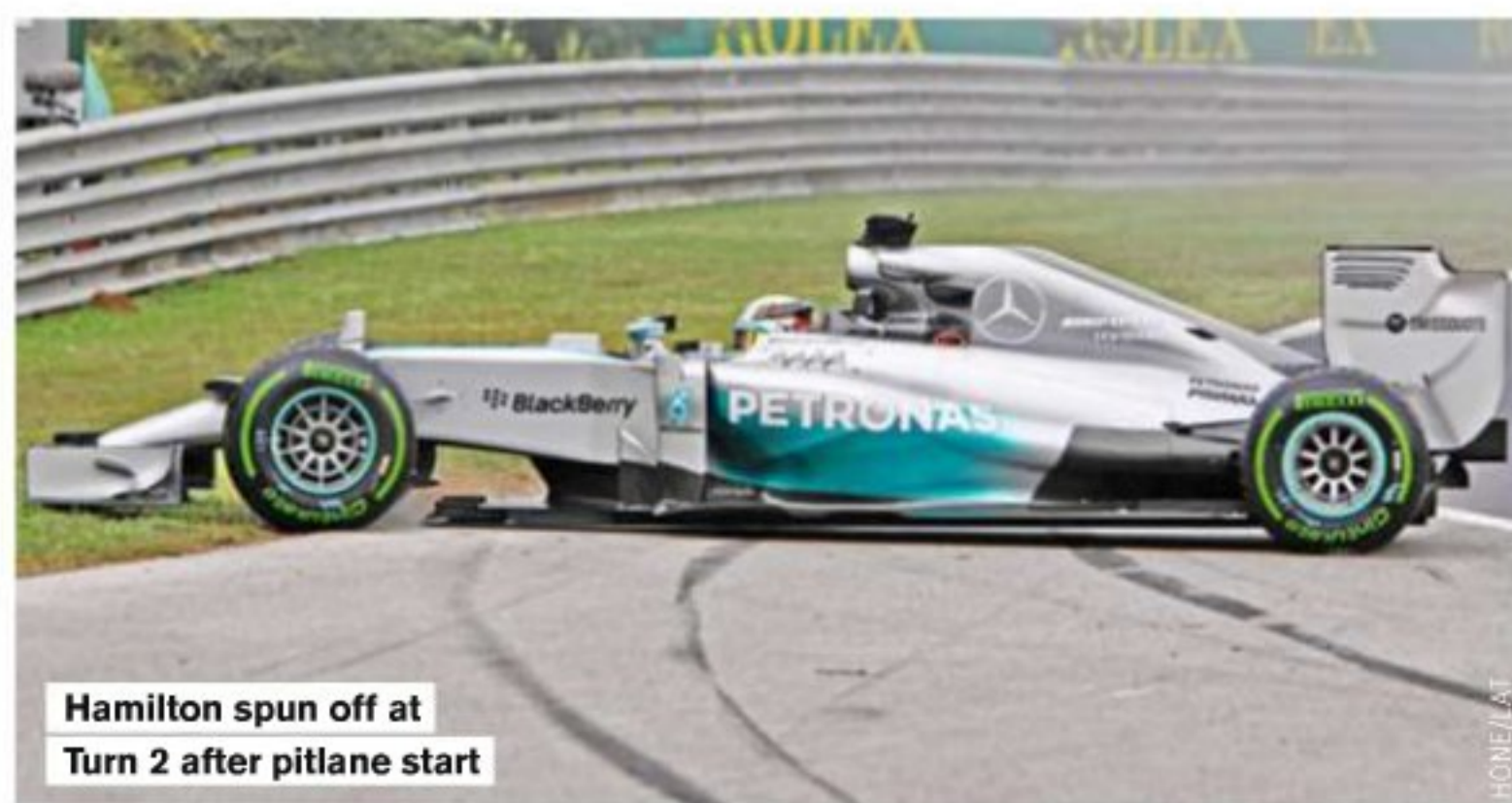

Hamilton spun off at Turn 2 after pitlane start



Ericsson's shunt was well timed for Ricciardo

COATES/LAT

deduced the same. Only the two Williams runners followed Ricciardo in, both Massa and Bottas stopping for mediums rather than more softs.

"Yes, it was on the early side, but it enabled us to cut the race in half for the next two stints," said Horner. "We effectively split our cars and left Seb out because he'd stopped a lap later on the previous stint. Then it was a question of running our race."

PHASE THREE RICCIARDO BIDES HIS TIME

When the race got back under way on lap 27, there were still five drivers realistically in contention. Alonso led from Vergne, but the Frenchman's Toro Rosso was never going to be quick enough to fight for victory in dry conditions, with Rosberg, Vettel, Hamilton and Ricciardo queued up behind.

At this stage, patience was Ricciardo's biggest virtue. He knew that the further he went before his final stop, the shorter the stint he would have on fresh softs at the end of the race. Add to that the fact that he wanted to be able to attack later in this stint, once others had stopped, and it was essential not to be too aggressive and root his tyres.

"Where Daniel was very intelligent was he didn't burn up his tyres in the pack and had enough rubber when those guys pitted," said Horner. "He was then able to use his pace and put in a long stint."

Ricciardo sat in sixth, giving him a box seat to watch Hamilton chasing Rosberg for fourth. But it wasn't long before the next flurry of pitstops came. On lap 32 Rosberg stopped for another set of softs. Vettel then dropped his Red Bull exiting the last corner, spinning across the track, very lightly kissing the inside wall and flat-spotting his tyres. This forced Vettel into the pits on lap 33 and reduced the number of victory contenders to just four, with Vergne then also removing himself from the mix by stopping for mediums a lap later.



Alonso leads from Vergne and Rosberg

COATES/LAT



COATES/LAT

PHASE FOUR A FOUR-HORSE RACE

Alonso and then Hamilton headed for the pits on laps 38 and 39 respectively, the Spaniard opting for softs and, everyone assumed, one more stop, and Hamilton opting for mediums and a run to the end.

This allowed Ricciardo to move into the lead, with Massa on his mediums temporarily holding second place. Initially, in clean air the plan was for Ricciardo to build enough of a gap to avoid dropping behind the Williams when the Red Bull took on its final set of tyres. But Massa was struggling and stopped for the final time on lap 45, meaning he was no longer a concern. So Red Bull's plan then focused on Ricciardo extending the stint as long as possible while his lap times held up.

But there was a potential problem. One of the cylinders of the Renault engine propelling Ricciardo had, according to a sensor, drifted outside its operating parameters. On lap 43, shortly before Massa pitted, Ricciardo's pace dropped by a second.

"I had a scare in the middle of the race, for a few laps we had some issues," said Ricciardo, who had to reset a series of fail codes. "Basically, we were down on power and had to get a bit crazy on the switches, so I thought the race



Perez stacked his Force India and caused second safety car

THOMPSON/GETTY

could have potentially ended early. But we got through that."

His 'switch craziness', with the assistance of Renault, succeeded in disabling what was reckoned to be a misbehaving sensor, restoring the Red Bull to full pace. Ricciardo's lead over Alonso stood at 16 seconds once the problem was solved. From laps 44-52, Ricciardo lost a total of around a second to Alonso – remarkable considering how much fresher the Ferrari driver's tyres were – but then dropped a second per lap for the next two laps, meaning he was around 12 seconds clear when he swung his Red Bull into the pits.

PHASE FIVE THE FINAL SHOOT-OUT

With 16 laps remaining, the situation was simple. Alonso led on soft rubber that would be 32 laps old by the flag. Hamilton, on mediums and also running to the end, was second ahead of Rosberg, who had to stop again.

While Mercedes was keen to play this down, Rosberg had clearly lost time behind Hamilton. The Briton had been asked to cede position to allow Rosberg to make the most of his soft rubber but refused to give way, understandably in the circumstances. After all, Rosberg did not mount a serious attack and



Into the closing laps and Ricciardo catches Hamilton and Alonso



Ricciardo celebrated his second F1 win of 2014 in style



Ricciardo makes his crucial final pass on Alonso

DUNBAR/LAT

seemed to struggle to stay in DRS range.

It was a misstep by Mercedes, albeit a forgivable one given the focus on maximising its own race result, and the pitwall didn't force the issue.

Rosberg's lap times slowed by close to three quarters of a second when he caught Hamilton. He spent 11 laps behind him before pitting at the end of lap 56 and rejoining at least three places lower than he would have done had he got past Hamilton. By the time he cleared them, he was 23s behind the lead battle. Was that enough to cost him victory? Possibly, although it's perhaps more likely that he would have ended

up behind Ricciardo anyway, meaning that at most it cost him second or third.

Once Rosberg had cleared Kimi Raikkonen and the two Williams-Mercs, the lead quartet was running in reverse order of tyre health. Hamilton chipped away at Alonso's lead and with 10 laps to go was right with the Ferrari. Alonso was increasingly struggling for grip but, aside from once straightlining the chicane, didn't put a foot wrong in a quite remarkable drive.

Hamilton, who had some problems that slightly compromised his end-of-straight speed, couldn't find a way past Alonso. This allowed the charging



Lewis ignored team order request

COATES/LAT

Ricciardo: 'Once I got close enough to Fernando, I knew I just had to go for it'

Ricciardo to close in and, with eight laps remaining, he joined the lead battle.

Hamilton had to turn his attention to defending. With just four laps to go, he had a slight lock-up at Turn 1, allowing Ricciardo to get a run on him into the following left-hander. Hamilton defended to the inside and Ricciardo, locking up himself, slung his Red Bull around the outside and made the move stick. From that moment, it was a foregone conclusion that he would pass Alonso for the lead – and the win.

Ferrari's man, recognising that he was a sitting duck and that defending too robustly might also cost him a place

to Hamilton, wasn't able to put up too much of a fight when Ricciardo made a fine dive up the inside at the first corner next time around. "There was only one way to win it and that was to get around them," said Ricciardo. "Obviously I had the advantage of the fresher tyres, but I knew they wouldn't make it easy."

"I attempted to pass Lewis into Turn 2 two laps before I eventually got him, but just locked up and went too wide. I had a second crack at it and I still locked up but I managed to just hang on and had a bit more grip around the outside."

"Once I got close enough to Fernando, I knew I just had to go for it. Being in that sandwich, Lewis was still in the DRS zone so I couldn't waste too much time."

Once past, Ricciardo pulled a five-second lead by the flag, while Alonso did a great job to keep Hamilton at bay.

Rosberg caught both late on, attempting to go around the outside of Hamilton at Turn 2 on the last lap and finding himself running out of road at the exit when his team-mate forced him wide. But the championship fight and the acrimony between the two Mercedes drivers was just the support act at the Hungaroring.

Ricciardo was the star, proving beyond any doubt that he is now one of the gold-standard drivers in F1. ❧

HOW THE RACE WAS WON

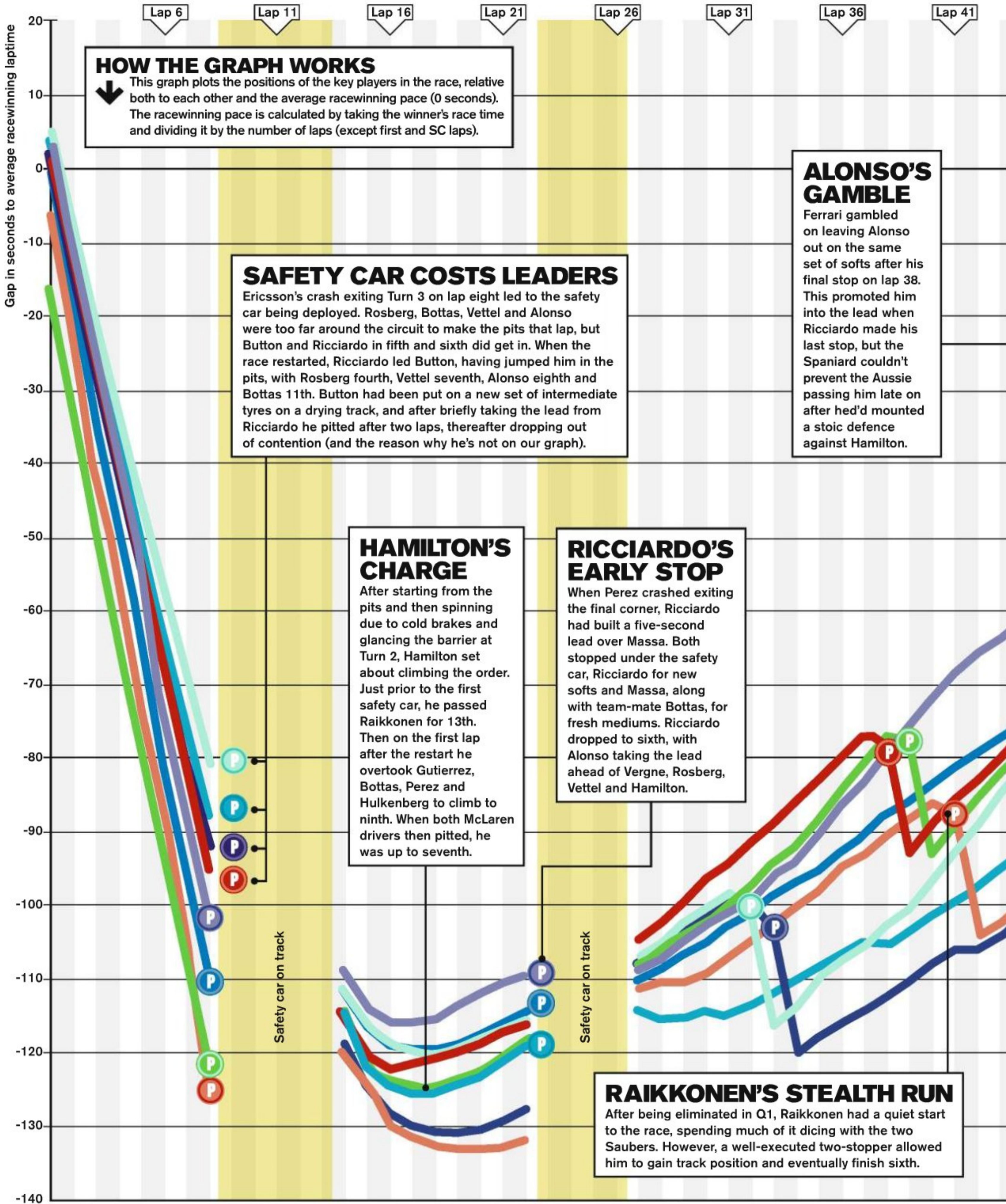

Lap 46 Lap 51 Lap 56 Lap 61 Lap 66

RICCIARDO'S FINAL STINT

After making his final stop on lap 54, Ricciardo ran fourth and picked up a place when Rosberg pitted. Having been 10 seconds behind leader Alonso when he emerged, Ricciardo rapidly closed the gap to second-placed Hamilton with 10 laps to go. On lap 67 he passed Hamilton at Turn 2, overtaking Alonso for the lead at Turn 1 a lap later.

ROSBERG'S CHARGE

Rosberg rejoined in seventh, 26s off the lead, after his final stop. He quickly overtook Raikkonen and Massa, and gained a place to run fourth when Bottas stopped. At the end of lap 61, he was 23.334s off the lead, but ended the race right on Hamilton's tail and only 6.361s off the lead after a charge on his newer soft rubber.

MERCEDES TEAM ORDERS DEBATE

Rosberg pitted for the second time on lap 32, taking softs and committing to one more stop. Hamilton came in seven laps later, taking mediums to run to the end. This put the pair's strategies on a collision course. On lap 45, Rosberg caught Hamilton and his lap times dropped from the mid-1m27s bracket into the low to mid-1m28s. Hamilton was told to let him by, but refused, with Rosberg eventually making his final stop on lap 56.

- Daniel RICCIARDO
- Fernando ALONSO
- Lewis HAMILTON
- Nico ROSBERG
- Felipe MASSA
- Kimi RAIKKONEN
- Sebastian VETTEL
- Valtteri BOTTAS

TRACKSIDE VIEW

EDD STRAW
GRAND PRIX EDITOR

edd.straw@haymarket.com

@eddstrawF1

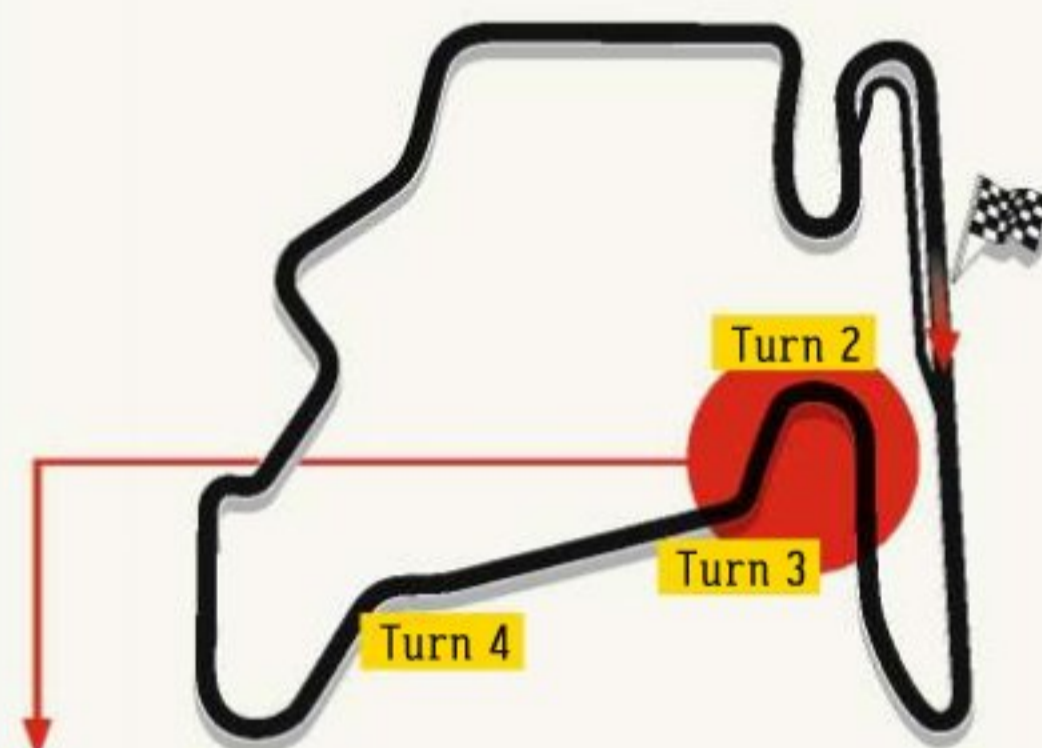

The Hungaroring has an unfairly bad rep. Yes, it's a relatively tight and twisty circuit, where overtaking can be difficult, but it offers a genuine driving challenge. It's a circuit of trade-offs, both in terms of set-up and technique.

Watching at Turns 2 and 3 on Friday morning rams this home. Turn 2 is a 180-degree slow left-hander, leading downhill into the fast Turn 3 right-hander. They look innocuous enough – one slow and the other little more than an acceleration zone. But it's a sequence that's very easy to get wrong on the entry, with both Red Bulls struggling here early on, Daniel Ricciardo in particular.

Regularly, he pays the price for drifting a little wide at the exit, meaning he has to yank the car more quickly to the left side of the circuit to set it up for Turn 4, with the rear end becoming unsettled as he goes from left lock to right lock, which forces him to modulate the throttle. This part of the track betrays the difficulty of getting the braking and corner-entry characteristics right when you have Renault propulsion.

'Turns 2 and 3 make up a sequence that is very easy to get wrong on the entry'

This has been an area where Sebastian Vettel has struggled all year – not just with the performance of the car under braking, but during the turn-in phase. In Hungary, things did seem to be improving. He too was labouring a little, with the car tricky under braking, but he was able to carry more speed through Turn 3.

The pattern seemed to continue throughout practice, with Vettel just having the edge in terms of pace over Ricciardo. But, ironically, it was at exactly this part of the track that Ricciardo pulled off his great pass around the outside of Lewis Hamilton during the race, clearing the one obstacle separating him from leader Fernando Alonso.



STORIES OF THE RACE

Rounding up the action from the Hungarian GP

EDD STRAW
GRAND PRIX EDITOR



Hamilton ignored team order to let Rosberg past



COATES/LAT

24

Hamilton defies team orders – and gets Lauda’s backing

LEWIS HAMILTON REFUSED A DIRECT order to let Mercedes team-mate Nico Rosberg pass him for third place during the Hungarian Grand Prix.

The team usually ensures that its title-contending drivers are on similar strategies, varying only tyre-compound choice, but the race situation in Hungary led it to split the pair. When Rosberg made his second stop on lap 32, he took soft tyres with a plan to stop once more, while Hamilton stopped seven laps later and took mediums to get him to the end. The German then pitted again after being held up, catching Hamilton late on and unsuccessfully attempting to pass him for third on the last lap.

Mercedes motorsport boss Toto Wolff confirmed

that the order was given from the pitwall. But when Hamilton refused, saying over the radio “I’m not letting him past me, if he gets close enough to overtake he can overtake”, the team decided against forcing the issue and backed down.

“If I let him past then he could pull away and come back at me later,” said Hamilton. “I was very, very shocked that the team would ask me to do that.”

World championship leader Rosberg was surprised by Hamilton’s refusal to yield, although stressed that he had not asked for the team orders himself.

“I didn’t want it – it was the team that informed me he was going to let me past,” said Rosberg. “That was it. I don’t know what happened then. We need to discuss it.”

Niki Lauda, the Mercedes team’s non-executive chairman, backed Hamilton’s decision on the basis that Rosberg was able to stay within DRS range and mount an attack.

“The team was under enormous stress because the race was a very difficult one, there is no question,” said Lauda. “Therefore I do understand that Lewis said ‘Why? Why should I stop now in the middle of the circuit to let my team colleague by?’ He is fighting for the championship. So from my point of view, Lewis was right. Why the call came, this happened out of panic.”

Wolff revealed after the race that the team will re-evaluate its policy on team orders.

ROSBERG’S LAP TIMES

This shows how Rosberg’s times dropped off once he became stuck behind Hamilton during his third stint after catching him on lap 46

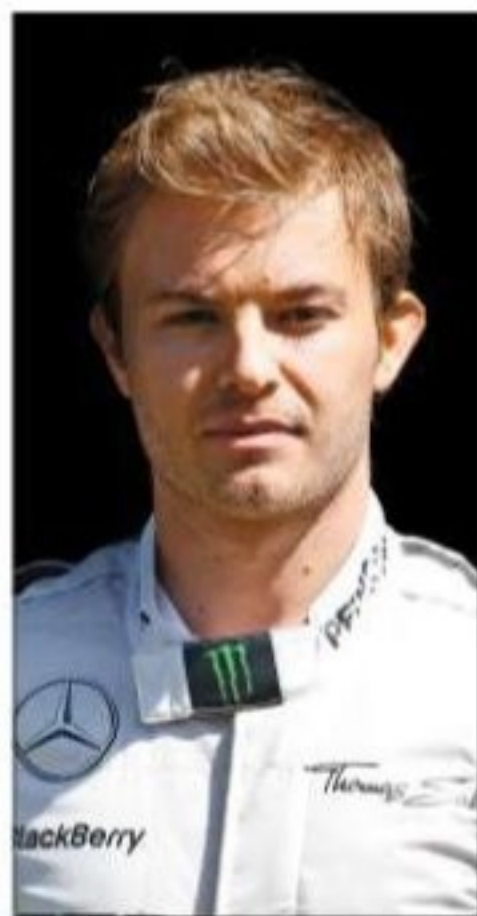

Alonso comes close to first win of 2014

FERRARI'S DECISION TO GIVE FERNANDO

Alonso a 32-lap stint on soft Pirelli tyres after his second pitstop brought him close to a shock victory.

Alonso took the lead when Daniel Ricciardo made his final stop with 16 laps remaining. Although struggling with tyres that were not giving him the best grip, with the team fearing that they might 'fall off a cliff' and force a late stop, Alonso drove superbly, with a brief excursion across the chicane his only mistake.

While Alonso held off Lewis Hamilton for the lead, Ricciardo passed him on the run to Turn 1 three laps from home, with the Ferrari hanging on to claim second.

"We need to think carefully about this second place because we need to be aware that there's a huge amount of work to be done," said team principal Marco Mattiacci.



Alonso was a star of the race

ETHERINGTON/LAT



GIBSON/GETTY

Circumstances removed Vettel from lead battle

Poor result for Vettel, but he's happier

SEBASTIAN VETTEL COULD ONLY FINISH seventh in a race won by Red Bull team-mate Daniel Ricciardo, but appears increasingly confident in the handling of his car.

The reigning world champion qualified second, matching his best starting position of the season, and ran third in the early stages behind Valtteri Bottas. But he was stung by the timing of the first safety car and dropped to seventh. He was left out when Red Bull opted to split its strategy at the second safety car, bringing leader Ricciardo in. Vettel's spin exiting the final corner at the end of

lap 32 forced him to make his next stop earlier than planned, switching to mediums.

"No damage, I didn't hit the wall – just," said Vettel. "Unfortunately with the first safety car, we were in the wrong engine mode at the restart and I had no power and lost a position to Fernando [Alonso] and another car. It was not a good race."

But team principal Christian Horner believes that Vettel has taken a step forward. "This is the happiest I've seen him so far this season," he said. "He was very convincing in qualifying and seems more comfortable in the car."



Raikkonen checks out Bianchi's time

Raikkonen suffers qualifying disaster

KIMI RAIKKONEN FAILED TO ESCAPE Q1 IN Hungary thanks to Ferrari's mistaken belief that his first qualifying run was fast enough.

Raikkonen was seven tenths slower than team-mate Fernando Alonso on his first run thanks to struggling on the medium-compound Pirellis. That left him 13th, but plans for a later run on softs were abandoned. This was because, with Lewis Hamilton and Pastor Maldonado out, the team believed that the four cars from Marussia and Caterham would not escape the bottom-six cut-off by beating Raikkonen's existing time.

Marussia's Jules Bianchi then bumped Raikkonen down to 17th – and out of Q2 – in the dying seconds.

"The team told me, 'We are fine, we don't need to go out,'" said Raikkonen. "I questioned it a few times, but they said there was no need." Raikkonen recovered to sixth in the race, his best result of the season.

Fuel fire destroys Hamilton's Merc

LEWIS HAMILTON HAD TO START THE HUNGARIAN Grand Prix from the pits after a leak in a fuel line led to the rear of his Mercedes catching fire in Q1.

This happened while Hamilton was on his first qualifying lap. He parked the car in the pit entry, bringing out the red flags, with the fire doing significant damage.

The team rebuilt his car around a replacement chassis overnight, allowing him to start from the pitlane and charge from last to third. "I think it's getting to the point where it's beyond bad luck," said Hamilton, who suffered a brake failure at the same stage of Q1 at the German GP a week earlier. "We need to do better."

The fire meant that Hamilton's pole-position drought, which dates back to May's Spanish GP, now stands at six races, with title rival Nico Rosberg taking five poles during that period.

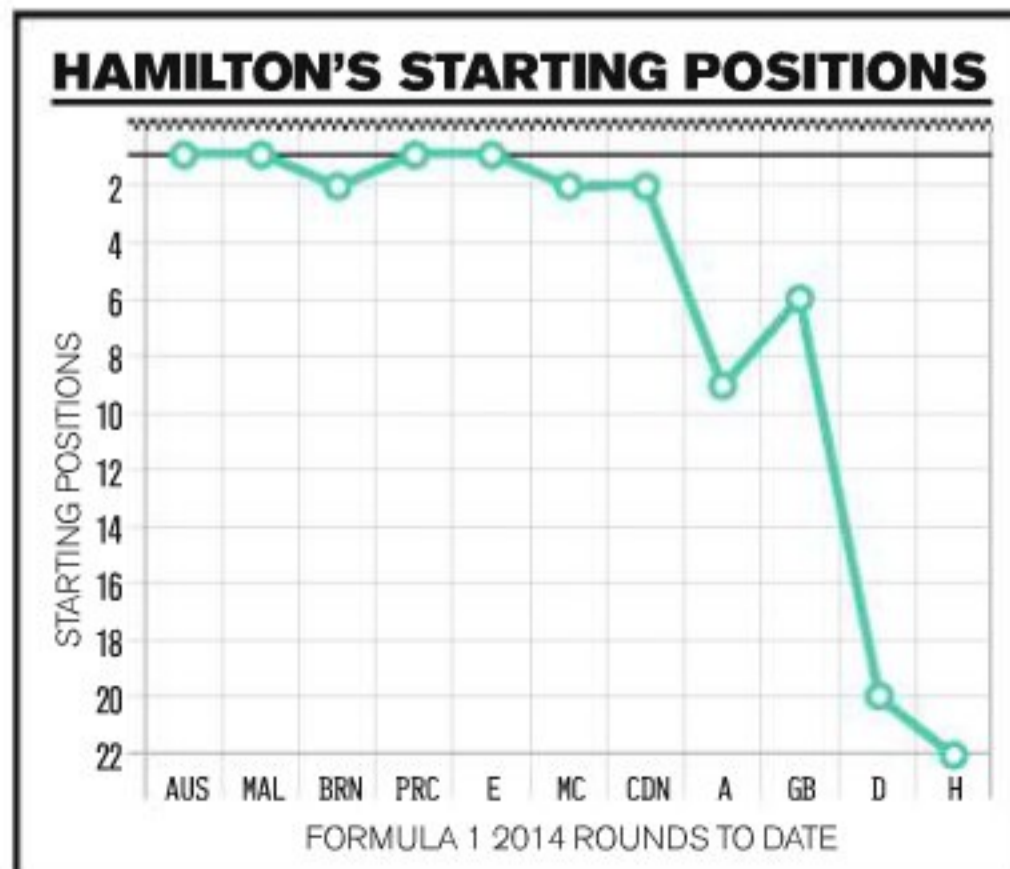

Q&A

FERNANDO ALONSO

"WE NEED CRAZY RACES FOR A PODIUM"



GIBSON/GETTY

Is second place painful, or are you satisfied?

Extremely satisfied. It has been a tough weekend, a tough season in general, so to get a podium is always a nice surprise. We took a gamble, we risked today just trying to get the victory. We went close, but I'm extremely proud of the job we did.

You needed all your experience today...

We had a combination of things that made the race difficult to execute, difficult to understand and we took our opportunities. We need crazy races to get some podiums and today we took the opportunity.

What does the podium mean to you and Ferrari?

It means a lot. We had some tough races recently and to see one Ferrari on the podium again is the best news. Unfortunately, at the first safety car we went a little bit out of position. We stopped the lap afterwards and we lost a couple of places. We had to attack, we had to overtake a couple of people and just 10 laps to the end we were discussing if we should stop and secure fourth place. It tastes like a victory for us.

Do you think this is one of the best races of your career?

I don't think that it is one of the best in my career. It has been a good and a complex race to execute and perform. You needed to make decisions during the race and all of them were, together with the team, the best we could. On the podium, the support from people has been amazing.

STORIES OF THE RACE

McLaren endures tyre strategy disaster

JENSON BUTTON'S HUNGARIAN GRAND PRIX was ruined by McLaren's decision to give him a fresh set of intermediates at his first pitstop in anticipation of rain that never came.

Button ran fifth early on and was the best placed of the cars able to pit on the lap Marcus Ericsson crashed, bringing out the safety car. Although he lost a place to Daniel Ricciardo in the pits, this left him second. But while the rest took slicks, he was given intermediates. This was

later blamed on a rain-radar computer software glitch. "We believed it would rain – the radar clearly indicated it would," said racing director Eric Boullier. "We didn't know something was wrong with the software." Button briefly took the lead at the restart, but had to pit for slicks after two laps, eventually recovering to 10th. "There were lots of wrong decisions in that race," said Button. "I feel like I did everything right, and in every track condition, which is why it's tough. The first stint was great, but it went downhill from there."

It's true that with everybody on slicks we understood something was wrong and clearly we understand our call was wrong



Eric Boullier



26

Grosjean's race ended early after an unforced error



STALEY/LAT

Grosjean crashes under safety car

ROMAIN GROSJEAN'S HUNGARIAN GRAND PRIX came to an embarrassing end when he crashed while running under the safety car.

Grosjean was 15th when he made the error. He was trying to keep temperature in his slick tyres on a track that was still damp, and fired his Lotus into the barriers on the run out of the Turn 3 right-hander.

"I made a mistake when I was trying to keep the tyres warm," explained Grosjean. "Unfortunately, I touched the white line and spun, and that was it."

Technical director Nick Chester accepted that the mistake was forgivable given the conditions.

"It was unfortunate for Romain because the conditions were really tricky," said Chester. "A wheel on a wet kerb was all it took for him to spin off."

Williams struggles for pace at Hungaroring

WILLIAMS LACKED THE PACE TO EXTEND ITS RUN of podium finishes to a fourth grand prix in Hungary, even though both Valtteri Bottas and Felipe Massa each ran as high as second during the race.

Bottas qualified third and was second during the first stint of the race after passing Sebastian Vettel. The Finn was unable to pit immediately when the first safety car was deployed, and a combination of that and his 5.2s stop dropped him to 11th. From there, he was able to recover only to eighth.

Massa climbed to second thanks to the first safety car period, but later struggled on the medium-compound Pirellis and finished fifth, behind the four

cars contending for victory. Both drivers stopped for the slower medium Pirellis on lap 23 because the team did not believe it would be possible to do the rest of the race on softs with only one more stop.

"The main problem was the pace of the car," said engineering chief Rob Smedley. "In qualifying, with the hotter track temperatures, we went all right, but today [raceday] the track temperature cooled and we couldn't get any pace out of the car."

"However, in terms of what we tried to execute in the race, I don't think it was fundamentally flawed. We got both cars home, but we were always on the back foot in terms of pace."



Neither Williams looked a threat over the weekend

COATES/LAT

WILLIAMS VERSUS MERCEDES

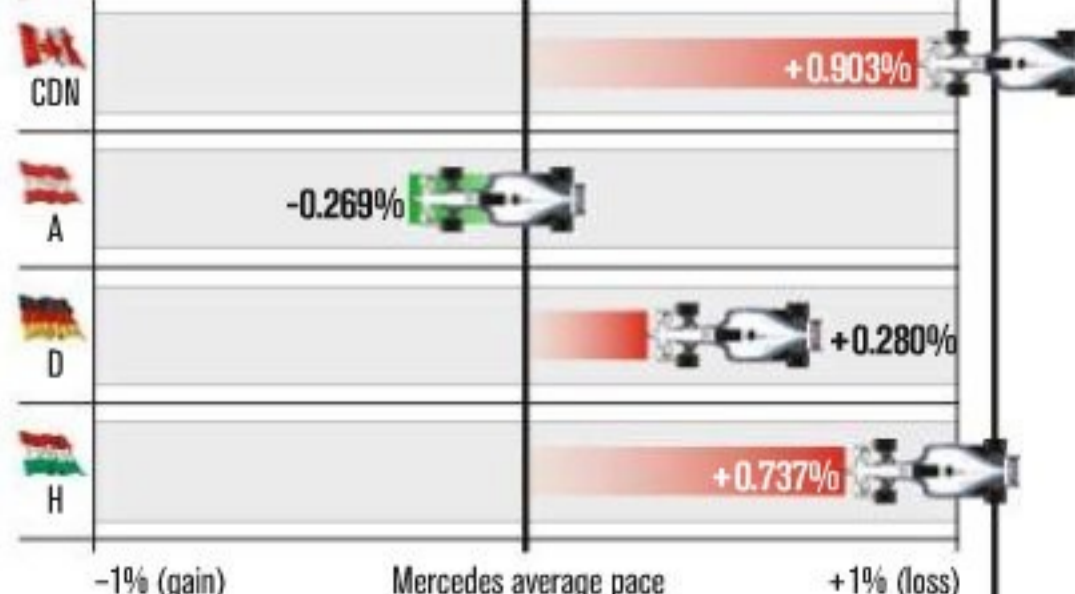

This shows the qualifying pace of Williams relative to Mercedes during recent race weekends. Silverstone is not included because of the rain in qualifying.



Button led briefly on second set of intermediate tyres



Vergne heads Rosberg and Vettel after second safety car

Vergne stars during wet early stages

JEAN-ERIC VERGNE FINISHED NINTH, BUT RAN as high as second during the race in Hungary thanks to a combination of damp conditions and good strategy.

The Frenchman started eighth and climbed to fourth thanks to the top four runners not being able to pit immediately when the first safety car was deployed and Jenson Button having to stop for more tyres two laps after the restart. Vergne then moved up to second when Daniel Ricciardo and Felipe Massa pitted. He opted to stop for mediums on lap 34, running to the end and dropping to ninth, which was still a good result given his machinery.

"The race was really nice, and I had a lot of fun being in second position for some time," said Vergne. "I knew that I didn't have the pace to keep up with the others around me to the end of the race, but it was a great moment."

DRAWING BOARD



Gary Anderson, technical consultant

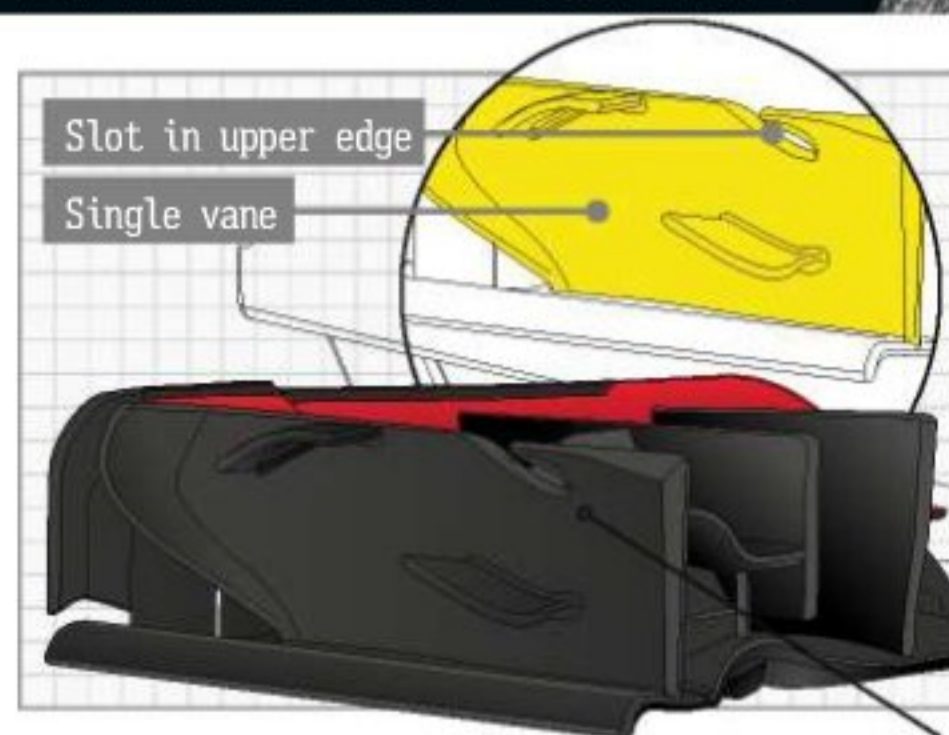

Lotus adds small endplate cut-out

➔ One of the critical aerodynamic regulation changes this year was the reduction in the width of the front wing by 7.5cm on each side. This alters how the endplate diverts the airflow around the outside of the front tyre.

The new endplate on the Lotus has a small cut-out on the upper surface, with a pointed section. This works in conjunction with the curved vane behind it, reducing the airflow that wants to spill over the top of the endplate. The rest of it is very similar to what Mercedes currently uses – in that Lotus has gone from a twin vertical sideplate to a singular one, with the trailing edge exit lower and more rearward.

This is aimed at getting the endplate to connect to the airflow that is being displaced as the tyre rotates on the ground. The low pressure area pulls the airflow around the tyre contact patch and this connection allows the airflow to be scavenged from this area more easily.

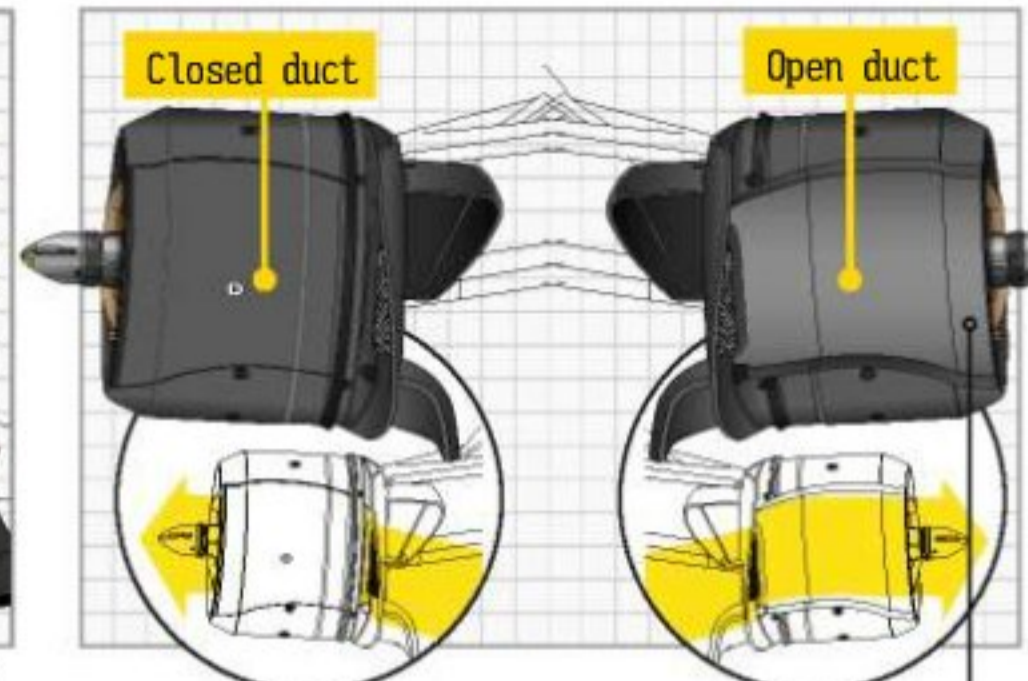

Mercedes tunes brake cooling

➔ One of the most significant factors influencing tyre temperature is the brake cooling airflow. The teams tune how this hot airflow escapes between the brake ducts and the wheel, both in terms of overall effect and on different sides of the car.

This undercut section on the left-hand outer shell of the Mercedes' brake duct (right graphic) allows some of that cooling air to be diverted before it passes through the disc. This means that a cool air skin is reducing the heat transfer into the rim.

On the right-hand side of the car it is closed (left graphic), so that the tyre will get that little bit hotter. The reason for this is that in Hungary the left-front tyre will get hotter more easily than the right-front.

This is because the track configuration puts more of a load on the front left, which can be exacerbated when ambient temperatures are high, as they were particularly during Friday and Saturday in Hungary.

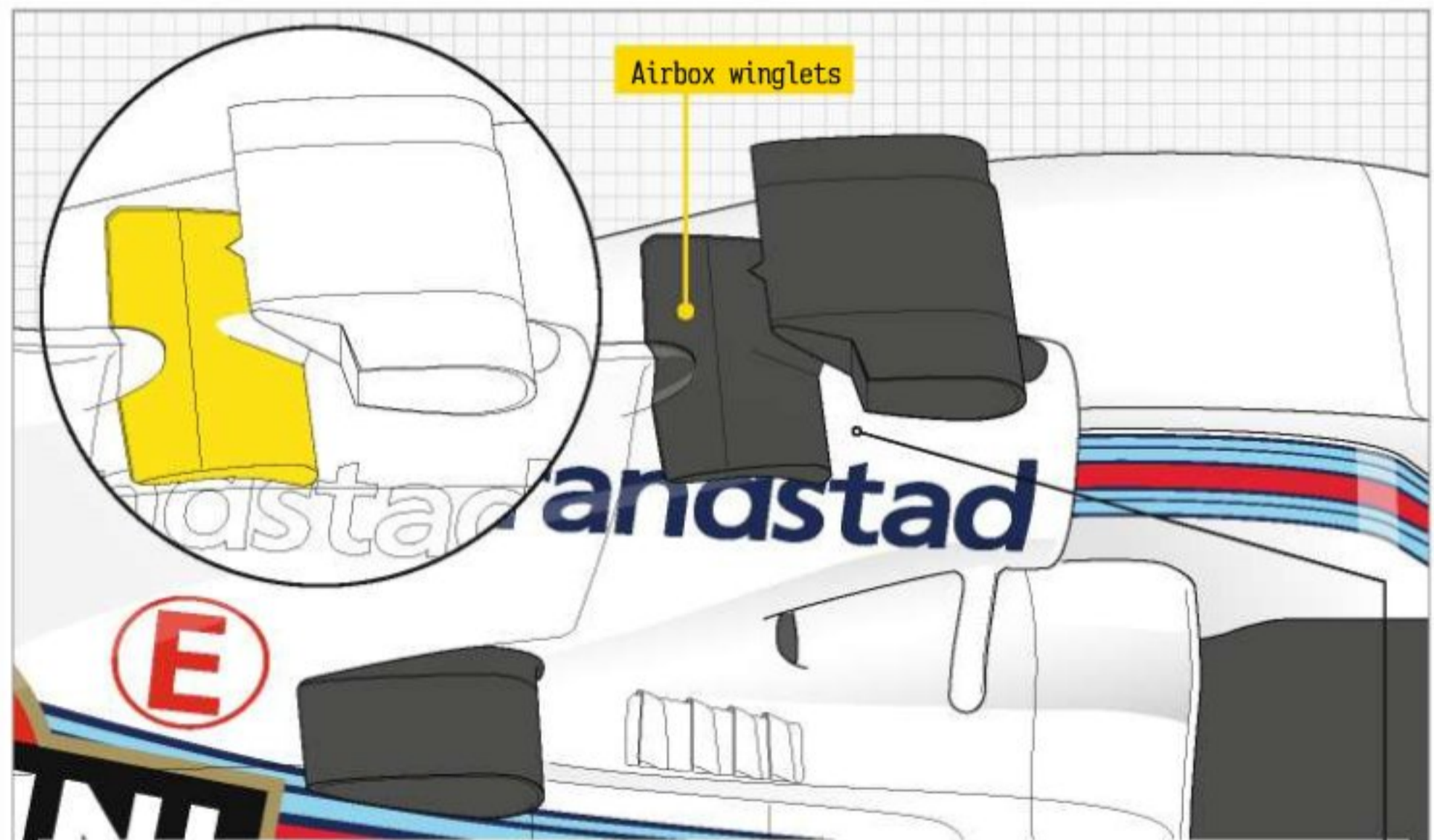

Williams airbox wings aid airflow

➔ Monaco and Hungary used to be the circuits where we would see all sorts of strange aerodynamic components as these two tracks are less critical to aerodynamic efficiency, meaning drag is less of a penalty.

Williams has a very efficient aerodynamic

package, but for circuits such as Monaco and Hungary it lacks that little bit of overall downforce.

With that in mind, Williams was the only team to fit some small winglets behind the airbox intake area. These wings give a small amount of downforce and also help redirect the airflow towards the rear wing.

Illustrations by Craig Scarborough

TEAM BY TEAM

RED BULL



RED BULL-RENAULT RB10

1
6/10

SEBASTIAN VETTEL

Start 2nd Finish 7th
Strategy 2 stops
(inter/soft/medium)

3
9/10

DANIEL RICCIARDO

Start 4th Finish 1st
Strategy 3 stops
(inter/soft/soft/soft)

The reigning world champion team's status as best of the rest was reclaimed in Hungary, with Vettel taking a front-row slot and Ricciardo struggling a little in qualifying and lining up fourth. Lack of power off the line cost both drivers places, but while the timing of the safety car lost Vettel some ground, it made Ricciardo's race.

Strategically, Red Bull played it perfectly with Ricciardo, bringing him in under the second safety car and allowing him a late-race charge on the soft rubber. Vettel, meanwhile, was unable to get back into the hunt for victory thanks to his spin exiting the last corner.

Slower than Mercedes, but some luck and a well-managed race was enough to swing the balance.

MERCEDES



MERCEDES F1 W05

6
8/10

NICO ROSBERG

Start 1st Finish 4th
Strategy 3 stops
(inter/soft/soft/soft)

44
8/10

LEWIS HAMILTON

Start 22nd (pits) Finish 3rd
Strategy 2 stops
(inter/soft/medium)

After a fuel line leak led to Hamilton's car catching fire early in qualifying, Mercedes motorsport boss Toto Wolff admitted that reliability needed to improve. However, with a brand-new car built up overnight to start from the pits for Hamilton, and Rosberg on pole, the possibility that the two drivers would end up dicing on track seemed unlikely.

The timing of the first safety car deployment cost Rosberg what might well have been a winning position, while Hamilton made rapid progress early on to get into the hunt for victory.

The team orders confusion was unnecessary, for while it did compromise the result, but in the circumstances Hamilton was always likely to refuse to concede.

FERRARI



FERRARI F14 T

7
7/10

KIMI RAIKKONEN

Start 16th Finish 6th
Strategy 2 stops
(inter/soft/soft)

14
9/10

FERNANDO ALONSO

Start 5th Finish 2nd
Strategy 2 stops
(inter/soft/soft)

The Ferrari was a slightly more competitive proposition around the tight Hungaroring than it had been on the straights of Hockenheim, but it was not the transformation that the near-victory suggests.

Poor timing in qualifying meant Alonso finished his key Q3 lap too early, perhaps missing out a tenth or two in terms of improving track conditions. As for Raikkonen, he was always going to be vulnerable as the slowest of those not sent out for a second attempt and on the faster rubber.

Alonso's strategy gamble meant that he led late on, but was powerless to keep Ricciardo at bay, while Raikkonen recovered well from 16th on the grid to sixth despite struggling to make up ground in the early stages.

28

SAUBER



SAUBER-FERRARI C33

21
8/10

ESTEBAN GUTIERREZ

Start 13th Finish DNF
Strategy retired
(inter/soft)

99
7/10

ADRIAN SUTIL

Start 11th Finish 11th
Strategy 2 stops
(inter/soft/soft)

The Swiss squad confirmed what was suspected at Hockenheim – that the loss of FRIC suspension had made it relatively more competitive. While its qualifying pace still wasn't quite top 10, the car was a decent proposition in the race and both drivers had good battles with Raikkonen's Ferrari.

Gutierrez, who had jumped Sutil at the start, was a realistic contender for points before an ERS problem put him out, while Sutil took a strong 11th place after narrowly losing out to Button for 10th.

While the team remains pointless, Hungary showed the car is more competitive and should be in a position to start picking up at least a point or so in the second half of 2014.

TORO ROSSO



TORO ROSSO-RENAULT STR9

25
9/10

JEAN-ERIC VERGNE

Start 8th Finish 9th
Strategy 2 stops
(inter/soft/medium)

26
6/10

DANIIL KVIAT

Start 10th (pits) Finish 14th
Strategy 2 stops
(inter/soft/medium)

Toro Rosso continued to be a legitimate top-10 qualifying contender, with Vergne making Q3 and Kvyat on his way to doing so before locking up and spinning at Turn 12 on his final Q2 effort.

Vergne was able to climb as high as second after the first two safety cars and gave a good account of himself. The team's low-drag philosophy gave his car decent straightline speed and allowed him to stay ahead, but that was never going to last. While ninth seems superficially disappointing, it was about where he should have been.

Kvyat's race was ruined by the engine cutting on the grid, although it's not clear whether driver, team or engine provider was to blame for that.

WILLIAMS

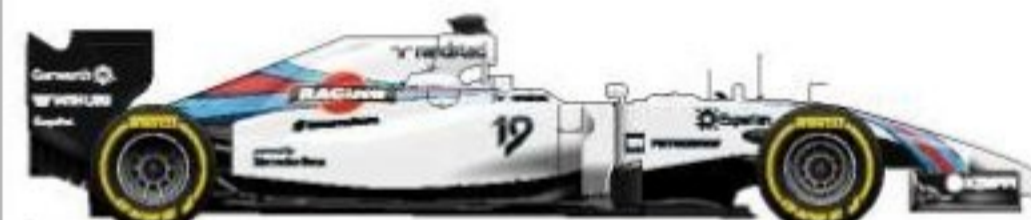

WILLIAMS-MERCEDES FW36

19
8/10

FELIPE MASSA

Start 6th Finish 5th
Strategy 3 stops
(inter/soft/medium/medium)

77
8/10

VALTTERI BOTTAS

Start 3rd Finish 8th
Strategy 3 stops
(inter/soft/medium/soft)

After three races as best of the rest, the twisty Hungaroring was never going to play to the strengths of the Williams. But a package of car upgrades, including a new rear wing and a winglet mounted just behind the rollhoop, helped to ensure that the FW36 remained competitive.

The belief that soft tyres would not allow it to pit its drivers at the second safety car and then make only one more stop led to a switch to mediums, which probably wasn't quite as costly as it appeared. More of a problem for Bottas, who ran second early on, was losing several seconds in his first pitstop, which compounded the poor timing of the first safety car.

For the reasons behind the driver weekend ratings, visit AUTOSPORT.COM

LOTUS



LOTUS-RENAULT E22

8
3/10



ROMAIN GROSJEAN

Start 14th Finish DNF
Strategy retired
(inter/soft)

13
5/10

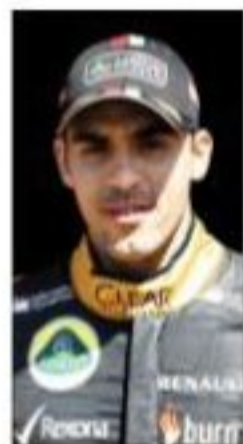

PASTOR MALDONADO

Start 20th Finish 13th
Strategy 3 stops
(inter/soft/soft/soft)

It was the same old story for Lotus, which remains a lower-midfield contender thanks to an underpowered, troublesome engine harnessed to a chassis that isn't very easy to get balanced. The loss of FRIC suspension has served only to make matters worse.

Maldonado appeared to have a slight edge on Grosjean during practice, but an energy store problem before he had set a time in Q1 cast him to the back of the grid. From there, he was never going to recover into points contention, even before he slid into Bianchi's Marussia while trying to pass it at Turn 1.

Grosjean's race was ignominious, crashing under the safety car while trying to keep his tyres warm.

McLAREN



McLAREN-MERCEDES MP4-29

20
7/10



KEVIN MAGNUSSEN

Start 21st (pits) Finish 12th
Strategy 2 stops
(inter/soft/medium)

22
8/10



JENSON BUTTON

Start 7th Finish 10th
Strategy 3 stops
(inter/inter/soft/medium)

McLaren should have left Hungary with a decent points return, but instead had to be satisfied with the one that Button salvaged for 10th place.

Both drivers made it to Q3, but Magnussen underestimated how slippery the track was at the start of his first lap, locking up and piling into the barriers. The result was him having to start from the pits in a car built up around a new chassis. Once the team gambled on rain returning and left him out under the first safety car, his hopes of recovering were gone.

Button, however, had a great opportunity and would have been in the mix for a strong finish, but for McLaren's terrible weather forecasting and a second set of inters.

FORCE INDIA



FORCE INDIA-MERCEDES VJM07

11
5/10



SERGIO PEREZ

Start 12th Finish DNF
Strategy retired
(inter/soft)

27
4/10



NICO HULKENBERG

Start 9th Finish DNF
Strategy retired
(inter/soft)

The flurry of recent upgrades has not been enough to allow Force India to continue to fight for top six results every week, but the car remains a solid top-10 runner. Unfortunately for the team, both drivers let themselves down with needless errors.

Hulkenberg, who ran well early on, had a brief off-track moment and then clobbered the back of team-mate Perez while trying to pass him at the final corner. He lost his front wing and piled into the wall. Not long after, Perez lost control exiting the same turn and slammed into the pitwall.

Without those mistakes, both would likely have banked valuable points and consolidated the team's fifth place in the constructors' championship.

MARUSSIA



MARUSSIA-FERRARI MR03

4
6/10



MAX CHILTON

Start 18th Finish 16th
Strategy 2 stops
(inter/soft/soft)

17
8/10



JULES BIANCHI

Start 15th Finish 15th
Strategy 3 stops
(inter/soft/soft/soft)

Marussia went into the August break with a sense of relief having successfully defended ninth place in the constructors' championship. But with few recent upgrades, it slipped further behind the midfield stragglers.

A change of chassis for Chilton, who had found the one he had used since Austria pulled to the left, made the driver much happier, only for him to be limited to 8000rpm by an electrical problem for his second qualifying run. Bianchi put in a great last Q1 lap to bump out Raikkonen, whose one, not particularly quick, lap on the slower medium Pirellis wasn't good enough.

Bianchi's race was blighted by being hit by Maldonado at Turn 1, while Chilton has a solid run to finish behind him.

CATERHAM



CATERHAM-RENAULT CT05

9
4/10



MARCUS ERICSSON

Start 19th Finish DNF
Strategy retired
(inter)

10
7/10



KAMUI KOBAYASHI

Start 17th Finish DNF
Strategy retired
(inter/soft)

The gains made relative to Marussia thanks to the loss of FRIC suspension became clear in Hungary – to the point where it seemed Caterham had the upper hand. That was before Bianchi banged in his final qualifying lap, four tenths faster than Kobayashi. But with an upgrade package planned for the Belgian Grand Prix after the August break, at least the team appears to have regained some impetus.

Unfortunately, neither driver lasted long in the race. Ericsson, who also has a weight disadvantage, has struggled badly with a balance problem that hasn't seemed to affect Kobayashi, and shunted out of last place on lap eight. Kobayashi lasted a little longer before a fuel system problem forced him out.



STANDOUT PERFORMANCE

Fernando Alonso

Alonso came close to winning and drove superbly on ageing tyres in the closing stages, reminding everyone of how desperately he deserves to be in a title-contending car. He did have one brief excursion at the chicane, but otherwise was flawless. He showed great precision to keep Hamilton behind, but was never in with a hope of holding off Ricciardo.

"This circuit didn't change our performance, but today we had a chaotic race and we took every opportunity that we had in front of us"

RESULTS

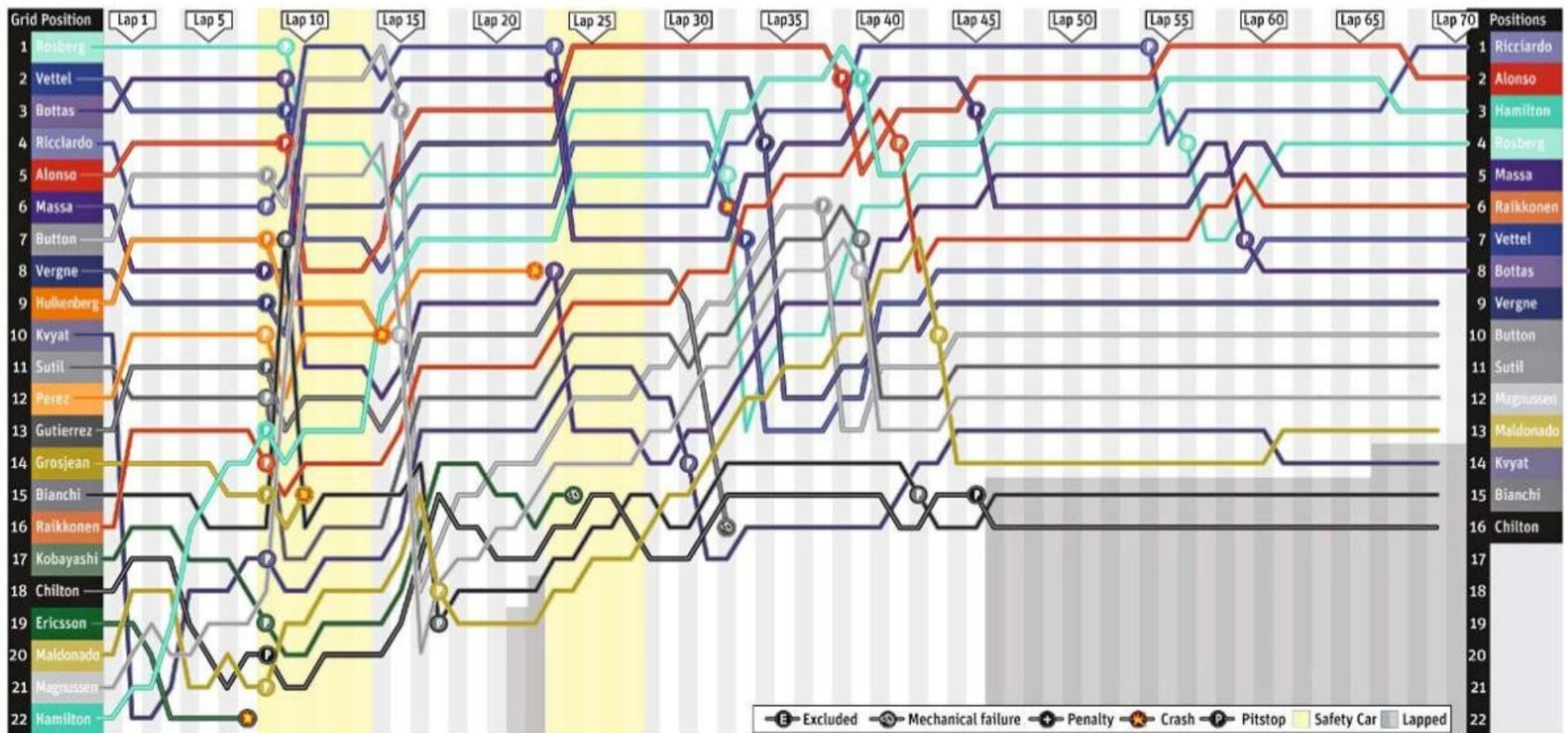

PRACTICE 1: Friday

POS	DRIVER	TIME
1	HAMILTON	1m25.814s
2	ROSBERG	1m25.997s
3	RAIKKONEN	1m26.421s
4	ALONSO	1m26.872s
5	VETTEL	1m27.220s
6	MAGNUSSEN	1m27.357s
7	VERGNE	1m27.683s
8	RICCIARDO	1m27.782s
9	BUTTON	1m27.804s
10	MASSA	1m27.960s
11	GUTIERREZ	1m27.967s
12	HULKENBERG	1m28.101s
13	KVYAT	1m28.208s
14	MALDONADO	1m28.266s
15	BOTTAS	1m28.330s
16	PEREZ	1m28.376s
17	GROSJEAN	1m28.593s
18	SUTIL	1m29.025s
19	KOBAYASHI	1m30.363s
20	ERICSSON	1m30.892s
21	CHILTON	1m31.004s
22	BIANCHI	1m31.248s

PRACTICE 2: Friday

POS	DRIVER	TIME
1	HAMILTON	1m24.482s
2	ROSBERG	1m24.720s
3	VETTEL	1m25.111s
4	ALONSO	1m25.437s
5	MAGNUSSEN	1m25.580s
6	RAIKKONEN	1m25.730s
7	RICCIARDO	1m25.983s
8	BOTTAS	1m25.999s
9	BUTTON	1m26.234s
10	MASSA	1m26.402s
11	KVYAT	1m26.689s
12	VERGNE	1m26.703s
13	HULKENBERG	1m26.789s
14	SUTIL	1m26.919s
15	PEREZ	1m27.013s
16	MALDONADO	1m27.019s
17	GROSJEAN	1m27.021s
18	GUTIERREZ	1m27.480s
19	KOBAYASHI	1m28.370s
20	BIANCHI	1m28.469s
21	CHILTON	1m28.586s
22	ERICSSON	1m29.036s

PRACTICE 3: Saturday

POS	DRIVER	TIME
1	HAMILTON	1m24.048s
2	ROSBERG	1m24.095s
3	VETTEL	1m24.455s
4	RICCIARDO	1m24.678s
5	BOTTAS	1m24.685s
6	ALONSO	1m24.769s
7	RAIKKONEN	1m24.818s
8	MAGNUSSEN	1m24.867s
9	VERGNE	1m25.162s
10	KVYAT	1m25.170s
11	MASSA	1m25.231s
12	BUTTON	1m25.468s
13	MALDONADO	1m25.829s
14	GROSJEAN	1m25.859s
15	SUTIL	1m25.934s
16	GUTIERREZ	1m26.023s
17	HULKENBERG	1m26.035s
18	PEREZ	1m26.142s
19	KOBAYASHI	1m27.560s
20	CHILTON	1m28.083s
21	ERICSSON	1m28.605s
22	BIANCHI	1m28.821s

Weather: 29C, sunny

Weather: 33C, sunny

Weather: 29C, sunny



Sun sets on F1 for summer break

TEE/LAT

QUALIFYING TIMES

POS	DRIVER	QUALIFYING 1	QUALIFYING 2	QUALIFYING 3
1	ROSBERG	1m25.227s (2)	1m23.310s (1)	1m22.715s
2	VETTEL	1m25.662s (5)	1m23.606s (2)	1m23.201s
3	BOTTAS	1m25.690s (6)	1m23.776s (4)	1m23.354s
4	RICCIARDO	1m25.495s (4)	1m23.676s (3)	1m23.391s
5	ALONSO	1m26.087s (10)	1m24.249s (6)	1m23.909s
6	MASSA	1m26.592s (14)	1m24.030s (5)	1m24.223s
7	BUTTON	1m26.612s (15)	1m24.502s (7)	1m24.294s
8	VERGNE	1m24.941s (1)	1m24.637s (9)	1m24.720s
9	HULKENBERG	1m26.149s (12)	1m24.647s (10)	1m24.775s
10	MAGNUSSEN	1m26.578s (13)	1m24.585s (8)	no time
11	KVYAT	1m25.361s (3)	1m24.706s	-
12	SUTIL	1m26.027s (9)	1m25.136s	-
13	PEREZ	1m25.910s (8)	1m25.211s	-
14	GUTIERREZ	1m25.709s (7)	1m25.260s	-
15	GROSJEAN	1m26.136s (11)	1m25.337s	-
16	BIANCHI	1m26.728s (16)	1m27.419s	-
17	RAIKKONEN	1m26.792s	-	-
18	KOBAYASHI	1m27.139s	-	-
19	CHILTON	1m27.819s	-	-
20	ERICSSON	1m28.643s	-	-
21	HAMILTON	no time	-	-
22	MALDONADO	no time	-	-

Weather: 27C, cloudy

QUALIFYING STATISTICS

	HEAD TO HEAD		
VETTEL	4	7	RICCIARDO
ROSBERG	7	4	HAMILTON
RAIKKONEN	2	9	ALONSO
GROSJEAN	10	1	MALDONADO
MAGNUSSEN	5	6	BUTTON
PEREZ	2	9	HULKENBERG
GUTIERREZ	6	5	SUTIL
VERGNE	6	5	KVYAT
MASSA	4	7	BOTTAS
CHILTON	3	8	BIANCHI
ERICSSON	2	9	KOBAYASHI

POLE POSITION TROPHY

ROSBERG
BRN MC CDN GB D H 6

HAMILTON
AUS MAL PRC E 4

MASSA
A 1



Vettel fans show their devotion

HONE/LAT

SUPERLICENCE PENALTY POINTS

Drivers	1	2	3	4	5	6	7	8	9	10	11	12
BIANCHI	X	X	X	X								
BOTTAS	X	X										
ERICSSON	X	X										
MAGNUSSEN	X	X										
MALDONADO	X	X	X	X								
PEREZ	X	X										
SUTIL	X	X										
VERGNE	X											

Anyone who gets to 12 points will be suspended for one race

Reliability remains Mercedes'

Some may think there is a conspiracy against Lewis Hamilton, but **JONATHAN NOBLE** argues



32

THOMPSON/GETTY

Lewis Hamilton's brilliant recovery from pitlane start to podium, plus the Mercedes team orders row, dominated talk in the paddock in the immediate aftermath of the Hungarian Grand Prix. But as F1 heads to its summer break and prepares for the second half of the campaign, Mercedes has a much bigger issue to focus on: improving reliability.

Just a week after Hamilton's hopes of fighting for victory in Germany were wrecked by a brake failure during qualifying, the Briton faced trouble early in Q1 at the Hungaroring when a fuel leak turned into an inferno and forced a change of chassis.

His run of problems this year – both in races and qualifying – served to ramp up accusations from his fans of favouritism towards team-mate Nico Rosberg.



Lauda and Toto aim to give drivers equal chances

ETHERINGTON/LAT

But while such conspiracy talk is excessive, the reality is Mercedes needs to improve to ensure neither of its drivers lose out through no fault of their own.

DELIBERATE SABOTAGE THEORY IS NONSENSICAL

As well as the two qualifying problems he has faced this year, Hamilton has suffered two race retirements compared to Rosberg's single DNF. Hamilton suggested straight after his qualifying fire in Hungary that his run of reliability woes had become more than just a coincidence.

He said: "I think it is getting to the point where it is beyond bad luck. We need to do better."

While some interpreted his comments as suggestions of a conspiracy, the idea of a team deliberately hobbling one of its drivers with brake failures and fuel fires is utter nonsense.

Reacting to accusations of favouritism, Mercedes non-executive chairman Niki Lauda said: "I hate this

discussion. Both guys, from day one, have the same cars, everything is equal.

"Unfortunately the engine that failed was Lewis's. These things should not fail. We're going to fix them. We want both to have the same material and race each other the way they want."

Mercedes' own title ambitions are best served by having both its drivers at the front of the grid – and it has devoted a great deal of time this year in trying to keep its drivers racing on an equal footing.

There would be no logic in making such efforts to allow its drivers to race, have the hassle of flashpoints like Spain and Monaco, plus invest millions of pounds in car development and driver wages, to then secretly favour one over the other.

Last season, it was Rosberg – and not Hamilton – who faced the

biggest worry

the truth is a bigger challenge for Mercedes



Hungary fire was latest issue to strike Hamilton



Both Silver Arrows hit trouble in Canada

HOW RELIABILITY HAS PANNED OUT

Lewis Hamilton's spectacular failures in qualifying for the German and Hungarian GPs highlighted how big a role reliability is going to play in the title fight outcome this year.

Although the issues prompted wild

talk of a conspiracy to deliberately favour Rosberg, the reality is that both drivers have had to live with car failures during the campaign.

Here is the run down of the issues that both men have faced in 2014.

HAMILTON	FORMULA 1 ROUNDS	ROSBERG
Engine stopped in FP1 Spark plug insulator failure	FP1 DNF AUSTRALIA	
	MALAYSIA	
	BAHRAIN	
FRIC issue in FP1 limits running	FP1 CHINA	RACE Telemetry problem, finishes 2nd
	SPAIN	FP1 ERS problem limits FP1 running
	MONACO	
ERS-K failure, brake failure	DNF CANADA	RACE ERS-K failure, finishes 2nd
	AUSTRIA	FP1 ERS problem limits FP1 running
MGU-K problem in FP2 limits running	FP2 BRITAIN	DNF Gearbox failure
Brake disc failure in Q1	Q1 GERMANY	
Fuel leak in Q1 causes fire	Q1 HUNGARY	

KEY	Failures occurring in free practice	Failures occurring in qualifying	Problems in races (not terminal)	Problems in races resulting in DNF
------------	-------------------------------------	----------------------------------	----------------------------------	------------------------------------



Rosberg has had the better luck in the races

biggest share of reliability problems. The German retired from the Australian, Chinese and Hungarian GPs with mechanical issues, while Hamilton's only non-finish came from car damage caused by a puncture he suffered early in the Japanese GP.

If a team did want to deliberately

hold back one of its drivers, there are more nefarious ways of doing it that would not arouse suspicions – or even make the driver aware of an issue.

A team could, for example, overfill his car with fuel to hold back its speed – an extra 10kg of fuel would automatically add 0.3 seconds to a lap without a driver knowing why he was

slower. Or a team could run an engine software map that did not produce maximum power.

THE NEED TO REACT

Analysis of the reliability issues that Hamilton and Rosberg have faced this season shows both men have suffered their fair share of issues; it is not just restricted to one side of the garage (see above). The only difference is that Hamilton's failures have come in more high-profile situations, such as races and qualifying, whereas Rosberg has hit trouble more often in practice sessions.

Mercedes' reliability record is on course to be worse than last year, but that is also no surprise judging by the difficulties all teams have faced in getting on top of the new hybrid technology. The team set up a working group over the winter to

ensure its reliability is as good as it can be.

The German firm has also been open in press conferences and its social media channels that its reliability, especially on Hamilton's car, has not been good enough.

While trying to keep a lid on the team orders controversy in Hungary, Mercedes motorsport boss Toto Wolff knows what his outfit needs to be more worried about right now. "Reliability is our main concern," he says. "So we have to push flat out and understand why it is happening.

"We are trying to sort and fix problems and when you fix problems you are running behind things, you are chasing and can't really catch up.

"We need to calm down, analyse everything properly and come back with more power after the break."

An epic title battle depends on it.

Making his point to McLaren

Kevin Magnussen made a dream start to his F1 career but looked in danger of fading away. Now he's making a case for being at McLaren long-term. **BEN ANDERSON** looks at how he's changed

There is something of a revolution going on in Formula 1 at the moment. The young talents are rising up. They are going to run the world some day.

Daniel Ricciardo and Valtteri Bottas are part of this shift, challenging establishment thinking with consistently brilliant performances and results over the first half of this season. Kevin Magnussen is also making waves of his own this year, but in a much quieter way. His journey, while no less important, has also been rockier.

It all began so well. Magnussen bowled into F1 as a fresh-faced rookie and came away from his first grand prix with a podium finish. Instant fame, instant glory, but instant pressure...

Things change very quickly in sport and they immediately took a turn for the worse for the Dane, who spent the next six races (Monaco aside) generally being overshadowed by his McLaren team-mate Jenson Button. Gradually, it began to look as though that stunning first race might be a flash in the pan; that maybe Magnussen wasn't the future superstar McLaren thought it had nurtured.

But the young Dane has turned things around in the last few races, and his dramatic crash at Turn 1 in the rain in Q3 at the Hungaroring last weekend hasn't changed McLaren's increasing belief that Magnussen is on the right path. He's scored points in three of the last four GPs, and his qualifying performances in Austria and Germany – in a difficult car – were genuinely impressive.



Magnussen has looked stronger in recent races

The future for McLaren's current driver line-up is unclear. Negotiations over extending Button's stint at the team have stalled, and the Woking squad is known to be courting Ferrari's Fernando Alonso while maintaining a non-committal stance on Magnussen.

But the Dane has started to make a strong case for cementing his own F1 future with McLaren recently, and a change in mentality has been key to this turnaround.

BEATING ROOKIE SYNDROME

Following May's Monaco Grand Prix, McLaren racing director Eric Boullier suggested Magnussen was suffering from "rookie syndrome", whereby a young driver with a lot of success behind him comes into F1 and struggles to adjust to working with an uncompetitive car.

As reigning champion in Formula Renault 3.5, Magnussen admits frustration at not being in a winning car this year has hurt him at times.

"To be honest I'm still frustrated not to be winning," Magnussen tells AUTOSPORT. "I'm used to winning in my junior career. It's not that I've won every championship I've done, but I've always won races and I've always been at the top knowing that I was fighting for victories.

"I'm not anymore, so that's an unusual situation, but it's something I need to accept. It's part of F1 – you're not winning every year and there's no way you can win in all your years in F1; no one's ever done that, or ever will do that."

Boullier has a track record in nurturing young drivers – famously helping Romain Grosjean get his career back on track after a difficult F1 debut with Renault in 2009. Boullier says Magnussen has made excellent progress since accepting the need to alter his attitude.

"It's true Kevin did some mistakes and went through exactly the same stages [as Romain]," Boullier explains. "We've talked about this many times and I've explained where he needs to go. You have to take the pain.

"I've tried to be as close as possible to him and monitor very carefully across the weekends what is going on for him, which means data, body language, stress level, environment, and the people around him.

"We've talked often, but in the end he really came back and rebuilt himself. Now it's very interesting because he has enough experience and knows the tricks to run in F1 – to

manage tyres or fuel and still be fast.

"Since Germany we told him 'now be yourself' because you have all the tools in your hands, and you can feel he is starting to enjoy it and deliver more speed."

TURNING THINGS AROUND

Magnussen credits June's Austrian GP (where he qualified sixth and finished seventh – at the time his best result since Australia) as the point at which F1 started to "click" for him, though he still feels there is more to come.

"The balance of the car, my driving, how we managed the qualifying, everything kind of clicked there," Magnussen explains. "It's taken time, and when you get to F1 you don't want to mess up, so I find myself a little under the limit sometimes.

"I've come into other things earlier in my career where I just expected to win straight away, expected too much of myself, messed up and just got into a bad rhythm of crashing. I don't want that to happen in F1 so I've taken a small step back.

"At the moment, because I'm learning so many things, there is a lot of stuff in my head and I'm thinking a lot. It's not natural, and I need to get over that. Then I think it will be much better."

CONVINCING McLAREN

This suggests there is even more to come from Magnussen, and the key now is convincing McLaren he's the right driver to help lead the team into its future engine partnership with Honda.

Boullier won't be drawn on



He's learned quickly and improved a lot in terms of his confidence in his own ability to set the car up. He's a straightforward guy and one of the easiest team-mates I've worked with

Jenson Button

MAGNUSSEN'S HIGHS AND LOWS

HIGH
Finishes on the podium on his F1 debut in Australia

LOW
Stop/go penalty for punting Kimi Raikkonen in Malaysia

LOW
Finishes well adrift of Button in Canada

HIGH
Beating team-mate Button until engine issue in Monaco

HIGH
Outqualifies and outraces Button in Austria

HIGH
Qualifies fourth in Germany

LOW
Crashes out of Q3 in the wet at the Hungaroring

LOW
Collides with Felipe Massa at Turn 1 in Germany

DUNBAR/LAT



35

McLaren's plans for its driver line-up, but reckons Magnussen's future is very much in his own hands. "Kevin has started to really blossom and that will help Jenson keep his own level as high as possible," Boullier tells AUTOSPORT. "The apprenticeship is finished for Kevin now and, even if we allow him a couple of mistakes, now I need to understand the potential."

"He will be strong enough to have a good future in F1. We tell him to do your job the best you can and we'll see. It is up to him." ❧



Motor Racing International



**MOTOR RACING
INTERNATIONAL**
Formula One and
Le Mans Tours 2014



Monza - 7 September

ITALIAN GRAND PRIX

Weekends & Longer Tours
Based in Como

Singapore - 21 September

SINGAPORE GRAND PRIX

Spectacular Night Race
Scheduled Flights
5 Nights in Singapore

Suzuka - 5 October

JAPANESE GRAND PRIX

5 Nights in Nagoya
Scheduled Flights

Austin - 2 November

UNITED STATES GRAND PRIX

Texas Hosts F1's
Instant Classic

Budapest - 27 July

HUNGARIAN GRAND PRIX

Weekend by Air
Budapest & Vienna
2-Centre Holiday

Spa - 24 August

BELGIAN GRAND PRIX

Selection of Tours by Coach,
Air or Eurostar
Self Drive Packages

Yas Marina - 23 November

ABU DHABI GRAND PRIX

5 Nights in Abu Dhabi City
The Season Climax

www.motorracinginternational.uk.com

The 22nd edition of the MRI Tour Collection is now available. Visit our website for full details. As ever, we feature the F1 World Championship and the Le Mans 24 Hour Race. A small selection of our vast choice of travel arrangements is outlined above.

Put your trust in the UK's only fully bonded, independent motorsport travel specialist.



Apply NOW for your FREE brochure. Ring our 24 hour dial-a-brochure service quoting reference: 'AS9'
01304 612424 info@motorracinginternational.uk.com

Fifteen questions for Jean-Eric Vergne

Q Who was your childhood hero?

A Ayrton [Senna]. Easy. And Zinedine Zidane

Who has been your biggest rival?

I have two rivals and I can't decide who was the strongest: Robert Wickens or Daniel Ricciardo.

Who was your childhood hero?

Ayrton [Senna]. Easy. And Zinedine Zidane as well.

When were you happiest?

What makes me happy is growing up, in terms of results, your understanding of the sport, and as a person. I feel happy when I feel that I am getting stronger and better.

Which living person do you most admire and why?

The French president?! I'm kidding. To be honest, Bernie Ecclestone. Really. I'm impressed with what he's done in Formula 1. I don't know what other people think but I think what he has done for F1 is great. He made it the best sport in the world, and that's the sport I love. I think he has done the most for our sport.

What was your most embarrassing moment?

It was in karting, when I was 14. It was my first race in Belgium. I was in a fight for the podium and I was not aware that the signals were different at the start/finish line towards the end of the race. In France, they give you a signal when there is one lap to go. In Belgium they tell you when it's two laps to go, then one lap, then the chequered flag. So when I saw the signal I thought that meant it was the last lap. I crossed the finish line with my head down because I was fighting hard, and of course I didn't see the signal for one more lap to go... or the

chequered flag. But I thought it was the end of the race. I came back to the pits... and no-one was there.

What is your most treasured possession?

I don't have many things. I don't think I can say I 'own' my girlfriend! Maybe the first painting I bought.

Who would play you in a film of your life?

Me. I like acting.

What is your favourite smell?

Good food. When you arrive in a house and there is a smell of good food that makes you hungry. It's something that creates another wish, that's nice.

What is your guiltiest pleasure?

The ones I have are too good to be shared. I want to know what David Coulthard chose!

Who would you like to say sorry to and why?

I don't live in the past. If I feel sorry I say it at that moment. I am someone who says what he thinks. I have no-one I wish to apologise to.

What does success feel like?

Success is something you treat pretty normally. When you get success, you have worked so hard, so it is just the fruit of your work. It's nice. I remember when I was winning races, which is not happening at the moment, I was happy, but I came down straight away. You have to be quite calm about it. And you always need to remember that when you succeed, it is harder to stay on top. When you go down it can be hard.

What has been your biggest disappointment?

I don't have any. I'm really happy with what I have right now, so I don't have much disappointment.

Is there anything from your past you would like to change?

Everybody can say that. You are



JEV reckons he can act, likes a good bike ride and cries a lot



always better now than you were before. Of course if I go back now with more experience I would do some things better. But that's how life is and no-one can change it so I don't have any bad things.

How do you relax?

I like cycling. Even if it's not relaxing, to go out when it is a beautiful day I

think it's the best. You come back and you have done something worthwhile with the day. You don't feel guilty because you haven't done anything. It feels good, it refreshes your mind.

When was the last time you cried?

Every day! I don't know. Out of the car I can be a sensitive person, but I can't remember. ☹



ROLEX

ROLEX

Turvey, Tincknell and
Dolan celebrate Le Mans
class win last month



38

The Jota in the pack

Success at Le Mans has helped the Jota Sport team to reinforce its reputation in sportscar racing.

GARY WATKINS traces the team's history and talks to boss Sam Hignett about what the future holds

The British Jota Sport team is on a roll right now. It has just notched up the biggest victory in its history with LMP2 honours at last month's Le Mans 24 Hours, it's in the running for the European Le Mans Series title, it has claimed an amazing run of pole positions in the series and is forging links with Audi Sport. Not bad for a team only three years back in the prototype ranks, or so you might think.

The reality is that Jota is no Johnny Come Lately. The British team joined the LMP ranks for a two-year stint in the ELMS (then known as the Le Mans Endurance Series) in 2004. It stopped racing under its own name after 2005, but the Kent-based squad continued to run prototypes for other teams. The Zytek factory, Charouz, Pickett/Cytosport and Corsa Motorsport were all teams to benefit from Jota's expertise over the years.

Jota had started as a vehicle for the driving

aspirations of team founders Sam Hignett and John Stack, hence the LMES programme with a Zytek 04S LMP1 that took them to the Le Mans 24 Hours in year two. With that box ticked in 2005, it was time "to commercialise the team", according to Hignett, who's still at the helm today.



Turvey leads at Imola in 2013,
his first year with the team

The link with Zytek resulted in Jota being contacted to run the British constructor's short P2 programme in 2006, while it also became a service provider for the DAMS team in the inaugural season of the A1GP World Cup of Motorsport in 2006-07 and subsequently (and briefly) ran the Team Russia entry. It was through this series that Jota made contact with Czech entrant Toni Charouz.

"I talked to him about a prototype programme and gave him some figures," recalls Hignett. "I didn't hear anything until Lola rang us up to tell us that our car was ready."

That deal resulted in Jota running a Lola-Judd B07/10 in the 2007 Le Mans Series for Stefan Mucke and Jan Charouz to fifth in the championship and a top-10 result at Le Mans.

Jota started running under its own name again in 2008 in Porsche Carrera Cup GB with Sam Hancock, who had found backing from 'Twitter Dragon' Simon Dolan. The entrepreneur, who



TOYOTA HYBRID

TOYOTA HYBRID

Jota's finest hour came with victory in LMP2 at Le Mans

S. BLOXHAM/LAT



Team co-founder Hignett remains as squad's boss

"I know Simon would be interested in LMP1-L – if there's true competition"

JOTA BOSS SAM HIGNETT

was a title-winning kickboxer as a lad, noticed on a trip to Le Mans in '07 that he was younger than many of the drivers and thought, 'I can do this'.

Dolan's involvement was the start of a new chapter for Jota. He graduated through Radicals, through a Group CN Ligier and the GT4 category to GT2 and a first assault on Le Mans with an Aston Martin Vantage in 2011. A move into prototypes followed and yielded success almost straightaway with a P2-class win on an outing in the Spa round of the World Endurance Championship round with Dolan and Hancock.

Hancock was replaced by Oliver Turvey for 2013 because, says Hignett, "tutee and tutor were becoming one and the same". The idea was to bring in a new driver "to mix things up to unlock the next level of Simon's potential".

Turvey and Dolan won a race, might have won more and, together with Lucas Luhr, probably would have won Le Mans but for a broken front wishbone. What is a fact is that Turvey was on

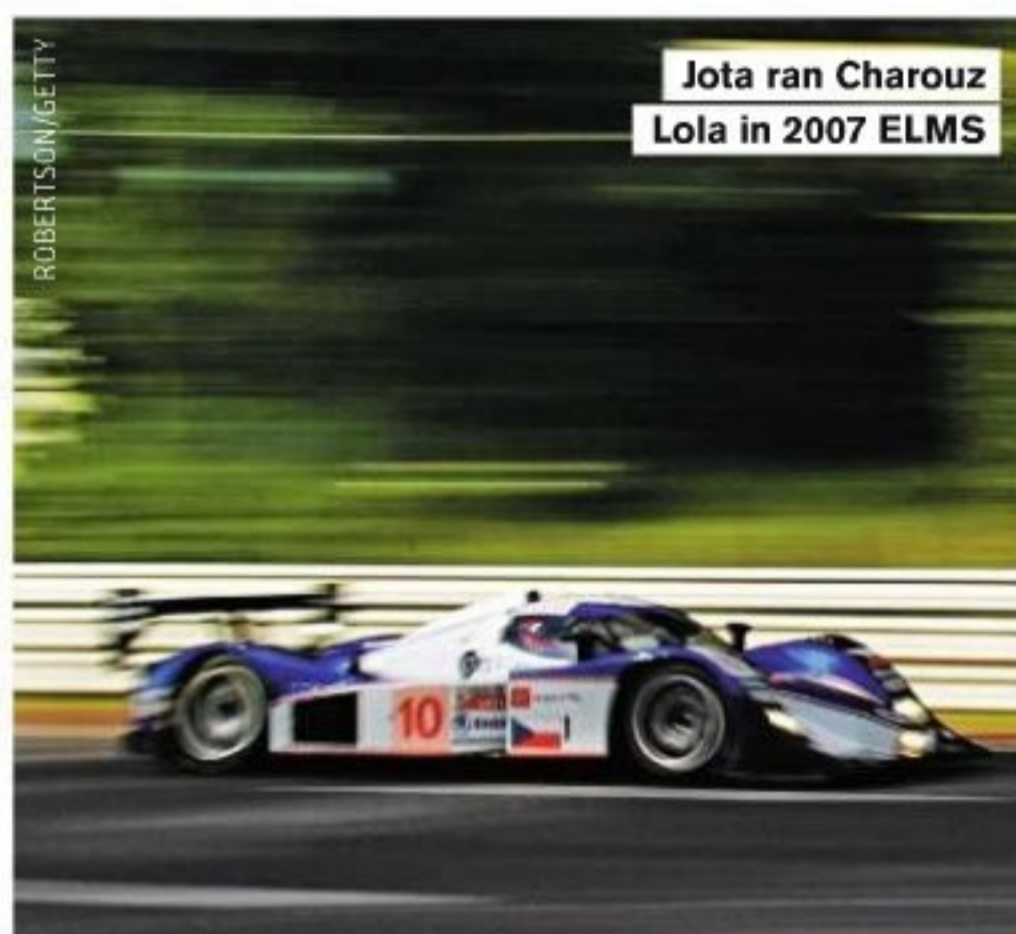

Jota ran Charouz Lola in 2007 ELMS

pole on all but one occasion over the course of the five-race series. It is a run that's continuing this year: the Jota Zytek-Nissan Z11SN has never been off pole in the three races so far.

Harry Tincknell, a Formula 3 racer in Britain and Europe, was placed with the team by his mentor and manager Allan McNish and he's notched up two of the poles. The newly-retired world champion was also instrumental in new prototype driver, Felipe Albuquerque, joining the team to get up to speed ahead of his appearances in the third R18 e-tron quattro at Spa and Le Mans. He did the business in qualifying at Imola, scene of Jota's first victory of the season.

As part of the deal, Audi reserve Marc Gene raced the car at the Spa WEC round and practised at Le Mans before he took Loic Duval's spot in the #1 Audi. That meant a call to Turvey to complete a line-up that went on to win the race.

The aspirations of Jota, which also has a secondary programme running Mazda MX5s in a range of events and an division restoring and running historic machinery, for the moment centre on winning the ELMS title and then trying to retain its P2 crown at Le Mans.

A move into the LMP1-Light class for privateers isn't out of the question, reckons Hignett. The fact is that Jota would be racing in P1 this year had a multi-year deal with Aston Martin Racing run its course. Its appearances in GT4 and GT2 in 2010 and '11 respectively were meant to be a prelude to Jota racing one of the ill-fated Aston AMR-Ones.

"I know Simon would be interested in LMP1-L," says Hignett, "but only if the category grows and there is true competition."

TEAM ORIGIN: FROM GROUP N TO LMP2

The Jota team was born of humble origins. It all began with a Group N racer built out of a Honda Integra Type-R from a company car fleet, one mechanic and a truckie whose day job was nailing 'For Sale' signs to gateposts.

Estate agent and property developer John Stack – Jota comes from letters in his christian and surname – had sponsored Barwell Motorsport boss Mark Lemmer in TVR Tuscans and then fancied racing himself. He commissioned the Integra from Barwell, who happened to be in contact with a young Formula Vauxhall driver called Sam Hignett. They joined forces for an attack on the 2000 Spa 24 Hours and a couple of VLN races on the Nordschleife.

Barwell also had a couple of Renault Clio V6 one-make racers for sale that went Jota's way.

"It was a bit of a leftfield choice, but Stacky liked the look of them," remembers Hignett, whose father Tim had also briefly been an entrant through his L&C BMW dealership in Kent, winning the Willhire 24 Hours in 1991. "We went around Europe for a year with just the two of us, our mechanic and the truckie."

Stack and Hignett both had aspirations to race at Le Mans and an unfancied Pilbeam SR2 racer was the first step to fulfilling the dream.

The car was retubbed for year two and the old chassis sold for scrap for £50. "That probably got us through the week," says Hignett. "Things were that tight back then."

Two years in the FIA Sportscar Championship were followed by a move up into LMP1. The team had been looking to buy the DBA4 prototype that ultimately went to Creation and eventually took that team's name. Which is why Jota ended up buying a Zytek and beginning a relationship that continues to this day.



Pilbeam SR2 was first choice

“I REALLY NEED TO DOMINATE TO STAKE MY F1 CLAIM”

With four rounds of the GP2 season remaining, Jolyon Palmer is in a commanding points lead with DAMS. He reflects on the campaign, and looks ahead to F1, with **CHARLES BRADLEY**

You can tell a lot about someone when they've just been beaten. AUTOSPORT sits down with Jolyon Palmer just an hour after Mitch Evans has defeated him by pulling off a tidy alternate-strategy victory in Silverstone's GP2 feature race. No matter that Palmer finished a close second and extended his healthy points lead, he's "gutted" and "annoyed". We remind him it's only actually cost seven points. He retorts: "It's more than that – it's nice to have another win, especially at Silverstone." It clearly matters a lot.

When we'd last spoken at length, ahead of the season, Palmer couldn't wait to get started with the DAMS team that's won two of the last three GP2 drivers' titles (Romain Grosjean in 2011 and Davide Valsecchi in '12). He knew the opposition was going to be tough, with a brace of highly rated Formula 1-affiliated rookies – Stoffel Vandoorne and Raffaele Marciello – as well as rivals he'd been up against for a while: Felipe Nasr, Stefano Coletti and Johnny Cecotto. He also knew, in year four of his GP2 career, it genuinely was make or break time for his F1 ambitions.

"I was confident I would be fighting for the title because I had a really good test with DAMS at the end of last year," he says. "Over the winter the team and I were really, really hungry to do well together. From the first day of pre-season testing I was feeling good with the team, but even from that point I would never have predicted we would be doing this well."

S. BLOXHAM/LAT



Bahrain victory was first of two wins...



...with the second coming in Monaco

And what a season so far: two wins, three poles, eight podiums, a worst finish of seventh (the reversed-grid race at Monaco, so even that's skewed) and a 100 per cent front-row qualifying record until last weekend at the Hungaroring.

What's made the difference? "The main thing is the qualifying, which is the basis for the whole weekend," he says. "That way if we have a bad race – we finished fifth in Austria – then you're still in the hunt for the points on Sunday. There's no pressure to salvage a top eight or work hard to get on the podium if you start at the front." (Note that a 'poor race' is fifth!)

Just like his grand prix driver father Jonathan was, Jolyon is very analytical when it comes to his racing. When you push him on why qualifying was a weakness previously, boy do you get a comprehensive answer. Imagine what his feedback to engineers is like...

"At the end of last year [with Carlin] I was qualifying really well – I was in the top three in the last three rounds – and what not many people know about was that we changed the chassis after the Nurburgring, because I'd started the year terribly. I couldn't qualify at all – Monaco was my only top 10 [in the first six events]."

"I was actually qualifying pretty reasonably in 2012 with iSport, so we couldn't work it out and there were some differences in the set-up between the two cars [his team-mate was current title rival Nasr], differences in the feedback. And after scratching our heads for half a year we decided that there was nothing to lose, let's try this."

"No one likes to blame a dodgy chassis because you can't quantify how much – it's a bit of a lame excuse... We did change it and I won in Budapest from seventh on the grid. Then I qualified 7, 3, 1, 3 [he shows great recall there] when I couldn't get in the top 10 before, and was fighting for the podium in every feature race and won two – nearly three. Although it can't be proven, it looks like that was holding me back in the first half of last year."

Does it help that his closest rival, Nasr, was his team-mate last year, giving him some insider knowledge of how Carlin ticks?

"A little bit," he allows. "Sometimes it feels like I can predict what they will do. I kind of think occasionally that I can see his mindset, but then they do something completely the opposite!"

"I guess there is some element in that, but he's not been that quick [in qualifying] until now: one third place, apart from that he's been fifth and sixth in qualifying [Nasr confounded him by taking pole in Hungary last Friday and they fell out with each other in the races, see next pages]."

He's raced well and he's picked up some good points and he's taken three wins, which has given him a lot more confidence as well.

"But in terms of pure pace I think Racing Engineering are probably a bigger threat. I definitely don't see it as just me against Nasr at the moment. Over the season so far he's been the one that has been collecting the points so that's why he's second. It's a competitive field and the threat could still come from anywhere."

But if he manages all those threats, with the lead he's held for the majority of the season, then F1 is the clear target for 2015.

"Basically the aim is to be on the grid next year, that's clear," he says. "We're speaking to some teams about a link, or a progression to that. But it's still early stages and my main focus is to win GP2. That's something that's

happening in the background really. With the season that I've had so far, we're in quite a strong position for it."

And beating some F1 junior and reserve drivers week in, week out doesn't do any harm either: "It's good having them there because it means [the teams] are all watching GP2, but FP1 runs and a lot of those opportunities are taken by those guys who were signed up at the start of the year, and that's something I've not done."

"We'll have to see how it pans out at the end of the year. I'm feeling confident that if I win the championship I can be on the grid. How I see it is that at the end of the year some spaces will open up, and I've got to be in the best position to make myself appealing to teams."

He's also smart enough to realise that he won't make the F1 grid on talent alone, and aware of the 'Davide Valsecchi/Fabio Leimer syndrome' if the opportunity/money isn't there to progress.

"I think it's a given at the moment that you need to bring something; we're working on the commercial side," he confirms. "There are people that are interested, but it's early days from that point of view as well."

"That's how it works nowadays. Everyone's bringing something. I can do a good job on track and I'm feeling reasonably confident we can get the package together, and if there's a space at the end of the year, that's the goal."

As last weekend's Hungarian races showed, Palmer isn't about to back off as the series enters its second half, and is targeting more wins to avoid falling into a trap that he's already identified from previous seasons.

"I'm not looking too much at the championship, because I've seen that the last two champions didn't make F1," he says. "I rate Leimer really highly, but he was a little bit Mr Consistent – especially in the second half – picking up points, and he didn't really stand out. I think that was a problem for him."

"What I can learn from that is that you can win the championship like that but it's not necessarily guaranteeing you a drive [in F1]. My aim is to win as many races or get as many podiums as I can. I recognise that it's my fourth year and I really need to dominate to stake my claim."

If he finishes the job he will become the first British GP2 champion since Lewis Hamilton (spooky fact: Palmer was just eight days older than Hamilton was when each of them took their first GP2 wins). Now 23, Palmer may not graduate with equal fanfare as Hamilton in 2007, but he clearly deserves his F1 opportunity just the same. ☞



Palmer Jr plans to get to F1 like his father

PALMER IN GP2

76	4	4	TEAMS:
STARTS	POLES		• ARDEN
			• iSPORT
			• CARLIN
			• DAMS
	SEASONS CONTESTED		
	2011	2012	
	2013	2014	
5 FASTEST LAPS			
10	RACES LED	389	
5	WINS	POINTS	

GP2

Hungaroring (H)

July 26-27

Round 7/11



RESULTS

RACE 1: 35 LAPS, 95.253 MILES

1	ARTHUR PIC (F)	1h00m18.627s
Campos Racing; Grid: 3rd-1m28.643s		
2	ADRIAN QUAIFE-HOBBS (GB)	+3.151s
Rapax; Grid: 22nd-1m29.462s		
3	TAKUYA IZAWA (J)	+3.661s
ART Grand Prix; Grid: 26th-1m30.427s		
4	JOLYON PALMER (GB)	+3.828s
DAMS; Grid: 6th-1m28.791s		
5	DANIEL ABT (D)	+5.111s
Hilmer Motorsport; Grid: 14th-1m29.125s		
6	FELIPE NASR (BR)	+5.190s
Carlin; Grid: 1st-1m28.436s		
7	STOFFEL VANDOOORNE (B)	+6.213s
ART Grand Prix; Grid: 5th-1m28.740s		
8	NATHANAEL BERTHON (F)	+7.038s
Venezuela GP Lazarus; Grid: 18th-1m29.217s		
9	TOM DILLMANN (F)	+7.605s
Caterham Racing; Grid: 2nd-1m28.618s		
10	MARCO SORENSEN (DK)	+8.102s
MP Motorsport; Grid: 9th-1m28.935s		

Winner's average speed: 94.762mph. Fastest lap: Mitch Evans, Russian Time, 1m32.705s, 105.711mph.

RACE 2: 28 LAPS, 76.197 MILES

1	VANDOOORNE	43m54.536s
Grid: 2nd		
2	PALMER	+3.328s
Grid: 5th		
3	NASR	+4.254s
Grid: 3rd		
4	BERTHON	+17.211s
Grid: 1st		
5	ABT	+17.780s
Grid: 4th		
6	PIC	+25.326s
Grid: 8th		
7	CONOR DALY (USA)	+26.815s
Venezuela GP Lazarus; Grid: 13th		
8	RAFFAELE MARCIELLO (I)	+34.706s
Racing Engineering; Grid: 19th		
9	MITCH EVANS (NZ)	+38.981s
Russian Time; Grid: 12th		
10	SORENSEN	+40.368s
Grid: 10th		

Winner's average speed: 104.121mph. Fastest lap: Vandoorne, 1m32.541s, 105.889mph. All drivers in Dallara-Mecachrome GP2/11.

DRIVERS' CHAMPIONSHIP

1	PALMER	192	6	EVANS	92
2	NASR	149	7	PIC	70
3	VANDOOORNE	109	8	LEAL	66
4	CECOTTO	100	9	RICHELMI	41
5	COLETTI	96	10	MARCIELLO	30

TEAMS

1	DAMS	233	4	RACING ENGINEERING	126
2	CARLIN	215	5	TRIDENT	122
3	ART GRAND PRIX	135	6	RUSSIAN TIME	92

POINTS SYSTEM EXPLAINED

Race 1: 25-18-15-12-10-8-6-4-2-1 to top 10 finishers. Race 2: 15-12-10-8-6-4-2-1 to top eight. Pole for race one: 4. Fastest lap of top 10 finishers in each race: 2.

Quaife-Hobbs (right) was promoted to second on Saturday



Vandoorne left Nasr trailing in sprint race



Pic the younger posts first win

Arthur Pic and Stoffel Vandoorne won the races in Budapest, but it kicked off between title rivals Jolyon Palmer and Felipe Nasr.

By CHARLES BRADLEY

LIKE DANIEL RICCIARDO 24 HOURS LATER, ARTHUR Pic had good reason to thank an early safety car that laid the cornerstone for his feature race victory on Saturday. Not even a one-lap, final-tour restart could break his stride, as he scored his maiden GP2 win with Campos Racing.

It was a weekend of firsts, as Felipe Nasr recorded his first-ever series pole at the 30th attempt, setting two laps good enough for the top spot over Tom Dillmann. "We have been working on the car for qualifying," said Nasr. "It was something we needed to improve on, and we tried some changes and it seems to be working now."

But Nasr made a poor start, the Carlin driver allowing Caterham's Dillmann to briefly nose in front, before wresting the lead back on the exit of the first corner. Points leader Jolyon Palmer (DAMS) made the best getaway, atoning for his worst qualifying of the year to leap from sixth to third. He then had to hold off ART's Stoffel Vandoorne at Turn 3, and straightlined Turn 6, along with Dillmann.

Palmer moved into second, passing Dillmann at Turn 1 on lap two, but made little impression on Nasr's lead until the moment that changed the

race. Palmer's team-mate Stephane Richelmi clashed with Kimiya Sato at Turn 10, which sent Richelmi piling into the tyrewall.

Under the resultant safety car, those who started on the soft-compound tyre – Raffaele Marciello, Pic and Daniel Abt – made perfectly timed, and effectively free, mandatory pitstops. But Marciello, who was in the best position of all and on course for victory, was judged to have passed Vandoorne as he entered the pits under the safety car and was then pinged for speeding in pitlane.

At the restart, Nasr used the lapped Sato as a buffer to Palmer, but the Brit was straight on the leader's case. They circulated as one for the following 11 laps, Palmer passing him at Turn 1 on lap 25 only for Nasr to hang on around the outside. Nasr then pitted from the lead, but the time he'd lost battling Palmer meant he rejoined well behind those that had stopped under the safety car – down in 13th as many others had yet to pit.

Palmer stopped a lap later, the 'overcut' putting him out in front of Nasr, but the Brazilian passed him at Turn 2, only for Palmer to fight back. Nasr then passed him again at Turn 6 during a thrilling wheel-to-wheel duel.

Vandoorne now led, but was on a doomed strategy that was compounded by a second safety car on lap 30. This was for a horrendous crash by Sergio Canamasas, whose refusal to yield in a side-by-side race with Nathanael Berthon exiting Turn 1 sent him plunging heavily into the barriers.

Pic inherited the lead, while his closest pursuer, Caterham's Rio Haryanto, was forced out when his left-rear wheel parted company under the safety car. Stefano Coletti, who'd been delayed in a collision with Julian Leal early on, was now second, ahead of Adrian Quaife-Hobbs (who started 22nd

FOR IN-DEPTH RESULTS forix.autosport.com **FORIX**



Pic emulated brother Charles by winning for Campos/Addax squad



Palmer (7) put two tough passing moves on Nasr

but was one of six cars to take the maximum first safety-car benefit), Takuya Izawa and Abt.

There was just time for a single-lap restart before the time curfew, and Pic held on with ease. Palmer, who repassed Nasr with a robust move at Turn 1 just before the safety car, grabbed fifth from Abt at the restart, while Nasr finished seventh ahead of Marciello. "Even at the end, I still had some tyres left on the last lap," said Pic, who ran a mammoth 30 laps on the medium tyre. "I don't know if, without the first safety-car period, the win would have been possible today."

But Coletti and Marciello were both given 20s time penalties, for the Leal collision and safety-car overtake respectively, promoting Quaife-Hobbs to second, Izawa to third and Palmer to fourth. "I had Vandoorne next to me, who all of a sudden slowed down in front of the safety-car line, which caused me to pass him unintentionally," said Marciello.

Sunday's sprint race was much more straightforward. Berthon, who'd been promoted to reversed-grid pole after surviving his Canamasas

clash, made a terrible start, so Vandoorne led from Nasr. Palmer passed Abt (again) at Turn 1 with a great outbraking lunge, then dispatched Berthon with another good move at Turn 2 on lap five.

Nasr was next in his sights, the Brazilian still annoyed with the robust way Palmer had brushed him aside at Turn 1 on Saturday. "He's done the same thing again!" he complained on the radio as Palmer repeated his determined Turn 1 lunge, elbowing Nasr out on to the kerbs at the exit.

"Normal racing," opined Palmer, with Nasr's version: "I expected better driving from him." It led to some further pantomime on the podium after they'd already exchanged heated words on the weighing scales in parc ferme.

Berthon held off Abt for fourth, with Pic and a swift-starting Conor Daly next up. Quaife-Hobbs survived being savaged by Dillmann at Turn 6 but was himself given a post-race penalty, which elevated Marciello into the points. He'd charged up from 19th, while team-mate Coletti was again penalised for a clash, much to his annoyance. ❧



Giermaziak leads
Thiim and Bamber

PORSCHE SUPERCUP HUNGARORING (H),
JULY 27 RD 6/10

Giermaziak adds to title advantage

KUBA GIERMAZIAK EXTENDED HIS CHAMPIONSHIP lead in the Porsche Supercup with a lights-to-flag victory at the Hungaroring on Sunday, his third win of the season.

Giermaziak annexed his second pole position of the year by almost two tenths of a second from title rival Earl Bamber, as track temperatures soared to more than 50C. Hockenheim winner Nicki Thiim, who dislikes this circuit, started third and jumped ahead of a sluggish-starting Bamber to run second at Turn 1 in much cooler conditions on race day.

Thiim got close to Giermaziak as they filed through Turn 2, but the Pole had the Dane covered, and that's as close as he would come to losing the lead. But it took until the 10th lap for Thiim's resolve to break, as he slipped back over a second from Giermaziak's car for the first time.

Third-placed Bamber kept the pressure on Thiim for the majority of the race, but slipped back at the end as his tyres went off. The Kiwi has now slipped nine points behind Giermaziak in the title race.

Alex Riberas finished fourth. Having run with the leaders early on, he fell back into the clutches of Michael Ammermuller. The Spaniard just held on, as Ammermuller kept Konrad Motorsport duo Klaus Bachler and Christopher Zochling behind him.

Fabien Thuner, who drove the car usually piloted by frontrunner Kevin Estre, was a first-corner casualty after qualifying seventh, hitting Silverstone winner Clemens Schmid. Ben Barker profited from this, finishing eighth ahead of Philipp Eng.

● Charles Bradley

RESULTS

1 Kuba Giermaziak (Lechner Racing Team), 14 laps in 26m03.231s; **2** Nicki Thiim (Lechner), +1.758s; **3** Earl Bamber (Fach Tech Auto); **4** Alex Riberas (Attempto Racing); **5** Michael Ammermuller (Lechner); **6** Klaus Bachler (Konrad Motorsport); **7** Christopher Zochling (Konrad); **8** Ben Barker (Lechner); **9** Philipp Eng (Team Project 1); **10** Sean Johnston (Project 1).
Points **1** Giermaziak, 96; **2** Bamber, 87; **3** Ammermuller, 64; **4** Barker, 57; **5** Eng, 50; **6** Christian Engelhart, 50.



First-corner chaos removed
Thuner and Schmid

WILLIAMS

GRAND PRIX RACE DAY HOSPITALITY

CONFERENCE CENTRE

Watch an F1 race live at the home of Williams. The Williams Conference Centre offers a unique way to experience the thrills of a Grand Prix with a live link up to the team at the track. A Race Day at Williams includes the opportunity to browse the Williams Grand Prix Collection as well as test your speed in our simulator.

T 01235 777900
E EVENTS@WILLIAMSFI.COM
W WILLIAMSFI.CONFERENCES.COM
[@WILLIAMSFI.CONFERENCECENTRE](https://FACEBOOK.COM/WILLIAMSFI.CONFERENCECENTRE)
[@WILLIAMSFI](https://TWITTER.COM/WILLIAMSFI)





Status twins Stanaway (left) and Yelloly enjoy champagne moment

ALL PICS: S.BLOXHAM/GP3

GP3 SERIES HUNGARORING (H), JULY 26-27 RD 5/9

Stanaway soaks up all the pressure

RICHIE STANAWAY AND PATRIC NIEDERHAUSER were the winners at the Hungaroring, both leading from start to finish but under contrasting amounts of pressure from behind across the two races.

Stanaway scored his maiden GP3 pole on Saturday morning, and converted that into his second win of the season for Status Grand Prix that afternoon. He beat championship leader Alex Lynn of Carlin to pole by 0.035s, recording his time just before red flags flew – and Lynn himself was relieved to salvage a front-row starting spot after traffic had ruined his qualifying until then. “I could’ve been P24,” he admitted.

Stanaway made a decent start, but nothing like the flyer that Arden’s Robert Visoiu made from P4. Although he locked up at Turn 1,

Visoiu clung to second, while the slow-starting Lynn (too much wheelspin) had to pass Niederhauser around the outside of Turn 2 to regain fourth, with Stanaway’s team-mate Nick Yelloly grabbing third.

Any ideas that Stanaway harboured of romping to victory vanished as Visoiu hounded him throughout. Stanaway’s major moment on the kerbs at Turn 4 on lap eight gave Visoiu added hope, and it was clear that Stanaway’s tyres were in poor shape as the race wore on.

“I was trying to stay in front of Robert by the smallest possible margin in order to try to save the tyres,” he said. “It wasn’t quite enough and I still had some tyre deg.” Making his life even harder was the loss of his right-side mirror, so he couldn’t see if Visoiu was making an attack.

The crunch came at Turn 6 with a couple of laps remaining. Stanaway had slid wide at the preceding corner, allowing Visoiu to get alongside at the chicane. But as Visoiu put the power down, with the lead at his mercy, his car snapped sideways and on to the grass. “That was my mistake; I should probably have waited more,” he rued.

Harshly, Visoiu also lost second to Yelloly, which meant a Status one-two. Lynn took fourth, just ahead of Carlin team-mate Emil Bernstorff, who grabbed fifth from Niederhauser near the end. Brits Jann Mardenborough, Dino Zamparelli and Dean Stoneman were next up, as title contender Jimmy Eriksson trailed home a disappointed 10th.

The Arden squad appears to have perfected its starts this season, so it was no surprise to see Niederhauser shoot past poleman Zamparelli at the start of race two. Zamparelli managed to hold the second Arden car of Mardenborough at bay for second, and attacked Niederhauser at Turn 2.

Although Zamparelli stayed on Niederhauser’s pace for the opening three laps, he fell away thereafter. Mardenborough kept a threatening Lynn behind for third, scoring his second podium finish in a week, with Visoiu in fifth.

Stanaway’s worries that his driving style was too aggressive on this



Visoiu lunged at Stanaway at first corner

compound of tyre proved unfounded as he made two great passes, on Bernstorff at Turn 8 on the opening lap and Stoneman at Turn 2 on the third tour, to finish sixth.

● Charles Bradley



Niederhauser fended off Zamparelli's early attacks to win race two

RESULTS

Race 1 1 Richie Stanaway (Status Grand Prix), 17 laps in 27m36.453s; 2 Nick Yelloly (Status), +2.606s; 3 Robert Visoiu (Arden International); 4 Alex Lynn (Carlin); 5 Emil Bernstorff (Carlin); 6 Patric Niederhauser (Arden); 7 Jann Mardenborough (Arden); 8 Dino Zamparelli (ART Grand Prix); 9 Dean Stoneman (Marussia Manor Racing); 10 Jimmy Eriksson (Koiranen GP).
Race 2 1 Niederhauser, 17 laps in 27m31.893s; 2 Zamparelli, +1.504s; 3 Mardenborough; 4 Lynn; 5 Visoiu; 6 Stanaway; 7 Bernstorff; 8 Stoneman; 9 Marvin Kirchhofer (ART); 10 Patrick Kujala (Manor). **Points** 1 Lynn, 134; 2 Stanaway, 103; 3 Eriksson, 85; 4 Bernstorff, 85; 5 Kirchhofer, 80; 6 Yelloly, 74.

UNITED SPORTSCAR INDIANAPOLIS (USA), JULY 25 RD 8/11

Another Fittipaldi wins at Indianapolis

ACTION EXPRESS RACING SWEPT back to the top of the championship standings with a finely judged victory in the traditional pre-NASCAR weekend Brickyard Grand Prix on the Indianapolis Motor Speedway road course. It was the first win for Coyote Corvette DP pairing Christian Fittipaldi and Joao Barbosa since the season-opening Daytona 24 Hours, catapulting them ahead of brothers Jordan and Ricky Taylor by a slim two-point margin with three races remaining.

LMP2 cars filled the top three positions on the grid but it was a different story on raceday. After starting fourth, Fittipaldi set the tone with an aggressive move in Turn 1, making contact with the rear of previous-round winner Gustavo Yacaman, whose OAK Racing Morgan-Nissan was sent spinning. Scott Sharp, driving the HPD ARX-03b that had been qualified on pole by Ryan Dalziel, maintained his advantage only as far as the end of the back straight, where he succumbed to another bold manoeuvre from Fittipaldi.

The first hour included several lengthy cautions that proved pivotal to strategy when the remainder was run entirely under green. Fittipaldi and Barbosa were alone among the leaders in not requiring a late pitstop for fuel.

Reigning Indy Lights champion Sage Karam made just his fourth sportscar start, joining veteran Scott Pruett in the Ganassi team's Riley-Ford EcoBoost after Memo Rojas was forced out due to an injury sustained two weeks earlier in Canada. The youngster wisely straight-lined the first corner in avoiding Fittipaldi and Michael Valiante (Spirit of Daytona Corvette), then settled into fourth, which became second following the first caution. Pruett remained within sight of Barbosa before requiring a splash of fuel with eight minutes remaining.

Valiante and Richard Westbrook earned their fourth consecutive podium finish ahead of the Taylors,



Action Express boys (5) retook series lead

whose Dallara Corvette sustained a broken diffuser in the early skirmishes. Sharp/Dalziel finished a disappointed fifth following a spin for the Scot while applying pressure to Pruett at two-thirds distance.

The GTLM category, for once, was relatively tame. The resurgent Risi Ferrari of Giancarlo Fisichella/Pierre Kaffer was the class of the field following a slight BoP adjustment, but one small mistake by the Italian polesitter proved to be the difference between first and second. The beneficiaries were Jonathan Bomarito and Kuno Wittmer, who secured a long-overdue maiden victory in their factory-run Dodge SRT Viper. Jan Magnussen/Antonio Garcia (Corvette) maintained their points lead with a sensible drive to fourth.

The PC class was notable for a

spectacular drive by IndyCar regular and sportscar debutant Jack Hawksworth. The Yorkshireman caught RSR team-mate Bruno Junqueira in the closing stages, then stole through into the lead with just three laps remaining to clinch the victory for himself and Canadian Chris Cumming. Junqueira and Duncan Ende had to make do with second ahead of runaway series leaders Jon Bennett/Colin Braun.

Much of the drama once again was attributable to the GTD class, which saw six different makes qualify among the top six positions: BMW, Dodge SRT, Ferrari, Audi, Porsche and Aston Martin. The race was equally competitive. Once the strategies had played out and Paul Dalla Lana's fine early work in the Turner Motorsport BMW Z4 (which had been qualified on the pole by Dane Cameron) was undone by a spin into the gravel, Californian Jeff Westphal and 2013 Grand-Am champion Alessandro Balzan, from Italy, emerged in front with their Scuderia Corsa Ferrari.

● Jeremy Shaw

RESULTS

1 Christian Fittipaldi/Joao Barbosa (Coyote Corvette DP), 108 laps in 2h46m02.720s; 2 Sage Karam/Scott Pruett (Riley-Ford EcoBoost MkXXVI), +48.964s; 3 Michael Valiante/Richard Westbrook (Coyote DP); 4 Jordan Taylor/Ricky Taylor (Dallara Corvette DP); 5 Scott Sharp/Ryan Dalziel (HPD ARX-03b); 6 John Pew/Oswaldo



Viper broke through for first GTLM win

Negri Jr (Riley-Ford). **PC 1 Chris Cumming/Jack Hawksworth**; 2 Duncan Ende/Bruno Junqueira; 3 Jon Bennett/Colin Braun. **GTLM 1 Kuno Wittmer/Jonathan Bomarito (Dodge Viper SRT GTS-R)**; 2 Giancarlo Fisichella/Pierre Kaffer (Ferrari 458 Italia); 3 Michael Christensen/Patrick Long (Porsche 911 RSR); 4 Jan Magnussen/Antonio Garcia (Chevrolet Corvette C7.R); 5 Oliver Gavin/Tommy Milner (Corvette); 6 Bill Auberlen/Andy Priaulx (BMW Z4 GTE). **GTD 1 Jeff Westphal/Alessandro Balzan (Ferrari 458 Italia)**; 2 Bryce Miller/Christopher Haase (Audi R8 LMS); 3 Ben Keating/Jeroen Bleekemolen (Dodge Viper SRT GT3-R). **Points 1 Fittipaldi/Barbosa, 249**; 2 Taylor/Taylor, 247; 3 Valiante/Westbrook, 238; 4 Gustavo Yacaman, 232, 5 Pruett, 225; 6 Ed Brown/Johannes van Overbeek, 209. **PC 1 Bennett/Braun, 200**; 2 Martin Fuentes, 156; 3 Renger van der Zande, 153. **GTLM 1 Magnussen/Garcia, 219**; 2 Wittmer/Bomarito, 206; 3 Priaulx/Auberlen, 197; 4 Dominik Farnbacher/Marc Goossens, 195; 5 Milner/Gavin, 192; 6 Christensen/Long, 188. **GTD 1 Bill Sweedler/Townsend Bell, 193**; 2 Cooper MacNeil/Leh Keen, 184; 3 Miller/Haase, 183.



Hawksworth starred on PC one-off



BTCC RACE GUIDE

After a host of KX successes over the opening part of the season, we look ahead to the year's climax



“ The mid-season break is a great time for reflection, but the seven-week gap between races on the British Touring Car Championship bill is certainly no time to relax.

There are always things to be done. Whether you have had a fantastic start to the season or not, the break gives you a chance to reflect on what you have achieved and look at areas where you think you can improve. Even if you are leading the points, there is always more you can do - be that talking to the team or going

through data - to make yourself even stronger over the second half of the championship campaign.

Our KX Akademy candidates have had an impressive first half of the season. Josh Cook is leading the Renault Clio Cup, and David Pittard is right in the Ginetta GT Supercup hunt in his maiden season with three wins.

Other members of the programme have shown race-winning pace but there is no time for any of them to rest on their laurels. The KX Akademy was designed to unearth

winners and that is what we are interested in. It is about pushing to the maximum in any given circumstances and that is what we want over the remaining half of the season.

I will be giving it everything I have got to land the touring car title in my MG KX Clubcard Fuel Save MG6 and I expect no less from the members of our Akademy. It will be a dramatic showdown, and I hope everyone can take the maximum from it. Enjoy the title battles! ”

JASON PLATO

“Now is the time for all of the KX Akademy candidates to push to their maximum”

-  @KXENERGY
-  @KXAKADEMY
-  KX ENERGY
-  WWW.KXAKADEMY.COM



SAM TORDOFF

BTCC WITH MG KX CLUBCARD FUEL SAVE MG6

Sam Tordoff's victory at Donington Park in April underlined his progress as a battler in the high-profile British Touring Car Championship.

The MG KX Clubcard Fuel Save MG6 racer added to his win from 2013 but, more than that, it also showed that he has taken a step forward in terms of consistency. That was one of his aims at the beginning of the campaign.

Tordoff is one of only four drivers to have scored points in all of the 15 rounds so far this year. "It has been a bit up and down," explains the Yorkshireman. "We have had a win, which has been great, but we have struggled in other places. But

looking ahead I think four of the next five tracks will play to our MG's strengths. I am very confident."

Tordoff is eighth in the standings but says he has his sights on a huge improvement over the second part of the campaign. "I am looking to the top four in the points," he says. "The series is so tight and competitive that it is hard to get a meaningful advantage, but things will play well for us from now on. We are going to Snetterton next, which was the scene of my first BTCC win, and I am hoping I can repeat what I did last season. That would be the perfect launch pad for an attack over the latter part of the year." ●



DAVID PITTARD

GINETTA GT SUPERCUP WITH SV RACING WITH KX

There was a broad grin on David Pittard's face as he signed off the opening half of his maiden Ginetta GT Supercup Championship at Croft in June.

He had just won his third race of the season to cut the points gap to the leader to a mere 29 points with 12 races still to go. It has been a remarkable debut season.

"It has been more than I could have dreamed," says 22-year-old Pittard. "I knew it would be tough over the opening part of the season as we were a new team and we had to learn the car. We always knew that the second half of the

season would be our strongest so we aimed to just collect as many points as we could to start with and then move forward from there, but it has gone so well."

The highlight of the year so far was Thruxton, where the Letchworth ace took two wins and a second place in the three rounds. "That was sensational," he recalls. "It was my first visit to the circuit and I was within a whisker of doing the triple. It really gave me the confidence to know I belonged in that company and that's where I aim to stay."

"We will be strong everywhere from here on in, so I have to target the championship. That will be my aim and I will be pushing as hard as I can." ●



ALEX MORGAN

RENAULT CLIO CUP WITH SV RACING WITH KX

Alex Morgan has a clear goal for the remaining rounds of this year's Renault Clio Cup season - he wants to make an impact.

The Welshman is fifth in the standings after a flying start to the season with two victories at Brands Hatch in April followed by a podium finish at Donington Park. Since then, however, things have been difficult. A mystery straight-line speed problem, allied to electrical issues earlier on in the campaign, have left him struggling.

"I have certainly learned how to defend well," says the 27-year-old. "It has been a tough middle part of the year after starting

so well. We have had our engine sent back to Renault and it has investigated to see if there is a problem. We should be back at the front at Snetterton."

Morgan took a third place finish on a recent foray into the Eurocup Renault Clio in Germany, and he says that has given him a confidence boost ahead of the final eight races of the UK contest.

"I know I have the speed, because I proved it at the Nürburgring," he explains. "I hope I can carry that momentum into the UK series and I am desperate to get back to the front. From now on, I will be going for wins and really trying to make an impact. It is important that I make the right impression." ●



JOSH COOK

RENAULT CLIO CUP WITH SV RACING

Josh Cook's aim at the start of the season was to win the Renault Clio Cup. At the half way stage of the campaign, he is in the best possible place to do that by sitting pretty at the head of the points table.

He has had three wins so far and a run of seven podiums in eight races pushed him well ahead of the rest. However, an unfortunate clash at the last round at Croft meant that he was put on the back foot with a non-finish.

"That was a setback," admits 23-year-old Cook, "but we still have a cushion at the top of the table when you take dropped scores in to account. It shows that you just can't let up in this series because there are so many good drivers out there who will punish you."

Cook's wins have included a double victory at Donington Park

- and he says the victories have been down to the hard work of the team.

"The cars are new to everyone this year, but SV Racing with KX has worked tirelessly to get the most from them," says the Bristol man. "We are still learning every time we go out as well. There is more to come, but I will need that edge if I want to maintain my challenge to seal the Renault Clio Cup." ●



ANT WHORTON-EALES

RENAULT CLIO CUP WITH SV RACING

Although he has yet to taste victory in this campaign, Ant Whorton-Eales is confident that a second-half charge can thrust him right in to contention for the Renault Clio Cup this season.

The SV Racing with KX driver has had three podiums to keep his points tally ticking over and says he is relishing the run in.

"It has been a bit up and down for me so far, but I have tried hard to keep the points coming in," he explains. "I was really strong in the second half of the season last year and I hope I can carry that over to this year."

"We are getting there with the new car and there are still things we can discover and I think some of the tracks will play to my strengths as well. I have a few low scores to drop at the end of the year. When you take that in to account, my position isn't so bad."

Whorton-Eales says that his plan for the rest of the season is to consistently land big points scores.

"I just need to be careful, but also take the chances when they crop up in the races. I need to make sure I am as far inside the top six as I can be at every meeting," says the 20-year-old. "I am always looking to improve. If I can do that, then the results will follow." ●



ASH HAND

RENAULT CLIO CUP WITH SV RACING

From a tough start to the season for Ash Hand, the Nuneaton racer has been one of the strongest improvers across the course of the opening ten races of the year - and he is tantalisingly close to taking his breakthrough win in the Renault Clio Cup.

The 20-year-old has suffered from car problems in a couple of the rounds which have blunted

his charge, but his showing last time out at Croft has filled him with optimism for the remaining events.

He was second and third in North Yorkshire at the end of June, and he says that is a sign of the way he has improved as a driver: "I feel I am becoming much stronger and that is due to more seat time and more experience."

"At Croft, I had to come from the back of the field to take a

podium and that showed that the car is good and my driving is improving too. I really want to keep that form going."

He has targeted that maiden win at Snetterton this weekend, a circuit he knows well. "It is one of my favourite tracks," says Hand. "I went well there last season in my first year in Clios and with the pace we have shown this year, I hope we can put it all together. I will be trying my hardest." ●



WIN THIS CAR*



The NEW 3 door 1.0 Volkswagen up! ...YOURS FOR A YEAR.



Simply tell us in no more than 200 words why you'd love to WIN the new Volkswagen up!



Jason Plato and the KX Academy drivers will be racing at five more venues across the course of the season as the championships draw to their close. Here's our guide to the season's tracks that you can keep safe so you know where you can check out the action.

ROUNDS 16, 17 AND 18
SNETTERTON 2-3 AUGUST

The challenging 300 layout is narrow but a test for the handling of the cars with some long, fast corners
 BEST VIEWING POINT ■ **Agostini's** spectator bank offers great vantage point
 POTENTIAL FLASHPOINT ● **Montreal** hairpin on lap one is a crunch-fest

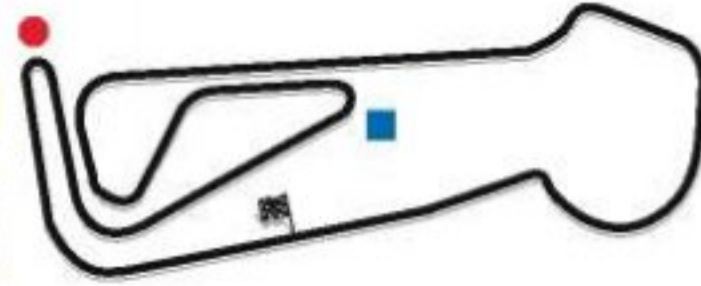

ROUNDS 19, 20 AND 21
KNOCKHILL 23-24 AUGUST

Scotland's only round is held on this breathtaking rollercoaster of a track with blind crests and huge dips
 BEST VIEWING POINT ■ Go to the **John R Wier** chicane to see the cars fly
 POTENTIAL FLASHPOINT ● **The hairpin** is where the door-bashing happens

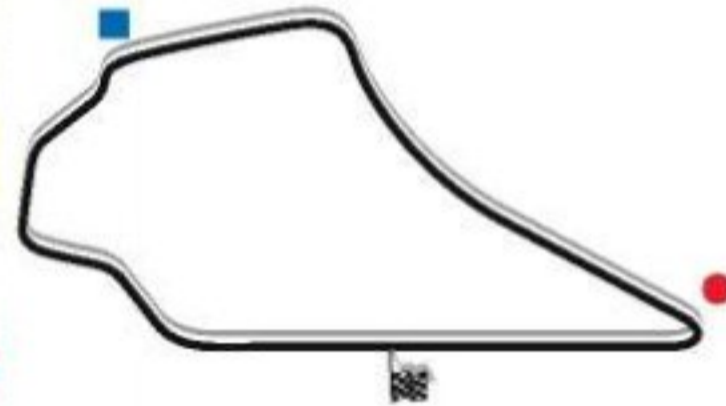

ROUNDS 22, 23 AND 24
ROCKINGHAM 6-7 SEPTEMBER

The oval-plus-infield combination always delivers great action and the entire track is visible from the grandstand
 BEST VIEWING POINT ■ **Main grandstand** is where you can see the whole track
 POTENTIAL FLASHPOINT ● **Deene Hairpin**, where the cars slow from the oval



ROUNDS 25, 26 AND 27
SILVERSTONE 27-28 SEPTEMBER

The National configuration of Britain's GP track is short and it keeps the cars tightly grouped
 BEST VIEWING POINT ● **Luffield** for a close-up view of the overtaking
 POTENTIAL FLASHPOINT ■ **Luffield** again - it is a real hot spot

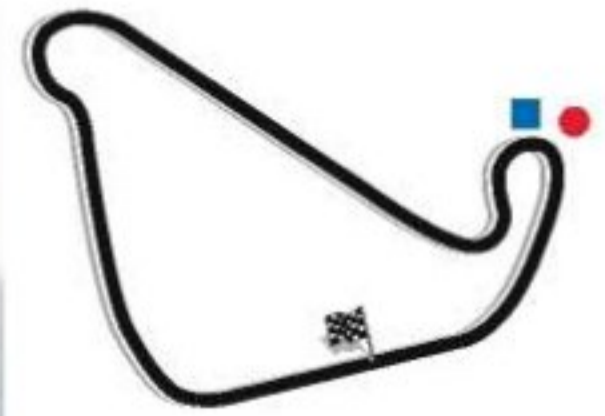

ROUNDS 28, 29 AND 30
BRANDS HATCH GP 11-12 OCTOBER

The final round of the championship takes place on one of the country's most majestic backdrops, the GP track
 BEST VIEWING POINT ■ **Venture** around the GP loop for real speed
 POTENTIAL FLASHPOINT ● **Surtees** nearly decided last year's title

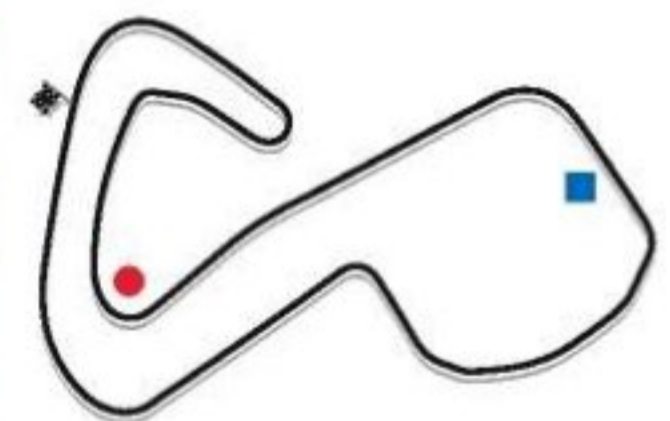

KX QUESTION TIME
 presented by
AUTOSPORT **MOTORSPORT NEWS**

Come and join in the fun!

The hugely popular KX Question Time, where you get to ask the questions and win prizes, is back. Come and meet the stars of the BTCC, including racers Jason Plato and Sam Tordoff, along with ITV commentator David Addison among other guests.

For details of the remaining KX Question Times, keep checking the KX facebook page

Where: Tyrrells Restaurant and Bar, just outside the Snetterton paddock
 When: From 1830hrs, Saturday, August 2. Entry: Free (circuit admission required)



NASCAR SPRINT CUP INDIANAPOLIS (USA), JULY 27 RD 20/36

Gordon makes it five at the Brickyard



Hendrick crew salutes
Gordon's celebration

JEFF GORDON CELEBRATED THE 20th anniversary of his victory in NASCAR's inaugural Brickyard 400 by winning the event for a record fifth time. In the process he cemented his position atop the Sprint Cup's largely irrelevant points table, dealt a big blow to Hendrick team-mate Kasey Kahne's chances of making the Chase, and conquered what has recently been his Achilles' Heel: the late-race restart.

Gordon and Kahne soon emerged as the class of the field, despite Indianapolis's hard-to-pass nature resulting in myriad strategy variations that kept reorganising the order until everyone merged back onto the same tactic during the final yellows. Kahne – for whom victory was much-needed amid a generally miserable season so far – led Gordon early in the last stint but had made

the earliest final pitstop of the frontrunners and was marginal on fuel. This was a fact that Gordon – who had no such concerns – was determined to exploit as he relentlessly pressured his team-mate.

A late caution for Ryan Truex's slowing car shouldn't have worked in Gordon's favour given what he described as his "terrible" record on restarts of late, but this time he nailed it perfectly as Kahne floundered on the inside line. While Gordon surged away to his second win of 2014, Kahne trickled home sixth on an empty tank, a result that did at least inch him closer to a provisional Chase spot via his points score.

Joe Gibbs trio Kyle Busch, Denny Hamlin (from 27th on the grid) and Matt Kenseth filled second to fourth places, with Joey Logano and top

rookie Kyle Larson sandwiching Kahne. Kevin Harvick dominated qualifying but battled underwhelming handling all race and finished eighth.

● Connell Sanders Jr

RESULTS

1 Jeff Gordon (Chevrolet SS), 160 laps in 2h39m41s; 2 Kyle Busch (Toyota Camry), +2.325s; 3 Denny Hamlin (Toyota); 4 Matt Kenseth (Toyota); 5 Joey Logano (Ford Fusion); 6 Kasey Kahne (Chevy); 7 Kyle Larson (Chevy); 8 Kevin Harvick (Chevy); 9 Dale Earnhardt Jr (Chevy); 10 Austin Dillon (Chevy). **Chase grid**
1 Brad Keselowski, 3 wins/666 points; 2 Jimmie Johnson, 3/628; 3 Gordon, 2/717; 4 Earnhardt, 2/693; 5 Carl Edwards, 2/603; 6 Logano, 2/591; 7 Harvick, 2/565; 8 Kyle Busch, 1/609; 9 Hamlin, 1/572; 10 Aric Almirola, 1/496; 11 Kurt Busch, 1/456; 12 Kenseth, 0/661; 13 Ryan Newman, 0/606; 14 Clint Bowyer, 0/577; 15 Larson, 0/562; 16 Dillon, 0/559.

FORMULA RENAULT NEC SPA (B), JULY 25-26 RD 4/7

Jorg mullers them at Spa before penalty

KEVIN JORG WON BOTH RACES AT SPA on the road, but he lost the second with a post-race penalty.

The Swiss had crept forward before lights out – he was stationary when the race started, but the damage was already done. And his post-race time penalty was draconian, as the field was bunched under the second safety car of a race that never really got going.

The first was a good one though. As lightning flashed around the circuit, Jorg utterly dominated. Ben Barnicoat looked solid for second until the final lap, before a problem with locking rear brakes culminated in the engine cutting briefly at Stavelot, and suddenly Louis Deletraz and Steijn Schothorst were in the tow.

Solid defending from Barnicoat saw off Deletraz, who in turn had Schothorst sweeping round his outside at the Bus Stop. A dramatic finish, but the order stayed the same.

Schothorst inherited victory in race

two, the final safety car caused when Raoul Owens speared into the Les Combes barriers while trying to pass Seb Morris. What was shaping up into an epic fight for third on the road between Deletraz, Gustav Malja, Ukyo Sasahara and Barnicoat never took shape in just four laps of racing.

● Marcus Simmons

RESULTS

Race 1 **1 Kevin Jorg**, 11 laps in 25m57.511s; 2 Ben Barnicoat, +9.607s; 3 Louis Deletraz; 4 Steijn Schothorst; 5 Ryan Tvetter; 6 Gustav Malja. **Race 2**
1 Schothorst, 8 laps in 25m17.411s; 2 Deletraz, +0.388s; 3 Malja; 4 Ukyo Sasahara; 5 Barnicoat; 6 Matthew Graham. **Points** **1 Schothorst, 169;** 2 Barnicoat, 156; 3 Deletraz, 151; 4 Sasahara, 112; 5 Malja, 111; 6 Levin Amweg, 107.



Jorg became first two-time NEC winner of '14



NASCAR TRUCKS

Darrell Wallace Jr (above) won on the dirt oval at Eldora after withstanding great pressure from Kyle Larson, which ended when a broken brake line smacked Larson into the wall with two laps to go. Ron Hornaday Jr took second ahead of Ryan Blaney, who takes the series lead from reigning champion Matt Crafton.

IMSA SPORTSCAR

Stevenson Racing maintained its streak of success as Andrew Davis and Scotsman Robin Liddell guided their Chevy Camaro Z/28.R to its third win of the season at Indianapolis Motor Speedway, and the third in a row for the team. Teenager Trent Hindman (Fall Line BMW) extended his championship lead by finishing second with John Edwards.

BRAZILIAN FORMULA 3

Pedro Piquet won both Curitiba races from pole position to the flag. In the first he was followed home by up-and-coming team mate Vitor Baptista, who had to fight string opposition from Matheus Leist to win Class B for older cars. The second race had the same top three.

BRAZILIAN TOURING

Allam Khodair led all the way from pole in race one at Curitiba, but the RZ Motorsport driver had to fight hard to keep his Toyota Corolla ahead of the Bassani Racing Corolla of Denis Navarro. Thiago Camilo was a close third from series leader Ricardo Mauricio, both in Hondas. From sixth on the reversed grid, Camilo's efforts paid off with half a lap to go in race two when he snatched the lead from Gabriel Casagrande's Chevrolet Cruze, with Vicente Orige third.

LAMBO SUPER TROFEO

After early leader Alberto di Folco hit brake problems, Edoardo Piscopo (in the car started by Milos Pavlovic) fended off a relentless attack from Jeroen Mul in a gripping opening race at Spa. The second race provided another win for the Italo-Serbian duo, with Mul second again. Simone di Luca was a distant third in both.

NASCAR NATIONWIDE

Ty Dillon took his maiden Nationwide win at Indianapolis, in a Chevy run by his granddad, Richard Childress, and with his dad as spotter. He led home Kyle Busch and Matt Kenseth.

GLOBAL RALLYCROSS

Ken Block took his Ford Fiesta to Victory Lane at Charlotte. Joni Wiman was running second but got passed by Sverre Isachsen, while clever use of the joker lap promoted Nelson Piquet Jr to third.



MAINTAIN



PH NEUTRAL WHEEL CLEANING WITH A DIFFERENCE.

Cleaning chromed or polished wheels has always been difficult. Standard pH neutral products are unable to shift seated brake dust and acids and alkaline cleaners can damage your finish and make your new wheels look worn and tired. In comes Dragon's Breath; pH neutral wheel cleaning with a difference. Dragon's Breath causes a chemical reaction with baked on brake dust, infiltrating the contamination and changing its colour and state. Now water soluble, brake dust will rinse off freely from paint and metal finishes safely and effectively.



Phone 01323 287980 or go online for your local stockist



www.valetpro.co.uk

Valet PRO
PROFESSIONAL VALETING SUPPLIES

SUBSCRIBE TO AUTOSPORT FOR ONLY £6 EVERY 6 ISSUES

PLUS FREE DIGITAL EDITION SUBSCRIPTION
& UNLIMITED ACCESS TO AUTOSPORT.COM



SUBSCRIBER BENEFITS...

- ✓ **JUST £6** for your first 6 issues, thereafter pay only £34.99 every 13 issues
- ✓ **NEVER** miss an issue
- ✓ **FREE** delivery direct to your door
- ✓ **UNLIMITED** access to news and views from the paddock
- ✓ **ACCESS TO** subscriber-only offers and discounts

**CALL 08448 488 817 AND QUOTE ASP014 OR VISIT
www.themagazineshop.com/aspo-asp014**

Terms & Conditions: This offer is open to UK residents only. If you require any assistance following the purchase of your subscription, then you can speak to a member of our customer service team on 01795 592 974, calls are charged at local rate. Overseas rates are available on +44 (0) 1795 592 972. Please allow 35 days for delivery of your first issue. To activate your Autosport online account visit <https://secure.autosport.com/subs/activate.php> and enter your activation code (your personal magazine subscriber number which will be included in your welcome email/letter) along with your email address to access your extra Autosport content. Price is £6 for your first 6 issues then continuous Direct Debit payments of £34.99 every 13 issues unless you cancel. Direct Debit rates are fixed for 12 months after which they may be subject to change - should prices change you will be informed in writing. Details of the Direct Debit guarantee are available on request. Should you wish to cancel the subscription thereafter it will be cancelled on expiry of your current term. Savings are based on the standard UK cover price of £3.60. Offer ends 31st December 2014.



WELCOME TO THE **TW STEEL** DMAX CHAMPIONSHIPS



NEW
Weight Classes
for 2014

Lights Min 70Kgs
Inters Min 85Kgs
Heavies Min 100Kgs

Prices are £190* per Endurance Round £165* per Heats Round
£295* to enter both

Cumulative Loyalty Discount of 2.5% for each round entered.
A full season of Heats Racing for £1476* or Enduro Racing for
£1699*

20 April 2014	Whilton Mill
18 May 2014	Rye House
15 June 2014	Daytona Milton Keynes
20 July 2014	PF International
17 August 2014	Clay Pigeon
21 September 2014	Whilton Mill
19 October 2014	Daytona Milton Keynes
16 November 2014	Daytona Sandown Park

*all prices include VAT

Tel: 0845 644 5504
www.daytonamax.co.uk

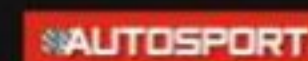



Jones leads Gelael and Bryant-Meisner

ALL PICS: EBREY/LAT

BRITISH FORMULA 3 SPA (B), JULY 25-26 RD 4/7

Jones takes a hat-trick as Merhi stars

ED JONES MAY HAVE WON ALL THREE British Formula 3 Championship races at Spa, but the star of the series' Spa 24 Hours-supporting weekend was Roberto Merhi.

Emirati Jones headed home Sean Gelael in two of the races, and was given a very hard time by the Indonesian in the finale, in which Gelael led the way for five laps before Jones slipstreamed past up the Kemmel straight – with two wheels on the grass. This was a proper race, and Gelael stayed close in Jones's mirrors all the way to the flag.

Both Jones and Gelael brought their F3 European Championship Carlin Dallara F312s. In other words, the chassis was the same as that used by Merhi and his Double R Racing team-mates, as well as the Fortec Motorsport boys, but Jones and Gelael were powered by the new-spec Volkswagen engines.

These are considerably more powerful than the old-spec units. And, while FIA rules dictate that they must be eligible for points, the team elected not to register

them, thereby defusing any upset.

But what few predicted was that the new cars would struggle on the Cooper tyres, exacerbating their weight handicap, which slowed them in the middle sector. Gelael couldn't get within 3.5 seconds of his time on Hankooks from last month's European round, while there was no comparison for Jones – he was returning from two months off recovering from broken vertebrae. For him, the relatively easy Spa (long straights, smooth surface) would provide a gentle rehabilitation before he ventures into the hard-braking spine-jolter of the Red Bull Ring next weekend.

Merhi, who was only doing this weekend to qualify himself for a planned Macau Grand Prix attack, had never driven the F312-generation Dallara until Thursday's free practice. And then he missed most of the first session with a problem that prevented his Mercedes engine running cleanly. By the following lunchtime, he had set the fastest-ever race lap of Spa in a current-generation car with an old-spec engine on Coopers (ie eclipsing the cream of 2012). Then, later on Friday, he took the fight magnificently to Jones. The spectacular Merhi held on at the front of the reversed-grid race until the final lap, when Jones – who had been biding his time and saving his tyres – made his move into Les Combes.

For his part, Merhi had an



Merhi was superb on F3 return

engine-cutout glitch on the final couple of laps, suspecting a fuel-pump problem. Before that, he had set the fastest middle sector time (from Les Combes to Stavelot) of everyone – by more than one second... Owing to possible concerns about the engine in the wake of this race, he was withdrawn from Saturday's finale, his Macau qualification task already completed.

John Bryant-Meisner therefore claimed maximum points in the finale, the Swede giving Performance Racing a strong return to British F3. It was a solitary drive, doing what he had to do – more impressive was the first race, in which he stayed pretty close to Merhi.

In the first two races it was the Motopark cars of German F3 Cup racers Indy Dontje and Nabil Jeffri that filled the top six, but they were excluded from the second for non-conforming fuel – which the team held its hands up to.

Fortec duo Matt Rao and Martin Cao stepped forward in the finale. They showed much-improved form – and, for a change, had a clean run – to have a great fight for fourth, won by Brit Rao on a weekend where he took the series lead. Sam MacLeod bounced back from a shunt in race one to win a big battle with Dontje and Jeffri for sixth.

● Marcus Simmons

RESULTS

Race 1 1 Ed Jones (Dallara-Volkswagen F312), 12 laps in 30m27.854s; 2 Sean Gelael (D-V F312), +2.473s; 3 Roberto Merhi (D-Mercedes F312); 4 John Bryant-Meisner (D-V F310); 5 Indy Dontje (D-V F308); 6 Nabil Jeffri (D-V F311).

Race 2 1 Jones, 13 laps in 29m52.656s; 2 Merhi, +0.862s; 3 Gelael; 4 Bryant-Meisner; 5 Sam MacLeod (D-V F308); 6 Matt Rao (D-M F312).

Race 3 1 Jones, 14 laps in 31m53.571s; 2 Gelael, +1.092s; 3 Bryant-Meisner; 4 Rao; 5 Martin Cao (D-M F312); 6 MacLeod. **Points** 1 Rao, 129; 2 Cao, 125; 3 MacLeod, 121; 4 Andy Chang, 103; 5 Camren Kaminsky, 78; 6 Marvin Kirchhofer, 54.



Bryant-Meisner took maximum points in race three

Spa 24 Hours Spa (B)

Blancpain Endurance Series
Round 4/5

July 26-27

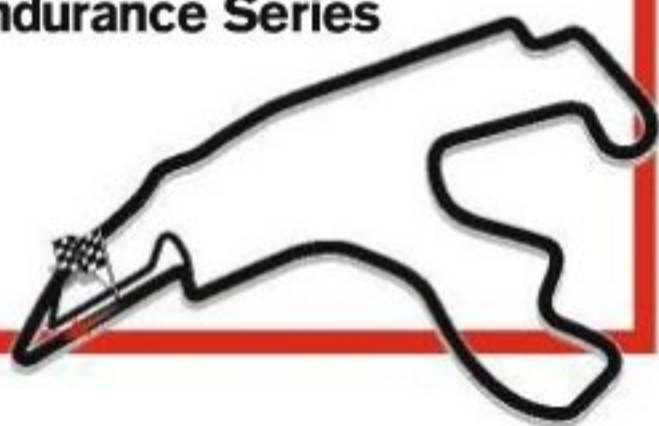

RESULTS

527 LAPS, 2293.54 MILES

1	L Vanthoor (B)/M Winkelhock (D)/R Rast (D) Pro WRT Audi R8 LMS ultra (Q1-2m18.710s)	24h00m42.485s
2	L Luhr (D)/D Werner (D)/M Palttala (FIN) Pro Marc VDS Racing BMW Z4 GT3 (Q14-2m19.717s)	+7.077s
3	C Mies (D)/F Stippler (D)/J Nash (GB) Pro WRT Audi R8 LMS ultra (Q5-2m19.032s)	-1 lap
4	E Sandstrom (S)/S Ortelli (MC)/G Guilvert (F) Pro Sainteloc Racing Audi R8 LMS ultra (Q4-2m18.989s)	-2 laps
5	M Gotz (D)/M Buhk (D)/J Jaafar (MAL) Pro HTP Motorsport Mercedes SLS AMG GT3 (Q20-2m20.442s)	-4 laps
6	M Cioci (I)/N Hommerson (B)/L Machiels (B)/A Bertolini (I) Pro-Am AF Corse Ferrari 458 Italia GT3 (Q23-2m20.746s)	-7 laps
7	A Sims (GB)/A Smith (GB)/A McCaig (GB)/O Bryant (GB) Pro-Am Ecurie Ecosse (Barwell) BMW Z4 GT3 (Q15-2m19.747s)	-7 laps
8	A Piccini (I)/S Wyatt (AUS)/M Rugolo (I)/C Lowndes (AUS) Pro-Am AF Corse Ferrari 458 Italia GT3 (Q16-2m19.753s)	-8 laps
9	N Verdonck (B)/B Schneider (D)/H Primat (CH) Pro HTP Motorsport Mercedes SLS AMG GT3 (Q7-2m19.166s)	-9 laps
10	D Turner (GB)/R Abra (GB)/J Osborne (GB)/M Poole (GB) Pro-Am MP Motorsport AMR Aston Martin Vantage GT3 (Q22-2m20.721s)	-10 laps
11	Y Buurman (NL)/A Christodoulou (GB)/M Parisy (F) Pro Black Falcon Mercedes SLS AMG GT3 (Q21-2m20.492s)	-10 laps
12	M Fassler (CH)/A Lotterer (D)/B Treluyer (F) Pro WRT Audi R8 LMS ultra (Q12-2m19.569s)	-11 laps
13	G Smith (GB)/A Meyrick (GB)/S Kane (GB) Pro M-Sport Bentley Continental GT3 (Q6-2m19.093s)	-11 laps
14	M Basseng (D)/F Hamprecht (D)/F Salaquarda (CZ) Pro ISR Audi R8 LMS ultra (Q29-2m20.882s)	-13 laps
15	A Montemini (I)/F Castellacci (I)/S Gai (I)/A Rizzoli (I) Pro-Am Scuderia Villorba Corse Ferrari 458 Italia GT3 (Q24-2m20.753s)	-13 laps
16	O Pla (F)/E Clement (F)/B Lariche (F)/N Armindo (F) Pro-Am TDS Racing BMW Z4 GT3 (Q45-2m22.111s)	-14 laps
17	A Leclerc (F)/J d'Ambrosio (B)/D Tappy (GB) Pro M-Sport Bentley Continental GT3 (Q39-2m21.331s)	-15 laps
18	F Perera (F)/L Lasserre (F)/E Dermont (F)/M Bonanomi (I) Pro-Am Pro GT by Almeras Porsche 911 GT3-R (Q27-2m20.822s)	-17 laps
19	J-P Belloc (F)/C Bourret (F)/P Gibon (F)/J Canal (F) Pro-Am SOFREV ASP Ferrari 458 Italia GT3 (Q47-2m22.319s)	-18 laps
20	F Bouvy (B)/J-L Blanchemain (F)/C Kelders (B)/V Radermecker (B) Pro-Am WRT Audi R8 LMS ultra (Q33-2m21.084s)	-21 laps
21	M Griffin (I/R/L)/D Cameron (GB)/A Mortimer (GB) Pro-Am AF Corse Ferrari 458 Italia GT3 (Q25-2m20.780s)	-23 laps
22	L Bady (F)/F Barthez (F)/E Debard (F)/T Vautier (F) Pro-Am SOFREV ASP Ferrari 458 Italia GT3 (Q28-2m20.826s)	-24 laps
23	D Andersen (DK)/M Jensen (DK)/J Yeomans (USA) Pro-Am Insight Racing Ferrari 458 Italia GT3 (Q42-2m21.591s)	-25 laps
24	F Guedes (P)/P Mann (USA)/A Talkanitsa (BY)/C Mezard (F) GTR AF Corse Ferrari 458 Italia GT3 (Q51-2m23.213s)	-25 laps
25	W Reip (B)/F Strauss (D)/A Buncombe (GB)/N McMillen (USA) Pro-Am RJN Motorsport Nissan GT-R Nismo GT3 (Q13-2m19.613s)	-26 laps

Winners' average speed: 95.52mph. Fastest lap: Schneider, 2m20.452s, 111.55mph. There were 61 starters. In each car, first-named driver started; driver in italics set qualifying time.

CHAMPIONSHIP: PRO

1 VANTHOOR	74	6 MIES/NASH/STIPLER	46
2 S'STROM/ORTELLI/G'VERT	67	7 WINKELHOCK/RAST	43
3 MEYRICK/SMITH/KANE	59	8 BUHK	40
4 PARENTE/DEMOUSTIER	49	9 KORJUS/ESTRE/SOUCEK	33
5 VERDONCK/PRIMAT	48	10 LUHR/WERNER/PALTTALA	32

CHAMPIONSHIP: PRO-AM

1 RIZZOLI/GAI/CASTELLACCI	77	4 COMANDINI/AMOS	41
2 SMITH/McCAIG/BRYANT	65	5 HASSID/CATSBURG	39
3 ABRA/POOLE/OSBORNE	45	= SIMS	39

POINTS SYSTEM EXPLAINED
25-18-15-12-10-8-6-4-2-1 to top 10 finishers in each class.



FOR IN-DEPTH RESULTS
forix.autosport.com



Audi denies BMW in fight to the finish

German manufacturers' two crack Belgian teams bring the best together for a battle that ebbs and flows. By **GARY WATKINS**



AUDI WAS ALWAYS GOING TO WIN THE RACE TO the flag in the final hour to notch up its third Spa 24 Hours victory in four years. Rene Rast had little problem coming back from 20 seconds down in the WRT R8 LMS ultra he shared with Markus Winkelhock and Laurens Vanthoor after the Marc VDS BMW team gambled on sending Dirk Werner on his way without fresh tyres at the final pitstops. But the reality was that the Bimmer had looked on course for victory late on Sunday morning.

The winning Audi and the BMW Z4, which Werner shared with Lucas Luhr and Markus Palttala, swapped the lead back and forth through the night after getting out of synch on pitstops during a chaotic period of four quickfire safety cars that straddled the second and third hours of

this double-points round of the Blancpain Endurance Series. The problem for WRT and its number-one crew was that the BMW was going further on a tank of fuel.

Werner and co were getting close to the maximum 65 minutes allowed, while the Audi could barely manage an hour between stops. Shortly after the 19-hour mark, the BMW reached the point where it was going to save a pitstop and, for many, win the race.

Those included WRT team boss Vincent Vosse, who had brought together who he and most others regard as the best three Audi R8 drivers in the world for this race and this race only.

"After six hours, I was confident, but early in the morning things appeared to be switching around," explained Vosse. "I wasn't sure at all



This was the 24 Hours' 90th anniversary



It was close between WRT
Audi and Marc VDS BMW

that we were going to do it.”

The problem for the winning Audi was a refuelling issue that would cost it time in the pits if WRT tried to put a full load in the car. That resulted in the decision to short-fuel, meaning the R8 was going up to four laps fewer than its rival.

Yet as soon as the BMW's better fuel mileage appeared to have put Werner, Luhr and Palttala in the pound seats, Rast began making significant inroads into its deficit. Palttala was struggling after taking over from Werner.

“When Dirk came in to hand over to me, he had no pitlane speed limiter,” explained the Belgian-based Finn. “It was an electronic problem, which meant the ABS and the traction control switched themselves off. We lost the limiter and the dash, so overall we lost quite a lot of time.”

Rast overtook Luhr on the track late in the 21st hour, which appeared to give the Audi victory. But this race – the 90th-anniversary edition of the Belgian enduro – fittingly had another couple of twists and turns to go.

The Audi, which had already stopped twice for front brakes compared with the BMW's once, was pushed into its garage for new pads and discs in the penultimate hour. That put the BMW back ahead with Werner at the wheel, but such was Rast's advantage over the BMW that an eight-second deficit disappeared in six laps.

The fuel cycles of the Audi and the BMW had now converged and, when they stopped for the final time with 40 minutes to go, Marc VDS opted to roll the dice and not give Werner new Pirellis. That gave him the 20-second advantage, but Rast wasn't concerned.



Mies, Stippler and
Nash joined team-
mates on podium

“I was pretty confident that I could catch him, because I know how the tyres feel after one stint – we didn't double-stint at all today,” said the German. “When the team said I was 20s behind, I said, ‘OK, he won't make it home ahead of me.’”

Rast was true to his word, closing down Werner once again with relative ease and taking the lead with six laps to go.

Rast, who drove more than his fair share in the closing stages because Vanthoor was feeling unwell, admitted that he was “very tired and very emotional” at the finish. And quite rightly so. He and Winkelhock became the fourth and fifth drivers to win the 24-hour enduros at Spa and the Nurburgring in the same year.

The Marc VDS boys weren't as disappointed as you might think at the finish. The team was never convinced it was going to beat the Audi and Palttala insisted that “if you'd said a week ago that we'd finish second, we would have signed for it.”

The team's eggs had all been in one basket from early in the race. Jorg Muller, who shared the ▶

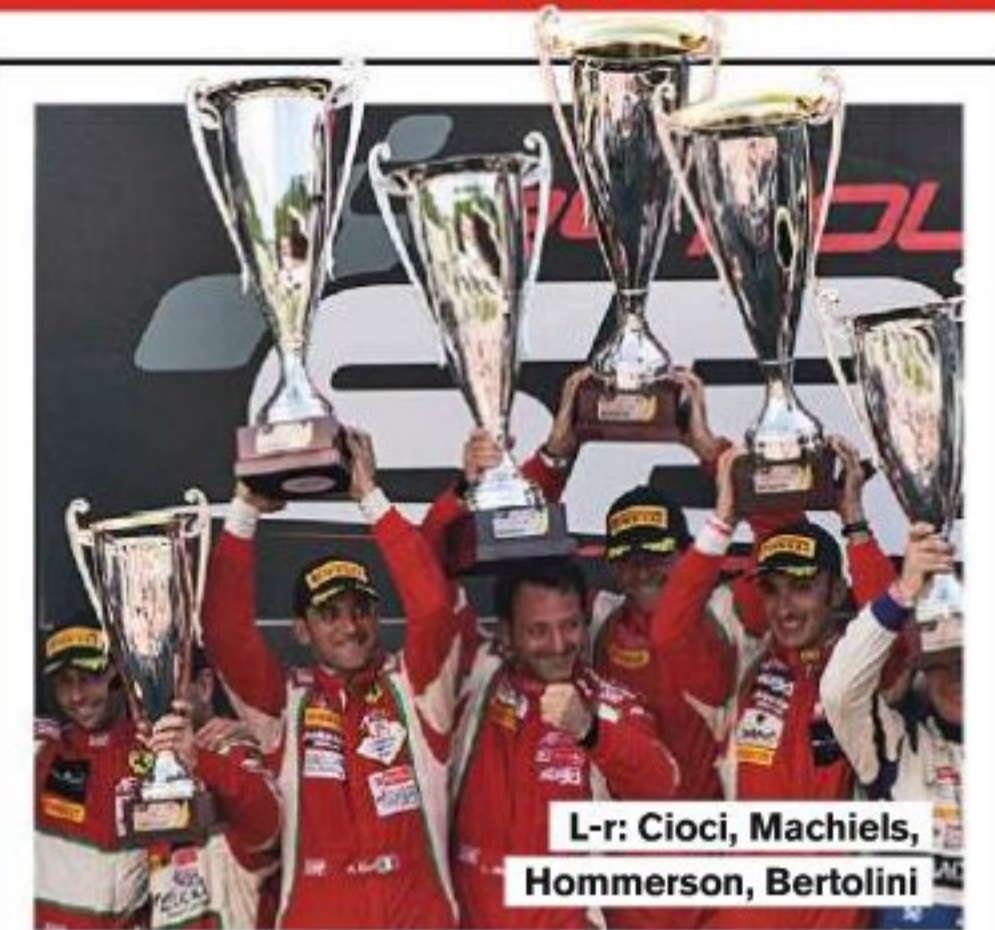

L-r: Cioci, Machiels,
Hommerson, Bertolini

PRO-AM

Italians inspire Ferrari fightback

THE WINNING PRO-AM CUP LINE-UP FROM AF Corse wasn't thinking about class victory 20 minutes into the Spa 24 Hours. Marco Cioci had been feeling something awry with his Ferrari 458 Italia when a tyre let go in Eau Rouge. A day later, the Italian, factory driver Andrea Bertolini and amateurs Niek Hommerson and Louis Machiels were celebrating an unlikely victory.

The puncture and the slow lap back to the pits put Cioci a lap and a half down, but after that the foursome – and he and Bertolini in particular – “drove like a sprint race” for the remainder of the race. The Ferrari also didn't need to change brakes, which proved crucial in the final stages.

The Barwell-run Ecurie Ecosse BMW Z4 had been at the sharp end of the class battle throughout in the hands of factory driver Alexander Sims, Oliver Bryant, Andrew Smith and Alasdair McCaig. The Ferrari moved ahead when the Bimmer stopped for brakes, but the German car wasn't quite the force afterwards.

The BMW's front brakes started binding after its change of pads and discs. That forced the team to wind the bias to the back, which left Sims short of rear braking as he strove to close down the winning Ferrari over the course of a triple stint leading up to the chequered flag.

The Briton had looked odds-on for the victory, especially as Hommerson and Machiels decided that they rather than Cioci would complete the final two hours. Barwell, however, decided to play it safe in the closing stages.

“Second is a really huge result for a small team like us,” said team boss Mark Lemmer. “We had the strategy to lead at six hours, which we did, and we were second at 12 hours. We wanted the points today and now we're second in the championship.”



Scottish BMW from
Surrey came close



Race was suspended due to serious crash

team's other car with DTM stars Maxime Martin and Augusto Farfus, tagged a Ferrari at La Source during the mad 90 minutes, the car losing seven laps to front-end repairs.

The front took another knock in a collision with what the team described as a rabbit, but was probably a hare. Whatever it was, the long-eared lagomorph caused sufficient damage to put the car out of the race in the ninth hour.

Audi returned to competitiveness at Spa after failing to truly challenge one year ago, thanks to a series of changes to the Balance of Performance regulations. The R8 received a larger-diameter air-restrictor and a 10kg weight break, although it also required a raise in the rear rideheight. The BMW, meanwhile, was hit with an extra 15kg of ballast.

Qualifying suggested that SRO technical director Claude Surmont had got his calculations for a so-called B-category track, a high-downforce venue, more or less spot on. Vanthoor took pole, but the first 13 cars – representing eight manufacturers in the Friday evening Super Pole session for the fastest 20 qualifiers from Thursday – were separated by a second.

There was little to choose between the Audi and the BMW, although it appeared that the R8 had the greater consistency of performance across the race. Palttala saw it a different way: "All I know is that we drove flat-out all the way," he said. "When we were going really fast, it seemed they had something in hand and could always react. I think they had better performance today."

Third place was taken by the second of WRT's three Pro Cup entries. The car shared by Christopher Mies, Frank Stippler and James Nash led early on in the hands of the first-named, but ultimately didn't have the same consistency of performance across its driver line-up to challenge.

The car also lost time when the race was red-flagged shortly before one-quarter distance to



Bentleys couldn't match their three-hour form

allow seriously injured British amateur Marcus Mahy to be airlifted to hospital – where he was conscious and moving on Sunday – after his Kessel Ferrari 458 Italia was involved in a horrific incident on the exit of Stavelot. Mies was brought into the pits after the red flags were shown and the team changed the front brakes. There's no rule against that, although there is the proviso that the car takes a drive-through penalty.

Mies actually had to take two drive-throughs, because he came in for the first time when the safety car was still out. That isn't permitted, so he had to return.

A further lap down was the Sainteloc Audi shared by Stephane Ortelli, Edward Sandstrom and Gregory Guilvert. They had been in the fight until Sandstrom had a brake disc – the right front – explode on him on the exit of Blanchimont. He managed to zig-zag through the four cars ahead of him without hitting anything, but the time lost left the car two laps down at the finish.

Andre Lotterer, Benoit Treluyer and Marcel Fassler weren't going to repeat their Le Mans 24 Hours victory of June – they weren't consistently quick enough for that – but they had a realistic shot at a podium until Treluyer tagged Mike Parisy's Black Falcon Mercedes-Benz SLS AMG at La Source in the 19th hour, losing 11 laps to repairs.

Mercedes never looked likely to repeat its 2013 Spa victory. The winning team from last season, HTP Motorsport, got its additional entry for Maximilian Buhk, Maximilian Gotz and Jazeman Jaafar home in fifth. The car lost time early on with a slow brake change.

Gotz reckoned Merc wasn't involved in a fair fight: "In the Blancpain Sprint Series we are about the same speed as the Audis. We are faster on the straight and they are faster in the corners. Now they are faster on the straights as well."

Bentley missed out on a top-10 result with the best of its Continental GT3s. The car shared by Steven Kane, Guy Smith and Andy Meyrick ended up 13th after losing time with a damaged brake line early in the race and then an ECU change and a trip into the garage for a new splitter.

McLaren had a disastrous Spa, all three of its MP4-12Cs entered in the Pro class going out before the race was much more than 12 hours old. Kevin Estre was in the mix in the ART entry early on until a boost-pressure sensor went down, and then the flywheel failed on the car he shared with Andy Soucek and Kevin Korjus.

The first and second-placed Audi and BMW had only minor glitches through the 24 Hours. They probably evened things out, so we almost certainly got the right result to go with the thrilling finish. ☘

IN THE PADDOCK

GARY WATKINS
SPORTSCAR CONTRIBUTOR

@gazzasportscars



IT WAS ONE OF THOSE BIZARRE SITUATIONS where you rub your eyes and wonder if what you're seeing is really happening. The run of four safety cars early in the race took some believing.

Every time the race went green, there was another incident. So much so that the 24 Hours ran for 30 laps behind the safety car without a full racing lap under green-flag conditions.

Safety cars have a habit of breeding safety cars, but the problem was obvious. Drivers were switching off their brains rather than switching on their tyres. The excitement of a green flag proved too much for many and they went too fast on cold tyres.

Amateur drivers were the biggest culprits. That's not a criticism, merely an observation that might help in trying to avoid a repeat in the future.

Responsibility must, to a greater rather than lesser extent, lie with the teams of the drivers who caused the incidents. The engineers and team managers must demand caution from their charges, and an amateur driver is going to need more input from the pit wall during the whole yellow-flag procedure than a pro who's been around the block. There was a marked absence of weaving to maintain tyre temperature from some cars.

That might be easier said than done given that one team sent a driver out without a rear diffuser after a breakage last weekend. The consequence was inevitable: the car ended up in the barrier. That was as irresponsible – if not more so – as anything we saw from pumped-up hobby racers at Spa during the 24 Hours.



HTP Merc was high-profile casualty

BIG NUMBER

80

Percentage of Spa 24 Hours participations that have led to a podium for the WRT Audi team – four out of five. Not to forget the four overall podiums team co-owner Vincent Vosse took as a driver, between 2002 and 2009.

GT3 could get World Cup race

A 'WORLD CUP' FOR GT3 CARS

organised along national lines has been put forward by Blancpain Endurance Series boss Stephane Ratel.

Ratel has made the proposal to the FIA in reaction to an idea from the governing body for a World Cup announced late last year. It announced plans for an FIA label that could be taken by national championships, and then these series would come together for an end-of-season event.

No series have taken up the idea, so Ratel has come up with his own plan to create a one-off GT3 spectacular at the end of each season.

"It is not about taking the best cars from particular series, but getting as many brands as possible on the grid, with each car raced by two drivers of the same nationality, to reflect the international flavour of GT3," he explained.

"We could have a Brazilian BMW, for example, and a French McLaren."



Success could depend on bespoke tyre, not Pirelli



Omani Aston leads Italian Ferrari, French Ferrari and British Audi!

Ratel explained that his idea would involve fully-professional driver line-ups, pro-am pairings and teams of all amateurs "to reflect the spirit of GT3".

The race would take place some time between December and February and would run to a sprint format of two one-hour races. No timescale has been set, but it is unlikely to come about until 2015/16.

Ratel is not suggesting that he and his eponymous organisation promotes the World Cup. He wants the FIA to put the event out to tender

to race tracks and promoters.

The idea has met with tentative approval from potential entrants.

Vincent Vosse, boss of the Spa-winning WRT Audi team, said: "It could work, but the big question is what tyres we would run on. If we are on Pirellis, everyone will say that the Blancpain teams have an advantage.

"If we are on Hankooks, everyone will say that the ADAC GT Masters teams have an advantage.

"The best idea is if we had a tyre that no one normally runs on. Then it could be a really good idea."

Aussie Erebus team plans Spa attack for 2015

THE AUSTRALIAN EREBUS V8 Supercars and Australian GT Championship team is aiming to contest next year's Spa 24 Hours.

Team owner Betty Klimenko and husband Daniel, who runs the GT operation, attended last weekend's Spa event on a fact-finding mission ahead of a potential campaign with a pair of Mercedes-Benz SLS AMGs in 2015. It also placed Australian GT

Championship frontrunner Richard Muscat – who is part of the Erebus Academy – an engineer and two mechanics with the German Black Falcon Merc team for the race.

"We are saying that we are aiming to be here next year," said the team owner, whose squad won the 2013 Bathurst 12 Hours with a line-up including Mercedes legend Bernd Schneider. "We can't confirm it yet,

but that is the hope. We were actually planning to come this year, but it didn't work out.

"We would come with our own cars, the Australian series drivers, plus a few ringers."

The Erebus GT operation has previously raced outside Australia in the Macau GT Cup last year and a GT Asia Series round at Zhuhai to qualify for the end-of-season blue riband.



Erebus aims to bolster Merc attack – this is fifth-placed HTP car

RICARD TO GO 1000KM

The 1000km round of next year's BES will switch from the Nurburgring fixture in September to Paul Ricard in June. Ratel believes the event, which will again have a points coefficient of 1.5, will be good preparation for the Spa 24 Hours and help maintain grid levels after the event. The five-round BES calendar remains unchanged for 2015 with races at Monza, Silverstone, Ricard, Spa and the 'Ring.

BSS GETS INTEREST

Ratel is negotiating with promoters in Italy, Germany and Russia in addition to Antonio Hermann in Brazil (see AUTOSPORT, July 10) to host rounds of the seven-date Blancpain Sprint Series next season.

BAKU DATE FIRMED UP

The Baku round of the BSS in Azerbaijan has finally been confirmed for November 2. The race will take place on the same 2.72-mile circuit as last year with minor modifications to its chicanes.

AF TOP OF THE GENTS

AF Corse reprised its Pro-Am victory in the Gentlemen Trophy amateur class with Alexander Talkanista Sr, Peter Mann, Francisco Guedes and Cedric Mezard. The British Parker team ended up second, five laps down with its Audi R8 LMS ultra shared by Julian Westwood, Carl Rosenblad, Ian Loggie and Leo Machitski after a disastrous start that left the car dead last. The car also survived a late scare with an electrical fire.

RIZZOLI – TOO GOOD?

The stewards refused to hear a protest against the Villorba Corse Ferrari team's Pro-Am driver line-up. Andrea Rizzoli had been upgraded from bronze to silver status ahead of the event, which would have meant the team was unable to run ex-F1 driver Andrea Montermini, but the Italian team successfully argued with SRO that it had already registered its drivers for Spa when the change was made.

TROPHY FOR BRIDES

A perpetual trophy was awarded for the first time to the winners of the Spa 24 Hours this year. The art deco-styled piece of silverware, given to race organiser the Royal Automobile Club de Belgique by BES boss Stephane Ratel's eponymous organisation, includes the names of the previous 66 winners of the event.



Stretton's F1 win in epic Classic

There were plenty of star drives and great racing at the 2014 Silverstone Classic, but the crash that claimed the life of Denis Welch cast a shadow over the event. **KEVIN TURNER** was there



58

The performances of current tin-top stars Rob Huff and Gordon Shedden, and a sensational FIA Masters Historic Formula 1 race were the highlights of another fine Silverstone

Classic, sadly overshadowed by the death of Denis Welch (see page 76).

Former World Touring Car champion Huff drove a trio of cars, but it was his efforts in the 2000 BTCC Ford Mondeo Super Tourer that grabbed attention.

Owner Richard Meins had finished 12th in Saturday's encounter, in theory giving Huff some work to do if he was to take the fight to the pacesetter Honda Accords of James Dodd and Stewart Whyte, which had dominated race one. But an unbelievable start got Huff to third by the time the pack reached Village, whereupon he went around the outside of Whyte to take second on the inside into the Loop.

A scrappy first lap for Whyte, which included three moments, left Dodd and Huff in a race of their own. Rob got a good run out of Copse on lap two and passed the Honda on the blast to Maggotts Curve. Although he could not break away, Huff placed the Mondeo perfectly to thwart Dodd's attacks,

and the Ford took the flag just 0.7s ahead. "What an amazing bit of kit, a real touring car," said Huff. "That was tough. James put up a hell of a fight."

Whyte completed the podium after a lonely run, but there were some excellent performances behind. Double BTCC champion John Cleland had been part of a four-car tussle for third in race one, only securing the spot on the final lap with some inspired overtaking.

He had even more to do on Sunday, after a tap from Neil Smith's Alfa Romeo 156 at the first corner. Cleland somehow held the ensuing broadside slide in front of the 36-car pack and the fired-up Scot charged back into contention. Eighth at the end of lap one, the Vauxhall Vectra was sixth next time through, and dispatched Simon Garrad's Renault

Laguna for fourth on lap three. He matched Whyte's pace thereafter but was too far back to threaten.

Shedden's star turn came in older touring car machinery. Driving the Dynamics-prepared Ford Lotus Cortina he was due to share with Honda team-mate Matt Neal, the 2012 BTCC champion qualified on pole for the U2TC race. He proceeded to put on an enthralling display of wheel-to-wheel battling with the similar car of Richard Meaden.

The duo swapped places several times, squirming and sliding as they left the rest trailing, before Shedden was hampered with a slow puncture. He was still with Meaden when he came in for the mandatory pitstop, but a holed radiator meant Neal never made it out.

"It was so exciting and really

clean," said Meaden after handing over to car owner Grant Tromans, who cruised to victory. "It just shows the BTCC drivers are good guys really!"

The fight behind was more fraught and second could have gone several ways. Soloist Alex Furiani was best-of-the-rest initially, but lost time during the stops, then suffered a sheared axle tube on his Alfa GTA.

Despite a spin, Fortec boss Richard Dutton – driving the Cortina started by engine guru Neil Brown – emerged to beat the Banks family Alfa and Richard Shaw/Jackie Oliver, whose BMW TiSA was hobbled by gearbox issues.

Shedden had said "we'll get it patched up and go and cause some chaos in the Mustang race" after climbing out of the Cortina, but



Stretton won frantic F1 race after superb passing move in Tyrrell



Padmore topped field as F3 made Classic bow

CLASSIC F3 SILVERSTONE, JULY 26-27

Padmore Marches to Henton Trophy F3 double

Forty years after Brian Henton dominated the opening season of two-litre F3 in Great Britain, driving a works March-Toyota 743 run by Mike Rowe, Nick Padmore controlled both legs of the special Classic F3 celebration race in the 783/793 in which Mike Korten won his national title five years later.

Padmore qualified Max Smith-Hilliard's 'for sale' car on pole on Friday, then continued where he left off on the Brands Hatch GP circuit a fortnight earlier, hurtling clear of a 33-car, eight-marque field in the WDK Motorsport-prepared machine. Delightfully, he received his trophy from 'Superhen' himself!

Bicester-built cars filled two of the top three places both days, Martin Stretton pushing Nick hardest on his F3 debut in Grant Tromans' ex-Michel Ferte Martini-Alfa Romeo MK39. In something of a 'groundhog day' result, David Shaw finished third both days in the ex-Mike White March 803B backed when new by race sponsor Autowindscreens.

Chevron B43 pilots Simon Jackson and Richard Trott squabbled over the minor placings with former CF3 champion Jamie Brashaw's ex-Kenny Acheson March 793, while the

ex-Riccardo Patrese '76 European title-winning Chevron B34 commanded attention in Shaun Lynn's hands.

The French F3 Classic class within the event was hard-fought too, Ian Jacobs — who, ironically, lives in neighbouring Whittlebury — scoring a well-deserved maiden victory on Saturday in his ex-Gerhard Berger Martini MK37. He fell behind Eric Martin (ex-Olivier Grouillard MK39) on Sunday after Fabrice Notari (Ralt RT1) ceded second with a spin. Bernard Honorat (ex-Didier Theys Ralt RT3) grabbed third.

● Marcus Pye

BRIAN HENTON TROPHY CLASSIC F3 (10 LAPS)

1 Nick Padmore (March-Toyota 783/793) 21m33.494s (101.07mph); 2 Martin Stretton (Martini-Alfa Romeo MK39) +5.138s; 3 David Shaw (March-Toyota 803B); 4 Simon Jackson (Chevron B43); 5 Jamie Brashaw (March-Toyota 793); 6 Richard Trott (Chevron-Toyota B43).

Class winners Ian Jacobs (Martini-Alfa Romeo MK37); Graham Kiddy (Dastle-Lotus Mk10).

Fastest lap Padmore 2m08.305s (102.13mph).

RACE 2 (10 LAPS) 1 Padmore 21m28.255s

(101.48mph); 2 Stretton +8.045s; 3 Shaw; 4 Trott; 5 Jackson; 6 Brashaw. **CW** Eric Martin (Martini-Alfa Romeo MK39); Kiddy.

FL Padmore 2m07.607s (102.69mph).

the big bangers proved capable of producing their own drama in the first pre-1966 touring car event.

Leo Voyazides muscled past the similar Ford Falcon of Mike Gardiner at Village on lap one, only to run wide at the Loop. As he came back on it was briefly four abreast for the lead, with Gardiner, Tom Roche's Ford Mustang and Shedden door-to-door. Voyazides came off worst, just holding on to a tank-slapper, while Gardiner took the lead.

Voyazides got back to second by the end of the lap and soon closed the three-second gap to Gardiner. He took the lead towards Abbey on lap five, but Gardiner dived back by into Brooklands on the penultimate tour. Voyazides gave him room and retook the lead decisively as the V8s snarled towards Stowe. ▶



Huff (left) and Dodd put on a fine tin-top display on Sunday



Shedden battles Meaden on his U2TC debut



Voyazides/Hadfield added to their 2013 victory

FIA MASTERS SPORTSCARS SILVERSTONE, JULY 26

Lolas clean up after fleet Chevron falls from first

When soloist Martin O'Connell tripped over a car during lappery as he fired Sandy Watson's lithe Chevron-FVC B19 out of Chapel Curve onto the Hangar Straight on lap eight, Saturday evening's FIA Masters Historic Sports Car became a V8 slugfest with Chevrolet-powered Lola T70s to the fore.

Chris Harris hustled Grant Tromans' big coupe past Leo Voyazides' on lap two, then assumed the lead on O'Connell's demise and fought the Greek off until Leo relayed Simon Hadfield on lap 10, one tour after the window opened.

A lap later, Harris' handover to Richard Meaden was clumsy, costing the team any victory chance, for once late stoppers Robert Oldershaw (Lola-FVC T212/c) and Ewan McIntyre (McLaren M1C) had enjoyed brief moments glory atop the charts Hadfield thundered ahead.

He duly went away from Steve Tandy, who was overhauled for second by Andy Wolfe in Jason Wright's Squadra Kenny Rogers T160-based T70 and, after a

splendid chase, Meaden with two laps to run. Tandy attacked anew, but couldn't stop the journalists scooping the final podium place.

F3 winner Nick Padmore, now in Phil Hall's T212, turned the tables on Oldershaw/David Gathercole (who stalled in the pits) to take Marko division honours. The T70 Spyder of Jon Minshaw completed a Lola lock-out of the top seven places. First interloper was the Ferrari 512M of Jamie Campbell-Walter who howled back to eighth after owner Paul Knapfield gyrated into Club.

● Marcus Pye

FIA MASTERS HISTORIC SPORTS CARS

(23 LAPS) 1 Leo Voyazides (Lola T70 Mk3B) 51m32.780s (97.35mph);

2 Jason Wright/Andy Wolfe (T70 Mk3B) +54.320s; 3 Chris Harris/Richard Meaden (T70 Mk3B/c); 4 Steve Tandy (T70 Mk3B/c); 5 Phil Hall/Nick Padmore (Lola T212); 6 Robert Oldershaw/David Gathercole (T212/c); CW Hall/Padmore; Jon Minshaw (Lola T70 Mk2 Spyder); David & Sam Carrington-Yates (Chevron B16); Georg Kjallgren/James Littlejohn (Daren Mk2); Mark Bates (Porsche 911 RSR); Arthur Bruckner (Lotus 23B). FL Hadfield 2m08.231s (102.19mph).

Roche and Shedden enjoyed a duel for third until the Cortina again wilted on the final lap, meaning there was a Mustang on the podium in the Mustang Celebration Trophy.

After jumping Voyazides at Abbey, Gardiner got within half a lap of winning race two. He held off the red Falcon until spinning at Copse a couple of miles from home. Somehow Voyazides missed his gyrating rival to win, while Gardiner recovered to second. "Mike drove beautifully – I couldn't have overtaken him without the mistake," offered the victor.

Roche's fading invitation-class machine completed the podium, just ahead of Henry Mann, who was top 'standard' Mustang.

There was more late drama in the first Masters F1 thrash when runaway leader Michael Lyons suffered a right rear puncture on his Hesketh 308E. With other potential frontrunners Greg Thornton (Lotus 91/5, fuel pressure) and Steve Hartley (Arrows A4, engine failure) also hitting trouble, Ollie Hancock (Fittipaldi F5A) was left to defeat Martin Stretton, having his first race in Martin Adams' Tyrrell 012.

The second encounter was the real thriller, more like an old-school Formula Ford race, with the lead group at one stage comprising five cars. Hancock initially led from a feisty Stretton, with Christophe D'Ansembourg's Williams FW07C and the remarkable Lyons – from row nine! – joining them inside four laps. Lyons blew by the Williams on the Wellington Straight, but just as the 23-year-old looked set to contest the lead he lost third gear.

As Hancock provided the cork in the bottle, Hartley was on his own burn from the stern, made possible by an overnight engine change by Mirage Engineering's men. He made it by Lyons when the Hesketh ran wide at Luffield on lap five.

The crucial move – probably the pass of the weekend – came on

the next tour when Stretton went around the outside of Hancock at Brooklands. Although his best lap was almost two seconds off the quickest, Stretton's consistency thereafter and the battle behind enabled him to edge clear to victory.

In the Benetton-liveried Tyrrell's wake, the passing and repassing continued until Hartley finally overcame Hancock on the outside at Abbey. He pulled away, leaving Hancock to lose the final podium spot when balked by the lapped Frank Lyons, but insufficient time was left to catch Stretton.

James Cottingham (Jaguar E-type) put in one of the drives of the meeting in the RAC TT for pre-1963 GTs, but even that couldn't prevent Ferrari 250 SWB duo Jackie Oliver and Gary Pearson taking victory. Oliver led from pole, but a huge sideways moment ending lap one dropped him briefly to fourth.

The 1969 Le Mans winner was soon second again and caught Cottingham, but the E-type driver was consistent and precise in defence. Oliver eventually barged by with an aggressive move into the Club chicane, though Cottingham was still close when the Ferrari pitted.

There was a chance the Jag could challenge the yellow machine, but when the Drabble family Reliant Sabre spun on oil at Becketts, Cottingham gyrated in avoidance. He lost 8-10s and Pearson easily controlled things thereafter.

The Martin Hunt/Patrick Blakeney-Edwards AC Cobra snatched third from the smoking and brakeless Jon Minshaw/John Clark E-type on the final lap.

Pearson and brother John were also major players in the Woodcote Trophy. John ran fifth early on in their Jaguar D-type, but lost time when he followed John Young's Cooper-Jaguar into the International pits, while the teams waited in the National paddock!

Fred Wakeman led in his Cooper, ▶



Legends lead F1 parade

David Brabham and Sir Stirling Moss led the Formula 1 parade marking 50 grands prix at Silverstone. The event also celebrated 100 years of Maserati and the life of David's father, Sir Jack Brabham

EBREY

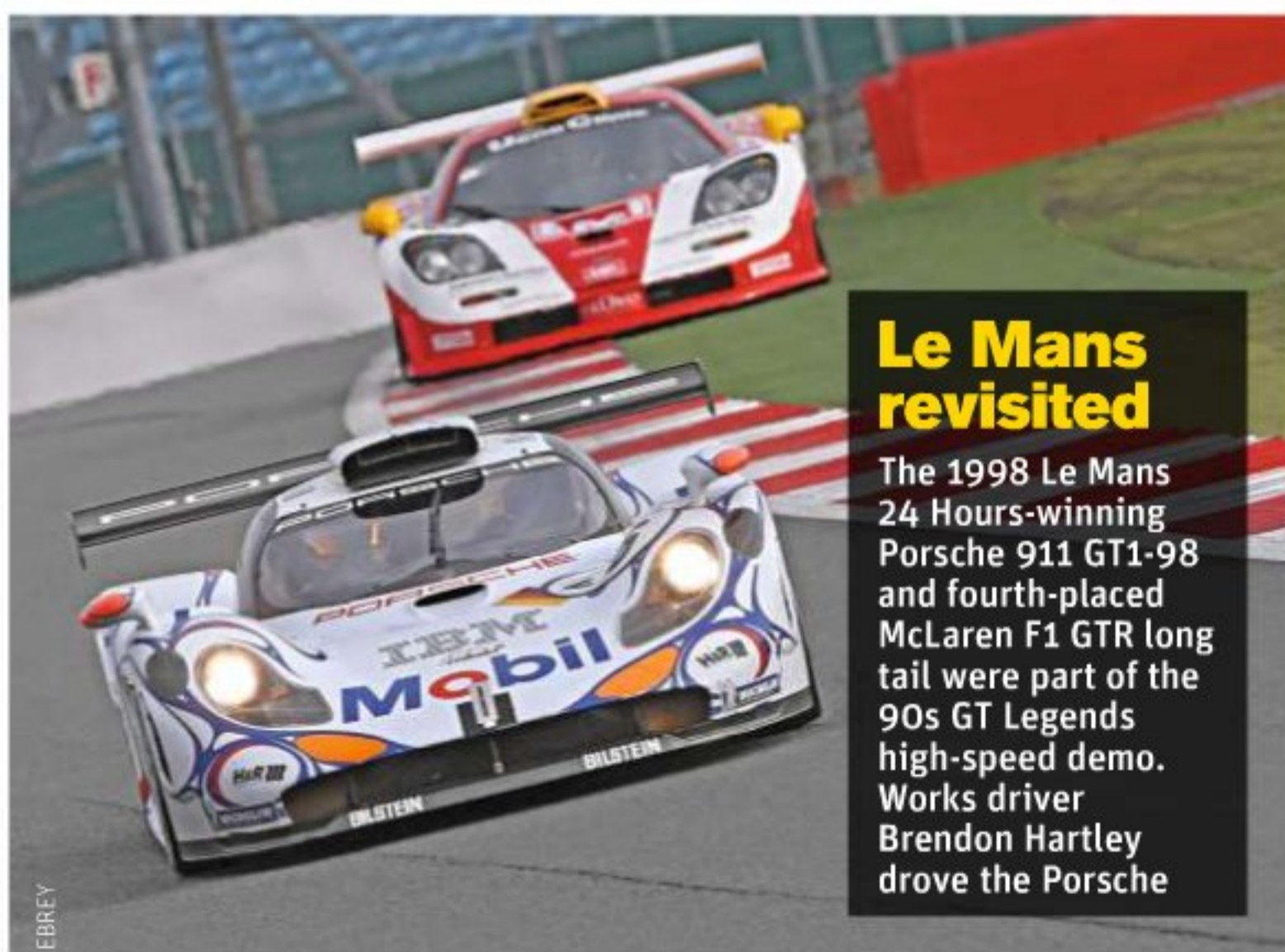

Le Mans revisited

The 1998 Le Mans 24 Hours-winning Porsche 911 GT1-98 and fourth-placed McLaren F1 GTR long tail were part of the 90s GT Legends high-speed demo. Works driver Brendon Hartley drove the Porsche

EBREY



Theodore back on track

Philip Hall had a first outing in his 1978 Theodore TR1 in the FIA Masters Historic F1 races. Sadly, the car suffered niggles and made several pitstops and was unclassified in the two events

EBREY



Awesome Audis

Two Audi A4s made it out for the brace of Super Touring races, driven by Paul Smith and Werner Huber. Both retired on Saturday, but Smith (pictured) made it to 10th on Sunday after starting from row 18

WALKER



Mustang magic

The Mustang Trophy, celebrating 50 years of the American V8, attracted 30 Mustangs, but Falcons won both encounters

EBREY



www.longstone.com
Tel+441302 711123

Michelin Competition Tyre Sizes	ETRTO Tyre sizes	CompetitionRim Sizes in Inches
16/53-13 TB15	175/60 R 13	5.0"-7.0"
16/53-13 TB5 F	175/60 R 13	5.0"-7.0"
20/53-13 TB15	225/45 R 13	7.0" - 9.5"
20/53-13 TB5 F	225/45 R 13	7.0" - 9.5"
17/58-14 TB5 F	185/60 R 14	5.0"-7.0"
15/60-15 TB15	170/65 R 15	4.5" - 7.0"
18/60-15 TB15	215/55 R 15	6.0" - 8.0"
18/60-15 TB5 F	215/55 R 15	6.0" - 8.0"
18/60-15 TB5 R	215/55 R 15	6.0" - 8.0"
23/59-15 TB5 R	265/40 R 15	8.5"-11.0"
23/62-15 TB15	270/45 R 15	8.5" - 10.5"
23/62-15 TB5 F	270/45 R 15	8.5" - 10.5"
23/62-15 TB5 R	270/45 R 15	8.5" - 10.5"
26/61-15 TB15	295/40 R 15	10.0"-12.0"
26/61-15 TB5 F	295/40 R 15	10.0"-12.0"
26/61-15 TB5 R	295/40 R 15	10.0"-12.0"
29/61-15 TB15	335/35 R 15	11.0"- 14.0"
29/61-15 TB5 R	335/35 R 15	11.0"- 14.0"

All road legal



NEW arrival to MSA list 1B



Michelin TB5R

**Michelin TB15
Intermediate**

**Michelin PB20
Full wet**



◀ chased by Geraint Owen's Kurtis. With the latter machine likely to fade — "I've given him a car with tyres that are on fire and brakes that are non-existent," said Owen after handing to Charles Knill-Jones — the delays of Young and Pearson, and de Dion tube failure on the rapid Lotus-Bristol 10 of Rick Bourne, Blakeney-Edwards seemed to have an easy task after climbing aboard the leading car. But Gary Pearson and Chris Ward (in for Young) weren't yet done.

Pearson closed in at 2-3s per lap, and Silverstone instructor Ward was another 1-2s faster. A right-rear puncture finished off Ward's chances of victory, but Pearson climbed to second and fell 13s short of PBE. The incredible Ward took more than half a minute out of the winner after his tyre change and only just failed to demote the Kurtis from the podium.

As usual, Formula Junior provided some great racing, but the winning margins were surprisingly sizeable. Poleman David Methley (Brabham BT6) and Sam Wilson (Lotus 20/22) were too quick for the opposition in Saturday. They swapped places several times before Wilson took the initiative at Abbey after half distance. Methley chased hard, but got caught out in traffic and spun, clipping a backmarker. Multiple race winner

Jon Milicevic's Cooper T59 thus finished second, 19s behind Wilson.

On Sunday, Methley's Brabham jumped out of first gear at the start, leaving Wilson to scream clear once again. Methley's recovery became the main focus and, using some impressive angles, yielded third.

After a slow start, Jon Minshaw laid the foundations for Stirling Moss Trophy success, sharing his Lister-Jag with Phil Keen. Minshaw caught leader Ward's Costin-bodied version, blunted by a misfire, and took the lead, only to be wrong-footed in traffic and allow Ward back ahead. Keen nevertheless led after the stops, while Bobby Verdon-Roe climbed to third in the Ferrari started by Nick Leventis, despite a slipping clutch. Dion Kremer (Lotus 17) also starred, finishing fourth from the back after

a throttle spring broke in qualifying.

Bob Berridge played with Katsu Kubota early in Saturday evening's Group C contest, even letting the Nissan pilot lead, but the Mercedes C11 rumbled off to victory when the Japanese made a mistake at Village.

Michael Lyons (Gebhardt) was a clear third until an ECU circuit breaker popped out. That should have allowed Steve Tandy (Nissan RC90K), recovering after a spin, to complete the podium, but the remarkable Mike Donovan managed to pip him in his C2 Spice.

Fresh from F1 action, Kubota started from the pitlane in race two, leaving Berridge on his own. The Nissan had reached third, behind Justin Law's Jaguar, when he spun.

Philip Walker (Lotus 16) and Jason Minshaw (Brabham BT4) doubled-up in the HGPCA pre-1961 and

pre-1966 GP races. Walker led race one throughout, but a lurid Sunday getaway gave the initiative to Julian Bronson. The Scarab man made life difficult for Walker, but once the Lotus went ahead into Stowe, the result never looked in doubt.

Minshaw took less than a lap to recover from his slow start in race one and kept Jon Failey at arm's length as Brabhams finished one-two, helped by the Miles Griffiths' Cooper popping a driveshaft. Minshaw started better in race two, restarted after the Welch accident. Fairley was again closest, but Griffiths stormed from the back to third.

TVRs should have been first and second in the pre-1966 GT enduro, but Mike Whitaker's half-spin into the Luffield gravel meant the dominant Sean McInerney was the only Griffith on the podium. ❖



Cottingham tried hard to prevent Ferrari win in pre-63 GTs



Minshaw/Keen Lister (left) took Stirling Moss Trophy race

SUPER TOURING TROPHY (9 LAPS)

1 James Dodd (Honda Accord) 20m02.280s (97.84mph);

2 Stewart Whyte (Accord) +3.075s; 3 John Cleland (Vauxhall Vectra); 4 Simon Garrad (Renault Laguna); 5 Neil Smith (Alfa Romeo 156); 6 Graeme Dodd (Nissan Primera).

Class winners Steve Soper (Ford Capri); Andrew Wolfe (Opel Belmont); Jan Bot (BMW E30 M3); Craig Davies (Ford Sierra RS500); Mark Wright (Ford Escort).

Fastest lap J Dodd 2m12.398s (98.97mph).

RACE 2 (10 LAPS) 1 Rob Huff (Ford Mondeo) 22m06.854s (98.53mph); 2 J Dodd +0.710s; 3 Whyte; 4 Cleland; 5 Patrick Watts (Peugeot 406); 6 G Dodd. **CW** Wolfe; Davies; Bot; John Young (Ford Capri); Wright. **FL** Huff 2m11.701s (99.49mph).

SIR JOHN WHITMORE TROPHY

U2TC (20 LAPS) 1 Richard Meaden/Grant Tromans (Ford Lotus Cortina) 52m30.262s (83.09mph); 2 Neil Brown/Richard Dutton (Cortina) +22.653s; 3 Andrew & Max Banks (Alfa Romeo Giulia Sprint GTA); 4 Richard Shaw/Jackie Oliver (BMW 1800 TiSA); 5 Dion Kremer (Cortina); 6 David Tomlin/Martin Stretton (Cortina). **CW** Shaw/Oliver; Josh Beebe (Austin Cooper S). **FL** Gordon Shedden (Cortina) 2m31.961s (86.23mph).

MUSTANG CELEBRATION TROPHY PRE-1966 TOURING CARS (BOTH 8 LAPS) 1 Leo Voyazides (Ford Falcon) 20m15.678s (85.98mph); 2 Mike Gardiner (Falcon) +0.799s; 3 Tom Roche (Ford Mustang); 4 Neil Brown (Mustang); 5 Jackie Oliver (Mustang); 6 Mike Whitaker (Mustang). **CW** David Tomlin (Ford

Lotus Cortina); Jonathan Lewis (Austin Cooper S). **FL** Voyazides 2m29.936s (87.39mph).

RACE 2 1 Voyazides 20m10.509s (86.35mph); 2 Gardiner +19.353s; Roche; 4 Henry Mann (Mustang); 5 Whitaker; 6 Roger Wills (Mercury Comet Cyclone). **CW** Tomlin; Lewis. **FL** Voyazides 2m30.232s (87.22mph).

FIA MASTERS HISTORIC F1

(7 LAPS) 1 Ollie Hancock (Fittipaldi F5A) 13m43.845s (110.97mph); 2 Martin Stretton (Tyrrell 012) +4.264s; 3 Christophe D'Ansembourg (Williams FW07C); 4 Aaron Scott (March 761); 5 Manfredo Rossi di Montelera (Brabham BT42/44); 6 James Hanson (March 2-4-0). **CW** Stretton; D'Ansembourg; Katsu Kubota (Lotus 72). **FL** Michael Lyons (Hesketh 308E) 1m54.497s (114.44mph).

RACE 2 (11 LAPS) 1 Stretton 21m38.318s (110.79mph); 2 Steve Hartley (Arrows A4) +2.675s; 3 D'Ansembourg; 4 Hancock; 5 Lyons; 6 Scott. **CW** Hartley; Hancock; Kubota. **FL** Hartley 1m54.485s (114.46mph).

COMBINED (18 LAPS) 1 Stretton 35m26.427s (110.78mph); 2 Hancock +5.320s; 3 D'Ansembourg; 4 Scott; 5 Rossi di Montelera; 6 Ian Simmonds (012). **CW** Hancock; D'Ansembourg; Kubota.

RAC TOURIST TROPHY PRE-1963

GTs (19 LAPS) 1 Jackie Oliver/Gary Pearson (Ferrari 250 GT Berlinetta) 50m05.061s (82.75mph); 2 James Cottingham (Jaguar E-type) +20.541s; 3 Martin Hunt/Patrick Blakeney-Edwards (AC Cobra); 4 Jon Minshaw (E-type); 5 Wolfgang Friedrichs/Simon Hadfield (Aston Martin DB4GT); 6 Nick Naismith (DB4). **CW** Cottingham; Andrew

Bentley/Sam Wilson (Ginetta G4); Gareth Burnett (Porsche 356B Carrera GT2). **FL** Oliver 2m32.535s (85.90mph).

RAC WOODCOTE TROPHY PRE-1956

SPORTSCARS (23 LAPS) 1 Fred Wakeman/Patrick Blakeney-Edwards (Cooper T38) 1h00m08.807s (83.43mph); 2 John & Gary Pearson (Jaguar D-type) +13.376s; 3 Geraint Owen/Charles Knill-Jones (Kurtis-Chrysler 500S); 4 John Young/Chris Ward (Cooper-Jaguar T33); 5 Harry Wyndham (D-type); 6 Ben Eastick (D-type). **CW** Owen/Knill-Jones; Wolfgang Friedrichs/Simon Hadfield (Aston Martin DB3S); Stephen Bond (Lister-Bristol); Mark Midgley/Chris Woodgate (Aston Martin DB3); David Cottingham (Ferrari 500 TRC). **FL** Ward 2m30.851s (86.86mph).

PETER ARUDEL TROPHY

HISTORIC FORMULA JUNIOR (BOTH 9 LAPS) 1 Sam Wilson (Lotus 20/22) 21m23.533s (91.64mph); 2 Jon Milicevic (Cooper T59) +19.311s; 3 Michael Hibberd (Lotus 27); 4 Manfredo Rossi di Montelera (Lotus 22); 5 Westie Mitchell (De Tomaso); 6 Stuart Roach (Alexis Mk4). **CW** Andrew Wilkinson (Lynx T3); Will Mitcham (U2 Mk2); Andrew Taylor (Cooper T56); Patrick Barford (EFAC Stanguellini). **FL** David Methley (Brabham BT6) 2m20.674s (93.15mph).

RACE 2 1 Wilson 21m34.106s (90.90mph); 2 Milicevic +2.054s; 3 Methley; 4 Andrew Hibberd (Lotus 22); 5 Rossi di Montelera; 6 Mitchell. **CW** Wilkinson; Mitcham; Crispian Besley (T56); Michael Gans (Stanguellini FJ). **FL** Methley 2m21.211s (92.79mph).

STIRLING MOSS TROPHY PRE-1961

SPORTSCARS (21 LAPS) 1 Jon Minshaw/Phil Keen (Lister-Jaguar Knobbly) 52m10.458s (87.80mph); 2 Chris Ward (Lister-Jaguar Costin) +13.529s; 3 Nick Leventis/Bobby Verdon-Roe (Ferrari 246S); 4 Dion Kremer (Lotus 17 Prototype); 5 Barry Wood/Tony Wood (Knobbly); 6 Roger Wills (Lotus 17). **CW** Kremer; Keith Ahlers/Billy Bellinger (Lola Mk1 Prototype); Ewan & Jamie McIntyre (Lotus 15); Malcolm Harrison/Patrick Watts (Rejo Mk3); Stephen Bond (Maserati 250S). **FL** Minshaw 2m24.860s (90.46mph).

GROUP C (BOTH 16 LAPS)

1 Bob Berridge (Mercedes C11) 30m24.405s (114.75mph); 2 Katsu Kubota (Nissan R90CK) +25.066s; 3 Mike Donovan (Spice SE88); 4 Steve Tandy (Nissan R90); 5 Adrian Watt (Spice SE89); 6 Shaun Lynn (C11). **CW** Donovan; Tandy. **FL** Berridge 1m50.735s (118.33mph).

MASERATI CENTENARY TROPHY

HGPCA PRE-1961 GP CARS (9 LAPS) 1 Philip Walker (Lotus 16) 21m57.323s (89.29mph); 2 Julian Bronson (Scarab Offenhauser) +9.267s; 3 Tony Wood (TecMec Maserati F415); 4 Fred Harper (Kurtis 500); 5 Michael Steele (Connaught C-type); 6 Tony Smith (Ferrari 246 Dino). **CW** Harper; Ian Nuthall (Alta F2); Clive Wilson (Cooper T43); Allan Miles (Maserati 250F-CM7); Richard

Pilkington (Talbot Lago T26SS). **FL** Walker 2m24.824s (90.48mph).

RACE 2 (8 LAPS) 1 Walker 19m27.774s (89.51mph); 2 Bronson +3.146s; 3 Wood; 4 Smith; 5 Steele; 6 Barrie Williams (Aston Martin DBR4). **CW** Marc Valvekens (DBR4/4); Miles; Nuthall; Wilson; Stephen Rettenmaier (OSCA Tipo G4500). **FL** Walker 2m24.013s (90.99mph).

JACK BRABHAM MEMORIAL TROPHY HGPCA PRE-1966 GP CARS

(9 LAPS) 1 Jason Minshaw (Brabham BT4) 21m03.898s (93.07mph); 2 Jon Fairley (Brabham BT11) +3.425s; 3 Peter Horsman (Lotus 18/21); 4 Andy Middlehurst (Lotus 25 R4); 5 William Nuthall (Cooper T53); 6 John Harper (Cooper T51). **CW** Middlehurst; Nuthall; Peter Studer (Lotus 24); Tony Ditheridge (Cooper T45). **FL** Minshaw 2m18.516s (94.60mph).

RACE 2 (7 LAPS) 1 Minshaw 16m20.826s (93.21mph); 2 Fairley +1.482s; 3 Miles Griffiths (T51); 4 Horsman; 5 Middlehurst; 6 Nuthall. **CW** Griffiths; Middlehurst; Studer; Ditheridge. **FL** Minshaw 2m18.291s (94.75mph).

INTERNATIONAL TROPHY PRE-1966 GTs (24 LAPS)

1 Sean McInerney (TVR Griffith) 1h00m55.535s (85.95mph); 2 Nathan Kinch (Jaguar E-type) +19.819s; 3 Chris Scragg/Matt Nicoll-Jones (E-type); 4 Michael Gans/Andy Wolfe (AC Cobra); 5 Roger Wills (Bizzarrini 5300GT); 6 Andrew Haddon/Shawn Lynn (Cobra). **CW** David Grace/Rob Huff (Austin-Healey 3000); Urs & Arlette Muller (Lotus Elan 26R); Malcolm Paul/Rick Bourne (TVR Grantura). **FL** Nicoll-Jones 2m26.090s (89.69mph).

CLASSIC CAR FEATURE



Championship winning from 1990–1992, until a regulation change excluded the GT-R in 1993

This car was originally imported from Japan in September 2005. Since being in the UK it has had 2 owners. The car has several old MOT's and lots of receipts with it, so lots of history. It seems that a lot of the work has been carried out by Norris Designs, JDM Garage & was mapped by Thor Racing. It was mapped on 26th June 2013 when it made a conservative 510bhp. This car was originally a red car but has now been sprayed the blue that you see in the pictures to create a replica of the hugely successful CALSONIC R32 of the early 1990s.

The R32 GT-R was introduced into the Australian Touring Car Championship in 1990 and promptly ended the reign of the previously all-conquering Ford Sierra Cosworth, winning Bathurst 1000 Classic in 1991 and 1992.

This success led to the Australian motoring press nicknaming the car Godzilla due to it being a "monster from Japan".

As Australia was the first export market for the car the name quickly spread. Such was GT-R's dominance that it is seen by some as a significant factor in the demise of Group A Touring Car racing, the formula being scrapped soon after.

The BNR32 (R32 GT-R) would end up winning 29 straight victories out of 29 races in the Japanese motorsport. The GT-R proceeded to win the JGTC Group A series championship 4 years in a row, and also had success in the Australian Touring Car

I am asking 12,750 but am open to reasonable offers. Give me a call or email me if you would like any further details and spec of car, or to discuss the price.



RESTORATION AND RESPRAY SERVICE REPAIRS SERVICING ENGINE, GEARBOX AND REAR AXLE REBUILDS

FERRARI AND ITALIAN MARQUES RESTORATION AND SERVICE

- Competitive, fixed price agreement prior to work commencing.
- Collection and return in covered transport within the UK mainland.

WWW.GTBRESTORATIONS.CO.UK

Unit 3, Station Road Industrial Estate, Elmwell, Suffolk, IP30 9HR Tel. 01259 242105 Email enquiry@gtbrestorations.co.uk

Tolman Motorsport

THE PROGRESSIVE MOTORSPORT COMPANY

LOTUS 19 MONTE-CARLO RECREATION
BUILT BY TOLMAN MOTORSPORT

PHOTO CREDIT: THE ROYAL AUTOMOBILE CLUB

RESTORATION · RECREATION · FABRICATION
RACE SUPPORT · PREPARATION · ENGINEERING

WWW.TOLMANMOTORSPORT.CO.UK
+44 (0) 8452 306 205

TOLMAN MOTORSPORT LIMITED, UNIT B, THE OLD STATION YARD
OXFORD ROAD, MARTON, WARWICKSHIRE, CV23 9RU, UK

CLASSIC CAR FEATURE

45 years of experience



in pre & post war cars



Work from drawings or original components
Full CNC 4-axis machining capabilities
Full pattern shop association
Full foundry association
Digitising facility



Restorations
Recreations
Engine building
Circuit support
Storage



Restoration of aluminium or steel bodywork
Manufacture of complete bespoke coachwork
Chassis restoration and complete production
Wings, radiator grilles, fuel tanks, etc.
Design service available



Telephone +44 (0) 2392 254 488
Fax +44 (0) 2392 254 489
Email info@jswl.co.uk



www.jswl.co.uk

Pipers Wood Industrial Park,
Waterlooville, Hampshire,
PO7 7XU, England.



CLASSIC CAR FEATURE

Omicron CLASSIC LANCIA SPECIALISTS



- ★ **Parts** new, reproduction and secondhand
- ★ **Restoration** full or partial concours restorations
- ★ **Bodywork** panelwork, paintwork and trim
- ★ **Engines** standard to competition specification
- ★ **Suspension** also gearbox, brakes & steering
- ★ **Competition** race and rally preparation

We work on cars and components sent from all over the world, and can assist with the import and export aspects.

ALSO—DALLARA F307-Toyota to hire for MSV's F3 Cup or for use at the Walter Hayes meeting in November

Omicron Engineering Ltd.,

The Long Barn, Mulbarton, Norwich, NR14 8JS
Tel +44 (0)1508 570351 ★ Fax +44 (0)1508 570795
email sales@omicron.uk.com ★ www.omicron.uk.com

REDLINE ENGINEERING UK CLASSIC CAR RESTORATION & SERVICING



0845 2415557

Web: www.redlinepe.co.uk
Email: info@redlinepe.co.uk



- Full/ part restoration to concours standard
- Servicing
- Mechanical repairs
- Fault finding
- Upgrades
- Trimming
- Collection & delivery service
- Wiring

AUTOSPORT

IF YOU'D LIKE TO
ADVERTISE YOUR
PRODUCTS AND
SERVICES IN THE
MARKETPLACE CALL:

0208 267 5865



**RIVERSDALE
RESTORATION**

Specialist restorers
of 50's and 60's
historic racing cars
and classic vehicles

Tel: 01747 838495
www.riversdale-restoration.co.uk

PERFECTION

WHEN ONLY THE 'BEST' INSURANCE WILL DO



PRESTIGIOUS INSURANCE TO COVER...

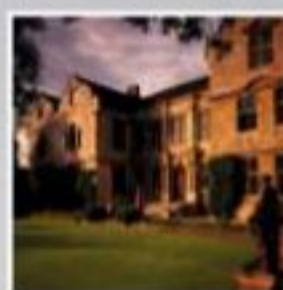

COMMERCIAL
& RESIDENTIAL



LIFESTYLE
& TRAVEL



FINE ART &
COLLECTABLES



PRESTIGE
MARQUES



- Peter Best Insurance -
Supporting clubs & their
members since 1985

TEL: 01376 574000

180 High Street, Kelvedon
Colchester, Essex CO5 9JD



Authorised and Regulated by the
Financial Conduct Authority

WEB DIRECTORY

CAR BROKERAGE

RACING CARS FOR SALE
ALAN CORNOCK FCS
BUYING - SELLING - BROKERAGE
www.racingcarsforsale.co.uk
TEL: 01480 891212

ENGINES

JULIAN GODFREY
ENGINEERING
visit our new online shop www.racetuners.com

EXHAUSTS

Inconel & Stainless Steel Specialists
SIMPSON
Race Exhausts
Tel: 01753 532222
www.simpsonraceexhausts.com

GEARBOXES

Gearboxman.com
COMPETITION TRANSMISSION SERVICES
Gearboxes & Axles for Road, Race, Rally and more
Telephone: 01582 840008 Fax: 01582 840007

HELMET GRAPHICS

Mike Fairholme Designs
Sole approved painter of Aral helmets.
Silver Birches, Corby Birkholme, Nr Grantham, Lincs NG33 4LE.
Tel: 01476 550630. Fax: 01476 550029.
email: fairholmedesigns@btconnect.com
www.fairholmedesigns.co.uk

MEMORABILIA

FINAL LAP
For Everything Formula One
www.finallap.net **WE BUY AND SELL**
+44 (0) 1245 287588 / 07771 920345

MEMORABILIA

GRANDPRIXGRAPHICS
SPECIALISTS IN MOTORSPORT GRAPHICS
RACE CARS, SUPPORT VEHICLES,
F1 TYPE BOTTLES, SIGNS.
07902061423 or 01992 666913
www.grandprixgraphics.co.uk

RACE PARTS

ARE DRY SUMP SYSTEMS
ARMSTRONG RACE ENGINEERING INC.
WWW.DRYSUMP.COM (916) 652-5282

RACE PRODUCTS

Lola 210 & 212 cars and parts
Cosworth FVC, FVA,
BDG, BDA
Lotus Twin Cam & Pinto engines www.davidgathercole.co.uk

RACE PRODUCTS

PORSCHESHOP
10% off with website
voucher code AUTOTEN
Or Call: 0121 585 6088

Pit to Car Autotel
Radio solutions **Digital Race Radio**
0044(0)1508 528837
www.raceradio.co.uk

JJC) race and rally
PASSIONATE ABOUT MOTORSPORT
www.jjcraceandrally.com

RACE PRODUCTS

msar LONDON
MOTORSPORT
SHOWROOM
WWW.MSAR.CO.UK

MARDI GRAS MOTORSPORT
www.mardigras.co.uk

OMP **YB RACING**
MOTORSPORT & PERFORMANCE
WWW.YBRACING.COM

RACEWEAR

demon tweeks
MOTORSPORT *Direct*
www.demon-tweeks.co.uk

Grand Prix Racewear THE RACEWEAR EMPORIUM
WWW.GPRDIRECT.COM
08435 070 858

at power
www.atpower.co.uk
+44 (0)1953 857800

TRAILERS & TRANSPORTERS

BRIAN JAMES TRAILERS
» Connected to you
www.brianjames.co.uk

PRG TRAILERS
www.prgtrailers.co.uk
Phone no: +44 (0) 1270 812402

Image Manufacturers of bespoke split rim alloy wheels
www.imagewheels.co.uk
IMAGE WHEELS INTERNATIONAL LTD.

AUTOSPORT

TO ADVERTISE IN THE WEB DIRECTORY
PLEASE CALL 020 8267 5992
OR EMAIL: autosport.ads@haymarket.com

BRIAN JAMES TRAILERS

» Connected to you



Photograph courtesy of Litchfield Motors.

www.brianjames.co.uk

Night shift

High performance, cutting edge technology, Race Transporter enclosed designs offer fast, safe and efficient vehicle transportation. Crossing continents, travelling through many years our trailers have served at every race or rally.

With bright LED ambient lighting, and carefully designed interior space Race Transporter trailers operate day and night.

Main photograph, Race Transporter 6 with double assistor ramps, interior LED lighting, high level tyre rack and work bench combination.

Race Transporter range from £ 7,099 (excl. VAT).



RACE TRANSPORTER

T +44 (0)1327 308 833

For more information and details of your local BJT dealer please call or visit our website.



☎ 0117 950 9294

HOPKINS
MOTORSPORT

Europe's Largest Motorhome-Office-Hospitality Vehicle

AVAILABLE NOW FOR SALE OR HIRE

TRAILERS & TRANSPORTERS



ULTIMATE IN LUXURY

BUILT TO IMPRESS

Everybody in motorsport has different requirements, be it mobile garages, living, offices or hospitality or a combination; Hopkins Motorsport will build your vision - however radical!

A revolutionary design with 1,100 sqft of living space incorporating 4 slide out pods, a hydraulic pop up roof to achieve three levels with 2.1metre of headroom in each level and still be able to travel legally throughout Europe. Once at a venue this vehicle can be easily set up by one person in under an hour!

This extraordinary vehicle will accommodate eight people in homelike comfort and luxury.

www.hopkinsmotorsport.com

THE RACE TRANSPORTER SPECIALISTS

NEW & USED SALES :: RENTAL :: REFURBISHMENT

ORDERS NOW

BEING TAKEN FOR 2015 DELIVERY POP
UP ROOF & HYDRAULIC SLIDE OUT
VEHICLES TO ANY SPECIFICATION

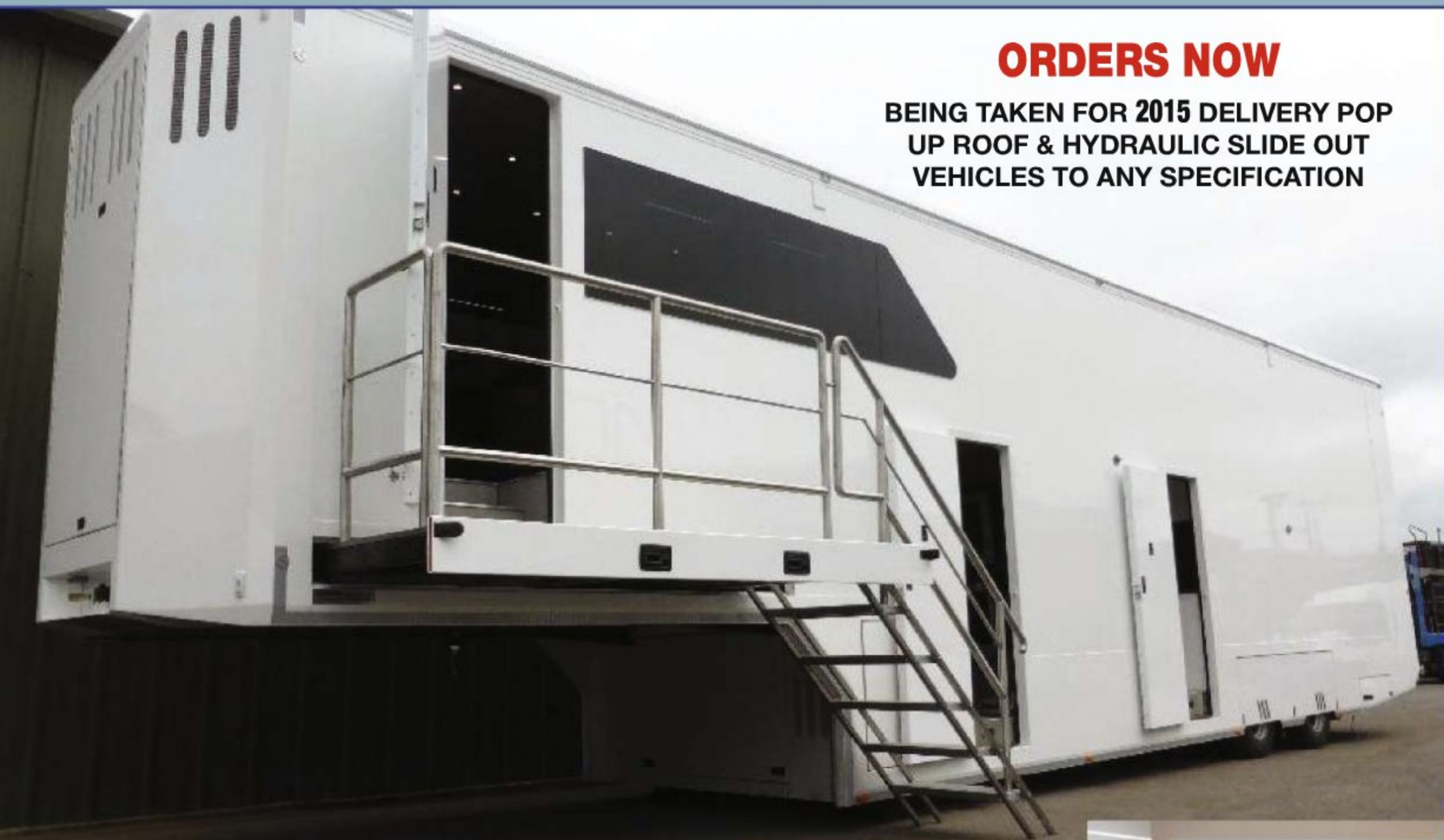

New build 2014:

- Top deck carrying capacity 2 GT cars.
- Lower deck design to carry 2 formula cars & pit equipments, at the circuit it converts to a workshop and Engineers room.
- Management office.
- Drivers changing & relaxation room/ storage room.
- 9kw Silent generator, hydrovane compressor, Satellite, 13.5 x8m awning, Air conditioning in all rooms.
- Available now for sale or hire.

In build on 2008 chassis:

Multi car or Bulk freight transporter with removable office. Carrying capacity up to 5 Touring cars, adjustable height bench's that also fold up for bulk freight, removable office for upto 8 people, air conditioning, data Tv's, etc. available 1-9-14.

Available 1-11-14

6 identical 4 car transporters complete with workshops & offices from our rental fleet please call for details prices from £90,000 to £110,000 depending on age.

TRAILERS & TRANSPORTERS

WOODFORD TRAILERS



www.WOODFORDTRAILERS.com
HIGH QUALITY TRAILERS FOR CLUB, PRIVATE AND PRO MOTORSPORTS



Email: sales@woodfordtrailers.com

CALL US NOW **01327 263 384**

PRG TRAILERS

Finest Built British Trailers.



PRG Trailers | Cheshire | UK | Tel: +44 (0) 1270812402
Web: www.prgtrailers.co.uk | Email: info@prgtrailers.co.uk

AUTOSPORT

IF YOU'D LIKE TO ADVERTISE YOUR
PRODUCTS AND SERVICES IN THE

MARKETPLACE CALL:

0208 267 5865

TRAILERS & TRANSPORTERS

WELCOME TO YOUR MOTOR HOME!

HOSPITALITIES FOR CHAMPIONS

BISCHOFF SCHECK AG

WWW.BISCHOFF-SCHECK.COM

MARKETPLACE

CAR TYRES

FOR ALL YOUR

AVON
 TYRES
MOTORSPORT
 RACING TYRES
 Inc. ACB 10 Formula Ford
 Contact

BMTR LTD
 Tel: 0121 331 1122
 Fax: 0121 331 1144
 email: sales@bmtr.co.uk
 see our new website at www.bmtr.co.uk

FLOORING

Kiwi Tiles
 Interlocking Plastic Floor Tiles, as used by leading race teams throughout Europe.



- Easy Installation & removal
- Many colours
- Lightweight
- Strong and durable
- Compact & easy to store
- Top quality
- Value for money

Stock Colours:
 Red, Blue, Green,
 Yellow, Silver, Orange,
 Grey, Black, White,
 Dayglo Red

Ralt Engineering
 Tel: 01865 883354 Fax: 01865 883789
 Email: enquiries@kiwitiles.com
 www.kiwitiles.com

SPARES & ACCESSORIES

Stainless feet & Castors



All Goods In Stock, Next day delivery, Buy Online.

01327 312664
 www.stainless-feet.co.uk

MEMORABILIA

F1 COLLECTORS .COM



#1 FOR F1 MEMORABILIA & AUTOGRAPHS
 We buy and sell F1 items
AYRTON SENNA specialists
 Call CHRIS GRINT
01763 274448
 email: sales@f1collectors.com

RACE PRODUCTS

• EXPERT ADVICE
 • MASSIVE STOCK
 • RAPID DELIVERY

demon tweeks
 MOTORSPORT Direct



adidas

CALL TODAY **0844 375 2196** LOW CALL RATE CALLS MAY BE RECORDED FOR TRAINING PURPOSES MEDIA CODE: PZ252A

www.demon-tweeks.co.uk

AUTOSPORT

IF YOU'D LIKE TO ADVERTISE YOUR PRODUCTS AND SERVICES IN THE MARKETPLACE CALL:

0208 267 5865

RACE & RALLY CARS

1962 Lotus 22 FJ



Chassis No. 22-J-5, Restored to a high standard, Race ready subject to individual set-up, 1 hour on fresh Ivey/Richardson (test time only) U.S.

125K o.n.o.

Jon Fossi 503-708-1183 or
 Jon@jonfossi.com

WWW.REIGERSUSPENSION.COM

The best suspension for:

- Rally
- Rallycross
- Autocross
- MotoCross
- Quads
- Sidecar Cross
- Rallye Raid
- Trial



REIGER
 Racing Suspension

Reiger Suspension BV
 Moleneik 5a
 NL-7255 AX Hengelo Gld.
 Tel.: +31 (0)575-462077 Fax: +31 (0)575-463314
 Info@reigersuspension.com

MOTORSPORT JOBS

Gearbox Engineer

- Creation of specifications for drive train components
- Coordination of development activities with external partners
- Design work (CAD), including PDM creation
- Budget control for the development activities
- Data evaluation
- Definition for future drive train development

Requirements

- Engineering degree (automotive/mechanical)
- Expertise drive train development
- CAD
- Motorsport experience

We expect the candidate to be self-motivated and proactive, with excellent communication skills and the ability to work to very tight deadlines within a dynamic team environment, often with minimal supervision.

We look forward to receiving your full application, in writing or via e-mail to:

Volkswagen Motorsport GmbH

Human resources

Ikarusallee 7a

D-30179 Hannover

jobs@volkswagen-motorsport.com



Motorsport



SS TUBE TECHNOLOGY
ENGINEERED BY DESIGN

SS Tube Technology is an engineering company supplying Formula 1 and other categories at the pinnacle of motorsport technology. SS Tube Technology designs, develops

and manufactures a range of advanced products including high performance exhaust systems, heat shields and thermal management solutions. Automotive and other high performance markets are also served by the company.

Due to our continuing business growth we are seeking to recruit for the following roles:

PRODUCTION MANAGER: Leading a team of Operators / Technicians in your production area, you will be responsible for day to day planning & running of all aspects of the process, ensuring maximum utilisation of machines and people, delivering on time in full, maximising performance efficiency and adherence to Quality, Standard Operating Procedures & Regulatory Requirements at all times.

CNC TUBE BENDING OPERATORS / TECHNICIANS: Experienced Operator/ Technicians who can operate and set NC and/or CNC tube bending machines.

GRADUATE TECHNICIAN: You will have a higher level vocational qualification and be interested in the development and manufacture of new products and processes for the motorsport industry. This role requires a very practical approach and the successful candidate will need to have a high level of talent and commitment.

DESIGN / PRODUCTION ENGINEERS: You will be involved throughout the lifecycle of a project, from defining customer requirements, through to completed parts and tooling design and implementing the manufacturing processes required. You must have a good practical and theoretical engineering background, with a positive, flexible can-do attitude.

Other opportunities within SS Tube Technology include: SKILLED FABRICATORS / SHEET METAL WORKERS, BUSINESS DEVELOPMENT ENGINEER and ENGINEERING STUDENT WORK PLACEMENT

We offer a competitive package for all roles, and there is significant potential for career development within SS Tube Technology as the business expands and grows into new markets.

To apply please email hr@sstubetechnology.com stating which job you are applying for. For more details visit www.sstubetechnology.com



At McLaren we are totally committed to one objective..... To Win.

Within the inspirational McLaren Technology Centre we are constantly striving to develop a high performance culture. This focus and passion to encourage innovation, and the uncompromising commitment to achieve extraordinary things has enabled us to create one of the most successful and prestigious race teams in world motorsport.

We currently have the following exciting opportunities:

- MRL 367 SENIOR MODEL DESIGN ENGINEER
- MRL 407 SURFACING TEAM LEADER - AERO DESIGN
- MRL 416 SIMULATION DEVELOPMENT ENGINEER
- MRL 420 6 X CNC MACHINE TOOL PROGRAMMER/ SETTER/OPERATOR- DAYS AND NIGHTS
- MRL 421 QUALITY ENGINEER - CONCEPT & DESIGN
- MRL 425 TEST/ RACE ENGINEER
- MRL 426 PERFORMANCE ENGINEER

If you have what it takes to make a difference and the drive to shape the next chapter of our story, we would like to hear from you. Please visit www.mclaren-jobs.com Please quote Autosport when applying for the above vacancies.



Linked in



Business & Product Development Manager - Autosport International & Performance Car Show

We are looking for a Business & Product Development Manager to join Autosport International and the Performance Car Show. This represents a good opportunity to develop a career at Haymarket Exhibitions, and join one of Haymarket's flagship events, and Europe's largest and most influential motorsport exhibition.

Based in our offices at Teddington Studios in South West London, and reporting to the Show Director, the role primarily involves selling stand space and developing new business through phone, face-to-face contact and network opportunities. The successful candidate will already possess proven sales experience, and have the ability to sell at all levels, from smaller companies to larger corporate clients. Previous experience in exhibitions is an advantage, although not essential, but being able to sell and communicate the benefits that exhibitions can deliver is vital. An interest in motorsport and cars is useful, but not essential. The successful candidate will have the opportunity to get immersed in motorsport and cars as attendance at related exhibitions, motorsport events and client meetings will be required.

Haymarket Exhibitions is one of the UK's largest consumer exhibitions company with shows ranging from Autosport International to Clothes Show Live and is part of the Haymarket Media Group, Britain's largest privately owned media company.

If you are interested in applying for this opportunity please visit the Careers section of our website www.haymarket.com or alternatively email your CV with a covering letter to: recruitment@haymarket.com

haymarket

MOTORSPORT JOBS



Love racing?

Have an equal passion for the written word?
We're looking for you!

If you can't get enough of the fast-moving world of motorsport then we have a similarly fast-paced and challenging opening within our communications team.

You could be crafting copy in support of Dunlop's British Touring Car involvement, on behalf of SEAT and its racing involvement or Europe's biggest motorsport show, Autosport International.

First-rate written and communication skills are required for this role, which will involve the development of a range of written materials, from press releases, internal newsletters to websites and presentations. Working within the comms team, languages and experience within PR roles would also be advantageous.

If you've got the determination to succeed in the highly-competitive motorsport industry then we want to hear from you.

Please provide two samples of your writing (one will ideally be a press release), your CV and salary expectations together with a covering letter to

GeorginaB@rsm-auto.com | www.rsm-auto.com



Radical is the world's leading sports-racing car manufacturer

Due to extraordinary global demand for the new RXC and an increase in sales of our SR3 & SR8 race cars, we are expanding the workforce at our Peterborough base. These new vacancies represent a fantastic opportunity to become part of the team about to launch the RXC Turbo road car alongside our extensive range of trackday, school & race cars.

We are looking for the following positions:-

SALES DEVELOPMENT MANAGER

With the expansion of the sales department we have a vacancy for a dynamic sales person to identify and develop sales opportunities in the UK and to work with our global distributor network. A motorsport background would be advantageous but not essential. International travel and flexible working hours are part of the requirements of this role.

RACE MECHANICS & PRODUCTION CAR ASSEMBLERS

Must have strong mechanical ability, have a can-do attitude and a drive to succeed. The ideal candidate will have previous race team experience at this level. The role includes some weekend and international travel to race meetings and events so flexibility is essential.

COSTING / PURCHASING ANALYST

Required to rationalise bills of materials and streamline job costing of both car production and customer support/services sectors of the business. The applicant will show excellent attention to detail and accuracy.

PRODUCTION ENGINEER

To work with Managing Director to streamline and develop all production processes in main areas; Fabrication, Production, Bodyshop. A logical approach to a wide array of factory processes required, as is attention to detail and previous experience.

Additionally:

ENGINE & CHASSIS DATA ENGINEER

TIME-SERVED ENGINE BUILDERS / TECHNICIANS

EXPERIENCED ENGINE DYNO TECHNICIAN

Please apply in writing including detailing which position you are applying for and a copy of your CV to,

Jim Walker, Radical Sportscars,
24-26 Ivatt Way Business Park, Westwood, Peterborough, PE3 7PG
jimw@radicalsportscars.com



We are looking for outstanding people to join us and continue our push towards the front of the grid.

With a focus on competitiveness and innovation, Sahara Force India is an inspirational and rewarding place to work. We are investing heavily in our future success but above all we are investing in the right people. If you are interested in being part of our successful Journey, please contact us regarding the following opportunities:

RACE ENGINEER

In this key position reporting to the Chief Race Engineer, you will be responsible for the operation, strategy, development, reliability and overall optimisation of the race car and driver performance.

You must have excellent communication skills; be confident in your own decision making abilities; high levels of accuracy; and maintain professional working standards in pressured and rapidly evolving situations.

Candidates must be able to demonstrate a strong background in performance / strategy engineering, vehicle dynamics or aerodynamics along with an excellent working knowledge of data analysis packages and lap simulation tools; possess a strong understanding of technical and sporting regulations and must be able to build and maintain strong and trusting working relationships.

PERFORMANCE ENGINEER

We are looking for an outstanding engineer to join our Race Engineering group both trackside and at the factory.

The successful candidate must have a strong understanding and working knowledge of all aspects of race performance, strategy and software packages. You must be able to demonstrate previous experience in data preparation and analysis, vehicle science development or aerodynamic performance. You will have the ability to contribute to the development of new analysis methodologies, tools and techniques.

You must have excellent communication skills; be confident in your own decision making abilities & suggestions for improvement; high levels of accuracy; and maintain high working standards in pressured situations.

The successful candidates must:

Be currently eligible to work in the UK

Have previous relevant experience working within a high level motorsport environment

Be able to demonstrate an innovative and flexible approach to problem solving and possess the ability to work through problems in a scientific and analytical way

Be able to integrate quickly into existing teams and be actively involved in many aspects of each department

Have good communication and analytical skills and be able to work to tight deadlines, often under pressure

Be highly self-motivated, thrive in a challenging environment and have a flexible approach to working hours

For details of our current vacancies and to apply please visit our recruitment page: www.forceindiaf1.com/recruitment

Closing date: 8th August 2014

No agencies



Barwell
MOTORSPORT

Ecurie Ecosse and Barwell Motorsport would like to thank all of their partners whose support helped Oliver Bryant, Alasdair McCaig, Alexander Sims and Andrew Smith claim a memorable second place in the Pro-Am class and seventh overall at last weekend's 24 Hours of Spa with their BMW Z4 GT3.



BLACK BULL
PoweredByBlackBull.com



ELEPHANT
LONDON

Ragus®
PURE SUGAR ENERGY



Find more issues at
magazinesdownload.com

CLUB AUTOSPORT

NATIONAL RACING • HISTORICS • RALLYCROSS • HILLCLIMB • TRACK TESTS



Welch, 69, died after opening-lap crash at Silverstone

HUMBLE PYE

AFTER WHAT, IN MOST RESPECTS, had been a triumphant Silverstone Classic, the Formula 1 Wing paddock was a desolate place on Sunday evening. As news spread that proud BRDC member Denis Welch, one of historic racing's most popular characters, had died as a result of a first-lap accident in the pre-1966 Historic Grand Prix car race, moods darkened. Few could believe that the Austin-Healey legend blessed with such phenomenal car control was gone.

Welch started racing at Mallory Park in 1965. He progressed from Mini to Ford Anglia, racing against Gerry Taylor's Swish 105E, then briefly tried a single-seater Merlyn before buying a fuel filling station near Burton-on-Trent in '77. In '81 its workshops morphed into Denis Welch Motorsport, now hub of the universe for Healey racers worldwide.

Denis adored big Healeys, and his wheel-twirling virtuosity, particularly in the wet, earned many fans. Nobody could get a Healey as sideways as him and retrieve it. At Snetterton in June, where he partnered son Jeremy to finish second in the AUTOSPORT 3 Hours, he was in his element. But he was not a one-trick pony, as three successive Monaco GP Historique Formula Junior victories in a Merlyn Mk5/7, plus Lotus 23B successes attested.

Former FIA Thoroughbred Grand Prix champion Michael Schryver, a friend and rival in FJunior and Guards Trophy sportscars, called him "the best person to race against; the one competitor you could always trust". Malcolm Verey, who enlisted Welch to share his Jensen 541R and Allard-Cadillac J2 at former co-driver Willie Green's suggestion, added: "Denis was inspirational in many ways. He looked after the machinery so beautifully, always had a smile on his face and was seriously quick."

His loss, and other fatalities over the past two seasons, has deepened a void which will refocus minds on the sport's inherent dangers. And, I suspect, urge a few drivers to hang up their helmets.
Marcus Pye

Racer killed in Classic crash

Lotus driver suffers fatal injuries in Pre-1966 GP crash at Silverstone

EXPERIENCED HISTORIC RACER Denis Welch died following an accident on the opening lap of last Sunday's Jack Brabham Memorial HGPCA Pre-1966 Grand Prix car race at the Silverstone Classic.

The 69-year-old Staffordshire driver, known worldwide for his prowess in Austin-Healeys, was racing Malcolm Ricketts's 1500cc Alfa Romeo-engined Lotus 18 when it was launched into a roll as the tight midfield pack bunched through the Loop. The car landed upside down on the edge of the track and its roll hoop was observed to have folded.

A statement from the organisers read: "The event organisers, the race organisation and the circuit's medical and emergency services will all now be cooperating with the police and the MSA, UK motorsport's governing body, to conduct a full investigation."

It is believed the incident was triggered when Welch's left-front tyre touched the right-rear wheel of Eddy Perk's similarly powered Heron. Both started from the back of the grid after retiring from Saturday's race.

"It all happened so quickly," said Perk. "Denis came past me on the right-hand side in the air. I think I saw the underside of his car."

The British-based Dutchman jumped from his undamaged car and ran to Welch's aid. "I was scared of fire," said Perk. "I was at Zandvoort in 1970 and Piers Courage's [fatal] accident happened in front of my eyes. I feared that again."

Marshals and medics were quickly on the scene, and carefully extricated Welch from the car. He was transferred to the circuit's medical centre, where he died.

Both cars involved – plus Italian Andrea Guarino's Lotus 18 and Alan

Baillie's Cooper, lightly damaged in peripheral incidents – were impounded for detailed inspection pending official inquiries.

HOOLE INJURED

The only other race stoppage on the 22-event bill came in Saturday's FIA Masters Historic Formula 1 round when veteran Sid Hoole's Ensign N173 speared left into the barrier before Village corner, then barrel-rolled. His team believes that a steering-arm failure caused the accident, which involved no other competitors.

Hoole, 70 – who has raced historic cars every season since 1972 – was initially taken to Oxford's John Radcliffe Hospital for body scans.

He was later transferred to Milton Keynes Hospital where surgeons operated on Sunday to repair a shattered knee, lower-leg fractures and associated ligament damage. He also suffered several broken ribs.

"It will be a long job but he'll be back," said wife Sue on Monday. "[Masters boss] Ron Maydon's been marvellous and everybody has been so helpful since Sid's accident. But my heart goes out to Tina [Welch], Denis's wife. We've known them 40 years and I cannot imagine what the family is going through."



Welch was racing Lotus 18 at the Classic



Pye (right) with Welch at the 2014 AUTOSPORT 3 Hours



AUTOSPORT EXCLUSIVE

Formula Renault UK to return for 2015

76

Formula Renault UK will be revived next season after a three-year hiatus, with organisers bringing the latest-specification car to Britain for the first time.

The current Tatuus-designed FR2.0/13, used in Renault's flagship Eurocup and also the Northern European Cup and ALPS categories, will form a two-tier championship alongside the pre-existing two-litre machines used in the club-level Formula Renault BARC series.

FR UK was axed before the start of the 2012 season due to a lack of interest, though FR BARC continued with the Tatuus chassis first introduced in 2000.

It experienced a surge in entries after the main championship's demise but grids have fallen in the two subsequent seasons and next year will be absorbed into the reintroduced UK championship as a secondary class.

The series will retain backing from existing title sponsor and tyre supplier Protyre, and offer separate titles for Class A and Class B.

BARC regulations blocked a similar two-tier plan in 2012 with the old Tatuus and the short-lived Barazi/Epsilon model introduced in 2010. Grovewood boss Simon North, whose company promoted FR UK before the SRO took over in 2011 and is behind the new plan as part of its current role in charge of FR BARC, said such a move was now vital.

"The championship as it is now has gone as far as it can," said North, who is targeting an even split of Class A and Class B car for 2015.

"It needs a new direction. We have recent history of this going very badly wrong. It needs to be different and reflect what's happening now.

"I've started from a blank sheet of paper, and talked to the teams to build it from the ground up again."

WORKING WITH EUROPE

AUTOSPORT understands teams provisionally agreed to the promoter's proposal ahead of last weekend's BARC meeting at Brands Hatch.

Traditionally domestic squads



Struggling FR BARC will be absorbed into FR UK as Class B

like Scorpio Motorsport are encouraged by the possibility of branching out into NEC and ALPS series, while ex-UK outfits such as Mark Burdett Motorsport are interested in returning (see panel).

"I think it's a proactive way of moving it forward," said Scorpio boss Jon Pettit. "We [the teams] all agreed it in principle and are positive because we can use it within different championships."

European single-seater and sportscar outfit Strakka Racing, which recently announced a move into two-litre Renault, has also said it would be open to running drivers in the UK.

Fortec Motorsports boss Richard Dutton welcomed the return of a fully-fledged UK championship and was confident it would work on a single-seater scene that will also include BRDC Formula 4 and a



FR UK will support NEC at Silverstone with the new car

BLANCPAIN



FR UK last ran in 2011

FORTEC, BURDETT BACK PLANS

SINGLE-SEATER POWERHOUSE
Fortec Motorsports has backed the reintroduction of Formula Renault UK, while it could also return Mark Burdett's eponymous squad to racing in Britain.

Fortec has continued to compete in the two-litre category in this country since the main series' demise in 2012, but this year has run only one car in FR BARC, for Alex Gill.

Richard Dutton, whose outfit has focused mainly on Eurocup, Northern European Cup and ALPS commitments, said the two-litre Renault ladder in Europe made sense for teams and the drivers.

"It's something I think will work and work well," he said. "Why

shouldn't it? There are already cars in the UK, probably 12 cars I should think, and it makes sense for drivers because they can do the British championship and go on to Europe."

Burdett, whose team runs BRDC Formula 4 champion Jake Hughes and Raoul Owens in NEC, said it was important for drivers to have the option of racing the current car in the UK. "It's very early stages but we'll look and see how it develops and we'll support it as much as we can," he said.

"I think Europe is the way to go but everybody has to learn racecraft somewhere. Some drivers spend all year testing those cars so it makes sense to have it in the UK."

FORMULA RENAULT SPEC

CHASSIS	Tatuus-built FR2.0/13
ENGINE	two-litre Renault
BRAKES	Caparo AP
POWER	210bhp
GEARBOX	SADEV seven-speed
WEIGHT	505kg (unloaded)



"We have recent history of this going very badly wrong but this has started from a blank sheet of paper"

Simon North, FR BARC promoter (right)

revised British Formula Ford championship run to new FIA Formula 4 regulations.

"British Renault was very strong for many, many years and it was very sad when it died," said Dutton. "It would be very good to have it back. We'll definitely support it again. It will definitely work."

"You've got a stepping stone for drivers with Formula Renault. They can stay with the same car for two or even three years – like you used to in the old days of FR UK."

Burdett, whose eponymous squad is a European Formula Renault regular but has not competed in the UK since the main championship folded, said that Britain's transitional



single-seater scene made it hard to gauge exactly how the series would be received but agreed the formula's popularity proved it had a place in the UK.

"I think there's definitely a market for it," he said. "Where it sits in the UK I'm not 100 per cent sure but it used be one of the strongest championships and that was only three or four years ago."

MANAGING BUDGETS

Top-level Formula Renault UK budgets before it was axed were around the £200,000 mark when it held a regular slot supporting the British Touring Car Championship.

The calendar will likely comprise

six triple-headers, while Class A (for newer cars) will have a seventh round as part of the Northern European Cup on the Silverstone Grand Prix circuit, similar to the previous-generation series' Eurocup slot at the same circuit.

It is hoped that the FR BARC's one-off position on the Silverstone TOCA package will be retained, and become one of the six core meetings. The aim is that having five standalone events will keep costs significantly lower than before.

"The entry fees were very high at the time and three- or four-day meetings makes it more expensive," said Dutton. "If it's cost-effective [this time around], it will help."

Pettit said he was optimistic budgets would not spiral to previous heights.

"The new car we're talking £60,000, which will have to be taken into the driver's budget, but I think it's still going to be realistic."

"If it's a six-round championship it's not going to be far off £100,000 and it will sit in that place where I do believe there is a market."

SCOTT MITCHELL
ASSISTANT EDITOR

scott.mitchell@haymarket.com
@ScottMitchell89



JUST WHEN YOU THOUGHT THE

single-seater scene in Britain was braced for a straight 'Battle of the F4s' next season, Renault enters the ring. That the old Tatuus warhorse is finally preparing for the end is not surprising – revival of the French marque's flagship UK series is.

It's bold, and means there will still be three mainstream junior single-seater categories next season, but there is merit in the proposal.

Renault's two-litre category has been at the top of the junior single-seater tree in Europe for a few years now, and it was not that long ago we thought the same of it over here in terms of sub-Formula 3 series.

A proven car was the bedrock of the category's success in its previous life and you can't underestimate the value of a series that has a car with serious development mileage. The 'new' Tatuus and a more streamlined calendar (to make sure costs don't spiral like before) could return those former glories.

Consider as well that the new British Formula Ford car will be slower in 2015 because its EcoBoost engine has to be detuned to fit in with the FIA F4 regulations the championship will embrace from next season. Jonathan Palmer's BRDC Formula 4 has not pretended to be anything other than an entry-level category (a strategy that has paid off so far) and the pace of the car reflects that relative to FR.

The new Tatuus will likely be several seconds a lap quicker than the others, depending on the circuit, meaning FR UK could work as a second domestic step on the ladder. Does the UK need that? Possibly not. We saw (and continue to see in Europe) how good the Tatuus is for drivers making the jump from karting, so it's not like FR UK would be daunting to rookies. But budget decides a young driver's next move more often than talent and the benefit of attracting both first- and second-years is clear to see.

It's naive to think these series will not take drivers away from one another, and FR UK will have to work to become top dog in Britain again, but perhaps the more significant scrap will be fought out below. So where does that leave us? Ah, yes – the Battle of the F4s...

Will FR UK affect F4 battleground?



Henry Surtees Challenge, Buckmore Park, 8 October 2014

A Race You Can't Afford To Miss

Now in its fourth year, this unique, annual event brings together the best of young motorsport talent to compete for a fantastic array of prizes, that will aid them in their race programme preparation for 2015. Importantly, the Challenge also raises much needed funds to support the work of the Henry Surtees Foundation (HSF); saving lives, improving quality of life for people with injuries and inspiring young people to fulfil their potential. In the first twelve months of the new HSF-supported service, Kent, Surrey and Sussex Air Ambulance have performed 69 emergency blood transfusions.

The Challenge will once again be using the superb Club100 Birel karts and seeks to attract karters, with cars in mind, and for returning racers from all classes of motorsport wishing to progress their career. Drivers must hold an MSA National B licence and be in their 16th year or above, be a member of Club 100 Premier and Clubman Spirit members or a Buckmore Park Elite driver. Entry costs £500.

A list of the superb prizes awarded in 2013:

- A full kit of Puma race clothing – 1 suit, 3 pairs



of gloves, 2 pairs of shoes and 3 pairs of lifestyle shoes for the winner – donated by Puma SE

- 2 pairs of lifestyle shoes for second place – donated by Puma SE
- 1 pair of lifestyle shoes for third place – donated by Puma SE
- Visit to Red Bull Racing in Milton Keynes for a maximum of four people, with a half day simulator experience for two people and evaluation by an F1 race engineer, donated by Christian Horner
- A fully-funded race drive in the Michelin Clio Cup Series with Protyre's upcoming 'Autumn Cup' event. The winner also has the opportunity to secure an assisted drive in the 2014 Michelin Clio Cup Road Series.
- Test Day, donated by Ginetta
- Formula Renault Eurocup Test with Manor Competition
- A test for two drivers in Eco Boost Formula Ford cars. The two winners will each be offered a full day of testing, including both video and data analysis with Falcon motorsport in conjunction with Ford
- A BARC Formula Renault or BRDC Formula 4 test, donated by Hillspeed
- GP3 test in Abu Dhabi, donated by Carlin Motorsport. Travel and accommodation donated by others
- An Arai GP6 S helmet prepared and painted to drivers own design – donated by Arai
- Shell Pilota Experience at Ferrari, Maranello, Italy – driving on their Fiorano test track plus visit to the F1 facility – donated by Shell. Travel arrangements made and donated by Travel Places
- A pair of VIP F1 tickets for British Grand Prix including Paddock entry - donated by Bernie Ecclestone
- A supply of Teng Tools to the value of £1,000.00 - donated by IQ Supplies (Teamvise Limited)
- Motorsport custom-fit Driver Communication Earpieces together with Hearing Healthcare Package – donated by Hearing Electronics Limited valued at £500



- A session on a simulator at iZone - donated by Andy Priaulx
- Full website package and online branding, plus a three month social media package, donated by 5G Creative
- A pair of tickets to the Autosport Awards, December 2013 – donated by Haymarket Publications



British GT

Sharp leaves Ginetta squad

GINETTA ACE TOM SHARP HAS quit the manufacturer's customer British GT squad and is hoping to complete the season in another GT3 team.

Sharp, 23, has endured a difficult first two seasons in British GT with the IDL-CWS G55 team since graduating to the series as Ginetta GT4 Supercup runner-up in 2012.

The BRDC SuperStar still wants to contest the final two rounds at Brands Hatch and Donington Park.

"It's been very difficult for a number of reasons, and I just need to be in a car that gives me the best possible chance of a result in the last two rounds," said Sharp. He has also not ruled out working with

former team-mate Colin White again, but said their partnership was "up in the air".

He added: "Brands is my favourite track and it's a big weekend for me. I can bring a budget and my main objective is to stay in GT3 in a car that I think can win it."

Sharp won 20 races in two seasons of racing in the flagship Ginetta category, but has registered a best finish of only eighth since moving into British GT and has had six retirements in 18 races.

The Briton was running fourth during the last round at Spa-Francorchamps when the car's left-rear wheel broke at Eau Rouge. He and White had earlier been penalised for an on-track collision during White's stint.



G55 has struggled to get results this year

EBREY/LAT

British GT

British GT set for live TV in 2015

BRITISH GT COULD HAVE LIVE TV coverage for every round next season, according to SRO boss Stephane Ratel.

This year, only the Silverstone 3 Hour race in June was due to be shown live on Motors TV, although the coverage was delayed and shown 'as live', while highlights packages appear on BT Sport and Channel 4.

Ratel said: "The series is now at the level where it deserves live television coverage, and we are trying to make that happen for next season. That is our intention, but we do not know how we are going to make it happen. We only know that we want to make the championship better."

Ratel also wants to reinvigorate the GTC class for one-make Porsche 911 GT Cup, Lamborghini Gallardo Super Trofeo and Ferrari 458 Challenge racers.

The move is part of his tentative plan to run separate races for the GT4 class at some races next season.

The GTC cars would join the main grid of GT3 machinery when the GT4 cars have separate races, while all three classes would race together at circuits such as Silverstone and Spa where there is greater pits capacity.



HAWKINS

In brief

Smith out after shunt

British Touring Car and GT podium finisher Jeff Smith was ruled out of the second Clio Cup Series race at Brands Hatch last weekend. The 48-year-old was unhurt in a huge race-one crash, which did considerable damage to his car (pictured).

Kents to headline again

The Formula Ford Festival at Brands Hatch will again be headlined by Kent-engined cars this season, organisers have confirmed. The October 25-26 event will include four FF1600 classes (Post-'89, Pre-'90, Pre-'82 and Pre-'72), as well as the final rounds of the Fiesta, Fiesta Junior, Irish Fiesta and Sports 2000 championships.

Turkington is class act

British Touring Car Championship leader Colin Turkington took a class podium on his historic racing debut at the Silverstone Classic last weekend. The 2009 BTCC champion qualified his Sam Thomas Racing-prepared BMW CSL fourth in class and 29th overall for the Super Touring Car Trophy. He then moved up to 20th overall and third in the over two-litre Group 2 class in Saturday's race.

Bryant in SVR Ginetta

Ex-British GT racer and double Scottish Ford Fiesta champion Rory Bryant will race in the Ginetta GT4 Supercup round at Knockhill on August 23-24. SV Racing, new to the championship this season but second in the drivers' standings with David Pittard, has recently purchased a second G55, which Bryant will drive.

Kenyan's RX outing

Tejas Hirani made his rallycross debut at Pembrey, finishing second in the RX150 final behind Marc Scott. The 16-year-old Kenyan took part in the event after his uncle witnessed the category supporting the world championship at Lydden Hill in May.

Carrera Cup GB

Aussie ace to Carrera Cup GB

AUSTRALIAN GT CHAMPIONSHIP leader Richard Muscat will contest the Porsche Carrera Cup GB rounds at Snetterton this week, while Chevron driver Jordan Witt will also join the series.

Muscat, who raced in the Spa 24 Hours last weekend with the Black Falcon Mercedes team, is a protege of the Erebus squad that competes in V8 Supercars. The Aussie Porsche GT3 Cup Challenge champion will be run by Redline Racing for the August 2-3 meeting at the Norfolk track and has already tested the new 911 there.

"We finished the Snetterton test where I was hoping to be," said Muscat. "I learned a lot that I can take into the race weekend. Hopefully, we can challenge for a win."

Witt, who helps develop the Chevron GT racers, will join Muscat at Redline.



Newey Jr has eye on F4

HAWKINS

BRDC F4

Newey Jr tests BRDC F4

THE KARTING SON OF RED BULL Formula 1 technical guru Adrian Newey is looking at a move into BRDC Formula 4 next season.

Harri Newey, who races in German KF2, tested with frontrunning F4 squad Douglas Motorsport at Brands Hatch last Friday, his 16th birthday.

Newey will test the car again in August and is eyeing participating in

the F4 Winter Series with a view to a full 2015 campaign.

"I'm considering this championship for next year," he said. "It makes sense to do it, but nothing's decided."

Meanwhile, Arden-backed Young Racing Driver Academy find Omar Ismail is also weighing up a 2015 graduation from karts, sampling the series' test car at Bedford Autodrome.

Comprehensive motorsport insurance products to keep you on track;

- ✔ Worldwide On Track
- ✔ Personal Accident
- ✔ Storage and transit
- ✔ Track day
- ✔ Liability
- ✔ Commercial

Please complete an online quote request form at – www.ryanmi.com
Email – info@ryanmi.com Tel – +44 (0)1799 524202

Ryan Motorsport Insurance Limited is an appointed representative (557405) of Independent Broking Solutions Limited who are authorised and regulated by the Financial Services Authority, registration number 312026





MGR driver made it five wins in a row

FORMULA RENAULT BARC BRANDS HATCH, JULY 26-27 BARC

Fittipaldi gives rivals the full Brazilian

TWO STYLISH WINS AT BRANDS HATCH on Sunday by Pietro Fittipaldi took his season's tally to six and strengthened his position at the top of the Formula Renault BARC drivers' standings.

The Surrey-based Brazilian, who took a win on the Grand Prix circuit at Brands in the BRDC Formula 4 series last season, was never headed as he led home Matteo Ferrer in each contest on the Indy layout.

Italian Ferrer had taken pole for race one from Fittipaldi and initially appeared to get the best getaway. At Paddock on the opening lap though,

Fittipaldi swept around the outside and grabbed a lead he would never surrender. "I knew I had to get ahead at the start as this is where the race could be won," said the winner.

As the field continued on the first tour, Colin Noble tangled with Piers Hickin, spearing Hickin's car into heavy contact with the barriers along Cooper Straight and bringing out the safety car.

Once racing resumed, Fittipaldi saw off Ferrer's challenge and won by just over 2.6 seconds, while Alex Gill claimed third ahead of Tarun Reddy,

Fittipaldi made the most of his pole position in race two, blasting into an immediate lead. Ferrer led the chase in second, pursued by Gill and Hickin, his team having done a great job to get his car repaired in time for the second encounter.

Hickin, who had arrived at Brands second in the points, rewarded his team's efforts by grabbing third from Gill with a fine move at Paddock on lap 11 of 24.

As Fittipaldi eased to his second success of the weekend, Hickin began to close down Ferrer, who was

struggling with tyre wear.

The Brit closed the gap to 0.7 seconds by the finish, but was unable to take the place.

● Mark Libbeter

RESULTS (27 LAPS) 1 Pietro Fittipaldi 23m26.837s (83.45mph); 2 Matteo Ferrer +2.683s; 3 Alex Gill; 4 Tarun Reddy; 5 Patrick Dussault; 6 Travis Jordan Fischer.

Fastest lap Ferrer 46.442s (93.63mph).

RACE 2 (24 LAPS) 1 Fittipaldi 18m45.039s (92.76mph); 2 Ferrer +3.721s; 3 Piers Hickin; 4 Gill; Dussault; 6 Reddy. **FL** Hickin 46.277s (93.96mph).

JUNIOR SALOONS BRANDS HATCH, JULY 26-27 BARC

Oh it's such a perfect Day

A FIRST-RACE SAFETY-CAR PERIOD and a red flag in race three could not deter Alex Day from netting three highly impressive wins.

Day won the first race on Saturday by nearly five seconds from James Dorlin, who jostled hard with Ben Colburn throughout. In the second event, Colburn went one better, making the decisive move on Ben Mills for second.



Day netted Brands treble

The third, non-championship, event was stopped after two laps following a shunt at Graham Hill bend involving Benn Tilley and Brad Hutchinson.

Day capped his perfect weekend by winning the restarted race after taking the lead at Druids on lap three, before leading home Colburn and Dorlin.

● Mark Libbeter

RESULTS (15 LAPS) 1 Alex Day 16m21.963s (66.42mph); 2 James Dorlin +4.966s; 3 Ben Colburn; 4 Charlie Morgan; 5 Edward Moore; 6 Ben Mills. **FL** Day 1m00.200s (72.23mph).

RACE 2 (16 LAPS) 1 Day 16m12.544s (71.54mph); 2 Colburn +1.960s; 3 Mills; 4 Morgan; 5 Dorlin; 6 Benn Tilley. **FL** Mills 59.916s (72.57mph). **RACE 3 (11 LAPS) 1 Day;** 2 Colburn; 3 Dorlin; 4 Morgan; 5 Moore; 6 Tom Stockton. **FL** Day 59.860s (72.64mph).

MAZDA MAX 5 BRANDS HATCH, JULY 26-27 BARC

Loversidge wins thriller at the flag

THE SECOND MAZDA MAX 5 RACE AT Brands Hatch on Sunday ended in thrilling style as Ian Loversidge denied Paul Roddison a double success within yards of the finish.

Roddison was unbeatable in the first encounter, winning comfortably from championship pacesetter Jonathan Cryer and Jonathan Halliwell, while Loversidge charged through from the fifth row of the grid to fourth by the end.

Cryer briefly led at the start of race two, before Roddison retook the initiative by Paddock on the second lap. Behind, Loversidge was making rapid progress. Having got ahead of Halliwell and Cryer, he closed right



Loversidge prepares to attack Roddison

up to Roddison. On the penultimate lap Loversidge briefly took the lead at Clearways, but Roddison was back in front by Paddock. Loversidge then repeated the move last time around and edged out Roddison by a mere 0.071 seconds at the flag.

● Mark Libbeter

RESULTS (18 LAPS) 1 Paul Roddison 20m07.192s (68.44mph); 2 Jonathan Cryer +2.331s; 3 Jonathan Halliwell; 4 Ian Loversidge; 5 Geoff Gouriet; 6 Thomas Collins. **Class winner** Amy Barker. **FL** Loversidge 57.209s (76.01mph). **RACE 2 (21 LAPS) 1 Loversidge 20m20.255s (74.83mph);** 2 Roddison +0.071s; 3 Cryer; 4 Halliwell; 5 Gouriet; 6 Collins. **CW** Barker. **FL** Loversidge 57.102s (76.15mph).

KUMHO BMW BRANDS HATCH, JULY 26-27 BARC

Dominant Wrigley a fresh winner

FORMER CHAMPION COLIN WELLS scored his third win in three starts in race one at Brands on Saturday, but Tom Wrigley denied him a double with a dominant success in the second contest on Sunday.

After the first start had to be aborted due to mechanical problems for Stephen Lanfermeijer's E36 M3, Wells led away from pole hounded by Wrigley and Mike Hibbert. A sideways moment at Clark Curve later around the lap dropped Hibbert back to fifth, handing third to Peter Seldon and fourth to Karl Skitt.

Wells and Wrigley pulled clear of Seldon thereafter, while Hibbert worked his way back into fourth by passing Skitt on lap seven of 23. The top three remained unchanged until the flag, but Skitt would reclaim fourth when Hibbert was penalised for exceeding track limits.

Wrigley cantered to victory in race two, having got ahead of Wells by the end of the second tour. Seconds later, third-placed Seldon spun exiting Graham Hill Bend. As he recovered, a fabulous five-car battle for the last podium slot ensued.



Skitt headed the tussle, but was relieved of the position by Hibbert on lap 11 at Graham Hill Bend. A brief excursion into the Paddock gravel would relegate Skitt to seventh, allowing Jim Cannon, Lanfermeijer and Seldon through respectively.

In the races for Classes B-D, Darren Morgan-Owen beat Robert Salisbury to overall victory in the opener after coming out on top in a race-long duel for the lead.

Further back, Dave Heasman and Paul Travers enjoyed an exciting battle for the lead in Class C until

colliding at Clearways at half-distance, handing the class win to Alan Thompson.

Salisbury reversed the result in race two, leading home Morgan-Owen and double podium man Dominic Surdi. ● Mark Libbeter

RESULTS CLASS A (BOTH 23 LAPS) 1 Colin Wells (M3 CSL) 20m19.780s (81.99mph); 2 Tom Wrigley (E36 M3) +2.392s; 3 Peter Seldon (E36); 4 Karl Skitt (1 Series); 5 Jim Cannon (Series 1); 6 Colin Whitmore (E36). **FL** Wells 52.409s (82.97mph). **RACE 2** 1 Wrigley 20m15.159s (82.30mph);

2 Wells +4.093s; 3 Mike Hibbert (E36 M3); 4 Cannon; 5 Stephen Lanfermeijer (E36); 6 Seldon. **FL** Wrigley 51.570s (84.32mph). **RESULTS CLASSES B, C & D (BOTH 22 LAPS)** 1 Darren Morgan-Owen (E36) 20m20.172s (78.40mph); 2 Robert Salisbury (M3) +4.520s; 3 Dominic Surdi (M3); 4 Adrian Gilbert (E36); 5 Alan Thompson (E36 328i); 6 Dave Heasman (328i Saloon). **CW** Thompson; Greg Marking (318is). **FL** Morgan-Owen 54.417s (79.91mph). **RACE 2** 1 Salisbury 20m09.753s (79.08mph); 2 Morgan-Owen +0.661s; 3 Surdi; 4 Heasman; 5 Paul Travers (328i Coupe); 6 Gilbert. **CW** Heasman; Marking. **FL** Morgan-Owen 54.055s (80.44mph).

CLIO CUP SERIES BRANDS HATCH, JULY 26-27 BARC

Robinson eases to double

MIKE ROBINSON ENHANCED HIS position at the top of the Renault Clio Cup Series points with two victories at Brands Hatch last weekend, controlling both races from start to finish.

Robinson led race one from pole position, chased by Jeff Smith, Smith's son Brett, Paul Streater and David Dickenson. The top five ran close together in the early stages before Smith Jr spun at Surtees on lap 10.

Streater grabbed second from Smith Sr on the same lap, while Smith Jr recovered, climbing back to seventh by the end of the race.

Soon after, Dickenson forced his way past Smith Sr before the BTCC and British GT podium finisher

lost control of his car between Paddock and Druids and crashed hard into the outside barriers, prompting a race stoppage. After extricating himself from the car, Smith was taken to the medical centre for precautionary checks.

Robinson was declared the winner of the shortened event from Streater and Dickenson, who scored his first podium finish since taking a win at Oulton Park in mid-May.

"Thankfully, I made a good start and I could then control the race from there," Robinson said afterwards.

Accident damage, plus aggravation of an ankle injury, ruled Smith Sr out of the second contest, a race Robinson again led from the start. Dickenson followed close behind, staving off



Smith Jr and Streater. By lap three, Streater had lost fourth to Luke Herbert before Tom Butler slid off at Clearways, bringing out the safety car.

Once racing resumed, Robinson continued to assert his authority on the race and kept his nerve to score his second win of the weekend from Dickenson and Smith Jr.

Fifth-placed Ollie Pidgley took victory in the Sport class in race one ahead of Peter Bennett. Bennett took the spoils in race two though as Pidgley was pitched into a spin on Cooper Straight in the closing laps.

Despite dropping to third on the opening lap, Anton Spires fought back to win the first of two separate Road

Series encounters, leading home Luke Pinder and Jessica Hawkins.

Spires dropped back to third again in Sunday's contest, but was unable to overhaul Nic Harrison, leaving Pinder to win convincingly. ● Mark Libbeter

RESULTS (12 LAPS) 1 Mike Robinson 10m55.951s (79.55mph); 2 Paul Streater +1.854s; 3 David Dickenson; 4 Luke Herbert; 5 Ollie Pidgley; 6 Peter Bennett. **CW** Pidgley. **FL** Streater 53.636s (81.07mph). **RACE 2 (21 LAPS)** 1 Robinson 21m23.835s (71.13mph); 2 Dickenson +1.169s; 3 Brett Smith; 4 Herbert; 5 Streater; 6 Brett Lidsey. **CW** Bennett. **FL** Bennett 53.455s (81.35mph).





Champion Godfrey was one of only two finishers

BRITISH RALLYCROSS CHAMPIONSHIP PEMBREY, JULY 26-27

Godfrey wins again in attritional final

REIGNING BRITISH RALLYCROSS champion and current series leader Julian Godfrey has been crying out for more competitors in the Supercar division all season. And for the fourth round at Pembrey in South Wales, his wish was granted.

Ten cars entered the event, and Irish ex-title winner Ollie O'Donovan set fastest time in both of the first two heats to sit his Ford Focus on pole position for the final, alongside Andy Grant, with Godfrey on the outside of the front row. Steve Harris and the returning Pat Doran claimed row two.

O'Donovan made the best start, followed by Godfrey's Fiesta as Doran lunged his Citroen down the inside of both at the first corner. He made contact with O'Donovan, damaging their cars and allowing Godfrey to sneak through to lead ahead of last qualifier Colin Anson and Harris. Grant's Focus, meanwhile, was stuck at the start with a differential failure.

Doran pulled off on lap one, while O'Donovan ran at the back of the field ahead of Steve Hill, who had

also got caught up in the first-corner drama. Harris's Focus then lost its left-rear wheel at the start of lap two, putting him out of the race and bringing out the red flags.

With the remaining cars back in parc ferme and no engineers allowed to work on their machines before the restart, only the three undamaged cars of Godfrey, Simon Horton and Anson eventually made it back to the grid. Godfrey claimed the first corner and pulled out a lead of more than 30 seconds over Horton in the five laps, while Anson retired on the final tour.

Godfrey has been desperate to be forced to work for his fourth title in succession, but he also has a knack of keeping his nose clean and staying out of trouble. "That was quite easy in the end," he said. "It would have been better if there had been more cars out in the restart to make it more of a race, but that's the way it is."

"Ollie got a good start in the first one, I tucked up behind him, then we braked, but Pat came down the inside of both of us and as Ollie turned into



Corner won in Supernational

the corner they made contact.

"For sure it's looking good for the championship now, especially with Steve [Harris] not doing so well."

Guy Corner led the first lap of the SuperNational final, but spun his Peugeot at the start of lap two, handing the lead to Mike Howlin's Fiesta. Corner recovered to third, and quickly passed points leader Stuart Emery for second. Over the following two laps Corner consistently closed the gap to Howlin and made a brave move on the final loose section of the

last lap to seize the lead and his maiden victory. Howlin was second ahead of the Corsa of Allan Tapscott.

Current champion Graham Rodemark took victory in the Swift Sport Category, while Charlie Bean beat title rival Drew Bellerby in the Junior Swifts. Marc Scott again dominated the RX150 division, and Polish driver Tomasz Marciniak won a closely fought Hot Hatch final. Ray Morgan earned himself another Retro Rallycross win.

● Hal Ridge

RESULTS

SUPERFINAL (ALL 5 LAPS) 1 Julian Godfrey (Ford Fiesta) 4m29.762s; 2 Simon Horton (Subaru Impreza) +33.103s; no other finishers.
POINTS 1 Godfrey, 86; 2 Steve Harris, 55; 3 Steve Hill, 39; 4 Horton, 32; 5 Ollie O'Donovan, 29; 6 Colin Anson, 27

SUPERNATIONAL 1 Guy Corner (Peugeot 206) 5m12.817s; 2 Mike Howlin (Ford Fiesta) +1.098s; 3 Allan Tapscott (Vauxhall Corsa); 4 Gary Dixon (Vauxhall Astra); 5 Vincent Bristow (BMW 328); 6 Stuart Emery (Peugeot 206).

SUZUKI SWIFT 1 Graham Rodemark 5m24.055s; 2 Tristan Ovenden +0.745s; 3 Chris Mullen; 4 Darren Scott; 5 Jack Brown; 6 Rob Maynard. **JUNIOR SWIFT 1 Charlie Bean**

5m51.009s; 2 Drew Bellerby +1.030s; 3 Jennie Hawkes; no other starters. **SUPER1600 1 Phil Chicken (Citroen C2);** 2 Jack Thorne (C2); no other starters. **RX150 1 Marc Scott 5m04.537s;** 2 Tejas Hirani +9.555s; 3 Jake Harris; 4 Kevin Feeney; 5 Adam Sargent; 6 Larry Sargent.

HOT HATCH/MINI 1 Tomasz Marciniak (Citroen Saxo) 5m24.800s; 2 Jeff Hope-Davies (Saxo) +1.146s; 3 Mariusz Mehlberg (Peugeot 106); 4 Craig Lomax (Saxo); 5 David Bell (Mini); 6 Rebecca Ryder (Mini). **Class winner Bell.**

RETRO RALLYCROSS 1 Ray Morgan (Ford Escort) 4m09.707s; 2 Barry Stewart (Porsche 911) +1.067s; 3 Marc Griffin (Ford Fiesta); 4 Ian Biagi (Mini Clubman); 5 Paul Smith (VW Polo); 6 Lance Foster (Rover Mini).

Poleman O'Donovan was hit at Turn 1



PRE-'83 TOURING CARS CADWELL PARK, JULY 26-27 BARC

Escort man defeats the mighty Jaguars

CHAMPIONSHIP LEADER STEPHEN

Primett secured another double win in his Ford Escort, but was kept on his toes in both races by a determined Andrew Harrison (Jaguar XJS).

Primett just managed to hold the lead into Charlies on the opening lap of race one, with Harrison on his tail and David Howard's Jaguar XJ12 close too. It only took a couple of laps, however, for Howard to lose contact with the lead duo, who continued nose to tail until the final laps.

On occasions Harrison had a nose

inside, but found Primett's defence too tight. "He dances that Escort perfectly around this circuit," confessed Harrison.

The winning margin was over three seconds, which didn't really reflect Harrison's efforts, while Howard was a subdued and solitary third. Behind, David Osborne's Triumph Dolomite Sprint kept Mark Fowler (Ford Capri) at bay during their race-long duel.

Harrison rocketed away from the start of race two, with Primett fighting for second with Osborne and

Howard. Osborne held the place exiting Charlies, but was passed by Primett at Park before Howard followed at the start of lap two.

As they approached the Mountain for the second time, Primett made an audacious dive down the inside of Harrison to catch the leader unawares and emerged in front.

Gradually the advantage became decisive, with Harrison losing second to Howard as they started the penultimate lap. Osborne and Fowler continued their earlier duel, but Fowler got the verdict on this occasion, having darted ahead into Park on lap seven. Nic Strong's Capri settled into sixth.

● Peter Scherer

RESULTS (BOTH 9 LAPS) 1 Stephen Primett (Ford Escort) 15m50.496s (74.54mph); 2 Andrew Harrison (Jaguar XJS) +3.424s; 3 David Howard (XJ12); 4 David Osborne (Triumph Dolomite Sprint); 5 Mark Fowler (Ford Capri); 6 Nic Strong (Capri). **CW** Harrison; Fowler; Neil Bray (Ford Fiesta); Allan Weyman (Chevrolet Camaro). **Fastest lap** Primett 1m44.007s (75.69mph). **RACE 2 1 Primett 15m44.728s (75.00mph);** 2 Howard +5.013s; 3 Harrison; 4 Fowler; 5 Osborne; 6 Strong. **CW** Howard; Fowler; Bray. **FL** Primett 1m42.990s (76.44mph).



THUNDER SALOONS, CLASSIC SALOONS & HISTORIC TOURING CARS CADWELL PARK, JULY 26-27 BARC

Robinson swoops to mighty Falcon double

ANDY ROBINSON'S MIGHTY V8 FORD

Falcon rumbled to a dominant winning double, but there was plenty of action behind.

The Escort Cosworth of Dave Cockell and Vaughan Fletcher's Impreza led the initial chase. But as Cockell made second secure, Fletcher suffered handling problems that left Adie Hawkins (Alfa Romeo 33) and the BMW M3 of Garrie Whittaker harassing him. Hawkins had third from lap six, but Fletcher seemed set to hold off Whittaker until a last-lap spin at Park reversed the positions.

Robinson and Hawkins both got the jump on Cockell at the start of race two after the Escort driver missed a gear. Whittaker joined in and gradually their duel allowed

Fletcher to challenge and secure third into Coppice on the penultimate lap.

Paul Bellamy and Des Thresh had a terrific duel in their BMWs, and deservedly shared their class wins.

Four-car battles lit up both Historic Touring Car races, but Eifion Jones's Lotus Cortina just had the edge to make it a double victory.

Phil Manser's Mini started from race-one pole, but couldn't hold on to Jones from the start. Richard Sprigg (Anglia) and Andy Messham (Mini) joined them and continued to battle line astern for most of the race.

Manser tried every manoeuvre to unseat Jones, but had to accept second place. Sprigg and Messham dropped back to engage in their own sparring match, which went

Messham's way on the last lap.

Manser did manage to nose ahead of his rival in the second race, which proved equally close again for all four cars. Sprigg was successful in reversing his earlier defeat at the hands of Messham.

● Peter Scherer

RESULTS THUNDER SALOONS (BOTH 10 LAPS) 1 Andy Robinson (Ford Falcon) 15m49.521s (82.91mph); 2 Dave Cockell (Ford Escort Cosworth) +3.125s; 3 Adie Hawkins (Alfa Romeo 33); 4 Garrie Whittaker (BMW E36 M3); 5 Vaughan Fletcher (Subaru Impreza); 6 Andy Robey (M3). **CW** Cockell; Hawkins; Paul Bellamy (M3). **FL** Robinson 1m33.748s (83.98mph). **RACE 2 1 Robinson 15m46.133s (83.21mph);** 2 Hawkins +4.366s; 3 Fletcher; 4 Whittaker; 5 Cockell; 6 Robey. **CW** Hawkins; Fletcher; Des Thresh (M3). **FL** Robinson 1m32.700s (84.93mph). **CLASSIC SALOONS AND HISTORIC TOURING CARS (BOTH 8 LAPS) 1 Eifion Jones (Lotus Cortina) 15m27.548s (67.90mph);** 2 Phil Manser (Austin Mini Cooper) +0.654s; 3 Andy Messham (Mini Seven); 4 Richard Sprigg (Ford Anglia 105E); 5 Tony Preston (Morris Minor); 6 Steve Barber (Ford Anglia). **CW** Manser; Preston; Pietro Caccamo (Lancia Fulvia); Stuart Radford (Triumph 2000). **FL** Messham 1m53.647s (69.27mph). **RACE 2 1 Jones 15m23.318s (68.21mph);** 2 Manser +0.631s; 3 Sprigg; 4 Messham; 5 Preston; 6 Barber. **CW** Manser; Preston; Caccamo; Radford. **FL** Sprigg 1m53.212s (69.54mph).



Cadwell in brief

Pre-'93 Touring Cars

Jack Stanford's BMW M3 headed home father Roger's similar car in both races at Cadwell. Stanford Jr (pictured) led the first from start to finish, before taking the lead at Park on the fourth lap of race two, which ended chaotically when the safety car split the field in two. David Hickton and Ryan Gorman fought for third, each taking a podium place.

Classic FFord 2000

While Chris Lord fended off Ian Pearson in the first race at Cadwell, Paul Wighton eased away to a dominant win. Pearson fought his way past Lord approaching the Mountain on lap five, but his engine let go four laps later and handed the place back to Lord. In race two Lord chased Wighton all the way to the flag in vain, despite a missed gear for Wighton near the end.

Blue Oval Saloons

With frontrunners Craig Rainer and Pantelis Christoforou out after a collision at the start, barely half the field took the restart at Cadwell. Gary Wait's Escort Cosworth shot off like a missile in both races, but Jason Davies's patience paid off and his Sapphire Cosworth took a dominant double win. Despite a spin at Hall Bends, Wait held on to second from the rapidly closing Rainer.

Citroen 2CV

Caryl Wills just held off Pete Sparrow to take the first race win after a hectic battle as Richard Lambert and Lien Davies looked on. Kris Tovey dominated the second race from the opening lap, with only Matt Lambert close after Peter Rundle had mechanical problems. Mick Storey was left a distant third.

Classic FFord 1600

Mike Gardner (pictured) made it eight wins in a row in his Crossle 30F, but his double victory this time was made all the harder when he spun away the lead in race one as he crested the Mountain. Stuart Kestenbaum's Van Diemen retired from the lead with a broken driveshaft, leaving Leandro Guedes just holding off Andrew Smith for second, before Smith reversed the positions in race two.



Smith fends off
Belsey's Spyder



FORMULA VEE ANGLESEY, JULY 26-27 750MC

Smith back on lead form as Vees thrill

ALL PICS: STEVE JONES

THE FORMULA VEE CHAMPIONSHIP put on an impressive spectacle on Anglesey's Coastal Circuit, with multi-car lead battles and some excellent overtaking moves on show.

Paul Smith put to bed his reliability gremlins and bad luck in his title defence to deliver his first victory of the year in a hectic race one.

Smith had a great start from pole position, but lost the lead to outside-front-row man Martin Farmer at Rocket on the first lap.

That closed up the leaders and instigated a four-way battle for the

lead, with Peter Belsey and Daniel Pitchford joining the fray. The four men jostled for position but, after a brief spell in the lead for Belsey, Smith sneaked away to win by 1.78s at the finish.

Pitchford fought past Belsey with a lap to go to take second, with Farmer – struggling with understeer – settling for fourth having missed a gear entering Rocket. The race ended under red flags with cars littered all over the outside of the track after a series of late incidents.

Race two featured a more reserved

start as the top four remained steady for the first segment, with Smith leading Farmer, Belsey and Pitchford. Farmer passed Smith on lap six, which started a lap-by-lap lead change between the duo, who constantly towed each other out of Church and up the hill towards Rocket.

Neither appeared to want to lead the race on the final lap and become a sitting duck for slipstreaming, but Farmer gambled and defended magnificently at Rocket to fend off Smith for the win.

Pitchford and Belsey rounded out

the top four, with Peter Studer taking fifth and Class B honours in both races.

● Jack Benyon

RESULTS (9 LAPS) 1 Paul Smith (AHS Dominator) 11m23.99s (73.42mph); 2 Daniel Pitchford (AHS GAC) +1.78s; 3 Peter Belsey (Spyder Mk2); 4 Martin Farmer (GAC); 5 Peter Studer (Sheane Jordan); 6 Ian Jordan (Sheane Jordan). **Class winner Studer. Fastest lap Smith 1m14.92s (74.48mph).** **RACE 2 (12 LAPS) 1 Farmer 15m08.65s (73.69mph);** 2 Smith +0.42s; 3 Pitchford; 4 Belsey; 5 Studer; 6 Jordan. **CW Studer. FL Belsey 1m14.70s (74.70mph).**

CIVIC CUP ANGLESEY,
JULY 26-27 750MC

No Coastal double for pacey Galea

THE CIVIC CUP ENJOYED A BUMPER 23-car grid at Anglesey, with both race winners taking a victory and a fifth place apiece.

Bernard Galea carried his Friday practice speed through to both qualifying and race one with a lights-to-flag win, while Rich Hockley came out ahead of Luke Sedzikowski after a race-long battle for second.

The top 10 from race one were reversed in race two to decide the starting order. Robert Baker, who had an off at Rocket in the first



Galea won from pole

race, took his fifth victory of the year after leading from lap four.

Brook Pitchford scored a well-earned second as Tim Evans headed Hockley and Galea.

● Jack Benyon

RESULTS (BOTH 11 LAPS) 1 Bernard Galea 14m53.99s (68.66mph); 2 Rich Hockley +8.76s; 3 Luke Sedzikowski; 4 Danny Winstanley; 5 Robert Baker; 6 Tim Evans. **FL Galea 1m20.51s (69.31mph).** **RACE 2 1 Baker 15m00.61s (68.15mph);** 2 Brook Pitchford +7.57s; 3 Evans; 4 Hockley; 5 Galea; 6 Winstanley. **FL Baker 1m20.60s (69.23mph).**

TOYOTA MR2 ANGLESEY, JULY 26-27 750MC

MR2 leaders share spoils

MATTHEW PALMER AND JIM DAVIES continued their season-long battle at the front of the grid in the MR2 Cup, as they shared the Anglesey spoils.

In race one, Davies struggled to get close enough to overtake Palmer, but he did eventually find a way past on the start-finish straight.

Davies then missed a gear at the exit of the banking, causing Palmer to hit the slow-moving Davies in his left rear, although it only caused cosmetic damage. Still Palmer sneaked through

to win ahead of Davies, Shaun Traynor and Stuart Nicholls.

Race two followed a similar pattern, but this time Davies could consistently mount a charge on the straights, and led from the third lap onwards. Traynor and Nicholls were again inseparable in their fight for third, although their race-one positions were reversed by the end.

● Jack Benyon

RESULTS (BOTH 11 LAPS) 1 Matthew Palmer (Toyota MR2 Mk2) 15m12.60s (67.26mph); 2 Jim Davies (MR2 Roadster) +0.19s; 3 Shaun Traynor (Mk2); 4 Stuart Nicholls (Roadster); 5 Kristian White (Mk2); 6 Matthew Wallis (Mk2). **CW Gareth Newton (Mk1); Davies. FL Davies 1m21.84s (68.18mph).** **RACE 2 1 Davies 15m08.17s (67.59mph);** 2 Palmer +1.24s; 3 Nicholls; 4 Traynor; 5 Wallis; 6 White. **CW Newton; Palmer. FL Davies 1m21.66s (68.33mph).**



Davies heads rival Palmer

RGB ANGLESEY, JULY 26-27 750MC

Cutmore proves a cut above in RGB

JOHN CUTMORE DELIVERED AN impressive double RGB win in his Spire GT3, leading all but one lap over the course of both races.

Alastair Boulton came closest to challenging the race leader in race one and briefly led, but failed to fend off the challenging Spire at Peel.

Once through, Cutmore set about building up a gap and kept Boulton at arm's length for the rest of the race. Scott Mittell rounded out the podium spots with Paul Rogers a distant fourth.

Race two was in the same ilk, but this time Cutmore led into Turn 1, and didn't cede a single lap for the race's entirety.

Erstwhile championship leader Matthew Higginson made up for a poor Saturday qualifying, due to a sheared bearing, and fifth in the opening encounter by becoming



Cutmore scythes through traffic

Cutmore's closest challenger in the sequel. He finished second in a damage-limitation race for the title.

Mittell had looked quick early on, but he pulled in at the National circuit hairpin to retire on lap six, leaving Rogers to take the last step on the rostrum (having just missed out on the honour in the opener) ahead of Boulton, who pipped Duncan Horlor for fourth with two laps to go.

● Jack Benyon

RESULTS (BOTH 12 LAPS) 1 John Cutmore (Spire GT3) 14m19.54s (77.90mph);

2 Alastair Boulton (Spire GT3) +3.33s; 3 Scott Mittell (Mittell MC-52B); 4 Paul Rogers (Contour RGB09); 5 Matthew Higginson (Spire GT3); 6 David Wale (Spire GT3). **CW** Colin Spicer (Wildmoor DM1 RS). **FL** Cutmore 1m10.83s (78.78mph).

RACE 2 1 Cutmore 14m18.13s (78.03mph);

2 Higginson +6.11s; 3 Rogers; 4 Boulton; 5 Duncan Horlor (Spire GT3); 6 Oliver Hewitt (Spire GT3). **CW** David Watson (MNR GM2). **FL** Cutmore 1m10.52s (79.13mph).



Anglesey in brief

MX5 Cup

Brian Chandler (pictured) was the class of the MX5 field, with three wins and three fastest laps. Ben Short was second to Chandler in all three races, with Sam Gendy third in races one and three. James Rogers broke his record of finishing fourth at every event this season by netting third, fourth and fifth.

750 Trophy

Rockingham race winner Christian Pederson won the first 750 Trophy race, but didn't start the second, leaving Roger Rowe to take victory. Rowe could only manage fourth place in race one, as Pederson led Martin Kemp and Michael Harvey at the finish. Harvey also took a podium in race two, behind Rowe and Don Rawson. David Whetton and Alastair Frayling-Cork shared Class A honours.

Locost

Matthew Brooks scored his first Locost win, and doubled up in race two in a dream weekend for the Huddersfield driver. After the chaotic last meeting at Rockingham, incidents were at a minimum, and no red flags interrupted proceedings. Michael Roots finished runner-up in both races with Danny Andrew and Nick Selby taking third in races one and two respectively.

Sports Specials

A pair of Eclipse SM1s bossed the field in the Sports Specials, with Paul Boyd and Clive Hudson taking races one and two respectively. Nick Holden impressed in the Ariel Atom, leading the early running in the first race before falling away, and took second in race two, the highest overall finish of any Class C car all weekend.

Clio 182

Patrick Fletcher won the first Clio 182 race of the weekend, but he suffered from his success in race two, taking 90kg of ballast to the grid with him after winning the previous three races before this weekend. With Fletcher struggling in race two, Trevor Gregory (pictured) recovered from an earlier ABS issue to take the win, with Fletcher fourth.



Albone bounced back to win second race

750 FORMULA ANGLESEY, JULY 26-27 750MC

Bartholomew wins but Albone recovers

DAVID BARTHOLOMEW SCORED A first and a second place in the 750 Formula races, as points leader Billy Albone made up for car gremlins in race one to win the sequel.

Bartholomew was up to second on lap two after starting on the outside of the second row, and he set about hunting down Albone, who had moved ahead of Bill Cowley to take the lead.

Bartholomew took the lead on lap five shortly before Albone's car began to fall back, dropping him to sixth and allowing the new leader to scamper clear from Cowley.

Albone again started at the front of the grid for race two and any sign of reliability issues had clearly vanished as the Sandy driver recorded the fastest lap of the race and brought the car home 16 seconds in front of Bartholomew.

Bartholomew had been as low as seventh after a poor getaway, but made the most of the PRS 1b's impressive straightline speed to slipstream a succession of cars out of Church and up towards Rocket. He hauled his way up to second on lap seven, overtaking Cowley with another slipstream manoeuvre.

Cowley finished third to complete a double podium.

● Jack Benyon

RESULTS (BOTH 12 LAPS) 1 David Bartholomew (PRS 1b) 15m03.17s (74.14mph);

2 Bill Cowley (Cowley MkIV) +8.74s; 3 Andrew Kemp (Racekits Falcon); 4 Chris Gough (CGR02 EVO); 5 Dave Robson (SDAR/83); 6 Billy Albone (Batten 3). **CW** Ian Barley (Racekits Falcon). **FL** Bartholomew 1m13.76s (75.65mph). **RACE 2 1 Albone 14m49.21s (75.30mph);** 2 Bartholomew +16.41s; 3 Cowley; 4 Mark Glover (Racekits Falcon); 5 Robson; 6 Gough. **CW** Barley. **FL** Albone 1m12.84s (76.61mph).

Murray struggled in the opener, but won race two



FORMULA FORD 1600 KIRKISTOWN, JULY 26 500MRCI

Rapid Murray wins again at Kirkistown

DEMPSTER

THE FORMULA FORD 1600 RUNNERS formed up for their main race on a damp grid, and the surface remained greasy throughout, which didn't suit pacesetter Niall Murray quite as much as some others.

So far this year Motorsport Ireland-backed Murray has been Kirkistown's 'winningest' driver, and qualifying suggested that this state of affairs was likely to continue.

But rain levelled the playing field a bit, and following the usual first-lap sorting and shuffling it was Noel Dunne leading with Jake Byrne in

close attendance, while some explored the limits of both grip and the track.

Byrne spent much of the race looking for a way past the wily Dunne and his well-developed RF01, and when the veteran made a small mistake two laps from home the black Ray was past. But a lap later it was Byrne's turn to make a slip and Dunne needed no further encouragement, powering through to take the win.

Behind them Alan Davidson continued his strong season, bringing his '89 Mondiale home ahead of the Murray brothers. Niall took fastest

lap on the way to a fourth-place finish, while saloon ace Eoin proved to be a dab hand at this single-seater lark, bringing the RF99 used last year by Niall into fifth place.

Normal service was resumed for race two, as Niall Murray streaked away from pole, while an optimistic move by his brother at Colonial sent Dunne skywards and into Byrne. Both continued, but Davidson and Adrian Pollock slipped past and into the other podium positions.

Davidson clinched the Pre-'90 championship with four rounds left

to run, while a brace of strong runs netted the Pre-'87 title for Mike Todd.

● Richard Young

RESULTS (15 LAPS) 1 Noel Dunne (Van Diemen RF01); 2 Jake Byrne (Ray GR13) +0.470s; 3 Alan Davidson (Mondiale M89S); 4 Niall Murray (Van Diemen LA10); 5 Eoin Murray (Van Diemen RF99); 6 David Quinn (RF99). Class winners Davidson; Mike Todd (Mondiale M84S); Arnie Black (Crossle 32F). Fastest lap N Murray 1m06.315s (81.297mph). RACE 2 (10 LAPS) 1 N Murray; 2 Davidson +4.797s; 3 Adrian Pollock (Van Diemen DP08); 4 Byrne; 5 Dunne; 6 Todd. CW Davidson; Todd; Black. FL N Murray 1m07.259s (80.296mph).

86

FIESTA ZETEC KIRKISTOWN, JULY 26 500MRCI

Turkington returns in style

DEFENDING CHAMPION JAMES Turkington reappeared for his first Fiesta outing of the year and immediately stamped his authority on proceedings, although he had his mirrors full of the pack for much of the time.

Starting from pole in the very wet first race, it took Turkington a lap or two to disentangle himself from his pursuers, who were led variously by Andrew Blair, Ryan Campbell, Ian McCallister and Mondello interloper Shane McFadden.

Turkington was able to draw away

to win as the quartet slithered round in close company, with Blair and Campbell holding on behind.

The second race was dry, but the result was the same, despite the best efforts of all concerned.

● Richard Young

RESULTS (10 LAPS) 1 James Turkington; 2 Andrew Blair +6.977s; 3 Ryan Campbell; 4 Shane McFadden; 5 James Hanna; 6 Paul Magill. FL Blair 1m21.142s (67.080mph). RACE 2 (8 LAPS) 1 Turkington; 2 Blair +3.201s; 3 Campbell; 4 Ian McCallister; 5 Hanna; 6 Magill. FL Turkington 1m16.740s (70.928mph).



Champion Turkington took dominant brace

DEMPSTER



Macaulay resisted race-long pressure

DEMPSTER

FORMULA VEE KIRKISTOWN, JULY 26 500MRCI

Macaulay holds on to win

THE FORMULA VEE A-CLASS RACE had barely got under way when red flags flew after Brendan O'Brien launched his Leastone skywards over the rear wheel of Justin Costello's similar car at Fishermens.

An impressive aerial display left him stranded the right way up with the medical crew in attendance. It took some time to extricate him, but his injuries were confined to bruises — and a bent Leastone.

At the restart, Adam Macaulay took his second Kirkistown Vee victory in as many months in a

shortened race, although he was under constant pressure from Kevin Grogan and Jimmy Furlong.

Fourth place fell to Sean Newsome, who had earlier won the B & C Class race, despite the determined efforts of Gavin Buckley.

● Richard Young

RESULTS (10 LAPS) 1 Adam Macaulay (Sheane FV01); 2 Kevin Grogan (Leastone JH002) +0.063s; 3 Jimmy Furlong (FV93); 4 Sean Newsome; 5 Colm Blackburn (JH004); 6 Stephen Morrin (JH004). FL Grogan 1m05.609s (83.289mph).

SALOON AND GT KIRKISTOWN, JULY 26 500MRCI

Finn flies to victory before Hutchinson strikes back

AFTER DAMP WEATHER EARLIER ON, conditions had improved by the time the Saloons and GTs came out to play, and Jim Hutchinson's mouthwatering SHP Escort sat on pole among the GTs with the Ginettas of David Beatty and Connaire Finn behind.

Hutchinson streaked away as expected, but behind him there was wholesale confusion at the chicane as Simon Quinn's rapid Civic pulled off with flames pouring from its engine. Several laps passed before normal service was resumed, by which time Finn had established himself in second, while Richard Ryan (BMW M3) and Gerry McVeigh (Mitsubishi) commenced a spirited battle for saloon honours.

Lap by lap Finn stalked the Escort, inching closer every time, but a spirited defence by



Hutchinson Escort won race two

Hutchinson kept the Ginetta at bay until the final tour at Fishermens when contact sent the Escort spinning, allowing Finn through

to take the honours.

A disgruntled Hutchinson rejoined to claim the runner-up spot, with Beatty third after disentangling himself from the saloon battle, which went to Ryan. Post-race Finn and Hutchinson went for a cosy chat with the clerk of the course, but the result stood.

Hutchinson was in front again at the start of race two, with Finn in pursuit before the Ginetta took to the grass at Debtors Dip in the closing stages following an unsuccessful attempt to take the lead.

Finn was back on the Escort's tail by the finish, but Hutchinson kept ahead to claim the win, with Beatty

third again. McVeigh took saloon honours in fourth, while Ryan had his hands full keeping Hugh McEvoy's GT-class Elise at bay and eventually finished fifth.

● Richard Young

RESULTS (13 LAPS) 1 Connaire Finn (Ginetta G50); 2 Jim Hutchinson (SHP Escort) +25.710s; 3 Richard Ryan (BMW M3); 4 Gerry McVeigh (Mitsubishi Evo); 5 David Beatty (Ginetta G50); 6 Hugh McEvoy (Lotus Elise). CW Ryan. FL Beatty 1m00.584s (89.843mph). **RACE 2 (10 LAPS) 1 Hutchinson; 2 Finn +0.294s; 3 Beatty; 4 McVeigh; 5 Ryan; 6 McEvoy. CW McVeigh. FL Finn 1m00.971s (89.272mph).**



Ryan took class win

BRITISH HILLCLIMB CHAMPIONSHIP WISCOMBE PARK, JULY 26-27

Great Hall takes double

WITH ONLY ONE PREVIOUS WIN TO his name, Will Hall added two more to his CV at Wiscombe Park last weekend and took his first outright hill record in the process.

Trevor Willis went quicker in the second set of class runs, but Hall came back at him and equalled the new record in earning his second win.

"This is the result of years of work by a small team, but especially by [Force Racing constructor] Ian Dayson," said Hall, who had been congratulated over the phone by champion and points leader Scott Moran.

Because his new record was taken in class runs, Willis did not gain a bonus point, and he was third each time in the main run-offs, twice beaten to second by Jos Goodyear. The second run-off shot for Goodyear included a wild slide through the Gate where the track enters the woods, but he continued a spectacular run.

Tom New's pair of fourths lifted him to seventh in the points, equal with John Bradburn, whose regular consistency seems to have disappeared. Alex Summers was not

on Goodyear's pace and replicated his error at last year's Wiscombe event by breaking a driveshaft while tyre spinning before starting the first run-off. He recovered to set fifth-fastest time in the second run-off.

Wallace Menzies continued his post-Shelsley Walsh shunt on-track rehabilitation. Although he has yet to get back to previous scoring levels he can be reasonably satisfied with progress so far, netting fifth and ninth at Wiscombe.

Richard Spedding did very well to match the more powerful Force Suzuki of David Uren and maintain 10th in the championship.

Jerseyman Jason Mourant came to his nearest mainland round and scored in each run-off. After being forced to miss last weekend's Guernsey rounds following ferry issues, Simon Fidoie put his advanced little Wraith into both run-offs. Championship sponsor Graham Wynn also missed the Guernsey boat, but was at Wiscombe and got into the final shoot-out, although he didn't score.

● Eddie Walder



Hall set a new record on his way to two wins

RESULTS

ROUND 21 1 Will Hall (3.5 Force-Nissan WH) 33.89s; 2 Jos Goodyear (1.3s GWR-Suzuki Raptor) 33.94s; 3 Trevor Willis (3.2 OMS-RPE 28) 34.45s; 4 Tom New (4.0 Gould-Judd GR55) 34.98s; 5 Wallace Menzies (3.2 DJ-Cosworth Firestorm) 35.29s; 6 Dave Uren (1.3t Force-Suzuki PC) 35.99s; 7 Richard Spedding (1.6 Force Suzuki PC) 36.18s; 8 Jason Mourant (3.2 OMS-RPE 25) 37.66s; 9 Simon Fidoie (1.0 Empire-Suzuki Wraith) 37.79s; 10 John Bradburn (3.5 Gould-Cosworth HB GR55) 40.55s; 11 Tony Hunt (1.3s Force-Suzuki PC) 50.27s; Alex Summers (1.3s DJ-Suzuki Firehawk) DNS.

ROUND 22 1 Hall 33.79s BTD & record; 2 Goodyear 34.22s; 3 Willis 34.36s; 4 New 34.61s; 5 Summers 34.70s; 6 Spedding 35.83s; 7 Uren

36.08s; 8 Bradburn 36.56s; 9 Menzies 36.99s; 10 Mourant 37.52s; 11 Fidoie 37.62s; 12 Graham Wynn (1.4t Force-Suzuki LM01) 38.49s. **Class winners** Bob Ridge-Stearn (1.8 Lotus Elise) 46.64s; Tony Bunker (3.8t Nissan GT-R) 44.90s **record**; Chris Howard-Harris (1.8 Caterham Superlight) 42.34s; Ben Bonfield (1.4 Austin Mini) 45.38s; Paul Webster (2.0 Mazda MX5) 45.39s; Tim Painter (3.6 Porsche 997 GT3) 43.09s; Rod Thorne (5.0 Pilbeam-Rover MP43) 37.94s; Liam Cooper (1.0 Force-Suzuki HC) 37.96s; Spedding 36.59s; Goodyear 34.33 **record**; Willis 33.79s **joint BTD and record**. **POINTS** 1 Scott Moran, 180; 2 Willis, 166; 3 Hall, 149; 4 Summers, 116; 5 Goodyear, 104; 6 Menzies, 83; 7 Bradburn & New, 79; 9 Roger Moran, 67; 10 Spedding, 57.

SUBSCRIBE TO AUTOSPORT AND GET...

A FREE PAIR OF BOLLÉ SUNGLASSES



OSCAR TORTOISESHELL



OSCAR BLACK



+PLUS+

FREE DIGITAL EDITION
SUBSCRIPTION & UNLIMITED
ACCESS TO **AUTOSPORT.COM**

FREE GIFTS

- ✓ **FREE PAIR OF BOLLÉ SUNGLASSES**
Choose between Oscar black or Oscar tortoiseshell
- ✓ **FREE SUBSCRIPTION TO THE AUTOSPORT DIGITAL EDITION**
and unlimited access to **AUTOSPORT.com**

SUBSCRIBE NOW!



- ✓ Save 25% on the cover price
- ✓ Pay just £34.99 every 13 issues by direct debit

Visit: www.themagazineshop.com/aspo-m0714p

08448 488 817

Or call and quote **M0714P**
Please have your bank details ready.

Offer ends August 7 2014.

themagazineshop.com

THE BENEFITS OF SUBSCRIBING!

- ✓ Never miss an issue
- ✓ Free delivery direct to your door
- ✓ Unlimited access to news and views from the paddock
- ✓ Access to subscriber-only analysis and comment

This offer is open to UK residents only. If you require any assistance following the purchase of your subscription, then you can speak to a member of our customer service team on 01795 592 972, calls are charged at local rate. Overseas rates are available on +44 (0) 1795592 972. Please allow 35 days for delivery of your gift and first issue. The gift will be sent under separate cover from the magazine. Should we run out of gifts, you may be offered an alternative gift – there is no cash alternative. To activate your AUTOSPORT online account visit <https://secure.autosport.com/subs/activate.php> and enter your activation code (your personal magazine subscriber number which will be included in your welcome email/letter) along with your email address to access your extra AUTOSPORT content. Direct Debit rates are valid for one year after which they are subject to change – should prices change we will inform you in writing. We ask that you enter into a Direct Debit agreement with the intention that your subscription will continue for a minimum period of 12 months, even if the frequency of payment is for a shorter period, however, you will still have the right to cancel your Direct Debit in accordance with Direct Debit Guarantee. Should you wish to cancel your subscription it will be cancelled on expiry of the current term which will not be refundable, other than in exceptional circumstances. If a gift is included as part of the subscription offer we reserve the right to request the return of the gift. Details of the Direct Debit Guarantee are available on request. Savings are based on the standard UK cover price of £3.60. Offer ends August 7 2014. Haymarket Media Group Ltd uses a best-practice layered Privacy Policy to provide you with details about how we would like to use your personal information. To read the full privacy policy please visit our website www.haymarket.com/privacy or call us on 08448 482 800. Please ask if you have any questions as submitting your personal information indicates your consent, for the time being, that we and our partners may contact you about products and services that will be of interest to you via post, phone, e-mail and SMS. You can opt-out at ANY time by emailing the datacontroller@haymarket.com or by calling 08448 482 800.

NATIONAL RESULTS ROUND-UP



Roger Stanford leads son Jack, but it was the younger BMW driver who topped pre-'93s at Cadwell

CADWELL PARK
JULY 26-27, BARC



PRE-1993 TOURING CARS (9 LAPS) 1 Jack Stanford (BMW E30 M3) 15m13.770s (77.54mph); 2 Roger Stanford (E30) +4.406s; 3 David Hickton (M3); 4 Ryan Gorman (M3); 5 Graham Myers (Ford Sapphire Cosworth); 6 Brian Lilley (Ford Escort Cosworth). **Class winners** Hickton; Lilley; Simon Ward (Vauxhall Astra GTE 16V); Colin Stubbs (Rover 216 GTi); Allan Weyman (Chevrolet Camaro). **Fastest lap** J Stanford 1m40.108s (78.64mph). **RACE 2 (7 LAPS)** 1 J Stanford 15m30.252s (59.24mph); 2 R Stanford +4.537s; 3 Gorman; 4 Hickton; 5 Myers; 6 Dean Cranham (M3). **CW** Gorman; Ward; Jerry Hampshire (Renault 5GT Turbo); Stubbs. **FL** J Stanford 1m39.009s (79.52mph). **CLASSIC FORMULA FORD 2000 (14 LAPS)** 1 Paul Wighton (Van Diemen RF82) 21m36.153s (85.03mph); 2 Chris Lord (RF82) +17.659s; 3 Peter Chippindale (RF82); 4 Chris Levy (RF83); 5 Clive Wood (RF82); 6 Rodney Toft (RF82). **CW** Steve Gardiner (Reynard SF80). **FL** Wighton 1m30.844s (86.66mph). **RACE 2 (13 LAPS)** 1 Wighton 20m14.971s (84.24mph); 2 Lord +0.151s; 3 Chippindale; 4 Levy; 5 Wood; 6 Dale Spruce (SF80). **CW** Spruce. **FL** Lord 1m31.559s (85.99mph). **PRE-2005 PRODUCTION TOURING CARS & HONDA V-TEC CHALLENGE (BOTH 9 LAPS)** 1 Robert Burkinshaw (Honda Integra Type R) 15m37.670s (75.56mph); 2 Marc Kemp (Honda Civic Type R) +29.857s; 3 Simon Jessop (Integra Type R); 4 Andy Smith (Honda Accord); 5 Dawn Boyd (Civic Type R); 6 Andy Gee (BMW 325i E30). **CW** Kemp; Jessop; Gee; Steve Rowles (Proton Satria GT1); Phil Waller (Peugeot 206 GTi). **FL** Burkinshaw 1m42.487s (76.82mph). **RACE 2** 1 Burkinshaw 15m35.651s (75.73mph); 2 Jessop +20.330s; 3 Kemp; 4 Boyd; 5 Darren Smea (Integra); 6 Rowles. **CW** Jessop; Kemp; Rowles; Mohammed Elshimy (Peugeot 206); Jason Hennefer (Ford Fiesta). **FL** Burkinshaw 1m42.690s (76.66mph). **CLASSIC FORMULA FORD 1600 (BOTH 13 LAPS)** 1 Mike Gardner (Crosle 30F) 21m07.226s (80.76mph); 2 Leandro Guedes (Van Diemen RF80) +11.110s; 3 Andrew

Smith (Van Diemen FA73); 4 Steve Pearce (Van Diemen RF78); 5 Chris Stuart (RF80); 6 Matthew Wrigley (Merlyn Mk20). **CW** Smith. **FL** Gardner 1m35.855s (82.13mph). **RACE 2** 1 Gardner 21m00.599s (81.19mph); 2 Smith +16.762s; 3 Guedes; 4 Stuart Kestenbaum (Van Diemen RF79); 5 Simon Davey (RF80); 6 Stuart. **CW** Smith. **FL** Gardner 1m36.082s (81.94mph). **BLUE OVAL SALOONS (5 LAPS)** 1 Jason Davies (Sapphire Cosworth) 8m34.425s (76.52mph); 2 Gary Wait (Escort Cosworth) +7.791s; 3 Alexander Owen (Sierra RS Cosworth); 4 John Edwards-Parton (Fiesta); 5 Graham Myers (Sapphire); 6 Paul Finney (Fiesta). **CW** Wait; Edwards-Parton; Adrian Tuckley (Fiesta XR2). **FL** Davies 1m40.381s (78.43mph). **RACE 2 (9 LAPS)** 1 Davies 15m13.795s (77.54mph); 2 Wait +14.278s; 3 Craig Rainer (Escort Mk2); 4 Pantelis Christoforou (Escort); 5 Owen; 6 Ashley Bird (XR4i). **CW** Wait; Christoforou; Edwards-Parton; Tuckley. **FL** Rainer 1m38.992s (79.53mph). **2CV (BOTH 10 LAPS)** 1 Caryl Wills 21m42.964s (60.42mph); 2 Pete Sparrow +0.342s; 3 Richard Lambert; 4 Lien Davies; 5 Glenn Oswin; 6 Paul Robertson. **FL** Sparrow 2m07.816s (61.59mph). **RACE 2** 1 Kris Tovey 21m29.945s (61.03mph); 2 Matt Lambert +8.277s; 3 Mick Storey; 4 Robertson; 5 Tom Perry; 6 Oswin. **FL** Lambert 2m07.248s (61.87mph). **ALLCOMERS (12 LAPS)** 1 Ashley Bird (Ford Sierra XR4i) 21m43.662s (72.47mph); 2 Nathan Osman (BMW 320is) +36.971s; 3 Andrew Sheraton (BMW E30); 4 Nick Haldane (BMW 325); 5 Colin Stubbs (Rover 216 GTi); 6 Kenneth Adlard (Alfa Romeo 145). **FL** Bird 1m44.039s (75.67mph).

ANGLESEY
JULY 26-27, 750MCI



RENAULT CLIO 182 (BOTH 11 LAPS) 1 Patrick Fletcher 15m17.70s (66.88mph); 2 Martin Hammersley +0.48s; 3 Matt Fincham; 4 Martin Ward; 5 Matthew Holtom; 6 David Boucher. **FL** Hammersley 1m22.11s (67.96mph). **RACE 2** 1 Trevor Gregory 15m13.78s (67.17mph); 2 Hammersley +5.74s; 3 Fincham; 4 Fletcher; 5 Bill Gregory;

Gregories collide in the second Clio race at Anglesey



JONES



A Brands triple fell to Bennett

Ward. **FL** T Gregory 1m22.10s (67.97mph). **LOCOST (BOTH 11 LAPS)** 1 Mathew Brooks 15m16.44s (66.98mph); 2 Michael Roots +4.52s; 3 Danny Andrew; 4 Matthew Booth; 5 Nick Selby; 6 Richard Jenkins. **FL** Brooks 1m22.38s (67.73mph). **RACE 2** 1 Brooks 15m18.26s (66.84mph); 2 Roots +0.17s; 3 Selby; 4 Andrew; 5 Jenkins; 6 Sian Stafford Atkinson. **FL** Selby 1m22.54s (67.60mph). **SPORTS SPECIALS (BOTH 12 LAPS)** 1 Paul Boyd (Eclipse SM1) 15m02.78s (74.17mph); 2 Clive Hudson (SM1) +0.52; 3 Edward Ives (Elite Pulse); 4 Nick Holden (Ariel Atom Cup); 5 Paul Collingwood (Sylva J15); 6 Patrick Mortell (Rogue Xenon). **CW** Ives; Colin Benham (STM Phoenix). **FL** Boyd 1m13.98s (75.43mph). **RACE 2** 1 Hudson 15m06.79s (73.84mph); 2 Holden +0.59s; 3 Boyd; 4 Ives; 5 Mortell; 6 Anton Landon (Cyana MK2). **CW** Holden; Adrian Cooper (Procomp LA Gold); Holden. **FL** Boyd 1m14.31s (75.09mph). **MXS CUP (ALL 11 LAPS)** 1 Brian Chandler 15m22.47s (66.54mph); 2 Ben Short +4.60s; 3 Sam Gendy; 4 James Rogers; 5 Jack Sycamore; 6 Andrew Coombs. **FL** Chandler 1m22.95s (67.27mph). **RACE 2** 1 Chandler 15m16.14s (67.00mph); 2 Short +5.88s; 3 Rogers; 4 Gendy; 5 Ed Gay; 6 Coombs. **FL** Chandler 1m22.10s (67.97mph). **RACE 3** 1 Chandler 15m25.96s (66.29mph); 2 Short +0.76; 3 Gendy; 4 Jonathan Hughes; 5 Rogers; 6 Sycamore. **FL** Chandler 1m23.02s (67.21mph).

BRANDS HATCH
JULY 26-27, BARC



RENAULT CLIO CUP ROAD SERIES (BOTH 15 LAPS) 1 Anton Spires 14m57.635s (72.66mph); 2 Luke Pinder +1.879s; 3 Jessica Hawkins; 4 Sarah Franklin; 5 Jonathan Creasey; no other finishers. **CW** Pinder. **FL** Spires 58.686s (74.09mph). **RACE 2** 1 Pinder 14m47.805s (73.47mph);

2 Nic Harrison +8.922s; 3 Spires; 4 Hawkins; 5 Creasey; 6 Franklin. **CW** Harrison. **FL** Spires 58.547s (74.27mph). **SEVENESQUE SERIES (ALL 18 LAPS)** 1 Tony Bennett (Caterham R300) 15m29.175s (84.24mph); 2 Ian Conibear (Caterham 7) +8.743s; 3 Stephen Garner (Westfield Megabus); 4 Bruce Wilson (Caterham CSR Superlight); 5 Peter Hargroves (Caterham SLR); 6 Mick Grant (Tiger R6). **CW** Wilson; Grant. **FL** Bennett 50.671s (85.82mph). **RACE 2** 1 Bennett 15m27.878s (84.35mph); 2 Conibear +0.162s; 3 Garner; 4 Paul Adams (Mercedes SLK); 5 Wilson; 6 Rod Birley (Caterham 7). **CW** Adams; Wilson. **FL** Conibear 50.871s (85.48mph). **RACE 3** 1 Bennett 15m36.150s (83.61mph); 2 Conibear +3.788s; 3 Garner; 4 Adams; 5 Hargroves; 6 Birley. **CW** Adams; Hargroves; Grant. **FL** Conibear 50.209s (86.61mph).

KIRKISTOWN
JULY 26, 500MRCI



IRISH FORMULA VEE CLASSES B & C (12 LAPS) 1 Sean Newsome (Sheane FV94); 2 Gavin Buckley (Sheane FV99) +0.335s; 3 Stephen Morrin (Leystone JH004); 4 Anthony Cross (Sheane FV10); 5 Shane McBride (Sheane FV01); 6 Brendan O'Brien (Leystone JH004). **FL** Newsome 1m07.061s (81.17mph). **ROADSPORTS/STRYKERS (12 LAPS)** 1 Jim Larkham (1.3 Radical PRO6); 2 John Benson (2.0 Crosle 375) +29.031s; 3 Graham Moore (1.3 GMS Honda); 4 Mark Francis (1.0 GMS Honda); 5 Mark Baker (1.8 Sylva Stryker); 6 Des Bruton (1.8 Sylva Stryker). **CW** Moore; Baker. **FL** Larkham 1m06.674s (81.636mph). **RACE 2 (10 LAPS)** 1 Larkham; 2 Benson +1.464s; 3 Dave Griffin (1.8 Sylva Stryker); 4 Iain Leinster (1.0 Westfield Honda); 5 John McCandless (2.0 Crosle 475); 6 Jimmy Dougan (1.0 GMS Honda). **CW** Griffin; Leinster. **FL** Larkham 1m03.003s (85.89mph).



Teddington Studios, Broom Road, Teddington, Middlesex TW11 9BE, UK.
Tel: +44 (0) 20 8267 5804 Fax: +44 (0) 20 8267 5922
E-mail: autosport@haymarket.com Website: www.autosport.com

EDITOR
Charles Bradley ext.5889
charles.bradley@haymarket.com

DEPUTY EDITOR
Marcus Simmons ext.5807
marcus.simmons@haymarket.com

GROUP F1 EDITOR
Jonathan Noble ext.5810
jonathan.noble@haymarket.com

GRAND PRIX EDITOR
Edd Straw ext.5887
edd.straw@haymarket.com

F1 ASSISTANT EDITOR
Ben Anderson ext.5425
ben.anderson@haymarket.com

FEATURES EDITOR
Kevin Turner ext.5432
kevin.turner@haymarket.com

EDITOR AUTOSPORT.COM
Glenn Freeman ext.5309
glenn.freeman@haymarket.com

DEPUTY EDITOR AUTOSPORT.COM
Matt Beer ext.5811
matt.beer@haymarket.com

MANAGING EDITOR
Peter Hodges ext.5903
peter.hodges@haymarket.com

RALLIES EDITOR
David Evans
david.evans@haymarket.com

ART EDITOR
Lynsey Row ext.5914
lynsey.row@haymarket.com

SENIOR DESIGNER
Michael Cavalli ext.5381
michael.cavalli@haymarket.com

PHOTOGRAPHS
LAT Photographic

PRESENTER/SUB-EDITOR
Henry Hope-Frost ext.5835
henry.hope-frost@haymarket.com

ASSISTANT EDITOR
Scott Mitchell ext.5370
scott.mitchell@haymarket.com

GROUP PICTURE EDITOR
Peter Mills ext.5918
peter.mills@haymarket.com

AUTOSPORT.COM TECHNICAL TEAM LEADER
Geoff Creighton
geoff.creighton@haymarket.com

AUTOSPORT.COM DEVELOPER
Tomasz Trznadel
tomasz.trznadel@haymarket.com

OFFICE MANAGER
Joanne Grove ext.5804
joanne.grove@haymarket.com

SPECIAL CONTRIBUTORS

Gary Watkins	Dieter Rencken	Pablo Elizalde
Marcus Pye	Gary Anderson	
Mark Glendenning	Alan Eldridge	

CORRESPONDENTS

ARGENTINA Tony Watson	ITALY Roberto Chinchero	David Phillips, Robin Miller, Jeremy Shaw
AUSTRALIA Phil Branagan	JAPAN Iiro Takahashi, Len Clarke	UK & EIRE Jack Benson, Jonathan Crawford, Dan Cross, Kerry Dunlop, Leanne Fahy, Paul Healy, Linda Keen, Jamie Klein, Mark Libbeter, Stephen Lickorish, Marc Orme, Graham Read, Hal Ridge, Peter Scherer, Ian Sooman, Oliver Timson, Ian Titchmarsh, Matt Upton, Eddie Walker, Richard Young
AUSTRIA Gerhard Kuntzschik	NEW ZEALAND Bernard Carpenter	
BELGIUM Gordon McKay	RUSSIA Gregory Golyshov	
BRAZIL Lito Cavalcanti	SOUTH AFRICA Richard Asher	
FINLAND Esa Illiainen	SPAIN Raimon Duran	
GERMANY Rene de Boer	SWEDEN Tege Tomvall	
GREECE Dimitris Papadopoulos	USA Jonathan Ingram,	

ADVERTISING
Tel: +44 (0) 20 8267 5389
Fax: +44 (0) 20 8267 5850
E-mail: autosport.ads@haymarket.com

AD PRODUCTION
Tel: +44 (0) 20 8267 5740 Fax: +44 (0) 20 8267 5320

DISPLAY SALES MANAGER
Martin Lee, ext.5389
martin.lee@haymarket.com

CLASSIFIED ADVERTISING
Rachelle Francis-Dottin, ext.5992
rachelle.francis-dottin@haymarket.com

ONLINE ADVERTISING
Alex Newberry, ext.5244
alex.newberry@haymarket.com

LEAH MIMMS
Leah Mimms, ext.5846
leah.mimms@haymarket.com

MATT SIMPKIN
Matt Simpkin, ext.5820
matt.simpkin@haymarket.com

ADVERTISING DIRECTOR
Matthew Witham

LICENSING DIRECTOR
Jim James

PRODUCTION MANAGER
Ailsa Donovan, ext.5639
ailsa.donovan@haymarket.com

PRODUCTION CONTROLLERS
Jade Hamann, ext.5588
jade.hamann@haymarket.com

MARC BAKER
Marc Baker, ext.5563
marc.baker@haymarket.com

CLASSIFIED SALES MANAGER
Jonathan Whitehead, ext.5908
jonathan.whitehead@haymarket.com

SUBSCRIPTIONS

UK 0844 848887
OVERSEAS +44 (0)1795 592 974
EMAIL autosport@servicehelpline.co.uk

AUTOSPORT, ISSN number 0269946X, is published weekly by Haymarket Media Group, Teddington Studios, Broom Road, Teddington TW11 9BE, United Kingdom. The US annual subscription price is \$235. Airfreight and mailing in the USA by agent named Air Business Ltd, c/o Worldnet Shipping Inc., 156-15, 146th Avenue, 2nd Floor, Jamaica, NY 11434, USA. Periodicals postage paid at Jamaica NY 11431. Subscription records are maintained at Haymarket Media Group, Teddington Studios, Broom Road, Teddington TW11 9BE. Air Business Ltd is acting as our mailing agent.

BACK ISSUES
Tel: 0844 848887

MARKETING MANAGER
Karen McCarthy, ext.5658
karen.mccarthy@haymarket.com

LICENSING AND SYNDICATION
LICENSING MANAGER
David Ryan, ext.5024

MANAGEMENT

GROUP DIRECTOR
Tim Bulley

GROUP COMMERCIAL DIRECTOR
Ben Guyman

GROUP EDITOR
Anthony Rawlinson

PUBLISHER
Stuart Williams

PUBLISHING MANAGER
Samantha Jempson

SPECIAL EVENTS MANAGER
Laura Coppin

DIGITAL SPECIAL PROJECT MANAGER
Simon Strang, ext.5093
simon.strang@haymarket.com

DIGITAL PRODUCT MANAGER
Simon Grayson, ext.5346
simon.grayson@haymarket.com

© 2014, HAYMARKET MEDIA GROUP LTD
Publishing, trade and further subscription details on www.autosport.com. While due care is taken to ensure the contents of AUTOSPORT are accurate, the publishers and printers cannot accept liability for errors and omissions. Advertisements are accepted for publication in AUTOSPORT only upon Haymarket Media Group Ltd's Standard Terms of Acceptance of Advertising, copies of which are available from the Advertising Sales Department of AUTOSPORT.

CIRCULATION TRADE ENQUIRIES
Frontline Ltd, Park House, 117 Park Road, Peterborough, Cambs, PE21 2TS. Tel: +44 (0)1733 556161. Printed in England by Wyndeham Heron Ltd. Cover and centre sections printed by CSM Impact, Basingstoke. Colour origination: FME, 90-92 Pentonville Road, London N1 9HS. ISSN 0269-946X. AUTOSPORT, Incorporating Autoclassic, is published weekly by Haymarket Consumer Media, Teddington Studios, Broom Road, Teddington, TW11 9BE, UK.

EDITORIAL DIRECTOR
Mark Payton

CREATIVE DIRECTOR
Paul Harpin

STRATEGY AND PLANNING DIRECTOR
Bob McDowell

PUBLISHING DIRECTOR
Patrick Fuller

MANAGING DIRECTOR
David Prasher

CHIEF EXECUTIVE
Kevin Costello

Haymarket is certified by BSI to environmental standard ISO14001

haymarket

PEFC
This product is from responsible managed forests and controlled sources.
www.pefc.co.uk

THIS WEEK

LETTERS • BEST PICS • LATEST GEAR • ON TRACK & SCREEN • ONLINE

What you think of the motorsport news of the past week



Hamilton has had his share of trials and tribulations

Good time to take a breather

So Formula 1 is taking a short break. Phew! As a Lewis Hamilton fan my nerves could do with the holiday.

We've gone from jubilation at Silverstone, to despair and relief in Germany, then utter disbelief and complete admiration in Hungary. Add to that team orders (which in my opinion Lewis was right to ignore),

Bottas being a star in the making and Ricciardo, who just keeps on improving. The drivers continue to deliver on track – let's hope the FIA and Bernie can do the same.

Right, where's that drink. Here's to some trouble-free Saturdays for Lewis when F1 returns.
Kevin Friday, by email

Hamilton – right or wrong?

I feel strongly that he was right to maintain his position and finish third. A truly exciting and memorable race by all – world champions past and future at their best.

Ray Strutt
East Grinstead, West Sussex

There is controversy over

Mercedes informing Lewis Hamilton to cede a place to Nico Rosberg as he was on a different strategy. With hindsight it was too early in the race to issue orders. That Lewis ignored the order is understandable as it must go against his competitor's instinct.

Having said that, Mercedes as a team wanted one of their cars to finish first. At that point Nico had a better chance.

I don't like team orders and I agree with a recent suggestion in AUTOSPORT that removing the radio communication might stop this happening mid-race.

Michael Copeman
Crowborough, East Sussex

Growing up in the North East,

grand prix racing could have been happening on the moon as far as I was concerned. Then one Saturday my father said we were off to the Odeon in Newcastle. As I settled in my seat the music started and I was transported into a world of

noise, colour, glamour and danger!

My father told my mum it was the first time I had ever sat for three hours without saying a word! On my return home I took three cereal boxes and immediately began practising heeling and toeing, which served me well when I drove my first racing cars.

So to all the young people out there, look up a great gentleman called James Garner, then play *Grand Prix* on your iPad. I promise you won't speak for three hours during your summer holiday and your mum and dad will be forever grateful to this wonderful actor.

Sean Wallace
Leighton Buzzard, Bedfordshire

In pictures

Images around the globe, from Spa to Silverstone via Indianapolis



ENDURO RACING, MODERN STYLE
The mammoth GT field gets under way at the Spa 24 Hours. It was a bruising encounter and in the end Audi beat BMW by just seven seconds

XPB

ENDURO RACING, CLASSIC STYLE
The thundering Lola T70 of Leo Voyazides and Simon Hadfield heads to victory in the Masters Sportscar race at Silverstone as dusk falls on Saturday

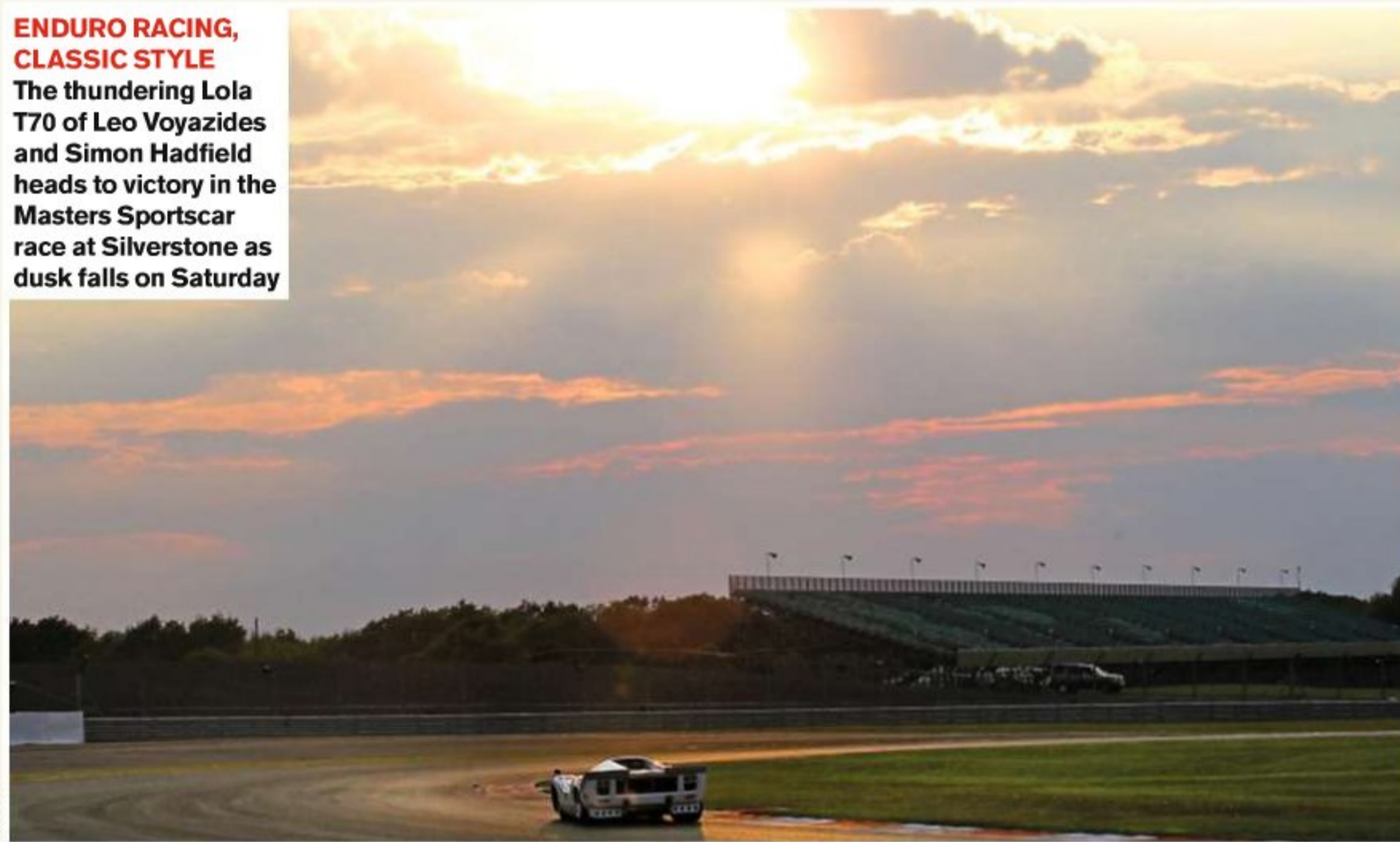

WALKER

GORDON FAMILY CELEBRATION
Jeff Gordon's children help the NASCAR star celebrate after the championship leader scored his fifth Brickyard 400 victory last weekend



LAT

JUMP JET UNDER THE HAMMER
One of the more unusual items in the Silverstone Classic auction was this ex-Falklands War Harrier GR3. It sold too, for just over £100,000



EBREY

In the shops

Desirable new releases

F1 CIRCUITS FROM THE AIR

£25 – autosport.com/shop
Produced in conjunction with Google Earth and written by ex-AUTOSPORT editor Bruce Jones, this book offers a unique aerial appreciation of 28 venues, including current and defunct tracks. Every circuit gets the satellite treatment with analysis of each corner and plenty of great memories from races past.



LOTUS 49 1:43 MODELS

£33.99 – autosport.com/shop
Quartzo excellent-value Lotus 49 replicas are limited to just 1398 units worldwide. Choose from the traditionally liveried car in which Jim Clark took his final GP win – in South Africa in 1968 – or the Gold Leaf-branded car used by Graham Hill to win next time out in Spain after Clark's untimely death.



GRAVEL 2014 WRC BOOK

£10 – lisastatham.co.uk
Illustrator Lisa Statham has added her unique and refreshing style to this 48-page guide to WRC 2014 and its drivers, teams and events. Each of the series' 13 events is covered with an off-beat image and explanatory text that best conveys its culture and history. Check the website for details and her full range of work.

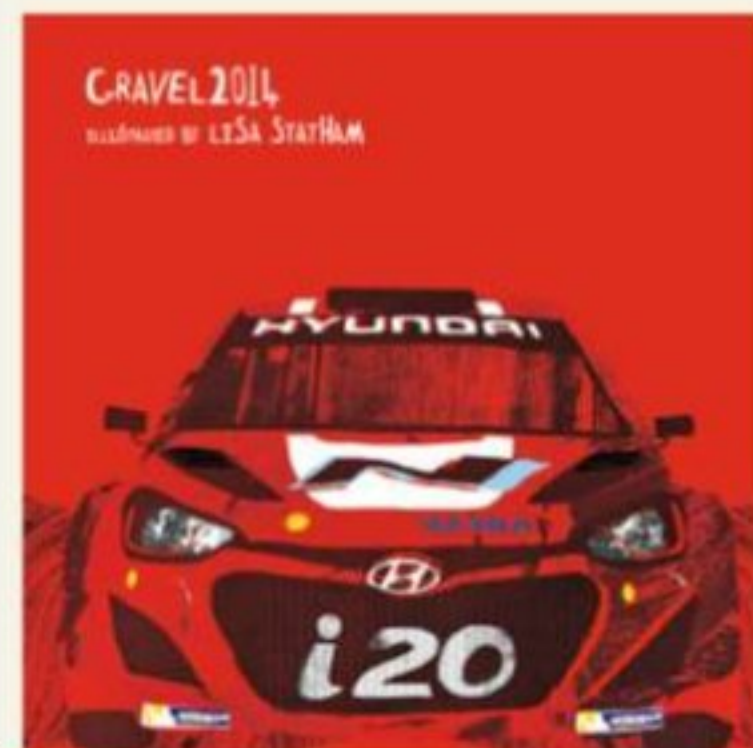

WHAT'S ON

ON TRACK IN THE UK

SNETTERTON

BARC

August 2-3

snetterton.co.uk

The British Touring Car Championship returns after its half-term break. Colin Turkington's WSR BMW leads the standings after four wins in the past six races, but the Norfolk circuit should be better suited to the Hondas and MGs. Support comes from Formula Ford, the Ginetta GT4 Supercup, Renault Clio Cup, Ginetta Juniors and Porsche Carrera Cup.

Head to Norfolk for BTCC thrills



EBREY/LAT

CROFT

HSCC

August 2-3

croftcircuit.co.uk

The North Yorkshire circuit celebrates a weekend of nostalgia, featuring a wealth of rorty racers from the Historic Sports Car Club's legion of single-seater, sportscar and tin-top series.

ANGLESEY

CSCC

August 2-3

angleseycircuit.com

The picturesque circuit on the Welsh coast welcomes the Classic Sports Car Club. Eleven different series, including the CSCC's own in-house categories for low-budget tin-top and GT cars, will duke it out over two days.



FJunior fun at Croft

WALKER

DONINGTON PARK

MGCC

August 3

donington-park.co.uk

Sunday's MG Car Club one-day affair should be entertaining, with the MG Trophy, Metro Cup and Ecurie GTS series among those on show.

HAWKINS



Caterhams in action at Brands

by the Roadsport and Academy classes, plus the BRSCC's Mazda MX5 Championship.

BRANDS HATCH

BRSCC

August 2-3

brandshatch.co.uk

This weekend is a Caterham-fest at Brands, with the flagship Superlight R300 category leading the bill. It will be joined

SILVERSTONE

BDC

August 2

silverstone.co.uk

The annual Bentley event will include the traditional handicap and scratch races for the British



presented by AUTOSPORT NEWS

Join us at the KX Question Time at Snetterton's BTCC round on Saturday August 2, at Tyrrell's, from 18:30 and question the panel after qualifying. Snetterton's line-up will include former champions Jason Plato and Fabrizio Giovanardi, Snetterton race winner Sam Tordoff, and ITV commentator David Addison. Ask a good question at the filmed event and you could win a prize. **FREE ENTRY**

marque, as well as Morgan and Aston Martin encounters.

PEMBREY

BARC

August 2-3

barc.net

Sports 2000s and Welsh Sports and Saloons share this six-race bill.

DONINGTON PARK

BRSCC

August 2

donington-park.co.uk

One-hour Fun Cup race, followed by a four-hour Fun Cup enduro.

ON TRACK AROUND THE WORLD



MCKLEIN/DE

Finland is one of the star events on WRC calendar

RALLY FINLAND

World Rally Championship

Rd 8/13

Jyvaskyla, Finland

July 31-August 3

wrc.com

DTM

Rd 6/10

Red Bull Ring, Austria

August 3

dtm.de

EUROPEAN FORMULA 3

Rd 8/11

Red Bull Ring, Austria

August 2-3

fiaf3europe.com

WORLD TOURING CAR CHAMPIONSHIP

Rd 8/12

Rio Hondo, Argentina

August 3

fiawtcc.com

NASCAR SPRINT CUP

Rd 21/36

Pocono, Pennsylvania, USA

August 3

nascar.com

V8 SUPERCARS

Rd 8/14

Queensland Raceway, Australia

August 2-3

v8supercar.com.au

V8 STOCK CARS

Rd 5/12

Goiania, Brazil

August 3

stockcar.com.br



WTCC is off to remote Argentina

Your guide to the best events taking place in the UK and around the world – plus TV and online

ON TELEVISION

THURSDAY JULY 31

1830-1930 BT Sport 2 LIVE
WRC: Rally Finland SS4
2100-2145 Sky Sports F1
F1 Classic Races: 1989 Monaco GP

FRIDAY AUGUST 1

0500-0600, 1430-1530 ESPN
United SportsCar: Indianapolis
0630-0730 BT Sport 2
WRC: Rally Finland highlights
1830-1930 BT Sport 2 LIVE
WRC: Rally Finland SS13
2200-2230 BT Sport 1
Rally Finland highlights
2235-2305 Motors TV
Rally Finland highlights

SATURDAY AUGUST 2

0515-0630 BT Sport 1 LIVE
V8 Supercars: Queensland Race 1
0730-0830 BT Sport 1 LIVE
V8 Supercars: Queensland Race 2
1000-1105 Motors TV LIVE
European F3: Red Bull Ring Race 1
1745-1845 ESPN LIVE
DTM: Red Bull Ring qualifying
1900-2000 British Eurosport LIVE
WTCC: Rio Hondo qualifying
2235-2305 Motors TV
Rally Finland highlights
0000-0030 BT Sport 1
Rally Finland highlights

SUNDAY AUGUST 3

0645-0830 Motors TV LIVE
V8 Supercars: Queensland Race 3
0820-0950 Motors TV
NASCAR Nationwide: Iowa



0950-1100 Motors TV LIVE
European F3: Red Bull Ring Race 2
1100-1800 ITV4 LIVE
British Touring Cars: Snetterton
1100-1200 BT Sport 2 LIVE
WRC: Rally Finland powerstage
1215-1415 BT Sport 2 LIVE
DTM: Red Bull Ring
1700-1755 Motors TV
European F3: Red Bull Ring Race 3
1800-2000 British Eurosport LIVE
WTCC: Rio Hondo Races 1 & 2
1800-2200 Premier Sports LIVE
NASCAR Sprint Cup: Pocono
2030-2300 ESPN LIVE
IndyCar: Mid-Ohio
2235-2305 Motors TV
Rally Finland highlights
0000-0030 BT Sport 1
Rally Finland highlights

MONDAY AUGUST 4

1000-1100, 1600-1700 BT Sport 2
Rally Finland highlights
2130-2230 ESPN
NASCAR Sprint Cup: Pocono highlights

TUESDAY AUGUST 5

2000-2100 BT Sport 1
Motorsport Tonight

ONLINE

HOT ON THE WEB THIS WEEK

You **Tube** SILVERSTONE CLASSIC 2014 MUSTANG TROPHY



SEARCH FOR: Tom Roche Mustang v Gordon Shedden Cortina Silverstone Classic 2014 Part 1 (14:46). The power of Roche's Ford Mustang takes on the handling of Shedden's Lotus Cortina in the first pre-'66 touring car race at the Silverstone Classic, after a contretemps with the Ford Falcon of eventual winner Leo Voyatzides.

AUTOSPORT+

Kubica and Ogier grilled by AUTOSPORT... and each other

Our rally expert David Evans recently joined a select group of journalists to sit down with WRC king Sebastien Ogier and F1 star-turned-rally driver Robert Kubica for an epic conversation. Read it in full – and enjoy the drivers quizzing each other more than they listen to the media!

GET AUTOSPORT ON THE MOVE

IN THE IPAD ISSUE THIS WEEK

- HIGHLIGHTS FROM THE SILVERSTONE CLASSIC AND SPA 24 HOURS
- ON SALE ALL OVER THE WORLD FOR ONLY £2.99

DOWNLOAD IT NOW FROM AUTOSPORT.COM



Revved up over what's on the box

A thrilling race, where the outcome was in doubt right until the finish, punctuated by some hefty-looking shunts and broadcast across two TV channels at opposing times. Wow, that was some Spa 24 Hours.

While the grand prix in Hungary had us on the edge of our sofas, a 24-hour race is meant to be more a test of endurance than a thrill-a-minute, what-will-happen-next roller-coaster ride. Nobody at Spa seemed to have taken this on board.

One thing the Hungaroring didn't have was a race stoppage due to a quite horrendous-looking crash. The sight of Marcus Mahy slumped at the wheel of his totalled Ferrari 458 on the exit of Stavelot

was bad enough, but as the camera panned around you could also see Vadim Kogay's similar car burning fiercely – a truly apocalyptic vision.

The only fortunate aspect of the



scenario was the fact that Motors TV's commentators, David Addison and John Watson, are two proper pros: just what you need in a serious situation.

While adhering to the initial sombre tone, they had an awful amount of filling to do – more than an hour's worth. Ben Constanduros was also doing some serious legwork in the pits, speaking to all the right people at a very difficult time.

Watson is a great pundit with proper opinions, never afraid to shoot from the hip. As a former grand prix driver, he carries great gravitas too.

Before the race-stopping crash, there had already been a series of massive shunts – many involving gentlemen drivers, as well as some

pros. "I could race a GT car, but I choose not to," said Wattie. "You're either a professional driver or you're not."

Once they'd stopped crashing, a proper race broke out. The winners were separated by 7s, and a side-by-side dice for 11th raged in the final hour. "You'd think this was lap two, not lap 513," quipped Addison.

Eurosport also broadcasted some live coverage, but neglected to show either the start or finish, and then had a random 'as-live' segment of the race on Sunday evening (with five hours to go in a race that had already finished) when a highlights show would have been perfect.

How very odd.
Revved Up

Alan Minshaw

“I got back in and started it and the whole car ignited, which delayed us!”

■ Spa 24 Hours ■ July 27-28, 1985 ■ Volkswagen Golf GTI ■ First British crew to make the finish



The Minshaw/Greenhalgh/
Kaise Golf GTI presses on
to a 22nd-place finish

I'VE BEEN VERY FORTUNATE to have raced all sorts of cars over a very long period – in the UK and abroad, in period and in historics – so it's hard to pick one race that really stands out. But I've got one!

It was the 24 hours at Spa-Francorchamps, that iconic event that was a round of the European Touring Car Championship for many years, in 1985.

Alan Greenhalgh asked me to join him for the Belgian all-day-and-all-nighter, together with his friend Daniel Kaise, who had driven for the Northelle VW Golf Team in 1984. Obviously we'd all had extensive experience of racing Golfs, but I'd never driven at Spa before so it was like jumping in at the deep end.

One interesting fact is that part of Alan Greenhalgh's family was Wallonian and his grandfather was Bourgmestre Discry – the Mayor of Spa. He'd long had an affinity with the place, having been taken there in the 1960s to watch, so he knew the place and the track well. It was pretty

exciting to be part of team in an event full of star teams like the Schnitzer BMWs, TWR Rovers and Eggenberger Volvos and big names like Gerhard Berger, Marc Surer, Gianfranco Brancatelli, Jean-Louis Schlesser and co.

Qualifying went without any particular dramas that I can remember – we were in the bottom half of the top-20 in the

up-to-1600cc Division 1, among hordes of other Golfs, Toyota Corollas and the odd Honda Civic and Ford Escort.

When the race got going we settled down and things were going well. After a few hours we were leading the class, which was great.

I got into the car to do one of the night-time sessions and soon encountered a bit of drama. Every

time I braked I felt what I thought was water swishing around my feet. I figured it might be a good time to come into the pits!

On examination the team discovered it wasn't water but petrol! They cleaned it all up, found out where the leak was and fixed it. When I got back in and started it the whole car ignited, which delayed us for about an hour.

It hadn't done any permanent damage so we decided to battle on and all seemed OK.

Near the end of the race when Alan G was driving he got caught out in the wet while on slicks and spun into the gravel. We thought it was game over. However, the helpful marshals managed to drag him out of the gravel after a considerable time and we drove to the finish where we ended up 22nd overall and, crucially, the first British team home.

It was a great adventure on a classic track that I remember fondly. *Alan Minshaw was talking to Henry Hope-Frost*

PROFILE

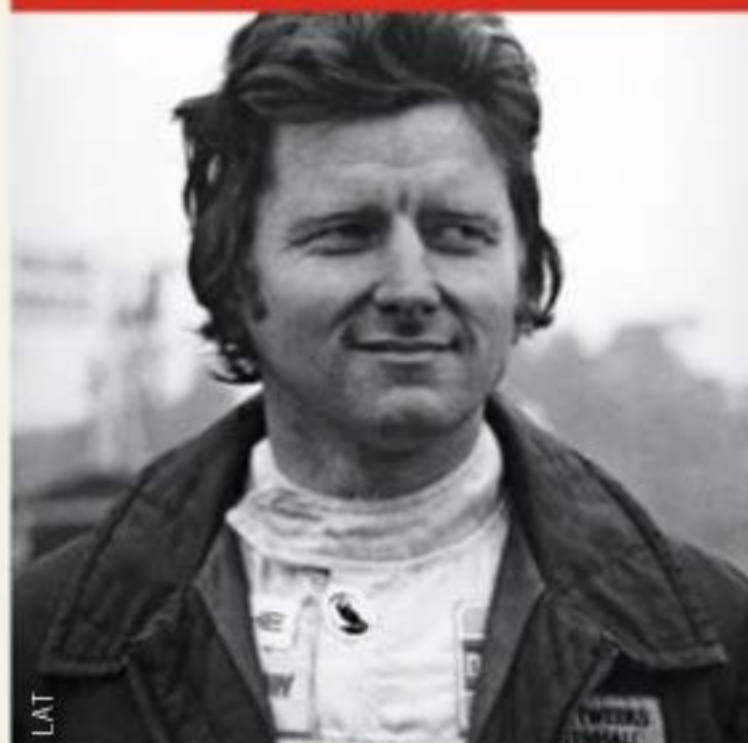

ALAN MINSHAW FOUNDED

the hugely successful Demon Tweaks racewear and accessories emporium more than 40 years ago and has raced for longer than that. Synonymous with VW Golfs and BMW M3s in the distinctive DT livery, he won numerous class awards in the '80s. He has also raced and collected historic machinery for many years, often alongside his three sons Jon, Jason and Guy.

NEXT WEEK THE STORY AFTER IMOLA '94
Special issue: Guest edited by Damon Hill



NF Approved
Versions for
France In Stock

If you drank 4 pints between 9pm and midnight, you could still be over the limit until 11am the following day*. That's why almost 1 in 5 drink drive accidents happen the "morning after"**.

AlcoSense quickly and accurately shows your blood alcohol level, so you know when you're clear.



AlcoSense One
Only £29.99
Entry level breathalyser. Provides a reading up to 1.5 times the UK drink drive limit. Accurate to +/-0.02%BAC at the drink drive limit. Recommended waiting time between tests: 1 hour



AlcoSense Lite
Only £39.99
Reliable
Intermediate level sensor for good accuracy, blow tubes for improved sample quality.
Clear
Results in seconds. Alerts you when close to or over the drink drive limit.

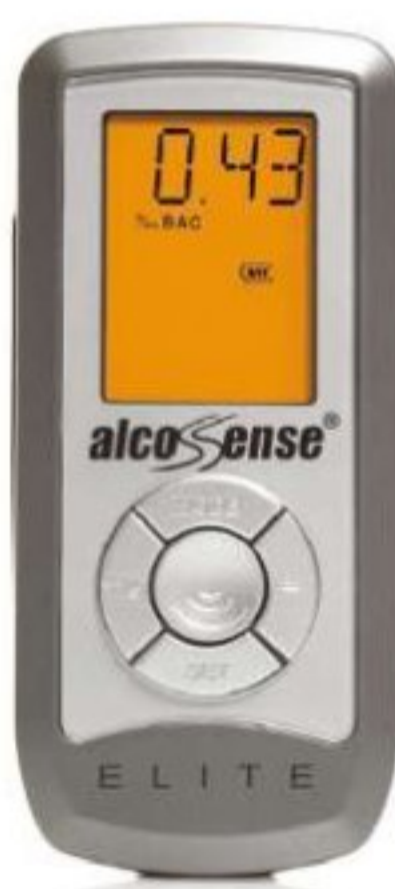

AlcoSense Elite
Only £59.99
Accurate
Premium semi-conductor sensor for high accuracy, blow tubes improve sample quality.
Consistent
Blow Pressure Sensor and self cleaning increases accuracy and consistency.
Clear & Future Proof
Results in seconds. Alerts you when you when close to or over the limit. Recalibratable for many years of use.

WHATCAR?
BEST BREATHALYSER UNDER £40

WHATCAR?
BEST BREATHALYSER UNDER £100

Available nationwide at Halfords & in selected Boots Stores. Find your local outlet at alcosense.co.uk/dealer-location/



that's helpful that's
halfords

alcoSense[®]
ALCOHOL BREATHALYSER

Order at www.alcosense.co.uk or call 0800 195 0088

** 17.1% of drink drive accidents are between hours of 5am and 1pm (Source: Dept. for Transport, Road Accidents and Safety Annual Report 2010)
* 4 Pints of Abbot Reserve contain 14.8 units of alcohol (Source: Greene King) and each unit takes 1 hour to leave the body (Source: NHS). Therefore 14.8 hours after 9pm the alcohol will have passed from the body.



THE SEAT LEON

From just **£175** per month
with **£1,930** of free equipment*



NAVIGATION SYSTEM

FULL LED HEADLIGHTS

DAB DIGITAL RADIO



TECHNOLOGY TO ENJOY

SEAT Leon 5DR SE 1.2 TSI 110PS – Solutions representative example based on 10,000 miles per annum**

Duration:	36 months	SEAT UK Deposit contribution†:	£1,000.00	Optional final payment:	£7,519.15	Amount of credit:	£12,434.62
35 monthly payments of:	£175.00	Retail cash price:	£17,235.00	Option to purchase fee²:	£60.00	Representative APR:	4.9% APR
Customer deposit:	£3,800.38	Acceptance fee¹:	£125.00	Total amount payable:	£18,629.53	Rate of interest:	4.1% fixed
Fixed full deposit:	£4,800.38						

4.9% APR representative plus £1,000 towards your deposit† FOLLOW US ON: **SEAT.CO.UK**

Official fuel consumption for the SEAT Leon in mpg (litres per 100km); urban 32.5 (8.7) - 72.4 (3.9); extra-urban 49.6 (5.7) - 91.1 (3.1); combined 42.8 (6.6) - 85.6 (3.3). CO₂ emissions 154 - 87 g/km.

Standard EU Test figures for comparative purposes and may not reflect real driving results. Model shown is the Leon 5DR SE 1.2 TSI 110PS at £17,235 RRP with optional metallic paint at £530 RRP, electric sunroof at £765 RRP, 17" Dynamic alloy wheels at £380 RRP and full LED headlights at £1000 RRP. **Offer may be varied or withdrawn at any time. Retail Sales only. †Payable with first payment. ‡Payable with optional final payment. 4.4p per mile excess mileage charges apply. †£1,000 deposit contribution is available to customers who purchase their car with Solutions personal contract plan. Terms and conditions apply. Finance examples include technology pack. Further charges may be payable if vehicle is returned. Indemnities may be required. Subject to vehicle availability. Subject to status. Available to over 18s in the UK from participating dealers only. SEAT Finance, Freepost SEAT Finance. Subject to each model specification and cost option fitment. Pricing and finance valid from 1st July to 30th September 2014. *Offer available on SE and FR models when ordered before 30th September 2014 from participating dealers only. £1,930 RRP refers to optional specification if priced individually.

SEAT recommends Castrol EDGE Professional