

# AUTOSPORT

www.autosport.com • NOVEMBER 21 2013 • £3.50

**US GP ACTION**

## VETTEL'S RECORD BREAKER

World champion's eighth straight win sets new standard



**PLUS**



**MACAU MASTER**  
Brit Lynn wins 60th GP



**RALLY GB**  
Ogier stars, Kubica rolls



# GTi IS BACK



PEUGEOT RECOMMENDS TOTAL Official Fuel Consumption in mpg (l/100km) and CO<sub>2</sub> emissions (g/km) for the 208 GTi are: Urban 34.4 (8.2), Extra Urban 60.1 (4.7), Combined 47.9 (5.9) and CO<sub>2</sub> 139 (g/km). MPG figures are achieved under official EU test conditions, intended as a guide for comparative purposes only, and may not reflect actual on-the-road driving conditions.

## NEW PEUGEOT 208 GTi

MOTION & EMOTION



PEUGEOT

**POLE POSITION**

# Why we should enjoy F1 history being made

FOR AN UNPRECEDENTED EIGHTH TIME IN A ROW IN a single season, we were treated to a Sebastian Vettel masterclass in last weekend's US Grand Prix.

While it was hardly the result to breathe life into this moribund season, it is churlish to fail to acknowledge the sensational job Vettel and his Red Bull team are doing.

We are witnessing history being made, and while it may not be making the hairs on the back of your neck stand up, in years to come people will look back at the record book and marvel at the achievement.

I say we should celebrate the collective brilliance of all involved in creating such a landmark, while hoping that the rest can raise their games for 2014.

Speaking of amazing feats, AUTOSPORT sends hearty congratulations to Alex Lynn for a stunning drive in the Macau Grand Prix last weekend.

Lynn beautifully combined outright pace with a pragmatic racing approach and reaped the rewards. What a fabulous way to cap his season.



**ANDREW VAN DE BURGT EDITOR-IN-CHIEF**  
andrew.vandeburgt@haymarket.com  
@AvdaB



**PRIVATE EAR**



**FIND US ON**



Cover Image: Dunbar/LAT  
Insets: XPB/LAT, McKlein

**PIT & PADDOCK**

6 **THIS WEEK IN F1**

9 **MARK HUGHES: MPH COLUMN**

10 **THIS WEEK IN MOTORSPORT**

13 **THE INSIDE LINE: JOST CAPITO**

14 **UNITED STATES GRAND PRIX**

Vettel makes it eight in a row to eclipse the single-season record. Full report from Austin, plus all the results, driver-by-driver analysis and the technical upgrades

**DEBRIEF**

32 **FRANCHITTI FORCED TO QUIT RACING**  
Scot heeds medical advice after Houston shunt

34 **PEREZ AND McLAREN: THE FALLOUT**  
The truth behind the end of a one-year relationship

36 **F1 FACING AN UGLY FUTURE**  
Why regulations are forcing car aesthetics to suffer

38 **BRAZILIAN GP PREVIEW**  
Can Vettel make it nine in a row; farewell to the V8 powerplants as F1 makes way for 1.6-litre turbos

**RACE CENTRE**

44 **WRC WALES RALLY GB**  
Ogier completes his title-winning year in style

54 **MACAU F3 GP**  
Brit Alex Lynn triumphs for Prema Powerteam

58 **WTCC MACAU**  
Muller and Huff share the street-track spoils

61 **NASCAR; SCIROCCO MACAU MASTERS; MACAU GT CUP**

**FEATURES**

64 **GP2 REVIEW**  
The full story of Fabio Leimer's title-winning year

66 **GP3 REVIEW**  
How F1-bound Daniil Kvyat got the job done

**SUBSCRIBE FOR A FREE GIFT**

82 **FREE ASTON POLO SHIRT**  
Subscribe for a great free gift and digital package

**CLUB AUTOSPORT**

79 **FERRARI LAUNCHES JUNIOR SERIES**  
Scuderia plans winter initiative in America

80 **BRITISH ACES EYE EURO FRENAULT**  
Barnicoat, Hughes and Robertson target '14 move

83 **MSV TEAM TROPHY EXCLUSIONS**  
Paddock altercation leads to driver punishments

85 **NATIONAL REPORT**  
BARC Rockingham

86 **TOCA SUPPORT REVIEWS**  
Renault Clio Cup, Porsche Carrera Cup, Ginetta GT Supercup and Ginetta Junior seasonal surveys

**THE BACK STRAIGHT**

90 **THIS WEEK**  
Readers' letters; best pictures; product reviews

92 **WHAT'S ON**  
The best track and TV action in the coming week

94 **RALLY OF MY LIFE: GUY FREQUELIN**  
The Frenchman recalls the 1976 Monte Carlo Rally

# THE BIG PICTURE

The Spark-Renault SRT\_01E FIA Formula E series racer finally got its first airing last week when Lucas di Grassi gave it a run at La Ferte Gaucher near Paris





# This week in F1

## BATTLE FOR SECOND IS ON

Mercedes, Ferrari and Lotus all head into Sunday's Brazilian Grand Prix in contention to finish second in the constructors' championship.

The German marque holds the initiative in the battle for second, leading Ferrari by 15 points. Lotus is the outside contender, a further 18 points back, meaning that it would need both cars to score well in Brazil and the others to falter to leap to second.

Mercedes is odds-on to clinch second, a significant step forward from last year's fifth place. Fernando Alonso has suggested finishing ahead of Mercedes might have been too ambitious a target for Ferrari.

"Maybe that was too optimistic a goal," he said. "We need to be more realistic and know that fighting for second place was a dream and maybe that dream is difficult to make come true."

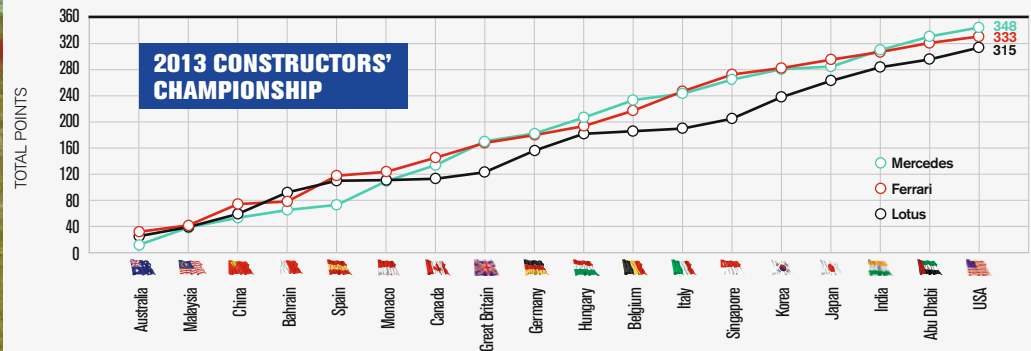

6



## Hamilton Merc chassis cracked

Lewis Hamilton used a replacement chassis in the United States GP after two large cracks were found in his Abu Dhabi car. "We knew he had some excursions over kerbs and things, but when we actually got here and started to strip everything down, the damage was pretty significant," said team principal Ross Brawn.



## Alonso proud to be runner-up

Fernando Alonso described himself as "proud" to have sealed second in the championship at Austin. "We clearly don't have the second quickest car, so second is a reward for me," he said.

### MOST WORLD CHAMPIONSHIP RUNNER-UP FINISHES

- Stirling Moss, 4 (1955-58)
- Alain Prost, 4 (1983, '84, '88, '90)
- Graham Hill, 3 (1963-65)
- Nigel Mansell, 3 (1986, '87, '91)
- Fernando Alonso, 3 (2010, '12, '13)

\*Michael Schumacher was officially second twice, but he also scored the second-most points in 1997 prior to his exclusion for hitting Jacques Villeneuve at Jerez.

For all the breaking news, visit [AUTOSPORT.COM](http://AUTOSPORT.COM)



## KVYAT MAKES HIS DEBUT

New Toro Rosso signing Daniil Kvyat made his F1 weekend debut at Austin, driving Jean-Eric Vergne's Toro Rosso during Friday-morning practice. The Russian, who will race for the team next year, completed 20 laps, ending the session two-tenths of a second adrift of team-mate Daniel Ricciardo.

### DID YOU KNOW?

Kvyat is the fourth driver to run on Fridays for Scuderia Toro Rosso. He joins current race drivers Ricciardo (eight times) and Vergne (three times), while Neel Jani has the most appearances with 18 outings in 2006.

"I think I accumulate energy and I explode. It is not that I am crazy"



Pastor Maldonado backs away from suggestions Williams deliberately held him back at Austin

## Piquet has heart surgery

Triple world champion Nelson Piquet is recovering after heart surgery. The 61-year-old has had a stent implanted in an artery to improve blood flow.



## Kovalainen called up

Heikki Kovalainen was called up by Lotus to fill in for Kimi Raikkonen for the United States and Brazilian GPs.

This is because Raikkonen had back surgery last week, which his management has stated went successfully. When Lotus's efforts to recruit Nico Hulkenberg from Sauber fell through because, according to the German, it was too much of a risk to take a two-race deal, Kovalainen was chosen.

The Finn adapted well to the long-wheelbase version of the Lotus E21, qualifying eighth just over half-a-second off team-mate Romain Grosjean. In the race, he was on target for points when a loss of front downforce because of a wing problem forced him to make an extra stop.

"I didn't know what to expect but I think we would have been right up there in the mix for good points," admitted Kovalainen. "I haven't had big problems this weekend even though it was a late call-up."



## MAGNUSSEN SIGNS 2014 McLAREN RACE DEAL

McLaren has confirmed Formula Renault 3.5 champion Kevin Magnussen will partner Jenson Button next season. He replaces Sergio Perez, who team principal Martin Whitmarsh is helping to find another seat for 2014.

### McLAREN'S ROOKIES

Kevin Magnussen will be the ninth driver to start his first world championship race driving a works McLaren. The other eight are:

- Peter Gethin**, 1970 Dutch GP
- Jody Scheckter**, 1972 United States GP
- Gilles Villeneuve**, 1977 British GP
- Bruno Giacomelli**, 1977 Italian GP
- Alain Prost**, 1980 Argentinian GP
- Michael Andretti**, 1993 South African GP
- Jan Magnussen**, 1995 Pacific GP
- Lewis Hamilton**, 2007 Australian GP



## Ward pulls out of FIA election

David Ward has pulled out of the election for the FIA presidency after failing to secure the required support to stand. This means Jean Todt is almost certain to go into the election unchallenged.



DoweeGP scored 185 points in the US round of the Castrol EDGE Grand Prix Predictor. The team predicted seven of the top-10 finishers as well as the entire podium, pole position and fastest lap. It's not too late for you to sign up and play and there's a Samsung Galaxy Tab 3 up for grabs for the top score in Brazil. Play free at [www.gppredictor.com](http://www.gppredictor.com)

# TEAM SPIRIT STANDARD. WORLD RALLY CHAMPIONS\* 2013



In its debut season, Volkswagen has not only won the drivers' and co-drivers' World Rally Championship\* 2013 title, but also the manufacturers' title. The secret of success: the Polo R WRC with 315 hp, a powerful TSI engine, outstanding four-wheel drive technology and the passion of a unique team.

\*subject to the official publication of the results by the FIA.

**RALLYTHEWORLD.COM**  
**EXCITEMENT WE SHARE**



WORLD RALLY CHAMPIONS\*  
2013



# Mark Hughes

## MPH



Quantum physics meets F1 – not a great leap forward in motive power or aero, but the strange state the sport has got itself into

**S**chrodinger's cat is used as a thought exercise to illustrate the principle of 'super-position' in quantum physics theory. The cat is locked in a box containing a sealed jar of poisonous gas and a radioactive source which might or might not decay in a given time period. If radioactive decay is picked up by a Geiger counter, a hammer smashes the jar, the gas is released and the cat dies. If no atoms begin decaying in the time period, the jar stays intact and the cat survives.

So during the time of the experiment – before the observer has checked the outcome – the cat might be either alive or dead. Before the observation has been made, the cat has to be considered both alive *and* dead – and this is analogous to the behaviour of sub-atomic particles in the real world; both the cat and the particles depend upon an observer to determine their state.

Until that moment they do not have a definitive state. They hold super-position. Only observation causes that super-position reality to collapse into one possibility or the other.

At the time of writing there was a Quantum situation in F1 – with the possible future of the Lotus F1 team relying on the reality or otherwise of Mansoor Ijaz's Quantum investment group's money. It may or may not be there. The money holds super-position.

Which was creating an interesting parallel super-position regarding Pastor Maldonado's prospects of



issue of costs which are not sustainable and, outside of the big four teams, has come to increasingly depend upon drivers bringing a big chunk of the running costs.

The type of backers coming to the fore – associated with the sovereign wealth of nations such as Venezuela and Russia – are seeing more value in being associated with a sportsman rather than a team. From their perspective it's a much more appealing, human, personal and inspiring partnership. But that doesn't make them pay-drivers in the old sense. They are still professional sportsmen; they just receive the income from someone other than the team.

But it's increasingly taking the teams out of the driving seats and putting the new 'sovereign' drivers

**“The stakes in making the right call could be the very future of the Lotus team”**

joining Lotus. Quantum's Ijaz is briefing that he does not believe a professional sportsman should pay to compete and that, as such, he does not consider Maldonado to be a professional sportsman! Which is why his stated preference was for Nico Hulkenberg (who may or may not already have signed for Force India).

All of which, as one might imagine, was making the Lotus management rather nervous; on the strength of the wishes of someone whose investment group held a state of super-position, they were having to consider turning down a driver who definitely does bring \$40 million of PDVSA money (as has already been observed during his stint at Williams). The stakes in making the right call could be the very future of the team.

It all illustrates the ridiculous situation F1 has got itself into since the manufacturer-money taps were switched off, along with their junior driver schemes, a few years ago. F1 has failed to properly address the

into them. “It's bizarre,” laughs Damon Hill. “The next stage for negotiation is going to be drivers insisting on a seat of the team's board. Imagine!”

One resolution to the apparent paradox of super-position – one that has gained increasing acceptance in the scientific community in recent years – is the multiple universe theory whereby every outcome is a branch event, each of which creates a new universe for that event. So that in any given universe, the cat is never both dead *and* alive, but always either dead or alive. Both universes are equally real but do not interact with each other.

So whether we see Pastor Maldonado in a Lotus or a Sauber next year, his drive paid for by the exploitation of natural resources derived in part from dead dinosaurs beneath the ground (ie oil), might depend on which universe we end up in.

Strange times indeed. ❧

# This week in motorsport

## BIG SPORTSCARS BACK AT BRANDS

Top-line sportscar racing will return to Brands Hatch after 18 years with a round of the renamed Blancpain Sprint Series next season.

The event for the championship currently known as the FIA GT Series takes the May 17-18 slot at the Kent venue

vacated by the DTM.

The renaming of the championship in line with the Blancpain Endurance Series has allowed the two to be linked. Blancpain GT drivers' and teams' champions will be crowned on the basis of points scored across both.



10

## Pickett goes PC for 2014

American Le Mans Series champion team Pickett Racing will race in the new United SportsCar Championship next season.

The squad will run an LMPC one-make ORECA-Chevrolet FLMO9. Team boss Greg Pickett said this was "only one piece of the puzzle for 2014".



DOLE/LAT



## Munnich joins World Rallycross

Munnich Motorsport, which departed from World Touring Cars with a victory for Rob Huff in Macau last weekend, will focus on the new World Rallycross Championship next year.

Team boss Rene Munnich, a four-time German rallycross champion, will drive a lone Audi A3 SuperCar (above), but has left the door open to a potential three-car effort for 2015.

## KENT'S SPORTSCAR CLASSICS



LAT

### 1970 Brands Hatch 1000km

Pedro Rodriguez stars in the wet to take a five-lap victory with Leo Kinnunen aboard a JW Automotive Porsche 917.



LAT

### 1982 Brands Hatch 1000km

Porsche driver Jacky Ickx (l) comes from behind at the maiden Brands Group C race to seal his first world title in a factory 956.



LAT

### 1996 Brands Hatch 4 Hours

Major sportscar racing returns for this one-off Global GT Endurance fixture. Porsche's controversial 911 GT1 wins.

## New Audi LMP1 tests

Audi's 2014 Le Mans 24 Hours challenger has already tested.

Audi Sport boss Wolfgang Ullrich told AUTOSPORT that the new car, built to the 2014 LMP1 rulebook, had tested on schedule before the end of September and had already undertaken a second run at undisclosed venues.

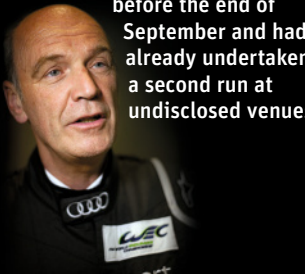

KALISZ/LAT

For all the breaking news, visit [AUTOSPORT.COM](http://AUTOSPORT.COM)



## Mazda to run factory LMPs

Mazda will mount a factory campaign on the Prototype class of next year's United SportsCar Championship.

SpeedSource will run two Lola B12/80s powered by the Japanese manufacturer's SKYACTIV-D turbodiesel engine, which was developed for racing in a Mazda6 in the experimental GX class in Grand-Am this year. Drivers have yet to be announced.



## Abt enters Formula E with Audi

Audi will support an entry from its factory DTM squad Abt Sportsline in the all-new Formula E championship,

which kicks off next year. Team boss Hans-Jurgen Abt said that it would not be a fully-fledged manufacturer entry.

## In brief



### BELCHER TO BTCC

Renault Clio Cup midfielder Simon Belcher will graduate to British Touring Cars next year in a Toyota Avensis. The former Legends racer's machine will be run in by Handy Motorsports with engineering support from Speedworks.

### JORDAN TO ASI

BTCC champion Andrew Jordan is the latest star name to confirm his appearance at AUTOSPORT International at Birmingham's NEC on January 11-12. For more information and to buy tickets, log on to [autosportinternational.com](http://autosportinternational.com).

### BAYNE HAS MS

NASCAR Nationwide Series regular Trevor Bayne, 22, has been diagnosed with multiple sclerosis. The Roush Fenway Ford driver, who won the 2011 Daytona 500, plans to continue racing.

### CONWAY'S NEW SEAT

Mike Conway has secured a 'road-course only' deal for the 2014 IndyCar season with Ed Carpenter Racing. Rival team Andretti Autosport has signed Indy Lights frontrunner Carlos Munoz.

### PRIAULX LEAVES DTM

BMW's Andy Priaulx will switch from the DTM to the manufacturer's United Sportscar effort next year. He tested a factory RLL-run Z4 GT3 at Sebring and Daytona this week.

### TURVEY'S BAKU SEAT

Oliver Turvey will race a McLaren MP4-12C GT3 at the Baku FIA GT Series finale this weekend. The Brit, a test driver for McLaren's Formula 1 team, will share an MRS-run car with ex-F2 champion Andy Soucek.

### BENTLEY BOYS NAMED

Guy Smith, part of Bentley's 2003 Le Mans-winning line-up, will be behind the wheel when the marque returns to motorsport at the Gulf 12 Hours at Yas Marina on December 13. He joins Andy Meyrick and Steven Kane.



## Lynn gets DAMS test

Macau Grand Prix winner Alex Lynn tested for Formula Renault 3.5 champion team DAMS at Aragon this week. The 20-year-old Briton has yet to decide whether to remain with Prema Powerteam for a second Formula 3 European Championship assault or step up to a more powerful series.

Carlin, meanwhile, ran Dean Stoneman, Nick Yelloly and Matt Parry while Oliver Rowland drove for Fortec.

## 2014 DPs hit the track

The revised breed of Daytona Prototype that will race in next year's United SportsCar Championship ran for the first time at Sebring last weekend.

The Action Express team's latest Coyote Corvette ran the updates that will bring the performance of the DPs towards that of LMP2 machinery. Joao Barbosa set a best lap just over two seconds slower than this year's LMP2 pole at the Sebring 12 Hours.



## Indy Lights run for Harvey

GP3 race winner Jack Harvey will test for leading Indy Lights squad Schmidt Peterson Motorsports at Sebring next week. Harvey and his backer, the Racing Steps Foundation, are assessing his options outside of European racing.

**P66 GP3 REVIEW**

## TURKINGTON TESTS VW

Colin Turkington, the 2009 British Touring Car champion, tested a Team Hard Volkswagen Passat at Silverstone last week. Turkington, who finished fifth overall in a WSR BMW this year, is uncertain to remain with the team for 2014.

- Triple Eight was also at Silverstone, running Chris Smiley, who won his test as a result of his success in the Mini Challenge this year.





Porsche recommends Mobil 1 and MICHELIN

Please visit [www.porsche.co.uk/mission2014](http://www.porsche.co.uk/mission2014) for further information.

**Every time we build a new race car,  
we question every single part.  
Except for one.**

### **Mission 2014. Our Return.**

After more than a decade Porsche is returning to top-level racing in 2014 – to the FIA World Endurance Championship and its highlight, the 24 Hours of Le Mans.

Our strategy? The same that we follow when developing every Porsche – starting from the ground up and questioning every detail. We take nothing for granted. Except for the principle behind everything we've built for more than 60 years: Intelligent Performance.

Come along on our mission at [porsche.co.uk/mission2014](http://porsche.co.uk/mission2014) and watch us develop our prototype first-hand.



**PORSCHE**



# Jost Capito

## The inside line

Volkswagen's WRC boss reflects on the team's double title success and warns it'll come back fighting again next season

**R**ally GB was a great way for Volkswagen Motorsport to finish its first season at the highest level of the World Rally Championship. Another win for Sebastien Ogier and another very strong performance from Jari-Matti Latvala and Andreas Mikkelsen was fantastic for the whole team. The 1-2-5 finish was the best of the year for us.

This event is a notoriously difficult rally, but from the side of Volkswagen Motorsport, it was actually quite straightforward. This was, I would say, one of the least difficult rallies. We had no punctures and absolutely no technical problems with the Polo R WRCs. This isn't the rally in which we have to worry about the car being really strong nor do we have worries about the power.

Obviously, the car has to be reliable, but the challenge on this event is usually more for the drivers in what can be some really tricky conditions. But our drivers had no problems either.

Coming to the start of this event, we were in the very nice position that we had won the manufacturers' and drivers' championships, so we told the drivers that they could go and do their rally. This was their rally and they could do what they wanted.

Jari-Matti was very strong, but he couldn't find the feeling in the stages on Saturday morning and that's where he lost the chance [to fight for the win]. And when you have a driver like Ogier with a 25-second-



And there was certainly a lot of enthusiasm for Rally GB out on the road, where the stages were fully packed with fans. The rally moved north this year and into a new service park in Deeside. I don't know about this service park, it was quite a long way away from the stages, which made it difficult for the spectators to follow the rally and it made it quite difficult for the team to follow the rally. There wasn't much going on in service between six in the morning and six at night, but then on Saturday night it was absolutely packed.

So, that's it for this year. We have now finished our first season and we have to be pleased with it. But one thing is absolutely certain, despite another strong result from Volkswagen Motorsport, one thing we will not be doing next year is standing still and just waiting to win again. We know we have to work, we know that we have

**“This year we took the others by surprise, but our rivals will not be sleeping over the winter”**

plus advantage then it is very difficult for anybody to challenge him. Sebastien was able to control the rally at the front and drive only as fast as he had to.

This is another rally where he has shown what he is capable of. He came here without much experience and without good results yet he leads from the start to the finish.

But all of the guys really did their rallies well. And, of course, this is a fantastic way to end what has been a fantastic year – not just in terms of the results on the stages, but also from other sides for us as well.

On the final day of the rally, not only were we successful in the sport, but Volkswagen Motorsport's Facebook page also moved past one million people. When we started out this year, we only had 60,000 followers and in 11 months or something we have now gone past a million – this shows the real enthusiasm that people have for what we are doing.

to remain very competitive – we know that it is more difficult to retain the title next year than it is to win it for the first time this season.

This year we took the others by surprise, but our rivals will not be sleeping over the winter, they will get more focused and make fewer mistakes next year. I think they made some mistakes earlier this year because they were surprised at the performance that we had in the first few rallies. But I am pretty convinced this will not happen again, they will be in a different mindset when they come to the start of next year.

The challenge for us next year is to keep the motivation up. We need to tell the guys that this will not get easier, it will only get harder from here. Through the season you have seen that this is our way – nobody gets big-headed or arrogant, we don't behave like we are better than anybody else or anything like that. This was our team spirit in Wales, as it will be going into 2014. ❧

# THE RACE REPORT

QUALIFYING • TRACKSIDE VIEW • LAP CHART • DRIVER BY DRIVER • RESULTS

## Vettel reaches a new high

On a weekend when managing tyre degradation was the name of the game, Vettel was once again peerless, scoring a record eighth consecutive win in one F1 season. **MARK HUGHES** reports



## AT A GLANCE



'Vettel's stream of fastest laps alarmed Red Bull, but he was the fastest of a field conserving its tyres'

**UNITED STATES GP**  
Austin

**ROUND** 18/19

**LAPS** 56

**WINNER**  
Sebastian Vettel  
1h39m17.148s

**POLE POSITION**  
Sebastian Vettel  
1m36.338s

**FASTEST LAP**  
Sebastian Vettel  
1m39.856s

**RACE RATING**  
★★★★★ Grosjean managed to split the leading Red Bulls, with all drivers fighting to save their tyres

**DRIVERS' STANDINGS**  
Vettel 372pts  
Alonso 227pts  
Hamilton 187pts



**Vettel and Webber qualified one-two once again for Red Bull, while Grosjean was best of the rest**



STALEY/LAT

## QUALIFYING 12:00, 16.11.2013

16



The grid may have had a relatively normal look to it, but the strong winds and varying track temperatures threw the delicate balance askew up and down the pitlane and there was a lot of on-the-hoof improvisation in adapting. Rising serenely above all that was Red Bull, the most robust tyre choice possible of hard and mediums suiting the RB9 perfectly, allowing it to run even more rake than usual and gifting it an advantage over the best of the rest that turned out to be 0.8s.

So, as the only two drivers not to even try a pair of mediums in Q1, Sebastian Vettel and Mark Webber had two new sets each for Q3 and were therefore perfectly placed for a gunslinger's showdown for pole in Texas.

The beautiful fast, flowing rhythm of the circuit in sector one and at the end of three is perfect territory for Webber, the sort of old-school layout that makes it

all about stretching the elastic, pushing for new limits rather than the intricate slow-turn acrobatics that Vettel is so adept at. With two poles in the previous three races, Webber felt he was again in the game, on Saturday at least.

For the banker first runs, he was two-tenths up on Vettel. Game most definitely on. Into the pits they each trailed, separated by about 20 seconds, a new set of mediums each fitted, their mould lines still sharp as they left the garages. Through the Silverstone-type flows of sector one Webber knocked a full three-tenths off his earlier benchmark. Vettel trailed by almost two-tenths. Through the middle sector they were more evenly matched, but still Webber shaded him. It all hung on the final sector. Through the fiddly second-gear Turns 13 and 14 Webber was clean and quick, through the long fast multiple-apex right of Turns 16 and 17 he was flying once more — but he felt

there was more time to be had through the final two right-angled Turns 19 and 20. He couldn't leave that time there — not with a rival like Vettel there to pounce. So he attacked — and that's where it all slipped away. "Turn 19's blind," he explained. "You cannot see the apex sitting so low down in the car, and so it's a leap of faith how accurate you are and how much you commit to that accuracy. I committed but I wasn't accurate enough and I got out wide, ran out of road."

Vettel duly made a clinically clean run through that final sector, faster than Mark through both the tight twists and 19/20 — and pole was his, the 44th of his career, the eighth of this year, by the margin of just over 0.1s. Not for the first time on these tyres, his discipline in how much to take from them early in the lap played its part in his achievement. "On the first run in Q3 I had started to feel uncomfortable with the rears towards the end of the lap," he explained, "so I tried a little to keep it clean on the second run early in the lap." Judging the balancing point between how much to surrender early in the lap for how big the gain would be later was very much a part of his pole. "Mark just seemed to be getting closer and closer to me as the weekend went on," said Seb in reference to their progress through practice, "and in the end I was only just able to hang on."

"Yeah, sometimes you're happy that you've done everything you can and you're still behind," said Webber, "but today it definitely slipped through my

fingers. It would've been nice to get another pole even with a few grey hairs."

Romain Grosjean's Lotus emerged as best of the rest once again, 0.817s adrift of Vettel. He'd been able to get through Q1 with just a single run on the hards (though he did do an aborted in/out lap on mediums) and after using his first set of mediums to get through Q2 his first Q3 run was a conservative banker lap. He squeezed out as much as he reckoned was in the car on his second attempt and was well satisfied to have brought the car's balance back after the change in conditions. It was notable that the Lotus was among the very slowest at the end of the straights, and not particularly quick on corner exits. Almost all of its speed was coming from braking performance and corner entry. Heikki Kovalainen did a solid stand-in job in the sister car, getting through to Q3 where, on his last remaining set of fresh mediums, he qualified eighth, just over half-a-second off Grosjean.

Nico Hulkenberg continued his excellent form to qualify the Sauber in fourth place. He'd been amazed at how bad the car had felt in Q1 and Q2 compared to earlier in the morning. "The wind had changed a lot and it was a tailwind through most of the first sector — and our car is very sensitive to wind direction. But we made some changes for Q3 and it was much better." The time came on his single set of fresh mediums and on the second of a two-lap run. Team-mate Esteban Gutierrez also got into Q3 and qualified 10th, 0.7s off, but was subsequently demoted



DUNBAR/LAT



10 places for badly impeding Pastor Maldonado's Williams in Q1.

The Mercedes did not respond well to the change in conditions. Nico Rosberg failed to make it out of Q2, 14th fastest amid armfuls of oversteer through the quick sections. Getting the fronts up to temperature before the rears were too hot was proving tricky. Lewis Hamilton was less adversely affected. He did a single two-lap Q3 run that yielded him fifth-fastest time.

Fernando Alonso did a superb Q2 lap that got the Ferrari through to the shoot-out against all expectations and, once there, he slotted it sixth quickest. The car reacted very badly to the drop in track temperatures, reluctant to bring its front tyres up to temperature and amplifying its already poor traction. "The hotter the track the better it is

**'Getting the fronts up to temperature before the rears were too hot was proving tricky'**

for us here," said Alonso. Felipe Massa couldn't get on top of the tyre behaviour and even before encountering traffic on his Q2 run was not placed to have made it through. He was 15th.

McLaren had looked in reasonable shape through the practices and Sergio Perez managed to carry this through into qualifying, with a solid effort to get him through then a particularly good lap in Q3 for seventh, a quarter-second faster than Kovalainen's Lotus. Team-mate Jenson Button again lost the balance of the car as the track changed and could make no sense of it, leaving him out of Q3, 13th fastest in Q2 and carrying a three-place grid penalty for a red flag infringement the day before.























Valtteri Bottas put the Williams ninth on the grid, having been fourth quickest in Q2. He spoilt his single Q3 lap with a few errors at the end but had been superb in understanding and applying how the tyres needed to be prepared in the conditions. Pastor Maldonado didn't do as well and was impeded twice, leaving him stuck in Q1.

**P30 FULL RESULTS & POINTS**



COMTES/LAT

**THE GRID**

 2 WEBBER RED BULL 1m36.441s Medium	 1 VETTEL RED BULL 1m36.338s Medium
 4 HULKENBERG SAUBER 1m37.296s Medium	 3 GROSJEAN LOTUS 1m37.155s Medium
 6 ALONSO FERRARI 1m37.376s Medium	 5 HAMILTON MERCEDES 1m37.345s Medium
 8 KOVALAINEN LOTUS 1m37.715s Medium	 7 PEREZ McLAREN 1m37.452s Supersoft
 10 RICCIARDO TORO ROSSO 1m38.131s Medium	 9 BOTTAS WILLIAMS 1m37.836s Medium
 12 ROSBERG MERCEDES 1m38.364s Medium	 11 DI RESTA FORCE INDIA 1m38.139s Medium
 14 VERGNE TORO ROSSO 1m38.696s Hard	 13 MASSA FERRARI 1m38.592 Medium
 16 SUTIL FORCE INDIA 1m39.250s Medium	 15 BUTTON McLAREN 1m38.217s* Medium
 18 VAN DER GARDE CATERHAM 1m40.491s Medium	 17 MALDONADO WILLIAMS 1m39.351s Medium
 20 GUTIERREZ SAUBER 1m38.034s** Medium	 19 BIANCHI MARUSSIA 1m40.528s Medium
 22 PIC CATERHAM 1m40.596s*** Medium	 21 CHILTON MARUSSIA 1m41.401s Medium

\* 3-place grid penalty  
\*\* 10-place grid penalty  
\*\*\* 5-place grid penalty

**TRACKSIDE VIEW**

**Mark Hughes**  
GRAND PRIX EDITOR

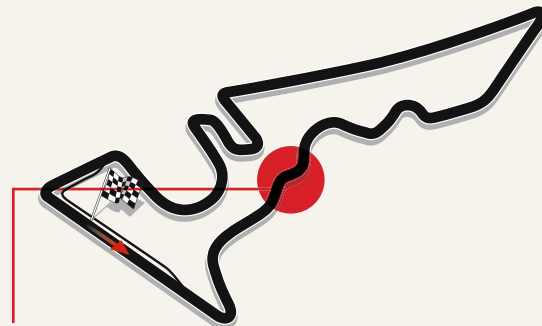

The Austin early-morning fog has lifted and the machines are finally uncaged. At the fast sweeps of Turns 4-5, with a sixth-gear entry and an inconvenient tightening that grudgingly forces a downchange, a Texan take on Maggotts/Becketts, they are running free. There's still enough moisture in the air for vapour vortices to form on the corner of the rear wings for a second or so just before they turn in. Heikki Kovalainen is playing himself into the Lotus gently, letting the stream of info and sensations come at him at processable speed. Jenson Button and Sergio Perez make for an interesting comparison here, the latter's turn in more abrupt and aggressive, Jenson's manipulation of the car around the apex of 5 carrying more momentum. Up at the highest part of the track, Turns 8 and 9, a graceful sequence of lines up the hill and where the sun is now bright enough to bleed out the cars' colours, the Red Bulls are running so much rake they look like very fast triangles. Sebastian Vettel's speed out of Turn 9 is in a different league to anyone else's, though he's regularly getting out of shape under braking for Turn 8 – for the simple reason he's arriving there faster than anyone else, courtesy of his speed out of 7.

**'The Red Bulls are running so much rake they look like very fast triangles'**

The Ferraris are great to watch through this sequence, their lack of traction making the conflict between lateral grip and acceleration visibly obvious. Fernando Alonso is much more disciplined here, patient with the throttle at a place where Felipe Massa just cannot resist the temptation to powerslide.



**Button's approach was less aggressive than Perez's**

# WE ARE FAMILY

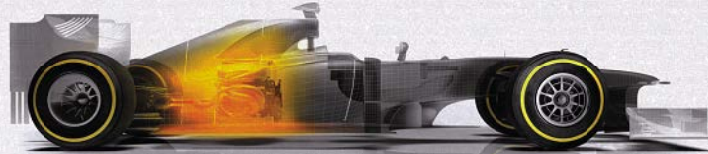

**FORMULA ONE INSPIRED ENERGY ENGINES**



**NEW RENAULT CLIO†**  
From £129 per month\*, plus 1 year's free insurance\*\*



**ALL-NEW RENAULT CAPTUR CROSSOVER†**  
From £179 per month\*

**FORMULA ONE TECHNOLOGY = BETTER FUEL ECONOMY + REDUCED EMISSIONS**

Our Formula One inspired ENERGY engines deliver up to 21% better fuel consumption and reduced CO<sub>2</sub> emissions. Book a test drive today at [renault.co.uk/formulaone](http://renault.co.uk/formulaone)

**4** **FOUR YEARS WARRANTY**  
**ROADSIDE COVER INCLUDED**  
**SERVICING FINANCE PACKAGE**



**DRIVE THE CHANGE**



The official fuel consumption figures in mpg (l/100km) for the Renault range are: Urban 27.2 (10.4)–78.5 (3.6); Extra Urban 45.6 (6.2)–94.2 (3.0); Combined 36.7 (7.7)–88.3 (3.2). The official CO<sub>2</sub> emissions for the range are 178–83g/km. Based on EU Directive and Regulation 692/2008 test environment figures. Fuel consumption and CO<sub>2</sub> may vary according to driving styles, road conditions and other factors. †Cars shown are Clio and Captur Dynamique S MediaNav TCe 90 S&S from £189 and £219 per month.

† Terms and exclusions apply. Warranty 100,000 miles. Service 48,000 miles. Visit [renault.co.uk/4plus](http://renault.co.uk/4plus) for details. Finance provided by RCI Financial Services Limited, PO Box 149, Watford WD17 1FJ. Guarantees and indemnities may be required. You must be at least 18 and a UK resident (excluding the Isle of Man and Channel Islands) to apply. \*Rental stated is for Renault Lease. If you choose Renault Lease then you will not own the car. When you have paid the final rental at the end of the contract, you can keep using the car and pay an annual rental equivalent to one monthly rental. Typical example: Renault Clio Expression 1.2 16V 75 with insurance included, customer deposit £2,624 inc. VAT followed by 48 monthly payments of £129 inc. VAT, final payment £3,835 inc. VAT. Typical example: New Captur Dynamique MediaNav TCe 90 S&S, customer deposit £2,849 inc. VAT followed by 48 monthly payments of £179 inc. VAT, final payment £5,846 inc. VAT. A finance facility fee of £149 will be payable with the advance rental. Available at participating dealers only. Offers cannot be used in conjunction with other schemes or finance offers and are available on new vehicles when ordered before 31 December 2013. Cars shown may have optional metallic paint, available at an additional £495 (or £595 for i.d. paint), plus £300 for painted roof on Captur. \*\*Insurance is available to Renault Finance customers only (exc. Northern Ireland) with a new Renault Clio Expression 1.2 16V 75. Visit [renault.co.uk/insurance](http://renault.co.uk/insurance) for details.

**Vettel leads as Webber loses out to Grosjean and Hamilton (left)**



## RACE 13.00, 17.11.2013



That Texan sun still has some power even by mid-November and so when finally it appeared on race day, and the track temperature rose as high as 37C, having at times during practice hovered below 20, it threw all those finely honed engineering calculations askew. No-one had hard data and instead of being able to comfortably do a flat-out one-stop race, the teams instead went into the afternoon emphasising to their drivers they would keep them advised – after having paid very close attention to the tyre temperature monitors. Sure enough, rear tyre heat degradation became the limiting factor – defining pretty much everyone's race as a cagey push/pull, yin-and-yang affair. It was neither a flat-out contest nor a carefully pre-calculated 'drive to a delta' race.

**'It was a waste of a beautiful track and a breathtaking collection of cars'**

Everyone was reacting rather than planning, being very careful to stay on the favoured one-stop strategy. You wanted your tyres in good shape at the end of each stint, so you could attack or defend. So you needed to conserve for big stretches of the race – but how close did you dare let the guy chasing you get, risking the loss of track position? It wasn't straightforward. In the meantime the fans who had flocked to the place were subjected to long stretches of the race when drivers were

just circulating, not daring to get the cars out of shape, leaving lots of margin everywhere, just driving to the numbers. The numbers from the rear tyres determined the laptime numbers. It was a waste of a beautiful track and a breathtaking collection of cars and drivers. This format of racing is not doing the sport justice.

Sebastian Vettel extended his consecutive race-winning streak to eight, regardless. Once he'd secured pole the day before, it never looked in doubt that he would. The RB9's raw pace advantage was among the biggest it had enjoyed all season; it was just a question of how best to utilise it. The unique geometry of the Turn 1 here, a hairpin with a wide approach, means that the outside line is invariably favoured. So Vettel's only real threat – his team-mate Mark Webber – was seriously disadvantaged by the error he'd made on the penultimate corner of his qualifying lap. That handed pole to Vettel and ensured Webber, from the disadvantageous inside starting slot, was going to struggle even to come out of that turn in second place.

That's exactly how it played out. Vettel's start was good enough to retain his position, Webber was mugged from the dirtier side, found himself pinched in to the inside, obliging him to lift to avoid snagging Vettel – all of which lost him enough momentum to drop a place to Romain Grosjean's Lotus into the

turn and Lewis Hamilton's Mercedes coming out of it. If it had been difficult to see a threat to Vettel before...

Following Vettel, Grosjean, Hamilton and Webber in the colourful pack snaking its way down the hill from that hairpin to the flat-out kink of Turn 2 ran Nico Hulkenberg's Sauber, Fernando Alonso's Ferrari, Valtteri Bottas' Williams and Paul di Resta's Force India, the latter two having passed Heikki Kovalainen who looked slightly race-rusty off the start, his reactions a little tardy. The Lotus was then shuffled back a couple more places at Turn 12, the tight left at the end of the long back straight, Heikki running wide and demoted to 12th by Daniel Ricciardo's Toro Rosso and Nico Rosberg's Mercedes. A second or two later the safety car lights neutralised the race: through the right-handed kink of that back straight Adrian Sutil was running the Force India's tyre sidewalls right alongside those of Pastor Maldonado to his left. Adrian didn't seem to realise the Williams was still there as he began to ease across to the left and in an instant he was in the midst of a top-gear spin, arrested only by the barrier.

Vettel took up where he left off as racing resumed at the end of the fourth lap and he pulled out almost 2s on Grosjean, adding a further few tenths each lap. The safety car laps had helped with everyone's tyre life, but still it was marginal and there wasn't much ▶

**Sutil crashed out early and was race's only retirement**





# TW STEEL®

BIG IN OVERSIZED WATCHES



BE AMBITIOUS



OFFICIAL TIMING PARTNER

[WWW.TWSTEELUK.COM](http://WWW.TWSTEELUK.COM)

► action as everyone settled into a tyre-conserving groove. Even outside the top 10, everyone except Toro Rosso's Jean-Eric Vergne had started on the option (medium) tyre. It was faster and almost as durable as the prime (hard) but still those rear temperatures would soon be creeping up. Above a certain temperature threshold they lose a lot of grip, the structure simply unable to cope with the loads. Up and down the pitlane, engineers held their drivers on a leash. Over the next few laps Vettel eased away from Grosjean who in turn pulled out a similar margin over Hamilton, with Webber itching to get past the slower Mercedes but unable to find a way; with the DRS activated the Red Bull was hard up against the rev limiter quite early down that back straight. No-one was flat-out at this stage. There would be brief flat-out



**Hamilton's Mercedes ran third early on but couldn't hold off Webber's Red Bull**

DUNBAR/LAT

**'Hamilton gave chase before being reminded his rear temperatures were looking bad'**

phases at crucial moments, allowing the gaps to ebb and flow but without really breaking the stalemate.

But with Grosjean leaving Hamilton well behind, the closely following Webber could not afford to simply sit and wait, and on the 13th lap he put a beautifully judged late-braking move on the Merc at the end of the second DRS zone into turn 12, sweeping around Lewis' outside. Hamilton gave chase briefly before being reminded over the radio that his rear temperatures were beginning to look bad and that he needed to back off once more to avoid the prospect of having to two-stop. So for a time Hamilton slipped back towards Hulkenberg and Perez, Alonso and Bottas behind. "It was a question of



**Kovalainen hit trouble after bad start**

COATES/LAT

looking after the tyres but staying just out of range of those behind," explained Lewis. "If Hulk did a lap that was a tenth faster I'd make sure my next one was two tenths faster, but you couldn't really do any more than that with what we had."

He was at least faring better than team-mate Rosberg who was continually being thwarted by Ricciardo's defence of 10th place, with Kovalainen looking on from close quarters. Heikki was first of the scheduled pitters, on lap 17, very early for a one-stop. It would ensure he undercut those immediately ahead of him but was relying heavily on being able to access the Lotus' easy tyre use to have his hards do the remaining 39 laps.

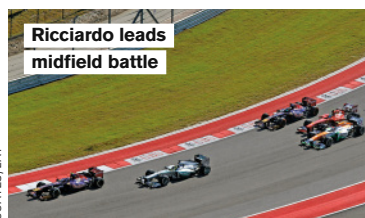

**Ricciardo leads midfield battle**

COATES/LAT

With drivers going into the late stages of the opening stints, those still with their tyres in good shape were let off the leash – notably Alonso, who proceeded to hound Perez relentlessly for fifth place, with Hulkenberg's fourth tantalisingly just beyond. But passing around here is difficult and Sergio played the defensive game perfectly. Rosberg finally nailed a move on Ricciardo and set off after di Resta, who was finding the Force India to be harder on the tyres than usual and had lost touch with Bottas ahead of him, the Williams still tracking the Perez/Alonso dice closely.

McLaren brought Perez in at the end of lap 22, defending from any possible undercut attempt by Alonso. But ►



**Alonso charged, but the scoreboard tells the story of 2013**

ROLEX	
LAP	19
1	UET
2	GRO
3	WEB
4	HAM
5	HUL
6	PER
7	ALO
8	BOT
9	DIR
10	RIC

HONE/LAT

## FRIDAY

**0940** Belated start to FP1 as medical helicopter can't fly due to fog.

**0940** **Hamilton** complains as FP1 starts: **"The furniture outside is all in the way of my box, I thought I was going to hit it."**

**0954** Red flag due to **"further problems with medical helicopter"**.

**1025** **Ricciardo** is asked if he is ready. He deadpans: **"I've been ready for an hour and a half."**



**1028** Session resumes as replacement medical helicopter arrives after original suffers antenna problem.

**1035** Toro Rosso's rookie **Kvyat** is told: **"You went forwards with the brake bias, we want you to go backwards, the opposite direction."**

**1040** **Alonso** runs wide onto the run-off at Turn 12.

**1052** **Webber** inquires: **"Everything OK on the brakes, mate? Losing the rear at Turn 1."**

**1056** **Hamilton** is told: **"Fuel corrected we think you're around Alonso's pace."**

**1056** **Gonzalez** stops at Turn 13. **"Something happened, the engine switched off suddenly. I think I had a blow out. I can't get neutral."**

**1310** In FP2, **Rosberg** reports: **"Too much understeer everywhere at the moment."**

**1332** **Maldonado** is asked for his comments: **"Everything is wrong"** is his succinct reply.

**1339** **Button** complains: **"Rear grip is poor. All through speed range, from braking to exit."**

**1355** **Di Resta** reports: **"Absolutely shocking. No grip."**

**1421** **Chilton** spins at the final corner. **"Just had complete brake failure, the pedal went completely to the floor. Not much I could do."**

**1427** As the cherry picker retrieving Chilton's car gets stuck, **Hulkenberg** says: **"Jesus, how long do they need to get that car away?"**

COATES/LAT



Red Bull's Webber pitstop set another new record

DUNBAR/LAT



TEE/LAT

► Ferrari left its man out there, nervous of committing him to a long final stint. This worked to Fernando's advantage. As he remained out, rear tyres still just about hanging on, Perez was behind Esteban Gutierrez's Sauber (which had pitted under the safety car to get out of synch), the pair of them restricted to the pace of the long-running, prime-tyred Vergne. Gutierrez scabbled by the Toro Rosso into Turn 12 on the 25th lap and Perez did the same a lap later. On that cue, Ferrari brought in Alonso. As the Ferrari accelerated out of the pitlane, Perez was bearing down the pit straight at a vastly higher speed, but behind. Alonso scabbled ahead, just before they arrived at Turn 1.

Sauber responded to Alonso's stop by bringing in Hulkenberg next lap, Nico maintaining position over the Ferrari thanks to his earlier 3s cushion, but still behind Hamilton, who had stopped on lap 25. Twenty-five seconds before Hulk's stop, race leader Vettel had pitted from an 8s lead, in command and unleashing only what he needed from the car. "I could feel even as I drove to the grid that the car felt better than it had in qualifying and was feeling similar to how it had been on Friday. It was about pacing yourself to the range of the tyres and you're very busy with that and so it's a nice feeling to see you

**'Grosjean knew where he had to be fast, and where he could afford to take it easier'**

are pulling out the gap even so. It means you can take it a bit easier in some crucial places to look after the tyres and benefit from that later in the stint."

He had, in fact, taken a little more out of this first set than was ideal. "Yes, the last couple of laps on the softs I was struggling because when I was running into traffic, the tyres were [cooling] off so we were actually the first to come in this time, despite the big gap."

"They just had too much speed for us, basically," said Grosjean, who pitted on lap 29, one after Webber's record pit stop, timed by the team at 1.95s, to change the wheels. Webber then began chasing him down, the Red Bull's advantage over the Lotus having increased by a couple of tenths now that both had switched to the harder tyre. After the stops Mark was 2.2s adrift of Romain but closing fast. Four laps later he was less than a second behind and it seemed inevitable that a move was coming. But no sooner had Webber



Hulkenberg holds off feisty Perez

TEE/LAT

arrived on the Lotus'tail than he dropped over 1s off his earlier pace. Was there a problem?

"No, just the tyre temps getting too high," related Webber. "Romain drove a very good race. He was very strong in the last part of the first sector – which is where you need to be close [for the DRS detection point] and to get out of there close behind him onto the straight. It's super-super difficult to stay close there. I did what I could for most of the time but also the tyres are screaming at you for lap after lap and you have to drop back, give them a

breather, then go again." Grosjean knew where he had to be fast, and where he could afford to take it easier: "So long as he remained small in my mirrors into Turn 12, I knew I was ok, so I knew I had to be very fast through eight/nine." He delivered perfectly yet again under big pressure. Vettel's lead meanwhile extended to over 10s.

The Grosjean/Webber battle was being conducted around 10s up the road from Hamilton, who still narrowly headed Hulkenberg, Alonso and Perez. Bottas had exited his stop behind the out-of-sequence Gutierrez and so had



**Bottas kept the big teams in sight to score his first F1 points**



**Bianchi topped close Marussia and Caterham battle**

dropped off the back of that battle and furthermore was having to conserve the tyres for even longer than most. But when he was given permission to attack the Sauber, he responded. On the 35th lap he scabbled ahead into Turn 12, but was in too deep, enabling Esteban to retake the place as they exited. But Bottas was close enough behind in the DRS detection point onto the pit straight to get a good run on him into Turn 1. Again, Gutierrez fought him off but Valtteri simply hung on around the outside as they went downhill through the flat-out Turn 2. For a moment the

Sauber began to run out towards him but the Williams stayed absolutely on-line, its driver refusing to be intimidated. "I only got a couple of laps each stint in which I could push," explained Bottas, now up to eighth place, "so I had to do it then." Gutierrez would pit, dropping down to the lower orders soon enough and Bottas' real challenge was now to stave off a challenge from Rosberg while looking after those tyres.

Rosberg had earlier passed the struggling Kovalainen who, a few laps after his stop, had suddenly lost what

the team could see was 20 points of front downforce very suddenly. The understeer was severe and after a few laps Heikki was called in and the whole front wing assembly was replaced. It lost him what would probably have been a points finish. No obvious problem could be found with the wing and it's suspected it could have been tyre rubber in the slot gaps.

With 20 laps to go Alonso went into attack mode, slashing the gap to Hulkenberg's fifth place so that by the 40th lap he was right with it and looking for a way by. The Ferrari was the fastest car on the track at this point, but with the proviso that the faster cars were not flat out. He got a DRS run on the Sauber down the pit straight going into the 46th lap, went for the outside into Turn 1, holding Nico in tight and forcing him out wide while Fernando got the Ferrari rotated beautifully, allowing him to switch sides and pass on the run down to Turn 2. It had been an impressive charge but there'd surely be a price to pay in tyre stress.

Hamilton saw that Alonso, and not Hulkenberg, was now in his mirrors. "I had to step it up for a few laps after that," Lewis explained. It was enough to force Alonso to accept his charge had ended. Soon the rear tyres began to wilt. Massa's had already done so, ►

## SATURDAY

**0929** Alonso has near miss in FP3 with Maldonado: "We nearly crash!" he says. His engineer Andrea Stella says: "Sorry, I didn't see that."

**0958** Massa, in P17, complains: "Lots of understeer, just slow."

**0959** Sutil misunderstands a call: "Pits this lap and WHAT?" He's told: "Pits this lap for a START!" The penny drops: "Ah, OK, OK."

**1001** Bottas reports of his final run: "Not much more grip from the option tyre actually."

**1207** Hamilton asks in Q1: "Track slow?" He's told: "A-firm."

**1219** Sutil complains: "Damn this [bleep]ing traffic." He then goes off at Turn 1 with brake failure.

**1242** Rosberg goes out in Q2 and says: "Just got massive oversteer in the first sector. I don't know if the magic was the problem, it was on. It was very, very difficult."

**1252** At the start of Q3, Kovalainen's engineer Mark Slade forgets who his driver is: "No more KERS, Kimi, I mean, Heikki."

**1257** Ahead of his final Q3 effort, Vettel says: "I'd like to go plus-two on front wing."

**1302** Webber is told he's P2: "[Bleep]ed the last corner up."

**1302** Rocky tells Vettel: "P1, atta boy. Shake 'n bake baby." He replies: "Yes! Yes, boys. Good job, nice work, shake 'n bake."

**1303** Grosjean shouts "Yee-haw, my God, the high-speed was interesting!" over P3 in Q3.

**1304** Hamilton rues of his run: "Shoulda pushed for two laps."

**1304** Alonso is praised: "You put a lot of yourself into this performance; well done from all of us."

**1504** Gutierrez given a 10-place grid penalty for impeding Maldonado.

**1519** Chilton given a drivethrough penalty in first five laps of the race for impeding Maldonado and Sutil in Q1.





Grosjean drove brilliantly to take second for Lotus squad

'Vettel reeled off the laps, Rocky reminding him not to take too much from the tyres'

► Felipe forced to switch to a two-stop on lap 38, dropping him out of a battle with Ricciardo and Button.

Up front, Vettel reeled off the laps, Rocky constantly reminding him not to take too much from the tyres. But he wasn't. The continuous stream of fastest laps alarmed the team – but they were merely the fastest of a field that was conserving its tyres. He was metering out the Red Bull's performance quite sparingly, the gap over Grosjean significant but not big. Webber's challenge on the Lotus was fading along with Mark's tyres in the

PENNINGTON/GETTY

## THE RACE LAP BY LAP

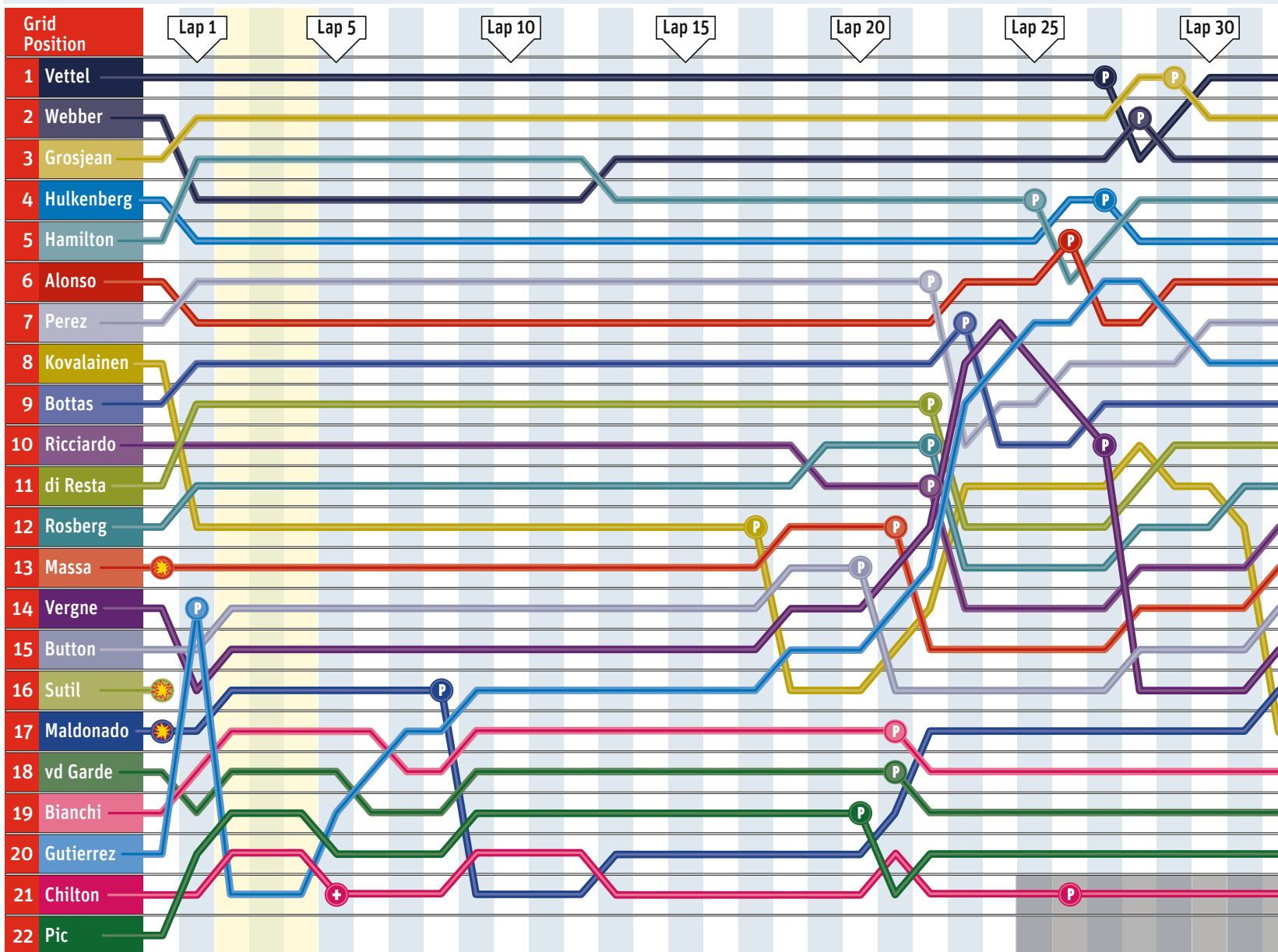





**Vettel's victory rounded off biggest ever F1 win streak**

HONE/LAT

last couple of laps. Bottas was flying now he'd been allowed to let rip to keep him out of reach of Rosberg and meanwhile Hulkenberg was coming back at Alonso, the Ferrari's rear end squirming and sliding as Fernando tried to get the power down. Into the last lap the Sauber came screaming down the inside into Turn 1. Alonso saw him coming, stayed out wide going in, then simply repassed him on the

exit. Hanging onto fifth place had to count as a very good result with the Ferrari in its current state – and it sealed Alonso second place in the championship.

Perez dropped off the back of the Alonso/Hulkenberg battle in the last few laps but remained out of range of Bottas. Behind Rosberg for the final point was Jenson Button, the McLaren having squeezed past the strategy-bust

di Resta and Ricciardo in the closing stages of the race.

Vettel's victory gave him yet another record in the sport's history – the biggest consecutive win streak within a season. Despite this huge accomplishment, he was still deeply impressed that he was being interviewed by Mario Andretti. "You're a legend," he said to the '78 world champ. And in time, so Seb will be too. ❧

## SUNDAY

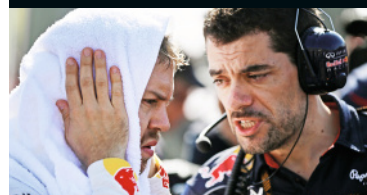

HONE/LAT

**1302** Vettel is told before start: "Hold throttle during clutch slip."



**1305** Sutil crashes after contact with Maldonado, and reports: "I'm off, tyre off, on the straight." Safety car is required.



**1313** Just before race resumes, Button is told: "There is some damage to the front wing."



**1314** Chilton serves his drivethrough penalty for impeding in qualifying.

**1320** Maldonado says: "There is some vibration in the car" – his wing is broken. He is given a black and orange flag and pits.



**1329** Hamilton is told to manage his tyres under attack from Webber: "That's what I'm doing, man, let me focus." Webber passes him.



**1332** Hamilton is urged to look after his tyres: "I'm trying to manage that, I'm TRYING to." Then later adds: "I don't have the grip, man."



**1353** "Tyres are gone now," says Vettel and pits from the lead.



**1400** Hamilton: "You need to give some feedback, man, about my tyres, my temperatures. When to push more, less..."



**1405** Webber complains: "Brake vibration is unbelievable."



**1422** Kovalainen is told: "We think we've lost KERS."



**1427** Hamilton hits the roof: "Blue flag!" Pic is told: "Let Hamilton past, Charles."



**1443** Grosjean is delighted: "Yee-haw, boys, well done, guys. I cannot do more, 100 per cent."



**1444** Webber says: "We can only race for every five laps or so on these tyres; we gave it a crack."



**1445** Joy at Williams: "That was a smash! Great job." Bottas responds: "Yeah, I know it!"



**1549** Vergne is hit with a 20-second post-race penalty for Gutierrez clash, relegating him from 12th to 16th.

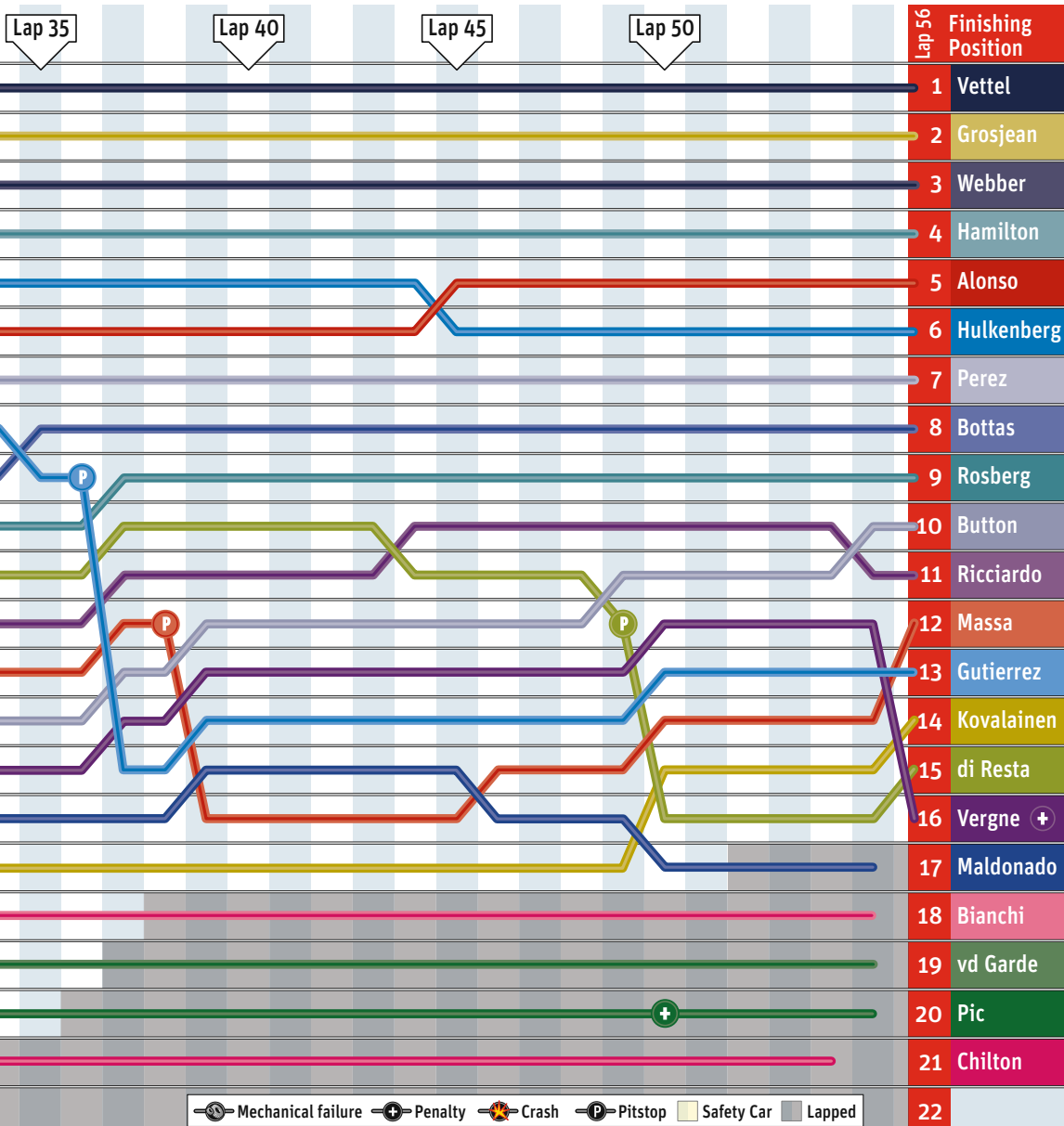

# TEAM BY TEAM

## RED BULL



### Eight out of eight wins for Vettel

**1**  
9/10  
Event rating

CIANFLONE/GETTY

**SEBASTIAN VETTEL**  
Red Bull-Renault RB9-03  
Start: 1st; Finish: 1st  
Strategy: 1 stop  
(medium/hard)



The race was nothing but a masterclass for F1's donut king, who celebrated his victory in now trademark style. Savvy car positioning ensured he held the lead off the line even though Grosjean's launch was better, and he nailed the safety car restart to ensure he was out of DRS range. The only downside of Vettel's weekend was that his run to pole was not completely emphatic and he relied on Webber underachieving.

**2**  
8/10  
Event rating

THOMPSON/GETTY

**MARK WEBBER**  
Red Bull-Renault RB9-04  
Start: 2nd; Finish: 3rd  
Strategy: 1 stop  
(medium/hard)



Webber had the speed to beat Vettel in qualifying largely thanks to his pace in the high-speed sweeps of the first sector, but a ragged run through the final two corners let him down. His race start was fine, but he got outmanoeuvred by both Grosjean and Hamilton at Turn 1 and while he had the machinery under him to beat the Lotus, he never got close enough to attack. Fast, but the imperfections cost him pole and second.

## FERRARI



### Alonso impressive, Massa struggles

**3**  
9/10  
Event rating

XPBLAT

**FERNANDO ALONSO**  
Ferrari F138-299  
Start: 6th; Finish: 5th  
Strategy: 1 stop  
(medium/hard)



The extent of his post-Abu Dhabi injuries might have been exaggerated by some, but he was visibly worse for wear. Not that he let it show on track, though the car probably did have the potential to be a couple of places higher on the grid had he strung together his three best sectors. Drove superbly in the race, particularly late on with rear tyres well past their best, ensuring Hulkenberg stayed behind. A very convincing performance.

**4**  
5/10  
Event rating

XPBLAT

**FELIPE MASSA**  
Ferrari F138-298  
Start: 13th; Finish: 12th  
Strategy: 2 stops  
(medium/hard/medium)



Massa described this as his toughest weekend of the season and it was hard to argue with him. While he didn't hit anything, he struggled badly with tyre warm-up. Although it was less of a problem in the race, he found it very difficult to make much progress, even on fresher option rubber in his final stint after rolling the dice on a second stop in the hope of fluking a safety car. A poor weekend.

26

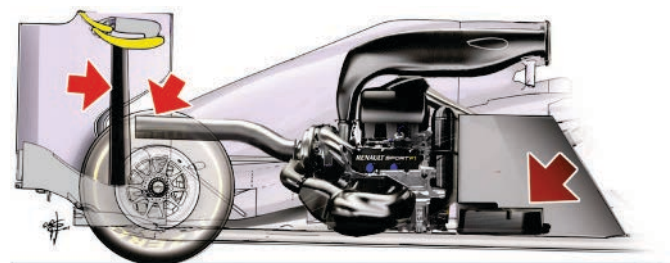
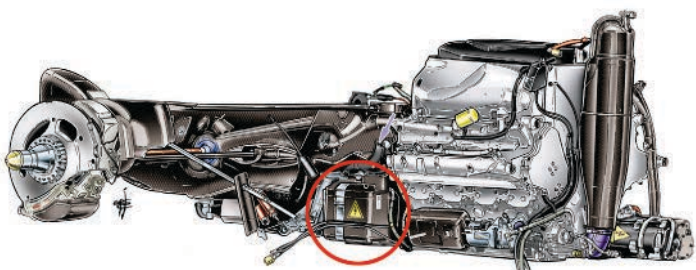

## 2014 KERS AND FRONT WING

➔ Shown here is the battery pack and front wing stipulations for 2014. No longer will Red Bull's split battery pack outside the front tub be allowed. Instead a single unit, weighing a minimum of 25kg, must be mounted beneath the fuel tank. The front wing is narrower – putting its extremities in the middle of the front tyres, totally altering the airflow regime of the whole car.

**GARY ANDERSON:** The fuel tank size has gone down, from 150kg to 100kg capacity. The battery pack will weigh around 25kg. The mass weight at the start of the race will be very similar but the weight distribution will move forwards. The reason for

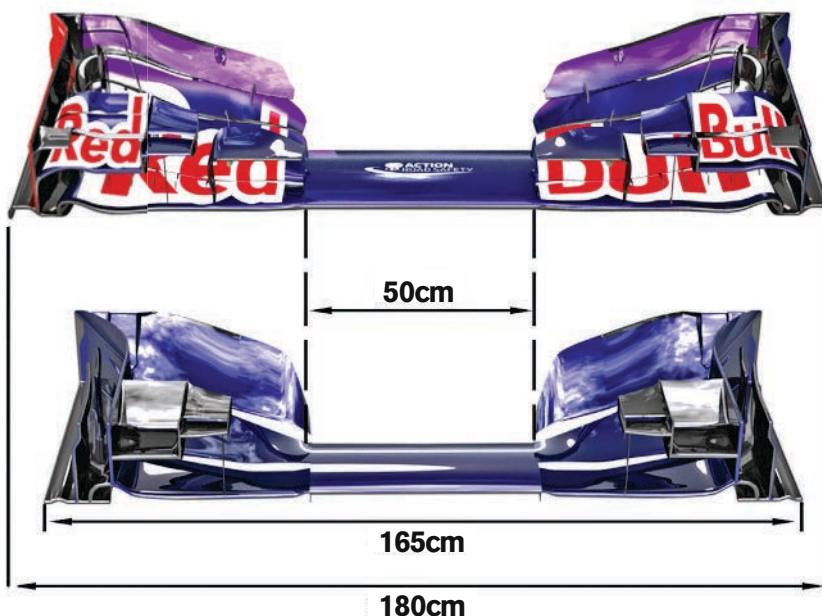

having it rearwards is that the weight distribution would change more. As the fuel load reduces, the centre of gravity of the current Red Bull system moves rearwards. With the mandated 2014 layout it will do so less.

The wing is narrower but the neutral section in the centre remains the same. The foot on the endplate is a bit smaller. It will make it more significant how the car works with the steering lock on. At the moment when the wheel is steered, a big space is created in the area behind that section of the wing. With the new wing, that space behind the wing will be considerably less, because of where the wing ends.

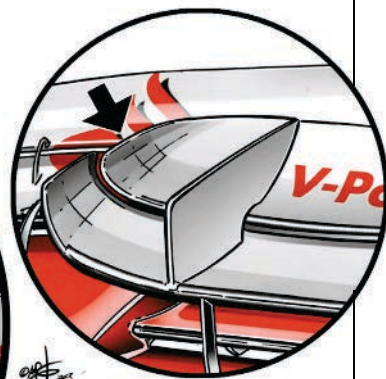
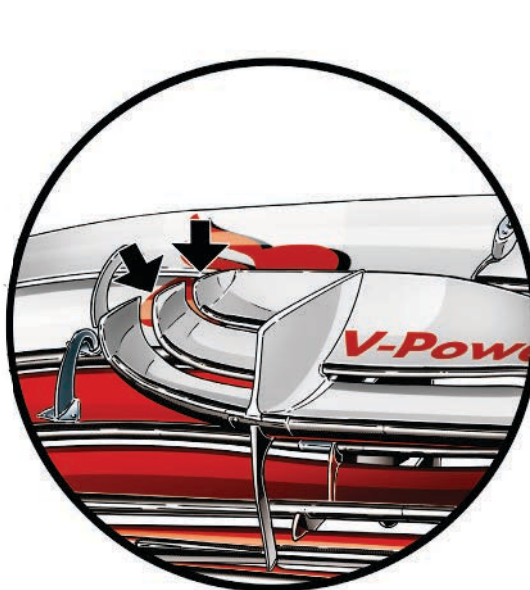
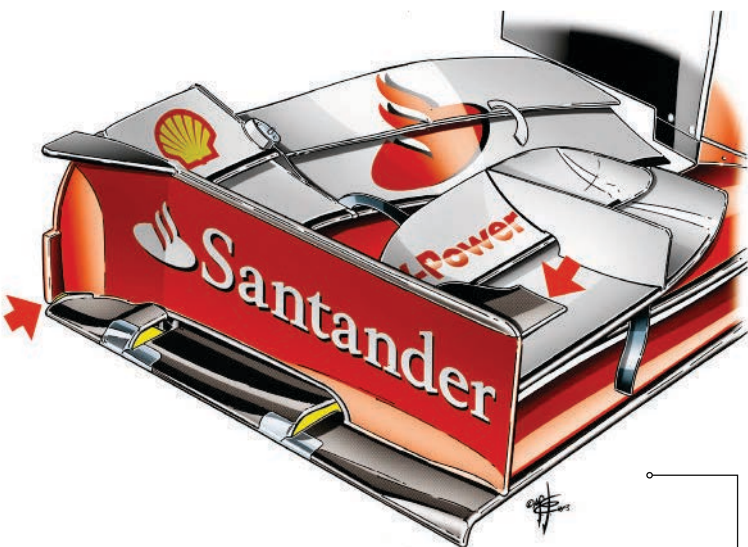

## FERRARI FRONT WING

➔ Ferrari modified the outer section of the front wing endplate, with a more contoured gurney flap at the rear. This modification was tried but not used. It also introduced a triple upper flap arrangement in place of the previous double. This was retained for both qualifying and race.

**GARY ANDERSON:** The trailing edge gurney flap is interesting. It's usually better to have the gurney flap going onto the foot like this to maximise the flow through there. That flow going over the top of the foot is what really works those two slots – and they are effectively extensions of the wing flap and getting the airflow beneath there will reduce the stall of the flap. This gurney flap will help the airflow through those slots.

The small trim from curved to vertical would have a significant effect on how this part of the endplate works. Especially with steering lock applied.

From the height reduction of the back flap they've been pursuing for a few races now, it looks as though Ferrari is trying to reduce the loading on that section of wing in order to get better airflow to the underfloor – then trying to recover that wing loading from the front of the wing and the extra bits there that do not have much influence on the underfloor. If correct, it's a very basic fault to be attending to so late in the season.

The new triple upper flap arrangement is to recover the front end lost when the height of the back flap on the main wing has been reduced.

## McLAREN



### Kicked-out Perez blitzes Button

**5**  
6/10  
Event rating

XPB/LAT

**JENSON BUTTON**

McLaren-Mercedes MP4-28-04  
Start: 15th; Finish: 10th  
Strategy: 1 stop  
(medium/hard)



A very tough weekend, Button was among those struggling to get the tyres to work in difficult conditions during qualifying. He made no excuses for his problems, which left him buried in the midfield. Made hard work of it, but to his credit kept his head down and pulled off a good pass on Ricciardo to salvage a point late on. Couldn't get the car to work and paid the price. Underwhelming.

**6**  
8/10  
Event rating

XPB/LAT

**SERGIO PEREZ**

McLaren-Mercedes MP4-28-02  
Start: 7th; Finish: 7th  
Strategy: 1 stop  
(medium/hard)



Outqualifying JB for third consecutive race was a good riposte to McLaren's dropping him. His style far better suited to achieving the right tyre temperature, helping him outpace Button by a couple of tenths in Q2. The race started encouragingly, he was in the scrap with Alonso and Hulkenberg, but like in Abu Dhabi, he struggled with tyre deg. Still a good performance, outrunning JB.

## LOTUS



### Great America road trip for Lotus

**7**  
7/10  
Event rating

PENNINGTON/GETTY

**HEIKKI KOVALAINEN**

Lotus-Renault E21-05  
Start: 8th; Finish: 14th  
Strategy: 2 stops  
(medium/hard/medium)



Getting to Q3 when he'd never driven the Lotus before was a superb achievement, even though he was half a second off Grosjean. 14th in the race sounds dire, but he was on course for eighth when the front wing suddenly lost a heap of downforce early in his second stint, forcing another stop. A KERS failure halted any chance of recovery. A good job in tricky circumstances.

**8**  
10/10  
Event rating

XPB/LAT

**ROMAIN GROSJEAN**

Lotus-Renault E21-04  
Start: 3th; Finish: 2nd  
Strategy: 1 stop  
(medium/hard)



What revealed the most about Grosjean's maturity was not his quality pace to be best of the rest, or his jump to second off the line, or him being the only driver to at least keep Vettel vaguely honest. It was the calm, clinical way that he dealt with pressure from Webber's potentially faster Red Bull late on to ensure his second was safe. This was a flawless performance from an emerging star.

# MERCEDES



## Hamilton more convincing of Meracs

9

5/10  
Event rating



**NICO ROSBERG**  
Mercedes F1 W04/03  
Start: 12th; Finish: 9th  
Strategy: 1 stop  
(medium/hard)



Like so many others, Rosberg's weekend was dictated by quality tyre warm-up issues. He struggled badly on Saturday thanks to being far too conservative in the way he attacked the rubber in the build-up to his flying laps, and the penalty was to start in the midfield. Made little progress from there, but did prevail in a few fights at key moments to pick up two points, although his ultimate pace was not as convincing as Hamilton's. A disappointing weekend.

10

9/10  
Event rating



**LEWIS HAMILTON**  
Mercedes F1 W04/04  
Start: 5th; Finish: 4th  
Strategy: 1 stop  
(medium/hard)



While his radio messages, in which he variously demanded to be left alone and given less information and then insisted he needed more, did not paint him in the most glorious light, this was actually a very good weekend from Hamilton. Didn't have the car to finish on the podium, but managed to end up fourth, which was about all that could be expected. Probably should have beaten Hulkenberg on Saturday, but beyond that this was very much a return to form.

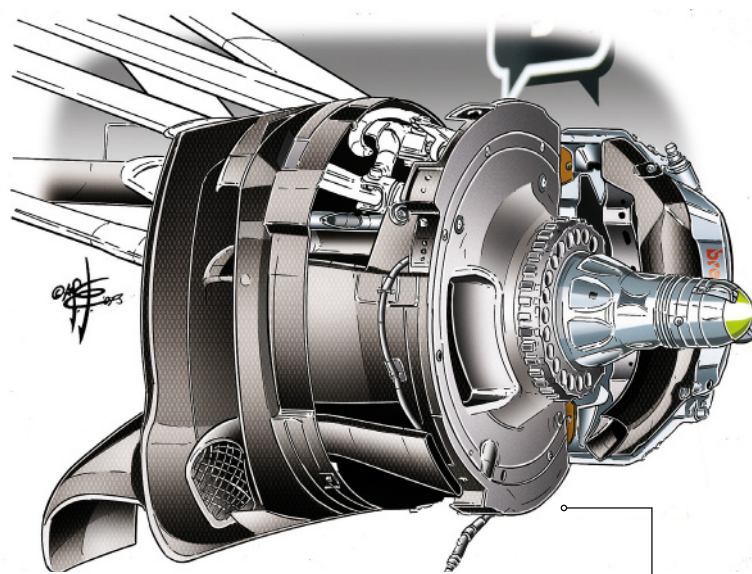

## MERCEDES BRAKE CALIPER

➔ Mercedes had a new specification of Brembo brake caliper on Lewis Hamilton's car, to address the issue of brake pedal feel he has been struggling with ever since joining the team.

**GARY ANDERSON:** One of the things Lewis has been complaining about is that he doesn't have good feel from the brakes, compared to that which he had at McLaren. He is one of the last of the late brakiers, so if you take the feel away you are depriving him of one of the tools in his toolbox. One of the ways to address this would be with the stiffness of the caliper. If it is totally rigid, it's an on/off switch. If you reduce the stiffness a little you've always got that bit of feel in the pedal to allow you to be more progressive in adding or reducing the pedal pressure.

28

# SAUBER



## Strong showing from the Hulk

11

9/10  
Event rating



**NICO HULKENBERG**  
Sauber-Ferrari C32-03  
Start: 4th; Finish: 6th  
Strategy: 1 stop  
(medium/hard)



Hulkenberg's qualifying performance was exceptional. But given the Sauber isn't the best off the line, he was always going to lose ground at the start. After dealing with Perez's challenge, the battle was with Alonso, who passed him on lap 44. Hulk came back at him but couldn't make a last-lap move stick – considering the state of the Ferrari's tyres, he arguably should have done. A strong showing, but not perfect for that reason.

12

5/10  
Event rating



**ESTEBAN GUTIERREZ**  
Sauber-Ferrari C32-04  
Start: 20th; Finish: 13th  
Strategy: 2 stops  
(medium/hard/medium)



While making Q3 was a good effort, the fact that he failed to improve on his Q2 time and ended up three quarters of a second off his team-mate suggested there was far more to come. Ten-place grid penalty for impeding Maldonado meant he was always on the back foot and the gamble on early safety car stop didn't quite pay off, although he would have been 11th but for the collision with Vergne. Overall, a little underwhelming.

# FORCE INDIA



## A weekend to forget for Force India

14

7/10  
Event rating



**PAUL DI RESTA**  
Force India-Mercedes VJM06-04  
Start: 11th; Finish: 15th  
Strategy: 2 stops  
(medium/hard/medium)



The Force India wasn't particularly competitive at Austin, but di Resta got within a tenth of Q3 and kept himself in the hunt for a decent proportion of the race until the tyres cried enough while he was on course to score points. He ended up having to make an extra stop, which left him 20-odd seconds off the top 10. A decent effort, and certainly better than Sutil's weekend, ultimately though on a hiding to nothing.

15

4/10  
Event rating



**ADRIAN SUTIL**  
Force India-Mercedes VJM06-03  
Start: 16th; Finish: DNF  
Strategy: retired  
(medium)



Sutil could have spared himself a lot of trouble by staying at home. A brake disc failure near the end of a messy Q1 meant he didn't make Q2. His race didn't even last one lap, as he collided with Maldonado and speared into the wall on the back straight. Sutil suggested an exclusion zone was required around Maldonado, but the replays suggest it might have been the Force India that moved over on the Williams...

## WILLIAMS



### More points – at last – for Williams

**16**  
4/10  
Event rating



CIANFONE/GETTY

**PASTOR MALDONADO**  
Williams-Renault FW35-03  
Start: 17th; Finish: 17th  
Strategy: 1 stop  
(medium/hard)



Maldonado made no attempt to hide his unhappiness with Williams now his departure has been confirmed. But any suggestion that the team had deliberately held him back in qualifying was absurd. The reality is he was one of a number of drivers who simply did not get on top of tyre warm-up in qualifying, leaving him a massive 1.5s off Bottas in Q1. Had an irrelevant race, although possibly wasn't to blame for the Sutil clash.

**17**  
9/10  
Event rating



XPB/LAT

**VALTTERI BOTTAS**  
Williams-Renault FW35-01  
Start: 9th; Finish: 8th  
Strategy: 1 stop  
(medium/hard)



Revelled in the improved balance of the Coanda-less Williams and stunned in Q1 and Q2. But ninth in Q3 was an underachievement as he lapped four tenths off his best time thanks to a moment running wide when he should have been at least seventh and maybe even fifth. Drove an exemplary race and didn't look like a driver fighting for his first points finishes. A wonderful performance all weekend, save for that disappointment in Q3.

## TORO ROSSO



### Tyres the deciding factor for Toro

**18**  
5/10  
Event rating



XPB/LAT

**JEAN-ERIC VERGNE**  
Toro Rosso-Ferrari STR8-03  
Start: 14th; Finish: 16th  
Strategy: 1 stop  
(hard/medium)



As is often the case for JEV, the pace was there in fits and starts but he couldn't put everything together when it counted. Having matched Ricciardo in Q1, he didn't get the tyre warm-up right in the next stage of qualifying and ended up half a second slower. His race pace was decent enough and he would have finished right with Ricciardo had he not instead had a needless collision with Gutierrez on the last lap.

**19**  
7/10  
Event rating



XPB/LAT

**DANIEL RICCIARDO**  
Toro Rosso-Ferrari STR8-01  
Start: 10th; Finish: 11th  
Strategy: 1 stop  
(medium/hard)



As usual, was able to outperform Vergne in qualifying, although in the race both he and his team-mate turned in very similar performances and ended up dicing for 11th on the last lap. Held his own early on and held up quicker cars, but as the race went on the Toro Rosso regressed to the mean. Inevitably, there are question marks about whether he should have kept Button behind for the final point, although by then his tyres were shot.

## CATERHAM



### Pic penalties but Giedo 'class pole'

**20**  
5/10  
Event rating



XPB/LAT

**CHARLES PIC**  
Caterham-Renault CT03-06  
Start: 22nd; Finish: 20th  
Strategy: 1 stop  
(medium/hard)



Another difficult weekend for the Frenchman, who knew he had a five-place grid penalty before qualifying when the team had to break a gearbox seal to make repairs. Qualifying was OK, but slower than his team-mate. In the race, settled in behind Bianchi and van der Garde, but picked up another penalty for ignoring blue flags, so he finished 30s behind. Pace reasonable, but could do without the penalties.

**21**  
7/10  
Event rating



XPB/LAT

**GIEDO VAN DER GARDE**  
Caterham-Renault CT03-04  
Start: 18th; Finish: 19th  
Strategy: 1 stop  
(medium/hard)



Wasn't delighted to sit out Friday morning practice in favour of Alexander Rossi at a track he'd never driven before. To his credit, he recovered well and bagged 'class pole' at the front of the Caterham/Marussia pack, one tenth ahead of Pic. Lost out to Bianchi at the start and spent the rest of the race failing to get back past him, thanks to the straightline speed of the Marussia. Lost the battle at the back, but a decent weekend.

## MARUSSIA



### Qually hell but 10th in constructors'?

**22**  
8/10  
Event rating



XPB/LAT

**JULES BIANCHI**  
Marussia-Cosworth MR-02-02  
Start: 19th; Finish: 18th  
Strategy: 1 stop  
(medium/hard)



Not for the first time this season Bianchi went into qualifying in an unpromising situation, but thanks to some set-up changes was able to pull a good lap out the bag. A small mistake, though, in sector one prevented him outpacing van der Garde. Jumped the Caterham at the start and then kept him behind. An excellent performance, and exactly what Marussia needs to defend its 10th place in the constructors' title.

**23**  
4/10  
Event rating



XPB/LAT

**MAX CHILTON**  
Marussia-Cosworth MR-02-03  
Start: 21st; Finish: 21st  
Strategy: 1 stop  
(medium/hard)



Another weekend during which things didn't come together in qualifying. Set-up problems meant an unstable car, leading to him being almost nine tenths off. Then he was given a drive-through to be served in the first five laps of the race for impeding in Q1. Held Bianchi's pace early on but, after serving the penalty, fell into blue flag hell and ended up 70s off his team-mate. Performance below the recent standards he's set for himself.

# UNITED STATES GP RESULTS



GILHAM/GETTY

## PRACTICE 1: Friday

POS	DRIVER	TIME
1	ALONSO	1m38.343s
2	BUTTON	1m38.371s
3	BOTTAS	1m38.388s
4	GUTIERREZ	1m38.532s
5	ROSBERG	1m38.657s
6	HAMILTON	1m38.979s
7	MASSA	1m39.005s
8	WEBBER	1m39.083s
9	HULKENBERG	1m39.158s
10	MALDONADO	1m39.200s
11	GROSJEAN	1m39.238s
12	PEREZ	1m39.256s
13	KOVALAINEN	1m39.487s
14	SUTIL	1m39.699s
15	DI RESTA	1m39.836s
16	RICCIARDO	1m39.863s
17	KVYAT	1m40.065s
18	VETTEL	1m40.662s
19	ROSSI	1m41.399s
20	CHILTON	1m41.605s
21	PIC	1m42.054s
22	GONZALEZ	1m43.716s

## PRACTICE 2: Friday

POS	DRIVER	TIME
1	VETTEL	1m37.305s
2	WEBBER	1m37.420s
3	ROSBERG	1m37.785s
4	HAMILTON	1m37.958s
5	KOVALAINEN	1m38.073s
6	GUTIERREZ	1m38.229s
7	HULKENBERG	1m38.254s
8	GROSJEAN	1m38.255s
9	BUTTON	1m38.269s
10	ALONSO	1m38.461s
11	SUTIL	1m38.719s
12	MASSA	1m38.938s
13	PEREZ	1m38.941s
14	RICCIARDO	1m39.246s
15	DI RESTA	1m39.410s
16	BOTTAS	1m39.512s
17	VERGNE	1m39.579s
18	MALDONADO	1m39.784s
19	PIC	1m40.376s
20	VAN DER GARDE	1m40.563s
21	CHILTON	1m46.226s
22	BIANCHI	1m47.009s

## PRACTICE 3: Saturday

POS	DRIVER	TIME
1	VETTEL	1m36.733s
2	WEBBER	1m36.936s
3	HAMILTON	1m37.064s
4	HULKENBERG	1m37.272s
5	GROSJEAN	1m37.345s
6	BUTTON	1m37.534s
7	ROSBERG	1m37.578s
8	PEREZ	1m37.583s
9	BOTTAS	1m37.747s
10	SUTIL	1m37.748s
11	ALONSO	1m37.763s
12	GUTIERREZ	1m37.774s
13	KOVALAINEN	1m37.879s
14	MALDONADO	1m38.022s
15	RICCIARDO	1m38.109s
16	DI RESTA	1m38.275s
17	MASSA	1m38.408s
18	VERGNE	1m38.636s
19	PIC	1m39.578s
20	VAN DER GARDE	1m40.056s
21	BIANCHI	1m40.825s
22	CHILTON	1m41.293s

## FRIDAY TESTERS

	1	KVYAT	1m40.065s
	2	ROSSI	1m41.399s
	3	GONZALEZ	1m43.716s



COATES/LAT



COATES/LAT

Weather: Dry

Weather: Dry

Weather: Dry

## QUALIFYING TIMES

POS	DRIVER	QUALIFYING 1	QUALIFYING 2	QUALIFYING 3
1	VETTEL	1m38.516s (8)	1m37.065s (1)	1m36.338s
2	WEBBER	1m38.161s (4)	1m37.312s (2)	1m36.441s
3	GROSJEAN	1m38.676s (10)	1m37.523s (5)	1m37.155s
4	HULKENBERG	1m38.339s (5)	1m37.828s (6)	1m37.296s
5	HAMILTON	1m37.959s (2)	1m37.854s (7)	1m37.345s
6	ALONSO	1m38.929s (15)	1m37.368s (3)	1m37.376s
7	PEREZ	1m38.367s (6)	1m38.040s (9)	1m37.452s
8	KOVALAINEN	1m38.375s (7)	1m38.078s (10)	1m37.715s
9	BOTTAS	1m37.821s (1)	1m37.439s (4)	1m37.836s
10	GUTIERREZ	1m38.082s (3)	1m38.031s (8)	1m38.034s
11	RICCIARDO	1m38.882s (13)	1m38.131s	-
12	DI RESTA	1m38.894s (14)	1m38.139s	-
13	BUTTON	1m38.588s (9)	1m38.217s	-
14	ROSBERG	1m38.743s (11)	1m38.364s	-
15	MASSA	1m39.094s (16)	1m38.592s	-
16	VERGNE	1m38.880s (12)	1m38.696s	-
17	SUTIL	1m39.250s	-	-
18	MALDONADO	1m39.351s	-	-
19	VAN DER GARDE	1m40.491s	-	-
20	BIANCHI	1m40.528s	-	-
21	PIC	1m40.596s	-	-
22	CHILTON	1m41.401s	-	-

## QUALIFYING STATISTICS

	HEAD TO HEAD	
VETTEL	16	2
ALONSO	10	8
BUTTON	9	9
RAIKK'N/KOVAL'N	11	7
ROSBERG	7	11
HULKENBERG	17	1
DI RESTA	11	7
MALDONADO	8	10
VERGNE	4	14
PIC	10	8
BIANCHI	16	2
WEBBER	2	16
MASSA	8	10
PEREZ	9	9
GROSJEAN	7	11
HAMILTON	1	17
GUTIERREZ	1	17
SUTIL	7	11
BOTTAS	10	8
RICCIARDO	14	4
VAN DER GARDE	8	10
CHILTON	2	16



ETHERINGTON/LAT

## BAD BOYS & ENGINE USAGE

	PENALTIES		FINES		ENGINES	
VETTEL	0	€25,200	8			
WEBBER	3	€35,000	8			
ALONSO	0	€16,000	8			
MASSA	3	€10,400	8			
BUTTON	1	€1000	8			
PEREZ	1	€600	8			
RAIKKONEN	2	€2500	8			
GROSJEAN	3	€0	8			
ROSBERG	0	€1300	8			
HAMILTON	1	€0	8			
HULKENBERG	2	€3000	8			
GUTIERREZ	4	€1800	8			
DI RESTA	0	€5700	8			
SUTIL	2	€1000	8			
MALDONADO	0	€120,000	8			
BOTTAS	0	€10,900	8			
VERGNE	0	€10,000	8			
RICCIARDO	1	€0	8			
PIC	3	€0	8			
VAN DER GARDE	3	€12,400	8			
BIANCHI	2	€2800	7			
CHILTON	2	€300	8			



# Concussion risk stops Franchitti

Head injuries are a hot topic in American sport at the moment.

As Dario Franchitti is forced to call time on his career, MARK

GLENDENNING looks at the issue from a motorsport perspective



**L**ate last year, Dale Earnhardt Jr suffered two concussions in six weeks. Under doctors' orders he was benched for a couple of NASCAR races; a verdict that he freely admitted he'd never have reached if left to his own devices.

"If I didn't need to get in a race car and go get hit again, I needed somebody to tell me that, because I was going to have a hard time making that decision for myself," he said at the time. "I feel perfectly fine, but I don't want to keep getting hit in the head."

Almost 12 months later, as NASCAR was putting the final touches to its new mandatory baseline concussion testing policy, Dario Franchitti was being transported from the Houston street circuit to a nearby medical facility after a massive accident in the second race of the IndyCar double-header. He'd be diagnosed with fractures and a concussion, the latter of which ultimately led to the three-time Indy 500 winner and four-time champion announcing his retirement on medical advice last week.

According to specialists, the 40-year-old will make a full recovery from his current injuries, concussion included. The concern is the potentially life-long ramifications of another blow to the helmet.

Under NASCAR's system, drivers will be required to undergo a baseline test to establish a benchmark for their verbal and visual memory, processing speed and reaction time, thereby giving medical staff an indication of each individual's brain function in a healthy state. In the event of a concussion, this can then be used as both an aid in evaluating the effects of an injury, and for informing decisions over the driver's return to competition.

When the new policy was announced last month, most of the coverage that it generated revolved around the doubts expressed by 2012 Sprint Cup champion Brad Keselowski, who harbours concerns about over-conservative diagnoses sidelining drivers unnecessarily.

"I'm trying to be open-minded to the idea that [doctors] can help us," Keselowski said in Martinsville. "If you have the test and you come back later and score





Third Indy win came in 2012



DANBOYD/LAT USA

Concussions are being researched in NASCAR



THACKER/LAT USA

five per cent worse, is that OK? Is it 10 [per cent]? Is it one? It's just another subjective field for doctors who don't understand our sport."

While Earnhardt's example suggests that Keselowski's 'drivers know better' philosophy might not hold much water, there's some merit to his argument that doctors may want to play it safe.

Conversations about concussions are becoming increasingly common in American sport. Recently, the NFL agreed to a \$750 million settlement with 4500 former players suffering the aftershocks of a career spent sustaining blows to the head.

Franchitti is yet to speak about his premature exit from the sport, although all the signs from those close to the Scot point to a decision that was essentially made for him. It is a problem that has left Chip Ganassi Racing with an enormous hole to fill and very few candidates qualified to fill it [see sidebar], but Ganassi himself said

that the decision, unhappy as it is, has his complete backing.

"Let's just say that I'm probably 180 degrees different to how the [2012] NASCAR champion feels about having doctors around, and their input," he said. "To break a bone is one thing; to have a surgical procedure is another. But when it comes to your head, I think it's important that everybody understands that's probably the least known area of expertise by any doctor. They're just in the last four or five years of understanding what injuries there are and the implications of those injuries.

"I don't think it matters what your sport is," Ganassi added. "No one wants to be told they have to stop. People want to leave on their own terms. I have to be very careful about what I say, because I'm obviously not a doctor. [But] I think we've all seen and understood the impact that those kinds of injuries can have long term if they're not diagnosed properly." ❧

EXPERT VIEW



Sir Stirling Moss  
British motorsport legend

When the injuries from my Goodwood crash in 1962 forced me to end my career early, I had to go through coming to terms with it. It was a mental thing. It probably took me the best part of a year to accept it even though I had made the right decision. My whole life depended on motor racing.

I don't know exactly what Dario's situation is, but my recovery after my Goodwood crash was slow. It was a tough time, but everybody in motorsport was very nice.

The press were continually on at me about when I was going to come

back so I went and did a test at Goodwood. My times were quite competitive, but it was no longer automatic.

When I did the test I had every hope I could continue. I'd injured myself before so it wasn't a problem, but I realised I had to stop. I thought it would be unsafe to continue. I should have waited – I think if I'd waited it might have come back.

When I stopped, I had a contract with BP and my name was quite valuable so I was still connected to the sport. I hope Dario will stay on the scene as an ambassador.

WHO GETS FRANCHITTI'S SEAT?

There's a degree of irony in the fact that the driver who most closely approximates the qualities required of a replacement for Dario Franchitti is, technically, already contracted to Ganassi. This driver has proven

championship and Indy 500-winning credentials, is fast in open-wheelers on all of IndyCar's various track configurations, and is high-profile enough to do justice to a sponsor like Target.

But with Juan Pablo Montoya off to Penske next year from Ganassi's NASCAR team, and most other worthy contenders already contracted elsewhere, the team has been casting its net wide. It has not ruled out new arrival Tony Kanaan stepping up to run alongside Scott Dixon, but such a move may not be the shoo-in that many have assumed.

Three-time IndyCar champion Sam Hornish Jr has reportedly already brushed off an approach; the 34-year-old remaining committed to his NASCAR career. Some on F1's periphery have also shown interest in the seat, including Sergio Perez and Lucas di Grassi. Ganassi's plan to run four cars next year means that one of this group might be considered to run alongside Charlie Kimball in the fourth car if Kanaan is promoted, but other factors, including their lack of oval experience, could count against a claim to Franchitti's seat. As Rubens Barrichello proved last year, F1 credentials alone are not enough.



CZOBAN/AUTOSTOCK

Comprehensive motorsport insurance products to keep you on track;

- Worldwide On Track
- Personal Accident
- Storage and transit
- Track day
- Liability
- Commercial

Please complete an online quote request form at – [www.ryanmi.com](http://www.ryanmi.com)

Email – [info@ryanmi.com](mailto:info@ryanmi.com) Tel – +44 (0) 1799 524202

Ryan Motorsport Insurance Limited is an appointed representative (557405) of Independent Broking Solutions Limited who are authorised and regulated by the Financial Services Authority, registration number 312026



News of McLaren  
axe came as a  
shock to Perez

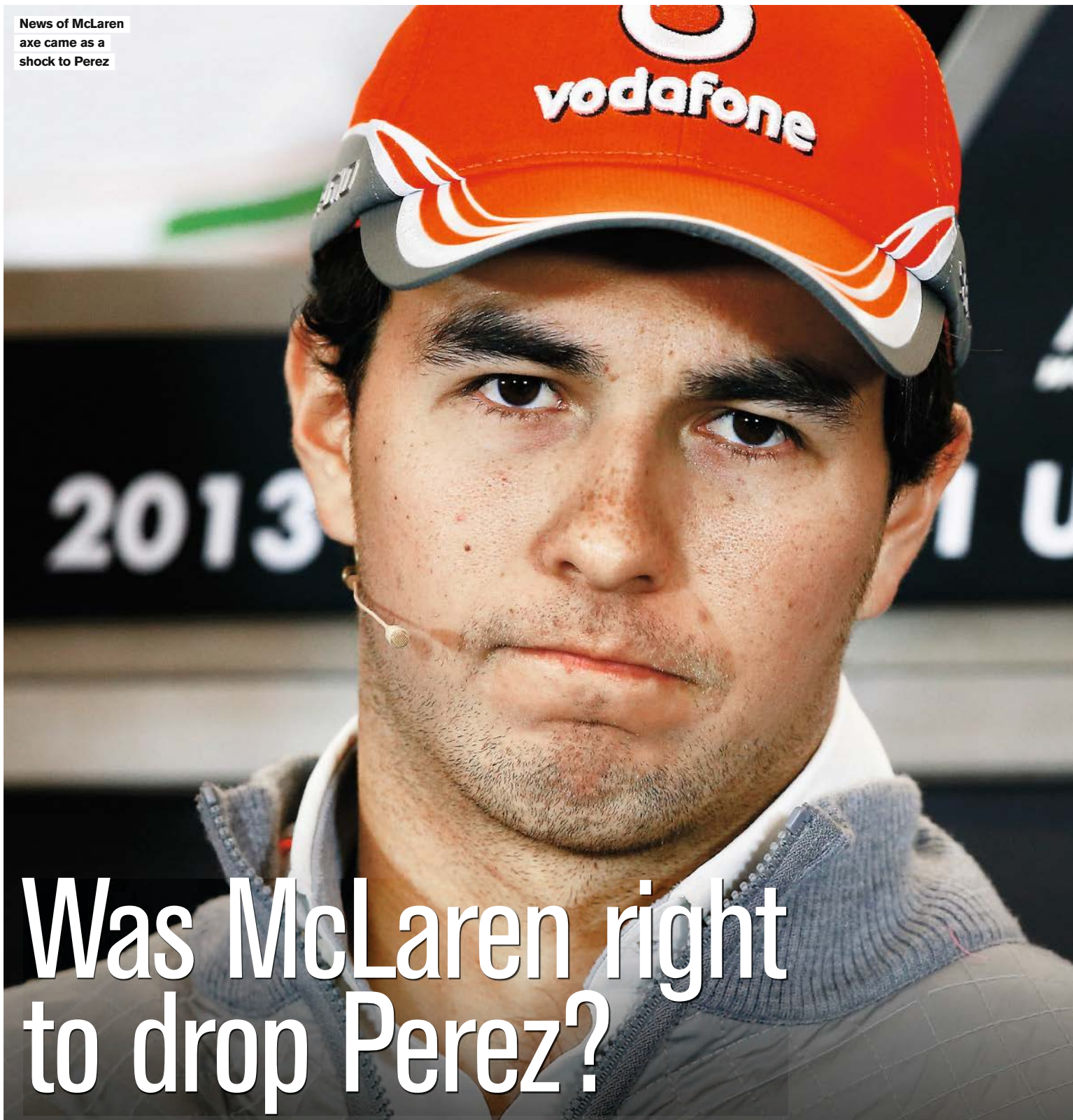

# Was McLaren right to drop Perez?

The decision to replace Sergio Perez with rookie Kevin Magnussen after just one season has been criticised in some quarters. **EDD STRAW** asks if McLaren's decision was justified

PENNINGTON/GETTY

## THE FIGHT FOR F1'S FINAL 2014 SEATS



COATES/LAT

**Max Chilton**  
Is "confident" of staying with Marussia and claims "the contracts are done" but unsigned.



DUNBAR/LAT

**Esteban Gutierrez**  
Mexican rookie looks a long-shot to stay on with Sauber, with his hopes depending on finance.



COATES/LAT

**Nico Hulkenberg**  
Lotus is the first choice, Force India the fallback. Time short for Lotus to complete a deal.



COATES/LAT

**Heikki Kovalainen**  
Is a strong contender for a return to a Caterham race seat even though he cannot bring money.



COATES/LAT

**Pastor Maldonado**  
PDVSA is looking for a new team after agreeing to leave Williams. Lotus and Sauber are favourites.

Button has had the upper hand for most of 2013



Just over a week before McLaren announced Kevin Magnussen would replace Sergio Perez alongside Jenson Button in 2014, the Mexican was confident of staying on. He even claims to have signed a contract and sent it to the team for completion before being informed of his fate in the week before the United States Grand Prix, which he understandably described as “a shock”.

Regardless of the timing of McLaren’s sudden *volte face*, the bottom line is that Perez had not made a cast-iron case to stay on. Had he done so, he would have had a deal in place before Magnussen emerged as a credible rival.

McLaren team principal Martin Whitmarsh has been cagey about the reasoning behind the decision and is understood to have been keen to retain Perez in the face of doubts elsewhere in the team. It is certainly legitimate to question Perez’s rate of development in 2013, even though allowances have to be made for adapting to a top team.

While Perez already had two seasons with Sauber under his belt and three podiums, it was always going to take time to adapt. The speed has been there in fits and starts, as demonstrated by the fact his race pace was as good as identical to Button on his McLaren debut in Australia, but consistency has been a problem.

“You can win in your first races if your car is competitive, but F1 is so

**PEREZ:** “It has been a long learning curve, but I think I developed OK. To get the rhythm and the last little details right takes time”

tough at this level,” said Perez in an interview with AUTOSPORT in Abu Dhabi. “I was quick straight away, but to get the rhythm, the consistency and the last little details right takes time. I’m not that experienced and if I look back at my whole year there have been places where if I go back right now, I would do much better.”

In Singapore, Perez claims to have made a significant step forward in terms of understanding the set-up nuances of the car for qualifying in particular. Potentially, this claim is supported by his good form during the past three weekends, when he has done very well relative to Button. But there remained serious concerns about his rate of learning among some working with him.

Perez believes that, technically, “it has been a big learning curve but I think I developed OK”; but doubts remained about his ability to assimilate information and whether he would be able to reach the level of understanding the team required.

The other problem for Perez has

been Button. The 2009 world champion rejected a new longer-term deal and instead let the team pick up the option it had on his services for 2014. This means he has no ties to McLaren beyond the end of next season. With question marks over whether the 33-year-old will stay on, or perhaps even remain in F1, there were concerns about having to go into the 2015 season with two new drivers if Perez underachieved next year.

With Fernando Alonso top of McLaren’s and Honda’s shopping list for 2015, bringing in Magnussen for next season makes sense. Most strikingly, the Dane’s pace and adaptability when he drove the troublesome McLaren MP4-28 at Silverstone in July cast doubt over whether both race drivers were consistently getting the best out of the car.

Perez is unquestionably a worthy grand prix driver and as he joins the current drivers (see below) still chasing a drive for next year, he deserves to find a seat for 2015.

But McLaren’s objective is to run the great rather than the good and Perez was not seen to have the potential to emerge as a team leader. He has been unfortunate to find himself in the team in one of its most difficult seasons but, simply put, he did not beat Button – highly-regarded at McLaren but seen more as a number one-and-a-half than a number one – often enough, quickly enough.

## BUTTON V PEREZ

The only direct yardstick for a driver’s performance is his team-mate. Jenson Button has been the stronger McLaren performer this year, but Perez has outpaced him in the past three weekends

While Button still has more points than Perez, 61 points to 41, their qualifying record is now even – at nine apiece. Discounting Melbourne, where Perez gambled on slicks and was over three seconds slower than Button, the qualifying gap between the two in the last segment of qualifying in which both appeared is just 0.078 seconds in Button’s favour.

	BUTTON	PEREZ	GAP
<b>AUSTRALIA</b>			
Qualifying	10th	15th	3.250s
Race	9th	11th	1.737s
<b>MALAYSIA</b>			
Qualifying	8th	10th	0.961s
Race	17th/DNF	9th	N/A
<b>CHINA</b>			
Qualifying	8th	12th	0.530s
Race	5th	11th	28.575s
<b>BAHRAIN</b>			
Qualifying	10th	12th	0.212s
Race	10th	6th	10.663s
<b>SPAIN</b>			
Qualifying	14th	9th	0.565s
Race	8th	9th	2.232s
<b>MONACO</b>			
Qualifying	9th	7th	0.509
Race	6th	16th/DNF	N/A
<b>CANADA</b>			
Qualifying	14th	12th	0.307s
Race	12th	11th	2.622s
<b>BRITAIN</b>			
Qualifying	11th	14th	0.433s
Race	13th	20th/DNF	N/A
<b>GERMANY</b>			
Qualifying	9th	13th	0.664s
Race	6th	8th	10.310s
<b>HUNGARY</b>			
Qualifying	13th	9th	0.232s
Race	7th	9th	37.205s
<b>BELGIUM</b>			
Qualifying	6th	13th	0.663s
Race	6th	11th	41.142s
<b>ITALY</b>			
Qualifying	9th	8th	0.013s
Race	10th	12th	1.438s
<b>SINGAPORE</b>			
Qualifying	8th	14th	0.255s
Race	7th	8th	0.466s
<b>KOREA</b>			
Qualifying	12th	11th	0.003s
Race	8th	10th	2.893s
<b>JAPAN</b>			
Qualifying	10th	11th	0.141s
Race	9th	15th	31.889s
<b>INDIA</b>			
Qualifying	10th	9th	0.334s
Race	14th	5th	48.407s
<b>ABU DHABI</b>			
Qualifying	13th	8th	0.388s
Race	12th	9th	12.569s
<b>USA</b>			
Qualifying	13th	7th	0.177s
Race	10th	7th	30.586s



**Charles Pic**  
Signed by Caterham last year on a “multi-year” deal, but far from certain to stay on in 2014.

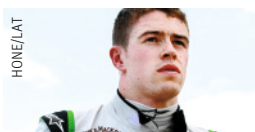

**Paul di Resta**  
Back on form but could be standing up when the music stops even though the team had him under contract.



**Adrian Sutil**  
Expects to stay on at Force India next season but still not a foregone conclusion that he will.



**Giedo van der Garde**  
Well-backed and with a decent rookie season under his belt. In a good position to stay at Caterham.

# Formula 1's ugly future

With debate raging about 2014's new-look cars, **EDD STRAW** and **CRAIG SCARBOROUGH** look at the science behind the droopy noses and if the sport needs to work harder to prevent ugly cars

**W**hen AUTOSPORT.com revealed the expected new look of Formula 1's noses last week, the ugliness caused by the 2014 regulations became a major talking point among fans. Not for the first time when it comes to Formula 1 car aesthetics, attempts were made to prevent this from happening.

"It's gut-wrenching to see a car go in that direction because it just doesn't do the sport any good," explains Force India technical director Andrew Green. "But the performance led us that way.

"We demonstrated that design

earlier this year in the Technical Working Group. A sketch was brought to the meeting by Bob Bell saying this is what a car could look like with these regulations and everybody laughed. He showed it to the group and asked if we were sure we wanted to end up with a car like this and we all said nobody would ever do that!

"To define a regulation with the ambiguity in there gives us freedom to exploit it, but it would need a set of regulations that were proscriptive to stop it, which would leave us all stuck with the same thing which is also not what we want."

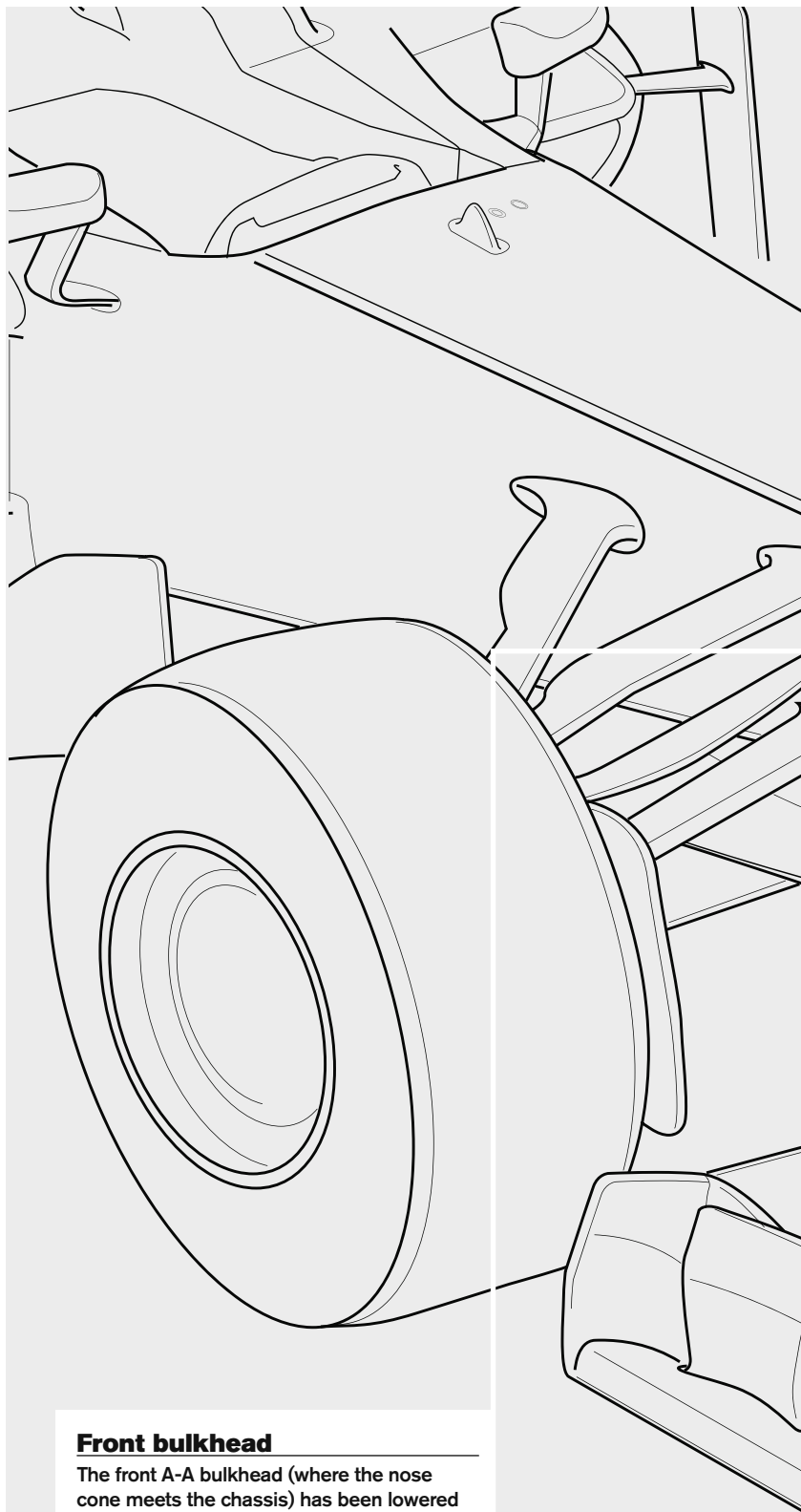

### Front bulkhead

The front A-A bulkhead (where the nose cone meets the chassis) has been lowered slightly for 2014 to just 525mm high. This has a fixed size of 300mm wide and 275mm high.

## EXPERT VIEW



**Gary Anderson**  
Technical consultant

I never liked ugly cars, but if the windtunnel defines that it needs to look ugly to go quick, that's fine. Ugliness does grow on people because we have got used to things like the stepped nose and the wide front wing in recent years. It can be dangerous to try to make the cars look aesthetically pleasing – there is a danger it will not allow designers

enough leeway for innovation. With the nose, there is no doubt the rules make it very difficult to design a car that looks good and it would be possible to have made a few changes to improve the situation. But while the looks of the car do matter and there is certainly merit in considering the aesthetics when writing the regulations, there's a fine balance to be struck.

## F1'S UGLIEST NOSES



2012 Sauber C31



2004 Williams FW26



1996 Forti FG03



1980 Ferrari 312T5



1971 March 711

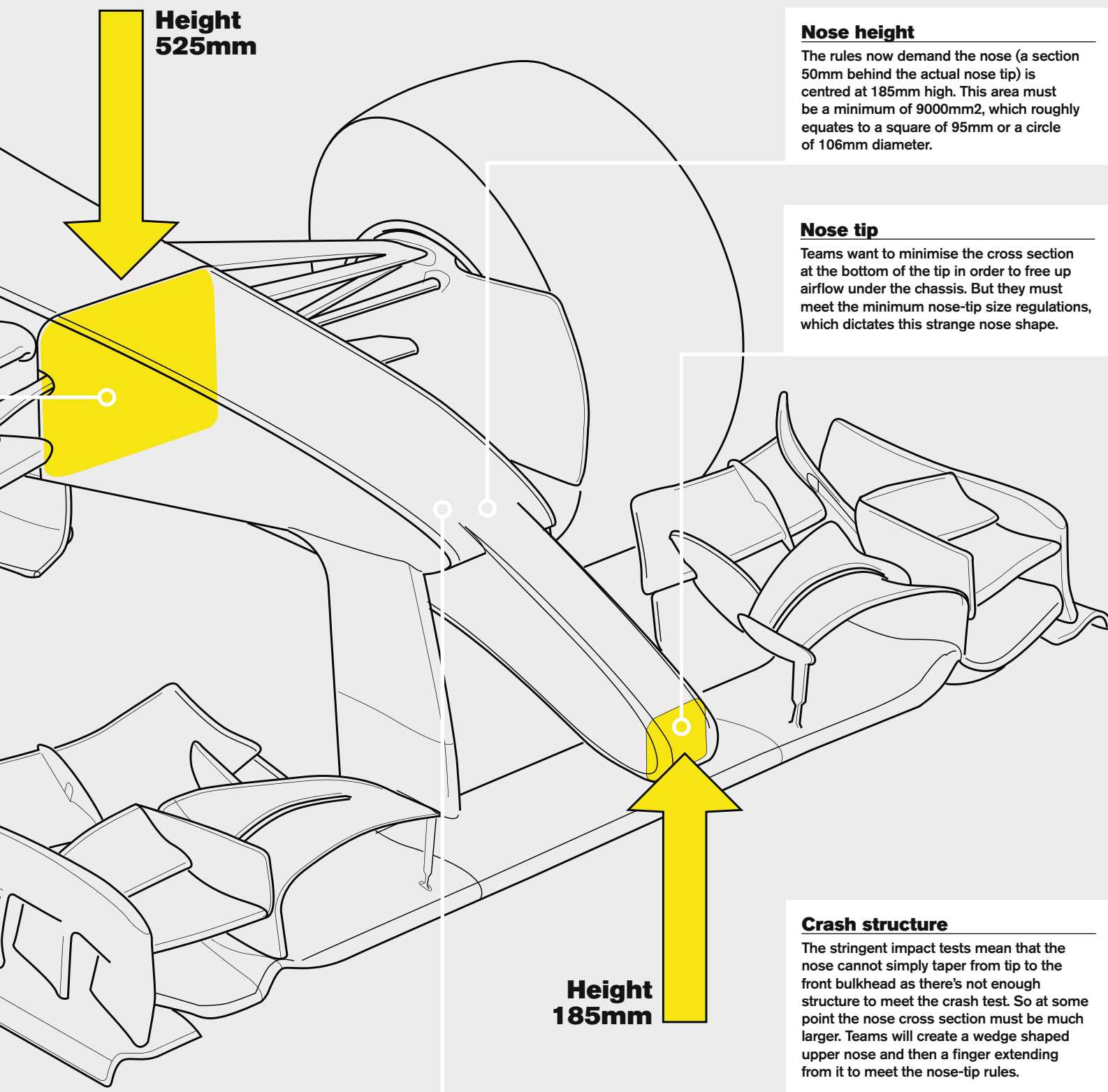

### Nose height

The rules now demand the nose (a section 50mm behind the actual nose tip) is centred at 185mm high. This area must be a minimum of 9000mm<sup>2</sup>, which roughly equates to a square of 95mm or a circle of 106mm diameter.

### Nose tip

Teams want to minimise the cross section at the bottom of the tip in order to free up airflow under the chassis. But they must meet the minimum nose-tip size regulations, which dictates this strange nose shape.

### Crash structure

The stringent impact tests mean that the nose cannot simply taper from tip to the front bulkhead as there's not enough structure to meet the crash test. So at some point the nose cross section must be much larger. Teams will create a wedge shaped upper nose and then a finger extending from it to meet the nose-tip rules.

### TECHNICAL VIEW

**Adrian Newey**

Red Bull chief technical officer

"Our job is to make the car as quick as possible rather than to win any styling awards so we are at the mercy of the regulations. The regulations have caused some ugly areas. The stepped noses aren't as



attractive as they used to be. The narrow-track cars have looked a bit out of proportion compared with the pre-'98 cars. With the low nose next year, there could be some awkward looking aesthetics. It's something that should be given more consideration when the regulations are drawn up.

### COMMERCIAL VIEW

**Toto Wolff**

Mercedes motorsport boss

A fast car is a beautiful car and we will get used to whatever the shape of the car is next year. An F1 car should be a good-looking car and it's a matter of getting used to it. Last year, with the stepped nose, by the end of the year nobody talked about it anymore.





# BRAZIL GP PREVIEW

IN ASSOCIATION WITH **sky SPORTS F1 HD**

## FIRST CORNER

315m

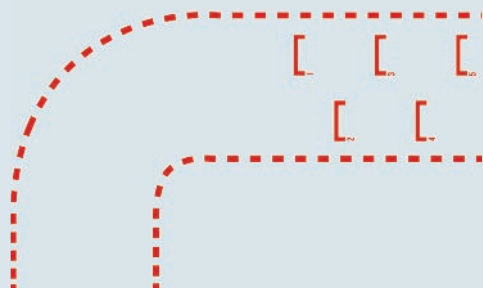

Interlagos is a short circuit and the distance between pole position and the off-camber first turn is just 315m – the ninth shortest run to turn one the drivers have faced all season.

## OVERTAKING STATS

If overtaking statistics from last year's Brazil GP are anything to go by, we are in for a treat this weekend. The 2012 race further proved Interlagos is one of the best tracks on the calendar for overtaking.

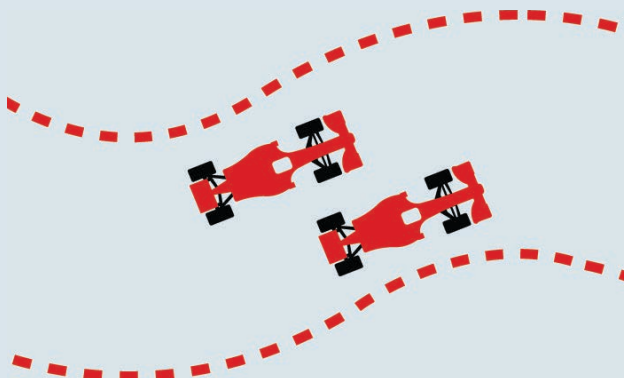

## FULL THROTTLE



64%

A fairly high percentage of the lap – 64% – is spent at full throttle around the short 2.68-mile Interlagos circuit, ranking the track eighth highest for its flat-out potential.

## PITLANE

The pitlane is around average in length at 385m and pitlane loss is low at 19s.



### INTERLAGOS

Pitlane length	385m
Length rank	12th longest
Pitlane loss	19 seconds



MELBOURNE

SILVERSTONE

## SAFETY CARS

Last year's race actually finished under safety car conditions, the weather playing a massive part in the events that took place. There's a pretty high chance we'll see the safety car in action again this weekend, Interlagos being seventh in the Safety Car league table.



USA/INDIA

SINGAPORE

## FUEL PENALTY

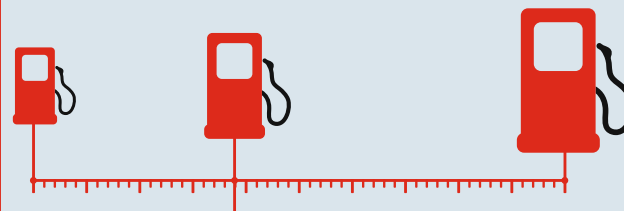

Because of the short lap here, only 1.9kg of fuel is needed to complete a lap, the second lowest consumption after Monaco. Fuel penalty is light at 0.3s lost per lap for every 10kg of fuel carried.

## GEAR CHANGES

Each lap of the Sao Paulo track requires 48 gear changes, which is low. But considering how short the lap is, it's actually an average number of changes.



### INTERLAGOS

Circuit Length	2.677 miles
Race Laps	71
Race Distance	190.083 miles
Lap Record	Juan Pablo Montoya, 1m11.473s (2004)
Corners	15 (10 Left, 5 Right)
Circuit Direction	Anti-Clockwise
Corners <62mph	2
Corners >155mph	2

## WEATHER

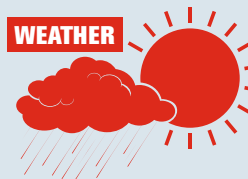

### MONTHLY AVERAGES

Daily sunshine	4.8hrs
Rainfall	140mm
Min temp	16.3C
Max temp	25.9C

Sao Paulo has a monsoon-influenced humid subtropical climate. Rain is often a factor here, unpredictable conditions often spicing up the season finale.

COMPLETE COVERAGE OF THE ENTIRE RACE WEEKEND ON **sky SPORTS F1 HD**

## THURSDAY

1300 Sky Sports F1  
LIVE Drivers' Press Conference

## FRIDAY

1145 Sky Sports F1  
LIVE Free Practice 1  
1545 Sky Sports F1  
LIVE Free Practice 2

1800 Sky Sports F1  
LIVE Team Principal Press Conference  
2000 Sky Sports F1  
LIVE The F1 Show

## SATURDAY

1245 Sky Sports F1  
LIVE Free Practice 3  
1500 Sky Sports F1  
LIVE Qualifying

## SUNDAY

1430 Sky Sports F1  
LIVE Brazil GP

## ALL WEEK

Classic Brazilian grands prix will be shown throughout the week.

100%

## GRAND PRIX SUPERGRID

AUTOSPORT's technical correspondent Gary Anderson has compiled this index, created by taking each driver's percentage deficit to the outright pace so far this year. The graphic shows each driver's average over the 18 races run so far in 2013 compared with the theoretical absolute pace, which is expressed as 100.

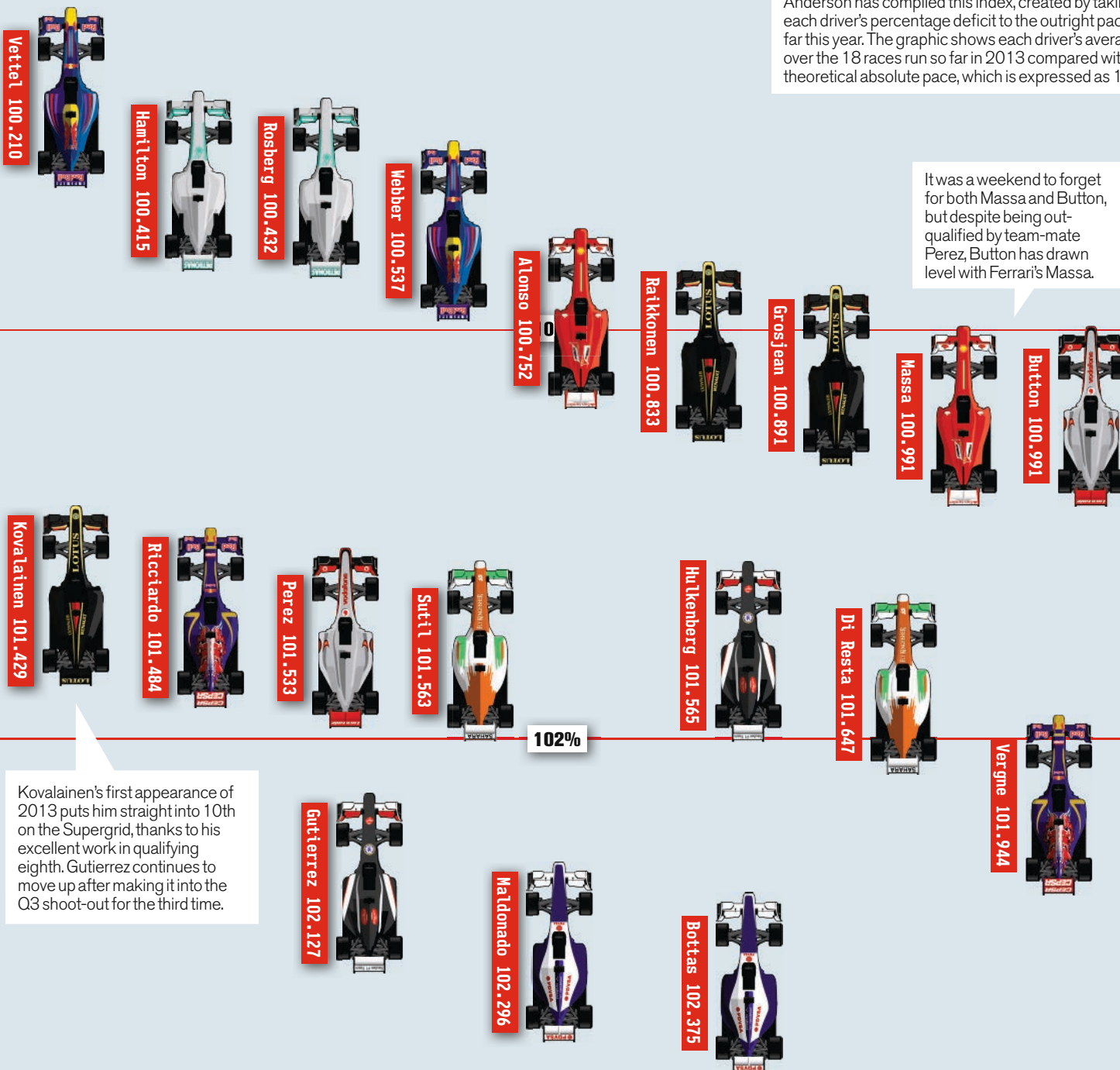

It was a weekend to forget for both Massa and Button, but despite being out-qualified by team-mate Perez, Button has drawn level with Ferrari's Massa.

Kovalainen's first appearance of 2013 puts him straight into 10th on the Supergrid, thanks to his excellent work in qualifying eighth. Gutiérrez continues to move up after making it into the Q3 shoot-out for the third time.

102%

Bottas clawed a huge amount of time back on Maldonado after he made Q3 for the second time this year while the Venezuelan fell at the first hurdle. He'll need more of the same in Brazil to swap positions.

## AND THE REST...

There wasn't a lot of change among the bottom four, although Bianchi split the Caterhams in qualifying and continues to do so on the supergrid despite Van der Garde out-qualifying Pic.

Pic (Caterham)	104.059
Bianchi (Marussia)	104.242
Van der Garde (Caterham)	104.628
Chilton (Marussia)	104.985

Watch the Brazil GP live on Sky Sports F1 HD – go to [sky.com/F1](http://sky.com/F1) or call 0844 2410826



# BRAZIL GP PREVIEW

## Full throttle for V8 farewell

The Brazilian Grand Prix on Sunday is the final race for Formula 1's current engines.

**CRAIG SCARBOROUGH** explains the secrets of how their throttles have performed since 2006

**F**ormula 1's 2.4-litre V8 engines will have their swansong at Interlagos this weekend. Introduced in 2006, Sunday will be the last time we hear a full grid of cars open up the throttles of their V8s at the start of a grand prix.

The throttle is the valve in the engine that alters the airflow through the inlet towards the combustion chamber. Engine power is modulated by the valve restricting or allowing airflow. There is a valve for each cylinder, operated by fly-by-wire.

With the demand to provide optimum flow through the inlet for both the need for full power on the straights but not in the corners, the choice of throttle valve type is

critical. Different designs suit wide-open throttles better than part throttle settings. The choice is down to the engine designer and the shape of the desired power curve.

There are three common throttle types. Firstly, the slide throttle, or guillotine as used on the Cosworth DFV. A flat slide sat over each bank on inlets on the V8 featuring holes corresponding to the four inlets. As the slide moved the holes would open up the inlet for more airflow until a fully open throttle was achieved. It worked well, but needs space between the inlets to accommodate the length required.

More traditional is the butterfly throttle. Each inlet has a thin plate mounted to a central shaft. When

the throttle is closed, the plate blocks the inlet tract. As the shaft rotates with the demand for more power, the plate opens up the inlet. The movement of the plate mimics a butterfly flapping its wings; hence the name. As more throttle is demanded, the plate rotates in the inlet until it sits in line with the inlet at full throttle – the only obstruction is the profile of the butterfly and the shaft it is mounted to.

More recently, the roller throttle has become popular. This uses a solid cylinder passing through the inlet, with a hole machined through to form the inlet when the throttle is open. In this position, the inlet is completely unobstructed for maximum power. As the throttle

closes the cylinder covers off the inlet to form a part closed throttle.

For butterflies, the downside is that when open it obstructs the inlet. This can be offset by slightly larger inlet diameters but Renault believes this costs around 4bhp. But at part-throttle, the butterflies produce a cleaner through flow, such that drivability is better when in-between on and fully-on the throttle.

Conversely, the roller throttle is perfect for maximum power, with an obstructed inlet tract, but it performs less admirably at part throttle causing a lack of drivability.

The roller throttle is used by Cosworth and Mercedes and the butterfly by Ferrari and Renault.

Wide open throttle

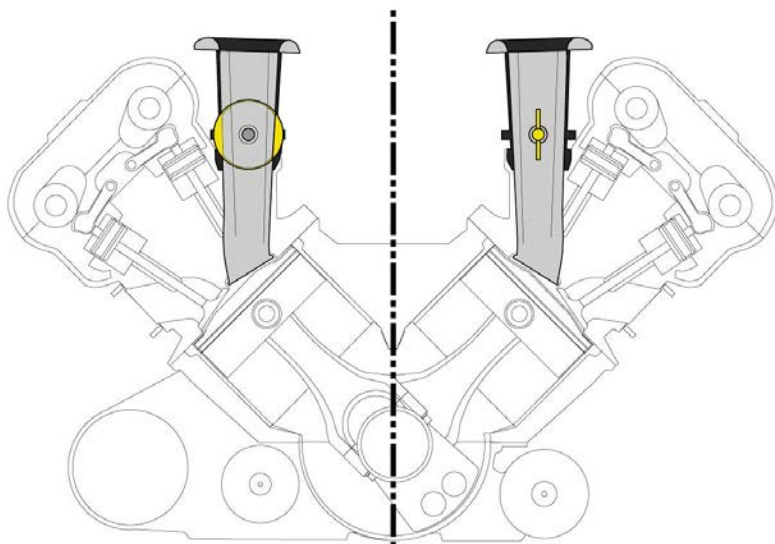

Roller butterfly

Part throttle

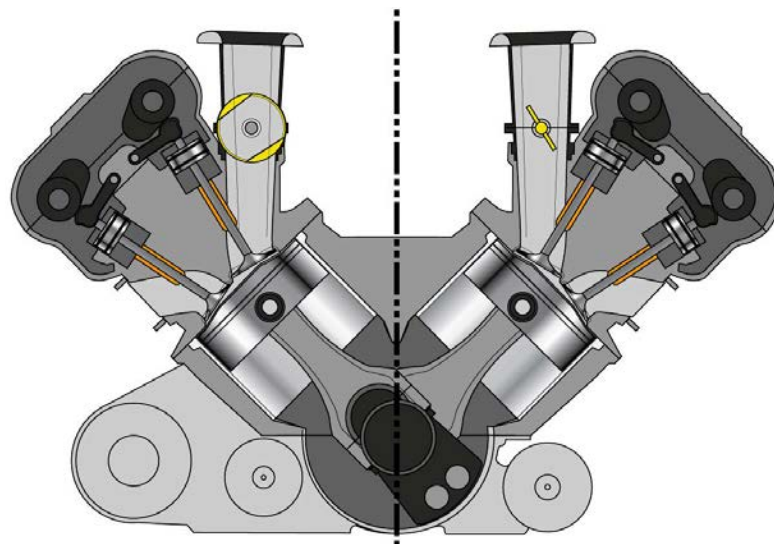

Roller butterfly



## THE CIRCUIT BRIEF



**PAUL DI RESTA**  
Force India driver

I enjoy the circuit, but at the same time it's quite tricky because of the undulating layout and there are some unusual corners.

It's also quite a tough track on your neck because of the anti-clockwise layout and the high number of left-hand corners. After three races on very new circuits it will make a nice change to go back to one of the classic old-school tracks. It's a circuit that usually produces good racing.

It's also a track that has a history of producing rain, so that can add an extra element.



Anti-clockwise track is physically tough

DUNBAR/LAT



DRS Detection 1

DRS Zone 1

### PASSING SPOT

<b>SENNAS</b>	
Approach	194mph
Apex	67mph/96mph
Gear	2
Braking distance	109m
Braking time	2.09s
Braking force	5.29g



FERRARO/LAT

### THE STORY OF 2012

Sebastian Vettel recovered from a first lap incident to seal his third consecutive world championship, while Jenson Button won an action-packed rain-affected race during which Lewis Hamilton and Nico Hulkenberg clashed while fighting for the lead. A recovery to sixth was enough for Vettel to seal the title, with rival Fernando Alonso finishing second.



FERRARO/LAT

### POTENTIAL FLASHPOINT



TEE/LAT

<b>TURN 4</b>		
Approach	193mph	Braking distance 81m
Apex	91mph	Braking time 1.27s
Gear	3	Braking force 5.28g

# RACE CENTRE

REPORTS • NEWS • ANALYSIS • OPINION

61 **NASCAR Sprint Cup Homestead** Jimmie Johnson secured his sixth title in Florida, to leave him just one short of the record of legends Richard Petty and Dale Earnhardt





**44 WRC Great Britain**  
Kubica rolls on factory debut  
as Ogier ends year with victory



**54 F3 Macau Grand Prix**  
Lynn wins on 60th anniversary  
of classic single-seater event



**63 Sciroccos Macau**  
Soper crashes at start of  
'Masters' race, Huisman wins



# Ogier signs off in style in Wales

World champion Sebastien Ogier had never managed to tame Britain's round of the WRC, but he made amends for that with a consummate victory in a new-look Welsh event. By **DAVID EVANS**



## AT A GLANCE



"I had some bad memories of this rally. I was fast, but not always able to finish. Now I have the dream"  
SEBASTIEN OGIER

**RALLY GB**  
Deeside

**ROUND** 13/13

**STAGES**  
22

**WINNER**  
Sebastien Ogier  
3h03m36.7s

**MOST STAGE WINS**  
Sebastien Ogier

**POWERSTAGE WINNER**  
Thierry Neuville

**RALLY RATING**  
★★★★★ New-look rally was great but the contest was a bit dull

**DRIVERS' STANDINGS**  
Ogier 290pts  
Neuville 176pts



# Rally GB



Deeside (GB), November 14-17  
World Rally Championship  
Round 13/13

## RESULTS

22 STAGES, 194.112 MILES

<b>1</b>	<b>SEBASTIEN OGIER (F)/JULIEN INGRASSIA (F)</b>	
	VW Motorsport Volkswagen Polo R WRC #8	<b>3h03m36.7s</b>
<b>2</b>	<b>JARI-MATTI LATVALA (FIN)/MIIKKA ANTILA (FIN)</b>	<b>+21.8s</b>
	VW Motorsport Volkswagen Polo R WRC #7	
<b>3</b>	<b>THIERRY NEUVILLE (B)/NICOLAS GILSOUL (B)</b>	<b>+1m24.5s</b>
	Qatar WRT (M-Sport) Ford Fiesta RS WRC #11	
<b>4</b>	<b>MADS OSTBERG (N)/JONAS ANDERSSON (S)</b>	<b>+1m48.2s</b>
	Qatar M-Sport WRT Ford Fiesta RS WRC #4	
<b>5</b>	<b>ANDREAS MIKKELSEN (N)/MIKKO MARKKULA (FIN)</b>	<b>+2m03.4s</b>
	VW Motorsport Volkswagen Polo R WRC #9	
<b>6</b>	<b>MARTIN PROKOP (CZ)/MICHAEL ERNST (CZ)</b>	<b>+7m37.5s</b>
	Jipocar Czech National Team M-Sport Ford Fiesta RS WRC #21	
<b>7</b>	<b>DANI SORDO (E)/CARLOS DEL BARRIO (E)</b>	<b>+8m26.9s</b>
	Citroen Total Abu Dhabi Citroen DS3 WRC #3	
<b>8</b>	<b>ELFYN EVANS (GB)/DANIEL BARRITT (GB)</b>	<b>+11m13.1s</b>
	Qatar M-Sport WRT Ford Fiesta R5 #75	
<b>9</b>	<b>JARI KETOMAA (FIN)/TAPIO SUOMINEN (FIN)</b>	<b>+12m16.2s</b>
	DMACK-Autotek Ford Fiesta R5 #88	
<b>10</b>	<b>MARK HIGGINS (GB)/CARL WILLIAMSON (GB)</b>	<b>+13m21.0s</b>
	Symtech Racing Ford Fiesta R5 #34	

## OTHERS

**R** ROBERT KUBICA (PL)/MICHELE FERRARA (I)  
Abu Dhabi Citroen Total Citroen DS3 WRC #10 **SS11-accident**

## DRIVERS' CHAMPIONSHIP

<b>1</b>	<b>OGIER</b>	<b>290</b>	<b>6</b>	<b>OSTBERG</b>	<b>102</b>
<b>2</b>	<b>NEUVILLE</b>	<b>176</b>	<b>7</b>	<b>NOVIKOV</b>	<b>69</b>
<b>3</b>	<b>LATVALA</b>	<b>162</b>	<b>8</b>	<b>LOEB</b>	<b>68</b>
<b>4</b>	<b>HIRVONEN</b>	<b>126</b>	<b>9</b>	<b>PROKOP</b>	<b>63</b>
<b>5</b>	<b>SORDO</b>	<b>123</b>	<b>10</b>	<b>MIKKELSEN</b>	<b>50</b>

## MANUFACTURERS' CHAMPIONSHIP

<b>1</b>	<b>VW MOTORSPORT</b>	<b>425</b>	<b>4</b>	<b>QATAR WORLD RALLY</b>	<b>184</b>
<b>2</b>	<b>CITROEN TOTAL</b>	<b>280</b>	<b>5</b>	<b>JIPOCAR CZECH NATIONAL</b>	<b>65</b>
<b>3</b>	<b>QATAR M-SPORT</b>	<b>190</b>	<b>6</b>	<b>ABU DHABI CITROEN WRT</b>	<b>63</b>

## STAGE TIMES

<b>SS1 GWYDYR</b> (3.91 miles) Fastest: Ogier 4m43.1s Leader: Ogier	<b>SS12 GARTHEINIOG 2</b> (11.55 miles) Fastest: Latvala 8m47.8s Leader: Ogier
<b>SS2 PENMACHNO</b> (6.53 miles) Fastest: Ogier 5m18.9s Leader: Ogier	<b>SS13 DVFI 2</b> (13.36 miles) Fastest: Latvala 12m54.5s Leader: Ogier
<b>SS3 CLOCAENOG 1</b> (4.67 miles) Fastest: Neuville 4m25.9s Leader: Ogier	<b>SS14 DVFNANT 1</b> (13.23 miles) Fastest: Latvala 12m21.1s Leader: Ogier
<b>SS4 HAFREN 1</b> (19.97 miles) Fastest: Ogier 18m41.0s Leader: Ogier	<b>SS15 CHIRK CASTLE 1</b> (0.93 miles) Fastest: Sordo 1m31.3s Leader: Ogier
<b>SS5 SWEET LAMB 1</b> (2.49 miles) Fastest: Sordo 2m54.7s Leader: Ogier	<b>SS16 CHIRK CASTLE 2</b> (0.93 miles) Fastest: Neuville 1m34.2s Leader: Ogier
<b>SS6 MYHERIN 1</b> (19.88 miles) Fastest: Latvala 18m16.0s Leader: Ogier	<b>SS17 DVFNANT 2</b> (13.23 miles) Fastest: Ogier 12m22.8s Leader: Ogier
<b>SS7 HAFREN 2</b> (19.97 miles) Fastest: Ogier 18m57.8s Leader: Ogier	<b>SS18 PENLLYN</b> (8.38 miles) Fastest: Ostberg 7m15.1s Leader: Ogier
<b>SS8 SWEET LAMB 2</b> (2.49 miles) Fastest: Ogier 2m56.8s Leader: Ogier	<b>SS19 CLOCAENOG 2</b> (4.67 miles) Fastest: Ogier 4m18.0s Leader: Ogier
<b>SS9 MYHERIN 2</b> (19.88 miles) Fastest: Ogier 18m27.8s Leader: Ogier	<b>SS20 KINMEL PARK 1</b> (1.36 miles) Fastest: Ogier 1m33.2s Leader: Ogier
<b>SS10 GARTHEINIOG 1</b> (11.55 miles) Fastest: Mikkelsen 8m46.5s Leader: Ogier	<b>SS21 KINMEL PARK 2</b> (1.36 miles) Fastest: Ogier 1m32.0s Leader: Ogier
<b>SS11 DVFI 1</b> (13.36 miles) Fastest: Mikkelsen 12m51.1s Leader: Ogier	<b>SS22 GREAT ORME</b> (2.92 miles) Fastest: Latvala 2m38.5s Leader: Ogier

**Rally route** In the biggest change since 1999, Rally GB moved to North Wales in its entirety for the first time ever. Gwydyr was back on the route for the first time since 1969 and Penmachno since 1996. As well as the mid-Wales classics, Chirk Castle and Kinmel Park were added as RallyFest stages. Service moved from Cardiff to Deeside.

**FOR IN-DEPTH RESULTS**  
forix.autosport.com

Ogier savoured his winner's trophy



JUST OUTSIDE RALLY GB'S SHINY NEW DEESIDE headquarters somebody had planted some new trees. There was undoubted significance to Toyota – whose land they were on – but the correlation between them and the rebirth of Britain's round of the world championship was impossible to ignore. Symbolism done, the rally was won at a canter by Sebastien Ogier. But, of equal importance, the people were back. And they were back in time for a further demonstration of Volkswagen domination, with Jari-Matti Latvala backing up his team-mate with second. The final podium spot was well celebrated by Thierry Neuville who clinched second in the points as a result.

### LEG ONE (100.69miles)

**Overcast/sunny – ambient temperature range on stages 7-14C**

Ogier wasn't sure. "No rain?" he said. "You think no rain? OK." Not convinced. "But still," he reasoned, "the fog... It's not raining now, but the rain is never far away on this rally."

Typically, the world champion was chasing as much meteorological information as possible before he decided where to run on the road. Running order was one thing, but also on his mind

was the pressing matter of three stages in the North Welsh November night.

"If the fog comes, it can be like hell," the Frenchman said darkly.

In the end, Ogier had gone for second on the road. "I think first quickest is the best place," he said. "But my place gives me the chance to look at some of the braking marks on the road."

Leaving the quayside in Conwy, there was drizzle in the air. But by the time Latvala arrived at the start of Gwydyr, just outside Llanrwst, the night was clear.

With the added aid of moonlight, Ogier went quickest. And could have gone quicker.

"I didn't have the confidence to go as fast as the grip would allow," he said. So he pushed a bit harder in Penmachno and extended his lead by a further nine tenths of a second. The rhythm had arrived. But the limits were yet to be explored.

"No big attack yet," smiled the man chasing his ninth win of the season at the end of SS2.

Latvala lost his early second place to a charging Neuville, who demoted him courtesy of going fastest in Clocaenog. But, the wet conditions allied to the varying pace and technical nature of the



**They turned mud, asphalt, gravel and snow into pure gold.**

Congratulations to Jan Kopecký and Pavel Dresler for winning the gruelling 2013 European Rally Championship\* title. The fact that they are the first Czech crew ever to win the ERC is simply the icing on the cake.

\*subject to confirmation of the results by the FIA

# THIS WAY TO THE TOP



## 2014 INDY LIGHTS SCHEDULE

March 30	⤵	Streets of St. Petersburg
April 13	⤵	Streets of Long Beach
April 26	⤵	Barber Motorsports Park
April 27	⤵	Barber Motorsports Park
May 9	⤵	Indianapolis Motor Speedway
May 10	⤵	Indianapolis Motor Speedway
May 23	◀	Indianapolis Motor Speedway
July 6	◀	Pocono Raceway
July 20	⤵	Streets of Toronto
August 2	⤵	Mid-Ohio Sports Car Course
August 3	⤵	Mid-Ohio Sports Car Course
August 17	◀	The Milwaukee Mile
August 23	⤵	Sonoma Raceway
August 24	⤵	Sonoma Raceway

Schedule subject to change. ◀ Oval ⤵ Street/Road Course

**FROM THE PALM** tree-lined streets of St. Petersburg, Fla., to the shorelines of Long Beach, Calif., and the famed Indianapolis Motor Speedway, the 2014 Indy Lights Presented by Cooper Tires schedule promises an exciting playing arena to showcase the rising stars of the top rung of the Mazda Road to Indy ladder system. A total of 14 races will culminate with the crowning of a champion and a scholarship package of nearly \$1 million for the titleholder to advance to the IndyCar Series in 2015.

Highlights of the 2014 schedule include new doubleheader rounds at all road course events with a "sprint" race on Saturday of 40 minutes and a "feature" on Sunday of 60 minutes.

There is also a reduction in the number of oval races — from five to three — but the now traditional Freedom 100 race will remain intact as Indy Lights drivers take center stage at the Indianapolis Motor Speedway on Carb Day, the final practice day for the Indianapolis 500.

Indy Lights races will move from a Saturday race date to a Sunday slate next season, revving up the crowds as the checkered flag falls just prior to the start of IndyCar Series main events. All races will feature same-day coverage on the NBC Sports Network with international rights held by ESPN International.

The mix of three street circuit, four road course and three oval events ensures the proper blend of tracks to provide the necessary training for Indy Lights drivers as they prepare to advance to the IndyCar Series. Three of the top-five finishers in this year's Indianapolis 500 were from the Indy Lights ranks — winner Tony Kanaan (the 1997 Indy Lights champion), runner-up Carlos Muñoz (a third-place finisher in this year's Indy Lights championship), and fourth-place finisher Marco Andretti (a 2005 Indy Lights graduate).

Sage Karam, 18, is proof that the ladder system works. After claiming the 2010 USF2000 crown, Karam completed two years







# Mazda Road TO INDY



© 2013 Andersen Promotions. All Rights Reserved.

of Pro Mazda competition — finishing third in the title chase last year — before advancing to Indy Lights where he recently captured the championship title after besting teammate Gabby Chaves in a thrilling title fight that came down to the wire in the season finale. He will use his prize and awards package of up to \$1 million to aid his ascent to the IndyCar Series next year.

Unique, unparalleled and successful, the Mazda Road to Indy program has caught the attention of drivers from every corner of the globe, leading many to focus their careers on America with the IndyCar Series and Indianapolis 500 as their ultimate goals. With

Andersen Promotions now at the helm as promoter of the series, advances are being seen across the board — including an updated car for 2014 and a new chassis debuting in 2015.

The new Indy Lights series is ticking all the boxes for up-and-coming drivers — a high-tech equipment package to develop and showcase their skills; competition and a level playing field; high profile events; a television package; a proper prize money program and the opportunity to advance; a cost-effective series to enter and a marketable series to sell to sponsors; and a series that activates and promotes as does its partners.

“This is the reason I came to the U.S.A.,” said

Tristan Vautier, 2013 IndyCar Series Rookie of the Year/2012 Indy Lights Champion/2011 Pro Mazda Champion, after winning the Indy Lights title last season. “I knew if I could accomplish this first objective to win Pro Mazda, I’d get my chance in Indy Lights and now I have a scholarship to IndyCar. It’s a young but amazing program that you don’t find anywhere else.”

To find out more on the series and the Mazda Road to Indy, visit [www.indylights.com](http://www.indylights.com).

For additional information, please contact:  
Jason Penix, Director, Development Series  
INDYCAR/Andersen Promotions  
[jpenix@indycar.com](mailto:jpenix@indycar.com)

Microsoft



# FORZA | 5 MOTORSPORT

Forza Motorsport 5 is a cinematic automotive journey, starring the world's greatest cars and tracks. Built from the ground up to take advantage of Xbox One and the infinite power of the cloud, no game better delivers the wide-eyed thrill of racing.

**Pre-order now. Available 22.11.13**



Scan here for exclusive Xbox content



[Xbox.com/Forza](http://Xbox.com/Forza)



Neuville scored  
strong third spot



MCKLEIN/LAT

► stage really had the Belgian thinking.

“That one was tricky!” he said, looking relieved to get to the end – especially 0.4s up on Ogier. He had feared a heavy landing might have damaged the gearbox, with the ratios becoming difficult to select. This was a problem for his fellow M-Sport driver Mads Ostberg in fifth place, his Ford would undergo a transmission change back in Deeside.

Just ahead of Ostberg was top Citroen runner Mikko Hirvonen in fourth place.

“That was difficult, I couldn’t find the rhythm... or any grip,” said the Finn, who added that the lack of a pre-event test had compromised his chances of a second Rally GB success. That said, a career change could well be on the cards following the impressive whack he gave a rugby ball at the selection of running order.

Out front, Ogier was pleased with his night and the decision to run second.

“That last stage was messy,” he said. “It was good to follow Jari’s lines.”

Just a handful of hours after switching their bedside lights off, the crews were up and about for an 0630 Deeside departure, bound for the most southerly stages of the route. Two loops of Hafren, Sweet Lamb and Myherin lay in wait.

First in, Latvala needed a good run to contain Ogier’s 5s advantage. He got the exact opposite. He could find no confidence on Friday’s opener.

“It was no good,” he said, disconsolately. He’d softened the Polo for the first full day and while it was giving good traction in the sticky stuff, he’d lost some stability in the high-speed bits.

“I like these roads, but I can’t find the feeling,” added Latvala.

Ogier, by comparison, was at his confident best and thundered through Hafren to demolish the field, stretching his advantage to 12.9s.

The story of the stage was of Robert Kubica, however. The Pole crashed his factory DS3 WRC off the road and out of an impressive seventh place.

Citroen’s day was brightened by an unexpected quickest time from Dani Sordo through Sweet Lamb. But it darkened on the following Myherin test, where Hirvonen became the second Citroen driver to drop it comprehensively in three stages.

Hirvonen’s co-driver Jarmo Lehtinen wasted no time in fronting up responsibility for the shunt. “It was my mistake,” he said. “I can’t explain why, but I do know what happened. We have a long flat-right

tightens into medium-right and what I said was: “Long flat-right right tightens...” And then after a while I thought: “Fuck! I didn’t say it until the end.” So I said it then, but we were already rolling.”

Kubica was caught out in the mud. “I misjudged the grip on the braking,” he said. “I made a mistake not noticing the mud on the surface and, when I braked, I locked the front wheels. I tried to recover it with the handbrake but we ran out of road. It was quite steep and we ended upside down.”

Kubica would be back for Saturday, while Hirvonen was heading for the bar.

If Latvala was going to be able to engage in the victory fight, it would have to come through Myherin – his favourite stage on the route. He did it. Fastest. Back to second and Ogier’s lead chopped back to 13.5s.

Ogier was honest in his explanation, saying: “I think I fell asleep a little bit!”

It wouldn’t happen again. Wide awake, Ogier cleaned up through the afternoon – winning the three re-run stages.

“I’m happy with the day,” he said. “But still we have half of the rally to do, so nothing is finished yet. The lead is quite good, but tomorrow is a new day for me on the stages.”

The lead in question was 20.1s over Latvala. And, crucially, Ogier had beaten Latvala through the Finn’s favourite test.

“Was he upset by this?” asked Ogier.

Upset? Probably not, but he was ready with a typically reasoned response. He’d been 2.2s down through the stage and he knew where it had gone.

Neuville was still struggling for traction, but he admitted it was difficult to risk all in an effort to get the 40s back on Latvala, when third was good enough for the runner-up spot in the points. It was a question of battles and wars for the Belgian.

Ostberg was half a minute off his team-mate, having spent much of the day trying to find a way of dialling out understeer at the exit of the corners. He also endured a two-wheeled moment first time through Sweet Lamb, a place that has been known to collect the odd factory M-Sport car... Evgeny Novikov ended the day just 4s down on Ostberg, despite a problem with the launch control on his car through the morning.

There was no chance for either Fiesta driver to lift, however, with Andreas Mikkelsen’s Polo just 1.1s behind the Russian.

#### POSITIONS AFTER DAY ONE

1 Ogier/Ingrassia	1h34m48.0s
2 Latvala/Anttila	+20.1s
3 Neuville/Gilsoul	+1m02.6s
4 Ostberg/Andersson	+1m30.8s
5 Novikov/Minor	+1m34.5s
6 Mikkelsen/Markkula	+1m34.6s

#### LEG TWO (61.15 miles)

##### Overcast – ambient temperature range on stages 6-14C

Latvala’s hopes of challenging Ogier were pretty much shot in Saturday’s opener, where he dropped 3s to the leader.

“I had too many cautions in my pace notes,” he said. “I didn’t have the spark in to put the pedal to the metal. My notes warned me of the mud, but the rain last night seemed to have washed it away and there was grip. But then sometimes I pushed harder and there was no grip. Not good. I lost this rally a little bit by being too cautious in the recce.”

No such problems for Ogier, who felt there was more grip in today’s stages, but running in reverse order made it more difficult.

“It is better to be further ahead on the road,” he said, “but it’s OK. I am happy, the gap is good and we can be sensible.”

A timing problem left him without splits on the first stage, but he controlled his pace from then on.

It was another Volkswagen that topped the timesheets in Gartheiniog and Dyfi first time through, as Mikkelsen made the most of ►



Latvala flew to  
runner-up spot

MCKLEIN



**A pacenote error did for Hirvonen in Myherin**

GARY JONES/WILL JONES

▶ running ahead of the leaders in marginally less muddy conditions. That and being engaged in a cracking three-way scrap for fourth gave him the urgency needed for back-to-back scratch times. By the end of SS11, he was up to fourth.

And Novikov was off the road. By a long way. "I think it was a mistake from the recce," he said. "I put some distance between a flat-out corner and a fourth-gear right, but when we came at speed the distance wasn't there."

The Fiesta wasn't the only thing rolling in Dyfi as Kubica booked himself an early bath for the second day in succession. But this time he wouldn't be back. "There was a misunderstanding in the pace notes," he said. "We rolled twice."

With some hastily re-touched notes of his own, Latvala was quickest on the re-run stages, but frustratingly Ogier had everything completely under control, dropping 0.7s on Garth and 0.6s on Dyfi. More confident of the car and the notes in the slipper and muddier conditions of Dyfnant, Latvala hauled 7.9s out of Ogier. The lead was down to 17.1s. Was Ogier concerned?

Not a bit. With a shrug and a smile... "I was too cautious. I can afford to give away a bit."

The gap was back to 20.3s after two runs around Chirk. On a steady day for the leader, he still managed to add 0.2s to his advantage.

Neuville said Mikkelsen's early speed had caused him to up his pace a little but he was still content with the final place on the provisional podium.

Mikkelsen eased his way 7.3s clear of Ostberg for fourth on a very impressive day for the two-time IRC champion, where he was only 0.2s slower than Ogier through the day's 61 competitive miles.

Things were not quite as rosy directly behind; the atmosphere in the #4 Fiesta was more than a little testy as Ostberg felt co-driver Jonas Andersson needed to improve on note delivery.



**Evans starred on his way to WRC2 victory**

MCKLEIN

"I can't remember the corners if they are coming six or seven ahead," said Ostberg.

**POSITIONS AFTER DAY TWO**

1 Ogier/Ingrassia	2h33m47.6s
2 Latvala/Anttila	+20.3s
3 Neuville/Gilsoul	+1m14.4s
4 Mikkelsen/Markkula	+1m34.4s
5 Ostberg/Andersson	+1m41.7s
6 Prokop/Ernst	+6m42.0s

**LEG THREE (32.26 miles)**

**Overcast – ambient temperature range on stages 6-13C**

Ogier wouldn't rest and couldn't concentrate on the questions at the end of Dyfnant on Sunday morning. As soon as he saw the timing board he relaxed, visibly.

It was only 0.6s, but it was enough. "It was important," he said, "to show Jari-Matti that he had no chance to come back. We can relax a bit more now, but it's not finished until it's finished."

But in reality, it was finished. With no split times, Neuville admitted he was worried about the 20s difference between himself and the battling Norwegians – so he stayed on it and added a further five to his buffer.

Mikkelsen's hopes of holding fourth were spoiled with a spin, which dropped him back behind Ostberg. Ostberg's first scratch time of the event was enough to keep the VW down in fifth through Penlyn and an even bigger spin from Andreas in Clocaenog sealed the deal for Ostberg.

Finally, Mads looked more like his old self. "I'm enjoying this battle," he said, heading for Kimmel and the Orme with 17s in hand. "Yes, it's quite stressful, but it's good to be driving like this."

Not even Mikkelsen – the man who holds the Great Orme record – could overturn such a big gap and the third Polo would remain fifth at the finish.

Predictably, Ogier was delighted with his ninth win and 11th podium in 13 starts and Neuville was almost as chuffed with a third that rewarded him with second over the season.

Further down the order, there was relief from Prokop at getting to the finish of what had been a tough event for the Pole, while Sordo was one place back in seventh – the Spaniard's five-minute penalty eventually only costing him one position.

And then came the first of the brilliant Brits, with Elfyn Evans's eighth giving him WRC2 victory and Mark Higgins rounding out the top 10, sandwiching Finn Jari Ketomaa.

And that was that. Unfortunately, the competition didn't live up to what was a fantastic new route, but there was no denying that Ogier's dominance was deeply impressive.

Haven't we heard that before somewhere? ❧

**IN THE SERVICE PARK**

**David Evans**



FOURTEEN MONTHS AGO RALLY GB CHIEF Andrew Coe talked about returning Britain's round of the World Rally Championship to the top of the tree. Last week was a massive step towards that goal.

It's no secret that Wales has been in the bottom three in the league table of events far too often in recent seasons – and on more than one occasion it has come within a hair's breadth of being dropped. Not any more. Last week shot the event into the top three WRC rounds of the season. Now comes the hard work... the push for the top of the table.

Massive credit has to go to Andrew Kellitt for delivering a rally for the people last week. Granted, there were rough edges (the control of spectators was woeful in Chirk Castle), but on the whole the event was a rally we could finally be proud of.

And it provided a fitting finale for Volkswagen's season of absolute dominance. The Polos were simply sublime in and out of Deeside. The one disappointment? Robert Kubica not going the distance. An RAC rookie mistake in the mud put him out of the running while a predictable misunderstanding on the notes (courtesy of him being forced to translate every corner from Italian to Polish) put him out of the rally. Upside down in Dyfi was not a fitting end to Kubica's contemporary World Rally Car debut. He's better than that.



MCKLEIN

**REMEMBER WHEN**

NOVEMBER 17-21 1973



**Britain first hosted a WRC event?**

Britain's first World Rally event started 40 years ago last weekend. Ford Escort RS1600 ace Timo Makinen and co-driver Henry Liddon beat Roger Clark/Tony Mason by five minutes on the RAC.



Crowds flocked to the special stages

## Rally GB set for long WRC future

**LAST WEEKEND'S RALLY GB HAS SECURED** its future in the world championship with an event that improved beyond the expectation of most in the series.

M-Sport team principal Malcolm Wilson, one of the event's fiercest critics in the past, led praise for the rally.

Wilson said: "I'm excited by this rally. It's great to see so much interest in rallying and this event sends out a really positive message – especially when you think where we've been for the past 10 years, without interest or spectators. I'm pleased for everybody involved with this – it's just a shame it's taken a decade to get here.

"I'm surprised at how quickly they've turned this around. There's a long way to go to be best in the world, but we've had more people in service here at six in the morning than we had in Cardiff City Centre at midday or in the evening."

Rally chiefs implemented wholesale route and service-park changes for the Deeside-based event. The only problem came out of the popularity for the rally, which caused major spectator problems at Chirk Castle on

Saturday, with the local police reporting a 10-mile traffic jam on the A5 as fans tried to get to the stage near Wrexham.

Event chief executive Andrew Coe said his team would learn from this year and move forward for 2014.

Coe said: "This has been a massive achievement to reinvigorate and redesign this event in the way we have. The degree of success has taken us slightly by surprise, resulting in the issues at Chirk. We hold our hands up to that. We're on the right track and we will go away and look at the way we work with the spectators. It's a nice problem to have and one we'd have liked not so long ago."

The all-new Deeside service park was a major hit with fans as more than 10,000 packed in – for free – to watch the cars being fettled alongside a concert from Republica and a firework display.

Local hero Elfyn Evans, who took his maiden WRC2 win and finished eighth overall in an M-Sport Fiesta, said: "Seeing the numbers of cars parked on the verges at the side of the road, it's amazing."



Williams co-drive class-winning Lancer

### WILLIAMS STARS ON DEBUT

British Olympic skeleton gold medalist Amy Williams has confirmed she hopes to return to rallying following her incredible World Rally Championship debut class win, co-driving alongside Tony Jardine in a Mitsubishi Lancer. The pair finished 24th overall, but took the class by more than three minutes.

### EVANS BAGS WRC 2 VICTORY

Elfyn Evans is hoping his maiden WRC2 win will be enough to cement his future in the WRC. "I want a full programme in the WRC next season," he said. "I know it's a big ask, but that's where I want to be. Winning at home in Wales is a fantastic end to the season."

### CRONIN CRASHES OUT

Three-time British Rally champion Keith Cronin's hopes of landing a Citroen DS3 R5 drive next year went south when he crashed out of Rally GB on the first day. He returned to the action on Saturday, but the Citroen Top Driver award went to Frenchman Sebastien Chardonnet.

### HIGGINS FINISHES IN TOP 10

Mark Higgins made the top 10 on his return to world championship rallying in Britain last week. On a one-off Ford Fiesta R5 drive, the Manxman took third in WRC2 and 10th overall, despite a persistent misfire on his car.

### GILSOUL WINS BEEF TROPHY

Thierry Neuville's co-driver Nicolas Gilsoul was the latest recipient of the Michael Park 'Beef' Trophy, awarded to the season's outstanding co-driver in the spirit of Park, who died in a crash on Rally GB in 2005.

### HACKER CAUSES TIMING GLITCH

Timing firm SIT blamed a cyber attack for the lack of results from Rally GB. Volkswagen team boss Jost Capito's anger at the lack of results was typical of the feeling across the service park. "I think F1 gets more attacks and there is never a problem. This is unacceptable for a world championship."

### KORHONEN WINS WRC3 CLASS

Recently crowned British Rally Champion Jukka Korhonen put his free entry to Rally GB to good use by winning the WRC3 class in Wales. Korhonen was actually outpaced by fellow Citroen DS3 R3T runner Quentin Gilbert, but Gilbert was not eligible for WRC3 having scored on six rounds already this season.



Korhonen triumphed

## Kubica assessing 2014 options

### ROBERT KUBICA HASN'T RULED OUT

staying in the World Rally Championship next season – despite a disastrous factory debut with Citroen in Wales.

The Pole only completed four stages and rolled his factory DS3 WRC twice. He crashed out first on Friday and then on Saturday morning, with the second accident ruling the car out of action completely.

Prior to the first crash, he had been running in seventh place and setting times that were quicker than his Citroen team-mate Dani Sordo.

"I said before this rally started that it would not affect my decision for next season and it doesn't," said Kubica.

"I have to think about next year and what happened in Wales was disappointing, but doesn't make a difference."

Kubica admitted the loss of his season-long co-driver Maciek Baran, who quit the sport before the event, did have an impact on his rally. He said: "I don't want to blame this situation, but it didn't help my World Rally Car debut."

Asked whether he would stick with his new co-driver Michele Ferrara next season, Kubica said: "I have a think first of all, if I need a co-driver in my future."

Kubica praised Ferrara's efforts, while confirming the second shunt came courtesy of a misunderstanding about the notes for that corner.



Kubica woes made for a miserable rally for Citroen

F3

Macau (PRC)

November 16-17

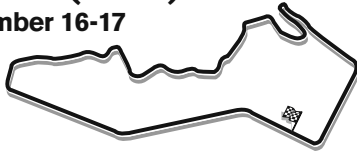

RESULTS

MAIN RACE: 15 LAPS, 57.04 MILES

1	ALEX LYNN (GB)	37m37.975s
	Prema Powerteam Dallara-Mercedes F312; Grid: 1st	
2	ANTONIO FELIX DA COSTA (P)	+1.173s
	Carlin Dallara-Volkswagen F312; Qualifying: 4th	
3	PIPO DERANI (BR)	+6.795s
	Fortec Motorsport Dallara-Mercedes F312; Grid: 5th	
4	ALEXANDER SIMS (GB)	+8.203s
	T-Sport Dallara-Nissan F312; Grid: 6th	
5	JORDAN KING (GB)	+9.573s
	Carlin Dallara-Volkswagen F312; Grid: 7th	
6	JAZEMAN JAAFAR (MAL)	+15.547s
	Carlin Dallara-Volkswagen F312; Grid: 12th	
7	CARLOS SAINZ JR (E)	+16.976s
	Carlin Dallara-Volkswagen F312; Grid: 9th	
8	TOM BLOMQUIST (GB)	+26.160s
	Fortec Motorsport Dallara-Mercedes F312; Grid: 24th	
9	NICHOLAS LATIFI (CDN)	+29.288s
	Carlin Dallara-Volkswagen F312; Grid: 13th	
10	ESTEBAN OCON (F)	+30.914s
	Prema Powerteam Dallara-Mercedes F312; Grid: 10th	
11	YUHI SEKIGUCHI (J)	+32.854s
	Mucke Motorsport Dallara-Mercedes F312; Grid: 14th	
12	YUICHI NAKAYAMA (J)	+33.790s
	TOM'S Dallara-Toyota F312; Grid: 18th	
13	WILL BULLER (GB)	+34.265s
	Fortec Motorsport Dallara-Mercedes F312; Grid: 8th	
14	HARRY TINCKNELL (GB)	+36.532s
	Carlin Dallara-Volkswagen F312; Grid: 27th	
15	KATSUMASA CHIYO (J)	+36.902s
	B-Max Engineering Dallara-Toyota F312; Grid: 19th	
16	ANTONIO GIOVINAZZI (I)	+37.584s
	Double R Racing Dallara-Mercedes F312; Grid: 15th	
17	NELSON MASON (CDN)	+39.877s
	Jo Zeller Racing Dallara-Mercedes F312; Grid: 28th	
18	DENNIS VAN DE LAAR (NL)	+1m01.651s
	Mucke Motorsport Dallara-Mercedes F312; Grid: 25th	
19	ED JONES (UAE)	+1m29.025s
	Fortec Motorsport Dallara-Mercedes F312; Grid: 23rd	
20	LUCAS WOLF (D)	-1 lap
	URD Rennsport Racing Dallara-Mercedes F312; Grid: 16th	
21	KEVIN KORJUS (EST)	-2 laps
	Double R Racing Dallara-Mercedes F313; Grid: 26th	
R	RAFFAELE MARCIELLO (I)	9 laps-acc damage
	Prema Powerteam Dallara-Mercedes F312; Grid: 3rd	
R	STEFANO COLETTI (MC)	7 laps-accident
	EuroInternational Dallara-Mercedes F312; Grid: 11th	
R	SUN ZHENG (PRC)	6 laps-accident
	Double R Racing Dallara-Mercedes F312; Grid: 21st	
R	FELIX ROSENQVIST (S)	0 laps-accident
	Mucke Motorsport Dallara-Mercedes F312; Grid: 2nd	
R	SEAN GELAE (RI)	0 laps-accident
	Double R Racing Dallara-Mercedes F312; Grid: 17th	
R	JOHN BRYANT-MEISNER (S)	0-laps-accident
	Fortec Motorsport Dallara-Mercedes F313; Grid: 20th	
R	LUCAS AUER (A)	0 laps-accident
	Prema Powerteam Dallara-Mercedes F312; Grid: 22nd	

Winner's average speed: 90.94mph. Fastest lap: King, 2m11.547s, 104.07mph.

**QUALIFYING RACE RESULTS:** 1 Lynn, 10 laps in 24m41.968s (Qualifying; 3rd-2m11.639s); 2 Rosenqvist, +2.411s (Q2-2m11.622s); 3 Marciello (Q1-2m11.555s); 4 da Costa (Q5-2m12.083s); 5 Derani (Q7-2m12.144s); 6 Sims (Q11-2m12.698s); 7 King (Q10-2m12.616s); 8 Buller (Q12-2m12.768s); 9 Sainz (Q14-2m13.173s); 10 Ocon (Q15-2m13.333s); 11 Coletti (Q17-2m13.777s); 12 Jaafar (Q8-2m14.087s); 13 Latifi (Q16-2m13.551s); 14 Sekiguchi (Q18-2m13.833s); 15 Giovinazzi (Q20-2m14.018s); 16 Wolf (Q19-2m13.938s); 17 Gelael (Q24-2m14.657s); 18 Nakayama (Q21-2m14.308s); 19 Chiyo (Q27-2m15.253s); 20 Bryant-Meisner (Q23-2m14.570s); 21 Sun (Q28-2m18.912); 22 Mason (Q25-2m14.706s); 23 Korjus (Q13-2m13.053s); R Auer (Q4-2m12.052s); R Jones (Q26-2m14.975s); R Blomqvist (Q6-2m12.111s); R van de Laar (Q22-2m14.310s); R Tincknell (Q9-2m12.409s).

FL: Rosenqvist, 2m12.312s, 103.46mph.



# Chosen-one Lynn lights up the streets

Briton Alex Lynn felt it was his time to win the biggest junior single-seater race of the year and he duly made the most of the calling. **MARCUS SIMMONS** was there

"YOU DON'T WIN THIS RACE – MACAU CHOOSES you." Alex Lynn was in profound form after his victory in the qualifying race for the Macau Grand Prix on Saturday afternoon, and it was a statement that does ring true in some ways. Yet this didn't take into account the fact that, when you *are* the one chosen by Macau, you have to make the most of it.

Lynn grabbed his opportunity with both hands, putting in an inch-perfect performance to take the honours in the most important race in junior motorsport. This was a magnificent win and came after four days of intense competition among an incredibly evenly matched leading quartet of Lynn, 2012 winner Antonio Felix da Costa, Raffaele Marciello and Felix Rosenqvist.

If you looked closely enough the signs were there in second qualifying on Friday afternoon. Lynn had become stranded on his own on-track while Marciello and Rosenqvist were together. Yet he unleashed an incredible lap – the very last driver to cross the line after the chequered flag – that left him just 0.084 seconds adrift of pole.

What was remarkable about it was that, circulating with only his own company, he did not enjoy the benefit of a tow such as Marciello and Rosenqvist had. Factoring this in, the lap would have given him a second Macau pole by 0.3s.

He was on the limit and admitted to hitting the wall "about three times" during the session...

Luckily, it wasn't as serious as the single time he'd hit the wall in Thursday qualifying, when he creamed his Prema Powerteam Dallara-Mercedes into the barriers at Fisherman's Bend. It's a measure of his self-assuredness that, having topped free practice in the morning, he was

unfazed and knew that he had a car that could put him right in the hunt the following day.

He might not have gained a slipstream in qualifying, but that's exactly what he did get at the start of the preliminary race. A good getaway enabled him to draft bravely around the outside of Rosenqvist at the Mandarin Oriental kink, the car squirming underneath him and Lynn later thankful to Rosenqvist for giving him room. But the Swede had enough time to redraft Lynn and, under braking for Lisboa, clearly had the edge.

This, arguably, was the most crucial point of Lynn's weekend. Instead of braving it out with Rosenqvist and putting himself on a flatbed truck for an ignominious ride back to the paddock, he put everything into checking up. "I braked quite late and ran a bit wide," he said. "I had to really get on the brakes otherwise I was going to hit the barriers. I'd already decided to concede the lead, but now it was all about surviving."

With Lynn slightly unsettled by this, Rosenqvist stormed into an early advantage, but this was eliminated thanks to the safety car. When the race restarted, the Mucke Motorsport Dallara-Merc was a sitting duck as Lynn pulled to the outside on the approach to Lisboa and completed the move perfectly.

Now we saw the pace that Lynn's qualifying speed had suggested. Within four laps he'd pulled out 2.1s on Rosenqvist, and from then on it was a case of keeping it clean.

Behind the leading duo, Marciello pulled off a great move into Lisboa to pass da Costa for third on the fifth lap. The Italian had put in a great pole lap, which seemingly came from nowhere as he had not pushed at all up to that point, but a



Lynn has won the biggest race on the F3 calendar

sluggish start dropped him to fifth.

Da Costa was well in the mix in the Carlin Dallara-Volkswagen originally earmarked for Daniil Kvyat, and was highly impressed with Marciello's pass. "I have to give him a lot of credit – he really sent it in there," said the Portuguese.

Now Marciello closed on Rosenqvist, who felt that his grip had gone away under the safety car and that perhaps he hadn't worked his tyres hard enough. But as the race entered its closing stages Rosenqvist pulled away, setting the fastest lap.

So Rosenqvist entered Sunday still in with a very good chance of a win that would at least partially have redeemed his narrow defeat to Marciello in the European F3 Championship. But Sunday was when it all got a little bit messy...

Pipo Derani got a monster start from fifth on the grid and drew alongside Rosenqvist and Marciello into Mandarin Oriental, while Lynn out front was wondering who'd be the first to draft him into Lisboa and give him extra work to do.

Derani jinked to the outside, and Rosenqvist found himself in the middle with no room. Marciello had nowhere to go, light contact was made and Rosenqvist was out of the race with suspension failure. Marciello sustained slight damage too, causing oversteer to his Prema car.

The incident enabled the incredulous Lynn to get to Lisboa in front. "I was looking in my mirrors and it looked like a massive mess," he said. "That gave me enough going into Lisboa."

Again there was an early safety car, and even here Lynn got some breathing space as Derani was preoccupied with defending – and losing – second place to da Costa on the run to Lisboa. It was a perfect illustration of Lynn's 'Macau



chooses you' prophecy.

Da Costa had looked strong all week, and was the only one of the four main contenders to keep it out of the barriers throughout the event. But he didn't have enough for Lynn. Then, suddenly, with four laps to go he halved the gap to 1.3s.

Marciello may have been struggling with oversteer, but it looked very much as if he understeered into the tyres at R Bend, and then shot across the track to hit the barriers on the inside. Three laps after passing Derani, he was out of the race, and the yellow flags for his crash caused Lynn to back off considerably...

Da Costa was now almost within towing range, and Lynn's engineer Jean-Francois Levere advised him to change his approach: "He told me, 'OK, you have to take more risk.' I pushed like crazy and then it was a case of counting down the laps."

It was a great win in a fantastic race, and da Costa – a classy and elegant man who showed no signs of his recent Toro Rosso F1 disappointment – acknowledged: "At least we made him sweat for it, but he drove a magnificent race. The goal was to win or at least put up a good fight, and that's what I did so I have to be happy with the result."

Derani, who is planning a move to the States to race in Pro Mazda next season, put in the best performance of his F3 career to retake third once Marciello had crashed. The Brazilian's Fortec Dallara-Merc was very much in the eyesight of Alexander Sims, who'd also been in the mix when the pack jostled down to Lisboa and had to be brusque with his defence from Will Buller.

Sims reckoned he could have brought the T-Sport Dallara-Nissan to third place. "We had plenty but on about lap 10 I had a warning that the engine temperature was too high," he said. "So I had to pull out of his slipstream and start short-shifting. Then when it suddenly dropped from 95 to 40 we figured it was a sensor problem. Without that I could have had a podium."

Not too far behind him was Jordan King, who shrugged off crashes in each of the two free-practice sessions to take the trophy as the best rookie. He was initially behind a frantic scrap between Buller, Carlos Sainz Jr and Stefano Coletti. This came to a rather messy end on the seventh lap, when Sainz got into the slipstream but found himself on the dirty line on the inside of Lisboa. Even though he braked early, the sheepish Spaniard speared into Coletti, who in turn forced Buller down the escape road.

Sainz got off most lightly, and recovered to seventh – with a damaged front wing – on a weekend when the Carlin man proved he had at least podium pace, but lost touch with the main contenders thanks to a rare electrical problem in

the crucial second qualifying session.

King was freed and up to fifth, and impressed everybody by closing on Sims in his Carlin machine and – on the final lap of the race – setting the fastest lap of the entire week.

Another Carlin driver, Jazeman Jaafar, climbed to sixth. He was also further down the grid than expected, copping a five-place penalty for improving his best middle sector time in qualifying under yellow flags. The Malaysian said he was on new tyres and backed off for the flags, but not enough to prevent an improvement.

Behind Sainz, Tom Blomqvist made it a sons-of-world-rally-champions seven/eight by putting in a superb drive from 24th on the grid to finish eighth. On his return to the Fortec team with which he won the 2010 Formula Renault UK title, he looked absolutely in the hunt in qualifying, and was sitting on pole before the session was restarted after its third red flag.

Traffic torpedoed his hopes and he dropped to sixth, which at least made his stalling at the start of the qualifying race slightly less public. Having driven for EuroInternational all season, Blomqvist was caught out by the different handbrake procedure developed by Fortec, "and as soon as I got going I got a massive thump from behind". That was Harry Tincknell, who had looked strong in first qualifying but failed to get a tow the next day. Both men were out on the spot, causing the safety car and putting themselves towards the back of the grid for the grand prix. Tincknell recovered to 14th, then proved what a nice chap he is by helping the Carlin boys pack up.

Another likely contender in a similar situation was Lucas Auer, who ran third in the qualify race but got drafted by Marciello and da Costa at the restart, then hit the wall at San Francisco Bend while defending from Derani. In the GP itself, he slammed into the back of Sean Gelael at Mandarin Oriental when the Indonesian braked to avoid the crashing John Bryant-Meisner, this causing the safety car.

Canadian Nicholas Latifi did a solid job to take ninth and finish as second best Macau rookie – and make it five Carlin drivers in the top nine. He may have struggled to hold off Esteban Ocon had the race been a lap or two longer. The Lotus protege was a star of the event on his debut in a current F3 car, and then stalled at the start of the final. He was 23rd at the end of the opening lap and did a fantastic job to climb to 10th.

Ocon was run by Prema, and all the indications are that he will be sticking with the team in 2014 for European F3. He is a champion for the future, but Prema's champion for today is Lynn, a magnificent Macau winner. ▶

# Great products aid race winners!



## Driven Racing Oil XP9

Driven Racing Oil has a huge range of race oils from SAE0W up to SAE15W-50 weight to cover any serious racer's needs. The race oils in the XP range have more than 4 times the amount of anti-wear additives than API rated modern oils and are boosted with friction reducing additives to enhance power. Thanks to the latest base oil mPAO synthetic technology they are extremely temperature stable meaning that you can run thinner oils compared to standard "race oils".

## Anglo American Oil Company

Distributor of:



**RACE FUELS**

BORN FROM JOE GIBBS RACING

**DRIVEN**  
DRIVEN TO WIN RACING OIL



+44 (0)1929 551557

info@aaoil.co.uk



## TJ Ripper fuel jug

The TJ Ripper fuel transfer jugs are sturdy and designed for easy, spill and vapour free filling of fuel tanks. A clever dry-break nozzle means that no fuel comes out until the nozzle is compressed.

The TJ Ripper jugs are available in white, red, blue and orange and in 10 and 20 litre sizes. A square design reduces space in transport. There are different adaptors available to ensure that the TJ Ripper jugs can be used in a variety of tank designs.

[www.aaoil.co.uk](http://www.aaoil.co.uk)



## IN THE PADDOCK

## Marcus Simmons



EVERYTHING IN THE GARDEN OF TOP-CLASS Formula 3 looks rosy at the moment, but if it is to remain so then steps must be taken immediately from the top level.

The absorption of the remaining British F3 'stragglers' into the FIA's F3 European Championship for 2013 provided us with a fantastic series and, subsequently, a great Macau Grand Prix. Grids of up to 30 cars have been the norm, and the quality has been high.

But all series in motorsport go through booms and slumps. And the worry is that when this happens in Euro F3 it could prove critical for the category worldwide.

We understand that it costs Dallara around £1.7million to do the research and development, and tooling, into designing and constructing a new F3 model, and that the cars cost £84,000.



If European F3 dropped to, let's say, 18 cars, and top-class Japanese F3 retained its current level of seven, then that means F3 is pretty much no longer a cost-effective project for Dallara. It could stop building them, or push the prices up.

What the FIA must do is to make sure every encouragement is given to national or regional F3 championships, so that even if European F3 grids fell, the category overall would be immune. FIA president Jean Todt was in Macau, and we must hope that he has listened to voices within the category.

Such a measure would, of course, ensure the continued success of the Macau Grand Prix. After all, if European F3 grids fall, where is a full entry of 30 (as it will return to next year) going to come from?



## KING WANTS CARLIN STAY

Top Macau Grand Prix rookie Jordan King hopes to remain with Carlin for a second season in the F3 European Championship. The British F3 champion confirmed to AUTOSPORT that he hopes to sort the deal soon. Team boss Trevor Carlin said: "I'd love for him to stay. We've just got to sort the budget and stuff, but the will is strong from both sides. He's quick and he's only going to get better."

## JONES AIMING FOR FORTEC SEAT

European F3 Open champion Ed Jones hopes to remain with Fortec Motorsport and step up to the F3 European Championship in 2014. The Anglo-Emirati contested F3 Open with Team West-Tec, but combined it with a parallel programme in the Formula Renault Eurocup with Fortec, for which he has driven since the start of his career in cars.

## Anger at pitlane arrangement

## BRITISH TEAMS T-SPORT AND DOUBLE R

Racing were left fuming over the Macau GP qualifying procedure, which they respectively claimed cost Alexander Sims and Kevin Korjus good grid positions.

Three red flags in the quicker Friday session allowed for very few flying laps, and the two teams were further disadvantaged by being stationed towards the end of the pitlane.



Macau procedure puts cars in numerical order in the pits, with the previous year's winning team taking #1, followed by the various champions from the current year and so on.

But the increase in size of F3's 'superteams' means that the rest have been forced ever further down the pitlane – Carlin and Prema took the first 10 slots between them.

Double R boss Anthony 'Boyo' Hieatt said: "It's a clusterfuck. The organisers have got to sort something out. Kevin didn't come past the finish line to log a flying lap until four minutes to go."

T-Sport chief Russell Eacott added: "It's OK for Carlin and Prema, but if you're not in the top 10 you're knackered. Multi-car teams should be split up."

Macau race co-ordinator Barry Bland said: "We're probably changing the system, although nothing has been approved, and you can't please everybody."

Bland hinted that this could be by flipping the order in the pitlane so that the top teams are at the first stalls – as in Formula 1 – or by lottery.

## Carlin angry over Merc ratios

## TOP TEAM BOSS TREVOR CARLIN HAS

described a FIA dispensation that allows Mercedes-powered car to run gearboxes with a longer top-gear ratio at the Macau as "bullshit!"

Carlin, whose team is the top Volkswagen squad in F3, joined many in the paddock who were angry that Mercedes was allowed the ratio.

F3 rules allow a fixed number of ratios in the gearbox for a season, but Mercedes was given its break for Macau in the summer.

"It [the decision] is illegal, but someone pulled some strings to allow it in," said Carlin. "Why not allow them an extra 2mm on the airbox as well?"

"It's not the difference between winning and losing, but it has helped them, otherwise they wouldn't have



pushed for it. They've gained an unfair advantage because someone thought it was all right. If I'd asked for a specific ratio they'd have told me where to go!"

## THEODORE NAME TO CONTINUE?

Theodore Racing boss Teddy Yip Jr hopes to continue backing cars in the Macau Grand Prix after Alex Lynn won in the team's colours on its return for the first time in 21 years. Yip's father Teddy Sr was synonymous with the Macau GP and won the event six times, most famously with Ayrton Senna in 1983. Yip Jr is also the principal of GP3/sportscar squad Status Grand Prix.

## KORJUS HOPES EXTINGUISHED

GP3 ace Kevin Korjus was out of luck in Macau after showing strong pace on his return with Double R Racing. The Estonian topped the second free practice session, but retired from the qualifying race with engine failure with a lap to go. His fire extinguisher went off in the GP itself, causing him to retire with visibility problems.

## MASTERS DATE CONFIRMED

The Masters of F3 will be held at Zandvoort on July 6 next season, race coordinator Barry Bland confirmed to AUTOSPORT in Macau. Bland was also working on a Middle East event in the new year comprising two or three days of testing and a double-header race, enabling teams to blood new drivers and the new engines, but said that an "obstruction was put in the way".

## OCON'S NEAR MISS

Lotus protege Esteban Ocon might have earned his spurs in the Macau Grand Prix, but that did not impress the bouncer at the bar where all the teams and drivers congregated on Sunday night. He was barred entry, causing GT winner Edoardo Mortara to intervene to allow the Frenchman, 17, access!



## WTCC Macau (PRC) November 17



Round 12/12

### RESULTS

RACE 1: 9 LAPS, 34.23 MILES

<b>1</b>	<b>YVAN MULLER (F)</b>	<b>22m54.522s</b>
	RML Chevrolet Cruze 1.6 T; Grid: 1st-2m28.933s	
<b>2</b>	<b>TIAGO MONTEIRO (P)</b>	<b>+1.265s</b>
	Honda (JAS) Honda Civic WTCC; Grid: 2nd-2m29.933s	
<b>3</b>	<b>ROB HUFF (GB)</b>	<b>+1.592s</b>
	Munnich Motorsport SEAT Leon WTCC; Grid: 4th-2m30.107s	
<b>4</b>	<b>NORBERT MICHELISZ (H)</b>	<b>+5.147s</b>
	Zengo Motorsport Honda Civic WTCC; Grid: 5th-2m30.224s	
<b>5</b>	<b>ALEX MACDOWALL (GB)</b>	<b>+7.096s</b>
	Bamboo-Engineering Chevrolet Cruze 1.6 T; Grid: 6th-2m30.248s	
<b>6</b>	<b>JAMES NASH (GB)</b>	<b>+7.632s</b>
	Bamboo-Engineering Chevrolet Cruze 1.6 T; Grid: 8th-2m30.723s	
<b>7</b>	<b>MARC BASSENG (D)</b>	<b>+18.148s</b>
	Munnich Motorsport SEAT Leon WTCC; Grid: 11th-2m31.482s	
<b>8</b>	<b>STEFANO DASTE (I)</b>	<b>+20.644s</b>
	PB Racing BMW 320 TC; Grid: 15th-2m32.666s	
<b>9</b>	<b>TOM BOARDMAN (GB)</b>	<b>+21.213s</b>
	Special Tuning Racing SEAT Leon WTCC; Grid: 12th-2m34.989s	
<b>10</b>	<b>TOM CORONEL (NL)</b>	<b>+21.806s</b>
	ROAL Motorsport BMW 320 TC; Grid: 10th-21m31.287s	

Winner's average speed: 89.64mph. Fastest lap: Muller, 2m31.573s, 90.32mph.

RACE 2: 11 LAPS, 41.83 MILES

<b>1</b>	<b>HUFF</b>	<b>1h23m32.152s</b>
	SEAT; Grid: 7th	
<b>2</b>	<b>PEPE ORIOLA (E)</b>	<b>+0.732s</b>
	Tuenti Racing Chevrolet Cruze 1.6 T; Grid: 12th-2m31.800s	
<b>3</b>	<b>CORONEL</b>	<b>+1.173s</b>
	BMW; Grid: 1st	
<b>4</b>	<b>NASH</b>	<b>+2.909s</b>
	Chevrolet; Grid: 3rd	
<b>5</b>	<b>MACDOWALL</b>	<b>+3.428s</b>
	Chevrolet; Grid: 5th	
<b>6</b>	<b>MULLER</b>	<b>+4.642s</b>
	Chevrolet; Grid: 9th	
<b>7</b>	<b>BASSENG</b>	<b>+5.665s</b>
	SEAT; Grid: 10th	
<b>8</b>	<b>GABRIELE TARQUINI (I)</b>	<b>+30.963s</b>
	Honda (JAS) Honda Civic WTCC ; Grid: 33rd*-2m29.991s	
<b>9</b>	<b>HENRY HO (MAC)</b>	<b>+47.079s</b>
	Team Engstler BMW 320si; Grid: 22nd-2m37.142s	
<b>10</b>	<b>CELIO ALVES DIAS (MAC)</b>	<b>+48.255s</b>
	China Dragon Racing Chevrolet Lacetti; Grid: 30th-2m42.959s	

Winner's average speed: 30.04mph. Fastest lap: Muller, 2m31.437s, 90.40mph.  
\*—engine change grid penalty

### CHAMPIONSHIP

<b>1</b>	<b>MULLER</b>	<b>431</b>	<b>6</b>	<b>MICHELISZ</b>	<b>185</b>
<b>2</b>	<b>TARQUINI</b>	<b>242</b>	<b>7</b>	<b>NYKJAER</b>	<b>180</b>
<b>3</b>	<b>NASH</b>	<b>226</b>	<b>8</b>	<b>MONTEIRO</b>	<b>164</b>
<b>4</b>	<b>HUFF</b>	<b>215</b>	<b>9</b>	<b>ORIOLA</b>	<b>164</b>
<b>5</b>	<b>CHILTON</b>	<b>213</b>	<b>10</b>	<b>CORONEL</b>	<b>163</b>

### YOKOHAMA TROPHY

<b>1</b>	<b>NASH</b>	<b>208</b>	<b>4</b>	<b>BENNANI</b>	<b>102</b>
<b>2</b>	<b>MACDOWALL</b>	<b>168</b>	<b>5</b>	<b>D'ASTE</b>	<b>96</b>
<b>3</b>	<b>NYKJAER</b>	<b>134</b>	<b>6</b>	<b>O'YOUNG</b>	<b>66</b>

### POINTS SYSTEM EXPLAINED

In each race: 25-18-15-12-10-8-6-4-2-1 to top 10 finishers. 5-4-3-2-1 to top 5 qualifiers.



Chilton had a bad weekend

XPB/LAT



Huff signed off with victory

## Huff stays tough as the racing gets rough

**MAYHEM IN MACAU, SOME POSTERS READ;** *The Clash in Cotai*, others. They were referring to Manny Pacquiao's forthcoming welterweight boxing fight, but the World Touring Car Championship's visit fitted the billing just as well.

Race one was the sparring contest: clinical, professional and with little collateral damage. Race two was the darker side, lurching on the ropes, staggering punch-drunk from one chaotic melee to another. "This is just Macau" was one take; "a shit storm," was a second.

Through the chaos it was Yvan Muller and Rob Huff who shared the wins, in many ways a fitting roster for the final race of the old order, the farewell party before the WTCC ushers in its sweeping regulation changes for 2014.

Muller took first blood, ending Huff's four-year run of poles by over a second. Despite his switch to a less competitive SEAT, Huff was still fourth, outdone only by the champion and Honda's works duo of Tiago Monteiro and Gabriele Tarquini.

Given Muller's dominance it was clear that the first run down to Lisboa would be crucial to any bid to deny him. His hand was therefore strengthened when an engine fault was discovered on Tarquini's Civic and he was forced to change it, meaning the Italian missed the start of the Macau opener.

Muller had only to defend from Monteiro through Mandarin, which he did with typical style. From there victory was effectively assured: the RML Chevrolet man pulled a gap of 1.7 s by the end of the first lap, extended that further and had enough of a cushion to cruise in the final laps.

Monteiro held off Huff to clinch second, while Zengo Honda's Norbert Michelisz defended well from Bamboo Chevy pair Alex MacDowall and James Nash to claim fourth. Tom Chilton had been involved in the fight, but after being passed by Nash — his rival for third in the points — he was nerfed into a wall and out of the race by Pepe Oriola, a move earning the Spaniard a 30s penalty.

Marc Basseng was next up for the Munnich squad, while Oriola's penalty moved Stefano D'Aste, Tom Boardman and Tom Coronel up.

ROAL BMW driver Coronel then led for much of the second race, a far messier affair dominated by two wild crashes, numerous wrecks and a similar number of stewards' investigations.

The chaos began at the first turn. From sixth on

the grid, Michelisz tagged Chilton at Turn 1, broke the front right corner of his car and speared into the wall, bouncing back into the pack and triggering a chaotic sequence that accounted for Michelisz, Boardman, Mehdi Bennani, Konstantins Calko, Hugo Valente, Mikhail Kozlovskiy and Darryl O'Young.

After a lengthy stoppage the grid was reset and the race restarted under the safety car. Coronel once again held the advantage ahead of Lada's James Thompson, Chilton, Nash, Huff and MacDowall. Behind that quintet, Monteiro and Muller clashed through San Francisco: the Frenchman squeezed into the wall but continuing, while Monteiro suffered race-ending damage.

The race settled into something resembling calm until lap five, when Chilton slowed suddenly with exhaust damage. Crawling around Maternity he was hit by Eurico De Jesus, whose stricken Accord ended up sideways across the track.

With little advanced warning the front pack did well to slow down when they came across the scene, but those behind exercised less caution. Filipe de Souza, Jo Merszei and Michael Soong all arrived too quickly and ploughed into the bottleneck in front, causing general chaos.

The reds flew and another long stoppage followed. At the final restart Coronel again led, but Huff picked off Thompson and then the Dutchman to claim a lead he would not relinquish. He has now triumphed six times on the streets of Macau.

There was still more drama when Oriola slammed into Thompson — in the same place he hit Chilton — before nailing Coronel through Mandarin to seal second. This time he escaped major censure. Nash, MacDowall and Muller were next while Tarquini, who started in the pits, took a drive-through penalty and still came home ninth.



Coronel led race two

XPB/LAT



## IN THE PADDOCK

## Sam Tremayne

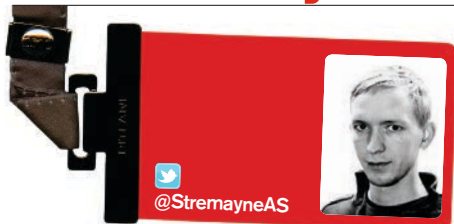

SOMEWHERE BETWEEN LAPS ONE AND FIVE of its Macau finale, the WTCC crossed the line between unavoidable and unacceptable.

When you throw 33 cars at a narrow street circuit, you're bound to suffer damage. To that extent, the pile-up at Turn 1 was essentially one of those things: shocking and extremely damaging yes, but preventable? Not really.

The second melee was a different category. As soon as Eurico de Jesus hit Tom Chilton, the roadblock he formed was a clear danger. Yellows waved, but even slowing down to 50mph (about the speed they hit, quite literally, the scene) was no way near enough.

So where does the blame lie? Some pointed the finger at invitational drivers, in terms of both a swelling of the WTCC grid (this year's Macau finale featured the second largest entry in series history) and a weakening of driving standards.

And while Filipe de Souza for one certainly needed to exercise more caution – he flew into the bottleneck and almost became airborne when he collided with Yvan Muller – it was also true that those down the order had increasingly less time and space to take avoiding measures.

That latter dynamic suggests the marshals and race control needed to do more. As good as Macau is at removing vehicles rapidly, one waved yellow 50 yards before the crash was simply not an adequate warning about what lay ahead.



Locals did not show well

## BIG NUMBER

18

Retires in race two, a WTCC record. Only 15 cars finished, while Fredy Barth didn't even start after a heavy qualifying crash.



## Brits rule the roost on city streets

## ROB HUFF AND JAMES NASH BROKE NEW

ground in the WTCC, with the former taking a record sixth win on the streets of Macau and the latter becoming the first Independent to break into the championship top three.

Both men achieved their respective feats amid the mayhem of the second race. Huff fought through from seventh on the grid to sit third at the final restart, and then picked off James Thompson and Tom Coronel in successive runs down to Lisboa to move into a lead he would not surrender. He also finished third in the opening race, meaning his final weekend for the Munnich SEAT squad was also his most successful.

"I don't think I came here thinking a win was realistic, but at the same time anything is possible in Macau," said Huff, who claimed his 2012 world title on the same streets. "I'm just so happy with the results. The team kind of saved me really this year, so this was for them."

Nash meanwhile stole ahead of Chilton away from the start of race one, and then likewise moved ahead in the championship – by just one point – when he finished sixth and Chilton retired with damage.

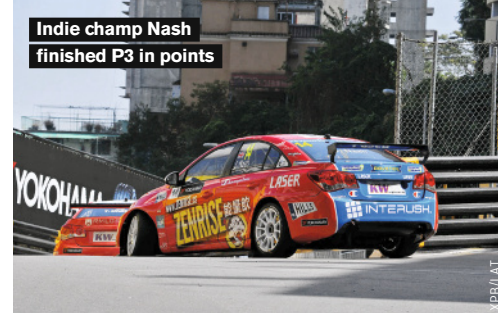

Indie champ Nash finished P3 in points

The pair were locked together again in race two, only for Chilton to fade with exhaust damage. Nash finished fourth and thereby sealed third in the championship, the highest points position achieved by a concurrent Yokohama Trophy champion.

"It was a nerve-racking weekend, but I'm pleased that I achieved what I set out to do," Nash said. "To be the first independent to finish in the top three is great"

## Muller bids farewell to RML

## YVAN MULLER ADMITTED HE WAS FIGHTING

his emotions and had a lump in his throat heading into the Macau finale, his final race with the crack RML squad before he formally switches to Citroen for next year.

The Frenchman has claimed 27 wins, 61 podiums and three world crowns during his four-year spell with RML – three of those being as Chevrolet's works team. He admitted his comprehensive race-one win was the perfect foil to an emotional farewell weekend.

"The target was to leave with a win," he told AUTOSPORT. "But even with that I was fighting my emotions going into race two. I took my time getting round to the grid because I had a lump in my throat."

"I'm very pleased to have worked in a team like this, and with guys like this: they're fantastic. For me it's been a great season too, and a great atmosphere. Unfortunately we couldn't bring the car home in one piece in race two [Muller finished sixth but suffered damage in the second melee, but otherwise it's been a great way to celebrate my last weekend with this crew.]"

## MULLER'S RML CAREER IN THE WTCC

Year	Wins	Poles	Fastest laps	Position
2010	3	2	1	1st
2011	8	4	8	1st
2012	9	0	8	3rd
2013	7	7	7	1st



Muller collects an RML memento

## CORONEL: STOPPAGES COST WIN

Tom Coronel believes race's two stoppages cost him a potential WTCC win in Macau. "I was ahead and in control," he told AUTOSPORT. "But the second red flag eradicated my advantage, and then you don't have to be a genius to see I was passed twice on the straight – there was nothing I could do. Still it was a good race and it's good to at least go home with a trophy."

## ENGSTLER: 25 AND OUT?

Franz Engstler admits he still does not know whether he will be on the WTCC grid next year, or whether his 25th Macau appearance will be his last. "It was a wild way to celebrate 25, very crazy," said the Team Engstler owner/driver and one-time WTCC race winner. "And maybe it is my last. It's still very complicated for 2014 – we have the sponsors and the desire, but we need to do it with a German marque and we are getting no help from BMW."

## BOARDMAN'S BREAKTHROUGH

Tom Boardman said breaking into the pole-position shootout for the first time in Macau was a "massive" breakthrough for his Special Tuning squad. The Briton claimed the final spot in Q2 at the expense of Pepe Oriola – just 0.045s split the pair – and went on to finish ninth in the opening race, matching his best result of the season. He was then a helpless victim of the Turn 1 accident in the second race.

## CAMPOS CHAOS

While nearly every team suffered damage over the weekend, Campos Racing was hit particularly hard. Hugo Valente and Konstantins Calko were both caught up in the first melee of race two, having crashed of their own volition in race one. Valente and Michael Soong also suffered heavy damage in qualifying, while Soong and Calko had a further three shunts in testing and practice.

## LADA MISSES BEST RESULT

James Thompson said he was "devastated" to lose out on what could have been Lada's best result in WTCC history when Pepe Oriola nudged him into the wall at the left-hander before Maternity in race two. "Once we had the second restart I knew it would be difficult, and I had to let Rob Huff and James Nash go. I was still happy, but Oriola's move was just nonsense: you can't pass there. If you try and do it, someone will end up in the wall."

# Sandwell

shot peening & specialist metal coatings

## Good design sometimes needs a little help...

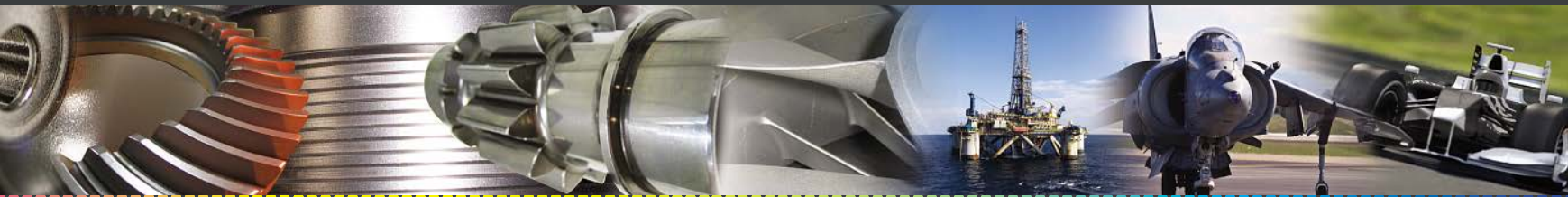

...that's why global race teams use Sandwell as a prime supplier of performance engineering solutions.

- Controlled Shot Peening
- Superfinishing
- Low Friction Coatings
- Kephos Coatings

Sandwell works with design and development engineers throughout the world of manufacturing to improve component performance.

- Improve component fatigue life
- Increase component strength
- Improve reliability
- Reduce component weight
- Reduce surface friction
- Apply corrosion resistant coatings

NASCAR SPRINT CUP HOMESTEAD (USA), NOVEMBER 3 RD 36/36

# Johnson takes sixth title

Six of the best for  
Johnson and his crew



## NASCAR TRUCKS

Matt Crafton claimed the title just by starting at Homestead, and therefore guaranteeing himself the minimum number of points available for a last-place finish. The ThorSport Toyota driver finished 21st after being caught up in a multi-truck crash at the first attempt of a green-white-checkered finish. Kyle Busch won to give his #51 Toyota the owners' title with Ryan Blaney (Kesowski Ford) second.

## AUSTRALIAN F3

Tim Macrow won at Sandown on his 100th start in the series and with it took his second title – his first since 2007. The Team BRM Dallara-Mercedes driver had finished second in races one and two, behind title rival and team-mate John Magro. Simon Hodge took a pair of third places with Mygale-mounted Nick Foster the other.

## BRAZILIAN TOURING CARS

Felipe Gama won both races at Cascavel in his Full Time Racing Toyota Corolla, the second with a 22-lap climb from eighth on the reversed grid to the front. Ricardo Mauricio retired with faulty electrics in race one and finished seventh in race two to see his points lead cut to 17 by Ricardo Zonta, with 50 still on offer.

## NZ V8 TOURING CARS

Jason Bargwanna – now with the Richards Toyota squad – kicked off his title defence with two wins and a second at Pukekohe. The long-time Holden driver defeated Tony Ross's similar Camry in races one and three, but lost victory in the second to a sensational final-lap pass by his rival.

## SUD-AM F3

A win – his 15th in the series this year – and a second place at the fast Cascavel circuit netted British F3 race winner Felipe Guimaraes the title for the Hitech team. Leonardo de Souza, second to Guimaraes in the opener, won the reversed-grid second encounter.

## NASCAR NATIONWIDE

Austin Dillon became the first man to take the title without winning a race, thanks to a 12th-placed finish at Homestead. The Richard Childress Chevy driver beat his Joe Gibbs Toyota rival Sam Hornish by three points, the latter finishing eighth. Brad Keselowski (Penske Ford) won.



**JIMMIE JOHNSON TOOK ANOTHER STEP** towards NASCAR immortality when he claimed his sixth Cup title at Homestead last weekend.

Needing only to finish 23rd in the season finale, Johnson ended up crossing the line in ninth place, but getting there was not without its challenges, the biggest of which arrived on lap 193 of 267.

Running comfortably in the top 10 all afternoon, the Hendrick Motorsports driver pitted for fresh rubber during the sixth caution period and resumed in eighth when a stack-up at the following restart threatened to derail his championship aspirations.

Stuck in a pack and with no where to go, Johnson banged into title-rival Matt Kenseth and came off worst, suffering damage to his Chevrolet's left-front fender and dropping back to 23rd as a consequence.

A further caution period allowed his team to analyse the damage, which was mostly superficial, and Johnson went back to full-on charge mode as if nothing had occurred.

What happened next, however, was a fine recovery drive during which he filtered his way through the field and ended the day 19 points ahead of Kenseth – who finished second to Joe Gibbs Toyota team-mate Denny Hamlin. In doing so, Johnson traded in the nickname "Five-Time" for "Six-Pack" instead. Kenseth needed a miracle to

outscore Johnson, but it was not for want of trying as the 2003 champion put in a dominant performance and led a race-high 144 laps.

The polesitter managed to retain command through the majority of the first half of the race – thwarting attempts at dethroning him from the likes of Kyle Busch and Dale Earnhardt Jr – before Hamlin took the metaphorical baton and controlled the second portion.

His eventual victory came at the end of a troublesome season for the 32-year-old American – after being sidelined for a month with a fractured vertebra following a collision at Fontana in May – who was able to extend his streak of winning in eight consecutive years.

Earnhardt claimed third, ahead of Martin Truex Jr in what was his last outing for Michael Waltrip Racing,

both of whom ran conservative races at the south Florida venue.

The final race of the season also marked the departure of Mark Martin who, after 31 years and 763 starts, bowed out with a 19th place finish, behind IndyCar-bound Juan Pablo Montoya who had made his debut at Homestead seven years ago.

● Connell Sanders Jr

## RESULTS

**1 Denny Hamlin (Toyota Camry)**, 267 laps in 3h03m52s; **2 Matt Kenseth (Toyota)**, +0.799s; **3 Dale Earnhardt Jr (Chevrolet SS)**; **4 Martin Truex Jr (Toyota)**; **5 Clint Bowyer (Toyota)**; **6 Brad Keselowski (Ford Fusion)**; **7 Kyle Busch (Toyota)**; **8 Joey Logano (Ford)**; **9 Jimmie Johnson (Chevy)**; **10 Kevin Harvick (Chevy)**. **Points** 1 Johnson, 2419; 2 Kenseth, 2400; 3 Harvick, 2385; 4 Kyle Busch, 2364; 5 Earnhardt, 2363; 6 Jeff Gordon, 2337; 7 Bowyer, 2336; 8 Logano, 2323; 9 Greg Biffle (Ford), 2321; 10 Kurt Busch (Chevy), 2309.

Hamlin (l) beat title-contending team-mate Kenseth (r) to victory



# CONGRATULATIONS SAM BIRD

**GP2 SERIES VICE-CHAMPION  
TEAMS CHAMPION WITH RUSSIAN TIME**



Photo by Malcolm Griffiths - GP2 Media

**The dictionary is the only place where  
success comes before work.**

**5 Wins, 2 Pole Positions, 3 Fastest Laps, with a brand new team.  
Winner of the Pirelli Award for Best Tyre Management.**

Thank you to all that have provided their invaluable support this year, including **MERCEDESAMG PETRONAS** Formula One Team, **RUSSIAN TIME**, Pro Performance, Toby Colliver, Bell Helmets, Puma, Onlineability, JST Nutrition, Mike Hayton and Sam's loving fans all over the world.

Thank you to those that have helped us get to this point, including **BP UK**, Noble Group, Richard Meins, Celebfilms.co.uk and the BRDC.

**Talent always prevails. Let's keep pushing.**

[info@cjmotorsport.co.uk](mailto:info@cjmotorsport.co.uk)



Larini (01) could do nothing about Huisman

SCIROCCO R CHINA MASTERS CHALLENGE MACAU (PRC), NOVEMBER 18-19

## Huisman becomes a Macau Master

DUNCAN HUISMAN PICKED UP A FIFTH victory in Macau with a comfortable win in the Volkswagen Scirocco R China Masters.

The Dutchman, a four-time winner of the Guia race, overtook poleman Alain Menu off the line and safely navigated a safety-car period and subsequent restart to lead every lap en route to a 1.5-second victory over ex-Formula 1 racer Nicola Larini. Mike Conway finished third.

"I knew the start was key because only myself and Larini were flat

through Mandarin," Huisman said. "I made nine practice starts. It paid off.

"This was also unfinished business. I had to give eighth to Andy Priaulx while racing in the WTCC in 2007, which would have given me reversed-grid pole. It was great to have this chance to put that to rest."

The safety car was triggered at the start as Steve Soper and Stefan Johansson tripped over each other metres after the line, spearing into the wall and early retirement as a result. The pair had also collided in

qualifying. Soper, to his amusement and Johansson's mock consternation, picked up the best crash award.

Menu also exited on the first lap; after his poor start he fell to fourth, and was attempting to fight back when five-time Le Mans winner Emanuele Pirro went off at Moorish. Menu was too close to avoid contact, and both men were eliminated.

Thomas Fjordbach had worked his way up to fourth when the safety car came out, but quickly lost ground to Tim Harvey and Conway once the

race restarted.

IndyCar racer Conway then attacked Harvey and eventually stole through at Turn 1 two laps from the end, but ran out of time to close on Larini and Huisman.

● Sam Tremayne

### RESULTS

1 Duncan Huisman, 8 laps in 26m46.766s; 2 Nicola Larini, +1.500s; 3 Mike Conway; 4 Tim Harvey; 5 David Brabham; 6 Thomas Fjordbach; 7 Andrea Reggiani; 8 Ni Amorim; 9 Julian Bailey; 10 Keisuke Kunimoto.



Mortara benefitted from Engel's woes

MACAU GT CUP MACAU (PRC), NOVEMBER 17

## Mortara takes 'nicest win'

EDOARDO MORTARA TOOK WHAT HE described as "probably the nicest victory I've ever had" with a stunning win in the GT race at Macau.

With his Audi reckoned to be up to 100bhp down on the opposition, Mortara should have had no chance around Macau and was lurking in fourth place during the early stages.

The race took some time to get going. Stefan Mucke, with a punctured tyre on his Aston Martin, swerved Earl Bamber's Porsche into the wall at San Francisco, causing a huge pile-up that eliminated many of the international racers. At the restart, Mucke, with his Aston now repaired, then tapped a slow car

into the first kink and caused another shunt.

After the two safety-car periods, Maro Engel appeared on course for victory in his Erebus Mercedes, only to pick up a puncture from debris and park in the barriers.

Asian-based Swiss Alexandre Imperatori picked up the lead in his

Porsche, while Mortara pulled an audacious and breathtaking move on Renger van der Zande's Merc to take second into the left-handed Hospital bend.

Imperatori was baulked horrendously when the tardy Jacky Yeung got his Lambo in the way exiting the Melco hairpin on the penultimate lap. With van der Zande drawing alongside, Mortara had nowhere to go other than to tap Imperatori at Fisherman's Bend. As the Porsche slid wide, Mortara moved into the lead, and Danny Watts speared his United McLaren inside both Imperatori and van der Zande at R Bend to take second!

Van der Zande then tried an ambitious move on Imperatori for third into Lisboa that predictably ended in the barriers.

"This is a race I will never ever forget," said Mortara.

● Marcus Simmons

### RESULTS

1 Edoardo Mortara (Audi R8 LMS), 12 laps in 37m12.211s; 2 Danny Watts (McLaren MP4-12C GT3), +1.504s; 3 Alexandre Imperatori (Porsche 911 GT3-R); 4 Marchy Lee (Audi); 5 Li Zhi Cong (Porsche); 6 Richard Meins (McLaren).



**CHAMPIONSHIP POSITIONS**

1	FABIO LEIMER (CH)	Racing Engineering	201
2	SAM BIRD (GB)	Russian Time	181
3	JAMES CALADO (GB)	ART Grand Prix	157
4	FELIPE NASR (BR)	Carlin	154
5	STEFANO COLETTI (MC)	Rapax	135
6	MARCUS ERICSSON (S)	DAMS	121
7	JOLYON PALMER (GB)	Carlin	119
8	STEPHANE RICHELMI (MC)	DAMS	103
9	ALEXANDER ROSSI (USA)	Caterham Racing	92
10	TOM DILLMANN (F)	Russian Time	92
11	JON LANCASTER (GB)	Hilmer Motorsport	73
12	JULIAN LEAL (CO)	Racing Engineering	62
13	ADRIAN QUAIFE-HOBBS (GB)	MP Motorsport/Hilmer Motorsport	56
14	MITCH EVANS (NZ)	Arden International	56
15	ROBIN FRIJNS (NL)	Hilmer Motorsport	47
16	JOHNNY CECOTTO (YV)	Arden International	41
17	KEVIN CECCON (I)	Trident Racing	28
18	DANI CLOS (E)	MP Motorsport	25
19	RIO HARYANTO (IND)	Barwa Addax Team	22
20	NATHANAEL BERTHON (F)	Trident Racing	21

**WINS**

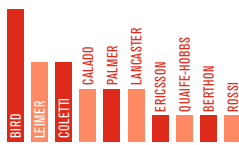

<b>SAM BIRD</b>	5
FABIO LEIMER	3
STEFANO COLETTI	3
JAMES CALADO	2
JOLYON PALMER	2
JON LANCASTER	2
MARCUS ERICSSON	1
ADRIAN QUAIFE-HOBBS	1
NATHANAEL BERTHON	1
ALEXANDER ROSSI	1

**POLES**



<b>SAM BIRD</b>	2
MARCUS ERICSSON	2
FABIO LEIMER	1
STEFANO COLETTI	1
JOLYON PALMER	1
STEPHANE RICHELMI	1
ALEXANDER ROSSI	1
TOM DILLMANN	1
JOHNNY CECOTTO JR	1

**POINTS SYSTEM EXPLAINED**

Race 1: 25-18-15-12-10-8-6-4-2-1 to top 10 finishers.  
 Race 2: 15-12-10-8-6-4-2-1 to top eight.  
 Pole for race one: 4. Fastest lap of top 10 finishers in each race: 2.  
**RACES:** Sepang, March 23-24; Sakir, April 20-21; Barcelona, May 11-12; Monaco, May 24-25; Silverstone, June 29-30; Nurburgring, July 6-7; Hungaroring, July 27-28; Spa-Francorchamps, August 24-25; Monza, September 7-8; Singapore, September 21-22; Yas Marina, November 2-3.

**SUPERGRID 2013**

Qualifying positions not included when a driver was unable to set a time due to any problem where the driver is not at fault. Positions taken before any grid penalties applied  
 \* Didn't contest all races

1	3.6	LEIMER	2	4.6	BIRD
3	5.4	NASR	4	5.7	ERICSSON
5	7.6	RICHELMI	6	7.7	DILLMANN
7	8.5	CALADO	8	9.4	PALMER
9	9.5	FRIJNS*	10	10.3	COLETTI
11	10.3	ROSSI*	12	11.8	EVANS
13	14.3	CECCON*	14	14.5	LEAL
15	14.6	CANAMASAS	16	14.7	CECOTTO
17	15.2	HARYANTO	18	15.5	BERTHON
19	16.0	LANCASTER*	20	17.4	CLOS*
21	17.5	QUAIFE-HOBBS	22	17.7	TRUMMER
23	18.3	BINDER	24	19.5	ABT
25	19.9	ROSENZWEIG	26	21.0	DE JONG

# Leimer times it to perfection

After a tricky start, you could set your watch by the Swiss racer's second half of the season. **By CHARLES BRADLEY**

**A**s national stereotypes go, Fabio Leimer was the epitome of Swiss clockwork efficiency – for the second half of the GP2 season at least. Although he didn't lead the championship at the end of a race weekend until September, there was something irresistible about his momentum and he fended off Sam Bird's late title charge with precision – apart from crashing on the slowing-down lap in Singapore!

It marked Racing Engineering's second GP2 title after Giorgio Pantano's success in 2008 (100 per cent reliability it should be noted), and was Leimer's fourth full season in the category – his second with the Spanish team. Like Pantano, however, he'll find the step into F1 difficult unless he boasts major financial support.

**HOW IT WAS WON**

Leimer kicked off with two consecutive feature race victories, in Malaysia and Bahrain, but his Sunday events were blighted by shunts. This carried over into his feature races too at Barcelona

and Monaco, where he was twice removed (by James Calado and Johnny Cecotto Jr respectively) and subsequently lagged behind in the points race.

Although 66 points in arrears of Rapax's pacesetter Stefano Coletti, he kept his head up. Then came Silverstone, and something weird happened: a late-race collision between the two sent Coletti spinning out while Leimer recovered to finish fourth.

Like some badly scripted, body-swap B-movie, Leimer scored heavily in every race that followed, just as Coletti had done until that point. Conversely, Coletti went into a freefall; third place at the Nurburgring (from 13th on the grid after a tyre gamble paid off) was his only points finish in the final dozen races.

Coletti's average finish in the first eight races was a staggering 2.6; afterwards it was 15.7. Just as with Team New Zealand in the America's Cup, the wind bewilderingly vanished from his sails.

**STANDOUT PERFORMANCES**

Like Leimer and Coletti, Bird has been around at this level for some years now, and this was his most convincing season yet. His Russian Time team was new to the category, taking the entry (and backbone of mechanics and set-up data)







STALEY/LAT

of former champions iSport, blended with the German Motopark F3 outfit.

Bird was left to rue a couple of 'if only's': like grid penalties at Sepang and Budapest, like battling Jolyon Palmer so hard at Barcelona that he ended his race in the gravel instead of on the podium, like a lacklustre Nurburgring weekend and – when it mattered most – stalling on the front row in the Yas Marina decider.

But there were five glorious victories, plus successive poles at Spa and Monza. If any driver from the class of GP2 2013 looks ready for F1 right now, it's Bird.

That pre-season favourite Calado (who led the most laps in his 2012 rookie season) salvaged third place from his hotchpotch of a season was a victory of sorts. Staying with ART Grand Prix, with continued backing from Racing Steps Foundation, he should've been contesting for wins at every round, but appeared to be on the back foot from the start.

His two wins were both sprint races, and first-lap exits in Sepang and Barcelona were a reflection of his anxiety to gain track position when he could. But there were also beautifully tenacious drives that displayed his hunger to succeed. His graduation to F1 Fridays with Force India was well deserved.

Felipe Nasr was another of whom much was expected but he failed to deliver to his potential; he still hasn't won a GP2 race in 46 attempts – an unbelievable stat.

His average finish was third across the first four race weekends, but non-finishes at Silverstone (not his fault), Spa (his fault) and Monza (not his fault) were costly and his challenge petered out.

### SOMETHING TO REMEMBER

Three new teams joined the series, and between them newcomers Russian Time and Hilmer Motorsport shared nine victories – highlighting that picking drivers with talent over budget does pay. MP Motorsport scored a podium at Monaco, and did well to save Dani Clos from the career scrapheap too.

### SOMETHING TO FORGET

Some of the driving standards displayed at this level were frankly unacceptable. And some of the stewards' decisions simply weren't fit for purpose to discourage it. So it happened again and again, and it was the same names who were repeat offenders (yes Johnny Cecotto Jr and Sergio Canamasas, we mean you).

### WHAT NEXT?

Series chiefs have assuaged the fears of team bosses by retaining the current chassis for 2014. This is sensible on many levels, not least the fact F1 is making a huge regulation change and it would be impractical to mimic this.

As in F1, wallet size is outweighing talent in many GP2 teams' driver selections, so a reduction in flyaway events next year would also be welcome. Moscow joins that calendar; Campos regains control of the Addax team. ❧

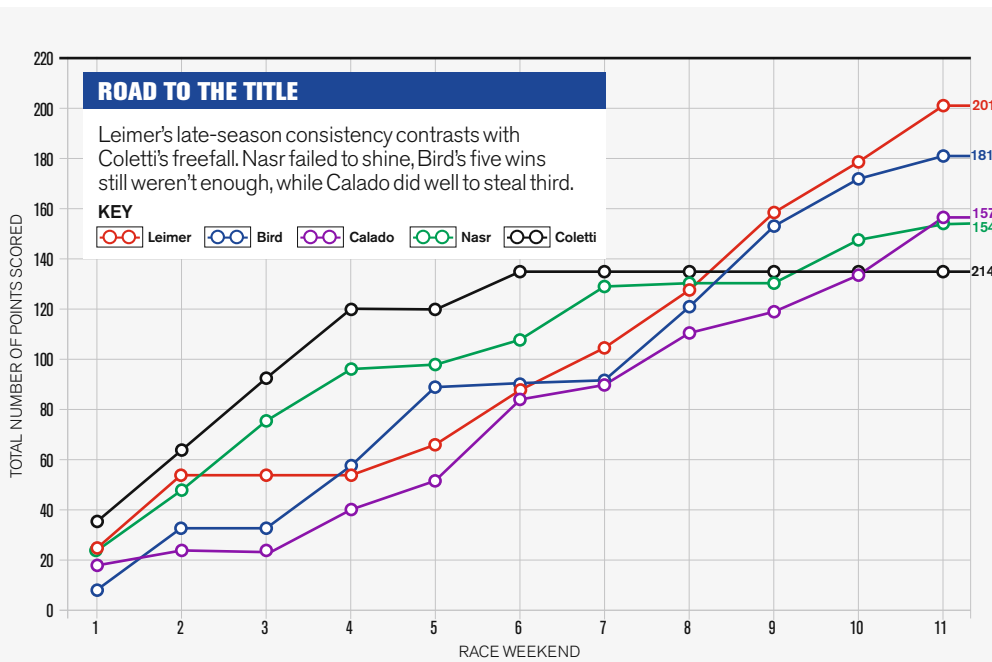

## TOP 10 DRIVERS



### 1 SAM BIRD

Began the season with the handicap of a brand-new outfit in Russian Time, but steered the ship impressively to the teams' title at the first attempt. Five wins showed he possesses more maturity than ever; jury is still out on whether he can ever seal a title. His stock has never been higher, but is that enough to find him a berth in F1?



DUNBAR/LAT

### 2 FABIO LEIMER

Became Mr Consistency by the end of the year, but looked anything but a title contender – despite winning feature races in Bahrain and Malaysia – after a wretched run in Barcelona and Monaco.

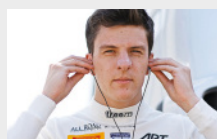

### 3 JAMES CALADO

Started the year as clear title favourite, but not all appeared well at ART. Salvaged his season by snatching third in points, but two sprint-race wins weren't the step he was looking for after that impressive 2012.



### 4 FELIPE NASR

No wins, no poles, no fastest laps – how could this be? Was the model of consistency at the start of the season – missing a Bahrain win by 0.008s – but his heavy-scoring form just faded away.



### 5 JOLYON PALMER

One thing's for sure, his reputation as a top overtaker is assured. What needs improving is his qualifying speed (Singapore pole showed he can do it), and a little more consistency. Should start as favourite next year.



### 6 MARCUS ERICSSON

Before the Nurburgring, was 19th in points in one of the fastest cars. Then he won, and took four more podiums that rocketed him to sixth. Speed's not in question; his all-round game is.



### 7 STEFANO COLETTI

The curious case of Dr Jekyll and Mr Hyde: Dr Jekyll's average finish for the first 11 races was fifth; then Mr Hyde took over and that plummeted to 17th. Quite why this happened, nobody seems sure.



### 8 ALEXANDER ROSSI

The season ended too soon for Rossi, who missed the opening round but proved his quality with a podium on his series return. Struggled for consistency mid-season, but was back on from Monza and ended the year with his first win.

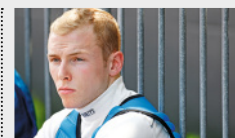

### 9 JON LANCASTER

Remarkable return to the series for the underfunded Yorkshireman. Third in his first start at Barcelona, two sprint-race wins (Silverstone and Nurburgring) came despite qualifying 16th and 17th! If he can sort one-lap pace, the rest is there.



### 10 ROBIN FRIJNS

There's a couple of full-season drivers who had a shout for this spot, notably Mitch Evans and Stephane Richelmi, but Frijns' Barcelona win proved just how good he is. It's a travesty his career has stalled.

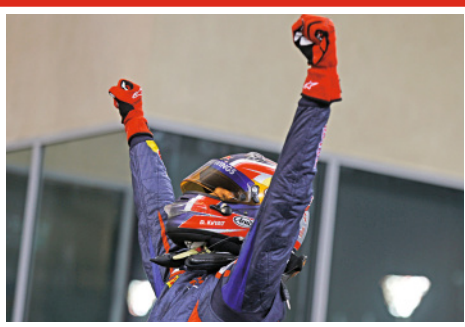

## CHAMPIONSHIP POSITIONS

1	DANIIL KVIYAT (RUS) MW Arden	168
2	FACU REGALIA (RA) ART Grand Prix	138
3	CONOR DALY (USA) ART Grand Prix	126
4	TIO ELLINAS (CY) Marussia Manor Racing	116
5	JACK HARVEY (GB) ART Grand Prix	114
6	NICK YELLOLY (GB) Carlin	107
7	KEVIN KORJUS (EST) Koiranen GP	107
8	ALEXANDER SIMS (GB) Status GP/Carlin	77
9	AARO VAINIO (FIN) Koiranen GP	75
10	CARLOS SAINZ JR (E) MW Arden	66
11	ROBERT VISIOIU (RO) MW Arden	44
12	LEWIS WILLIAMSON (GB) Bamboo Engineering	44
13	PATRIC NIEDERHAUSER (CH) Jenzer Motorsport	33
14	MELVILLE McKEE (GB) Bamboo Engineering	31
15	GIOVANNI VENTURINI (I) Trident Racing	26
16	DEAN STONEMAN (GB) Koiranen GP	20
17	ALEX FONTANA (CH) Jenzer Motorsport	18
18	DINO ZAMPARELLI (GB) Marussia Manor Racing	13
19	DAVID FUMANELLI (I) Trident Racing	6
20	PATRICK KUJALA (FIN) Koiranen GP	5

## WINS

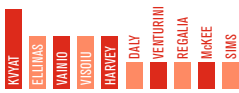

DANIIL KVIYAT	3
TIO ELLINAS	2
AARO VAINIO	2
ROBERT VISIOIU	2
JACK HARVEY	2
CONOR DALY	1
GIOVANNI VENTURINI	1
FACU REGALIA	1
MELVILLE McKEE	1
ALEXANDER SIMS	1

## POLES



DANIIL KVIYAT	2
TIO ELLINAS	1
CONOR DALY	1
KEVIN KORJUS	1
FACU REGALIA	1
AARO VAINIO	1
CARLOS SAINZ JR	1



Ellinas took two wins and a pole

### POINTS SYSTEM EXPLAINED

Race 1: 25-18-15-12-10-8-6-4-2-1 to top 10 finishers.  
 Race 2: 15-12-10-8-6-4-2-1 to top eight.  
 Pole for race one: 4. Fastest lap of top 10 finishers in each race: 2.  
**RACES:** Barcelona, May 11-12; Valencia, June 16; Silverstone, June 29-30; Nurburgring, July 6-7; Hungaroring, July 27-28; Spa-Francorchamps, August 24-25; Monza, September 7-8; Yas Marina, November 2-3.

## SUPERGRID 2013

Qualifying positions not included when a driver was unable to set a time due to any problem where the driver is not at fault. Positions taken before any grid penalties applied  
 \* Didn't contest all races

1	KVIYAT	3.5	2	KORJUS	4.7
3	SAINZ	4.9	4	ELLINAS	5.6
5	DALY	5.7	6	REGALIA	6.0
7	HARVEY	6.1	8	SIMS*	6.5
9	YELLOLY	6.6	10	VAINIO*	7.0
11	FONTANA	10.4	12	VISIOIU	10.5
13	NIEDERHAUSER	11.1	14	WILLIAMSON*	11.8
15	ZAMPARELLI	12.9	16	VENTURINI	13.6
17	McKEE*	14.3	18	FUMANELLI	15.4
19	KUJALA	17.0	20	FONG*	17.3
21	ERIKSSON	19.2	22	SA SILVA	20.2
23	ZONZINI	21.6	24	WEBSTER	21.7
25	GOMEZ	23.5	26	CULLEN	25.0

## GP3 REVIEW



# Kvyat's teenage kicks

He started the season as a GP3 rookie, but Daniil Kvyat ended it as champion and heading to F1. By **CHARLES BRADLEY**

**D**aniil Kvyat has a favourite English phrase: "The full shebang". It's something the 19-year-old Russian picked up from his MW Arden team (his interpretation is 'winning from pole, preferably with fastest lap') and he ran with it in the second half of the GP3 season. Surely he couldn't have expected "the full shebang" to include impressing so much that he'd take a Formula 1 race seat by the end of it?

Toro Rosso's shock decision – revealed on the eve of the title showdown – is not without its merits, as Kvyat displayed huge potential this year. Winning the title in his rookie season was impressive enough, but the manner in which he built his momentum into an irresistible force was probably a key deciding factor.

And how Kvyat handled it. Despite being besieged by the media in Yas Marina (well, the ones who could be bothered to seek out the GP3 paddock), Kvyat simply bossed the opening race of the final round with victory from pole plus fastest lap. The full shebang, as they say in Bashkortostan.

## HOW IT WAS WON

You wouldn't have predicted the Kvyat title march from the opening round at Barcelona. Pre-season the talk was of the tyres falling apart, as Pirelli's rubber hadn't been strengthened to accommodate the power hike to a 400bhp V6 engine and associated increases in aerodynamic loads (laptimes at Barcelona were over 4s quicker than 2012).

Kvyat and his MW Arden team were all at sea in the opening round. The pace was OK, but tyre life wasn't even close to a race distance. But when we got to the Valencia standalone (over a month later) we got to see this combination's true form on a much less abrasive circuit, while Pirelli reacted

with some tougher boots following that event.

An opening-lap mistake there proved costly, but at least two solid points-scores were a foundation on which he could build at Silverstone with a pair of fourths. Then another setback: battery failure at the Nurburgring, and a second zero points haul. With only eight weekends, now Kvyat would have to do all his scoring from six of them.

And how he did. Of his total points haul, 76 per cent (128) came in the second half of the season. His first podium came in Hungary; his first win at Spa. Then the clinchers: two wins, two poles and two fastest laps at Monza and Yas Marina. Job done.

## STANDOUT PERFORMANCES

Facu Regalia entered the final round of the championship having been its most consistent scorer. His career has been decidedly average thus far, but he took a huge step forward with ART Grand Prix this year. Up against drivers with far more impressive CVs – not least his own team-mates (Conor Daly and Jack Harvey) – Regalia looked truly convincing. Until he fell at the final hurdle, and failed to score a single point in Abu Dhabi.

Tio Ellinas benefited from a second year with Manor in the series, albeit effectively a step



Regalia was the surprise package of the season



**Kvyat impressed Red Bull on his way to the GP3 crown**

## TALKING POINT

Here's a stat that will astound and amaze: not a single successful overtaking manoeuvre for the lead took place after the opening lap of any GP3 race this year. Last year, that figure was 14!

There's little doubt that the big power hike to the 3.4-litre V6 engine over the winter affected the aerodynamics of the car. The main issue was front-end grip, as the fragile Pirellis tended to suffer badly in the wake of another car.

Even at Monza, home of the slipstream and scene of absolute thrillers in 2010 and '12, Daniil Kvyat and Jack Harvey led their races from start to finish. So unless the leader made a mistake, or burnt-out his tyres, victory was assured.

The series responded with CFD evaluation, then track tests by Kimi Raikkonen and Mitch Evans to enhance the prospects by trying different front wings and tyre compounds in an attempt to solve the problem.

Let's hope they're successful.

**Wheel-to-wheel racing at Monza during 2012...**



KALISZ/LAT

**...but things were more professional there this season**



FERRARO/LAT

forward with the 120bhp extra available this year. His was a strange year, with victories in the season opener and closer, but a wretched mid-season run of scoring (four points from six races) killed his title hopes having led the championship from the start until only three rounds to go. Getting taken out of the lead at Spa, and then by his own team-mate at Monza, didn't help.

Regalia's ART team-mates Daly and Harvey were right in the mix, but just failed to find that spark that Kvyat produced. The amazing Alexander Sims returned to the series, and in just four race weekends finished eighth in points! Nick Yelloly and Kevin Korjus all proved classy contenders; Aaro Vainio and Carlos Sainz Jr should have produced better.

### SOMETHING TO REMEMBER

C'mon, feel the noise! After three seasons of that terrible tractor-like 280bhp turbo drone, we had a lovely howling V6 produced by AER. Reliability was excellent, and keeping the same chassis was eminently sensible. Sorting out the aero to allow the cars to overtake each other, hmmm – work in progress.

### SOMETHING TO FORGET

Beyond the Talking Point (see panel above), there wasn't too much to complain about. There were some odd gaps in the calendar – a month between rounds one and two, and a long wait before the final round. The stewarding seemed a bit more sensible than GP2, although Carlos Sainz Jr should have been banned for his antics in race two at Silverstone, and Harvey likewise at Spa.

### WHAT NEXT?

Perhaps it's fitting as we have our first Russian champion in Kvyat that Sochi is added to the calendar and GP2 newcomer Russian Time makes its GP3 bow in 2014, buying out Bamboo Engineering's entry. Besides that, our spies also inform us that there might be a tweak to the race format on the horizon. ❧

## TOP 10 DRIVERS



### 1 DANIIL KVYAT

Two disastrous events, a couple of merely good rounds and four mega ones. This was a tough series to win, arguably with more strength in depth than GP2. A fast learner, and he'll need to be in F1. But if he can get things rolling like he did in GP3, who knows what his limits are? He hasn't found them yet.

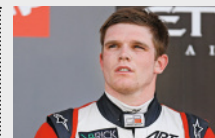

### 2 CONOR DALY

Boy, this is a tough call to put him second. But Daly was the driver who took the fight to Kvyat. Still has some tough edges to polish, his jump-start at Silverstone and Monza shunt proving costly.

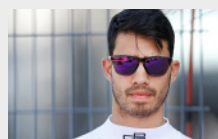

### 3 TIO ELLINAS

Like Daly, Ellinas has a tremendous swagger to his driving style. Loves nothing better than getting his head down and charging, but his attempt to defend his series lead, rather than push, bit him.



### 4 FACU REGALIA

A big improvement in his confidence levels was reflected in all aspects of his driving. He looked really quite convincing at many circuits, but couldn't quite deliver when he had to. Outsourcing his team-mates was no mean feat in itself.

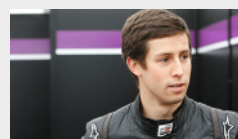

### 5 ALEXANDER SIMS

Fabulous performances every time in part-season with Status (in one meeting he scored almost all of that team's points!) and then Carlin. Should have won at the Nurburgring, and then did so at Spa. Quick and smart. A class act.



### 6 JACK HARVEY

Scrappy start, from which he recovered well. But dreadful error at Spa, when he caused himself to have a huge accident, was a major blot on his copybook. A shame, as Silverstone and Monza wins were sublime.

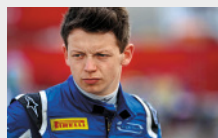

### 7 NICK YELLOLY

No wins, but one of the best racers out there, highlighted by his charge from last to 12th in Valencia after a technical infringement in qualifying. Came closest to victory at Silverstone, and chased Kvyat at Monza.



### 8 KEVIN KORJUS

This cheeky little Estonian put in some decent performances. Two poles showed his pace (although his Barcelona one was stripped due to a practice transgression) but lack of wins, and two non-scores, were disappointing.



### 9 AARO VAINIO

Expected to be a title challenger with the Koiranen team in his third year in the category. Despite his two wins there were too many anonymous days and found himself dropped for the impressive Dean Stoneman at Abu Dhabi.

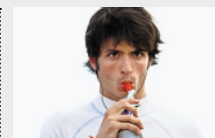

### 10 CARLOS SAINZ JR

Undoubtedly a top performer, but put firmly in the shade by fellow Red Bull junior Kvyat. Brilliant pace at Spa, recording one of the best pole laps of 2013, but only two podiums were not good enough.

# WEB DIRECTORY

## CAR BROKERAGE

**RACING CARS FOR SALE**  
ALAN CORNOCK FCS  
BUYING - SELLING - BROKERAGE  
[www.racingcarsforsale.co.uk](http://www.racingcarsforsale.co.uk)  
TEL: 01480 891212

## ENGINES

**JULIAN GODFREY**  
**ENGINEERING**  
visit our new online shop [www.racetuners.com](http://www.racetuners.com)

## EXHAUSTS

Stainless Steel Exhaust Specialists  
**SIMPSON**  
Race Exhausts  
Tel: 01753 532222 follow us on:  
[www.simpsonraceexhausts.com](http://www.simpsonraceexhausts.com)  

## GEARBOXES

 Rally & Race  
Gearboxes, GearKits,  
LSDs and Driveshafts  
Tel: 01782 280136 Fax: 01782 269913  
Email: [sales@eliteracingtransmissions.com](mailto:sales@eliteracingtransmissions.com)  
[www.eliteracingtransmissions.com](http://www.eliteracingtransmissions.com)

**Gearboxman.com**  
COMPETITION TRANSMISSION SERVICES  
Gearboxes & Axles for Road, Race, Rally and more  
Telephone: 01582 840008 Fax: 01582 840007

## HELMET GRAPHICS

**Mike Fairholme Designs**  
Sole approved painter of Arai helmets.  
Silver Birches, Corby Birkholme, Nr Grantham, Lincs NG33 4LE.  
Tel: 01476 550630. Fax: 01476 550029.  
email: [fairholmedesigns@btconnect.com](mailto:fairholmedesigns@btconnect.com)  
[www.fairholmedesigns.co.uk](http://www.fairholmedesigns.co.uk)

## MEMORABILIA

 **FINAL LAP**  
For Everything Formula One  
[www.finallap.net](http://www.finallap.net) **WE BUY AND SELL**  
+44 (0) 1245 287588 / 07771 920345

**JMJ AUTOMOBILIA**  
America's #1 supplier of CART and FORMULA One Racing memorabilia. Large selection of signed original collectables. See our ad under marketplace Memorabilia. Call or For a mail listing at (609) 575 1143 or visit: [www.JMJAuto.com](http://www.JMJAuto.com)

## MODELS

[www.Diecast](http://www.Diecast)  
  **race models.com**  
Specialists in 1:2 Scale Replica F1 Helmets

## MOTORSPORT MEDICALS

**Dr Mitchell**  
MSA, ACU and FIA medicals and ECG testing, also CAA pilot's and DVLA HGV medicals all available at weekends and at short notice.  
For appointment call: 01 582 731 754  
or E-mail: [drmitch@nildram.co.uk](mailto:drmitch@nildram.co.uk)   
Situated near Luton, Beds, 45 minutes from London, close to M1 Junction 11

## RACE CAR PREPARATION

 **MRR**  
Matt Roach Racing  
Race Car Preparation Specialist  
01 268 207000 [matt@mattroachracing.com](mailto:matt@mattroachracing.com)  
[www.MattRoachRacing.com](http://www.MattRoachRacing.com)

## RACE PARTS

**ARE DRY SUMP SYSTEMS**  
ARMSTRONG RACE ENGINEERING INC.  
[WWW.DRYSUMP.COM](http://WWW.DRYSUMP.COM) (916) 652-5282

## RACE PRODUCTS

**Pit to Car** **Autotel**  
Radio solutions **Digital Race Radio**  
0044(0)1508 528837  
[www.raceradio.co.uk](http://www.raceradio.co.uk)

 **msar**  
LONDON  
MOTORSPORT  
SHOWROOM  
[www.msar.co.uk](http://www.msar.co.uk)

**PIPER**  
[www.pipercams.co.uk](http://www.pipercams.co.uk)

## RACE PRODUCTS

 **JJC** **race and rally**  
PASSIONATE ABOUT MOTORSPORT  
[www.jjcraceandrally.com](http://www.jjcraceandrally.com)

**PORSCHESHOP**  
[www.porscheshop.co.uk](http://www.porscheshop.co.uk) 5% off with voucher code: **AUTOFIVE**  
+44 (0)121 585 6088  
    

**demon tweeks**  
MOTORSPORT *Direct*  
[www.demon-tweeks.co.uk](http://www.demon-tweeks.co.uk)

## RACEWEAR

      
RACEWEAR | KARTWEAR | SIMULATION  
[WWW.GPRDIRECT.COM](http://WWW.GPRDIRECT.COM)

AUTHORISED DISTRIBUTOR  
 **YBRACING**  
MOTORSPORT & PERFORMANCE  
[WWW.YBRACING.COM](http://WWW.YBRACING.COM)

OLD HALL PERFORMANCE LTD T: 02476 717 100  
 **RED LINE**  
SYNTHETIC OIL  
  
RED LINE [sales@redlineoil-europe.com](mailto:sales@redlineoil-europe.com) [www.redlineoil-europe.com](http://www.redlineoil-europe.com)

## THROTTLE & DRY SUMP SYSTEMS

 **at power**  
[www.atpower.co.uk](http://www.atpower.co.uk)  
+44 (0)1953 857800

## TRAILERS AND TRANSPORTERS

**BRIAN JAMES TRAILERS**  
» Connected to you  
[www.brianjames.co.uk](http://www.brianjames.co.uk)

## WHEELS

**Image**® Manufacturers of bespoke split rim alloy wheels  
[www.imagewheels.co.uk](http://www.imagewheels.co.uk)  
IMAGE WHEELS INTERNATIONAL LTD.

**BRIAN JAMES TRAILERS**

»» Connected to you



[www.brianjames.co.uk](http://www.brianjames.co.uk)

## Discovery of Light

Driving efficiency and improving fuel consumption, the latest Race Transporter models feature advanced aluminium and lightweight composite construction.

With modern edge styling, and carefully designed interior space Race Transporter trailers demonstrate all the capability you require.

Race Transporter range from £ 7,099 (excl. VAT).



**T +44 (0)1327 308 833**

For more information and details of your local BJT dealer please call or visit our website.

**RACE TRANSPORTER**

# TRAILERS & TRANSPORTERS

## WOODFORD TRAILERS

Call Us Now! tel. 01327 263 384

www.woodfordtrailers.com sales@woodfordtrailers.com



**RL 2000**  
£4,900 + vat



**RL 3000**  
£5,950 + vat



### Mazda Bongo Campervan in Lotus f1 team logo

- 1.5 turbo diesel auto with poptop roof the van will
- keep 2 adults and 2 children, comes with full camping conversion
- gas hob, sink, fridge, 240volt and 12volt power supply air conditioning
- brand new alloy wheels and tyres comes with 12mths warranty £14950.00

www.eastmidsmotorhomes.co.uk

01636 819932 /07944397880

## PRG TRAILERS

Finest Built British Trailers.



PRG Trailers | Cheshire | UK | Tel: +44 (0) 1270812402  
Web: www.prgtrailers.co.uk | Email: info@prgtrailers.co.uk

# RACE & RALLY CARS

## GINETTA G55 GT3



Full 2013 Spec - Large spares package included - Most cost effective GT3 car  
For more info contact - tom.sharp@idluk.com - 07912 489796

## 1973 GRD F 3



1600 Lotus Twin Cam with mech. petrol injection, sliding throttle. Excellent condition,  
2 set of wheels, additional smaller wing. Eligible for Monaco Historic Grand Prix.  
FIA Historic Technical Passport with the car.

**£47,000**

Contact: JFTAB@T-online.de

### FOR SALE

3 x 1994 TYRRELL 022 F1 CARS + SPARES + ENGINE

CHASSIS 1: 3rd at Spanish GP – Blundell. 4.0 Judd (Yamaha) engine, paddle shift, traction control, ground up rebuild - £150,000

CHASSIS 3: Spa & Monza – Katayama. 4.0 Judd (Yamaha) engine, paddle shift, traction control, racing in BOSS GP - £150,000  
All pit equipment needed to run the cars & a set of spare wheels is included.

CHASSIS 5: Jerez, Suzuka & Adelaide – Katayama. Roller / Show car - £25,000

Judd (Yamaha) GV3.5L V10 with zero miles – £30,000  
Comprehensive spare packages also available (approx. 8,000 spares available including all major assemblies)

FOR ALL DETAILS & PHOTO'S PLEASE CALL  
PHIL STRATFORD +1 949 310 4215



# AUTOSPORT

TO ADVERTISE YOUR PRODUCTS  
AND SERVICES HERE CALL:

**0208 267 5992**

# RACE & RALLY CARS

## JCW MINI CHALLENGE CAR FOR SALE

- Large spares package available at extra cost.
- Daf rigid truck also available.



Email: [leeallen1@hotmail.co.uk](mailto:leeallen1@hotmail.co.uk)  
or Call 07802 496 988

GT MARQUES offer for sale championship winning 911 GT3 Cup cars. 16 Pole positions, 8 wins. Both cars returned to new condition.

Serious enquiries only by email please: [paul@gtmarques.com](mailto:paul@gtmarques.com)



## Join Volkswagen Castrol Cup in 2014 season!



Fierce and well-balanced competition, great prizes and fantastic atmosphere – this is the Volkswagen Castrol Cup – an innovative racing series, which in 2014 will take place on tracks in Slovakia, Czech Republic, Germany, Hungary and Poland. If you want to be a part of competitive fight among the pack of international drivers in powerful, professionally prepared race cars join Volkswagen Castrol Cup in 2014 season!

This cup is amazing. The same cars and tyres means even chances for every driver – Tomasz Gollob, Speedway World Champion.



In the 2014 Volkswagen Castrol Cup will be held for the second season. Cup's organizer plans further increase of the attractiveness of competition. Thanks to the cooperation with Volkswagen Motorsport, Volkswagen Racing Poland team will prepare new versions of the GTI Golfs, with modified aero package and engine with extra power.

New philosophy of Cup's organization:

- race car and its transport to races during the whole racing season (14 races, 14 free practices, 7 qualifications)
- test day before and during the season
- full service maintenance during training and racing throughout the season
- fuel for training and racing
- high performance tires

- all track entry fees
- approved racing overall and a package of clothing with Cup branding
- advertising space on the car and on the racing overall
- 3 VIP tickets allowing to access the racing venues and the VW hospitality zone
- catering on every racing weekend (including training days)
- briefings and lectures, about driving techniques, using telemetry systems, and track safety, etc.
- marketing and media package
- valuable prizes: Volkswagen Golf VII and money prizes, with total amount of **116 000 €** to share

The whole package above is available for **43 000 €** (net price), regarding **5000 €** is paid in advance till 15 January 2014.

The main prize for the winner of the Cup is the new Volkswagen Golf as well as the amount of **30 000 €**. The runner-up receives **20 000 €**, and the third driver **10 000 €**. The money will be spend on further racing career development.

Drivers will also be rewarded after each race. The first eight drivers will receive the amount of **8 000 €** to share during each racing weekend.

Drivers will use race-prepared Golfs whose specification was developed in collaboration with Volkswagen R GmbH and Volkswagen Motorsport – Volkswagen departments dealing with sports cars. Car will be equipped with a 2.0 TSI petrol engine, which produces as much as 320 bhp (270 bhp + 50 extra bhp thanks to Push – to – Pass

system, whose activation for a short time spices up the competition). Cars are equipped with a sports suspension and other components adapting them to racing including a professional telemetry system.

More information on our website: [www.volkswagencastrolcup.pl/en](http://www.volkswagencastrolcup.pl/en)



Volkswagen Castrol Cup:  
[www.vwcastrolcup.pl/en](http://www.vwcastrolcup.pl/en)  
Volkswagen racing polska:  
[www.vwrcing.pl](http://www.vwrcing.pl)

Find us on Facebook:  
[facebook.com/volkswagencastrolcup](https://www.facebook.com/volkswagencastrolcup)  
Adam Gładysz, mob.: +48 602 495 549

# MARKETPLACE

## CAR TYRES

FOR ALL YOUR  
**AVON**  
 TYRES  
**MOTORSPORT**  
 RACING TYRES  
 Inc. ACB 10 Formula Ford  
 Contact

**BMTR LTD**

Tel: 0121 331 1122  
 Fax: 0121 331 1144  
 email: sales@bmtr.co.uk  
 see our new website at www.bmtr.co.uk

## FLOORING

### Kiwi Tiles

Interlocking Plastic Floor Tiles, as used by leading race teams throughout Europe.

- Easy installation & removal
- Many colours
- Lightweight
- Strong and durable
- Compact & easy to store
- Value for money
- Top quality

Stock Colours:  
 Red, Blue, Green,  
 Yellow, Silver, Orange,  
 Grey, Black, White,  
 Dayglo Red

#### Ralt Engineering

Tel: 01865 883354 Fax: 01865 883789  
 Email: enquiries@kiwitiles.com  
 www.kiwitiles.com

## MEMORABILIA

### F1 COLLECTORS .COM



### #1 FOR F1 MEMORABILIA & AUTOGRAPHS

We buy and sell F1 items  
 Ayrton Senna specialists  
 Call CHRIS GRINT 01763 274448  
 email: sales@f1collectors.com

### JMJ Automobilia

SUPPLIERS OF RACE  
 MEMORIBLIA SINCE 1992

Florida, USA

**(609) 575-1143**

email: [JMJAUTO.COM](mailto:JMJAUTO.COM)  
[WWW.JMJAUTO.COM](http://WWW.JMJAUTO.COM)

## RACE PRODUCTS

- EXPERT ADVICE • MASSIVE STOCKS • RAPID DELIVERY



[www.demon-tweeks.co.uk](http://www.demon-tweeks.co.uk) QZ252A

DON'T DELAY, CALL TODAY

**0844 375 2196**

**demon-tweeks**  
 MOTORSPORT Direct  
LOW CALL RATE CALLS MAY BE RECORDED FOR TRAINING PURPOSES

### London Motorsport Showroom

[www.msar.co.uk](http://www.msar.co.uk)



msar UK agent for **SCHROTH** RACING

ORDER HOTLINE: 020 8655 7877

## RACEWEAR

# Grand Prix Racewear

08435 070 858 | [WWW.GPRDIRECT.COM](http://WWW.GPRDIRECT.COM)

**"WHEN ONLY THE BEST WILL DO GPR RECOMMEND SCHROTH"**

SCHROTH RACING HANS® DEVICES  
 FROM JUST - £325+VAT

PROFESSIONAL PRODUCTS & SERVICES FOR THE PROFESSIONAL DRIVER



## RACE EQUIPMENT



Major Stockists of  
 Professional Quality  
 Motorsport Components

### Free Catalogue

If you would like a copy of our catalogue then please contact us, alternatively you can download a PDF version from our website.



- Expert Advice
- Large Stocks
- Fast Delivery
- Competitive Prices

Stocked Brands Include:

**tilton**

**BOSCH**

**Fragola**  
 Motorsport Hose & Fittings

**Lifeline**  
MAIN DEALER & AUTHORISED SERVICE CENTRE

**FK ROD ENDS**

**STACK STACK STACK**

**MSD**  
**IGNITION**

Over 20 years of experience in motorsport components. Conveniently located at:  
 Unit 40, Silverstone Circuit, Towcester, Northants, NN12 8TN  
 For more information please visit our Silverstone store, website or telephone:

**01327 857991**

[www.competitionssupplies.com](http://www.competitionssupplies.com)

# AUTOSPORT

TO ADVERTISE YOUR PRODUCTS  
 AND SERVICES HERE CALL:

**0208 267 5992**



# MARKETPLACE

WWW.REIGERSUSPENSION.COM 

The best suspension for:

- Rally
- Rallycross
- Autocross
- MotoCross
- Quads
- Sidecar Cross
- Rallye Raid
- Trial



Reiger Suspension BV  
Molenenk 5a  
NL-7255 AX Hengelo Gld.  
Tel.: +31 (0)575-462077 Fax: +31 (0)575-463316  
info@reigersuspension.com



## REVOLUTION COMPETITION ▲ WHEELS

**REVOLUTION  
4 SPOKE RACE  
WHEELS ARE  
BACK!**



SIZE	OFFSET RANGE	C DIMENSION (BACKSPACE)	APPROX WEIGHT KGS
13 X 5.5	-17 TO 13	60 TO 90	4.0 TO 4.6
13 X 6.0	-13 TO 17	73 TO 103	4.1 TO 4.7
13 X 6.5	-06 TO 24	85 TO 115	4.2 TO 4.8
13 X 7.0	00 TO 30	98 TO 128	4.3 TO 4.9



SIZE	OFFSET RANGE	C DIMENSION (BACKSPACE)	APPROX WEIGHT KGS
13 X 8.0	-13 TO 17	97 TO 127	4.4 TO 5.0



**NOW AVAILABLE WITH:**  
MORE OFFSET RANGE  
GREATER BRAKE CLEARANCE  
HIGHER LOAD RATING

SIZE	OFFSET RANGE	C DIMENSION (BACKSPACE)	APPROX WEIGHT KGS
13 X 10.0	-38 TO -08	97 TO 127	5.3 TO 5.9

### HISTORY

REVOLUTION WHEELS HAVE BEEN MANUFACTURING WHEELS SINCE 1967.

### PEDIGREE

REVOLUTION WHEELS HAVE SUPPLIED SOME OF THE MOST PRESTIGIOUS MOTORSPORT TEAMS AND DRIVERS OVER THE LAST 47 YEARS.

### INNOVATION

REVOLUTION WHEELS ARE FOREVER PUSHING THE BOUNDARIES OF ENGINEERING AND DESIGN.



Coen Motorsport and Cicuito Cartagena are pleased to announce a new service available to the motorsport fraternity that will allow enjoyment of the beautiful and historic Murcia region of Spain where daytime temperatures rarely fall below 20 degrees even in winter.

A number of places will be available for drivers and teams to store, prepare and even repair their cars in our workshops at the circuit.

So whether it is testing, car/driver development or just a holiday for the other half, this could be for you. Luxury accommodation at a sports resort that is within 25 minutes of the track and airport can be arranged.



For details of the resort go to [www.winnersinternational.eu](http://www.winnersinternational.eu)  
Long and short terms deals are on offer so for more information email on [info@winnersinternational.eu](mailto:info@winnersinternational.eu)

## For more information contact:

Revolution Wheels Dept, SCP Limited, Apollo, Lichfield Road Industrial Estate, Tamworth, Staffordshire. B79 7TA. UK

Tel: +44 (0) 1827 64111 Fax: +44 (0) 1827 63911

Mobile: +44 (0) 7702 845264 Email: [revolution@scp-uk.com](mailto:revolution@scp-uk.com)

Web: [www.revolutionwheels.com](http://www.revolutionwheels.com)



# MOTORSPORT AUCTIONS

[motorsportauctions.com](http://motorsportauctions.com)

## CLASSIFIED ADVERTS & AUCTIONS

THE GO TO WEBSITE  
TO BUY & SELL  
ALL THINGS  
MOTORSPORT

**Special Offer**  
Discount Code **MA101**

To celebrate the launch of [motorsportauctions.com](http://motorsportauctions.com) we invite you to list as many items as you like, and enjoy a 70% discount against our standard rates for every listing you make. This offer runs from November 12th 2013 until February 15th 2014.

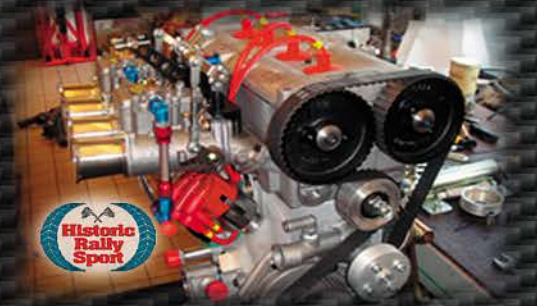

image © Harald Illmer

www.brr.de  
**BRR** BAUMSCHLAGER  
RALLYE & RACING

Simply register on the site, enter your advert and include up to 20 photographs. As you go through the checkout process, enter discount code MA101 into the box on the checkout page and press the update button.

CLASSIFIED ADVERTS  
STOREFRONTS  
FEATURED VENDORS  
DISPLAY ADVERTISING



Historic Rally Sport

**A GLOBAL SELLING PLATFORM**

[www.motorsportauctions.com](http://www.motorsportauctions.com)



**ASTACAR**  
ASTACAR MOTORHOMES

# MARKETPLACE



## HOW CONFIDENT ARE YOU DRIVING ON SNOW & ICE?

**ICE DRIVING IN SWEDEN IS THE ULTIMATE DRIVING EXPERIENCE.....CONTROL THE POWER .....**

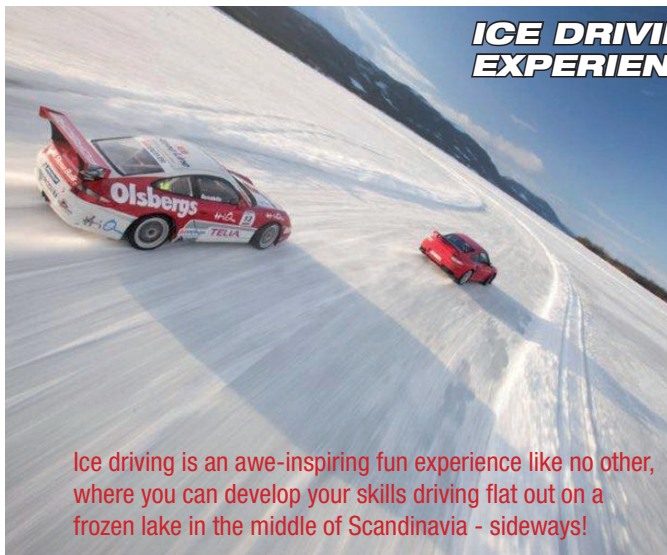

Ice driving is an awe-inspiring fun experience like no other, where you can develop your skills driving flat out on a frozen lake in the middle of Scandinavia - sideways!

Other Courses include:  
Fun weekend, Corporate events for clients or Team Building,  
One to one Race driver training course also available.

- Proven Techniques
- Swedish Rally Instructors
- English Speaking Course
- All inclusive of accommodation and meals
- 2 days on the ice

**check out the video clip – [www.icedriving.net](http://www.icedriving.net)**

*“How can I describe the experience of ice driving?....Stunning? Unbelievable? Organisation - seamless, hotel - understated Scandinavian luxury, food - first class, tuition - clear and patient, cars - new Porsches and Golf 4x4, snowmobiles - nearly new and good protective gear too...Fantastic! Thanks to you all” Phil – Surrey*

For details of all the courses and available dates in Feb/Mar 2014 - Contact Abi on Tel: 01625 427683, Mob: 07900 245 459 or email [abi@f1.co.uk](mailto:abi@f1.co.uk) for further details and availability.



## DRIVING INNOVATION FORWARD IN WORKSHOP DESIGN & STORAGE



- New race bays
- Machine shops
- Stand-alone workstations
- Mobile storage units
- Workbenches, trolleys & racking for workshops



System Store Solutions are pioneering the latest design and installation of motorsport workshops and transporters to teams in classic/historic racing right through to Formula One.



Providing a total design, layout and installation of storage products from the FAMI range including project management, consultation, technical advice and no obligation site surveys.



01622 859522

[sales@systemstoresolutions.com](mailto:sales@systemstoresolutions.com)

[www.system-store.com](http://www.system-store.com)

# MOTORSPORT JOBS

**MERCEDES AMG**  
**PETRONAS** FORMULA ONE TEAM

Mercedes-Benz has been setting the standard in racing for over 100 years. The MERCEDES AMG PETRONAS Formula One™ Team continues the proud history of the legendary Silver Arrows with the clear ambition of winning the FIA Formula One™ world championships. Based in Brackley, UK, we are recruiting highly motivated, talented new members of our team.

Please find further information about our current vacancies and our team in the 'join our team' area of our website [www.mercedes-amg-f1.com](http://www.mercedes-amg-f1.com)

**WIND TUNNEL TECHNICIAN** REF: SW771  
(fixed-term early and late shifts)

Reporting to the Wind Tunnel Operations Manager you will be operating the wind tunnel, executing model changes and improving quality and productivity of the facility. The ideal candidate will have an engineering qualification and strong practical skills, demonstrate an understanding of mechanical and electronics systems, a high level of computer literacy and be familiar with instrumentation systems and data analysis tools (PI toolbox).

We are looking for people to join the team that can be flexible in their hours and approach, have a 'can do' attitude, and are team players with great verbal and written communication skills. You will have the ability to work under minimal supervision to strict deadlines, in a professional manner.

In return for your hard work and commitment, we offer a competitive package, including bonus, life assurance, private medical cover, Mercedes-Benz company car lease scheme, 25 days holiday, an on-site gym, subsidised restaurant facilities and the opportunity to work in a truly unique environment.

To apply for this position please see our website, and then forward your CV and letter of application including the following; your current remuneration details and salary expectations, the job title and reference and where you saw the advertisement to [recruitment@mercedes-amg-f1.com](mailto:recruitment@mercedes-amg-f1.com)

Closing date: 6th December 2013

NO AGENCIES PLEASE



**AUTOSPORT**

**LOOKING TO RECRUIT FOR 2013?**  
**THE LATEST SELECTION OF**  
**MOTORSPORT JOB VACANCIES**  
**UPDATED EVERY WEEK.**

- The Motorsport Jobs page of the website receives on average 200,000 page impressions per month
  - The magazine you are looking at has a readership of 144,000 (Source: NRS Survey Q3)
  - All appointment adverts placed in Autosport magazine are listed on the website.

contact [rachel.brock@haymarket.com](mailto:rachel.brock@haymarket.com)  
or call **0208 267 5820**

All adverts placed will be featured in the jobs section of [www.autosport.com](http://www.autosport.com)

MOTORSPORT JOBS

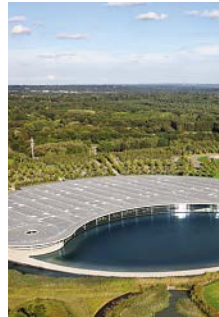

**McLaren**

**CREATING YOUR LEGACY**  
**THANKS TO OURS**

McLaren Automotive Careers

**WE WANT YOU ON OUR TEAM:**

**SENIOR AERODYNAMICIST**  
**AERO SURFACE DESIGNER**  
**CHIEF ATTRIBUTE ENGINEER**  
**PRINCIPAL ENGINEER (VEHICLE DYNAMICS)**

McLaren Automotive has built an unrivalled reputation for technology thanks to the outstanding team behind the name. We strive to continue that success into a new era and we'd love you to share the journey with us. There are now exceptional opportunities available to join our dynamic team.

As a growing company, we are developing new processes, technologies and products. Help us to shape our future with challenging new ideas and boundless enthusiasm.

Join us and be part of the legacy of McLaren Automotive. Evolve your career as together we evolve McLaren.

Send your CV to [natalie.robles@mclaren.com](mailto:natalie.robles@mclaren.com)



[WWW.McLAREN-JOBS.COM](http://WWW.McLAREN-JOBS.COM)



# MOTORSPORT JOBS



## DESIGNERS

We are currently seeking experienced designers to become a key part of our committed and improving design team. You will have a minimum of 2 years relevant experience (5 years for Senior) within the F1 environment. A practical and pro-active nature regarding a multitude of projects is a requirement, as you will form part of a project-based environment. Responsibility for appreciating the scope and delivery of projects is a must. The successful applicants will be expected to take on any design task with enthusiasm and proven ability. Ideally, with an excellent working knowledge of CATIA V5 and the ability work with minimal supervision.

## SENIOR MODEL DESIGNERS

We are currently seeking experienced Senior Model Designers to become a key part of our committed and improving design team. You will have a minimum of 4 years relevant experience within the Formula 1 environment. A Degree/Masters or other qualification in Mechanical Engineering will be an advantage. A Practical and proactive nature regarding a multitude of projects is a requirement, as you will form part of a project based environment. The successful applicant will be proficient in 3D mechanical design and surfacing, preferably CATIA V5.

## MODEL DESIGNERS

We are currently seeking experienced Model Designers to become a key part of our committed and improving design team. You will have a minimum of 2 years relevant experience within the Formula 1 environment. A Degree/Masters or other qualification in Mechanical Engineering will be an advantage. A Practical and proactive nature regarding a multitude of projects is a requirement, as you will form part of a project based environment. The successful applicant will be proficient in 3D mechanical design and surfacing, preferably CATIA V5.

## CNC MACHINIST

Set and operate machines as identified and determined within the desired time lines.

To meet productivity targets and completion deadlines as specified via production process documentation and line management. Verify compliance of loading schedules/priorities and ensure compliance of quality procedures. Able to read 2D Drawings and have experience of using Heidenhain controls would be an advantage.

This position is required to work alternate double-day shifts.

## STRATEGY ENGINEER

We are looking for an engineer to reinforce our strategy group in view of the 2014 increased race strategy challenges.

The position is within the Race Engineering Department and may involve extensive travelling. The successful candidate will report to Caterham F1's Chief Engineer.

Some of the main areas in which he/she will be involved are:

- Strategy event preparation
- Assessment of in-event main strategic parameters (tyre performance and degradation, pace difference against competitors, energy management requirements)
- Preparation of pre-event strategy plan
- Decisional support on in-event race strategy
- Analysis of post-event strategically relevant events
- Extensive competitor analysis

The successful candidate will have:

- A degree in Engineering, Mathematics, Physics or Statistics
- Knowledge of Matlab
- Motorsport experience is preferred (especially F1 or Le Mans)
- Coding capabilities an advantage
- A flexible and methodical approach

## RACE TEAM ELECTRICIAN

As part of the race team you will be responsible for all of the garage and on car wiring systems as well as the lifting of electrical parts on the car.

You should have experience of Raychem and MIL spec wiring systems as well as a good understanding of sensors installations on racing cars. It is essential that you are trained in mains electrical installations; ideally you will hold a 17th edition IEE wiring regulations certificate.

You must have good communication skills and be able to work to tight timescales in a team environment.

**Please send a covering letter and cv to [hr@caterhamf1.com](mailto:hr@caterhamf1.com)**

**Closing Date for Applications: 20 December 2013**

# CARTEK

MOTORSPORT ELECTRONICS



### Innovative products:

- Solid State Battery Isolators
- Power Distribution Modules
- Wireless Steering Wheel Controls
- Coolant Sensors
- FiA Rain Lights
- Shift Lights



[www.CARTEKMOTORSPORT.com](http://www.CARTEKMOTORSPORT.com)  
**CARTEK AUTOMOTIVE ELECTRONICS Ltd**  
 44 (0)2380 637600  
[info@cartekmotorsport.com](mailto:info@cartekmotorsport.com)

## The next generation of Silkolene Motorsport Oils

# FUCHS TITAN RACE

email: [info@710oil.co.uk](mailto:info@710oil.co.uk) tel: +44 (0) 1253 640612 [www.710oil.co.uk](http://www.710oil.co.uk)



# Congratulations James Nash



Products to meet market legislation and line-fit requirements



Line-fit, Tier 1, Tier 2 and Aftermarket fit accessories

proud sponsors



[www.vgroupinternational.com](http://www.vgroupinternational.com)  
 OEM Dept: +44 (0) 870 70 60 198

British Built for Motor Manufacturers, Globally

# CLUB AUTOSPORT

NATIONAL RACING • HISTORICS • RALLYCROSS • HILLCLIMB • TRACK TESTS



## Ferrari to run new winter series

Formula 1 giant aims to train budding single-seater drivers in Florida

### FORMULA 1 POWERHOUSE

Ferrari will run a new four-round winter series in America early next year, to help train aspiring professional single-seater racers.

The Ferrari Driver Academy's Florida Winter Series will take place on three US circuits next January and February.

Following a collective test at Homestead on January 22 there will be races at Sebring (Jan 25-27) and Palm Beach (Feb 3-5), before a return to Homestead for two events on two layouts on Feb 12-14 and Feb 17-19.

Each meeting will comprise four hours of practice, two 30-minute qualifying sessions, and three 30-minute races. The series will cost €95,000 to enter and will be limited to 15 drivers, all using identical Tatuus FA010B Formula Abarth cars powered by 195bhp Fiat engines.

Ferrari engineers will centrally operate the cars (one engineer for every three cars), and will organise seminars to educate the drivers on car

behaviour and set-up changes. Drivers will also be allowed to bring their own engineers to the events.

Luca Baldisserrri, the Ferrari F1 team's former chief engineer, now head of the Driver Academy, described it as "an opportunity for drivers to see things they will never have the opportunity to see during a normal season".

"It's not a championship, but a way to let drivers train during the winter, especially those from Europe where it is difficult to find representative weather conditions," he told AUTOSPORT.

"It's competitive, because at the end of the day there's always competition when drivers are racing together, but there's no prize. The big value is the opportunity for the driver to learn in parallel with the track time.

"There is 3000km, which is a good amount of mileage, and drivers will meet together with the engineers to discuss what the car is doing, the telemetry, driving style, racecraft; it's an educational programme.

"It's something original for sure.

We want to see drivers who want to learn, rather than just going around and not knowing what they are doing."

Baldisserrri said drivers from the FDA would also take part, to keep them occupied over the winter as well as help the other participating drivers.

Baldisserrri named Marussia F1 racer Jules Bianchi, newly crowned FIA F3 champion Raffaele Marciello, and Formula Renault 2.0 ALPS winner Antonio Fuoco (who shook down the first eight cars to be used in the series at Fiorano recently) as FDA drivers who would likely be drafted in.

### FLORIDA WINTER SERIES

#### Key elements of new scheme

**Cost:** €95,000 for the full series.

**Car:** Formula Abarth Tatuus FA010B.

**Engine:** 1400cc Fiat turbo (195bhp).

**Track time:** Four hours free practice, two 30-minute qualifying sessions, three 30-minute races per event.

**Calendar:** Four rounds at three circuits: Sebring, Palm Beach and Homestead, plus a pre-season test at Homestead.

### BEN ANDERSON NATIONAL EDITOR

ben.anderson

@haymarket.com

@BenAndersonAuto



### FERRARI'S DRIVER ACADEMY

is all about trying to help young single-seater talents prepare for a future in Formula 1, and its latest initiative sounds intriguing.

It's no secret that finding quality track time during the European winter is nigh on impossible. That's why the New Zealand-based Toyota Racing Series (run every January and February) has proved so popular.

It seems FDA boss Luca Baldisserrri (who worked with Gerhard Berger and seven-time world champion Michael Schumacher at Ferrari) has been inspired by TRS' effect on Italian protegee Raffaele Marciello, who raced there in 2012 and went on to enjoy a stellar rookie season in Formula 3.

A hundred grand seems a steep proposition for a series in which you don't win anything, but maybe removing that purely competitive element will allow drivers to focus on learning rather than trying to beat each other.

Running the cars centrally should ensure equality in the classroom (FDA driver Antonio Fuoco – the new Formula Renault ALPS champion – managed to lap within a tenth of a second in eight different cars during a recent shakedown test at Fiorano) and the value of the opportunity to work with professionals from such a highly regarded motorsporting entity as Ferrari should not be underestimated.

Baldisserrri has plans to expand the concept into the United Arab Emirates if things work out in Florida. Marussia F1 racer and FDA driver Jules Bianchi raves about the work the scheme does, so this could turn out to be a great opportunity for aspiring racers to steal a march on their opposition, instead of kicking their heels waiting for the weather in Europe to improve.

BESPOKE  
RACE SUITS



Grand Prix  
Racewear

BESPOKE RACEWEAR SPECIALISTS  
IN HOUSE DESIGN

08435 070 858 | WWW.GPRDIRECT.COM





Charlie Robertson tested for Mark Burdett Motorsport at Donington last week

Formula Renault

# British aces targeting FRenault NEC

THREE OF BRITAIN'S MOST promising young single-seater drivers are aiming to graduate to Formula Renault NEC next season.

BRDC Formula 4 champion Jake Hughes and fellow McLaren AUTOSPORT BRDC Award finalist Charlie Robertson tested for Fortec's Formula Renault 2.0 outfit at Paul Ricard this week.

Robertson, 16, who also tested for Mark Burdett at Donington, said: "It went well, I think. I was learning

the car so it took a bit of time to get into it. It was an eye-opener.

"Eurocup is very competitive and you've got to find your feet. NEC is the plan, it's the most likely. I'm about to start my fourth year in cars so I need to expand my experience."

Hughes, who won the F4 title in his first year of car racing, is not ruling out an immediate jump to the Eurocup, but admitted NEC was the more probable option.

"NEC would be my likeliest option,"

he said. "A lot of people persuade you away from Eurocup for your first year but it's been done before and there's no reason why we couldn't do it."

Meanwhile, the Racing Steps Foundation is aiming to place its McLaren-backed junior driver Ben Barnicoat, who wrapped up the Formula Renault BARC Autumn Cup on his car racing debut last weekend, in Formula Renault 2.0 for his first full season of car racing.

RSF coordinator Derek Walters

said: "The scene in the UK is a mess unfortunately and I don't suppose it is going to get resolved until 2015.

"Britain seems to be giving way to Europe and it's very sad.

"It will be NEC or ALPS. He'll go off and do some winter testing with Fortec in 2.0 in Spain [at Barcelona, Jerez and Valencia] and then we'll sit down with Fortec and decide which championship he does, and whether he can do two or three rounds of the other to give him a full programme."

British Formula Ford

## Ginetta team Century to make British Formula Ford comeback

LEADING GINETTA GT OUTFIT

Century Motorsport intends to run two cars in British Formula Ford next season.

Century won three races in this year's Ginetta GT Supercup and ran Declan Jones to runner-up in British GT4.

The team last appeared in Formula Ford in 2010, running a variety of drivers in a Juno chassis.

Team boss Nathan Freke, who won the British Formula Ford title in 2006, said: "We're hoping to run two cars next year alongside our Ginetta Supercup and British GT programmes.

"When we looked within the TOCA paddock for a class that was right for us, Formula Ford was top of that list.

"We've got plenty of experience with these cars and it's a very cost-effective



Century ran Juno in Formula Ford in 2010

way to get onto the UK's premier motorsport platform."

Rival squad Falcon Motorsport is holding a five-day test in Spain ahead of a planned three-car entry next year, while Meridian Motorsport has purchased Dan Cammish's title-winning Mygale SJ-13 from JTR and re-signed Connor Mills.

Porsche Carrera Cup GB

## Lloyd wants Porsche Cup deal despite losing scholar backing

PORSCHE CARRERA CUP GB

race winner Daniel Lloyd is determined to drive in one of the marque's single-make championships next season despite no longer being its UK scholar.

Lloyd spent the last two seasons contesting the British championship after winning the scholarship in 2011, but now loses the £80,000-a-season funding the prize brought with it.

He was recently beaten to Porsche's international scholarship, which provides €200,000 towards a Supercup campaign, by ex-New Zealand A1GP racer Earl Bamber, the new Asia champ.

Despite the setback, Lloyd is hoping he can raise the necessary funding to

make the move to the Supercup or remain in the UK series when it adopts the latest 911 model for next year.

"Supercup or another season in Carrera Cup GB is where I want to be next year ideally", he said. "It's all about the budget we can raise, though, so we are looking at different things. There are some exciting possibilities."



Lloyd's Porsche backing has gone

### Quick and competitive Track Day Insurance

The first online "quote and buy" system solely for the track day user, supplied by established track day and motorsport insurance provider - Ryan Motorsport Insurance

INSUREMYTRACKDAY.COM

- ✓ Damage to your car on a track day, regardless of fault.
- ✓ Any circuit in Europe, including Spa and Nürburgring Nordschleife.
- ✓ Inclusive cover for barrier damage at the Nordschleife.
- ✓ Vehicle recovery available for circuits in Great Britain.
- ✓ Organisers and Clubs - promotional rates and discounts
- ✓ Storage and transit for vehicles and trailers

Log on to [www.insuremytrackday.com](http://www.insuremytrackday.com) to obtain your online quote today.

Insure My Trackday is a trading name of Ryan Motorsport Insurance who are an appointed representative (557405) of Independent Broking Solutions Limited who are authorised and regulated by the Financial Services Authority, registration number 312026



BRDC F4

## Vernon rejoins Hillspeed team for BRDC F4 winter series finale

**FORMULA RENAULT BARC RACE**  
winner Kieran Vernon will make his BRDC Formula 4 debut this weekend.

The 23-year-old has not raced this year, but will reunite with the Hillspeed team that ran him to fifth in Formula Renault last season for the F4 winter championship finale at Brands Hatch.

Vernon has competed in a variety of categories since finishing second in the 2007 Ginetta Junior championship, but has not contested a full campaign since finishing fourth in the final season of Formula Palmer Audi in 2010.



Hillspeed ran Vernon to fifth in his 2012 FR BARC season

"The opportunity came up and I have a good relationship with the team, having raced with them last year," said the former Porsche Carrera Cup GB scholar, who will line up alongside frontrunner Jake Cook and Dimitris Papanastasiou.

"I haven't raced this year so I'm really looking forward to getting back out again. Hillspeed will put out a good car as they always do, I'm confident in myself, and we can target four strong results next weekend, and hopefully we'll be getting on the podium."

Hillspeed's Richard Ollerenshaw believes Vernon will quickly adapt to the BRDC F4 car.

"Although he's been away from racing for a year and the F4 car is completely new to him, we're confident he'll be on the pace very quickly," he said.

"Kieran is a quality driver, as he's proven in every category he's raced, and if all goes to plan we'd love to get a deal together with him for F4 in 2014."

Main championship competitor Gosia Rdest will also contest the Brands round, returning to F4 with Douglas Motorsport.

FIA F4

## Italy set to adopt FIA F4 rules to replace struggling Formula Abarth

**AN FIA FORMULA 4 SERIES IS** tipped to be run in Italy next season, with Southern European junior powerhouses Prema Powerteam, EuroInternational and Jenzer Motorsport among the teams.

AUTOSPORT understands the initiative will use the new Tatuus chassis powered by Fiat engines, as a replacement for Formula Abarth.

Formula Abarth started in 2010 as a European series but was downgraded to national status in '13 and has struggled with poor support.

Leading karting promoter WSK is understood to be linked to the new FIA-rules series, which is scheduled to begin in the middle of May.

EuroInternational boss Antonio Ferrari said: "It looks very good. We already have so much interest and it looks like we will run four cars."

Prema Powerteam chief Rene Rosin added: "We are ready, but we won't know for sure until we have more information."



FIA Formula 4 is set to be replaced by Italian F4

British GT

## Ex-champion Stanley to return to British GT4 in Fox Ginetta G55

**EX-BRITISH GT4 CLASS CHAMPION** Jamie Stanley will make his return to the category next season with the first team to commit to running a GT4-specification Ginetta G55.



Stanley won GT4 in 2010

Stanley will return to the Fox Motorsport squad with which he won the 2010 title, driving alongside team boss Paul McNeilly, with whom he shared an FF Corse Ferrari 430 GT3 at Silverstone this season.

The 2010 class champion said: "I'm thrilled to join Fox Motorsport in the team's new challenge and I can't wait to start."

"We are delighted to be returning to the Ginetta family, they are dedicated to nurturing talent, whether it's drivers or teams, so we know we're in good hands."

● A GT4-spec Trident Iceni tested at Blyton recently, as the car maker ramps up development ahead of the Dubai 24 Hours.

## HUMBLE PYE

### The voice of club racing



Wells was runner-up in the Macau GP's FMasters China race

## It's good to see underfunded Brits chasing their dreams

Seeing too many of our most able young drivers' careers stall when they deserve full-time seats on the international stage exercises me far more than not having competed myself – at fun level – for a couple of seasons.

Being blessed with a platinum spoon in one's mouth (silver is no longer sufficient) has oiled aspirants' passage to the sport's top echelons since it began. Anybody who believes more than half the current Formula 1 field is there on merit is deluded, but hasn't that always been the case? What is now financially almost impossible is getting past rung two of the car ladder. In recent weeks, though, I've been heartened by the results of a couple of personable young Brits who have not been gifted opportunities by deep pockets. Dan Wells and Craig Dolby have left their marks before influential audiences through sheer determination, personal sacrifice, innovative networking, and unshakeable self-belief.

Wells, 22, blipped my radar in 2010, when he raced my pal John Percy's Formula Ford 1600 Van Diemen RF91 superbly then showed huge promise in Formula Renault UK. But he had to refocus last year when the championship was canned. His bold decision to relocate from Salisbury to Hong Kong – initially with backing from crowdfunding website GoFundMe – is paying off. Dan works tirelessly

to attract and keep investors, and second in the Macau GP's FMasters China challenge race, with Paul Ip's well-connected KCMG team, should send his stock rocketing.

Prior to Zhuhai's World Endurance Championship round, triple Superleague Formula race winner Dolby, 25, had raced but twice since the series ended in 2011. I watched the '06 Formula Renault 1.6 Belgium champion take victory consummately at Snetterton twice – in a Ford Lotus Cortina in '11 and an Aston Martin GT4 this September – thus I was delighted when the British Touring Car Championship tester earned a leg-up into ADR-Delta's squad.

Craig impressed in the LMP ORECA-Nissan shared with '02 British F3 champion and A1GP star Robbie Kerr, and Thai-born Tor Graves (formerly Sriachavanon). I was me who introduced Formula First stand-out Kerr to dear old Bob Graves when the electronics magnate, brilliant engineer and VSCC Amilcar racer sought to support a cash-strapped youngster in FRenault when he promoted his adopted son to a 'pro' team for '98. Bob, who died last year, would have been thrilled to see another hotshoe get a break. And use it well.

## Marcus Pye

**"Dan Wells and Craig Dolby have left their marks through sheer determination and self-belief"**

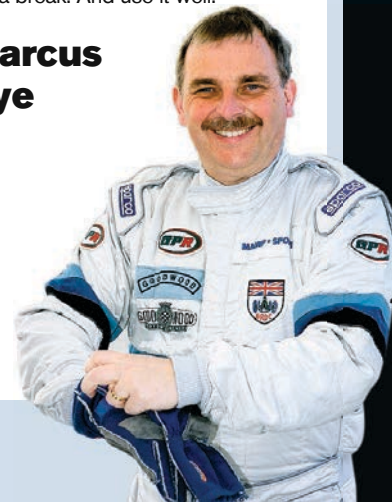

# SUBSCRIBE TO AUTOSPORT AND GET...

# ASTON MARTIN RACING POLO SHIRT



**RRP**  
**£39.95**

## +PLUS+

**FREE DIGITAL EDITION  
SUBSCRIPTION &  
UNLIMITED ACCESS  
TO AUTOSPORT.COM**



[www.astonmartinracingstore.com](http://www.astonmartinracingstore.com)

## FREE GIFTS

- ✓ Free Aston Martin Racing polo shirt. This polo shirt is black, with subtle team branding printed on the left chest.
- ✓ Free subscription to the AUTOSPORT Digital Edition and unlimited access to AUTOSPORT.com

## SUBSCRIBE NOW!



- ✓ Save 19% on the cover price
- ✓ Pay just £36.99 every 13 issues by direct debit

Visit [www.themagazineshop.com/autosport-m1013p](http://www.themagazineshop.com/autosport-m1013p)

Or call and quote M1013P

# 08448 488 817

Please have your bank details ready.  
Offer ends December 5, 2013.

[themagazineshop.com](http://themagazineshop.com)

## THE BENEFITS OF SUBSCRIBING!

- ✓ Never miss an issue
- ✓ Free delivery direct to your door
- ✓ Unlimited access to news and views from the paddock
- ✓ Access to subscriber-only analysis and comment

**Terms & Conditions:** This offer is open to UK residents only. Overseas rates are available on +44 (0) 1795592 972. Please allow 35 days for delivery of your gift and first issue. The gift will be sent under separate cover from the magazine. Should we run out of gifts, you may be offered an alternative gift – there is no cash alternative. To activate your AUTOSPORT online account visit <https://secure.autosport.com/subs/activate.php> and enter your activation code (your personal magazine subscriber number which will be included in your welcome email/letter) along with your email address to access your extra AUTOSPORT content. Direct Debit rates are valid for one year after which they are subject to change – should prices change we will inform you in writing. We ask that you enter into a Direct Debit agreement with the intention that your subscription will continue for a minimum period of 12 months, even if the frequency of payment is for a shorter period, however, you will still have the right to cancel your Direct Debit in accordance with Direct Debit Guarantee. Should you wish to cancel your subscription it will be cancelled on expiry of the current term which will not be refundable, other than in exceptional circumstances. If a gift is included as part of the subscription offer we reserve the right to request the return of the gift. Details of the Direct Debit Guarantee are available on request. Savings are based on the standard UK cover price of £3.50. Offer ends December 5, 2013. Haymarket Media Group Ltd uses a best-practice layered Privacy Policy to provide you with details about how we would like to use your personal information. To read the full privacy policy please visit our website [www.haymarket.com/privacy](http://www.haymarket.com/privacy) or call us on 08448 482 800. Please ask if you have any questions as submitting your personal information indicates your consent, for the time being, that we and our partners may contact you about products and services that will be of interest to you via post, phone, e-mail and SMS. You can opt out at ANY time by emailing the [datacontroller@haymarket.com](mailto:datacontroller@haymarket.com) or by calling 08448 482 800.



Winch leads Thomas but things got rough later on



**BMW Super Tourer tests**

Paul Smith tested his BMW E36 320i (above) at Donington Park last week. He hopes to run the car in the Super Touring Trophy in 2014.

**Clios back to Thruxton**

Thruxton has replaced Silverstone on the Clio Cup UK's 2014 calendar. The championship, which is still composed of nine rounds, will now join the BTCC in travelling to the Hampshire circuit on May 3-4. Organisers made the change so drivers and teams can contest the Clio Eurocup, which races at Paul Ricard in France on the Silverstone weekend (September 27-28).

**House returns to VWs**

Double Volkswagen Cup champion Phil House will continue in the category in 2014. The 33-year-old won back-to-back championships in 2004 and 2005, and returned for a full season in 2013 after some time out. "I absolutely loved it," said House, who won once this year driving a new Scirocco. "I now feel ready to really go for it"

**MSVT Team Trophy**

**Drivers excluded after paddock altercation**

**TWO MSVT TEAM TROPHY DRIVERS**

were belatedly excluded and hit with licence penalty points after an "unacceptable" paddock altercation at Brands Hatch earlier this month.

Perry Winch was judged to have driven in the paddock at excessive speed and in an unsafe manner after a Team Trophy race on November 10. Team-mate Andy Wilmot was found guilty of abusive behaviour. The pair's Renault Clio had an

on-track collision with David Thomas' similar car, and their post-race appeal was thrown out due to a lack of witnesses.

According to MSVR's race operations manager David Scott, Winch drove deliberately recklessly through the paddock, while Wilmot "sought out the person he believed was guilty, jumped on the bonnet and kicked both the doors".

Thomas said Wilmot – who is also an ARDS instructor at the circuit – would

also have his case referred to the MSA.

"They both expressed a degree of remorse but it was extreme enough to warrant strong action and that's what it got," he said. "If they [the officials] don't come down heavy, anarchy will rule.

"You don't want to do any of those things just to send a message, but I hope making firm decisions do that. The drivers have got a responsibility to themselves and it's unacceptable behaviour."

**Mini Challenge**

**Mini ace tests BTCC MG6**

**MINI CHALLENGE FRONTRUNNER**

Chris Smiley had his first British Touring Car test last week as a prize from the Mini series.

Smiley won the test in a Triple Eight MG6 after taking nine victories in the Mini Challenge this season (see AUTOSPORT, October 17). He had three runs at Silverstone, under the guidance of BTCC race winner Sam Tordoff.

"The day was absolutely amazing – the realisation of a dream for me," said Smiley. "To get to work with a team as professional as Triple Eight was amazing.

"The MG6 was brilliant to drive. It was more accessible than I'd expected, mainly due to the format of it being front-wheel-drive and turbocharged, like the Mini. But the MG took everything to the next level. It gives you real confidence to push."

Team boss Ian Harrison added: "Chris was very impressive to work with. He wasn't daunted by the day at all and jumped at the chance to try everything we suggested.

"Chris has shown the Mini Challenge can produce its fair share of talent."



Smiley heads out for BTCC run



**V8 IROC racer back on track for 2014 campaign**

Former ASCAR driver Mike Luck had a run in this ex-Al Unser 1977 IROC Chevrolet Camaro at Silverstone last week. Owner John Truslove, who also drove, hopes to run the car in CSCC Special Saloons events next season.

**VTEC Challenge**

**Honda VTECs join classic tin-tops**

**THE HONDA VTEC CHALLENGE**

will join the Classic Touring Car Racing Club for the club's 40th anniversary season in 2014.

The VTEC saloons, which have run alongside the BARC's ailing Production Touring Car Trophy category this year, will now run with the CTCRC's Pre-2005 Production Touring Car grid, which has secured a title sponsorship deal with Toyo Tyres.

Both series will contest seven double-header race meetings on the same grid, but competing to their own separate rules and points structures.

The CTCRC has announced a provisional calendar for 2014, which includes visits to Donington Park, Croft, Snetterton, Silverstone International, Brands Hatch, and an October away day at Spa. The annual Classic Festival will move from Mallory Park to Cadwell Park.

**Scottish racing showcase**

The Scottish Motor Racing Club will host two open evenings next week in a bid to encourage more people into Scottish motorsport. John Clark's Aberdeen BMW dealership (November 26) and Pentland Land Rover dealership in Edinburgh (November 28) will host the events. Speakers will include John Cleland, Ryan Sharp, Lewis Williamson, Glynn Geddie, Rory Butcher, Alasdair McCaig, Ross Wylie and Aiden Moffat.

**Historic Motoring Awards**

Ex-BTCC racer Andy Middlehurst's restoration of Jim Clark's 1966 US GP-winning Lotus 43 was a winner at the Historic Motoring Awards last week. Masters Historic F1 won 'race series of the year', the Aston Martin Owners' Club was named 'club of the year', and the Silverstone Classic claimed 'motorsport event of the year'.

**New work at Donington**

Work has started on a new viewing area near the Craner Curves and Old Hairpin at Donington (below).

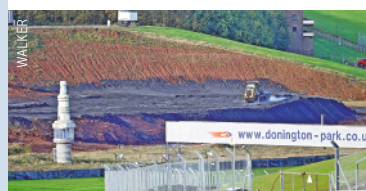

# FASTEST SHOW ON EARTH



**CARS** F1® cars, touring cars, rally cars, oval, performance, historic and karting. **STARS** F1® drivers and motorsport celebrities. **ACTION** Live Action Arena, Caterham Experience and indoor karting track.

**EXHIBITORS** Over 600 motorsport companies, cars, technology, accessories and merchandise.

**TICKETS INCLUDE ACCESS TO THE PERFORMANCE CAR SHOW**

## BOOK NOW

[AUTOSPORTINTERNATIONAL.COM](http://AUTOSPORTINTERNATIONAL.COM)

CALL 0844 581 1370



/Autosport.International.Show



@Autosport\_Show



## AUTOSPORT

INTERNATIONAL

### The Racing Car Show

9 - 12 January 2014 NEC

9-10 January Trade Only Days

**Barnicoat won twice to secure title on single-seater debut**



EBREY

**BARC ROCKINGHAM, NOVEMBER 16**

# Barnicoat makes his mark

MCLAREN PROTEGE BEN BARNICOAT gave the clearest possible indication of his immense potential on his single-seater debut last weekend.

The Racing Steps Foundation-backed driver won two out of three races at Rockingham to seal the Formula Renault Autumn Cup title.

Announcing his arrival in car racing in remarkable style, the 16-year-old bagged a hat-trick of poles, and only a bold first-lap pass in race two by experienced Fortec team-mate Hongwei Cao prevented a clean sweep of wins against a small but strong six-car field.

Barnicoat led from lights-to-flag in round one, scorching to a 6.5s winning margin over MGR rookie Alex Gill, who fought back impressively after too much wheelspin at the start. In only his third race, Gill also shone with some very strong overtaking.

In round two, Cao produced the move of the weekend at Deene on the first lap to rocket from fourth into the lead. Darting to the outside into the braking zone, Cao somehow

found the required grip to pass Jamun's Pietro Fittipaldi, Gill and Barnicoat before opening an incredible 1.7s advantage over the first 1.94 miles of racing. Barnicoat pressured late on, but Cao didn't put a wheel wrong.

Barnicoat was again the star performer in the finale as he sealed the title in winning ways, but he was pressed hard by Fittipaldi during the opening laps. The Brazilian eventually had to settle for third after being passed by Fortec's impressive Croatian rookie Martin Kodric.

Scuderia Vittoria's Devon Modell was prevented from claiming two wins in the non-points scoring Clio Cup Series races. Easing to a clear 7.6s victory in the opener, Modell was forced out of the lead of the 45-minute 'enduro' late on with a broken clutch.

Team-mate and former Legends competitor Jamie Clarke, returning to track action for the first time in several years, was a surprise winner in only his second Clio race.

Norway's Tommy Ostgaard swept

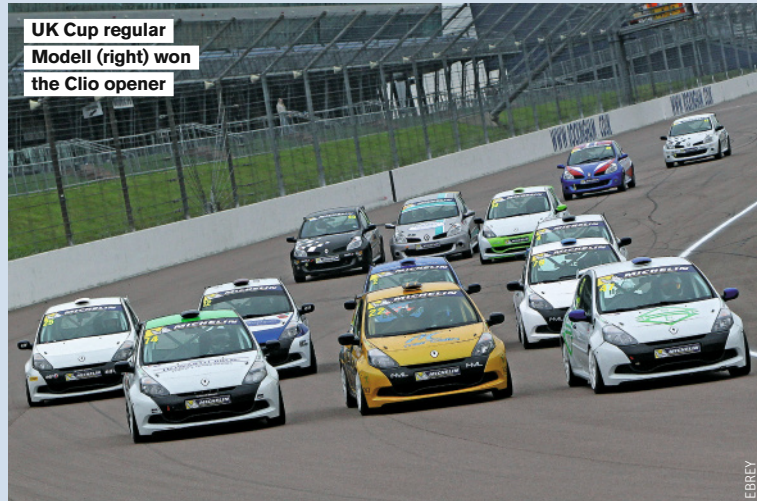

**UK Cup regular Modell (right) won the Clio opener**

EBREY

into the lead at the expense of Modell, but his hopes of victory were dashed three laps from the end when he was caught out by oil at Deene.

Clarke gladly inherited the lead and went on to win by more than 12s from the recovering Ostgaard, while category regular Brett Lidsey finished third. Westbourne Motorsport's newcomer Charles Ladell, meanwhile, starred in race one to finish second ahead of Ostgaard. In the Road Series class, Jake Honour — the cause of the deposited oil in race two — did the

double; his first wins.

David Brooks won both BARC Sports and Saloon encounters at the wheel of his Vauxhall Tigra. He just saw off a race-long challenge from the similar machine of Malcolm Blackman in race one, only 0.1 seconds separating the pair at the end of 14 laps.

In race two he headed home Dale Gent's Subaru, which took second after a see-saw battle with Blackman, who was forced to retire on lap 11.

● Marc Orme

**Gent won this race two battle for second after Blackman (91) retired**



EBREY

**FORMULA RENAULT BARC AUTUMN CUP (ALL 15 LAPS)**

**1 Ben Barnicoat;** 2 Alex Gill +6.512s; 3 Hongwei Cao; 4 Martin Kodric; 5 Yosuke Yamazaki; no other finishers. **Fastest lap** Barnicoat 1m18.430s (89.04mph). **RACE 2 1 Cao;** 2 Barnicoat +0.420s; 3 Gill; 4 Kodric; 5 Pietro Fittipaldi; 6 Yamazaki. **FL** Barnicoat 1m18.180s (89.33mph). **RACE 3 1 Barnicoat;** 2 Kodric +2.430s; 3 Fittipaldi; 4 Cao; 5 Gill; 6 Yamazaki. **FL** Kodric 1m19.007s (88.39mph). **POINTS 1 Barnicoat, 96;** 2 Cao, 79; 3 Kodric, 74; 4 Gill, 73; 5 Yamazaki, 56; 6 Fittipaldi, 45. **CLIO CUP SERIES (14 LAPS) 1 Devon Modell;** 2 Charles Ladell +7.607s; 3 Tommy Ostgaard; 4 Jamie Clarke; 5 Brett Lidsey; 6 Graham Field. **Class winners** Michele Faissola; Jake Honour; Lee Linford. **FL** Modell 1m30.539s

(77.13mph). **RACE 2 (30 LAPS) 1 Clarke;** 2 Ostgaard +12.882s; 3 Lidsey; 4 Ladell; 5 Field; 6 Honour. **CW** Honour; Faissola; Linford. **FL** Modell 1m30.600s (77.08mph)

**BARC SPORTS & SALOON CHALLENGE (BOTH 14 LAPS)**

**1 David Brooks (Vauxhall Tigra);** 2 Malcolm Blackman (Vauxhall Tigra) +0.146s; 3 Dale Gent (Subaru Impreza); 4 Paul Eve (Ford Sierra Sapphire); 5 Malcolm Harding (Mercedes SLK); 6 Ricky Hunn (Peugeot 205). **CW** Stuart Carr (Caterham); Brian Allen (Ford Fiesta XR2i). **FL** Blackman 1m27.059s (80.22mph). **RACE 2 1 Brooks;** 2 Gent +14.061s; 3 Eve; 4 Mike Thurley (Vauxhall Tigra); 5 Hunn; 6 Harding. **CW** Carr; Allen. **FL** Blackman 1m27.224s (80.06mph).

Files came of age  
in 2013 and delivered  
UK and European titles



2013 RENAULT CLIO CUP UK REVIEW

# Files wears Clio crowns

Team Pyro racer bagged titles in Britain and Europe after stepping up from podium finisher to race winner and getting the better of Paul Rivett and Stefan Hodgetts on the TOCA package. By **SCOTT MITCHELL**

ALL PICS: EBREV/LAT

86

The 2013 Renault Clio Cup UK season gave the series' third-generation model an appropriate send-off, with a campaign that featured eight race winners and a new champion.

Two drivers stood out with four wins apiece, but Paul Rivett and Stefan Hodgetts were comprehensively beaten to the title by the consistency of Josh Files. The third-year Team Pyro driver had visited the podium in each of his first two campaigns in Clios, but made a noticeable step up for a season that also ended in the Eurocup Clio title.

Despite Files' eventual winning margin, picking a champion looked extremely difficult in the early stages with five winners in the first six races. After James Colburn and tin-top debutant Alex Morgan (returning to racing after four years out) shared the wins at Brands Hatch, Rivett won twice at Donington Park before Lee Pattison and Hodgetts triumphed at Thruxton.

Rivett's Donington double, which edged him clear in the points, came by beating Files by half a second in

the opener and then just 0.013s in the second race, and their rivalry would come to define the season.

A pair of podiums at Thruxton for Files put him back on the triple champion's tail and, after Rivett moved ahead with a win and third place at Oulton Park, Files fought back again with his maiden Clio win at Croft to lead Rivett by three points into the summer break.

"We'll never give each other an inch, but we'll always leave a car width," said Rivett after leading home Files in the Snetterton opener, reducing the gap to just one point.

From then on Files was in the ascendancy. He triumphed in race two by four seconds as Rivett finished fourth, before the season's big turning point came in the next round at Rockingham.

Rivett had a disaster. Contact on the second lap of the first race with Josh Cook ended his race and he only managed sixth in the sequel as Files, having followed Hodgetts home in the opener, finished second to Ant Whorton-Eales — who had dived past half the grid under braking for Deene on lap one to rocket from 12th to first.

That weekend boosted Files' points lead to 52, or 38 with dropped scores and a minor points penalty — for punting team-mate Morgan into a spin in the Rockingham sequel — accounted for. But if the rivalry lost its edge in Northamptonshire, it was eradicated entirely when Rivett suffered an Achilles tendon injury while instructing at Brands Hatch one week before the decider.

Files only needed to avoid exclusion to wrap up the title and — despite shunting in testing with Pyro team-mate Ash Hand and causing extensive damage to his car — did so with a conservative run to fourth in the first race.

Though that was surprisingly tame for a Clio Cup round, the drama was being saved for the season's final thrash. In a race punctuated by three safety car periods, Cook led Mike Bushell and Whorton-Eales in a six-car battle that looked to be set for a dramatic conclusion when the second safety car dived for the pits with just three laps remaining.

But before the race had a chance to resume properly, fourth-placed Hodgetts lost control on the entry to Clearways and swerved straight across the front of Morgan. Hodgetts was turned into the concrete pitwall as Morgan limped home fourth with severe damage.

Hodgetts' shunt typified a bizarre campaign in which he tied with Rivett as the most successful driver with four wins, taking his tally to 13 out of the 44 races he has contested over three full Clio seasons, but he remains without a title after myriad problems at Brands and Donington stalled his campaign early on.

With his stricken car requiring recovery, the season concluded under the race's third safety car. Cook was victorious in the outgoing Clio's final race, a muted end by the series' frenetic standards. Only time will tell if the new 2014 car can match the expectations set by its predecessor. ❧

## THREE WHO STOOD OUT

### 1 Josh Files

It took 41 races for Files to become a Clio Cup race winner and just six more to become a champion. His consistency was key, and four wins on the continent to take the Eurocup crown capped off a stellar season.

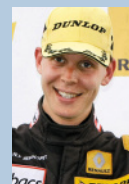

### 2 Alex Morgan

The ex-single-seater racer spent four years on the sidelines before joining the Clio Cup, yet he won the second race of the season and was ever present at the sharp end on his way to second in the points for Team Pyro.

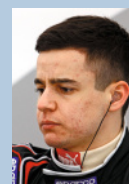

### 3 Paul Rivett

Achilles tendon injury one week before the finale scuppered any chance of an unlikely title triumph. Used all his experience to be right in the mix for a second crown before his race-one nightmare at Rockingham.



## CHAMPIONSHIP STANDINGS

DRIVER (TEAM)	POINTS	WINS
1 JOSH FILES (Pyro)	384	2
2 ALEX MORGAN (Pyro)	330	1
3 PAUL RIVETT (Stancombe)	304	4
4 JAMES COLBURN (Westbourne)	300	2
5 JOSH COOK (JHR)	288	1
6 STEFAN HODGETTS (SV)	276	4

Other winners: Lee Pattison (JHR) 1; Ant Whorton-Eales (SV) 1

2013 PORSCHE CARRERA CUP GB REVIEW

# Meadows at the double

The reigning champion took the wind out of the sails of Dean Stoneman's motor racing comeback by claiming his second consecutive title against a small but strong field. By **SCOTT MITCHELL**

**M**ichael Meadows became the first driver since Damien Faulkner to clinch back-to-back Porsche Carrera Cup GB titles after overcoming a spirited season-long fight from Jonas Gelzinis.

Though the grid peaked at 13 cars in a difficult year, and regularly attracted 10 or fewer, five drivers won races throughout the season. This highlighted a competitive nature to the series belied by its small entry.

While Meadows and Gelzinis utilised four years of experience in the Carrera Cup to emerge as title protagonists, they were both led in the early stages by Porsche rookie Dean Stoneman. Making his return to competitive motorsport after two years on the sidelines battling testicular cancer, the Redline Racing man flew to two wins and the championship lead on his debut at Brands Hatch. He should have won again at Donington, but after qualifying on pole for race one he erred in each encounter to let Meadows through to triumph.

Stoneman led Meadows and Gelzinis in the points as the championship moved to Thruxton, where Meadows qualified on pole. Stoneman made a storming getaway from third to lead into Allard, before cutting across Meadows and sending him spinning. Stoneman ended the race third, behind Daniel Lloyd and Gelzinis, with Meadows sixth after flat-spotting all four tyres in the moment. "I owe him one now," he fumed afterwards.

Meadows bounced back to beat Lloyd to the win in race two as Stoneman retired with a tyre blowout, but amid the controversy, Gelzinis' sixth podium in the first six races had nudged him into a one-point



Meadows (leading) was the first driver since '05 to retain the title

lead over Meadows, with Stoneman now a further 11 points in arrears.

What followed was an incredible sequence of races in which Meadows – desperate for another title after switching from Redline to the Samsung-backed GT Marques squad over the winter – was often the fastest driver, but would follow up dominant performances with costly errors. In his wake would come Jutta man Gelzinis, stealthily picking up points and podiums to remain in the title race, while Stoneman gradually lost touch.

Meadows won twice at Oulton Park and beat Gelzinis to second in the opener at Croft, but was one of the victims in a first-corner accident that wiped out half the field at the start of race two. Stoneman won on the road from pole, but was judged to

have braked deliberately early into the first turn. He disagreed, arguing that a biff from Meadows left him with no choice but to stamp on the brakes, but was excluded nonetheless.

Gelzinis thus inherited the victory but won twice at the next round at Snetterton on merit – aided by Meadows jumping the start and finishing fifth in the opener – to bring himself level on points.

Meadows was back on top at Knockhill with two crushing wins, but then spun into retirement at Rockingham. Gelzinis, who had a poor weekend in Scotland, duly picked up a pair of podiums in Corby to once more move back into championship contention.

But Meadows was faultless at Silverstone, winning the opener before following the returning

## CHAMPIONSHIP STANDINGS

DRIVER (TEAM)	POINTS	WINS
1 MICHAEL MEADOWS (GT Marques)	325	8
2 JONAS GELZINIS (Jutta)	310	3
3 RORY BUTCHER (Celtic Speed)	266	3
4 DANIEL LLOYD (Team Parker)	249	1
5 DEAN STONEMAN (Redline)	231	5
6 VICTOR JIMENEZ (Redline)	194	0

Stoneman – who was banned for the races at Rockingham following another incident at Knockhill – home in the second race as Gelzinis managed a fifth and a third.

That meant the advantage was with Meadows for a finale held in awful October conditions at Brands Hatch. Rory Butcher cruised to victory in the opener as Stoneman crashed out in pursuit, with Meadows third behind Gelzinis – meaning a finish in race two would win the title. Despite qualifying on pole, Meadows started from the pitlane – allegedly to fix a faulty radio – and clinched the crown with sixth, one place behind Gelzinis.

Further ahead, Stoneman completed a rollercoaster season with a robust last-lap pass on Daniel Lloyd to win. His title charge unravelled after his Croft exclusion, but what put the boot in was the suspended two-race ban he picked up at the same time. That was activated at Knockhill after contact with Butcher, which caused him to miss both races at Rockingham. Had he avoided the dramas, who knows how different the outcome might have been. ❧

## THREE WHO STOOD OUT

### 1 Michael Meadows

He made it hard for himself with spins at Brands and Rockingham, and a jump start at Snetterton, but ultimately was a deserving champion. He won the most races and looked on another level in some qualifying sessions.



### 2 Dean Stoneman

Probably the year's main talking point. Fifth in the points might not seem much to write home about, but won five races barely two years after cancer nearly killed him. On-track controversies scuppered his title chances in the end.



### 3 Jonas Gelzinis

All credit to the Lithuanian, who put together a championship challenge despite rarely having the raw speed of his rivals. When he did, he was faultless, and when he didn't he picked up points. An admirable effort.



Ingram's Rockingham display capped an impressive year



2013 GINETTA GT SUPERCUP REVIEW

# Ingram nets his hat-trick

The KX Akademie-backed racer dominated the GT Supercup as a chassis problem scuppered main rival Carl Breeze. **SCOTT MITCHELL** looks back at a stellar season for the ex-Ginetta Junior champion

ALL PICS: EBREV/LAT

**T**om Ingram finally completed the hat-trick of Ginetta titles he had been denied in 2012 with an astonishing display of GT Supercup dominance this season. After his graduation to the G55 category last year yielded six wins and third overall, the 20-year-old was a cut above his rivals this year. Eleven wins and 22 consecutive podium finishes – a run that almost stretched from the first round to the last – meant he added the G55 crown to his Junior and G50 triumphs in 2010 and '11 with five races to go.

Such control of the title fight was not immediately obvious, though. He lay second in the points to Matt Nicoll-Jones after one win on the opening weekend, and though he assumed top spot one round later, he would have to wait until the ninth race of the campaign before he notched up his second.

By then, defending champion Carl Breeze already had five wins to his name, and 17-year-old Pepe Massot – fresh from his first season of car racing in Juniors – had won at both Brands and Donington.

Despite scoring a trio of second places at Donington (round two), and a third, a second and a win at Thruxton (round three), Ingram was not satisfied. “We need consistency,” he admitted after the third round, “but we need wins as well”.

They would not come at Oulton Park – returning Century Motorsport boss Nathan Freke took a sensational double to see to that – but two more second places edged Ingram further clear of Breeze, who was twice off the podium in fourth.

Ingram then blasted to a trio of victories at Croft, while Breeze managed a pair of rostrums in the first two races but failed to finish the

last. More significantly, though, this was the moment Breeze and his Total Control Racing team realised there was a championship-crippling issue.

A serious car problem was apparent, TCR and Ginetta agreed on that, but a raft of changes failed to cure it. The issue lay with the chassis, but as TCR boss Lee Brookes explains, changing it was not a viable option: “We could have given him another car but that would have cost a lot of money. He did a superb job to finish second; you really had to push that car right to the limit.”

Racing wounded in the second half of the year, Breeze won just once more and qualified no higher than 10th in the final three rounds.

With the threat of his main title rival neutralised, Ingram was relentless. He won again at Snetterton, and claimed two podium finishes behind fellow victors Breeze

## CHAMPIONSHIP STANDINGS

DRIVER (TEAM)	POINTS	WINS
1 TOM INGRAM (JHR)	763	11
2 CARL BREEZE (TCR)	626	6
3 MATT NICOLL-JONES (Academy)	521	2
4 ROB BOSTON (JHR)	514	2
5 PEPE MASSOT (JHR)	492	2
6 MARK DAVIES (TCR)	470	1

Other winners: Nathan Freke (Century) 2; Jamie Orton (Century) 1

and Mark Davies, then finished second twice to Nicoll-Jones at Knockhill before brilliantly winning the final race. His performance at Rockingham was the best of the season. He comfortably won the opener before demolishing the rest of the field in the second race, winning by half a minute in an 18-lap race. That put him on the brink of the title, and true to form he wrapped it up with a victory in the opening race at Silverstone, leading home a JHR podium lockout. Another win followed in the second race.

After a campaign of the highest quality, Ingram's season ended prematurely when an ambitious move from Nicoll-Jones at Brands in race one sent him flying into the tyre wall, writing his car off. His retirement – and withdrawal from the remaining two races – did allow another battle to take centre stage, however. This was the fight for third in the points, one in which Nicoll-Jones, Rob Boston, Davies and Massot were engaged. Boston won twice, but Nicoll-Jones just held on with a second and third. ❧

## THREE WHO STOOD OUT

### 1 Tom Ingram

Remarkable season in which he blended his obvious raw ability with title-winning consistency. Was already a winner before main rival Breeze's car woes, which don't detract from his achievements. Eleven wins prove Ingram was the class act.



### 2 Carl Breeze

The 2012 champion won five of the first nine races and was second in the points despite non-finishing twice, but his title bid was derailed by a mysterious chassis problem. Used his experience to wrestle the car to places it didn't belong.



### 3 Pepe Massot

A mid-season dip cost the young Spaniard (who only turned 18 after the season finished) to third in the points. Two wins in the first six races suggest the Junior graduate is a special talent. If he stays for next season, he'll be a title challenger.

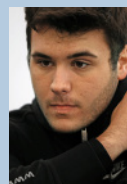



2013 GINETTA JUNIOR REVIEW

# Woodhead is a cut above

The 2012 Ginetta Junior Winter Champion carried that momentum into this season to get the better of his older rivals, giving HHC Motorsport its second consecutive crown. **By SCOTT MITCHELL**



Woodhead in familiar territory: leading the field at Thruxton

## THREE WHO STOOD OUT

### 1 Harry Woodhead

Ten wins from the first 10 races and a podium from every race he started. Nobody can doubt that Woodhead was the driver most deserving of the title this year. Was dominant despite being younger than his main rivals.

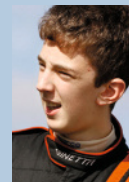

### 2 Keith Donegan

Emerged as the driver likeliest to beat Woodhead in the second half of the year. Snetterton win was superb. Silverstone double was even better, as he bested the champ (no longer driving for the title) in a straight fight.

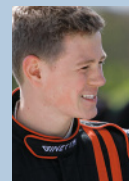

### 3 James Kellett

Ended the year only sixth, but top rookie – a good omen if he chooses to return in 2014. He was on the podium in his first meeting, managed to clinch his first win, and generally showed well throughout. Also dominated the winter series.



**W**ith the notable exception of rookie winner Nigel Moore, this season Harry Woodhead replicated the efforts of every Ginetta Junior champion before him.

The HHC Motorsport driver laid the groundwork in his debut season last year, picking up five podiums on his way to a credible sixth overall, ticking all the boxes before attempting the prerequisite title challenge in his sophomore campaign. He wrapped up the Winter Series title shortly before his 15th birthday and hit the ground running when the main series kicked off at Brands Hatch in spring.

Any hopes that the equally experienced Ollie Chadwick, Keith Donegan and Will Palmer would help replicate the titanic title fight between 2012 equivalents Charlie

Robertson, Sennan Fielding and Niall Murray were short-lived. As early leaders Tom Jackson and Donegan faltered in the opener, Woodhead pounced – setting a trend for the year by being faultless while his rivals dropped the ball. That he won the second race at a canter while a train of cars scrapped over second place was also a sign of things to come.

Woodhead repeated 2011 champion Seb Morris' feat of winning the opening four races by extending his run of victories at Donington Park, but unlike Morris he would not stop there. At Thruxton, Oulton Park and Croft, his rivals – often led by Chadwick or Palmer, with Donegan in the mix as well – would try to get on terms with the 15-year-old, but each time they would be bested.

By the time the championship reached mid-distance, Woodhead's perfect 10 was a far cry from the form of his rivals, all of whom struggled even to string together two consecutive podiums. But over the summer break, his challengers regrouped – and came out fighting.

At Snetterton, Donegan claimed his first win in the opener, while a superb move from rookie Jack Mitchell earned him a breakthrough

victory in the second race. But Woodhead was ever present in both fights, and emerged with a pair of second placed finishes.

Donegan won the opener at Knockhill as well, before Woodhead matched Morris' win tally from 2011 with his 11th victory. Chadwick notched up his third retirement of the year, but Palmer was beginning to find form and scored a pair of podium finishes. That continued at Rockingham, where Palmer finally strung it all together to complete what he had threatened to do at Thruxton (scene of his first pole) and took a win. The opening race heralded another new winner as well – James Kellett – who, like Mitchell, was contesting his first year of car racing.

Second and third at Rockingham was enough to secure Woodhead the title, but he wanted more than that and entered Silverstone with one goal: getting the standalone win record for the season. Donegan, however, had other plans. The Irishman completed his transformation into the best driver behind Woodhead by taking a terrific double, as once again Chadwick (who started race one from pole) and Palmer came undone in the middle of the lead pack.

## CHAMPIONSHIP STANDINGS

DRIVER (TEAM)	POINTS	WINS
1 HARRY WOODHEAD (HHC)	609	11
2 KEITH DONEGAN (Douglas)	475	4
3 WILL PALMER (HHC)	406	1
4 OLLIE CHADWICK (JHR)	394	2
5 TOM JACKSON (Privateer)	390	0
6 JAMES KELLETT (HHC)	365	1

Other winners: Jack Mitchell (Privateer) 1



Teddington Studios, Broom Road, Teddington, Middlesex TW11 9BE, UK.  
Tel: +44 (0) 20 8267 5804 Fax: +44 (0) 20 8267 5922  
E-mail: mail@autosport.com Website: www.autosport.com

**EDITOR-IN-CHIEF**  
Andrew van de Burgt  
andrew.vandeburgt@haymarket.com ext.5974

**EDITOR**  
Charles Bradley  
charles.bradley@haymarket.com ext.5889

**GROUP F1 EDITOR**  
Jonathan Noble ext.5810  
jonathan.noble@haymarket.com

**F1 EDITOR**  
Edd Straw ext.5887  
edd.straw@haymarket.com

**FEATURES EDITOR**  
Kevin Turner ext.5432  
kevin.turner@haymarket.com

**NEWS EDITOR**  
Glenn Freeman ext.5309  
glenn.freeman@haymarket.com

**REPORTS EDITOR**  
Jamie O'Leary ext.5811  
jamie.oleary@haymarket.com

**MANAGING EDITOR**  
Peter Hodges ext.5903  
peter.hodges@haymarket.com

**RALLIES EDITOR**  
David Evans  
david.evans@haymarket.com

**DEPUTY NEWS EDITOR**  
Sam Tremayne ext.5952  
sam.tremayne@haymarket.com

**ART EDITOR**  
Lynsey Row ext.5914  
lynsey.row@haymarket.com

**PRESENTER/SUB-EDITOR**  
Henry Hope-Frost ext.5835  
henry.hope-frost@haymarket.com

**CHIEF SUB-EDITOR**  
Marcus Simmons ext.5807  
marcus.simmons@haymarket.com

**NATIONAL EDITOR**  
Ben Anderson ext.5425  
ben.anderson@haymarket.com

**SENIOR DESIGNER**  
Michael Cavalli

**PICTURE EDITOR**  
Peter Mills ext.5918  
peter.mills@haymarket.com

**AUTOSPORT.COM TECHNICAL TEAM LEADER**  
Geoff Creighton  
geoff.creighton@haymarket.com

**AUTOSPORT.COM DEVELOPER**  
Tomasz Trznadel  
tomasz.trznadel@haymarket.com

**AUTOSPORT.COM USER INTERFACE DEVELOPER**  
Theo Pape  
theo.pape@haymarket.com

**OFFICE MANAGER**  
Joanne Grove  
joanne.grove@haymarket.com ext.5804

**PHOTOGRAPHS**  
LAT Photographic

**SPECIAL CONTRIBUTORS**

Mark Hughes	Dieter Rencken
Gary Watkins	Gary Anderson
Marcus Pye	Giorgio Piola
Mark Glendenning	Alan Eldridge
	Jim Bamber
	Pablo Elizalde
	Matt Beer

**CORRESPONDENTS**

<b>ARGENTINA</b> Tony Watson	<b>ITALY</b> Roberto Chinchero	Martin, David Phillips,
<b>AUSTRALIA</b> Phil Branagan	<b>JAPAN</b> Iro Takahashi, Len Clarke	Diego Mejia, Robin Miller,
<b>AUSTRIA</b> Gerhard Kuntzsch	<b>NEW ZEALAND</b> Bernard Carpinter	Jeremy Shaw
<b>BELGIUM</b> Gordon McKay	<b>RUSSIA</b> Gregory Golyshov	<b>UK &amp; EIRE</b> Jonathan Crawford,
<b>BRAZIL</b> Lito Cavalcanti	<b>SOUTH AFRICA</b> Richard Asher	Dan Cross, Kerry Dunlop,
<b>FINLAND</b> Esa Illoinen	<b>SPAIN</b> Raimon Duran	Leanne Fahy, Paul Healy,
<b>GERMANY</b> Rene de Boer	<b>SWEDEN</b> Tege Tornvall	Paul Jurd, Linda Keen,
<b>GREECE</b> Dimitris Papadopoulos	<b>USA</b> Jonathan Ingram, Bruce	Mark Libbeter, Stephen
		Lickorish, Scott Mitchell,
		Marc Orme, Graham Read,
		Hal Ridge, Peter Scherer,
		Ian Sowman, Oliver
		Timson, Ian Titchmarsh,
		Matt Upton, Eddie Walder,
		Richard Young

**ADVERTISING**  
Tel: +44 (0) 20 8267 5820  
Fax: +44 (0) 20 8267 5850  
E-mail: autosport.ads@haymarket.com

**COMMERCIAL MANAGER**  
Rachel Brock,  
ext: 5820  
rachel.brock@haymarket.com

**DISPLAY ADVERTISING**  
Gary-Lee Hoebbeck,  
ext: 5276  
garylee.hoebbeck@haymarket.com

**LUKE RICKETTS**  
Luke Ricketts,  
ext: 5961  
luke.ricketts@haymarket.com

**DON RUPAL**  
Don Rupal,  
ext: 5244  
don.rupal@haymarket.com

**CLASSIFIED ADVERTISING**  
Peter Musumeci,  
ext: 5992  
peter.musumeci@haymarket.com

**SUBSCRIPTIONS**  
UK 0844 8488817  
OVERSEAS +44 (0)1795 592 974  
EMAIL  
autosport@servicehelpline.co.uk  
AUTOSPORT, ISSN number 0269946X,  
is published weekly by Haymarket Media Group, Teddington Studios, Broom Road, Teddington TW11 9BE, United Kingdom. The US annual subscription price is \$225. Airfreight and mailing in the USA by agent named Air Business Ltd, c/o Worldnet Shipping Inc., 156-15, 146th Avenue, 2nd Floor, Jamaica, NY 11434, USA. Periodicals postage paid at Jamaica NY 11431. Subscription records

**BACK ISSUES**  
Tel: 0844 8488817

**MARKETING MANAGER**  
Karen McCarthy, ext: 5658  
karen.mccarthy@haymarket.com

**LICENSING AND SYNDICATION LICENSING MANAGER**  
David Ryan, ext: 5024

**DIGITAL SPECIAL PROJECT MANAGER**  
Simon Strang, ext: 5093  
simon.strang@haymarket.com

**DIGITAL PRODUCT MANAGER**  
Simon Grayson, ext: 5346  
simon.grayson@haymarket.com

**CIRCULATION/TRADE ENQUIRIES**  
Frontline Ltd, Park House, 17 Park Road, Peterborough, Cambs, PE21 2TS. Tel: +44 (0)1733 555161. Printed in England by Wyndeham Heron Ltd. Cover and centre sections printed by CSM Impact, Basingstoke. Colour origination: FMS, 90-92 Pentonville Road, London N1 9HS. ISSN 0269-946X. AUTOSPORT, incorporating Autoclassic, is published weekly by Haymarket Consumer Media, Teddington Studios, Broom Road, Teddington, TW11 9BE, UK.

**EDITORIAL DIRECTOR**  
Mark Payton

**CREATIVE DIRECTOR**  
Paul Harpin

**STRATEGY AND PLANNING DIRECTOR**  
Bob McDowell

**PUBLISHING DIRECTOR**  
Patrick Fuller

**MANAGING DIRECTOR**  
David Prasher

**CHIEF EXECUTIVE**  
Kevin Costello

Haymarket is certified by BSI to environmental standard ISO14001

PEFC Certified  
This product is from sustainably managed forests and controlled sources  
www.pefc.co.uk

# THIS WEEK

LETTERS • BEST PICS • LATEST GEAR • ON TRACK & SCREEN • ONLINE

## What you think of the motorsport news of the past week



Spectator Stages make rally action more fan friendly

## Rallying stages a revival

Great to see 'Spectator Stages' back on Rally GB. Kimmel Park was awesome! Having on-site catering, entertainment, shops and the big-screen made a big difference to us, especially my two boys who were blown away by it and will now be rally fans forever.

Taking them into the forests has never appealed, even though that's purist rally action, so the Kimmel stage was a halfway

house but worked well.

It begs the question, why can't WRC do live stages? Clearly it's not impossible judging by the evidence on the big screen. One request to the organisers: can we see more rally action from the stages and hear more from the drivers? Otherwise, I'm a very satisfied customer who'll come again.

**Dean Rappleton (and family), by email**

### If Wales Rally GB proved one

thing, it is that the public's enthusiasm for rallying remains as strong as ever.

The event felt reinvigorated, attracting an overwhelming number of spectators at times. The sheer quantity of people trying to access Saturday's Chirk Castle spectator stage took everybody by surprise and left some disappointed. We apologise to anybody who missed out; they can rest assured important lessons will be learned.

We pay tribute to the 3500 volunteer marshals and officials who ensured that the rally ran safely and effectively. Further thanks go to a new addition this year: our team of Rally Makers.

We also thank all the competitors, organising team, emergency services, landowners, fans and media who contributed so much. We are also very appreciative of Toyota's support in providing the base for our service park

and Rally HQ at its plant in Deeside.

Finally, we extend our gratitude to the Welsh Government for its continued support, and to its local counterparts.

**Andrew Coe, chief executive, International Motor Sports Rob Jones, acting chief executive, Motor Sports Association**

### Lotus's decision to run Heikki

Kovalainen instead of Davide Valsecchi is evidence that the reserve driver programme is a travesty. What's the point of nurturing a talent within the team only to give the drive to someone else when the opportunity arises?

**Michele Robecchi By email**

### Pastor Maldonado needs to

look at himself when having problems. Blaming Williams at the US GP, even claiming 'sabotage', is preposterous.

No team would do such a thing. I bet they can't wait to see the back of him.

**Richard Hargrave Hitchin**

### I felt compelled to write to add

my thanks to Jim Bamber for providing so much laughter over the years I've been reading AUTOSPORT!

As an F1 fan of nearly 20 years, Jim's cartoons have been a much-loved constant. The ironic twists on rivalries and dramas were captured brilliantly and so uniquely. I can still remember drawing the drivers in 'Bamber style' in the back of my school exercise books!

I was lucky enough to meet Jim at AUTOSPORT International. The attention he was getting is proof that you don't need to be an F1 driver to generate a following in the sport.

**Naomi Gotts By email**

# In pictures

Exciting images around the globe, from Texas to Miami, via North Wales



**VW IS WRC'S KING OF THE CASTLE**  
 Andreas Mikkelsen howls past Chirk Castle during Wales Rally GB en route to fifth place. His team-mates Sebastien Ogier and Jari-Matti Latvala took a dominant one-two

ROSE/GETTY

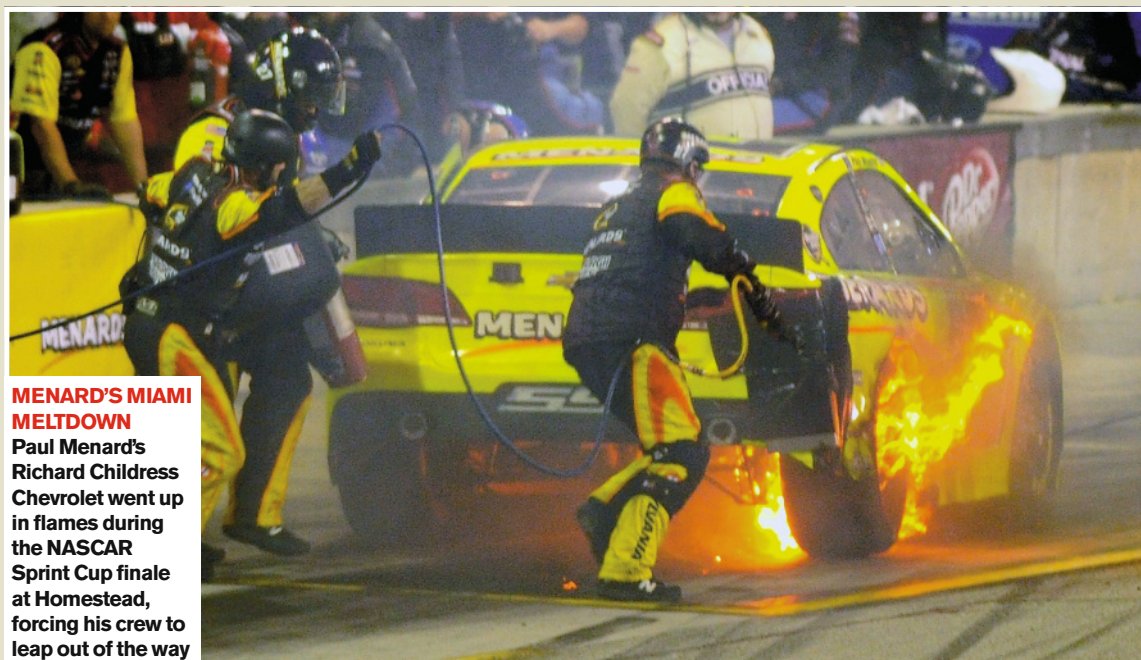

**MENARD'S MIAMI MELTDOWN**  
 Paul Menard's Richard Childress Chevrolet went up in flames during the NASCAR Sprint Cup finale at Homestead, forcing his crew to leap out of the way

TILTON/LAT



**THESE BOOTS ARE MADE FOR GRID WALKING**  
 The US Grand Prix grid girls appeared resplendent in red cowboy (cowgirl, surely?) boots while doing their thing ahead of the race in Texas

TEE/LAT

**McLAREN FANS GET TO TOON IN AT AUSTIN**  
 A Mexican fan gets to pose with 'Sergio Perez' and 'Jenson Button', the stars of McLaren's viral cartoon sensation *Tooned*, during the US GP weekend



COATES/LAT

## In the shops

Desirable new releases

### 'FORMULA LEGEND' GAME

Free - itunes.com

This iPhone game lets you focus on the strategic elements of grand prix racing as you try to work your way from the back to the front of the grid through a career mode. As well as managing tyre and fuel usage, in-race challenges such as reacting to the start, performing two-second pitstops and negotiating sections of track and/or backmarkers all play a part in determining your results.

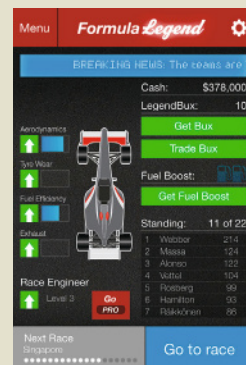

### REVELL RED BULL RB8 MODEL

£22.99 RRP - revell.eu

Revell's latest plastic kit is a highly detailed (particularly at this price) replica of the Red Bull RB8 driven to a third world title in 2012 by Sebastian Vettel. The 1:24-scale model comes with engine, rear diffuser and suspension that apes the real thing. The sister #2 car of Mark Webber that helped Red Bull to a hat-trick of constructors' crowns is also available. All you need to complete this miniature world-beater is paint, glue and patience.



### McLAREN IPHONE 5 COVER

£10.49 - autosport.com/shop

McLaren's popular online *Tooned* cartoon series has spread its wings and can now be found on this official iPhone 5 cover. Featuring images of 'Jenson' and 'Sergio' and their tech chief Professor M (voiced by Alexander Armstrong) on the back, as well as contrast edging, the cover is made from a durable softshell material and allows access to the camera, buttons and charging socket.



# WHAT'S ON

## ON TRACK IN THE UK

### BRANDS HATCH

**MSVR**

**November 23**

[brandshatch.co.uk](http://brandshatch.co.uk)

Three drivers are covered by just two points in the race to land the inaugural BRDC F4 Winter Championship title. Matthew Graham and series debutant Jake Cook split the wins in the first round and share the championship lead, too, with Falco Wauer just a couple of points behind. Other races include the non-points scoring Britcar 'winter warmer', and the night-time finale to the series' Production Championship.



Cook takes a share of the series lead to Brands

FOLRMULAA.COM

## ON TRACK AROUND THE WORLD

Lowndes leads Whincup by just six points in the V8 Supercar title battle



HORSBURGH/LAT

### BRAZILIAN GRAND PRIX

**Formula 1 World Championship**  
Rd 19/19  
Interlagos, Brazil  
November 24  
[formula1.com](http://formula1.com)

### V8 SUPERCARS

Rd 13/14  
Phillip Island, Australia  
November 23-24  
[v8supercars.com.au](http://v8supercars.com.au)

### FIA GT SERIES

Rd 6/6  
Baku, Azerbaijan  
November 23-24  
[fiagt](http://fiagt.com)

### SUPER TC2000

Rd 12/12  
San Luis, Argentina  
November 24  
[super-tc2000.com.ar](http://super-tc2000.com.ar)

Vettel will be out to make it nine in a row in the final GP



FERRARO/LAT

Your guide to the best events taking place in the UK and around the world – plus TV and online

## ON TELEVISION

### THURSDAY NOVEMBER 21

0715-0745, 1500-1530 **Eurosport**  
 Inside the WTCC  
 1300-1345 **Sky Sports F1 LIVE**  
 F1 Brazilian GP:  
 Drivers' Press Conference  
 1800 **Sky Sports 4**  
 Johnny Mowlem's World Travels  
 2000-2200 **Sky Sports F1**  
 Classic F1: Brazilian GP 2008  
 2305-0040 **Motors TV**  
 F3 Macau GP: Highlights

### FRIDAY NOVEMBER 22

1105-1145 **Sky Sports F1**  
 Classic F1: Brazilian GP 1993  
 1145-1350 **Sky Sports F1 LIVE**  
 F1 Brazilian GP: Free Practice 1  
 1300-1445 **BBC2 LIVE**  
 F1 Brazilian GP: Free Practice 1  
 1350-1545 **Sky Sports F1**  
 Classic F1: Brazilian GP 2001  
 1545-1800 **Sky Sports F1 LIVE**  
 F1 Brazilian GP: Free Practice 2  
 1555-1735 **BBC2 LIVE**  
 F1 Brazilian GP: Free Practice 2  
 1800-1845 **Sky Sports F1 LIVE**  
 F1 Brazilian GP:  
 Team Principals' Press Conference

### SATURDAY NOVEMBER 23

0350-0420 **Channel 5**  
 Motorsport Mundial  
 0855-0955 **ITV4**  
 Motorsport UK  
 1245-1410 **Sky Sports F1 LIVE**  
 F1 Brazilian GP: Free Practice 3  
 1255-1405 **BBC2 LIVE**  
 F1 Brazilian GP: Free Practice 3

1300-1400 **ESPN**  
 NASCAR Sprint Cup:  
 Homestead Highlights  
 1300-1420 **Motors TV**  
 V8 Supercars: Phillip Island Race 1  
 1500 **Sky Sports 3**  
 Johnny Mowlem's World Travels  
 1500-1745 **Sky Sports F1 LIVE**  
 F1 Brazilian GP: Qualifying  
 1500-1720 **BBC1 LIVE**  
 F1 Brazilian GP: Qualifying  
 1530-1705 **Motors TV LIVE**  
 FIA GT: Baku Qualifying Race  
 1745-1945 **Sky Sports F1**  
 Classic F1: Brazilian GP 2003

### SUNDAY NOVEMBER 24

0815-1035 **Motors TV LIVE**  
 FIA GT: Baku Championship Race  
 0840-0940 **ITV4**  
 WRC: Rally GB Highlights  
 1215-1415 **Sky Sports F1**  
 Classic F1: Brazilian GP 2007  
 1300-1500 **Motors TV**  
 V8 Supercars: Phillip Island  
 Races 2 and 3  
 1500-1815 **Sky Sports F1 LIVE**  
 F1 Brazilian Grand Prix  
 1500-1805 **BBC1 LIVE**  
 F1 Brazilian Grand Prix  
 1900-2000 **BBC2**  
 F1 Brazilian GP: Highlights  
 2100-2200 **Sky Sports F1**  
 F1 Brazilian GP: Highlights

### MONDAY NOVEMBER 25

0215-0305 **ITV**  
 Motorsport UK  
 2100-2305 **Motors TV**  
 FIA GT: Baku Highlights

## ONLINE

### HOT ON THE WEB THIS WEEK

**YouTube** HIRVONEN BRINGS DIRE WRC SEASON TO MUDDY END



**SEARCH FOR:** CRASH: Mikko Hirvonen/ Jarmo Lehtinen @ Wales Rally GB 2013 (1:36)  
 In what may well prove to be his final WRC event in a Citroen DS3, Finn Mikko Hirvonen goes ploughing in the Myherin test during last weekend's Wales Rally GB. Co-driver Jarmo Lehtinen takes the blame for failing to tell Mikko that the flat-out corner wasn't quite flat.

### AUTOSPORT+

Exclusive content coming up in our premium website this week

AUTOSPORT's F1 team analyses the events of Austin last weekend before looking ahead to the finale at Interlagos, including an interview with Brazilian star Felipe Massa as he heads into his final race as a Ferrari driver. We also look at what was good and what was not about this year's Wales Rally GB.

### GET AUTOSPORT ON THE MOVE

- IN THE IPAD ISSUE THIS WEEK...
- HIGHLIGHTS FROM RALLY GB, INC HIRVONEN'S CRASH
- ON SALE ALL OVER THE WORLD FOR ONLY £2.99

Download it now from [autosport.com](http://autosport.com)



# Revved up over what's on the box

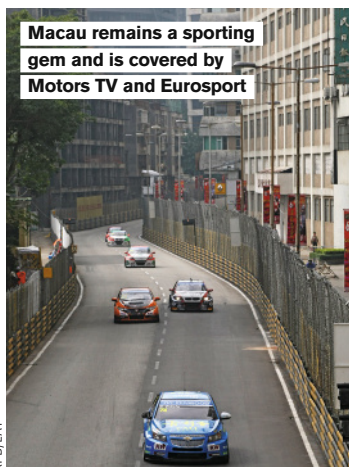

Macau remains a sporting gem and is covered by Motors TV and Eurosport

ONE EASY WAY OF ESTABLISHING what sort of motorsport 'fan' you may have encountered is to ask their opinion on the Macau Grand Prix. If they stare back blankly, they're probably part of the myopic F1-only set and therefore further conversation is unnecessary.

If there's even a hint of recognition that it's one of the greatest sporting events in the world, never mind in racing, you've found someone worth speaking to.

Given the time zone it's in, live coverage is not essential, especially as between them Motors TV and Eurosport had all the race action comprehensively covered.

The WTCC action on Eurosport was done with its usual zeal, but Motors got off to a stuttering start when the Porsche

Carrera Cup Asia race began commentary-free. Had the race been for slightly more interesting-sounding cars, this might have been no bad thing, but when a horrible piece of feedback heralded the arrival of the excitable Simon Hill, it was a blessed relief.

Mark Cole joined the comms team for the impressive line-up of Scirocco Masters. But he and Hill took an age to react to the starline crash between Steve Soper and Stefan Johansson because they were too busy prattling on about it having happened previously to notice it had happened again!

Before the main F3 event, we were treated to a re-run of the qualifier, which featured some cracking onboard footage

from the car of Antonio Felix da Costa. But once again their reaction time to anything taking place mid-prattle was slower than a Cliff Thorburn safety shot.

Garrulously, the misses continued into the feature, in which Alex Lynn had almost made it to Lisboa before Hill noticed he'd made a cracking start, while Raffaele Marciello's huge crash had finished before they'd spotted it had started. It was highly annoying, but not enough to detract from the spectacle.

The races were lacking in excitement for the wins – with Lynn's effort exceptionally good – but watching drivers keep off the walls of the best track in the world simply never gets dull.

**Revved Up**

# Guy Frequelin

“We were leading Sandro Munari by one second – it was incredible”

■ Monte Carlo Rally ■ January 19-23, 1976 ■ Porsche 911 ■ Leading the famous event he loved



Frequelin's Porsche led the '76 Monte but fell back to seventh

MCKLEIN/DAE

**MAYBE I SHOULD SAY THE** Rally of Argentina in 1981 is my best memory from being a rally driver. You know, in this year I won the rally in a Lotus Sunbeam, with Jean Todt co-driving, but I won it with a collar around my neck. I had a problem with my neck after a very big jump and it took many injections with some painkillers to get me to the end.

But I think, for me, it has to be Rallye Monte Carlo. Just the name of this event is so special. I like this rally, I really like it. It's so difficult – all the time you never know what is coming around the next corner. I did Monte Carlo a lot of times and I think I led the event three or four times, but I never won it – even though I had some good speed during the rally.

The most important one for me and the rally which I will always remember was the 1976 event. The year before I had driven an Alfa Romeo [2000 GTV] and

finished in the top 10 [eighth], but for this year – 1976 – I had a Porsche 911, a Group 3 car, and Jacques Delaval as my co-driver.

Before the rally started, we had to choose which tyres we wanted to use. In those days, the rally was really, really long and we had to go through a lot of stages in Sanremo before we got into France. We had

to choose between a slick tyre with a small design and some studs or we take the narrow snow tyre without the stud. We chose to take the narrow tyre, a Michelin.

We were fighting hard against the Lancia Stratos of [Sandro] Munari and when we came out of Sanremo, we were four minutes and 26 seconds behind him. Mid-way

through the second day we got to the Saint Jean-en-Royans stage, which was 38 kilometres long. We stayed on the narrow tyre and we made some good time through this stage. We were four minutes and 27 seconds faster than Munari! We were now leading by one second. It was incredible!

It was a shame though, because on the road to Burzet (two stages later) we had a problem with the gearbox and we broke first gear. We were not the leader after that and in the end we finished further back, in seventh place. Just to talk about these stages, Saint Jean-en-Royan and Burzet brings back the memories and makes me remember this rally fondly – especially when we were leading.

I did the rally many more times and scored some nice results – I was third in 1978 and second in '81 – but it was always a shame that I didn't win the event that I liked so much. ✘  
*Guy Frequelin was talking to David Evans*

## PROFILE



**GUY FREQUELIN TOOK ONE** WRC win, in Argentina in '81, with future FIA president Jean Todt, and finished second to Ari Vatanen in the final points. When he retired from driving, Frequelin took control of Citroen Racing, initially running its Dakar assault and then its vastly successful WRC campaign with Sebastien Loeb – a driver Frequelin (known as 'Grizzly') mentored. He retired at the end of 2007.

**NEXT WEEK** FULL BRAZILIAN GRAND PRIX REPORT  
Plus: We drive the BTCC-winning Honda!

# Driving in France?

You'll need one of these by law



On 1st March 2013 the French Government made it law for all vehicles travelling in France to carry an unused 'NF' approved alcohol breathalyser, like the AlcoSense NF breathalyser.

At only £5.99 for a Twin Pack AlcoSense will keep you safe and legal in France. Available now at Halfords and [www.alcosense.co.uk](http://www.alcosense.co.uk).



Scan here for more info or to order



Available Nationwide from

**that's helpful that's**  
**halfords**

# alcoSense®

ALCOHOL BREATHALYSER

Order at [www.alcosense.co.uk](http://www.alcosense.co.uk) or call **0800 195 0088**

Certified to NFX20-702, Certificate No. 5030. Now Group UK Ltd, Unit 3, Maidenhead Enterprise Centre, Cordwallis Street, Maidenhead, Berkshire SL6 7BE

# The new A-Class.



A Daimler Brand



**Mercedes-Benz**  
The best or nothing.

Official government fuel consumption figures in mpg (litres per 100km) for new A-Class range: urban 32.1 (8.8) - 62.8 (4.5), extra urban 48.7 (5.8) - 85.6 (3.3), combined 40.9 (6.9) - 74.3 (3.8). CO<sub>2</sub> emissions: 161 - 98 g/km. Official EU-regulated test data are provided for comparison purposes and actual performance will depend on driving style, road conditions and other non-technical factors. The new A-Class range starts from £20,370.00 on-the-road. Model featured is a new A 45 AMG 4MATIC at £39,715.00 on-the-road featuring optional Intelligent Light System at £570.00, 19" AMG alloy wheels multi-spoke design painted black at £970.00 and brake callipers painted red at £330.00 (on-the-road price includes VAT, delivery, 12 months' Road Fund Licence, number plates, first registration fee and fuel). Some combinations of features/options may not be available. Please contact your Mercedes-Benz Retailer for availability. Prices correct at time of print 10/13.