



MODEL X

EMERGENCY RESPONSE GUIDE

This guide is intended only for use by trained and certified rescuers and first responders. It assumes that readers have a comprehensive understanding of how safety systems work and have completed the appropriate training and certification required to safely handle rescue situations. Therefore, this guide provides only the specific information required to understand and safely handle the fully electric Model X in an emergency situation. It describes how to identify Model X, and provides the locations and descriptions of its high voltage components, airbags, inflation cylinders, seat belt pre-tensioners, and high strength materials used in its body structure. This guide includes the high voltage disabling procedure and any safety considerations specific to Model X. Failure to follow recommended practices or procedures can result in serious injury or death.

The high voltage battery is the main energy source. Model X does not have a traditional gasoline or diesel engine and therefore does not have a fuel tank. The Model X comes in various types. The images in this guide might not match the vehicle you are working on.



Safety Information.....	2	Opening the Falcon Wing Doors Without Power.....	24
Warnings.....	2	Removing the Falcon Wing Door.....	25
Identifying the Vehicle	3	High-Tension Springs.....	26
Badging.....	3	Opening the Hood.....	27
Touchscreen.....	4	Opening the Trunk.....	28
Electric Vehicle Components.....	5	High Voltage Labels.....	29
High Voltage Components.....	5	Example of a High Voltage Label.....	29
High Voltage Battery.....	6		
DC-DC Converter and Front Junction Box.....	7		
High Voltage Cables.....	8		
Charger.....	9		
Drive Units.....	10		
12V Battery.....	11		
Stabilizing the Vehicle.....	12		
Chock All Four Wheels.....	12		
Shift Into Park.....	12		
Disabling the High Voltage System.....	13		
Front Trunk First Responder Cut Loop.....	13		
Cutting the First Responder Loop.....	14		
Airbags and Components.....	15		
Airbags.....	15		
Airbag Inflation Cylinders.....	16		
Seat Belt Pre-Tensioners.....	17		
Reinforcements.....	18		
Reinforcements and Ultra High Strength Steel.....	18		
No Cut Zones.....	19		
Rescue Operations.....	20		
Fully or Partially Submerged Vehicles.....	20		
Pushing on the Floor Pan.....	20		
Firefighting.....	20		
High Voltage Battery - Fire Damage.....	21		
Lifting the Vehicle.....	22		
Lift Areas.....	22		
Opening the Vehicle.....	23		
Using the Key.....	23		
Opening the Doors With Power.....	23		
Opening the Doors With or Without Power.....	23		
Opening the Falcon Wing Doors With Power.....	24		



This document contains important instructions and warnings that must be followed when handling Model X in an emergency situation.

WARNINGS

- ⚠ Warning: Always use appropriate tools, such as a hydraulic cutter, and always wear appropriate personal protective equipment (PPE) when cutting Model X. Failure to follow these instructions can result in serious injury or death.
- ⚠ Warning: Regardless of the disabling procedure you use, ALWAYS ASSUME THAT ALL HIGH VOLTAGE COMPONENTS ARE ENERGIZED! Cutting, crushing, or touching high voltage components can result in serious injury or death.
- ⚠ Warning: After deactivation, the high voltage circuit requires two minutes to de-energize.
- ⚠ Warning: The supplemental restraint system (SRS) control unit has a backup power supply with a discharge time of approximately ten seconds. Do not touch the SRS control unit until after 10 seconds.
- ⚠ Warning: Handling a submerged vehicle without appropriate PPE serious injury or death can result.
- ⚠ Warning: When fire is involved, consider the entire vehicle energized and DO NOT TOUCH any part of the vehicle. Always wear full PPE, including self-contained breathing apparatus (SCBA).
- ⚠ Warning: When cutting the first responder loop, double cut to remove an entire section. This eliminates the risk of the cut wires accidentally reconnecting.
- ⚠ Warning: Never cut the high tension springs attached to the falcon wing doors. These springs might cause portions of the door to rise rapidly if the weight of the doors is reduced through the removal process. Serious injury or death can result from cutting or rapidly releasing the high tension springs.



BADGING

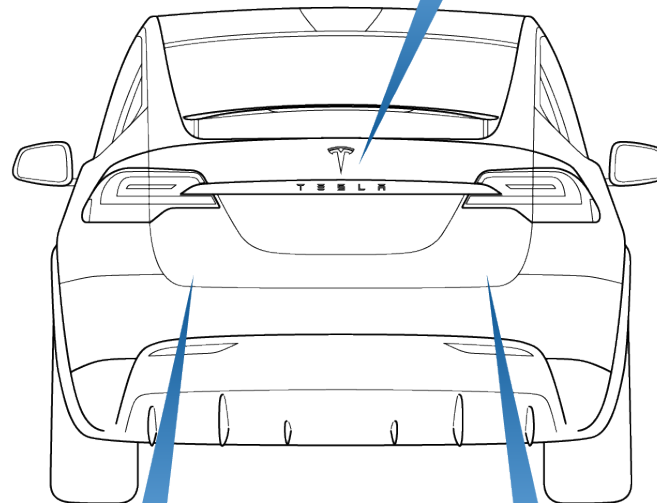
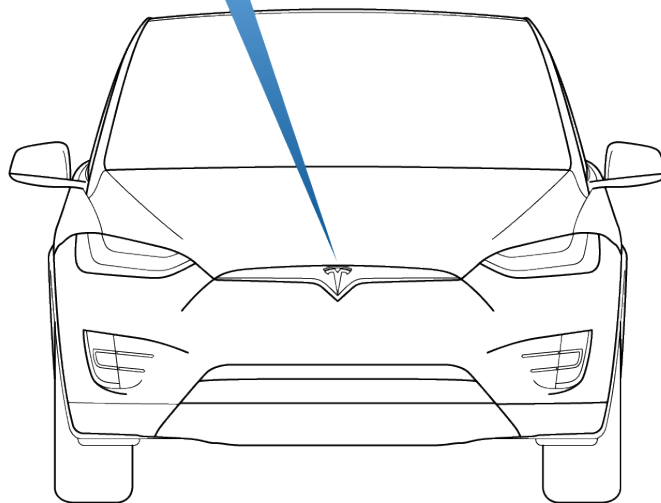

MODEL X

P30D

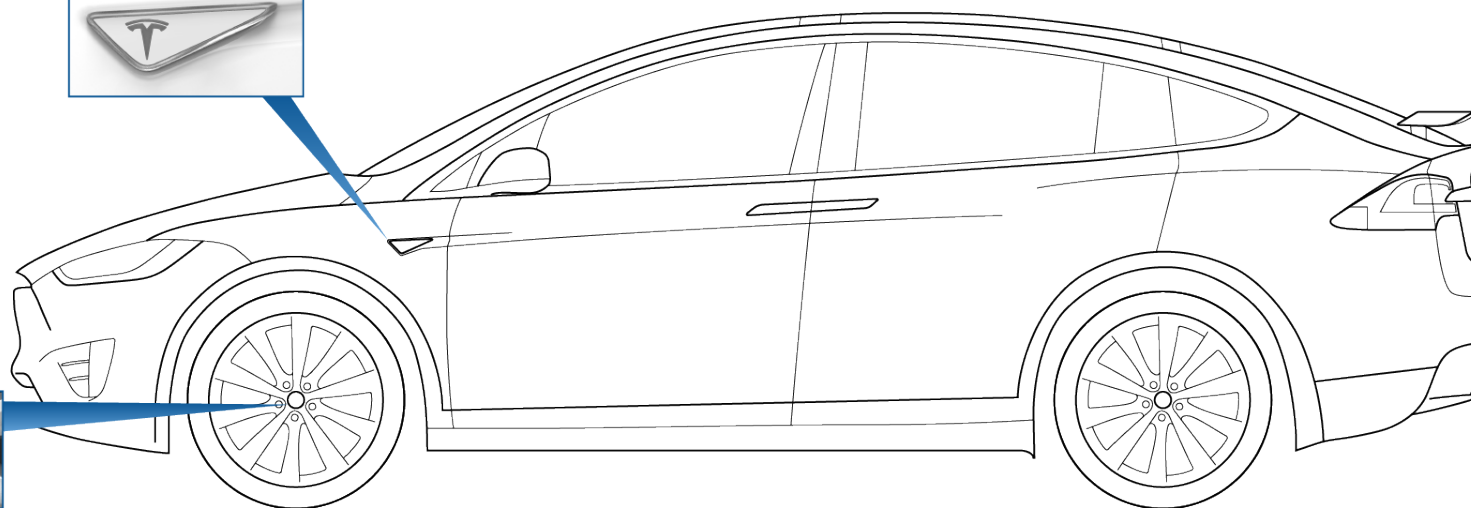



TOUCHSCREEN

Model X has a 17" touchscreen.





HIGH VOLTAGE COMPONENTS

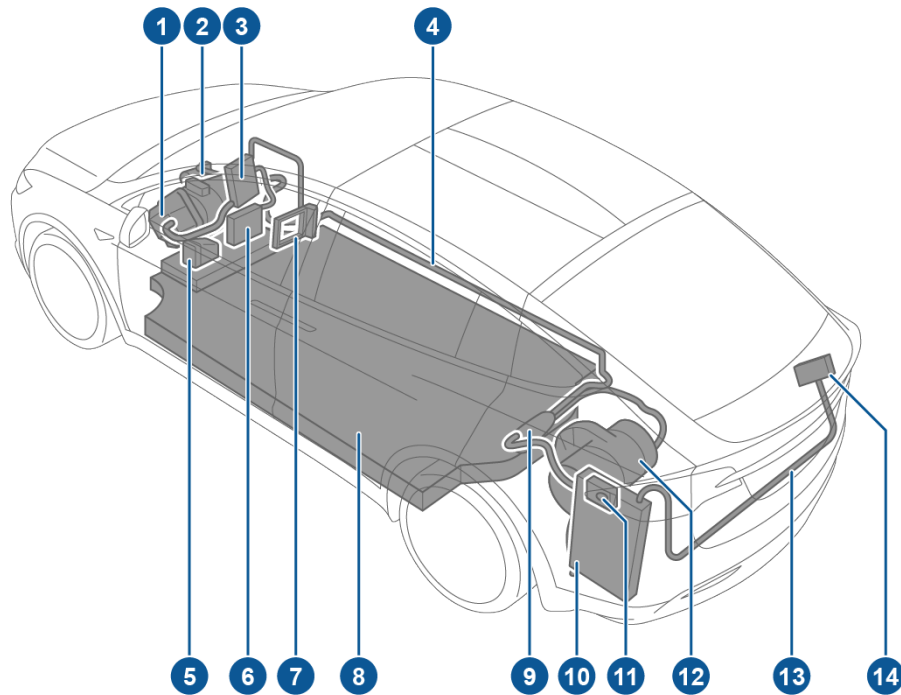

1. Front drive unit
2. AC compressor
3. Front junction box
4. High voltage cabling
5. Battery coolant heater
6. DC-DC converter
7. Cabin heater
8. High voltage battery
9. Rapid splitter
10. Charger
11. Charge port
12. Rear drive unit
13. High voltage cabling to rear HVAC assembly
14. Rear HVAC assembly



HIGH VOLTAGE BATTERY

Model X is equipped with a floor-mounted 400 volt lithium-ion high voltage battery. Never breach the high voltage battery when lifting from under the vehicle. When using rescue tools, pay special attention to ensure that you do not breach the floor pan.

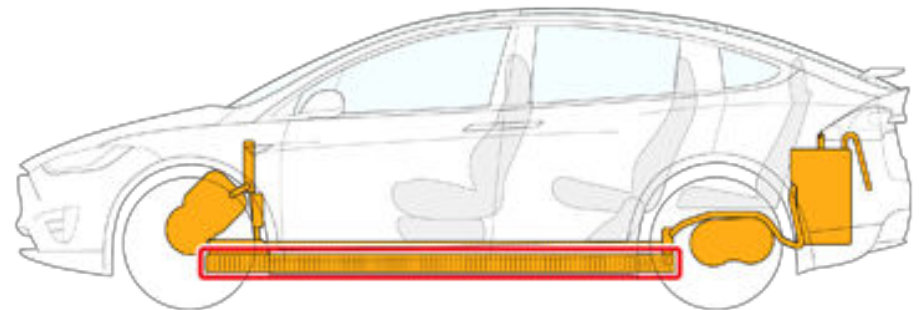
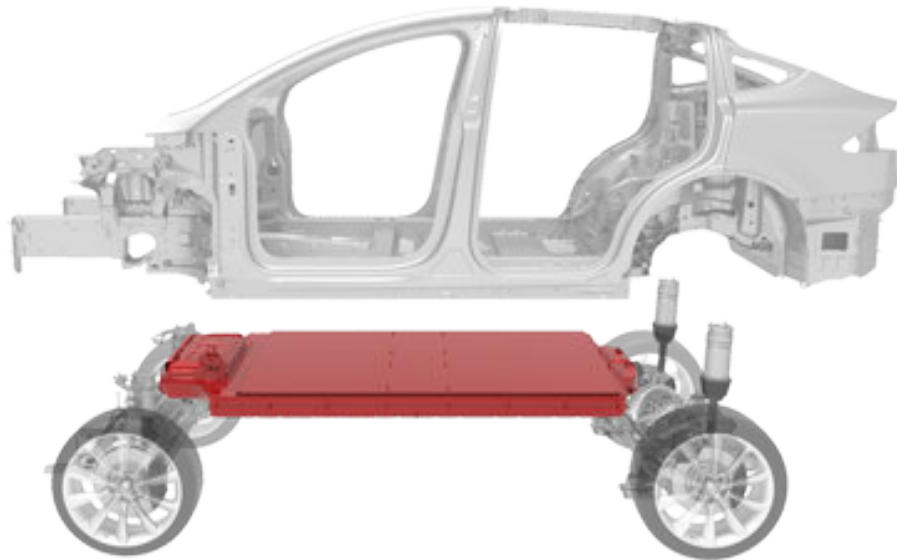

▲ Warning: Regardless of the disabling procedure you use, ALWAYS ASSUME THAT ALL HIGH VOLTAGE COMPONENTS ARE ENERGIZED! Cutting, crushing, or touching high voltage components can result in serious injury or death.



DC-DC CONVERTER AND FRONT JUNCTION BOX

High voltage is present at the DC-DC converter and front junction box, as highlighted in red. The DC-DC converter transforms the high voltage current from the 400 volt battery to low voltage to charge the Model X 12 volt battery. The front junction box provides power to various components, such as the battery heater, the air conditioning compressor, and the cabin heater. Use caution when cutting in this area during a dash lift and dash roll procedure. Use work-around techniques, if necessary.

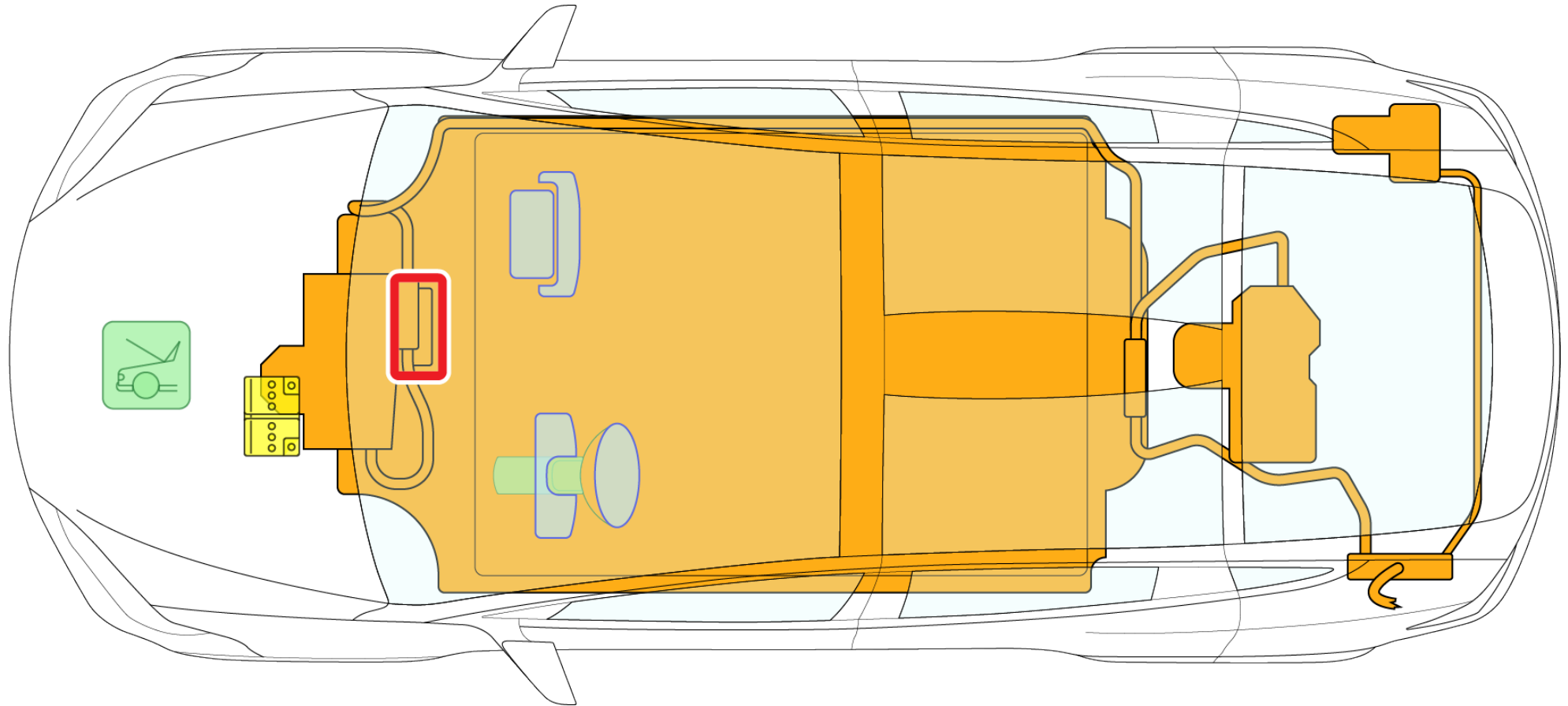

⚠ Warning: Regardless of the disabling procedure you use, ALWAYS ASSUME THAT ALL HIGH VOLTAGE COMPONENTS ARE ENERGIZED! Cutting, crushing, or touching high voltage components can result in serious injury or death.



HIGH VOLTAGE CABLES

High voltage cables are shown in orange.

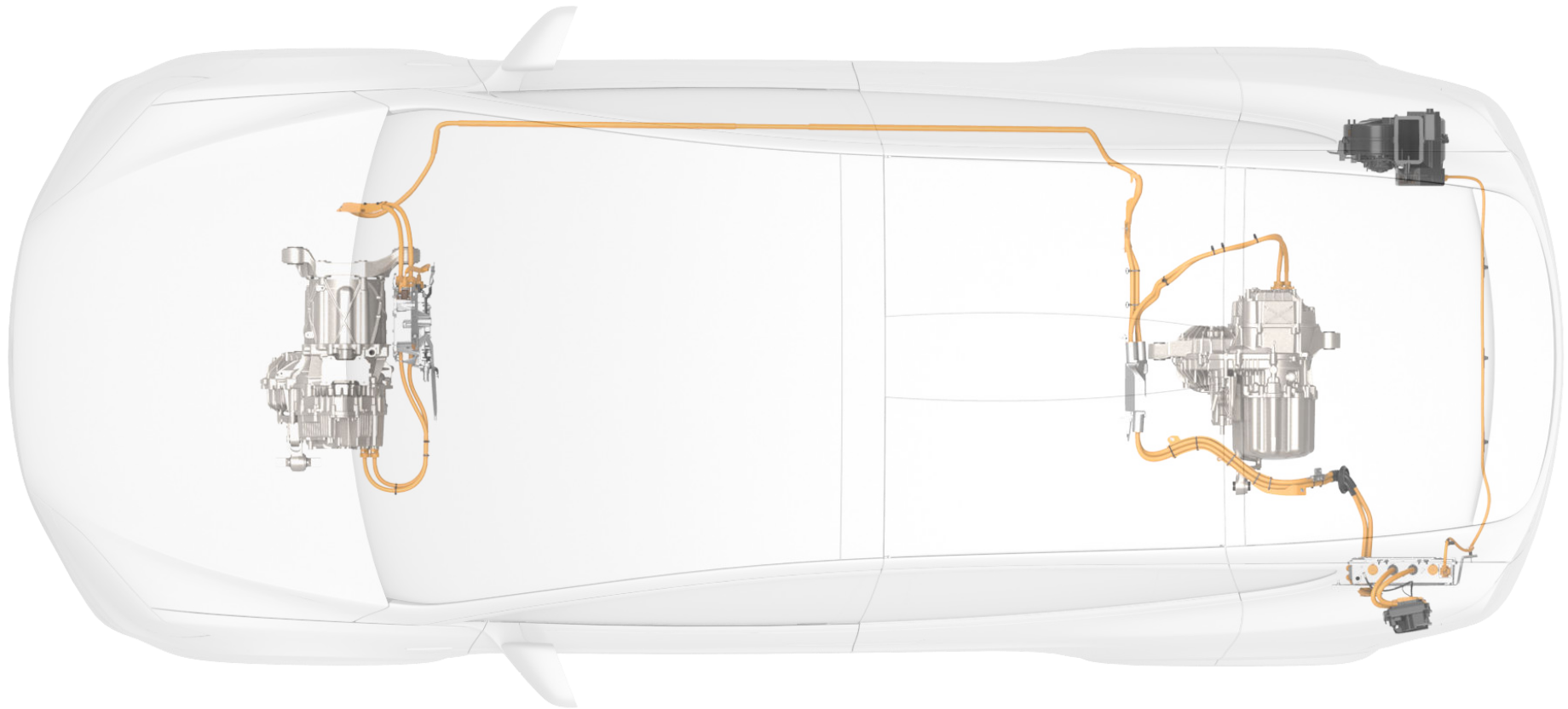

⚠ Warning: Regardless of the disabling procedure you use, ALWAYS ASSUME THAT ALL HIGH VOLTAGE COMPONENTS ARE ENERGIZED! Cutting, crushing, or touching high voltage components can result in serious injury or death.



CHARGER

Model X has one charger located inside the left-hand side quarter panel. This charger converts AC current from a charging station to DC for charging the high voltage battery. It also routes high voltage to the rear HVAC, if equipped. The high voltage junction box, integrated into the charger, routes any surplus energy from regenerative braking back to the battery.

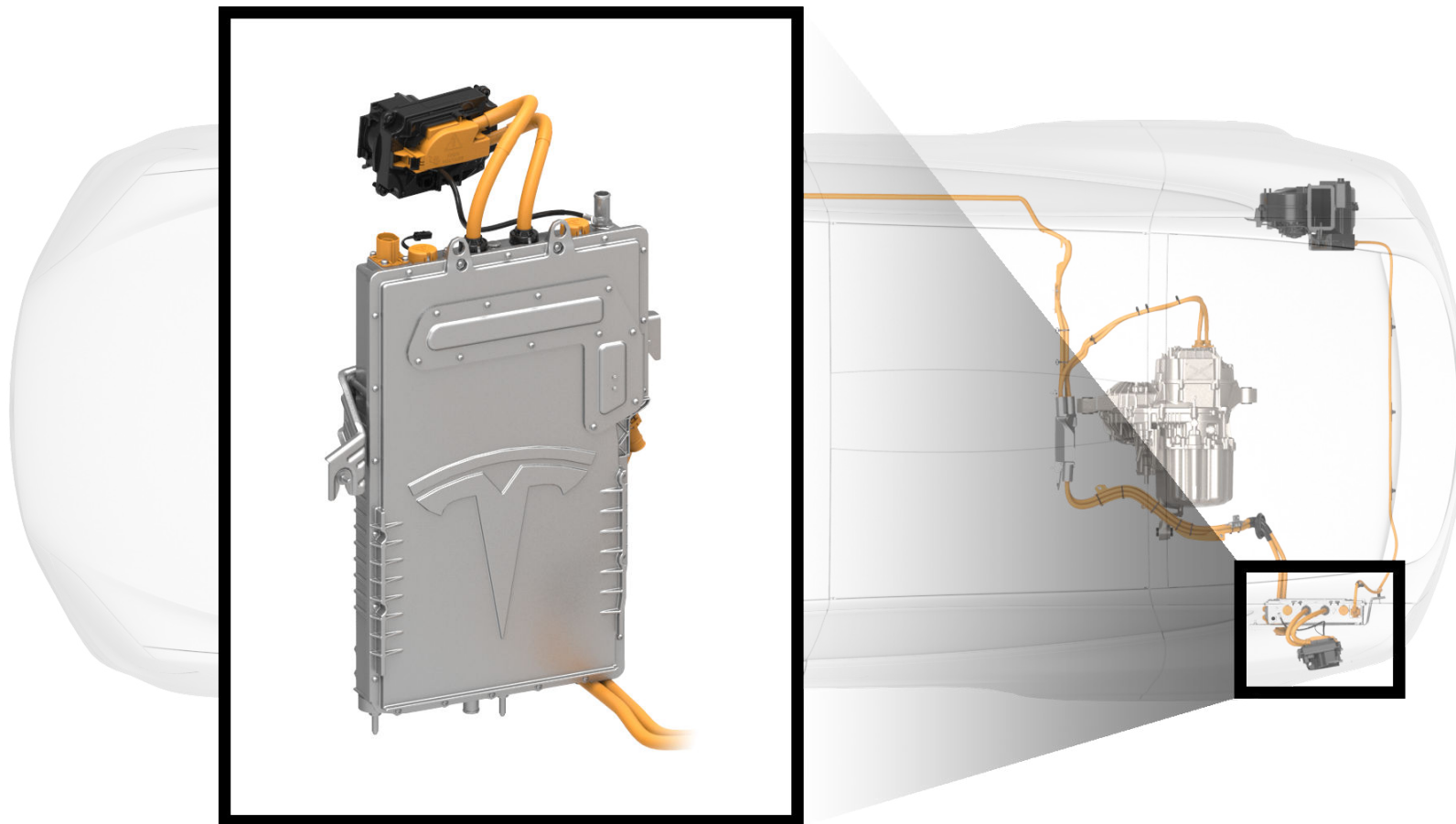



DRIVE UNITS

The front drive unit is located between the front wheels, and the rear drive unit is located between the rear wheels. The drive units, shown in red, convert the DC current from the high voltage battery into three-phase AC current that powers the wheels.

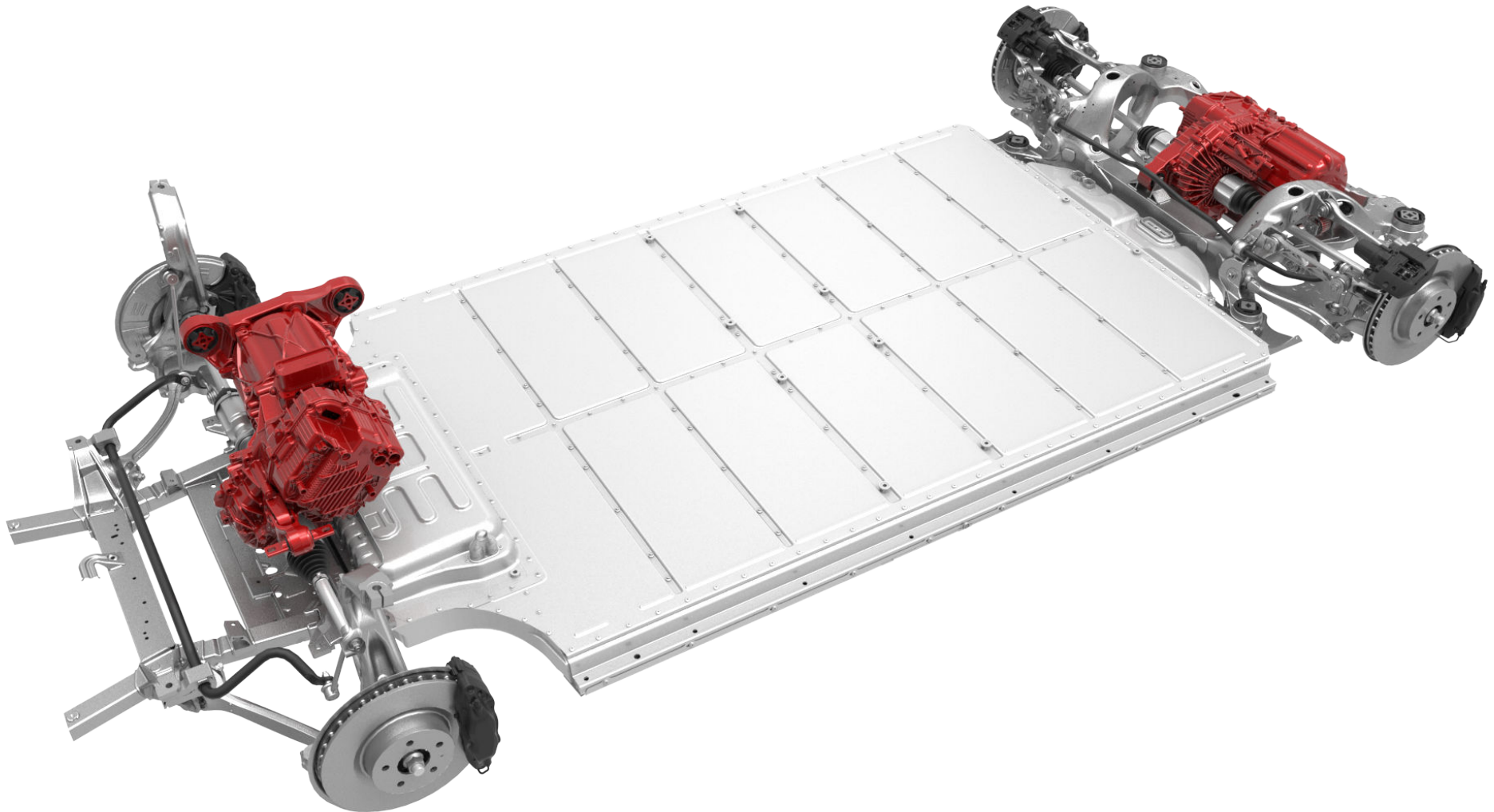



12V BATTERY

In addition to the high voltage system, Model X has a low voltage system. Its 12 volt battery operates the supplemental restraint system (SRS), airbags, windows, door locks, touchscreen, and interior and exterior lights. The DC-DC converter in the high voltage system supplies the 12 volt battery with power to support low voltage functions, and the 12 volt battery supplies power to the high voltage contacts, allowing high voltage power to flow out of the high voltage battery. The 12 volt battery, outlined in red, is located under the hood and the plastic access panel.

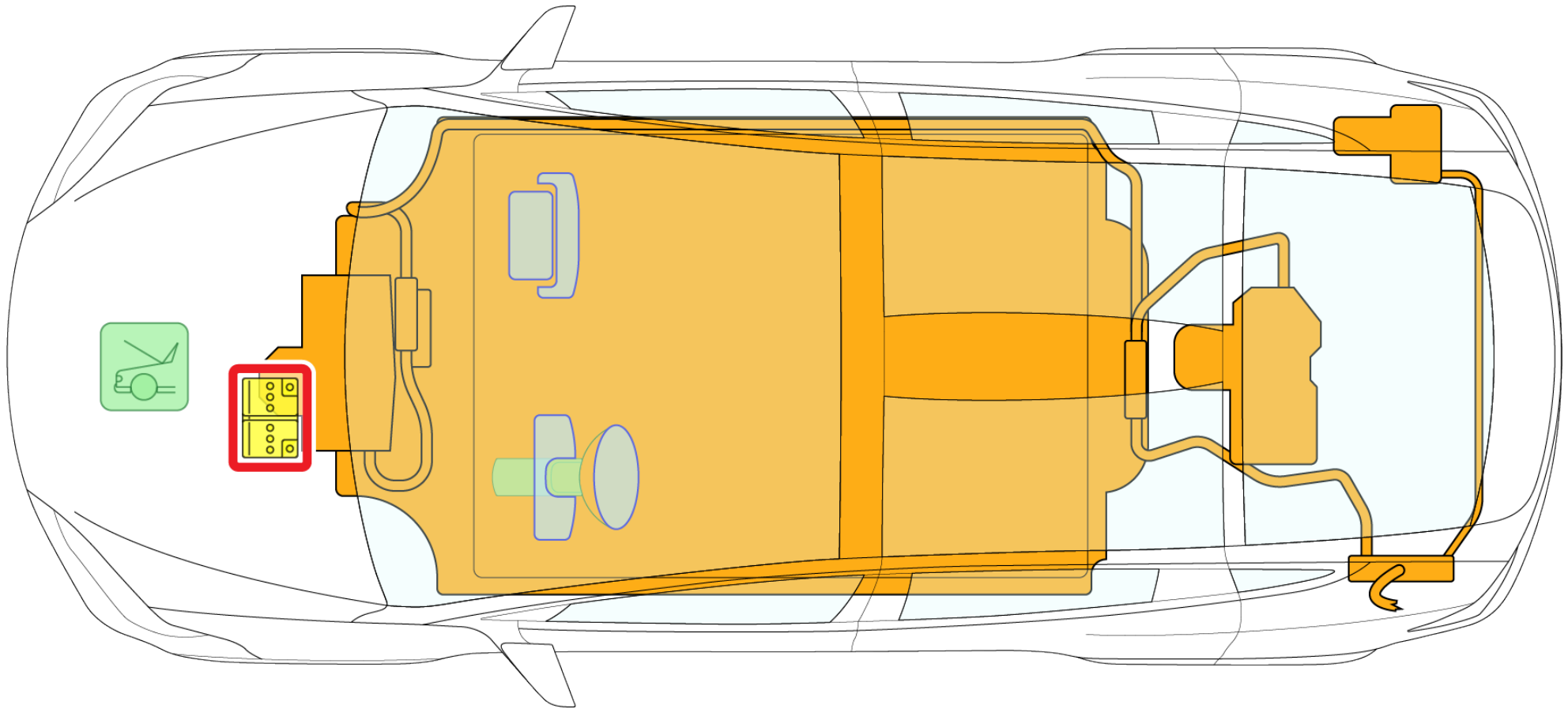



CHOCK ALL FOUR WHEELS

Drivers can choose a setting that determines whether or not Model X will "creep" when a drive gear is selected. If this setting is off, Model X does not move unless the accelerator is pressed, even if shifted into Drive or Reverse. Therefore, never assume that Model X will not move. Always chock the wheels.

If Vehicle Hold is braking Model X, the Vehicle Hold indicator light displays on the instrument panel. To disengage Vehicle Hold, press and release the brake pedal.

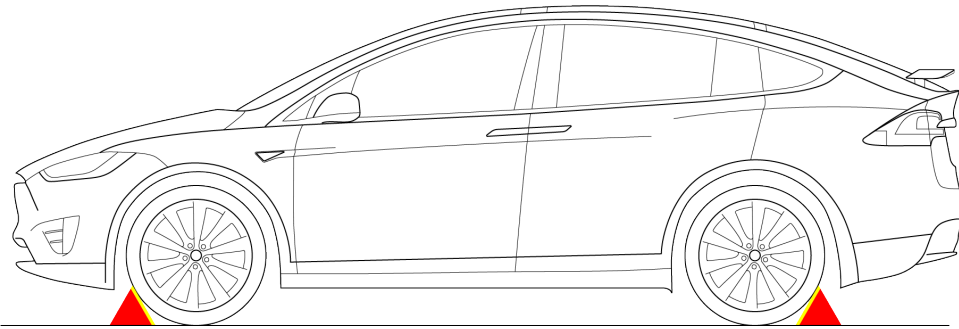

SHIFT INTO PARK

Model X is silent so never assume it is powered off. Pressing the accelerator pedal even slightly can cause Model X to move quickly if the currently active gear is Drive or Reverse. To ensure that the parking break is engaged, press the button on the end of the gear selector to shift into Park. Whenever Model X is in Park the parking brake is automatically engaged.

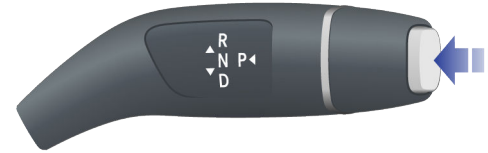



FRONT TRUNK FIRST RESPONDER CUT LOOP

The front trunk first responder cut loop consists of two low voltage wires. Cutting this loop shuts down the high voltage system, outside of the high voltage battery, and disables the supplemental restraint system (SRS) and the airbag components. Refer to [Cutting the First Responder Loop](#) on page 14 for instructions.

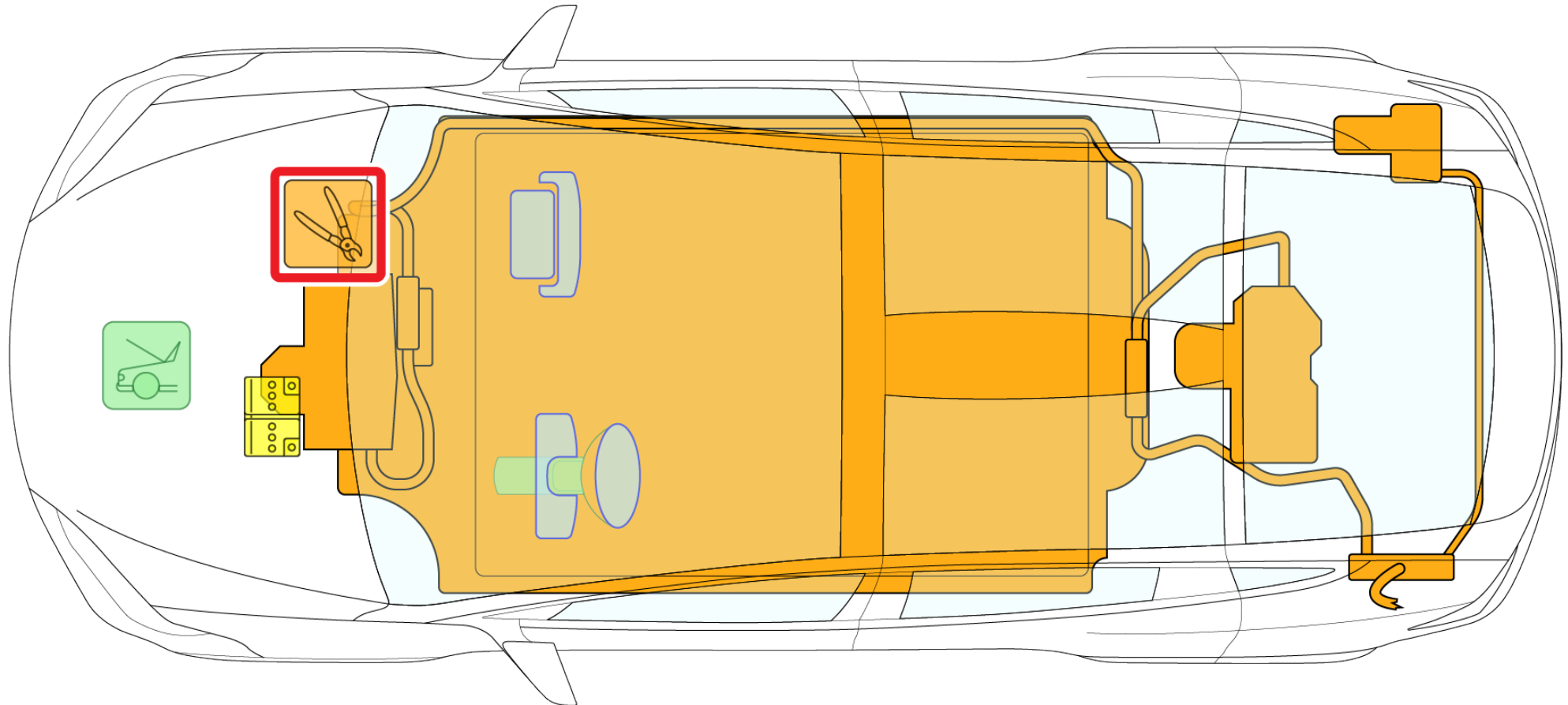



CUTTING THE FIRST RESPONDER LOOP

When cutting the loop, double cut to remove an entire section. Doing so eliminates the risk of the cut wires accidentally reconnecting.

1. Open the hood. Refer to [Opening the Hood](#) on page 27 for instructions.

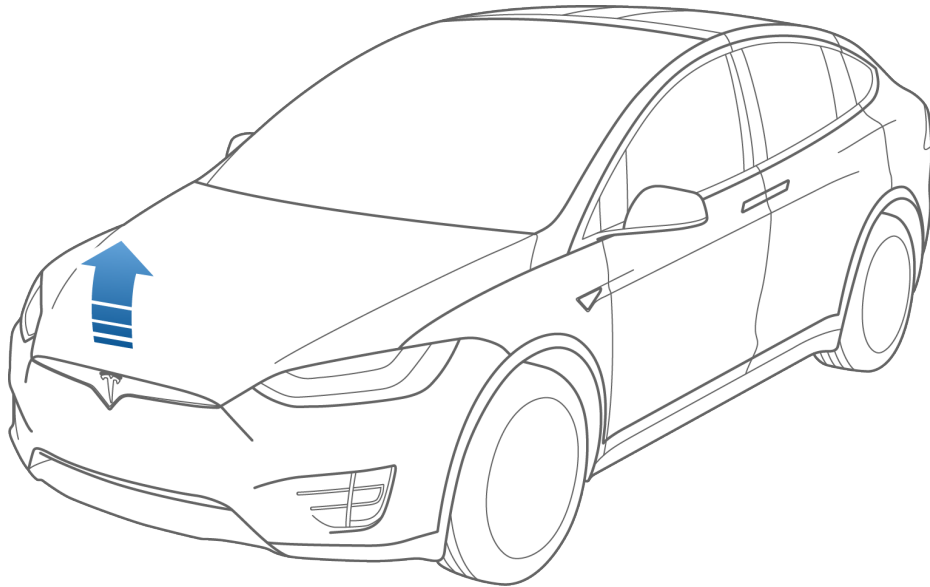

2. Remove the access panel. Pull the rear edge upwards to release the clips that hold it in place. Maneuver it towards the windshield to remove.

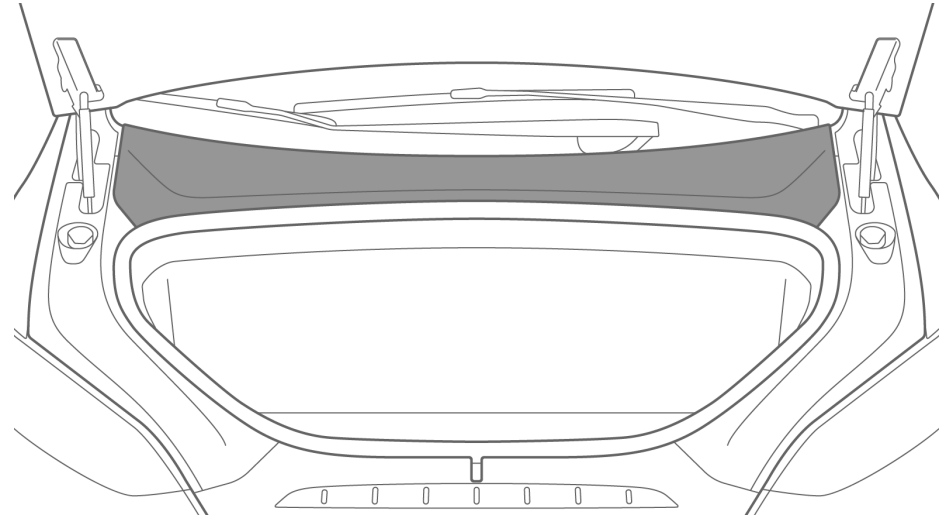

3. Double cut the loop to remove an entire section. The cut loop is located under the plastic access cover.

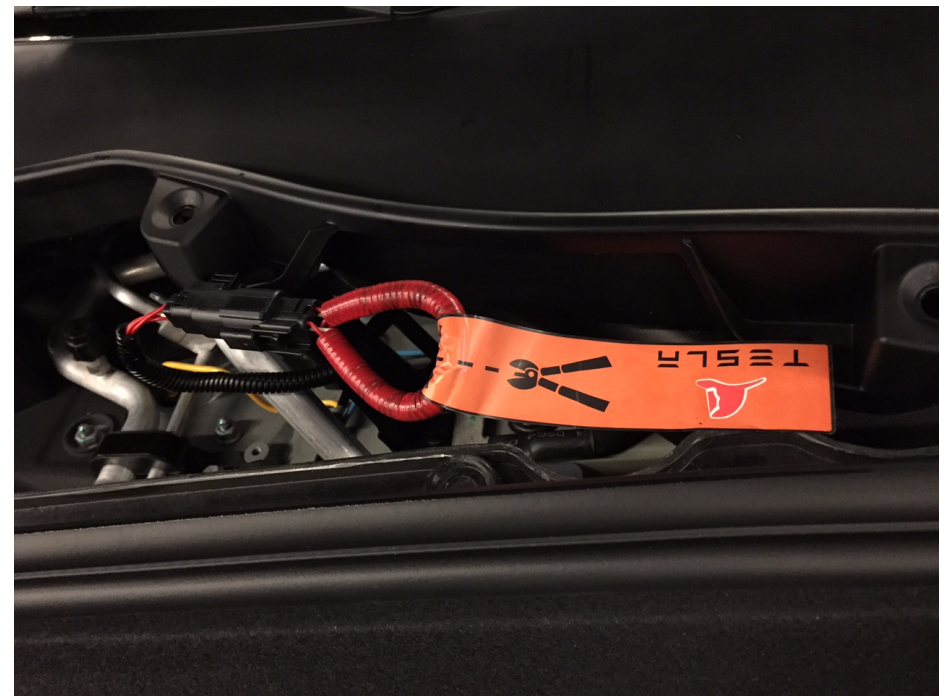



AIRBAGS

Airbags are located in the approximate areas shown here. Airbag warning information is printed on the sun visors.

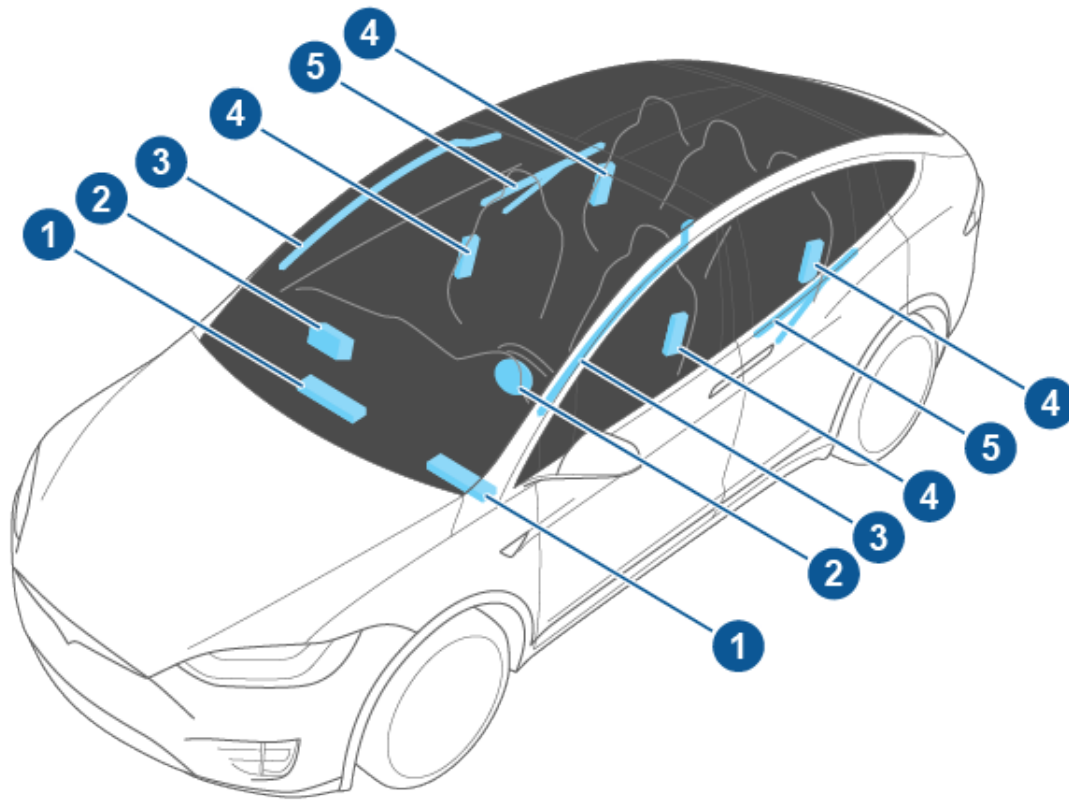

1. Knee airbags
2. Front airbags
3. Curtain airbags
4. Seat-mounted side airbags
5. Door-mounted airbags



AIRBAG INFLATION CYLINDERS

Airbag inflation cylinders are located in the A-pillars and in the falcon wing doors, as outlined in red.

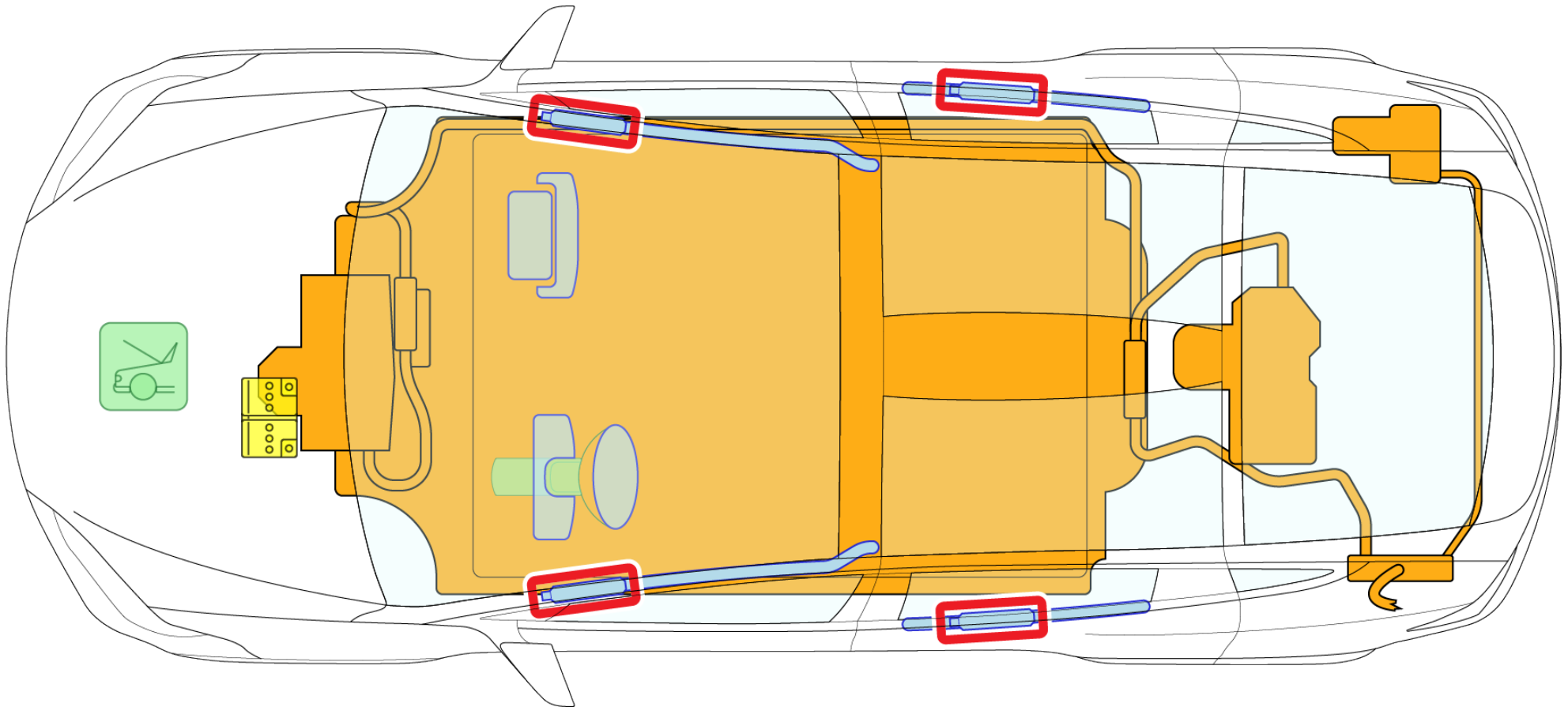



SEAT BELT PRE-TENSIONERS

Pre-tensioners are located in the B-pillars, as outlined in red.

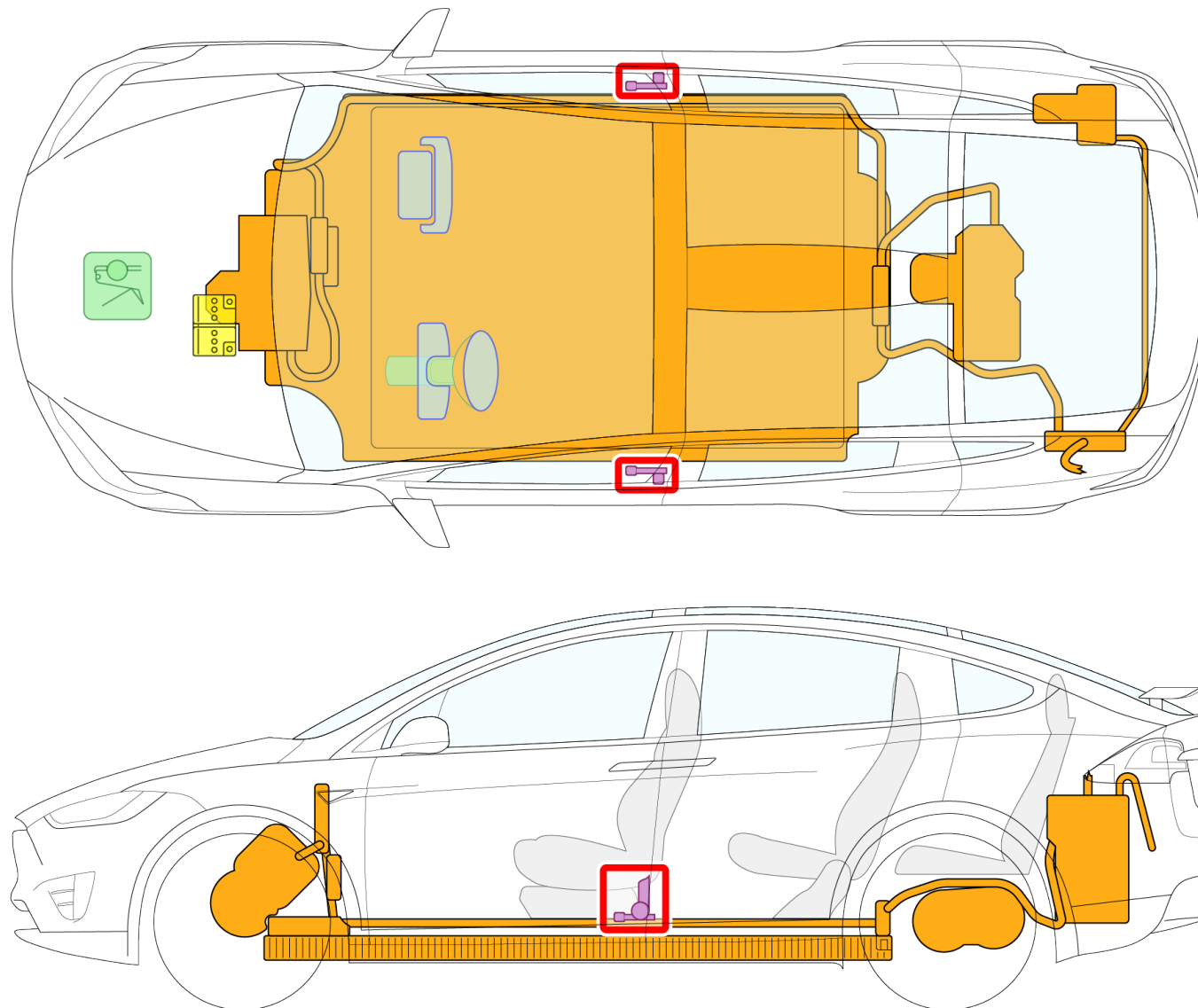



REINFORCEMENTS AND ULTRA HIGH STRENGTH STEEL

Model X is heavily reinforced to protect occupants. The A-pillars and B-pillars are built with boron steel. The B-pillar is additionally reinforced with a dual-phase 980 steel pipe that runs from the roof rail to just below the latch striker. Suitable tools must be used to cut or crush these areas. Reinforcements are shown in teal below.

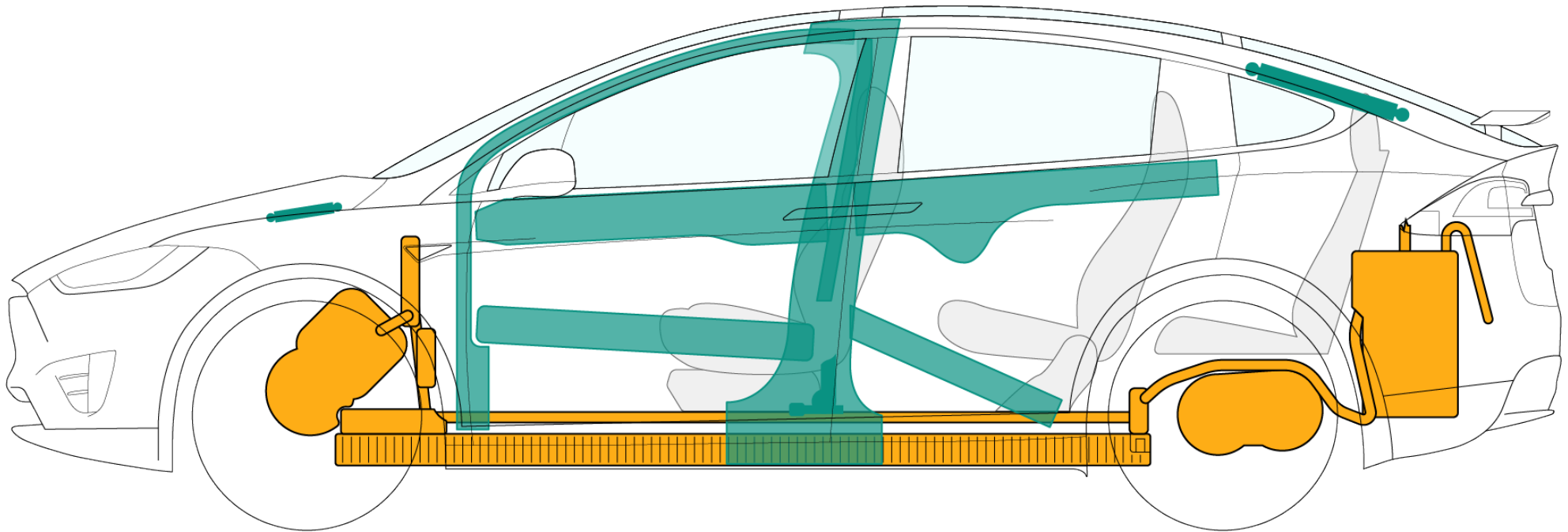



NO CUT ZONES

Model X has areas that are defined as "no-cut zones" due to high voltage, gas struts, SRS components, airbags, or other hazards. Never cut or crush in these areas. Doing so could result in serious injury or death. The "no-cut zones" are shown in pink.

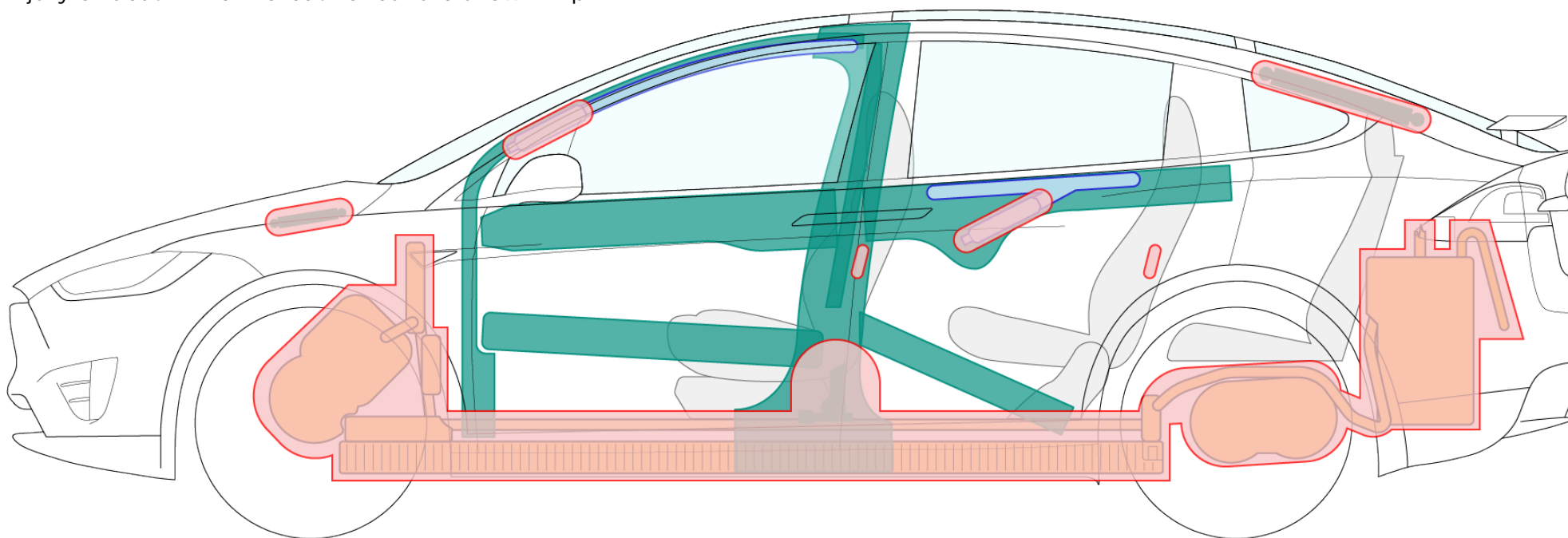



FULLY OR PARTIALLY SUBMERGED VEHICLES

Treat a submerged Model X like any other vehicle. The body of the vehicle does not present any greater risk of shock in water. However, as a precautionary measure, handle any submerged vehicle while wearing the appropriate PPE. Remove the vehicle from the water and continue with normal high voltage disabling.

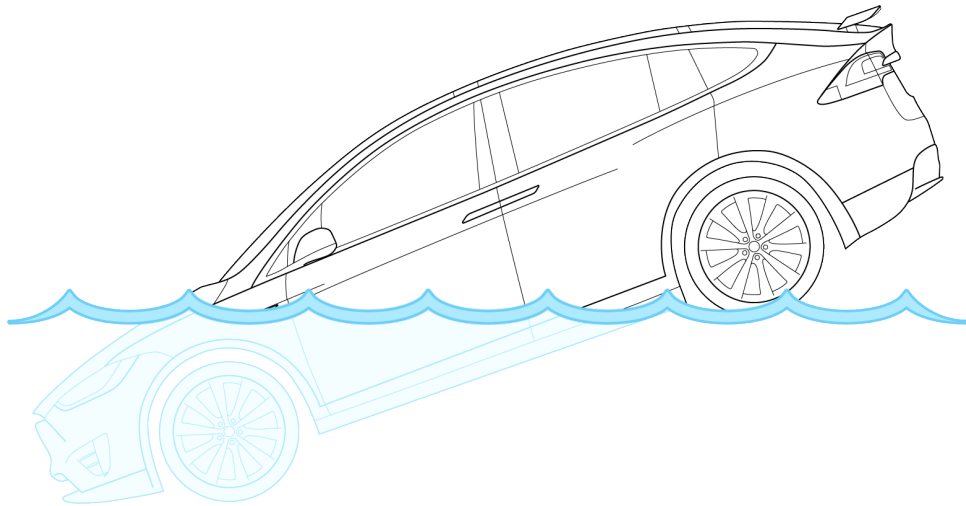

PUSHING ON THE FLOOR PAN

The high voltage battery is located below the floor pan. Never push down on the floor pan from inside Model X. Doing so can breach the high voltage battery, which can cause serious injury or death.

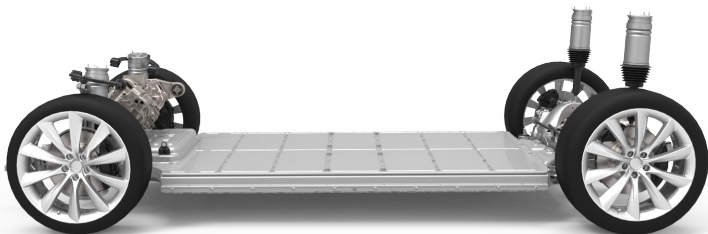

FIREFIGHTING

Extinguish small fires that do not involve the high voltage battery using typical vehicle firefighting procedures.

During overhaul, do not make contact with any high voltage components. Always use insulated tools for overhaul.

Stored gas inflation cylinders, gas struts, and other components can result in boiling liquid expanding vapor explosion (BLEVE) in extreme temperatures. Perform an adequate knock down before entering a hot zone.

If the high voltage battery catches fire, is exposed to high heat, or is bent, twisted, cracked, or breached in any way, use large amounts of water to cool the battery. **DO NOT** extinguish with a small amount of water. Always establish or request an additional water supply.

Battery fires can take up to 24 hours to extinguish. Consider allowing the battery to burn while protecting exposures.

Use a thermal imaging camera to ensure that the high voltage battery is completely cooled before leaving the incident. The battery must be monitored for at least one hour after it is found to be completely cooled. Smoke or steam indicates that the battery is still heating. Do not release the vehicle to second responders, such as law enforcement and towing personnel, until there has been no heating detected for one hour.

Always advise second responders that there is a risk of battery re-ignition. After Model X has been involved in submersion, fire, or a collision that has compromised the high voltage battery, always store the vehicle in an open area at least 50 ft (15 m) from any exposure.



HIGH VOLTAGE BATTERY - FIRE DAMAGE

A burning or heated battery releases toxic vapors. These vapors include sulfuric acid, oxides of carbon, nickel, lithium, copper, and cobalt. Responders should protect themselves with full PPE, including self-contained breathing apparatus (SCBA), and take appropriate measures to protect civilians downwind from the incident. Use fog streams or positive-pressure ventilation fans (PPV) to direct smoke and vapors.

The high voltage battery consists of lithium-ion cells. These cells are considered dry cells. If damaged, only a small amount of fluid can leak. Lithium-ion battery fluid is clear in color.

The high voltage battery, the drive unit, the charge controllers, and the DC-DC converter are all liquid cooled with a typical glycol based coolant. If damaged, this blue coolant can leak out of the battery.

A damaged high voltage battery can create rapid heating of the battery cells. If you notice smoke coming from the battery, assume the battery is heating and take appropriate action as described in [Rescue Operations](#) on page 20.





LIFT AREAS

The high voltage battery is located under the floor pan. A large section of the undercarriage houses the high voltage battery. When lifting or jacking, only use the designated lift areas, as shown in green.

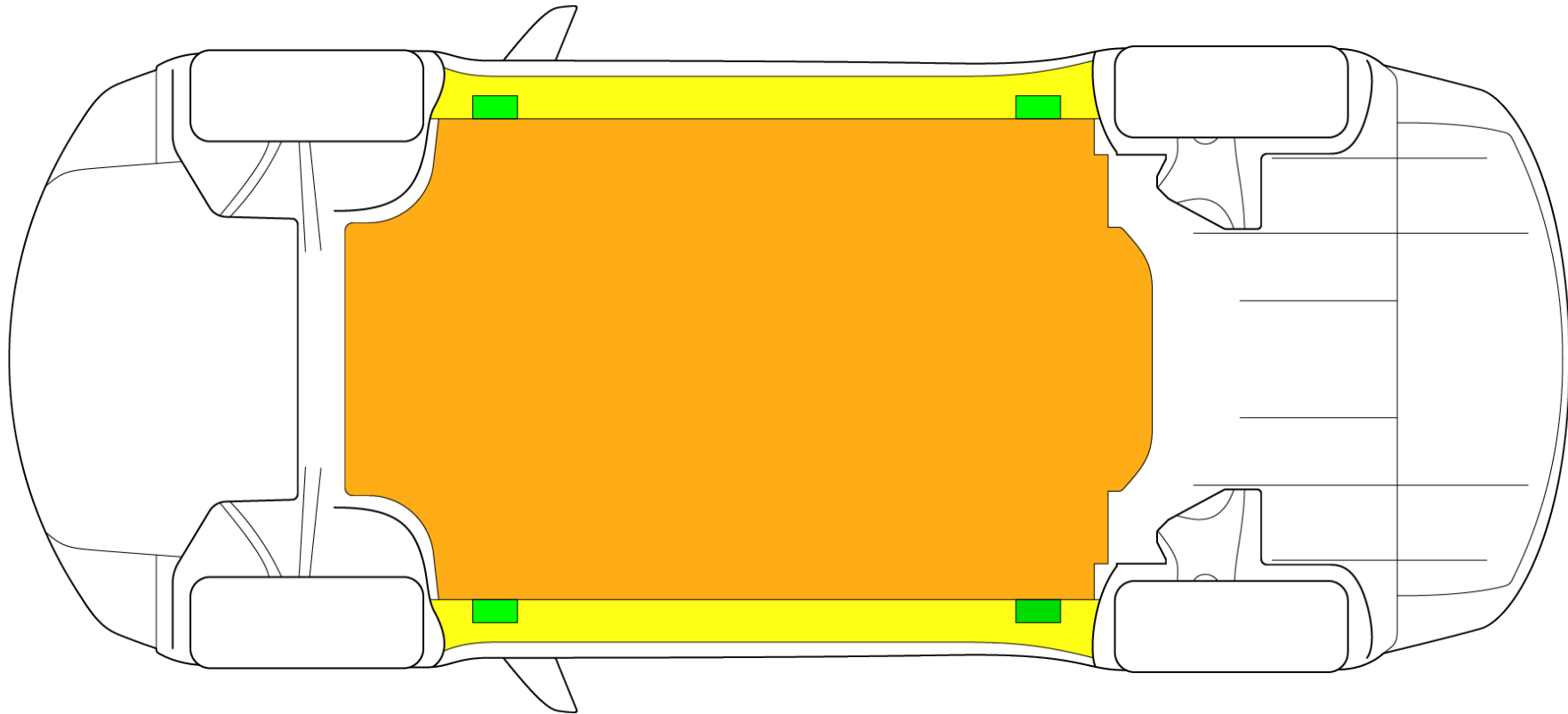
▲ Warning: DO NOT USE THE HIGH VOLTAGE BATTERY AREA TO LIFT OR STABILIZE MODEL X.



-  Appropriate lift areas
-  Safe stabilization points for a Model X resting on its side
-  High voltage battery



USING THE KEY

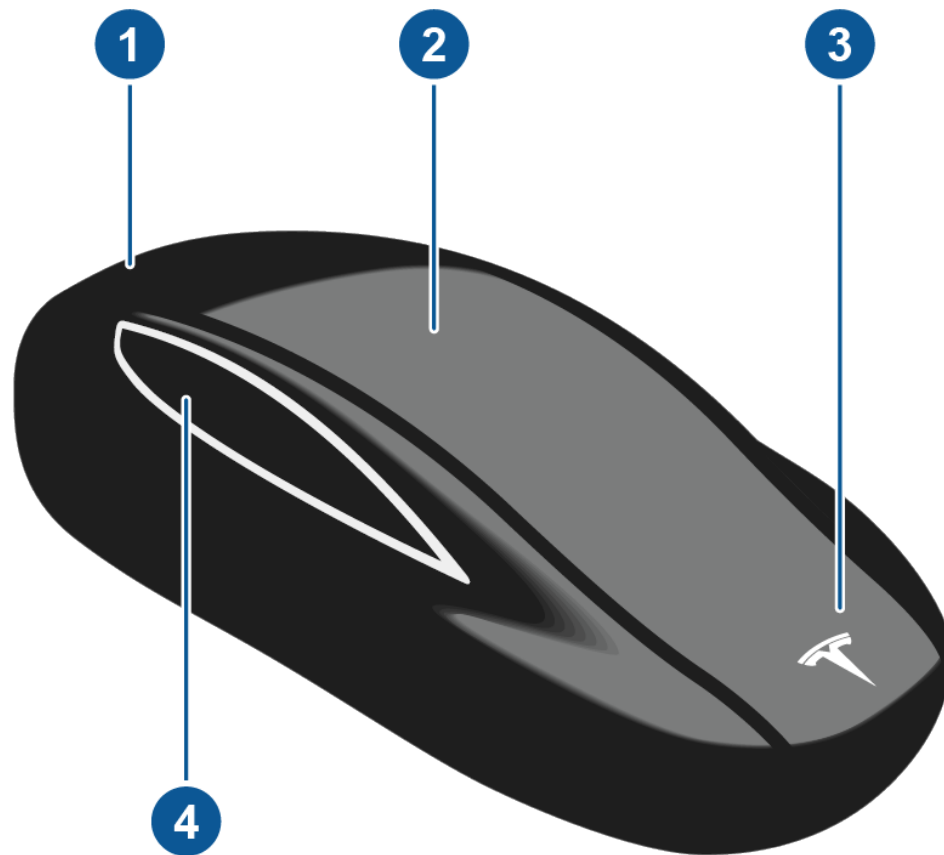

Use the key buttons as shown below.

1. Rear trunk. Double-click to open the rear trunk.
2. Unlock all. Double-click to unlock doors and front and rear trunks.
3. Hood/front trunk. Double-click to open the hood to access the front trunk.
4. Falcon wing doors. Double-click to open/close the associated falcon wing door.

OPENING THE DOORS WITH POWER

To open the Model X doors from the outside with 12 volt power in place, press the exterior handles.

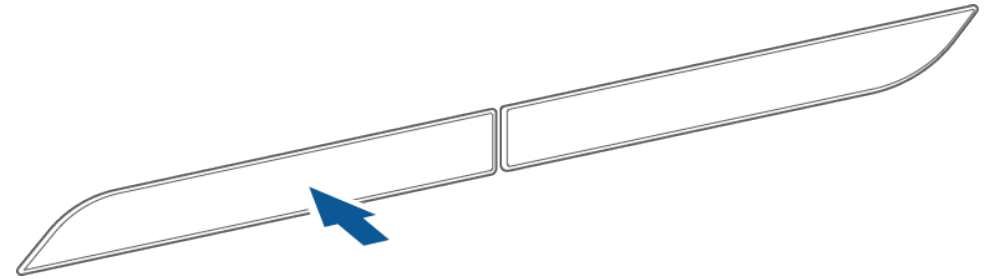

OPENING THE DOORS WITH OR WITHOUT POWER

To open the front doors from inside Model X, pull the handle towards you.

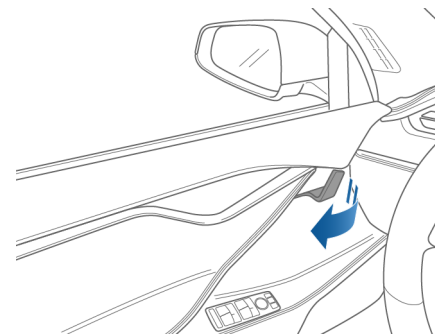



OPENING THE FALCON WING DOORS WITH POWER

To open a falcon wing door from inside Model X when the 12 volt power is on, press the button located on the inside of the B-pillar.

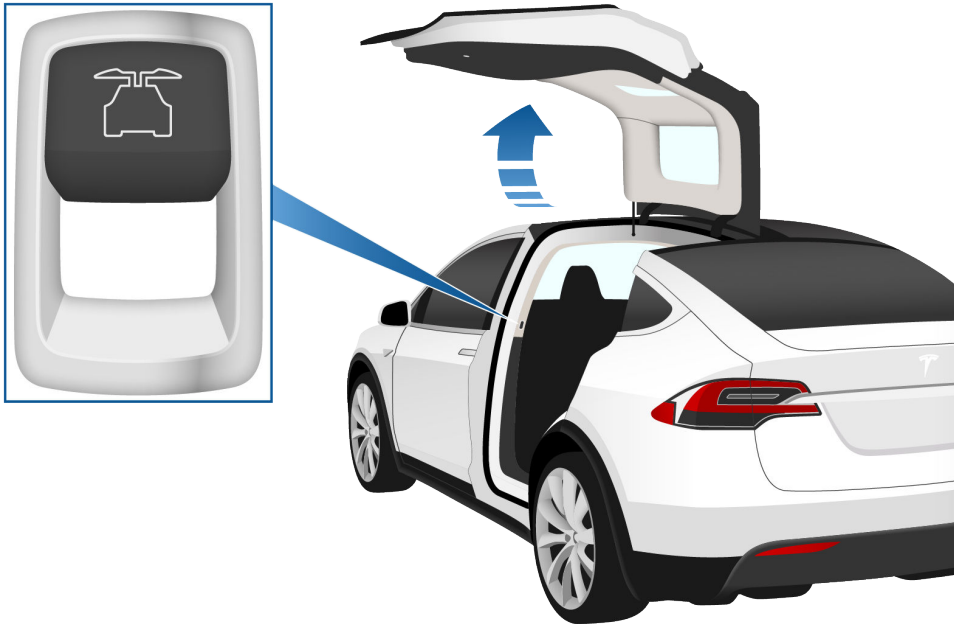

OPENING THE FALCON WING DOORS WITHOUT POWER

Without 12 volt power, the falcon wing doors can only be opened from the inside of the vehicle. Remove the speaker grill from the door and pull the mechanical release cable down and towards the front seat, as shown below. After the latch has released, manually lift up the doors.





REMOVING THE FALCON WING DOOR

Model X falcon wing doors open up and over the vehicle. In case of severe damage, you might need to cut or pry the doors from the vehicle. The locations of the hinges and latch are shown in red.

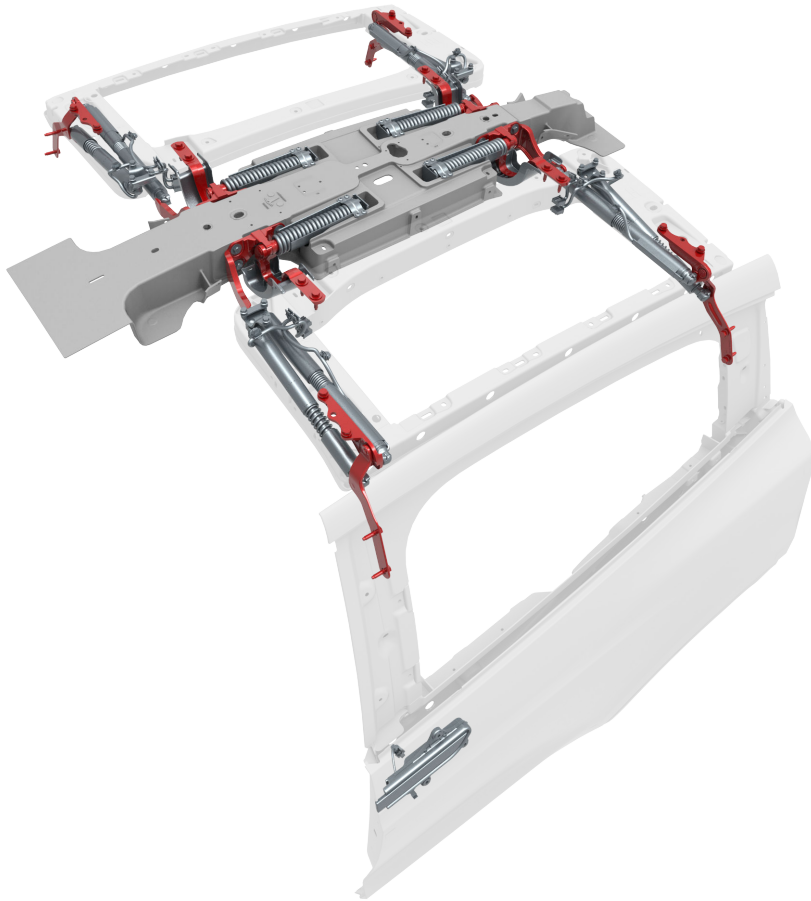



HIGH-TENSION SPRINGS

Model X falcon wing doors are equipped with high tension springs that assist with normal door opening. These springs might cause portions of the door to rise rapidly if the weight of the doors is reduced through the removal process. Remain clear of the upper roof section of the door while performing door removal on Model X. The locations of the high tension springs are shown in red.

- ⚠ Warning: Never cut the high tension springs attached to the falcon wing doors. Serious injury or death can result from cutting or rapidly releasing the high tension springs.





OPENING THE HOOD

Model X does not have a traditional internal combustion engine. Therefore, the area that would normally house the engine is used as additional storage space. Tesla calls this area the “Front Trunk.”

To open, use one of the following methods:

- Touch the front trunk on the touch screen.
- Double-click the front trunk button on the key.



- Pull the release cables located in the tow attachment on the front bumper. You need to release the tow hook cover first to expose the straps, and then pull the straps, labeled A and B, in alphabetical order to open the primary and secondary latches.

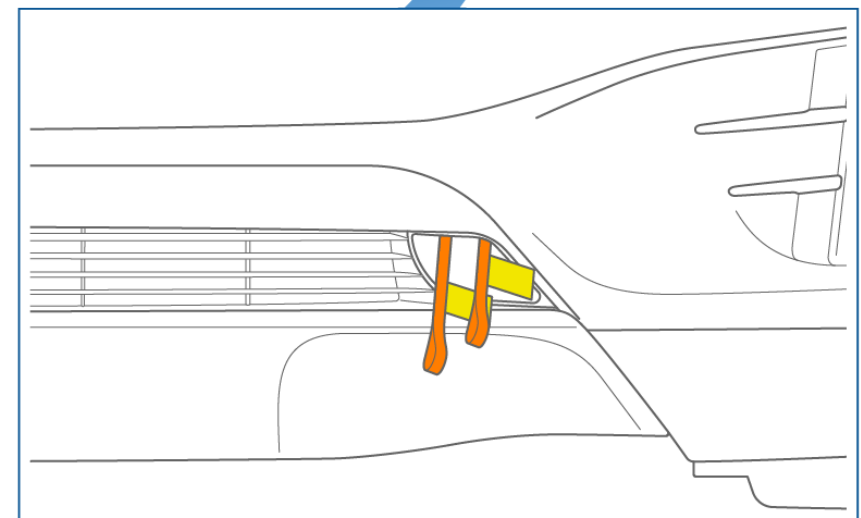
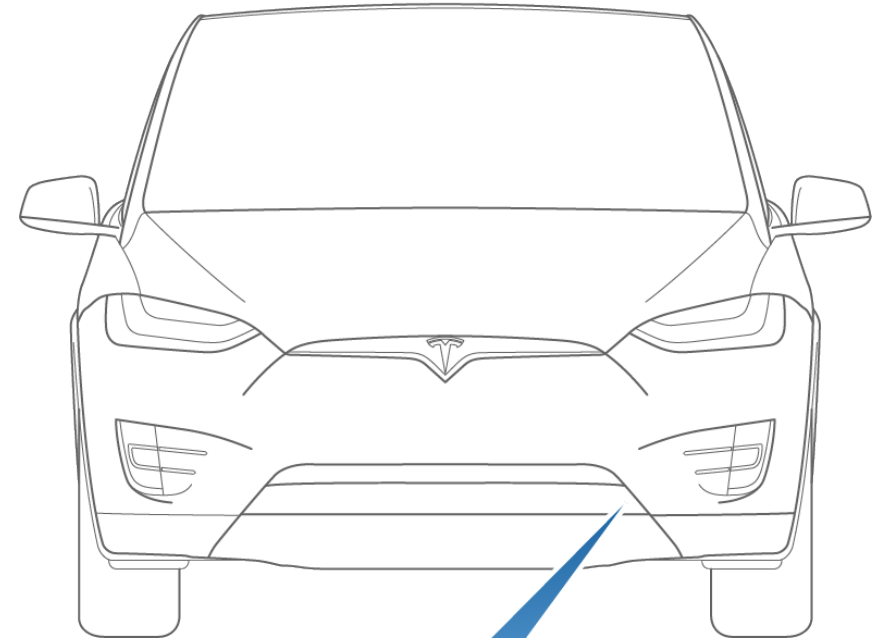



OPENING THE TRUNK

Use one of the following methods:

- Touch Trunk on the touchscreen CONTROLS window.
- Double-click the trunk button on the key.
- Press the switch located under the exterior handle.

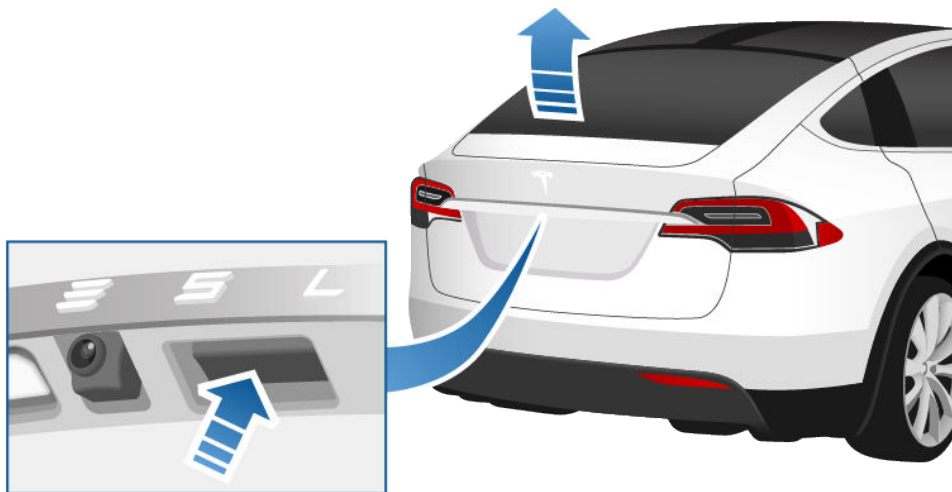
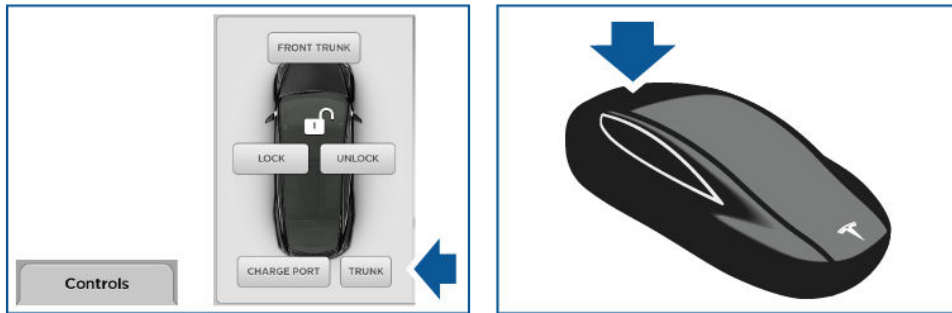



EXAMPLE OF A HIGH VOLTAGE LABEL

An example of the label located on a high voltage component is shown below.

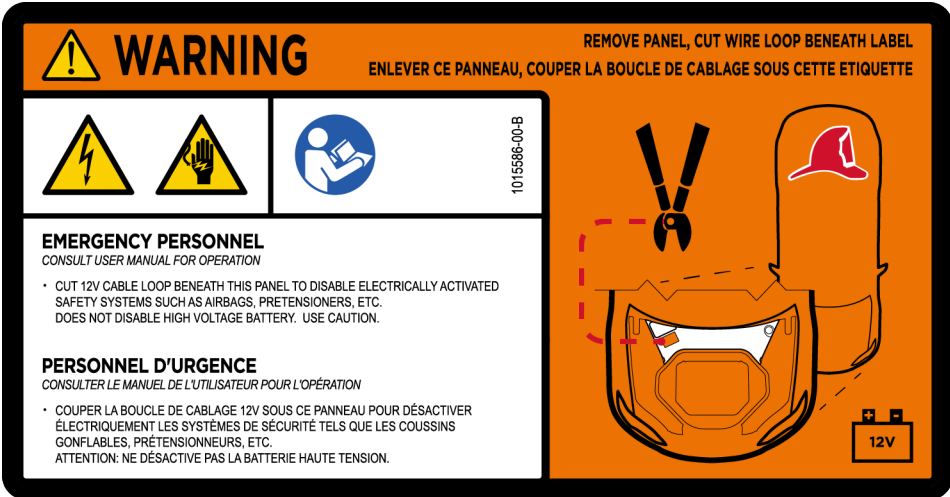



A

airbag inflation cylinders [16](#)
airbags [15](#)

B

badging [3](#)
battery
 12V [11](#)
 high voltage [6](#)

C

cables, high voltage [8](#)
charger [9](#)
cut loop for first responders [13](#)

D

DC-DC converter [7](#)
doors
 opening the falcon wing [24](#)
 opening the front [23](#)
 removing the emergency [25](#)
drive units [10](#)

F

firefighting [20](#)
fires [20, 21](#)
first responder, cutting the cut loop [14](#)
floor pans, pushing on [20](#)
fluids [20](#)

H

high voltage components
 battery [6](#)
 cables [8](#)
 charger [9](#)
 DC-DC converter [7](#)
 drive units [10](#)
 junction box, front [7](#)
 overview [5](#)

high-tension springs [26](#)
hood, opening [27](#)

I

identifying the vehicle [3](#)

J

jacking the vehicle [22](#)
junction box, front [7](#)

K

key, using [23](#)

L

labels, high voltage [29](#)
lift areas [22](#)

N

no cut zones [19](#)

P

park gear [12](#)

R

reinforcements, location of [18](#)
rescue operations
 firefighting [20](#)
 floor pans, pushing on [20](#)
 submerged vehicles [20](#)

S

seat belt pre-tensioners [17](#)
second responders [20](#)
smoke [21](#)
stabilization points (jacking) [22](#)
stabilizing the vehicle [12](#)
submerged vehicles [20](#)



T

touchscreen [3](#)
trunk, opening [28](#)

V

vapors [21](#)

W

wheels, chocking [12](#)

TESLA

3500 Deer Creek Road
Palo Alto, CA 94304

© 2015 TESLA MOTORS, INC. All rights reserved.

All information in this document and all MODEL X_s software is subject to copyright and other intellectual property rights of Tesla Motors, Inc. and its licensors. This material may not be modified, reproduced or copied, in whole or in part, without the prior written permission of Tesla Motors, Inc. and its licensors. Additional information is available upon request. TESLA MOTORS_®, TESLA ROADSTER_®, TESLA_®, T_®, and MODEL S_® and MODEL X_® are registered trademarks of Tesla Motors, Inc. in the United States. TESLA™ is a trademark of Tesla Motors, Inc. in the United States and other countries. All other trademarks contained in this document are the property of their respective owners and their use herein does not imply sponsorship or endorsement of their products or services. The unauthorized use of any trademark displayed in this document or on the vehicle is strictly prohibited.