



Guide to pH Analysis for Professional Winemakers.





Contents

Table of Contents

	Why pH Matters	pg 4
	What You Need	pg 7
	How to Measure	pg 9



Introduction

Are you analyzing your wine properly?

pH is a vital parameter throughout the winemaking process. Alison Crowe of Winemaker Magazine says “pH is the backbone of a wine.”

Accurate pH analysis requires the right equipment, proper sampling, and effective execution. Time invested in pH analysis without the right equipment and process wasted.

This eBook focuses on how to implement an effective pH analysis program. It covers how pH affects wine quality, the necessary tools, and how to use these tools to get accurate results.



Hanna Note

- **Improper technique of pH testing can result in errors of up to 0.5 pH - enough to result in wine spoilage and serious quality issues.**



Why pH Matters

What is pH?

In technical terms, pH is the hydrogen ion activity in a solution. It's measured on a scale of 0 to 14, with 7 being neutral. pH is also known as $\text{pH} = -\log [\text{H}^+]$.



pH is one of the most important analytical tests in winemaking. pH measurements start with harvest and conclude once the wine has been bottled. The accuracy of a pH measurement will impact many winemaking operations such as **fermentation, aging, fining, stabilization, and bottling**. Improper calibration, storage, or cleaning of the pH electrode may cause inaccurate readings which will impact the chemistry and sensory perception of the wine.

Hanna Note

- Even though there is a correlation between pH and acidity, they are mutually exclusive.
- Acidity is the concentration of acid present in wine, measured by titration.
- pH is the degree to which something is acidic or basic, measured using a pH meter and electrode.



Why pH Matters

What is the desired pH range?

A pH between 3.0 and 4.0 is optimal for most wines. Although some winemakers will craft a wine outside this range, the risks must be considered. Wines in the higher end of this range run the risk of spoilage.

What pH range should you aim for?

	Must/Juice pH	Finished pH
White wine	< 3.3 pH	3.0 to 3.3 pH
Red wine	< 3.4 pH	3.3 to 3.5 pH

Techniques for adjusting pH

Malolactic fermentation	Can be used to raise pH
Cold stabilization	Can be used to raise or lower pH
Blending	Can be used used to raise or lower pH
Acid addition	Can be used to lower pH



Why pH Matters

How does pH affect the chemistry of your wine?

- **Microbial stability:** Prevents spoilage by inhibiting microbial growth
- **Sulfur dioxide (SO₂):** Increases the effectiveness of SO₂ to protect wine and juice against spoilage; required for proper calculation of SO₂ addition
- **Malolactic fermentation:** Affects performance of malolactic bacteria to convert malic acid to lactic acid.
- **Protein stability:** Plays a role in haze formation and its treatment.
- **Sensory attributes:** Influences the appearance, aroma, and taste

Hanna Note

- Wine with a pH 3.6 or less has a lower chance of bacterial growth and oxidation.



What You Need

Here is what you need for good testing set up

- **pH meter:** *Must have* –2 point calibration, temperature compensation, 0.01 pH resolution and a mV scale.
Good to have – Calibration check, GLP, logging.
- **pH electrode:** *Must have* – PTFE junction, glass body, combination.
Good to have – Built-in temperature sensor.
- **Magnetic stirrer:** A stirrer should have variable speed control to allow for proper sample mixing. Mixing will ensure a faster electrode response, greater stability, and more accurate measurements.
- **Electrode holder:** An electrode holder will help hold the electrode in the correct position for measurement. A holder also helps to avoid damage to the glass pH bulb (it can break when it hits the magnetic stir bar).
- **Labware:** 100 mL sample beakers (2), 300 mL waste beakers (2), lab wash bottle with deionized or distilled water (1).

Hanna Note

- Bracketing is the process of calibrating a pH meter to points above and below the expected pH range of the samples being tested.
- pH 3.00 and 7.01 calibration buffers are ideal for bracketing the pH of a wine sample, increasing measurement accuracy.



What You Need

What you need for good testing set up (continued)

- **Calibration buffers:** Calibration ensures the electrode is synced to the meter. Use pH 3.00 and pH 7.01 buffers for optimal results.
- **Cleaning solutions:** Clogged junctions are the number 1 reason for poor performance in pH measurement. In wine this is particularly important because wine samples (must, juice etc) leave residues on the junction of the pH electrode that will clog it.
- **Storage solution:** A dry pH electrode is the second most common reason for poor performance in pH measurement. A dry pH bulb slows the exchange of ions (pH reading), creating false readings (you record the pH value because you think it is stable, but it is still drifting), or worse prevents the electrode from working.
- **Refilling solution for electrodes:** The filling solution of a pH electrode becomes contaminated through the testing process. Emptying out the filling solution and replacing it with fresh solution will help rejuvenate the electrode making it faster, and more responsive.



What You Need

Features of an Ideal pH Meter



Flexibility: A hybrid meter that gives you the option to use it as a portable or benchtop instrument with a built-in battery will give the greatest versatility.

Ease of use: Measurement, configuration, calibration, diagnostics, and logging should be easy to do with data management features including direct / USB data transfer and the ability to save large data logs.

Simple maintenance: An ideal pH meter has electrode diagnostics to inform you in the event that your calibration buffers may be contaminated or the electrode needs to be cleaned.



What You Need

Features of an Ideal Electrode

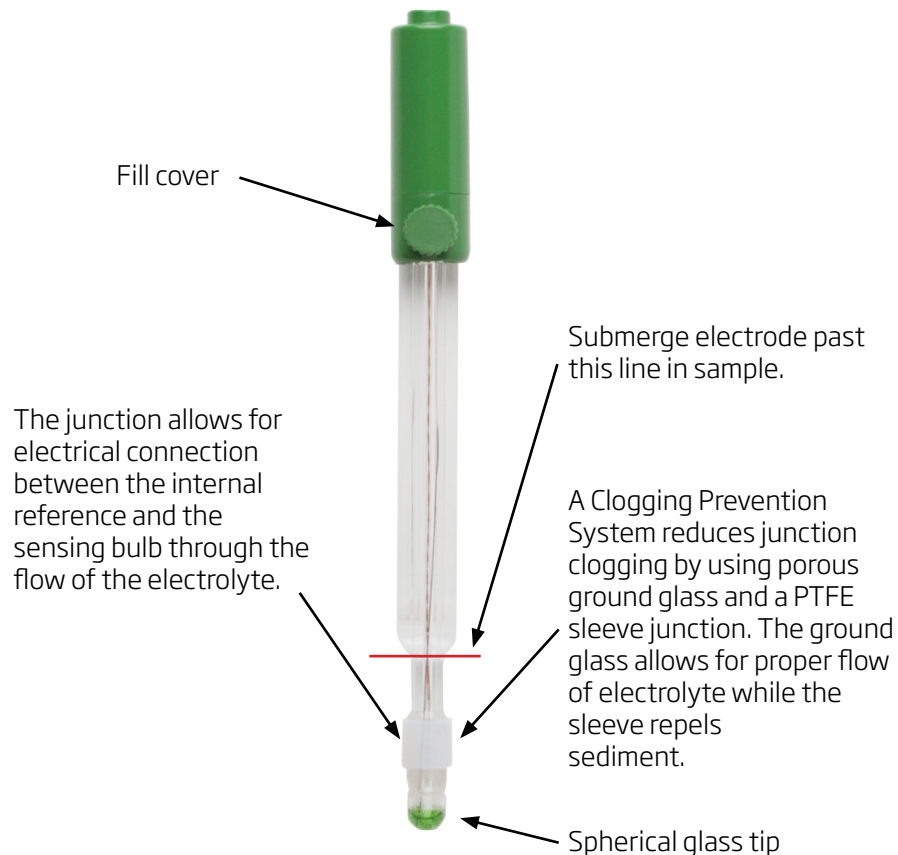

An Ideal pH Electrode Should be Designed for Wine

Spherical bulb: A pH electrode with a spherical sensing bulb is optimal for wine measurements. The spherical shape provides a wide area of contact with the wine sample, providing a faster response time.

Anti-clogging: Testing wine can be harsh on electrodes. Deposits of sediment on the glass tip and electrode junction decrease electrode performance. Dirty electrodes can cause readings to be up to 0.5 pH units off, even if calibration has been performed.

Temperature sensor: The electrode should have a built-in sensor to make temperature measuring and logging easy.

Hanna Note

- Handling the glass tip of the electrode, wiping it clean, or failing to clean correctly reduces its working life and can impact accuracy.



What You Need

Features of Ideal Solutions



Hanna Note

- Calibrating to pH 3.00 and pH 7.01 reduces measurement errors in wine.
- Use fresh buffers for calibration and replace buffers which have been opened for more than six months.
- Always keep the electrode fill solution topped off.

Solutions Should be Certified and Wine Specific

Calibration buffers: Technical buffers are NIST traceable and come supplied with a Certificate of Analysis. The pH 3.00 buffer is designed to calibrate your pH meter to bracket the required pH range of your wine.

Electrode cleaning solutions: Specially designed cleaning solutions remove wine, juice, and must stains and deposits without damaging the electrode.

Electrode storage solution: A storage solution is designed to keep the electrode bulb hydrated and ensure optimum performance. Properly stored electrodes exhibit higher accuracy and have a longer lifespan.

Electrode fill solution: The electrode fill solution, or electrolyte, electrically connects the pH meter and electrode with the wine sample being tested. Levels of electrolyte should regularly be maintained.



What You Need

Equipment

- 1 pH meter
- 2 Wine/must electrode with clogging prevention system
- 3 Compact magnetic stirrer and electrode holder
- 4 100 mL beakers (2)*
- 5 Lab wash bottle*

Solutions

- 6 pH 3.00 buffer
- 7 pH 7.01 buffer
- 8 Cleaning solution for wine deposits
- 9 Electrode storage solution
- 10 Electrode fill solution specific to electrode



*Not included in the HI2020W Kit



How to Measure

1 Calibration

a. Prepare the electrode

- Remove the protective/storage cap from the electrode.
- If the pH bulb is dehydrated, store in storage solution overnight.
- Remove the fill hole screw cap.

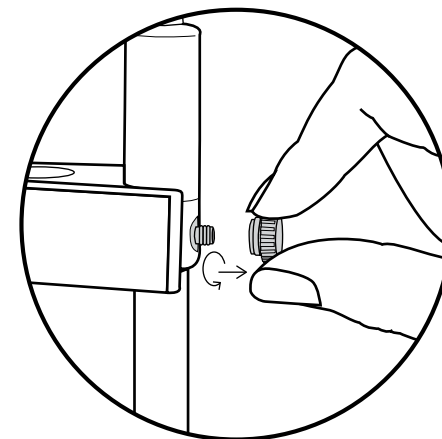

b. Prepare the calibration buffers

- Fill 2 beakers with enough pH buffer solution 7.01 to cover the pH electrode junction (approximately 75 mL in a small beaker). Use one of the beakers to rinse the pH electrode and the second for the actual calibration.
- Repeat for pH 3.00 buffer.

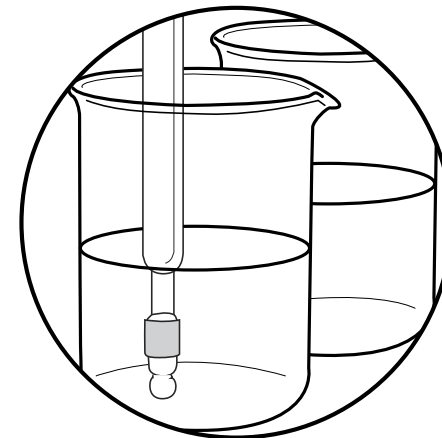



How to Measure

c. Perform a calibration

- Rinse the pH electrode in the pH 7.01 rinse beaker and stir gently for 4 to 6 seconds.
- Place the electrode in the pH 7.01 calibration beaker and stir gently for 4 to 6 seconds. Wait for the reading to stabilize (digits on the LCD stop changing for at least 5 seconds) and confirm the calibration.
- Rinse the pH electrode in the pH 3.00 rinse beaker. Stir gently for 8 to 10 seconds.
- Place the electrode in the pH 3.00 beaker and stir gently for 4 to 6 seconds. Wait for the reading pH reading to stabilize and confirm the calibration.

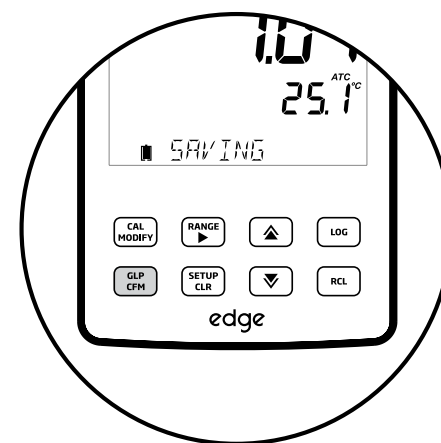

Hanna Note

- Calibrate the electrode after extended storage, cleaning, and before use.
- If readings are slow to stabilize (more than 30 seconds) the electrode may need to be cleaned or the electrolyte may need to be changed.



How to Measure

2 Measure

- Do not start taking measurements unless the pH electrode has been properly hydrated and calibrated.
- Fill 2 beakers with enough sample (juice, must, etc) to cover the pH electrode junction (approximately 75 mL in a small beaker). Use one of the beakers to rinse the pH electrode and the second for the actual measurement.
- Rinse the magnetic stir bar.
- Place the measurement beaker with the sample on the stirrer and drop the magnetic stir bar into it. Make sure the beaker is well centered on the stirrer.
- Turn the stirrer on. Set the speed to circulate the sample in the beaker without creating a vortex from a speed that is too high.
- Place the electrode in the rinse beaker and stir gently for 4 to 6 seconds
- Clip the pH electrode onto the electrode holder and lower it until the junction is fully immersed.
- Wait for approximately 1 minute before recording your measurement (the pH reading is stable when the digits do not change for at least 5 seconds).

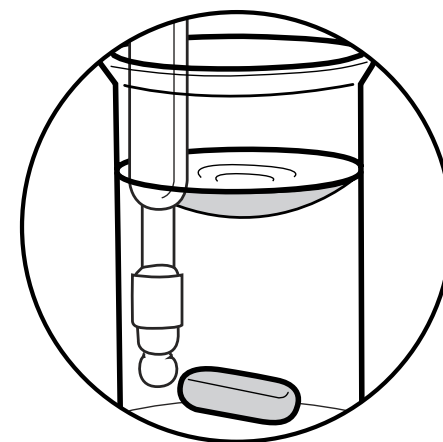



How to Measure

3 Clean and Store

- Once you are finished measuring your samples, unclip the pH electrode from the electrode holder and rinse it with water until all wine stains are removed.
- Examine the pH electrode to determine if it needs to be refilled with fill solution (the level of the internal solution is less than ½ inch from the fill hole).
- If it is clear that wine/must is present inside the pH electrode (easier to spot with red wines because you see the red stains inside), then empty, rinse, and refill the electrode with fill solution. Close the fill hole with the cap.
- Fill a small beaker with cleaning solution for wine deposits or wine stains
- Immerse the pH electrode for at least 10-20 minutes. Make sure the junction is covered.
- Fill the storage cap of the pH electrode to the half point with storage solution and replace the storage cap on the electrode. Make sure there is enough storage solution in the cap to cover the tip of the pH electrode.

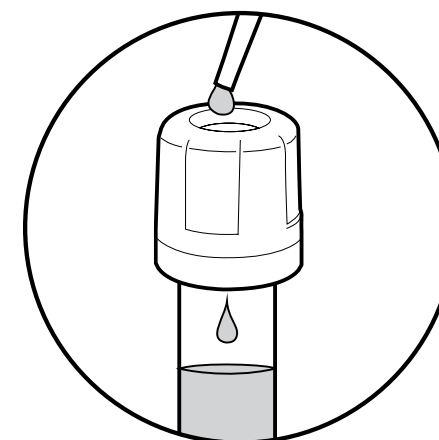
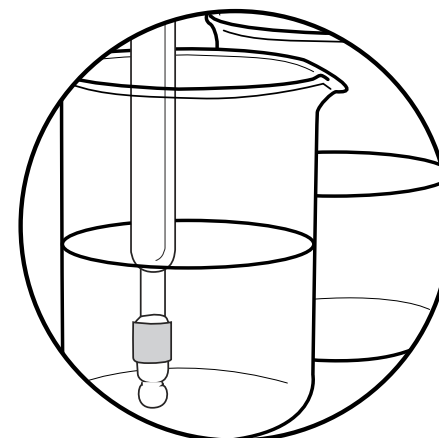



How to Measure pH

1 Prepare and Calibrate

- Remove electrode storage cap - if bulb is dry, place in solution overnight
- Remove electrode fill cover
- Fill 2 beakers with enough pH 7.01 buffer solution to cover the pH electrode junction (about 75 mL in a small beaker)
- Use one of the beakers to rinse the pH electrode and the second for the actual calibration
- Repeat for pH 3.00 buffer solution
- Rinse the pH electrode in the pH 7.01 rinse beaker and stir gently for 4-6 seconds
- Place the electrode in the pH 7.01 calibration beaker and stir gently for 4-6 seconds
- Place the electrode in the pH 7.01 calibration beaker and stir gently for 4-6 seconds
- Wait for the reading to stabilize (reading is stable for at least 5 seconds) and confirm it
- Rinse the pH electrode in the pH 3.00 rinse beaker and stir gently for 8-10 seconds
- Place the electrode in the pH 3.00 beaker and stir gently for 4-6 seconds
- Wait for the reading pH reading to stabilize and confirm it

2 Measure

- Do not start taking measurements unless the pH electrode has been properly hydrated and calibrated
- Fill 2 beakers with enough sample (juice/must) to cover the pH electrode junction (about 75 mL in a small beaker)
- Use one of the beaker to rinse the pH electrode and the second for the actual measurement
- Rinse the magnetic stir bar
- Place the measurement beaker with sample on the magnetic stirrer then drop in the stir bar
- Make sure the beaker is well centered on the stirrer
- Turn the stirrer on with speed set to circulate the sample without creating a vortex (too much speed)
- Place the electrode in the rinse beaker and stir gently for 4-6 seconds
- Clip the pH electrode onto the electrode holder and lower it until the junction is fully immersed
- Wait about 1 minute before recording measurement (reading is stable when the digits do not change for at least 5 seconds)

3 Clean and Store

- After measuring samples, unclip the pH electrode from holder and rinse
- Ensure all wine stains are removed
- Examine the pH electrode - refill if the level of the internal solution is less than ½ inch from the fill hole
- Empty, rinse, and refill the electrode with fill solution if it is clear that wine/must is present inside the pH electrode
- Fill a small beaker with cleaning solution for wine deposits or wine stains
- Immerse the pH electrode for at least 10-20 minutes with junction covered
- Fill the storage cap of the pH electrode to the half point with storage solution
- Replace the storage cap on the electrode
- Make sure there is enough storage solution in the cap to cover the tip of the pH electrode

THANKS FOR READING!

The edge wine pH kit for professional winemakers.



Limited
time offer
\$699
+ Free Shipping

Kit includes:

- edge pH meter HI2020
- Wine pH electrode HI10480
- Buffers and solutions

Bonus

- Magnetic stirrer

To order go to hannainst.com/wine-edge-ph

Visit us at
hannainst.com

Email us at
wine@hannainst.com

Call us at
877-MY-HANNA