

Anniversary partners:



# The leading motorsport technology publication since 1990

# Racecar

# engineering™



April 2015 • Vol 25 No4 • [www.racecar-engineering.com](http://www.racecar-engineering.com) • UK £5.95 • US \$14.50

Peter Wright investigates

## Formula 1 2015

and power unit development

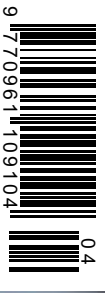

### Advanced cooling

Tuning airflow through the latest grand prix cars

### F3 controversy

Russian design adds diversity to European grid

### American legend

How GENESIS software helped Pratt and Miller develop the Corvette C7.R

# Xtraordinary All-Fluid Filters

4 DIFFERENT SERIES... MODULAR... TONS OF OPTIONS



**71 SERIES** - Our largest capacity filters. 2.47" diameter; Two lengths. Reusable SS elements: 10, 20, 45, 60, 75, 100 or 120 micron; High-pressure core. Choice of AN style or Quick Disconnect end caps. Options include: differential pressure by-pass valve; auxiliary ports for temp probe, pressure regulator, etc.; Outlet caps with differential pressure gauge ports to measure pressure drop.



**72 SERIES** - Same large-capacity, 2.47" diameter body as our 71 Series but with a 2-piece body that couples together with a Clamshell Quick Disconnect for quick service. 72 Series uses the same stainless steel elements, mounting hardware and end fittings as 71 Series.



## 71 SERIES MULTI-STACK - FAILSAFE STAGED FILTRATION

Multi-Stack adapter sections allow the stacking of two or more 71 Series bodies, long or short, so you can combine a variety of filtration rates or backup elements. Use a coarse micron screen element to filter out large debris upstream, followed by a tighter micron second-stage element to get smaller contaminants. Options include: adapters with take-off ports to facilitate the use of a differential pressure gauge which monitors contamination levels in all stages of the filter assembly.



Stack and Stage For Maximum Protection On Race Day

## SPACE SAVER SERIES - OUR MOST COMPACT FILTERS

3 Body Styles - 7 Choices of Screens

About 1 1/8" diameter, they fit everywhere and they do the job right for so many applications! 2 sets of O-Rings for a variety of racing fluids. Choose from 10, 20, 40, 60, 75, 100, or 120 micron screens to suit all needs.



**SPACE SAVER DRY SUMP** - Same space-saving size, these dry sump filters include a coarse-screen #16 mesh filter that protects your pump in high-volume race applications.



## INTRODUCING THE NEW 70 SERIES

Compact 1.97" diameter body features a springless design to maximize filtering area in tight spaces. 70 Series filters are ideal for applications where space and weight are of primary concern. Bodies are available with AN-style end caps, sizes -4 through -12, in heavy or lightweight wall versions. 70 Series filter elements come in two varieties: pleated cellulose (10 or 20 micron) or reusable pleated stainless steel wire (10, 20, 45, 60, 75, 100, or 120 micron). Undercut inlet end caps (sizes -4 through -10) offer a maximum weight savings and modern look.

### 70 SERIES Pleated Stainless Steel or Cellulose Elements



Follow us on Instagram #XRPracing

Like us on Facebook/XRPinC

Go to [WWW.XRP.COM](http://WWW.XRP.COM) for catalog downloads & new products or contact us for 100-page color catalog.



THE XTREME IN RACECAR PLUMBING

UNITED STATES XRP, Inc. sales@xrp.com tel 562 861 4765 fax 562 861 5503  
EUROPE JLS Motorsport motorsport@lister.co.uk tel 44 (0) 121 525 5800 fax 44 (0) 121 525 4833

**COVER STORY**

- 18 Formula 1 2015**  
Peter Wright explores the 1600bhp power unit

**COLUMNS**

- 5 Ricardo Divila**  
Testing does not always go to plan...
- 7 Mike Blanchet**  
...But with modern techniques it can go well!

**FEATURES**

- 8 F1 2015 On track**  
Looking at this season's rules and the new cars
- 16 F1 power units**  
How three manufacturers have developed new engines
- 29 Racecar is 25!**  
In the first of a series, we look through our archives and pick out some great features. This month, it's the turn of Formula 1
- 32 From Russia with controversy**  
A highly innovative new Formula 3 car could upset the status quo

The racing was good at the Daytona 500 in February, and Ford took victory before the introduction of a new rule book in Atlanta a week later

**TECHNICAL**

- 39 Consultant**  
Does size matter? It does with wheels
- 43 Databytes**  
Using solid state technology
- 47 AeroBYTES**  
A final look at the BTCC Merc in the tunnel
- 50 F1 cooling systems**  
Optimising open wheel cooler layouts
- 58 Evolving the Corvette**  
Tuning the design of the C5.R, C6.R and C7.R
- 67 Electrical systems**  
Gemma Hatton discusses connectors
- 74 Asymmetric correlation gathering**  
Simulating a Sprint Cup car on an oval
- 80 Stockcar Engineering**  
NASCAR's new rule book put to the test

**BUSINESS NEWS & PEOPLE**

- 84 Industry News**  
Viewing figures down in F1, up in NASCAR
- 84 Racecar People**  
Marcello Lotti discusses TCR
- 97 Products**  
Two innovations for F1 teams
- 98 Bump Stop**



Subscribe to *Racecar Engineering* – find the best offers online  
[www.racecar-engineering.com](http://www.racecar-engineering.com)

Contact us with your comments and views on [@RacecarEd](https://twitter.com/RacecarEd) or on [Facebook.com/RacecarEngineering](https://www.facebook.com/RacecarEngineering)



# SOLUTIONS MADE OF PASSION

At Kaiser we manufacture the Racechassis, -engine and -gearbox components our customers require within the shortest possible and agreed production time. We manufacture prototypes and small batches for the top end of motorsport, aerospace and the automotive industry.



## F1 RACE PARTS

- suspension wishbones and rods (incl. carbon)
- torsion bars incl. scragging and antiroll bars
- rockers, hubs, spacers, nuts
- shock absorbers (incl. rotary-dampers)
- steering housings
- steering racks and pinions
- steering columns, quick releases and paddles
- hydraulics
- brake calipers and -cylinders
- chassis parts in metal and carbon
- engine valvetrain
- conrods
- crankcases
- cylinderheads
- pump bodies, gears and shafts
- clutch components
- gearbox-cases
- gearbox-internals
- gearbox-hydraulics
- turbo components
- energy recovery system and e-motor components
- and many more ...

**Kaiser Werkzeugbau GmbH**

Gewerbegebiet Helferskirchen

56244 Helferskirchen · Germany

Tel. +49 2626 9243-0 · Fax +49 2626 9243-20

[www.kaiser-wzb.de](http://www.kaiser-wzb.de) · [kontakt@kaiser-wzb.de](mailto:kontakt@kaiser-wzb.de)

**KAISER®**



# ‘Worry is rust on a blade’

Keep calm and carry on as the world of pre-season testing inflicts itself upon you

The usual laid-back timeless early design period telescopes into a desperate scrabble to finish all drawings and kick it out to fabrication and machining, with the result that early parts are baroque rococo gilded and etched masterpieces, and the later, near to end of design bits are lashed-up get-it-to-the-shop floor so as not to hold up the build. Of course, the missing parts are not simply a bolt on, they are always the base of the pyramid. All adhere to the hallowed 80-20 rule, as in 80 per cent of the time is used for 20 per cent of the project, money, parts, problems.

Assuming the car finally gets bolted together, it gets loaded on the truck to go to the test venue. Unsurprisingly, the said loading happens in the early hours of the morning, and before the tail lift closes some more hastily finished part gets tossed in to be fitted to the racecar at the track. The really late parts travel in luxury as hand luggage.

After the whole presentation shtick has been done – the sponsors duly waving at the public and the drivers enthusing about how this year ‘for sure’ a cornucopia of results will shower on them, it is then time to take the car out on track and show what it can do. Or what it could do if they managed to fire it up.

Several huddles over laptop and telemetry screens see the engine guys, electricity bods and IT experts squabbling over whose bit is responsible for the non-responsive lump of metal not doing what it did so easily in the workshop. Back then, it also had some batteries to get the proceedings underway, and it hadn’t been checked in its normal start setup.

## It’s tough out there

At this point the team decides to jump start it anyway, as modesty screens hide the car from the ravenous press and all its systems have been warmed by outside umbilicals which have been busily running water and oil through heaters. It is sent out for its installation lap, when things are checked with the car in motion, not necessarily very fast and for one lap only.

In days of yore we learned also to send it out with a few litres of fuel, enough for the one lap, as it would be a smaller bonfire if anything leaked or ignited for any reason. This had been learned the hard way, through experience, by an unnamed team, when a glowing pile of slag was all that was left of the gleaming new, fully-fuelled car when it stopped on the main straight and the track’s fire tender had empty extinguishers.

On one of my shakedown we had a brand new Fittipaldi F8, trucked up from the base at Reading to Snetterton. On the first lap Keke Rosberg came barrelling out of Coram and onto pit straight only to remember he should pit for a checkover. The last



Technical gremlins can leave even the best-funded teams feeling frustrated

minute lunge for the pit entrance resulted in getting on to the dusty part of the track and the car came to a crunching halt against the end of the pitwall. A very short life for that monocoque and a very apologetic driver. We were not amused. However, as Keke routinely made the car perform at least a second faster than we expected, all was forgiven.

When new systems come out to play as the new engine and ERS systems are unveiled, the track time to down time ratio tends towards infinity. The sight of multi-million shekel organisations not being able to produce more than a couple of laps in a row attests to the penalties of pushing the frontiers. It’s even more embarrassing when the car comes back at the end of a towrope. Still, even that’s more desirable than arriving on a flatbed truck, as that means something major has broken.

Even small and seemingly unrelated events leave teams red-faced. The car itself, fettled to within

an inch of its life, might work OK, only to have the test brought to its knees by a failure of ancillaries – mundane bits like tyre warmers or, that perennial favourite, telemetry not working and leaving the engineering gaggle in the dark as to what is going on with their state-of-the-art pride and joy.

A classic example was Ferrari once upon a time a long time ago turning up to a straight line test in winter only to find that the hydraulic actuators were so cold that the seals leaked. There was no generator to provide defrosting services in the first truck, so the back-up was summoned. In true Ferrari style, the truck was washed, and arrived at the track, albeit without the necessary generator

either. A third was dispatched and also arrived in pristine condition, but by then the day was lost.

The increasing complexity of ERS systems, engines with flow meters and cutting edge technology means that first runs are increasingly very hit or miss occasions, the powerplant team having usually underestimated the development and execution times, the F1 shenanigans the previous year blemishing somewhat the view that this was a discipline that far outshone any other industry in technology. This year’s return of Honda-McLaren showed that – notwithstanding having two giants of the industry pouring their best efforts into the project, the reality is that even with all this expertise the team only managed to complete six laps in two days.

## Victory from defeat

The spin doctoring going on makes Dr. Pangloss seem like a pessimist. ‘It is demonstrable,’ said he, ‘that things cannot be otherwise than as they are; for as all things have been created for some end, they must necessarily be created for the best end. Observe, for instance, the nose is formed for spectacles, therefore we wear spectacles. Swine were intended to be eaten, therefore we eat pork all the year round: and they, who assert that everything is right, do not express themselves correctly; they should say that everything is best.’ Or to put it another way, don’t say the team spent the entire day running around like headless chickens.

When all is said and done, first tests are similar to bungee jumping – you throw yourself right off the edge and hope everything will be alright. 

**Multi-million shekel organisations not being able to produce more than a couple of laps in a row attests to the penalties of pushing the boundaries**

# QUALITY AND RELIABILITY



**HIGHER FLOW RATES**  
**LESS FRICTION**  
**MORE POWER**

With more than 40 years of experience manufacturing high performance racing valves, Supertech utilizes the finest material and design to make available the most durable, high performance racing valves on the market today. Supertech valves are forged, CNC machined, and hand polished for strength and reliability.

All Supertech parts are measured against the strictest tolerances in the industry and utilize finite element analysis, enabling us to provide a high performance product, without sacrificing durability. Regardless of your high performance needs, Supertech is the best choice for you if quality, durability and performance are vital to your needs.



3580 Charter Park Dr. San Jose, CA. 95136 USA  
[www.supertechperformance.com](http://www.supertechperformance.com)

(408) 448-2001



# The lost art of testing

How the role of the test driver has changed with the emergence of technology

**B**elieve me, there is nothing, absolute nothing, half so much worth doing as simply messing about in boats. So said the Water Rat to the Mole in Kenneth Grahame's 'The Wind in the Willows.'

I beg to differ.

Around this time of year I become very envious of those test drivers chosen to shake down a brand new racecar, whatever its type. Especially privileged are those who are the first to drive a prototype design, something I was fortunate enough to do quite frequently a good many years ago. While racing is ultimately what it's all about, there is considerable anticipation and excitement in being strapped into a machine that is the culmination of many months of research, design and manufacture by a bunch of dedicated people. You now have the responsibility of proving, ultimately via the stop-watch, whether all the winter's effort and hard work has been worthwhile – or not.

Give me a fresh and sunny early spring morning with a clear track to venture out upon and an intensive day of testing ahead and I am a supremely happy man.

## Lack of driver input

I was doubly fortunate in my job because the professional and experienced engineers and mechanics at Lola meant that the cars normally ran well from the off without niggling problems that might otherwise have turned expectation into frustration. Of course, everything was a lot simpler back then as the cars didn't have any complicated electronics to introduce baffling glitches. Equally though, there was no simulation software to draw upon during the design stage, much of the work being empirical and based on estimated load cases, and very basic wind tunnel input.

To some extent, despite my envy, I feel a little sorry for the test drivers of today because so much of the car's behaviour and characteristics has been determined quite accurately in advance, which must have reduced the importance of the driver's 'feel' and feedback, and hence the satisfaction to be gained from 'sorting' the car. This is particularly relevant to developing for series production, where a different approach may be needed compared to setting-up a car specifically

to one's own preferences and, of course, for individual circuits. The prevalence now of one-make formulae frequently means evolution rather than a clean-CAD-screen creation, and/or an adaption of an existing basic design. This means that for the test driver, test sessions are a venture rather than an adventure into the unknown and, while it's considerably safer, it's also much less of a buzz.

Back then it wasn't unusual to be trying radical aerodynamic and suspension concepts, some of which could bring unsuspected 'moments' when the driver really started to explore the car's limits. The odd sudden small fire or something a bit critical starting to fall off was not unknown either, generally passing without major mishap, although it did keep you on your toes. I think this led one to

a solution of paraffin and talcum powder which performed a similar function. The exact recipe remains a close secret still, of course...

However, I do wish that we had had the benefit of basic data-logging, which undoubtedly would have saved a lot of time and money and would have been very interesting to work with. Drivers now are clearly more skilled at detail set-up because of these tools. But, as with many engineers who bemoan the limitations of the fixed-specification cars that they work on, there must be some among them who feel deprived of the deep-down involvement that comes with tackling the basic dynamics of vehicle behaviour. There is great satisfaction to be had from developing a raw concept into a fast and competitive racing car.

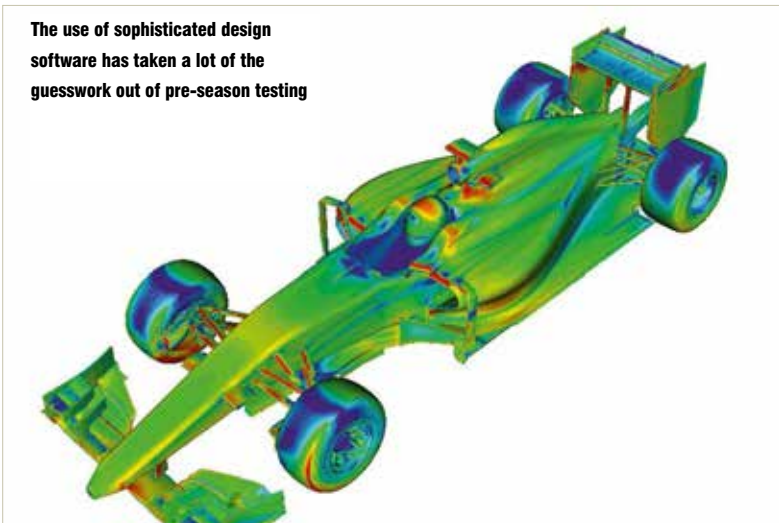

**The use of sophisticated design software has taken a lot of the guesswork out of pre-season testing**

## Back to the future?

One aspect of testing that I largely missed out on was tyre evaluation, as the chassis development was generally carried out on the spec rubber for the category of the car concerned, from F Ford to F3000. However, the introduction of radial racing tyres made clear the difference in suspension geometry and driving style required compared to the conventional cross-plyes. This is pertinent to the current move in F1 to turn back the clock and have much wider rear tyres. In common with many others I love the look, but many advocating this seem not to

develop a heightened sensitivity to what was going on. I vividly remember one incident – a moment of instability when going flat stick through a quick corner led to the discovery of a suspension ball joint pulling out. Without this awareness a hefty shunt would have been on the cards and the cause may never have been found, whereas instead a swift replacement of the part meant that testing resumed and an analysis of the faulty component could be made to avoid a recurrence.

Looking back I wonder at how unscientific the approach to testing was in many respects. However, I note with wry amusement the emergence in the last few years of Flo-Vis paint on F1 cars to highlight the aero traces and compare these with wind tunnel and CFD predictions. We used this very practical device quite a lot, but rather than buying an expensive chemical we simply mixed-up

understand that this won't bring back the pre-1980s controlled power slides that are great to indulge in and exciting to watch. The main advantages of radial construction are superior traction under acceleration and braking, plus minimal 'growth' at high wheel speeds. The downside is that their behaviour at breakaway is not very progressive. I can't see any F1 racing tyre supplier going back to cross-plyes as any claim to technology drawdown for road tyres would be lost.

Perhaps it will soon be time to move away from these rubber bladders filled with air that have been around almost as long as the automobile towards a new technology. Michelin have been researching an airless tyre but whether it will be suitable in time for racing only time will tell. Nonetheless, you can be sure that the services of a test driver will be needed to develop and prove it.



**Especially privileged are those who drive a prototype design**

# What's new?

Racecar Engineering looks at the new season's key regulation changes and sees how the teams are reacting to the new guidelines

By SAM COLLINS

**A**t first glance, there is little change for the 2015 Formula 1 season, especially when it comes to the rulebook. There have been barely any changes over the winter, and the few that there have been introduced do little to affect the overall design of the car. Changes regarding the noses and the size of the front impact structures have led to the front of the car looking different, and visually the rest of the car looks similar compared to last year. As always, however, there is more to the story.

In 2014 the FIA introduced revised rules relating to the height of the front impact structures, but an unintended consequence of this was the 'adult entertainment' look of the front of the cars. They were widely ridiculed and for 2015 new, much wider front impact structures were introduced, as well as a more gradual gradient on the nose itself and the front of the chassis.

'An awful lot of work had to go into the nose,' says Pat Symonds, chief technical officer for Williams. 'At first glance, the regulations look quite innocuous, but in reality there is a lot of work there. The new front bulkhead and nose geometry had much more of an impact than we had initially anticipated and the effect on the aero was profound. The team has worked hard on pulling back the deficit these regulations have made for us. It is about the balance of aerodynamic solutions that can structurally get through the crash test too. Aerodynamically we wanted quite a short nose, but you want quite a long nose to get through the crash test, so there was some balancing to do there.'

This season sees a wide range of solutions of nose design on display along the pitlane. Teams such as Ferrari, McLaren, Sauber and Toro Rosso have opted to use wide, long noses, where the tip of the front impact structure sits forward of the leading edge of the front wing. Others, such as the Mercedes and Lotus, use shorter noses that sit behind the front wing. With both solutions, the new wider front impact structure sits in the area where teams want to get as much air under the nose as possible, so they are experimenting with different ways of achieving this. The Lotus twin tusk design of 2014 has been outlawed.

'The noses were an aerodynamic loss,' James Key, Toro Rosso technical director admits. 'It changed the flow in that area and as a result I think noses will be a development item this year, perhaps more so even than last

year. We have things in the pipeline in that area that will improve things. Whether everyone will devise the same solution remains to be seen, but there is a lot more to come.

'We crash test at Cranfield and there have been a lot of visits there, and not just us either, to the point that our car will look totally different by the start of the season.'





**‘With the 2015  
power units  
everybody can  
change everything’**

— Andy Cowell





**Top:** The Toro Rosso features some interesting ducting around the roll hoop, most noticeably the car has grown 'ears'. These additional ducts cool systems toward the rear of the car, likely the transmission and possibly the MGU-K

**Above:** The C34's nose section is now bigger in volume and lower to the ground, which has a considerable impact on the aerodynamics of the entire car – the nose and front wing play a key role in determining how the air flows around the front wheels and how effectively the central and rear sections of the car function aerodynamically

Another consequence of the revised nose section is that a number of teams, including Ferrari, Sauber and McLaren, have revised their 'brake cooling' aerodynamic elements and the wheel design itself. Some, including McLaren, have also used so-called 'blown nuts' to optimise flow around the front wheels and in the wake of the front wing endplates.

The nose changes have also had a major impact on the packaging at the front of the cars, especially on the front bulkhead which traditionally houses the inboard front suspension pickups, the torsion bars, dampers, master cylinders, steering rack and a number of electronic components. However, this area has been substantially reduced in size on a number of the 2015 cars, and it has led some teams to explore unconventional solutions, particularly in terms of the suspension. 'It's a big packaging exercise,' says Key. 'We had a strict rule of giving the guys the surface and saying everything has to fit inside that, and they achieved it all. At the moment the suspension is quite conventional, with torsion bars and dampers, but we have a lot of ideas, a long list of stuff. But we have not put that on the car yet.'

A more major but almost invisible rule change has had a huge impact on the suspension systems used in F1. Part-way through the 2014 season, the FIA announced that it felt that some, if not all, of the



hydraulically interconnected suspension systems used in Formula 1 were illegal. The governing body felt that the systems infringed article 3.15 of the technical regulations and that they constituted a moveable aerodynamic device. Strictly speaking, the systems did not breach article 3.15, but no team felt it worthwhile to test that stance and all of the teams removed the systems with immediate effect. For 2015 they have now formally been banned with the addition of the wording 'any specific part of the car influencing its aerodynamic performance must remain immobile in relation to the sprung part of the car.' This could also conceivably outlaw McLaren-style suspension 'blockers'.

With this rule change, and the packaging demands at the front of the car, many teams are taking the lessons learned in the years leading up to 2014 with the hydraulically interlinked suspension, and are applying them in a different way. The Marussia team had developed something 'different to anything seen in F1 before' for its stillborn MNR1 2015 design, while others are rumoured to be developing systems that drop torsion bars altogether.

Some other relatively minor safety rule changes have also been introduced in the wake of Jules Bianchi's crash at Suzuka last season. In 2015, the Zylon anti-intrusion panels, which are bonded to the sides of the monocoque, have been extended upwards and rearwards.

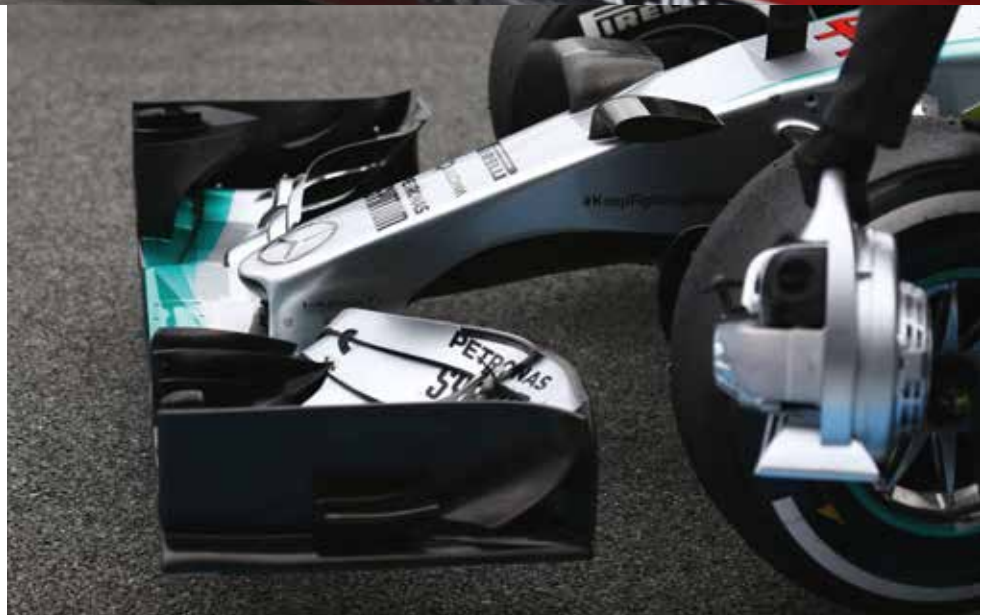

**Top: The rear of Ferrari's SF15-T is noticeably different from the 2014 car. The bodywork is now more tightly sculpted, and is a result, in part, of using more efficient radiators for improved cooling**

**Above: Mercedes and Lotus have opted for shorter noses that sit behind the leading edge of the front wing**

With so few rule changes, the teams and power unit manufacturers have been working hard on understanding the lessons of 2014 and optimising their cars around the power units.

The only major rule change in terms of power units is the reintroduction of variable inlet trumpets, a feature that could be used to improve efficiency and flatten out the power curve somewhat. It is a technology that is thought to feature on all of the 2015 power

units and is a subject which we will cover in greater depth in a future edition.

When the new engine formula was introduced at the start of last season, it allowed for annual updates to the power unit on a gradually descending scale, eventually arriving at a fully frozen specification by 2019 (see V23N11 for full details). Each year until that point the manufacturers can present a set of updates to the FIA for their power units which





**Top:** The back end of the McLaren is the tightest in the field and the sculpted rear ends are a particular trend in 2015  
**Middle:** A number of teams have redesigned their front wheels to improve airflow around the front of the car following changes to the rules around the nose. **Above:** Red Bull's Daniil Kvyat knocked the car's wing off during testing at Jerez and a lack of a replacement meant the team had to run some basic installation programmes with a wingless car while a new one was being flown out from the UK

would then be homologated for the season to come. After homologation each year, no updates other than those made for the reasons of reliability, safety or cost would be allowed. The trouble is that, for some reason, the FIA failed to publish a homologation deadline in the 2015 rules, which the manufacturers have now deemed to be tacit allowance to gradually phase in updates as the season goes on.

In 2015, up to 48 per cent of the power unit can be replaced (subdivided into 32 tokens), with the only elements of the design to be fixed being some dimensions including cylinder bore spacing, deck height and bank stagger, the air valve system and some aspects of the crankshaft design, so some manufacturers are clearly planning to bring in new parts during the year within that 48 per cent allowance.

Despite this, Mercedes has claimed that its PU109B power unit is essentially all-new, despite the rules seemingly stating that they can only be 48 per cent new. 'I don't think there are many parts carried over from last year, I think the majority of parts are changed either for performance or reliability,' explains Andy Cowell, Mercedes AMG HPP managing director. 'This power unit is completely new. If you look at the table of tokens you can change a lot. Combustion is down as three tokens for example. Changing that means a new cylinder head, piston, valves, injector and some associated parts, all within those three tokens. So when you think about it, the 32 tokens are actually very, very generous. Coupled with that, you can change anything for reasons of reliability, and everyone has to do more miles. Basically in 2015 everyone can change everything, because of the 32 tokens and the reliability increase required to go down from five power units to four.'

## Stricter gearbox rules

This has left the teams able to focus on integrating the power units better, leading to the cars featuring smaller cooling apertures as more efficient ways to cool the cars have been found and introduced. For example, Ferrari has changed the type of radiator cores it uses. 'The reduction in cooling is really just a case of second time around the loop – the heat rejection and cooling requirement numbers for the engine have not changed, it is just a case of looking through everything again and optimising,' adds Adrian Newey of Red Bull. For more about the current F1 cooling solutions turn to page 50.

In terms of transmissions, little has changed year on year, with each gearbox still having to last for six races. 'We count it as 3300km,' explains Xtrac's technical director Adrian Moore. 'This is made up of 250km on Saturday, and 300km on Sunday. Of course, not everybody does this as it depends on how far they run on Saturday morning and how far they get in qualifying and the race, but that is our target.'



# INTELLIGENCE CONNECTED



Flexible Hose and Fittings

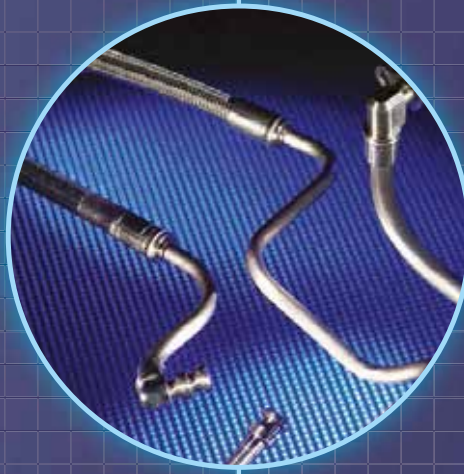

Rigid Lines and Swagel

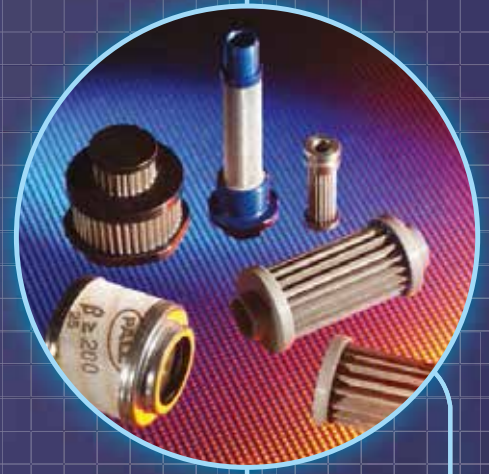

Filtration

It's not by accident that, over the years, we have developed many successful partnerships with customers throughout motorsport – particularly in F1, endurance racing and WRC.

By applying intelligent analysis of their problems in the area of fluid transfer in high performance, high energy situations, we have established ourselves capable of providing innovative and cost-effective solutions.

## SERVICES:

- 3D cad design service
- hose assembly
- hard-line manufacture
- cnc machining
- filtration design
- laser marking

## PRODUCTS:

- **Titeflex smoothbore and convoluted hose products and fittings**
- **Swagel fittings and hard-line system solutions**
- **Pall Filtration systems**
- **CIRCOR Industria solenoid valves**

# FHS

M O T O R R A C I N G

INTELLIGENT CONNECTIONS

Maintain system integrity, save weight, cut costs.  
**Make the connection now.**

To find out how the quality of your own fluid transfer requirements can be improved, call our Technical Sales Team on

**+44 (0) 1753 513080**



Toro Rosso's STR 10 managed 353 laps during testing at Jerez. The car's speed is described as solid, not spectacular

## Manor reborn?



The collapse of two teams and the reported financial troubles of three more made for pretty bleak reading at the end of the 2014 season. But at least one of the two failed outfits is trying to fight back – Marussia has come out of administration (the British equivalent of chapter 11 bankruptcy) and hopes to get onto the 2015 grid under the Manor Racing banner. The team intends to run its pair of 2014 specification Marussia MR03 chassis at the start of the season in a move that has proven somewhat controversial.

The tubs would be modified with the larger anti-intrusion panels required by the rules, but otherwise the cars would be entirely legal to run in 2015 with the notable exception of the nose. In January this year the F1 strategy group indicated that

Marussia and Caterham would be allowed to start the season with 2014 specification noses, but the details of this remain unclear.

'The team has been busy preparing its 2014 cars and at the same time it is pressing on with the development of its 2015 car to ensure it can supersede the 2014 car as soon as possible,' reads a statement from Manor Racing. 'The team has a significant number of staff already working on both its 2014 and 2015 cars. It also has the benefit of being able to recruit further staff from the rich pool of experienced and talented F1 personnel who were left unemployed following the closure of Marussia and Caterham and job cuts made by other teams.' It is likely that Manor will not have the resource or capability to build its MNR1 design as the wind tunnel model

was dismantled and the parts sold off at auction now reside in two separate private collections. In addition the team's factory in Banbury, England, has been taken over by the Haas F1 Team along with its computational capability (and reportedly the design data of the MNR1).

Its likely recourse will be to build 'B Spec' MR03s either using new tubs made from modified moulds, or to modify the two existing chassis by replacing the forward upper section of the chassis. Additionally, packaging Ferrari's 2015 specification power unit may be problematic within the 2014 MR03 bodywork, so the old spec Ferrari 059/3 power units may be used as they remain legal under the 2015 rules, although they do not have the required longevity, which would see the team incur grid position penalties.

The eight homologated gear ratios were designed to be in the gearbox for this mileage.'

One change to the 2015 sporting regulations means that teams can no longer make changes to their gear ratios during the season. 'Last year teams were allowed one instance of a ratio tooth count change during the season, i.e. in effect they could decide to change some or all of their eight homologated ratios for up to eight different homologated ratios,' Moore elaborates. 'They were also allowed five jokers, where they could change ratios from a sealed gearbox to identical items without penalty. In 2015 the ratio tooth count change is no longer allowed, and neither are the jokers.'

Far too often in the world of sportscar racing, an erroneous statistic is repeated claiming that the winner of Le Mans does more running in one race than a grand prix car does in an entire year. When looking at the gearbox it is clear that this is not the case. 'With our ultra high specification gear design, materials, heat treatment and finishing processes the gear ratios are intended to be durable for at least the 3300km,' Moore claims. 'In 2014 the winning Le Mans car completed 379 laps in the race which is 5165km. Comparatively an F1 car's gearbox is sealed for 3300km, which is actually more than 60 per cent of a Le Mans distance – significantly different to a few years ago when F1 gearboxes were overhauled after every race.'

But despite the stability of the regulations it appears that few, if any, of the teams have carried over their transmissions from 2014. One notable trend in 2015 is toward very tight rear ends on the cars, to the point where McLaren has dubbed the MP4-30 the 'Size zero racing car'.

## More compact rears

This is an area of focus for almost every team and has led to not only revised transmissions but also substantially different suspension layouts. 'The suspension is very different,' Key reveals. 'We heavily revised what we did last year for both aero and suspension reasons. With suspension you have the structural stuff, like compliance levels, but aero wants to have the thinnest possible elements, whereas structures want the thickest possible. You have to look at all of it, the mechanical grip, the ride and the platform control. Suspension has a huge aero influence so you have to go round a loop of how to optimise things, and we have done that more with this car than ever before.'

Some teams have gone even further and Force India has replaced the torsion bars at the rear with a new hydro-mechanical system. While the VJM08 had still to be seen as RCE went to press, it seems likely that these changes were made for packaging reasons.

Overall, though, it seems that all but one of the 2015 cars taking to the grid is a mild evolution of the same teams 2014 concept, just with a great many detail refinements, and not a few very small innovations. 

# 7-POST RIG @ TRE

# TRE

VEHICLE  
DYNAMICS

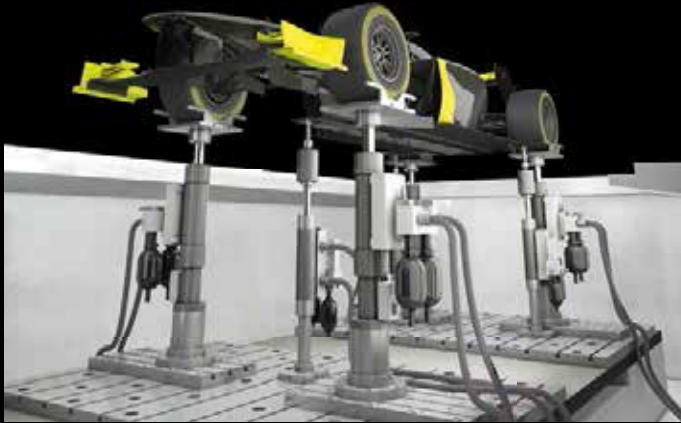

## seven post rig (Servotest)

- latest technologie and most advanced spec in Europe
- Formula cars, sportscars, rally, off road
- amplitude wheel actuators 125 mm
- amplitude aero actuators 150 mm
- maximum forces wheel actuators 36 kN
- maximum forces aero actuators 29 kN
- 72 analog inputs ( $\pm 10$  V)
- 72 analog outputs ( $\pm 10$  V)
- highly experienced staff
- customised postprocessing available
- consulting for operating, post processing and car setup



## high end damper dyno

- maximum velocity 6 m/s
- maximum force 36 kN
- amplitude 100 mm
- customised postprocessing
- lifecycle tests
- function development



**SAVE YOUR DATE FOR SEASON 2015/2016**



[www.TRE-gmbh.com](http://www.TRE-gmbh.com)



**TRE GmbH**

**Nachtweide 35**

**67433 Neustadt/Germany**

**Phone +49 6321 8786-0**

**info@tre-gmbh.com**

# Survival of the fittest

Examining the different approaches to F1 engine design

**A**t the time RCE went to press the 2015 power units had not been homologated and were all running in test specification, but despite this we could still glean some information about their development. Mercedes has introduced some major changes to its power unit which can be seen externally – it has dropped its ‘log’ exhaust which was thought to use Birman style pulse converters (see V25N1) to improve gas flow to the turbine and switched to a more conventional manifold design, which makes the power unit somewhat wider in the cars. The plenum is also more bulky due to the use of variable inlet trumpets, something that has created a visible bulge on the engine cover of some cars. ‘The thermal efficiency of this year’s engine is a step on from last year, and it’s all about taking that chemical potential energy, converting it into useful energy through combustion, and then not losing it through friction,’ explains Andy Cowell of Mercedes AMG HPP.

Meanwhile Renault arrived at the opening test with what was thought to be a heavily upgraded 2014 specification power unit, rather than its full 2015 design. ‘We have made some fundamental changes to gain performance and reliability,’ reveals Rob White, deputy managing director of Renaultsport F1. ‘We have upgraded every system and sub-system with items that will give the most performance prioritised. The principal changes involve the internal combustion engine, turbocharger and battery. The ICE will have a new combustion chamber, exhaust system and variable trumpets. The compressor is more efficient, while the energy recovery systems are able to deal with more severe

Honda’s return to F1, after a seven-year-hiatus, has been beset with technical glitches



## The return of the 1000bhp Formula 1 engine?

In recent months some in Formula 1 have become dissatisfied with the current rulebook. There are a number of motivations – some clearly want to break the dominance of Mercedes-Benz, while others feel that the cars themselves are not spectacular enough and the new power units are just far too expensive.

'I think things have got a bit out of kilter,' says Adrian Newey of Red Bull. 'In my opinion, Formula 1 should be a blend between the performance of the driver, the chassis and the engine,

but I think the current regulations have swung too much in favour of the engine and have given us a very restrictive set of rules in terms of the chassis. It makes it very hard for a chassis manufacturer to make enough of a difference to overcome that.'

As a result, many have called for the rules to be changed and want to see an increase of power to 1000bhp while also possibly increasing the relevance of the chassis. It seems that most F1 teams are in agreement that the power output should be increased

to 1000bhp, but few seem to agree on the best way to do it, or even when to do it (2016, 2017 or later). However, suggestions for changing the fuel flow limit or removing it all together seem to have been rejected, for now.

There are still proposals to freeze the specifications of all hybrid system components in an effort to cut costs, but again there is no agreement. However, there is apparently a consensus on changing the chassis rules to improve the look of the cars while increasing the maximum width

to 2000mm (currently 1800mm) and using wider rear tyres.

Putting the calls for 1000bhp cars into context is Andy Cowell of Mercedes-AMG HPP, who points out that it is achievable. 'The maximum power output if we get 100 per cent thermal efficiency with the current rules is 1200kW plus 115kW, so when we reach that number we have reached perfection. There is nothing stopping us getting to that number apart from a technology breakthrough, hard work and time.'

**“I think Renault did a good job of developing the engine over the winter, but you don't overcome a 10 per cent deficit in a few months”**

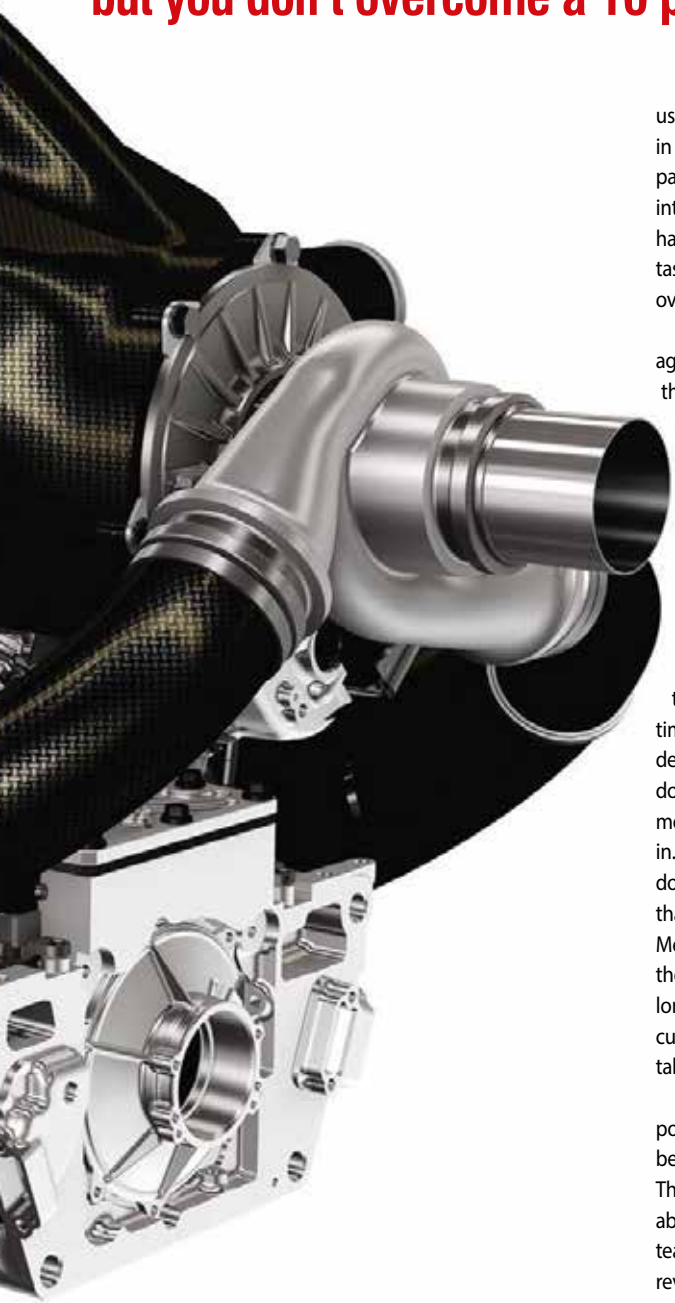

use. The 2014 unit was already well placed in its centre of gravity. We have tidied up the packaging to give greater ease of integration into the chassis. Many systems and functions have been also rationalised to further ease the task. In short, there are very few pieces carried over between the 2014 and 2015 power units.'

But at Jerez, Renault's reliability gremlins again showed their heads. A few days before the start of the test a defect in a water pump shaft was noticed on the dyno and this limited running time for the two Red Bull-branded teams. One of Renault's customers feels that there is still significant ground to made before the manufacturer catches up with Mercedes. 'Renault felt that the power deficit to Mercedes was about 10% per cent at the end of last year, and that's a big number', admits Adrian Newey. 'It is not easy to overcome a deficit like that in a very short time. I think Renault did a very good job of developing the engine over the winter, but you don't overcome a 10 per cent deficit in a few months and that is the position we are currently in. We are better than last year but we are still down on where Mercedes were last year, and that does not take into account any findings Mercedes have made over the winter. That's the nature of the engine business – it's a much longer lead time, with a slower development curve than the chassis side because the parts take so much longer to manufacture.'

Ferrari has been unusually coy about its power unit, possibly as a result of its old design being graded overweight and underpowered. The Italian firm has not disclosed many details about its development at all, however the team's technical director James Allison has revealed some information about the targets

for the 2015 design. 'Early on in the 2014 season the power delivery was not particularly sophisticated and it was quite tough for the drivers to get the type of throttle response that they wanted. It was improved a lot during the season and we have taken that a step further for the SF15-T', he explains. 'A definite weakness of last year's car was that the amount of electrical energy that we were able to recover from the turbo was not really good enough for producing competitive power levels during the race. It was one of the reasons Ferrari's qualifying performance was relatively stronger than the race performance last year. As a result we have tried to change the architecture of the engine to make it a better compromise between qualifying and racing performance. Then there is plain, simple horsepower. An enormous amount of work has gone into all aspects of our combustion efficiency to try to make sure that in this fuel-limited formula, where every team is only allowed to burn the same amount of fuel, every single compression stroke and every single ignition stroke is extracting the maximum amount of horsepower on the road.'

Honda has struggled to be able to get its RA615H power unit to run properly at all in the back of the McLaren MP4-30 and during its first two tests at Abu Dhabi (fitted to a 2014 chassis) and Jerez it failed to set a representative lap time. As a result, details about the design of the power unit are scarce, but it appears to have a Mercedes-style slit turbo charger, and may feature some innovative technology around the combustion chamber. When running, the unit creates a very different sound to the other three, although this may simply be because it was not being run at full power. 

# Efficiency drive

The learning continues for Formula 1's engineers as development for the 2015 season continues apace

By PETER WRIGHT



The challenge set by the FIA's regulations is to see how fast you can go around the racetrack for 200 miles using a limited amount of energy

Someone once famously said, generally attributed to Albert Einstein, that the definition of insanity was doing the same thing over and over and expecting different results. F1 is results driven, and moves quickly in response to results below expectations. It would seem that Formula 1 teams have taken this quotation to heart.

Ferrari, McLaren, Red Bull and Lotus have all instigated changes of management, and/or engine, and/or drivers, and/or engineers in an attempt to halt the slide in results experienced with the introduction of the new regulations in 2014. Meanwhile, Mercedes and Williams have changed almost nothing for 2015. And thus a reasonable prediction for the new F1 season would be for Mercedes and Williams to continue achieving at the level they achieved last year, while the others, well, we will have to wait and see.

To gain a greater perspective it is necessary to step right back and look at the bigger picture at the top level of motorsport. F1 and its equivalent GP formulae pre-1950, has always been an effective promotional tool for the motor industry, should they have a reason to promote the image motorsport provides. Mercedes created much of the brand identity it has today through technical superiority in

Grand Prix racing during the 1930s, and by achieving that superiority by a significant margin. It cemented that reputation post war, but since then it hasn't seen the need to commit to F1 until 2010, when it bought Brawn GP and a works Mercedes-Mercedes was seen for the first time since 1955. Why now? Because Mercedes recognises that automotive engineering is going through seismic changes with the need to reduce fuel consumption and CO<sub>2</sub> emissions, and it foresaw the need to promote its technical superiority in these new technologies and to re-establish the brand as the best in the new era. It has been reported that Mercedes' promotional yield from F1 in 2014 was worth \$2.5 billion, for an expenditure of \$400 million.

Ferrari also wishes to promote its brand and its cars through motorsport, but the image it wishes to promote is not that of economy. Motorsport, i.e. F1, is its sole means of advertising its road cars, and it must succeed regularly to justify the price it demands for its cars. It is inevitable that Ferrari will use whatever it has at its disposal in terms of influence to maintain F1 in that role. The other manufacturers, Honda and Renault, are desperate to receive reflected glory by beating Mercedes and Ferrari. McLaren-Honda may even find it has an

identity crisis as McLaren wishes to promote performance, while Honda's main market is becoming focused on high efficiency cars.

Thus we have multiple promotional objectives for the key stakeholders in F1. The volume motor industry wishes to promote economy and sustainability. The specialist performance sector wishes to promote an image of overwhelming performance. Red Bull wishes to promote its own brand image, the main attribute of which is to enable people to stay awake. FOM, the operational arm of CVC, simply wishes to entertain people sufficiently that they are happy to part with their money. F1 is a fine balance between business, entertainment, and marketing, and as the world changes in all these three areas, F1 is struggling to keep up. So focused and responsive to the engineering challenge, it seems lost in these other disciplines.

Anyway, I found myself in Jerez for the first F1 test of 2015. The nature of the current F1 regulations is such that the technical challenge set by the FIA's regulations is to see how fast you can go around the racetrack for 200 miles using a limited amount of energy delivered at a limited peak rate. Thus the technical story I have tried to gather at this start of the second year of these regulations is: a) What has F1 achieved so far? and b) How?





**Mercedes enjoyed a positive Jerez test – the team’s cars managed 515 laps, 40 per cent more than they achieved in 2014’s equivalent test**

The total energy issued for a race is 4.3GJ (1200kWhr), and it can be used at a peak rate of 1.2 MJ/second, or 1200kW (1609 bhp).

The powertrain designers’ objective is pretty straightforward: to deliver as much of the 1200 kW to the flywheel as possible, when required. The chassis designers’ objective is more complex: to apply this power to cover the 200 miles as quickly as possible, without allowing the integral of the power applied to exceed 1200kWhr. The drivers’ objective is to deliver this strategy during the race weekend.

Before 2014, a 200-mile F1 race typically used an unlimited 6.6GJ of energy to complete, and the peak rate at which it could be delivered was not limited, other than by the capacity and peak RPM of the 2.4-litre V-8, 18,000rpm, NA engines. The masters of achieving the new objective are undoubtedly Mercedes, and so I set out to find out the ‘What?’ and the ‘How?’ from Andy Cowell, managing director of Mercedes AMG High Performance Engines. The key question I asked him was ‘Where does all the energy go?’

First things first. The figure of 1200kW input power equivalent to the 100kg/hour regulated fuel flow rate is Andy’s figure, and equates to a fuel energy density of 43MJ/kg – significantly more than the FIA-regulated WEC fuel at 39.5MJ/kg. This is likely explained by the high level of bio-components in the WEC fuel; ethanol has an energy density of just 26.4MJ/kg. F1 does not directly regulate fuel energy density.

Cowell was never going to reveal the output of either the 2014 or 2015 Mercedes engine, so a different approach was necessary. I offered up the figure of an SFC = 200g/kWhr that I had heard from a reliable source. This figure gives:

<b>Input power (fuel):</b>	<b>1200kW (1609bhp)</b>
<b>Output at crankshaft:</b>	<b>440kW</b>
<b>Output from MGU-K (generated by MGU-H):</b>	<b>65kW</b>
<b>Total at flywheel:</b>	<b>505kW (675bhp)</b>
<b>Overall efficiency:</b>	<b>42%</b>

I have made an assumption here, based on the rumours and figures that always rush

in to fill a vacuum. The difference between the Mercedes engine and the other two in 2014 was the amount of power the MGU-H was able to extract from the exhaust. The permitted maximum it can deliver to the MGU-K is 120kW, of which 115kW goes to the flywheel. Based on the further assumption that Renault and Ferrari are just about as capable of generating power from a turbocharged engine, I have estimated the split between crank power and MGU-K power as generated by the MGU-H as above.

Cowell’s reaction was intriguing: ‘That would be the 2014 Renault figure then?’ Now we have something to play with. Adrian Newey stated that Red Bull estimated that the 2014 Renault was 10 per cent down on power compared to the Mercedes, and Renault stated in its 2015 press kit that the new power unit would deliver 850bhp. All teams reverse-engineer the performance of their competitors using the GPS data distributed by the FIA. Factor this in and the numbers would become as follows:

<b>Input power (fuel):</b>	<b>1200kW (1609bhp)</b>
<b>Output at crankshaft:</b>	<b>440kW</b>
<b>Output from MGU-K (generated by MGU-H):</b>	<b>115kW</b>
<b>Total at flywheel:</b>	<b>555kW (744bhp)</b>
<b>Overall efficiency:</b>	<b>46%</b>

## **All F1 teams reverse-engineer the performance of their competitors using the FIA’s GPS data**

McLaren and Honda have teamed up once again and have suffered teething problems in pre-season tests

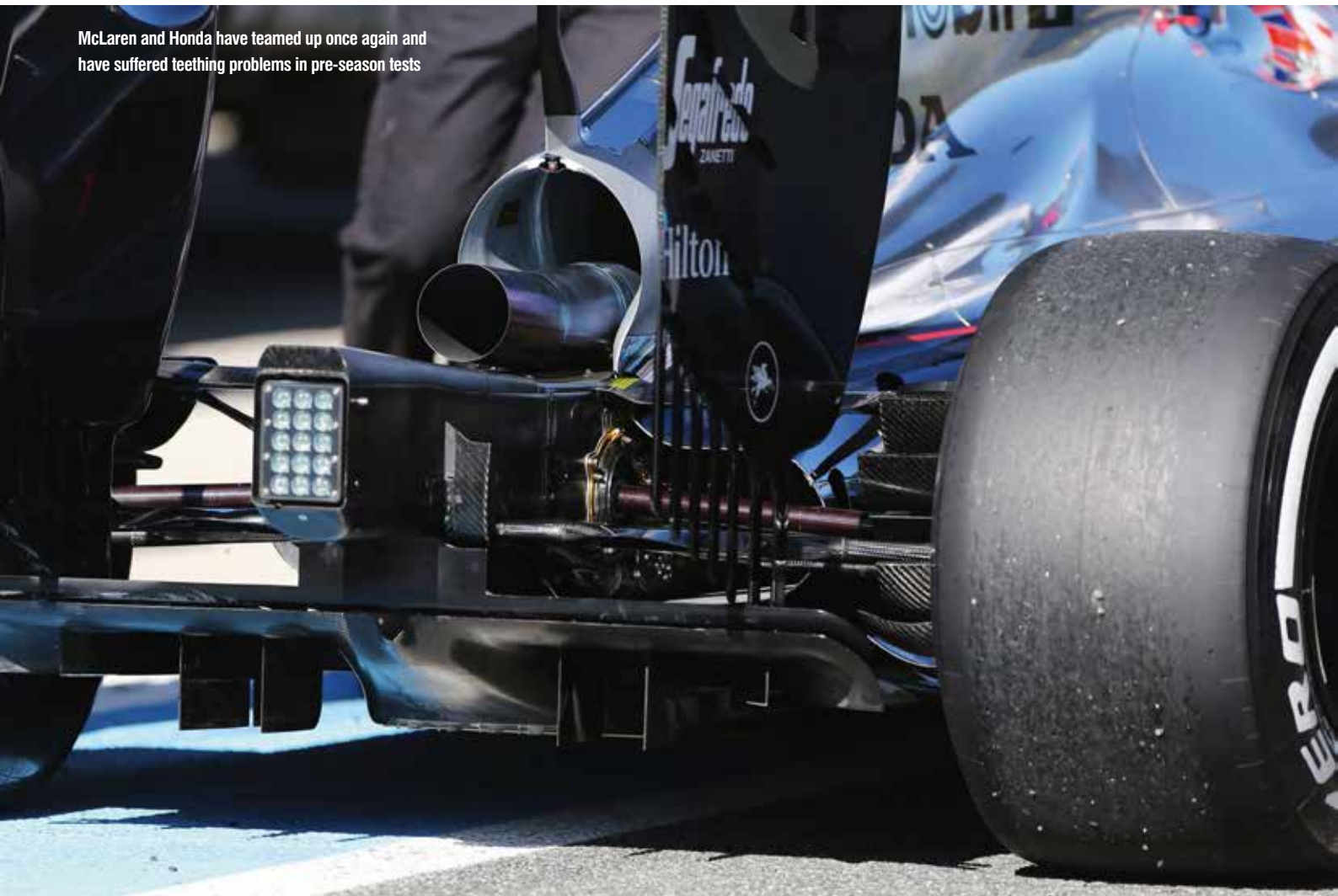

These figures are based on all the additional power coming from the MGU-H.

Pre-2014, NA F1 engines achieved an overall efficiency of around 33 per cent, so this is a remarkable 39 per cent improvement; surely complete justification for the change in powertrain regulations.

Cowell next described some of Mercedes' development philosophy behind this achievement, while being careful enough not to divulge sufficient numbers to enable the full picture to be revealed. He describes the whole process as 'the science of marginal gains': thousands of tiny incremental improvements, which, while almost insignificant in isolation, add up to a significant gain in performance.

It turns out that the limited number of tokens a powertrain manufacturer may use in 2015 – 32 in total – is actually no limitation on what it may change on the engine. Because the 2015 engines are limited to four per driver, compared to the five permitted in 2014, all aspects of the powertrain have to be made more reliable. As there is no limit on the number of components that may be changed for reliability reasons, it is perhaps unsurprising that the engines for 2015 are 'all-new', with 'virtually no carry-over components'. Mercedes' powertrain is no exception.

The core development area of the new breed of F1 powertrains is the combustion chamber (valued at three tokens). For the R&D behind any changes, Mercedes AMG HPP have a single-cylinder research engine at Brixworth, a very sophisticated and comprehensively equipped tool for optimising ports, piston crown, combustion chamber, valve geometry, timing and lift, injector nozzles, coils, spark plugs, and fuel, as well as charge pressure and exhaust systems. Cowell described this ongoing programme as being almost university-like, with scientists, chemists and engineers cooperating in the quest for ever greater efficiency. 'The management of peak cylinder pressures is the key. You have to become the Master of the knock,' he explains. Cue Christie Moore's The Knock Song – an Irish folk song about miracles.

A large part of this research involves Petronas. In 2012, Petronas Lubricants International (PLI), part of the Malaysian state-owned Petronas group, invested €70 million to expand its R&D activities in Turin, at the former site of FIAT Lubrificanti. It now employs 100 people there and is a significant resource for the F1 programme. Dr Andrew Holmes, director of research and technology at PLI, revealed that Petronas had homologated just one fuel in 2014 for use by the Mercedes powertrain teams

that use their fuel. Many hundreds of fuels had been developed and tested, but just one deployed in races. Since the start of 2014, they concentrated their R&D efforts on 2015. If this is indicative of all of the Mercedes AMG HPP's combustion research efforts, it is a revealing picture of an organisation that is clear and confident in the fundamentals of what it is doing.

For 2015, Mercedes have a Bosch 500bar fuel injection system available, although Cowell was not forthcoming about whether the full 500bar is being used or not. There are two issues that have to be addressed: firstly, the pressure signal must not exceed 500bar, and due to the high-pressure pump and the fast response injectors the pressure is 'spiky'. Secondly, there is a trade-off between performance gains and fuel pump power. However, high pressure does offer gains including better control of droplet size (being direct injection, there is little time for fuel to vaporise and so droplet size becomes critical); position of the spray pattern; timing of the injection events (Cowell would not reveal whether there are more or less than five injection events, but this technology is key to shaping the pressure rise in the cylinder); and greater precision of the quantity of fuel injected.



After combustion, the area of most interest is the turbine-compressor and its MGU-H. Road car engine turbochargers are a compromise between flow rate, boost pressure, compressor speed and efficiency. The characteristics of a turbocharger are conventionally expressed as a compressor map. The road car objective is to provide high efficiency throughout the operating range. Modern turbochargers include variable geometry in the turbine nozzle to widen this high-efficiency region. The inclusion of an MGU-H in series with the turbine and compressor enables the turbocharger to be operated as a constant-speed device, and hence there is no need for VG. The design of the turbine and compressor can be optimised around pressure ratio and mass flow.

Cowell was very cagey about both turbine and compressor efficiencies, but it was clear that both are above 80 per cent. Formula 1 does not allow ceramic turbines, and from a comment he made about turbines sometimes being difficult to disassemble from their housings, due to high temperature creep of the turbine wheel, Mercedes would appear to be operating at the limit of permitted materials. The engine is still a tuned engine with individual exhaust primaries leading to the turbine. Variable geometry intake trumpets are permitted in 2015 and they are used on the Mercedes engine. It is clear that tuning of both intake length and exhaust lengths is still critical for the torque curve on these highly turbocharged engines.

On the subject of electrical machine efficiency Cowell was inevitably not much more forthcoming. However, he did state that the 120kW permitted MGU-K delivered 115kW, giving a combined efficiency of the MGU and its control electronics of 96 per cent. An efficiency of each device of around 98 per cent is exceptional. 'It is so difficult to cool these devices – the small size and low surface area of the power electronics and the tight windings of the armature coils make it difficult to get the coolant into close contact with the hot surfaces to transfer the heat away. The eddy current generated heat in the high speed rotor is even harder to remove,' he explains.

As to the final breakdown of energy flows, Cowell was only prepared to suggest a loss

## F1 engineering was set an enormously challenging task in 2014, and it has shown just how effective it can be

figure for 40 per cent of the total through the exhaust tailpipe, as being illustrative of what F1 has achieved.

If the only goal of the F1 powertrain regulations was efficiency, and there were no other constraints imposed, what would Mercedes build? 'Smaller engine capacity; fewer cylinders (four or less); lower RPM; higher boost,' says Cowell. The indication is that the 267cc cylinders are too small for ideal combustion, that friction losses are too great and that higher boost could be obtained if single-stage compressors were not mandated.

### Road relevance

As to the relevance of all this R&D to future road vehicles, Cowell believes that much of it is directly transferable, in particular: torque delivery; low mass and size; high efficiency combustion; and low heat to coolant. What packaging advantages could be had in a small road car if a typical 140cv passenger car powertrain was built to F1 size, weight, and cooling parameters? Interesting question.

I also spoke to Pat Symonds, chief technical officer to the Williams F1 team. If Williams didn't quite use the available power of the Mercedes powertrain to the greatest effect, they did waste the least in overcoming the drag of the car.

The objective of the chassis designer is somewhat more complex than that of the powertrain's. His task is to waste as little of the available power at the flywheel in getting



Ferrari was fast out of the blocks at the first test after a major management overhaul over the winter



**WE DON'T 3D, WE WINDFORM.**



F1 front nose: Aerodynamic application for F1 wind tunnel.



WINDFORM, THE NEXT GENERATION OF 3D PRINTING. SINCE 1996, WINDFORM MATERIALS HAVE MADE IT POSSIBLE FOR LASER SINTERING TECHNOLOGY TO CREATE HIGH-PERFORMING PARTS. HIGHLY-FUNCTIONAL, BEAUTIFULLY FINISHED AND PROVEN RELIABLE. FREE-FORM DESIGN AND THE ABILITY TO BUILD SUPERIOR PROTOTYPES.

**WINDFORM, IMPOSSIBLE APPLICATIONS ARE NOW POSSIBLE.**

**WINDFORM**<sup>®</sup>  
MATERIALS FOR ADDITIVE MANUFACTURING

[www.windform.com](http://www.windform.com)    [info@windform.com](mailto:info@windform.com)

**Input power distribution  
(1,200kW fuel in)**

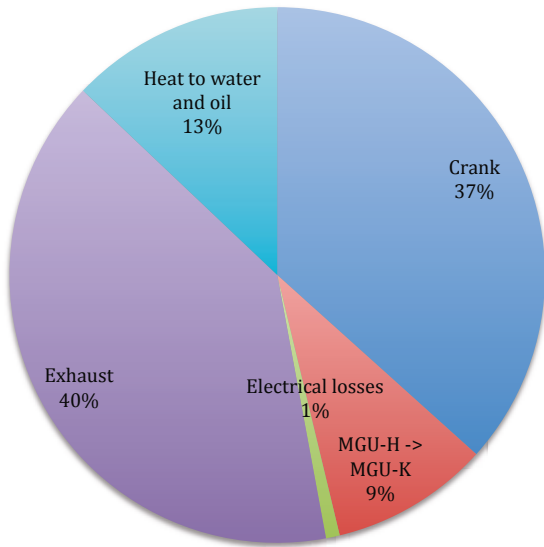

**Dissipation of flywheel power  
(555kW)**

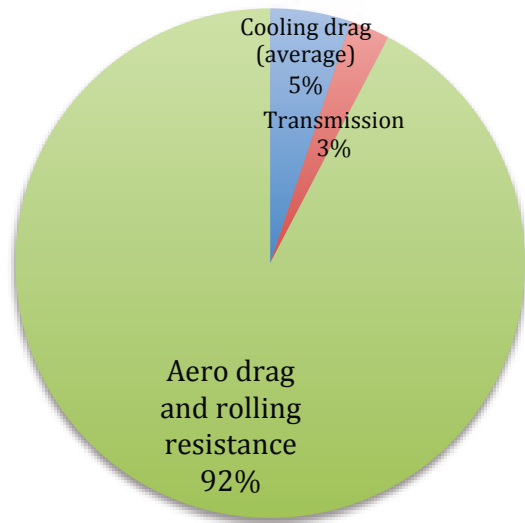

around the circuit as quickly as possible, while using a limited amount of total energy over the duration of the whole race. If it was a simple, straight-line race it would just be a matter of reducing drag as much as possible and choosing a top speed compatible with the fuel flow rate and the total fuel available. But there are corners, and the energy used in the direct exchange for kinetic energy (2.6MJ at Jerez Vmax), and the subsequent recovery of as much as possible, via the MGU-K, and storage in the batteries is a matter of developing a circuit-specific, driver-executed strategy embodied in the powertrain and chassis software. The driver remains in charge of tactics, i.e. executing the strategy, as only he can deal with what is going on around him. To add to the complexity, drag becomes a compromise with the requirement for downforce to minimise the loss of kinetic energy at each corner.

While the objective may be complex, it is understandable enough, but the strategic trade-offs of powertrain settings, MGU-K use, chassis and aerodynamic settings, and driver options are incomprehensible unless one is intimately involved in performance simulation, race simulation, and the development work drivers carry out in the car simulator, never mind the effect of the best laid plans of the other competitors, accidents and the weather.

Thus one can only look at the information available. Easy parts first: the transmission

absorbs 2.5 per cent of the power it is transmitting: 14kW at full power. The resistance to motion at any given speed comes from aerodynamic drag (a function of downforce) + cooling drag (the power needed to dissipate the heat) + tyre rolling resistance + other rolling resistances (bearings etc.). Tyre rolling resistance is mainly a function of toe settings, with camber and pressure only having small effects,' says Symonds. 'Total rolling resistance is small relative to drag. It is hard to separate out the cooling drag from overall drag, because, if we didn't have to dissipate the heat losses from just about everything that produces, transmits or controls power, the whole aerodynamic package would be radically different.'

'What we do is to dig into CFD results to look at radiator loads and hence drag. Running at 30°C and 55 m/sec we see a loading varying from 184N to 371N depending on the cooling exit configuration. Bearing in mind the radiator installation angle, this gives a drag of between around 3.5 points and seven points – so around 3.5 per cent to seven percent of total drag.

'The loads are the loads on the radiator faces themselves, so no account is taken of any turning losses in the ducts or indeed any duct losses or the gains that may be made if full dynamic head were available in the lateral positions of the radiators. It also takes no account of any thrust from heating of the air by the radiators,' Symonds continues.

Taking the total power absorbed by drag and other resistances, at max speed, as 555kW, less transmission losses of 14kW = 541kW, then cooling absorbs 19-38kW, depending on how the car has been setup.

With these figures, we can now do a power audit of the car at full power and full speed:

**Input power (fuel): 1200kW**  
**Output at crankshaft: 440kW**  
**Output from MGU-K (generated by MGU-H): 115kW**  
**Total at flywheel: 555kW (744bhp)**

**Losses to water and oil, inc. internal friction: 155kW**  
**Loss to exhaust: 480kW**  
**Electrical losses (MGU-H + MGU-K): 10kW**  
**Total losses: 645kW (865bhp)**

**Transmission losses: 14kW**  
**Power to cool car (average setup): 29kW**  
**Power to overcome drag and rolling resistance: 512kW**  
**Total Power to propel car at Vmax: 555kW (744bhp)**

Which leaves the issue of kinetic energy recovery. Energy management in F1 is so important to raise performance that there is no chance of finding out how teams go about it. All we can do is to consider the fundamentals:

In the simplest terms, the powertrain ECU manages the fuel energy, responding as determined by the software to the driver's demand for torque, apportioning crankshaft torque and MGU-K torque according to its best estimate for fuel efficiency. MGU-K energy

**“If we didn't have to dissipate the heat losses from drag, the whole aerodynamic package would be radically different”**

# Open architecture simulators that put you in control



With open architecture for hardware and software, a standard Cruden DIL/HIL simulator is both a ready-to-run tool and an engineering blank slate.

Completely accessible, you are free to create your own, unique simulator.

- Easy integration of vehicle modeling packages (IPG, CarSim, VI-Grade, VeDYNA, SIMPACK, dSPACE etc.) or our fully open Simulink Vehicle Model (CVSM)
- Apply your own motion-cueing algorithms
- Incorporate your own hardware

We can have you up and running quickly, with a full simulator package, including on- and off-board projection system, backed up with support, maintenance and consultancy.

Find out more - [www.cruden.com/motorsport/](http://www.cruden.com/motorsport/)

Race car  
development  
**Driver training**  
Race strategy &  
preparation

Sauber failed to score during the 2014 season but caught the eye at Jerez with some fast times



can either come from the battery (limited in quantity to 4MJ/lap or 33.3 seconds at 120kW, but free in terms of fuel use), or from the MGU-H (unlimited but only available when the compressor doesn't need it, and only semi-free in terms of fuel).

The chassis engineers and driver have to manage the battery's energy. Acquiring the permitted 2MJ/lap is the first priority, then returning as much as possible at chosen moments, up to 4MJ/lap, is determined by the circuit strategy and the driver's tactics at any given stage of the race. Symonds says: 'The kinetic energy recovery is pretty fully developed and on most tracks we recover the full 2MJ/lap. However, how we use it requires a lot of work to setup an automatic system to execute the optimum strategy for a particular circuit. In applying the chosen strategy there is no one optimum tactic, it depends on battery SoC, tyres, overtaking, etc. The driver changes settings to apply tactics and may be advised by the team, which has the bigger picture. This is not too demanding on drivers, providing they have trained adequately in the simulator, and it is not really a driver differentiator.'

There is a suggestion that teams are using the unlimited MGU-H to charge the battery during cornering, when full power and maximum fuel flow rate are not required, in order to be able to increase power and hence acceleration out of a corner. It is well established that the optimum time to use the battery-to-MGU-K allowance is at the start of

a straight, in order to achieve high speed as quickly as possible. Thus the fuel allowance is traded between a time when it is not required at the maximum flow rate, to a time when full fuel flow is at the limit; however, this energy must flow via the battery, which is not particularly efficient.

### F1's future

I questioned the apparent trend for Williams to use less fuel than the Mercedes, and Symonds attributed this to the Williams having less drag, but also less downforce and less overall speed. He considered that they were unable to use the lower average fuel consumption to go faster, and instead used it to start races with less fuel and less weight. The cars are just about unlimited by the race fuel limit on most tracks, but when they are the drivers practice extensively in the simulators to maximise their speed while adhering to the limit.

Mercedes has done its homework, and benefited from their performance margin in 2014 to start development early. How much others have caught up will not be clear until Mercedes unleash their full performance. The Ferrari looks good, with Sebastian Vettel obviously revelling in the car's handling, and Kimi Räikkönen looks like a driver transformed, while Renault and Red Bull stuttered at Jerez. And McLaren-Honda? The body language of their personnel did not correlate with what was happening on track and so it remains to be seen if their optimism is justified.

As for the future, I am perplexed by the assumption that 1000bhp engines, more downforce and wide tyres will automatically make the cars more spectacular and the racing more entertaining. Back in 1986, when cars had anywhere between 1200-1500bhp and sticky tyres for qualifying, allied to unstable flat bottoms and stiff suspension, they were undoubtedly spectacular. I recall Dr Harvey Postlethwaite musing that he wished the drivers would stop complaining about the handling, as, if they ever thought 1000+hp and flat bottoms would handle nicely, they must be mad.

In the intervening 30 years F1 engineers have learned, through computer simulation and control systems, to understand and take control of power output and aerodynamic characteristics, and achieve benign handling. Add to this the need to look after the tyres, if anyone thinks 1000bhp engines will lead to spinning wheels and lurid slides, they are wrong. Top speeds will be higher, as will corner speeds with all the safety implications that brings, but who can judge the speed of the cars by just by watching them from the far side of the run-off area? The dinosaurs of 30 years ago have evolved into fast, agile, and efficient cheetahs, if not quite yet into pussycats.

F1 engineering was set an enormously challenging task in 2014, and it has shown how effective it can be in solving engineering and technical problems. This should be shouted from the rooftops to attract a world that is about to realise the full implications of climate change (or not as the case may be), and not throw it all into the dustbin in order to attract elements of a fan base that has turned away from motor racing towards the siren lure of low-cost entertainment afforded by their electronic devices and on the internet. 

**The limited number of tokens a powertrain manufacturer may use in 2015 – 32 – is actually no limitation on what it may change on the engine**

# AT THE HEART OF THE WORLD'S MOST POWERFUL ENGINES.



Our commitment to engineering precision performance cranks, rods, cam followers, and other components has allowed Arrow Precision to supply the world's top motor manufacturers, tuners and engine builders. Give us your requirements and we will find a high-performance solution, no matter how extreme.

+44 (0) 1455 234 200

[www.arrowprecision.com](http://www.arrowprecision.com)



**BRITISH DESIGNED.  
BRITISH ENGINEERED.**

# NOW AVAILABLE IN PRINT & DIGITAL EDITIONS

## SPECIAL SAVINGS WHEN YOU SUBSCRIBE

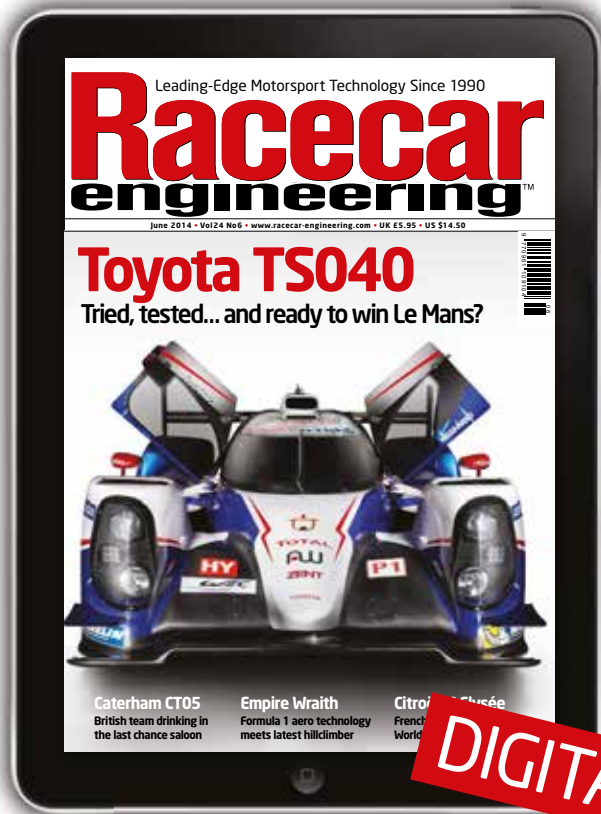

- NEVER MISS AN ISSUE
- GET IT BEFORE IT HITS THE SHOPS
- KEEP AHEAD OF THE COMPETITION

- READ ON YOUR IPAD, KINDLE OR ANDROID DEVICE
- ACCESS YOUR ARCHIVE AT THE CLICK OF A BUTTON
- ENHANCED DIGITAL CONTENT COMING SOON

### Special Subscription Rates: 1 year (12 issues)

#### Print

UK £49.99 (usually £71.40 - SAVING 30%)  
US \$99.99 (usually \$174 - SAVING 43%)  
ROW £69.99 (usually £99 - SAVING 30%)

#### Digital

UK £44.99 (SAVING 37% off the cover price)  
US \$69.99 (SAVING 60% off the cover price)  
ROW £44.99 (SAVING 37% off the cover price)

 [www.chelseamagazines.com/racecar-P504](http://www.chelseamagazines.com/racecar-P504)

 +44 (0)1795 419 837 quote P504D

 [www.chelseamagazines.com/racecar-P504D](http://www.chelseamagazines.com/racecar-P504D) (for digital)

# Quarter century

For the last 25 years, Racecar Engineering has provided leading technical analysis. We take a look back through the Formula 1 highlights

**B**ack in 1990, Ian Bamsey decided that there was a gap in the market and he developed a concept that had already been around for a few years in book form. The process of the launch of Racecar Engineering has been widely documented. Here, we present the case that, for a quarter of a century, the magazine has provided some of the best technical analysis and reportage in the world. The magazine is proud to work with quality engineers such as Peter Wright, Simon McBeath and Ricardo Divila, and is also proud to have new talent, such as Gemma Hatton on the team of writers. We also follow the careers of students who present some amazing theses, and go on to work with teams around the world.

Here, in the first of a series, we look back at some of the Formula 1 features that have run in the magazine, stories that demonstrate the depth of analysis for which the publication has become so well known. The features run in full in a new members area on the website, which also gives access to our archive.

[www.racecar-engineering.com/members](http://www.racecar-engineering.com/members)

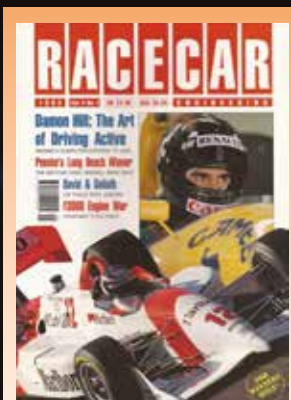

Active suspension led to the accusation that Formula 1 cars were becoming too easy to drive in 1993. Ian Bamsey interviewed Damon Hill, whose testing skills did much to refine the active Williams. With active suspension, ABS, traction control, intelligent diffs, fly-by-wire throttle, Bamsey asked, why have a driver at all?



Back in 1998, in issue Volume 8 Number 9, there were rumours that the McLaren MP4/13 had a regenerative braking system, and that sparked the interest of Australian engineer, John Ballantyne, who set out to investigate how a system could relieve the brakes of some of

their workload. He investigated the possibility of hydraulic pumps in each wheel, although the unsprung weight penalty rendered that to be unviable. He then moved on to lightweight generators. Visit the website to read the full article, and see what his final conclusion was.

Damon Hill was Williams' test driver in 1992 and was instrumental in developing the Williams FW15C that competed in 1993. Read what it was like to drive the car in our new members area, [www.racecar-engineering.com/members](http://www.racecar-engineering.com/members)





The 1998 season saw a fascinating technical battle. Not only was regenerative braking a rumour, but long and short wheelbase configurations were a reality, and an important performance tool. This concept may not be new but, according to Peter Wright at the time, the 1998 season placed particular

emphasis on this tool. New grooved tyres were introduced, reducing the contact patch with the road, and the regulation width of the cars changed too, meaning all-new designs. Some got it right, some got it wrong. Read Peter's summary; [www.racecar-engineering.com/members](http://www.racecar-engineering.com/members)

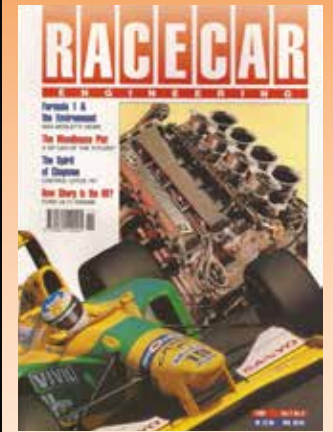

Back in 1992, Max Mosley was the FIA President and had clear views on the choices that were facing Formula 1 at the time. 'Either it has to retain its current concept, in which case it must work closely with several motor manufacturers, or it must be devised purely for entertainment,' he said in an interview with Racecar's then editor, Quentin Spurring. He also laid out the platform for environmentally friendly racing, or technology that 'is relevant to the motor industry, or it will go bust.' Read the interview in full at [www.racecar-engineering.com/members](http://www.racecar-engineering.com/members)



Things don't always go smoothly behind the scenes at Racecar Engineering and occasionally, on press day, the cover feature has fallen out of bed and the staff are staring at some blank pages and need an idea, quickly. This was the case for Racecar Engineering Volume 16, Number 2. The feature in

which BAR took its '067 Lakester' Formula 1 car to Bonneville and ran it at 413.205kmh, or 265.754mph, filled the gap. Not only does that make it the fastest F1 car in history, but also the fastest cover feature in RCE's 25 years. Sam Collins managed a concept to delivery time of just 35 minutes.



Barred! Well, that was the cover line of Racecar Volume 15 Number 1, which featured BAR's front torque transfer system, and the reasons why it had to go



RACING

BALANCED BRAKING PERFORMANCE

All the way to the APEX

BITE

DECELERATION

MODULATION

RELEASE

THE DRIVER'S PAD

FERODO RACING BRAKE PADS

developed and engineered to perform in all four phases of the braking event.

In addition to the bite and deceleration expected from a world class race pad, Ferodo pads offer the superior modulation and instantaneous release for maximum exit speeds.

www.ferodoracing.com



SELECTED RANGE NOW AVAILABLE THERMALLY BEDDED

# The art of diversity

**How Russian manufacturer Artline Engineering's novel new design is challenging convention and the natural order of Formula 3**

By **OLEG STOZHKO**

International F3 has long been an arena for great battles, not only for drivers, but the open regulations of the class mean that it is a battleground for engineers too. For the past decade almost every single car in the competition has been a Dallara, and the Italian firm's cars have become a benchmark, but now there are new contenders that hope to raise the bar. French constructor Mygale is expected to return to F3 in 2016, but another manufacturer will also be on the grid this season.

ArtLine Engineering as a chassis manufacturer was founded just under two decades ago when it was established by Georgian engineer Shota Abkhazava in 1998. One of its key staff, Sergei Piskunov, has been its main designer since the very beginning – before joining ArtLine he worked with the founder of the team at the Soviet era Laboratory of Speed Automobiles (LSA) and graduated from the Moscow Automobile and Road Institute. His design credits include a number of single seaters including cars such as the Gardarika and Astrada. The Gardarika was a late 1980's F1600 car with a tube frame and a very interesting mono shock suspension layout. That idea was then transferred to his first F3 car, the Astrada.

Once ArtLine had been founded it started to contest the Russian F3 Championship using a pair of standard Dallara chassis, and thanks to the company's contacts in Italy it ran drivers such as Fabio Babini and Maurizio Mediani.

After a few seasons, and once the company felt it had the right level of knowledge, it constructed its own F3 design from scratch in 2004. It contested a number of races in both Finland and Germany and later introduced an updated version in 2008, but the world wide economy had seen the size of the F3 market collapse and there were no customers for the new car. It was decided that the rivalry with Dallara would have to wait, and the company concentrated its efforts on producing cars for Russian Formula 1600 class.

Today ArtLine Engineering is a truly international organisation, with bases in Russia, Georgia and Germany. And, after years of preparation and study, the company feels it is now ready to take the next step and return to International F3. Its new design, the ArtTech



Carbon monocoque is manufactured by Russian composites specialists NCC

P315, has been designed to inject some diversity into the FIA championship and will be used as a training ground for Russian and Georgian engineers. But what makes this car, which should have finished its shake down tests at Georgia's Rustavi Autodrom by the time you read this, so interesting?

## Build Shop

The car is being constructed at a new facility, built in the former Moskvitch car factory in Moscow. A Russian company, NCC will manufacture the carbon fibre monocoque, made of carbon and zylon layers, although the first three chassis have been prepared by NICSCI in Italy as the Moscow facility is still under construction. The chassis itself is noteworthy

because it features a carbon fibre roll hoop integrated into the chassis, a technique rarely seen even in motorsports higher echelons.

Visually, the ARTTech P315 is very different to other recent F3 designs, including the dominant Dallara range. Piskunov and his engineering team have taken their inspiration from the latest generation of grand prix cars and the front end features a high, wide nose and tight rear end to efficiently guide the air flow in the best possible way. The car was designed with the idea of guiding extra airflow into the diffuser region. The high and wide nose cone allows a greater width between front wing pylons, directing more clean airflow under the floor, the same approach as adopted by recent F1 cars.

**“Our solution with a central exhaust is nothing more than a return to the classic layout for an F3 car of the mid-1990s, such as the Dallara F399”**



**ArtTech is still waiting for the FIA Single Seater Technical Working Group to make a decision on whether its slippery bodywork adheres to their strict regulations**



**P315 uses F1-inspired pull rod actuated dampers and torsion bars for a lower mass centralisation**

The car's designers claim that the overall aero package has a lift-to-drag ratio 10-12 per cent better than most F3 cars at the same angles of attack, while the drag is significantly lower and aero maps are smoother. The P315's base aero setup has 39 per cent of its downforce on the front and 61 per cent on the rear. But some clever tuning provides a possibility for an extreme balance shift to the front if it's required. And even in this case oversteering tendency won't be an issue, its designers claim.

Another interesting detail on the racecar is the exhaust exit, which is mounted centrally and oriented to an aerodynamically neutral zone between the rear wing profiles. Despite the fact that in isolation it is aerodynamically neutral and doesn't help to generate downforce itself, it still helps to guide the airflow in that area. Although it is claimed to be a completely legal solution, there is some controversy regarding this element of the design, and the FIA Single Seater Technical Working Group is reportedly still considering whether it can be used in competition (see Bump Stop, P98). This has caused a delay to the homologation of the P315 as its designers await a decision on

whether or not its slippery bodywork is actually legal, which may mean that the P315 racecar may encounter the wrath of the stewards at the first race of the season!

'At the end of the day, F3 is an engineering class racing, and cars, in our opinion, have to be constructed within the limits listed in the technical regulations, and not as a simple copy of some other cars,' says ArtLine's founder Shota Abkhazava. 'Our solution with a central exhaust is nothing more than a return to the classic layout for an F3 car of the mid-1990s, such as the Dallara F399. Despite this, representatives of the FIA Single Seater Technical Working Group told us that such a solution can be too effective and give ARTTech P315 an aerodynamic advantage over the Dallara F312, which is unacceptable. We believe that Dallara must make some changes and improve the car, while we should not give up on the solutions we have come up with for our racecar as they are not currently prohibited by technical regulations.'

## **Suspension**

Many of the suspension concepts on the new car were evaluated on the older ArtLine designs,

from the ARTTech F1605 (2004) to the ARTTech F24-Z5 (F3 car raced in German F3 Cup in 2008).

As is the case with the car's aerodynamic package, a quick look at the design renders on these pages reveals that the suspension of the P315 is also unconventional in F3 terms. It features F1-style pull rod actuated dampers and torsion bars all round. The idea of using pull rod suspension comes directly from F1, and it has allowed the car's designers to create a very compact rear end compared to other F3 cars. At the same time, a pull rod has allowed the engineers to create a lower centre of mass as rockers, torsion bars and the anti-roll bar are all arranged on the monocoque floor. According to the designers the car's pull rod design and the way it attaches to the upright provides extra range for understeering and oversteering control by managing the weight balance over the front or rear axle.

Using torsion bars is also relatively unconventional in F3 where most cars use coil springs, mainly manufactured by Eibach. ArtLine has taken this approach before – its 2004 car had torsion bars at the rear, while its 2008 car featured them all round. According to the team, using torsion bars helps minimise frictional losses and provides better service management as the bars can be changed quickly, which is important during racing weekends and test sessions.

A possibility of using a third element both on the front and rear of the racecar was considered in 2004 with the ARTTech F1605, and was eventually introduced on the 2008 car. The P315 has been designed to accommodate third elements front and rear. The third element at the rear is located inside the clutch housing, and its adjusters are situated outside, which means no tooling is required to make adjustments. The F3 technical regulations mandate the use of a specific dampers, which were homologated in



**SUBSCRIBE  
TO RACECAR  
ENGINEERING**



**PRINT  
EDITION**

**SAVE 30%**

**1 year from just £49.99  
with free postage**

To order, go to:  
**Chelseamagazines.com/racecar-P504**  
Or call +44(0)1795 419 837  
quote code P504



**DIGITAL  
EDITION**

**SAVE 37%**

**1 year from just £44.99  
with instant delivery worldwide**

To order, go to:  
**Chelseamagazines.com/racecar-P504D**

UK Direct Debit rates quoted. Special Overseas and Credit Card rates also available



**Centrally-mounted exhaust exit flies in the face of convention, but has upset the sports governing body in the process**

2013 and 2014, but they are not exactly ideal for the layout of the P315 so its designers are currently in talks with the FIA to be able to homologate some new more suitable dampers.

As is the case with other F3 cars, the ARTTech P315 is designed to operate using a wide range of tyres from different manufacturers. As a result the suspension has all of the usual features to allow setup and tuning.

'The history of the ArtLine racing team started with racing and modifying Dallara cars, so our engineers know how the leading teams operate with what is almost a spec car. As a manufacturer ArtLine is bound to offer to the market the most competitive base car with as many suspension and aero setups possible. So there will be a large choice of different OEM spare parts for any customers which decide to tune their P315,' Piskunov explains.

**Engine**

One of the main difficulties in using a pull rod rear suspension was to find the best placement for the starter motor, because its usual installation area on the side wall of the clutch housing is occupied by rear suspension elements. It was this question that appeared to trouble HWA (Mercedes) and Volkswagen and both refused to adapt their engines to accommodate the Russian car.

'While a development of the chassis was progressing, ArtLine contacted all known F3 engine manufacturers. However, the replies varied greatly. For example, HWA-Mercedes flatly refused to cooperate, as we are not well enough known in the market,' explains P315 Project Manager Egor Nazarov.

'The Volkswagen representatives welcomed us and provided all the necessary information for the design of the chassis, but could not continue the work on the adaptation of the engine to the ARTTech P315, citing a lack of budget and strict technical requirements. The

Japanese engineers from TOM's expressed their willingness to integrate their engine with our chassis, but the work was prevented by several geographical and economic factors: TOM's does not want to participate in the European championship, which is a priority for us, because of the expensive and complicated logistics and ArtLine is not yet ready to deliver the P315 to Japan or Australia because it still needs to be properly brought to the market. In turn, Neil Brown Engineering and ORECA reacted to our question with interest and friendliness. Our plans for ARTTech P315 participation in the European championship conveniently coincided with NBE's and ORECA's plans to expand their presence in the market. To date, both engines are fully compatible with the ARTTech P315 chassis, and we're very much looking forward to the start of the competitive season.'

ArtLine has made three P315 chassis so far, two of which will be entered into the FIA European Championship by its works team. Of course, the factory would like to see its ARTTech P315 cars painted in the race colours of some famous European teams, but discussions with potential buyers have only just begun – until potential customers see the car running on track nobody is willing to commit. 'It's no secret that Dallara cars have been dominating in F3 for the past 20 years. All the staff at ArtLine treat this manufacturer with great respect and consider it a huge honour to have the opportunity to compete with them. This is why we decided to take part in the most prestigious European championship, where the level of competition is the highest of all, from the very first season,' explains ArtLine team principal Vasily Antipov. 'The ARTTech P315 is a quite a sophisticated racecar. But that complexity of working with the machine is due to a strong desire of achieving the best results in the competition. In other words, as we say in Russia, in this case, the game is worth the candle.'



What's the  
**secret**  
about the new 911 GT3 Cup's  
**new brakes?**



**It's Quicker.**



# TMG: Inside the home of high performance

Behind the scenes at Toyota's state-of-the-art motorsport research and development facility

**T**oyota Motorsport GmbH (TMG) is a uniquely-equipped engineering facility, one of very few in the world capable of turning a clean sheet of paper into a fully developed vehicle all under one roof. The Cologne-based company has offered its services to external companies since 2010, providing companies from throughout the automotive and motorsport world, including Formula 1, with access to its unique range of development and manufacturing facilities. Simultaneously, TMG develops and runs the hybrid LMP1 race car, which won last year's FIA World Endurance Championship, and Toyota's new World Rally Championship project.

Much of TMG's work with motorsport clients focuses on research and development, utilising the vast range of tools first constructed for Toyota's own Formula 1 programme.

Aerodynamic development is a cornerstone of TMG's portfolio, with two near identical wind tunnels capable of both full-car and model testing. The tunnels feature a number of key technologies which not only improve the quality of data but also increase the amount of data for a given time. This includes a continuous motion system as well as laser measurement using particle image velocimetry (PIV).

With development processes honed during years of top-level motorsport activity, TMG also serves various motorsport clients with CFD analysis and design work. That computational capability stretches beyond the scope of aerodynamic research, with composite component design and strength and weight optimisation among its specialities. A driver-in-the-loop simulator is also available, and has more than 20 laser mapped circuits, a wraparound screen with five projectors and a six degrees of freedom motion platform. LMP1, F1, GP2, GT and road car models are available and others can be developed depending on client demand.

TMG does not just offer services in the simulated environment. It also has an unrivalled real world testing capability offering more than 200 tests in a 2600m<sup>2</sup> testing area. Customised test rigs are on offer as are single axis rigs, geometric measurement, vibration testing, complete car stiffness mapping, unique and world beating transmission testing systems. Allied to those there is a seven post rig which has proved very popular with smaller motorsport teams who want the benefit of its accurate analysis of kinematics without the up-front cost of construction, an MTS 329 full car road simulator and transmission testing rigs.

TMG's expertise also has an extensive in-house powertrain, design, development and evaluation capability. It includes several high-end dyno cells capable of handling very high performance engines, rigs for clutch, heat, friction and fuel system testing as well as a radiator wind tunnel. One key facility is a hybrid and EV powertrain test system capable of dealing with both production car and top level motorsport designs.

But TMG offers more than just design testing and evaluation. It also has a large manufacturing capability which is used by clients from a wide range of industries. This includes a high-capacity additive manufacturing facility (12 machines) for SLS and laser sinter prototyping common in wind tunnel models, as well as CNC milling and turning machines, cutting-edge composites technology and a fabrication department.

Every year TMG demonstrates the fruits of such R&D technology via its works motorsport and customer racecar programmes. But due to the high level of confidentiality expected of it, you probably will never know even half of the top-level motorsport teams showcasing TMG's technology on race circuits around the world this racing season. 



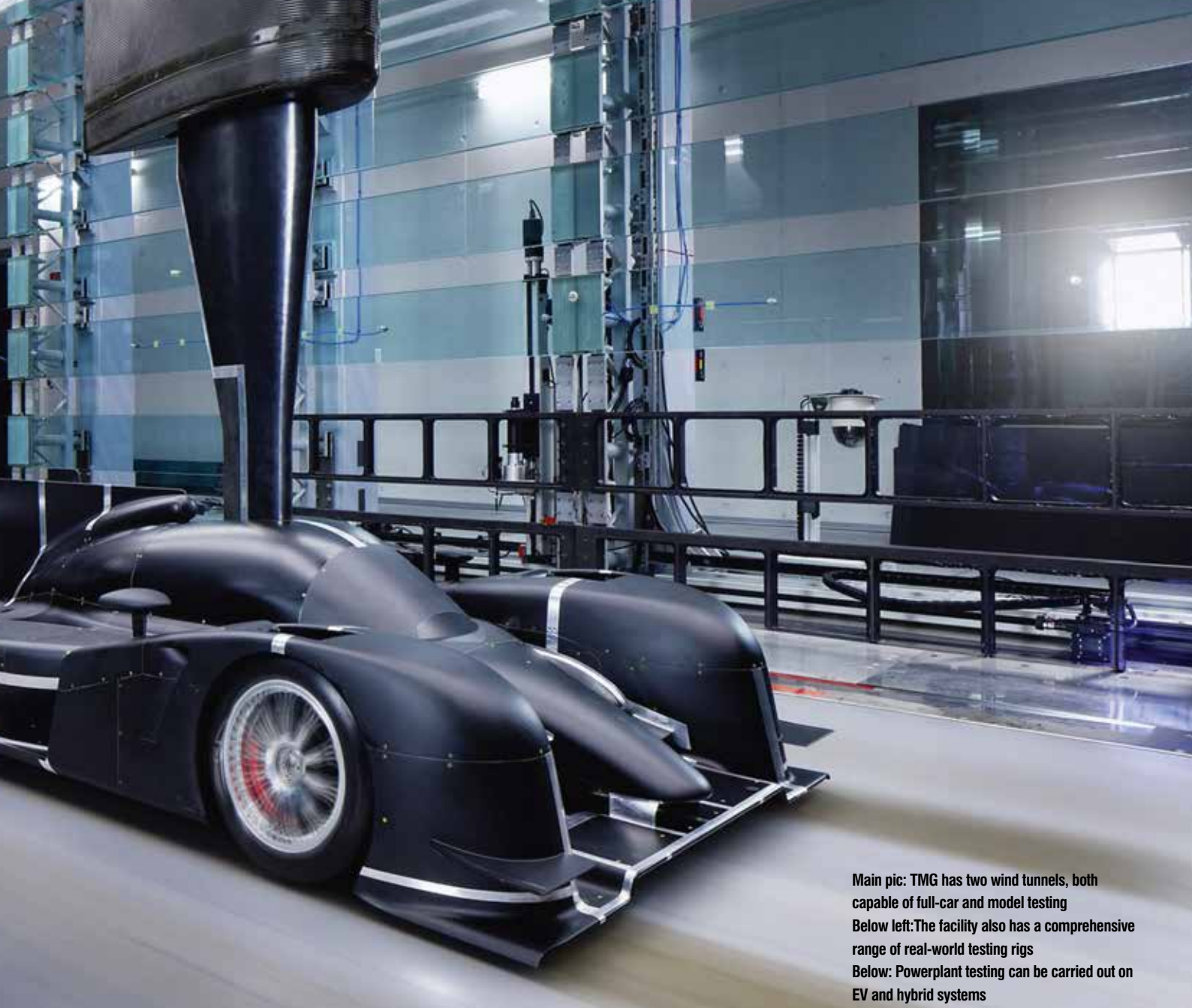

Main pic: TMG has two wind tunnels, both capable of full-car and model testing  
Below left: The facility also has a comprehensive range of real-world testing rigs  
Below: Powerplant testing can be carried out on EV and hybrid systems



# 47 Years of Experience Engineering and Manufacturing Racing Fasteners

*It doesn't matter where you race,  
ARP has the fasteners to win  
championships*

Manufactured entirely in the U.S.

4,500 catalog items and  
specials by request

ARP fasteners provide  
strength and reliability  
for every type of racing.

ARP fasteners  
are manufactured  
entirely in our own  
ISO 9001:2008 and AS9100  
registered facilities in  
Southern California.

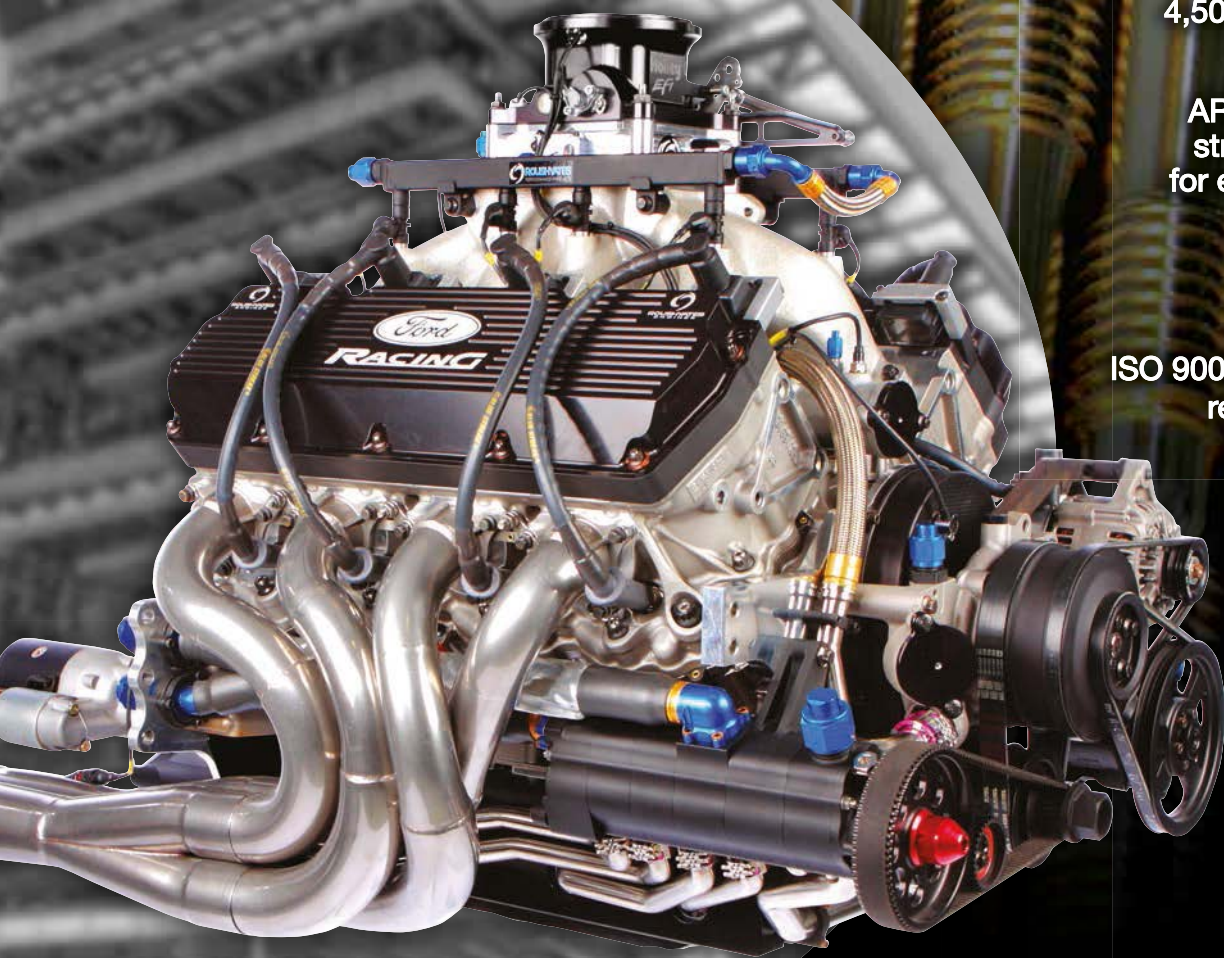

*Roush Yates Ford FR9 utilizes both off-the-shelf  
and custom manufactured fasteners*

**ARP**  
automotive *Racing* products



Download our 2015 catalog

[www.arp-bolts.com](http://www.arp-bolts.com)

1863 Eastman Ave • Ventura, CA 93003

Outside the U.S. +1.805.525.1497 • Toll-free in the U.S. 1.800.826.3045

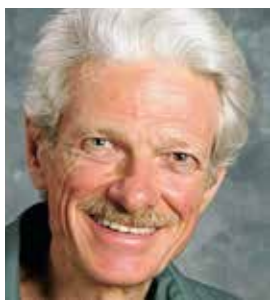

# A bit more about scrub radius

When it comes to steering offset, there is a difference

## The consultant says

Last month I responded to a question on scrub radius, in relation to upright design. I said that scrub radius per SAE terminology is not really a radial measurement but a front-view offset. A reader has pointed out that the ISO has more recently created a standard of its own for this terminology that is more semantically rational.

Per ISO standard, scrub radius is not synonymous with front-view steering offset. ISO steering offset is what the older SAE standard calls scrub radius, and ISO scrub radius is a quantity not included in the SAE

terminology. It is the radial distance from the contact patch centre to the steering axis, taken normal to the steering axis. That is, it is the length of the moment arm for ground plane forces about the steering axis.

That moment arm can then have any angular orientation, but its length cannot have a negative value. So if we're using this definition of scrub radius, there really cannot be such a thing as a negative scrub radius.

However, there can be such a thing as a negative ISO steering axis offset or SAE scrub radius, and the sign convention is the same

per ISO or SAE: negative when the steering axis intersects the ground plane outboard of the contact patch centre and intersects the wheel plane above ground; positive when the steering axis intersects the ground plane inboard of the contact patch centre and intersects the wheel plane below ground.

ISO steering axis offset or SAE scrub radius is largely independent of trail and is close to being a strict function of upright and wheel design. As such it is not greatly affected by caster. ISO scrub radius is also influenced by wheel and upright design.

# Left-offset lower control arm mounts with left-offset engine?

## Question

We are building our first straight rail super late. In looking at suspension mounting choices, I have noticed most manufacturers, when building front clips, are utilising offset inner pivot points. We have built front clips here in the past and have also utilised offset. The difference is that our offset was to the right (moving equal length lowers to the right of the mass). The manufacturers I have seen are moving their inner pivot location to the left, which would require shorter left side lower control arms to enhance left side weight.

What are the benefits of this design? I realise that a shorter left LCA would affect camber gain, as well as moment centre, but what else could be going on here?

## The consultant says

The length of the lower control arms has no effect on left side weight, and the theory that one can or should take moments about the force line intersection is incorrect, although modelling based on this theory will be close to correct when the suspension is close to symmetrical and right and left suspensions have some anti-roll or both have some pro-roll.

That said, does it make sense to use a longer lower control arm on the right side than on the left, for an oval track car with the engine offset to the left? Probably so. In particular, there is a case for this when the track includes dissimilar turns, as for example at Pocono.

When the turns are alike, we can get away with almost any front end geometry by adjusting the static settings to suit. When the turns are dissimilar, and the suspension displacements are different in the different turns, or when there are right turns, suspension geometry becomes more important.

In a stock car, there is a limit to engine setback which dictates that the engine will be between the control arms. Generally, the block, cylinder heads, and exhaust headers will limit where we can put the inner pivot axes of the upper arms. If the engine is offset to the left, then the inner pivots of the upper arms will be offset to the left, and the left upper arm will be shorter than the right upper. If we want similar upper to lower length ratios right and left, the inner pivots for the lower arms should be offset to the left as well.

The length of the upper arm, relative to the lower, doesn't really control camber

gain (camber rate of change with respect to ride displacement). Instantaneous front view swingarm length controls that, and that depends on the relative angles of the arms rather than their lengths. The length and length relationship of the control arms affect front view swingarm length rate of change. We might say this is not camber gain but camber gain gain. Camber gain is the first derivative of camber with respect to suspension displacement. Camber gain gain would be the second derivative of camber with respect to displacement, or the first derivative of camber gain with respect to displacement.

By keeping the control arm length ratio similar on both sides of the car, we keep the rates of change of camber gain and geometric anti-roll similar, or at least in a somewhat similar relationship to each other, on both sides of the car. If the track is banked, right suspension displacement will be greater than left, so having both upper and lower arms longer on the right probably will be desirable for most applications.

Additionally, offsetting the steering rack along with the lower arm inner pivots will probably simplify steering shaft routing.



**When the turns are alike, we can get away with any front end geometry**

# How big are wheels going to get?

Examining the forces which determine the size of car wheels

## Question

When does the current trend to increasing wheel diameter reach a limit, or sharply diminishing returns? Even on street cars 20 and 21 inch diameter wheels are common. As wheel diameter increases the weight increases, as does the rotational inertia. It takes power to compensate for both of these characteristics, and both increase more than linearly with diameter. Yes, there is more room for bigger brakes, but 18 inch wheels would seem to provide more than adequate brake space for most applications. There are other factors, including gyroscopic forces, increased car polar moment of inertia (more stability but lower manoeuvrability) and unsprung weight.

## Horses for courses

One thing that makes this tricky is that this is not purely an engineering decision. For road cars, it is heavily influenced by fashion, which in turn is influenced by the desire to cultivate planned obsolescence. In racing, generally the rules dictate wheel size.

From an engineering standpoint, there isn't any 'knee in the curve': there isn't any point of sharply diminishing returns on increased wheel diameter. There are gradually increasing penalties and gradually diminishing returns.

To some extent, we can look at tyres and brakes similarly, and also clutches. They are all friction devices. With each of them, there is a lower size or swept area threshold below which there is simply no way to get even marginally adequate performance. Above that

minimum, there exists a trade off matrix that involves force capability, size, weight, cost, temperature sensitivity, and longevity. We can improve any of these factors at the expense of some or all of the others.

The size, weight and cost aspects are pretty straightforward, although the other aspects include some subtleties that may not be immediately apparent.

When we make a tyre larger in diameter, with similar section dimensions and construction for a given inflation pressure, the contact patch theoretically should stay the same width and length. Its area should equal load divided by inflation pressure, or a fairly constant percentage of that. The static deflection should therefore decrease, because with a larger diameter that contact patch length subtends a smaller arc. Any given portion of the tread should spend less time in contact with the road. This should reduce operating temperature and tread wear. Rolling resistance should also decrease. We can then trade some of these gains away for better traction if we wish, by using a softer tread compound with more hysteresis. We may opt to make the sidewalls more vertically compliant and get similar static deflection but a longer contact patch.

Larger diameter tyres do a better job of bridging small surface irregularities. They have an easier time climbing over and/flattening deep snow or mud in front of them.

I mentioned that larger diameter tyres theoretically should last longer. In a street use

context, it is logical to question whether it is worthwhile to cart around an extra six months' or year's supply of rubber, when it would cost no more and maybe even cost less to simply replace cheaper tyres more frequently. Also, tyres sometimes do not last the life of the tread – sometimes they get damaged, sometimes they get blisters or belt separations and sometimes they just get too old and hard. Most of these factors favour cheaper tyres, replaced more often – ergo, smaller diameter.

For roadgoing performance cars, there is also a limit to how soft we can make tread compounds and still have reasonable puncture resistance.

This may not matter where tyre size is governed by the rules, but there is in theory some advantage to having larger diameters for racing in that the tyre will heat less in a long-duration turn and will therefore not go off as rapidly due to heat cycling. This could advantage a car with large diameter wheels in a production car class where the rules require the use of the same size tyres as original equipment. On the other hand, if the tyres that are needed to be competitive like to run hot and cars have difficulty getting them up to temperature, large diameters could be a disadvantage. It could even be good or bad according to the weather.

With brakes, bigger size lets us use pad compounds having more friction at low temperatures without fading in hard use. Alternatively, more size will let us use a pad with less low-temperature friction but better high-temperature properties and still get adequate panic stop torque. Overall, the task of finding a suitable mix of torque, temperature tolerance, and longevity gets much easier as the brake gets bigger.

Larger diameter wheels, then, are a fad but they do have some functional advantages. They are not an unmixed blessing but they probably make more functional sense than upholstering the outside of the roof. 

## Tyres sometimes do not last the life of the tread – they get damaged, blistered or old and hard



Larger wheels have the advantage of allowing larger brakes, but there are penalties if they go to extremes

### CONTACT

**Mark Ortiz Automotive** is a chassis consultancy service primarily serving oval track and road racers. Here Mark answers your chassis setup and handling queries. If you have a question for him, get in touch.

**E:** markortizauto@windstream.net

**T:** +1 704-933-8876

**A:** Mark Ortiz

155 Wankel Drive, Kannapolis  
NC 28083-8200, USA



IMPERIAL RANGE



METRIC RANGE



TENDER | HELPER

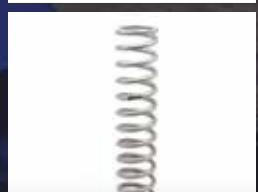

OFF ROAD



COIL SLEEVE



BUMP STOPS

**DOMINATE THE TRACK. RULE THE STREET.**

**ERS | Eibach Race Spring System**

- Over 1,300 single components - main and tender springs - metric and imperial, various auxiliary race suspension accessories, ready and in stock on 5 continents
- Comprehensive Program of single components
- Single Main Springs with highest rate-linearity and lowest rate tolerance
- Progressive Characteristics via set-up of different springs serially - double or even triple spring combinations
- Extreme Low Weights achieved through Super Hi-Ten materials and manufacturing technology
- Smallest Solid heights, maximized spring travels and higher maximum loads
- Spring Surface Stabilization through specialized shot peening
- Every ERS Spring preset to block
- Block and Sag Resistant
- Smallest Tolerances and precise plane parallelism of spring ends
- High Dynamic Durability - under Motorsports conditions
- High quality corrosion protection by phosphating and epoxy coating
- Springs Printed with part-number (speaking code = rate and dimensions)
- Individual protective single box packaging



eibach.com



# The right tools for the job...

**Enabling exceptional service and supply  
of championship-winning castings.**

By working closely with our clients, we deliver outstanding results.  
Right people, right technology, right expertise. **Right tools for the job.**

[www.gwcast.com](http://www.gwcast.com)



EXCELLENCE THROUGH INNOVATION™



GRAINGER & WORRALL

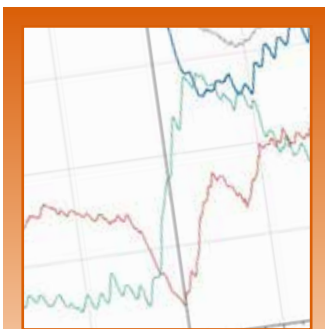

Databytes gives you essential insights to help you to improve your data analysis skills each month, as Cosworth's electronics engineers share tips and tweaks learned from years of experience with data systems

# Pulse Width Modulation setup

## Using relays to manage power consumption

Last month's article looked at Pulse Width Modulation, and how PWM could be implemented, technically, on a PWM compatible power device. This month we will look at how a system must be configured, practically, in order to implement PWM. This will include a brief look at current demands, and how relays can be used to manage devices with high power consumption.

In order for any electric power consuming device to operate, it requires a potential difference across it, or voltage. This is usually made up of a positive voltage supply, either directly from the battery or an output from another vehicle device, and a negative connection such as chassis ground, a low-level voltage or ground output from an on-board device. This is a basic fundamental of any electronic device and one which is central to motorsport wiring harness design when it comes to power consumers.

When wishing to control a device via PWM, these basic principles are

still followed by modulating either the positive or negative side of the device. This means that the potential difference across it also modulates, which gives the desired response. From a principle perspective this may seem very basic, but in order to implement correctly in practice there are some areas which may need some care.

### Direct versus relay

Four examples will be given for driving a device with PWM. The first two of these are basic, with direct connection of the PWM signal to the load device, and the second two include the implementation of a relay to drive a device.

The first example, as shown in **Figure 1**, is a schematic of how a device could be driven using a high side PWM output from a PWM-enabled device. In this simple configuration, the low side of the load device is fixed to chassis ground while the high side of the load device is modulated by the PWM-enabled device.

The second example, shown in **Figure 2**, shows how a device could be connected when driving directly from a low side PWM output. In this example, the high side of the device is connected directly to the battery and the low side is modulated from the PWM device.

Both of these examples would give the same response from the device, provided the PWM is configured in the same way. The only difference is one switches to a high level (high side) and one switches to a low level (low side). This, in principle, works well. However, in these cases all of the power which is being consumed by the load device is also being fed into the PWM-enabled device. For low current applications or devices with high power capable PWM outputs, this is acceptable. However, when driving a 10Amp Fan from a 1Amp PWM pin these schematics are not appropriate. It is these instances where a relay is required.

Relays are commonly used throughout electrical power systems

## Mechanical relays are inexpensive and only need basic wiring, however they have slower switching times

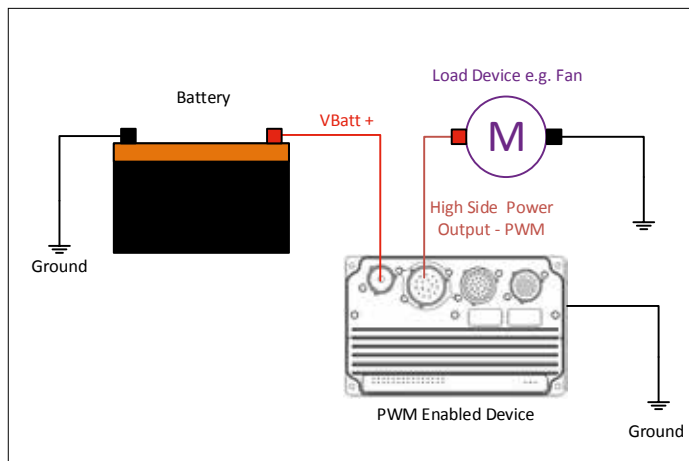

Figure 1: High side PWM

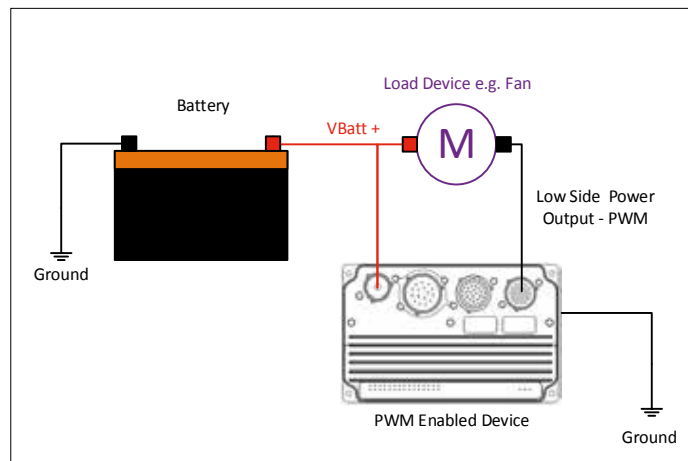
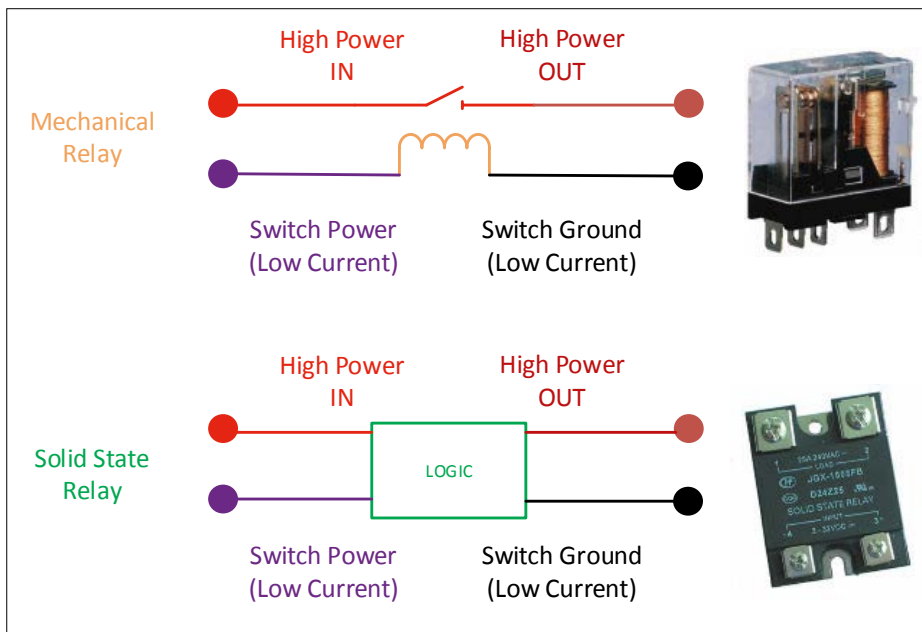

Figure 2: Low side PWM



**Solid state relays use intelligent circuitry to close the high current switch**

Figure 3: Relays

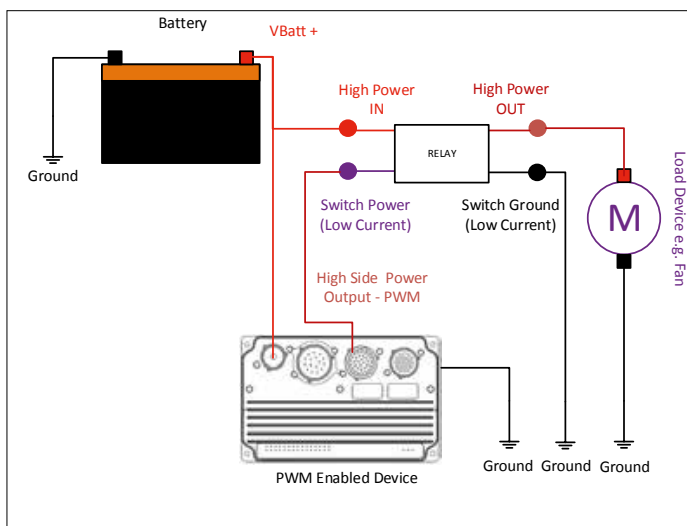

Figure 4: High side PWM with relay

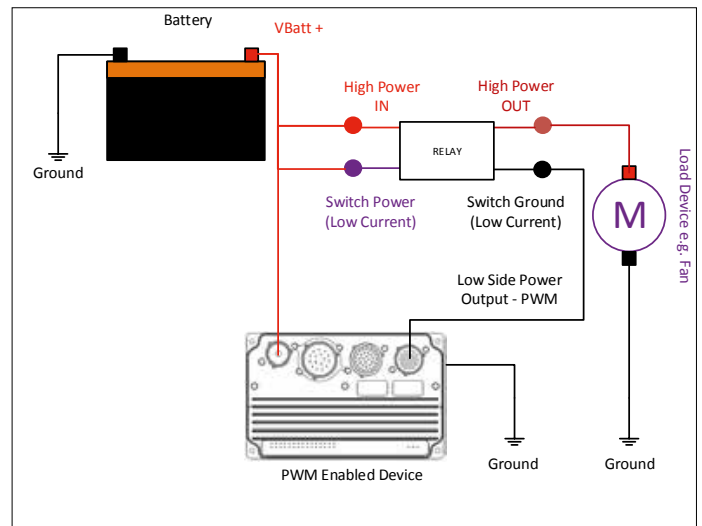

Figure 5: Low side PWM with relay

and in short, they allow switching of high current circuits, with a low current input. There are two types of relay which will be discussed – a mechanical relay and a solid state relay, as shown in **Figure 3**.

A mechanical relay uses a low current circuit to induce a magnetic field, which then closes a mechanical switch of a high current circuit. A solid state relay is essentially the same, but uses more intelligent circuitry in order to close the high current switch, depending on the logic state of the low current switch.

The choice of relay used needs to be considered depending on the application. Mechanical relays are inexpensive and only need basic wiring, however they have slower switching times when compared to

the more expensive, faster switching solid state relays. For use with a PWM application, which is a fast modulating signal, solid state relays are the more common choice as they can respond fast enough.

Most commonly, relays can be used to switch the high side of a device. However, there are relays which are capable of switching the low side as well. The principles for both remain the same.

**Figure 4** and **Figure 5** show how PWM can be implemented with the integration of a relay to drive a high current load device, even if the PWM current capability is low. Note how the load device high side supply comes from the relay in both instances, with the PWM high side or low side determining which side

of the low current side of the relay is modulated. If the relay is used to switch the low side of the device, the schematics would be similar. However, instead of high power in of the relay connected to the battery's positive terminal, it would be linked to ground, and the high power out would be linked to the low side of the load device. The positive side of the load device would then be linked to the battery's positive terminal.

Last month's article gave a software and theoretical overview of PWM, and combining this with the practical information provided in this month's article, configuring and implementing a PWM-driven load device on a racing car should now be possible.

**COSWORTH**

Produced in association with Cosworth

Tel: +44 (0)1954 253600

Email: ceenquiries@cosworth.com

Website: www.cosworth.com

# The Lightest, Most Flexible Hose and Fitting Combination Available!

**USA North Carolina**

704.793.4319  
sales@bmrsusa.com

**California NEW!**

714.415.0080  
socalsales@bmrsusa.com

**UK Slough**

01753.545554  
sales@bmrsuk.com

[www.bmrs.net](http://www.bmrs.net)



**Ferrea**  
RACING COMPONENTS

## Competition Plus Hollow Stem Valves



Ferrea Racing Competition Plus Hollow Stem Valves are 22% lighter than conventional stainless steel alloy valves. Their proprietary manufacturing process gun drills and micro polishes the bore of the valve stem. These valves are also made from Super Alloy materials which resist heat much better than conventional Inconel materials.

- Friction Welded Hard Tips
- Radial Groove (Shot Peened & Rolled)
- Micro Polishes & Gun Drilled Stems  
(22% lighter than conventional stainless alloy valves)
- "Avionics" Chrome Plated Stems (10 microns thick)
- Superflow (undercut) Stems (Improved flow design)
- 42 Rc Seat Hardness (Long life - resists fatigue fractures)



**FERREA RACING COMPONENTS**

Tech Line: 954-733-2505 • Toll Free: 888-733-2505  
[www.ferrea.com](http://www.ferrea.com)

FOLLOW US ON:   

**Pankl**  
RACING SYSTEMS



High Tech | High Speed | High Quality



**Pankl Engine Systems GmbH & Co KG**

A member of Pankl Racing Systems

A-8600 Bruck/Mur, Kaltschmidstrasse 2-6

Phone: +43(0)3862 51 250-0

FAX: +43(0)3862 51 250-290

e-mail: [engine@pankl.com](mailto:engine@pankl.com)

[www.pankl.com](http://www.pankl.com)



# Team Wix explores downforce at MIRA

Concluding our aerodynamic study of the BTCC Mercedes A Class

The devil is in the detail, and this applies no more so than to the aerodynamics of the current manifestation of British Touring Cars, where front and rear aerodynamic devices are essentially specified in the technical regulations. But there are some degrees of freedom, and in such a close-fought category, small changes can make a huge difference.

Wix Racing debuted the new model Mercedes A Class in the BTCC in 2014, and had a good first season with the car, chief engineer Paul Ridgeway and his team sealing tenth overall in the championship, bagging a couple of fastest laps, and a race win in the final event of 2014. So a visit to the MIRA full-scale wind tunnel in late autumn 2014 provided an opportunity to try some detail changes well ahead of the upcoming season – see **Photo 1**.

In our two previous instalments we saw how relatively subtle changes to front and rear bumper designs, and adjacent panelling at the rear, enabled worthwhile gains to be made. **Table 1** shows the difference between the baseline setup, as run in the final race of 2014, and the results after the bumper changes in the wind tunnel. To preserve a degree of confidentiality we are using 'delta (Greek letter Δ) values' for now only, which show the

differences between two sets of data, rather than publishing actual coefficients.

To put this data into some sort of context, remembering that BTCC cars were never intended to be high downforce cars, the gain in efficiency (-L/D) represented around a 25 per cent improvement. Clearly then, although drag had crept up a little, solid progress had been made on downforce, and on front downforce in particular, from which front-wheel-drive touring cars seem to benefit most.

We're going to round off our studies on the BTCC Mercedes A Class with a look at some other interesting details tried during the session, one of which was an adjustment to the spoiler at the rear of the roof. By removing some packers underneath the spoiler it was possible to lower it slightly, by 5mm (0.2in) at the leading edge and by 10mm (0.4in) at the trailing edge.

The changes to the aerodynamic parameters are as shown in **Table 2**.

This was an interesting result. As expected, a modest gain in rear downforce was achieved, and it seems reasonable to suppose that this was the result of improving the flow slightly to the rear wing – all BTCC entrants are required to visit the MIRA wind tunnel with a road variant of the car they intend running so that the standardised rear wing location may be set to achieve parity across the field in terms of drag and downforce. A small adjustment range is then allowed. What was unusual here is that if we assume the additional downforce came from the rear wing, it was not accompanied by an increase in drag. It is possible that the wing picked up additional downforce only in the centre, and that the strength of its vortex drag, which emanates primarily near the wing ends,



**Table 1 – the overall changes so far in the wind tunnel session, compared to the 2014 end of season baseline**

ΔCD	Δ-CL	Δ-CLfront	Δ-CLrear	Δ%front	Δ-L/D
+0.009	+0.049	+0.044	+0.006	+1.00%	+0.108

**Table 2 – the effects of lowering the roof spoiler**

ΔCD	Δ-CL	Δ-CLfront	Δ-CLrear	Δ%front	Δ-L/D
0.000	+0.005	-0.004	+0.008	-3.98%	+0.012



Photo 1: Wix Racing's Mercedes A Class



Photo 2: Lowering the roof spoiler very slightly had a tangible effect



Photo 3: At the height the wing was located it was only just receiving a clean airflow



Photo 4: The smoke plume within the wake shows how close the wing is to the wake itself



Photo 5: At reduced ride height the airflow is reluctant to pass through the underbody

**Table 3 – the effects of lowering Front ride height by 20mm**

$\Delta$ CD	$\Delta$ -CL	$\Delta$ -CLfront	$\Delta$ -CLrear	$\Delta$ %front	$\Delta$ -L/D
-0.022	+0.017	+0.040	-0.024	+10.52%	+0.074

**Table 4 – the effects of lowering the front ride height by 50mm**

$\Delta$ CD	$\Delta$ -CL	$\Delta$ -CLfront	$\Delta$ -CLrear	$\Delta$ %front	$\Delta$ -L/D
-0.007	-0.002	+0.021	-0.024	+10.24%	+0.004

**Table 5 – the effects of lowering front AND rear ride heights by 50mm**

$\Delta$ CD	$\Delta$ -CL	$\Delta$ -CLfront	$\Delta$ -CLrear	$\Delta$ %front	$\Delta$ -L/D
-0.024	-0.061	0.000	-0.062	+32.24%	-0.123

was unaffected, but this would be unusual. Could it be then that lowering the roof spoiler by just 10mm at its trailing edge reduced the car's wake size and the pressure drag associated with that, and this offset any induced drag gains created by the wing? See Photos 2, 3 and 4.

## Rake and ride height

Altering the rake of a racecar can make big differences to total downforce levels and balance. BTCC cars are permitted to run a flat splitter panel under the front compartment that extends to the standardised front cross member, but the rest of the floor must remain as per the production donor. So how would the Mercedes A Class respond to adjustments to rake and ride height? The static minimum ride height is quite high at 80mm, but under dynamic conditions this could change substantially. So, with time running short, some quick changes were made, the first of which saw front ride height reduced by 20mm (0.8in); the results are in Table 3.

In the context of this type of car, these were significant changes, and any change that produced a useful benefit in both downforce and drag is one that it would be nice to exploit. Given the static minimum ride height regulation, this configuration may be one that is attained only during braking; nevertheless it could provide an exploitable benefit.

The front ride height was then lowered by another 30mm (1.2in), and the results compared to the setting prior to any ride height adjustment are shown in Table 4.

This additional, rather extreme increment of front ride height reduction saw some of the initial benefits reduced, drag returning to closer to the 'pre-front compression' level, with roughly half of the front downforce benefit of the 20mm front ride height reduction being lost, although front downforce was still greater than at baseline ride height. Interestingly, rear downforce didn't decrease any further, and the initial balance shift ( $\Delta$ %front) remained very similar.

Finally, the rear ride height was lowered by 50mm (2.0in) to regain the original rake but at much lower ride height, and Table 5 gives the results, relative to the original rake and height.

The stand-out result here was the loss of rear downforce, together with a return to the same front downforce as at the original ride height. We might speculate that, in the absence of a rear diffuser, reduced mass flow through the whole underbody was now choking off downforce gains from under the car. It looked as though a modest front ride height reduction was the best configuration from these trials – see Photo 5.

**Next month:** We'll move on to new project. Thanks to Nigel Rees at GSD Racedyn, James Kmiecik, and all at Wix Racing.

## CONTACT

**Simon McBeath** offers aerodynamic advisory services under his own brand of SM Aerotechniques – [www.sm-aerotechniques.co.uk](http://www.sm-aerotechniques.co.uk). In these pages he uses data from MIRA to discuss common aerodynamic issues faced by racecar engineers

Produced in association with MIRA Ltd



**Tel:** +44 (0) 24-7635 5000

**Email:** [enquiries@mira.co.uk](mailto:enquiries@mira.co.uk)

**Website:** [www.mira.co.uk](http://www.mira.co.uk)

# Precision Lapping

www.kemet.co.uk  
sales@kemet.co.uk  
+44 (0) 1622 755287



When **the** difference between **winning** and losing can be 1/1000th of a second, having critical components Lapped and Polished **by Kemet** can give you the edge!

**Kemet**

**Lane**  
MOTORSPORT

HIGH PERFORMANCE CONNECTORS  
AND ACCESSORIES FROM STOCK

- CONNECTORS
- HEAT SHRINK BOOTS
- ASSEMBLY TOOLING
- PROTECTIVE CAPS
- PANEL GASKETS
- NUT PLATES
- 3D CAD MODELS



MANUFACTURED BY  
**SOURIAU**  
HellermannTyton  
**Weald**

FC LANE ELECTRONICS LTD  
WWW.LANEMOTORSPORT.COM  
MOTORSPORT@FCLANE.COM  
TEL. +44 (0) 1403 790 661

# Cooler by design

Formula 1 teams have had to go on something of a journey of discovery when it comes to cooling. Cranfield University student Pierre Salmon looks at how computational fluid dynamics can help the teams to extract the most from their cooling systems



The enlarged sidepods of the 2014 cars saw a major reduction in aerodynamic efficiency

Cranfield University's Advanced Motorsport Engineering MSc allows students to get closer to Formula 1 through interaction with professionals in the industry, detailed academic courses, a group design project and an individual thesis. One of the 2014 theses looked at evaluating the required air mass flow rate through the sidepods needed to reject the waste heat produced by the F1 powertrains to comply with the new 2014 regulations. Computation fluid dynamics was used to investigate the potential cooling and aerodynamic benefits of five different

configurations and any effects they might have on the performance of the engine.

The 2014 F1 technical regulations concerning powertrains have provided considerable challenges to the engineers regarding the packaging of the cooling system. The addition of a turbocharger has resulted in more required heat rejection to the air flowing through the sidepods. The oil and water cooling requirement for the engine remains relatively the same for the 2014 V6 engine compared with the 2013 V8 engine, but the addition of the charge air cooler results in a much higher requirement of cooling air mass

flow. There is also an increase in electronics cooling requirement from the higher power outputs of the MGU-K and more complex energy management electronics. A strong need therefore exists to find a solution that could possibly reduce the cooling requirements or find a cooling configuration that allows for the highest heat rejection rates.

Designing the most efficient cooler configuration has ample benefits as it affects the three performance differentiators of the 2014 season – power, aerodynamics and reliability. Firstly, effective cooling of the charged air reduces the density of the air going

Figure 1: Airflow through the heat exchanger clusters with charge air cooler in yellow, oil cooler in red and water cooler in blue. These five layouts were simulated

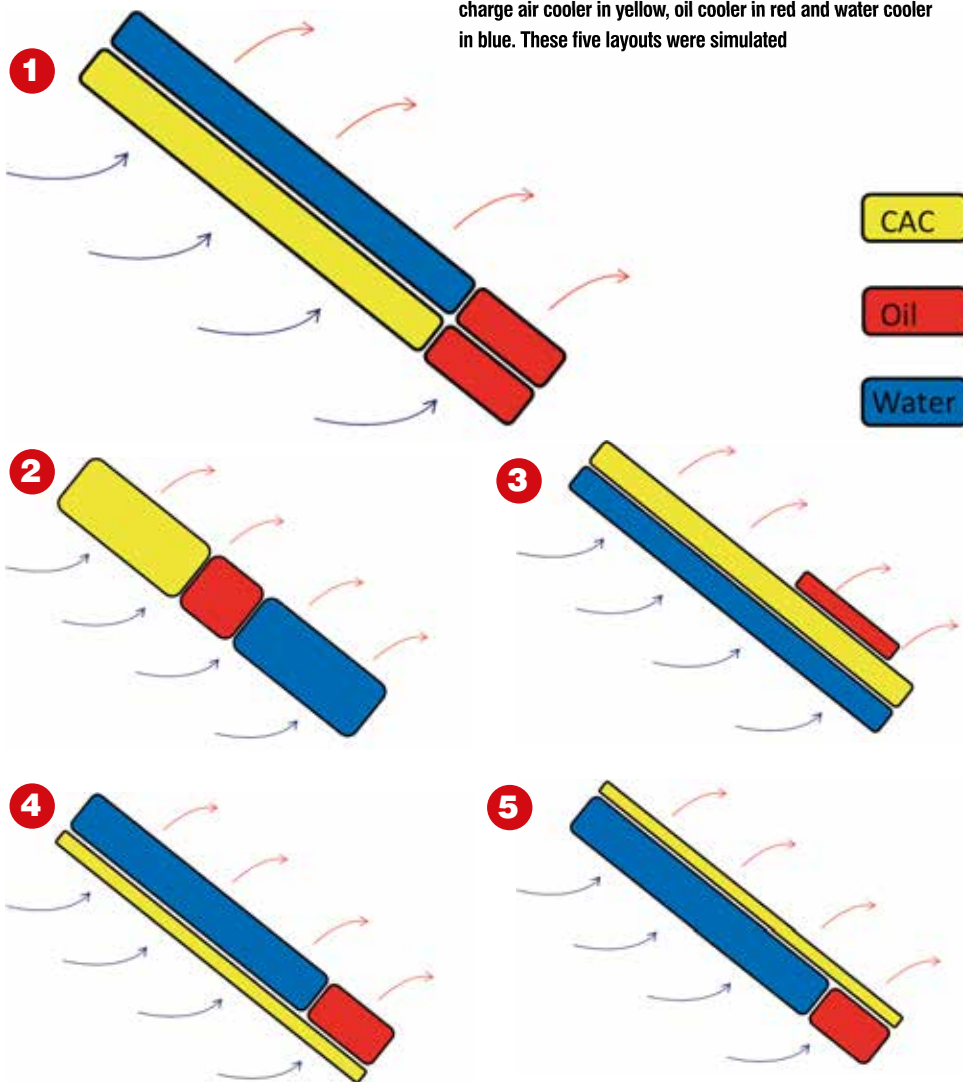

Core length performance																
	Configuration 1			Configuration 2			Configuration 3			Configuration 4			Configuration 5			
	CAC	WRAD	ORAD	CAC	WRAD	ORAD	CAC	WRAD	ORAD	CAC	WRAD	ORAD	CAC	WRAD	ORAD	
Length in mm	30	30	30	60	60	60	25	25	20	30	45	45	23	37	37	
Height in mm	635	635	150	317	317	150	785	785	217	768	551	218	768	551	218	
Number of hot tubes	38	38	18	19	19	9	47	47	13	46	33	13	46	33	13	

into the cylinder. This allows more molecules of oxygen per unit volume to be reacted and means more fuel can be combusted per cycle, allowing for a higher IMEP. Secondly, the effective cooling of the air, water and oil will reduce the average operating temperature of the engine and so extend the life of the engine. The reliability and life of all the components in the engine is crucial to the successful operation and racing of the car since only five powertrains were allowed per season per driver in 2014.

The enlarged sidepods of the 2014 cars provide a major reduction in aerodynamic efficiency of the vehicle as they slow down

more air and reduce the clean flow of air to the rear of the vehicle. It would therefore be of benefit to any team to be able to increase the heat transfer abilities of the cooling systems and reduce the cooling air mass flow rate.

## Transferring heat

An increased efficiency of the engine fluid cooling will also free up cooling capacity for the electronics and turbocharger. Throughout the 2014 pre-season testing it was found that efficient cooling of the cars' systems resulted in major gains in reliability and performance, and the first half of the 2014 season saw numerous

iterations of bodywork to optimise the cooling of the vehicles. In this project, the cooling from an air to air charge air cooler (CAC), a water radiator (WRAD) and an oil radiator (ORAD) are considered. The typical mass flow rates of air through the sidepods would be between 1.2 and 2.1kg/s, depending on vehicle velocity and sidepod inlet area. The 2014 engine needs to reject around 113kW of heat from the water radiator, around 41kW from the CAC and in the region of 58kW from the oil radiator.

The five different configurations see the CAC, WRAD and ORAD placed in a way as to maximise the heat transfer or reduce the

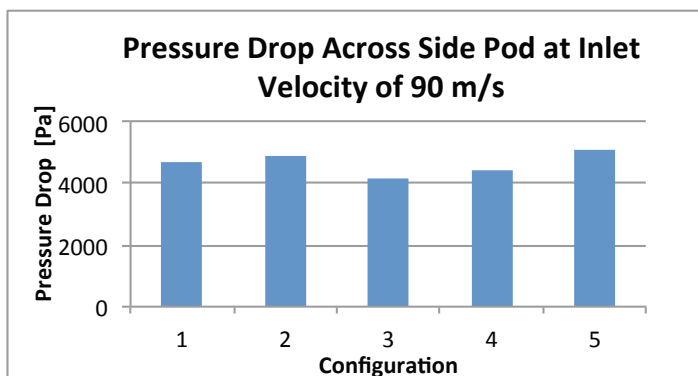

Graph 1: Interestingly, the pressure drops are similar across all configurations

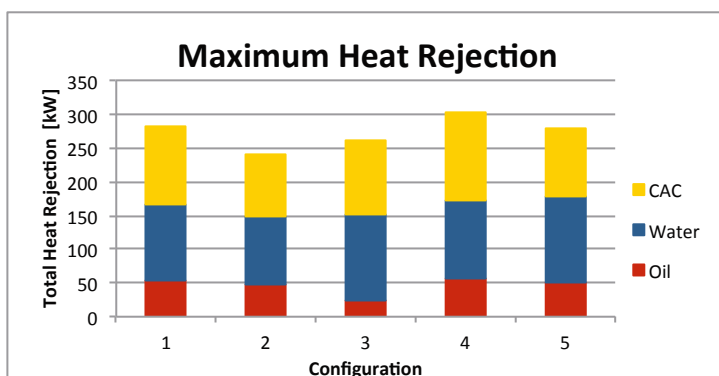

Graph 2: This demonstrates how CAC influences heat rejection

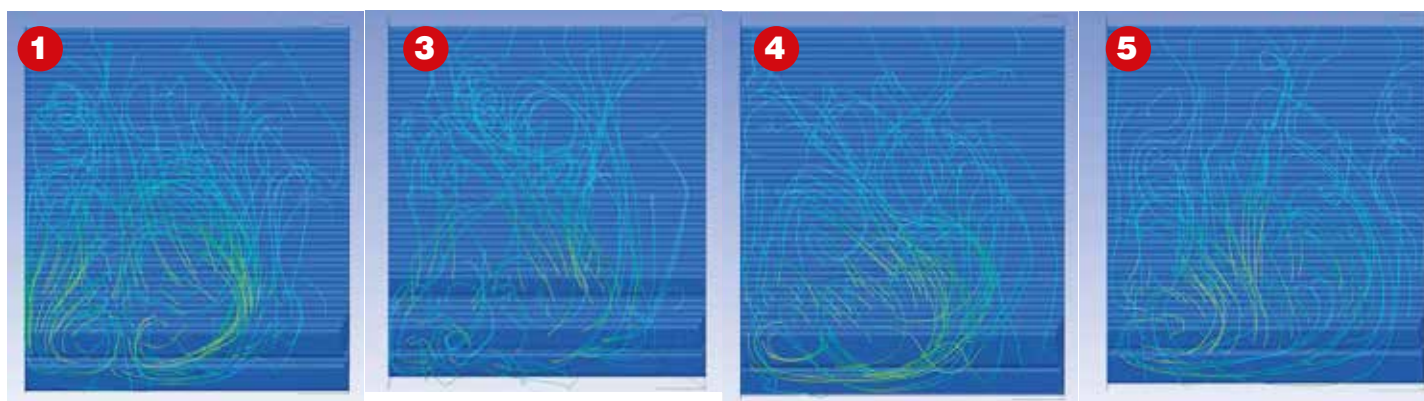
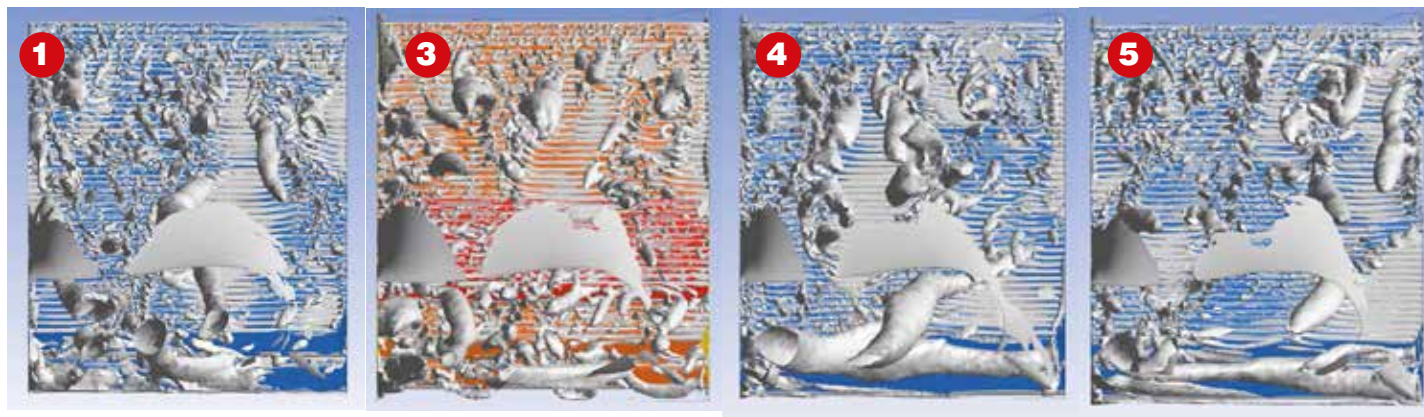

Figure 2 (above) and Figure 3 (below): The flow structure behind Configuration 3 might appear more chaotic but the strength of rotational flow behind all of the cores is important



external pressure drop across them. Extreme Temperature Difference (ETD) is the main driver behind heat rejection from coolers and designers typically 'sweat off' the heat as much as they can by staggering the hotter surfaced heat exchangers behind the colder ones as in **Configuration 4**. Another strategy is to have all heat exchangers exposed to the cool inlet air and size them relative to their heat rejection requirement, as per **Configuration 2**.

The geometry of each heat exchanger is optimised to provide similar performance while maintaining a specified volume. It is often the greatest challenge for aerothermodynamicists to package these relatively bulky devices around the engine and in the sidepod. Dense cooling cores are used to maximise the surface

area and fin efficiency, with fin density being as high as 21 fins per inch. The fin efficiency of each core is also crucial as this allows for greater heat transfer to the cooling air. It is also important to understand how the heat exchangers affect the performance of other heat exchangers downstream. If you imagine the heat exchangers are packed very close together inside the sidepod, then once the air has passed through the front heat exchanger, it has warmed up and is traveling slower and is more laminar, all of which negatively affects heat transfer. Traditionally louvres are used to break down the aerodynamic and thermal boundary layers along the fins to re-establish high temperature gradient and turbulent flow near the heated surface.

Front wheel tyre wake is also an issue as this highly turbulent air, which is moving at a slower relative velocity, will inhibit heat rejection performance of the cooling system in the sidepod if it were to enter it directly. Aerodynamicists now cleverly use the Y-250 vortex to help divert the wheel wake around the lower side of the sidepod. Not only does this help with reducing drag, but it also allows for faster cleaner moving air to enter the sidepod and effectively, and predictably, extract heat from the cores. See **Figure 1**.

The CFD process used a generic sidepod geometry generated in Catia V5, with the five different cooling cores input as finite tubes of varying temperature. There were in excess of 25 million cells in the meshes and the simulations

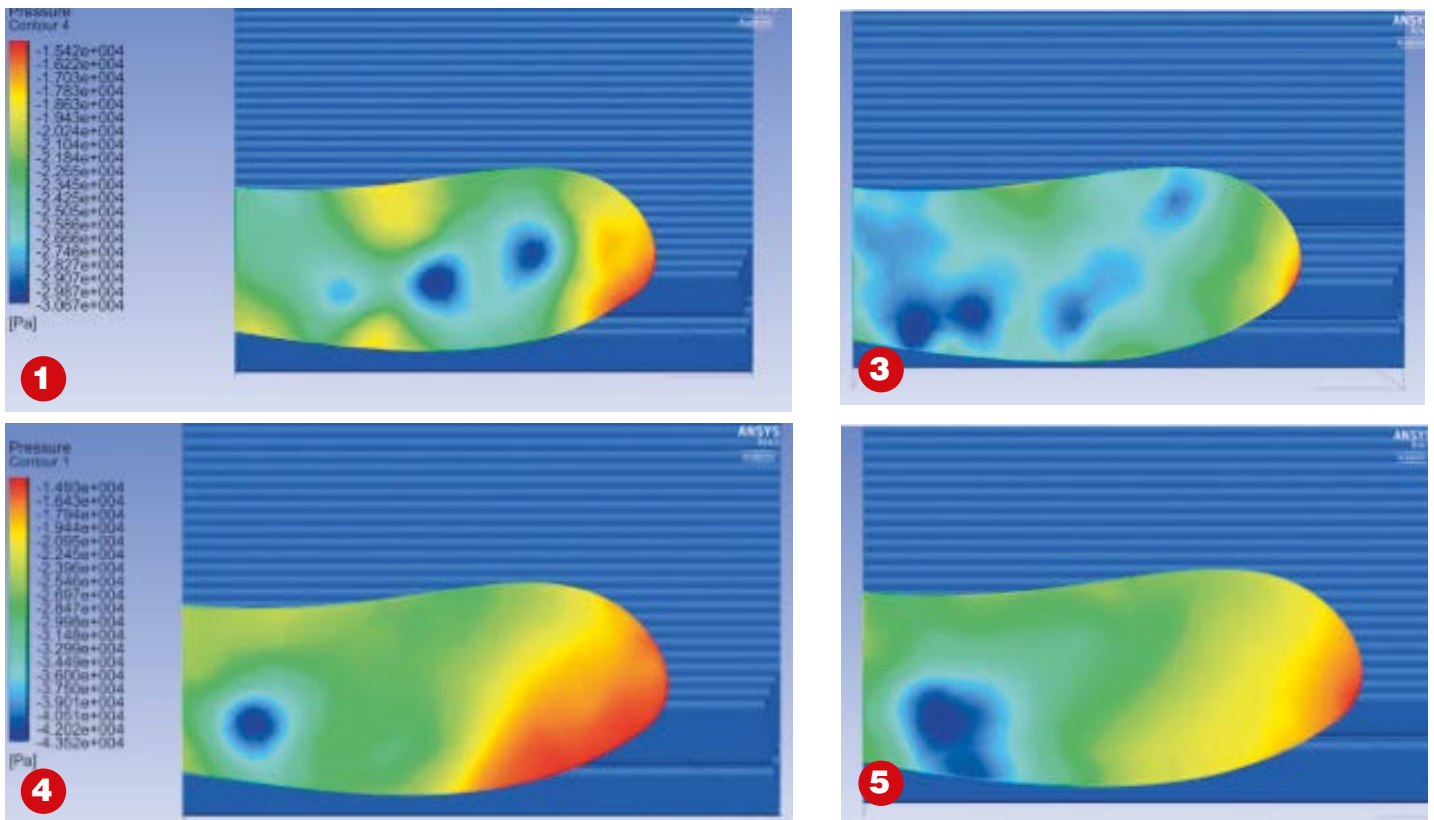

Figure 4: Pressure gradients show the core regions of the vortex – the calmer the vortex, the longer longer its length

took four days each to run on the Cranfield High Performance Computing Cluster. The macroscopic heat exchanger model was not used because obtaining the heat rejection to mass flow rate correlation curves from an F1 team are like trying to find hen's teeth. In addition, the separation events and effects of tube geometry was interesting to see, so the full detailed CFD was done in order to gain as much information as possible.

What is interesting to note is that **Configuration 4** yields the highest heat rejection rate at the car's maximum velocity of 90m/s. This is due to it having the cooler CAC in

condition. The ideal situation would be to have uniform air mass flow distributions through the cooling cores, and no severe pressure gradients at the outlet. Observing the rear of the sidepod (so looking forward towards the outlet) we can see a comparison of the outlet velocity streamlines of each configuration.

### Rotational flow

The flow structure behind **Configuration 3** might appear more chaotic, but of importance is the strength of the rotational flow present behind all the cores. **Configuration 1** shows a double counter-rotational structure, with the

pressure region results in the rotational flow structure being established.

Observing the Q-Criterion 0.018, vortex filaments show how the rotational flow structures develop in the sidepod after the cores. **Configuration 3** shows smaller and fewer vortices than **Configuration 1**. The counter-rotating vortices of **Configuration 1** are shown, and the two larger vortices labelled near the top of **Configuration 3** dissipate due to longitudinal acceleration as the cross sectional area decreases near the outlet.

The vortex exiting on the left (1) is produced from, initially, the flow over the last row of

## Designing the most efficient cooler configuration has ample benefits as it affects the three performance differentiators – power, aerodynamics and reliability

front of the warmer radiator, so the absorption of heat into the cooling air is maximised. The pressure drop across the configurations are also of interest because it is no good having a cooling system that rejects the heat but costs a significant internal aerodynamics drag penalty.

Now, what is of further importance is to observe what the air is doing after it has left the cooling cores and how this affects the rear of the vehicle. The air velocity uniformity at the sidepod outlet is of concern because it affects the aerodynamics at the rear of the car. The sidepod inlet shape determines the air mass flow distribution and thus the outlet flow

primary stronger vortex on the right-hand side, which develops initially due to the non-uniform pressure distribution aft the cores. This induces the left-hand side counter-clockwise vortex due to viscous shear forces between particle layers.

**Configurations 4** and **5** show similar trends in a strong rotational flow structure aft the cores, where the region of low mass flow rate results in lower particles per volume, which directly relates to a lower pressure, which accelerate high pressure particles region towards it. The high pressure particles already have momentum towards the sidepod exit, and their gradual acceleration towards the low

tubes at the bottom of the water radiator rolling over and creating a standing vortex. As the air flow from higher layers exits the cores it follows the flow and encourages the rotational flow laterally (around the axis indicated by the dashed arrow), which wraps around and then rotates around an axis perpendicular to the page as the vortex nears the exit, due to the lower pressure aft the core from the non-uniform pressure distribution mentioned before. The difference in strength between the vortices of **Configuration 4** and **5** is that with **Configuration 4**, the flow encounters the longer radiator tubes last, and so the flow is

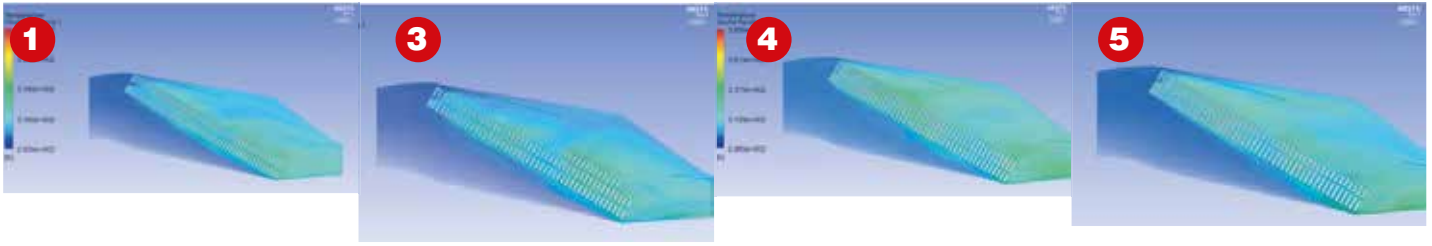
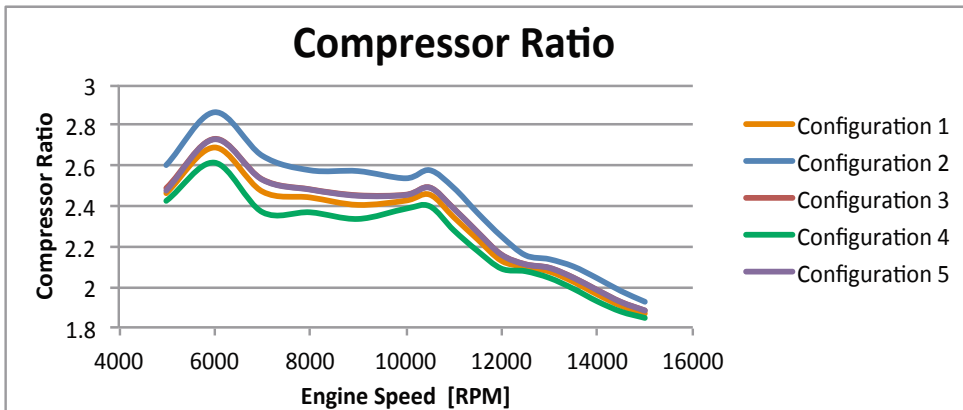
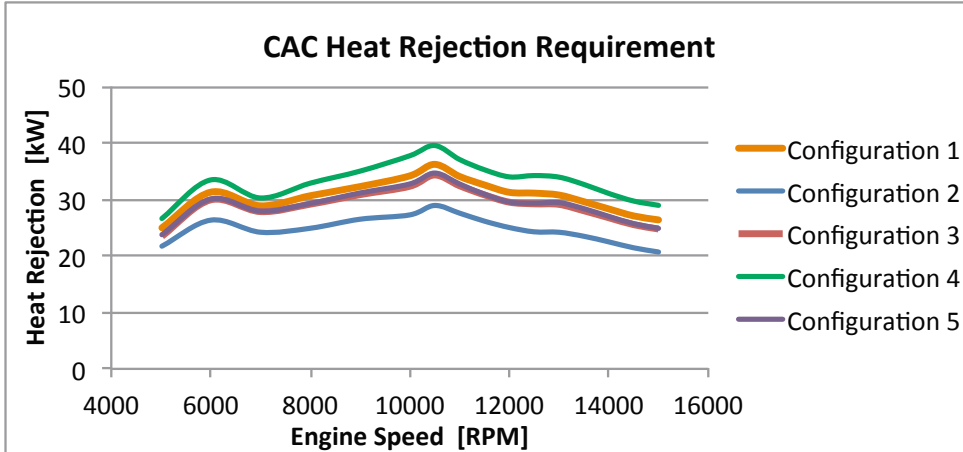

Figure 5: This shows the temperature gradients and airflow into and out of the cooling cores



disturbed less than with **Configuration 5** with the shorter CAC tubes at the rear.

The less disturbed flow of **Configuration 4** has a higher velocity (boundary layer build up and effective flow area) and the higher the exit velocity the higher the tangential velocity of the vortex. The higher tangential velocity, due to Newton's first law, results in a larger radius, but this also increases the volume of the vortex and a lower core pressure is experienced, increasing centripetal acceleration, Newton's Second Law. The equilibrium state between the two forces results in a faster spinning stronger vortex, observed by **Configuration 4**.

### Hotspots

The right-hand side vortex is also rotating clockwise, but is slightly weaker, and in the case of **Configuration 5**, is dissipated before the outlet because the flow accelerates in the longitudinal direction as the cross-sectional area decreases. The core regions of these vortices (inside the filaments) are relatively calm, where viscous dissipative forces damp out any large scale turbulent fluctuations. Generally this helps preserve the core region of the vortex and helps extend the life of the vortex. The resulting pressure contours at the outlet is shown below, where **Configuration 3** has the lower pressure gradients due to more uniform flow, and **Configuration 4** and **5** have the strong vortex's low pressure in the filament core. As a result of the sidepod outlet flow conditions, it could be speculated that in the future teams might want to make use of this flow in their aero packages.

The thermal energy exchange between the heated surfaces and the cooling air can be gauged by the temperature differences of the air after the cores. The following images show the temperature rise inside the sidepod. **Configuration 3** clearly shows a hotter region just behind the oil radiator as the air is being heated by three stacks of cores. A noticeable difference between **Configuration 4** and the other configurations is the uniformity of the air temperature after passing through the cores.

In contrast, **Configuration 1** and **3** have regions of higher temperature and regions of lower temperature, showing variation of the mass flow rates through the cores. Ideally, equal mass flow rates of air through all the rows of the cores should be achieved with optimisation of the sidepod inlet shape, plan view shape and



McLaren 2014 right hand side cooler arrangement unclothed showing two different types of heat exchanger

# THE NEW EVOLUTION IN TE'S MOTORSPORT MICRO CONNECTORS



## DEUTSCH AS Micro Xtra<sup>LITE</sup> HE Connector

### Ultra lightweight

- Compact size 2 shell
- No need for backshells for boot termination
- 6 x AWG24 contacts

### Fast, easy installation

- Suitable for blind mating
- Positive locking coupling mechanism
- 6 keyway orientations



## TAKE THE LEAD WITH THE DEUTSCH AS MICRO XTRA<sup>LITE</sup> HE CONNECTOR WITH 6 CONTACTS

TE Connectivity (TE) introduces its DEUTSCH AS Micro XtraLite HE connector - one of the market's smallest diameter, lightest AS connectors for when space is at its most restrictive. Able to complement the ASX-3 and -5 options, this high performance interconnect helps to give you the edge in an environment where even the smallest component can be a true game changer.

Learn more at [www.te.com/deutsch](http://www.te.com/deutsch)



©2014 TE Connectivity Ltd. All Rights Reserved. DEUTSCH, TE Connectivity and the TE connectivity (logo) are trademarks.



## Performance Silicone Race Parts

We develop and test our hoses with the top teams and competitors in motorsport. Our products receive the ultimate test of durability and allow us to offer you a product you can rely on. With the world's most comprehensive range of Universal Race Parts, we offer an array of shapes and sizes making any configuration possible.



THE WORLD LEADER IN  
PERFORMANCE SILICONE HOSE





A 2014 DF1 engine needs to reject around 113kW of heat from the water radiator and 58kW from the oil radiator

Figure 6: This is a cooling map for Configuration 4 around Spa

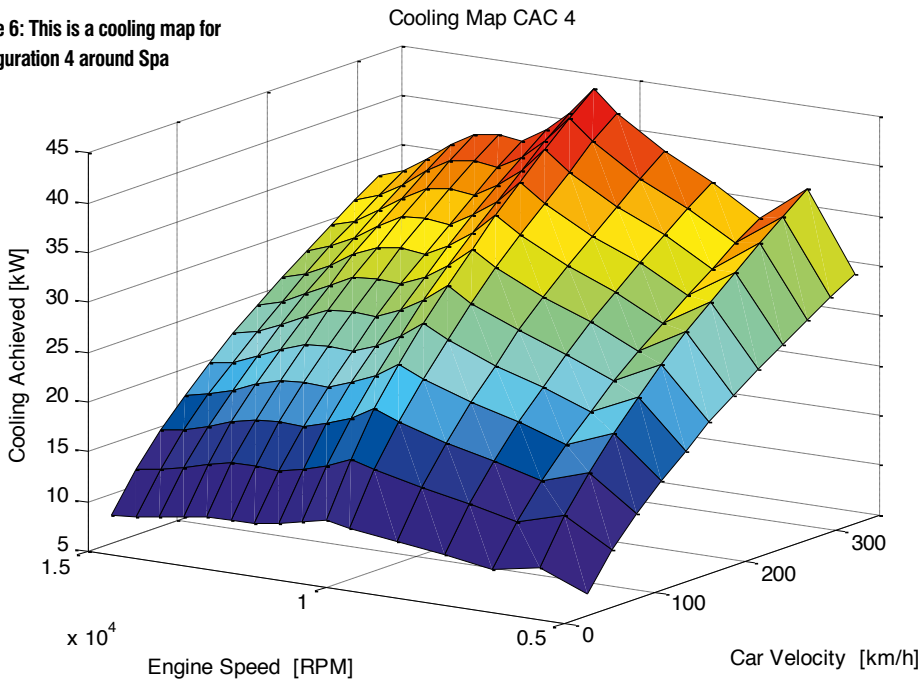

Heat Rejection along Spa

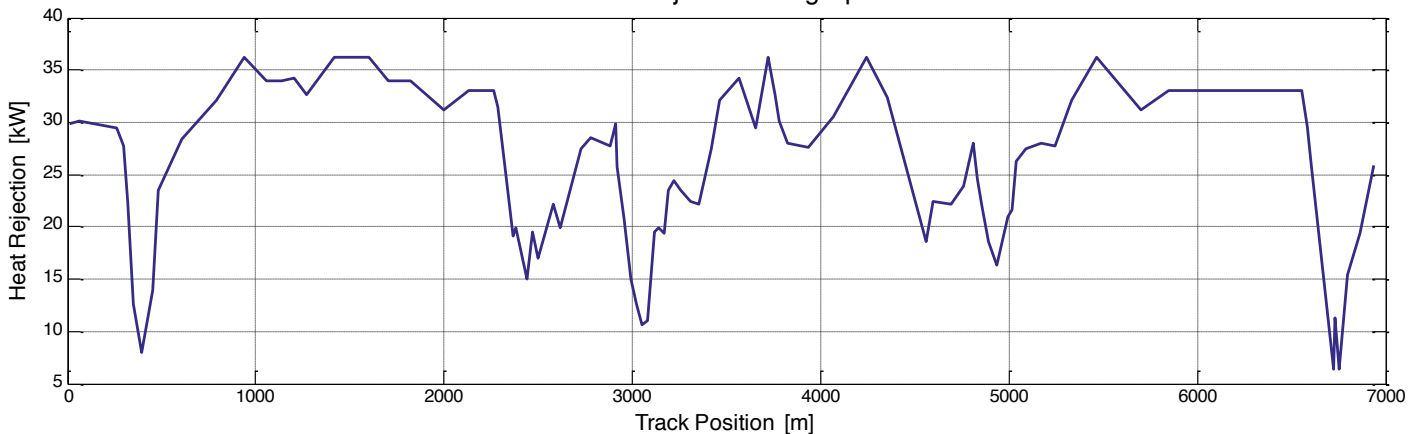



Figure 7: The lower the speed, the less effective the car's cooling performance

exit duct shape. This image clearly shows the temperature gradients and streamline flow into and out of the cooling cores.

The affect of these CFD results were then applied to an engine simulation of a 2014 regulation F1 engine. The CAC was of particular interest as it determines the temperature leading into the combustion chamber, and this has a major impact of volumetric efficiency of the cylinders and the rate of evaporation of the fuel, amongst others which influence the overall combustion performance.

The advantage of having a CAC which cools the air down to a lower temperature is that this air has a higher density, and so more molecules of air can be induced by the engine per cycle allowing for improved engine breathing. **Graph 3** shows that, in order to achieve the same output power, for a poorer performing CAC, a higher pressure ratio over the compressor would be required. This higher pressure needed to pump this relatively hotter air would require more power from the turbine wheel, and so result in higher back pressure in the exhaust manifold – bad for scavenging, and less energy available for the MGU-H. The overall effective design of the cooling system has a holistic benefit on the F1 package, in so far as aerodynamics and power are concerned.

### Low speed cooling issues

It is also important to consider the performance of the CAC at low vehicle velocities, as the cooling and pressure drop is highly dependant of air velocity through the sidepods. A cooling map can be generated, which is a combination of the CFD and engine simulation work, which shows that at lower vehicle speeds the car might not be cooling exactly as much as is needed. These maps can then be used to perform an energy audit of the total watts of heat rejected over the course of a lap and this will provide engineers feedback on the cars performance and that of the cooling system. **Figure 6** shows a map for cooling **Configuration 4** and **Figure 7** is the heat rejection trace of around one lap of Circuit de Spa-Francorchamps. 

The all-new FlowSonic range of ultrasonic fuel flow sensors from Sentronics Limited is specifically designed to help limit peak engine power, balance performance, and promote energy efficiency in motorsport. It is offered in three specifications – Elite, Super, and Pro – to suit the full spectrum of racing categories, from F1 to F4 and LMP1 to GT3, as well as touring and rally cars. Key features and benefits include:

- ✓ Accuracy to +/- 0.25% of reading
- ✓ Repeatability to +/- 0.05% of reading
- ✓ Maximum flow rate of +/- 8000 ml/min
- ✓ 0°C to 105°C operating temperature
- ✓ Solid state with no moving parts
- ✓ Compact and lightweight
- ✓ Compatible with all fuel types
- ✓ Internal processing and diagnostics

The FlowSonic's second-generation fuel flow sensor technology is available for development and pilot competition use in 2015. Sanctioning bodies, championship organisers, OEM engine suppliers, fuel companies, and specialist race engine builders can visit [sentronics.com](http://sentronics.com) for full product data and contact us directly about our **demo programme**, with loan units now available to qualified prospects.

### ELITE



### SUPER



### PRO



SEE US AT AIS  
STAND E741

Sentronics Limited  
Unit 40, Downton Business Centre  
Downton, Salisbury  
Wiltshire SP5 3HU England

Telephone +44 (0)1725 513703  
Fax +44 (0)1725 513399  
Email [info@sentronics.com](mailto:info@sentronics.com)  
Web [www.sentronics.com](http://www.sentronics.com)

**sentronics**<sup>™</sup>

**ARC**, the best kept secret in efficiency.  
*"the choice of champions."*



Wind Tunnel, 7-Post, CFD, Gearbox Dyno,  
Reverse Engineering, Complete Service Package

[www.arcindy.com](http://www.arcindy.com) / [sales@arcindy.com](mailto:sales@arcindy.com) / 001.317.291.8600



# Better by design

**Corvette Racing has subjected its C7.R GTE contender, which debuted in 2014, to computational optimisation techniques that have produced dramatic results**

By **SIMON McBEATH**

**T**he renowned and long-running partnership between Chevrolet and Pratt & Miller Engineering, which builds the racecars and operate the competition programme, began in 1999 and has produced a trail of high profile wins including seven Le Mans titles in the GTE Pro class.

The programme began with the C5-R, which ran through to 2004 with GTS class wins at Le Mans in 2001, 2002 and 2004. The C6.R followed that with Le Mans GT1 class wins in 2005, 2006 and 2009 and the newly instigated GTE Pro class win in 2011. Then there's the tally of 82 ALMS race wins and 10 manufacturer wins.

In its debut season in 2014, the C7.R finished second in the GTE Pro class at Le Mans and claimed four race wins in the new TUDOR United Sports Championship GT Le Mans class. And the most the recent success saw the team enjoy a win and third in GTLM at Daytona in January.

Pratt & Miller Engineering (PME) design engineer Grant Browning proudly asserts that each Corvette model redesign was a step forward from the previous one, and that each model possessed sufficient potential to compete at the top of its class against the factory-backed teams. This was also the philosophy behind the C7.R programme, with design commencing at PME in 2013.

As in all top level race teams, PME has at its disposal the usual

computational modelling and simulation tools, and among these is VR&D's GENESIS structural optimisation software.

Browning takes up the story: 'GENESIS software was a tool we'd had at our disposal for two years, but until the C7.R design, it was only used in individual component or sub-assembly designs or redesigns.

'However, since our introduction to GENESIS, the implementation of optimisation to drive our designs

has grown. The C7.R was the first full car design where PME had the opportunity to implement optimisation into every facet of car design, thus providing a direct comparison to the C6.R GT2, an already well-developed and very competitive car, to evaluate the influence that GENESIS had.

'As the build [of the C7.R] progressed and our seemingly over-optimistic predictions began coming to fruition, the impact of optimisation

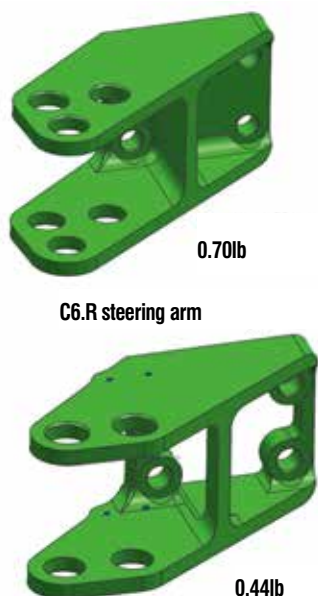

**Figure 1: PME's first optimisation study focussed on the Corvette's steering arms**

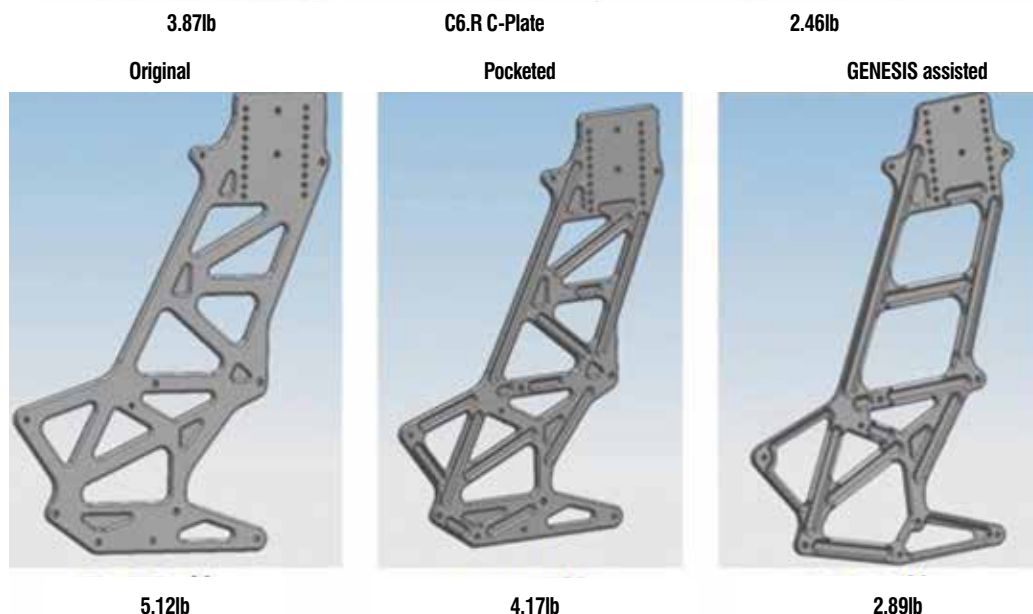
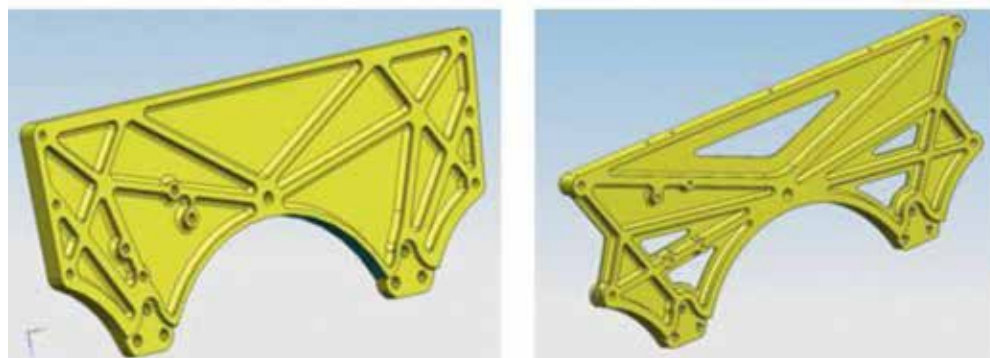

**Figure 2: Other early PME optimisation projects**

became obvious. The C7.R test car's torsional stiffness was 50 per cent higher, while the overall weight of the structural components was reduced by more than 65lb (29.5kg).

As track testing began, the feedback continued to be positive. From the lead engineer on car #4, Chuck Houghton, came this report: 'It seems like the increased chassis stiffness has helped a lot of the strange chassis dynamics that we used to have. We don't see the rear moving around as much as we used to and the racecar recovers a lot better over the kerbs and bumps.'

Once the race season started and the cars began to clock up some real miles and racing incidents, the structural components continued to display their worth.

Interestingly, there was some initial resistance within PME to the design directions being signposted by the results emerging from GENESIS, illustrated by a new steering arm design – **Figure 1**, the first parts to be optimised using GENESIS.

The optimised design, a machined alloy part, was 37 per cent lighter than its predecessor, saving 0.26lb (119g) per side, but apparently it took some persuasion to get a sceptical race crew to fit them. Grant Browning explains that 'once the crew had come around to the new design there was an incident that buckled

## “We don't see the rear moving around as much and the racecar recovers a lot better over the kerbs”

the steel tubular steering link but the steering arms remained unscathed. This opened the door for us to begin further implementing this approach to the design process.'

There was another unintended impact test: 'In the second half of the season the #3 Corvette, the car that was winning the championship at the time, was involved in a serious accident with another car, one that sent both drivers involved to the hospital and completely destroyed the car's chassis. Fortunately, the Corvette Racing crew was able to get our C7.R reassembled and ready for qualifying just two hours later.'

'This was more a test for the full car; uprights, control arms and roll cage. These had all been drastically lightened as optimisation had been heavily engrained into the entire car design and pushed further than some of our earlier optimisation projects.'

The incident confirmed that the weight saving and stiffness increases found in the optimisation work of the car had not compromised its resilience – see **Figure 2**.

So, substantial improvements in stiffness and weight had been achieved in individual components and importantly in the car as a whole. Browning is pragmatic about how these gains were found and quite naturally asserts that in a team of clever and experienced designers and engineers improvements are to be expected anyway. But he also gives credit to GENESIS, and perhaps more importantly to his team's use of the software, and says: 'The influence of GENESIS was not only felt through direct simulations run on the C7.R racecar, but also through the insight and understanding gained from our team through our previous use.'

'The reason that this secondary impact is so substantial is because we do not just take optimised results straight from the software and use the more efficient shapes created as a basis to make physical parts; rather, we see GENESIS as a tool to generate ideas, and also as one that can produce new metrics for evaluating and understanding. GENESIS, in

our hands, quickly became a tool that didn't simplify or accelerate our design process, but one that we pushed further to increase the potential for understanding, to achieve gains in our structural components and to give us an advantage on the track.'

This last point is taken up by Martin Gambling, managing director of GRM Consulting: 'Design time can be less with optimisation. Good use can add time but produces better results. However, you need to run different targets to see a range of results to understand the process, for example, when determining whether a component needs to be stiff or strong in bend, and so on, and avoid over emphasis on a dominant load case. With wing supports the loading is not only downforce we need to cater for; there are other forces which need to be taken into account such as the car being manually pushed along by the wing...'

Browning goes on to describe how the deployment of GENESIS has developed over time at PME: 'Our process for implementing GENESIS has been refined over the last couple of years and is typically used with topology optimisations, but it is similar for all our uses. Every case is a little different, but our general process has matured into common steps – see **Figure 3**.

'The process starts with a 'package protected volume'. Sometimes this is a big brick shape using all the packaging space possible, and sometimes it's an existing part we'd like to pull extra weight out of. From there, a set of load cases, constraints, and objectives will be input, and GENESIS produces the optimised results. Next, the results are critiqued, thoroughly

Figure 3: PME's optimisation process

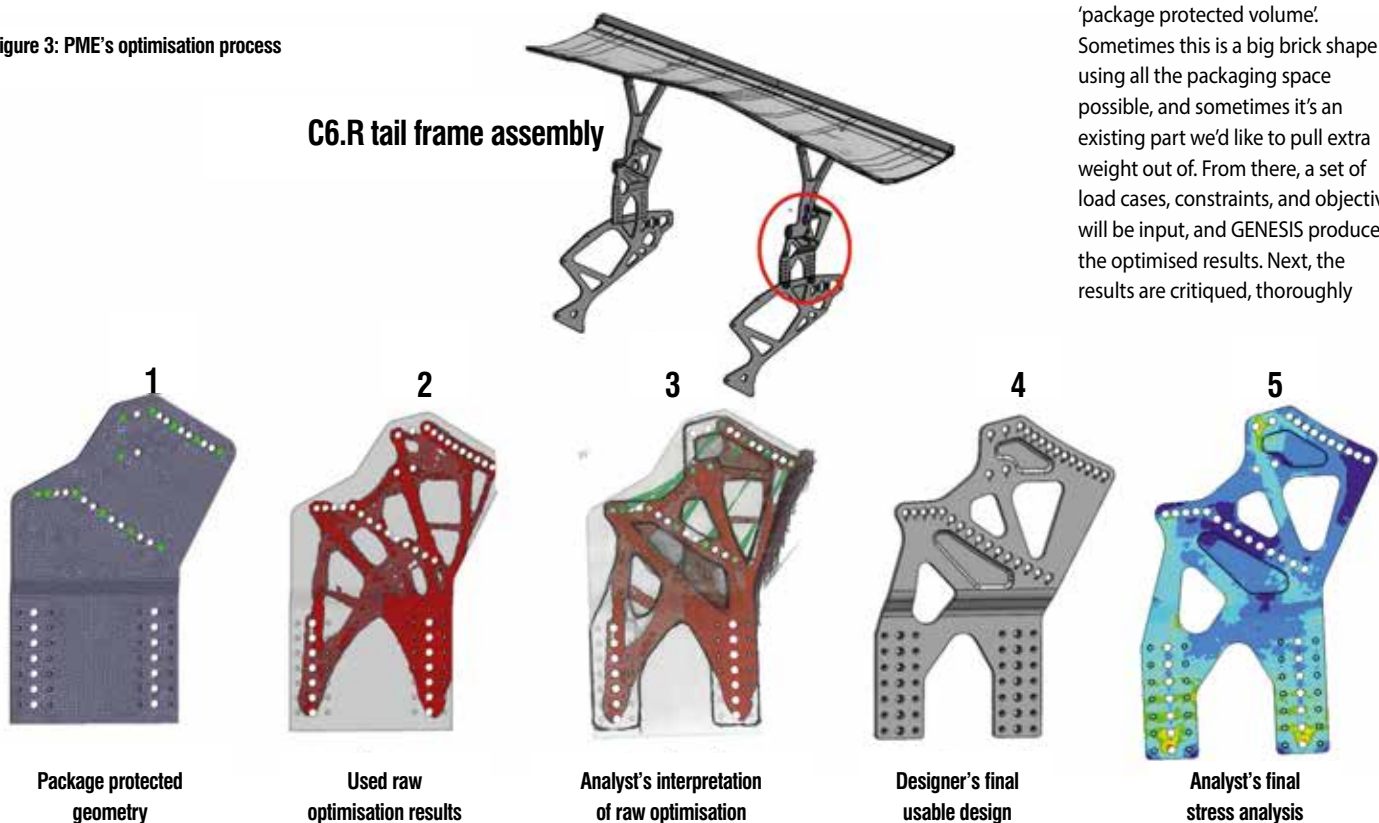

understood, and interpreted by the analyst. We have found these optimisation and interpretation steps to be critical in successfully implementing GENESIS.

'From there, the analyst and designer (which is sometimes the same person) will review the interpretation of the results and produce a usable design. The final step is to run a finite element analysis (FEA) on the components, ensuring

that stresses and stiffnesses are acceptable. In most situations, the last two steps are cycled through a few times to minimise weight within our acceptable stress limits.'

Taking up Gambling's point about the importance of understanding the process, Browning continues: 'everything down the line is based on the raw optimised results and these results are incredibly dependent on the many variables.

The first variable to address is the load cases. One might imagine that anyone implementing structural optimisation would already have a handle on the load cases because they've been running structural FEA to check stresses on components. In our experience, a model being optimised from scratch tends to be more susceptible to overly focused load cases than a design that took its shape because the designer thought it looked like it would do the job.

'Understanding these sensitivities and susceptibilities when using optimisation as an idea generator is critical to avoiding oversights that can lead to undesired behaviours or even component failure. Too heavy a reliance on the results without comprehending why they occurred can lead to problems.

'However, once these sensitivities are understood they can be utilised to gain knowledge and insight into a component and how it functions structurally. We regularly use a series of overly focused load cases to see how the optimised shape changes for each case and to gain an insight into how a different shape can influence our targeted responses.

'We would not use these responses as a design; they are just used as a metric for evaluation. Good results are dependent on a well-rounded set of load cases.

'In practice, components are exposed to an infinite number of loads. A finite set of load cases that sufficiently captures the possible loads is therefore required.'

In general, PME has found that understanding these responses is also important when weighting the relative importance of load cases. For example, when looking at the chassis of a racecar the usual objective is to improve its torsional rigidity, while yield stress is just a constraint that needs to be met. 'Yet torsional load cases are of the order of 20 times less than the maximum stress load cases. This mismatch of load cases creates an optimisation run that always biases the design towards the maximum stress load cases, even though optimising for torsion may be the original intent. This method of gaining a comprehensive understanding instead of just producing a base shape to design from can help to catch these types of issues,' explains Browning.

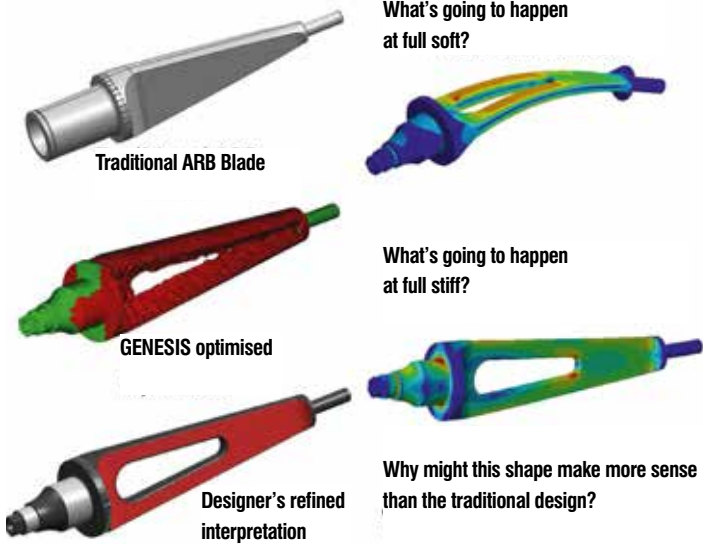
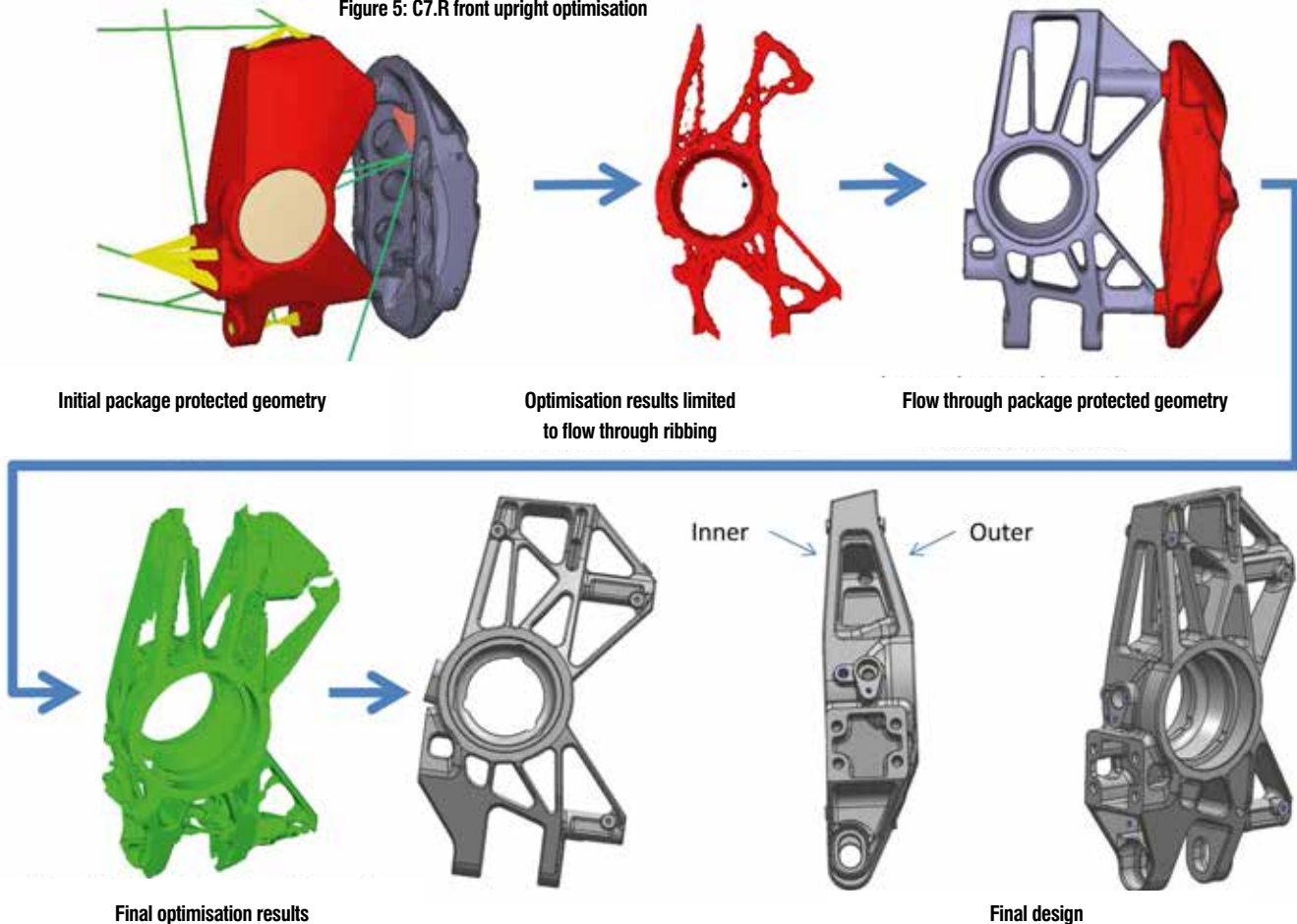

Figure 4: Answering key questions helped to understand responses, as in this ARB study

Figure 5: C7.R front upright optimisation





# CD34

THE BEST JUST GOT  
BIGGER



- > 8in widescreen LED backlit TFT
- > 9 tri-colour shift lights
- > 200Mbyte data-logging memory
- > Fully configurable layouts
- > Up to 100 display pages



[www.gems.co.uk](http://www.gems.co.uk)



# CUSTOM FUEL SYSTEMS



*INTERNAL COLLECTORS AND SURGE  
TANKS, FUEL PUMPS, FILTERS,  
FOAM BAFFLING & MUCH MORE!*

SOLE SUPPLIER

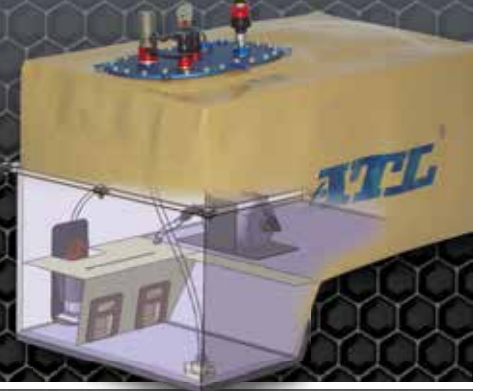

# REFUELLING EQUIPMENT



**STANDARD  
SAVER CELLS**

**ATLL LTD.COM**

**+44 (0)1908 351700  
sales@atlltd.com**

Some specific component studies further illustrate the importance of understanding why certain results and responses occur. PME looked at an anti-roll bar (ARB) blade to ask and answer some key questions, and

**Figure 4** shows the process involved. Browning says: 'As we asked the questions we came to the following conclusions: at full stiff, the centre of the blade does not have much load going through it because it's on the

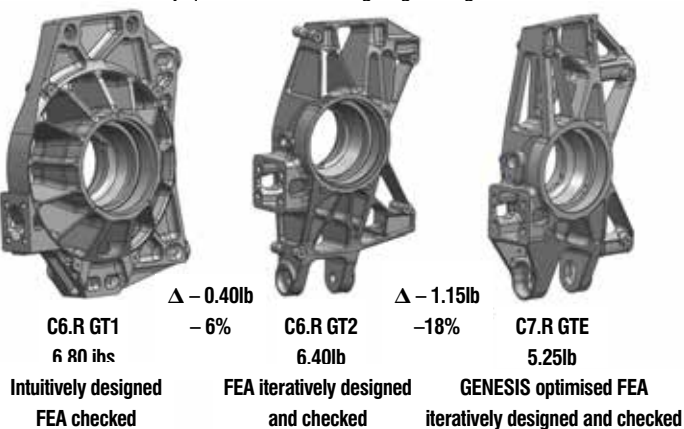

Figure 6: Front upright evolution

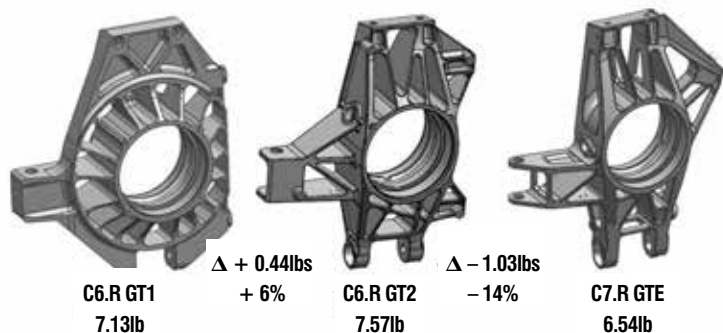

Figure 7: Rear upright evolution

neutral axis; at full soft, the centre of the blade does affect the stiffness, but that will only result in a larger range of adjustability; this design should allow for a higher maximum stiffness and lower minimum stiffness at a lower weight for the same packaging area. So, if we can keep the blade and bar combination stresses within our acceptable limits at maximum deflection, then this design could produce some advantages.'

The C7.R incorporated many such approaches, and overall knowledge was gained by regularly using GENESIS and endeavouring always to fully understand the results.

## Upright advantage

Taking a closer look at a key component, the suspension uprights, is also very instructive. Clearly the

uprights are critical, high-value components, being fundamentally the structural connections between the wheels and the suspension, and as such they have to deal with all kinds of loadings. They also make up a large proportion of the car's 'controllable' unsprung mass and are an obvious candidate for optimisation.

PME studied the front and rear uprights using essentially the same process described earlier, but with what GRM Consulting's Martin Gambling described as a 'clever modified approach to work around something of a shortcoming in the software' to address a specific requirement. Browning continues the tale: 'To some degree, the process followed our general optimisation design process, except that the first optimisation cycle produced the



Figure 8: Gains on the C7.R

## GRM Consulting and structural optimisation projects

**G**RM Consulting, the UK-based engineering design consultancy that, as a part of its business, is the UK and European distributor of VR&D's GENESIS, is constantly involved in interesting racecar projects and is a software supplier to most of the F1 grid. We saw in December 2012's issue (V22N12) a rather special case study on composite lay-up optimisation that used OptiAssist, a software package that extends the capabilities

of GENESIS specifically to aid the optimisation of composite laminates. In that case the application was a hypothetical study of how optimisation software could be used to help make an F1 car's front wing predictably flexible, a hot topic at the time and since – see **Figure 9**.

Less controversially, the Caterham F1 team (among others) was using the same set of tools to optimise its chassis ahead of the 2014 season. Through careful management of

laminates and properties (ply numbers and orientations) and in spite of much of the laminate and structure effectively being defined by specified lay-ups and impact structures in key areas, as well as almost constantly increasing load test standards, they were able to make an approximate 10per cent weight saving on each of their racecar's chassis – see **Figure 10**.

Currently GRM is involved in an automotive project that will surely

have motorsport applications in the future – optimising driveline components that incorporate complex, hybrid housing structures. The company has developed some new software techniques that can handle more types of load inputs than was previously possible and so tackle stress targets as well as vibration and stiffness targets. The company is justifiably excited about the possibilities of applying this technology in motorsport.

Figure 9: Front wing flex, courtesy of OptiAssist and GENESIS

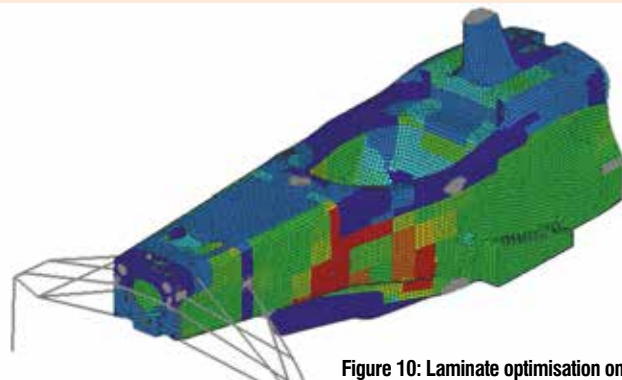

Figure 10: Laminate optimisation on a chassis model (Caterham F1)



World Leading Performance



### Valve Train Upgrades

- » VAC High Performance Valves & Springs
- » Essential for High HP cars
- » For BMW N54, S65, S54 and more



### Harmonic Dampers

- » VAC Exclusive for BMW M50, S54 and MORE!
- » Unbridles Horsepower and unleashes torque
- » Reduces engine wear from reduced vibration



### Billet Dry Sump Kits

- » Increases HP and Reliability
- » 4-cyl, 6 cyl, V8 & V10 applications
- » Full Kits with Pumps also available



### Clutch & Flywheel Kits

- » Rally, Race, & Carbon Clutches
- » Lightweight Flywheel included!
- » Twin & Triple Disc Clutches in 5.5" & 7.25"



SCHRICK



SAMSONAS



+1.215.462.4666

www.vacmotorsports.com

2501 Snyder Ave, Philadelphia, PA 19145, USA

sales@vacmotorsports.com



SS TUBE TECHNOLOGY  
ENGINEERED BY DESIGN

Design and manufacture of high performance exhaust systems and thermal management solutions.



SS Tube Technology Ltd  
Oxfordshire T: +44 (0) 1865 731018  
E: info@sstubetechnology.com  
www.sstubetechnology.com

SUPPLIERS TO F1, INDYCAR, TOURING AND SPORTSCAR,  
RALLY AND PERFORMANCE AUTOMOTIVE SECTORS



Proud Winners of The MIA Export Achievement Business Excellence Award 2014

## Structural optimisation with GENESIS

**W**e asked GRM Consulting's managing director Martin Gambling to explain how structural optimisation works. 'The typical CAE process is for a designer to develop a design and then the performance is assessed using CAE techniques. In terms of structural loading, the Finite Element Analysis (FEA) technique is often used. Using the FEA process, a design is assessed under one or more loading requirements and its performance is quantified. If the design does not meet the required performance the FEA analyst or the designer will revise the design iteratively until the performance is achieved.

'An optimisation code such as GENESIS, rather than being simply an analysis (FEA) code, is an optimisation code that can automatically change a design, iterating specific parameters in order to achieve specific performance

requirements. Several different optimisation methods are available, which are defined by the changes to the design that are being made.

'One of the key strengths of GENESIS is its ability to consider more than one loading requirement. A good engineer can arguably develop the best design for one requirement, possibly even two.

The GENESIS optimiser can consider many requirements and develop the best overall design to meet all of them in the most efficient way. These may be stiffness, strength, vibration, buckling, heat transfer and more.

'GENESIS provides a complete suite of optimisation capabilities. Each method is available for all analysis methods within Genesis and can efficiently consider combinations of multiple loading requirements. The methods are shown in **Figure 11**:

- **Topology optimisation**, which optimises by using only the required parts of the available design space.
- **Sizing**, which changes the thickness of panels (pressed steel panels, etc).
- **Topography**, which changes swage patterns.
- **Shape**, which unsurprisingly changes part shape.
- **Topometry**, which changes the thickness of material (in castings and mouldings, etc).
- **Composites**, where changes are made to ply shapes, their angles and the number of plies.

Topology optimisation is the process of determining the optimal material layout within a given design envelope. The example in **Figure 12** shows how only the material required to support vertical loading on the hook is retained.

design space for the second,' as seen in **Figure 5**. The reason for using this modified process is that we required an upright that allowed air to flow from the inner side of the upright to the outer side in order to cool the brakes. If an unrestricted optimisation were to be run, the inner and outer faces would be solid, blocking any flow through. We overcame this with a fabrication constraint, which through our normal process got us to a result that was then used as the package protected area for the final optimisation run. From there the design process continued as described earlier. **Figures 6 and 7** show not only the C7.R uprights and their weights, but also the C6.R GT1 and GT2 uprights for an idea of the changes and gains/losses made at each incremental design step.

### Value added

Grant Browning sums up PME's take on the use of structural optimisation software: 'GENESIS has been an invaluable tool that has yielded substantial growth in structural development. A breakdown of some weight and stiffness gains throughout the C7.R racecar illustrates this point – see **Figure 8**. When we began using GENESIS, our initial expectations were that it would provide a quicker way to get to our final designs by cutting down on the iterative process between FEA analysis and design revisions, and improve those final designs.

'Once we recognised the further potential of GENESIS as a tool, we expanded our uses far beyond our initial intentions into not only an idea generator but also a means of producing an increased level of understanding in load cases, structural responses and efficient structural patterns.

'When weighing the benefits and costs after exploring these additional facets we willingly abandoned the possibility of simplifying or streamlining the design process and instead pushed for more considerable gains in weight, stiffness and understanding that could yield advantages on the track, in exchange for the practical investment in further time and complexity!'

*Racecar Engineering's thanks go to Grant Browning at PME, and to Martin Gambling and Oliver Tomlin at GRM Consulting.*

### FIGURE 11: GENESIS optimisation capabilities

- Genesis provides the most complete suite of optimisation capabilities
- Each method is available for all analysis methods within Genesis and can efficiently consider combination of multiple loading requirements

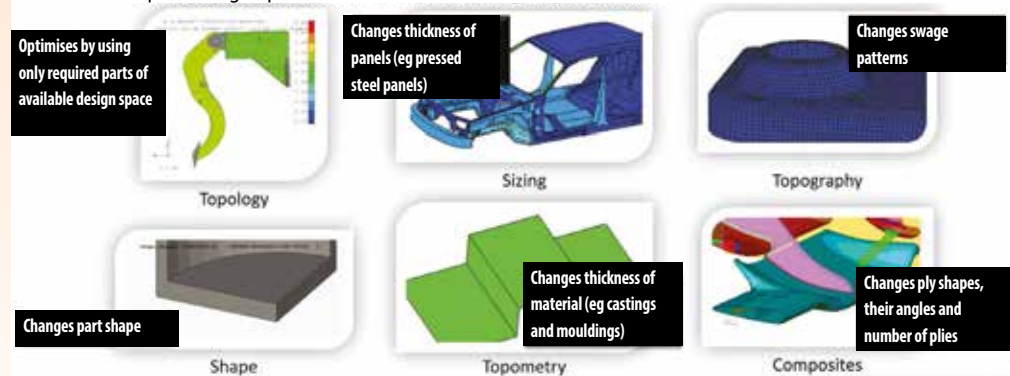

### Figure 12: Topology optimisation

- Topology optimisation is the process of determining the optimal material layout within a given design
- Example below show how only required material is kept to support vertical loading in the hook

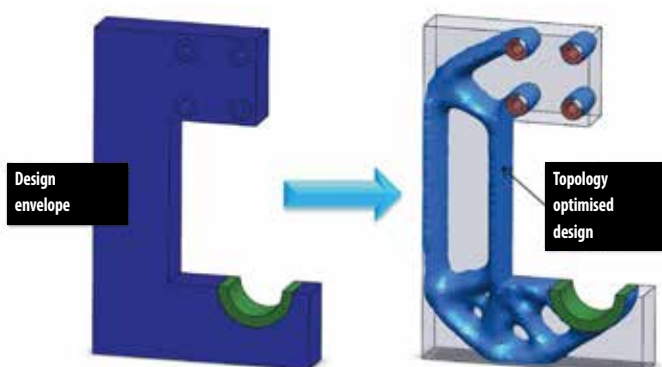

Intelligent control and distribution of battery power in a modern racing car.

# POWERBOX

## CONTROLLING POWER



Software included  
Free upgrade

### Main Features:

- Maximum 200 Ampere continuous.
- Inrush current per Channel 90A.
- 34 individually programmable output channels.
- Operated by 11 conventional, 32 CAN channels and by 20 virtual channels.
- Weight 680 gr.



CAN Membrane panel  
We Customize your design



Analog to CAN converter  
6 x Analog inputs to CAN.  
Board size 24x24mm.  
OEM board for your application.



8 x Tyre temperature  
to CAN in one small  
unit. Measure 8 points on  
your Tyre - Transmit CAN to  
Logger / Dashboard

OUR IDEA, DESIGN AND PRODUCTION - INTERESTED! SEE MORE ON [WWW.HPELEC.DK](http://WWW.HPELEC.DK)



HP ELECTRONIK

Virkelyst 10 · Gjellerup  
7400 Herning · Denmark

Tel. + 45 9626 4333  
Fax + 45 9626 4233

info@hpelec.dk  
www.hpelec.dk



## Design Smarter.



Embedded Software Tools Enabling Topology Optimisation in your Design Process

GTAM - Ansys Topology  
TruForm - Abaqus Topology

Truform SW - SolidWorks Topology  
GENESIS - Complete Structural  
Optimisation Toolset

Tel: +44(0)1926 889300 - info@grm-consulting.co.uk - @GRMConsulting - www.grm-consulting.co.uk

# -35mm Worlds apart

Our technology centre is the most advanced in Europe.

That is how we can achieve a negative radius of up to -35mm. Extreme engineering and precision that other performance cam manufacturers in Europe cannot match. All our camshafts and ancillaries have been developed by the best to be the best.



**HIGH PERFORMANCE  
ENGINEERING**

[www.kentcams.com](http://www.kentcams.com)

**Nº1**

*Kent Cams – the best in Europe:*

- No.1 for product development expertise
- The greatest performance increase of any single modification
- The widest range of camshaft ancillaries produced on site

● *The most advanced technology:*

- Negative radius to -35mm
- CBN wheels with constant surface speed
- Multi-angle lobes with CNC dressing
- Marposs 3D C and Z axis position probe
- Microphonic wheel dressing
- Lotus Concept Valve Train software

Cams + Pulleys, Belts & Chains :: Valves & Valve Springs :: Performance Cam Kits & Valve Spring Kits :: Followers & Tappets



**Call us first...**

*Trident*  
Racing Supplies



Unit 31 Silverstone Circuit Towcester Northants NN12 8TN  
T: 01327 857822 F: 01327 858096 [www.tridentracing.co.uk](http://www.tridentracing.co.uk)

# It all makes sense

**How data acquisition is allowing engineers to extract even more speed in their never-ending quest for faster lap times**

By **GEMMA HATTON**

**T**here are many secrets to going faster. Get a quick driver. Get better tyres, a better engine, a faster car.

The true secret, however, is to analyse as much data as possible – data shows the performance of the car, the behaviour of components and the errors of the driver. This is why F1 cars have more than 200 sensors, monitor 1000 channels and measure 15,000 parameters. However, it is not just the high end motorsport teams that benefit from this technology; data acquisition is so vital that it is found in nearly every level of motorsport. For example, GT cars monitor around 50 channels with 25 sensors, and even club level uses approximately 12 sensors. In fact, even in restricted championships such as Formula E, they are allowed to measure up to 200 channels.

A data acquisition system starts with the sensors that measure variables and output electrical signals, which are then transferred through connectors along cables. This generates a large network of cables throughout a racecar, known as the loom, which is powered by the Power Distribution Module (PDM). A data logger then converts all these electrical signals into readable information for the engineers to analyse and interpret.

Last year saw some of the most sophisticated data acquisition systems to date installed in cars due largely to the F1 teams trying to cope with the huge demands of the regulation changes, with heat management being a particular issue. In fact, F1 teams even had to integrate extra air cooling for the sensors, loom and connectors just to allow them to survive in such hostile conditions. 'One team changed their cooling requirements about 30 times last year,' explains Paul Webb, autosport sales and marketing manager for TE Connectivity, Deutsch. 'Sensors

and connectors can usually cope with running up to temperatures of 175degC, but teams have been running way above this. And then with the introduction of the hybrid powertrain, electromagnetic interference became a new issue for teams to deal with. Fortunately we've been developing fibre optics for a long time so we can solve these problems by using a fibre ferrule that goes into an autosport connector in high electromagnetic areas. This is something that both F1 and LMP1 teams are utilising.'

With strict testing restrictions still in place, race teams need to acquire as much data as possible every time the car rolls out of the pits. They also need a guarantee that the data is reliable – as many an engineer will testify, no data is better than wrong data.

## Sensors

Sensors have seen radical development over recent years with one unit now achieving multiple sensing applications. This has resulted in massive weight savings, which helps teams to achieve lighter looms.

This trend for smaller and lighter components, along with the thermal issues of the current F1 powertrains, has led to teams demanding miniature sensors that can withstand high temperatures, such as the ASU micro pressure transducer – see **Figure 1** – produced by KA Sensors. The stainless steel

construction uses a thin film to convert pressure into an electrical signal which is then processed with an on-board amplifier that outputs between 0.5–4.5V. Ten standard pressure ranges can be measured between 0–2 bar and 0–220 bar and the sensor can survive temperatures from –55 to 150degC. 'F1 teams want to increase the temperature range of all their pressure sensors up to 200degC and beyond, which is really pushing the boundaries of the



**Figure 1: KA Sensors high temperature pressure sensor can operate effectively between -55degC and 150degC. The current demand for F1 is to increase this to above 200degC and although modern sensing technologies can cope, the electronics cannot**



The wiring loom acts like the 'nervous system' of the racecar and transports the data back to the electronic 'brain' of the ECU

**Even in restricted championships teams are allowed to measure up to 200 channels**



A connector showing the power, signal and ground wires

technology,' says Peter Trevor, technical director of KA Sensors. 'From the bare sensing elements we can take the technology above 200degC, but it's the electronics that are slowing us down.'

Last year also saw four motorsport classes adopt fuel flow limits; GT500 and Super Formula in Japan implemented a fuel flow restrictor to ensure that efficiency was the primary performance objective, while F1 and LMP1 utilised an ultrasonic fuel flow meter to monitor the flow rather than restrict it. This led to the development of the Gill Sensors fuel flow meter for F1 and WEC, which essentially is a tube with an ultrasonic transducer at each end. An ultrasound wave is transmitted from one end, received by the other end and effectively transmitted back. The time taken for the wave to travel along this tube is measured, and the volume flow rate can then be calculated using the diameter of the tube, and by incorporating temperature compensation and the fluid properties the mass flow rate can be calculated to within +/-0.25 per cent per regulation.

Unfortunately, there were reliability issues with the original device which led to the Red Bull F1 team using their own mathematical solution instead. It was this that consequently resulted in second place finisher Daniel Ricciardo being disqualified from last year's Australian Grand Prix. Although the sensor went through radical development to prove it was worthy of the F1 grid, there is now an alternative solution produced by Sentronics.

'Its core technology is still the same, but it's the way we make the ultrasonic measurement which is very different to what is currently being used in F1,' explains Neville Meech, director of Sentronics. 'We have an all-metallic construction, there are no composite parts inside the sensor



The HP8440 Powerbox from HCl Systems replaces traditional fuses and relays by controlling all the power

and we have integrated electronics. Like all of our technologies, it is solid state so there are no moving parts, which means there is less potential for things to go wrong.'

This is essential, particularly for fuel flow metering, as other designs that use impellers or other components could break and thus end up in the engine, resulting in serious damage.

Another revolutionary technology that Sentronics' sister company, Reventec, has developed is the award winning linear position range of sensors. 'It is similar to a hall effect sensor as it uses magneto resistive technology,' explains Meech. 'There is a chip on the electronics that measures the magnetic flux field direction of a magnet. That chip remains fixed and as the magnet moves in front of it, the chip measures the angles of the flux field and then outputs a voltage, thus measuring the location of the magnet.'

The brilliance of this particular design lies in the fact that because the magnetic field flux angle is measured instead of the magnetic strength, unlike Hall Effect sensors it can measure through all non-ferrous materials up to 50mm with no difference in output. This is appealing to engineers that need a robust technology. It is completely unique; there is no other sensing technology that can do that.'

The high 5kHz (5000 times per second)

response rate makes it ideal for all suspension applications in motorsport. One example is an Indycar suspension rocker, where Reventec replaced the original plane bearing cap washer with a customised one which included a built-in sensor, and bolted the magnet to the existing rocker. This enabled the angular change of the magnet moving round the front face to be measured. Traditionally, a linear potentiometer would be used for such an application, which is where a wiper slides along a resistive strip that changes the resistance and thus the voltage output. However, the moving slider means wear is a major issue and can even result in no signal at all, but this is avoided with Reventec's rocker.

The benefit of this position sensor being able to reliably measure over large gaps also means that it is suitable for use in hydraulic cylinders where the chip cannot be positioned close enough to the magnet. 'Engineers now have a lot more freedom and it's much easier to package without having to modify the mechanical position,' says Meech. 'This is a very powerful technology which has infinite applications in motorsport and other industries.'

To advance this technology even further, the sensor has been designed to be modular and so multiple 'heads' can be integrated into the sensor to increase its measuring range. 'We are developing a variant that includes eight of these heads which we are hoping to release later this year,' reveals Meech. 'This will enable us to make long stroke sensors for shock absorbers and this market could open up – we could start to develop intelligent suspension systems that can

## The trend for smaller and lighter components has led to teams demanding more miniature sensors

**MOCAL**  
OIL COOLERS

- **THE MOST POPULAR COMPONENT IN MOTORSPORT**
- **COMPREHENSIVE RANGE OF COOLING ACCESSORIES**
- **BRITISH DESIGN & MANUFACTURE**

**FOR THE BEST IN OIL COOLING SYSTEMS...**

**...MAKE IT MOCAL!**



**WINNING RACES  
SINCE 1967**

**Worldwide enquiries  
go to:**

**[www.mocal.co.uk](http://www.mocal.co.uk)**

**USA enquiries go to:**

**[www.mocal.us](http://www.mocal.us)**

**0208 232 3525**



Like Us

**CRANFIELD  
MOTORSPORT SIMULATION**

**Innovation in simulation**

- Unique sustained G-Cueing
- Fully immersive
- Packaged and scalable solutions
- Derived from aerospace technologies
- High accuracy, low latency feedback



[www.cranfieldmotorsportsimulation.com](http://www.cranfieldmotorsportsimulation.com)

8736971387215873573257  
010111010101010

# In addition to obtaining reliable data, teams not only want to record high quality data, they also want to measure challenging variables

react to position as well as pressure.'

Another potential development is reducing the size of the ultrasonic sensor, making it more suitable for other industries. 'Everyone is interested in how much fuel they are using, so our ultrasonic sensor has huge potential to be smaller. We have chosen motorsport as our platform for exploiting technology, but all our sensors have much wider applications.'

## Every connection counts

With every sensor comes a connector, and the early 1990s saw the first range of connectors

developed specifically for motorsport. Those connectors came in the form of the 'Autosport Connector' produced by Deutsch Connectors, now TE Connectivity. 'We started off copying the military specification MIL-C-38999 unit (see **Figure 2**) as previously used on the Eurofighter, mainly for two reasons,' explains Webb. 'Firstly, teams understood that because it was military spec they could trust it, and secondly, we were making it anyway, so it wasn't a big stretch for us. It has actually gone full circle; the connector started off in the military, but the faster development demands of motorsport has led

to a much smaller and lighter design and now, because the military know that they are tested every other weekend on an F1 car, they've adopted the technology for other applications and it's now saving lives on the battlefield.'

As with most things in motorsport, connectors are always striving to be smaller and lighter. But the teams themselves are demanding a higher number of contacts to achieve either two sensors per connector or dual redundancy. For example, one of the smallest motorsport connectors, the AS Xtralite (measuring a tiny 7mm in diameter, shell size 2) was originally five-way which meant that teams were running two sensors with a shared ground (where each sensor is composed of three wires: power, signal, ground). By adding another contact, resulting in the AS Xtralite six-way series, teams can now have two sensors performing completely different tasks as each sensor has space for its individual power, signal and ground connection. Alternatively, the six-way also allows full redundancy, which is the main reason behind its success.

'The AS Xtralite six-way came about as a logical extension of the five-way, but the take-up has been phenomenal,' explains Webb. 'Simply because now, teams can achieve dual redundancy in the car within the same size connector due to the improved packaging.' With such high restrictions on testing in place, the importance of obtaining reliable data has led teams to make pure redundancy a major priority within their data acquisition systems.

In addition to obtaining reliable data, teams not only want to record high quality data, they also want to measure challenging variables, such as suspension travel, which requires high frequency measurements at around 20kHz (20,000 times a second).

'At these rates even the smallest break or disruption that is recorded is a big deal, but generally the problem is not found in the sensor, it is usually something to do with the loom design or installation,' explains Webb. 'People assume that connectors are indestructible but the connector by definition is a break point in the circuit, and therefore the installation of that is key to the performance of the sensor at the end. What worked particularly well on an engine one year, won't necessarily work on another. It is very much a trial and error process.'

Although all of TE Connectivity's connectors go through the same rigorous testing programme as the military specification 38999, Webb hints that it is still nowhere near some motorsport environments, such as the gearbox.

The main killer of electronic components is vibration, because every component has its own internal harmonic, or natural frequency. When

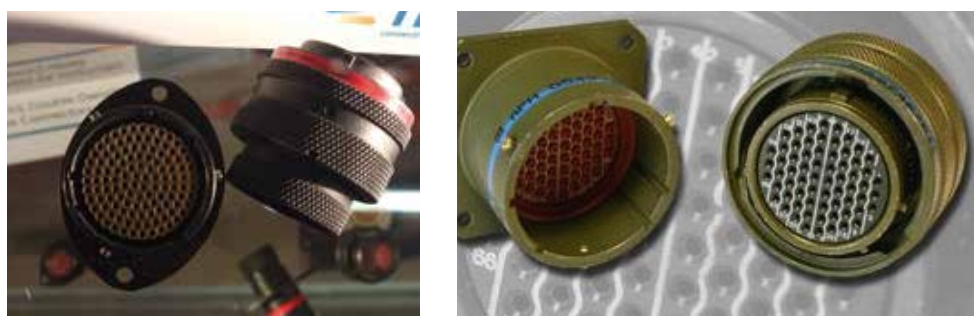

Figure 2: Many modern motor sport connectors are evolutions of a military connector used in the Eurofighter (right)



Figure 3: Black fretting marks on this contact are one of the earliest indicators of vibration damage



Figure 4: Vibration and the stress of high loaded cables have worn away this connector's zinc plating

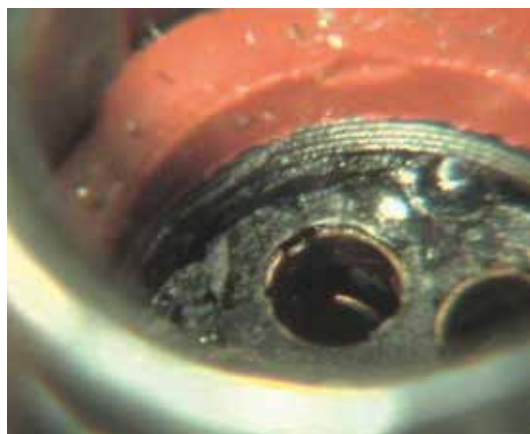

Figure 5: By removing the plug at a large angle, the insert has broken apart



Figure 6: One of the locking times is missing, which reduces the strength of the retention by 25% and any further damage could result in the contact to be pushed right back into the connector

the component the connector is attached, it vibrates, and when this vibration matches the natural frequency of the connector itself, resonance occurs. This results in a huge increase in amplitude at particular frequencies and essentially destroys the internals of the connector. This is commonly seen on thin carbon fibre plates and in high revving engines because both transmit energy extremely well.

'Vibration is a big issue that doesn't go away and every time the regulations are changed, different areas of the car suffer,' explains Webb. 'You can't dissipate the energy, but you can alter the way the energy attacks the electronics by either moving the component or changing the angle. The answer is always to just change something because it is the mass of what is being attacked that effects the amplitude and therefore the overall damage.' For example, a few years ago on an F1 engine, some Deutsch micro connectors in a small carbon fibre box that was screwed to the airbox were being destroyed. The problem was down to vibration and by simply putting a little rubber 'button' underneath the carbon fibre box, the focus of the vibration was moved which solved the issue.

The effects of vibration can cause many types of damage. **Figure 3** shows one of the early indications of vibration damage on a Deutsch connector, in the form of black fretting on the contact. The gold has been worn away and replaced with black marks, which leads to an increase in resistance, which increases the potential heat and creates a vicious circle.

Another sign of vibration is the wearing of zinc plating such as that found on the micro connector in **Figure 4**. Here, the mating plug has been subject to stress either from vibration or due to a too high load on the cable which is pulling the plug.

It is not just vibration that causes damage. User error, such as that seen in **Figure 5**, shows



**DC Electronics is a market leader in electronics and provides equipment to motorsport applications from NASCAR to the Bloodhound programme**

a micro with an insert that has broken out. This happens if the plug is removed at an angle, so it acts as a pivot and breaks the insert apart. Debris can also cause issues as shown in **Figure 6** where one of the locking tines that hold the contacts in place is missing. By losing this tine, the strength of the contact retention is reduced by 25 per cent and although it may survive, any vibration could cause the contact to push back into the connector.

To help mitigate the potential for user damage, TE developed a revolutionary design several years ago called System 30. Usually, when wiring up connectors, cables have to be crimped to a contact and then inserted into the holes at the back of the connector. Crimping essentially pressure forms a metal barrel of a terminal or a contact onto the end of an electrical conductor such as a wire. It is vital to obtain a successful crimp to ensure that the mechanical strength of the joint is high, requiring a high pull-off force, but also to achieve an electrical resistance that is equal to or less than that of an equal section of wire. This resistance depends on how the wires are

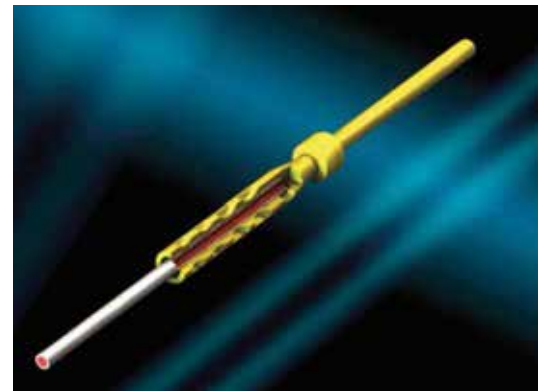

**Figure 7: System 30 offered an effective solution to manually crimp contacts onto wires. However, due to high costs and the lack of flexibility this system never took off in motorsport**

compressed as an over-compressed crimp will force the wires unevenly, which creates fractures in the contact bucket and results in high resistance and a poor connection. Once crimped, these contacts are inserted using special tools and an iso propyl alcohol (IPA) lubricant until the shoulder of the contact passes through the tines and locks into position.

This process is not only time consuming but there is potential for human errors to cause damage. 'System 30 used a different cable, so that the wire insulation didn't have to be stripped,' explained Webb. 'Instead, you just dropped the contact on and there was a double crimp, one at the front for the conductivity and one at the back to grab onto the insulation for strength. It was a real clever piece of design and we thought it was fantastic.' This never took off due to the high expense of the wires and the fact that it couldn't be spliced.

One development in connector technology was IS Motorsport's Mantis Quick Lok Micro Magnetic connector. This design uses two small circular magnets located either side of the pin arrangement, so rather than having to unclip

## The challenge is to have magnets that are strong enough to remain connected under load, but weak enough to disconnect when required

### Fibre optics

**F**ibre was first used in motorsport in the early 1990's as glass fibre for looms. However, due to its mechanical properties it was highly brittle and therefore not much use in racecars. Now plastic or optical fibres are used and are an effective alternative to copper for transmitting data while remaining robust. 'They are so flexible you can almost tie them in a knot, so you can route it round corners of a racecar that the glass fibres never could,' highlights Paul Webb. The major benefit of fibre optics is their resilience

to electromagnetic interference, which proved to be critical with the new ERS systems in F1. 'Teams were seeing false signals in the loom generated by the electromagnetic interference and needed to do something about it. With fibre optics, you can put as much electromagnetic interference in the area as you want and there are no problems. It ran last year in F1 and worked and it is yet another thing that teams have had to come to terms with.'

There is a compromise however, as an electro-optical converter is

required at either end to convert the signal from electrical to optical and back again. 'Currently we offer custom manufacture for fibre where we attach the ferrule to plastic optical fibre (POF) as teams require. This can be used in a standard AS size 16 cavity maybe with some copper contacts too, or in dedicated fibre connectors. We are thinking about actually introducing it into a connector because you can put so much data through fibre; you could have a single strand of fibre that goes between the two connectors, but it

makes the connectors bigger, more expensive and more complicated. People are not quite ready for that.' Fibre has had brief spells of popularity in motorsport, but keeping the ferrules clean is a challenge. Furthermore, glass fibres cause teams to worry about the fragility, vibration or mechanical damage but this is not a problem with the new POF. For very high data rates, flexibility and EMI protection, optical fibres provide an effective solution and a solution that we will continue to see in the top tiers of motorsport.



Figure 8: An example of an HCI formboard to help with assembling wiring harnesses

the connector, the magnets can be pulled apart. This has numerous advantages as the polarisation of the magnets makes it impossible to connect the wrong way round and allows quick connect and disconnect capabilities as well as blind mating. 'Take rally drivers for example, when they have a puncture they have to fix it themselves so they do not want to start pulling plugs and unclipping connectors,' explains Simon Swatridge, marketing manager for iS Motorsport. 'With our design the magnets will disconnect after a certain amount of force has been applied, so if the driver forgets to disconnect, it's not an issue. We took the initial concept to teams and after a while of trying to twist it, they found out that it was magnetic and all they had to do was pull it – they thought it was excellent.'

The challenge however, is to achieve the right balance between having magnets that are strong enough to remain connected under certain loads, but weak enough to disconnect when required. 'It is a fine line,' agrees Swatridge, 'but it's something we have been working on.' Another danger is the potential for interference caused by the magnets on cables. However initial testing has proved that this is not a concern. The most popular applications are likely to be in download leads and headsets and with the first iterations going on test during February we could see these components on track as soon as this season.

Other future developments for connectors include fibre optics and the continued trend of lightweighting. However, the physical constraints of a connector does mean that there is a restriction in just how small they

can go. 'We can make connectors smaller, but people's hands haven't got smaller, so you can only go down to a certain size. Also, it needs to withstand the physics of being screwed to a racing vehicle, so we have to have a certain amount of meat on these things for them to survive the distance of a grand prix or the Le Mans 24 hours,' highlights Webb.

'People always want something unique now, so expect more customisable solutions. Also different materials; there is a lot of discussion about graphene which is conductive, so there is a lot of stuff we are working on that has the potential to be revolutionary.'

## Looming performance

Looms or wiring harnesses can be regarded as the 'nervous system' of a racecar where the data obtained from sensors located throughout the car is transmitted back to the electronic 'brain' of the ECU, with the data logger tapping into this information and acting as the 'memory' section of the racecar's brain.

The process of generating a wiring loom is highly complex. Firstly, the number and type of sensors has to be decided upon along with other electronic components. From this, the required connectors can be defined and then the corresponding circuitry. Depending on whether the car power distribution system is fitted with a PDM or a fuse and relay system, the power circuits are then specified and CAD is used to determine the overall layout of the loom. 'We have to visualise how the harness will sit within the car and how large each 'leg' is which impacts its bend radius,' explains Mike Tickner, Director of HCI Systems. 'We also take

into account the expected heat signature of the car to ensure that the harness components used can survive in the hot areas using heat shielding. Furthermore, any wet areas require appropriate sealing of components and we also have to allow for clearance of moving parts such as pedals, steering column and suspension.'

A formboard is then generated (Figure 8) to help with assembly and then finally the harness is made. 'Depending on the size of vehicle the number of terminations can vary from 200 to 2000 and can take as long as 200 hours to make, test and inspect the harness.'

This process differs substantially depending on the type of car the harness is designed for. Low end Formula cars can run much smaller wires due to their lack of huge cooling fans and pumps, but at the top end, vibration levels are so extreme that standard connectors are no longer viable as the contacts begin to bounce resulting in noisy signals.

Another difference can be found in the electrical power distribution requirements for road derived racecars due to their large cooling fans which draw a huge initial current of 100A for a few milliseconds. HCI has implemented brushless fans where possible that are managed by a PWM feed from the ECU and reduced the initial current consumption to less than 25A which has decreased the weight of the loom hugely due to the use of smaller wire sizes.

'Replacing the fuse and relays with a power distribution management system is now becoming common place as this offers fantastic reliability with the added bonus of being able to manage the power from the battery in certain circumstances. For example, shutting down non-required systems while cranking etc along with programming in a 'limp home' mode should the car develop an issue and also having a retry function should the PDM see a power spike from a fan or pump. An old fuse system would have blown, potentially stopping the car, but a PDM can be programmed to retry the channel a number of times to see if the fault has gone away,' highlights Tickner.

As with most things in motorsport, there is a constant push for lightweight solutions and it is no different with looms. Recently released lightweight moulded parts have resulted in a 25 per cent weight saving but also means they are quicker to recover, helping harness building to become even more efficient.

'We have also designed some revolutionary formboard tables that can be held at various angles depending on what part of the harness building process is being progressed, which helps us to create formboards very quickly. Gone are the days of hitting nails into MDF sheets,' says Tickner.



**“We can make connectors smaller, but people’s hands haven’t got smaller, so you can only go down to a certain size”**

# Peterson

FLUID SYSTEMS

**OIL TANKS**

OPTIONAL HEATER BUNG

FULL INTERNAL BAFFLING

**MADE IN THE USA**

- AN aluminum fittings.
- Custom configurations available.
- No blowing oil.
- Better deaeration.
- Better lubrication.

1-800-926-7867 [petersonfluidsys.com](http://petersonfluidsys.com)

# KA sensors

Sense  
Measure  
Control

Pressure

Wheel Speed

Position

Laser Ride Height

Strain Gauging Service

Air/Fluid Temp.

Infra Red

Gear Shift Load Cell

Gear Lever Load Cell

UK +44 (0) 1476 568057    USA +1 (203) 792 8686

sales@kasensors.com    kasensors.com

**KAlibrated solutions for motorsport**

**UKAS accredited calibration and on-site technical support services to the motorsport industry.**

**Test Bed / Rig Calibration • Vehicle Instrument Calibration**

**FORMULA • SPORTS • TOURING • RALLY • PERFORMANCE**

*No-one measures up to our standards*

[www.youngcalibration.co.uk](http://www.youngcalibration.co.uk)

Unit 5, Cecil Pashley Way, Shoreham Airport, Shoreham by Sea, BN43 5FF +44 (0)1273 455572

# Asymmetric correlation techniques

When it comes to gathering useful data, the devil is in the detail

By DANNY NOWLAN



Asymmetric data gathering plays a crucial role in car setup on oval tracks

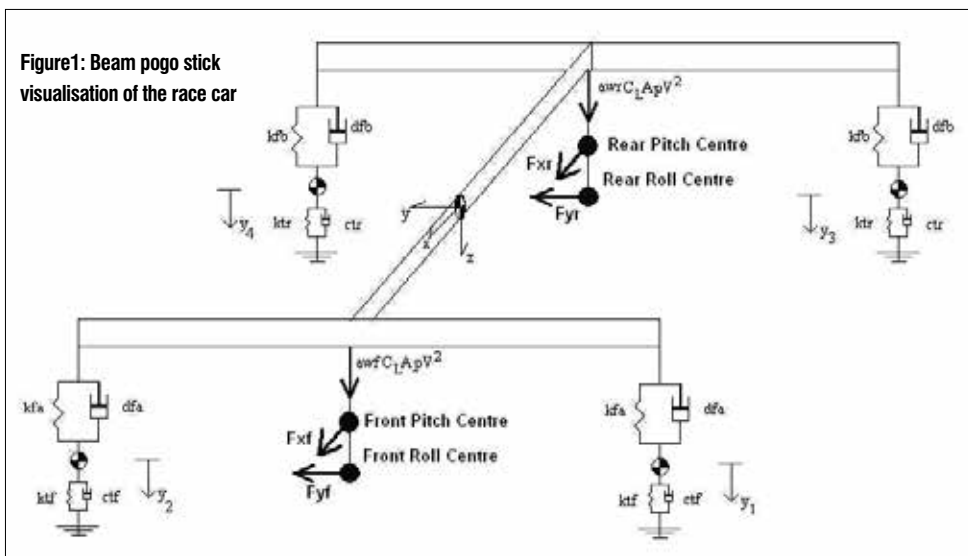

Figure 1: Beam pogo stick visualisation of the race car

Recently I have been doing a lot of asymmetric modelling work. In particular I have been working closely with NASCAR R&D. In the past when ChassisSim has been used on ovals I've simply turned over ChassisSim to the customer and left them to their own devices. This time though I've had to be more involved, which is actually a good thing because, in terms of correlating the model, there are some nuances of which you need to be aware.

Let me state from the beginning of this article that I will not be discussing data directly. Suffice to say I have had access to very sensitive information on which I have been sworn to secrecy. I don't take stuff like this lightly. That being said I realise that, particularly in North America, there is a large body of circle track

**On an asymmetric car the four springs have much more of a role to play. The big thing here is that the pitch and roll modes are now coupled**

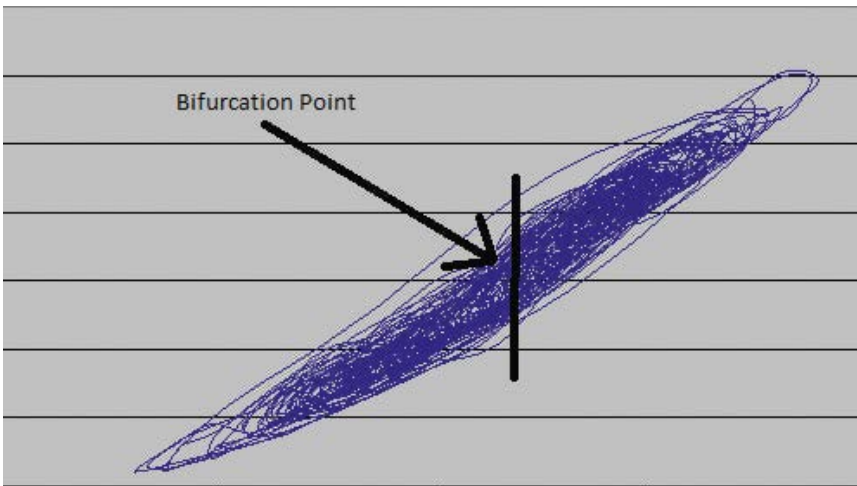

Figure 2a: Front left load vs damper displacement

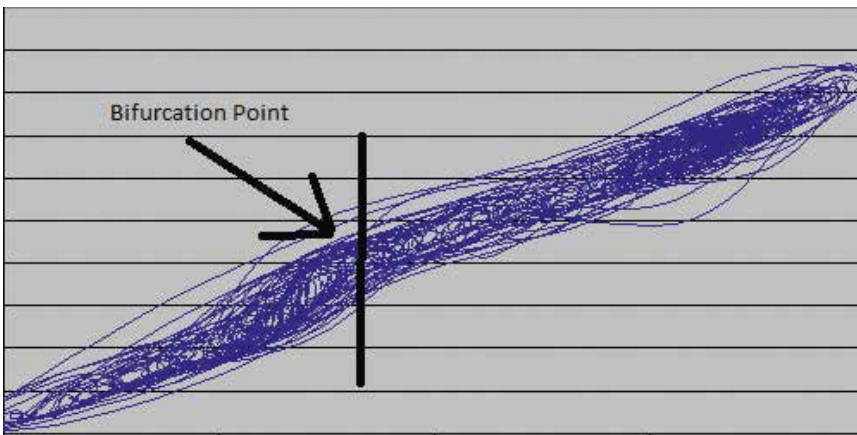

Figure 2b: Front right load vs damper displacement

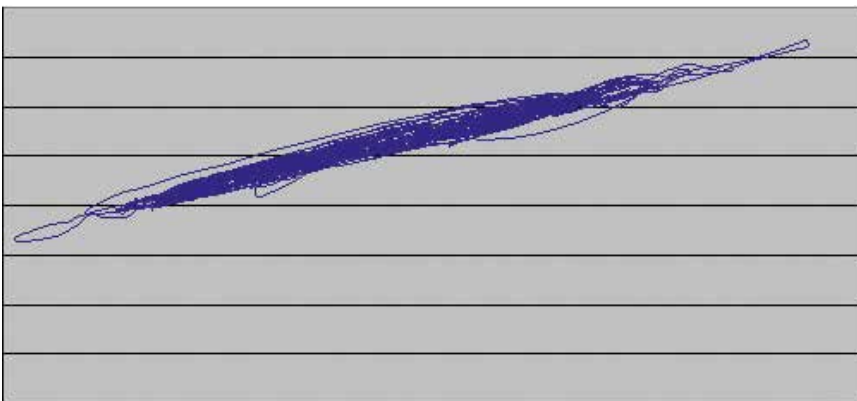

Figure 2c: Rear left load vs damper displacement

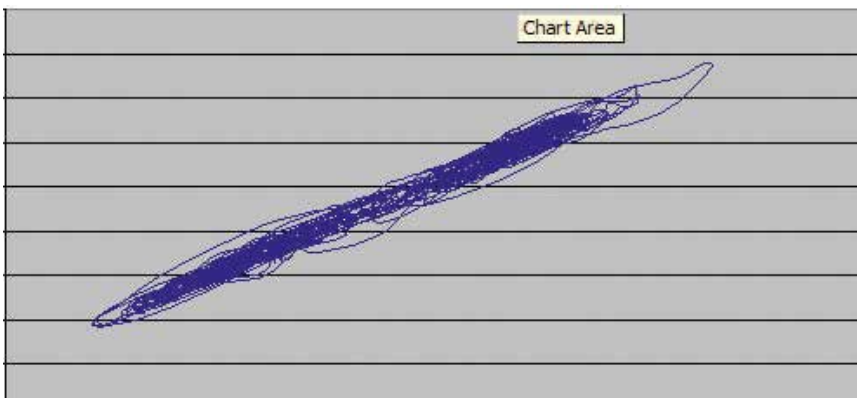

Figure 2d: Rear right load vs damper displacement

and oval racers who have expressed an interest in ChassisSim. Consequently, while I can't talk quantitatively, I can tell you what I did, and this is going to make your life a lot easier when you come to do this for yourself.

Also to keep things simple I'll assume linear motion ratios. While this isn't accurate, I'm using this as a teaching tool. If you understand how to do it for the linear case, the non-linear case becomes an extension of the former.

A review of the beam pogo stick model will tell you the key differences between a symmetric and an asymmetric car. This is presented in **Figure 1**.

## Spring rates

The thing to pay attention to is the four main springs. In a symmetric car, the front and the rear spring rates are the same. This makes life a lot easier because you have less to play with. On an asymmetric car, all of a sudden the four springs have much more of a role to play. The big thing here is that the pitch and roll modes are now coupled. For example, in a symmetric car, if the rear roll isn't matching up, you can typically double the bar rate and you can fix it easily. In an asymmetric case it's no longer just the bar. We now have different spring rates side to side that will make their presence felt. Not surprisingly it is easy to get lost in the analysis. The good news is that there are ways we can tackle this that will make your life a lot easier.

Our first port of call is to fit a good data system to the car and plot load vs damper displacement for all four corners. At first this might seem a little strange but this will tell you a wealth of information. The reason we are looking at this first is that it will tell us a lot about what the loads are doing, so we can then focus on other bits of the model. The load vs damper displacements are shown in **Figures 2a – 2d**.

The first things to look at are the two graphs of the rear springs. Looking at them they are both linear. This means that we don't have a rear roll bar. This makes correlating the rear really easy, but we have to quantify the different spring rates which tie in the pitch and roll correlation. In terms of calculating the spring rates this is what we are looking at in **Equation 1**.

Effectively the spring rate is the slope of **Figures 2a - 2d**. This is really important data. In



## EQUATIONS

### Equation 1

$$k_s = \frac{\Delta Load / MR}{\Delta damper}$$

Here we have

$k_s$  = Spring rate

$\delta Load$  = Change in Load

$\delta damper$  = Change in Damper movement

MR = Motion ration of the spring (damper/wheel)

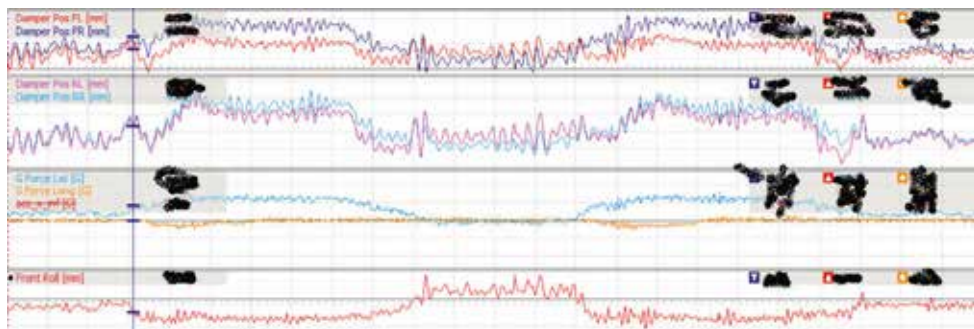

Figure 3: Looking at roll data

## EQUATIONS

### Equation 2

$$C_L A = \frac{Load_{FL} + Load_{FR} + Load_{RL} + Load_{RR}}{0.5 \cdot \rho \cdot V^2}$$

$$= \frac{9.8 \cdot (50 + 100 + 150 + 200)}{0.5 * 1.225 * (250/3.6)^2}$$

### Equation 3

$$L_{DAMP} = MR \cdot k \cdot m_d$$

$$= 0.6 \cdot 1000 \cdot 20$$

$$= 12000 N$$

$$= 1225.5 kgf$$

particular **Figure 2c** and **2d** give you the rear spring rates of the car. This is one less variable you need to worry about.

The reason the data looks like a blob as opposed to a line is the effect of bumps and damping. What you are looking for here is trends. Once you have the trends you can get cute with the details later. Don't do it the other way around as you'll drive yourself nuts.

## Bar rates

Where things get really interesting is the front. Looking at both **Figure 2a** and **2b** there is a distinct bifurcation point. Just a note on data analysis. If you ever see something like **Figure 2a** and **2b**, print it off and hold it up next to a light. If there are any non-linearities it will show up as plain as day. It's a rule of thumb taught to me by one of my physics professors. In both **Figure 2a** and **2b** there is a distinct bifurcation point where the gradient has changed slope.

Typically if you see something like this we have hit a roll bar. What we need to do now is to cross reference this with the data. The thing to pay attention to is quantifying the bifurcation point to when the roll kicks in. You are looking for a situation like the one in **Figure 3**.

You'll notice I have placed the cursor on the bifurcation point of the front left damper. Firstly you'll notice the bottom trace which is the front roll. Then you'll notice how the front roll has increased from zero at this point. If you see something similar to this you know the shape of **Figure 2a** is being influenced by the roll bar.

The good news is that if you have data like this then calculating the bar rate is easy. This should be your procedure:

- Calculate the main spring rate using the data to the left bifurcation point.
- Calculate the spring point post the bifurcation point.
- The bar rate is simply the difference between the two.

I prefer to calculate the bar rates from the most linear of the curves, which in this case is as shown in **Figure 2a**.

Now we have our spring rates the next step is to calculate the downforce, if there is any present on the vehicle. As per the symmetric car you are using exactly the same techniques to get yourself into the ballpark – that is; choose a point on the straight or low lateral acceleration and confirm with a hand calculation. Let me give you a quick example. Let's say we have our loads zeroed on the ground and we have this data set, as demonstrated in **Table 1**.

Calculating the  $C_L A$  we see **Equation 2**.

This is a bit of a Mickey mouse example but it illustrates the point.

Also, at this point in the game, let me offer some reflections about resolving load and damper channels. In my experience load cells are a bit like fish and chips, or romantic movies. They are either really good or really bad and there is no in-between. Consequently you must always sanity check them. The first port of call is **Figure 2a – 2d**. If it's not consistent then that is your first alarm bell. Fortunately in this case it was consistent, so that is the first pass mark.

Table 1

Parameter	Value
Load Front Left	50 kgf
Load Front Right	100 kgf
Load Rear Left	150 kgf
Load Rear Right	200 kgf
Speed	250 km/h

Table 2: Sanity checking numbers

Quantity	Value
Spring Rate	1000 N/mm
Damper Value	20mm
Load	700 kgf
Motion Ratio (damper/wheel)	0.6

The next step is to sanity check that the dampers and loads are telling you the same thing. To illustrate this let's consider an example, as illustrated in **Table 2**.

For the sake of this discussion, all motion ratios are linear and springs are linear. From the data, the load on the tyre from the damper data is shown in **Equation 3**.

As you can tell, there is a discrepancy here that needs to be addressed. In order to resolve this, tools such as wind tunnels, CFD and on track experience will be your best friends.

Now that we have spring rates and some idea of downforce we are now in a position to do correlation. Where things get a bit trickier than in the symmetric case is that separating the pitch and roll isn't as straightforward as it is with the symmetric case. So for correlation this will be our game plan;

- Correlate on the loaded side.
- Look at the unloaded side.
- Then check pitch and roll channels.

Working through this process the loaded side looks pretty good and this correlation is shown in **Figure 4**. For reference I have used the lap time simulation, but the reality is that the track replay simulation is just as good. Also the actual data is coloured and the simulated data is black. Looking at the right side the damper correlation is very good. Going down the straight there are some things we need to tidy up with the aeromap, but this is a good start.

Also let me state that particularly for the lap time simulation trace you are not looking for perfect correlation. At this stage you are looking for something that is in the ballpark so you can get basic validation done. Once you have reached this point, you can concentrate on getting an accurate model.

However, things need tidying up somewhat on the unloaded side. The correlation is as shown in **Figure 5**. Again coloured is actual, and black is simulated. Looking at the rears

**Load cells are a bit like romantic movies. They are either really good or really bad and there is no in-between. You must always sanity check them**

# JACOBS is a full service supplier to the Motorsport Community.



We provide engineering, construction, operations, and maintenance services for the motorsport community's most complex testing, research, and development facilities. To date, we have developed facilities for motorsport testing applications in Europe, Asia, and North America. Our wind tunnel experience spans the full spectrum of test section configurations: solid wall, open jet, slotted wall, and adaptive wall.

The latest release of our automated test measurement and control software, Test SLATE, offers a proven solution for integrating diverse hardware and subsystems, managing test configurations, and transforming test data into meaningful results.

We offer unique consulting services ranging from test planning to high powered computer simulation. We provide aerodynamic/flow analysis, stress and thermal analysis, acoustic analysis, and more to motorsport teams.

Please contact us to learn how we can support you!

## JACOBS

Jacobs Technology Inc.  
600 William Northern Blvd.  
Tullahoma, TN 37388 USA  
Phone: +1 931.455.6400  
Fax: +1 931.393.6211  
[www.jacobs.com](http://www.jacobs.com)  
[www.testslate.com](http://www.testslate.com)



## Rapid Electronic Solutions Worldwide

# dce

**Mooresville, NC**  
**USA: +1 (704) 230 4649**

- Lightweight Wiring Looms
- Power Assisted Steering
- Bosch M4 ABS
- Sensors
- Pneumatic Paddle Shift
- Data Acquisition
- Engine Management

[www.dcemotorsport.com](http://www.dcemotorsport.com)  
[sales@dcemotorsport.com](mailto:sales@dcemotorsport.com)

**Maldon, Essex**  
**UK: +44 (0) 1621 856451**



PERFORMANCE PARTNERS

turning power into performance

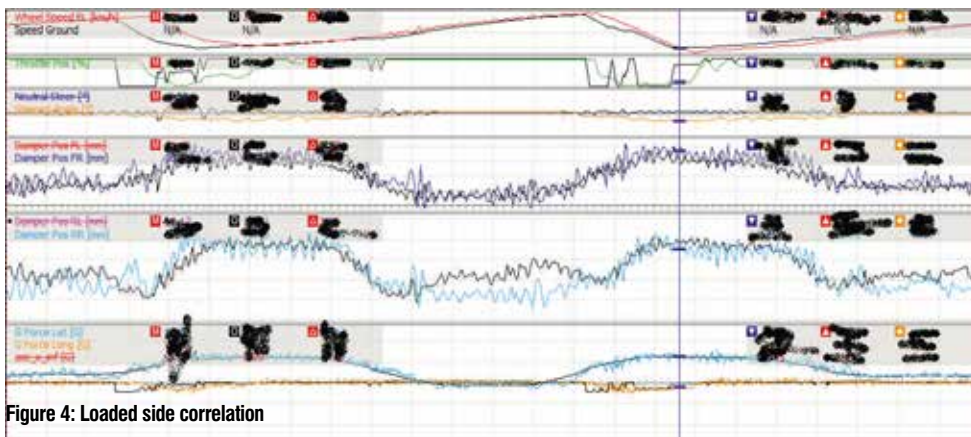

Figure 4: Loaded side correlation

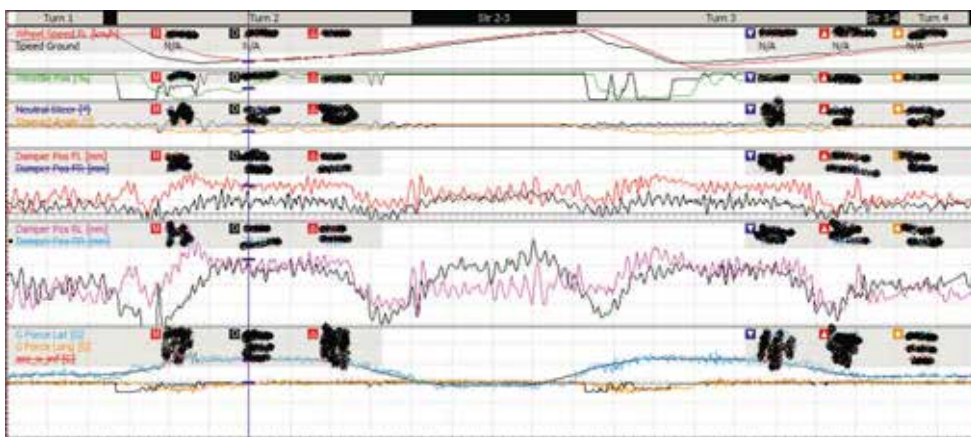

Figure 5: Unloaded side correlation

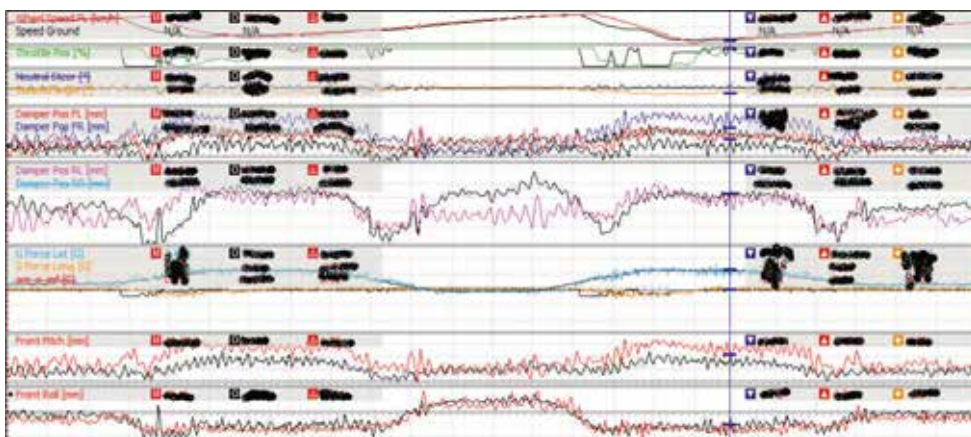

Figure 6: Effect of applying a softer front left spring and increasing rebound everywhere

## Achieving correlation for an asymmetric car isn't significantly different to its symmetric counterpart – it's just a bit more in depth

in mid-corner, we are actually pretty close to where we want to be. However, there is a discrepancy in the middle of the circuit, but the chances are we might need to refine the aeromap at that point. Looking at the data for the front left, it becomes apparent that it's down everywhere. This would indicate we need to slightly soften the front spring. However, the big area that needs to be worked on is on turn entry where the damper movement unloads everywhere. This indicates two things – we either need to increase rebound on the dampers or the aeromap needs attention.

Applying these changes yielded very interesting results, as shown in **Figure 6**.

Actual is coloured and simulated is black. The rear damper results have improved, particularly in the area that the inside rear has unloaded. This is especially apparent in Turn 2. Turn 1 needs work but this is being exaggerated by the speed difference. However, at a first pass it would appear the front dampers are worse, but as always the devil is in the detail. The raw front damper data would indicate we have gone backwards yet the pitch and the roll channels tell a very different story. Looking at the roll channel the correlation is very good. Given the linear nature of the springs and motion ratios, it would indicate we have the front mechanically sorted.

## Pitch values

The real giveaway that we're where we want to be is the pitch channel. Going down the straight the correlation is good. However, as we get into the corner the front pitch falls away and this is telling us we need to increase the downforce in this section of the aeromap. Remember, on an oval the normal loading of the car will increase, the car will compress on its springs and the ride height will go down due to the banking. You can see this on data as clear as a bell in places such as Daytona. Consequently we need to adjust the aeromap to suit the conditions.

Once we are at this point and the necessary modifications have been made we can start running tyre force optimisation and begin work on setting the car up.

In summary achieving correlation for an asymmetric car isn't significantly different to its symmetric counterpart – it's just a bit more in-depth. Our process starts by making sure we have good data on the racecar. We then plot load vs dampers for each corner of the car to quantify what the springing of the car is doing. We then sanity check the data and as per the symmetric car we then double check the aero results. We then move on to comparing both the loaded and unloaded dampers. We then make modifications and then tie this together using pitch and roll data. Once you arrive at this point you finally have a model you can use as the basis to get results.

# TOP QUALIFIER

Around the world or around the track, you won't find a higher quality line of bearings and rod ends with Aurora's proven 40 year track record.



**Aurora Bearing Company**  
901 Aucutt Road  
Montgomery IL. 60538



Complete library of cad drawings and 3D models available at:  
[www.aurorabearing.com](http://www.aurorabearing.com)

Ph: 630-859-2030

## Micro Sensors for Motorsport



### Non-Contact Position Sensors

*Linear, Rotary & Non-Uniform Position Measurement*

- Micro, lightweight custom designs
- Award winning, patented technology
- Sense through non-ferrous material
- Up to 40mm measurement gap
- Remote electronics for high temp. operation
- FIA® Homologated



### Liquid Level Sensors

*Petroleum, Diesel, E10, E20, Coolant*

- Capacitive & Hydrostatic Technologies
- Solid-State - No Moving Parts
- Precision Engineered
- Custom Designed
- 12 bit Resolution
- Remote Electronics Option
- FIA® Homologated



Discover more at [www.reventec.com](http://www.reventec.com)

Downton Business Centre, Salisbury, Wiltshire SP5 3HU UK

+44 (0)1725 557203 [info@reventec.com](mailto:info@reventec.com)

## JLS MOTORSPORT

### Air Jacks

- Designed & manufactured by JLS Motorsport, bespoke strokes are available.
- Manufactured with forged alloys & high tensile steels.
- Lightweight & compact in design.
- Delivering maximum performance & optimum safety.
- All Air Jacks are supplied with 3 location rings for positioning & alignment.



Air Jack Lance

Air Jack Probe

Made in the UK  
European Sales

JLS Motorsport  
email: [motorsport@jster.co.uk](mailto:motorsport@jster.co.uk)  
tel: +44 (0)121 525 5800  
fax: +44 (0)121 525 4833

USA Sales

**XRP** THE XTREME IN RACECAR PLUMBING

XRP Inc. email: [sales@xrp.com](mailto:sales@xrp.com)  
tel: 562 861 4765 fax: 562 861 5503

lister



## LEADING EDGE HEAT CONTROL.

LESS HEAT EQUALS MORE HORSEPOWER.

- IMPROVES PERFORMANCE & EFFICIENCY
- EASY TO APPLY
- UNIVERSAL PRODUCTS

### EXHAUST INSULATING WRAP



### FLOOR INSULATING MAT



### ADHESIVE-BACKED HEAT BARRIER™



### COOL-IT™ PLUG WIRE SLEEVES



Call (800) 274-8437 or visit [www.thermotec.com](http://www.thermotec.com) for a FREE CATALOG, technical support or a distributor near you.



# All change for 2015

## Will new rules coming into effect for the new NASCAR season shake up the order?

By SAM COLLINS

**A**s the NASCAR Sprint Cup teams arrived in Atlanta for the second race of the 2015 season, they were dealing with many unknowns. A significantly updated rule book was fully introduced in the run up to the race at the Georgia track, although many elements were also in force a week earlier at Daytona.

The rule book for the first time has been issued electronically and it contains almost 60 changes covering adjustments to the powertrain, aerodynamics and chassis that are designed to work in concert to deliver more flexibility to drivers and more adjustability to teams. 'We have had fantastic racing so far in 2014,' explains Gene Stefanyszyn, NASCAR senior vice president of innovation and racing development. 'We remain committed and are constantly looking to improve. Our fans deserve it and our industry is pushing for it. That will not stop with the 2015 package; the development will continue over many years to come.' The headline changes include a shorter rear spoiler (from eight inches down to six), something experimented with in 2014, along with a reduction of engine power, lower rear differential gear ratios and an optional driver adjustable track bar. Additionally a wider radiator pan has been introduced and the weight of the cars has been reduced by 23kg, simply by cutting ballast.

There have been changes under the engine cover too, as the power output of the cars has been cut significantly. In 2014 the 5.7-litre naturally aspirated V8 Cup engines produced between 860-900bhp, but this has been cut to around 725bhp via the use of a tapered spacer in the inlet, similar to those used in the Truck

series and Xfinity championship. The change to the lower rear differential gear ratios should see the maximum revs fall to around 9000rpm, while roller valve lifters replace flat valve lifters.

'The engine configuration as we know it is going to change considerably, and what it means is a different camshaft,' says Ford engine builder Doug Yates. 'Going from flat tappet to roller lifter is a step in the right direction for longevity, but as far as the cam design, the cylinder head, intake manifold and exhaust system, all of those things that are related to airflow have to change. It's not a total tear-up by any means. Gene Stefanyszyn and the guys at NASCAR have done a good job of talking to the engine builders and trying to get our input and feedback on how we would like to go about. That process explored many different ways of reducing power, but at the end of the day I think we as a sport have made a good and a cost-effective decision going forward. It's good for the engine shops, it's good for the teams and it's good for the sport. There are a lot of ways you can do it, but this makes sense for the current engine we have today.'

Major changes such as cutting engine capacity down to 5.0-litres were on the table at one point but that change was rejected, for now, although major changes such as using direct injection and more substantial downsizing could be on the horizon. The new engines will not be introduced until the second round, held in Atlanta, and the engine rules for the super speedways at Talladega and Daytona carry over from 2014.

'It's not fully appreciated, but the fact of the matter is that we've had the same engine for basically 25 or 30 years and it's at 850 or

NASCAR hopes the rule changes will lead to more exciting races



860 horsepower, where it used to be 500,' Pemberton said in explanation of the new rules. 'And we are at the same race tracks where we used to run 160 (miles per hour). We're now qualifying at 190 and running 213 going into the corners. There's been a lot of engineering and gains made across the board.'

Compounding the impact of the changes to the cars themselves is another rule change aimed at cutting costs which will make it much harder for teams to evaluate their developments. All private testing has been outlawed with race teams being instead invited to participate in NASCAR / Goodyear tests throughout the season. If a team is caught conducting private tests in secret then it will be hit with a 150 point penalty, a six week suspension for the crew chief and other team members and a minimum \$150,000 fine.

One thing that many of the teams would like to test will be tyre pressures, as NASCAR will no longer enforce a minimum tyre pressure for the 2015 campaign. This gives crew chiefs more control of how little they put in their tyres but

**“We remain committed and are constantly looking to improve. Our fans deserve it and our industry is pushing for it”**



also increases the risk of a blowout. Goodyear will continue to provide teams with a minimum tyre pressure recommendation, but teams do not have to abide by it. 'With Goodyear constantly working on its communications with the teams on tyre durability, it's putting it in the team's hands for different strategies,' Robin Pemberton explains. Pemberton went on to say that officials are working on having a tyre pressure monitoring system on the dashboard to give drivers a warning when tyre pressure is too low although it is still 'a fair old way away' from happening anytime in the near future.

But one change that will be immediately apparent when watching the races is the reduction of the number of officials in their distinctive white fire suits on pit road – NASCAR has cut their number from 43 down to just 10. Replacing them on pit road are HD cameras which will be constantly monitored by NASCAR officials sitting in the tech trailer. No fewer than 45 of these cameras will cover all of pit road and monitor two pit stalls each, and in addition to this the pit stalls will be laser measured.

One thing that they will be looking for is team members yanking on the side skirts of the cars. These panels on the lower part of the bodyworks are officially known as vertical rocker panel extensions and engineers in the teams found that if the panels were deliberately distorted during a pitstop by mechanics then an aerodynamic gain could be derived.

## Safety compromised?

Now teams who make unapproved adjustments under caution will have to come back in under caution, fix the car, restart at the rear of the field and then do a pass-through on pit road at pit-road speed under green. Teams who make unapproved adjustments under green will have to come in under green and fix the car to NASCAR's satisfaction. If NASCAR identifies a crew member who makes the illegal adjustment, it will issue that person a warning for the first offence and subsequently increase the sanctions for additional offences.

Another change is that the cameras and the few remaining officials will no longer monitor

the teams wheel changing in great detail. NASCAR will not penalise teams for missing lug nuts out on the car and this opens up the possibility of crew chiefs to gamble more with strategy, possibly making a late race stop and only using three or four lug nuts on the wheel rather than all five in order to get a faster stop and gain track position. It also allows wheel changers to take more risks as losing a lug nut is now far less of a penalty, but NASCAR will still penalise teams who lose wheels on track.

Even with all of the new rules, which were introduced after the homologation of the 2015 Camry, the new car seems to work as it won its debut race, the Sprint Unlimited at Daytona. Toyota may once again be back on the pace and closer to its first ever title, but its work is far from finished as NASCAR has already declared that it will release the 2016 rulebook in the Spring or early summer and RCE understands that it will contain some substantial changes.

For more depth on the new rules read Stockcar Engineering visit our website at [www.racecar-engineering.com](http://www.racecar-engineering.com).



# Logical processes

Highlighting the issue of falling standards in the engineers of tomorrow

**A**fter reading recent editions of Racecar Engineering, I find I am shocked at your correspondent Danny Nowlan's distress at the falling standard of engineers. Quite seriously this is an ongoing problem and one that has been chronicled by your magazine for some time.

When I was at Nissan Performance Technologies Inc we were joined by a computer whizz. Admittedly he knew computers inside out, but he seemingly did not know much else. I specced an insert for two sides of a honeycomb panel at an outside diameter of one-and-a-half inches, with a very shallow cone back with a flush face connected by a tubular centre for a bolt. Though the inserts did NOT show any problems over a season-and-a-half's worth of use, this computer expert insisted that the inserts should be increased in diameter to three inches with a concomitant increase in thickness. Later he convinced the powers-that-be that the front splitter was too weak and he was asked to redesign it – his resulting design consisted of 42 layers of six ounce carbonfibre cloth bonded together by epoxy resin. My thoughts at the time were that this new splitter would indeed be stiffer than a brick, but that it would also weigh the same as a very large barrel full of aforementioned bricks. Fortunately, common sense prevailed and the front splitter was never fitted to the racecar.

These problems are not unique to the racing business. One day, some years ago, I received a call from a person who said he was calling from a department at a unit of a state university. He asked for all of the data we had accumulated from running in the wind tunnel. My first reaction was one of 'who in the hell does this guy think he is?' I demurred and told him that I would have to speak to the president of Nissan Performance Technologies and call him back. He gave me his office number at the university and explained that he was only there on Fridays and the rest of the time he was to be found in a town east of San Francisco where the federal government has an atomic research test facility and NASA has a wind tunnel.

## Lack of basic knowledge

This person went on to release a book on aerodynamics which is simply a compilation of a number of papers written by others. I started to wonder about the students under his care. Over the decades I've found that this way of working is not unusual – often woefully underpaid graduate students are teaching classes and a large number of well researched books have been written about tenured instructors using students to teach classes.

I am further reminded of the monumental screw up of the Hubble Space Telescope, wherein one group of rocket scientists assumed that the drawings used metric dimensions, while another assumed imperial, with the results being very blurry photos from space. One related story not previously published was that after the mirror was bolted into the support cradle just before shipment to Cape Kennedy, the circle of nuts were being undone and galled

on the titanium bolts. Panic ensued, meetings were held and 'experts' from around the world were called together to try to fix it. A friend of mine, who is a degree-level qualified engineer, was working at the facility where the telescope was being assembled between racing stints. He had worked as a racing mechanic in the past and when he heard about the problem he just said 'ring them off'. The reply of 'Huh?' came and he explained 'just overtighten the nuts until the bolts break or the nuts strip off'. After the scientists lifted their jaws off the floor they did as he said and the problem was solved.

As Nowlan says, this problem cuts across all disciplines in our schools, and when one of your readers in 2002 pointed out that a Formula Student team had specced tubing for the chassis of a type that did not even exist my immediate question was 'where was the instructor?' Years later I found out the answer was he was either at his other job or was topping up a tan in the Bahamas.

My personal experience in learning is worth relating. My father was a genius. From my earliest memory I recall that whenever I asked the usual childish questions of who, what, when, why and how, he would reply with one of two answers – 'I think you can work that out for yourself' or 'lets see if WE can figure this out'. Often I could indeed figure it out but when I could not we would go through it together.

Today, with computers giving instant answers, the thinking is all done for us. When my father started my thought process at an early age I believe that short cuts in messages between neurons was started. Our bodies build up short cuts such as when we touch a hot surface. In this case the message does not have to travel from fingertip to brain and then on to the relevant muscles, but instead the signal goes direct to the muscle, the reflex action. In a similar way experience builds a short cut in our brains so that when we have a similar task to do, such as changing gear in a car or simply breathing, we don't have to think about it, we just do it. Of course, computers do some of this shortcutting for us now, so it is very important today to understand what all of the information we have access to actually means.

I hope Nowlan's shell shock will lead to more attention on the falling standard of engineers, not just across engineering, but across all standards of all disciplines.

**Richard H. Yagami**  
Ridgefield, CT



**Today, with computers giving instant answers, the thinking is done for us**



The Hubble Space Telescope was flawed by poor engineering practice



TOYOTA MOTORSPORT GmbH

# HIGH-PERFORMANCE AUTOMOTIVE TESTING

CUTTING-EDGE SIMULATION AND HARDWARE-IN-THE-LOOP TECHNOLOGY COMBINES WITH EXTENSIVE CHASSIS, COMPONENT AND ENGINE TESTING FACILITIES FOR PROJECTS LARGE OR SMALL



TMG brings the benefits of its experience in the high-performance world of motorsport to the wider automotive testing and development industry.

The 30,000m<sup>2</sup> facility in Cologne, Germany covers engine, chassis and component testing via virtual and real-world testing solutions, with highly-qualified, experienced engineers on hand to optimise every project.

From high-tech simulation and calculation techniques to a diverse range of R&D testing options, TMG can deliver performance, efficiency and value to a variety of projects.

As an award-winning service supplier to the automotive industry and beyond, TMG already provides bespoke solutions to several world-renowned external companies as well as cutting-edge research for Toyota Motor Corporation.

With expertise in the area of hardware-in-the-loop testing and advanced development processes, TMG is a pioneer in research and development.



# Pay TV deals blamed for sharp drop in Formula 1 viewing figures



Ecclestone points the finger of blame for the fall in Formula 1 TV audience squarely at pay-to-view TV deals

**Formula 1 saw its TV figures plummet in 2014 and the sport's boss, Bernie Ecclestone, has put the fall down to Formula One Management's (FOM) switch to pay TV deals in some markets over recent seasons.**

The sharp decline in viewers has been revealed in FOM's annual global media report, which was leaked to selected media before its official publication. Part of the report measures what is described as the number of unique viewers of a grand prix – that is anyone who has watched at least 15 minutes of a race.

These figures show that F1 lost 25m viewers worldwide last year, a fall of 5.6 per cent on the previous season's total, although this still leaves the total number of viewers at 425m for 2014.

Ecclestone has put the decline down to the growth in the pay TV networks that have taken a larger slice of F1 broadcasting, telling *Forbes* it 'reflects the move FOM has made towards pay TV in several markets over the last three seasons'.

In territories where pay-to-view is in place, its impact on the figures is clear. In the UK, where Sky shares the coverage with the BBC but is the only broadcaster to show every grand

prix live, the audience dropped by 1.5m last year, to 27.6m viewers in total.

Pay TV deals have also been struck in Spain, Italy and Germany in recent years and viewer numbers dropped in all three countries in 2014, with Germany seeing the largest decline, a 12.4 per cent fall to 27.4m viewers.

It's not all been bad news on the viewing front, though, and in Russia – which hosted its first grand prix at Sochi in 2014 – numbers were up by some 24.5 per cent, with a total of 15.4m.

However, while pay-to-view TV has led to a fall in audience figures, Formula 1 has still raked in more revenue because of the premium fees it charges these broadcasters for TV rights.

Meanwhile, as far as the teams are concerned, while the drop in viewing figures could possibly harm their ability to land sponsorship and the rates these deals can command – which are often based on the amount of TV exposure the teams can generate – the sport's move to pay TV has actually added to their short-term revenue. This is because they take up to 63 per cent of F1's profits as prize money. It's been reported that last year this came to \$797m.

## Skoda back on track with TCR

**Skoda could be about to make a sensational racing return by developing a car for the all-new TCR touring car category, *Racecar Engineering* has learned.**

The Czech factory, which is part of the Volkswagen Group, last raced at a professional level in the European Touring Car Championship in the early '80s, but has since concentrated on rallying.

However, TCR's director of communications, Fabio Ravaioli, has told *Racecar* that VW has said that it is planning on fielding Skodas in TCR, alongside its own VW Golf commitment – the latter of which will be run by Franz Engstler's Engstler Motorsport, a former WTCC driver who has switched to TCR.

Ravaioli said: 'We have met representatives of a few car

manufacturers. Audi, SEAT, Volkswagen, Ford, Honda and Opel are all supporting the TCR. Actually Bernhard Gobmeier, chief of motorsport for the Volkswagen Group, stated that he intends to involve Skoda too.'

Skoda's last high level racing campaign resulted in it winning the European Touring Car Championship in 1981, albeit as a

1.3-litre class winner – the ETCC was then run with a class structure with victors in each category, including overall winners, scooping the same number of points. Since then Skoda has largely concentrated on rallying and has in the past produced WRC cars and more recently its Fabia R5 and S2000 challengers.

Ravaioli added that TCR expects to see cars from SEAT, Ford, Honda and Opel out in its first event at Sepang, Malaysia, in March, with cars from other manufacturers joining as the season progresses.

Marcello Lotti, CEO at TCR promoter WSC, said: 'Honda and SEAT are OK. [VW] Golf has to develop the car and may not be ready for the first event but they will be there for the second, and Ford also will be in from the start. We also have Opel with the new Astra four-door 2000 that they are going to produce for their Trofeo [single make series] in 2016. We have other interested manufacturers but I cannot tell you the names today.'

For more on TCR go to Marcello Lotti interview on page 90.

XPB

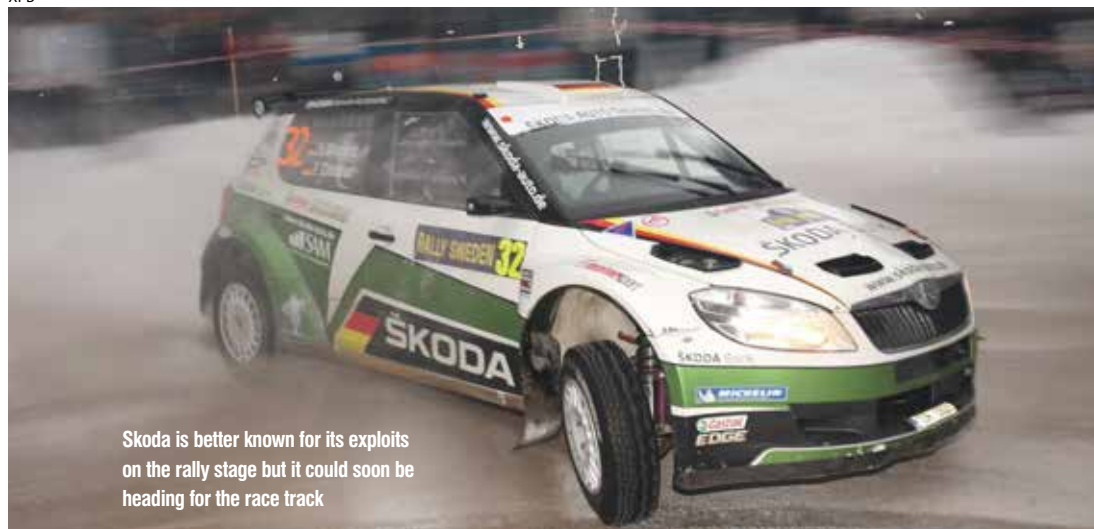

Skoda is better known for its exploits on the rally stage but it could soon be heading for the race track

# NASCAR boss upbeat about growth in race crowds

**NASCAR chairman and CEO Brian France says that the attendance figures for NASCAR events are now back on the up after a decline in recent years.**

The number of spectators attending NASCAR races had been falling since the onset of the



France says NASCAR is now attracting a growing number of spectators

global economic downturn in 2008, but now France says there are clear signs of an improving situation. He puts this transformation down to the upturn in the US economy and the recent falls in fuel prices – an important factor for the often far-travelling NASCAR fan.

While France did not supply figures to prove attendance was on the up, his views are backed up by recent financial results from International Speedway Corporation (ISC), NASCAR's publicly owned track-operating arm. These show that for the year ending November 30, 2014, total revenues were \$651.9m, compared to \$612.6m in 2013. Meanwhile, operating income for the full-year period was \$93.4m, compared with \$78.7m for the previous year.

France said: 'We know that the economy, fuel prices and all that are helping, finally coming down, finally getting a little bit better. It's taken a long time to get through that. We were hardest hit as you well know because of the length of [journeys] and the long stays our fans make when they go to events, hotel rooms and whatever else, and fuel prices and so on, are a

lot different than going to a football match or basketball game in their hometown, so that's changed things for us in that respect.'

ISC results also included its fourth quarter figures, which were also up, largely due, it says, to the new Chase format, which is designed to take the title down to the wire. Total revenues for the fourth quarter period ending November 30, 2014, were approximately \$199.8m, compared to revenues of approximately \$188.7m in the fourth quarter of 2013. Operating income was approximately \$39.8m during the same period compared to approximately \$29.5m in the fourth quarter of 2013.

Lesa France Kennedy, ISC chief executive officer, said the results 'exceeded our expectations'. She added that races late in the season benefited greatly from the Chase: 'With positive momentum from capacity management and consumer marketing strategies, coupled with strong corporate sales and excitement generated by the new Chase for the Sprint Cup Championship format, we achieved sellouts at Phoenix and Homestead-Miami,' she said.

## SEEN: Ferrari F1 Concept



This is what Ferrari thinks the Formula 1 car of the near future should look like. The Italian manufacturer has revealed these sketches of what it says is possible with only minor changes to the current technical regulations. It wanted to create a technologically

advanced, but also captivating-to-the-eye and aggressive-looking design concept, but staying close to the current technical regulations. 'Our challenge was to create something that was – to put it short – better looking,' Ferrari's design department claims.

## IN BRIEF

### Formula Libre

Teams saddled with redundant racecars might be interested to hear of an all-new championship set up by the BARC in the UK. While it's being called Formula Libre, the 16-round series, which will be held over six events, is not actually a complete free-for-all, but it is open to cars from some of the

professional championships that have sunk without trace in recent years. The BARC says it will run a minimum of three classes, for latest spec Formula Renault 2.0, pre-2012 Formula 3, and Formula BMW. The first round is set for Snetterton on the weekend of 9/10 May.

## Qatar in line to become third Gulf GP

**Sports-hungry Gulf state Qatar claims it is close to securing a Formula 1 race, which could be viable as soon as next year.**

Qatar is currently spending billions on staging major sporting events, the most well-known of which is the 2022 football World Cup, while it also already hosts MotoGP and WSBK events.

Some sources claim that Qatar is willing to pay a staggering £50m to host a grand prix, which will be a record amount for an annual race fee, even eclipsing the £46.3m paid by near neighbour Abu Dhabi. Because F1 race deals tend to stretch to 10 years, the final bill for Qatar could be at least half a billion pounds.

A Formula 1 grand prix deal was originally believed to be out of the question for the Qataris because of a pre-existing agreement between Bernie Ecclestone and Bahrain, signed in 2004 – the year it hosted its inaugural grand prix – which gave Bahrain exclusivity in

the Gulf region when it came to holding F1 events.

However, this was already waived for the Abu Dhabi race and now, according to Nasser bin Khalifa Al Attiyah, president of the Qatar Motor Sport Federation and a vice-president of the FIA, Qatar is also close to signing a contract with Formula 1 Management (FOM), the sport's operating company.

'We are about to sign contracts to organise a Formula 1 race,' Attiya told the *Gulf Daily News*. 'We have completed all the steps and there are only a few details before the official signature.'

Attiya went on to say that the race could take place as early as next year, but a slot in the 2017 calendar is probably more likely.

Qatar already has an F1 standard circuit in the shape of its floodlit 3.4-mile Losail track, which hosts the MotoGP race, but it's understood that there is a possibility that the grand prix could be a street race held in the Qatari capital, Doha.

# Moscow and London take Formula E back to full schedule

The all-electric Formula E series has announced a new street race close to the Kremlin in Moscow, replacing the round lost when Rio de Janeiro called off of its electric racecar championship event last year, and the series also confirmed the circuit in Battersea Park on which the London round will be held at the end of June.

The inaugural season boasts 11 rounds, the latter two a double-header in London. The schedule was spread over the latter part of 2014 and the first half of 2015.

The Moscow ePrix will take up its position in the schedule on June 6, with the Berlin race moved forward a week to May 23 to accommodate it. The Russian race will take place on a 13-turn street circuit adjacent to the Kremlin.

Sergey Ivanov, executive director of the Russian Automobile Federation: 'Formula E is a very interesting and above-average project which links motorsport with innovative science and technology. It is an historic event for Russian motorsport – for the first time, a race will take place in the heart of the city. We've been cooperating with [the] FIA and we are confident that the FIA Formula E Championship round in Moscow will be held in complete accordance with all the international standards.'

The British races in London were confirmed in January, with Wandsworth Council agreeing to a 15-turn, 2.92km circuit around Battersea Park. 'Having two races in London – the final two of the season – was an option we discussed at length with Wandsworth Council and means that London could well be

where the inaugural champion is crowned, making it a fantastic spectacle for the city and a great platform to showcase sustainable mobility and clean energy,' says Formula E CEO Alejandro Agag.

Mayor of London, Boris Johnson, was typically effusive about the summer event. He said: 'Formula E is set to be a superb addition to London's sporting calendar. The atmosphere will quite literally be electric and Battersea, which is already booming with the buzz of regeneration, will be alive with the excitement that this new, world-class event will no doubt spark.'

The remaining Formula E rounds to be held in 2015 are: Miami (March 14); Long Beach (April 4); Monte Carlo (May 9); Berlin (May 23); Moscow (June 6) and London (June 27/28). So far races in China, Malaysia, Uruguay and Argentina have taken place.



The proposed layout for the Moscow Formula E ePrix street race



The proposed layout for the 2.92km London Formula E ePrix track

## SEEN: Abarth Formula 4 engine



Germany's ADAC Formula 4 Championship is to run with Abarth engines this year. The famed Italian company will supply a race-tuned turbocharged four-cylinder unit based on the standard Fiat Abarth 500 engine. The 1.4-litre 414TF engine delivers

160bhp with a maximum torque of 250Nm. ADAC Formula 4 is to use a Tatuus chassis and Pirelli tyres and 10 teams had signed up to compete in the championship in 2015 at the time of writing. Its first race takes place at Oschersleben in late April.

## IN BRIEF

### Caterham sale

The assets of collapsed Formula 1 team Caterham have been put up for sale by its administrator. Caterham went into administration after last year's Russian Grand Prix, although it still raced at Abu Dhabi and took part in the test following the grand prix while the administrator, Smith & Williamson, tried to stoke up interest as part of its plan to sell the team as a going concern. It has been announced that Auction firm Wyles Hardy & Co is to sell off Caterham's cars, property and equipment, starting with the 2014 F1 chassis and show cars, plus the team's Leefield factory, race and simulator equipment. The auctions will take place through March, April and May. A series of on-line timed auction sales will be held covering the race equipment, engineering facility, F1 memorabilia, IT and communications, office furniture as well as private treaty sales for the race trailer fleet, the race simulator, Dell HPC super computer and autoclaves. Further details of the terms and conditions of the sale can be found at [www.wyleshardy.com](http://www.wyleshardy.com).

### German F3 axed

The German Formula 3 Cup will not take place in 2015. Germany's domestic F3 series had failed to attract enough entries for this season, while moves to merge it with the now defunct British Formula 3 Championship came to nothing. The championship was already facing a change of name from F3 to German Formula Open, as its planned three foreign rounds breached new FIA national F3 rules. The organisers of the F3 Cup have not ruled out a return for the series in future seasons.



CUSTOM BRAKE LINES | OIL COOLERS | HOSE | FITTINGS  
ADAPTERS | FILTERS | NOS | FUEL PUMPS & REGULATORS



FUELAB NOS Holley EARL'S WUS 26 STÄUBLE

Visit [www.earls.co.uk](http://www.earls.co.uk) for the full range  
Online Shop now Available

QUOTE "RCE10"  
WHEN ORDERING TO  
RECEIVE 5% DISCOUNT

Earl's Performance Products UK Ltd  
Units 15-16 Silverstone Circuit, Northants, United Kingdom NN12 8TL

+44(0)1803 869850 | [sales@earls.co.uk](mailto:sales@earls.co.uk)

ECU/Exchange Loom/Throttle Body Packages available

## Complex modern engine? We can manage it

ECU solutions for:  
Honda S2000 and K20A  
Ford ST170 and Duratec  
Toyota 2ZZ  
BMW Single / Twin VANOS  
Audi 1.8T and 5 cylinder  
Chevrolet LS7.



Our ECU's are capable of dealing with the most complex of modern engines without the need to change sensors or sacrifice key features such as variable camshafts.



Get the very best from  
any engine and from only **£495.00 + VAT.**

DTAfast, 10 Boston Court, Kansas Ave, Salford M50 2GN  
Tel: +44 (0)161 877 1419 Fax: +44 (0)161 877 7086  
Email: [office@dtafast.co.uk](mailto:office@dtafast.co.uk) Website: [www.dtafast.co.uk](http://www.dtafast.co.uk)

**PRO-SHIFT**  
electronic gearshift

Championship Winning  
**Semi-Automatic  
Electronic Gearshifters**  
for Racecars & Superbikes

Now available  
This superfast and highly sophisticated  
**Gearshifting PS3 Paddleshift System** suitable  
for **Racecars and Superbikes** with over 170  
adjustable parameters

**PS3 System**  
Offering Fully Closed Loop Gearshifting for  
both Racecars and Superbikes

**Auto-Blip & Downshift Lockout**  
For clutchless downshifts plus engine over-rev protection

**Graduated Ignition Cuts**  
Individually programmable for all gears

**Auto Upshift Facility**  
Max power upshifting at full throttle...!

For more information:

email: [info@proshift.com](mailto:info@proshift.com)  
telephone: +44 (0)1332 668100

[www.proshift.com](http://www.proshift.com)

## Racing Car Air Lift



- Lifts Vehicles Safely and Quickly
- Supplied Tested and Ready to Use
- 600 Kg S.W.L. Per Pair
- Full Range of Servicing Options Available
- Existing Supplier to Many Motorsport Teams



Tel: 024 7637 4114  
Fax: 024 7634 7520  
Email: [sales@camozzi.co.uk](mailto:sales@camozzi.co.uk)  
Web: [www.camozzi.co.uk](http://www.camozzi.co.uk)

# NASCAR star buys dirt Sprint Car series

**NASCAR team owner and three-time Cup champion driver Tony Stewart has bought the All Star Circuit of Champions Sprint Car Series.**

Stewart has agreed terms with previous owner Guy Webb to buy the series, which is for front-engined big-winged single seaters, which race on dirt tracks.

The co-owner of the four-car Stewart-Haas Racing organisation in the Sprint Cup has continued to compete in Sprint Cars throughout his NASCAR career, and is known to be a great fan of the category.

Stewart said: 'My passion for Sprint Car racing is well known, and the All Star Circuit of Champions series has been a pillar of the sport for a long time. Racing is my business and I look forward to building the series' already impressive legacy by taking it to a new level of success and sustainability.'

Dirt track racing already forms a large part of Stewart's motorsport business portfolio, which includes



**Race ace Tony Stewart has bought Sprint Car series**

ownership of the Eldorado Speedway in Ohio and his own race team in the World of Outlaws series, Tony Stewart Racing.

However, Stewart's extra-vehicular activity in Sprint Car racing has resulted in criticism from some quarters in recent years, particularly after a couple of very high profile incidents. In 2013 Stewart suffered a broken leg in an accident while competing at a Sprint Car race in Iowa. The injury forced him to miss the final 15 races of that year's NASCAR season. Also, in August of last year Stewart's car hit and killed fellow driver Kevin Ward Jr during a Sprint Car race. While he was cleared of any culpability in Ward's death he did miss three NASCAR races as he dealt with the emotional and legal repercussions of the accident.

Webb said he had put his 'heart and soul' into the All Star series, but he added: 'It gives me great peace of mind to hand over the reins to Tony Stewart. Tony is dirt track racing's biggest advocate, and he's always working in the best interest of Sprint Car racing.'

The All Star Circuit of Champions Sprint Car Series has a 50-race calendar for the 2015 season.

# NASCAR signs new merchandising deal

**NASCAR has signed a 10-year agreement with sports merchandising giant Fanatics, which will ultimately see a climate-controlled superstore-sized tent replacing the individual team merchandise trailers at Sprint Cup events.**

Fanatics is described by NASCAR as 'the market leader for officially licensed sports merchandise, [it] powers the e-stores for hundreds of the top sports leagues, teams and schools, including a long history running NASCAR's e-commerce business (NASCAR.com).'

Fanatics has acquired certain exclusive rights from NASCAR Team Properties (the merchandise marketing organisation which

comprises NASCAR and many of the teams) that will make the company the primary retailer of NASCAR team and driver merchandise at all 38 NASCAR Sprint Cup Series race weekends. NASCAR declined to comment on the financial details of the decade-long deal.

NASCAR tells us that the new trackside retail model will be phased in at events over the course of 2015. It will evolve from using trailers for each specific team or driver to displaying all merchandise in a climate-controlled superstore retail environment sometimes supported by smaller satellite retail outlets around the track.

Steve Phelps, NASCAR executive vice president and chief

marketing officer, said of the deal: 'A merchandise centre will provide a more personal, comfortable and convenient shopping environment for our fans. Partnering with an industry leader in Fanatics allows us to offer a comprehensive and seamless shopping experience.'

Ross Tannenbaum, president of Fanatics Authentic, said: 'Fanatics is extremely excited to partner with NASCAR and NASCAR Team Properties to greatly expand their at-track retail presence. We have taken the time to listen to the fans, teams, drivers and NASCAR were and look forward to using our market-leading scale, technology and production capabilities to deliver an improved experience.'

## SPONSORSHIP

Trading and investment specialist **Saxo Bank** has extended its sponsorship deal with the **Lotus Formula 1 team**. The firm's logo will now be seen on the rear wing and on the engine cover of the E23 racecar.

**The Force India F1 team** has entered into a sponsorship deal with leading insurance broker **Inter**. The Mexican company's logos will be displayed on the front wing of the Anglo-Indian team's VJM08 chassis, as well as on all team gear including the drivers' overalls. Inter says it was drawn to F1 because of the sport's unique global reach and its own desire to continue building up its international business base.

**Hyundai Motorsport's** second team in the **WRC** is to be sponsored by the Korean car giant's affiliate company **Hyundai Mobis** this season. Hyundai Mobis is a car parts concern established in 1977. Despite the different team names both Hyundai squads will be run from the same service area.

The **BRDC Formula 4 Championship** has picked up title sponsorship from **Duo**, a UK-based international company specialising in providing material processing systems to the construction industry.

## IN BRIEF

### Premium buy

Premium Motorsports, an outfit owned by Jay Robinson, has bought the assets of the Tommy Baldwin Racing No.36 car for the 2015 NASCAR Sprint Cup season. The car will now race with the number 62.

### TV winners

Total television audience numbers for last year's FIA World Rallycross Championship showed an increase of more than 550 per cent in dedicated coverage (live, as-live or highlights) on 2013, while broadcast hours showed a 444 per cent increase.

## SEEN: Lada Vesta TC1



LADA SPORT ROSNEFT started an intensive pre-season testing program with a brand new LADA Vesta TC1 car, which replaces the Granta model as LADA's FIA World Touring Car Championship (WTCC) challenger.

All three of the Russian manufacturer's drivers – Rob Huff, James Thompson and Mikhail Kozlovskiy – arrived at the team's technical base at Circuit de Nevers Magny-Cours,

France, to test the new-for-2015 Vesta ahead of the first WTCC round in Argentina (6-8 March).

In mid-January, the team conducted thorough tests on a new 380bhp ORECA-built engine, and its development will continue this week.

The LADA Vesta TC1 is a state-of-the-art racer derived from the road-going LADA Vesta, which will go into mass production in September 2015.

# CARTEK

MOTORSPORT ELECTRONICS

**NEW**



Battery Isolators



Power Control Panels



FIA Rain Lights



Shift Lights



Power Distribution Modules



Wireless Steering Wheel Controls



Coolant Level Alarms



**Suppliers to:**

- Porsche
- HWA AMG
- Ford
- KTM X-Bow
- Mini Challenge (UK)
- Kamaz
- V8 Super Cars

[www.CARTEKMOTORSPORT.com](http://www.CARTEKMOTORSPORT.com)  
**CARTEK AUTOMOTIVE ELECTRONICS Ltd**  
 +44(0)2380 457747 New number  
[info@cartekmotorsport.com](mailto:info@cartekmotorsport.com)

# PEGASUS



Exclusive North American  
 Motorsports Distributor for Beta Tools



Stocking distributor of  
 silicone hoses



US importer of  
 Jabroc® skid plate sheets



Stocking distributor of  
 MS21071 Apex Joints  
 (all sizes, 1/4" to 1 1/4")

... and much more!

Pegasus Auto Racing Supplies • New Berlin, WI USA  
 800-688-6946 • 262-317-1234

**PegasusAutoRacing.com**

Racers serving racers around the world since 1980

# D.A.T.A.S. LTD.

Data Analysis Tools And Simulation

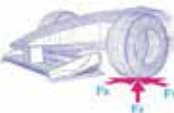

## RaceSim version 2.7.x

- Expert:** Steady state, transient, 4 post, optimisation, strategy, etc
- Standard:** Low cost lap simulation
- NasCar:** Stock cars with live axle
- RaceSimE:** For Formula E electric vehicles **New**
- RaceAlyzer:** Race strategy tool
- ManagePart:** Parts management tool

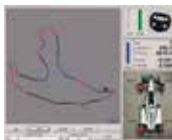

## Consultancy

- Vehicle Dynamics
- Racetrack support
- Software Development

## Multi Media

- Photo realistic virtual animations
- Technical Features for TV
- Animated virtual walk thro' grid



# DOCKING

Advanced Cooling Systems

- Water Radiators
- Intercoolers
- Oil Coolers
- Heat Exchangers
- System Design
- Ancillary Products

Manufactured to your requirements by the UK's leading supplier.

E [info@dockingengineering.com](mailto:info@dockingengineering.com)

Tel 00 44 (0) 1327 857164

Fax 00 44 (0) 1327 858011

Website [www.dockingengineering.com](http://www.dockingengineering.com)

Unit 15 Silverstone Circuit • Silverstone Northants • NN12 8TL • United Kingdom

D.A.T.A.S. LTD. THE OLD CHAPEL NORFOLK IP21 4XP

TEL: +44 (0)1603 506526 +44 (0)7802 770345

<http://www.datas-ltd.com> e-mail: [info@datas-ltd.com](mailto:info@datas-ltd.com)

INTERVIEW – Marcello Lotti

# Global vision

TCR is intended to be a global 'pyramid' for touring cars based on the proven GT3 concept. We talk to its creator about his bold new vision for saloon car racing

By MIKE BRESLIN



**'I wanted to establish a category on a global scale with a single set of technical regulations'**

**M**ore than a decade ago, Racecar Engineering ran a piece on Marcello Lotti's plans to set up a global touring car series, the World Touring Car Championship, which was launched in 2005 and is still going strong. Ten years on the same man has plans for a new global approach to tin top racing, yet the concept this time is very different.

Lotti's new project is called TCR. It was originally given the name TC3, but this was shelved in favour of the three letters (standing for Touring Car Racer) to avoid implying a link with the FIA's TC1, as the cars in WTCC are now known. It's a shame in a way, because that original name gives you the clearest indication as to where the inspiration for TCR originated: GT3. But more on that later, first of all, who is Marcello Lotti?

Lotti started his motorsport career as a successful rally co-driver before going on to run teams in rallying, touring cars and at Le Mans, and then becoming a promoter in 2000 with the European Super Touring Cup, from there moving on to the WTCC in 2005. He finished his spell at the WTCC at the end of 2013 and he is now CEO at WSC, the promoter of TCR.

Clearly Lotti knows his stuff then, but even granting this, does the world really need yet another type of touring car? 'This started in my mind many years ago, because I was really disappointed with the situation in touring cars at a national level,' Lotti explains. 'I never believed that you can have a successful international or world championship without a basic category at a national level. I wanted to establish a category on a global scale with a single set of technical regulations. This should arouse interest from the national dealers or importers and create an international market among the race teams for buying and selling cars and parts.'

But since the TCR concept was first proposed last year the landscape has changed, with the FIA unveiling its own two-tier blueprint for a touring car 'pyramid'. It will be based on the BTCC regulations and the Argentine production saloon regulations and will be called TCN-1 and TCN-2 respectively.

This doesn't phase Lotti, though. 'Nobody can impose something at a national level. Not me, not the FIA, nobody, because all the national federations have the freedom to decide for themselves. The national federation and the national promoter – because sometimes it's a private company – will follow what is interesting for them,' he says.

And it seems that many of them certainly find TCR interesting, with a fair number of federations and promoters already signed up. 'Asia and Portugal will run their series from 2015,' Lotti says. 'The Benelux countries, Russia, Italy, China, Spain and USA will run it as a promotional category within their existing championships in 2015 with the aim of running proper championships in 2016, while Central America, Thailand, South Africa and Germany are due to join in 2016.'

On top of this there is to be an Asian series, and also an international series, which deals with the pyramid aspect of growth from national to regional to global. The international

series, which Lotti admits will be a high profile shop window for the category, has gained significant kudos due to its link with F1 – it will be supporting three grands prix this year (Malaysia, China and Singapore).

Grids for the international series are expected to be around 16 to begin with, with 24 cars taking to the track by the end of the season. But the really interesting thing is the cars that will make up those grids, which takes us back to the basic concept. 'We saw that in a lot of national championships one car was always present, the SEAT Cup [Racer],' says Lotti. 'In Russia we found five SEAT Cups already racing, for example. So, we think perhaps this is what we need. So I looked at the technical specification of this car. It was very simple; a completely stock engine – with a wet sump, for example. They don't touch the engine, yet it still gives around 300 to 350bhp.'

'I started to discuss this with other manufacturers, saying: "Look, you can make the same car and sell a lot of cars around the world." But at the same time we can create a common interest in national touring cars, to have the same regulation, so it's easy to have a second hand market for teams, too.'

Lotti does not dispute the fact that the concept was in part inspired by GT3 and the way manufacturers have grasped the idea that there's money to be made from selling 'customer' GT cars – incidentally, the SEAT racer sells for around €70,000 and other TCRs are expected to come in at around that price. But another reason for the success of GT3 is its balance of



performance – there is little risk to a buyer of a racecar because the playing field is always levelled. It's here that Lotti believes TCR actually has an advantage over the GT3 series.

'It's practically the same concept as GT3,' Lotti admits. 'But there is one thing that will be easier for us, and that is the balance of performance. GT is for cars with different [amounts of] cylinder engines, different dimensions of cars and so on, but with TCR you have two-litre turbos and the same, practically, dimensions of the cars. So it will not be as complicated as it was in GT3 at the beginning.'

TCR intends to operate its balancing across three parameters: height, weight and engine restrictors, although with the latter it's slightly more complicated because the engines are standard production units. 'It's a road engine, which means they're all different. So instead we'll start on 100 per cent of the production restrictor, and then adjust it down to 95 per cent and then 90 per cent.'

The formula seems to have struck a chord with many manufacturers with cars from SEAT, Honda (JAS built), Ford (Onyx built), Audi, Volkswagen, Skoda and Opel all likely to run either this year or next.

The Opel entry is an interesting one, as it's expected to be the car the GM arm will use in its new-for-2016 Trophy series, in much the same way the SEAT came from the company's Cup championship. This, says Lotti, is one of the big selling points for manufacturers. 'If manufacturers are planning trophy [one make championships] then it's very easy for them to prepare the trophy car on the TCR spec, and then they have two platforms into which they can sell cars: TCR platform and trophy platform. It's a little bit like GT3 at the beginning, there were Ferrari Challenge cars, and other things like that, and this is very similar.'

Budgets should be relatively low, thanks to the standard nature of the car and engine, and teams already lined up for the first TCR International Series season include Onyx, West Coast Racing, Target Competition and Engstler Motorsport, with more waiting in the wings. Beyond the international series Lotti hopes a plethora of national championships will help 'recreate an interest around the touring car category' across the world. Whether TCR can succeed in this lofty aim only time will tell. But just possibly in 2025 Racecar Engineering will be starting a feature on TCR with: 'More than a decade ago ...'



## RACE MOVES

XPB



Grand prix winner and current WRC driver **Robert Kubica** has set up a team to run his own entry in World Rallying. The RK World Rally team will move into a new facility close to Lake Como in Italy later this year. **Marcin Czachorski** is the team co-ordinator.

**Rob Taylor**, formerly the chief designer for Red Bull and Jaguar in F1, has been put in charge of the design of the new-for-2016 Haas F1 car. The build of the US F1 entry has been entrusted to Dallara, but Taylor is to oversee the project.

**Allen Miller** is now head of Honda's US motorsport arm at Honda Performance Development (HPD). Miller's promotion places him in charge of on-track activities for HPD's IndyCar, sportscar and Pirelli World Challenge programmes.

HPD has assigned three experienced engineers to assist new motorsport boss **Allen Miller** (see above). **Troy Hanson** is to manage the IndyCar programme, while **Matt Niles** takes over Miller's role in endurance sportscars, while **Lee Niffenegger** will now look after the Pirelli World Challenge campaign.

**George Commins** has joined the Nissan works team in the V8 Supercars Championship to work as race engineer on the car driven by **Rick Kelly**. The move marks a return to Australia for Commins, who has spent the past six years in Europe, a period which included a stint with the Williams F1 team.

**Damien Clermont**, the FIA's chief administrative officer, is to head up a new working group within the governing body of world motorsport, which has been set up with the aim of finding a way to reduce team costs in F1.

A race fan hit by an overhead remote TV 'CamCat' camera cable at the 2014 Coca-Cola 600 is suing Fox Sports and Charlotte Motor Speedway for more than \$10,000. Fox has not used the technology since and the fan is the only one to take legal action. The cable was hit by 19 cars after it fell on the track. Results of the investigation into the failure remain private due to the suit.

**Chad Little** has been given the new role of managing director technical inspection/officiating at NASCAR. He will provide high-level oversight in all areas of technical inspection and officiating for its competition department. Little is a former Sprint Cup driver, who has spent more than 10 years at NASCAR, most recently serving as series director in the Truck Series and the Touring Series.

**Elton Sawyer** has been appointed managing director of the NASCAR Camping World Truck Series. Sawyer brings his expertise to NASCAR after a spell as director of team operations for Action Express Racing in the United SportsCar Championship.

**Brian Till** is the new race director and chief driver steward for US sports and touring car series the Pirelli World Challenge. Till is a former race driver who competed in the 1994 Indy 500 and a motorsport broadcaster.

**Chad Siegler** is now vice president business development at NASCAR, where he reports to senior vice president and chief sales officer **Jim O'Connell**. Siegler has been promoted from the post of vice president team marketing services. Before joining NASCAR in 2007 he was Sprint Nextel's manager of industry relations.

**Jeremy Moore** has switched from V8 Supercars, where he was a race engineer at Triple Eight Race Engineering's Red Bull Racing Australia squad, to the World Endurance Championship, taking up a post as performance engineer at the works Porsche LMP1 team.

**Grant McPherson** is now **Craig Lowndes'** race engineer at V8 Supercar outfit Red Bull Racing Australia, taking over the position vacated with the exit of **Jeremy Moore** from the team. **Andrew Trathen** has also joined the team as a junior design engineer.

# Renault Sport Formula 1 restructures for 2015

**F1 engine supplier Renault Sport F1 has shaken up its management structure in an attempt to make up for a disappointing first season under the new engine formula in 2014.**

Renault, which this year will supply just two teams in F1 – Red Bull and Toro Rosso – has now taken a ‘back to basics’ approach, centred on a restructuring at its Viry-Chatillon headquarters.

Cyril Abiteboul, managing director at Renault Sport F1, said: ‘Our new structure will emphasise the need for perpetual change and adaptation within Renault Sport F1. This will be achieved through two new functions. Chief technical officer, Rob White, will use his in-depth knowledge of Renault Sport F1 to set a strategy for the acquisition, development and utilisation of technical skills within the company, always with an eye on our F1.’

‘F1 performance is driven by human performance, so we have created

another stream in parallel to manage all organisational matters, procedures and protocols. Jean-Paul Gousset, who was previously head of production, is now responsible for this area, from the very smallest details to the large changes that together create the racing spirit we want to see in Viry-Chatillon.’

Another change at Renault Sport F1 is the creation of a development department, which will be headed by Naoki Tokunaga. Abiteboul said of this: ‘In addition to overseeing the engineering department, which is still managed by Jean-Philippe Mercier, Naoki will be directly responsible for performance and reliability groups.’

Remi Taffin will now oversee all track and factory operations, including assembly and dynos, in addition to his previous role as head of track operations. ‘Regrouping everything under one person greatly simplifies our lines of communications,’ Abiteboul explained.

# NASCAR announces high profile promotions

**Mike Helton has been elevated to the post of vice chairman of NASCAR, while its chief operating officer, Brent Dewar, has been added to the board of directors.**

Helton has held the position of NASCAR’s president since 2000 and has been with the sanctioning body in various roles since 1994. In his new post Helton will remain the senior NASCAR official at all its national series racing events, overseeing competition and working closely with chairman and CEO Brian France on long-term strategic planning. He also remains a member of the board of directors.

Dewar, who joined NASCAR in December 2013 after a long career in the automotive industry and later as

a consultant to a number of global companies, will assume additional day-to-day operational responsibilities in racing development, innovation and work with NASCAR partners and stakeholders.

France said: ‘Mike Helton’s steady hand and decades of experience in every facet of our business have made him a close, trusted adviser to me and my family, and his overall impact on NASCAR cannot be overstated.’

‘With a strong team ready to take on more day-to-day management responsibilities, I’m pleased to now have Mike in a role that will allow us to utilise his unique skills in advancing key priorities for the future of the industry.’

Commenting on Dewar’s addition to the board France said: ‘Adding someone as talented and experienced as Brent Dewar to our board will be highly beneficial to our company and the industry overall. Brent’s operational expertise already has made a big impact, and his understanding of how our sport works from multiple perspectives will bring immediate value to how we operate and future initiatives.’

Both moves are part of a long-term strategic plan which is spearheaded by France and which aims to strengthen NASCAR’s senior leadership team and broaden the responsibility for key areas of the business, NASCAR says.



Mike Helton is now vice chairman of NASCAR

## RACE MOVES – continued



XPB

V8 Supercars outfit Brad Jones Racing has made changes to its engineering lineup. **Andrew Edwards** (above) is now chief engineer, while **Paul Scalzo** and **Tom Wettenhall** have both moved up from data engineer to co-engineer a car each – Scalzo working alongside **Wally Storey**, Wettenhall with **Phil Keed**.

NASCAR has reinstated **Kelly Johnson**, a crew member in the NASCAR Sprint Cup Series, who was suspended from NASCAR after failing the governing body’s strict substance abuse policy.

**Pat Carvath**, a mechanic at BRM who was part of the crew that took **Graham Hill** to his 1962 world championship, has died at the age of 78. Carvath worked for BRM from 1952 until 1974. Former Tyrrell mechanic **John Lucas** has also died. He worked at the Surrey-based F1 team from 1975 until 1991.

**Jay Guy** has joined H Scott Motorsports as crew chief for a second full-time NASCAR Sprint Cup team. The two-car operation that has a partnership with Hendrick Motorsports to supply cars and engines, will also work closely with Stewart Hass Racing.

NASCAR Sprint Cup team owner **Mike Hillman** and Hillman Motorsports has formed a partnership with west coast businessman **Gordon Smith** as co-owner of the newly rebranded Hillman Smith Motorsports. The team will continue to use ECR Engines in its number 40 Chevrolet racecar.

Longtime ECR Engine chief operating officer **Richie Gilmore** has been promoted to the position of President. The former head of DEI Engines joined ECR in 2007 when RCR Engines merged with DEI and ECR was formed.

**Matt Braid**, the former managing director of Volvo Cars Australia, has joined the V8 Supercars championship as its commercial director. Braid worked at Volvo, for 11 years before leaving the company last September.

**Nathaniel Osborne** is now chief engineer at V8 Supercars squad Prodrive Racing (Australia), he was previously race engineer on one of the team’s Ford Falcons. Former Erebus engineer **Brad Wischusen** has joined the team to replace Osborne as race engineer for **David Reynolds**. **Jason Gray** is now also a race engineer at the team, stepping up from data engineer duties, while **Dilan Talibani** will also be on the squad’s race engineer roster.

**Barry Hay** has left V8 Supercars outfit Erebus Motorsport, where he was special projects manager, to take on the role of team manager at Lucas Dumbrell Motorsport. Hay had worked at Stone Brothers Racing – which morphed into Erebus in 2013 – for 15 years.

**Janelle Navarro** has joined V8 Supercars outfit Lucas Dumbrell Motorsport as its number one mechanic. Navarro has previously worked at Ford Performance Racing and Erebus Motorsport.

◆ Moving to a great new job in motorsport and want the world to know about it? Or has your motorsport company recently taken on an exciting new prospect. Then email with your information to **Mike Breslin** at [bresmedia@hotmail.com](mailto:bresmedia@hotmail.com)

# Race Only.

CREDENTIALS REQUIRED

**PRI2015**  
Indianapolis  
December 10-12, 2015



The *Performance Racing Industry Trade Show* showcases the latest in racing technology, ideas and new business opportunities. Connect with the world's top racing professionals and more than 1,100 exhibiting companies in Indianapolis this December.

Register Online at  
[www.pri2015.com](http://www.pri2015.com)



UK funding available through the Motorsport Industry Association (MIA)  
Contact Clare at [clare.kelly@the-mia.com](mailto:clare.kelly@the-mia.com)



# Don't stop now!

Why international motorsport cannot afford to rest on its laurels

**A**fter a busy winter of business deals let's take a look at how the next three years of growth in motorsport might take shape.

F1, NASCAR, IndyCar, WRC and sports/ GT racing face a period of great change, some by choice and some more by force.

The WRC is in recovery and is attracting new OEM brands with considerable budgets, which is good news for suppliers as world rallying was always good business, while the success of feeder series shows popularity is returning at all levels. Rallycross is catching the imagination of a new audience, demonstrating how motorsport can still be exciting 'sports entertainment' on TV. The FIA should work to merge their World Rallycross with the USA-based Red Bull Global Rallycross so everyone can benefit.

Congratulations go to the ACO and FIA for having the courage at Le Mans and WEC to encourage new energy efficient technologies, which is just what the motorsport supply chain needs. A wide range of classes is attracting OEM brand interest at many levels, so all is set for a good future. Add to this NASCAR ownership of the IMSA Tudor United Sports Car Series, and we see growth and strength in all major markets. Audiences, both live and on TV, are returning to enjoy a variety of sportscar and GT entertainment, which attracts increasing budgets from sponsors.

This growing activity in rallying and sportscar racing is good news for suppliers, and with changes in technical regulations planned for 2016 and 2017, many will enjoy improved business. The news that IndyCar is encouraging fresh ideas from potential suppliers for their new cars for 2017/18 should bring back long overdue success for that great US series.

The successful launch of the FIA's F4 series in the UK is a great result for Mygale and their suppliers, and showed many will pay for these new entry level single-seater cars. But it is a series that will cost entrants and competitors more than £150,000 to sample the best 'starter' available for new competitors.

Suppliers need to grow new markets outside of the mainstream major series. I would like to see the FIA, over the next five years, proactively work on developing motorsport in the hundred or more of their ASN's around the world, where the budgets of F4 are simply beyond a dream. What racers, clubs and suppliers in these countries need, urgently, is genuinely 'low-cost' entry level motorsport.

For many years, 'developed' motorsport countries grew and relied upon simple tubeframe chassis, with low cost engines. Our customers may 'demand' new materials and technology but this isn't the case in the majority of countries. Isn't this

exactly how new markets should start their own development and stimulate their local industry, just as happened elsewhere in the world? Our knowledgeable supply chain should build up these new markets, using their historic expertise and work with the FIA ASNs to keep entry-level costs really low. This would create volume, attract new customers for 'old' technology, and bring long-term growth. Our industry must directly help these ASNs to grow their domestic markets and so build a larger future marketplace.

NASCAR is handling a period of evolution, not revolution, needing to hold on to its many diehard fans while also attracting a new generation too. NASCAR's business model seems far more balanced than Formula 1 as the NASCAR series, consisting of many race categories, is owned and managed

numbers bring in sponsors. I'm confident the NASCAR family and their substantial marketing team will work this out, as they really know their business. Ongoing changes in the NASCAR technical regulations will always be a source of good business for our supply chains.

During the recent NFL Super Bowl spectacular, in a \$25m advertising spot entitled 'America Start your Engines', NBC Sports encouraged all 120 million viewers to 'Get some NASCAR in your life'. This light-hearted marketing stunt attracted more than 19 million hits on You Tube and shows how motorsport can, and should, be marketed; a powerful lesson which reminded all of us that we are in the entertainment business.

The long running, somewhat tedious business saga, based on the financial state of F1, sadly continues to dominate the launch of the F1 season. With no sensible solution in sight this is, predictably, damaging sponsorship income and creating even more complications for all.

This is a real shame as last year's championship was good TV, with a battle of different characters in Nico and Lewis dividing the loyalties of fans, and plenty of young pretenders to catch the audience too. Although poorly promoted, if at all, by FOM and the FIA, the advanced and expensive technology was complex enough to satisfy those fans who enjoy this part of the circus.

F1 business leaders, and the FIA as governing body of the sport, need to sort out their difficulties, and fast. The world of sports entertainment is littered with great sports that flew too close to the sun, crashed and burned. The lightning speed by which an audience can desert any sport is awesome and should never be underestimated. The increasingly limited access for F1 fans from the many Pay-TV

deals of FOM will make it harder to deliver the audience to attract sponsors.

Suppliers to F1 teams have paid a mighty price over the last few years from the closure of various teams and other expensive changes in regulations. They are vital to the lifeblood of F1 and deserve a brighter future from the world's greatest series.

The next three years will be full of great opportunities in motorsport for those who have the courage, energy, determination and resource to chase this business down. The MIA continues to grow fast to meet these increasing business demands, we exist to help you achieve your goals, so please contact us on [www.the-mia.com](http://www.the-mia.com) Good luck in the season ahead.

## The lightning speed by which an audience can desert any sport is awesome and should never be underestimated



**NASCAR's change in regulations will bring benefit to supply businesses, and it is not alone. There are opportunities in other areas of the sport**

by the long-established and experienced France family. This same family, as a major shareholder through the International Speedway Corporation of many race tracks, is directly responsible for attracting a paying audience and retaining their loyalty, while also working alongside their competitors. This gives management a hands-on feel for what their fans need on TV and at the track.

Is it really necessary for these surreal show cars, the epitome of gladiatorial racing combat, to be the same as showroom cars? They are really an advanced silhouette formula and don't need to keep their fans through a high technology story, as in F1. Their focus is on building support for the show, whether on TV or live, and know audience





Vin & Co Structures bespoke portfolios of carefully selected investment grade wines for private investors and collectors.

“ Whether you view fine wine as divine ambrosia or simply fermented grape juice this market will have you seeing pound signs £££ ”

JAMES RICHENS DIRECTOR

Get in-touch and build your fine wine portfolio today.

[www.vinandco.co.uk](http://www.vinandco.co.uk)

Email: [sales@vinandco.co.uk](mailto:sales@vinandco.co.uk) • Tel: +44 (0) 345 956 9699

45 Pont St | Knightsbridge | London SW1X 0BD

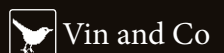
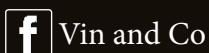

**AUTOSPORT**  
INTERNATIONAL  
**Engineering Show**

14 - 17 JANUARY 2016 NEC BIRMINGHAM

In association with **Racecar**  
engineering



**TECHNOLOGY**  
**SUPPLIERS**  
**BUYERS**

# **BUSINESS** **STARTS HERE**



**FOR MORE INFORMATION**  
**[WWW.AUTOSPORTINTERNATIONAL.COM](http://WWW.AUTOSPORTINTERNATIONAL.COM)**

## Fuel flow sensors Senstronics

New British company, Senstronics Ltd, has shown off its all-new range of FlowSonic ultrasonic fuel flow sensors. The FlowSonic line has been specifically designed to help regulate peak engine power, balance performance and promote energy efficiency. Its second-generation technology represents a viable alternative to the sensor fielded in the FIA Formula 1 World Championship and the FIA World Endurance Championship during 2014, delivering high level accuracy and repeatability in a robust and affordable package.

The FlowSonic is offered in three specifications – Elite, Super and Pro – to suit the full spectrum of racing categories, from Formula 1 to Formula 4 and LMP1 to GT3, as well as touring and rally cars.

The Elite flow meters are accurate to +/- 0.25% of reading, repeatable to +/- 0.05% of reading, can cope with a flow rate of +/- 8000



ml/min and have a working range of 0°C - 105°C operating temperature.

Every sensor in the range features no moving parts and is compatible with all fuel types.

[www.senstronics.com](http://www.senstronics.com)

## Heatshield ZircFlex FORM

Zircotec has released its first ever 'structural' ZircFlex® FORM heatshield. The new, more rigid and stainless steel heatshield will enable engineers to benefit from Zircotec's ceramic coating protection and the strength and ability to form structures. ZircFlex FORM is designed to protect drivers and componentry from conductive and reflective heat issues and offers higher levels of thermal protection than existing pressed aluminium and stainless steel products while retaining the lightweight and strength of metal.

It features a core of embossed (type 304) stainless steel sandwiched between two layers of Zircotec's proprietary ThermoHold® ceramic thermal barrier material. The thermal performance of the product is impressive with a conductivity of -0.3 W/m²K at 200degC, and when used as a contact heatshield it offers the following surface temperature reductions: -83degC for a hot surface of 200degC, and -180degC for hot surfaces of 500degC.

It's extremely lightweight and tips the scales at 2.9 kg/m². It can also be easily bent or formed to produce complex rigid shapes and structures with the added benefit that it can be cut by guillotine, by hand using snips or range of machine tools. The shielding comes in a range of surface finishes and is available in gold, silver or grey/green.

[www.zircotec.com](http://www.zircotec.com)

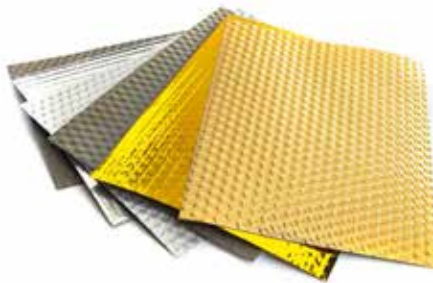

## Lapping and polishing

# The other meaning of lapping... and how it can lead to you lapping your competitors



Kemet International proves that it's not only race teams that are obsessed with lapping. The Kent-based company has been at the forefront of lapping and polishing techniques for more than 40 years, and has worked with several UK-based high performance race teams during that time.

Lapping is a process developed to generate extremely high levels of flatness, typically 0.5-1.0 micron, and can be performed on any material. This high precision flatness is critical for surfaces that need to seal against each other with no soft gasket material and helps to minimise friction when surfaces run against each other. This level of flatness

also spreads loadings evenly across larger surfaces, increasing the active life of a component.

Lapping also generates very good surface finish figures and Ra values (surface roughness) from 0.005µm to 0.050µm are easily achievable using the right combination of abrasive slurry and lapping plate material. These fine surface finishes reduce the initial wear characteristics of a component and can also be tailored to hold exactly the right amount of lubrication between components so there is no danger of them ever ringing together, even under extreme running conditions.

Lapping is also used to generate accurate convex or concave forms, allowing parts which distort under load to be produced to generate the best contact surface when under that load and overcome the distortions that lead to a smaller area of contact. Kemet International are also specialists in shoulder lapping, a process which accurately laps and polishes sealing faces that are part of a shaft. Developed initially for use within the aerospace industry, this is also extremely relevant for gear faces and hydraulic assemblies.

For further information, please visit [www.kemet.co.uk](http://www.kemet.co.uk) or email [sales@kemet.co.uk](mailto:sales@kemet.co.uk).



**PIT CREW**

**Editor**

Andrew Cotton  
 @RacecarEd

**Deputy editor**

Sam Collins  
 @RacecarEngineer

**News editor**

Mike Breslin

**Design**

Dave Oswald

**Chief sub editor**

Simon Toyne

**Technical consultant**

Peter Wright

**Contributors**

Mike Blanchet, George Bolt Jr, Ricardo Divila, Gemma Hutton, Simon McBeath, Danny Nowlan, Mark Ortiz, Oleg Stozhkov, Pierre Salmon, Peter Wright

**Photography**

James Moy

**Deputy managing director**

Steve Ross  
 Tel +44 (0) 20 7349 3730  
 Email steve.ross@chelseamagazines.com

**Head of business development**

Tony Tobias Tel +44 (0) 20 7349 3743  
 Email tony.tobias@chelseamagazines.com

**Advertisement manager**

Lauren Mills Tel +44 (0) 20 7349 3740  
 Email lauren.mills@chelseamagazines.com

**Advertisement sales executive**

Lucy Caller Tel +44 (0) 20 7349 3745  
 Email lucy.caller@chelseamagazines.com

**Marketing manager**

Will Delmont Tel +44 (0) 20 7349 3710  
 Email will.delmont@chelseamagazines.com

**Publisher**

Simon Temlett

**Managing director**

Paul Dobson

**Editorial**

Racecar Engineering, Chelsea Magazine Company, Jubilee House, 2 Jubilee Place, London, SW3 3TQ

**Tel**

+44 (0) 20 7349 3700

**Advertising**

Racecar Engineering, Chelsea Magazine Company, Jubilee House, 2 Jubilee Place, London, SW3 3TQ

**Tel**

+44 (0) 20 7349 3700

**Fax**

+44 (0) 20 7349 3701

**Subscriptions**

Subscriptions Department  
 800 Guillat Avenue, Kent Science Park  
 Sittingbourne, Kent ME9 8GU

**Tel**

+44 (0) 1795 419837

**Email**

racecar@servicehelpline.co.uk

**http://**

racecar.subscribeonline.co.uk

**Subscription rates**

UK £66 (12 issues)

USA \$162 (12 issues)

ROW £84 (12 issues)

**News distribution**

Seymour International Ltd, 2 East Poultry Avenue, London EC1A 9PT

**Tel**

+44 (0) 20 7429 4000

**Fax**

+44 (0) 20 7429 4001

**Email**

info@seymour.co.uk

**Printed by**

Southernprint Ltd

**Printed in England**

ISSN No 0961-1096

USPS No 007-969



www.racecar-engineering.com

# Russian politics

In producing the feature on the Russian ArtLine F3 car, it appears that we stumbled into something of a political minefield as a series of issues arose from the design of the ARTTech P315. The team is planning an assault on the FIA European Formula 3 Championship, but required a little bit of leeway in the interpretation of the regulations to get certain elements of the car into the final design.

In Formula 3, there is open chassis regulation, but here our Russian friends have hit a rather major stumbling block. Their chassis has to incorporate the homologated exhaust layout and, they say, this places a restriction on design and rather pushes designers to go down a similar path to Dallara. The team has argued that there will be no performance advantage and that the changes are necessary, and even offered to try to persuade Neil Brown Engineering to homologate another exhaust configuration.

The FIA is clear in its response. NBE has already homologated one exhaust, and cannot homologate another unless for reliability reasons. The exhaust must, as homologated, exit in the sidepod, not a central location at the rear. This does not fit with the Russian design to get around the pull rod suspension.

In a collective letter to the FIA Manufacturers' Commission, Single Seater Commission and Chairman of the Single Seater Technical Working Group, Vasily Antipov, director of ArtLine Engineering, Gavin Harrison, manager of Neil Brown Engineering and Serge Meyer, director of ORECA, outlined the problem. 'Since Formula 3 is not a single make series, but an engineering racing category, we believe that different chassis types with different aerodynamic and mechanical solutions should be welcomed to participate in the relevant championships, provided that they comply with the technical regulations,' they say in their letter. 'Nevertheless, the current technical regulations are explicitly composed around the only existing Formula 3 chassis up to date – Dallara F314, including the homologated dampers, gearbox casing and exhaust systems which are designed to fit only Dallara F312-F314 chassis.

Therefore, several design features implemented in ARTTech P315, such as pull-rod suspension layouts and exhaust system central tail pipes, cannot be homologated in our chassis due to unofficial prohibition by FIA Single Seater Technical Working Group based on the relevant articles of the Technical Regulations (2.7.5, 2.7.6, 5.1.2 a), which leave no room for us to suggest a chassis

significantly different from the current FIA F3 chassis, yet fully complying with all the specific and clearly defined provisions of the Technical Regulations.'

The FIA has invited the team to build the car as specified in drawings submitted by the team, but warned that it would then become a matter for the stewards of the first meeting to decide on its legality. The team accepted the challenge and will present its car at the first race.

It seems that the central exhaust is the only part of the design that cannot be adequately accommodated. The team has worked with Hewland Engineering and ITT-Motion Technologies to address another issue surrounding the gearbox casing and the two-way adjustable front and rear suspension dampers by installing valving systems to the standard dampers. It would appear that Dallara itself is not opposed to the new design of the gearbox, and so these issues at least appear to have been resolved.

So, it appears that it is all down to the engine. In the letter, ArtLine says that 'the current state of affairs is forcing every new chassis manufacturer willing to enter the Formula 3 market to bring along a new engine manufacturer supplying the engines exclusively to it. Otherwise, every new chassis manufacturer has to copy the design of existing chassis, thus

limiting its engineering capacity and marketing power.

'We believe this to be in breach of FIA Statute Article 1 (political discrimination i.e FIA's policy of turning FIA F3 European Championship into a single make series), Article 2 (failing to promote the development of motor sport) and Article 21 (failing to make proposals to World Motor Sport Council on subjects of common interest) as well as in breach of international anti-monopoly laws.'

The team says that it hopes to 'leave room for progress, yet supporting fair competition between manufacturers, teams and drivers' and that the letter was 'by no means... aimed at gaining an unfair advantage, or destabilising the Formula 3 market.'

This case is an interesting by-product of spec-formula racing. Should an element of technical homologation define a specific part of chassis design, and is that the skill of the designer, or should the FIA relax its stance and allow such modifications? Mercedes and Volkswagen are, according to the team, not willing to enter into negotiations, leaving the Russians with possible options; not take part in European F3, or homologate a new engine. Or turn up and race. It has chosen the latter.

**ANDREW COTTON** Editor

**This case is an interesting by-product of spec formula racing**

To subscribe to *Racecar Engineering*, go to [www.racecar-engineering.com/subscribe](http://www.racecar-engineering.com/subscribe) or email [racecar@servicehelpline.co.uk](mailto:racecar@servicehelpline.co.uk) telephone +44 (0) 1795 419837

\* *Racecar Engineering*, incorporating *Cars & Car Conversions* and *Rallysport*, is published 12 times per annum and is available on subscription. Although due care has been taken to ensure that the content of this publication is accurate and up-to-date, the publisher can accept no liability for errors and omissions. Unless otherwise stated, this publication has not tested products or services that are described herein, and their inclusion does not imply any form of endorsement. By accepting advertisements in this publication, the publisher does not warrant their accuracy, nor accept responsibility for their contents. The publisher welcomes unsolicited manuscripts and illustrations but can accept no liability for their safe return. © 2015 Chelsea Magazine Company. All rights reserved.

\* Reproduction (in whole or in part) of any text, photograph or illustration contained in this publication without the written permission of the publisher is strictly prohibited. *Racecar Engineering* (USPS 007-969) is published 12 times per year by Chelsea Magazine Company in England.



180 MPH WITHOUT MOVING AN INCH

Take cutting-edge wind tunnel technology. Add a 180 mph rolling road. And build in the best in precision data acquisition capabilities. When we created the world's first and finest commercially available full-scale testing environment of its kind, we did much more than create a new wind tunnel. We created a new standard in aerodynamics.



+1 704 788 9463

INFO@WINDSHEARINC.COM

WINDSHEARINC.COM

# What's the **secret** about the new 911 GT3 Cup's **new brakes?**



It's Quicker.™



OFFICIAL PARTNER

**PORSCHE**  
MOTORSPORT

**PFC**  
BREMSE