

# CAVAZOTTO

Rua Florianópolis, 570 - Centro - Coronel Freitas - SC - Brasil - CEP: 89840-000  
Telefone: +55 (49) 3347-0207 - cavazotto@cavazotto.com.br

## MANUAL DE MONTAGEM

### ROUPEIRO 3 PORTAS BRASIL

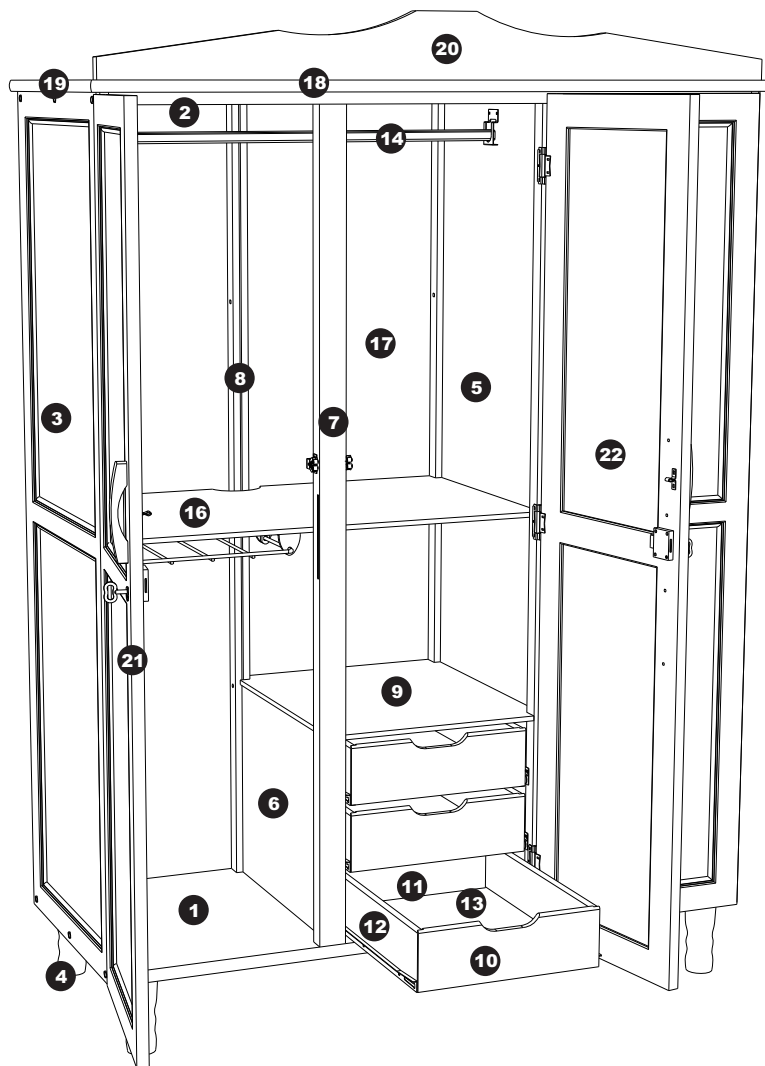

#### COMPONENTES

- |  |  |
|--|--|
| 1 - Base inferior (1220x500x23mm)                      | 12 - Travessa lateral da gaveta (x6)<br>(450x110x11mm) |
| 2 - Base (1220x500x23mm)                               | 13 - Fundo da gaveta (x3) (335x450x3mm)                |
| 3 - Lateral do roupeiro (x2)<br>(500x1545x20mm)        | 14 - Cabideiro (820x20x20mm)                           |
| 4 - Pés (x4) (50x50x90mm)                              | 15 - Prateleira menor (x3) (465x400x9mm)               |
| 5 - Divisória completa (500x1500x50mm)                 | 16 - Prateleira calceiro (x1) (820x465x9mm)            |
| 6 - Divisória esquerda do gaveteiro<br>(460x380x3mm)   | 17 - Fundo do roupeiro (x3)<br>(420x1545x3mm)          |
| 7 - Coluna frontal (50x1500x30mm)                      | 18 - Moldura frontal (1260x45x20mm)                    |
| 8 - Coluna traseira (30x1500x30mm)                     | 19 - Moldura lateral (x2) (515x45x20mm)                |
| 9 - Tampo do gaveteiro (500x425x9mm)                   | 20 - Detalhe (1260,120x20mm)                           |
| 10 - Travessa frontal da gaveta (x3)<br>(325x95x11mm)  | 21 - Porta do roupeiro (x2)<br>(390x1535x20mm)         |
| 11 - Travessa traseira da gaveta (x3)<br>(325x95x11mm) | 22 - Porta do roupeiro com espelho<br>(390x1535x20mm)  |

## FERRAMENTAS NECESSÁRIAS



Chave philips

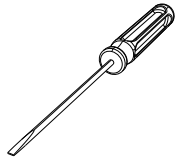

Chave de fenda

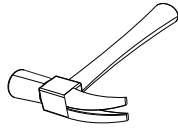

Martelo

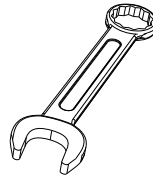

Chave de boca nº6

## FERRAGENS

**A**



Cavilha 8x30 (x4)

**B**

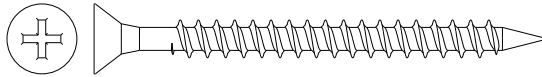

Parafuso philips 5,0x60mm (x4)

**C**

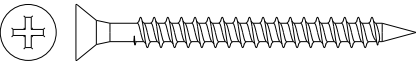

Parafuso philips 4,0x45mm (x22)

**D**



Tapa-furo  
10mm (x12)

**E**

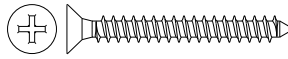

Parafuso philips 4x30mm (x13)

**F**



Parafuso philips  
3,5x16mm cabeça  
panela (x50)

**G**

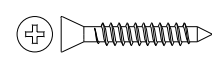

Parafuso philips  
3,5x25mm (x12)

**H**

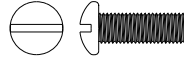

Parafuso fenda  
5/32x5/16 cabeça  
panela (x2)

**I**



Porca nº6  
(x2)

**J**



Prego 10x10 (x90)

**K**



Suporte para  
prateleira (x22)

**L**



Parafuso philips  
3,5x14mm (x24)

**M**

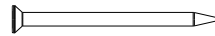

Prego 12x12 (x36)

## ACESSÓRIOS

**N**

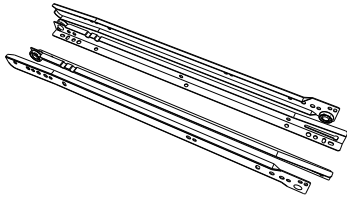

Par de correias (x3)

**O**

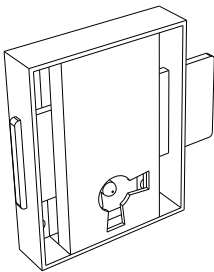

Fechadura (x3)

**P**

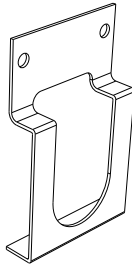

Suporte para  
cabideiro (x2)

**Q**

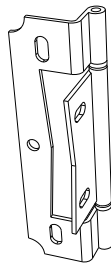

Dobradiça (x9)

**R**

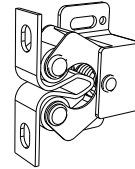

Fecho rolete (x3)

**S**

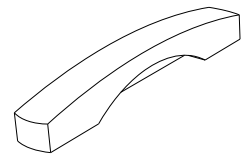

Puxador (x3)

**T**

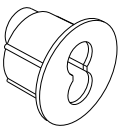

Guia para chave (x3)

**U**

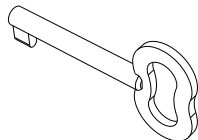

Chave (x3)

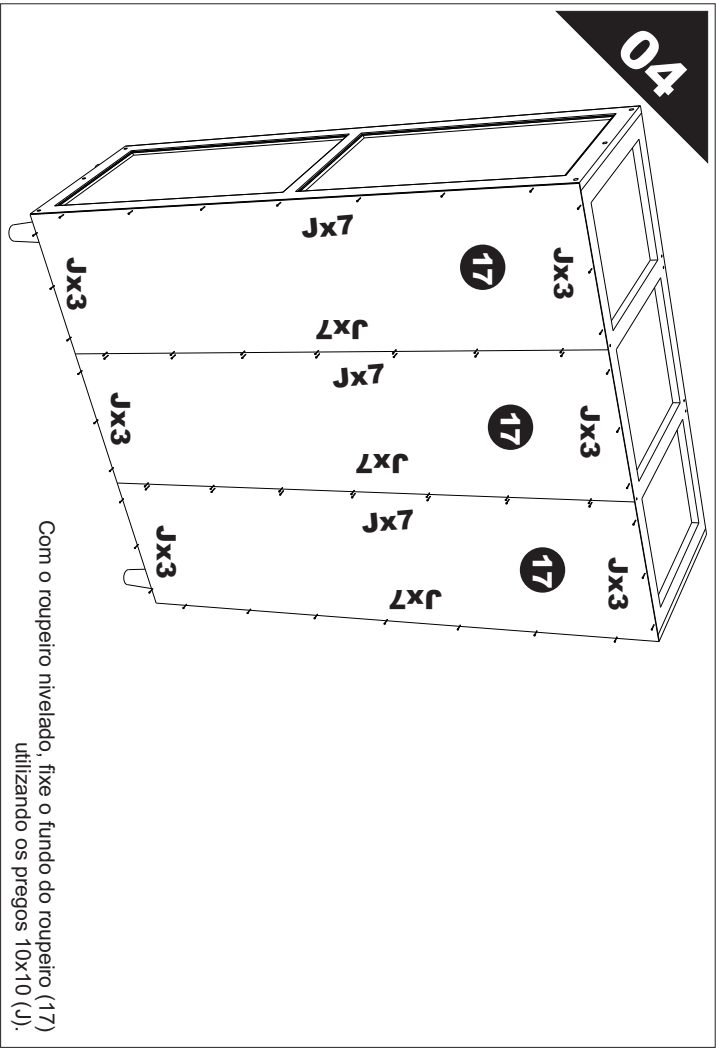
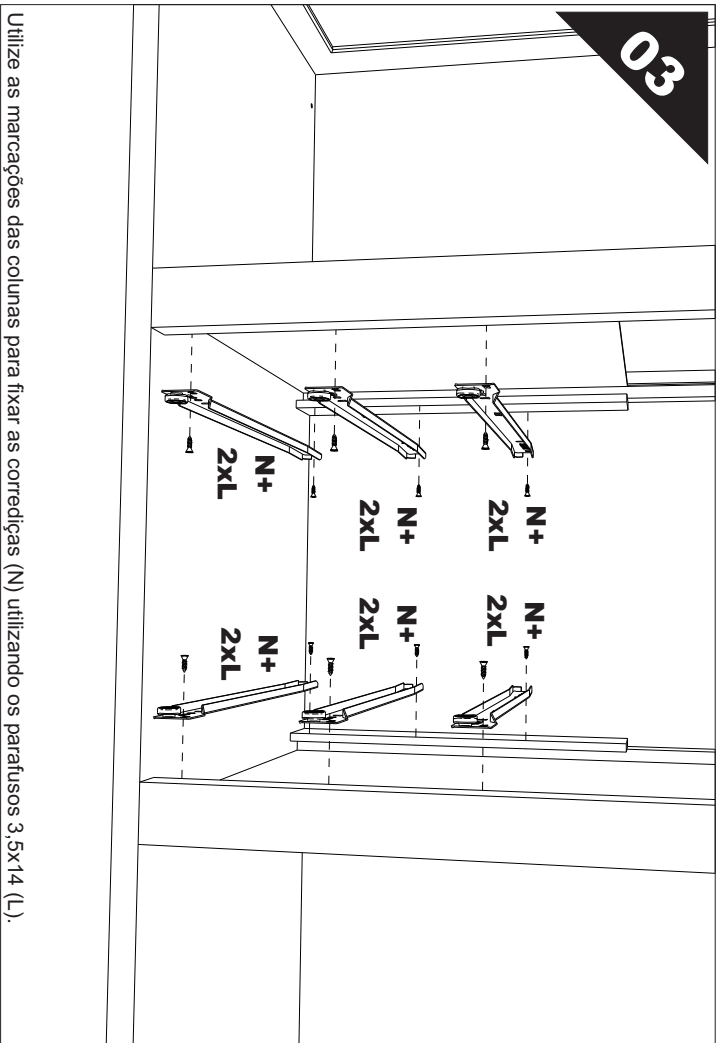
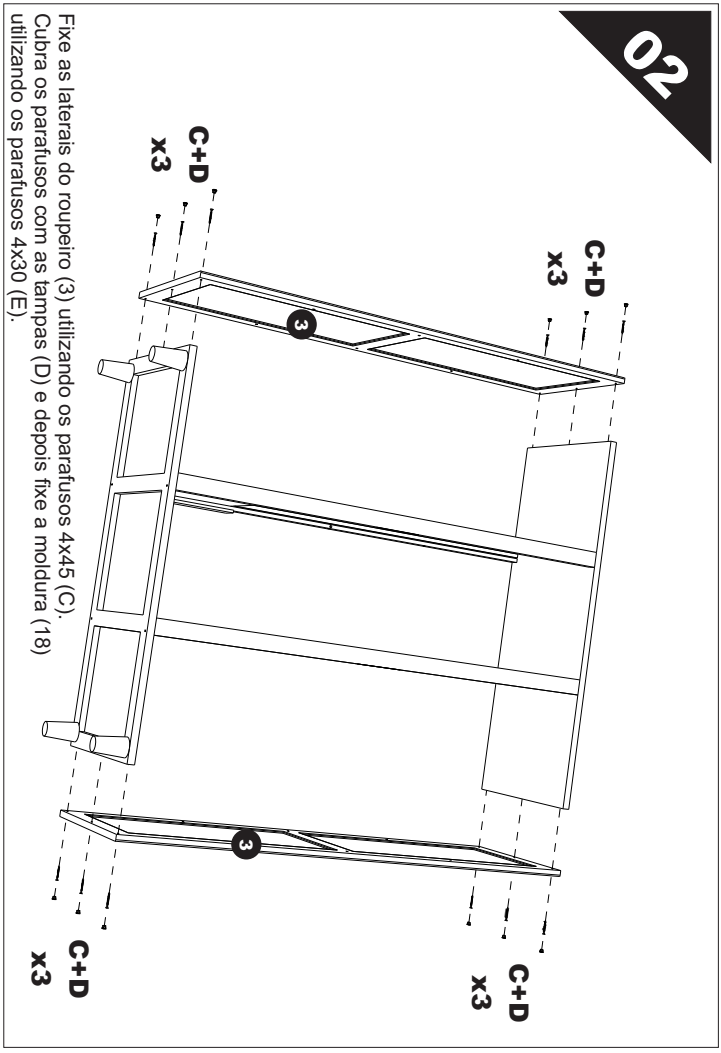
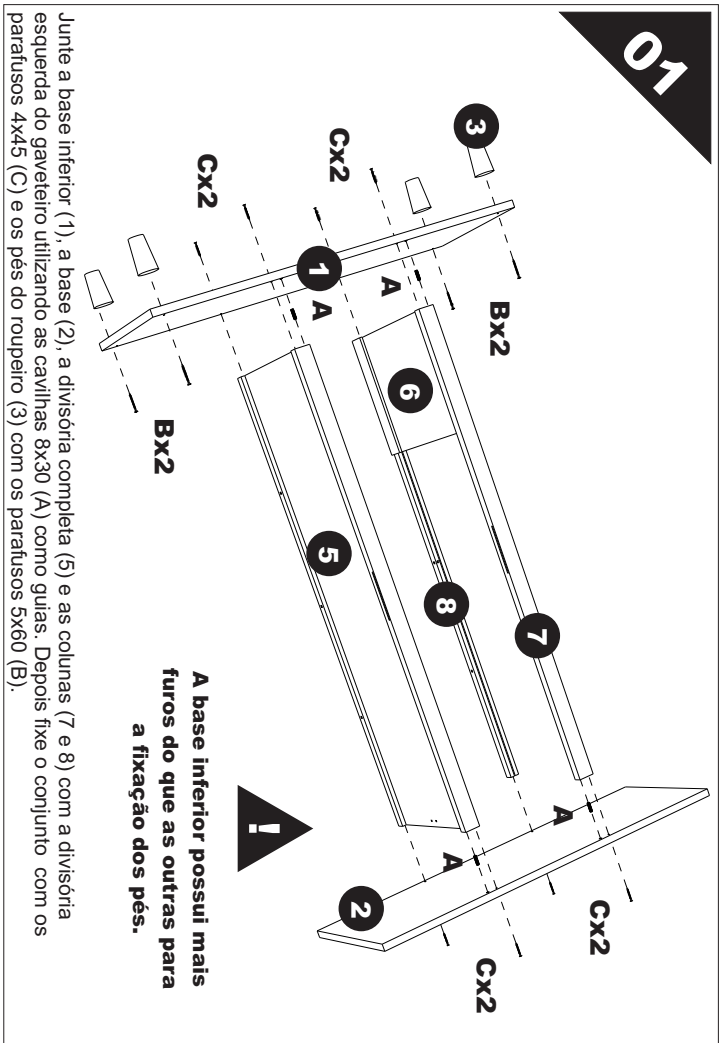

05

DETALHE 01

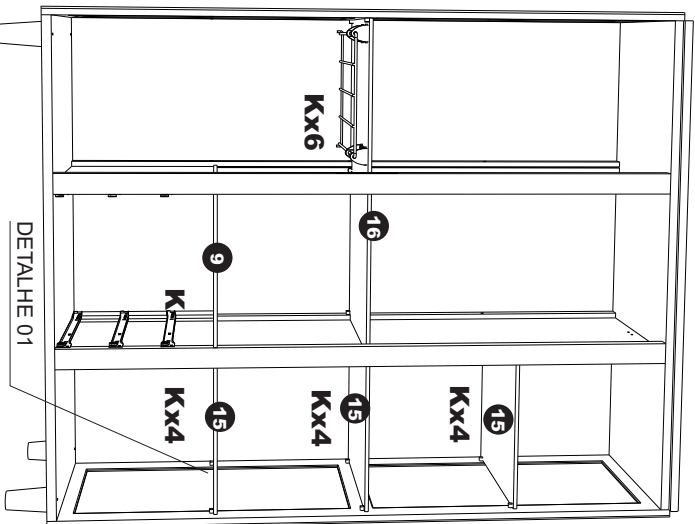
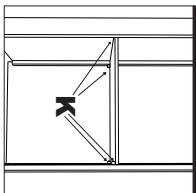

Insira os suportes para prateleira (K) nos furos localizados no interior do roupeiro e coloque as prateleiras menores (15), assim como a prateleira do calceiro (16) e o tampo do gaveteiro (9).

06

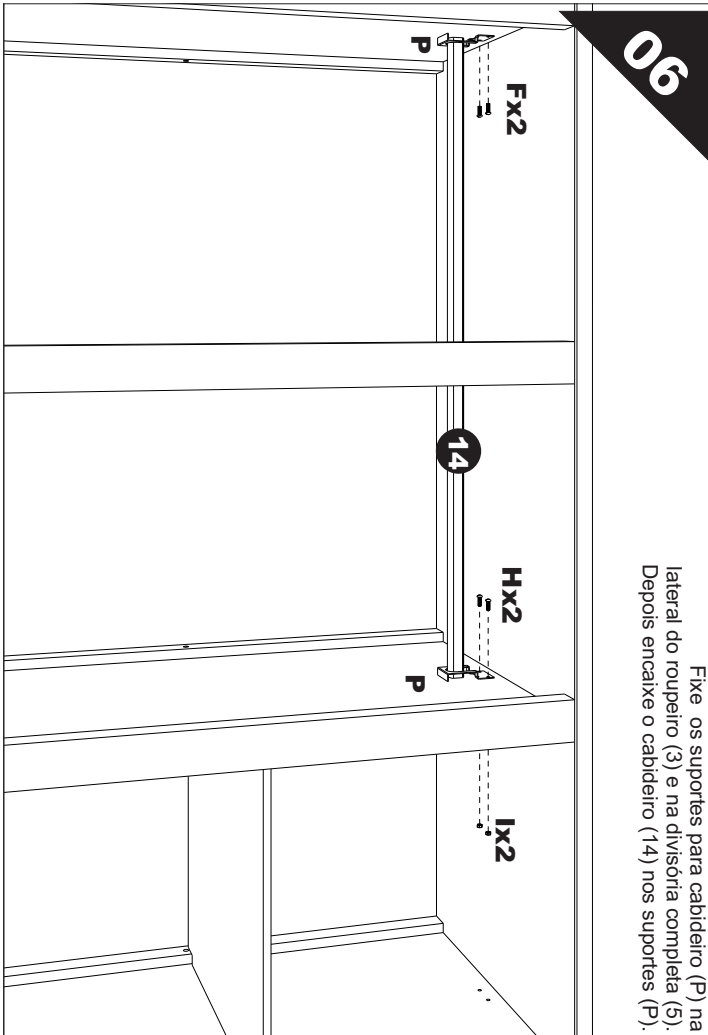

Fixe os suportes para cabideiro (P) na lateral do roupeiro (3) e na divisória completa (5). Depois encaixe o cabideiro (14) nos suportes (P).

07

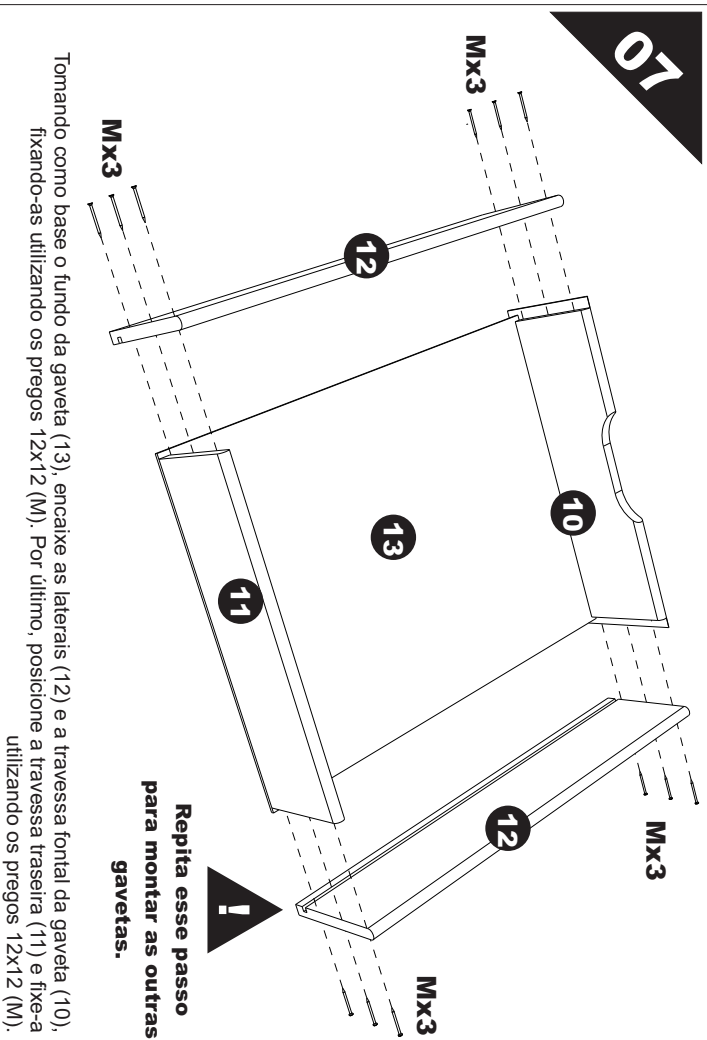

Repita esse passo para montar as outras gavetas.

Tomando como base o fundo da gaveta (13), encaixe as laterais (12) e a travessa frontal da gaveta (10), fixando-as utilizando os pregos 12x12 (M). Por último, posicione a travessa traseira (11) e fixe-a utilizando os pregos 12x12 (M).

08

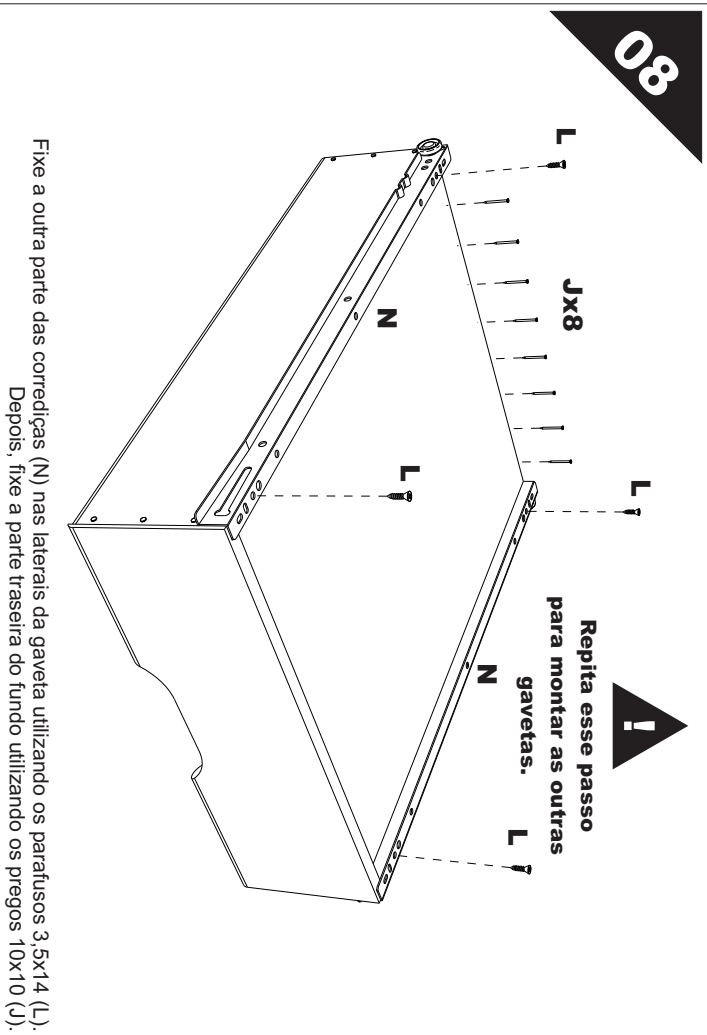

Repita esse passo para montar as outras gavetas.

Fixe a outra parte das corredeiras (N) nas laterais da gaveta utilizando os parafusos 3,5x14 (L). Depois, fixe a parte traseira do fundo utilizando os pregos 10x10 (J).

09

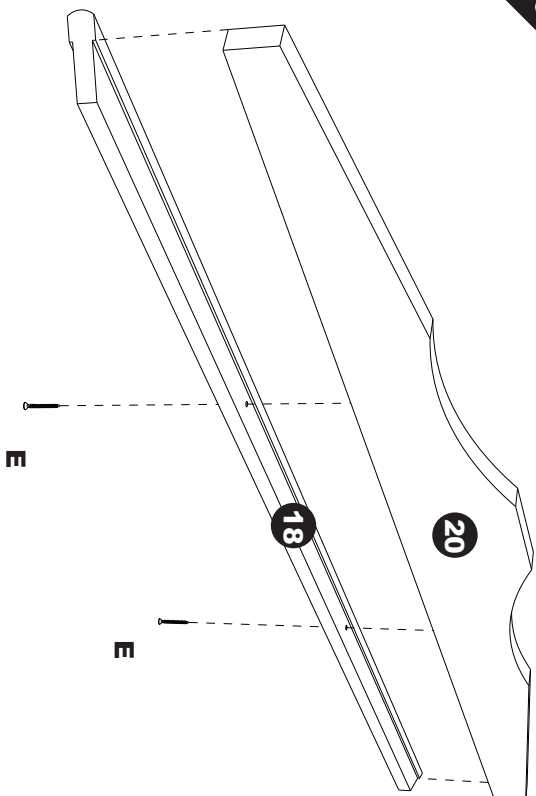

Alinhe o detalhe (20) na moldura frontal (18) conforme demonstra a imagem e fixe-os utilizando os parafusos.

10

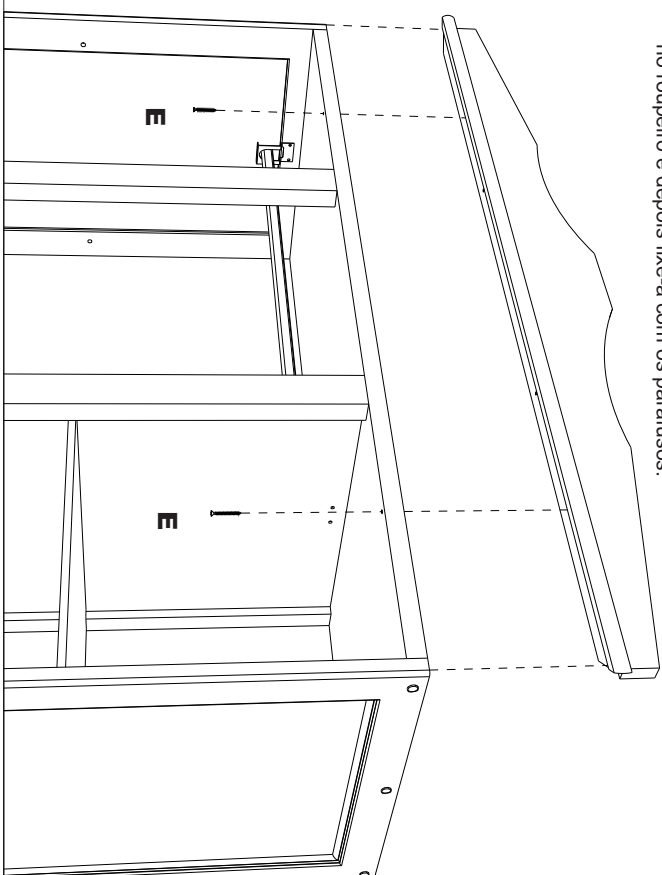

Encaixe e centralize a moldura com o detalhe no roupeiro e depois fixe-a com os parafusos.

11

Encaixe as molduras laterais (19) e fixe-as utilizando os parafusos nos locais indicados.

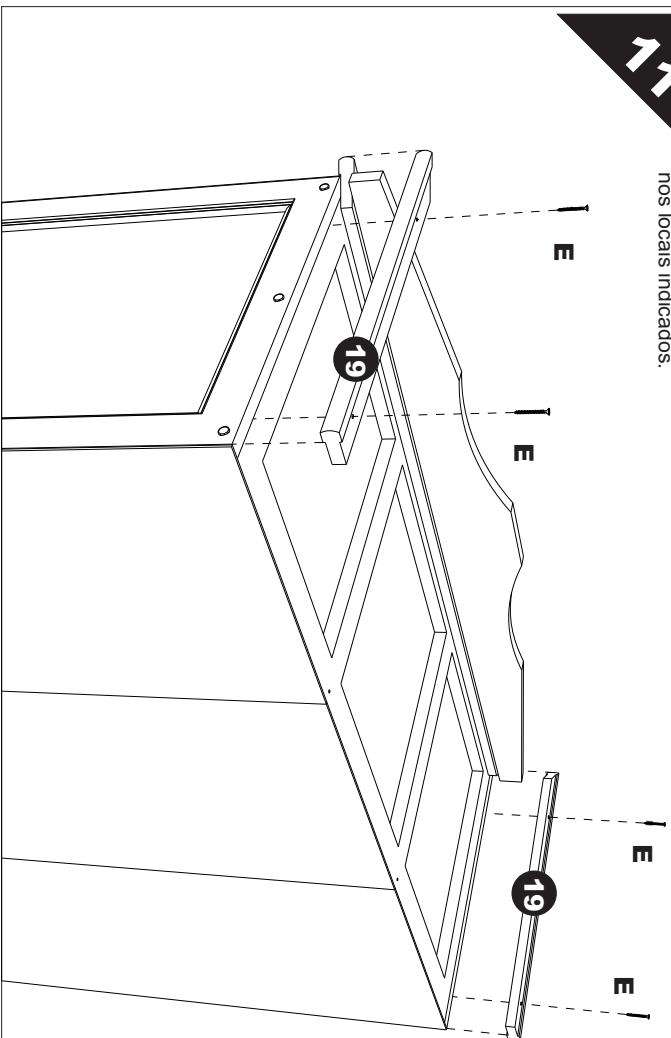

12

**!**  
A parte menor da dobradiça deve ser presa à porta.

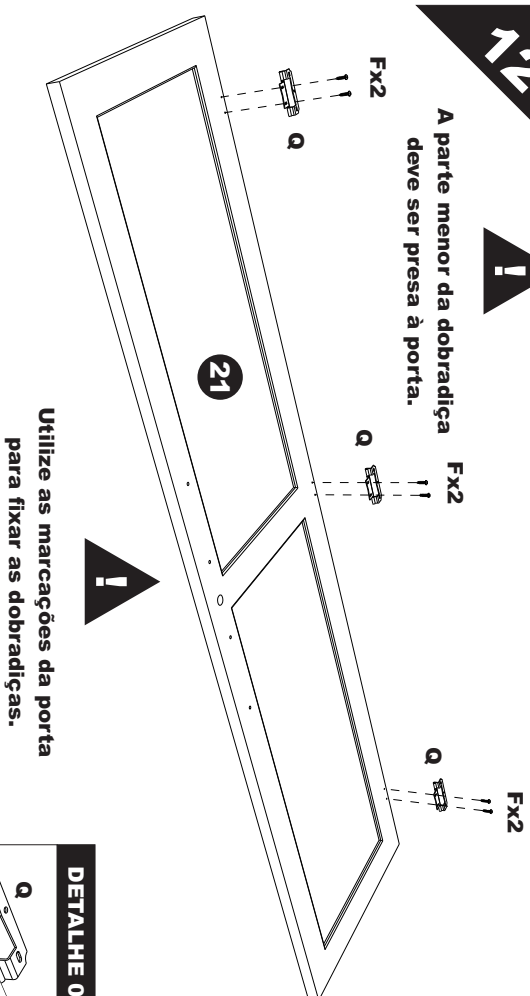

Utilize as marcações da porta para fixar as dobradiças.

Fixe a parte menor das dobradiças (Q) nas portas utilizando as marcações como auxílio.

DETALHE 02

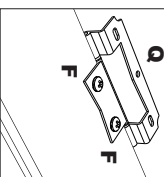

500mm

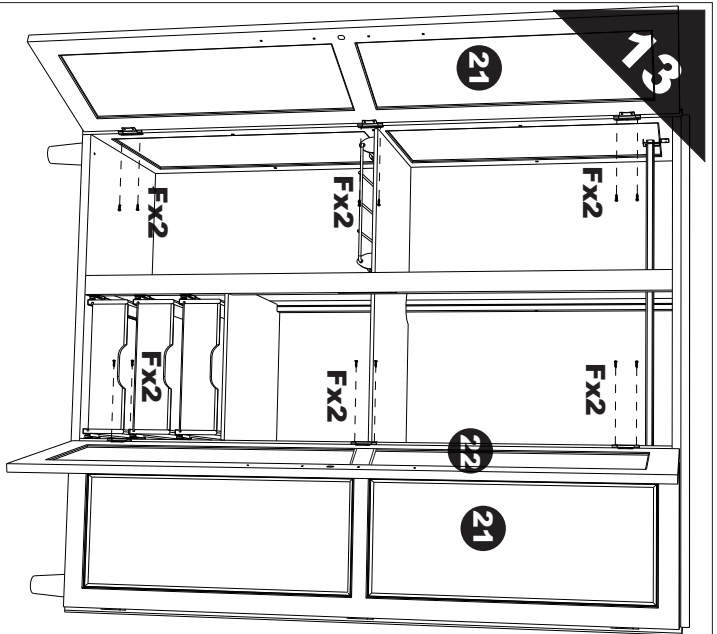
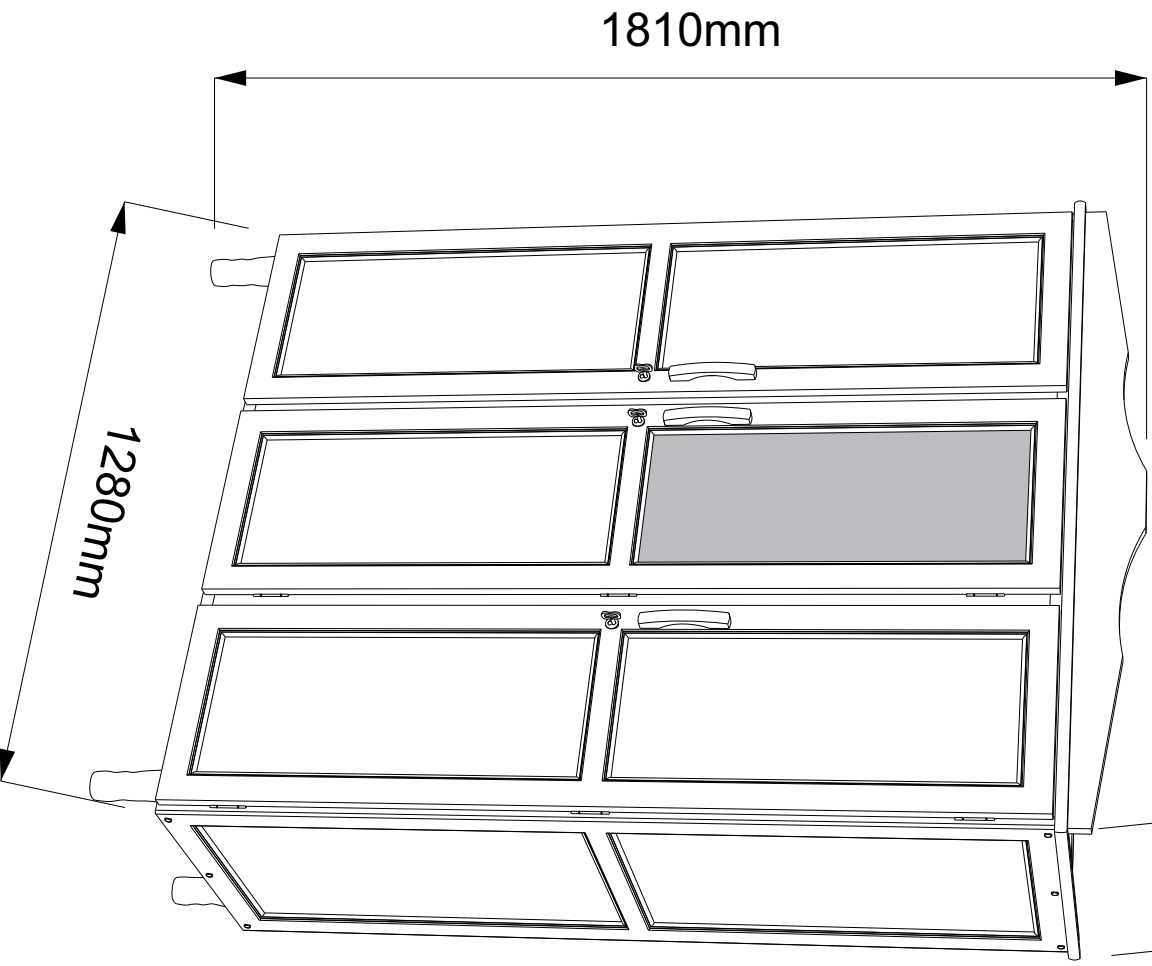

**!** Repita o passo para instalar as outras portas.

Fixe as portas no roupeiro de modo que fiquem alinhadas em suas alturas e centralizadas entre as colunas e as laterais do roupeiro.

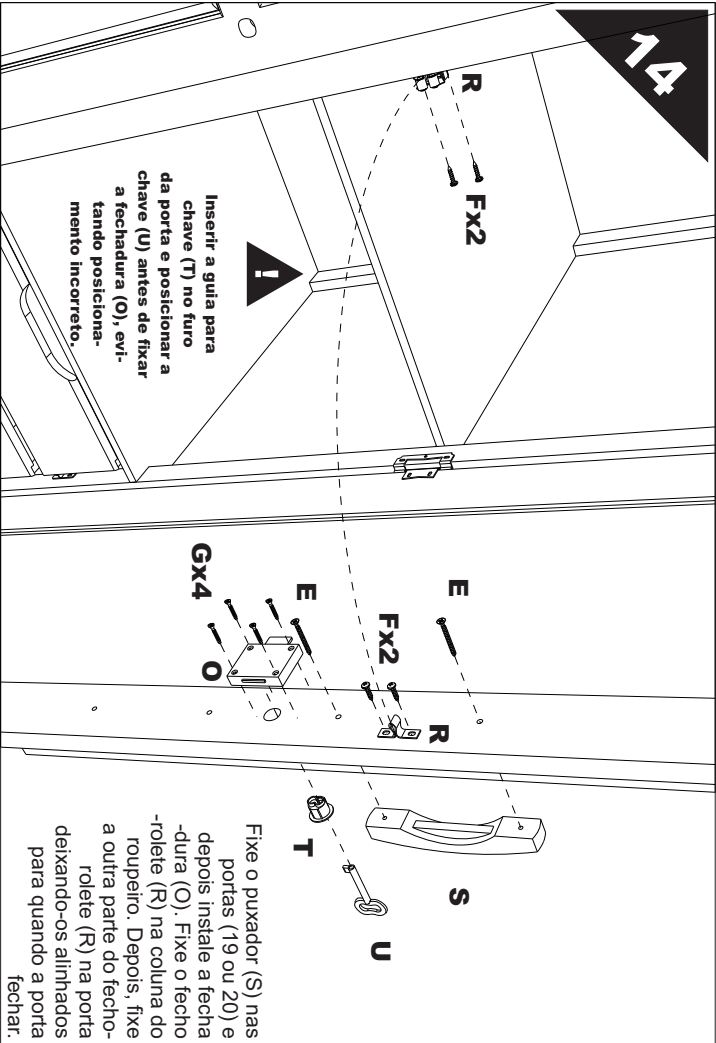

14