

# AUTOSPORT

**WORLD EXCLUSIVE**

www.autosport.com • AUGUST 22 2013 • £3.50

# DRIVEN!

**DAVID COULTHARD**  
FLAT-OUT IN LOEB'S  
RECORD BREAKER

“There’s plenty of  
get-up-and-go from  
Pikes Peak racer”



**PLUS**

**F1 IS BACK!**  
But how much  
does it all cost?

We analyse the  
astronomical  
numbers in full

haymarket



3 4 >  
C\$8.99



IMPERIAL RANGE



METRIC RANGE



TENDER | HELPER



OFF ROAD



COIL SLEEVE



BUMP STOPS

DOMINATE THE TRACK. RULE THE STREET.

ERS | Eibach Race Spring System

- Over 1,300 single components - main and tender springs - metric and imperial, various auxiliary race suspension accessories, ready and in stock on 5 continents
- Comprehensive Program of single components
- Single Main Springs with highest rate-linearity and lowest rate tolerance
- Progressive Characteristics via set-up of different springs serially - double or even triple spring combinations
- Extreme Low Weights achieved through Super Hi-Ten materials and manufacturing technology
- Smallest Solid heights, maximized spring travels and higher maximum loads
- Spring Surface Stabilization through specialized shot peening
- Every ERS Spring preset to block
- Block and Sag Resistant
- Smallest Tolerances and precise plane parallelism of spring ends
- High Dynamic Durability - under Motorsports conditions
- High quality corrosion protection by phosphating and epoxy coating
- Springs Printed with part-number (speaking code = rate and dimensions)
- Individual protective single box packaging



eibach.com

**POLE POSITION**

# Ricciardo/Raikkonen: F1 powerplay at work

IT FEELS LIKE AN EON, RATHER THAN A MONTH, SINCE the Hungarian Grand Prix. The twists and turns of Budapest are a world apart from Spa-Francorchamps, which poses an altogether different challenge for our world championship stars this weekend.

However, all talk today (Thursday) will be about Daniel Ricciardo's Red Bull Racing deal. With Kimi Raikkonen out of the frame – unless it was some last-ditch, football transfer-style powerplay – Mark Webber will be replaced by his fellow countryman. When it comes to career breaks, this is as big as it gets; expect Ricciardo to be asked “what will it take to beat Sebastian Vettel?” at least a hundred times this weekend!

If the will of internet opinion had its way, Raikkonen will be partnering Fernando Alonso at Ferrari next year. But as Mark Hughes so eruditely writes it in his column this week on page 9, would Luca di Montezemolo ever countenance the Finn's return? Mark thinks not.

While the intrigue plays out in the paddock, the proper stuff takes place at Eau Rouge, Les Combes and Pouhon – perhaps the final time you'll ever hear V8-powered F1 cars around there.



**CHARLES BRADLEY EDITOR**  
charles.bradley@haymarket.com  
@Autosport\_Ed

**BAMBER'S WEEK**

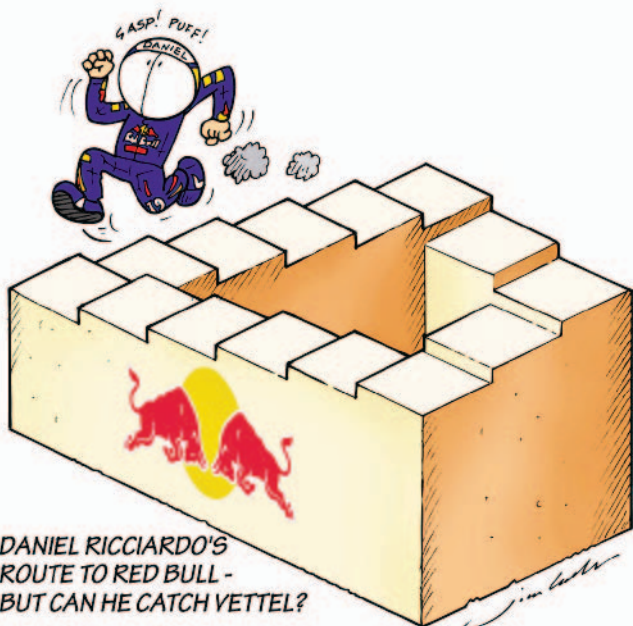

**FIND US ON**



Cover Image: Griffiths/LAT

**PIT & PADDOCK**

6 **THIS WEEK IN F1**

9 **MARK HUGHES: MPH COLUMN**

10 **THIS WEEK IN MOTORSPORT**

20 **BELGIAN GP PREVIEW**

F1's back after the month-long summer break

**DEBRIEF**

26 **HAMILTON'S TITLE SHOT**

Why Merc ace can give Vettel and Red Bull a fright

28 **INDYCAR PLANNING GLOBAL SPREAD**

US single-seater series considers expansion

30 **NEW SUPER GT CARS BREAK COVER**

Honda, Lexus and Nissan reveal DTM-style racers

33 **OBITUARY: KARL-HEINZ KALBFELL**

Remembering the former BMW Motorsport chief

**FEATURES**

12 **COULTHARD TESTS PIKES PEAK PUG**

David Coulthard straps himself into Sebastien Loeb's monstrous 208 T16 and goes for a blast

25 **15 QUESTIONS: SIR STIRLING MOSS**

'Mr Motor Racing' in the spotlight

34 **THE TRUE COST OF FORMULA 1**

How much do the 11 teams *really* spend each year?

56 **BRANDS F3000 SHUNT 25 YEARS ON**

The day Johnny Herbert's world turned upside down

64 **OULTON PARK'S 60TH BIRTHDAY**

Ian Titchmarsh on the Cheshire venue's milestone

**RACE CENTRE**

44 **DTM NURBURGRING**

Robert Wickens takes first win for Mercedes

46 **EUROPEAN F3 NURBURGRING**

Three out of three for Italian Rafaele Marciello

48 **FIA GTs SLOVAKIA**

Afanasiev/Simonsen beat rejuvenated WRT Audis

50 **AUTO GP NURBURGRING**

Karthikeyan and Sato win – Japanese takes lead

55 **NASCAR; GRAND-AM; SUPER GT**

**SUBSCRIBE FOR A FREE GIFT**

40 **FREE WILLIAMS CREDIT CARD CASE**

Subscribe for a great free gift and digital package

**CLUB AUTOSPORT**

83 **CLUB CLIOS TO EXPAND IN 2014**

Popular entry-level series gets championship status

84 **GT4 BOOST FOR GINETTA G55 RACER**

Yorkshire marque to graduate to British GT class

88 **REPORTS**

Silverstone MSVR; Thruxton BARC; Shelsley Walsh BHC; Snetterton Britcar; Donington Park BARC; Oulton Park BARC; Pembrey VSCC

**THE BACK STRAIGHT**

98 **THIS WEEK**

Readers' letters; best pictures; product reviews

100 **WHAT'S ON**

The best track and TV action in the coming week

102 **RACE OF MY LIFE: LAURENT AIELLO**

Victory in the blue-riband Monaco F3 GP in 1990

# THE BIG PICTURE

Former grand prix winner David Coulthard downloads Sebastien Loeb before trying his fearsome Pikes Peak Peugeot 208 T16. See how DC fared on page 12...





MICHELIN  
SEW  
USOCOME

RICHARD MILLE

208



GARETT/PS/LAT

# This week in F1

## RICCIARDO CLOSING ON RED BULL

Daniel Ricciardo is set to land the Red Bull seat for 2014 after Kimi Raikkonen was ruled out of contention for the drive.

The Australian, currently racing for Scuderia Toro Rosso, impressed during his test outing at Silverstone in July, and with Raikkonen's management confirming the Finn is not in the running for the seat, the way is clear for Ricciardo.

"Kimi will not be driving for Red Bull in 2014," manager Steve Robertson told AUTOSPORT. "We held some talks, but a deal will not be happening."

Raikkonen is now most likely to remain with the Lotus squad, although Robertson stresses that his driver does have other options.

Ricciardo has raced for Toro Rosso since the start of 2012, following an 11-race stint with the HRT squad. His promotion will open the way for Antonio Felix da Costa to graduate to Formula 1 as team-mate to Jean-Eric Vergne at STR.

Ricciardo tested RB9 at Silverstone



THOMPSON/GETTY



THOMPSON/GETTY

6

## SYMONDS GETS TO WORK IN WILLIAMS ROLE

Pat Symonds started work at Williams on Monday and will attend his first race as its technical director in Belgium this weekend.

Symonds, who quit as Marussia technical consultant last month, has taken over the role previously held by Mike Coughlan, who has now left the team. Symonds spent the first part of this week at

the Williams factory and will evaluate the workings of the race team at Spa.

One of the new technical director's short-term priorities will be to help boost the performance of the 2013 Williams, although he will also have a key role to play in the development of next year's car. "Hopefully [he can] deliver performance

to the end of the season on the FW35 and then help with the development of the FW36 for next year," said deputy team principal Claire Williams.

Symonds first came into Formula 1 with Toleman in 1981, enjoying world championship success in the mid-1990s and 2000s with Benetton/Renault.



COATES/LAT

### WILLIAMS TECHNICAL DIRECTORS

Symonds is only the fourth person to hold the title of technical director at Williams. Here are his predecessors...

#### PATRICK HEAD 1977-2004

Although he did not assume the title, which he is credited with creating, until the mid-1980s Head was effectively Williams's technical director for more than a quarter of a century. On his watch, the team won nine constructors' and seven drivers' titles.



DUNBAR/LAT

#### SAM MICHAEL 2004-2011

Groomed as Head's successor after joining from Jordan in 2001, he became technical director in 2004, leading the team to Brazilian GP victory. The ensuing years were a mixed bag and he eventually quit during a dismal 2011 campaign.



DUNBAR/LAT

#### MIKE COUGHLAN 2012-2013

Coughlan played a key role in getting Williams back to winning ways in 2012, when Pastor Maldonado won the Spanish Grand Prix. But his failure to turn around the team's difficult start to the 2013 season eventually led to him agreeing to part company with the team.



DUNBAR/LAT

For all the breaking news, visit **AUTOSPORT.COM**



## Force India plans base expansion

Force India is evaluating an upgrade to its facilities, with a new 60 per cent windtunnel being a possibility.

Team principal Vijay Mallya believes that the team's performances "will jump exponentially" with a better windtunnel, although he is waiting for clarity on the regulations.

The team is also looking at expanding its

Silverstone base (left), and is looking at land next to the current factory to facilitate its future growth.

### FORCE INDIA'S RISE

Since taking over the Silverstone-based squad (then named Spyker) in September 2007, Mallya has overseen its successful climb up the grid (see right).

### CONSTRUCTORS' CHAMPIONSHIP

2007	10th*
2008	10th
2009	9th
2010	7th
2011	6th
2012	7th
2013	5th

\*as Spyker



## BRAWN: ROSBERG 2013 FORM REFLECTS WELL ON SCHUEY

Mercedes team principal Ross Brawn believes Nico Rosberg's performance relative to Lewis Hamilton shows how well Michael Schumacher did during his comeback in 2010-12.

"Lewis brings a great reference to the team and is a great driver, someone whose raw ability you know is at the very top," said Brawn. "It was a little unfortunate with Michael as we didn't have this reference.

"Michael had a tough time with Nico on occasion. Was that because Michael wasn't as good as he was? Or because Nico was better than people

2010-2012			
Rosberg	vs	Schumacher	
324	Points	197	
1st	Best finish	3rd	
1st	Best qualifying	2nd	
5	Podiums	1	
2	Fastest laps	1	
50	Classified finishes	43	
40	Outqualified team-mate	18	

gave him credit for? I think everyone recognises now that Nico was better than people gave him credit for."



ETHERINGTON/LAT

**P26 LEWIS'S TITLE BID**

## Hulkenberg: Sirotkin 'a risk'

Sauber driver Nico Hulkenberg has warned his team that its plan to run inexperienced Russian teenager Sergey Sirotkin (right) next year is "ambitious, maybe a bit risky".

Sirotkin was at the team's Hinwil base earlier this week to start his preparation for next season.



DUNBAR/LAT

7

## Bianchi open to staying on

Jules Bianchi has described staying at Marussia as "a good option", even though he has been linked with a move to a bigger team for 2014. "Marussia will be a good team next year," said the Ferrari-contracted rookie. "We will have a new engine and all the teams start from zero again."



COATES/LAT

## MARUSSIA: NO 'TECH' RUSH

The Marussia team is hanging fire on appointing a new technical director to succeed Williams-bound Pat Symonds.

"The first thing we need to do is identify the type of person we are looking for; organisational/managerial-

led like Pat or a technical director with a design strength or aero background," said team principal John Booth.

"It could be an opportunity for us to take the next step from where we are, because the structure is in place now."

# Sharp. The new E-Class.



A Daimler Brand



**Mercedes-Benz**  
The best or nothing.

Official government fuel consumption figures in mpg (litres per 100km) for the new E-Class range: urban 20.3 (13.9) – 68.9 (4.1), extra urban 36.2 (7.8) – 68.9 (4.1), combined 28.3 (10.0) – 68.9 (4.1). CO<sub>2</sub> emissions: 234 – 109g/km. Model featured is an E 220 CDI AMG Sport (Automatic) at £41,245.00 on-the-road including optional LED Intelligent Light System at £1,280.00, Driving Assistance Package at £2,345.00, 18" AMG alloy wheels at £365.00 and 360° camera at £715.00 (on-the-road price includes VAT, delivery, 12 months' Road Fund Licence, number plates, first registration fee and fuel). Some combinations of features/options may not be available. Please contact your Mercedes-Benz Retailer for availability. Price correct at time of going to print.



# Mark Hughes

## MPH

Kimi Raikkonen's non-political approach to F1 may well be working against him getting the top-line drive for 2014 that he covets

**W**ith Daniel Ricciardo's 2014 presence at Red Bull expected to be confirmed soon (but not at the time of writing), Kimi Raikkonen's options for next season seem to have narrowed. Lotus is outwardly confident he will remain there. Ferrari, meanwhile, has publicly dismissed rumours about his return to Maranello, so it would be a brave gambler who put money on him being in red overalls next year.

Yet there is a huge amount of goodwill towards Raikkonen at Ferrari – apart from the man at the very top. Kimi and Luca di Montezemolo did not part on friendly terms after Ferrari paid his contract out early to make room for the 2010 arrival of Fernando Alonso. Kimi's penchant for saying what is on his mind – strong words, softly spoken – left the theatrical Ferrari president offended.

Cynics – including Raikkonen – maintain that the recruitment of Alonso in the Finn's place was all about bringing Santander on board as a sponsor. Regardless of how true that was, there was also a feeling that Raikkonen's laid-back personality was not what the team required of its team leader. It needed someone to push, to question, to initiate, to force the issue – to set the place buzzing to his very driven requirements, much as Michael Schumacher had done, in fact.

Historically, this is always how Ferrari has operated

liked there – and that has never changed. But would he be prepared to be anyone's number two? Given that this was essentially the role he was being considered for at Red Bull, too, how can someone with his gifts have fallen to this reduced stature?

It illustrates the personal chemistry necessary – through all levels of a team – to sustain a top-line career. Alonso has it with Ferrari and Sebastian Vettel with Red Bull. It's an ability to nourish a relationship in a way that allows demands to be made both ways, and that makes both parties partners in success. It requires that the driver then goes out and delivers. Simply being fast and getting into a good car will win you grands prix, and perhaps even a championship in the right circumstances. However, getting into this position of influence with a top team, becoming part of its fabric, getting under its skin – that demands a personality trait that Kimi does not possess, brilliantly talented though he remains.

All that aside, it would be fascinating to see him alongside Alonso. There would be days when he was faster, regardless of how much things were organised the way Fernando wanted them. It's inevitable that with two drivers of this calibre the advantage would swing between them, and seeing how Alonso reacted to that, whether he has taken on board the mistakes

**“Raikkonen's laid-back personality was not what Ferrari required of its team leader”**

at its best. Its periods of success have come when a strong-willed lead driver – John Surtees, Niki Lauda, Schumacher – set the tone for the rest of the team to follow. Raikkonen is not like that, and never could be. He will state what he needs, quietly, and then shrug if it's not delivered. Alonso, Ferrari felt, was much more the sort of character it needed as its number one, and it has had no need to question that judgement since.

However, from Ferrari's perspective, Raikkonen would be perfect as a number two. The requirements of the team's number two are that he be non-political, low maintenance, quick enough to keep the number one on his game at all times – and to score valuable points pretty much every time. With the current driver line-up, it's difficult to envisage Ferrari winning a constructors' championship.

On the ground floor, Raikkonen would be welcomed back with open arms, because he was always very well

he made at McLaren in 2007, would add an extra dimension to the season.

Ultimately, though, the things fans love about Raikkonen – very few words, but very straight words when they are delivered – are the things that have mitigated against even greater success in his career. His exceptional ability has ensured he remains a regular winner, and he's achieved what he's achieved.

However, at one of his final sponsor functions for Ferrari in 2009 at the then-new Abu Dhabi circuit – a vanity project of one of the team's backers – he was asked of his first impression of the track. He replied, “The first few corners are OK, the rest of it is shit.” It may have given him a mischievous sense of revenge, but it will have only have made di Montezemolo even more certain he'd made the right call. Getting Luca to go back on that belief, and the loss of face it would entail, is almost impossible to imagine. ❧

# This week in motorsport



10

## KIMI TESTS GP3 CAR

Kimi Raikkonen completed a surprise test outing in a GP3 Series car at Barcelona last week.

The 2007 Formula 1 world champion, who lies second in this year's standings, completed 58 laps in a GP3/13 Dallara as part of the series' development preparations for 2014.

"I was curious to see how the car handled, and it was actually fun

to drive," Raikkonen said. "There were a few issues regarding its behaviour, but we managed to solve most of them."

GP3 organisers hope the test – made possible by Raikkonen's relationship with Koiranen GP team manager Afa Heikkinen – will boost efforts to increase overtaking opportunities next year.



STALEY/GP3

STALEY/GP3

## OGIER TRIES DTM FOR SIZE

World Rally Championship leader Sebastien Ogier enjoyed a brief run in an Audi RS5 DTM car at the Nurburgring last weekend.

The Frenchman completed five laps of the short circuit alongside Audi's two-time series champion Mattias Ekstrom.

"I'm totally focused on the WRC at the moment," Ogier said. "But I can well imagine competing in the DTM once my rally career is over."



## IndyCar eyes Indy road layout

IndyCar will hold a test on the Indianapolis Motor Speedway road course in the coming weeks, and could add the track to its 2014 calendar.

Details are still being finalised, but it is expected cars will run on both the clockwise and anti-clockwise configurations to gather data.

Consultancy group BCG released a report last March recommending that the series add the Indianapolis road layout to its schedule.

For all the breaking news, visit **AUTOSPORT.COM**

## Pikes Peak Pug to return?

Peugeot Sport is considering a return to Pikes Peak next year in an effort to improve on Sebastien Loeb's record-breaking run up the Colorado mountain.

Team chief Jean-Christophe Pallier claimed it is possible to go quicker up the hill with the current car. "It's possible to do a time of less than eight minutes," reckoned Pallier.

**P12 COULTHARD DRIVES LOEB'S 208**



## HUFF TESTS CHINESE VW

World Touring Car champion Rob Huff has been drafted in to help develop the new breed of car contesting the China Touring Car Championship next year.

The Briton tested an RML-derived Volkswagen Polo GTi at Tianma for the Team Shanghai 333 Racing squad and then moved on to Guangdong for two days of driver-coaching duties with potential series entrants from China, Hong Kong and Korea. Cars in the series will run to an NGTC-style rules package featuring several key spec components.



## MONTOYA OPEN TO INDY RETURN

Juan Pablo Montoya admits he'd consider a single-seater return next year after Earnhardt Ganassi Racing last week confirmed he'll lose his drive in its NASCAR Sprint Cup team at the end of 2013.

The Formula 1 race winner took the Champ Car crown with the Ganassi team in 1999 and won the Indianapolis 500

in 2000 on what is his only IndyCar start to date.

While he insisted the ideal scenario would be to stay in NASCAR, the Colombian told US publication *Autoweek* he was "looking at everything - whatever I do, it has got to be in a winning car. That's the number one thought right now".

### MONTOYA'S NASCAR STATS

- S** Starts **240**
- P1** Pole positions **9**
- V** Victories **2 (both on road courses)**
- T** Best championship finish **8th (2009)**
- 10** Top-10 finishes **56**
- C** Chases made **1 (2009)**
- \$** Career winnings **\$32,403,053**



## DTM TESTS FOR SPA WINNERS

Spa 24 Hours winners Maxi Buhk and Maxi Gotz will make their DTM test debuts in previous-generation Mercedes C-classes at Lausitz on September 17.

Mercedes motorsport chief Toto Wolff confirmed to AUTOSPORT that further young drivers could be added to the line-up in the coming weeks.

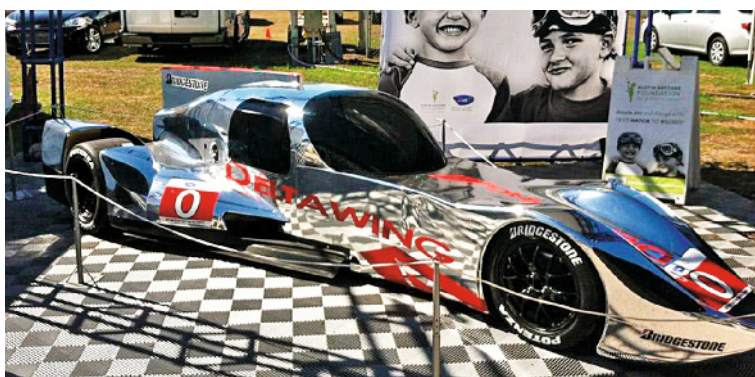

## DeltaWing coupe debut date set

The DeltaWing coupe will make its American Le Mans Series debut at Austin on September 21.

The experimental racer will test for the first time at the end of this month

ahead of its maiden race, and will then round out the season at Virginia and at Road Atlanta's Petit Le Mans event in October. British duo Andy Meyrick and Katherine Legge will drive.

## Stewart out for rest of season

Tony Stewart will miss the remainder of the NASCAR Sprint Cup while he recovers from a broken leg sustained in a sprint car crash earlier this month.

Mark Martin will replace the three-time champion at Stewart-Haas Racing for 12 of this year's 13 remaining races, while Austin Dillon - who stood in at Michigan last weekend - will take over for the Talladega race.

Martin's vacated seat in Michael Waltrip Racing's #55 will be taken by Brian Vickers, ahead of his full-time deal next year.

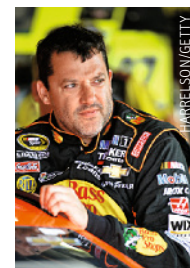

## In brief

### MOFFAT'S NEW DEAL

James Moffat has signed a multi-year contract extension with Nissan's factory V8 Supercar effort. The Australian, 29, joined the Kelly Racing-run Nissan programme this year.

### BRISCOE IS BACK

Ryan Briscoe has been given medical clearance to return to IndyCar action at Sonoma this weekend. He sat out the past two races after breaking his right wrist in a crash at Toronto last month.

### BUSHELL'S BTCC TEST

Renault Clio Cup frontrunner Mike Bushell made his British Touring Car test debut at Snetterton on Tuesday, driving a Chevrolet Cruze for Andy Neate's new squad, IP Tech Race Engineering.

### KERR BACK IN WEC

Robbie Kerr will return to the G-Drive/Delta-ADR LMP2 team for next month's World Endurance Championship round at Interlagos. His place alongside Tor Graves and James Walker will be taken by Rudy Junco for the following Austin race.

### THIIM JOINS ASTON

Nurburgring 24 Hours winner Nicki Thiim will join Christoffer Nygaard and Kristian Poulsen in its Pro-Am Aston Martin Racing Vantage GTE in the WEC at Interlagos. He takes the seat previously occupied by the late Allan Simonsen.

# THE HILLS

...with the sound of **DAVID COULTHARD** driving Sebastian Loeb's 875bhp, four-wheel-drive Pikes

12

# ARE ALIVE!

Peak Peugeot 208 T16 in the Styrian Alps. Here's what DC thought of the whole experience



**T**his summer it was pretty hard to miss Sebastien Loeb's record-breaking run up Pikes Peak – except, with one thing and another on my plate, I managed to! But standing beside it, looking for the doorhandle and the way in, I'm starting to think that's not such a bad thing.

The good thing is that I've got no preconceptions. I've seen Sebastien doing a few laps of the Red Bull Ring in the wet just before my run and he looked... handy. Now, courtesy of AUTOSPORT, it's my turn. The track's dried out quite nicely. Good news, but I'm still not sure what to expect.

### CENTRAL SEATING POSITION

It's quite a climb to get into the Peugeot 208 T16. A bit like a DTM car, the seating position is central, so you have to clamber over a fair bit of kit to get into the belts. Apart from moving the seat back a little bit – I'm a wee bit taller than Seb – everything fits. You'd find with pretty much all drivers, the distance from shoulders to steering wheel is very similar. How things have changed from the days when I was driving in the classic, Jim Clark straight-arm style in my Formula Ford days in 1989. As you move up the ranks and the cars become more and more powerful, you get closer and closer until the point where you're virtually chewing on the steering wheel.

Forward and semi-lateral vision is very good, which you'd expect from this sort of car. In fairness, when Seb was going up the hill, he was on his own and completely focused on corner to corner – he wasn't looking out for anybody else on the same piece of road.

Immediately, the car feels intuitive. And that goes for the pedals as well. Once in the zone and driving, everything totally comes to hand. A car that is not instinctive has been either been produced by an arsehole designer or an idiot racing driver. That's definitely not the case here. I don't know the design team at Peugeot, but the driver in question is definitely not an idiot!

### PHENOMENAL ACCELERATION

Coming out of the pitlane and accelerating hard, the car feels responsive and powerful. There's no launch control because it didn't need it: Pikes Peak is a rolling start, and I think Seb said he crossed the startline already doing 100mph.

The best corner for this car is definitely Turn 2, the hairpin. I'd like to see the acceleration data from an F1 car against the 208 for the first 10 to 15 metres from the apex – I think the Peugeot would be quicker with the four-wheel drive. There's plenty of get-up-and-go out of there, but you'd pretty quickly find the lighter F1 car coming past you.

The minor frustration in the car today is the gearing: it's quite short, which obviously works at Pikes Peak, but today it does mean I'm having to lift off the throttle at v<sub>max</sub>. We're hitting around 150mph, which is only about 10mph short of what we used to get from the DTM car, but it makes it hard to try and place where this 208 would sit in the scheme of things with DTM or endurance racing cars. It also makes it hard to judge the brakes...

### DECENT STOPPING POWER

I have to lift off the throttle coming into the two big braking areas which means, mentally, your timing is out. The carbon brakes and large-contact-patch Michelin tyres do their job and get the car slowed down well. It's unfair to compare this with a Formula 1 car – clearly nothing would compare with that sort of stopping power – but the 208 is maybe a little bit down on the DTM cars I'm used to as well. Don't forget DTM cars have a huge venturi beneath them and a splitter that's virtually rubbing along the ground – we know that's a very effective way to generate load.

### 'MASSIVE' AERODYNAMICS

The one thing you can't fail to notice about this car is that wing from the 908. It's massive! It's like Peugeot just took the biggest piece of aero they could find, stuck a three-inch gurney on the side and put it on the car. It certainly develops ▶



"How do I get in?"  
DC inserts himself  
in the cockpit





Suitably portentous skies  
as Peugeot beast is  
ready to rampage



Coulthard found the car had understeer through Turns 4/5

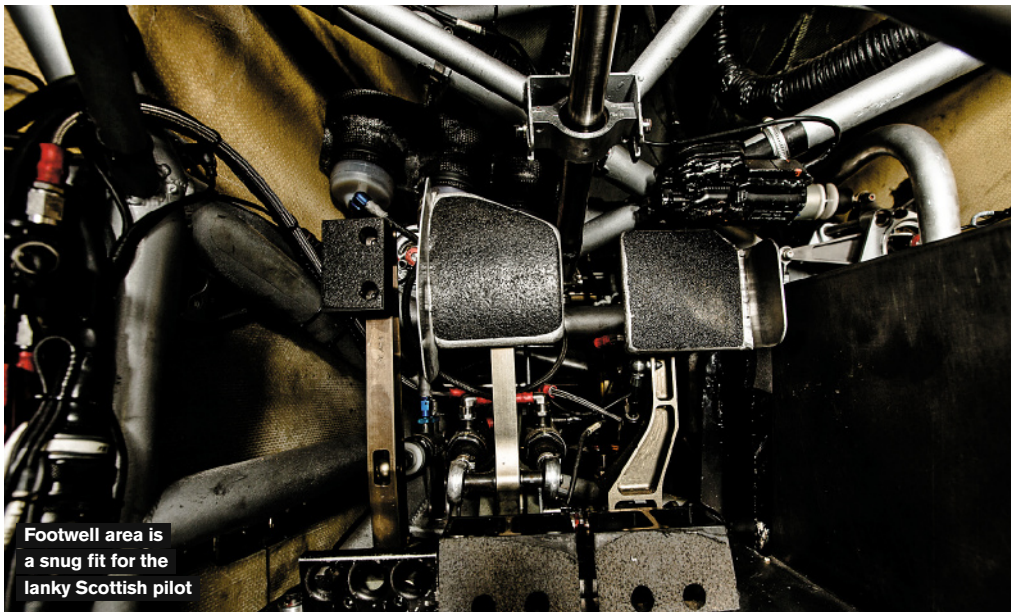

Footwell area is a snug fit for the lanky Scottish pilot



Where the 3.2-litre twin-turbo roar exits

◀ downforce at the rear, but for our test we are definitely lacking front-end grip at low speed. I would definitely be looking for more from that side of the car. Even at a circuit like Monaco, or any street circuit, I always wanted a load of front end at turn-in.

You can always turn away if you turn in too early, but if you turn in and nothing happens, you find yourself on a one-way ticket to the barrier.

Between Turns 4 and 5, the 208 moves towards understeer, and a flap or something at the front would help to correct that. Certainly, if you were setting it up in the classic style, where you give it 99.99 per cent in the race and 100 per cent on a qually lap, then you'd need a flap.

### SOFT SUSPENSION

As I mentioned about those two higher-speed corners at Turns 4/5, the front of the car doesn't feel quite as nailed as I would have thought. There are a couple of things to consider here though... I've driven Formula 1 for a lot of years and then in DTM, where the cars are totally connected to the track, because the team and the driver have the absolute set-up for the lap.

This car was built with a different race in mind, so it comes with some margin in it. And when you're racing to the top of a mountain with no run-off and clouds for crash barriers, maybe that's not such a bad thing...

The compliance of the suspension certainly

underlines that confidence-giving theory. I reckon with more and more time testing the car, and more and more time going up and down the mountain gaining confidence and knowledge of what was coming, the front end would be stiffened up quite a lot. As it is, it has a little of that soft-front, steer-from-the-rear feeling.

I can understand the reasons for this set-up. I grew up in the middle of the country and did a lot of my early driving around lanes where I was always reacting to the corner as it evolved and making up the apex, in effect. A lot of my road skills were reactive and I'd imagine that's what it's like for Sebastien in this case – this was a Tarmac stage with no notes, and you needed to



Apprentice and master:  
DC gets the lowdown  
from rally king Loeb

## LOEB'S GUIDE TO DRIVING T16



Paddle-shift gearbox,  
but it soon runs out  
of revs on racetrack

retain that ability to react to things in the car. On a lap, you know corner to corner what the car will do, what sort of load each wheel will have, where the slip is and what the optimal speed will be at entry, apex and exit – Sebastien and the team didn't really have that up the mountain.

### RUDIMENTARY GEARBOX

This is old technology and there's no getting around that. Coming from a world of seamless shifts in Formula 1, in this car it feels like you're being hit on the back of the helmet by a hammer every time you go up a gear. Not only is it clunky, but also pretty bloody annoying, knowing what's available from a modern F1 car. It's like me ▶

Track time is running down when, typically, the clouds finally deliver. Today is the day Sebastien Loeb will drive his record-breaking Peugeot in the wet. For the first time.

We'd arrived at a Red Bull Ring basking not only in the news that Formula 1 would be coming back, but also 37-degree temperatures. It was an absolute scorcher as Peugeot Sport carefully extracted its astonishing one-off machine from the back of a plain silver truck.

Installed in the pit garage, pre-start checks run through, the car was fired and idled on axle stands. The warm-up was completed with a dash up and down the gearbox and a couple of lock-to-locks to make sure the laptop was happy with the hydraulic fluid pressure and temperature.

Loeb into the car, slicks out of the blankets... and a clap of thunder louder even than the tickover of two very big turbos.

Bugger.

It wasn't even drizzle; it was full-on, flat-out rain. The pitlane was covered in 10 seconds and comfortably underwater in less than a minute.

The slicks had gone back into their covers. Fifteen minutes later and the rain eases. The track is sodden, but slowly clearing of standing water.

"We go out?" says Loeb.

We do what?

"Why not?" he adds, with a shrug and a smile.

Why not indeed?

Warmed wets are bolted on and, with a knock, a bang and a whistle, Loeb pulls first gear and departs the garage.

And flicks the wipers on for the first time ever.

Four laps later and he's back in. The car is warm, the track getting drier and drier. Everything is ready for David Coulthard.

After watching DC walk from one side of the car

to the other, before asking... "Which side do I get in?" I suddenly feel a little nervous. This is Peugeot's only child. And now AUTOSPORT – via an admittedly world-renowned F1 star – is being left to babysit.

"He will have no problem," says Loeb, sensing momentary unease. "For him it will be an easy car to drive. For sure, the power shouldn't impress him – not with what he knows. The braking is good, he can go quite late and finding the limit will be the thing which takes a little time.

"Four-wheel drive will be new to him, but if you don't slide then it's just giving you some more stability. OK, there may be more traction from the one hairpin at the other side of the track, but that's all. It was wet when I went there, but it is drying now and if he takes second out of this corner, I think this car could be quicker than a Formula 1 car out of there – but that's maybe the only place, because the rest of the circuit is maybe too fast for the gearbox we have in this car. We hit the rev limiter four times in top gear on the laps I just did."

The data shows that even on his out-lap, his first time on rain tyres in the wet, Loeb is on the limiter in top within seconds of being out of the pitlane.

"It was interesting in the wet," he smiles. "Just one time before I drove and it was a little bit humid, but not like this. The four-wheel drive helps, it felt OK. You could slide the car, but when you have too much angle in the car then you start to wonder where it wants to go..."

I could feel the downforce working, but I was too slow in the really fast corners to feel it so much – there was not so much grip on the line. The place I really felt the downforce here was in the braking and that was good.

"I am very glad it didn't rain on the startline in Pikes Peak. It would have been the same for everybody and I think we still had the best car for the race, but the sensation would not have been the same. It would have been slow. And we wanted the record."

David Evans



Coulthard enjoyed his run. Now he fancies a crack in Colorado!



Peugeot spotted a gap in programme after end of its LMP1 campaign

## TECH SPEC

**ENGINE** 3.2 litre, V6 twin turbo

**POSITION** mid-rear

**MAX POWER** 875bhp

**MAX TORQUE** 650lb ft

**GEARBOX** six-speed sequential, column-mounted paddleshift

**BODYWORK** carbon

**SUSPENSION** double wishbone/torsion bars/dampers all round

**BRAKES** 380mm carbon front/355mm carbon rear

**WHEELS** 18x13in mag-alloy

**TYRES** 31/71x18

**LENGTH** 4500mm

**WIDTH** 2000mm

**HEIGHT** 1300mm

**WEIGHT** 875kg



◀ taking away your multi-function telephone and giving you an early Motorola brick. Yes, you can make a telephone call, but you can only do it slowly. At the time, when we didn't know any better, we thought those phones were amazing, but once you've seen a smartphone you wouldn't want to go back.

This car was built to a budget and with an element of compromise, but if it was to go up against another car with seamless shifts, with a driver of the same ability, it would lose. I reckon an F1-style gearbox would be worth 1.5 to two seconds across an eight-minute 'lap'.

## 'NUMB' STEERING

The response from the car is relatively numb, but that could well be a characteristic of the four-wheel drive. When you drive four-wheel-drive road cars, you do tend to get that little bit of wander because of the different tolerances through the front wheels, which you don't get in a rear-drive car.

## BRILLIANT TRACTION

Obviously, the traction is very, very good in the car because of the four-wheel drive and you always feel there is plenty of grip there for you. That's where the car would have really excelled in the slow corners, and it's kind of a shame that we only have one slow corner on this track.

## DC'S CONCLUSIONS

The Peugeot 208 T16 is a tremendous amount of fun to drive. I would love to have spent longer with it and tried to work on the settings and then the lap times. There's no doubt that what Peugeot has produced is a fine piece of engineering, but a lot of it came from the parts from an endurance programme and it relied on the ability of a very, very talented driver. I'm talking about Sebastien at Pikes Peak rather than me at the Red Bull Ring!

Having had a go, I'm now ready to go and watch Seb going up the mountain. Maybe I'll have a go there next time... 🏎️



## THE STORY BEHIND THE 'FRANKEN-PUG'

Jean-Christophe Pallier, the chief engineer of Peugeot Sport, breaks into a smile.

"When did we finish the design study?" he says, inquisitively. "When we finished building the car!"

This project was given the green light at the end of November last year, having first been dreamed up by team principal Bruno Famin a couple of months earlier.

Peugeot has a history with Pikes Peak. If you're not familiar with that history, type the words: dance, climb, Vatanen and Ari into YouTube...

Peugeot's and Colorado's biggest mountain go back a bit. And, in light of the loss of the 908 endurance programme, there was a gap in the motorsport side of the business. The customer department was busying itself with a raft of new rally cars – including the stunning 208 T16 – but there was nothing for the factory to get its teeth into. Until Famin thought about returning the Lion to the top of that mountain.

The first work on the car started on December 1 and, as soon as parts were being drawn, they were being produced. All of the car's aero work was done on the computer – there was no time for the windtunnel.

"We took a lot from the 908," says Pallier, "and we thought about the engine as well, but the diesel was a little too heavy and, having eight cylinders, it was too long. Also, it had only one fuel pump – we needed more and there wasn't time for this to be designed."

The car tested for the first time four months after pencil was put to paper, at Peugeot's test track in south-west Paris. A week later, Sebastien Loeb was introduced to the team.

"We started the project without Sebastien," says Pallier. "When we started, we didn't know who would drive, but when we asked, he was very happy!"

By June the car had moved to the far side of the Atlantic and the serious testing was under way.

"The only things Sebastien wanted was a shorter ratio in the gears and some small set-up changes," says Pallier. "This was good, because we had no time for anything more."

And then, at 11am local time on June 30, the car was fired at the first corner proper.

"We all waited at the bottom of the hill," says Pallier. "It is difficult in the mountains to get the internet, so we had hired our own antenna to help with this, but just at the big moment – it went down. We had no splits. Nothing. I timed from my own watch and got to nine minutes. I thought, 'Something is wrong...' But it was fine. It was a good day."

David Evans

Pushing on in Austria. Coulthard got a taste of new kind of 'racer'





# BELGIAN GP PREVIEW

IN ASSOCIATION WITH **sky SPORTS F1 HD**

## FIRST CORNER

265m

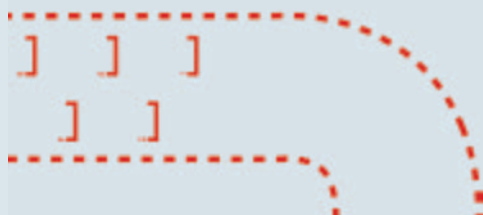

Despite being the longest and also one of the fastest tracks of the year, Spa's start-finish straight is a bit of an anomaly. At just 265m, it's the fifth shortest run to Turn 1 from the grid that the drivers will encounter all season. The bottleneck at La Source last year accounted for the retirements of Fernando Alonso, Lewis Hamilton, Romain Grosjean and Sergio Perez.

## OVERTAKING STATS

Underscoring its reputation as a racer's track, the 2012 Belgian Grand Prix was sixth in the list of circuits when it came to overtaking last season – not surprising at a venue that provides multiple passing opportunities.

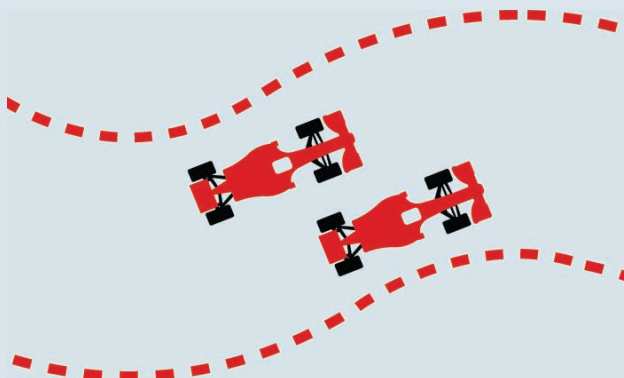

## FULL THROTTLE



70%

Only at Monza do drivers have their cars at full throttle for longer, with an astonishing 70 per cent of the 4.352-mile Spa circuit driven flat-out.

## PITLANE

One of the few statistics that is distinctly average about Spa is its pitlane length. Its 386m ranks it about halfway between the longest and the shortest encountered during the season. At 16.5 seconds, there's very little time lost getting in and out of the pits.



SPA	
Pitlane length	386m
Length rank	11th longest
Pitlane loss	16.5 seconds



MELBOURNE

SILVERSTONE

## SAFETY CARS

Last year's Spa race was a busy one for the safety car, and it has a 1.1 probability of being called out again over the coming weekend. There have been nine safety car periods during the past eight Belgian GPs.



USA/INDIA

SINGAPORE

## FUEL PENALTY



A lap of Spa requires 3.3kg of fuel, which is by far and away the biggest consumption at any circuit, so engineers design the maximum capacity of their cars' fuel tanks with the Belgian track in mind.

## GEAR CHANGES

Although the number of changes (48) per lap is the fifth highest of all the venues visited by the Formula 1 circus, the number of changes made against distance covered is relatively low – 37 per cent lower than what's required in Hungary, for example.



SPA	
Circuit length	4.352 miles
Race laps	44
Race distance	191.410 miles
Lap record	Sebastian Vettel, 1m47.263s (2009)
Corners	19 (10 left, 9 right)
Circuit direction	Clockwise
Corners <62mph	3
Corners >155mph	5

## WEATHER

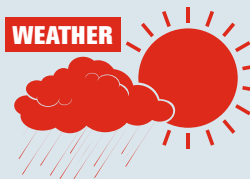

## MONTHLY AVERAGES

Daily sunshine	8.8 hrs
Rainfall	106mm
Min temp	13.2C
Max temp	21.5C

The heavily-forested Belgian Ardennes is well known for its microclimate and its propensity for rain.

COMPLETE COVERAGE OF THE ENTIRE RACE WEEKEND ON **sky SPORTS F1 HD**

### THURSDAY

1400 Sky Sports F1  
LIVE Drivers' Press Conference

### FRIDAY

0845 Sky Sports F1  
LIVE Free Practice 1  
1245 Sky Sports F1  
LIVE Free Practice 2

### SATURDAY

0945 Sky Sports F1  
LIVE Free Practice 3  
1200 Sky Sports F1  
LIVE Qualifying

### SUNDAY

0935 Sky Sports F1  
LIVE GP2 Sprint Race  
1130 Sky Sports F1  
LIVE Belgian GP

### ALL WEEK

Classic Belgian GP races shown throughout the week as a build-up to the 2013 race

100%

## GRAND PRIX SUPERGRID

AUTOSPORT's technical correspondent Gary Anderson has compiled this index, created by taking each driver's percentage deficit to the outright pace so far this year. The graphic shows each driver's average over the 10 races run so far in 2013 compared with the theoretical absolute pace, which is expressed as 100.

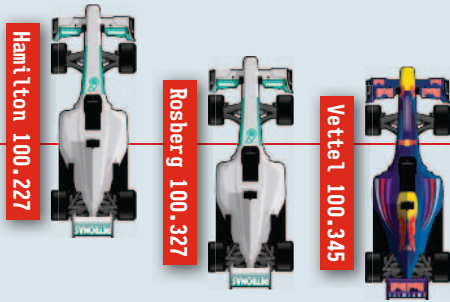

Fernando Alonso is back ahead of Mark Webber after Hungary. Webber's qualifying problems left him 10th on the grid, but he still finished fourth (one place above Alonso).

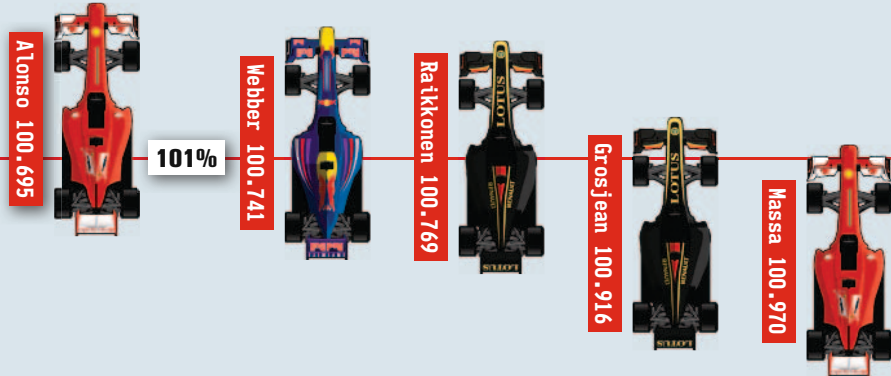

101%

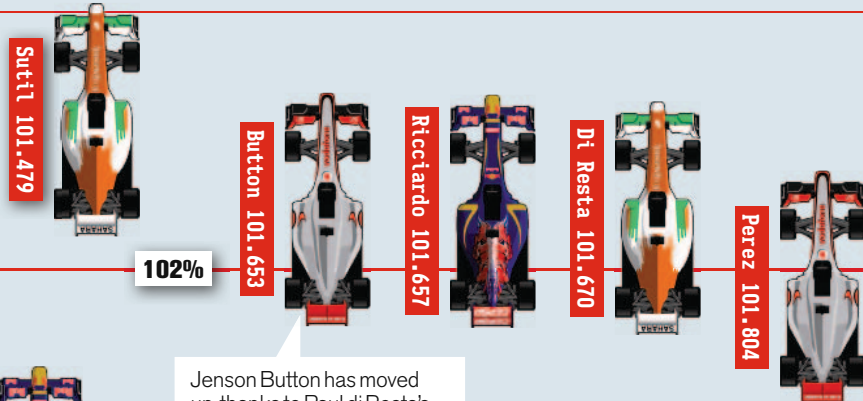

102%

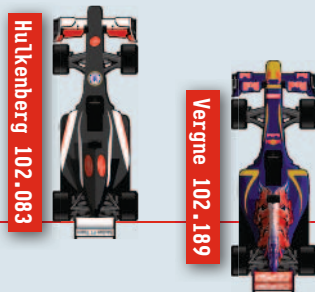

Jenson Button has moved up, thanks to Paul di Resta's lack of speed in Hungary. Button is actually further from the overall pace, but believes Spa will be better.

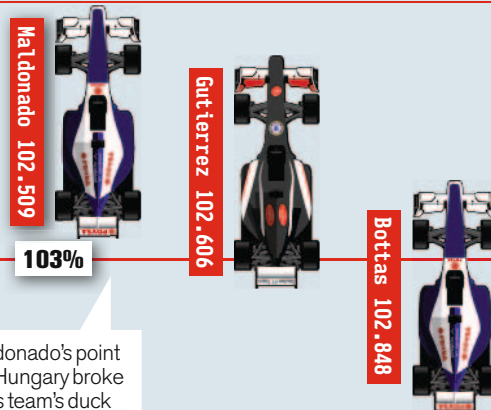

103%

Pastor Maldonado's point for 10th in Hungary broke the Williams team's duck for 2013. The Venezuelan has moved past Esteban Gutierrez's Sauber.

## AND THE REST...

All four drivers from the backmarker teams of Marussia and Caterham have fallen slightly away from the overall pace after their performances in the Hungarian Grand Prix.

Bianchi (Marussia)	104.264
Pic (Caterham)	104.322
Chilton (Marussia)	105.246
Van der Garde (Caterham)	105.301

Watch the Belgian Grand Prix live on Sky Sports F1 HD - go to [sky.com/F1](http://sky.com/F1) or call 08442410826



# BELGIAN GP PREVIEW

# Brakes: the hot topic

**Carbon discs can reach incredible temperatures when slowing an F1 car, which can result in high wear. ROBERTO ANTONIO PACE explains how technology is in a constant battle to keep pace**

**F**ormula 1 brake technology may not seem a particularly interesting on the surface, with few obvious major changes in recent years. The last time brakes grabbed the headlines was when carbon-ceramic discs were first introduced. However, even at a fast circuit such as Spa, braking is key to a car's lap time.

This season's Pirelli rubber has done a lot to refocus attention on brake technology. The tyres are heavier and have softer, grippier compounds. That added weight means the wheel has more inertia which, when combined with the increased grip, makes the braking system work harder.

These two main factors represent the reasons why brake discs can easily reach temperatures of close

to 1200C. Even though carbonfibre can withstand such high heat, the discs still have to operate within a certain window. In fact, they are at their optimal efficiency between 400 and 1000C. Anything below this will result in a much poorer brake performance.

Above 1000C, the wear rate of discs and pads rapidly rises. Previous generations of F1 braking systems, for instance, used to lose up to 4mm of disc thickness during the course of a race weekend because of the excessive heat.

To avoid high or premature wear, there are two options available to race engineers. The first is to keep the temperatures under control by optimising the airflow going through the brake assembly. This means

increasing the heat exchange between the frictional surfaces and the external airflow. The second option is to raise the disc temperature threshold, which is achievable only with a modification of the disc's structure.

Brembo has opted to include both options in its latest brake disc designs, incorporating 1000C cooling ducts and developing a new material called CER, which is an evolution of the previous CCR material.

Maurizio Assi, race engineer at Brembo, explains that CER and CCR materials both use the same construction techniques, so the disc is still made of carbonfibre sheets pressurised and cooked at certain temperatures.

The real change is in the autoclave process, where much higher

temperatures (above 1000C) and a few bars more pressure than used in the manufacture of CCR are reached. The most impressive thing, however, is the extended duration of the process, which now ranges over an order of months rather than weeks.

The main aim of this long and complicated operation is the carbonisation of the disc structure, to achieve the maximum stiffness and resistance under very high temperatures that only a material such as pure carbon is able to deliver.

Thanks to this improvement, disc wear has been reduced to just 1mm – rather than the previous 4mm – over the course of the race weekend, resulting in a constant braking performance and consistent pedal feedback for the driver.

22

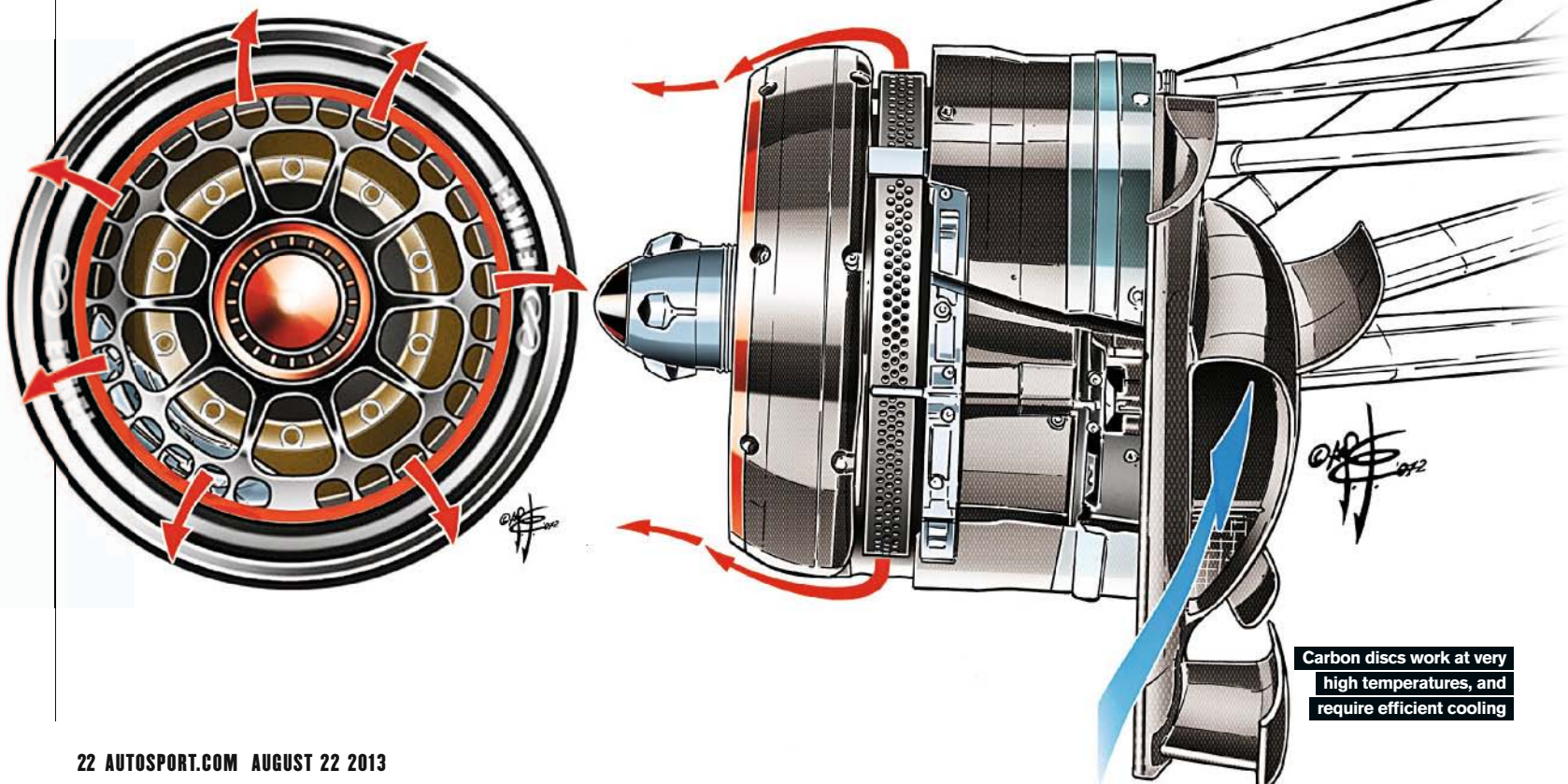

**Carbon discs work at very high temperatures, and require efficient cooling**

## THE CIRCUIT BRIEF



**KIMI RAIKKONEN**  
2009 BELGIAN GP WINNER

Spa offers very challenging high-speed corners, and you need to get the right set-up for the car. As we've seen so many times this year, a good grid position is extremely important. It will be decisive at Spa too, even though it's

maybe easier to overtake there than at some other tracks.

It's crucial to have a good car aerodynamically to tackle the fast corners, and it's a long lap, so to get the right time you really need to maintain the best rhythm.

I bet every driver likes Spa. For me, it is the greatest racing circuit in the world. It's my favourite place. I have liked it since my first visit in 2000 when I was in Formula Renault.

Drivers love challenge of high-speed corners



TEE/LAT

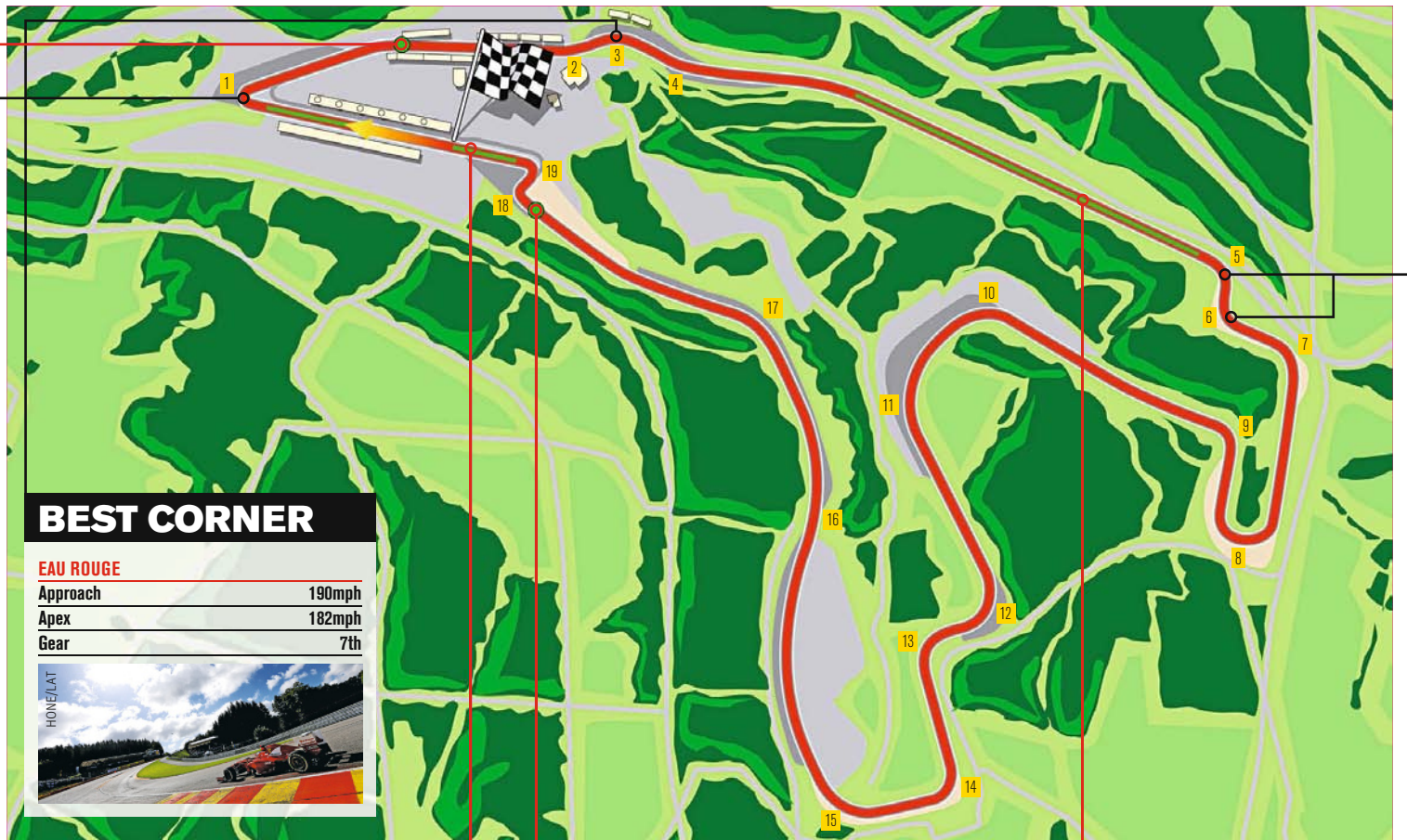

### BEST CORNER

#### EAU ROUGE

Approach	190mph
Apex	182mph
Gear	7th

HONE/LAT



DRS Detection 1

DRS Zone 2

DRS Detection 2

DRS Zone 1

## POTENTIAL FLASHPOINT

## THE STORY OF 2012

## PASSING SPOT

ETHERINGTON/LAT

Grosjean causes grief at La Source in 2012



#### LA SOURCE

Approach	181mph	Braking distance	123m
Apex	47mph	Braking time	2.92s
Gear	1st	Braking force	4.65g

Jenson Button started from pole and thankfully avoided the melee behind that resulted in Romain Grosjean taking out Fernando Alonso, Lewis Hamilton and Sergio Perez. The Brit's McLaren was in a good place that year, and Button ran out an easy winner. Sebastian Vettel clawed his way up from 10th place on the grid to finish second, with Kimi Raikkonen's Lotus rounding out the podium.



Button sprays the sparkling

ETHERINGTON/LAT

#### LES COMBES

Approach	200mph
Apex	88mph/93mph
Gear	3rd
Braking distance	92m
Braking time	1.43s
Braking force	5.58g



Pass and go: Les Combes

DUNBAR/LAT

What's the  
**secret**  
about the new 911 GT3 Cup's  
**new brakes?**



**It's Quicker.**



[www.pfcbrakes.com](http://www.pfcbrakes.com)

1.800.521.8874

# Fifteen questions for Sir Stirling Moss

**Q** What has been your biggest disappointment?

**A** Never to have raced at Indianapolis

**Who has been your fiercest rival?**

Fangio was my most revered rival but Jack Brabham was the fiercest.

**Who was your childhood hero?**

My father – he made me the person I am and I can see a lot of myself in him, with his inventiveness. He made me a suit of armour once and he also invented the nylon stylus for record players when the normal ones were scarce during the war.

**When were you happiest?**

Probably winning the British Grand Prix in 1955 but any time in general when I was racing – it is what I loved to do.

**Which living person do you most admire and why?**

Bernie Ecclestone – he saved F1 and put it where it is today.

**What has been your biggest disappointment?**

Never to have raced at Indianapolis. The reason was because I couldn't afford to spend the time away from the racing I knew and understood to comply with all their conditions of entry.

**What does success feel like?**

Very satisfying; show me a man who is second and I will show you a loser.

**What has been your most embarrassing moment?**

I was 16 and my mother caught me in the groom's cottage with Sylvia... What a cracker!

**To whom would you like to say sorry and why?**

Sylvia, because I didn't know enough about life when I was 16!

**What is your most treasured possession?**

My wife, Susie. I would be lost without her.

**Who would play you in the film of your life?**

Steve McQueen – good driver, great looking guy. I reckon he had more fun than I did!

**What is your favourite smell?**

Freshly baked bread.

**What is your guiltiest pleasure?**

I am rather hooked on *Judge Judy* and watch it whenever I can.

**If you could edit your past, what would you change?**

I would have waited longer before announcing my retirement. I was under enormous pressure from the media to make my decision and I therefore, in hindsight, feel I tested myself too early.

**How do you relax?**

I don't. My motto is 'movement is tranquility'.

**When was the last time you cried?**

If I see a programme about the suffering of animals I'm hopeless! But I recently watched a film called *Quartet* which had Susie and me blubbing!

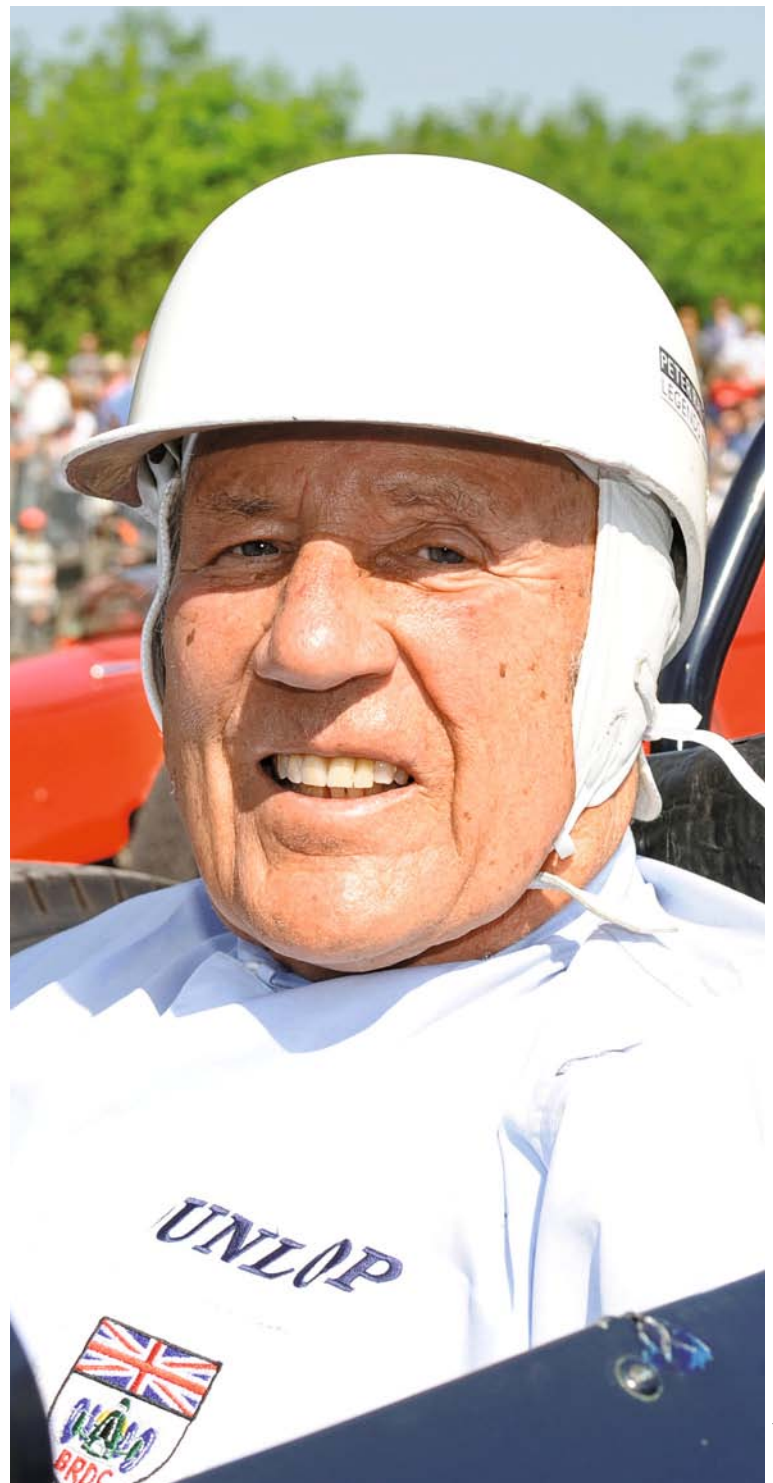

Moss just beats Brabham in Cooper duel at Aintree, 1958



# Hamilton's title shot

**Mercedes has played down its hopes of winning the championship this year, but Lewis Hamilton has a genuine chance. By EDD STRAW**

Lewis Hamilton sits 48 points behind Sebastian Vettel going into the second half of the Formula 1 season. But make no mistake: everyone at Mercedes believes he can win the world title.

That margin effectively equates to two race wins heading into a frenetic run of nine races in 14 weekends, but big gaps can close very quickly when you have the best

car. So far this season, Mercedes has consistently had the *fastest* car – seven pole positions is proof – but its ominous form in Hungary, where it was not only the quickest over one lap but also the *best* in race conditions, suggests it could now be the car of choice.

Mercedes top brass are publicly cautious. Motorsport boss Toto Wolff recently tried to dampen

its expectations, stating that “consolidation should be the agenda for the second half of the year, not looking at the championships”. But while Mercedes will not pursue this year’s crown to the exclusion of all else, including neglecting a 2014 car that could be a key foundation for the marque’s success during the next rules cycle, it has far from given up on the current machine.

Team principal Ross Brawn said: “For the rest of the season we’ll have to take a balanced approach over what’s needed this year, and what’s needed for this year *and* next year. But I think we’ll have a much more respectable second half.

“We’ve scored more points already than we did last year, and we’re just over halfway through. We’ve got a strong enough organisation to ensure we won’t let it slip.”

Mercedes has won three of the past five races, with Nico Rosberg winning the Monaco and British GPs and Hamilton taking his maiden victory for the team in Hungary. During that run, there were also two wins for Vettel and

Red Bull, with both Mercedes drivers struggling desperately with the old enemy, rear-tyre degradation, at the Nurburgring. Realistically, tyre use is the factor that will decide whether or not Mercedes can win the title.

The evidence from Hungary is very encouraging. Pirelli’s control tyres changed there to what is essentially a hybrid of the 2012 construction and this year’s compounds. Conditions at the Hungaroring should have been bad for Mercedes, with track temperatures above 45C in the race and lots of slow/medium-speed corners working the rear tyres hard.

Yet Hamilton won the race with relative ease and likely would have done so even if Vettel and Romain Grosjean had not lost time behind Jenson Button’s McLaren following their first pitstops. Before jumping to the conclusion that the Mercedes tyre woes are in the past, we will need to see how the car fares in hot temperatures on a track with some longer-load corners, which have traditionally exposed the rear-tyre



Hamilton has to hunt down Vettel's Red Bull



Hungary win could be Merc's turning point

BARON/GETTY

## BIGGEST POINTS TURNAROUNDS

This shows the largest points deficits overturned by a world champion. Figures are expressed in terms of the 2013 points system, based on 25 points for a win to allow comparison. For earlier points regimes, the numbers are generated by scaling up the advantage. The real points figure is included in brackets.

James Hunt beat Niki Lauda (1976)	97.22pts (35)*
Kimi Raikkonen beat Lewis Hamilton (2007)	65pts (26)
John Surtees beat Jim Clark (1964)	55.55pts (20)
Ayrton Senna beat Alain Prost (1988)	50pts (18)
Jody Scheckter beat Jacques Laffite (1979)	47.22pts (17)
Nelson Piquet beat Carlos Reutemann (1981)	47.22pts (17)
Keke Rosberg beat Didier Pironi (1982)	44.44pts (16)
Jack Brabham beat Bruce McLaren (1960)	43.75pts (14)
Niki Lauda beat Alain Prost (1984)	41.66pts (15)
Sebastian Vettel beat Fernando Alonso (2012)	40pts

\*Actual points in brackets

Opt 25pts 50pts 75pts 100pts  
POINTS SWING CONVERTED INTO 2013 SYSTEM

If Lewis Hamilton successfully turns a 48-point deficit into his second title, it would be the fifth-biggest turnaround in the history of the world championship. That statistic indicates how difficult a challenge he faces, even though the Mercedes is likely to prove the car of choice in the second half of 2013.

The biggest turnaround came in 1976, when James Hunt defeated Niki Lauda after being 35 points down after the German Grand Prix. Given that nine points were available for a win then, that equates to a deficit of 97.22 points in the modern era. But Hunt's comeback is distorted by Lauda's near-fatal accident at the Nurburgring, which sidelined the Ferrari driver for two races.

This means Hamilton was on the receiving end of the most dramatic turnaround in a situation unaffected by drivers missing races. In 2007, he was 26 points ahead of eventual champion

Kimi Raikkonen after winning the US GP, the equivalent of a 65-point lead today.

To be certain of overhauling leader Sebastian Vettel, Hamilton would need to, on average, outscore him by 5.4 points per race.

But as Hunt and Raikkonen, as well as John Surtees in 1964 and Ayrton Senna in '88 (albeit distorted by dropped scores) proved, that magnitude of turnaround is, for all its difficulty, possible.



FERRARI/LAT  
Raikkonen snatched 2007 title

management problems most starkly in the past.

The other encouraging factor is Hamilton's improving form. Realistically, Lewis is the driver Mercedes must get behind if he is to take his second drivers' title. Looking at it pragmatically, Rosberg's deficit to Vettel is a massive 88 points, nearly twice that of his team-mate's, and even with a stellar second half of the year it is fanciful to think he can take the title. Hamilton is far closer and after taking time to settle in, now appears to be hitting his stride. He has outqualified Rosberg four times on the bounce and seems relatively comfortable in his surroundings.

There are high hopes for the low-downforce packages to be used in the upcoming races at Spa and Monza. If Hamilton can win one of those two races and narrow the deficit to Vettel, he will set the tone for the rest of the season. The prospect of a Hamilton versus Vettel title scrap, with the Briton as the hare and the German as the tortoise, is a mouth-watering one.

## 2013 MERC DEVELOPMENTS

Mercedes has had a good rate of development so far this year. Here are three recent upgrades that worked.

### FRONT WING DETAIL ▶

Mercedes has made great strides with its front wing detail. In Hungary, a new rearward-facing upper element (red arrow) was introduced.

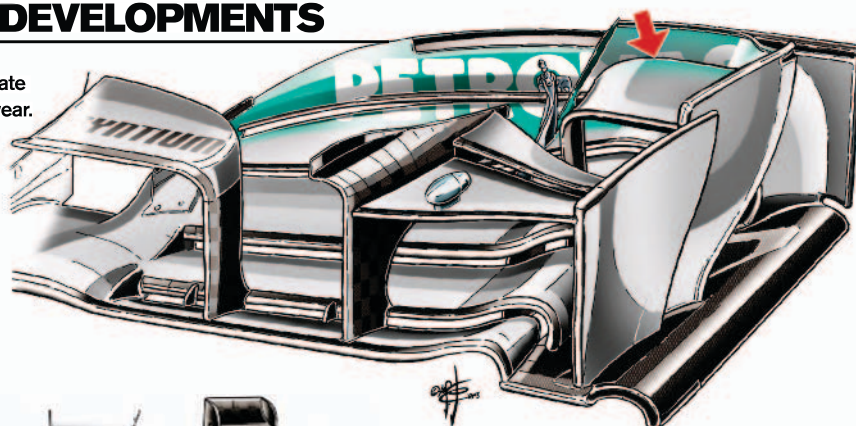

### REAR BRAKE DUCTS ▼

Introduced for Monaco, revised rear brake ducts were designed to take heat away from the disc and calliper, preventing it feeding into the tyre. Aero tweaks (numbered) helped to channel the air to work with the brake ducts.

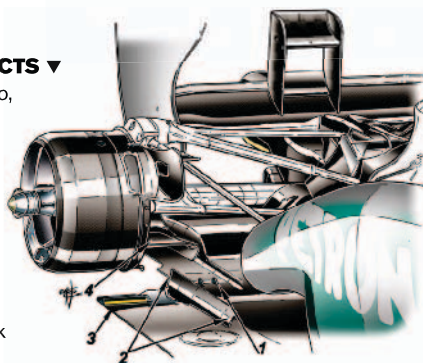

### NOSE ▶

In Germany, Mercedes ran a higher, slimmer nose with pillars sweeping forward. This is to better guide the air towards the middle of the underside of the car.





# IndyCar's global plan

The possibility of overseas races and winter dates is being considered to mitigate against the early finish to the main season. By **GARY WATKINS**

28

IndyCar has targeted a move outside of North America by 2015, with plans for a series of off-season races around the world that could form a winter championship.

The aim of the races would be to give IndyCar teams a new revenue stream over an off-season that looks likely to grow from next year.

New IndyCar boss Mark Miles is keen to bring forward the end of the domestic series to avoid competing for TV viewers with the US's National Football League and is

understood to have put forward a draft 2014 calendar ending in August.

Plans to bring IndyCar into the international sphere have been laid out by new president of operations and competition Derrick Walker. He outlined a number of scenarios, including non-points races, a winter or regional championship and even the possibility of the IndyCar main season starting overseas in January or February.

"We have teams that from the end of September through to the start of

the season in March don't have a lot to do," said the former CART and IndyCar team owner, who took up his post in May. "There's only so much testing you can do. Our teams need income. An international component to their season would help strengthen their financial position.

"Are we going to have 10 races outside North America? No. Could we have three, four or five? I'd like to think that is possible.

"International events are definitely something that IndyCar wants as part

of its DNA. US open-wheel racing has the capacity to travel. It has shown that before [see panel below]."

Walker stressed any additional flyaway races that were included in the championship would have to come early in the season to prevent the chance of the championship being decided away from home.

"We are not going to tear up our existing calendar, and we don't want our champion crowned at 1am in some faraway place," he explained. "But if there are races in January or

## MAJOR US SINGLE-SEATER RACES OUTSIDE THE US AND CANADA



### USAC

- 1971 Rafaela (RA)
- 1978 Silverstone (GB), Brands Hatch (GB)

### CART/CHAMP CAR

- 1980-81 Mexico City (MEX)
- 1991-2007 Surfers Paradise (AUS)
- 1996-2000 Rio de Janeiro (BR)
- 1998-2002 Motegi (J)



- 2001-06 Fundidora Park (MEX)
- 2001 & 2003 Lausitz (D)
- 2001-02 Rockingham (GB)
- 2003 Brands Hatch (GB)
- 2003-07 Mexico City (MEX)
- 2007 Zolder (B), Assen (NL)

### INDYCAR

- 2003-11 Motegi (J)
- 2008 Surfers Paradise (AUS)\*
- 2010-13 Sao Paulo (BR)

\*non-championship





IndyCar's domestic season could be cut short in 2014

EXPERT VIEW



Mark Glendenning  
US correspondent

IndyCar is under no illusions when it comes to the areas of its operations that need working on, and it's encouraging to see that it is open to ideas such as a winter series to help address them.

Some benefits are immediately obvious. The opportunity for teams to utilise otherwise dormant resources would be welcomed, and a winter series would also be a boon for the crew members who are only contracted during the racing season.

Not everyone is sold on the idea of adding flyaways, however. The Ganassi and Penske teams have both admitted their ambivalence in the past. There is also a line of thinking among some in the paddock that IndyCar would be better served

putting more into developing the events it already has, rather than adding new ones.

It's also unclear where the additional revenue for the teams would come from. Not all existing sponsors will be interested in the Middle East, for example, so presumably there will be a need to find extra backing specific to those events.

And then there is the series' recent track record with promoters in that part of the world: remember attempts to race in China? The flipside is that IndyCar will have had a chance to learn from that experience. It's also unfair to paint all prospective promoters with the same brush.

In summary, I like the thinking, but I'd like to see more details.



Walker (middle) is championing overseas races

MILLER/LAT

February leading into the domestic series, then it might make sense to include them in our championship.”

NO RACES FOR EUROPE

Races in Europe over the winter, said Walker, are unlikely because IndyCar is looking more towards warmer climates in developing motorsport markets. Those markets are likely to include Latin America and Asia, with a focus on India and the Middle East.

“The regions we’d go to would be defined by the ability for the races to

be properly funded,” he said. “We are interested to talk to any country, city or promoter who might be interested in putting on a race.

“Not every country can afford Formula 1, or even the World Endurance Championship. We could come up with a different package that could be of interest in different places around the world.”

The focus is likely to be on street circuits, Walker said.

“We have the ability to set up street events and make them work,”

he explained. “We have demonstrated that we can take racing to the people.”

The introduction of the overseas races will not be rushed, though.

“We want to strengthen our package before we go knocking on doors,” said Walker. “We were focused on unification [of Champ Car/IRL], then on the new car and now on creating better racing. Slowly but surely we’re putting our house in order.”

LINKS TO A1GP ORGANISERS

A European group called World Series Operations, with links to the A1GP World Cup of Motorsport in 2005-09 and subsequent attempts to relaunch the series, has put plans to IndyCar for a winter series under the IndyCar Global Challenge banner. It already has draft agreements in place with a number of promoters and has proposed a five-event schedule starting at the end of 2014.

WSO’s John Hynes, who was one of the investors in the A1GP-winning Team Ireland squad, said: “One of the biggest problems IndyCar has is carrying its teams through the long winter when they are not generating

‘IndyCar is looking more towards warmer climates than Europe, in developing motorsport markets’

income. We have a schedule of races that could bring IndyCar to a much wider audience.”

Plans for some kind of winter series appear to have the teams’ backing.

Andretti Autosport vice-president J-F Thormann said: “We are very much in favour of it. The domestic schedule ends so early, but we employ our personnel all year round, so it would be a good utilisation of human resources and assets. The important thing is to pull it off without adding financial stress to the teams.”

Thormann feels that the opportunity to work with WSO could be an attractive proposition.

“They have experience of what they did with A1GP [which Andretti competed in], so it looks viable,” he continued. “I’m sure we could do something interesting together.”



Andretti team ran in A1GP winter series

New Super GT cars from Lexus, Honda and Nissan on display at Suzuka



30

# Super GT homes in on DTM

Japan's grand touring car championship moved closer to its planned alignment with the German series with the unveiling of a new generation of GT machinery at Suzuka. **JAMIE O'LEARY** reports

Japan's Super GT championship took a major step towards its future alignment with Germany's DTM at Suzuka last weekend as a new generation of cars, which will make their race debuts next year, were seen in public for the first time.

Honda's striking NSX concept, the Lexus LF-CC and an all-new Nissan GT-R will carry their respective manufacturers' hopes in the series' premier GT500 division and pave the way for potential entries into the DTM in Europe and North America over the coming years.

The Honda and Nissan were demonstrated in a one-hour test session at Super GT's blue-riband event, the Suzuka 1000km, last

Saturday, while a technical problem for the Lexus kept it on the sidelines. All three cars will now be subjected to intense development programmes ahead of the new season.

Series organiser GTA has been a key player in establishing the common technical rulebook that will be shared between Super GT, the DTM and the new US version of the German series from 2017.

GTA chairman Masaaki Bandoh denied that the main reason behind the move towards the DTM's regulations was an underlying aim to make the championship more of a force internationally.

"I have two main roles within this process – to control costs and to improve safety," he said. "These cars,

with their carbon chassis, improve driver safety and will be cheaper than the cars we have now.

"They are also going to be closer in technology to what the manufacturers want to sell to customers. In addition to which, the DTM is cool!"

## NOT QUITE DTM CARS YET

The three cars bear a close resemblance to those that currently contest the DTM. Each is constructed around a spec carbonfibre chassis, produced in Germany by composite expert GERG Gruppe, and they share



GTA's Bandoh, Toyota's Takahashi, Honda's Sasaki and Nissan's Miyatani



No DTM plans for Nissan GT-R



Mid-engined Honda NSX



Lexus LF-CC did not run at Suzuka

many of the other 87 control parts mandated by the ITR.

Identical front and rear aerodynamic packages, and overall car dimensions bring the models far closer to the Audi RS5, Mercedes C-coupe and BMW M3 racing in the DTM than the current-spec Nissan GT-R, Honda HSV-010 and Lexus SC430, which do not conform to a rules package that would allow them to race outside of Super GT.

Chief among the differences between the current crop of DTM racers and the new Japanese cars are the engines being used. Super GT is ditching its 3.4-litre V8s in favour of turbocharged inline fours of two litres in capacity in a bid to retain a level of relevance

with each of the manufacturer's target road-car customers.

The DTM is likely to move to an identical engine formula in 2016 (and certainly by 2017), but for now it is persevering with four-litre V8s, producing around 480bhp.

Additionally, Honda's NSX is both mid-engined and features hybrid technology, neither of which are allowed under the current DTM regulations. It's something that Honda head of motorsport Hideo Sasaki admitted posed "a huge challenge" to his team of engineers.

Smaller details, such as the positioning of the fuel-filler openings (to make refuelling during the endurance races far easier), also differ from DTM cars, which have

'Chief among the differences between the current crop of DTM racers and the new Japanese cars are their engines'

not taken on fuel during races since the current breed of cars were introduced last year.

### WILL JAPAN JOIN THE DTM?

Keizo Takahashi, managing director of Toyota motorsport, said the timing of the new formula is ideal, should his company have ambitions to enter the DTM in the future.

"This allows us to have a stable competition in Japan based on these rules and be in a good position with our car if we want to expand beyond our own series," he said.

Series boss Bandoh confirmed to AUTOSPORT that discussions have already started with the DTM and Grand-Am to stage a non-championship event that will bring together competitors from all three series in the future, while Takahashi suggested it would be a good idea to hold this before full commonality of rules is established in 2017.

Shoichi Miyatani, president of Nissan's sporting arm, NISMO, said thoughts of a DTM entry would not be entertained at present, but refuted recent comments in the German media from the company's technical director of global motorsport, Jerry Hardcastle, that it had no interest in entering the championship due to the limited marketing benefit it can offer.

Miyatani said: "That is Jerry's opinion, not Nissan's opinion. We have not discussed it. There has been no decision from the executive level of Nissan."

Takahashi added that any entry from Toyota would be under the Lexus name and would almost certainly be run by Cologne-based Toyota Motorsport, which currently masterminds its World Endurance Championship programme.

"We have TMG in Europe and also Toyota Racing Development in the USA, which I expect would take the lead in this respect, but we have no decision yet," he said.

## SUPER GT TIMELINE

1993 Series established as All-Japan GT Championship.



1996 GT1/2 classes replaced with GT500/300. McLaren F1 GTR becomes only non-Japanese car to win overall title.

2002 First foreign round held at Sepang in Malaysia.



2004 Non-championship 'All-Star' race staged at Homestead, USA.

2005 Series renamed Japanese Super GT Championship.

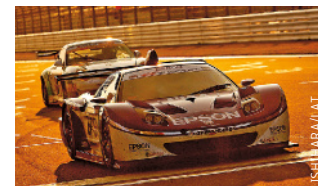

2007 'Japanese' dropped from series name as Super GT takes another step towards an international platform. Current rules package adopted.



2011 GT3 cars allowed into secondary 'GT300' class.

2014 New cars, based on DTM regulations, set for debut.

## Quick and competitive Track Day Insurance

The first online "quote and buy" system solely for the track day user, supplied by established track day and motorsport insurance provider - Ryan Motorsport Insurance

INSUREMYTRACKDAY.COM

- ✓ Damage to your car on a track day, regardless of fault.
- ✓ Any circuit in Europe, including Spa and Nürburgring Nordschleife.
- ✓ Inclusive cover for barrier damage at the Nordschleife.
- ✓ Vehicle recovery available for circuits in Great Britain.
- ✓ Organisers and Clubs - promotional rates and discounts
- ✓ Storage and transit for vehicles and trailers

Log on to [www.insuremytrackday.com](http://www.insuremytrackday.com) to obtain your online quote today.

# FASTEST SHOW ON EARTH



**CARS** F1® cars, touring cars, rally cars, oval, performance, historic and karting. **STARS** F1® drivers and motorsport celebrities. **ACTION** Live Action Arena, Caterham Experience and indoor karting track.

**EXHIBITORS** Over 600 motorsport companies, cars, technology, accessories and merchandise.

**TICKETS INCLUDE ACCESS TO THE PERFORMANCE CAR SHOW**

## BOOK NOW

[AUTOSPORTINTERNATIONAL.COM](http://AUTOSPORTINTERNATIONAL.COM)

CALL 0844 581 1370



/Autosport.International.Show



@Autosport\_Show

 **AUTOSPORT**  
INTERNATIONAL

**The Racing Car Show**

**9 - 12 January 2014 NEC**

9-10 January Trade Only Days

# Karl-Heinz Kalbfell

## (1949-2013)

**K**arl-Heinz Kalbfell, who died at the age of 63 from injuries sustained in a historic motorcycle crash at Brands Hatch last weekend, was the architect of BMW's successes in Super Touring and at the Le Mans 24 Hours, as well as its return to Formula 1 with Williams in 2000.

The German, who took over the reigns of BMW Motorsport in September 1988, threw his organisation's weight behind the Super Touring category after its withdrawal from the DTM following a regulations row at the end of 1992.

The factory Schnitzer team was sent to the British Touring Car Championship, won the '93 title and laid the foundations for the E36-shape 3-series to become the most successful car of the Super Touring era.

"Kalbfell said Schnitzer must go to the most competitive series," recalls team boss Charly Lamm, "because it would show if we were competitive and, if we were not, it would accelerate our development."

A BMW assault on Le Mans was already in Kalbfell's plan, according to Lamm.

"He said this to me very early," recalls the Schnitzer boss. "I always thought how the hell is he going to do that?"

The arrival of the BMW-engined McLaren F1 supercar and a re-birth of GT racing in Europe presented that opportunity. BMW backed a low-key effort with the Bigazzi team in 1996 and then mounted an attack on Le Mans and the new FIA GT Championship with the long-tail McLaren F1 GTR in 1997.

This programme and an involvement by McLaren in Super Touring development was an attempt by Kalbfell and long-time BMW Motorsport engine boss Paul Rosche to forge a relationship with a major team in readiness for a return to F1. The plan didn't work out with McLaren, so Kalbfell turned to Williams. This relationship yielded that return to F1 for BMW from 2000 and a winning assault on Le Mans in



**'The German, who took over the reigns of BMW Motorsport in September 1988, threw his organisation's weight behind the Super Touring category'**

1999 with the Williams-designed-and-built LMP prototype, the V12 LMR.

Kalbfell, who came from a marketing background, always had a plan for BMW

Motorsport, according to Lamm.

"He was a strong believer in the BMW's sporting heritage and knew the importance of motorsport to the brand," he says. "Kalbfell was a man of vision. He was very creative, but also very dedicated.

"He had an international view of motorsport. I remember our first meeting after he took over at BMW Motorsport. He told us that we had to go to Japan for the Fuji InterTEC 500Km race just a few weeks later."

Long-time BMW driver Steve Soper remembers Kalbfell "more as an ally than a boss" from his years at BMW throughout the 1990s.

"He was very influential in my career and my only real boss during my time at BMW," he says. "I had a very good relationship with him. He was a hard man, but a fair man."

Kalbfell took on a senior marketing role at BMW alongside his motorsport duties in 1994 and finally relinquished his responsibilities for racing over the winter of 1998/99 to Gerhard Berger. He subsequently worked for BMW's Mini and Rolls-Royce arms and then Alfa Romeo, Maserati and, most recently, Lotus in an advisory role.

Kalbfell was a keen biker and raced regularly at the Goodwood Revival.  
Gary Watkins



**Kalbfell oversaw BMW's move to Super Touring...**

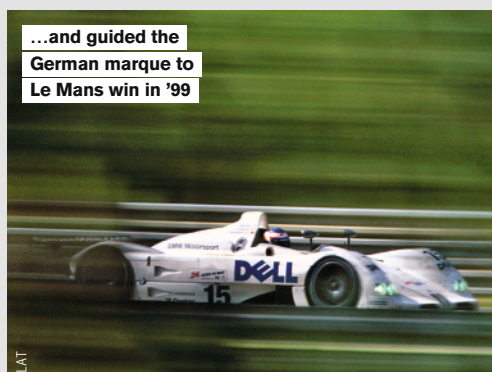

**...and guided the German marque to Le Mans win in '99**

LG



LG



LG

MARUSSIA £51m

CATERHAM £65m

SAUBER £90m

FORCE INDIA £100m

WILLIAMS £90m

TORO ROSSO £70m

RED BULL £235.5m

FERRARI £250m

MERCEDES £160m

F1 budgets vary considerably up and down the grid

# The true cost of Formula 1

The financial plight of F1 and its teams has been talked about a great deal in recent years, but what is the real picture? **DIETER RENCKEN** investigates who spends what



**McLAREN £160m**

**LOTUS £130m**

**M**oney makes the world go round, and this holds equally true in Formula 1. Without the folding stuff even the most sophisticated cars would sit silently in garages, devoid of fuel.

While F1 has been cash dependent since its inception, the global economic crisis and

voracious commercial rights holders have increasingly throttled independent teams so that now up to 40 per cent of the grid is endangered.

With budget and performance being symbiotic, disparities in finance are evident in the performance span, with the best funded running at the sharp end and cheaper operations bringing up the rear. The middle class is invariably betwixt and between; just as Mike's Mule is unlikely to wow Ascot, so the chances of Marussia winning Austin are zero.

With eight (of 11) teams – including heavyweights Red Bull Racing, McLaren and Mercedes – based in Britain, direct comparison of UK-domiciled operations is facilitated by ready access to Companies House data, which provides crucial information, such as turnover and profit and loss. However, the information is at best 18 months in arrears due to filing deadlines.

Therefore, for the purposes of this analysis best estimates have been applied across the board, including where teams fall outside the jurisdiction of British company law. In all instances a variety of sources were consulted and cross-referenced, including filings, known variables, informed assumptions and inside information.

As always, secrecy reigns, while varying (foreign) accounting systems, internal policies, shareholder objectives and economics complicate comparisons. Each pound banked/paid as dividend is one less dedicated to performance.

F1's contentious Resource Restriction Agreement further clouds matters, because buy-ins, outsourced services and in-house production contribute to the overall figure. So personnel-heavy teams are not necessarily inefficient, simply productive.

Formula One Administration earnings – aka 'Bernie (Ecclestone) Money' or FOM income – are paid to qualifying teams 12 months in arrears, spread over the February–November block. Four outfits – Red Bull, Ferrari, McLaren and Mercedes – receive varying Constructors' Championship Bonus (CCB) payouts from 2013, effective in 2014; Williams receives a lesser heritage sum.



## RED BULL RACING

Milton Keynes, Britain (Austrian owned)

Budget: £235.5m (estimated)  
Income: £240m

**Profit: £4.5m net**

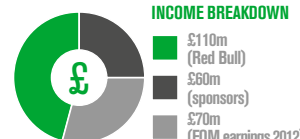

Red Bull's F1 operation consists of two intertwined companies: Red Bull Technologies, which produces cars and kit to order from Racing Bull Racing, and the race team management entity, with the overall spend bloated by inter-group deals. Companies House records RBT's 2011 turnover as £215m (declared profits £4m), while RBR registered a bottom line of £640k on £177m spend.

Adding 10 per cent for economics (2010/11 turnover increased by double that after RBR withdrew from FOTA/RRA activities) provides a global spend of £445m.

Actual spend – corrected for programmes undertaken on behalf of the group and deduction of income from Caterham and (small beer) Scuderia Toro Rosso customer activities – lies between RBT's turnover and the total, pointing to £250m annually for the overall RBT/RBR F1 operation.

Future growth in Infiniti sponsorship is likely to offset cost increases of (Renault) engines, while heightened revenues from existing and prospective sponsors will serve to reduce Red Bull's subsidies without materially raising the budget. Given the run of success, sponsors can be expected to shell out more in coming seasons.

CCB payments provide for incremental annual £50m revenue streams from 2013–onwards, albeit 12 months in arrears. The objective is for RBT/RBR to reduce dependence on their parent, while continuing to generate global exposure for the brand. So far so good – as long as Red Bull keeps the euros flowing in the interim. ▶

# THE SIZE OF FORMULA 1's TEAMS

The number of people employed by the teams varies hugely across the different operations. These graphics show the current number of employees per team.

👤 DENOTES 20 PERSONNEL

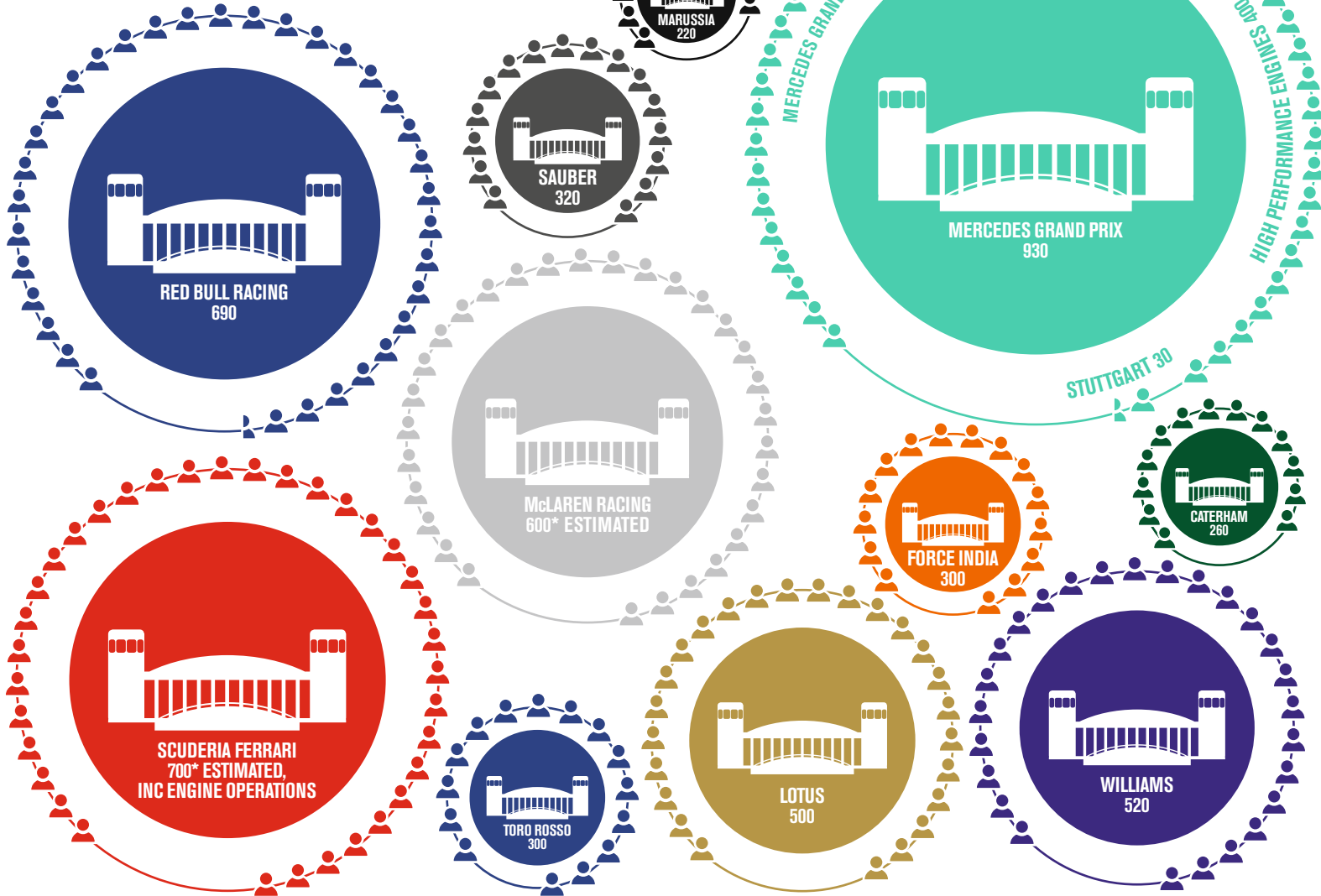

## SCUDERIA FERRARI

Maranello, Italy

Budget: £250m  
inc engines

Income: £260m

Profit: £10m (group) 2012

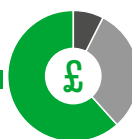

### INCOME BREAKDOWN

- £160m (sponsors, incl FIAT/Ferrari)
- £20m (customers)
- £80m (FOM earnings 2012)

Ferrari, already on preferential FOM terms through heritage, is the only F1 team producing an entire car in one location, doing so by sharing mainframe facilities with the road car division, which supports the Gestione Sportiva racing department in lieu of global advertising.

Engines are supplied to two customer operations, enabling costs to be further defrayed; these have been extracted to provide a purified base. Reduction programmes, both within and without Ferrari, enabled the sporting division to report an internal profit for the first time in 2011.

However, the company's corporate structure and internal accounting policies make it impossible to split revenues/profits, although all 2012 financial parameters improved over the previous year by an average of 10 per cent – with similar growth expected for 2013.



COATES/LAT

The Scuderia subscribes to the RRA, but reporting is complicated by the fact that Italy does not provide a ready-made cottage industry as per the UK – hence the vast proportion of components are manufactured internally, boosting headcount, with allocations for engine manufacture further compounding matters.

Ferrari's brand provides a powerful commercial pedestal, but the signs are tobacco company Philip Morris could reduce below-the-line activities – it has already called time on its pre-season Wroom programme – leaving a hole of up to £60m. Whether Ferrari will dip into profits in that case or find a replacement is the burning question. CCB status adds an annual £30m to heritage payments.



COATES/LAT

## McLAREN RACING

Woking, Britain

Budget: £160m

Income: £180m

Profit: £20m 2011



### INCOME BREAKDOWN

- £120m (sponsors)
- £60m (FOM earnings 2012)

McLaren Racing is a hard one to call because of the group's internal structure. The operation builds and races grand prix cars, but also provides customer support to rival squads Force India and Marussia, while sourcing engines from Mercedes.

# TEAM SPENDING

This is how the total estimated £1401.5m budget spent by the F1 teams per season breaks down

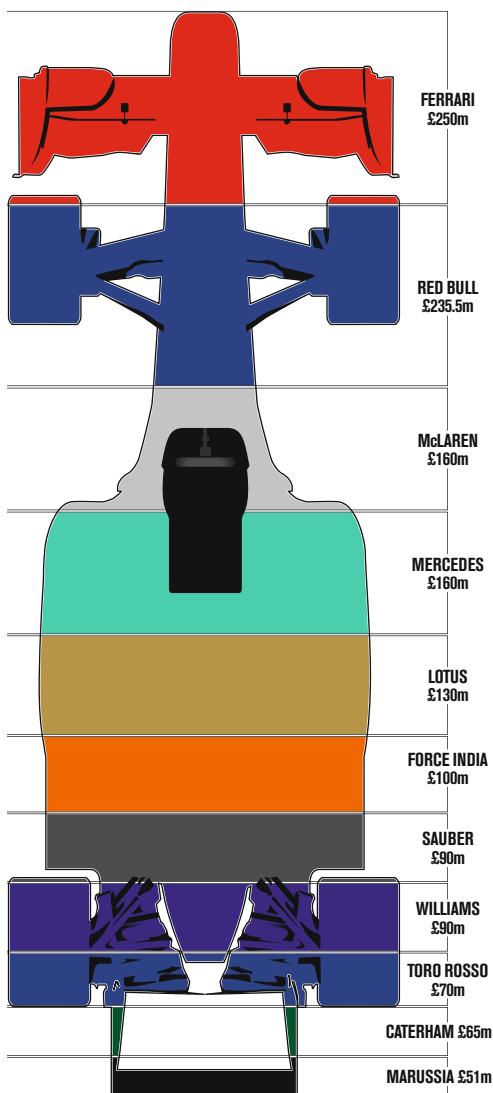

Then sister companies such as McLaren Automotive and McLaren Applied Technologies make direct and indirect contributions, yet Racing still records profits – to wit the largest attributable profit on the grid (£20m). Sharing group facilities reduces costs, but complicates accounting and headcount allocations.

McLaren's strength has long been the length, breadth and depth of its sponsor partnerships, and while the pending loss of Vodafone is a blow, its 10-year commercial and technical deal with Honda (commencing in 2015, with contributions expected sooner) provides for a bright future. Further sponsorship announcements are imminent and, as is the team's wont, likely to be blue chip.

Worryingly, though, Racing has not won a constructors' championship this millennium, and as FOM's contributions are paid on that classification, McLaren trails its direct competitors by at least £20m. CCB adds a further £50m annually, but the overall shortfall still equates to a valuable secondary partner, and creates cause for concern, particularly with regard to current performance.

The arrival of Sergio Perez boosted 2013 income via the Mexican's support from the Slims, the world's richest family.



## LOTUS

Witney, Britain (Luxembourg owned)

Budget: £130m

Income: £120m

Profit: -£10m

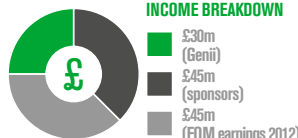

Neither fish nor fowl, Lotus uncomfortably floats in that middle ground between the majors and the independents, carrying large-team overhead absorption with modest sponsor income, yet without the CCB safety net.

Declared losses of £90m created headlines, but parent Genii Capital maintains that 75 per cent of that relates to shareholder loans and internal funding, structured as tax losses.

An announced sale of a 35 per cent share to the Infinity Racing consortium has yet to be completed for 'technical reasons'; but Lotus is confident the deal will go ahead, providing crucial investment and funding.

Despite these travails, Lotus, formerly Benetton/Renault F1, lies fourth in the constructors' rankings (third in 2012), with star driver Kimi Raikkonen second in the drivers', suggesting competent overall management. Financial performance nevertheless remains a worry, hence constant calls for increased F1 cost reductions.

Loss of a rumoured major deal for 2013 was a setback, although partnerships with Coca Cola, Microsoft and Unilever brands provide £15m per annum, with French connections delivering another £15m via Renault/Total.

Still, Genii pumps in £30m, with FOM earnings for this non-CCB team adding another £45m. It is surely an indictment of F1's business model that a team challenging for both titles requires shareholder loans to remain on the grid.

## MERCEDES GRAND PRIX

Brackley/Brixworth, Britain (German/Austrian controlled)

Budget: £160m inc engines

Income: £150m

Profit: -£10m 2011

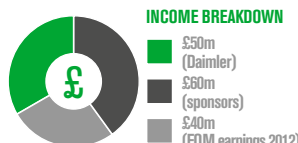

Mercedes F1's activities are split: Mercedes Grand Prix (race operation) and High Performance Engines (self-explanatory) are separate entities – albeit integrated – with MGP (and others) being HPE customers.

However, HPE cannot be isolated; nor can MGP's engineering satellite operating from Daimler's Stuttgart base. Combined, Mercedes has by far the largest spend in F1, with commensurate headcounts. These are, though, offset (marginally) by engine supply contracts with Force India and McLaren, the latter expiring in 2014 and with the former mutating into a customer partnership from 2014.



These activities explain top-heavy structures, with recent intensive staff recruitment drives pointing to a ramping up of activities, with, by extension, budget increases.

Mercedes GP is financed by a combination of Daimler funding, sponsorship, customer activities and FOM payments. Shareholding was diluted recently through the (still unregistered) allocation of shares to motorsport director Toto Wolff (30 per cent) and non-executive chairman Niki Lauda (10 per cent).

Although a member of F1's Strategic Committee, the Mercedes GP operation is not a full member of the CCB, qualifying for annual incremental payouts of £8m until 2015, which from then on increases to £10m.



## SAUBER

Hirwil, Switzerland

Budget: £90m

Income: £75m

Profit: -£15m

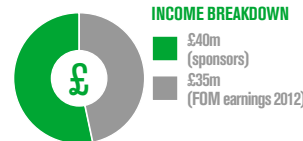

Like Lotus, Sauber swims mid-stream, having manufacturer-standard infrastructure inherited from its BMW tenure, combined with independent budget income. Unlike others, the team suffers in that it settles bills in Swiss francs – among the world's strongest currencies, so much so that it is artificially pegged against the euro – but invoices mainly in dollars, as is customary in F1.

This disparity, plus over dependence upon its Mexican sponsors, lies at the root of its current (well-documented) financial woes, which are expected to ease substantially once its much-vaunted partnership with a trio of Russian entities is fully on stream.

Owners Peter Sauber (founder, 67 per cent) and able lieutenant Monisha Kaltenborn (CEO, 33 per cent) fought against the odds to keep Sauber going after BMW pulled the plug after four years, the former dipping into life savings in recent times. The Russian deal materialised not a day too soon, albeit too late to salvage 2013 (although roubles are believed to be already flowing).

Swiss brands Rolex and UBS support commercial rights holder FOM, not their own... ▶

# WHO'S GETTING THEIR MONEY'S WORTH?

It's difficult to estimate exactly which team in F1 should be considered the best value for money. After all, in terms of pounds per point, the higher

scoring rate of the top teams makes them look far better value than outfits spending a fifth of the budget. However, a glance at the

constructors' championship, when seen alongside the budgets of each team, gives a much better indication of the over- and underachievers...

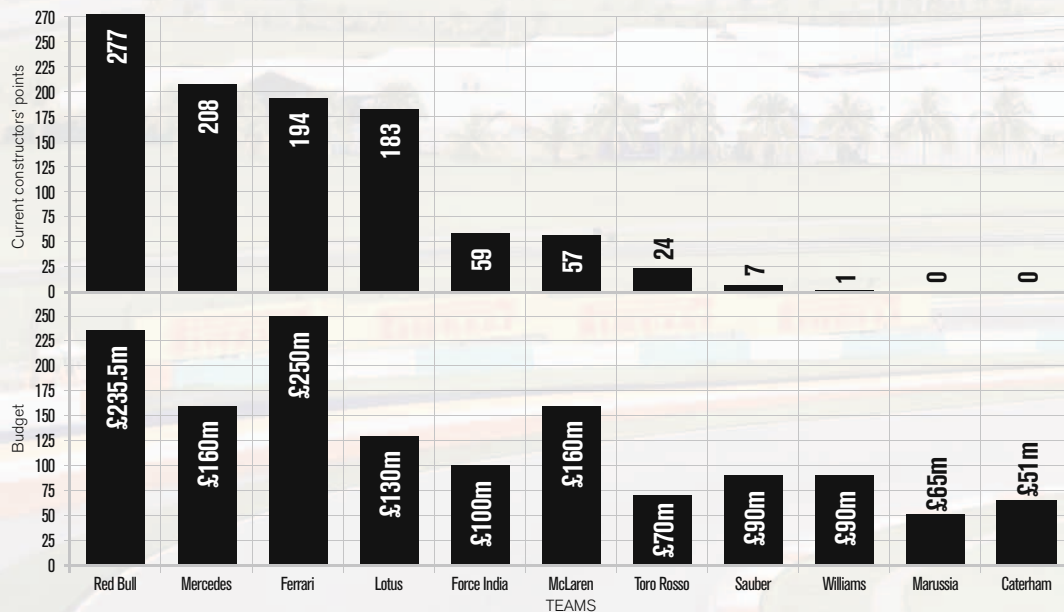

While there are limitations to this comparison, notably that Ferrari's budget includes its engine programme and makes the team's underachievement look more dramatic, it does show two key things.

In the grand scheme of things, it's clear there's a correlation between budget and achievement. While the order is not perfect, the big spenders

are generally up front and the small spenders are at the back.

Secondly, you can see which teams are performing better than they should do. At the front, Red Bull is one place higher than its budget suggests, although the distortion of the Ferrari figure makes that a moot point. Mercedes, Lotus, Force India and Marussia are one place stronger than

they should be. The biggest difference is at Toro Rosso, two places higher than its natural level.

The underperformers, Ferrari, McLaren and Williams, are at least two places lower than their potential based on budget estimates. Sauber and Caterham, meanwhile, are one place worse off.  
*Edd Straw*

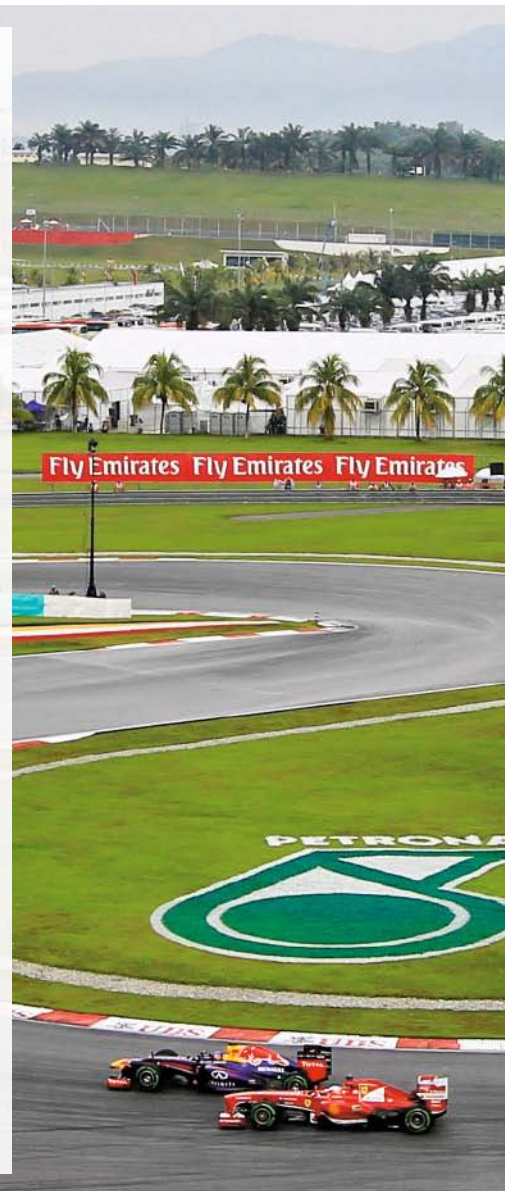

## FORCE INDIA

Silverstone, Britain (primarily Indian owned)

Budget: £100m  
Income: £75m  
Profit: -£25m

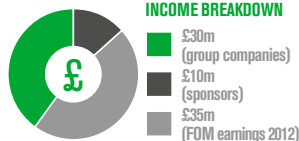

Despite similar headline numbers to Sauber, Force India's business model could not be more different, having emerged from Jordan/Midland/Spyker stewardship as a team owned 42.5 per cent each by two Indian billionaires and a minority Dutch shareholder.

The bulk of Force India's backing flows from group companies, with Vijay Mallya's liquor

conglomerate and the Sahara Group providing 30 per cent of its £100m budget, and sponsors/FOM providing a further 45 per cent. The balance is registered as a (tax) loss, surely creating cause for future concern as the Mallya and Sahara companies face challenges in India.

Still, major investments are planned for its Silverstone base, new sponsors have been signed and the team lies ahead of McLaren – from whom it sources technical services (which explains its headcount levels) – in the constructors' table.

For 2014 Force India has entered into a technical partnership with Mercedes GP, which can only stand it in good stead.



## WILLIAMS

Wantage, Britain (Frankfurt Stock Exchange listed)

Budget: £90m purified, exc Hybrid Power  
Income: £90m  
Profit: Even

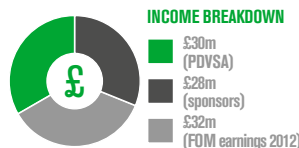

Williams forms part of a three-way dogfight with Force India and Sauber, yet has a unique business model, being F1's only listed team. Fifty per cent is held by founder Frank Williams, engineering partner Patrick Head has 9 per cent, Toto Wolff controls 15 per cent, an employees trust owns 3.5 per cent, with 20 per cent being publicly held.

Williams has two primary revenue streams: Venezuela's sovereign oil fund, PDVSA, courtesy of driver Pastor Maldonado, and FOM. Each contributes a third of the £90m budget. With Venezuela's government being unstable and FOM income being performance-linked – current results are the worst in the team's 35-year history – alarm bells should peal.

However, Williams recently restructured, holds a 2014-onwards Mercedes engine contract, has a strong brand name and a superb facility. Associate companies such as Williams Hybrid Power and Williams Advanced Engineering, plus customer contracts (that is, Formula E), keep the race team level. A deferred one-off £10m FOM heritage payment tipped Williams into paper profit of £5m in 2012.



Some teams are punching above their weight this season

39  
COATES/LAT

## SCUDERIA TORO ROSSO

Faenza, Italy (Austrian owned)

Budget: £70m



Income: £70m

Profit: Even



### INCOME BREAKDOWN

- £32m (Red Bull)
- £8m (other)
- £30m (FOM earnings 2012)

STR exists as a finishing school for the most promising of Red Bull's cadre of development drivers. As such, it does what it says on the tin, bringing youngsters through – but, with other than Sebastian Vettel (and possibly Dan Ricciardo in future), that is where it stops, because no further talent has made it to RBR.

Primary funding (45 per cent) is provided by Red Bull; FOM earnings add virtually the same. The balance comes courtesy a coterie of

Arab-controlled entities. Such is their input that rumours exist they've acquired (strenuously denied) shareholdings. Maybe, maybe not. Hives of activity around STR during Gulf races suggest deep links.

STR's budget is on the up, having last year doubled its (formerly Minardi) Faenza base, while recruitment for aero staff to service its Bicester windtunnel is ongoing. As a 'school', STR operates on a zero-sum basis, as long as Red Bull shells out.

## CATERHAM

Leaffield, Britain (Malaysian owned)

Budget: £65m



Income: £65m

Profit: £0m Even



### INCOME BREAKDOWN

- £26m (group)
- £9m (driver and other sponsors)
- £30m (FOM earnings 2012)

Eleventh for Vitaly Petrov in last year's Brazilian Grand Prix secured Caterham's 10th-place share of FOM's revenues, making a difference of £12m to its budget.

Founded in 2010 during the FIA's 'budget' team initiative, Caterham is funded by three streams: revenues derived from/via companies owned by Air

Asia boss and team founder Tony Fernandes, pay-driver contributions and FOM money. A road car partnership with Renault facilitates engines, with Caterham now firmly housed in its (acquired) Leaffield factory.

## MARUSSIA

Banbury, Britain (primarily Russian owned)

Budget: £51m



Income: £51m

Profit: £0m Even

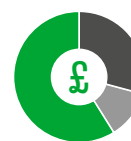

### INCOME BREAKDOWN

- £30m (Marussia)
- £15m (driver and other sponsors)
- £6m (FOM earnings 2012)

Marussia survives against all odds, posting strong results given non-existent status within FOM – which refuses point-blank to recognise the Anglo-Russian team commercially, yet charges for freighting cars and kit across the world. It is in the final year of its Column 3 income – provided by FOM to start-ups.

The eponymous Russian sportscar maker provides 60 per cent of funding, with the balance derived from drivers/sponsors. It enjoys tacit Ferrari support, which supplies engines for 2014. The question is who blinks first: FOM or Marussia? ❓



# SUBSCRIBE TO AUTOSPORT AND GET...

40



## 'DOM REILLY FOR WILLIAMS' CREDIT CARD CASE



**SUBSCRIBE NOW!**

Visit [www.themagazineshop.com/ASPO/M0813P](http://www.themagazineshop.com/ASPO/M0813P)

Or call and  
quote M0813P

**08448 488 817**

- ✓ Save 19% on the cover price
- ✓ Pay just £36.99 every 13 issues by Direct Debit

the **magazine**shop.com

Please have your bank details ready.  
Offer ends September 5 2013.

# PLUS FREE DIGITAL EDITION SUBSCRIPTION & UNLIMITED ACCESS TO AUTOSPORT.COM



## AUTOSPORT SUBSCRIPTION ORDER FORM

Please start my subscription to AUTOSPORT, paying just £36.99 every 13 issues by direct debit, saving 19% on the cover price. **Please send me my Free 'Dom Reilly for Williams' Credit Card Case**

**YOUR DETAILS** – must be completed (BLOCK CAPITALS PLEASE)

Title: \_\_\_\_\_ Name: \_\_\_\_\_

Surname: \_\_\_\_\_

Address: \_\_\_\_\_

Postcode: \_\_\_\_\_

Telephone: \_\_\_\_\_

Mobile: \_\_\_\_\_

Email: \_\_\_\_\_

**DIRECT DEBIT PAYMENT**  
(UK ONLY)



To the manager, bank name: \_\_\_\_\_

Address: \_\_\_\_\_

Postcode: \_\_\_\_\_

Name of account holder(s): \_\_\_\_\_

Bank sort code   -   -

Bank/building society account number

Please pay Haymarket Media Group direct debits from the account detailed on this instruction subject to the standards assured by the direct debit guarantee. I understand that this instruction may remain with Haymarket Media Group and, if so, details will be passed electronically to my bank/building society.

Signature(s): \_\_\_\_\_

Date: \_\_\_\_\_

**Terms & Conditions:** This offer is open to UK residents only. Overseas rates are available on +44 (0) 1795 592 974. Please allow 35 days for delivery of your gift and first issue. The gift will be sent under separate cover from the magazine. Should we run out of gifts, you may be offered an alternative gift – there is no cash alternative. To activate your AUTOSPORT online account visit <https://secure.autosport.com/subs/activate.php> and enter your activation code (your personal magazine subscriber number which will be included in your welcome email/letter) along with your email address to access your extra AUTOSPORT content. Direct Debit rates are valid for one year after which they are subject to change – should prices change we will inform you in writing. We ask that you enter into a Direct Debit agreement with the intention that your subscription will continue for a minimum period of 12 months, even if the frequency of payment is for a shorter period, however, you will still have the right to cancel your Direct Debit in accordance with Direct Debit Guarantee. Should you wish to cancel your subscription it will be cancelled on expiry of the current term which will not be refundable, other than in exceptional circumstances. If a gift is included as part of the subscription offer we reserve the right to request the return of the gift. Details of the Direct Debit Guarantee are available on request. Savings are based on the standard UK cover price of £3.50. **Offer ends September 5 2013.** Haymarket Media Group Ltd uses a best-practice layered Privacy Policy to provide you with details about how we would like to use your personal information. To read the full privacy policy please visit our website [www.haymarket.com/privacy](http://www.haymarket.com/privacy) or call us on 08448 482 800. Please ask if you have any questions as submitting your personal information indicates your consent, for the time being, that we and our partners may contact you about products and services that will be of interest to you via post, phone, e-mail and SMS. You can opt out at ANY time by emailing the [datacontroller@haymarket.com](mailto:datacontroller@haymarket.com) or by calling 08448 482 800.

**Please return this form to:**  
**AUTOSPORT**  
**FREEPOST RSBY-ZLLA-SZZS**  
**PO Box 326**  
**Sittingbourne ME9 8FA**

## FREE GIFTS

- ✓ Free 'Dom Reilly for Williams' Credit Card Case. Exclusively designed and hand-made for the Williams F1 team, this case is made from luxurious dark blue saffiano leather
- ✓ Free subscription to the AUTOSPORT Digital Edition and unlimited access to AUTOSPORT.com

## THE BENEFITS OF SUBSCRIBING!

- ✓ Never miss an issue
- ✓ Free delivery direct to your door
- ✓ Unlimited access to news and views from the paddock
- ✓ Access to subscriber-only analysis and comment

# RACE CENTRE

REPORTS • NEWS • ANALYSIS • OPINION

44 **DTM Nurburgring** Timo Glock gyrates after contact with Daniel Juncadella in an all-action race that provided a first-time winner in the shape of Mercedes' Robert Wickens

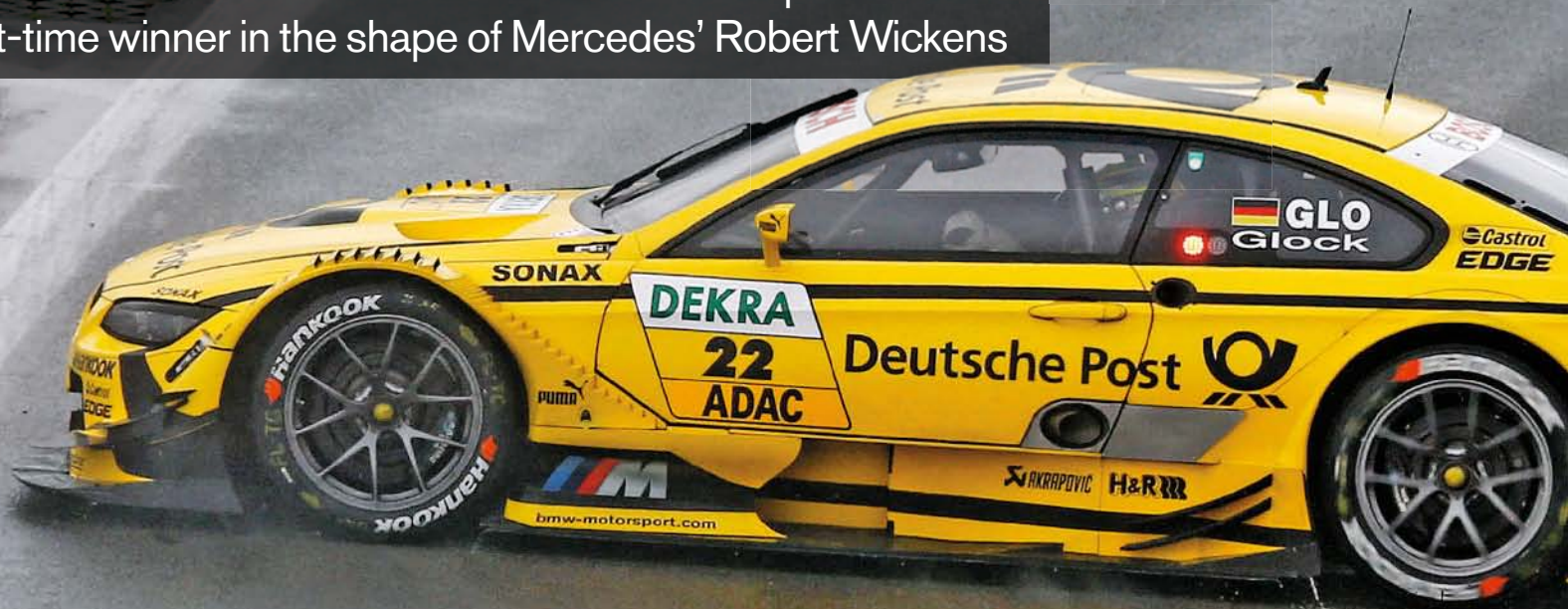

46 **Euro F3 Nurburgring**  
Marciello wins all three races as Rosenqvist falters



50 **Auto GP Nurburgring**  
Karthikeyan wins and spins as Sato retakes series lead



55 **Grand-Am Kansas**  
Taylor/Angellelli retake top spot in points with victory



PLMA

H&M

SYNTIUM

PETRONAS

SYNTIUM

BOSCH

JUN Juncadella

stern

DEKRA  
17  
ADAC

HANKOOK stern.de HANKOOK

SANDTLER H&M

PETRONAS

HANKOOK

XPB/LAT

# DTM

## Nurburgring (D)

August 18



Round 7/10



### RESULTS

47 LAPS, 105.98 MILES

1	ROBERT WICKENS (CDN)	1h15m33.710s	
	HWA Mercedes C-coupe; Grid: 7th-1m23.617s		
2	AUGUSTO FARFUS (BR)	+2.158s	
	RBM BMW M3; Grid: 1st-1m23.296s		
3	CHRISTIAN VIETORIS (D)	+9.749s	
	HWA Mercedes C-coupe; Grid: 8th-1m23.688s		
4	MIKE ROCKENFELLER (D)	+20.524s	
	Phoenix Racing Audi RS5; Grid: 11th-1m23.555s		
5	MARTIN TOMCZYK (D)	+27.104s	
	RMG BMW M3; Grid: 20th-1m24.225s		
6	ADRIEN TAMBAY (F)	+27.523s	
	Abt Sportsline Audi RS5; Grid: 14th-1m23.684s		
7	MARCO WITTMANN (D)	+29.540s	
	MTEK BMW M3; Grid: 2nd-1m23.445s		
8	MIGUEL MOLINA (E)	+33.037s	
	Phoenix Racing Audi RS5; Grid: 3rd-1m23.451s		
9	JAMIE GREEN (GB)	+39.972s	
	Abt Sportsline Audi RS5; Grid: 12th-1m23.574s		
10	PASCAL WEHRLEIN (D)	+40.486s	
	RSC Mucke Mercedes; Grid: 15th-1m23.687s		
11	FILIPE ALBUQUERQUE (P)	+40.908s	
	Team Rosberg Audi RS5; Grid: 17th-1m23.914s		
12	EDOARDO MORTARA (I)	+42.629s	
	Team Rosberg Audi RS5; Grid: 4th-1m23.648s		
13	MATTIAS EKSTROM (S)	+46.303s	
	Abt Sportsline Audi RS5; Grid: 9th-1m23.803s		
14	BRUNO SPENGLER (CDN)	+51.991s	
	Schnitzer Motorsport BMW M3; Grid: 10th-1m23.822s		
15	DIRK WERNER (D)	+57.649s	
	Schnitzer Motorsport BMW M3; Grid: 19th-1m24.198s		
16	ANDY PIAULX (GB)	+1m21.517s	
	RMG BMW M3; Grid: 22nd-1m24.505s		
17	GARY PAFFETT (GB)	-1 lap	
	HWA Mercedes C-coupe; Grid: 5th-1m23.514s		
18	TIMO GLOCK (D)	-1 lap	
	MTEK BMW M3 DTM; Grid: 13th-1m23.665s		
19	ROBERTO MERHI (E)	-1 lap	
	HWA Mercedes C-coupe; Grid: 21st-1m24.359s		
R	DANIEL JUNCADELLA (E)	29 laps-accident	
	RSC Mucke Mercedes C-coupe; Grid: 6th-1m23.617s		
R	TIMO SCHEIDER (D)	8 laps-accident damage	
	Abt Sportsline Audi RS5; Grid: 18th-1m24.091s		
R	JOEY HAND (USA)	0 laps-accident	
	RBM BMW M3; Grid: 16th-1m23.737s		

Winner's average speed: 84.16mph. Fastest lap: Wehrlein, 1m28.835s, 96.83mph.

### CHAMPIONSHIP

1	ROCKENFELLER	106	6	PAFFETT	57
2	VIETORIS	71	7	WITTMANN	39
3	WICKENS	70	8	EKSTROM	38
4	SPENGLER	67	9	WERNER	26
5	FARFUS	66	10	HAND	26

### MANUFACTURERS

1	BMW	251	3	AUDI	202
2	MERCEDES	229			

#### POINTS SYSTEM EXPLAINED

In each race: 25-18-15-12-10-8-6-4-2-1 to top 10 finishers.



Hand spun off at the start

FOR IN-DEPTH RESULTS  
forix.autosport.com



Wickens deserved his DTM victory

# Team's tyre tactics give Wickens first DTM win

WHERE TO START? A GOOD QUESTION, CONSIDERING the frantic and enthralling scenes at a wet/dry Nurburgring last weekend that made predicting a winner anybody's guess – for a third of the race at least.

Then, through the spray and chaos, emerged Robert Wickens to claim a memorable maiden DTM victory and erase any bitterness that might have arisen after his inherited Norisring win was taken away over a quirk in the rulebook.

Wickens' race, however, was nearly ruined at the second corner when he nudged Edoardo Mortara's Rosberg Audi into the Abt car of Mattias Ekstrom. With both RS5s gyrating and Timo Scheider having his own spin a few yards further on, Audi's race looked to be falling apart.

Seconds earlier, points leader Mike Rockenfeller had run off the track at Turn 1 to avoid the spinning Joey Hand. But it was these two actions that were the catalyst for a fascinating chain of events that would turn the battle for victory into a two-horse race.

Wickens and Rockenfeller were the horses in question; they just didn't know it yet.

First to the Phoenix Audi man – almost last – who dove into the pits under safety car conditions on lap two for wet tyres – an odd choice for the team to make, he thought.

"I knew the pit window hadn't opened yet, so it would not count as one of my mandatory stops, so I was unsure," said 'Rocky'. "But the guys had a plan, which I trusted. I'm glad I did."

By the time the pit window opened and the remainder of the field peeled in to shed their slicks, the Phoenix plan was clear. Rockenfeller led by more than 16 seconds from Audi stablemate Adrien Tambay, who quickly became the cork in a bottle containing polesitter Augusto Farfus – the initial leader – Miguel Molina and Wickens.

On lap 18, with Rockenfeller pulling out an advantage that would peak at more than 26 seconds, Wickens nipped by Molina for fourth at the chicane. Just a lap and a half later, he would

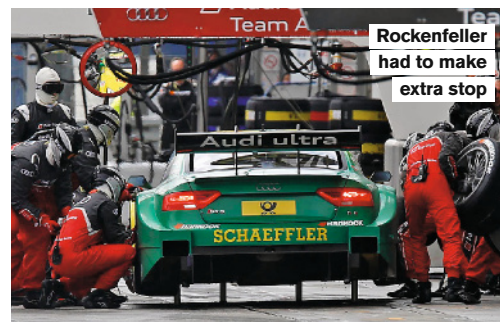

Rockenfeller had to make extra stop

pull off the move of the race as he went around the outside of both Farfus and Tambay in one moment of virtuosity at Turn 2.

"I was kind of hoping that they'd both stay to the inside, because I knew it was a risky move and that if they'd made contact, then I'd have been a gonner," said Wickens. "But when you're racing against 21 top drivers, you just have to have a bit of faith in them not to hit each other. I'm still surprised that it worked because I was only actually aiming [to pass] one of them."

A clear track ahead of him, Wickens reduced the deficit to Rockenfeller to a shade over 13 seconds, aided by option tyres that had been rubbered-in during the initial wet six laps (the Audi man started on primes, and so had to get the sheen off his now new options while Wickens charged).

This meant that when Rockenfeller made his final stop to switch back to the primes with six laps to go, Wickens was home and dry.

Rockenfeller, who finished in fourth place, wasn't too bothered by this. "One more pitstop, yes, but also fourth place," he said. "After I'd been last and then also gone off by myself at Turn 1 in the middle of the race, I was very satisfied with this result."

Rockenfeller now leads the championship by an increased margin of 35 points from Christian Vietoris, who stealthily made his way up to the final podium spot behind Farfus.

## IN THE PADDOCK

## Jamie O'Leary



THERE WERE PLENTY OF PEOPLE WHO doubted Toto Wolff's youth policy at the start of the year – myself included.

A reduced line-up of only six Mercedes C-coupes, piloted by only one driver with a DTM podium to his name (OK, a former champion in Gary Paffett, but you get the picture) didn't look likely to threaten Audi and BMW in 2013, despite the undisputed long-term potential of Christian Vietoris, Robert Wickens, Roberto Merhi, Daniel Juncadella and Pascal Wehrlein.

Halfway into the season, however, the decision to build for the future seems to be paying off.

Wickens, who AUTOSPORT did mark out as 'one to watch' in its season preview, has been sensational and thoroughly deserved his Nurburgring victory – especially after his 'hollow' inherited Norisring win was taken away.

The way Vietoris has consistently racked up the points has been just as impressive. While not having shown the dynamism of his Canadian team-mate, his ability to keep his nose clean and get somewhere close to Paffett on long-run pace with standard tyres has been key to his rise to prominence this year, even if he is yet to spray the champagne.

Wehrlein will surely gain better results once the RSC Mucke squad stops pointlessly leaving him out for too long on spent tyres, while Juncadella has shown signs that he may well have the ability to dominate this series over the next decade – that's unless Formula 1 manages to get its hands on him first!



“After the first corner, I thought, ‘Oh no!’”

Audi head of DTM Dieter Gass after seeing four of his cars spin inside the race's first 30 seconds.



## BMW set to race new M4 in 2014

## BMW CONFIRMED AT THE NURBURGRING

DTM round that it will ditch its M3 model – which is no longer being manufactured – at the end of the season and replace it with the all-new M4.

The manufacturer made the announcement in California on Saturday night, unveiling a concept version of the production M4 Coupe at the Pebble Beach Automobile Weekend.

BMW motorsport director Jens Marquardt confirmed to AUTOSPORT that the DTM version will be a totally new car, albeit one built using the 88 ITR-sanctioned parts mandated under the current technical regulations and also using several carry-over components.

Marquardt would not say when the new machine is expected to hit the track for the first time, indicating simply that: "It's still some way off. It will be a while before that happens."

The M3, which now has just three races of its competitive life remaining as a works machine, has taken 48 victories in the DTM, the first coming courtesy of Harald Grohs at Hockenheim in 1987 in the first-



generation E30-shape model that contested the championship until the end of the 1992 season.

Eric van de Poele lifted the 1987 championship trophy – despite not winning a race – with Roberto Ravaglia adding a second title in '89 and Bruno Spengler securing overall honours last year.

Like the current M3, the M4 will compete in coupe form, as dictated by the rulebook.

## Spengler and Paffett in wars

## THE TITLE ASPIRATIONS OF BRUNO

Spengler and Gary Paffett were dealt serious blows at the Nurburgring when both failed to score a point.

Reigning champion Spengler, who had been Mike Rockenfeller's closest rival at the start of the weekend, was a victim of several punts from Audi machinery, the most significant coming when Filipe Albuquerque helped him off while the pair squabbled over seventh place.

"I could see what happened today with the Audi tactics, and so could everyone else out there, so I don't think I really need to comment on it," said Spengler, who endured a second pointless race in a row as a result of contact with one of the Ingolstadt cars.

"The big problem was that with all the damage I had, there was no way to recover," continued the BMW driver. "It's a real shame. I'm not going to stop fighting, though. I'm fourth in the championship and it's a 39-point gap. The championship is still achievable."

Paffett, who was running inside the top eight early on, saw his hopes vanish when what Mercedes motorsport chief Toto Wolff described as "a risk that did not pay off", resulted in both the Briton and his HWA team-mate Roberto Merhi being given option slicks when the track was at its wettest as the pit window opened.

"A total waste of a weekend," said Paffett, who is now 49 points off the championship lead and behind stablemates Christian Vietoris and Robert Wickens. "I can't wait to get out of here."

Like 17th-placed Paffett, Merhi finished a lap down, but did set the fastest theoretical lap time of all.



## SCHEIDER ENDURES DIRE WEEKEND

Two-time DTM champion Timo Scheider's dismal year continued at the Nurburgring. Having spun as part of the race's Turn 2 melee, he retired with broken suspension after being turned into the barrier by Filipe Albuquerque and clipping the front of team-mate Jamie Green's Audi as he headed off the track.

## TOMCZYK ENDS POINTS DROUGHT

Martin Tomczyk said he was going to "go home, open a bottle of wine and smoke a cigar" after ending a drought of more than a calendar year without a point. The RMG BMW driver started 20th, but finished fifth thanks to dodging the first-lap chaos and timing his switch to slicks perfectly.

## WITTMANN MAKES ACE RECOVERY

Front-row qualifier Marco Wittmann staged a tremendous comeback to finish seventh after falling to the back of the pack after the first round of stops. The MTEK BMW driver was left out on slicks for one lap after the pit window opened, and crashed while leading at the hairpin on a wet surface.

## MOLINA TAKES FIRST 2013 POINTS

Miguel Molina made it into Q4 for the first time since 2011 and started in a season's best third place driving his Phoenix Audi. Afterwards, the bearded Spaniard declared: "I will shave if I get points tomorrow." He promptly finished eighth, despite going straight on at the hairpin while under pressure from Christian Vietoris at mid-distance.

## WEHRLEIN RUNS STRONGLY

Rookie Pascal Wehrlein set his maiden DTM fastest lap at the Nurburgring on his way to 10th place for the RSC Mucke Mercedes team. Wehrlein was on course for a top-six finish when he spun after slight contact with Roberto Merhi while lapping the Spaniard with seven laps to go.

# EURO F3

Nurburgring (D)  
August 16-18



Round 7/10



## RESULTS

RACE 1: 25 LAPS, 56.37 MILES

1	<b>RAFFAELE MARCIELLO (I)</b>	<b>34m39.637s</b>
Prema Powerteam Dallara-Mercedes F312; Qualifying: 1st-1m22.821s		
2	ALEXANDER SIMS (GB)	+6.147s
T-Sport Dallara-Nissan F312; Qualifying: 2nd-1m23.100s		
3	FELIX ROSENOVIST (S)	+7.604s
Mucke Motorsport Dallara-Mercedes F312; Qualifying: 3rd-1m23.123s		
4	JORDAN KING (GB)	+7.981s
Carlin Dallara-Volkswagen F312; Qualifying: 4th-1m23.191s		
5	LUCAS AUER (A)	+14.591s
Prema Powerteam Dallara-Mercedes F312; Qualifying: 6th-1m23.377s		
6	PIPO DERANI (BR)	+14.920s
Fortec Motorsport Dallara-Mercedes F312; Qualifying: 5th-1m23.216s		
7	MICHAEL LEWIS (USA)	+15.766s
Mucke Motorsport Dallara-Mercedes F312; Qualifying: 7th-1m23.462s		
8	FELIX SERRALLES (USA)	+25.166s
Fortec Motorsport Dallara-Mercedes F312; Qualifying: 8th-1m23.463s		
9	DANIIL KVYAT (RUS)	+25.633s
Carlin Dallara-Volkswagen F312; Qualifying: 13th-1m23.637s		
10	SVEN MULLER (D)	+27.379s
Ma-con Dallara-Volkswagen F312; Qualifying: 13th-49.365s		

Winner's average speed: 97.59mph. Fastest lap: Marciello, 1m22.577s, 98.31mph.

RACE 2: 25 LAPS, 56.37 MILES

1	<b>MARCIELLO</b>	<b>36m17.972s</b>
Qualifying: 1st-1m23.039s		
2	DERANI	+5.466s
Qualifying: 3rd-1m23.314s		
3	SIMS	+6.159s
Qualifying: 4th-1m23.370s		
4	KING	+6.841s
Qualifying: 5th-1m23.382s		
5	AUER	+9.159s
Qualifying: 6th-1m23.406s		
6	MULLER	+11.045s
Qualifying: 10th-1m23.645s		
7	ALEX LYNN (GB)	+11.382s
Prema Powerteam Dallara-Mercedes F312; Qualifying: 13th-1m23.750s		
8	SERRALLES	+12.637s
Qualifying: 7th-1m23.498s		
9	ROSENOVIST	+17.272s
Qualifying: 2nd-1m23.207s		
10	HARRY TINCKNELL (GB)	+18.453s
Carlin Dallara-Volkswagen F312; Qualifying: 8th-1m23.588s		

Winner's average speed: 93.18mph. Fastest lap: Rosenqvist, 1m22.624s, 98.25mph.

RACE 3: 25 LAPS, 56.37 MILES

1	<b>MARCIELLO</b>	<b>36m03.350s</b>
Qualifying: 1st-1m22.416s		
2	AUER	+3.234s
Qualifying: 2nd-1m22.685s		
3	DERANI	+15.928s
Qualifying: 5th-1m22.872s		
4	TINCKNELL	+17.707s
Qualifying: 9th-1m22.985s		
5	ROSENOVIST	+18.040s
Qualifying: 3rd-1m22.687s		
6	LYNN	+18.424s
Qualifying: 12th-1m23.100s		
7	LEWIS	+19.901s
Qualifying: 10th-1m23.045s		
8	MITCHELL GILBERT (AUS)	+21.627s
Mucke Motorsport Dallara-Mercedes F312; Qualifying: 11th-1m23.070s		
9	EDDIE CHEEVER (I)	+23.937s
Prema Powerteam Dallara-Mercedes F312; Qualifying: 13th-1m23.109s		
10	ANTONIO GIOVINAZZI (I)	+24.279s
Double R Racing Dallara-Mercedes F312; Qualifying: 18th-1m23.612s		

Winner's average speed: 93.81mph. Fastest lap: Marciello, 1m22.559s, 98.33mph.

## CHAMPIONSHIP

1	<b>MARCIELLO</b>	<b>372.5</b>	6	BLOMQVIST	122.5
2	ROSENOVIST	300	7	SERRALLES	104
3	AUER	211	8	KING	104
4	LYNN	202.5	9	DERANI	75
5	TINCKNELL	160	10	MULLER	71

POINTS SYSTEM EXPLAINED In each race: 25-18-15-12-10-8-6-4-2-1 to top 10 finishers.

FOR IN-DEPTH RESULTS  
forix.autosport.com

# Hat-trick hero Marciello pulls clear in title scrap



Marciello was always ahead

**THE MOMENTUM IN THE FORMULA 3 EUROPEAN Championship swung back towards Raffaele Marciello in a big way at the Nurburgring.**

Three pole positions and three wins, amounting to a maximum haul of 75 points for the Ferrari protege, turned what had been a decent advantage over nearest rival Felix Rosenqvist into something much more commanding. In short, this was the weekend on which the championship became the Italian's to lose.

Throughout qualifying the Prema Powerteam driver had an advantage of two or three tenths of a second over his nearest challenger, which was his own team-mate Lucas Auer, Mucke driver Rosenqvist or Alexander Sims of T-Sport, depending on which session you were watching.

And in the races the dominance was repeated as the 'Lello' who crushed allcomers with boundless speed and enthusiasm during the early part of the 2012 season returned to erase memories of the tetchy teenager who had looked far from convincing as a title protagonist at either Spielberg or the Norisring.

With enough pace to manage his rubber and still have enough in hand to dig deep when needed, Marciello ensured that nobody else got a look in as he took his victory total to 10 for the season so far.

"After Norisring race three, when Rosenqvist won and made the points gap small [24.5 points], I was very angry, so I came here with aggression to work off," said Marciello, who now sits 72.5 points clear after his rival, the form man of recent rounds,

suffered the kind of weekend that often derails a title bid. More of that later, though.

First, to Marciello, whose hopes of a seat in Ferrari's F1 young-driver test line-up last month were dashed by an FIA ruling to allow grand prix racers to drive in the wake of the Pirelli tyre fiasco. But he insisted that this – and the knock-on effect of allowing him to refocus his efforts on F3 – had not been a factor in his upturn in form.

"I have no problem in the mentality department," he made clear. "I don't care about F1 right now. I care about winning this championship, and only then will I start to think about the next step. What helped me was Prema giving me a fantastic car and me only having a break of four days since Norisring and keeping my training and focus up for this weekend."

Rosenqvist, unusually of late, was on the back foot after qualifying and wasn't his usual self after the lights went out.

"I'm usually the king of the starts," he said after race one. "But not today. My reaction was good, but then I nearly stalled it. It was a real shame because that was my one chance to beat Raffaele."

Already on a knife-edge with his clutch control, Rosenqvist went a bit too far in race two and stalled from the inside of the front row. A stirring fightback from 22nd to ninth might have entertained the crowds, but the Mucke Motorsport driver's reaction said all you needed to know about what the result meant in championship terms.

Race three was almost as bad for the Swede, who started it on used Hankooks all round and was unable to 'switch on' the fronts before Pipo Derani and Harry Tincknell had knocked him back to fifth – where he finished.

Ahead of that battle was Auer, who completed a Prema one-two with Derani in arrears (see right).

The other man to make the podium – twice – was Sims, making the last of his scheduled appearances for the Threebond Nissan-engined T-Sport team. He was second in race one and had a third in the second encounter later on, but did not finish race three after a collision with Felix Serralles and Daniil Kvyat.



Rosenqvist (6) trails Tincknell in race three

## IN THE PADDOCK

## Jamie O'Leary



TEAMS AND GOVERNING BODIES RARELY SEE eye to eye in motorsport so for that reason it was encouraging to hear of what was described by one FIA source as "the most positive meeting of minds this year between us and the teams" having taken place between last Saturday's Nurburgring races.

Among the issues discussed were those concerning the format of a race weekend and how to improve it.

The general feeling among the teams is that the current Friday schedule of FP1 – five minute break – FP2 – three-hour break – Q1 – 10-minute break – Q2 does not give enough time to analyse data, improve set-ups or even get an accurate feeling from the driver about what needs changing.

Moving the opening 40-minute practice session to a morning slot is what both parties hope for, as that would allow feedback to be turned into a tangible end result and ensure that drivers are educated in how to move the performance of their cars into an optimum window for the remainder of the weekend. It seems a sensible plea to make; F3 is, after all, supposed to be a key driver-development category.

But while the teams' alliance with the FIA is a powerful combination, neither actually runs the series. That role is performed by a subsidiary of the same company that owns DTM promoter the ITR – the very body that cut out Friday-morning running at such events this year.

With the championship certain to figure at the Hockenheim (twice), Nurburgring, Norisring and Spielberg DTM rounds next year, the ITR's agreement to resume Friday mornings is essential if this plan is to be pushed through. With all three DTM manufacturers also keen on the return of Friday practice, they may just get their wish.

## Cassidy hopes for F3 return

**NICK CASSIDY IS HOPEFUL OF RETURNING** to the Formula 3 European Championship grid in time for the next round at Zandvoort in late September, after missing last weekend's Nurburgring round.

The 19-year-old New Zealander made an impressive category debut with EuroInternational at the Norisring, finishing on the fringe of the top 10 twice and only losing a top-six spot in race one due to a yellow-flag infringement.

The Italian squad entered just a single car for its regular driver, Tom Blomqvist, in the Eifel mountains, with team principal Antonio Ferrari cagey on the reasons for doing so.

Ferrari said: "Our agreement was that this entry would be on a race-by-race basis, and we chose not to enter this event."

"Next week we will review the situation and see if we enter Nick for Zandvoort."

Cassidy attended the Nurburgring event as a guest of Formula Renault NEC front-runner Steijn Schotthorst, whose brothers Pieter and Bas race for Team Bleekemolen in the DTM-supporting Porsche Carrera Cup Germany.

The two-time Toyota Racing Series champion told AUTOSPORT: "We made quite a good job of it at Norisring and it's a big shame not to be racing here. I really hope Zandvoort happens for us."



## Derani takes maiden podiums

**ONE OF THE STAR PERFORMERS OF THE** Nurburgring weekend was Fortec Motorsport's Brazilian charger Pipo Derani.

Having been outscored and outqualified by his Puerto Rican team-mate Felix Serralles during the first half of the season, Derani, 19, scored his maiden podium finish in race two after resisting race-long pressure from T-Sport's Alexander Sims. He then followed it up with third the following day to add to a fifth place scored in race one.

Unlike the reversed-grid victories he took in British Formula 3 last season, these results were an indication



## NOT QUITE KING OF THE 'RING

Carlin's Jordan King was a model of consistency in Germany, the Briton qualifying fourth, fourth and fifth and taking a pair of fourth places in races one and two. His third race ended at the first corner when a collision with Tom Blomqvist left him with broken rear suspension.

## LYNN ENDURES TOUGH WEEKEND

Chronic understeer in qualifying as a result of a rideheight miscalculation led to Briton Alex Lynn's worst weekend of the year. After starting outside the top 10 in each race, the Prema Powerteam driver fought back to seventh and sixth spots in the second and third races respectively.

## MUCKE PAIR MOVES FORWARDS...

Mucke Motorsport duo Michael Lewis and Mitch Gilbert both took their best results of the year at the Nurburgring. American Lewis secured a pair of sevenths while Australian Gilbert was eighth in race three.

## ... AS NISSANY LANDS PENALTY

Mucke Motorsport's Roy Nissany was dropped five places on Sunday's grid for causing an avoidable collision with Lucas Wolf in race two. After spinning at Turn 1 he began to creep back towards the circuit as Wolf arrived on the scene. Nissany also failed to re-attach the steering wheel after the accident.

## FERRARIS MISSING IN ACTION

The Romeo Ferraris team was absent from the Nurburgring after Michela Cerruti decided to instead make her debut in Auto GP, which was supporting the DTM/European F3 weekend. The Italian team is expected to field Cerruti in two of the remaining three rounds of the year. Rival squad Van Amersfoort Racing has yet to find a replacement for Mans Grenhagen, who ran out of money ahead of July's Masters of Formula 3.

## BIG NUMBER

21

Number of single-seaters fielded by Fortec this season across the European and British Formula 3 series, FRenault Eurocup, NEC and BARC, and FRenault 3.5, according to team owner Richard Dutton. The Daventry-based team has won races in most of them this year as well...



# FIA GT Slovakia Ring (SK)

August 17-18

Round 4/6

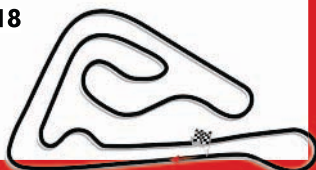

## RESULTS

MAIN RACE: 27 LAPS, 99.36 MILES

1	A SIMONSEN (S)/S AFANASIEV (RUS)	1h00m45.730s
HTP Gravity Charouz Mercedes SLS AMG GT3; Grid-6th		
2	NIKOLAUS MAYR-MELNHOF (A)/RENE RAST (D)	+4.148s
WRT Audi R8 LMS ultra; Grid-5th		
3	S ORTELLI (MC)/L VANTHOOR (B)	+4.991s
WRT Audi R8 LMS ultra; Grid-2nd		
4	EDWARD SANDSTROM (S)/FRANK STIPPLER (D)	+5.422s
WRT Audi R8 LMS ultra; Grid-9th		
5	RICARDO ZONTA (BR)/SERGIO JIMENEZ (BR)	+15.356s
BMW Team Brasil BMW Z4 GT3; Grid-8th		
6	HARI PROCZYK (A)/DOMINIK BAUMANN (A)	+22.783s
GRT Grasser Racing Team Lamborghini Gallardo LP560-4; Grid-14th		
7	ANDREAS ZUBER (A)/MIKE PARISY (F)	+27.438s
Sebastien Loeb Racing McLaren MP4-12C GT3; Grid-4th		
8	WOLFGANG REIP (B)/ALEX BUNCOMBE (GB)	+41.578s
R.J.N Motorsport Nissan GT-R NISMO GT3; Grid-12th		
9	FILIP SALAQUARDA (CZ)/FABIO ONIDI (I)	+44.835s
AF Corse Ferrari 458 Italia; Grid-13th		
10	KARUN CHANDHOK (IND)/JAN SEYFFARTH (D)	+33.895s
SMS Seyffarth Motorsport Mercedes-Benz SLS AMG GT3; Grid-19th		

Winners' average speed: 98.11mph. Fastest lap: Vanthoor, 2m03.982s, 106.88mph. First-named driver started race.

QUALIFYING RACE: 27 LAPS, 99.36 MILES

1	A PARENTE (P)/S LOEB (F)	1h01m58.216s
Sebastien Loeb Racing McLaren MP4-12C GT3; Qualifying-8th		
2	VANTHOOR/ORTELLI	+4.753s
Audi; Qualifying-9th*		
3	STEFAN ROSINA (SK)/PETER KOX (NL)	+5.354s
GRT Grasser Racing Team Lamborghini Gallardo LP560-4; Qualifying-2nd		
4	PARISY/ZUBER	+8.107s
McLaren; Qualifying-10th		
5	RAST/MAYR-MELNHOF	+13.701s
Audi; Qualifying-1st		
6	AFANASIEV/SIMONSEN	+14.195s
Mercedes; Qualifying-3rd		
7	CACA BUENO (BR)/ALLAM KHODAIR (BR)	+14.797s
BMW Team Brasil BMW Z4 GT3; Qualifying 4th		
8	JIMENEZ/ZONTA	+20.053s
BMW; Qualifying-19th		
9	STIPPLER/SANDSTROM	+21.023s
Audi; Qualifying-11th		
10	MAXI BUHK (D)/ALON DAY (IL)	+25.029s
HTP Gravity Charouz Mercedes SLS AMG GT3; Qualifying-9th		

Winners' average speed: 106.63mph. Fastest lap: Ortelli, 2m03.595s, 107.12mph. First-named driver started race. \*5-place grid penalty

## CHAMPIONSHIP

1	VANTHOOR/ORTELLI	94	6	KOX/ROSINA	36
2	SANDSTROM/STIPPLER	75	7	SEYFFARTH/CHANDHOK	31
3	RAST/MAYR-MELNHOF	63	8	PARENTE/LOEB	30
4	DAY/BUHK	53	9	ZONTA/JIMENEZ	29
5	ZUBER/PARISY	39	10	BUENO/KHODAIR	29

## PRO-AM

1	AFANASIEV/SIMONSEN	96	4	BUNCOMBE	59
2	BAUMANN/PROCZYK	88	5	REIP	56
3	VIEIRA/CAMPANICO	59	6	STUMPF	43

### POINTS SYSTEM EXPLAINED

25-18-15-12-10-8-6-4-2-1 for top 10 finishers in main race. 8-6-4-3-2-1 for top 6 finishers in qualifying race.



WRT Audis were quick in '12 spec

FOR IN-DEPTH RESULTS  
forix.autosport.com



Simonsen and Afanasiev took maiden win

# Back-on-form WRT team can't defy Gravity

THE WRT AUDI SQUAD BOUNCED BACK TO FULL competitiveness in the FIA GT Series at the Slovakia Ring and left with a firm grip on the championship. What it didn't do last weekend – for the first time this year – was win either of the two races. And it only had itself to blame.

WRT's trio of Audi R8 LMS ultras were truly on the pace for the first time since the opening weekend of the series at Nogaro. The reason was its decision to revert its fleet to 2012 specification, with the permission of the stewards of the meeting of course.

The move followed the failure of the FIA to adjust the Balance of Performance in the wake of Audi's disappointing showing at the Spa 24 Hours round of the sister Blancpain Endurance Series. That race, more than any other this year, backed up the claims of Audi and WRT boss Vincent Vosse that the 2013 R8 isn't a match for its rivals.

The problem was that France goes on holiday in August and a meeting of the FIA Committee that sets the BoP could not be convened. Whereas the Phoenix Racing Audi squad withdrew, championship leader WRT took an alternative course of action.

The team had run its cars in 2012-spec on the opening weekend of the championship courtesy of delays in the homologation of the 2013 package. Rene Rast plonked his Audi on pole in France and did the same at the Slovakia Ring.

The 2013 R8 has a larger-diameter air-restrictor than its predecessor, but the shape and profile of orifice means that it has less power. What's more, the latest car is 25kg heavier.

There was no doubt the old Audi had the edge in Slovakia, but WRT failed to convert that.

A protracted safety car period in the qualifying race meant Rast was unable to exploit his advantage to build up a gap for co-driver Nikolaus Mayr-Melnhof, and Sebastian Loeb was able to take the lead soon after the end of the pitstops. Mayr-Melnhof then came under pressure from Alon Day in the Gravity Charouz Mercedes SLS AMG and lost a further two places when he went off after contact was made as the Merc went past.

The Audi shared by Frank Stippler and Edward Sandstrom was in the wars, too. Sandstrom

crossed the white line leaving the pits and, even though he ducked straight back, was penalised.

The third car, which Laurens Vanthoor had started ninth after losing his time in Superpole (along with the two Loeb McLarens) for failing to leave the pits within the allotted time, made it up to second in Stephane Ortelli's hands courtesy of Day's penalty. Had Vanthoor started from his original fourth spot, he and his team-mate would almost certainly have won.

They also would have won the championship race had not Ortelli jumped what was admittedly a very confusing start (see right). That meant WRT's hopes rested on two cars that had started the main race from fifth and ninth positions.

Mayr-Melnhof pitted from fourth, but Rast got stuck behind Sergio Jimenez in the best of the BMW Team Brasil entries for four laps. By the time the German made it by, he was 7s down on the leader, and a surprise one at that.

The Pro-Am Gravity Charouz car had come through the mayhem to jump from sixth to second at the start with Andreas Simonsen at the wheel. That turned into the lead when Ortelli was given a drive-through, and the Audis were too far behind to challenge Sergei Afanasiev's Merc.

Just to prove what might have been, Vanthoor produced a storming drive to charge back to third after sneaking past Stippler on the final lap.

The WRT Audis crossed the line in second, third and fourth positions, but that represented a maximum points haul in class. And that means the team is now 1-2-3 in the championship.



Loeb/Parente won opener

## IN THE PADDOCK

## Gary Watkins



"Rene, are you on pole or am I?"

I WAS SURE THE BANGING I COULD HEAR across the Slovakia Ring on Saturday night was the final nail being hammered into the coffin of the ludicrous FIA GT Series qualifying system. It turned out I was wrong, but the good news is that the confusing Superpole session is not long for this world.

Series boss Stephane Ratel wanted to tweak Superpole, which allows each of the fastest 10 cars from qualifying one and two a pair of laps to set a time. He wants a more conventional one-at-a-time Superpole, as successfully used by the FIA GT Championship in the early noughties.

The plan was vetoed by Team BMW Brasil, which argued as a newcomer to the European tracks it needs every lap it can get. But Ratel remains hopeful that he can get his idea cleared for the series finale at Baku, a circuit new to everyone.

But getting rid of the two-lap Superpole is only the start: FIA GT qualifying needs a proper overhaul for next year. As a rule of thumb, if there's any room for confusion, the system isn't going to do its job.

## DID YOU KNOW?

Gravity Charouz Mercedes duo Andreas Simonsen and Sergei Afanasiev became the first Pro-Am runners to win a race outright in the FIA GT Series. Or at least the history books say that. Rene Rast and Nikolaus Mayr-Melnhof won at Nogaro before a pitlane infraction cost them victory. That 'result' also led to the duo being upgraded to the Pro Cup.



Day was just one driver eliminated at the start

## Start chaos eliminates favourites

## THE BODGED START OF THE CHAMPIONSHIP

Race removed four contenders for victory from the reckoning at the Slovakia Ring.

Stephane Ortelli triggered the mayhem when he jumped the start – his WRT Audi, on the outside of the front row, was four lengths ahead of polesitter Sebastien Loeb when he hit the gas as the lights went off.

Loeb, who clearly slowed as the safety car peeled into the pitlane, was no higher than fourth when he tagged the front of Ricardo Zonta's BMW Team Brasil Z4. That sent him into Peter Kox's Reiter-run Lamborghini Gallardo, which in turn cannoned into a fast-starting Alon Day in the Gravity Charouz Mercedes SLS AMG GT3.

The incident put the McLaren, Lambo and Merc out of the race and resulted in Ortelli and team-mate Vanthoor losing victory hopes thanks to a drive-through penalty.

Ortelli admitted that he had made a mistake, but he argued that there were mitigating circumstances.

It was the job of poleman Loeb, who won the qualifying race aboard his McLaren with Alvaro Parente, to control the speed of the pack, but as he went through the left-hand kink that leads onto the start-finish straight he clearly backed off. Ortelli suggested that, from his position in the inside of the corner, he couldn't see the McLaren.

"I couldn't see him and I looked in my mirrors and I still couldn't see him," explained the Monegasque. "Then, the lights came on and I went. It has to be my mistake, but I was keeping the speed and he wasn't."

Ortelli and the WRT team were not alone in questioning why the start was not aborted, given that the Audi was so far ahead of the pack. That would be the normal course of events when the grid is not formed up properly.



Charlotte 2005: a race Anderson did turn up to

## Anderson in team link denial

## ACTRESS AND MODEL PAMELA ANDERSON

was never due at the Slovakia Ring, but the team that bears her name was. It was no surprise when Racealliance by Pamela Anderson no-showed.

The German-based team, put together by sometime GT Open racer Markus Fux, had paid its entry fee, but withdrew the Ferrari 458 Italia due to have been driven by Vitantonio Liuzzi and Mathias Lauda last Wednesday, citing a non-arrival of sponsorship funds.

Yet the team was already shrouded in mystery. It uses the Racealliance name, under which the successful FIA GT team that won races as Jetalliance initially competed, but has no connection with it.

More to the point, it appears that it has no connection with Anderson either. The agency that represents the Canadian told AUTOSPORT that it would be sending a cease-and-desist letter to the team to stop it from using her name.

Anderson won't be involved should Racealliance show up at the next round at Navarra, but the series organisers aren't particularly hopeful on that one either.

## PARENTE/LOEB WIN QUALIFIER

Alvaro Parente pulled off a phenomenal start to jump from eighth to second at the first corner of the qualifying race, which set up his and Sebastien Loeb's victory. "I did something a little bit differently to in the past," said the Portuguese. "All I can say is that it is better if you can keep the turbo spinning at the start, that is logical".

## BRAZILIANS BEAVER AWAY

BMW Team Brasil duo Ricardo Zonta and Sergio Jimenez ran as high as second in the main race on the way to fifth place. It was an impressive result given that their Z4 GT3 had barely completed a flying lap and had undergone three gearbox changes ahead of the qualifying race.

## HAUPT MAKES FIA GT RETURN

Hubert Haupt returned to the FIA GT ranks after an absence of eight years. The one-time race winner from the old FIA GT Championship contested the Slovakia Ring event in a Seyffarth Motorsport Mercedes SLS AMG with pseudonymed racer 'Yenci Michael'.

## LAMBORGHINI TEAM RETURNS

Peter Kox and Stefan Rosina, regulars in FIA GT this year with the Reiter Lamborghini squad, switched chassis for the Slovakia Ring with the Reiter-run team's expansion to two cars. Albert von Thurn und Taxis, sharing with GT1 world champion Marc Basseng in Slovakia, took over the team's regular Gallardo LP560 for one simple reason — he owns it.



## FERRARI DUO WIN

The new AF Corse Ferrari Gentlemen's Trophy pairing of Michele Rugolo and Claudio Sdanewitsch, who race together in International GT Open, took a double class win in Slovakia. The duo will continue for the remainder of the season aboard their AF 458 Italia.



Cold-tyred Giovesi locks up to lose race-one lead

AUTO GP NURBURGRING (D), AUGUST 17-18, RD 6/8

## Sato 'ring fences championship lead

THIS WAS THE WEEKEND WHEN AUTO GP'S TITLE protagonists finally clashed antlers. Stepping out of their cars after two bouts of protracted wheel-banging, Sergio Campana and Kimiya Sato summoned up reserves of restraint to maintain their usual composure. Each would accuse the other of resorting to over-aggressive tactics but, pleasingly for those who had just enjoyed the ferocious scraps, race officials found no reason to act on the grievances.

Thanks to some fine overtaking and success in Sunday's reversed-grid race, Sato has wrestled back the lead in the drivers' standings – having entered the meeting tied on points with Campana. Narain Karthikeyan picked up the feature race victory on the series' maiden visit to the Nurburgring. Since switching mid-season to new berth Super Nova, the former Grand Prix driver has earned pole at every Auto GP meeting.

Karthikeyan made a flawless getaway in race one, in contrast to team-mate and recent GP2 debutant Vittorio Ghirelli, who struggled to gain traction from the dirty side of the front row. The Fasano-born driver briefly dropped to fourth behind compatriots Kevin Giovesi and Campana, before

recovering position on Campana around the outside of the long left-hander in the Yokohama S.

Armed with experience of the short-layout Nurburgring circuit from a campaign in German Formula 3 last year, Sato had arrived hell-bent on re-establishing his lead in the standings. The Japanese racer clinically grabbed fifth from Ibiza Racing's new recruit Tamas Pal Kiss at Turn 1 on lap seven, before honing in on the Hungarian's team-mate and effective team leader Campana.

The first of several flashpoints occurred three laps later. Sato attacked down the inside at the final corner following a small mistake by Campana at the NGK 'Schikane'. The pair touched, a tyre mark was deposited on Campana's sidepod and Sato was fourth. One corner later Campana recovered the position. The obvious lack of margin on display perhaps contributed to Euronova team boss Vincenzo Sospiri wisely calling in Sato for a mandatory tyre change. The battle resumed when Campana emerged from his own pit stop a lap later, maintaining intensity until Sato finally staged a break.

Up front, Giovesi gave impressive chase to Karthikeyan. When the leader stopped for tyres

five laps from home, the Ghinzani Motorsport team opted to leave Giovesi out for a further two tours. The tactic fleetingly appeared a success. Giovesi's rosso-hued machine emerged from the pitlane with track position and holding first place, only to suffer a massive front lock-up on cold tyres and overshoot Turn 1.

Karthikeyan's hopes of carrying momentum from his narrow victory over to Sunday's race two would be dashed by a first-corner melee in which he was sent spinning down to last. The debutant team and driver combination of Venezuelan Formula 3 graduate Roberto La Rocca and Comtec by Virtuosi picked up the reversed-grid pole position ahead of Robert Visoiu.

Away from the lights, the front-row men were jumped by Campana. At Turn 1, Visoiu tapped Pal Kiss sideways, who then cannoned into the unfortunate Karthikeyan. Campana led until pitting on lap nine, and rejoined the road just ahead of his old adversary Sato. Appearing to struggle for race pace, Campana was repossessed by La Rocca during the mandatory pit sequence.

Sato squeezed past both men in one well-judged and opportunistic manoeuvre on lap 12. Once free of the bottleneck, Sato pulled away to win by 8.5s. Ghirelli pounced on GP2 driver Daniel de Jong for second three laps from home. Behind Campana, the final piece of excitement occurred on the last lap when the valiant La Rocca suffered a half spin attempting to fend off the recovering Karthikeyan, who clinched a last-gasp fifth place.

● Peter Mills

### RESULTS

**Race 1** 1 Narain Karthikeyan (Super Nova International), 23 laps in 31m21.515s; 2 Kevin Giovesi (Ghinzani Motorsport), +2.324s; 3 Vittorio Ghirelli (Super Nova International); 4 Kimiya Sato (Euronova Racing); 5 Sergio Campana (Ibiza Racing); 6 Tamas Pal Kiss (Ibiza Racing). **Race 2** 1 Sato, 23 laps in 31m43.113s; 2 Ghirelli, +8.585s; 3 Daniel de Jong (Manor MP Motorsport); 4 Campana; 5 Karthikeyan; 6 Pal Kiss. **Points** 1 Sato, 150; 2 Campana, 148; 3 Ghirelli, 141; 4 Karthikeyan, 122; 5 Pal Kiss, 65; 6 Giovesi, 57.



Sato (16) retook the series lead from Campana (right)

# KX BTCC RACE GUIDE

## 24-25 August Knockhill

“ I was very proud to see KX Academy member and my MG team-mate Sam Tordoff break his British Touring Car Championship duck at Snetterton. It was a momentous day for him and it was a momentous day for the Academy scheme as well.

It means we have had winners in every category that we are represented in -

the BTCC, Renault Clios, Porsche Carrera Cup GB and the Ginetta GT Supercup - and it also proves the value of the Academy.

All of the drivers have embraced it and are using it as a stepping stone to get the results we know they are capable of - that's why we selected them in the first place. There's plenty of racing left over the remaining rounds, and we are

expecting more wins from all of our candidates this season.

Knockhill is a demanding circuit and it will be interesting to see who takes the track by the scruff of the neck.

The next exciting chapter is about to begin for the KX Academy as we are inviting candidates to sign up for 2014. To find out more, turn overleaf. ”

**JASON PLATO**



“ We have now had winners in every category we are represented in ”



 @KXENERGY

 @KXAKADEMY

 KX ENERGY

[www.kx-energy.com](http://www.kx-energy.com)

# BTCC with MG KX Momentum Racing



## SAM TORDOFF

A breakthrough win in the British Touring Car Championship was

the highlight of Sam Tordoff's Snetterton weekend, and he says the confidence boost will help him get even more out of the remaining 12 races.

The 24-year-old said he was looking for a strong weekend in Norfolk, and claiming pole position was the first step to victory. "We knew that we would have a good car at Snetterton," explains Sam. "But that ramped up the pressure. To see that I could deal with that, get pole and then fend off my team-mate to the flag was a huge boost for me.

The first win is the most important and it was such a great feeling."

Tordoff struggled with braking issues in race two and started the final event from the back. He battled up to fifth at the finish.

"I have learned that it is all about scoring consistently, and race two dented our hopes a bit," he says. "I am going to Knockhill with the aim of stringing together three strong finishes. That is the key to performing in the championship and that is something I have learned over the opening six rounds of the year. Knockhill is a tough track. I have raced there four times, and I think I am only just starting to learn it properly."



"The first win was such a great feeling"

Sam Tordoff

# Renault Clio Cup with KX Racing with SV



## STEFAN HODGETTS

A battling second place in the second race of the weekend at

Snetterton kept Stefan Hodgetts in the middle of the battle for this season's Renault Clio Cup title.

The 31-year-old admitted that a small mistake in qualifying put him on the back foot for the opening race, and being in the middle of the jostling pack caused his downfall during the ten-lapper.

Hodgetts, 31, says: "There was some bumping and boring into the opening hairpins and because I was in the pack in eighth I got hit. It was nothing intentional - it was just that the pack was tightly bunched.



That eventually led to broken steering. So I was delighted with a great start in race two when I went from eighth to second. By the time I had got there, the leader was too

far ahead for me to do anything about but I wasn't under any real pressure from the rest. After what had happened in race one, it was a great rescue job."



## ANT WHORTON-EALES

Ant Whorton-Eales suffered some disappointment at

Snetterton on a weekend when he should have been able to bank solid podiums through no fault of his own.

The 19-year-old made a fantastic getaway in the opening race of the weekend to run in a competitive third place, before a late-race lunge by a rival forced him off the track and he dropped down to seventh at the flag.

Whorton-Eales says: "I was hugely disappointed, because I was holding people off comfortably, and then I was attacked from nowhere. The stewards took action afterwards, but that was a podium lost for me."

In the second event, Ant was also knocked wide by a rival at the start and dropped to fourth. Then another assault later in the race pushed him down to eighth place at the end of the ten laps.

"Motor racing is tough, but we had huge frustration at Snetterton because we had two results taken away when they were there for the taking," he says. "I am just going to keep looking forward to the next rounds at Rockingham in September. It is my favourite track and I am very optimistic about how I will get on there."

"I made a great start in the second race"

Stefan Hodgetts



# Porsche Carrera Cup with Team Parker Racing



## DAN LLOYD

Despite showing frontrunning pace at Snetterton, Dan Lloyd said that his weekend, which netted a sole fourth place finish, was frustrating.

He started from the second row in the opening race and chased rival Rory Butcher home but Lloyd says he thought his car was capable of going faster. "I was bottled up," he says. "And although there are plenty of corners at Snetterton, it is

an incredibly hard track to overtake on."

In race two, the 21-year-old was battling over third with rival Michael Meadows as the pair rounded the opening corner, but contact between the two sent the Team Parker Racing car spinning down the track at 120mph. "That got my attention," says Lloyd. "I collected it together, but I was in last place. I was searing through the field, and I was back up to fifth, but then the driveshaft snapped and I was out."

The Yorkshireman is determined to put the disappointment behind him when the series reconvenes at Knockhill this weekend. "I am not

thinking about the title any more," says Lloyd. "All I can do now is go flat out for the wins and Knockhill is my first target."



# Ginetta GT Supercup with JHR



## TOM INGRAM

Despite sitting in pole position in terms of the title race, Tom Ingram says that he will not back off in his quest for race wins.

He achieved his target in the last round at Snetterton, fending off his rivals to land victory in the opening round of the weekend in Norfolk. The 19-year-old backed that up with a second place and a third

place in the next two rounds, but feels he might have been able to achieve even more.

"I found it frustrating because when I was stuck behind another car, there was no way to overtake," says Ingram. "The configuration of the track doesn't lend itself to passing. Once you get close behind another car, you lose the aerodynamic grip and then you struggle. Overall, I stayed on target

and got big points, but you always want more."

Ingram says he will put a sizeable accident that he had last time out at Knockhill behind him when the series returns to the Fife track this weekend. "Last time, I left the track in an air ambulance, which was unpleasant," he says. "But that will be right at the back of my mind. I am going for wins, and that is it," he declares.

professional races when he was unable to make progress through the pack due to the nature of the track in Norfolk.

"It was all very much follow-my-leader stuff, which I was surprised about because the track looks like it should have promoted overtaking," says Boston.

"I was fourth in race one following another car that I just couldn't overtake. I struggled to sixth in the second race when my clutch broke, then got fifth in race three. I have no idea how much quicker I could have gone in clear air, but I had the feeling that I didn't really get the chance to show my ultimate pace."

Despite that frustration, Boston says he is relishing the chance to get stuck in to the next rounds at Knockhill in Fife: "I love that type of track with lots of undulations and twists. I won't have the budget to test and I hope that won't affect me too much because I love racing there. I can't wait."



## ROB BOSTON

Three strong finishes for Rob Boston at Snetterton have cemented the 30-year-old's position in the top six of the Ginetta GT Supercup championship standings just past the halfway stage of the season.

The Doncaster-born ace says that despite landing a big points haul, he was left frustrated after three

# DO YOU HAVE WHAT IT TAKES? THE KX AKADEMY WANTS YOU!

**THE KX AKADEMY** is taking applications for its class of 2014 and like everything KX Energy does we only want the best, the brightest and the hungriest! Do you have what it takes to impress mentor Jason Plato?

So far, 2013 has been a great year. The Akademy class consisting of drivers Sam Tordoff, Tom Ingram, Ant Whorton-Eales,

Rob Boston, Stefan Hodgetts, Dan Lloyd and Mike Bushell have made great strides on and off the track and we're looking for the next group of young legends in the making!

The application for the 2014 KX Akademy can be found on the KX website at [www.kx-energy.com](http://www.kx-energy.com). Don't wait another second - racing glory is only a few clicks away.



# 24-25 August **Knockhill**



“ There is a real thrill to race a BTCC car around Knockhill. I enjoy it because the circuit rewards drivers who attack, and that is one of the ways I like to drive.

As well as that, the action remains tight because the circuit is so small, so you rarely get runaway winners. That means you have to be ready to get stuck in. If you have a car that is working well, then you

can slice through the pack and it is a really satisfying feeling. The crowd can get up and close to the cars in the paddock, which helps create a brilliant atmosphere. I really can't wait.”

## 5 REAL RADIO

4th gear, 100-110mph

This is a hard corner. The entry is bumpy but you are tempted to try to leave the stopping oh-so-late. Do that and make a mistake, and you will pay on the exit



## CHAMPIONS CLUBHOUSE

### KX QUESTION TIME

## 1 DUFFUS DIP

4th gear, 130mph

This is a corner you have to commit to, but if you are on the wrong line, it is hard to rescue it. It is a bumpy turn which is blind on the entry and you have to take some kerb - but not too much, otherwise it will ruin the left-hander

## 2 SCOTSMAN CORNER

3rd gear, 90mph

It's tough here because the car has load and yaw from Duffus Dip, and you have to brake hard, scrub off the speed and get the apex right. You have to go down two gears to third. It's all going on

## 4 CLARK'S

3rd gear, 110mph

There is a big change of camber in this uphill corner, which means you have to brake hard and make sure that you are on the right line. Going wide over the grasscrete on the exit can damage the tyres, so you have to be cautious

## 3 JOHN R WEIR CHICANE

4th gear, 120mph

You start this whole sequence by determining your line 'over the top' at the chicane. You might have a slight lift at the left-hander on the way in, but you have to have controlled aggression over the kerbs at the summit

## ROUND 7 ▶ SATURDAY AUGUST 24

Champions Bar, Knockhill from 1830 hosted by Alan Hyde



Live interviews, questions and debate at every round of the 2013 British Touring Car Championship. **FREE** entry to race fans (limited capacity).

Join us to hear the stories behind the headlines - what really happens behind the scenes from the people who make the decisions. And you can ask the questions.

If you're coming to Knockhill on Saturday August 24, join us for **KX Question Time** hosted by Alan Hyde at **the Champions Bar** - you ask the questions and you could go home with a great prize. Guests include **Jason Plato** and a host of other BTCC figures.



# ON TELEVISION ▶

LIVE ▶ 11.00hrs-1800hrs on **ITV4** and **ITV4 HD**

HIGHLIGHTS ▶ See listings for details.

NASCAR SPRINT CUP MICHIGAN (USA), AUGUST 18 RD 23/36

# Logano on top for Penske

JOEY LOGANO SCORED HIS FIRST NASCAR Cup win for Penske as veteran Mark Martin's strategy gamble failed at Michigan.

The opening laps of the 400-miler were unusually fraught, with three quick-fire cautions. But it was two late yellow-flag periods – both caused by Kyle Busch spinning – that led Martin's Michael Waltrip Racing team into throwing the fuel-mileage dice.

With track position, 54-year-old Martin led away at the final restart, and appeared to have the pace to keep poleman Logano and the charging Kevin Harvick at bay. But his Toyota was three laps short of fuel. The pattern of the race – and the loose handling of the cars around the two-mile superspeedway – suggested another was coming. It didn't, and Martin duly ran dry.

Logano was supposedly marginal on fuel too, but he sprinted away from Harvick to claim his first win since Pocono in June last year.

Kurt Busch had probably the strongest car in the opening half of the race, but lost track position when his Furniture Row team changed four tyres while most opted for just two fresh Goodyears.

He made a storming final restart,



but lacked the raw pace to challenge. Third place keeps his Chase hopes bubbling along.

It was a poor outing for points leader Jimmie Johnson. He was sent to the back after a switch to the spare car following a practice smash. He then raced into the top 10 when its engine blew.

His Hendrick team-mate Dale Earnhardt Jr was a victory contender until a blown tyre put him in the wall.

● Connell Sanders Jr

## RESULTS

**1 Joey Logano (Ford Fusion)**, 200 laps in 2h45m59.000s; 2 Kevin Harvick (Chevrolet SS), +1.019s; 3 Kurt Busch (Chevy); 4 Paul Menard (Chevy); 5 Clint Bowyer (Toyota Camry); 6 Marcos Ambrose (Ford); 7 Kasey Kahne (Chevy); 8 Jeff Burton (Chevy); 9 Greg Biffle (Ford); 10 Carl Edwards (Ford). **Points** 1 Jimmie Johnson, 813; 2 Bowyer, 772; 3 Edwards, 762; 4 Harvick, 749; 5 Kyle Busch, 706; 6 Matt Kenseth, 688; 7 Dale Earnhardt Jr, 679; 8 Brad Keselowski, 667; 9 Kurt Busch, 665; 10 Biffle, 663; 11 Kahne, 659; 12 Martin Truex, 653.



## GERMAN CARRERA CUP

Tolimit's British ace Sean Edwards (above) took his first win of the year at the Nurburgring, but lost ground to Kevin Estre in the title fight thanks to a drive-through in race two after contact with Alex Riberas. Christian Engelhart (Konrad) won race two.

## NASCAR NATIONWIDE

AJ Allmendinger won for the second time in 2013 at Mid-Ohio, the Penske Ford driver beating Michael McDowell and Sam Hornish Jr, who re-took the points lead from Austin Dillon by finishing third.

## NASCAR TRUCKS

Turner Scott Chevrolet driver James Buescher took his first win of the year at Michigan, beating Kyle Busch's Joe Gibbs Toyota and Ty Dillon's Childress Chevy.

## VW SCIROCCO R-CUP

South Africans dominated at the Nurburgring with Jordan Lee Pepper taking his first series win in race two after points leader Shaun van der Linde triumphed on Saturday. Brit Ross Wylie took fourth- and sixth-placed finishes.



GRAND-AM KANSAS (USA), AUGUST 17 RD 10/12

# Taylor takes points lead with victory

A BRILLIANT DRIVE UNDER IMMENSE pressure from Scott Pruett enabled Jordan Taylor, driving a Corvette for father Wayne's team, to take a third win of 2013 and move himself and Max Angelelli into the lead of the championship with two races to go.

Ganassi Riley driver Pruett also drove well, rebounding from another early mistake by Memo Rojas, but the Grand-Am series' most successful driver was unable to dislodge Taylor.

Erstwhile points leaders Alex Popow/Ryan Dalziel finished 11th after two early off-course excursions, while Jon Fogarty/Alex Gurney were eighth after Gurney fell victim to an

error by Sebastien Bourdais.

Alessandro Balzan/Leh Keen won GT in their Scuderia Corse Ferrari.

● Jeremy Shaw

## RESULTS

**1 Max Angelelli/Jordan Taylor (Dallara Corvette DP)**, 123 laps in 2h45m15.713s; 2 Memo Rojas/Scott Pruett (Riley-BMW MXXVI), +0.568s; 3 John Pew/Oswaldo Negri Jr (Riley-Ford); 4 Christian Fittipaldi/Joao Barbosa (Coyote Corvette); 5 Brian Frisselle/Burt Frisselle (Coyote); 6 Scott Mayer/Brendon Hartley (Riley-BMW). **Points** 1 Angelelli/Taylor, 269; 2 Fittipaldi, 267; 3 Alex Popow/Ryan Dalziel, 266; 4 Barbosa & Jon Fogarty/Alex Gurney, 265; 6 Rojas/Pruett, 264.

SUPER GT SUZUKA 1000KM (J), AUGUST 18 RD 5/8

# Ace Mako anchors a Honda success

GT RACING SUPERSTAR FREDERIC Makowiecki and Naoki Yamamoto won the Super GT series' blue-riband event, the Suzuka 1000km, in emphatic fashion.

Yamamoto ran inside the top three during the opening part of the race, the Dome Honda remaining in contention until Makowiecki hit the front during a second stint that was twice interrupted by the safety car.

Victory marked the first in Super GT for both drivers.

Double champions Ronnie Quintarelli and Masataka Yanagida took their NISMO Nissan to second while Britain's James Rossiter was a

fine third in the TOM'S Lexus he shared with Kazuki Nakajima.

● Jiro Takahashi

## RESULTS

**1 Frederic Makowiecki/Naoki Yamamoto (Honda HSV-010)**, 173 laps in 5h55m04.565s; 2 Ronnie Quintarelli/Masataka Yanagida (Nissan GT-R), +14.801s; 3 James Rossiter/Kazuki Nakajima (Lexus SC430); 4 Joao Paulo de Oliveira/Tsugio Matsuda (Nissan); 5 Andrea Caldarelli/Daisuke Ito (Lexus); 6 Andre Couto/Seiji Ara (Lexus). **Points** 1 Quintarelli/Yanagida, 84; 2 de Oliveira/Matsuda, 82; 3 Makowiecki/Yamamoto, 80; 4 Takuya Izawa/Takashi Kogure, 74; 5 Juichi Wakisaka/Hiroaki Ishiura, 68; 6 Rossiter/Nakajima, 68.





As Foitek rolls, Herbert (yellow car) is facing serious injury and Grouillard (green car) is collected in pile-up

# THE DAY JOHNNY HERBERT'S WORLD CAME CRASHING DOWN

In the blink of an eye, Johnny Herbert went from potential world champion to A&E critical care casualty and the spectre of having a foot amputated. **SAM SMITH** retells the story of a chaotic day

**A**t approximately 3.45pm on August 21 1988, the handful of spectators at Pilgrim's Drop were not entirely sure what they had just heard. Out of sight, before the cars came into view below the bridge, a thunderclap of shocking energy resonated through the concrete parapet and out into the woods. A split-second earlier Johnny Herbert had braced himself as much as he could, but it was too late even for that final indignity.

The ear-splitting impact rang out, resonating obscenely through the trees.

"As the car turned left I went to say, 'Oh shit,' recalls Herbert, 25 years on from the accident that almost claimed his left foot and his career. "But I only got to the 'Oh' part!"

After the noise came the violent conclusion to what was one of the largest chain-reaction accidents ever to occur on British racing asphalt. In seconds, the undulating stretch of track resembled the scene of an aircraft crash. Amid the dense woodland of the Brands Hatch Grand Prix loop, a Formula 3000 'heart of darkness' had played out in a shower of wheels, carbonfibre and fervent ambition that had burned far too intensely that afternoon.

"I clearly remember Paolo Barilla crying when we got back to the grid after the accident," recalls Mark Blundell, who along with the Italian was one of only nine drivers to make it through the destruction. "He was convinced someone had been killed because he had driven through the wreckage and, like me, had glanced in his mirrors. That had been a mistake because it really looked like a bomb site. It was a strange weekend all round; you could just feel it in the air."

Whirlpools of dark eddying energy build up and hang forbiddingly over certain weekends. Spa 1960, Indianapolis 1973 and Imola 1994 are obvious examples. At Brands Hatch that weekend,

the accidents had begun during Friday free practice with a hefty shunt for Enrico Bertaggia at Paddock Hill Bend, when his Dallara 3087 turned sharp left into the tyrewall. Spectators looked on aghast, first concerned but then astonished as the Italian walked out of a monocoque that had opened like a tin can. The incredulous Italian sidestepped from the wreck, eyes widened at his miraculous deliverance.

A day later, Michel Trolle was not so fortunate (see panel, page 63). The debate about the safety of F3000 cars had already started at the very first race of the year at Jerez, where the promising Steve Kempton broke his ankles in the morning warm-up. It continued at Monza in June, when Fabien Giroix suffered severe leg injuries and Massimo Monti cartwheeled his Ralt through an advertising hoarding and into the trees beyond the first Lesmo corner. The accidents in 1988 were horrendous, and that no-one was killed during the season was nothing short of a miracle.

It all came to a head at Brands. Herbert had been heading out of Surtees bend, and at the forefront of his thinking was the need to make up for his poor start in part two of an already-controversial race. In his F1-destined mind was winning the race and preparing for the Birmingham Superprix the following weekend, before confirming his place on the F1 grid with Benetton via his mentor, Peter Collins, for 1989.

But alongside him as he approached the Pilgrim's Drop bridge was Gregor Foitek. In a white Lola T88/50 and in plain white helmet, Foitek's simple exterior profile belied a more complex vision beneath. Wild-haired and wild, too, of reflex, the Swiss had carved a twitchy, cavalier figure in the paddocks of Europe that summer. There was no doubting his pace. But his somewhat desperate crave to impress cast doubts aplenty.

Given the chance to make it to F1 by his wealthy father Karl, Gregor had the substantial backing of his family's lucrative automobile



On the grid at Brands: future was bright for Herbert

LAT ARCHIVE

dealership in Zurich and this smoothed the path for him. But by the summer of 1988 he was hell-bent on ascending it in a blizzard of energy and coruscating performances.

Many assumed that 'Papa' Foitek was living a second career through Gregor. The intensity of the relationship did make some in the paddock uneasy and, while he was by no means the only 'competitive dad' in motorsport at that time, he was unforgiving and very hard on his son, exerting pressure for the younger Foitek to succeed.

"Gregor was wickedly quick but unsure ▶



# YOU CAN'T TRUST EVERYONE SELLING CARS ON THE INTERNET



You don't necessarily know who's behind selling a car when you buy online. You also need to be assured that what they say they are selling and what they are selling are the same thing. Buying from **Trusted Dealers** is the safest and most reliable way to buy a used car online. Owned by its members with hundreds of **franchised dealerships across the UK**, we can offer standards that other classified websites can't guarantee and that's why **What Car?** endorse our Ten Points of Difference.



Don't just buy from anyone. Search for trusted dealers.



**OUR TRUSTED DEALERS INCLUDE** ARNOLD CLARK · BEADLES · BRAYLEY · BRISTOL STREET MOTORS · CAFFYNS · CAMBRIA · CHAMBERS · CLEMO · COLLIERS · CO-OPERATIVE MOTOR GROUP · CURRIE MOTORS · DM KEITH · DRIVE MOTOR GROUP · EASTERN WESTERN HOLDINGS LTD · FG BARNES · FORD RETAIL · FROSTS CARS · GK GROUP · HARTWELL · HENDY · HOLDCROFT · HWM GROUP · INCHCAPE · JARDINE MOTORS · JCT600 · JOHNSONS · KINEHOLME GARAGE · LIFESTYLE EUROPE · LLOYD MOTOR GROUP · LOOKERS · MACKLIN MOTORS · MARSHALL · NIDD VALE · PENTAGON · PERRYS MOTOR SALES · PHOENIX · RIDGEWAY GROUP · RINGWAYS GARAGES · ROBINSONS · RON BROOKS · ROYCE ROBERTS SKODA · RYBROOK · SANDICLIFFE · SG SMITH · SHIELDS AUTOMOTIVE · SKY FORD · SNOWS · SPEEDWELL HONDA · STURGESS · SWANSWAY · TAGGARTS · TRIDENT · TRUST GROUP UK · WAYSIDE GROUP · WESTONS

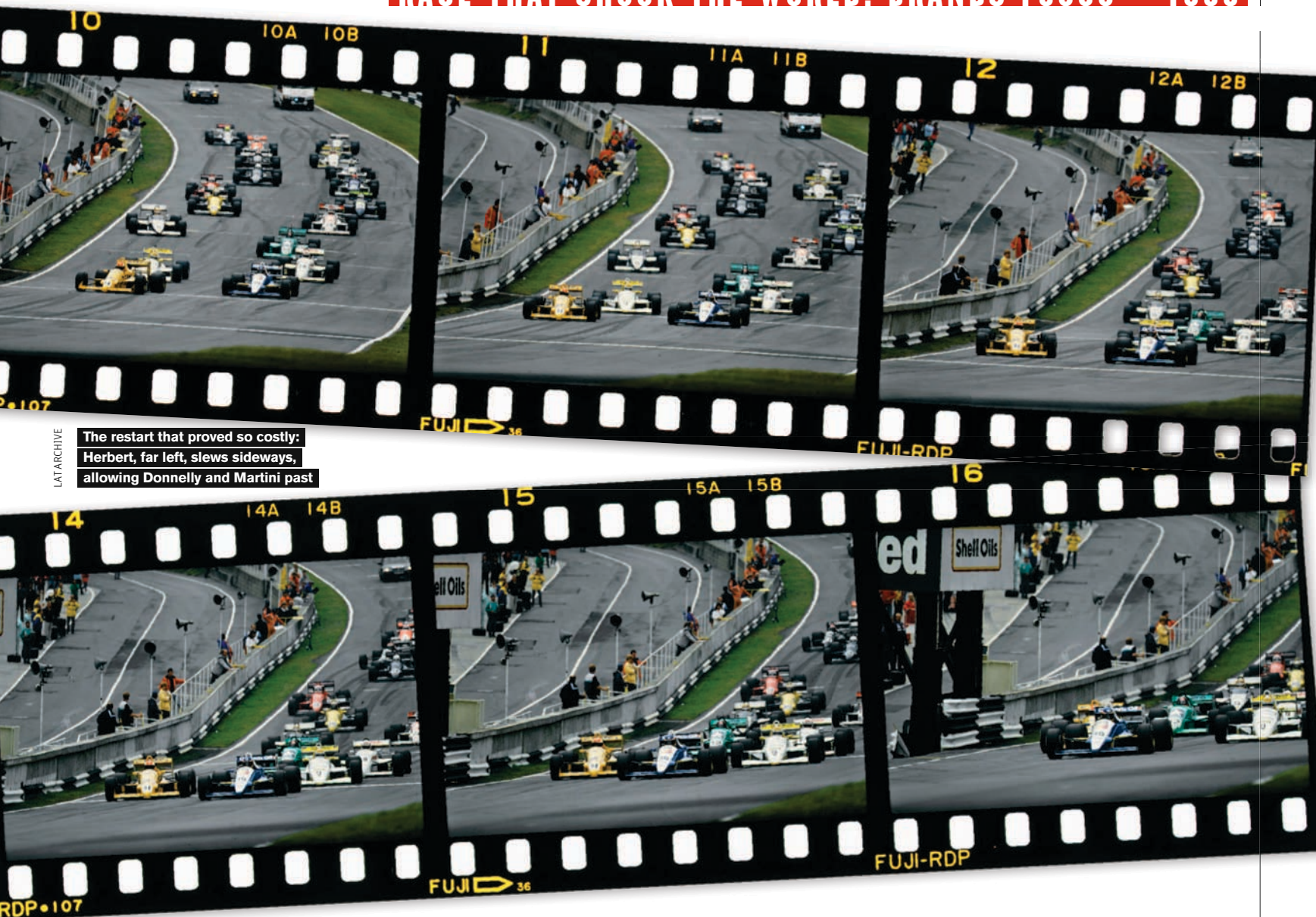

LAT ARCHIVE

The restart that proved so costly: Herbert, far left, slews sideways, allowing Donnelly and Martini past

◀ as to why or how,” recalls his engineer at GA Motorsport in 1988, David Luff. “He was a quiet guy who didn’t speak much English and generally kept himself to himself. But when it came to the cockpit he was seriously competitive and had a real natural aptitude. He did get into scrapes, but most drivers on the last rung up the F1 ladder do, don’t they?”

“I think the reason he was castigated so much after Brands was because of a mixture of these scrapes and also that he was a bit detached from the paddock gang. He didn’t speak English and didn’t socialise with his contemporaries. He was an easy and convenient target and I don’t think that was fair at all.”

Herbert and indeed some of the F3000 drivers were wary of Foitek. Out of the cockpit he often gave an air of almost lunar detachment. He was seriously fast, as Luff attests, but with the pace came an unpredictability and marginal understanding of spatial awareness that was causing concern from the very start of the season.

“At Vallelunga I had a run-in with him,” says Herbert. “In the race we were pretty much side by side and he started to come over on me, so I went to move away as I didn’t feel completely comfortable racing him. At the last possible moment he just turned in on me and I went off and slammed sideways into the end of the hairpin Armco which was in a ‘U’ formation. My head hit the barrier and I couldn’t remember much after that apart from the fact I needed to be more wary of Mr Foitek!”

Herbert had slight swelling of the brain that was eventually diagnosed by Professor Sid Watkins at his base in the London Hospital, Whitechapel. He was forced to miss the Pau round and rejoined the championship at Silverstone in June, but even then still took time to get back to race fitness.

By August, Herbert needed big points from the Brands/Birmingham back-to-back races, and after a faultless qualifying at Brands he was well on track for rejuvenating his title challenge. Pole was his by such a margin that he sat out most of the second phase of qualifying, watching with interest as his new team-mate Martin Donnelly – who had stepped up from Formula 3 to join him in Eddie Jordan Racing’s squad of Reynard 88Ds – was the only driver to get close to the time. After a recent impressive F1 test with Lotus, Johnny was on the crest of a wave.

The yellow Reynard 88D led the race comfortably, but when Roberto Moreno slammed hard in to the Paddock Hill Bend tyre wall, while going wheel to wheel with a defensive Foitek at the start of the 22nd lap, the red flag came out. Moreno, who led the championship after a trio of wins at Pau, Silverstone and Monza, was livid, and vented a very public condemnation of Foitek on the public-address system as he walked back to the pits to tell his engineer, Gary Anderson, about the holed monocoque that would be arriving in the paddock on the back of a flatbed truck. “He’s just crazy, completely crazy,” Moreno ranted. “I mean he just swerved across and hit me.”

All of this seemed to disrupt the previously serene Herbert, who was left to await the restart with a 12-second cushion in his pocket for the second tranche of the race. All of a sudden fate started to deal some unpleasant hands.

“It all began at the restart,” says Herbert. “I don’t know why I parked it [on the grid] where I did, with the back of the car in relation to the infamous Brands grid gradient. As the green light went on, it went a little bit sideways, but I still caught it. Now, of course, I went right down the dip, got a lot of wheelspin and dropped back behind Martin [Donnelly] and [Pierluigi] Martini. I was side by side with Foitek going into Paddock and he moved across to try and intimidate me, we banged wheels but I managed to stay ahead up to Druids.”

Through Graham Hill Bend and Surtees, Herbert if anything appeared to be thinking more of an attack on Martini rather than worrying about Foitek behind him. And then they headed out into the country...

“He had a slightly wider run and then he was able to get a bit of a quicker exit [from Surtees],” recalls Herbert. “On the exit I looked in the mirror to see where he was as I knew he could have a run going down to Hawthorns, but I didn’t really think it was on at all because it’s so narrow there. I saw him coming and I remember him diving left, I didn’t move and then he just touched the left rear of my car. Whatever he was trying, it was never going to work. He should have backed off but he just kept coming.” ▶

# 164-PAGE SPECIAL

# HUNT & LAUDA TRUE F1 HEROES

DRIVER • HERO • LEGEND

## JAMES HUNT

A CELEBRATION OF HIS AMAZING RACING CAREER



2 MAGS IN 1  
THE NIKI LAUDA STORY  
NIKI LAUDA  
A CELEBRATION OF HIS AMAZING RACING CAREER

**AUTOSPORT LEGENDS**

£5.99

DRIVER • HERO • LEGEND

## NIKI LAUDA

A CELEBRATION OF HIS AMAZING RACING CAREER

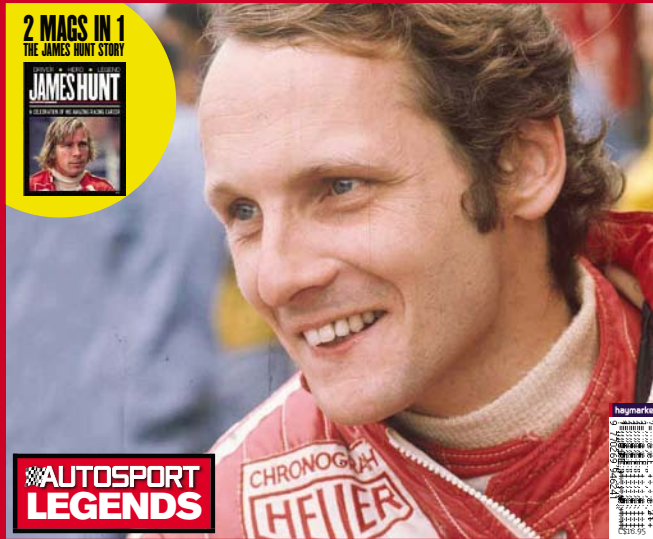

2 MAGS IN 1  
THE JAMES HUNT STORY  
JAMES HUNT  
A CELEBRATION OF HIS AMAZING RACING CAREER

**AUTOSPORT LEGENDS**

£5.99

# £1 OFF WHEN YOU PRE-ORDER A COPY

\*offer ends August 30, 2013.

# WWW.AUTOSPORT.COM/HUNTLAUDA

◀ In a split-second both cars were heading for the bridge parapet. Just watching the video footage of the accident again takes the breath away. For those involved and just behind travelling at approximately 160mph, it must have been utterly terrifying.

“I remember some fast and violent movements in the cockpit,” remembers Herbert. “My head was going forward and down so fast, and then I remember spinning and hitting something again, my head thrusting forward once more with massive pressure everywhere. I opened my eyes, looked forward and noticed the big hole in front of me. All I could see was Tarmac and some grass. Then I saw my knees but nothing behind or below them. I thought, ‘Well, they’ve gone wherever the front of the car has gone.’”

Those behind the incident soon became involved. Olivier Grouillard’s GDBA Lola T88/50 was instantly collected by Foitek’s and Herbert’s rebounding wrecks. The Frenchman suffered bruising after a fearsome impact with the Armco. Foitek was incredibly fortunate as his Lola barrel-rolled to destruction along and on top of the Armco on the right-hand side of the track, the unconscious driver’s helmet covered in mud and grass. Impacts with the Armco had punctured several holes in the monocoque. Claudio Langes, Andy Wallace, Russell Spence, Aguri Suzuki, David Hunt and Gary Evans all came to grief amid the cascade of wishbones, wheels and fragmenting carbonfibre.

For Mark Blundell and his Lola Motorsport T88/50, it was also way too close for comfort as he somehow made it through, more by chance than judgement, such was the speed of the unfolding horror.

“Part of Johnny’s wing endplate, quite a major bit of carbon, was heading straight for my helmet,” he says. “At the last minute it went low and lodged like an arrow between the nose on my car and the main plane of the front wing. My guys yanked it out when I got back to the grid but at one stage I thought it was going to cut my head clean off.”

For some of the survivors who had seen the shunt it all became a bit too much. Those who made it back to the grid ambled around, not quite believing what they had just witnessed. Many, such as the very distressed Barilla, were highly emotional. A barefooted James Hunt, working as a driver advisor for Jean Alesi and Volker Weidler on behalf of Marlboro, ran up to parc ferme to inspect the cars as they were salvaged. He returned with a drained pallor, shaking his head at what he’d seen.

“It was a pretty weird atmosphere because nobody really knew what was going on and exactly who might be hurt because so many had been involved,” recalls Blundell. “We all knew it was bad. There was just that sense of foreboding you get sometimes at a track. It seemed that you couldn’t just have a small accident anymore.”

Blundell, like most, had serious misgivings about Foitek even before the incidents that ▶



Foitek was blamed for both huge accidents



As Foitek rolls along the barrier, the pack takes avoidance



Blundell's Lola returned with part of Herbert's wing attached

LAT ARCHIVE

COLIN McMASTER

LAT ARCHIVE

# A barefooted James Hunt ran to inspect the cars, and returned with a drained pallor

◀ day: “He was one of those guys no-one was ever able to infiltrate; he just seemed to be a loner. There was something within him that could not control the red mist coming down and that seemed to be evident on a number of occasions. You just couldn’t trust the guy in wheel-to-wheel racing.”

Foitek was instantly and perhaps unjustly labelled as the significant contributory cause of the incident. His previous misdemeanours and propensity to be involved in contretemps with his adversaries had come back to haunt him. Yet some, including Foitek himself, even believe that he and Herbert didn’t touch and that the Reynard could have suffered a failure that pitched the car left and into him. This is swiftly discounted by Herbert’s engineer that day, Trevor Foster.

“We gave the car a thorough examination on the morning after the shunt back at [the Jordan team’s base at] Silverstone. There was no breakage we saw that could have contributed to the accident. It appeared to be just two hungry drivers occupying the same piece of Tarmac at the wrong time, with no quarter given.”

“Immediately after the shunt I got into a medical car and was taken to the scene,” says Luff. “Gregor was still in the car and just coming round. I have never seen anything like what I saw that day. It really did look like a plane crash. Gregor was sat in nothing more than a tub. It was just devastated and he was a very lucky boy to get away with just a small wrist fracture after rolling down the guardrail like that.”

For Herbert, still being extricated from his car, consciousness was leaving him. Yet a quarter of a century on he remembers surreal moments in gauzy, flickering hazes.

“I think Aguri came over to see if I was OK, but

I can’t remember any of that clearly. What I do remember is a marshal coming up to the cockpit and saying, ‘Are you OK?’, then he stepped to the front of the car and looked down. I caught his face just as his expression changed. He looked like he was going to be sick. That wasn’t very promising at all for me, and I think that’s when the body has its own way of protecting itself and the mind shuts down.”

Reynard chief Adrian Reynard and Foster arrived on the scene as Herbert was sedated with nitrous-oxide, removed from the remains of his car and taken to Queen Mary’s Hospital in Sidcup. Foster remembers the harrowing hours that followed.

“The surgeon came to see us before the operation and said that Johnny’s injuries were severe and that his left ankle was so badly damaged that his racing career was definitely over, and that there was a real possibility they would amputate,” says Foster. “We were very clear to him that whatever they did that night they should not take the foot off and that they should do whatever it took to save it.”

“They did an initial operation, which essentially was hoping for the best. I will never forget seeing him after the first operation. He just looked like a 10-year-old kid. He almost seemed to have lost weight and become dishevelled within the space of a few hours.”

While Herbert’s professional career hung in the balance, Donnelly took a comfortable victory from Martini and Blundell in the race’s second restart of the afternoon. All three had half-heartedly gone through the motions of a joyless podium ceremony. Donnelly in particular was wrestling with a variety of emotions.

“It was such a strange weekend with so much

going on,” recalls Donnelly. “EJ had wheeled, dealt and charmed me into a crazy contract that only he could come up with. I was also supposed to be getting some money for the seat, but of course there was a slim chance of that happening at all. Still, we had won the race, my first in F3000, and it was so important for me as I was at a real crossroads career-wise.”

“But we almost instinctively knew that Johnny was badly hurt, so it just didn’t feel right celebrating afterwards. There are all these conflicting emotions that want to come out of you after a race like that but they never do. We were all young and ambitious for F1. It really was war out there sometimes.”

In the days after the race, doctors were pondering the future of Herbert’s feet and preparing for more theatre sessions in hospital. After a weekend of chaos, the pieces had to be picked up. For 1989, governing body FISA made crash tests mandatory, as was the placing of the pedal boxes behind the axle line of the front wheels. The shockwaves of Brands ’88 reverberated all the way to March ’89 when, at the drivers’ briefing for the season’s opening grand prix at Rio Jacarepagua, Herbert came face to face with Foitek who, with EuroBrun, was also making his F1 debut.

“I walked in to my first drivers’ briefing and said hello and introduced myself to everyone,” says Herbert. “It was quite something doing that to all the heroes of the time: Piquet, Senna, Prost, Mansell... Then I stuck out my hand to this familiar face with curly hair. It was Foitek. By the time I had realised it was too late. He shook my hand and smiled. After all the pain and operations in the previous six months, here I was saying good morning to him like nothing had happened.” ❧

## “The surgeon said that there was a real possibility they would have to amputate”



Herbert's wreckage reveals why legs bore brunt of shunt



Donnelly (right) and Martini on muted podium

Aftermath: casualties are Foitek (far left), Wallace (red car), Grouillard (green, on track), Herbert (being tended), Langes and Suzuki (together on track), Chiesa (half on verge, right) and Evans (far right). Euser (climbing out) and Hunt (on verge, left) have stopped to help



## Michel Trolle: forgotten victim of Brands

In February 1990, Michel Trolle found himself in London for additional treatment to his ankles and knees that had been smashed to pieces so badly during practice for the Brands Formula 3000 race 18 months previously. It had taken nine months for the Frenchman to take his first steps after reconstructive surgery, and over a dozen operations were carried out on his broken joints and limbs.

"I had to go back to the circuit to see where it all happened," he says, 25 years on from the day his career and life changed forever. "I drove onto the circuit, it was a weekday and there was no-one around. I went to Dingle Dell in my hire car, stopped at the point where I crashed and just stared at the tyre wall in a kind of trance. A lot of people criticised the corner [which had been reprofiled ahead of the F3000 race weekend] but it was just the lack of run-off that

really hurt me, not the corner or circuit itself. There were only a few metres from the kerb to the wall. No time to even prepare for an impact."

As Trolle attempted to lay some of his demons to rest, an official circuit car stopped at the scene and asked Trolle to move on.

"This guy told me I was trespassing and told me to leave," he says. "I just looked at him blankly, not saying a word, and I got back in my car and left. It was quite an emotional moment for me but it had to be done. I had to see where everything changed for me."

Acknowledged as one of the very best of a bright crop of French drivers, Trolle was in discussions with both Larrousse and Tyrrell for a Formula 1 seat in 1989 and was due to sign a provisional agreement with the English team at the Belgian Grand Prix, the weekend after Brands.

He was unconscious for much of the aftermath



Trolle's free practice crash at Dingle Dell left him terribly injured

BENDANIELS

of his accident, but was not alone during the initial phase of treatment, as Johnny Herbert remembers.

"I was sedated a lot of the time but I have a vague memory of Trolle opposite me on the ward we were in," he says. "He obviously had a bit more morphine than me as he was completely out of it. I remember trying to whistle at him to get his attention but I couldn't do it properly. It must have been quite a comic scene for the nurses!"



# OULTON PARK AT SIXTY

**One of Britain's best circuits, Oulton Park  
celebrates its 60th birthday this year.**

**Regular visitor and leading commentator**

**IAN TITCHMARSH traces its history**



LATARCHIVE



LATARCHIVE

Lodge is devised: "I think we should put a devilishly-cambered right-hander here"

**T**he majority of the tens of thousands of fans who flock to Oulton Park these days, whether for the annual visits of the British Touring Car and British GT Championships or the biannual British Superbike Championship races, probably have little notion that they are entering a circuit that was once a major Formula 1 venue. Indeed, it was one even touted as a

potential location for the British Grand Prix itself. Between 1954 and 1972 many of the major F1 teams, including Scuderia Ferrari on a couple of notable occasions, supported the Oulton Park Gold Cup; better still, in 1967 and 1971 there were two F1 races at the Cheshire venue.

### CIRCUIT WITH A DIFFERENCE

Oulton Park as a race circuit was born into a world very different from today. In the early 1950s the runways and perimeter roads of World War 2 airfields were the staple diet of enthusiasts looking for somewhere to race in mainland Britain where the closing of the public highway for motor racing is illegal. Of the pre-war circuits, only Crystal Palace was about to re-open, while Brands Hatch was a ribbon of asphalt measuring less than one mile and running anti-clockwise.

Oulton would be very different. A small group of Cheshire enthusiasts led by former racing driver Reggie Tongue persuaded the incumbent owner of the Oulton Estate, Sir Philip Grey Egerton Bt, that the best use of his land would be a racetrack. Cheshire Car Circuit Ltd was formed to take a lease from Egerton and build and operate the circuit with the genial Rex Foster, at the time manager of the nearby Marley Tiles factory, as MD.

Although others had their part to play in the evolution of Oulton Park in its early decades, Foster was pivotal and his gentlemanly charm ensured that a visit to the Cheshire parkland venue was always an agreeable experience for

competitors and spectators alike.

The first iteration of Oulton turned right at The Cascades (sic) and curved round towards Clay Hill which it joined at the long-defunct Range Corner. It measured 1.504 miles in length but plans were already afoot to extend it alongside the lake towards Island Bend and, within a matter of weeks, to the hairpin, which was initially called Covert Corner until first Esso and subsequently Shell Oils paid good money to have their names associated with it.

Star turn of the first day's racing at Oulton Park, on August 8th 1953, was Tony Rolt, fresh from his victory for Jaguar with Duncan Hamilton in the Le Mans 24 Hours a few weeks earlier. At Oulton, Rolt was at the wheel of Rob Walker's Connaught A-type with which he won the Formula 2 race "making road racing look oh so easy" according to AUTOSPORT.

The paying public had not been admitted to this first meeting, attendance being restricted by the RAC to members of the organising Mid-Cheshire Motor Club, membership of which was no doubt usefully swollen for the occasion. On 3rd October a combined car and motorcycle event was open to all and some 40,000 came to see future Le Mans winner Ninian Sanderson take the Formula 3 final in his Staride-Norton. This was the only occasion when cars and bikes combined, although both continue to play a fundamental part in the circuit's destiny in their own particular ways.

Seven race meetings were scheduled for 1954, five for cars and two for bikes. First off was the British Racing Drivers' Club, which brought its hallowed British Empire Trophy from the streets of Douglas, Isle of Man, where it had been run since 1947, to the roads of the parkland. On the now extended 'Island' circuit, at 2.23 miles slightly shorter than today's equivalent, Alan Brown won the final in his Cooper-Bristol T20 (the rebodied ex-Mike Hawthorn single-seater) from Roy Salvadori in the Gilbey Engineering Maserati A6GCM, both cars bearing the scars of a clash at Old Hall Corner on the first lap of their heat. ▶

Where it all began in '53: single-seaters christen long-defunct Range corner

**“ONLINE ORDERING IS EASY AND THE NEXT DAY DELIVERY NEVER LETS ME DOWN.”**



...Within building maintenance, time is at a premium, so it's good to know that the goods will arrive when you need them. **Tony Duffy**

Trustscore for IronmongeryDirect is 9.3 of 10, based on over 2000 customer reviews.

**UK'S BIGGEST RANGE  
NEXT DAY DELIVERY  
MINIMUM 5 YEAR  
GUARANTEE  
FREE 'NO QUIBBLE'  
RETURNS**



**CALL TODAY FOR YOUR FREE CATALOGUE**

**IronmongeryDirect**  
MASTERS OF OUR TRADE

**0808 168 28 28**  
IronmongeryDirect.com

DOWNLOAD OUR FREE APP FROM YOUR APP STORE



OR TEXT **RBA16** to 62244 FREE!  
With name, address and email.

OFFICIAL TITLE SPONSOR  
**mce** insurance **BSB** BRITISH SUPERKITES

**MOTORSPORT INSURANCE**  
**WHATEVER YOU DO**

Give Simon and the friendly team a call:

**0844 338 69 37**



OPENING HOURS:  
Monday - Friday 9.00am-5.30pm













**BRITISH TOURING CARS**

**24/25 AUGUST**

- Advanced ticket discounts - saving ££s
- Weekend camping available (pre-book)
- Kids under 12 go FREE all weekend
- All parking on-site & absolutely FREE

- Big screen TVs to see all the action - LIVE
- Three awesome British Touring Car races
- Star names - Shedden, Plato and Neal
- Porsche GB, Ginetta & Formula Ford GB

**BOOK TICKETS NOW - [KNOCKHILL.COM](http://knockhill.com)**

**Stirling Moss (7) on his way to first (of five) Gold Cup wins in '54**



LAT ARCHIVE

## OULTON WELCOMES F1

◀ Formula 1 came to Oulton for the first time on 7th August 1954, almost exactly a year to the day from the circuit's opening meeting. The works Maserati 250F for Stirling Moss arrived from Italy too late for practice so Stirling started from the back but was soon in the lead and won the first Gold Cup comfortably from Reg Parnell's Ferrari 625.

Stirling won the Gold Cup again in a works 250F the following year ahead of Mike Hawthorn in a Lancia D50, having its first race under the auspices of Scuderia Ferrari. Hawthorn had qualified on pole position on Dunlops but for the race had to abide by Ferrari's Englebert tyre contract and, thus equipped, could not match Moss's pace.

Moss went on to win every F1 Gold Cup in which he competed, culminating in 1961 with the Ferguson P99, a milestone victory in that it was the first and only by a four-wheel-drive car in an F1 race, the last by a front-engined F1 car and, as it turned out, the maestro's last F1 victory. The road-circuit nature of Oulton Park was the ideal stage on which Moss could display his supreme talents: in addition to those five F1 Gold Cups he won two BRDC British Empire Trophy races (in Cooper-Climax T39 and Aston Martin DBR2) and, in the most atrociously wet conditions, the 1956 Daily Herald International Sports Car race in an Aston Martin DB3S.

For many years the Vintage Sports-Car Club ran its prestigious Richard Seaman Memorial Trophy at Oulton Park, usually won by one of the 1930s ERA voiturettes that seem so suited to the circuit.

However, in 1958 the VSCC pulled off something of a coup that rather upstaged the ERAs, when Mercedes-Benz brought along two of the pre-war Silver Arrows – a 1937 W125 and a 1939 W163. Contemporary Formula 1 drivers Peter Collins and Tony Brooks, the latter standing in for Mike Hawthorn, all of whom would win a Grand Prix in the coming weeks, shared the two cars between them. The sight, sound and smell pervading the atmosphere from these awe-inspiring machines left a lasting impression on everyone present.

Recovering from his Easter Goodwood accident, Moss was present for the 1962 Gold Cup to watch his heir apparent Jimmy Clark totally trounce a strong field in the radical Lotus 25, having been one of the first to lap Oulton at over 100mph along with BRM drivers Graham Hill and Richie Ginther in practice.

Clark repeated the feat the following year, both races being run to a full, two-hour, grand prix duration, the longest ever. Clark returned to Oulton as reigning world champion for the 1964 Spring Trophy meeting at which he won three of the day's four races in a borrowed sports-racing Lotus-Climax 19, Lotus Elan 26R and Lotus Cortina Mk1. He was ineligible for the fourth race, a British Formula 3 Championship round won by a certain Jackie Stewart in one of Ken Tyrrell's Cooper T72s. Before the year was out Stewart would be British F3 champion and driving for Lotus in F1 and F2.

The 1960s were probably the pinnacle of Oulton Park's status as a major international circuit. The Gold Cup was run for the one-litre F2 cars in 1964 and 1965, attracting the cream of the category – Jack Brabham won in '64 by a fifth of a second from Clark after swapping places throughout for over an hour of wheel-to-wheel dicing, while in '65 John Surtees (MRP Lola T60) prevailed by a similar margin over Denny Hulme with Graham Hill third, half a second adrift.

The introduction of the 3-litre formula for 1966 brought F1 back to Cheshire, Brabham winning three races in a row when an F1 Spring Cup was slotted in between the '66 and '67 Gold Cups.

For the first time since 1955 Ferrari came back to the Gold Cup in 1968 with three 312 V12s for Chris Amon, Jacky Ickx and Derek Bell in addition to which Jackie Stewart arrived with the Tyrrell Matra MS10. Graham Hill and Jackie Oliver were in the Gold Leaf Team Lotus 49Bs, Jack Brabham and Jochen Rindt in Brabham-Repco BT26s and Pedro Rodriguez and Piers Courage in BRM P126s, an

entry that would have done a world championship grand prix proud.

Stewart had the edge over Amon throughout but not by much, the New Zealander's car control that day as he drifted his glorious red machine around Old Hall and Lodge Corners creating images that remain classics of their kind to this day.

## BIG BANGERS ARRIVE

Good Friday 1969 marked the launch of Formula 5000 in the UK. This was the short-lived era of uncontrolled wings in Formula 1 and, since F5000 cars were constructed along F1 lines but with five-litre, stock block V8 engines, the very large crowd that came to Oulton that day was treated to a rare spectacle, both in sight and sound. Peter Gethin won in the McLaren-Chevrolet M10A from the similarly powered Surtees TS5 of David Hobbs that had started from pole position.

Although a fair few cars fell by the wayside during the race, F5000 was well and truly on its way, at the same time helping to establish Easter at Oulton as a major date in the diaries of race fans. By the time the F5000 cars returned to Oulton for the Gold Cup, to run with the F1 cars, their wings had been clipped following the accidents to the Lotus 49Bs of Graham Hill and Jochen Rindt in the Spanish Grand Prix. Disregarding the sparsely supported Madrid Grand Prix at Jarama, this was the first proper encounter between some of the top F1 teams and all the major F5000 teams.

With Stewart present in the Tyrrell Matra MS80 and Ickx in the works Brabham BT26 no one else was remotely in the hunt. Ickx was fresh from his win over the Matra driver in the German Grand Prix a fortnight earlier and was determined to repeat this result on the UK's smaller version of the Nordschleife. However, after losing an intense duel for pole by half a second and leading off the line into Old Hall Corner, Ickx could not resist Stewart's bid for the lead on lap two. He hung on to the Tyrrell's tail and retook the lead when Stewart headed for the pits with a loose battery. Jochen Rindt inherited second place in the unloved 4WD Lotus 63, with the best of the F5000 cars, Andrea de Adamich's Surtees TS5, a lapped third.

Non-championship F1 races generally were dwindling by now but, thanks to then boss John Webb's tireless efforts, Oulton retained its F1 Gold Cup for three more years. Indeed it even managed two F1 races in 1971.

A year earlier, John Surtees had given his ▶

**Jim Clark rounds Esso (now Shell) in second Gold Cup victory in '63**



LAT ARCHIVE

◀ eponymous TS7-Cosworth its maiden victory, although he had to settle for second to Jochen Rindt's Gold Leaf Team Lotus 72 in the second leg. Immediately after taking the flag Rindt parked his car at Old Hall, picked up his suitcase from the marshals' post, and was in his helicopter heading for a hillclimb in Austria almost before Surtees had completed his slowing down lap. Monza was two weeks away and Rindt had driven his last F1 race.

Pedro Rodriguez's BRM P160 led the 40-lap 1971 Good Friday race throughout, sharing a new lap record with Peter Gethin's McLaren-DFV M14A, which was a close second. Oulton's second F1 race of the year reverted to the two-part format.

By now Gethin was in a BRM P160 replacing Rodriguez, who had been killed in a sportscar race a few weeks earlier, and took pole position but come the race there was nothing he could do about Henri Pescarolo in a Frank Williams-entered March 711, falling to fifth after a pitstop with brake problems. The second part began with a superb scrap between Pescarolo, Gethin, Surtees (TS9-Cosworth) and Howden Ganley's BRM P153 until the first two tangled at Lodge Corner, Gethin retiring to the pits and Pesca a few laps later with brake failure.

After 18 years, frontline F1 bowed out from Oulton Park on Spring Bank Holiday 1972 when the usual large crowd saw Denny Hulme's Yardley McLaren-Cosworth M19A prevail over the JPS Lotus-Cosworth 72D of Emerson Fittipaldi, these two being split in the early stages by Oulton star performer Peter Gethin in a Marlboro BRM P160B. Another Oulton favourite, Brian Redman, brought the brand new Chevron-Chevrolet B24 home fourth, having earlier won the separate Formula 5000 encounter.

And it was F5000 that sustained spectacular single-seater racing for the next few years although the challenge and appeal of the circuit were not helped when the decision was taken to abandon the full circuit for cars and introduce, from Easter 1975, the shorter 1.65-mile Foster's circuit. This took the drivers right from Cascades to a sharp right-hander (Foster's) before heading back towards Knickerbrook.

Various reasons were given, including the cost of upgrading the safety requirements and the appeal to spectators of seeing the cars come round more often. The new section certainly provided some memorable Formula 3 action, including Andrea de Cesaris colliding with Nigel Mansell in 1979 and Ayrton Senna with Martin Brundle in 1983. Two years earlier future owner of Oulton Park, Jonathan Palmer, had wrapped up the British F3 Championship for the first time by taking the lead from Roberto Moreno at Foster's, the Englishman showing that it could be achieved without a collision.



**John Surtees heads  
Jackie Oliver in 1970;  
Rindt's Lotus is fifth**

## THE OWNERS OF OULTON

In 1964 Oulton Park had been acquired by Grovewood Securities to add to its Brands Hatch-led portfolio managed by John Webb. For the next two decades Webb ensured that Oulton's status as one of the country's major circuits continued to evolve.

In 1986 motor racing enthusiast and computer millionaire John Foulston acquired the Motor Circuit Developments circuits (Brands Hatch, Oulton Park, Snetterton and Cadwell Park) from Grovewood and within less than a year had sanctioned the re-introduction of the full circuit for car racing.

Formula 5000 had been replaced, via a season of free-for-all Group 8 single-seaters, by a British F1 Championship and then British Formula 3000. Speeds rose inexorably with the endless progress of technology and the first of two chicanes, between the Shell Oils hairpin and Hilltop, was inserted in 1987. Originally Foulston's, now Britten's, this corner was supplemented for 1992 by a chicane just before Knickerbrook as a consequence of the tragically fatal accident to Paul Warwick while leading the 1991 Gold Cup when his Formula 3000 Reynard 90D suffered suspension failure.

For a few more years the British Formula 3000 Championship survived on dwindling entries with both the International and Foster's circuits hosting rounds in 1996, the final full year. Gareth Rees's Reynard 95D won both races and left the outright

lap record for the longer circuit at 117.91mph. Rees also took pole position on the Foster's circuit at 121.63mph but it was Italian Luca Riccitelli (Reynard 94D) who claimed the official record in the race at 119.30mph.

At the end of 1999 the American Interpublic Group bought out the Foulston family interest in the Brands Hatch group of circuits and for the next few years, through its sporting division Octagon, invested in various improvements at Oulton Park including a new race control and pits, a re-surfaced paddock, and the impressive Fogarty-Moss Centre overlooking Cascades.

When Interpublic decided to bale out of its motor racing involvement in late 2003, Jonathan Palmer's MotorSport Vision took over and immediately set about realising the full potential of what Palmer describes as "one of the most beautiful circuits in the UK, both in terms of presentation and setting."

## OULTON UNDER PALMER

Settled into a comfortable middle age, Oulton Park's future as a fundamental part of the fabric of British motorsport, on two wheels or four, seems as secure as that of any circuit in the country.

"We are restricted to just four Sundays for racing but can work within that and we have a very good rapport with the local parish councils," says Palmer. "We aim to continue with the current programme of major events every year comprising BTCC, British GT and BSB and there would have been British F3 too had the series not been cut back.

"From March to October we have a race meeting every weekend, the majority on the full International circuit."

Oulton Park is the reason why many enthusiasts, particularly, but far from exclusively, those living in the North of the country, became addicted to the sport of motor racing. This weekend's Historic Sports Car Club-run Gold Cup meeting will be a 2013 highlight, bringing machines of the 1960s and 1970s back to the picturesque circuit for a three-day extravaganza.

"I suppose it is the jewel in the crown of our circuits," reckons Palmer, and that from the man whose company also owns the Brands Hatch Grand Prix circuit. This writer has visited Oulton Park every year since 1954 and has no doubt that in the hands of MSV it is in a better state than ever. ❧



**Oulton in 2013 plays  
host to all the top British  
series, including GTs**

# OULTON PARK 2013 TRACK LAYOUTS



ILLUSTRATION: ALAN ELDREDGE

69

## GTs AT OULTON

Although Oulton Park's most famous moments came with single-seaters, it played its part in the history of GT racing, too.

In March 1961 the Jaguar E-type was presented to the world at the Geneva Motor Show; less than a month later British racegoers were able to see two of these extraordinary cars at Oulton Park, making their racing debut in the hands of Graham Hill and Roy Salvadori.

Hill won in the dark blue Equipe Endeavour roadster and more than a few of those watching went away vowing one day they would own one.

The RAC moved its already venerable Tourist Trophy to Oulton Park from Goodwood for 1965, bringing with it a round of the FIA International GT Championship then being contested by Ferrari 250 GTs and Shelby American Cobras. Denny Hulme in Sid Taylor's two-litre Brabham-Climax BT8 won the race outright while – after a gruelling two-part race – John Whitmore's Alan Mann-run Cobra Roadster won the GT category.



Salvadori and Hill in Jaguar action at Deer Leap in '61

Two years later it was the turn of the FIA European Touring Car Championship to visit Cheshire, the combination of Andrea de Adamich

and his Autodelta Alfa Romeo Giulia Sprint GTA proving more than a match for various Porsche 911s, Ford Mustangs and Lotus Cortinas.

LAT ARCHIVE

# WEB DIRECTORY

## CAR BROKERAGE

**RACING CARS FOR SALE**  
ALAN CORNOCK FCS  
BUYING - SELLING - BROKERAGE  
[www.racingcarsforsale.co.uk](http://www.racingcarsforsale.co.uk)  
TEL: 01480 891212

## DRIVER DEVELOPMENT

eugene **O'BR**ien.co.uk  
**DRIVER DEVELOPMENT**  
Tel: 0775 383 5629

## ENGINES

**JULIAN GODFREY**  
**ENGINEERING**  
visit our new online shop [www.racetuners.com](http://www.racetuners.com)

## EXHAUSTS

*Stainless Steel Exhaust Specialists*  
**SIMPSON**  
*Race Exhausts*  
Tel: 01753 532222 follow us on:  
[www.simpsonraceexhausts.com](http://www.simpsonraceexhausts.com)  

## GEARBOXES

 Rally & Race  
Gearboxes, GearKits,  
LSDs and Driveshafts  
Tel: 01782 280136 Fax: 01782 269913  
Email: [sales@eliteracingtransmissions.com](mailto:sales@eliteracingtransmissions.com)  
[www.eliteracingtransmissions.com](http://www.eliteracingtransmissions.com)

**Gearboxman.com**  
COMPETITION TRANSMISSION SERVICES  
Gearboxes & Axles for Road, Race, Rally and more  
Telephone: 01582 840008 Fax: 01582 840007

## HELMET GRAPHICS

*Mike Fairholme Designs*  
Sole approved painter of Arai helmets.  
Silver Birches, Corby Birkholme, Nr Grantham, Lincs NG33 4LE.  
Tel: 01476 550630. Fax: 01476 550029.  
email: [fairholmedesigns@btconnect.com](mailto:fairholmedesigns@btconnect.com)  
[www.fairholmedesigns.co.uk](http://www.fairholmedesigns.co.uk)

## MEMORABILIA

 **FINAL LAP**  
*For Everything Formula One*  
[www.finallap.net](http://www.finallap.net) **WE BUY AND SELL**  
+44 (0) 1245 287588 / 07771 920345

**JMJ AUTOMOBILIA**  
America's #1 supplier of CART and FORMULA One Racing memorabilia. Large selection of signed original collectables. See our ad under marketplace Memorabilia. Call or For a mail listing at (609) 575 1143 or visit: [www.JMJAuto.com](http://www.JMJAuto.com)

## RACE PARTS

**ARE DRY SUMP SYSTEMS**  
ARMSTRONG RACE ENGINEERING INC.  
[WWW.DRYSUMP.COM](http://WWW.DRYSUMP.COM) (916) 652-5282

## RACE RADIO

**Pit to Car Autotel**  
Radio solutions **Digital Race Radio**  
0044(0)1508 528837  
[www.raceradio.co.uk](http://www.raceradio.co.uk)

## RACE PRODUCTS

**JJC) race and rally**  
PASSIONATE ABOUT MOTORSPORT  
[www.jjcraceandrally.com](http://www.jjcraceandrally.com)

## RACE PRODUCTS

 **LONDON MOTORSPORT SHOWROOM**  
[www.msar.co.uk](http://www.msar.co.uk)

**PIPER**  
[www.pipercams.co.uk](http://www.pipercams.co.uk)

**PORSCHE SHOP**  
[PORSCHESHOP.CO.UK](http://PORSCHESHOP.CO.UK) 5% off with voucher code: **AUTOFIVE**  
+44 (0)121 585 6088  
    

## RACEWEAR

**CROYDON RACE & RALLY CENTRE**  
[www.croydonraceandrally.co.uk](http://www.croydonraceandrally.co.uk)  
220-222 Portland Road South Norwood London SE25 4QB  
**For Racewear & Motorsport equipment**  
FORECOURT PARKING Tel: 020 8656 7031

**demon tweeks**  
MOTORSPORT *Direct*  
[www.demon-tweeks.co.uk](http://www.demon-tweeks.co.uk)

      
RACEWEAR | KARTWEAR | SIMULATION  
[WWW.GPRDIRECT.COM](http://WWW.GPRDIRECT.COM)

## RACEWEAR

AUTHORISED DISTRIBUTOR  
**OMP** **YBRACING**  
MOTORSPORT & PERFORMANCE  
[WWW.YBRACING.COM](http://WWW.YBRACING.COM)

## SPONSORSHIP

**The Million Pound Touring Car™**  
2013 British Touring Car Championships Contender  
Put your name/advertise your company on our front running Touring car in 2013/2014  
[www.themillionpoundtouringcar.co.uk](http://www.themillionpoundtouringcar.co.uk)

## THROTTLE & DRY SUMP SYSTEMS

  
[www.atpower.co.uk](http://www.atpower.co.uk)  
+44 (0)1953 857800

## TRAILERS & TRANSPORTERS

**BRIAN JAMES TRAILERS**  
» Connected to you  
[www.brianjames.co.uk](http://www.brianjames.co.uk)

  
[www.prgtrailers.co.uk](http://www.prgtrailers.co.uk)  
Phone no: +44 (0) 1270 812402

## WHEELS

**Image®** Manufacturers of bespoke split rim alloy wheels  
[www.imagewheels.co.uk](http://www.imagewheels.co.uk)  
IMAGE WHEELS INTERNATIONAL LTD.

**BRIAN JAMES TRAILERS**

» Connected to you



[www.brianjames.co.uk](http://www.brianjames.co.uk)

## Concours d'élégance

Carefully crafted, finely honed enclosed designs offer discreet, safe and efficient vehicle transportation. Style is always important, never more so than when in such illustrious company.

The latest Race Transporter models are testimony to the technology, craft and designs our dedicated engineers have developed.

Main photograph, Race Transporter 5 with high level tyre rack and work bench combination, Interior LED lighting pack and 'style 1' Alloy wheels.

Race Transporter range from £ 7,099 (excl. VAT).



**RACE TRANSPORTER**

**T +44 (0)1327 308 833**

For more information and details of your local BJT dealer please call or visit our website.

SCAN TO VISIT OUR SITE



New build in 2009 to carry 4 formula cars or 2 GT cars, management office, engineers room, removable drivers room with workshop below, 13.6m x 8m awning, 13.6m x 3m hospitality awning,



New build in 2009 to carry up to 3 Formula/radical size cars or 2 Rally cars, luxury living to accommodate up to 8 people, shower room, w/c room, master bedroom, 16Kva Onan generator, workshop, Awning etc.



**BESPOKE TRANSPORTERS**

*Built to suit your requirements and budget, orders being taken now for builds on new and used chassis.*

Both transporters were originally built new by us to high specifications and are available from the 15th October 2013.

[www.hopkinsmotorsport.com](http://www.hopkinsmotorsport.com)

0117 950 9294

**New & used Sales - Rental - Refurbishment**

**New for 2014**  
**DOUBLE DECK TRANSPORTERS**  
 from £110,000 to £195,000+vat

**New for 2014**  
**DOUBLE DECK POP UP**  
**ROOF TRANSPORTERS**  
 from £295,000+vat

# TRAILERS & TRANSPORTERS

**WOODFORD  
TRAILERS**

**Call Us Now! tel. 01327 263 384**

[www.woodfordtrailers.com](http://www.woodfordtrailers.com) [sales@woodfordtrailers.com](mailto:sales@woodfordtrailers.com)



**RL 2000**  
£4,900 + vat



**RL 3000**  
£5,950 + vat

## Paul Grimshaw Vehicle Movements Ltd

We specialise in moving.....

- Highperformance cars
  - Hi-value cars
  - Classics
  - Prototypes
  - Freight
  - Motorsport
  - Trackdays (From 1 car to 20!)
  - Race Truck Hire
- Throughout UK and Europe!**



Email: [info@pgvm.co.uk](mailto:info@pgvm.co.uk) or Join us on Facebook



[www.facebook.com/PaulGrimshawVehicleMovements](http://www.facebook.com/PaulGrimshawVehicleMovements)

**PRG TRAILERS**



**Finest Built British Trailers.**

PRG Trailers | Cheshire | UK | Tel: +44(0) 1270812402  
Web: [www.prgtrailers.co.uk](http://www.prgtrailers.co.uk) | Email: [info@prgtrailers.co.uk](mailto:info@prgtrailers.co.uk)

**PAUL SHEARD**

THE MAZDA MX5 SPECIALISTS



**RACE TRAILER FOR SALE**



1.5 Ton tail lift, hydraulic upperdeck, onboard generator, compressor, 12m x 6m awning 3 years old, internal wheel racks, powersockets, lots of storage, recent white paint job, excellent tyres, long test, can carry 4 saloons or 6 caterhams, very practical, ready to use Only £9695.

More Details Contact: 01260 279797 or 07717 536666

[www.paulsheardautos.com](http://www.paulsheardautos.com)



Mercedes-Benz

Global Specialists in  
American RV Sales & Rentals

## European Premiere

Unveiling the amazing  
**Mercedes  
Winnebago Via**

at the Düsseldorf  
Motorhome Show from  
31.08 to 08.09.13,  
Stand 14A47  
Hall 14.



*Global Specialists in  
American RV Sales & Rentals*



tel: +44 (0) 870 241 5614  
email: [info@stingrayRV.com](mailto:info@stingrayRV.com)  
web: [www.stingrayRV.com](http://www.stingrayRV.com)

[www.stingrayRV.com](http://www.stingrayRV.com)

# MARKETPLACE

## AUTOMOBILIA

F1 COLLECTORS .COM



**#1 FOR F1 MEMORABILIA & AUTOGRAPHS**

We buy and sell F1 items  
AYRTON SENNA specialists

Call CHRIS GRINT **01763 274448**  
email: [sales@f1collectors.com](mailto:sales@f1collectors.com)

**JMJ Automobilia**

SUPPLIERS OF RACE  
MEMORIBILIA SINCE 1992

Florida, USA

**(609) 575-1143**

email: [JMJ@JMJAUTO.COM](mailto:JMJ@JMJAUTO.COM)  
[WWW.JMJAUTO.COM](http://WWW.JMJAUTO.COM)

## CAR TYRES

FOR ALL YOUR

**AVON**  
TYRES  
MOTORSPORT

RACING TYRES  
Inc. ACB 10 Formula Ford  
Contact

**BMTR LTD**

Tel: 0121 331 1122  
Fax: 0121 331 1144  
email: [sales@bmtr.co.uk](mailto:sales@bmtr.co.uk)  
see our new website at [www.bmtr.co.uk](http://www.bmtr.co.uk)

## FLOORING

**Kiwi Tiles**

Interlocking Plastic Floor Tiles, as used by leading  
race teams throughout Europe.



- Easy installation & removal
- Many colours
- Lightweight
- Strong and durable
- Compact & easy to store
- Top quality
- Value for money

Stock Colours:  
Red, Blue, Green,  
Yellow, Silver, Orange,  
Grey, Black, White,  
Dayglo Red

**Rait Engineering**

Tel: 01865 883354 Fax: 01865 883789  
Email: [enquiries@kiwitiles.com](mailto:enquiries@kiwitiles.com)  
[www.kiwitiles.com](http://www.kiwitiles.com)

## INSURANCE



# TRACK DAY INSURANCE

Give Simon and the friendly team a call:

**0844 338 68 71**

[mcemotorsport.com](http://mcemotorsport.com)



OPENING HOURS:  
Monday - Friday 9.00am-5.30pm



## DRIVER DEVELOPMENT

**RACING DRIVERS** who want to fulfil their potential...

Let me Eugene O'Brien the UK's No. 1 Racing Driver Coach help you succeed in 2013



## How fast do you want to go?

- At test days and track days throughout the UK
- Develop your driving in either your own car or one supplied by us
- Help and advice on optimising your car set-up if required

Visit [www.eugeneO'Brien.co.uk](http://www.eugeneO'Brien.co.uk) or call 07753 835 629



Free Mobile Apps for:  
iPhone, Blackberry and Android!



## 50% OFF 12-month **tastecard** membership exclusively for Autosport readers £39.95 (NORMALLY £79.95)

A tastecard membership gives you 50% OFF or 2-FOR-1 across all courses in 7000 + fantastic UK restaurants. As a reader of Autosport you can get an exclusive rate of **£39.95** for a 12-month **tastecard** membership!

**tastecard** are giving Autosport readers an exclusive price for 12-month membership, making for a fantastic gift for yourself and all friends and family.

Enjoy 50% or 2-FOR-1 across starters, mains & desserts in 7000 UK restaurants - simply find search for a participating restaurant using [www.tastecard.co.uk](http://www.tastecard.co.uk) or one of the 3x Smartphone apps for iPhone, Android or Blackberry, follow the instructions and your food bill will be automatically halved!

Restaurants throughout the UK, including: PizzaExpress, Gourmet Burger Kitchen gbk, Zizzi, ASK Italian, La Tasca, Living Room and Prezzo, to AA rosette and Michelin rated establishments from Marco Pierre White, Gregg Wallace, Cyrus Todiwala MBE and Mark Baumann. Plus there are even gastro pubs and local haunts to choose from, the choice is absolutely staggering.

So why not treat yourself or someone special in your life to a **tastecard** membership, a truly unique gift that they will use all year round.

You can opt to get the card with a gift wrapped restaurant directory and personalised gift tag message attached, and can either have the pack delivered to you so that you can hand it over personally or directly to the recipient on a set date. With **tastecard** restaurants now nationwide, there has never been a better time to buy, or be bought, a 12-month **tastecard** membership.

Join over 800,000+ members who benefit from the taste ½ Price discount, with this exclusive offer for Autosport readers!

'Recently recommended in METRO, The Telegraph, The Guardian, The Daily Mail, Delicious Magazine, Olive Magazine and Jamie Magazine'



To join call 0800 5677 241 and quote **AUTO13** or visit [www.tastecard.co.uk](http://www.tastecard.co.uk)

Participating restaurants include:



Terms & Conditions: Full annual membership £39.95 (Normally £79.95). Closing date 311213. **tastecard** members must advance book where required, producing the card on arrival and when paying. **tastecard** discount not available in conjunction with any other promotion or offer. **tastecard** is a on-going subscription service. Gift wrapping optional extra.

# MARKETPLACE

## MOTORSPORT MANAGEMENT



**LOOKING FOR A NEW DIRECTION IN YOUR MOTORSPORT CAREER?**

CONTACT STRATOS TODAY TO DISCUSS THE WAY FORWARD.

- TAILORED CLIENT REPRESENTATION •
  - INVESTOR PARTNERSHIPS •
  - BRANDING DEVELOPMENT •
  - CAREER GUIDANCE •

**Tel: 0207 112 4929**

**Email: [info@stratossportsmanagement.com](mailto:info@stratossportsmanagement.com)**

**Web: [www.stratossportsmanagement.com](http://www.stratossportsmanagement.com)**

**[@stratossport](https://twitter.com/stratossport)**

## RACE PRODUCTS



Walkers Garage Ltd.

Northallerton DL7 9HT

0044(0)1609 777221

[www.walkersgarage.co.uk](http://www.walkersgarage.co.uk)

[www.teknofibra-racing.co.uk](http://www.teknofibra-racing.co.uk)

[www.walkers-radiators.co.uk](http://www.walkers-radiators.co.uk)

[www.tecno2.co.uk](http://www.tecno2.co.uk)

[www.energa-batteries.co.uk](http://www.energa-batteries.co.uk)

Heat resistant material  
to 1000 °C



**Bespoke radiator manufacture**



**Up to 5 years life expectancy**

360 cranking amps – 1.28 kg.  
600 Cranking amps – 2.25 kg.

- Importers & Manufacturers
- Teknofibra heat resistant materials
- Lightweight Lithium Batteries
- Walkers Competition Radiators
- Tecno2 Performance Products
- Competition wheel studs & nuts



## RACE PRODUCTS

**London Motorsport Showroom**  
**[www.msar.co.uk](http://www.msar.co.uk)**



**msar UK agent for SCHROTH RACING**

**ORDER HOTLINE: 020 8655 7877**



**Revealed:**  
The history of  
Formula One

Senna



Rindt



Prost



Villeneuve

Mansell



Fangio

Fittipaldi

Hawthorn

Piquet

Hill

Ascari



Clark

Hamilton



Taruffi

Button

FI Collectables • Team Memorabilia • Clothing

Buy • Sell • Evaluations

One of Europe's largest collections

+44 (0) 1245 287588 • +44(0) 7771 920345 • sales@finallap.net

www.finallap.net



**We have moved and are now fully open for business. We welcome you to our new premises, see website for details.**

# MARKETPLACE

## RACE PRODUCTS

*The Specialist Car Vacuum Cleaner. Powerful, Wall Mounted, Unique Stretch Hose*

\* Average Air Watt comparison see web site for details



2 x the power\*    15 x the power\*    40' / 12m hose    Flexible crevice tool    Soft dash brush    2 part carpet tool

Fixed crevice tool    Aluminum wand    Wand wall clip    Hard floor tool    Motor warranty    American built



01244 409 102



[www.garagevac.co.uk](http://www.garagevac.co.uk)

## RACE PRODUCTS

• EXPERT ADVICE • MASSIVE STOCKS • RAPID DELIVERY



[www.demon-tweeks.co.uk](http://www.demon-tweeks.co.uk) QZ252A  
 DON'T DELAY, CALL TODAY **0844 375 2196**  
**demon tweeks** MOTORSPORT Direct  
LOW CALL RATE CALLS MAY BE RECORDED FOR TRAINING PURPOSES

# AUTOSPORT

TO ADVERTISE YOUR PRODUCTS AND SERVICES HERE CALL:

**0208 267 5560**

## RACEWEAR

**Grand Prix Racewear**  
[WWW.GPRDIRECT.COM](http://WWW.GPRDIRECT.COM)



2013 **BESPOKE** MANUAL

RACESUITS KIT BAGS  
 BANNERS FLAGS  
 TEAMWEAR RADIO KITS  
 VEHICLE WRAPS



**08435 070 858**

RACEWEAR | KARTWEAR | SIMULATION

## RACE PREPARATION

**carbonfibrerepair.com**



- High quality carbon repairs
  - Competitive Pricing
  - Ultrasound testing facilities
- Contact us for a no-obligation quote  
 Tel: 01327 871847  
 Email: [mail@carbonfibrerepair.com](mailto:mail@carbonfibrerepair.com)  
 Please visit [carbonfibrerepair.com](http://carbonfibrerepair.com) for more details

MARKETPLACE

# MOTORSPORT JOBS

# AUTOSPORT

Want to advertise a motorsport job?

If you are recruiting in motorsport and wish to advertise with Autosport in print and online please contact [Rachel.Brock@Haymarket.com](mailto:Rachel.Brock@Haymarket.com) by email or call 020 8267 5820.

For all current vacancies advertised please visit our website [www.autosport.com](http://www.autosport.com)

## LOOKING TO RECRUIT FOR 2013? THE LATEST SELECTION OF MOTORSPORT JOB VACANCIES UPDATED EVERY WEEK.

- The Motorsport Jobs page of the website receives on average 200,000 page impressions per month
- The magazine you are looking at has a readership of 144,000 (Source: NRS Survey Q3)
- All appointment adverts placed in Autosport magazine are listed on the website.

contact [rachel.brock@haymarket.com](mailto:rachel.brock@haymarket.com)  
or call 0208 267 5820

All adverts placed will be featured in the jobs section of [www.autosport.com](http://www.autosport.com)

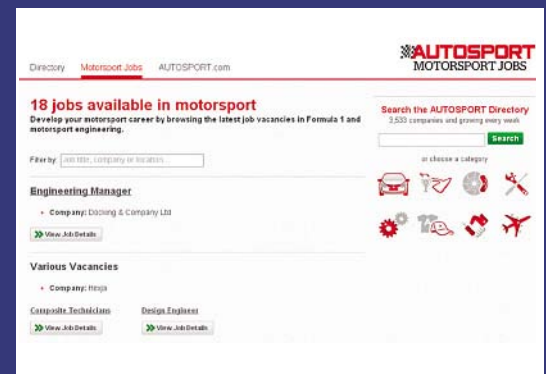

McLaren GT is the race car manufacturing arm of McLaren Group. Based in Woking, Surrey at the former home of McLaren Racing, the company is responsible for the development, build and sale of the successful 12C GT3 race car, the 12C GT Can-Am Edition and the recently announced 12C GT Sprint.

The McLaren GT team is growing and we are looking to recruit dedicated personnel for the following positions:

- GT031 Project Manager
- GT032 Customer Support Engineers
- GT033 Senior Design Engineer
- GT034 Design Engineers
- GT035 Bill of Materials Administrator
- GT036 Car Build Technicians
- GT037 Project Administrator
- GT038 Test Team Manager
- GT039 Trainee Machinist

For further information on the above roles or to apply, please send your CV to [hr@mclarengt.com](mailto:hr@mclarengt.com).

Closing Date for Applications – 13th September 2013



## And here are the views of some of our satisfied clients:

**“We received an unexpectedly large amount of responses in only a few days. We would definitely consider Autosport for any future recruitment needs.”**  
*Jose Santos, Race Engineer Matech Concepts*

**“Team WFR recognise Autosport magazine as one of the mainstream publications within the motorsport industry and therefore was an obvious choice when wishing to recruit new staff. We were thoroughly impressed with the extensive response to our advertisement and the quality of candidates that was received, just going to show that Autosport is read by high level motorsport professionals”**  
*Jody Firth, Team WFR*

**“At Flybrid Systems we have used Autosport as a single source to advertise a range of jobs from design and development engineering roles to assembly technicians and administrators. We have always had a strong response and on the last occasion we received over 200 applications for 6 posts!”**  
*Jon Hilton FIMechE CEng, Managing Partner, Flybrid Systems LLP*

# MOTORSPORT JOBS



**We are currently recruiting for the following positions:**

## **Senior Software Developer**

- Experienced software developer required to support the Head of Simulation to achieve department & company goals.
- Will be required to develop and maintain the team's custom simulation tools.
- Minimum 3 years of commercial experience in C++ and .Net software development using C#.
- Experience with SQL Server 2008 R2, OOP and Unit testing, together with WPF would be beneficial.
- A solid understanding of Vehicle Dynamics and data analysis methods required.

## **Senior Vehicle Dynamics Engineer (Simulator)**

- Experienced Vehicle Dynamics Engineer required to support the Head of Vehicle Dynamics to achieve department & company goals.
- Will have demonstrable experience of driver in the loop (DIL) tools, and techniques.
- Will be capable of defining, developing & optimising simulation models to enhance the effectiveness of the DIL.
- Will work with the DO, Aerodynamics, Race Engineering, & others in order to develop viable solutions that meet the performance targets.
- Identify & investigate new concept areas that can be used to improve car performance.
- Experience with vTag, ATLAS, Simulink and Matlab would be beneficial.

## **Rig Test Engineer**

- Support the Head of Rig Test to achieve department and company goals.
- Design and develop bespoke test rigs for sign-off and homologation of parts and systems for the F1 car.
- Take an active role in projects and assist in development of the Formula 1 car.
- Write and develop testing procedures and programs for various types of component and system tests.
- Write reports for issuing relevant information to a wide distribution list

## **Job Description: Engine Kitter (Traveling role)**

F1 Experience would be advantageous.

You will be responsible for all engines kitting at the factory and the circuit working in close relationship with the car crews.

You will be required to look after all life and non-life parts controlling the engine kits in conjunction with the lifting coordinators.

You will need to feel comfortable in communication with our engine supplier technicians.

A high level of computer competence will be required

You will report directly to the chief mechanic

This role is working with the mechanics and requires extensive travelling which will be approximately 170 days a year away from the UK.

You will be expected to take up other work as directed from the Chief Mechanic if your time allows.

Caterham F1 is a team determined to move forward and you will be expected to have the same level of enthusiasm, positive attitude and commitment in helping drive the team towards its goal.

**All applications to be sent to [hr@caterhamf1.com](mailto:hr@caterhamf1.com)**

**Closing date: 6<sup>th</sup> September 2013**



**WE ARE CURRENTLY LOOKING TO RECRUIT THE FOLLOWING POSITIONS AT RED BULL TECHNOLOGY:**

## **HR29071301 – COMPOSITE INSPECTOR TEAM LEADER (DAYS & NIGHTS)**

We have an exciting opportunity for a Composite Inspection Team Leader to join our Quality Department.

This challenging role will oversee the day to day running of a small team of Inspectors, ensuring specified processes and procedures are adhered to and components are to the correct quality and specification during manufacture.

The successful candidate will organise the team to ensure output targets are met and work with business systems to extract data to schedule workload and monitor production flow. The post holder will also take the lead responsibility for evaluation and decision making of how issues are handled.

This challenging position requires effective teamwork, clear communication, initiative and intelligent judgment to achieve and maintain production efficiently. Most importantly the successful candidate must have an unwavering dedication to the quality of the product produced.

You will also be experienced in CAD and have a good knowledge of Inspection Procedures along with the ability to deal with challenging situations and delivery pressures.

## **HR29071302 – COMPOSITE INSPECTOR**

We have an opportunity for a Composite Inspector to join our Quality department.

The successful candidate will be engaged in all aspects of in-process inspection ensuring composite components are to the correct quality and that specified processes and procedures are adhered to during manufacturing. Final inspection of parts and assemblies ensuring correct specification and race ready parts leave the factory.

You will be required to have extensive proven experience in a composite manufacturing environment with a sound knowledge of Inspection procedures and the ability to deal with challenging situations and delivery pressures.

The role will entail Inspection to CAD, thermal analysis, pressure testing, remote video inspection and the use of hand measuring instruments.

Applicants interested in applying for these roles will have proven experience and knowledge within a Composite Manufacturing/Inspection capacity. You will be self-motivated with a proactive approach. It is essential that you are an excellent communicator and that you have a flexible attitude to shift patterns.

These roles are based at Red Bull Technology's Factory in Milton Keynes.

**To apply for positions at Red Bull Technology and Red Bull Racing, please visit the recruitment page on our website [www.infiniti-redbullracing.com](http://www.infiniti-redbullracing.com).**

**Closing Date for Applications – 29<sup>th</sup> AUGUST 2013**

PLEASE NOTE: No Agencies please.



# Last chance to submit your entries

Deadline  
2 September 2013

Calling all students...  
**Win a money-can't-buy experience  
working in the British automotive  
industry and a £7500 cash prize**



#### THE AWARD

The Autocar-Courland Next Generation Award is a national competition to identify, support and develop the top automotive talent of the future. Entrants from UK universities are invited to answer a brief set by Autocar's editor-in-chief, Steve Cropley.

#### THE BRIEF

In no more than 500 words, describe an improvement (be it an invention, innovation, a legislative change, a change to corporate policy or the adoption of a new convention) that you believe would be a worthwhile benefit to the UK automotive business. You will be expected to demonstrate an understanding of how such an improvement could be made viable and what the wider implications of it might be.

Submissions will be welcomed from all disciplines, including engineering, marketing and communications, design and media. Special credit will be given to the originality of entrants' suggestions.

#### THE JUDGING

The six best entrants will attend a Dragons' Den-style judging day at the home of Autocar, where they will have the chance to present their ideas to a panel of leading industry executives. Three finalists will be invited to the Society of Motor Manufacturers and Traders' annual dinner, where the winner will be announced.

#### THE WINNER

The winner will receive a £7500 cash prize plus one month's work experience at each of the leading automotive organisations that are supporting the award. This will be a unique opportunity for the winner to acquire the contacts, experience and perhaps even a job offer.

For more details and to register for updates, go to

**[autocar.co.uk/nextgenerationaward](http://autocar.co.uk/nextgenerationaward)**

Supported by

Partners



# CLUB AUTOSPORT

NATIONAL RACING • HISTORICS • RALLYCROSS • HILLCLIMB • TRACK TESTS

WALKER



The club series has enjoyed strong debut season

## Clio Series to expand for 2014

### Leading Clio Cup UK teams praise plan for 12-race club championship

**THE CLUB-LEVEL CLIO CUP** series is set to become a fully-fledged championship next season.

A three-year deal has been agreed with organiser the BARC for the Michelin Clio Cup Series to expand after a successful trial season in 2013.

Its calendar will grow from eight rounds to 12, which AUTOSPORT understands will work as six double-headers run alongside Formula Renault BARC and the new Formula Renault UK 1.6 category.

Despite the first round only starting in May, the Clio Series has regularly attracted 12 to 14-car grids, consisting of classes for 'Race' and 'Road' models.

It will continue to cater for both classes, with an influx of current Clio Cup UK cars almost certain to join when the main Clio Cup UK introduces the latest, 1.6-litre turbo model next season.

Leading Clio Cup UK outfits Scuderia Vittoria and JHR intend to field four cars in the Clio Series next year. "It makes complete sense, I think there will be 20 cars on the grid," said Scuderia Vittoria boss Danny Buxton, whose team has run James Weston in the series this year.

"I think there's enough space for it because the concept is very different. The main series is quite a high step on the saloon ladder, whereas the club

championship is a real stepping stone and is going to be about half the cost.

"We'd like to run four cars so we welcome any interest. I love it, it's been really enjoyable."

JHR Team Principal Steven Hunter is similarly impressed by the burgeoning series' popularity.

"We've already got two drivers who want to do it with us and we're looking at running four cars," he said. "We've spoken to as many as eight drivers already with serious interest."

"The interest out there is astronomical, I genuinely can't think of any other category at the same level that will be able to compete."

Organisers are also hopeful other leading Clio Cup UK teams, such as Team Pyro (which was also involved in the series' early planning) will follow the example of Scuderia Vittoria and run cars in both.

Buxton, who has been one of the series' main backers, believes it is a practical and financially beneficial option for bigger teams, and that growing the grid will not frighten off privateer entries or road car racers.

"We've got the cars and parts, we've got all the data," he added. "If we can get a few youngsters coming through then we can offer them something going forward as well. It's a win-win situation all round."

"I don't think the top teams coming in would, or should, force anyone away. The club guys are the core focus of the championship. We just want to help."

**BEN ANDERSON**  
NATIONAL EDITOR

ben.anderson@haymarket.com  
@BenAndersonAuto



### THE CLIO CUP SERIES IS TO

become a fully-fledged championship next season and there is sense in this.

By formalising this lower tier beneath the flagship Clio Cup UK, organisers have aped the BARC format that worked so well for Formula Renault in its glory years – offering a cheaper alternative to those priced out of the premier playground, and an aspirational kindergarten for newcomers.

By committing to the concept for at least the next three years, Michelin and the BARC have protected residual value in current Clio Cup machinery when Renault's latest turbocharged model takes over in the top category from 2014. This ensures teams with current cars still have a place to use their assets, while simultaneously bolstering a second-hand market for those who wish to sell their kit on.

Events of the past few seasons prove that no series can afford to price itself above the market, and a club-level Clio championship should provide a safety net should the new-look Clio Cup UK not work out as planned next season. The more options the better for people who have cars to race, staff to keep busy, and bills to pay.

Elsewhere, organisers are taking stock and dreaming up schemes to grow grids in a difficult financial climate. Under Lawrence Tomlinson, Ginetta has pushed an affordable route into GT racing and has high hopes of expanding its GT Supercup grid by allowing in GT4-spec G50s from next year, thus (hopefully) attracting drivers and teams from outside the UK. It will be interesting to see what happens when its G55 model is homologated for GT4 too (see page 84).

Meanwhile, Britcar is looking to amalgamate grids and shorten races in an effort to entice more entries for 2014 (page 85). We wish James Tucker and his team well as they work to turn things around for 2014.

'Road' cars are part of Clio plan



WALKER



JHR runs in Clio Cup UK and is eyeing expansion to the club-level series

EBREVY/AT

G55s will be balanced against GT4 G50s for British GT in 2014



British GT

# Ginetta G55 to become a GT4 car

THE GINETTA G55 WILL BECOME eligible to contest the GT4 category of British GT next season.

The Yorkshire sports car builder introduced the G55 model into its TOCA supporting GT Supercup in 2011, alongside the previous-generation G50 car, and has also developed GT3 versions of the G55.

The G55 and G50 cars will be performance-balanced by series

organisers SRO with the aim of offering a level playing field in GT4. Ginetta sales director Michael Simpson, who races a GT3 G55 in British GT, said the GT3 programme would remain unaffected by the plan.

"The GT3 will remain untouched, the GT4 will just bear the same name," he told AUTOSPORT. "The G50 is in its sixth year and getting to be an old car now, while GT4 has changed from

being very basic in its early days to having more powerful cars.

"We felt it was time to introduce the G55 into GT4 to give us a newer car in that category. A G55 Cup car and a GT4 G50 are pretty much the same apart from bodywork, a couple of brackets, and the fact the exhaust runs down the side on the G55, so BOP shouldn't be a problem."

Ginetta hopes the move will give

G55 teams extra options for racing their cars, while a concurrent plan to open up the G50 class of the GT Supercup to GT4 versions should boost that grid by attracting racers from outside the UK.

"We can't grow the TOCA grid anymore as it is," Simpson added. "But this will give those guys who do Britcar, VLN and GT4 stuff [in G50s] the chance to be on the TOCA package."

## Formula Renault

### Fortec racers Parry and Aitken primed for Eurocup graduation

#### FORMULA RENAULT NEC LEADERS

Matt Parry and Jack Aitken look set to graduate to the Eurocup with the Fortec Motorsport team next season.

Both are in their debut seasons racing in Europe with the squad, with Caterham junior Parry holding a 121-point lead over Aitken at the head of the NEC standings.

Reigning InterSteps champion Parry has won five races this season, while Aitken, also an InterSteps graduate, is yet to win but has scored four podiums.

"The budget is pretty much there but we haven't signed a contract," Parry said. "You're never certain until it's signed but we're pretty confident. The aim is to win the championship in my first year."

Aitken said his 2014 plans would need to fit around his exams, but admitted the



offer was on the table and said he was eager to stay with the team.

"Like Matt says, nothing's signed, and I have A-Levels next year so need to make sure I can do all the rounds," Aitken said.

"Eurocup with Fortec is the natural progression. I've only been in cars two years but they've made it really costly."

## Historics

### Historic Formula Junior returns to Combe for Classic race event

#### HISTORIC FORMULA JUNIOR WILL

have its first stand-alone race at Castle Combe in more than a decade as part of the Wiltshire circuit's dedicated Autumn Classic event on October 6.

Following the success of last year's inaugural meeting, bigger grids of Austin-Healeys, Aston Martins and Jaguars are promised, the VSCC's popular Pre-War Sports Cars return, and FISCAR's new

'Fliers' set of 1100cc and 1500cc sports-racers of the '50s will make its public debut on the programme.

As part of the period-influential Bristol Motor Club's contribution to the meeting, it is hoped that some 500cc F3 cars will run. In addition, Julian Bronson – whose Bristol Forklifts concern joins Carole Nash Insurance as a title sponsor of the event – plans to demonstrate his F1 Scarab.



Comprehensive motorsport insurance products to keep you on track;

- Worldwide On Track
- Personal Accident
- Storage and transit
- Track day
- Liability
- Commercial



Please complete an online quote request form at – [www.ryanmi.com](http://www.ryanmi.com)

Email – [info@ryanmi.com](mailto:info@ryanmi.com) Tel – +44 (0)1799 524202

Ryan Motorsport Insurance Limited is an appointed representative (557405) of Independent Broking Solutions Limited who are authorised and regulated by the Financial Services Authority, registration number 312026

Britcar

# Britcar to undergo major revamp to revitalise its grids for 2014

**BRITCAR WILL UNDERGO** a "complete restructure" for 2014 in an attempt to boost numbers.

Britcar's flagship British Endurance Championship has struggled for consistent grids this year and the latest round at Snetterton, due to be held last weekend, was postponed to an as-yet-unscheduled date in November due to lack of entries.

The next Britcar meeting is the non-championship blue-riband event, the Silverstone 1000km in September, and series boss James Tucker is expecting a strong entry.

But he suggested next year's regular Britcar races would be slimmed down to

pairs of 1.5-hour events as part of a major restructure of the format, which would revert to a previous model of combining Production racers with the more exotic GT and prototype cars.

"We're having a complete restructure, going back seven years to [original] Britcar values," said Tucker, who is also keen to attract a wider variety of cars.

"We have to slim ourselves down to be competitive. I see other cars from other series coming in to race within Britcar.

"Amalgamating races will be the appeal. If you can get something that goes from a Mini to a McLaren, you've got steps, and drivers will stay with you for five years."



Series boss Tucker wants 'mid-noughties style' Britcar



## Hydrogen-powered Aston makes UK bow at Shelsley

Prodrive chief instructor Jamie Wall and BTCC ace Tom Onslow-Cole gave Aston Martin's hydrogen-powered Rapide S its UK track debut at Shelsley Walsh hillclimb's Aston Martin centenary celebration event last weekend.

Radical Sportscars

# Allison to contest rest of 2013 after making Radical SR3 bow

EX-BRITISH GT CHAMPION MATT

Allison plans to compete in the remainder of this year's Radical SR3 Challenge after making his series debut last weekend.

Allison was due to race in the

championship this season with 1992 British Touring Car champion Tim Harvey, but was thwarted by budget issues.

Allison, the 2006 GT champ, shared former Caterham and Ginetta Supercup racer Philip Broad's RAW Motorsports SR3 for the two races at Silverstone, finishing second on the road twice.

The pair was dropped to ninth in the second race after Broad picked up a 30-second penalty.

"I haven't raced since I did a few Clio rounds in 2011," Allison said.

"I'd intended on doing Radicals all year. That fell through, but now we are doing the rest of the season."



Allison ran at the front on SR3 debut

SNAPPY RACERS

# HUMBLE PYE

## The voice of club racing

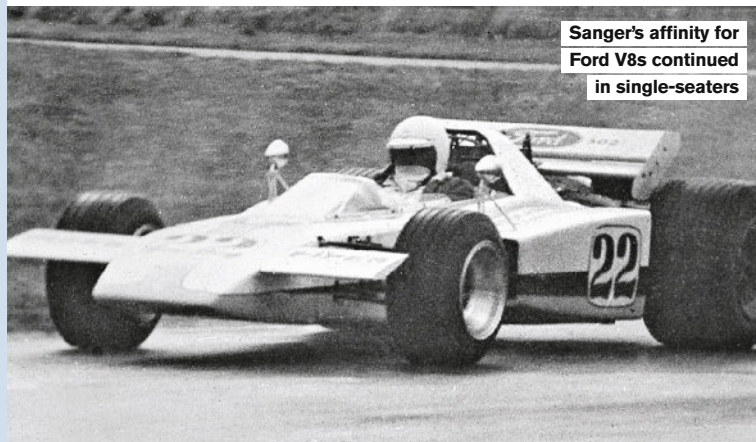

Sanger's affinity for Ford V8s continued in single-seaters

# Terry Sanger: 1934-2013

**N**ews of Terry Sanger's death, last Wednesday, aged 79, had not reached me by Castle Combe's Autumn Classic launch the next day. There I learned that the popular west countryman – who taught at its school days until a few years ago – was ill. For me, Sanger and Combe are synonymous. I first saw him race there in 1967.

Terry was wrestling with his thuggish Ford Cortina V8, enormous rear tyres protruding through cut-away arches. Subtle it wasn't, like most hybrid saloons (not Special, or Super!) of the era. Brian Tarrant's Austin A40-Chevrolet also entered my schoolboy orbit then, an even more agricultural device than the Cortina. He died after crashing it at Thruxton in June '71, while trying a longer diff ratio.

Sanger switched from racing motorcycles to cars, driving an AC Ace, Morgan +4 and Marcos GT – with which he contested the '65 Nurburgring 1000Kms with Simon de Lautour, later of Winfield racing school fame – before the ex-Terry Drury Cortina. A skilled engineer, he transformed its unruly handling and won often in it.

Burly, bearded Terry shared Drury's Ford GT40 in the '68 Targa Florio and the 1000kms of Monza, Nurburgring and Spa. He loved American V8 engines, and flew in a Falcon Sprint and a Chevrolet Camaro, in which he placed sixth in the '72 TT at Silverstone (with Martin Thomas) and 11th in the '73

Spa 24 Hours with Mike Crabtree and Jonathan Buncombe.

Unsurprisingly, Sanger was drawn to the fledgling Formula 5000, initially with sprinter Johnny Williamson's ex-Jackie Stewart/Chris Irwin F1 BRM P83 chassis, with a Ford V8 engine where its original BRM H16 sat. Fifth was his best result, in Brands Hatch's '69 finale. Peter Gerrish, who worked with him at Research Consultants, later installed a Rover V8.

Terry and Tony Hilder designed and built the big Harrier-Ford 'wedge' for 1971, but following contact with Keith Holland's McLaren M10B on its debut, both careered into Mallory Park's lake! After one shot in a Lola T190, the rebuilt Harrier returned with Chevy power, besting with seventh at Snetterton. After years in Jersey with ex-Cooper-Daimler sand racer John Fossey, Barry le Prevost took it on.

Sanger's single-seater swansong was a dramatic one, for he miraculously escaped from the ex-Alan Rollinson Lola T300 HU9 (loaned by Alan McKechnie), bisected by Mallory's Devil's Elbow barriers in July '73. Terry's life could easily have ended then, so 40 more years were a considerable bonus, not least to those who enjoyed his company and racing stories.

## Marcus Pye

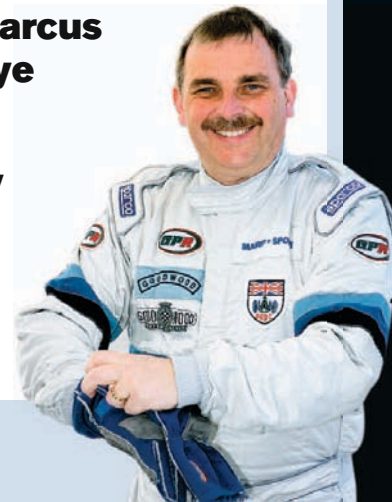

**"Burly, bearded Terry loved American V8 engines and flew in a Falcon Sprint and Chevrolet Camaro"**



**HODDESDON K.C.**



**2013 LONDON CUP** @ Rye House, Hoddesdon  
1st September 2013\*

Saturday testing available  
9.00am - 4.00pm UNINTERRUPTED  
\*incorporating HKC Club round

Race Entry Forms are available  
[www.hoddesdonkartclub.co.uk/londoncup](http://www.hoddesdonkartclub.co.uk/londoncup)

**INVITED CLASSES ARE:** Rotax Mini Max / Junior Rotax / Senior Rotax / Rotax 177 / Comer Cadet / Honda Clubman / Honda Cadet / IAME

- Full TV Coverage
- Great prizes including:
  - The chance to win a Fully Funded season in Ginetta Juniors for 2014
  - Formula 1 tour
  - Signed F1 memorabilia
- DVD available to purchase
- Live timing sheets on Saturday

Testing available from Thursday and Friday.  
For more information, or to book a pitbay please call **Jason Robinson** on **0798 4495158**  
Alternatively email: [pitbays@hoddesdonkartclub.co.uk](mailto:pitbays@hoddesdonkartclub.co.uk)



**PLUS MUCH MORE...**



**BRITISH CHAMPIONSHIP RACE SERIES**  
**RZR RACING.CO.UK**

**ULTIMATE 4X4 OFF-ROAD MX RACING**

**POLARIS** The All-Terrain Specialist  
**ACU** ALLSPORTS  
**NORA SX5** BRITISH SX5 CHAMPIONSHIPS  
**ATV**



**RZR RACING.CO.UK**

**FIND OUT MORE:**



**FOR MORE INFORMATION PLEASE CONTACT**  
**FREEPHONE: 08000 147 147**



**THE BIGGEST VODAFONE DMAX CHAMPIONSHIPS YET!**



Prices are £180 per Endurance Round and £165 per Heats Round  
**£280 to enter both**

Cumulative Loyalty Discount of 2.5% for each round entered.

A full season of Heats Racing for £1476 or Enduro Racing for £1610 inc VAT

Feb 17th	Daytona MK
Mar 17th	Daytona SP
Apr 21st	PF International
May 19th	Rye House
Jun 16th	Lydd
Jul 21st	Bayford Meadows
Aug 18th	Whilton Mill
Sep 15th	Red Lodge
Oct 20th	Daytona MK
Nov 17th	Daytona SP

**Tel: 0845 644 5504**  
[www.daytonamax.co.uk](http://www.daytonamax.co.uk)









**Monterey toasts Corvette's 60th**

The annual Monterey Motorsports Reunion gathered this special line-up of Chevrolet Corvettes to celebrate the US marque's 60th birthday last weekend.

PICIERIC SAWYER



**E-types will race for Coombs prize**

**Historics**

**Gold Cup to honour Coombs**

**JAGUAR E-TYPE RACERS WILL** compete for the John Coombs Trophy – named after the marque legend who died earlier this month – at this weekend's HSCC Oulton Park Gold Cup event.

The prize is particularly poignant because Guildford Jaguar dealer Coombs – universally known as Noddy – entered one of two pre-production E-types for Roy Salvadori to drive on the model's race debut at Oulton in April 1961.

That car went on to be rebuilt by the factory in Coventry as one of the works

lightweights, raced by Graham Hill, Jackie Stewart and Brian Redman among others.

Ex-Coombs Jag Mk1 'BUY 1' will form part of a special display to mark 60 years since the opening of Oulton Park in August 1953. Also included will be the March 711 in which Le Mans legend Henri Pescarolo won a heat of the 1971 Gold Cup.

Olympic champion cyclist Chris Hoy, who is racing in the Radical SR1 Cup this year, will make his historic racing debut in the 40-strong Historic Touring Car field, driving a Mini Cooper.

**VSCC**

**Rossi breaks back in Vintage shunt**

**HISTORIC RACER NICK ROSSI**

underwent spinal surgery in Carmarthen's West Wales General Hospital on Monday, following a bad accident at Pembrey during the VSCC's annual meeting the previous afternoon.

Rossi's Lotus 12 Formula 1 car landed upside down in the grass on the outside of Dibeni bend following contact with Mac Hulbert's ERA R4D. The Hawthorn Memorial race, in which they were disputing third place, was red-flagged.

Medics stabilised Rossi, 65, who was unconscious beneath the car (which had bounced across the track) after marshals reached him within seconds. He regained consciousness and was talking when he was transferred to hospital by ambulance.

Scans revealed that Rossi had suffered a damaged L2 lumbar vertebra, but consultants decided to treat the injury in Carmarthen rather than transfer the driver to a specialist unit in Cardiff, as was being considered on Sunday evening.



**TOJ was on display at Silverstone Classic**

**Historics**

**Tromans plots Spa race for TOJ**

**HISTORIC RACER GRANT TROMANS** may race his recently restored TOJ sportscar with Martin Stretton at next month's Spa Six Hours meeting.

The Monaco-domiciled Briton intends to enter the Cosworth DFV-powered SC304 in a Masters Proto 70s event.

Built by Jorg Obermoser in Bruchsal,

Germany, during 1976, the prototype was given its debut by the marque founder and F1 racer Rolf Stommelen in the '76 Dijon 500kms. Obermoser subsequently won an InterSerie race at Mainz-Finthen in it.

Dormant for years, the chassis has been rebuilt by Chevron B62 C2 designer Paul Fox and his Foxcraft Engineering team.



**Fletcher hurt in F4**

James Fletcher was forced to miss last Sunday's BRDC F4 rounds at Silverstone, after dislocating his shoulder in a collision with Gustavo Lima on lap seven of Saturday's first race (above). The Team KBS driver had qualified 15th. Although Lima's car rolled, he was able to race again on Sunday, but received a five-place grid penalty for his part in the incident.

**Wilson's Fortec drive**

Reigning Caterham R300 Superlight champion Paul Wilson will drive a Fortec Motorsport Mercedes AMG SLS GT3 car in the next round of the VLN series at the Nurburgring this weekend. He will partner 2013 R300 race winner Stuart Leonard.

**Fack wins VSCC sprint**

Second time out in his rare 1935 Railton Light Sports – a Hudson-based machine of which he is only the third owner – John Fack won his class in the VSCC's wet Pembrey Sprint last Saturday. Best time of the day was set by Eddie Gibbs in his Frazer Nash single-seater, who pipped Pete Candy's Riley 'Super Rat'.

**Masters to run US arm**

Masters Historic Racing is expanding into the USA after procuring the operations of America's historic Formula 1 organisers, Historic Grand Prix Inc. The American series will be called Masters HGP, and the organisation will be provisionally run out of MHR's existing UK office. The move will allow MHR to run standalone historic F1 races in the States, or as part of the FIA Masters Historic F1 championship.

**Coombs demos March**

Thruxton circuit director Bill Coombs demonstrated the Starline Racing-built replica of Brett Lunge's March 761 (below) as part of the track's CMSA Big Weekend. Coombs lapped in 1m11.152s in the March, compared with a 1m08.761s in his usual Tyrrell 009. Depending on progress with the March, Coombs intends to race it at the Zandvoort or Spa Historic F1 rounds.



JONES



SWR's Graham was top scorer at Silverstone

SNAPPY RACERS

**BRDC F4 SILVERSTONE GP, AUGUST 17-18 MSVR**

## Graham and Gunn triumph as Hughes stretches his lead

THERE WERE THREE WINNERS FROM three races again, as Matty Graham, Ross Gunn and Jake Hughes each tasted the victory champagne.

A double podium for Hughes helped him consolidate his points lead.

Poleman Graham (SWR) was never headed in the first race, as Hughes (Lanan) lost second to Charlie Robertson (HHC) as they rounded the Vale on the first lap.

Hughes closed back in on Robertson in the second half of the race and grabbed second by going round the outside at Brooklands on lap eight, but Graham was already four seconds down the road.

Raoul Hyman (HHC) slipped back as Seb Morris (Hillspeed) came through, but Morris copped a penalty for a yellow-flag infringement,

dropping him to sixth behind Jack Barlow (SWR) and James Greenway.

Gunn (Motionsport) was able to make a telling break from the start of race two, with Hyman heading the pursuit as Morris, Greenway and Barlow attempted to go through Village three abreast. Barlow emerged in third from Greenway, as Morris was forced onto the grass. The incident was reviewed twice and Barlow reinstated in the final results.

Hyman threatened Gunn for a couple of laps, but Barlow soon bridged the gap and was into second by the end of lap three, with Greenway and Robertson both following through a lap later.

Gunn eased himself through the final laps as Greenway closed on Barlow, taking his first podium.

"Raoul was fast for two laps, and I expected Jack to catch me, but I impressed myself with that one," said Gunn. Robertson settled in fourth, with Graham and Jake Dalton (MGR) completing the top six.

Graham nosed ahead of poleman Hughes out of Copse at the start of race three, and despite the intensity of their duel only Morris was able to join them in an early break.

It was side by side a couple of times before Hughes got ahead around the outside at Brooklands on lap three. Although Morris was still third, he had the squabbling Robertson and Barlow closing in.

Hughes eased away, and Graham was powerless to challenge. "Jake was just too fast for me," he admitted. The points leader took his win by 6.8

seconds, but Graham was relatively happy with his second place.

Morris retained third by four-tenths as Barlow had another late surge, which finally shook off race-long duellist Robertson.

● Peter Scherer

**RESULTS (ALL 10 LAPS)** 1 Matthew Graham; 2 Jake Hughes +4.427s; 3 Charlie Robertson; 4 Jack Barlow; 5 James Greenway; 6 Seb Morris. **Fastest lap** Hughes 2m06.127s (104.48mph). **RACE 2** 1 Ross Gunn; 2 Barlow +4.615s; 3 Greenway; 4 Robertson; 5 Graham; 6 Jake Dalton. **FL** Greenway 2m06.952s (103.80mph). **RACE 3** 1 Hughes; 2 Graham +6.839s; 3 Morris; 4 Barlow; 5 Robertson; 6 Raoul Hyman. **FL** Hughes 2m07.047s (103.72mph). **POINTS** 1 Hughes, 339; 2 Morris, 305; 3 Barlow, 300; 4 Graham, 275; 5 Dalton, 270; 6 Robertson, 268.

88

**F3 CUP SILVERSTONE GP, AUGUST 17-18 MSVR**

## Cliffe makes it four in a row after twice beating Powell

TRISTAN CLIFFE HAS TAKEN FOUR successive wins now after steering his Dallara F307 to a double victory over Alice Powell's similar version.

Louis Hamilton-Smith (F304) made the best start in race one, but it only lasted until Hanger Straight when Cliffe charged ahead. Powell then forced Hamilton-Smith into a mistake at Stowe on the second lap and set about trying to chase down Cliffe for the lead.

Cliffe hit a marker at Becketts, which was then collected by Powell, affecting her car's handling. While Cliffe increased his lead to a decisive 5.6s, Powell came under pressure from Alex Craven after he recovered from stalling at the

start, but she still had more than a second in hand at the finish.

Henry Chart came home fourth after losing out to the recovering Craven at Brooklands on lap four, leaving Hamilton-Smith and class winner Olly Rae to round out the top six finishers.

Cliffe was beaten away at the start of race two as Powell held the upper hand until Stowe on lap three. Cliffe soon eased himself clear, leaving Powell to hold off Craven, who rose to third on the opening lap at Hamilton-Smith's expense.

With just over a lap to go, Craven retired with a fuel problem and left Powell safe in second, with Hamilton-Smith taking the last podium spot,



Ex-Mono champ Cliffe is the form man in F3 Cup

SNAPPY RACERS

and James Cross, Chris Headlam and Rae completing the top six.

● Peter Scherer

**RESULTS (BOTH 10 LAPS)** 1 Tristan Cliffe (Dallara F307); 2 Alice Powell (Dallara F307) +5.621s; 3 Alex Craven (Dallara F307); 4 Henry

Chart (Dallara F302); 5 Louis Hamilton-Smith (Dallara F304); 6 Olly Rae (Dallara F301). **Class winner** Rae. **FL** Cliffe 2m01.657s (108.31mph). **RACE 2** 1 Cliffe; 2 Powell +2.171s; 3 Hamilton-Smith; 4 James Cross (Dallara F302); 5 Chris Headlam (Dallara F302); 6 Rae. **CW** Rae. **FL** Craven 2m02.154s (107.87mph).

GT CUP SILVERSTONE GP, AUGUST 17-18 MSVR

# Aston interloper Poole takes double victory

MARK POOLE TOOK TIME OUT FROM HIS British GT campaign to win two of the three races in his Aston Martin.

Poole dominated the first race to triumph by more than 33 seconds, only briefly losing the lead during the pitstops.

Martin Short's Ferrari 458 was second early on, but from the third lap it was Ron Johnson's BMW Z4 heading a vain chase of Poole. After Bob Berridge took over the Riley TDC from Nigel Mustill, he stormed through to snatch second on the last lap, with Johnson almost caught by Aaron Scott (Ferrari 458), too.

The first half of race two was behind the safety car after a multiple shunt on the first lap. Poole, Johnson, Ian Dockerill's Porsche 911 RSR and Alex Martin's Ferrari 458 were settled in the top four, and the order remained static after the restart.

In the final race, it was three for the lead, with Arwyn Williams (458) heading Johnson and Berridge.

Berridge was into second by Becketts on lap two, and Dockerill and Martin made it a five-car break. After several attempts, Berridge finally took the lead on lap six after contact with Williams. The former leader then spun and collected Johnson. Berridge



Poole's Aston leads bumper GT Cup field into Cose Corner

was therefore left clear, as Dockerill and Martin completed the podium.

● Peter Scherer

**RESULTS (18 LAPS) 1 Mark Poole (Aston Martin Vantage);** 2 Nigel Mustill/Bob Berridge (Riley TDC) +33.227s; 3 Ron Johnson (BMW Z4); 4 Arwyn Williams/Aaron Scott (Ferrari 458 GT3); 5 Martin Short (Ferrari 458 Challenge); 6 Charles Duyver/Charlie Hollings (458 Challenge). **CW** Duyver/Hollings; Ian Loggie/Chris Jones (Porsche 997 GT3); Ross McEwen/Rory Butcher (Porsche 996

GT3). **FL** Berridge 2m06.066s (104.53mph). **RACE 2 (10 LAPS) 1 Poole;** 2 Johnson +18.443s; 3 Ian Dockerill (Porsche 911 RSR); 4 Alex Martin (Ferrari 458 Challenge); 5 Duyver; 6 Peter Jennings (458 Challenge). **CW** A Martin; Don Grice (BMW V8); Ben Tompkins (Ginetta G50). **FL** Poole 2m05.555s (104.95mph). **RACE 3 (12 LAPS) 1 Berridge;** 2 I Dockerill +13.740s; 3 A Martin; 4 Duyver; 5 Tony Tarrant-Willis (Ferrari 458); 6 Jennings. **CW** A Martin; Rosen Daskalov (Sin); Mark Smith (Porsche 997 GT3); Patrick Gormley (Ginetta G50). **FL** Berridge 2m08.233s (102.76mph).



Solo racer Smith doubled up again in SR3 Challenge

RADICAL SR3 CHALLENGE SILVERSTONE GP, AUGUST 17-18 MSVR

# Unstoppable Smith wins again in Radicals

BRADLEY SMITH PROVED UNBEATABLE on his way to another double. Apart from the compulsory stops, Smith led race one throughout, with newcomers Philip Broad/Matt Allison his nearest challengers.

Darron Anley headed Andy Cummings for third in the first half, but Jeremy Ferguson came through strongly to clinch a podium spot.

Bradley Ellis took over the Cummings car and finished strongly, too. He was poised to challenge Ferguson as the flag came out.

With Smith down on the fifth row for race two, the odds were not in his favour. Ellis led from pole, but had

Alex Kapadia as a constant shadow for the whole of his stint. Phil Keen ran with the lead duo before dropping back into a solid third, well clear of Matt Bell and Allison.

Smith charged into contention and was up to fifth by lap four, but with his 2012 Radical Clubmans Cup rival Bell next in line, it wasn't going to be easy. "It had been fairly simple coming through until I reached Matt," said Smith. He decided to play it safe and held station until the stops.

Tom Jordan led in the Kapadia car after the stops, but Smith was into second after 17 laps and hit the front exiting Club Corner.

Jordan was then attacked by Broad and spun after contact at Brooklands. Broad was later penalised, so James Abbott/Oskar Kruger inherited second, with Jordan third, after Peter Belshaw's front upright broke.

● Peter Scherer

**RESULTS (17 LAPS) 1 Bradley Smith;** 2 Philip Broad/Matt Allison +12.341s; 3 Jeremy Ferguson; 4 Andy Cummings/Bradley Ellis; 5 Darron Anley; 6 Tom Jordan/Alex Kapadia. **FL** Smith 2m03.961s (106.30mph). **RACE 2 (19 LAPS) 1 Smith;** 2 Oskar Kruger/James Abbott +11.309s; 3 Jordan/Kapadia; 4 Bronislav Formanek/Josef Zaruba; 5 Ferguson; 6 Peter Belshaw/Phil Keen. **FL** Smith 2m05.320s (105.15mph).



## Monoposto

Kevan McLurg's Dallara scored a double win from a massive combined field of Monoposto single-seaters (above), but only after Adrian Wright retired his GEM from the lead of both races with fuel pump problems. In race one, the failure came on the penultimate lap, before Daniel Hands' Van Diemen ousted Russ Giles' Dallara for second. Wright was out after only three laps in race two, leaving Jeremy Timms' Speads to take second from Hands at Stowe. The red flags came out and ended the race early, just as Timms and Hands were poised to threaten McLurg's supremacy.

## Radical Clubmans Cup

Lewis Plato secured a winning double at Silverstone. In race one, he took Jesper Westerholm for second at the Loop on the opening lap, before taking Oskar Kruger in a repeat move four laps later. Having lost out to both Swedes at the start of race two, Plato was into second when Westerholm retired, but it took until lap eight to get by Kruger again. Steve Burgess was a distant third.

## Racing Saloons/PBMW

The combined grid mustered 55 cars at Silverstone (below), as Stephen Pearson's BMW managed a double victory. In race one, he led from lap three when Karl Cattliff's BMW went sideways at Luffield. Peter Seldon followed with Dan Roberts-Jefferson's VW Golf breaking the BMW dominance in fourth. Seldon led race two initially, but from lap three Pearson was in charge, with Cattliff taking second in the closing stages. Matt Parkes twice dominated the Production BMW section, finishing 17th overall in race one and 16th in race two. Liam Crilly and Harry Goodman scored a second and a third each as they joined Parkes on the podium.



# 'Ballsy' Halliwell picks up a pair

**JONATHAN HALLIWELL WAS VICTORIOUS** in both MaX 5 races at Thruxton last weekend, but David Chapman was snapping at his heels all the way.

Rain had made the Thruxton circuit very slippery for Saturday's race. "It was like a skating rink out there," said Halliwell, although he still led from the off, with Chapman in second following closely.

The lead changed at Cobb at the halfway mark, and what followed was a fascinating battle.

Halliwell, who seemed to have the advantage over Chapman in the fast, sweeping turns, got first place back at Goodwood two laps later.

Chapman was quicker in the twiddly bits, but although he fought back at Campbell the next time around, Halliwell was swiftly back through at Allard.

In a frantic final lap, Halliwell resolutely defended his lead through the complex. The pair of them were sideways going into the Club chicane, as Chapman tried a last-gasp move

for the lead. Halliwell just held on, crossing the line just 0.238 ahead.

"David was quicker in the tighter corners, but I had more balls in the faster ones," reckoned Halliwell.

Ben Short drove brilliantly in his Mki to come home in third, while an eight-car battle for fourth was won by Will Blackwell-Chambers after defending champion Paul Roddison slipped to seventh.

In a drier race two, Chapman made a poor start and dropped to third behind Short, but wrestled the position back at Church.

Short didn't give up, and while the pair squabbled, Halliwell eked out a four-second advantage.

Once Chapman got the better of Short, he homed in on Halliwell, setting a number of fastest laps — "that was for anyone who thinks I'm not brave enough in the corners" — and climbing all over the leader by the penultimate lap.

He looked all set to mount a challenge, but went wide at the Club



Halliwell (2) readies himself for victory as Chapman spins

chicane and rotated, handing victory to the MaX 5 co-founder.

"I had a good lead and made a couple of silly mistakes," Halliwell admitted later, while Chapman had enough time in hand over Short to recover from his spin and still take the flag in second place.

Roddison made amends for his race one showing by finishing fourth, after battling with Blackwell-

Chambers and Ian Loversidge. ● Matt Upton

**RESULTS (12 LAPS)** 1 Jonathan Halliwell; 2 David Chapman +0.238s; 3 Ben Short; 4 Will Blackwell-Chambers; 5 Jonathan Cryer; 6 Ian Loversidge. **Class winner** Short. **Fastest lap** Halliwell 1m39.392s (85.33mph). **RACE 2 (13 LAPS)** 1 Halliwell; 2 Chapman +17.829s; 3 Short; 4 Paul Roddison; 5 Loversidge; 6 Blackwell-Chambers. **CW** Short. **FL** Chapman 1m32.09s (92.09mph).



Frost twice was the beneficiary of Connew's woes

JAGUARENTHUSIASTS CLUB THRUXTON, AUGUST 17-18 BARC

# Frost's double delight after unreliability strikes his rival

**RODNEY FROST WAS VICTORIOUS** in two very entertaining Jaguar Enthusiast Club races, but he benefited from the mechanical misfortunes of Guy Connew.

Connew's XJ6 made the early running in race one, while XJS boys Terry Nicholls and Frost battled over second. The latter eventually got past Nicholls with a brilliant move around the outside at Club.

Frost then began to reel in Connew, who was now suffering from a fuel pick-up problem. A slow exit from Club allowed Frost to power in front on the start-finish straight at the beginning of the 12th lap.

Connew was once again at the front in race two, leading 12 of the 13

laps. Unfortunately for the Wallington man, an overheating engine would force his retirement.

Frost thus took his second victory of the weekend, with Chris Boon coming home in second after Nicholls retired in the early stages with clutch failure.

● Matt Upton

**RESULTS (BOTH 13 LAPS)** 1 Rodney Frost (XJS); 2 Terry Nicholls (XJS) +0.984s; 3 Guy Connew (XJ6 coupe); 4 Richard Coppock (XJS); 5 Chris Palmer (XJS); 6 Chris Boon (XJR). **CW** Connew; Laurence Squires (XJS). **FL** Frost 1m35.785s (88.54mph). **RACE 2** 1 Frost; 2 Boon +23.965s; 3 Lawrence Coppock (XJS); 4 Palmer; 5 Squires; 6 Simon Blunt (XJS). **CW** Boon; L Coppock; Squires. **FL** Frost 1m35.183s (89.10mph).

MG OWNERS CLUB THRUXTON, AUGUST 17-18 BARC

# Classy Palmer dominates in Thruxton race debut

**BEN PALMER SCORED AN IMPRESSIVE** double victory in the MG Owners Club Championship last weekend, on his racing debut at Thruxton.

The Maidenhead driver got a great start in race one and effortlessly pulled away from the rest in wet conditions. His closest rival, Lee Sullivan, crossed the line more than 16 seconds behind him. "I just managed to get my head down and keep consistent," said Palmer later.

Sullivan had snatched second from Robb Addison at Allard on the fifth tour. Poleman Addison slipped to sixth, but got back up to third after Andrew Rogerson and John O'Brien touched at Campbell.

Teenager Palmer, 18, didn't have

it all his own way in the second encounter. Addison took the initiative on lap six, only to lose it again at Church three tours later.

Addison tried to regain the lead at the complex on the final lap, but overcooked it and ran wide.

● Matt Upton

**RESULTS (9 LAPS)** 1 Ben Palmer (ZR160); 2 Lee Sullivan (ZR) +16.219s; 3 Robb Addison (ZR); 4 Andrew Rogerson (ZR160); 5 John O'Brien (ZR160); 6 David Mellor (ZR). **CW** Kendrick (MGF VVC); Jim Baynam (MGB Roadster); Jag Golhar (MG Maestro). **FL** Palmer 1m40.250s (84.60mph). **RACE 2 (10 LAPS)** 1 Palmer; 2 Addison +0.773s; 3 Vince Pain (ZR160); 4 Mellor; 5 Rogerson; 6 O'Brien. **CW** Mark Baker (MGF); Ashley Barnes (MG Midget); Golhar. **FL** Addison 1m31.580s (92.61mph).



Palmer's age and inexperience didn't show at Thruxton



Another win for Moran and the 400th for Gould marquee

ROBINSON

BRITISH HILLCLIMB CHAMPIONSHIP SHELSLEY WALSH, AUGUST 17-18

# Moran reclaims points lead

SCOTT MORAN EARNED THE GOULD marquee its 400th British run-off victory in the latest British Hillclimb bouts, reclaiming control of the championship as he did so.

Moran's lead now stands at just one point. However, before the landmark triumph Wallace Menzies took his fourth run-off victory of the year and earned his highest single-day score (19) to match Moran's haul with a shared second place later on.

The weekend was incredibly busy with the biggest entry this year.

As Moran closed it out with the win, previous series leader Trevor

Willis was finishing off a difficult Shelsley Walsh meeting. In round 25, he qualified and finished in fourth. He qualified one place better for round 26, although Menzies matched his time.

After receiving his prizes, Menzies was as relieved as he was victorious. "It's been a difficult early season, so this is reward to the team for their extra effort," he said. "I really want more wins in preparation for a bigger assault next year."

A pair of nines dropped Roger Moran to a distant fourth, while Alex Summers finished third and sixth.

**ROUND 25** 1 Wallace Menzies (3.2 DJ-Cosworth Firestorm) 23.48s; 2 Scott Moran (3.5 Gould-NME GR61X) 23.49s; 3 Alex Summers (1.3s DJ-Suzuki Firehawk) 23.94s; 4 Trevor Willis (3.2 OMS-Powertec 28) 23.95s; 5 Tom New (4.0 Gould-Judd GR55) 24.04s; 6 Deryk Young (4.0 Gould-Judd GR51) 24.08s; 7 John Bradburn (3.5 Gould-Cosworth HB GR55) 24.61s; 8 Jos Goodyear (1.6 GWR Raptor Extreme 2) 24.62s; 9 Roger Moran (3.5 Gould-NME GR61X) 24.68s; 10 Alastair Crawford (2.8 Gould-NME GR55) 24.96s; 11 Paul Haimes (1.3t Gould-Suzuki GR59) 25.12s; 12 David Uren (1.6 Force-Suzuki PC) 25.76s. **ROUND 26** 1 S Moran 23.31s **BTD**; 2= Willis & Menzies 23.78s; 4 Young 23.92s; 5 New 24.09s; 6 Summers 24.12s; 7 Goodyear 24.35s; 8 Bradburn 24.53s; 9 R Moran 24.57s; 10 Will Hall (3.5 Force-Nissan WH) 24.97s; 11 Crawford 25.12s; Haimes 45.30s. **CW** Tony Adams (1.8 Lotus Aldon Elise) 34.37s; Robert Lancaster-Gaye (3.6 Porsche 996 GT3) 32.15s; Allan Warburton (2.4 Caterham-DuraTec) 29.92s; Tim Dennis (1.4 Morris Mini Cooper 16v) 33.95s **record**; Keith Murray (1.4t Audi 80 Quattro) 29.03s **record**; Mike Turpin (2.2s Vauxhall VX220) 30.75s; Robert Kenrick (2.0 Caterham-DuraTec) 29.17s; Jane Millward (1.7 Lotus Elan S3) 37.38s on handicap; Malcolm Thorne (3.5 Lotus-Buick) 33.09s on handicap; Phoebe Rolt (1.1 Elva Formula Junior) 36.19s; Mike Hawley (4.5 Chapman Mercury 1) 38.10s on handicap; Graham Wynn (1.3s Force-Suzuki LM001) 26.44s; Rob Stevens (1.44s Force-Suzuki SR4) 25.92s; Mark Riley (0.5 Kieft Creamer Special) 37.95s; Tom Cowley (1.0 Cooper-JAP Mk6) 38.30s; Paul Knapp (0.6 Jodi Mk2) 31.09s; Simon Fidoe (1.1 Empire-Suzuki 002) 26.33s; Andrew Henson (1.6 Van Diemen-Ford RF91) 32.98s; Goodyear 24.80s; Summers 24.09s **record**; S Moran 23.64s; Briony Serrell (3.0 Aston Martin DB2/4 MkII) 45.97s on handicap; Alan Goodwin (1.6 Aldon-Ford AL3) 32.27s; Simon Durling (3.5 Brabham-Buick BT18) 29.17s **record**; Rodney Eyles (2.7 Pilbeam-Hart MP53) 26.99s. **POINTS** 1 S Moran, 210; 2 Willis, 209; 3 Menzies, 161; 4 R Moran, 134; 5 Hall, 109; 6 Summers, 106; 7 Bradburn, 96; 8 Goodyear, 67; 9 Young, 51; 10 Richard Spedding, 38.

Late starter Tom New again scored well, and is only one point behind 10th-placed Richard Spedding, who failed to qualify.

● Eddie Walder



JONES

## Ferrari Classic

James Cartwright (328 GTB, above) dominated both races at Thruxton. He got a great start in race one and, on a greasy track, built up a huge six-second lead by the end of the first lap. In race two, Cartwright won comfortably from Nigel Jenkins, who passed David Tomlin on lap one. After his engine cut out, Tomlin (308 GTB) recovered from a brief visit to the pits to snatch third back from Nick Taylor (Mondial).

## Marque Challenge

Tony Jardine looked set for victory in the first encounter at Thruxton, but a mechanical problem put the Aston Martin out two laps from the end, handing victory to David Smithies (Austin Healey). In the second event, James Cartwright started from the back of the grid, but worked his way to the front and wrestled the lead from Dan Cox (Austin Healey Sebring) at Church on lap eight. Three laps later, however, he suffered a puncture, allowing Cox through to take the victory.

## British Superkarts

Gavin Bennett and Liam Morley were having a terrific dice for victory in the first race at Thruxton. They exchanged places several times until Bennett was forced to drop out with tyre problems while leading. Bennett led the second race from lights to flag. He was hounded by Morley until the final lap when a puncture put Morley out of the reckoning. Toby Wall and Paul Platt both took wins in the F250 National Class.

## Alfa Romeos

After poleman Anthony George (156 Turbo) pulled off the track on the warm-up lap with a brake problem, it was Darelle Wilson (GT Diesel) who took an early lead in race one at Thruxton. However, Adie Hawkins' rapid Alfa 33 (below) soon powered past Wilson to score a dominant win. Worried about his gearbox, Hawkins started from the back of the grid in race two, but scythed up the order, eventually hitting the front on lap eight.



JONES



Webster just held on for victory in slick-shod M3

STYLES

BRITCAR PRODUCTION SNETTERTON, AUGUST 17

# Relieved Webster's tyre gamble pays off

HAVING DOMINATED THE OPENING laps of the combined Britcar Production and Sports enduro, and then overcome a minute-long success penalty at his mandatory pitstop to reclaim the lead, Keith Webster (BMW M3) looked set for a comfortable win.

Then the rain came, bringing with it a dilemma: stay on slicks and hope to make it home unscathed, or play safe by changing to wets, but risk losing control of the race.

While most of the field pitted, the wily Webster stayed out, gambling that the time he'd save would put him far enough ahead to win before his

rivals chased him down. It proved risky, as his lead was halved inside five laps. He held his nerve, however, to secure what he reckoned was his best Britcar win. "I had some big sideways moments — every corner was a drama," he confessed later.

The fast-closing SEAT Supacopa of Graham Johnson had to settle for second overall, comfortably beating third-placed Harry Cockill's version in the battle for Class 2 honours.

Nevertheless, it was an impressive solo drive from Cockill, having recovered from early ECU gremlins. Fourth went to Ginetta regular Flick Haigh, making her Britcar debut

partnering Tom Howard in an M3. She took the wheel for the second half, but lost time at the pitstops when a suspected pitlane limiter problem caused the car to stall.

● Oliver Timson

**RESULTS (41 LAPS)** 1 Keith Webster (BMW M3 E32); 2 Graham Johnson/Mike Robinson (SEAT Supercopa) +40.359s; 3 Harry Cockill (SEAT Supercopa); 4 Flick Haigh/Tom Howard (BMW M3 E46); 5 Cris Hayes/Andy Thompson (SEAT Cordoba WTCC); 6 Henry Dawes/Martin Parsons (SEAT Supercopa). **CW** Johnson/Robinson; Hayes/Thompson; Ashley Oldfield/Matthew Prier (Nissan 370Z); Robert Taylor/Graham Cox (Mini JCW). **FL** Webster 2m01.149s (88.22mph).



Haryett leads Sigmas away as Classics await their turn

CATERHAM SIGMA & CLASSIC GRADUATES DONINGTON PARK, AUGUST 17-18 BARC

## Haryett doubles up as charging Black just falls short

NICK HARYETT PROFITED WHEN THE top two drivers in Caterham Sigma – Amanda Black and Steve Humphreys – were eliminated on the first lap of the opening race.

Bill Scott, who started fifth, traded places with Haryett several times in the first 10 laps, as they wriggled away from a chasing pack headed by Peter Mullineux, who was up from row four.

However, Elstead man Haryett emerged with a more comfortable lead by the end of lap 11. “I gave

Nick a little nudge up the back and that broke my pace,” admitted Scott.

While Haryett extended his impressive record of being in the top two in every race he’s finished this season, Scott completed a hat-trick of second places.

Philip Richmond, who set the fastest lap as he scrambled back from a first-lap excursion at Redgate, completed the podium.

Black was back on pole position for race two, but struggled to engage second gear and dropped to 10th

place. She had a great drive back up the order in her “best race of the year”, but failed (by just 0.02s) to unseat Haryett from what had been an ample lead.

The concurrent Classic races (which started with a 20s delay to the Sigmas) were the domain of Graham Smith, the only driver to go the full distance in race one.

● Ian Sowman

**RESULTS – SIGMA (BOTH 16 LAPS) 1 Nick Haryett;** 2 Bill Scott +1.884s; 3 Philip Richmond;

4 Matt Siviter; 5 Peter Mullineux; 6 Yolande Humphreys. **Fastest lap** Richmond 1m23.376s (85.45mph).

**RACE 2 1 Haryett;** 2 Amanda Black +0.020s; 3 Scott; 4 Siviter; 5 Andrew Connolly; 6 Steve Humphreys. **FL** Scott 1m22.745s (86.10mph).

**CLASSIC (16 LAPS) 1 Graham Smith;** 2 Stuart Thompson -1 lap; 3 Andrew Outterside; 4 James Russell; 5 Paul Hawker; 6 Graeme Smith. **FL** Graham Smith 1m28.252s (80.73mph).

**RACE 2 (15 LAPS) 1 Graham Smith;** 2 Outterside +3.857s; 3 Thompson; 4 Higgins; 5 Hawker; 6 Graeme Smith. **FL** Graham Smith 1m26.968s (81.92mph).

SAXMAX DONINGTON PARK, AUGUST 17-18 BARC

## Streather pressure ends Wenham’s winning ways

GEORGE STREATHER BECAME the first driver to defeat Guy Wenham this season after the championship leader ended the first race in the barriers.

Wenham led from pole position with fellow front-row starter Martin Poole hung out to dry at Redgate and dropping to fourth.

Wenham was hounded by the Nuneaton-based Streather until a broken steering arm pitched him off at the chicane on the

penultimate lap. “The pressure from George caused my mistake; I hit a raised kerb a few laps before [I went off],” said Wenham.

Streather won by almost 15s from Poole, who got the better of James Dorlin at McLeans on lap three.

From the back of the grid, Tom Parker reeled in Dorlin and passed him for what became third on lap nine of 11.

Wenham made a poor start to race two, giving Streather an early



Streather (34) and Wenham go side by side in race two

break. The pair spent half of the seventh lap side by side until Wenham prevailed at the chicane.

The battle for third was resolved in favour of Poole, who took two attempts to get ahead of Dorlin.

● Ian Sowman

**RESULTS (BOTH 11 LAPS) 1 George**

**Streather;** 2 Martin Poole +14.928s; 3 Tom Parker; 4 James Dorlin; 5 Daniel Howard; 6 Tom Stockton. **FL** Guy Wenham 1m29.347s (79.74mph). **RACE 2 1 Wenham;** 2 Streather +6.294s; 3 Poole; 4 Dorlin; 5 Howard; 6 Parker. **FL** Wenham 1m29.862s (79.28mph).

LEGENDS DONINGTON PARK, AUGUST 17-18 BARC

## Brace Jr and Mickel win three each in Legends contests



Brace Jr heads Legends pack

JOHN MICKEL AND DEAN BRACE shared six victories between them in Donington’s Legends encounters.

Brace romped to a first race win with Mickel second from row eight.

Brace was up to second within three laps of the start of race two, but it took four more to pass Ben Power at Coppice. Mickel, however, won it at the chicane.

Brace led Saturday’s finale, until a spin at the Old Hairpin. He led much of Sunday’s opener, too, but Mickel, points leader James Holman and

Steve Whitelegg reeled him in, and Mickel went ahead on lap nine of 10.

Mickel led race five, but went off on oil. Dean Brace beat father Nick as Mickel recovered to third.

Holman retired from Sunday’s final as the three form men battled. Power led, but Brace prevailed.

● Ian Sowman

**RESULTS (8 LAPS) 1 Dean Brace;** 2 John Mickel +4.334s; 3 James Holman; 4 Ben Power; 5 Nick Brace; 6 Steve Whitelegg. **FL** Parker 1m23.908s (84.91mph). **RACE 2 (8 LAPS) 1 Mickel;** 2 D

Brace +0.065s; 3 Power; 4 Holman; 5 Paul Simmons; 6 Whitelegg. **FL** N Brace 1m24.252s (84.56mph). **RACE 3 (10 LAPS) 1 Mickel;**

2 Power +2.357s; 3 Guy Fastres; 4 Kenneth Jensen; 5 David Ward; 6 Jack Parker. **FL** Mickel 1m23.990s (84.82mph). **RACE 4 (10 LAPS) 1 Mickel;** 2 Holman +0.141s; 3 D Brace; 4 Power; 5 Simmons; 6 Jean-Michel Poncelet. **FL** Power 1m23.504s (85.32mph). **RACE 5 (10 LAPS) 1 D**

**Brace;** 2 N Brace +0.570s; 3 Mickel; 4 Simmons; 5 Holman; 6 Fastres. **FL** Mickel 1m23.643s (85.17mph). **RACE 6 (12 LAPS) 1 D Brace;** 2 Power +0.006s; 3 Mickel; 4 Simmons; 5 Fastres; 6 Whitelegg. **FL** Mickel 1m23.607s (85.21mph).

CLASSIC FF1600 OULTON PARK, AUGUST 17 BARC

# Gardner tops Medeiros in FFord thriller

MIKE GARDNER CAME OUT AHEAD IN a wheel-to-wheel duel with Adriano Medeiros to take the victory spoils in a Classic FF1600 knockout event.

In the opening heat, Stuart Kestenbaum's Van Diemen RF79 ousted the RF80 of poleman Gardner, but the latter snatched the advantage back as they exited Druids for the second time and pulled out a good lead.

Andrew Smith's Van Diemen FA73 was the winner of a race-long scrap with Simon Jackson's Javelin for class honours.

It was plain sailing for Medeiros in heat two, with Steve Hare equally comfortable in second as Paul Walton battled the whole way with Alan Fincham for third.

Steve Pearce's Van Diemen won the Last Chance Repechage race, after demoting early leader Mike Wrigley's Elden.

Medeiros managed to get the better of Gardner on the opening lap of the final, building a useful



Gardner (2) and Medeiros were the class of the field

lead as his rival fought to hold back Hare's challenge for second.

Despite a trip across the grass at Knickerbrook, Gardner not only retained his second place, but eased clear and closed down Medeiros.

Gardner traded places with Medeiros and made it stick for good on the final lap, just holding on to win by 0.06s.

● Peter Scherer

### RESULTS

**HEAT 1 (10 LAPS)** 1 Mike Gardner (Van Diemen RF80); 2 Stuart Kestenbaum (Van Diemen RF79) +12.107s; 3 Andrew Smith (Van Diemen FA73); 4 Simon Jackson (Javelin JL5); 5 Jon Nash (Van Diemen RF); 6 Colin Williams (PRS RW01). **Class**

**winner** Smith. **FL** Gardner 1m34.652s (84.66mph). **HEAT 2 (10 LAPS)** 1 Adriano Medeiros (Van Diemen RF79); 2 Steve Hare (Van Diemen RF81) +15.180s; 3 Paul Walton (Crosle 25F); 4 Alan Fincham (Van Diemen RF80); 5 Mark Turner (Jamun T12B); 6 Roger Newman (Van Diemen RF80). **CW** Turner; Michael Saunders (Hawke DL11). **FL** Medeiros 1m35.207s (84.17mph). **REPECHAGE (6 LAPS)** 1 Steve Pearce (Van Diemen RF78); 2 Mike Wrigley (Elden Mk8) +1.955s; 3 Ian Wood (Royale RP33); 4 Benjamin Hopton (Van Diemen RF80); 5 Paul Hubbard (Crosle 25F); 6 Steve Cole (Royale RP26). **CW** Wood; Wrigley. **FL** Pearce 1m38.309s (81.51mph). **FINAL (13 LAPS)** 1 Gardner; 2 Medeiros +0.060s; 3 Hare; 4 Kestenbaum; 5 Pearce; 6 Jackson. **CW** Wrigley; Wood. **FL** Gardner 1m34.605s (84.70mph).

NORTH WEST SPORTS SALOONS OULTON PARK, AUGUST 17 BARC

# Nothing can stop Allaway's Lotus Esprit

IT TOOK JUST THREE LAPS FOR SIMON Allaway's Lotus Daytona Esprit V8 to make up for a tardy start, before racing on to an easy victory.

Robert Spencer's Stuart Taylor Locosaki had the edge at the lights, from Garry Watson's Westfield and Joe Spencer's Locosaki. Allaway was third exiting Old Hall, while Watson had the legs of Spencer as they rounded Cascades, only to swap places again at Island Hairpin.

Their duel allowed Allaway to close in. The Lotus took second along Lakeside on lap two, led as they passed the pits and never looked back. "I had a few close

moments getting by, but was in the groove until I lost third gear and had to work harder," said Allaway.

Rob Spencer finally shook off Watson for second, as his brakes began to fade, while Joe Spencer was also forced to back off in fourth when his engine began to overheat.

There was plenty of action all through the field. Nick Cresswell's Caterham engaged in a hard fight for fifth with Philip Duncan's Westfield, after Steve Owen had crashed out in his Westfield at Knickerbrook on the third lap ("it just snapped away from me").

Duncan managed to escape to

secure fifth after nosing ahead of Cresswell on lap five. However, it was Duncan's charge through the backmarkers that made it stick, leaving Cresswell to settle for sixth.

● Peter Scherer

**RESULT (11 LAPS)** 1 Simon Allaway (Lotus Daytona Esprit V8); 2 Robert Spencer (Stuart Taylor Locosaki) +6.007s; 3 Garry Watson (Westfield SeiW); 4 Joe Spencer (Stuart Taylor Locosaki); 5 Philip Duncan (Westfield SeiW); 6 Nick Cresswell (Caterham Seven). **CW** Watson; R Spencer; Dennis Crompton (BMW M3 E36); Pete Edwards (Ford Escort RS1800); Graham Saul (Ford Fiesta XR2). **FL** Allaway 1m28.005s (91.05mph).



Allaway had to work a bit harder after his Lotus lost third gear



## Caterham Mega Grads

Six-time Caterham Graduate champion Jamie Ellwood took a double victory in contrasting weather at Donington. In streaming wet conditions on Saturday, he rapidly stretched out a convincing lead, but on Sunday Adrian Russell emerged ahead at the end of lap one. Five cars were involved in the lead battle until mid-race, when Michael Rowland's off split the pack when Ellwood was ahead (above).

## Sigmax & Super Grads

After a poor start put Ian Anderson at the head of the order initially, Jeremy Webb bounced back to win the opening race comfortably at Donington. Race two was very different – Webb led on only two laps, the fourth and the last, with Neil Shinner ahead for the rest. Dylan Stanley did the Super Grad double.

## Pickup Trucks

Former champion Nick Grindrod took a dominant win at Donington, a big gap opening up when David O'Regan spun into the gravel at the start. In race two, Grindrod retired from the lead with a gearbox failure as Michael Smith won. Championship leader Anthony Hawkins salvaged fourth after an early off at McLeans to add to his 10th in the first race.

## RAFMSA

Having taken pole by well over eight seconds in his Westfield V8, Darren Berris' dominant win was no real surprise at Oulton Park. Ian Smythe's Ford Fiesta Cosworth was just as secure in second. Ed Fuller's Tiger Super 6 completed the podium.

## Classic FF2000

Paul Wighton's Van Diemen RF82 (below) was a double winner at Oulton Park. Tom Pope threatened early on in race one, but spun off on the first lap. Marc Mercer and Ian Pearson held station in second and third from that moment on. Pope and Pearson followed Wighton home in a restarted race two.



**CLUB100**

It's *just* racing!

[www.CLUB100.co.uk](http://www.CLUB100.co.uk)



**Mitchell's red HRG pounced to win the Bill Phillips Trophy**

READ

**WELSH SPEED WEEKEND PEMBREY, AUGUST 17-18 VSCC**

# Hurtling HRG heads the pack

**HRG DRIVER ANDREW MITCHELL** was involved in the two closest finishes of last Sunday's splendid VSCC Hawthorn Memorial Trophies meeting at Pembrey, winning one and losing out in the other.

Having snatched the lead boldly at Dibení bend, Mitchell had to battle back past Charles Gillett's exuberant Frazer Nash Super Sports to triumph in a thrilling Bill Phillips Trophy race.

"When he passed me at the hairpin I thought that was it," said Mitchell, who grabbed a reprieve when the leader hesitated during lappery.

Later, Mitchell sliced his way through from the fifth tranche of a short handicap field, but as the top four dashed from Honda Curve to the finish line the hulking Delage Special of Argentinian visitor Torcuato Iriarte was 0.35s beyond reach. The photo finish in which Steven Smith (in Gillett's 'Nash') was a tenth behind Mitchell, with Tim Kneller's Riley on his tail and Justin Maers's fire-breathing GN Parker bearing down on them, was a

birthday delight for Iriarte's father.

Eight seconds blanketed the top eight at the chequer, testament to handicapper Colin Ayre's expertise. Good old Barry Foster (MG Montlhery) hung on grimly to win the other multi-start race by a comparatively luxuriant 2.36s.

Maers and his sensational low-flying Curtiss aero-engined jalopy had a busy day, highlighted when they thundered clear of chain-ganger Gillett for Vintage Racing Cars victory. As in the annual Phillips staple, a Morgan 'trike' finished third, this time with Duncan Wood rather than Sue Darbyshire up. Robert Cobden's rampant Riley Falcon Special pipped Maers in a tight scratch finale.

Of the three central tributes to 1958 world champion Mike Hawthorn, the Brighton Trophy race was a gripper in which Riley stalwart Dr David Pryke probed for a way past Dougal Cawley's extrovertly-conducted GN/Ford 'Piglet' before outraking it into Hatched's Hairpin.



**Pryke scored Hawthorn Brighton success in Riley**

READ

"It was death or glory," said Pryke. Unbeknown to either, Cawley had attracted a 10s jumped start penalty, which gifted Tim Hopkinson second.

Hotfoot from a Nurburgring double, Philip Walker – on his first visit to the testing Welsh venue since his supercharged MG days – cantered to Hawthorn Memorial and International Trophy successes in Lotus 16 and 15 respectively. He was chased in the former by Spanish Trophy winner Mark Gillies –

preparing Mary Smith's ex-Humphrey Cook/George Abecassis ERA R2A for Goodwood – but lapped the thin '50s sports car field in a demo of Colin Chapman's sleek two-litre machine.

The Pre-'61 racing car event ended abruptly on the final lap when Nick Rossi's Lotus 12 was launched into a roll following a clash of tyres with Mac Hulbert's ERA R4D entering Dibení. Rescuers freed Rossi from the inverted Lotus and he was hospitalised (see News, p87). Hulbert was badly shaken.

In stark contrast to Sunday's sunshine, Saturday's Team Relay race – preceded by a Sprint won by Eddie Gibbs in his monoposto Frazer Nash – was run in teeming rain. Riley men David Pryke, Richard Iliffe and Tim Kneller defended their title on handicap, having covered two laps fewer than scratch winners Cawley, Gillett and Maers.

Spectacular double winner Michael Cond worked through a five-car lead pack in the Welsh Sports and Saloons opener, which provided a modern contrast to the Vintage cars.

● Marcus Pye

**BILL PHILLIPS TROPHY: STANDARD & MODIFIED (HRG 1½-litre):** 2 Charles Gillett (Frazer Nash Super Sports) +0.16s; 3 Sue Darbyshire (Morgan Super Aero); 4 John Guyatt (Talbot Lago T150C); 5 James Potter (Riley 9 Brooklands); 6 Paul Waine (FN TT Replica). **Fastest lap:** Gillett 1m15.55s (69.29mph).

**PRE-WAR HANDICAP (BOTH 6 LAPS) 1 Torcuato Iriarte (Delage DI 50 Spl):** 2 Andrew Mitchell (HRG 1½-litre) +0.35s; 3 Steven Smith (FN Super Sports); 4 Tim Kneller (Riley 12/4 Special); 5 Duncan Wood (Morgan Super Aero); 6 Justin Maers (GN Parker). **FL Maers** 1m13.23s (71.68mph). **RACE 2 1 Barry Foster (MG C-type Montlhery):** 2 Gegan Thruston (Austin 7 Spl) +2.36s; 3 Simon Kelleway (Riley Sprite 12/4); 4 Nicholas Bennett (Alvis Silver Eagle); 5 Garry Whyte (Riley 12/4 Spl); 6 Christian Henriksen (Delage DI 50 Spl). **FL Rodney Seber** (Wolseley Hornet Spl) 1m21.44s (64.36mph).

**VINTAGE RACE CARS (10 LAPS) 1 Maers:** 2 Gillett +12.86s; 3 Wood; 4 Dougal Cawley (GN/Ford 'Piglet'); 5 Chris Hudson (Bugatti T35B); 6 Tim Dutton (Bugatti T35B). **FL Maers** 1m14.06s (70.78mph).

**PRE-WAR SCRATCH (6 LAPS) 1 Robert Cobden (Riley Falcon Spl):** 2 Maers +1.33s; 3 Eddie Gibbs (Frazer Nash SS); 4 Terry Crabb (ERA R12C); 5 Tim Greenhill (Wolseley Hornet Spl); 6 Gillett. **FL Cobden** 1m12.29s (72.51mph). **HAWTHORN BRIGHTON TROPHY: SPECIAL PRE-WAR SPORTSCARS (8 LAPS) 1 David Pryke (Riley 12/4 TT Sprite Rep):** 2 Tim Hopkinson (Riley Spl) +8.58s; 3 Cawley; 4 Tim Kneller (Riley 12/4 Spl); 5 Richard Iliffe (Riley Kestrel 12/4 Spl); 6 Clive Morley (Bentley 3/4½ Spl). **FL Cawley** 1m16.94s (68.13s).

**HAWTHORN MEMORIAL & SPANISH TROPHIES: PRE-1961 RACING CARS (10 LAPS) 1 Philip Walker (Lotus 16):** 2 Mark Gillies (ERA R2A) +9.92s; 3 Cobden; 4 Maers; 5 Gibbs; 6 Crabb. **CW Gillies.** **FL Walker** 1m08.23s (76.82mph).

**HAWTHORN INTERNATIONAL TROPHY: 1950s SPORTSCARS (10 LAPS) 1 Walker:** 2 Bruce Riches (Elva Mk5) -1 lap; 3 Christopher Mann (Alfa Romeo 3000PR); 4 Geoff Toms (Balino MM); 5 John Rogers (Connaught L2); 6 Howard Maguire (Playford-MG). **FL Walker** 1m09.39s (75.54mph).

**PRE-WAR SCRATCH (6 LAPS) 1 Hopkinson;** 2 Durward

Lawson (Riley Spl) +7.59s; 3 Jo Blakeney-Edwards (Frazer Nash Shelsley); 4 Bo Williams (Bugatti T35B); 5 Andrew Kellock (FIAT-AC); 6 Charles Jones (MG L-type Magna). **FL Hopkinson** 1m18.14s (63.41mph).

**VSCC TEAM RELAY HANDICAP (90 MINS) 1 The Good, The Bad & The Riley: Pryke, Iliffe & Kneller;** 2 Wilson Keppel & Betty; David Downes, Fred Boothby (MG J2s) & Anne Boursot (MG PA); 3 Brooklands Boys: Ian Standing, Andrew Baker & James Potter (Riley Brooklands); 4 The High Seas: Oliver Richardson, Hamish McNinch & Barry Foster (MG C-type Montlhery); 5 Beefeaters: Cawley, Gillett & Maers; 6 Twenty One: Claire Funnell, Stuart Rose & John Everett (Austin 7s).

**WELSH SPORTS & SALOONS (BOTH 16 LAPS) 1 Michael Cond (Sylva Riot-Suzuki):** 2 Keith White (BMW Z4-Vauxhall) +13.16s; 3 Neil Watts (Westfield-Ford Zetec SEi); 4 Jason Davies (Ford Sierra Sapphire Cosworth); 5 Andy Williams (Cosworth); 6 Melissa Luffarelli (Mini-Suzuki). **CW White;** Watts; Paul Flinders (Toyota MR2). **FL Cond** 1m01.02s (85.90mph). **RACE 2 1 Cond;** 2 White +29.80s; 3 Davies; 4 Williams; 5 Luffarelli; 6 Ken James (Loco Hornet). **CW White;** Davies; Flinders. **FL Cond** 1m01.51s (85.22mph).



# HENRY SURTEES CHALLENGE

## CALLING ALL YOUNG AMBITIOUS DRIVERS

**In its third year the Henry Surtees Challenge maintains its aim to bring together the best of young motorsport talent to compete for a staggering range of prizes that will aid them in their race programme preparation for 2014**

The Challenge will take place at Buckmore Park, Kent, on Wednesday 23rd October 2013, using the superb Club 100 Birel karts.

The Challenge, created by former F1 World Champion, John Surtees OBE, seeks to attract young drivers from all classes of motorsport, who are in their 16th year and over.

The top six drivers will be awarded the prestigious 'H' trophy; and at least the top six finishers will have a choice of the best career enhancing prizes ever offered at a kart meeting! Prizes for fastest lap, the most unlucky driver and a heavyweight prize for 80kg or above will also be awarded.

A full range of prizes, including test drives in national and international Formula will shortly be announced. At this early stage, the Henry Surtees Foundation is pleased to announce the continued support and generous donation of prizes from:



hillspeed



Drivers wishing to take up the Challenge should contact Sharon Bowness:  
**[sharon@henrysurteesfoundation.com](mailto:sharon@henrysurteesfoundation.com)**

An entry for the meeting costs £500 and will showcase a broad spectrum of motorsport talent. Drivers from single-seater formulas, touring, sportscar classes, karting and motorcycling will share the track in the all comers event. Drivers must hold an MSA National B licence and be in their 16th year or above or be a member of Club 100 Premier & Clubman Spirit members or a Buckmore Park Elite driver. Some prizes will be reserved for MSA licence holders only.

# NATIONAL RESULTS ROUND-UP

GRAHAM HOLBON



Steven Powell's truck catches fire after blowing its turbo at Donington

**SILVERSTONE**  
MSVR, AUGUST 17-18



**MONOPOSTO (9 LAPS)** 1 Kevan McLurg (Dallara F397); 2 Daniel Hands (Van Diemen O1) +7.439s; 3 Russ Giles (Dallara F396); 4 Kevin Mason (Dallara F301); 5 Jason Timms (Speads RMO7); 6 Geoff Fern (JKS TFR 11).  
**Class winners** Hands; Timms; Paul Britten (Van Diemen RFOO); Ryan Hayes (Jamun T25); Adrian Heath (Vauxhall Junior). **Fastest lap** Adrian Wright (GEM AW3) 2m09.499s (101.75mph). **RACE 2 (5 LAPS)** 1 McLurg; 2 Timms +0.683s; 3 Hands; 4 Peter Venn (Anson SA4); 5 Lee Cunningham (Van Diemen); 6 David Gambling (Dallara F302). **CW** Timms; Hands; Britten; Heath; Matt Hayes (Jamun M97Z). **FL** Timms 2m12.531s (99.43mph).  
**RADICAL CLUBMANS CUP (BOTH 10 LAPS)** 1 Lewis Plato (SR3); 2 Oskar Kruger (PR6) +0.315s; 3 Jesper Westerholm (PR6); 4 Steve Burgess (SR3); 5 Craig Butterworth (SR3); 6 Tony Wells (SR3). **CW** Kruger. **FL** Plato 2m05.240s (105.22mph). **RACE 2 1 Plato**; 2 Kruger +4.226s; 3 Burgess; 4 Marcel Marateotto (SR3); 5 Peter Belshaw (SR3); 6 Tom Jordan (SR3). **CW** Kruger. **FL** Plato 2m05.040s (105.38mph).  
**RACING SALOONS & PRODUCTION BMW (BOTH 10 LAPS)** 1 Stephen Pearson (BMW M3 E36); 2 Peter Seldon (BMW M3 E36) +9.545s; 3 Karl Cattliff (BMW E36 M3); 4 Dan Roberts-Jefferson (VW Golf); 5 Rick Kerry (BMW M3); 6 Jody Halse (BMW M3).  
**CW** Roberts-Jefferson; Reece Jones (Honda Civic Type R); Lawrence Ball (Jaguar XJS); Matt Parkes (BMW E30 320i). **FL** Pearson 2m29.545s (88.11mph). **RACE 2 1 Pearson**; 2 Cattliff +8.629s; 3 Seldon; 4 Roberts-Jefferson; 5 Kerry; 6 Eliot Dunmore (BMW 323i). **CW** Roberts-Jefferson; Jones; Ian Clark (Ford Capri GLX); Parkes. **FL** Pearson 2m29.097s (88.38mph).

**THRUXTON**  
BARC, AUGUST 17-18



**FERRARI CLASSIC (BOTH 13 LAPS)** 1 James Cartwright (328 GTB); 2 David Tomlin (308 GTB) +30.669s; 3 Nigel Jenkins (328 GTB); 4 Nick Taylor (Mondial T); 5 Nick Cartwright (328 GTB); 6 Tim Walker (328 GTB). **CW** Tomlin; Walker; Carl Burgar (Mondial QV). **FL** Cartwright 1m35.674s (88.65mph). **RACE 2 1 J Cartwright**; 2 Jenkins +4.479s; 3 Tomlin; 4 Taylor; 5 Wayne Marrs (328 GTB); 6 N Cartwright. **CW** Tomlin; Peter Everingham (328 GTB); Burgar. **FL** Cartwright 1m32.097s (92.09mph).  
**MARQUE CHALLENGE (BOTH 13 LAPS)** 1 David Smithies (Austin Healey 3000); 2 John Goldsmith (Aston Martin DB6) +3.635s; 3 Chris Clarkson (Austin Healey 3000 Mk1); 4 David Grace (Austin Healey 3000 Mk1); 5 Nick Taylor (Ferrari Mondial T); 6 Eric Woolley (Austin Healey Sebring). **CW** Goldsmith; Taylor. **FL** Tony Jardine (Aston Martin DBS V8) 1m31.560s (92.63mph). **RACE 2 1 Dan Cox (Austin Healey Sebring)**; 2 Smithies +15.282s; 3 Goldsmith; 4 Clarkson; 5 Taylor; 6 Richard Atkinson-Willes (Ferrari 308 GT4). **CW** Goldsmith; Taylor. **FL** James Cartwright (Ferrari 328 GTB) 1m30.975s (93.23mph).  
**250 SUPERKARTS (13 LAPS)** 1 Liam Morley (Anderson-DEA); 2 Jason Dredge (Anderson-PVP) +9.900s; 3 Charles Craven (Anderson-DEA); 4 Louis Wall (Anderson-RW Honda); 5 Stephen Clark (Anderson-KTM450); 6 Paul Platt (PVP-Redspeed Honda). **CW** Wall; Clark. **FL** Gavin Bennett (Anderson-DEA) 1m13.269s (115.75mph). **RACE 2 (12 LAPS)** 1 Bennett; 2 Craven +9.235s; 3 Dredge; 4 Platt; 5 John Riley (Anderson-KTM450); 6 Clark. **CW** Platt; Riley. **FL** Morley 1m13.978s (114.65mph).  
**ALFA ROMEO (13 LAPS)** 1 Adie Hawkins (33); 2 Darelle Wilson (GT Diesel) +14.482s; 3 Fraser O'Brien (Fiat Punto HGT); 4 Roger Evans (147 GTA); 5 Matt Daly (145); 6 Robin

**Lewis Plato twice**  
came from behind to win Radical Club Cup



SNAPPY RACERS

Eyre-Maunsell (75). **CW** Wilson; Evans; Daly; Herbert Bergmayr (75 V6). **FL** Hawkins 1m36.722s (87.69mph). **RACE 2 (12 LAPS)** 1 Hawkins; 2 Anthony George (156 Turbo) +0.969s; 3 Wilson; 4 Evans; 5 Bergmayr; 6 Chris Snowdon (16v). **CW** George; Wilson; Evans; Snowdon; James Ford (2.0 Twin Spark). **FL** George 1m26.109s (98.49mph).

3 Stevens; 4 Anthony Hawkins; 5 Paul Poulter; 6 Wilkinson. **FL** O'Regan 1m17.833s (91.53mph).

**OULTON PARK**  
BARC, AUGUST 17



**RAFMSA CHALLENGE (10 LAPS)** 1 Darren Berris (Westfield V8); 2 Ian Smythe (Ford Fiesta Cosworth) +1m07.399s; 3 Ed Fuller (Tiger Super 6); 4 Ian Fletcher (Fletcher Hornet Mk2); 5 Darren Howe (VW Golf Gti); 6 Gareth Nutley (Peugeot 205 Gti). **FL** Berris 1m35.968s (83.50mph).  
**CLASSIC FF2000 (14 LAPS)** 1 Paul Wighton (Van Diemen RF82); 2 Marc Mercer (Van Diemen RF82) +0.804s; 3 Ian Pearson (Van Diemen RF83); 4 Chris Lord (Van Diemen RF82); 5 Tom Pope (Van Diemen RF82); 6 Tony Hancock (Van Diemen RF82). **CW** Hancock; Antonio Armelin (Reynard SF79). **FL** Wighton 1m29.459s (89.57mph).  
**RACE 2 (4 LAPS)** 1 Wighton; 2 Pope +0.798s; 3 Pearson; 4 Lord; 5 Mercer; 6 Hancock. **CW** Hancock; Armelin. **FL** Mercer 1m29.844s (89.19mph).  
**PRE-'90 FF1600 (11 LAPS)** 1 Jamie Jardine (Reynard FF); 2 Stuart Kestenbaum (Van Diemen RF79) +12.426s; 3 Mark Turner (Jamun T12B); 4 Steve Cole (Royale RP26); 5 Benjamin Hopton (Van Diemen RF80); 6 David Billington (Van Diemen RF80). **FL** Jardine 1m35.939s (83.52mph).  
**BARC HANDICAP PURSUIT (19 LAPS)** 1 Myles Baker (Ford Fiesta ST); 2 Darren Berris (Westfield V8) +15.825s; 3 Chris Camp (Lexus IS200); 4 Russell Paul (Ford Fiesta ST); 5 Ian Fletcher (Fletcher Hornet Mk2); 6 Garry Wardle (Mini Cooper). **FL** Berris 1m47.351s (74.64mph).

**DONINGTON PARK**  
BARC, AUGUST 17-18



**CATERHAM MEGA GRADUATES (12 LAPS)** 1 Jamie Ellwood; 2 David Hewitt +6.087s; 3 Luke Embling; 4 Michael Rowland; 5 Adrian Russell; 6 Brett Ray. **FL** Ellwood 1m36.702s (73.67mph). **RACE 2 (16 LAPS)** 1 Ellwood; 2 Russell +7.874s; 3 Hewitt; 4 Ray; 5 Embling; 6 Nick Frost. **FL** Rowland 1m20.709s (88.27mph).  
**CATERHAM SIGMAX GRADUATES (BOTH 16 LAPS)** 1 Jeremy Webb; 2 Neil Shinner +8.656s; 3 Mick Whitehead; 4 Martin Amison; 5 Paul Turley; 6 Richard Pursglove. **FL** Webb 1m19.610s (89.49mph). **RACE 2 1 Webb**; 2 Shinner +0.022s; 3 Ian Anderson; 4 Whitehead; 5 Pursglove; 6 Nick Pancisi. **FL** Anderson 1m19.040s (90.13mph).  
**CATERHAM SUPER GRADUATES (BOTH 16 LAPS)** 1 Dylan Stanley; 2 Justin Cox +4.865s; 3 Gareth Cordey; 4 Jonathan Miller; 5 Toby Briant; 6 Roger Ford. **FL** Stanley 1m21.863s (87.03mph). **RACE 2 1 Stanley**; 2 Cox +0.183s; 3 Charles Elliott; 4 Briant; 5 Andy Molsom; 6 Ford. **FL** Briant 1m21.910s (86.98mph).  
**PICKUP TRUCKS (BOTH 16 LAPS)** 1 Nic Grindrod; 2 Michael Smith +10.583s; 3 Pete Stevens; 4 Pete Wilkinson; 5 David O'Regan; 6 Neil Tressler. **FL** Grindrod 1m18.166s (91.14mph). **RACE 2 1 Smith**; 2 Neil Tressler +4.400s;

**Gavin Bennett (0)**  
battled Liam Morley  
in Thruxton Superkarts



JONES

Teddington Studios, Broom Road, Teddington, Middlesex TW11 9BE, UK.  
Tel: +44 (0) 20 8267 5804 Fax: +44 (0) 20 8267 5922  
E-mail: mail@autosport.com Website: www.autosport.com

**EDITOR-IN-CHIEF**  
Andrew van de Burgt  
andrew.vandeburgt@haymarket.com ext.5974

**EDITOR**  
Charles Bradley  
charles.bradley@haymarket.com ext.5889

**GROUP F1 EDITOR**  
Jonathan Noble ext.5810  
jonathan.noble@haymarket.com

**F1 EDITOR**  
Edd Straw ext.5887  
edd.straw@haymarket.com

**FEATURES EDITOR**  
Kevin Turner ext.5432  
kevin.turner@haymarket.com

**NEWS EDITOR**  
Glenn Freeman ext.5309  
glenn.freeman@haymarket.com

**REPORTS EDITOR**  
Jamie O'Leary ext.5811  
jamie.oleary@haymarket.com

**MANAGING EDITOR**  
Peter Hodges ext.5903  
peter.hodges@haymarket.com

**RALLIES EDITOR**  
David Evans  
david.evans@haymarket.com

**DEPUTY NEWS EDITOR**  
Sam Tremayne ext.5952  
sam.tremayne@haymarket.com

**ART EDITOR**  
Aubrey Smith ext.5914  
aubrey.smith@haymarket.com

**PRESENTER/SUB-EDITOR**  
Henry Hope-Frost ext.5835  
henry.hope-frost@haymarket.com

**CHIEF SUB-EDITOR**  
Marcus Simmons ext.5807  
marcus.simmons@haymarket.com

**NATIONAL EDITOR**  
Ben Anderson ext.5425  
ben.anderson@haymarket.com

**SENIOR DESIGNER**  
Michael Cavalli

**PICTURE EDITOR**  
Peter Mills ext.5918  
peter.mills@haymarket.com

**AUTOSPORT.COM TECHNICAL TEAM LEADER**  
Geoff Creighton  
geoff.creighton@haymarket.com

**AUTOSPORT.COM DEVELOPER**  
Tomasz Trznadel  
tomasz.trznadel@haymarket.com

**AUTOSPORT.COM USER INTERFACE DEVELOPER**  
Theo Pape  
theo.pape@haymarket.com

**OFFICE MANAGER**  
Joanne Grove  
joanne.grove@haymarket.com ext.5804

**PHOTOGRAPHS**  
LAT Photographic

**SPECIAL CONTRIBUTORS**

Mark Hughes	Dieter Rencken	Jim Bamber
Gary Watkins	Gary Anderson	Pablo Elizalde
Marcus Pye	Giorgio Piola	Matt Beer
Mark Glendenning	Alan Eldridge	

**CORRESPONDENTS**

<b>ARGENTINA</b> Tony Watson	<b>ITALY</b> Roberto Chinchero	Martin, David Phillips,
<b>AUSTRALIA</b> Phil Branagan	<b>JAPAN</b> Jiro Takahashi, Len Clarke	Diego Mejia, Robin Miller,
<b>AUSTRIA</b> Gerhard Kuntzsch	<b>NEW ZEALAND</b> Bernard Carpenter	Jeremy Shaw
<b>BELGIUM</b> Gordon McKay	<b>RUSSIA</b> Gregory Golyshov	<b>UK &amp; EIRE</b> David Addison,
<b>BRAZIL</b> Lito Cavalcanti	<b>SOUTH AFRICA</b> Richard Asher	Jonathan Crawford,
<b>FINLAND</b> Esa Illoinen	<b>SPAIN</b> Raimon Duran	Kerry Dunlop, Leanne
<b>GERMANY</b> Rene de Boer	<b>SWEDEN</b> Tege Tornvall	Fahy, Paul Healy, Paul
<b>GREECE</b> Dimitris Papadopoulos	<b>USA</b> Jonathan Ingram, Bruce	Jurd, Paul Lawrence,
		Stephen Lickorish, Marc
		Orme, Graham Road, Hal
		Ridge, Peter Scherer, Ian
		Sowman, Oliver Timson,
		Ian Titchmarsh, Matt
		Upton, Eddie Webster,
		Richard Young

**ADVERTISING**  
Tel: +44 (0) 20 8267 5820  
Fax: +44 (0) 20 8267 5850  
E-mail: autosport.ads@haymarket.com

**COMMERCIAL MANAGER**  
Rachel Brock,  
ext: 5820  
rachel.brock@haymarket.com

**DISPLAY ADVERTISING**  
Gary-Lee Hoebbeck,  
ext: 5576  
garylee.hoebbeck@haymarket.com

**LUKE RICKETTS**  
ext: 5961  
luke.ricketts@haymarket.com

**DON RUPAL**  
ext: 5244  
don.rupal@haymarket.com

**CLASSIFIED ADVERTISING**  
Peter Musumeci  
ext: 5992  
peter.musumeci@haymarket.com

**SUBSCRIPTIONS**  
UK 0844 8488817  
OVERSEAS +44 (0)1795 592 974  
EMAIL  
autosport@servicehelpline.com  
AUTOSPORT, ISSN number 0269946X,  
is published weekly by Haymarket Media Group, Teddington Studios, Broom Road, Teddington TW11 9BE, United Kingdom. The US annual subscription price is \$295. Airfreight and mailing in the USA by agent named Air Business Ltd, c/o Worldnet Shipping Inc., 156-15, 146th Avenue, 2nd Floor, Jamaica, NY

**MANAGEMENT**

**GROUP PUBLISHER**  
Alastair Lewis

**PUBLISHING MANAGER**  
Samantha Jemson

**SPECIAL EVENTS MANAGER**  
Laura Coppin

**DIGITAL SPECIAL PROJECT MANAGER**  
Simon Strang, ext: 5093  
simon.strang@haymarket.com

**DIGITAL PRODUCT MANAGER**  
Simon Grayson, ext: 5346  
simon.grayson@haymarket.com

**© 2013, HAYMARKET MEDIA GROUP LTD**  
Publishing, trade and further subscription details on www.autosport.com While due care is taken to ensure the contents of AUTOSPORT are accurate, the publishers and printers cannot accept liability for errors and omissions. Advertisements are accepted for publication in AUTOSPORT only upon Haymarket Media Group Ltd's Standard Terms of Acceptance of Advertising, copies of which are available from the Advertising Sales Department of AUTOSPORT.

**EDITORIAL DIRECTOR**  
Mark Payton

**CREATIVE DIRECTOR**  
Paul Harpin

**STRATEGY AND PLANNING DIRECTOR**  
Bob McDowell

**PUBLISHING DIRECTOR**  
Patrick Fuller

**MANAGING DIRECTOR**  
David Prasher

**CHIEF EXECUTIVE**  
Kevin Costello

Haymarket is certified by BSI to environmental standard ISO14001

# THIS WEEK

LETTERS • BEST PICS • LATEST GEAR • ON TRACK & SCREEN • ONLINE

## What you think of the motorsport news of the past week



Any excuse for another touring car airborne at Dingle Dell pic

## The flight of the touring cars

Many thanks for the touring car special (August 15), especially the front-page photo of John Cleland in flight at Brands Hatch.

Seeing that took me back to the many happy hours spent 'camped out' at Dingle Dell whenever a meeting was held on the GP circuit, looking forward to seeing drivers attacking the kerbs on a hot lap, resulting in exciting moments

such as that seen on your cover.

As well as touring cars, who else can remember or indeed forget F3000 cars through that corner? Awesome, but sadly not very safe bearing in mind the proximity of the barriers, which is why it was altered to what we have today.

But to me it will always be Dingle Dell. Thanks for the memories.

**Keith Quinnell, Mansfield**

**I first started watching F1 in 1986 and now, approaching some 30 years later, find myself at a stage wondering how to take my interest in the sport one level further.**

It is, however, a regret of mine that it took me until 2004 before attending my first race, and that was of course at Silverstone. The atmosphere of the place screams history and nostalgia, but it is also thanks to the work of the BRDC, management team, marshals, stewards, vendors and volunteers that makes it such a special place to visit.

Over the years, there have been many memories involving Silverstone and there's no doubt that its place in the calendar owes a lot to its status not only as the home of British motor racing, but also as the true home of F1. I sincerely hope that the new owners

can provide many more happy memories for years to come.

**Michael Brierley**  
Stalybridge, Cheshire

**I was a guest of one of the GT4**

teams competing in the British GT Championship at Brands Hatch, and opened AUTOSPORT to read the report of another great GT race.

But one thing was missing, which was any mention of how the GT4 class battle unfolded. The only mention of a GT4 car was when they impacted on the overall race, which doesn't seem fair on the drivers and teams who are giving their all in the class throughout the season.

For races such as Le Mans you find space to report on each of the classes, so surely you could find space to print a few paragraphs summarising the GT4 race for all those who are interested.

Otherwise, keep up the good work.

**Matt Dean**  
Maidstone, Kent

*It's a balance of space and merit. Le Mans is an eight-page report, British GT is two. When there are so many competitive GT3 entries, it makes sense to focus on those unless the smaller class throws up something particularly interesting or becomes more competitive, as it did at Silverstone, when European teams bolstered the grid, added variety and the class then warranted its own sidebar – Ed*

**Pamela Anderson heads FIA GT** team. Checks date, it's not April 1. Checks name of team co-owner, is this for real?

**Richard Hargrave**  
Hitchin, Hertfordshire

See p49 for clarification – Ed



# In pictures

Exciting images from around the globe, from Slovakia to Spain, via Germany

**'WICKY BOBBY' SETS HIS SIGHTS ON VICTORY**  
Robert Wickens' orange Stihl-backed car is only fifth in this picture, but he'd charge his way to the front to score his maiden on-the-road DTM success



XPB/LAT

## In the shops

Desirable new releases

### McLAREN 50TH T-SHIRTS

£34.95 – mclarenstore.com

With designs by artist Nicolas Hunziker, these retro McLaren T-shirts have been commissioned to celebrate the legendary team's half-century. Five are available: the papaya orange M7A (Bruce McLaren's first winner from Spa in 1968, pictured below) and four world title winners – the 1974 M23B, the 1985 MP4/2B, the MP4/4 of 1988 (pictured right) and the '98 MP4-13. All are 100 per cent cotton and come in sizes S-XXL.



### PORSCHE TARGA FLORIO BOOK

£99.50 – chatters.co.uk  
(ISBN: 978-0-615-80440-8)

This stunning coffee-table book charts the history of Porsche at the Targa Florio. A glance at the cover image of the Gulf 908 hurtling through a mountainous hamlet tells you what sort of book this is: 324 pages of incredible images from two decades (1953-'73) of Porsche's love affair with the great Sicilian road race, complemented by endless, well-researched tales of strife and success.

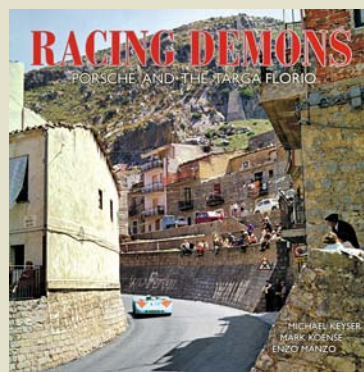

### MG METRO 6R4 1:18 MODEL

£79.99 – autosport.com/shop

Pay attention 6R4 fans: Sun Star has released one of its most detailed, large-scale diecast models to date. The 1:18 replica of the Rothmans (well, its ad-friendly 'Racing') machine used by Jimmy McRae to finish eighth in the 1986 RAC Rally is limited to 2,999 units worldwide and has opening doors and engine cover that show off superb detail.



### KIMI'S NEW DRIVE

As internet forums buzzed about his future, Kimi Raikkonen did what he does best – ignoring it all and driving a racing car. Here he is in a GP3 machine at Barcelona



STALEY/GP3

### A HARE-RAISING EXPERIENCE

A Slovakia Ring local goes for a hop through the gravel trap during the races, hopefully not on collision course with the FIA GT regulars



FABRE/SRO

### SHE'S JUST HOSING AROUND

The FIA Lotus Ladies Cup was in action at Slovakia Ring over the weekend. This is Fruzina Marenc having some pre-race fun in the paddock



# WHAT'S ON

## ON TRACK IN THE UK

### OULTON PARK

#### HSCC

August 24-26

[oultonpark.co.uk](http://oultonpark.co.uk)

The Oulton Park Gold Cup bills itself as the North's most prestigious race meeting, and there's sure to be a host of mouth-watering machinery in action for this weekend's edition, which will celebrate the 60th anniversary of the circuit. Qualifying takes place on Saturday, before a 20-race programme on Sunday-Monday, covering everything from 500cc F3 to late '90s Super Touring Cars. There will also be a special Porsche 911 50th anniversary display on Sunday morning, and a Spitfire air display on Monday lunchtime.

problems. The Fords and BMWs are improving, Knockhill's undulating turns should suit the nimble Hondas, and the tight final hairpin will be MG traction territory, so expect a close fight as usual on such a short track. Support comes from Porsche Carrera Cup, British Formula Ford, Ginetta GT Supercup and Juniors, and the Scottish Mini Cooper Cup, which replaces the absent Renault Clios.

### BRANDS HATCH

#### MSVR

August 24-25

[brandshatch.co.uk](http://brandshatch.co.uk)

The annual Lotus Festival returns this Bank Holiday weekend, and includes races for the Elise Trophy, Lotus Cup UK, Lotus Cup Europe, a Lotus Cortina 50th Anniversary race, Atom Cup, Champion of Brands FF 1600, Mk2 Golf GTi, VAG Trophy, Sports 2000 (with a full grid of 38 cars), and the Quaife/MN Saloons/Cannons Tin Tops. Classic Team Lotus will also demo some iconic F1 cars.

### DONINGTON PARK

#### CSCC

August 24-25

[donington-park.co.uk](http://donington-park.co.uk)

The CSCC is reporting a bumper entry for this two-day



BTCC shenanigans will continue in Scotland this weekend

EBREY/LAT

### KNOCKHILL

#### TOCA

August 24-25

[knockhill.com](http://knockhill.com)

Turbo-boost equalisation measures had an effect on the racing at last year's Knockhill BTCC round. There were murmurings of its impact at Snetterton last time out too, but we hope for the best this weekend. The Triple Eight MGs were the dominant force in Norfolk, but only came away with one win after reliability

meeting, which includes all its regular categories plus MGCC BCV8, Thoroughbred Sportscars and Triumph races.

### SILVERSTONE

#### 750MC

August 24-25

[silverstone.co.uk](http://silverstone.co.uk)

The 750 Motor Club's annual Summer Festival meeting, this year taking place on the latest International Circuit.

### SNETTERTON

#### BARC

August 24-26

[snetterton.co.uk](http://snetterton.co.uk)

Pickups and Legends support British Truck Racing.

### CASTLE COMBE

#### CCRC

August 26

[castlecombecircuit.co.uk](http://castlecombecircuit.co.uk)

Circuit championships, plus Ferraris, Porsche Club and Pre-'90 Formula Ford.

### MONDELLO PARK

#### CCC

August 25

[mondello.ie](http://mondello.ie)

FF 1600, Formula Vee, Formula Sheane, ITCC, Historics, Global Lights, Ginetta Junior, GTs.

### LYDDEN

#### British Rallycross

#### Championship

August 25-26

[lyddenhill.co.uk](http://lyddenhill.co.uk)

### GURSTON DOWN

#### British Hillclimb

#### Championship

August 24-25

[britishhillclimb.co.uk](http://britishhillclimb.co.uk)

### ULSTER RALLY

#### British Rally Championship

August 23-24

[rallybrc.co.uk](http://rallybrc.co.uk)

## ON TRACK AROUND THE WORLD



F1's back at majestic Spa after summer break

HONE/LAT

### BELGIAN GRAND PRIX

#### Formula 1 World

#### Championship

Rd 11/19

Spa, Belgium

August 25

[formula1.com](http://formula1.com)

### RALLY GERMANY

#### World Rally Championship

Rd 9/13

Trier, Germany

August 22-25

[wrc.com](http://wrc.com)

### INDYCAR SERIES

Rd 13/16

Sonoma, USA

August 25

[indycar.com](http://indycar.com)

### GP2 SERIES

Rd 8/11

Spa, Belgium

August 24-25

[gp2series.com](http://gp2series.com)

### GP3 SERIES

Rd 6/8

Spa, Belgium

August 24-25

[gp3series.com](http://gp3series.com)

### SCANDINAVIAN TOURING CAR CHAMPIONSHIP

Rd 6/8

Karlskoga, Sweden

August 24

[stcc.se](http://stcc.se)

### V8 SUPERCARS

Rd 9/14

Winton, Australia

August 24-25

[V8supercars.com.au](http://V8supercars.com.au)

### NASCAR SPRINT CUP

Rd 24/36

Bristol, USA

August 24

[nascar.com](http://nascar.com)

### PORSCHE SUPERCUP

Rd 6/8

Spa, Belgium

August 25

[porsche.com/motorsport](http://porsche.com/motorsport)

Your guide to the best events taking place in the UK and around the world – plus TV and online

**ON TELEVISION**

**THURSDAY AUGUST 22**

**0830-0930 ESPN**  
DTM: Nurburgring Review  
**1400-1445 Sky Sports F1 LIVE**  
F1: Drivers' Press Conference  
**2130-2300 Sky Sports F1**  
The Lost Generation

**FRIDAY AUGUST 23**

**0845-1100 Sky Sports F1 LIVE**  
F1 Belgian GP: Free Practice 1  
**0855-1035 BBC2 LIVE**  
F1 Belgian GP: Free Practice 1  
**1100-1135 Sky Sports F1 LIVE**  
GP2: Belgium Practice  
**1205-1245 Sky Sports F1**  
F1 Classic GPs: Belgium 1985  
**1245-1450 Sky Sports F1 LIVE**  
F1 Belgian GP: Free Practice 2  
**1250-1435 BBC2 LIVE**  
F1 Belgian GP: Free Practice 2  
**1450-1535 Sky Sports F1 LIVE**  
GP2: Belgium Qualifying  
**1615-1700 Sky Sports F1**  
F1 Belgian GP: Team Principals' Press Conference  
**1700-1800 Sky Sports F1**  
The F1 Show  
**1800-2000 Sky Sports F1**  
F1 Classic GPs: Belgium 2000

**SATURDAY AUGUST 24**

**0630-0655 Channel 4**  
The Grid  
**0725-0825 ITV4**  
Motorsport UK  
**0845-0920 Sky Sports F1 LIVE**  
GP2: Belgium Qualifying  
**0945-1110 Sky Sports F1 LIVE**  
F1 Belgian GP: Free Practice 3  
**0955-1105 BBC2 LIVE**  
F1 Belgian GP: Free Practice 3

**1000-1030 ITV4**  
DTM: Nurburgring Highlights  
**1200-1435 Sky Sports F1 LIVE**  
F1 Belgian GP: Qualifying  
**1210-1415 BBC2 LIVE**  
F1 Belgian GP: Qualifying  
**1435-1600 Sky Sports F1 LIVE**  
GP2: Belgium Feature Race  
**1615-1705 Sky Sports F1 LIVE**  
GP3: Belgium Race 1  
**1715-1945 Sky Sports F1**  
F1 Classic GPs: Belgium 2008  
**1930-2135 Motors TV**  
NASCAR Nationwide: Bristol

**SUNDAY AUGUST 25**

**0030-0430 Premier Sports LIVE**  
NASCAR Sprint Cup: Bristol  
**0700-0755 Channel 4**  
FIA GT: Slovakia Highlights  
**0820-0910 Sky Sports F1 LIVE**  
GP3: Belgium Race 2  
**0935-1040 Sky Sports F1 LIVE**  
GP2: Belgium Sprint Race  
**1100-1800 ITV4 LIVE**  
BTCC: Knockhill  
**1115-1215 ESPN**  
NASCAR Sprint Cup: Bristol  
**1130-1615 Sky Sports F1 LIVE**  
F1 Belgian Grand Prix  
**1210-1515 BBC1 LIVE**  
F1 Belgian Grand Prix  
**1615-1645 Sky Sports F1**  
GP Uncovered: Belgium 1958  
**1900-2000 BBC3**  
F1 Belgian GP Highlights  
**2100-0000 ESPN LIVE**  
IndyCar: Sonoma

**MONDAY AUGUST 26**

**0600-0830, 1345-1615 ESPN**  
IndyCar: Sonoma Highlights

**ONLINE**

**HOT ON THE WEB THIS WEEK**

YouTube **RALLY DRIVER/CO-DRIVER RELATIONSHIP GONE WRONG**



**SEARCH FOR:** The Funniest Rally Video Ever: "Samir, PLEASE!" (3:49)  
Indian National Rally championship duo Samir Thapar and Vivek Ponnusamy tackle a stage on the recent Coimbatore Rally in their Mitsubishi Evo X. Watch and weep as Ponnusamy proves beyond doubt his deeply untrusting co-driving credentials. Triple caution!

**AUTOSPORT+**

Exclusive content coming up in our premium website this week

**All the latest news & views from Belgium**

With Daniel Ricciardo seemingly on his way to his dream Red Bull drive, our team of newshounds will be out in force in the paddock at Spa-Francorchamps bringing you all the latest developments as the 2014 Formula 1 line-up begins to fall into place.

**GET AUTOSPORT ON THE MOVE**

- IN THE IPAD ISSUE THIS WEEK...
- WATCH THE FULL RACES FROM THE NURBURGRING DTM & EURO F3, PLUS FIA GTs, & NASCAR AND GRAND-AM HIGHLIGHTS
- ON SALE ALL OVER THE WORLD FOR ONLY £2.99



Download it now from [autosport.com](http://autosport.com) **AUTOSPORT**

**Revved up over what's on the box**

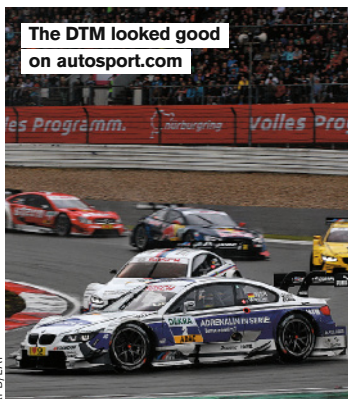

ACROSS THE COUNTRY, LURKING in the back of kitchen drawers and cupboards gathering dust and harbouring bacteria, there's a toasted-sandwich maker. Kept company by a pristine ice-cream maker and a SodaStream that'll never see the light of day again, these testaments to impulse-buy consumerism lay dormant despite (probably) being fully functional, in their own, one-dimensional way. A year ago I bought a smart TV, and while it's been used daily to view the usual bland fare offered up by broadcasters, the internet element of it felt as redundant as that sandwich maker once the initial zest

for ham-and-cheese toasties subsided. But last weekend, it finally came into its own. With Mrs Revved Up (rightly) vetoing a BT Sport subscription, and the MotoGP rights still six months or so away and its IndyCar plans sketchy at best, it was hard to argue splashing the cash for some DTM coverage (and a load more footie games). But with [autosport.com](http://autosport.com) showing the whole of the Nurburgring race, having the internet on my telly finally made sense. After spending about five minutes painstakingly entering the URL via the worst interface known to man, I was away. The picture wasn't HD, but if you're

used to watching classic '80s shows on ITV4, it was no worse than *Minder* or *The Professionals* look now. And it streamed without a glitch. From the chaotic opening lap to the victory celebrations, it was just like watching ESPN, only free. My views on the commentary team have been made before, so no need to repeat them, although the way the pitlane reporter appeared to have a different neck-tie for each interview was a unique touch. I imagine it'll be back to the cupboard for the dongle now, although I'll make sure it's close to hand for the next DTM race. **Revved Up**

# Laurent Aiello

“The guy from the ambulance came over and started shouting”

■ Monaco F3 GP ■ May 26 1990 ■ Dallara-VW 390 ■ Winning with tail-light from an ambulance



Despite dark visor, Aiello left Lohr trailing in his wake

**THIS WAS AN AMAZING** weekend, for so many reasons.

I was contesting the French Formula 3 Championship with Graff Racing and, because there was a round a week later at Pau, they didn't want to do Monaco because they wanted to keep my car safe. So when he learned this, my team owner from 1989, Daniel Gache, proposed that I raced one of his cars, a Dallara-VW. When I arrived in Monaco, he told me there was a problem with the sponsor, and it looked like I wasn't going to be able to race after all. But we found a solution while we were there, so we were good to go.

I qualified sixth, not bad for my first time in Monaco, but just before the race the weather turned. There was a big thunderstorm just as we were sat in the street at the back of the circuit. My first problem: I had a dark visor – a *really* black one! – and had no time to change my helmet.

To be honest, I felt frightened. To drive this kind of street circuit, with a lot of water on the track, it was so easy to go into the barrier. I was just

so scared before the race began!

We had not driven in the rain all weekend, so they gave us some practice laps. With five minutes to go until the warm-up lap, there was a marshal stood behind the car. He walks over and says: “The red light on your car isn't working. You cannot start the race.” What a disaster!

Fortunately one of my mechanics was very quick-thinking and had a fantastic idea, and he went to an

ambulance that was close by. He simply took a light from the ambulance and wired it to my car. They were waving the green flag just as he was finishing.

As soon as I drove through Ste Devote on the opening lap, I knew I had a good car in these conditions. Very quickly I got up to third place, passing Ellen Lohr on the first lap and some others hit trouble, but it was very difficult to see with my dark

visor. But my car was so quick: I passed Olivier Beretta at Loews on lap six, and passed Otto Rensing for the lead two laps later at the same place.

My car was flying; it was incredible. It was my first race in Monaco, in terrible conditions, so to win it by such a big margin [21.717s] was unbelievable. There were a lot of good drivers in that race – Olivier Panis, Alex Zanardi, Jorg Muller, Eric Helary – so it was a big moment for my career. If I could win there, in those conditions, I could win anywhere.

The shame for me was that, in previous years, whoever won the Monaco F3 race would be almost guaranteed to race Formula 1 in the future, so it was a pity that wasn't the case for me. But, as a Frenchman, it was a great feeling to win there. It was incredible.

Oh, and after the race the guy from the ambulance came over and started shouting at us. We told him: “Don't worry, we can buy you as many lights as you want now!”<sup>W</sup>  
*Laurent Aiello was talking to Charles Bradley*

## PROFILE



### SMALL IN STATURE, AIELLO

became a touring car giant. After his single-seater career stalled following two disastrous F3000 campaigns, he went on to win the French, German and British Touring Car titles. He also won the DTM with Audi, and the Le Mans 24 Hours – with Allan McNish and Stephane Ortelli – at his first attempt with Porsche. He retired from racing in 2005, and now lives in Bordeaux.

**NEXT WEEK** BELGIAN GRAND PRIX REPORT  
All the action from classic Spa track

# Challenge update

Radicals, GT and F3 Cup were in full action at Silverstone GP circuit 17-18th August with over 100 racers fighting to get a race seat at Daytona in 2014.

Starting off as a potential disastrous weekend for Sunoco Daytona Challenge leader Bradley Smith, with a car not working in a wet qualifying session, Bradley turned it around with a bang with 2 fastest laps and 2 race wins.

Lewis Plato is gaining momentum with a perfect weekend with 2 pole positions, 2 fastest laps and 2 race wins in the Radical Clubman's, extending his average points lead in the Sunoco GRAND-AM Challenge. However, hot on his heels are Alice Powell and Tristan Cliffe (rapidly increasing his average points) – the Camaro race seat at Daytona is still very much up in the air!



[www.sunocodaytonachallenge.com](http://www.sunocodaytonachallenge.com)



Bradley Smith

1	B Smith	Radical SR3 Challenge	116.50
2	J Abbott	Radical Euro SR3	79.92
3	K Calko	Radical Euro SR8	72.50
4	B Formanek	Radical Euro SR3	60.00
5	A Mortimer	Radical Euro SR8	59.17



[www.sunoco200challenge.com](http://www.sunoco200challenge.com)



Lewis Plato

1	L Plato	Radical Clubman's S	99.00
2	A Powell	F3CUP	89.92
3	T Cliffe	F3CUP	85.25
4	C Smiley	Mini Challenge	84.29
5	S Burgess	Radical Clubman's S	82.00



Who will triumph in the race to Daytona?  
Follow us on Twitter @Sunoco\_UK and on Facebook 'Sunoco UK' for updates on each race weekend.



## Next eligible races

Sunoco Daytona Challenge	Sunoco GRAND-AM Challenge
Radical Masters EuroSeries 7-8/9	Radical Clubman's 31/8
Radical SR3 & Speed EuroSeries 28-29/9	MINI, GT & F3 Cup 7-8/9



# Anglo American Oil Company

+44 (0)1929 551557 (tel) +44 (0)1929 551567 (fax) info@aaoil.co.uk www.aaoil.co.uk

# SUPERSTARS WORLD



### Visit the Kids Fun Zone:

- Simulator
- Bouncy Castles
- Trampolines
- Scalextric



### Also featuring...



### Advance tickets available now:

Saturday £10 • Sunday £20 • Weekend £25

Children 13 & under go free if accompanied by a paying adult

Advance ticket prices end on Wednesday 28th August at 5pm

### RACE DAY HOSPITALITY PACKAGE

From just £85 per person (includes admission ticket)

Telephone 0844 873 7343

[www.donington-park.co.uk](http://www.donington-park.co.uk)

Official Donington Park Racing



@DoningtonParkUK



**SAT 31 AUGUST / SUN 1 SEPTEMBER**