

# SINGER



*SLANT-O-MATIC*

503 Special

THE SINGER MANUFACTURING COMPANY

503\*



**SLANT-O-MATIC Special . . . designed for modern, functional and decorative sewing!**

\*A Trademark of THE SINGER MANUFACTURING COMPANY

Instructions for using  
***SLANT-O-MATIC***\*  
Special

## The *SLANT-O-MATIC* Special . . .

From the moment you see the new *SLANT-O-MATIC* Special, you'll know it's excitingly different. You'll marvel at its truly remarkable sewing . . . its almost unbelievable ease of operation . . . the amazing services it performs. You'll delight in the fine, sure beauty of its stitching . . . straight, zigzag and ornamental. And remember . . . it's made entirely in America.

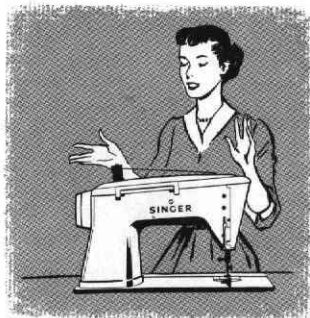

### DESIGNED WITH YOU IN MIND:

- Double easy threading. Face plate swings open to reveal threading chart. Handy "drop-in" bobbin located in *front* of the needle where it's easy to reach!
- Slant needle and gear drive . . . seeing is easier, sewing smoothest ever. Gear drive ensures trouble-free operation at all speeds without slipping or stalling.
- Built-in, eye-level stitch chart for easy reference *while you are sewing*. Information at a glance, that lets you select the fancy stitch you want!

To these major developments in sewing machine design, add the following **ADVANCED** features, and you have a machine far ahead in concept, unequalled in performance.

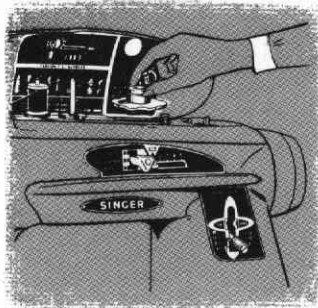

- **ELEVATOR TYPE** calibrated throat plates, lever operated. Easy to remove and replace.
- **HINGED FACE PLATE**, houses threading chart and swings open for easy access to oiling points.
- **SUPERFINE CONTROL** of stitch length ensures perfect satin stitch adjustment.
- **PERFECT** straight stitching.
- **BUILT-IN LIGHT** focused on sewing area.
- **NEEDLE CLAMP** holds one or two regular needles—same or different sizes for exciting two-needle stitching.
- **ALL MECHANISM COMPLETELY ENCLOSED** for maximum safety.
- **ALUMINUM CONSTRUCTION**, durable and light weight.
- **INTERCHANGEABLE FASHION\* DISCS**, one piece, easy to handle.
- **PEEPHOLE BOBBINS** show thread supply at a glance with bobbin in place.
- **AUTOMATIC THREAD CONTROL** ensures a smooth flow of thread from spool to needle for uniform stitch setting.
- **CONCEALED** automatic bobbin winder.
- **DIAL-OPERATED** pressure adjustment, calibrated to eliminate guesswork in duplicating settings.
- **STITCH LENGTH REGULATOR** with double pointers for easy, accurate stitch length adjustment.
- **HINGED NYLON SPOOL PINS**, self-positioning and self storing.
- **THREAD CUTTER** built into presser bar for added safety and convenience.

## SINGER SERVICE

Wherever you go you will find expert, dependable SINGER® Service close at hand. SINGER is interested in helping you keep your SINGER Sewing Machine in top running condition. That is why you should always call your SINGER SEWING CENTER if your machine ever requires adjustment or repair. Only from your SINGER SEWING CENTER can you obtain the services of a trained SINGER repair man and warranted SINGER® parts.



## EVERYTHING FOR THE WOMAN WHO SEWS

The answer to your sewing needs is at your SINGER SEWING CENTER. There you will find a wide choice of sewing aids, notions, sewing information and services. Look for the famous red "S" and SINGER trademarks on your SINGER SEWING CENTER and the ever ready SINGER Service Car. Look under SINGER SEWING MACHINE CO. in phone book, for address nearest you.

## PRINCIPAL PARTS OF SINGER\* MACHINE 503

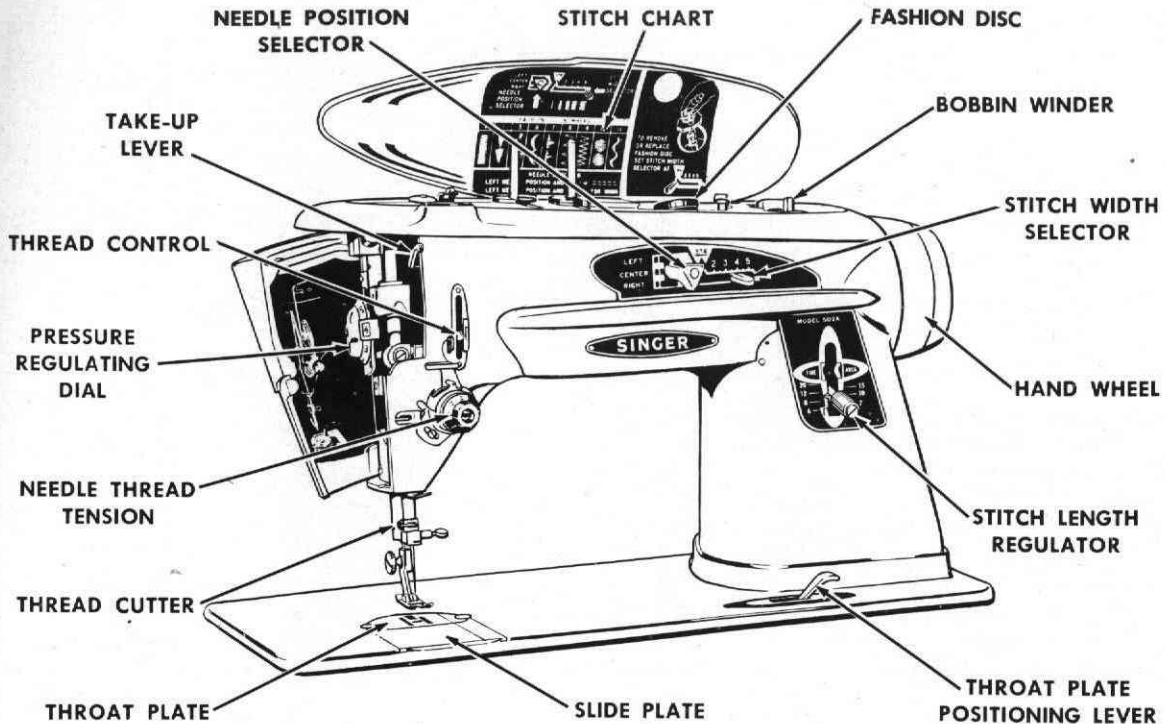

## FABRIC, THREAD, NEEDLE AND STITCH LENGTH CHART

FABRICS	THREAD SIZES	NEEDLE SIZES	MACHINE STITCHES PER INCH STRAIGHT STITCHING
<b>DELICATE</b> —tulle, chiffon, fine lace, silk organdy, fine tricot	Fine Mercerized 100 to 150 Cotton Synthetic Thread	9	15 to 20
<b>LIGHTWEIGHT</b> —batiste, organdy, jersey, voile, taffeta, silk crepe, plastic film	50 Mercerized 80 to 100 Cotton A Silk Synthetic Thread	11	12 to 15 (8 to 10 for plastic)
<b>MEDIUM WEIGHT</b> —gingham, percale, pique, linen, chintz, faille, satin, fine corduroy, suitings	50 Mercerized 60 to 80 Cotton A Silk Synthetic Thread	14	12 to 15
<b>MEDIUM HEAVY</b> —gabardine, tweed, sail-cloth, denim, coatings, drapery fabrics	Heavy Duty Merc. 40 to 60 Cotton	16	10 to 12
<b>HEAVY</b> —overcoatings, dungaree, upholstery fabrics, canvas	Heavy Duty Merc. 24 to 40 Cotton	18	8 to 10



## NEEDLES AND THREAD

This machine uses needles 15 x 1  
(Catalog 2020),  
Sizes 9, 11, 14, 16 and 18.

For perfect stitching, select correct needle and thread to correspond with fabric according to table on **page 6**. Be sure to use like threads for both needle and bobbin.

## NEEDLE INSERTION

Raise the needle bar to highest point by turning the hand wheel toward you. Loosen the needle clamp screw. Insert needle upward into clamp as far as it will go, with the flat side of the needle to the back and the **long groove toward you**. Tighten needle clamp screw.

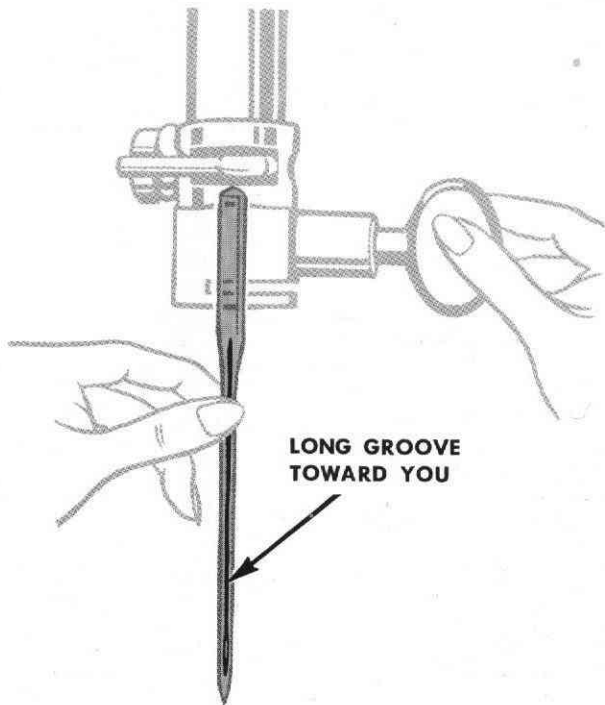

## UPPER THREADING—SINGLE NEEDLE

### Stitch Chart Open

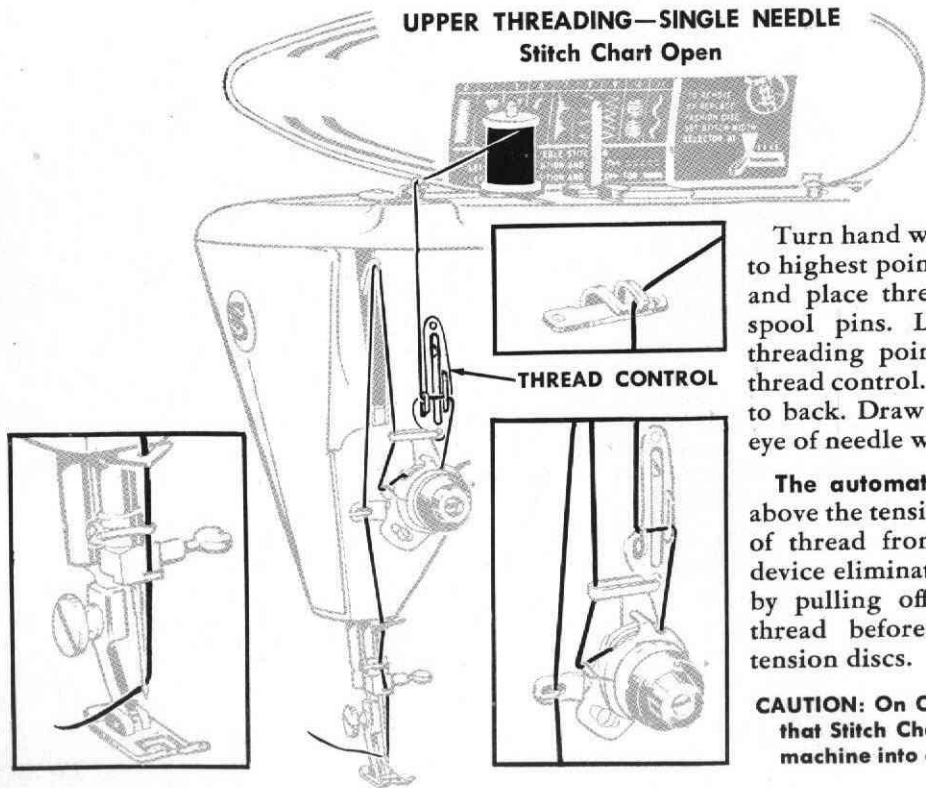

Turn hand wheel to raise take-up lever to highest point. Raise stitch chart cover and place thread on either of the two spool pins. Lead thread through all threading points shown, including the thread control. Thread needle from front to back. Draw sufficient thread through eye of needle with which to start sewing.

The **automatic thread control**, located above the tension, ensures a smooth flow of thread from spool to needle. This device eliminates spool weight and drag by pulling off a measured amount of thread before it passes through the tension discs.

**CAUTION:** On Console Models, make certain that **Stitch Chart** is closed before lowering machine into cabinet.

## UPPER THREADING—SINGLE NEEDLE Stitch Chart Closed

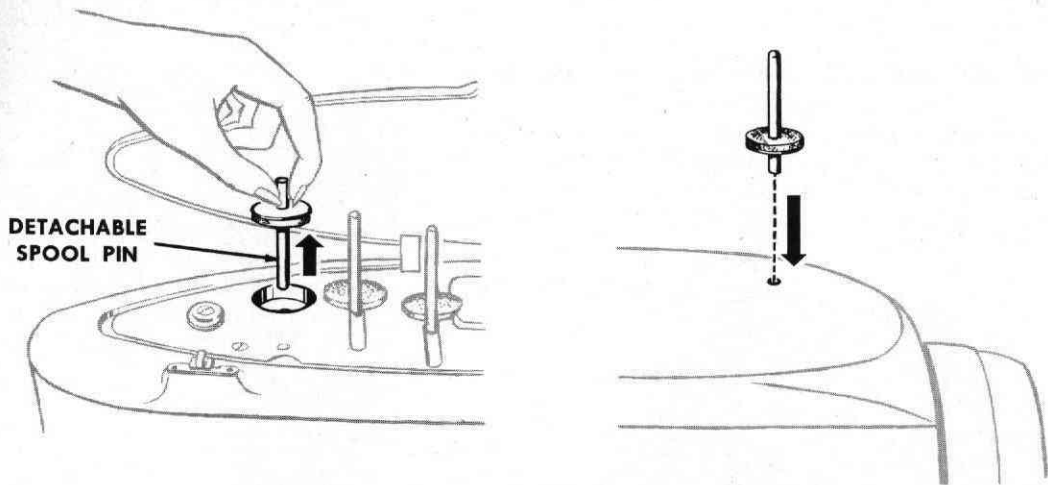

For added convenience, a detachable spool pin is provided so that single needle stitching may be done with the stitch chart closed. The spool pin is stored in a recess in the machine arm as shown above and is fitted into the hole provided in the top of the stitch chart cover when in use.

Turn hand wheel to raise take-up lever to highest point. Place thread on spool pin and lead through all threading points including the thread control, as illustrated on **page 8**.

## WINDING THE BOBBIN

- Loosen the stop motion wheel with the right hand.
- Place thread on the spool pin and lead between the tension discs, around thread post and through one of the four holes in top of bobbin.

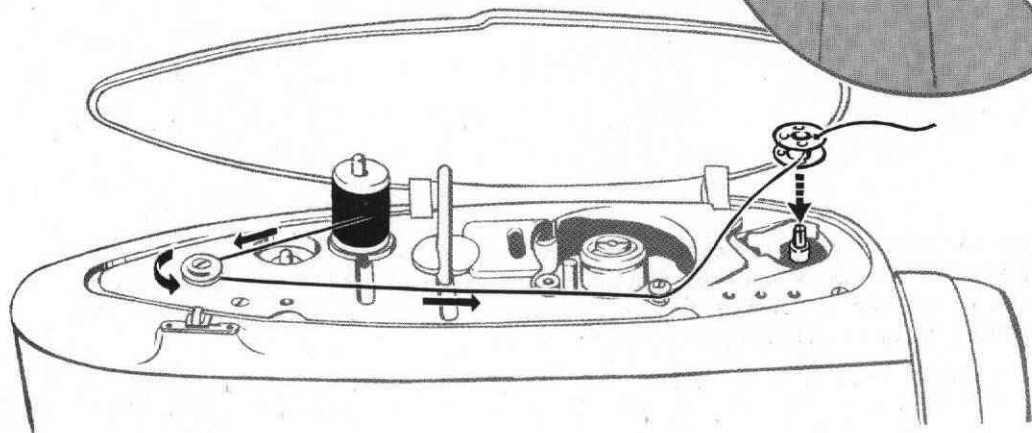
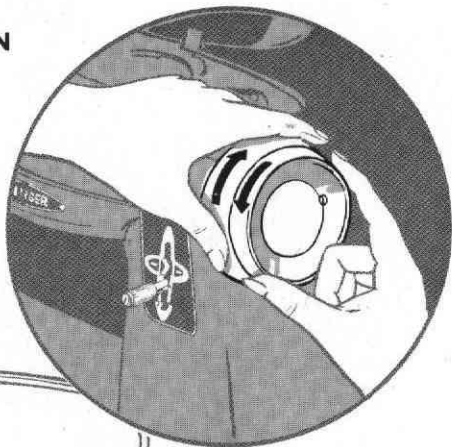

## WINDING THE BOBBIN (Cont'd)

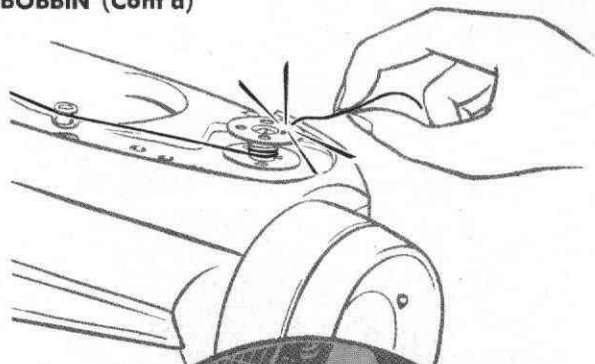
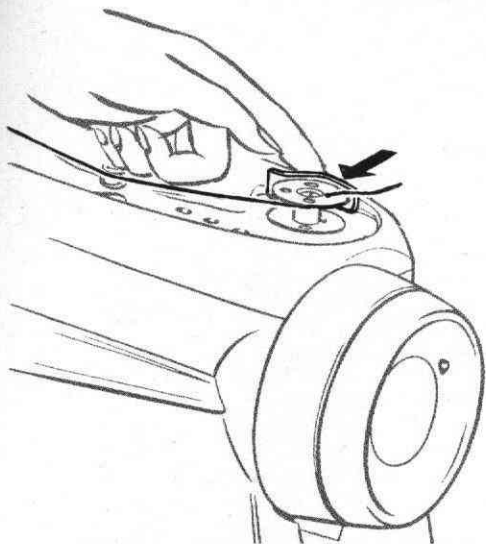

- Position bobbin on spindle and engage latch by pressing it against the bobbin.
- Hold thread end to start winding.
- Activate machine.
  - Full bobbin will automatically release.
  - Tighten stop motion wheel.

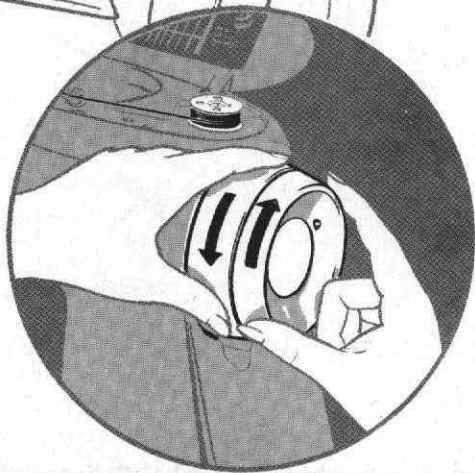

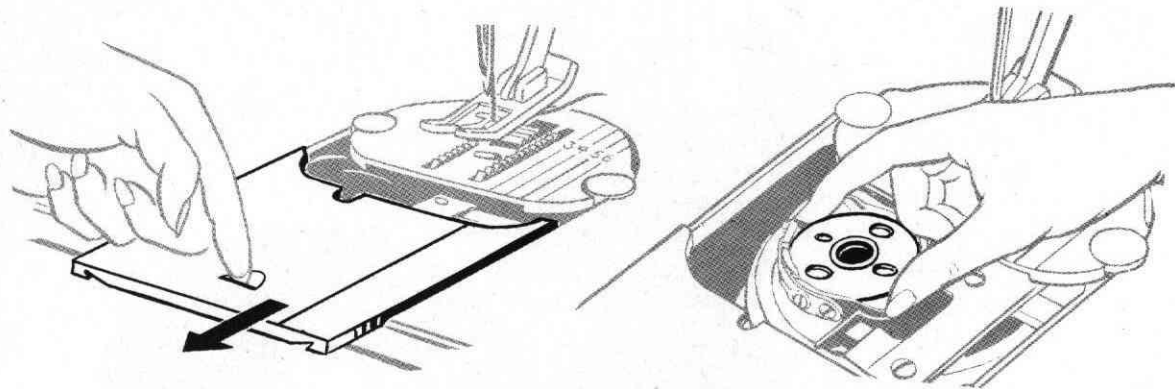
**REMOVING THE BOBBIN**

Open slide plate and lift out bobbin.

## THREADING THE BOBBIN CASE

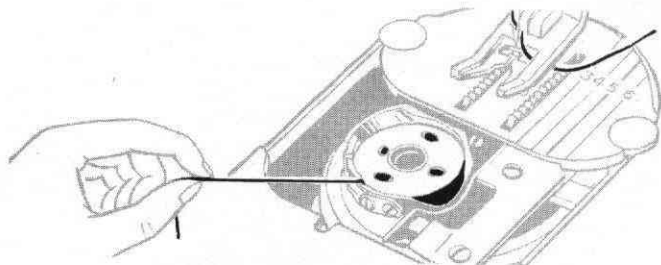
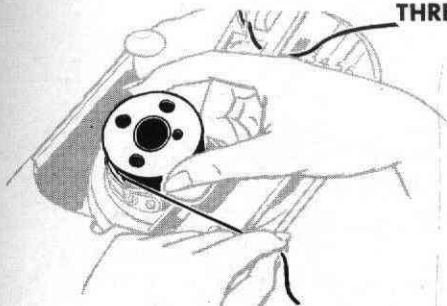

Hold bobbin so that thread leads off in direction shown. Place bobbin in case. Lead thread into slot and under spring.

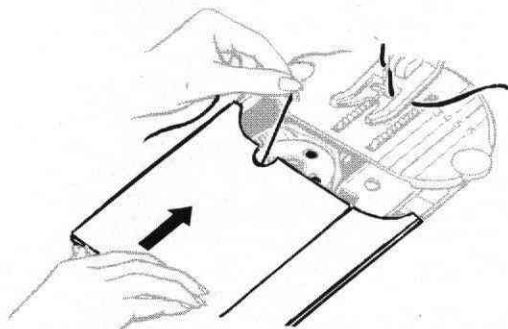
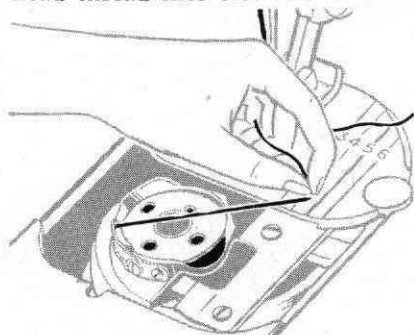

Draw thread into notch at end of spring, pulling off about 3 inches of thread across the bobbin.

Close slide plate allowing thread to enter notch.

## THROAT PLATE POSITIONS

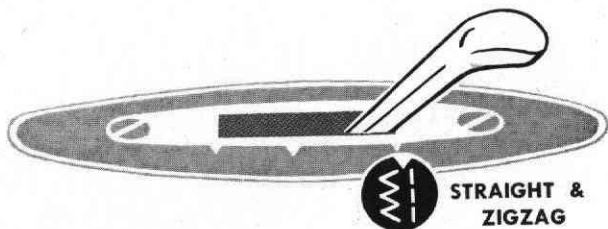
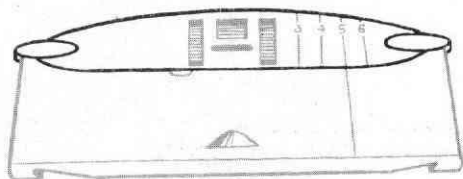

Throat plate in locked position for general sewing.

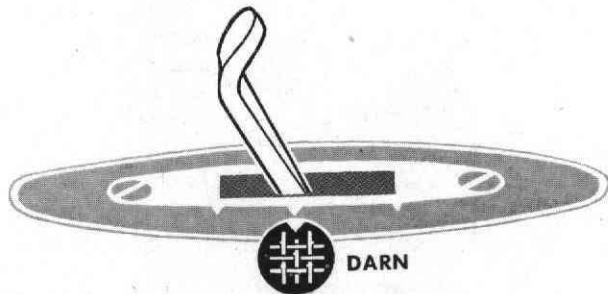
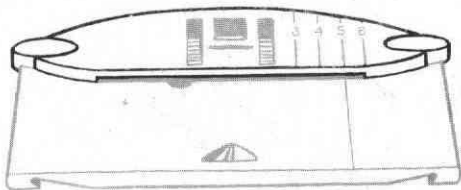

Throat plate in raised position for darning, embroidery and button sewing.



## THROAT PLATE

## REMOVAL AND REPLACEMENT

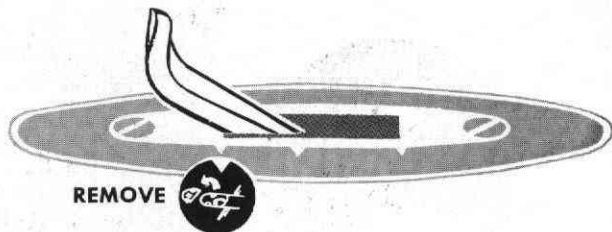
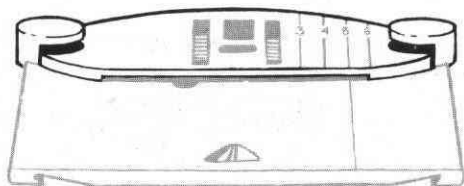

Throat plate in unlocked position for removal and replacement.

**TAKE-UP LEVER  
MUST BE IN  
LOWEST POSITION**

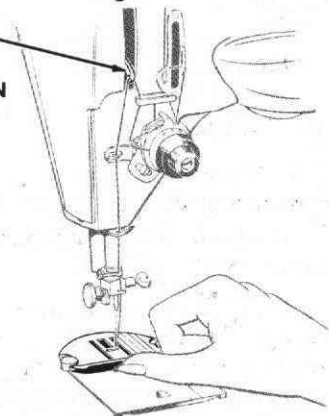

Raise presser bar. Turn hand wheel to drop take-up lever to its lowest point. Move throat plate lever to extreme left position. This preparation applies to both removal and replacement.

Remove throat plate by sliding it back.

Replace throat plate by sliding it on from rear.

Move throat plate lever to extreme right (locked) position.

Presser foot need not be removed for this operation.

## STITCH LENGTH REGULATOR

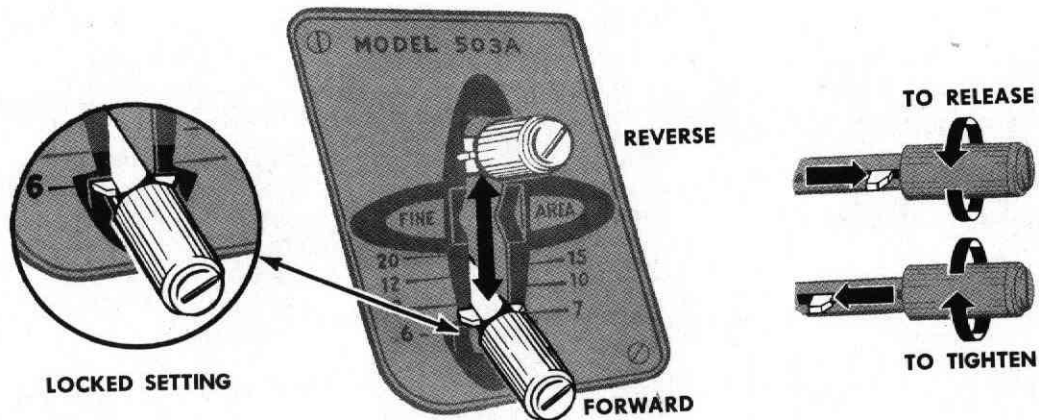

Numerals on the indicator represent the number of stitches per inch.

The upper indented area of the indicator represents "fine" stitch lengths above 20.

The lower indented area of the indicator allows the #6 stitch length setting to be "locked" in place when stitching folds, pleats or multiple layers of heavy fabric.

### To set stitch length

- Release pointer by turning thumb nut to left.
- Position lever for desired stitch length.
- Tighten pointer against plate by turning thumb nut to right.

Once the pointer has been positioned, reverse stitching is accomplished by raising the lever to its highest point. The #6 "locked" position must be unlocked for reverse stitching.

## PRESSURE ADJUSTMENTS

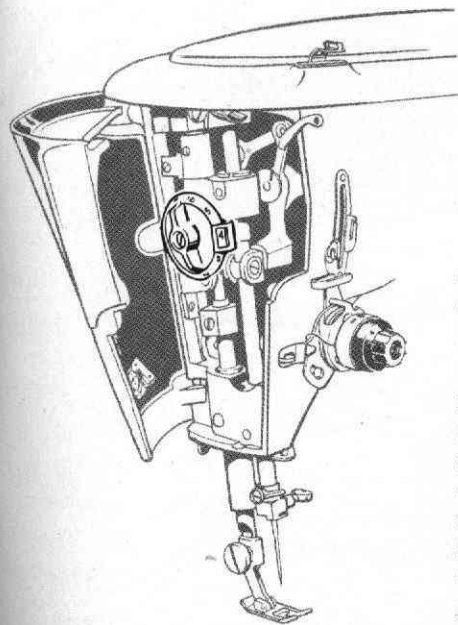

Increase



Decrease



Darning

To *increase* pressure, turn dial clockwise to higher number.  
To *decrease* pressure, turn dial counterclockwise to lower number.

Pressure can be easily regulated to enable fabric to feed smoothly, evenly, and without marring. Surface finish, weight and texture of fabric must be considered in determining the amount of pressure needed. The clearly numbered dial allows for a wide range of pressure adjustments for all types of fabrics—from the finest to the heaviest. Generally, heavy fabrics require heavy pressure; fine fabrics require light pressure. A pressure that is too heavy will mar smooth surfaces and pile fabrics; too light a pressure can result in poor feeding.

Pressure can be released by turning dial to “D”. This setting is recommended for darning without an embroidery hoop. For instructions see **page 62**.

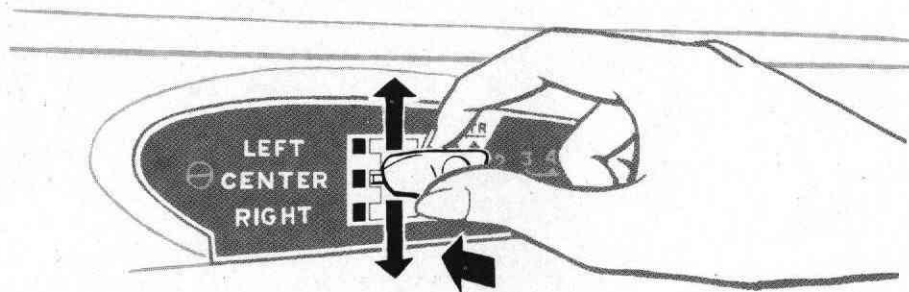
**NEEDLE POSITION SELECTOR**

- PUSH
- SELECT
- RELEASE

**LEFT, CENTER** and **RIGHT** needle position settings are available for the placement of both straight and zigzag stitching.

To position, push selector in and raise or lower to the desired setting.

Do not make any needle position adjustments while the needle is in the fabric.

## STITCH WIDTH SELECTOR

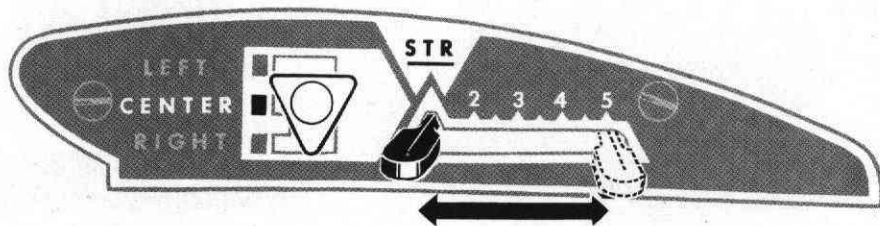

STRAIGHT STITCH SETTING: STR

ZIGZAG WIDTH SETTINGS: 2 TO 5

The Stitch Width Lever regulates the swing of the needle from its straight stitching position STR (zero width) to its maximum width position 5 (3/16 inch width).

To position, depress lever and slide it left or right to the setting desired. Numerals indicate four width settings, but intermediate settings may also be used.

Do not make any stitch width adjustments while the needle is in the fabric.

## NEEDLE THREAD TENSION STRAIGHT STITCHING

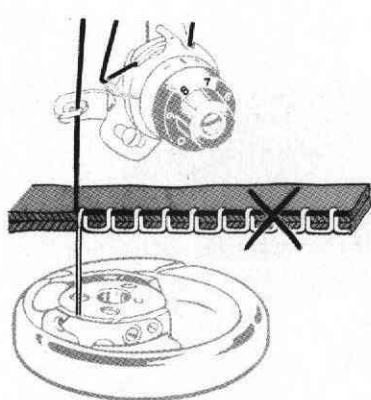

Needle thread tension too tight — correct by setting dial to lower number.

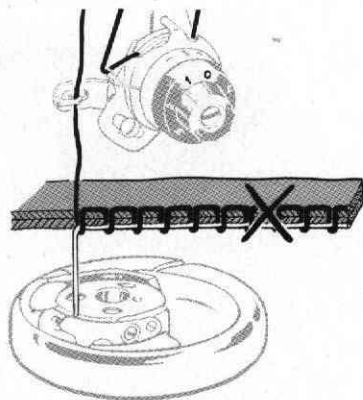
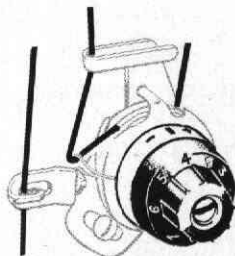

Needle thread tension too loose — correct by setting dial to higher number.

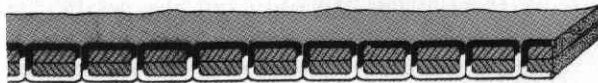

A perfectly locked stitch results with upper and lower tensions balanced so that needle and bobbin threads are drawn equally into fabric.

## BOBBIN THREAD TENSION STRAIGHT STITCHING

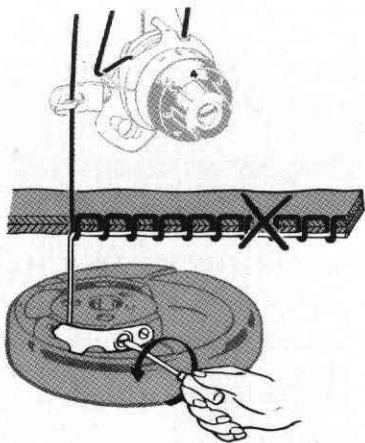

Bobbin thread tension too tight—correct by turning screw counterclockwise.

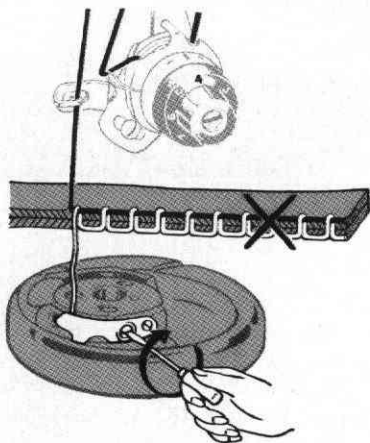

Bobbin thread tension too loose—correct by turning screw clockwise.



A perfectly locked stitch results with the upper and lower tensions balanced so that needle and bobbin threads are drawn equally into fabric.

## STRAIGHT STITCHING CENTER NEEDLE POSITION

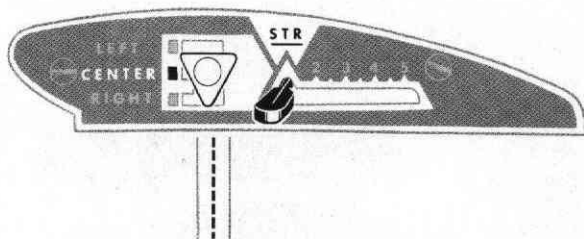

STITCH WIDTH LEVER: **STR**  
 NEEDLE POSITION: **CENTER**  
 GENERAL PURPOSE THROAT PLATE  
 AND PRESSER FOOT

OR

STRAIGHT STITCH THROAT PLATE  
 AND PRESSER FOOT

The general purpose throat plate and presser foot or the straight stitch throat plate and presser foot may be used when straight stitching in center needle position. The choice of fittings will depend on the fabric and sewing procedure. See **pages 24 and 28.**

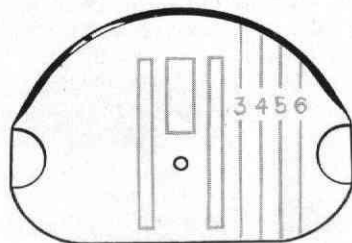
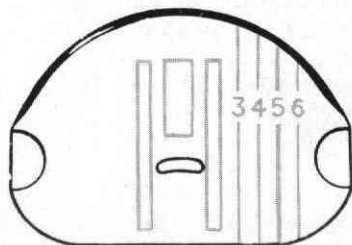



## STRAIGHT STITCHING LEFT AND RIGHT NEEDLE POSITION

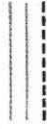
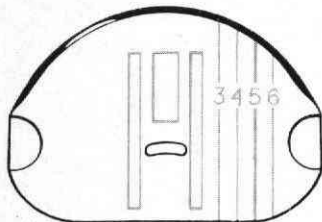
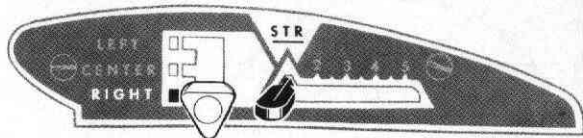
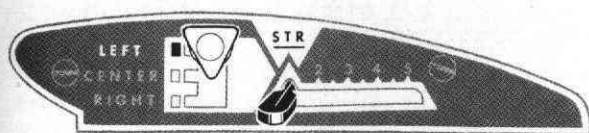

STITCH WIDTH LEVER: **STR**  
 NEEDLE POSITION: **LEFT OR RIGHT**  
 GENERAL PURPOSE THROAT PLATE AND PRESSER FOOT

To meet special requirements a line of stitching may be placed to the right or to the left of center. The general purpose throat plate and presser foot *must* be used with left and right needle positions.

Do not make any needle position adjustments while the needle is in the fabric.

## STRAIGHT STITCHING EQUIPMENT

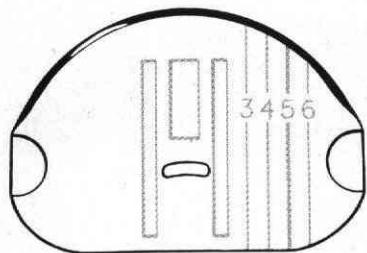

THE GENERAL PURPOSE THROAT PLATE AND PRESSER FOOT are used for all utility sewing and where there is occasion to alternate between straight and zigzag stitching in the sewing procedure.

The general purpose equipment *must* be used when placing a line of stitching to the left or right of center.

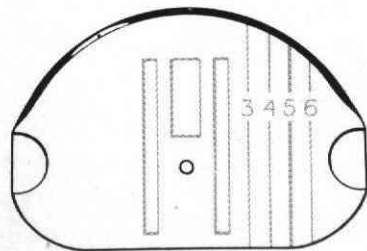

THE STRAIGHT STITCH THROAT PLATE AND PRESSER FOOT are used where fabric and sewing procedure require close control . . . for the precision stitching of curved and scalloped edges, top stitching, edge stitching, etc. This equipment should be used when stitching delicate or spungy fabrics, synthetics and knits.

## PREPARE TO SEW

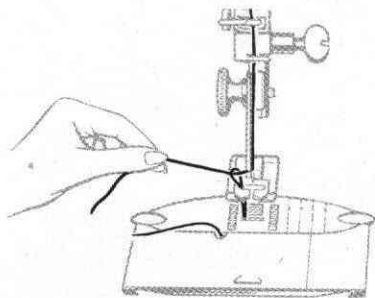
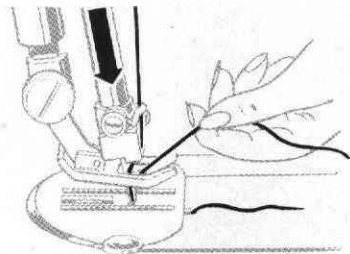

Hold needle thread lightly with left hand. Turn hand wheel so that needle enters plate and brings up bobbin thread.

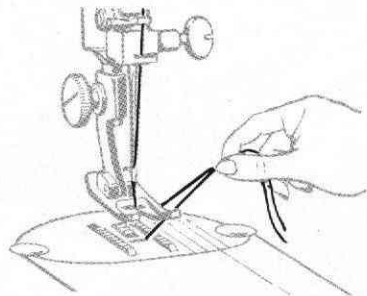
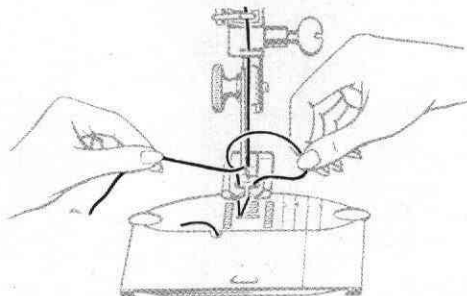

Pull end of bobbin thread through plate and place both needle and bobbin threads diagonally under presser foot.

## SEWING A SEAM

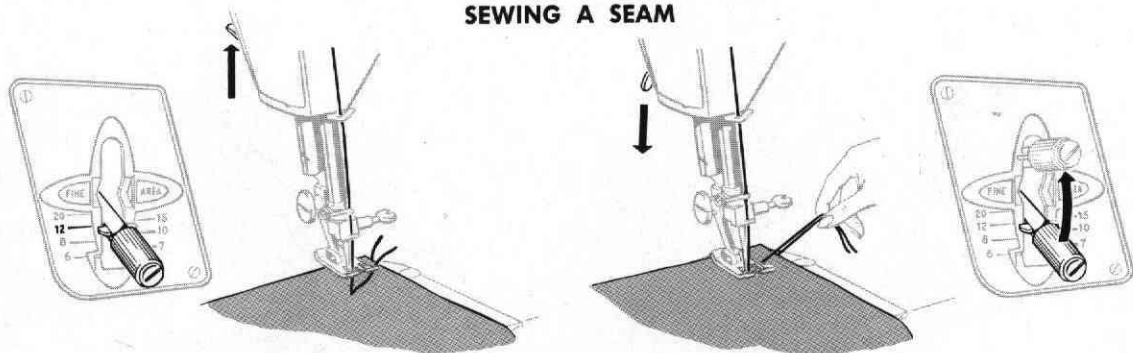

Set stitch regulator for stitch length desired. Position needle into fabric about  $\frac{1}{2}$  inch from edge and lower presser foot. Raise stitch regulator to reverse.

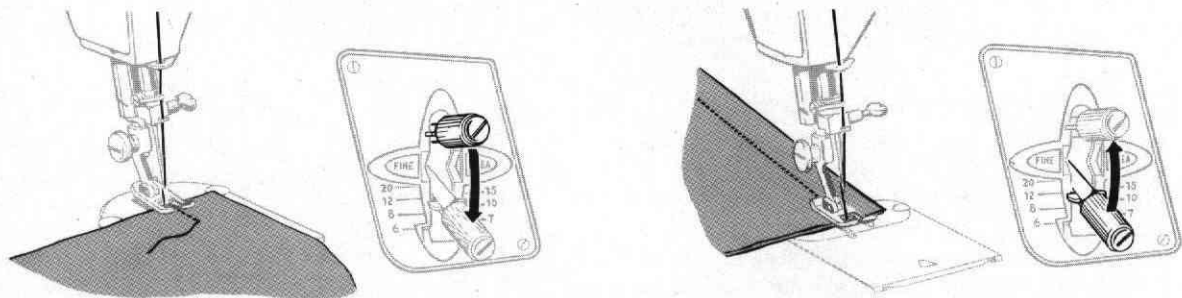

Back stitch to edge of fabric for reinforcement. Lower regulator for forward stitching of seam. Raise stitch regulator.

## SEWING A SEAM (Cont'd)

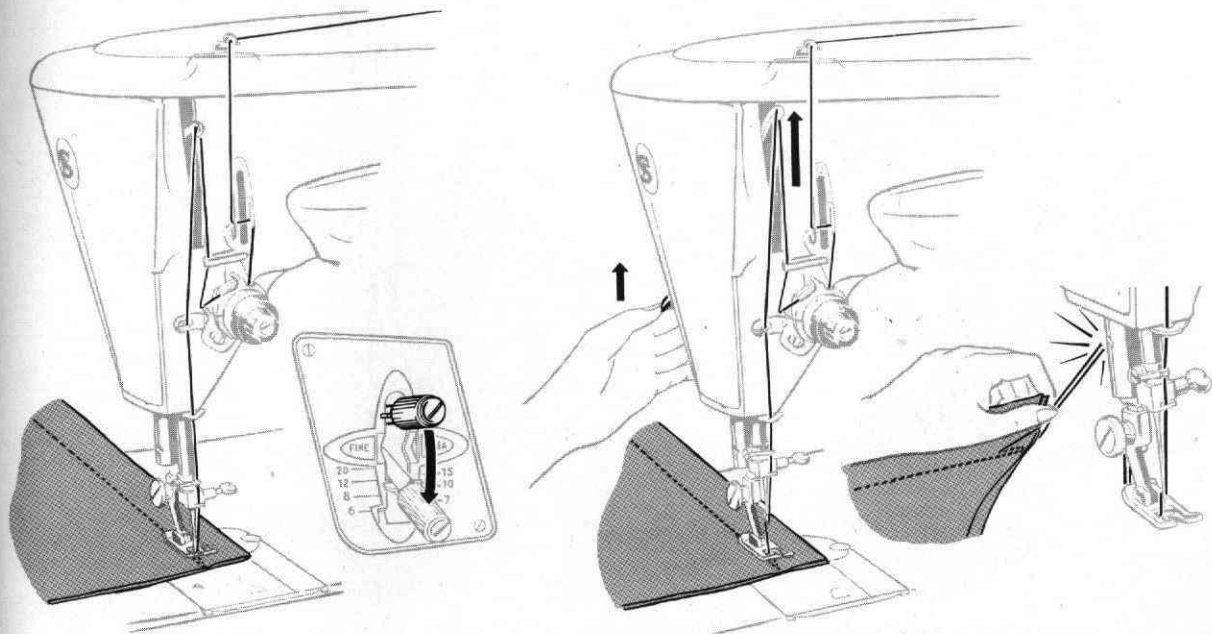

Back stitch to reinforce end of seam, and lower regulator to forward stitching position.

With take-up lever at highest point, raise presser foot and remove fabric.

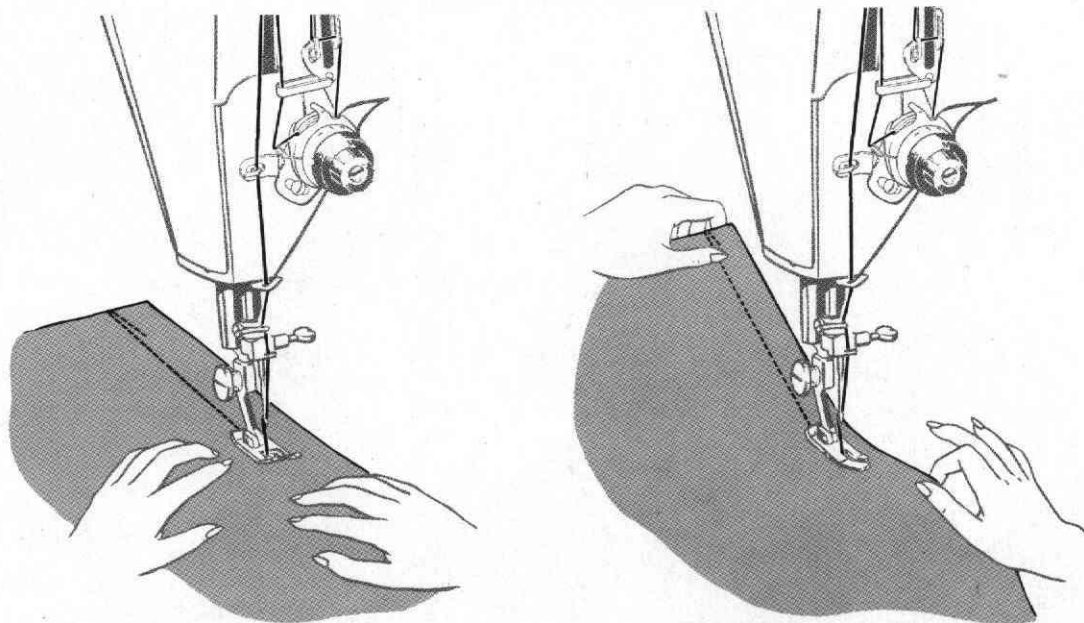
**GUIDING AND SUPPORTING FABRIC**

Most fabrics need to be guided only in front of the presser foot as shown at left. Many filmy sheers, crepes, knits, tricot, etc., require support while being stitched. For such fabrics use the straight stitch throat plate and presser foot and apply gentle tension by holding seam in front and back of the presser foot as shown at right.

## ZIGZAG STITCHING EQUIPMENT

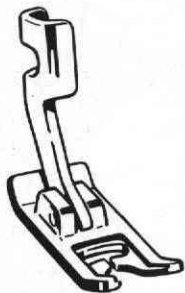
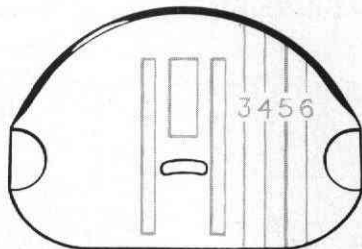
GENERAL PURPOSE  
PRESSER FOOT

GENERAL PURPOSE THROAT PLATE

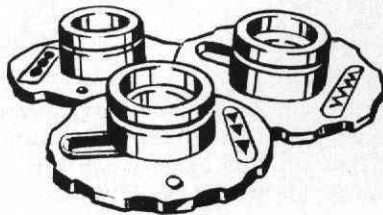

FASHION DISCS

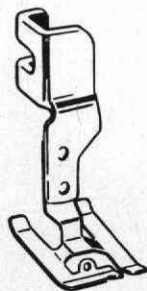
SPECIAL PURPOSE  
PRESSER FOOT

## STITCH LENGTH ADJUSTMENT FOR SATIN STITCHING

The FINE AREA of the stitch regulator with its inclined surface provides a means of gradually shortening the stitch length.

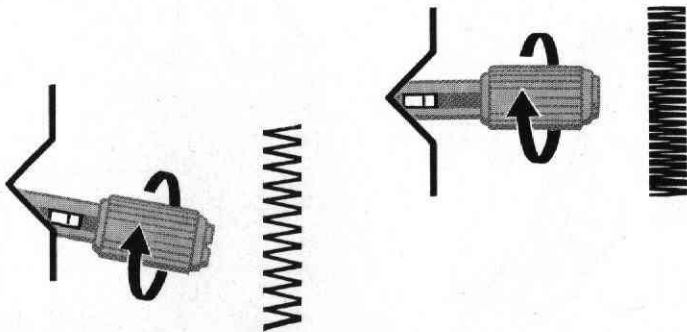
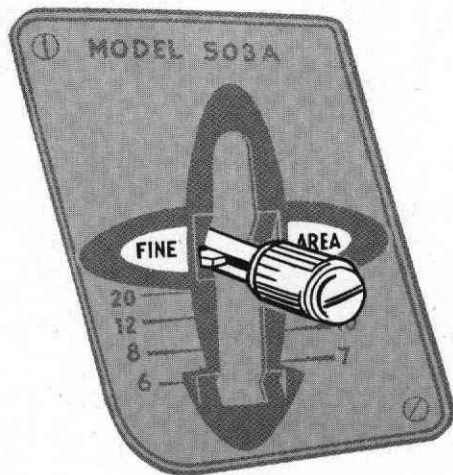

As the thumb nut is turned, the pointer rides up the incline until a closed satin stitch is obtained.

The exact stitch setting will vary with the texture of the fabric. It is advisable to make a test on a scrap of self fabric, using the Special Purpose Foot, before proceeding with the actual work.



## TENSION ADJUSTMENT FOR SATIN STITCHING

Satin stitching requires a lighter needle thread tension than straight stitching or open designs. The wider the satin stitching the lighter the tension required.

Wide satin stitching, (Stitch Width 5), requires the least amount of tension. For narrower satin stitching, slightly more tension should be used.

To determine correct tension setting, a test sample should be made on self fabric using the Special Purpose Foot. A properly balanced satin stitch should lie flat across the material. Any tautness or puckering usually indicates too high a needle thread tension.

Some soft fabrics may require the addition of a backing to insure good stitching results. Crisp organdy and lawn are suitable for this purpose.

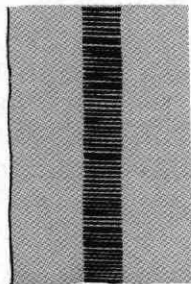
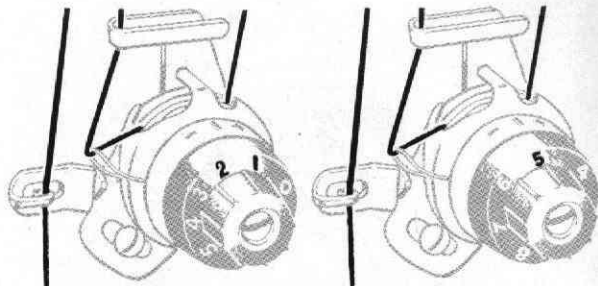

Correct

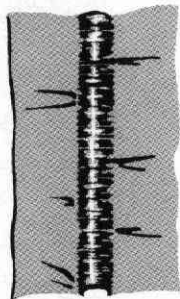

Incorrect

## ZIGZAG STITCHING

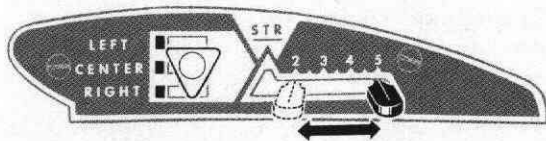
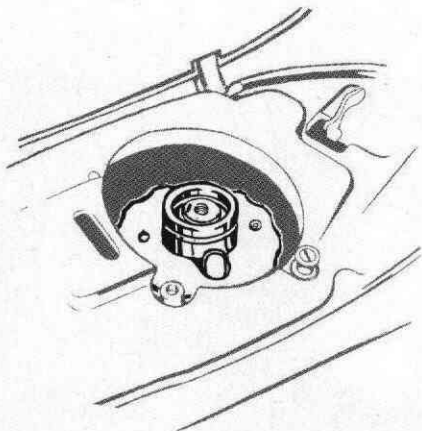

FASHION DISCS CONTROL STITCH PATTERNS.

NEEDLE POSITION LOCATES STITCHING AT LEFT, CENTER OR RIGHT.

STITCH WIDTH LEVER CONTROLS WIDTH OF STITCH PATTERN.

STITCH LENGTH REGULATOR CONTROLS LENGTH OF STITCH.

Nine removable FASHION Discs are furnished with the machine. The Zigzag Disc ① is supplied on the disc spindle in the machine. Eight additional discs are in the attachment set. Each disc produces an individual design, and is interchangeable with the Zigzag Disc.

## FASHION DISCS

The following interchangeable FASHION Discs are furnished with the machine.  
See page 34 for removal and replacement.

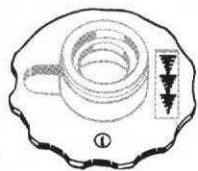

①



ARROWHEAD

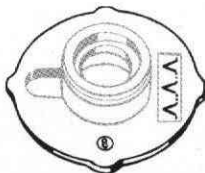

②

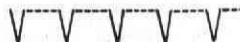

BLIND STITCH

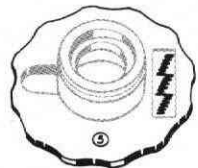

③

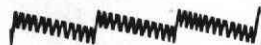

BANNER

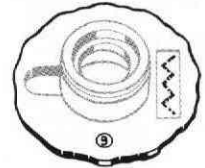

④



MULTI-STITCH

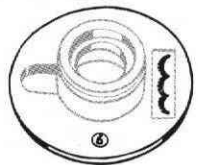

⑤



CRESCENT

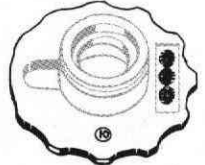

⑥

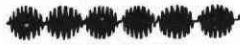

BALL STITCH

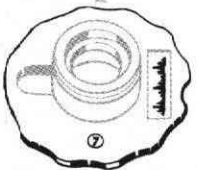

⑦



ICICLE

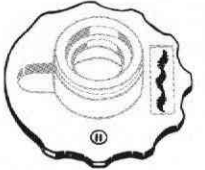

⑧



RIBBON STITCH

## REMOVAL AND REPLACEMENT OF FASHION DISCS

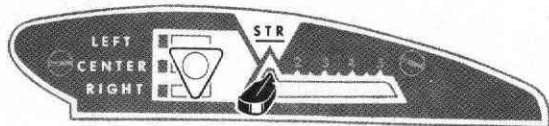

STITCH WIDTH LEVER: STR

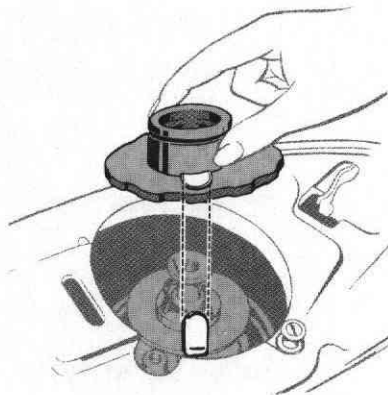

To replace FASHION Discs, set Stitch Width Lever at STR. Raise stitch chart at top of machine. Remove disc by pulling it upward. Place another disc on the spindle and push it downward until the disc snaps into place. Set Needle Position Selector and Stitch Width Lever at desired setting.

## CONTROL OF WIDTH ZIGZAG STITCHING

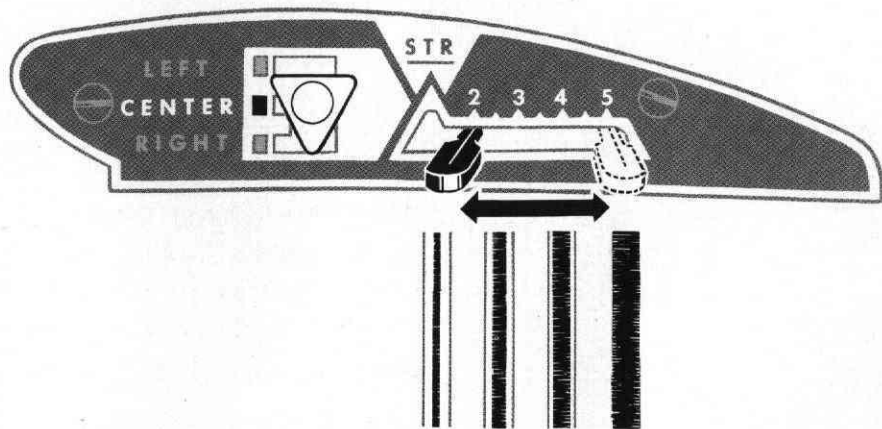

The width of the zigzag stitch is controlled by the Stitch Width Lever. As the lever is moved to the right, the width of the zigzag stitch is increased. Settings of 2 through 5 are indicated, but intermediate settings may also be used.

Do not make any stitch width adjustments while the needle is in the fabric.

## NEEDLE POSITIONS FOR ZIGZAG STITCHING

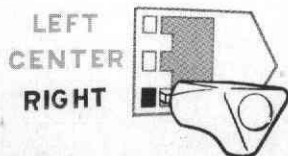
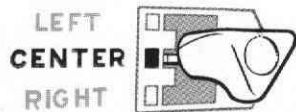
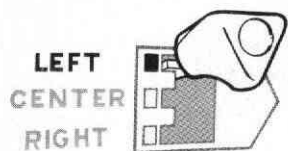
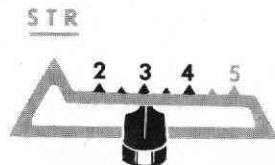

A needle position setting of **CENTER** places stitching in central needle position. Settings **LEFT** or **RIGHT** place stitching in left or right needle positions at widths less than 5.

**CENTER** needle position is preferred. **LEFT** or **RIGHT** settings are only used when special placement of stitching is desired . . . for example: buttonholes, button sewing.

Do not make any needle position adjustments while the needle is in the fabric.

## TWO NEEDLES

The needle clamp accommodates two 15 x 1 needles, generally of the same size. However, where special effects are desired, needles of different sizes may be used together, with corresponding threads. Loosen the thumb screw and insert the additional needle from the right. (See **page 7** for procedure.)

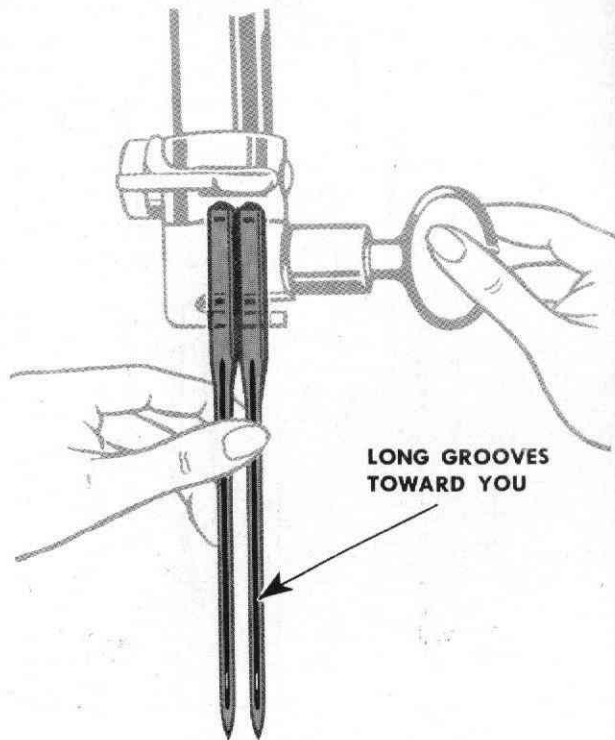

## TWO NEEDLES UPPER THREADING

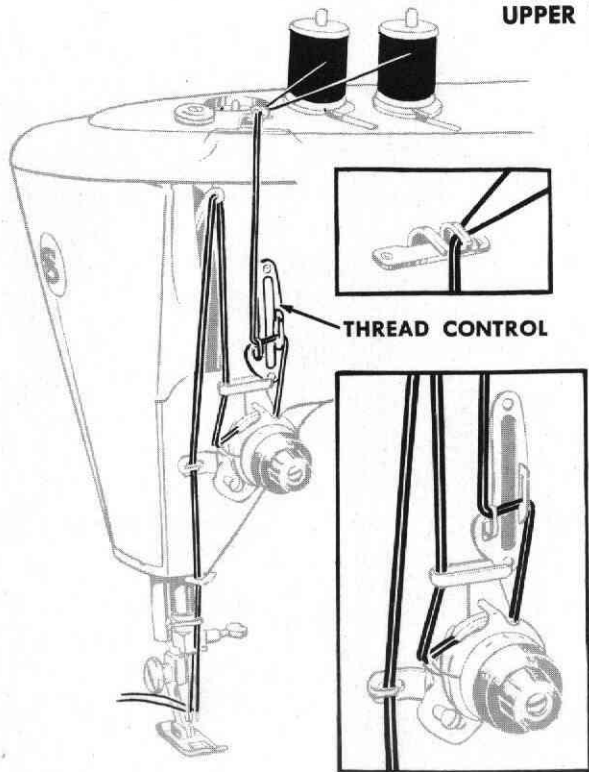

Use size 50 mercerized cotton thread.  
Thread as for single needle (see **page 8**).  
Make certain that both threads are separated by the center guide post of the thread control and by the center tension disc.  
Carry only one thread through the last guide before the needle, as shown below.

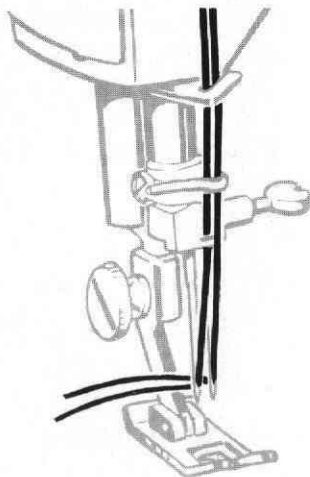



## TWO NEEDLES STRAIGHT STITCHING

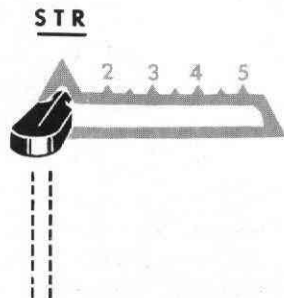
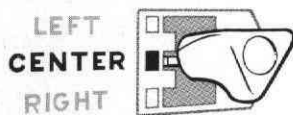
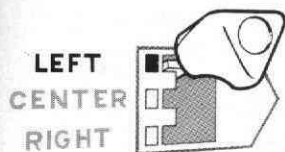

STITCH WIDTH LEVER: STR

NEEDLE POSITION: LEFT OR CENTER ONLY

GENERAL PURPOSE THROAT PLATE AND PRESSER FOOT

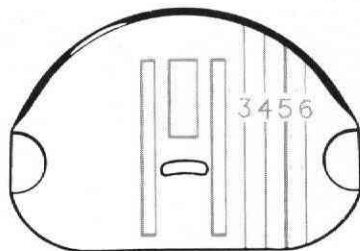

## TWO NEEDLES ZIGZAG AND DECORATIVE STITCHING

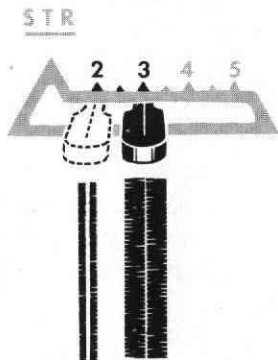
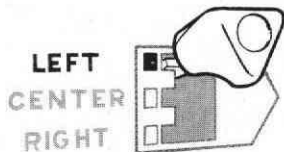

STITCH WIDTH LEVEL: **2** OR **3** MAXIMUM  
 NEEDLE POSITION: **LEFT** ONLY  
 GENERAL PURPOSE THROAT PLATE  
 GENERAL PURPOSE PRESSER FOOT  
 OR SPECIAL PURPOSE PRESSER FOOT

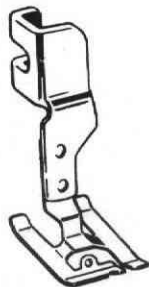
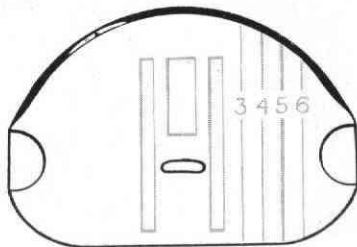
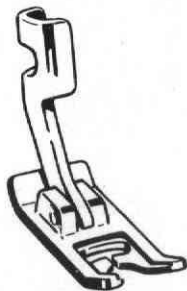

## DECORATIVE TWO NEEDLE STITCHING

BANNER .....  5CRESCENT .....  6ICICLE .....  7BLIND STITCH .....  8MULTI-STITCH .....  9

## SPECIAL PURPOSE FOOT

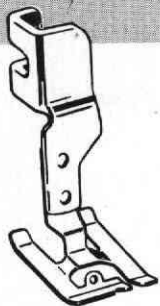

This light, flexible foot is designed for satin stitching. It provides maximum visibility and allows closely spaced zigzag stitches to feed evenly.

It is ideal for accurate placement of satin stitching in buttonholes, monograms, motifs and applique work.

The eyelet on the left side of the foot accommodates a filler cord.

## APPLICATIONS

Buttonholes  
Applique  
Monograms

Decorative Stitching  
Couching  
Motifs

## BUTTONHOLES

FASHION DISC: ZIGZAG   
STITCH WIDTH: SEE BELOW  
NEEDLE POSITION: **LEFT**  
THROAT PLATE: GENERAL PURPOSE  
SPECIAL PURPOSE FOOT  
STITCH LENGTH: FINE

To establish the correct stitch setting and length of buttonhole, a sample must first be made.

Three Stitch Width settings are available. Fabric weight and buttonhole size will determine the selection.

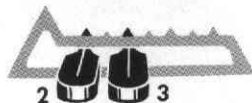
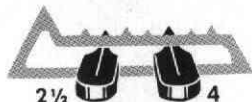

## BUTTONHOLES (Cont'd)

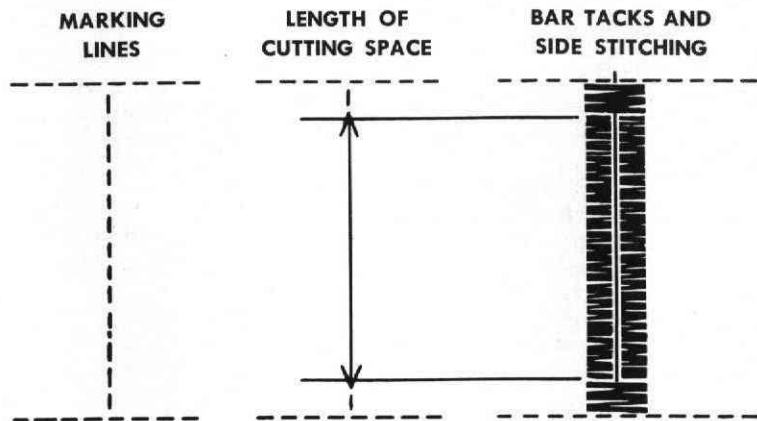

The length of cutting space, the opening through which the button passes, is measured by the width and thickness of the button.

The length of the finished buttonhole will be the cutting space plus  $\frac{1}{8}$  inch for bar tacks.

Work a sample buttonhole in the same fabric as the garment. Use a double fold, duplicating a facing, and include interfacing if this has been used.

## BUTTONHOLES (Cont'd)

**Procedure.** Set Needle Position Selector (**LEFT**) and Stitch Width Lever (see page 42). Place work under needle, aligning center marking of buttonhole with center score line of Special Purpose Foot.

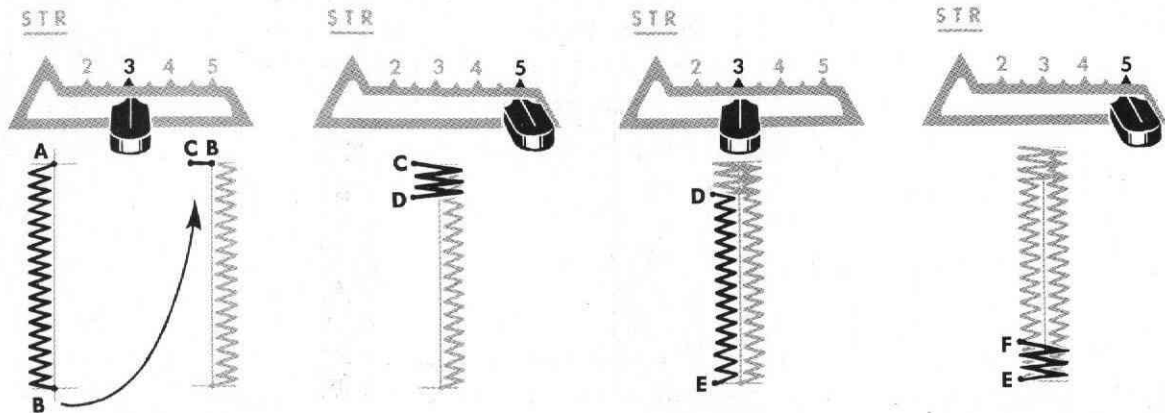

**Side Stitching.** Position needle in fabric at point A. Lower foot and stitch to end of marking. Leave needle in fabric at point B. Raise foot and pivot work on needle. Lower foot. Take one stitch without changing Width setting, bringing work to point C.

**Bar Tack.** Adjust Stitch Width for bar tacks and take no less than six stitches. Stop at point D.

**Side Stitching.** Readjust Stitch Width for side stitching. Complete work to point E. Leave needle in fabric.

**Final Bar Tack.** Adjust Stitch Width for bar tacks, and take no less than six stitches *in reverse*, ending at point F.

## BUTTONHOLES (Cont'd)

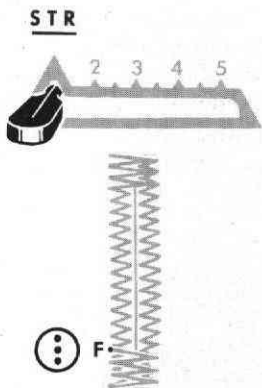

**Fastening Stitch.** To secure stitching, move Stitch Width Lever to **STR** setting and take three stitches.

Remove work, draw threads to underside, fasten and trim. Cut opening for button with sharp embroidery scissors.

**Raised or Corded Buttonholes.** Both #8 pearl cotton and buttonhole twist make suitable filler cords for raised buttonholes.

Place the spool of filler cord on the second spool pin. Carry the cord through the first thread guide, straight down between the center and back tension discs, into the large thread guide and then through the eyelet on the Special Purpose Foot. Draw the cord under and in back of the foot and proceed as for regular buttonholes.

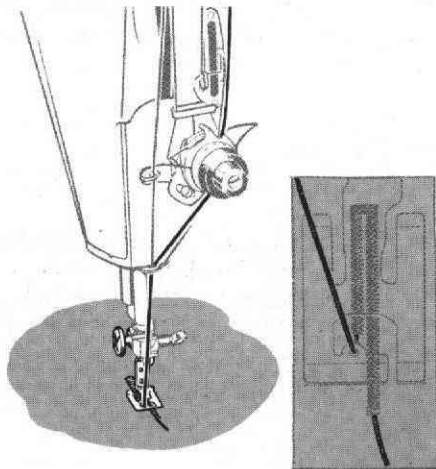

## APPLIQUE

Applique adds beauty and interest to wearing apparel, linens and household textiles.

Either contrasting or self-fabric may be used effectively. The most practical stitch in appliqueing is a closely set zigzag stitch (FASHION Disc ①) The width of this stitch may be varied to accommodate weaves and textures of fabrics.

Many of the FASHION Disc patterns present interesting ways to applique with decorative stitching.

**Preparation.** There are two methods by which applique work may be done. The appropriate method is determined by the fabric being used, and a test sample is advisable.

Position the design properly and baste it to the fabric. Attach the Special Purpose Foot to the presser bar.

**Method #1.** Insert FASHION Disc for the desired stitch pattern (FASHION Disc ① for zigzag stitch). Set lever for the desired width of stitch. Follow the shape of the design, outlining it entirely with applique stitching. Any excess fabric on the outer edges is trimmed after the stitching has been completed.

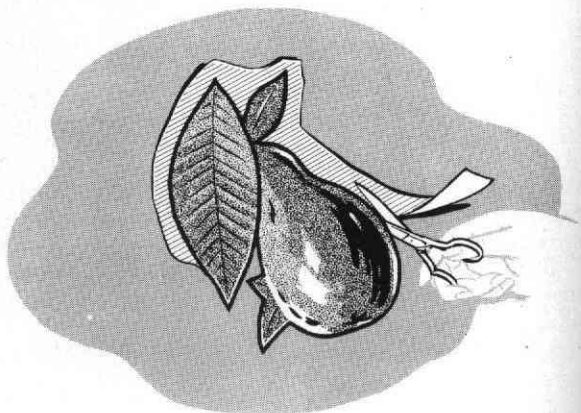



## APPLIQUE (Cont'd)

**Method #2.** Set Needle Position at **CENTER** and Width Lever at **STR** for straight stitching. Outline the entire design with a short stitch. Trim the raw edges to the stitching.

Select and insert the desired stitch pattern, set Stitch Width Lever for desired width of stitch, and overedge the design with this stitching. A smooth, uniform finish results, which requires no additional trimming.

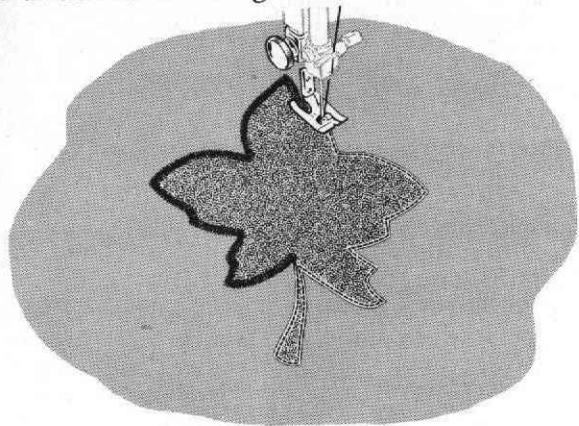

**Corded Applique.** The Special Purpose Foot, which provides for a filler cord, is perfect for corded applique work. Gimp, crochet thread or buttonhole twist are generally used.

See **page 45** for threading.

Either method of appliqueing may be used when cording is desired. The only change in procedure is the introduction of the cord, over which the applique stitching is formed.

This stitching technique results in a raised, dimensional effect, and is an ideal finish for lace applique.

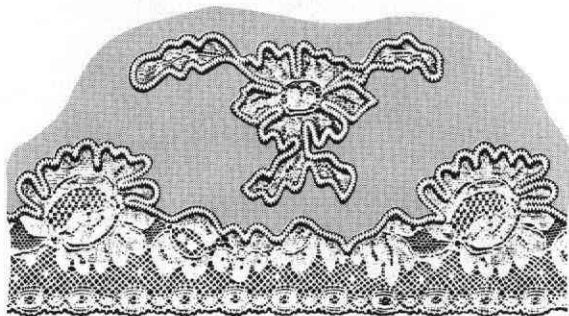

## MONOGRAMS AND MOTIFS

Many of the decorative stitch patterns lend themselves to the creation of attractive monograms and motifs. Designs may be purchased or created and transferred or traced to the right side of the material. A test sample should be made before proceeding with actual work to determine suitability of stitch pattern, stitch width, and spacing. Some fabrics may require a backing of lawn or organdy which can be trimmed close to stitching when work is completed.

To reproduce a specific portion of a stitch pattern, first stitch on a scrap of material until the desired point in the design is reached.

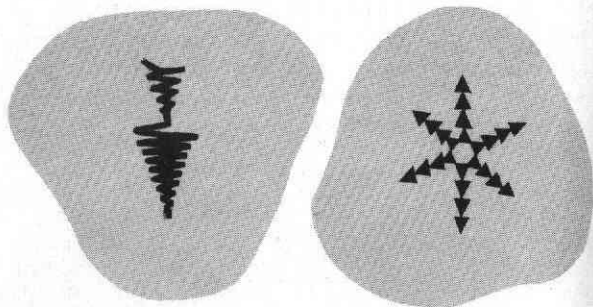

Remove test sample from under the presser foot and position motif or monogram under the needle. Lower presser foot and stitch. This procedure is recommended for all precise placement of leaves and flower petals.

The Special Purpose Foot is especially designed for accurate satin stitch placement.

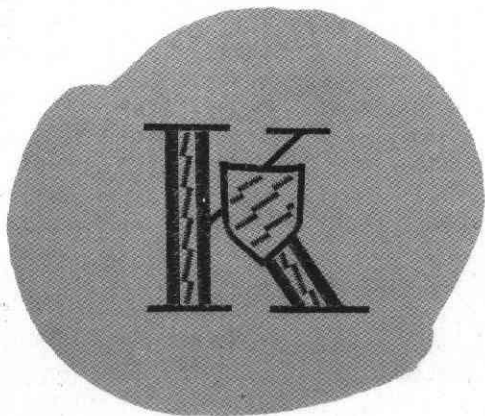

## MONOGRAMS AND MOTIFS

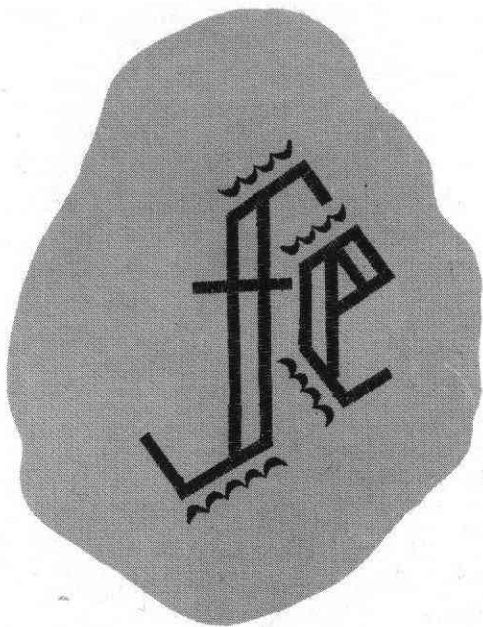

ZIGZAG .....  ①

CRESCENT .....  ⑥

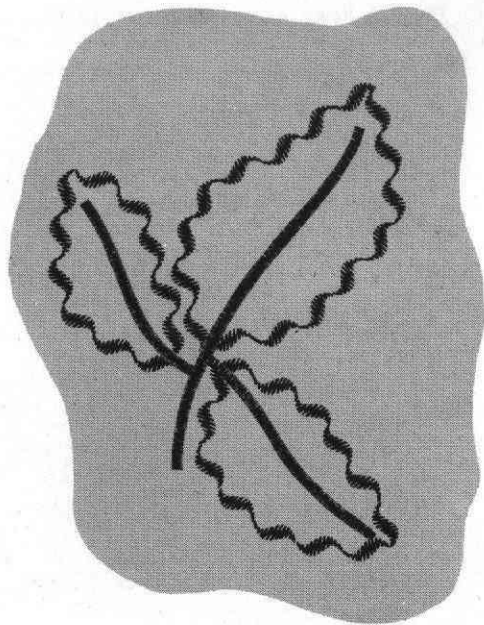

ZIGZAG .....  ①

RIBBON .....  ⑪

## BORDER DESIGNS

Border designs of unlimited variety can be created when several stitch patterns are used in combination. Simple or elaborate, delicate or bold, the width and density of the border can be varied according to the application.

In addition to the suitability of such stitching for linens, draperies, and apparel as border designs, it can be effectively used on plain fabrics to simulate stripes and plaids.

Bands of ribbon and lace, applied with stitch patterns, offer additional opportunities for unusual and dramatic treatments.

Before proceeding with the actual work, a test sample on self-fabric should be made.

Use the Special Purpose Foot. For soft or loosely woven fabrics, use a backing of crisp lawn or organdy.

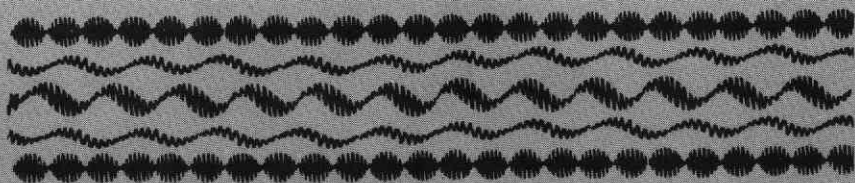

BALL .....  ⑩

RIBBON .....  ⑪

## BORDER DESIGNS

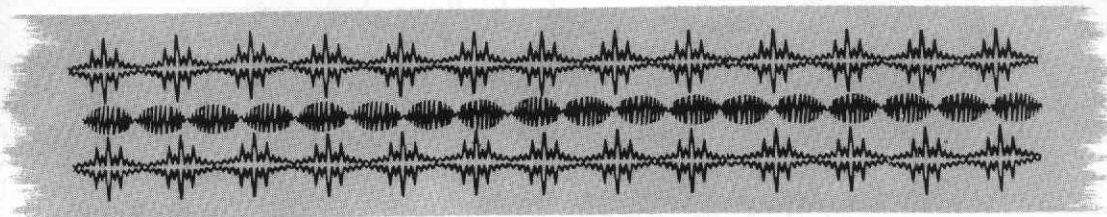

ICICLE .....  (7)

BALL .....  (10)

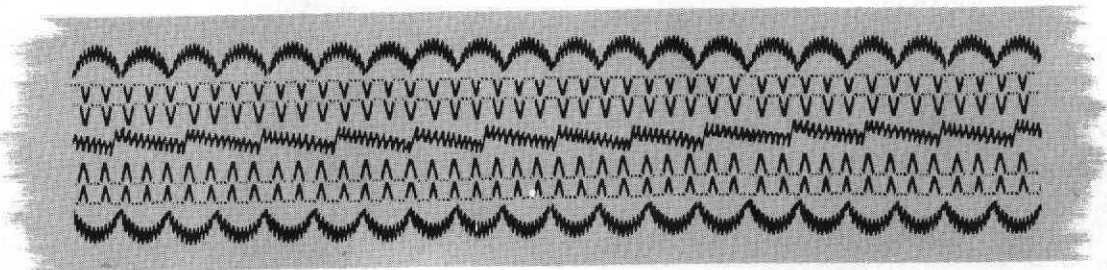

CRESCENT .....  (6)

BLIND STITCH .....  (8)

BANNER .....  (5)

## SEAMING SHEERS

FASHION DISC: ZIGZAG ①

STITCH WIDTH: 2

NEEDLE POSITION: CENTER

THROAT PLATE: GENERAL PURPOSE

STITCH LENGTH: FINE (ABOVE 20)

A dainty hair-line finish is particularly desirable for the inside seams of sheer collars, facings and yokes. Seam allowances that ordinarily show through are eliminated.

Both heavy duty thread and tatting thread make suitable filler cords (see **page 45** for threading).

Follow the seam outline covering the cord. Trim seam allowance close to line of stitching.

Turn and press.

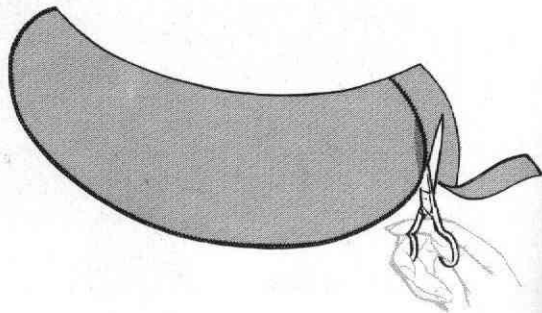
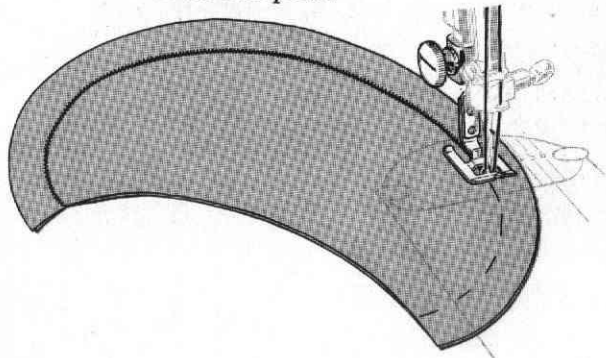

## COUCHING

Novel effects are obtained by couching gimp, yarn or braid with stitch patterns.

Spaced patterns are the most appropriate as they allow the decorative cords to show as part of the design.

The Special Purpose Foot is ideally suited to this work.

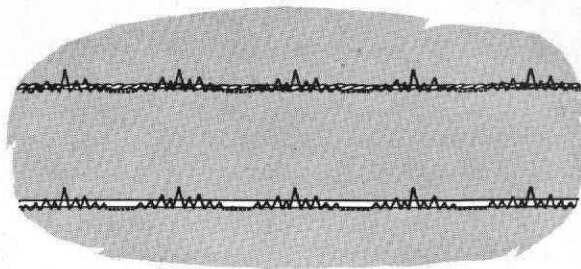

## LACE EDGING AND INSERTION

Delicate and durable zigzag stitching is especially appropriate for the application of lace edgings and insertions.

Many decorative stitch patterns can be used effectively serving as both finish and trim.

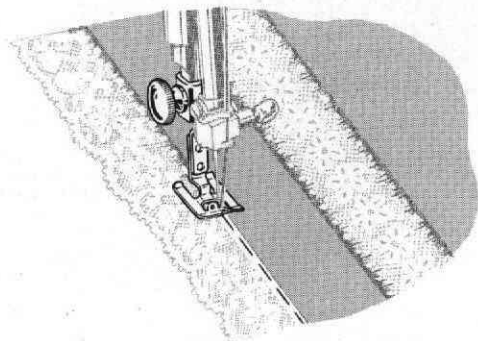

## BUTTON SEWING FOOT

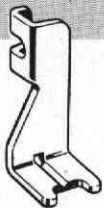

This short, open foot accommodates any two hole or four hole button, and holds it securely for stitching. The groove in the foot allows for insertion of a machine needle, over which a thread shank may be formed.

FASHION DISC: ZIGZAG   
 STITCH WIDTH: STR AND 4  
 NEEDLE POSITION: LEFT  
 THROAT PLATE: GENERAL PURPOSE (RAISED)  
 BUTTON SEWING FOOT

The space between the holes in the button determines the Stitch Width settings. Settings STR and 4 generally apply to standard buttons. The STR setting is constant, but 4 can be increased or decreased to accommodate buttons with unusual spacing.

With Fashion Disc  in place, set Needle Position at LEFT and Stitch Width Lever at STR. Raise throat plate. Position button under foot so that needle will enter left hole. Lower foot. Turn hand wheel toward you until needle rises out of fabric and is just above the foot.

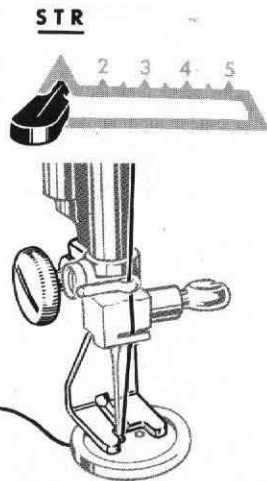



## BUTTON SEWING FOOT (Cont'd)

Set Stitch Width Lever at **4**. The needle should then enter into the right hole in the button. Take approximately six zigzag stitches in this position. End on the left side.

To fasten stitching, adjust to **STR** and take approximately three stitches.

## THREAD SHANK

In order to form a shank, stitching is done over a regular machine needle. Position button and lower button sewing foot. Place needle in the groove of the foot so the point enters the hole.

A large shank results when the heavy end of the needle is utilized.

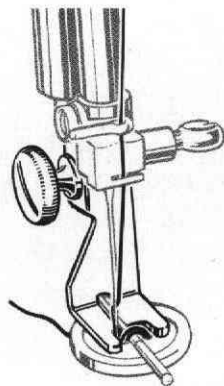
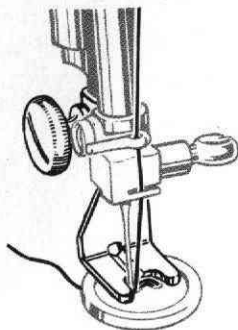
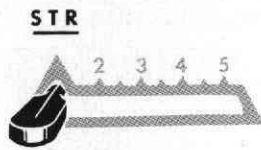
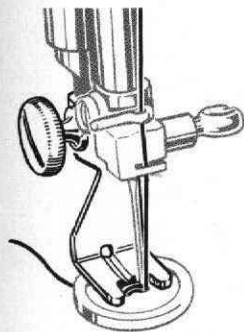
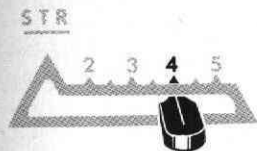

## GENERAL PURPOSE FOOT



Used with the general purpose throat plate this foot provides a wide needle slot which accommodates all stitch settings and can be used for most sewing operations.

### APPLICATIONS

Seams and Darts  
Mending and Darning

Blind Stitched Hems  
Seam Finishes

## SEAMS

### LINGERIE SEAMS

Dainty lingerie seams are made durable with zigzag stitching (FASHION Disc ). After straight stitching seam on the wrong side, press both seam allowances in the same direction. From the right side, top stitch with a fine zigzag setting ( $2\frac{1}{2}$  Width), letting the needle alternately enter the seam line and seam thickness. This finish is particularly suitable for bias seams.

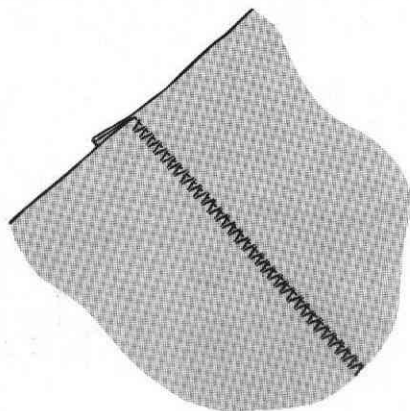

## SEAMS

## FLAT FELLED SEAMS

Zigzag stitching gives strength and durability to flat felled seams.

Form the seam to the right side of the fabric, taking full seam allowance, using a zigzag stitch (FASHION Disc ①, 3 Width).

Press the seam to one side, keeping the right side of the zigzag stitch uppermost.

Trim half the under seam allowance.

Turn the upper seam edge evenly over the trimmed seam and top stitch.

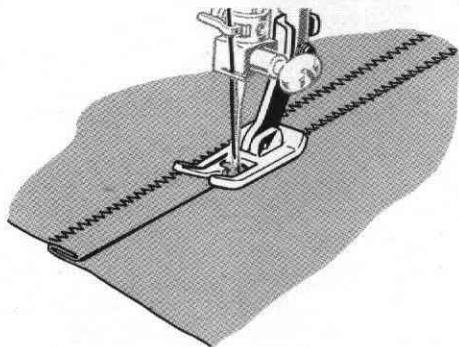

## KNIT FABRIC SEAMS

A fine zigzag stitch (FASHION Disc ①, Stitch Width between STR and 2) is ideal for seaming knit fabrics. It is particularly desirable for underarm seams, or other seams where elasticity and give are needed.

For neckline and waistline seams, where a stay is needed to prevent undue stretching, this same stitch can be used to apply seam tape. To insure a flat, smooth finish, position the seam tape with the edge exactly on the seam line. If seam is curved, pre-shape tape to fit by steaming, and baste in place.

Stitch, allowing the needle to alternately enter the seam tape and seam allowance.

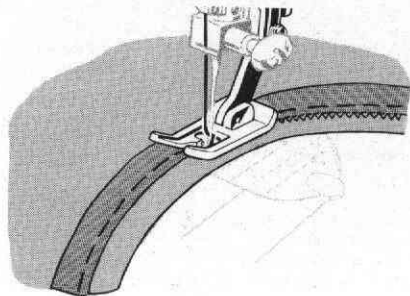

## SEAM FINISHES

Seam edges support the garment and should be given a durable finish where fabrics have a tendency to ravel.

The zigzag stitch (FASHION Disc ①) is ideal for such finishing. Place the stitching near the edge of the seam allowance, and then trim away excess fabric.

For an overedged seam, the blind stitch (FASHION Disc ⑧) makes a durable, bulkless finish. It is particularly suitable for lengthwise seams.

Seam edges should be trimmed evenly, and the stitch then formed over the raw edge.

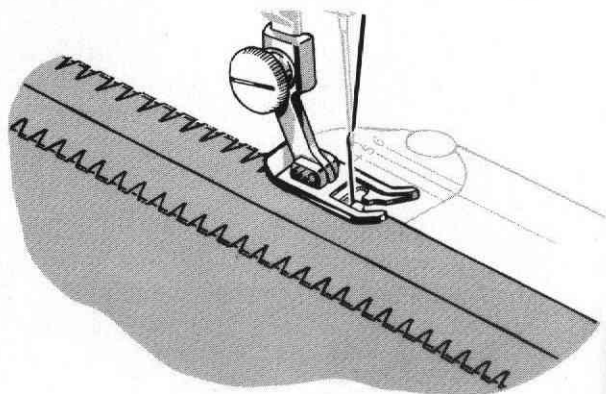
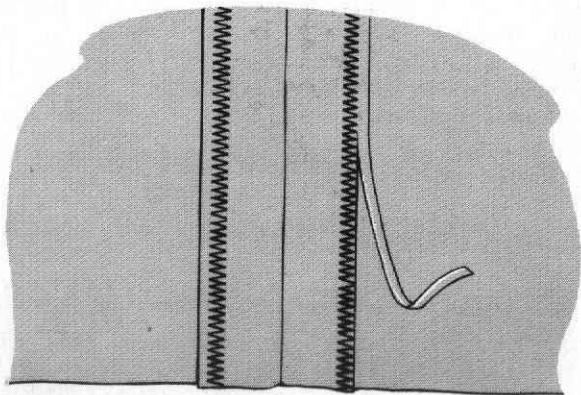

## DARTS

Darts provide fit and contour in a garment and should be accurately stitched.

A straight stitch dart is usually formed by stitching from the seam edge, tapering gradually to the point, where the last 3 or 4 stitches parallel the fold. Stitch beyond the fabric to form a thread chain  $\frac{1}{2}$  to  $\frac{3}{4}$  inch in length. Tie the thread ends into a single knot close to the stitching.

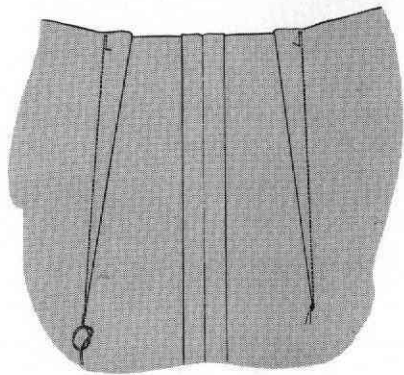

### SINGLE THREAD DARTS

Darts add styling and interest when stitched with the fold to the outside of garment. Thread ends at the point of the dart are eliminated when the single thread principle is employed.

Unthread the needle. Use the thread leading off the bobbin and rethread the needle from back to front. Tie bobbin and upper threads together.

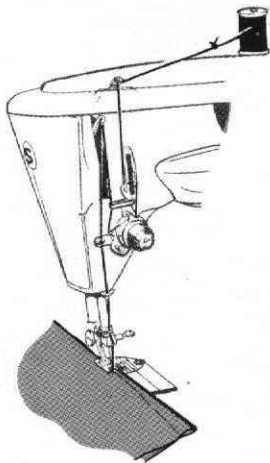

Draw bobbin thread up through threading points, winding enough on the spool to complete a single dart. Lower the needle into the very edge of the fold at the point of the dart. Take any slack out of the thread by turning the spool. Lower the presser foot and stitch carefully toward the seam edge.

This method is also ideal for inside darts in sheer fabrics as thread ends are eliminated at the point of the dart.

## DARTS IN INTERFACING

Non-woven interfacings can be shaped without bulk with zigzag stitching (FASHION Disc ⑩). The multi-stitch zigzag (FASHION Disc ⑨) may also be used.

Cut out the dart allowance on the stitching line and bring the raw edges together. Pin, over a muslin stay, and stitch. Back stitch at both ends.

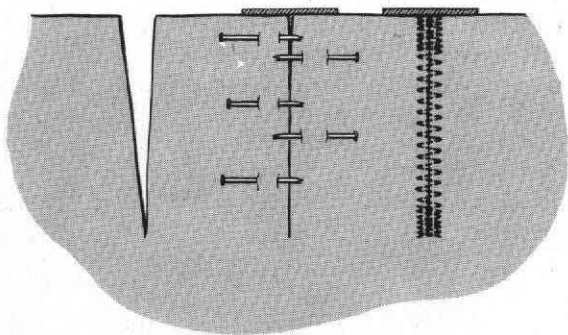

## BLANKET BINDING

The multi-stitch zigzag (FASHION Disc ⑨) is an excellent stitch for applying blanket binding and affords both a decorative and durable finish. Remove worn binding. Baste new binding securely in place and stitch. Adjust pressure, if necessary, to accommodate the thickness of the blanket.

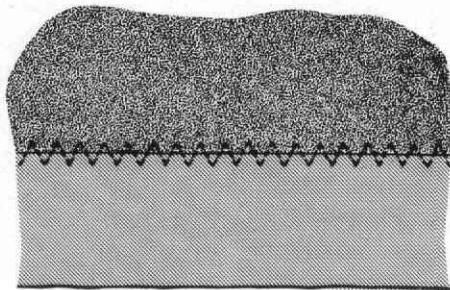

## MENDING

Zigzag stitching is well suited for all types of household mending. The multi-stitch zigzag (FASHION Disc ⑨) provides a firm, flexible bond for the repair of rents and tears, and is ideal for the reinforcement and application of elastic. Stitch length and width are regulated according to need.

**Tears.** Trim ragged edges. Place an underlay to the wrong side of the tear for reinforcement. Using the multi-stitch zigzag (FASHION Disc ⑨), follow the line of the tear bringing the edges together. Shorten the stitch length at ends and corners to give extra strength.

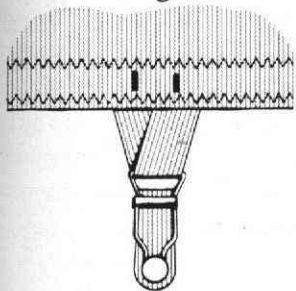

**Application of Elastic.** Elastic, such as used in waist bands, must be stretched as it is applied, to insure fullness required in the garment.

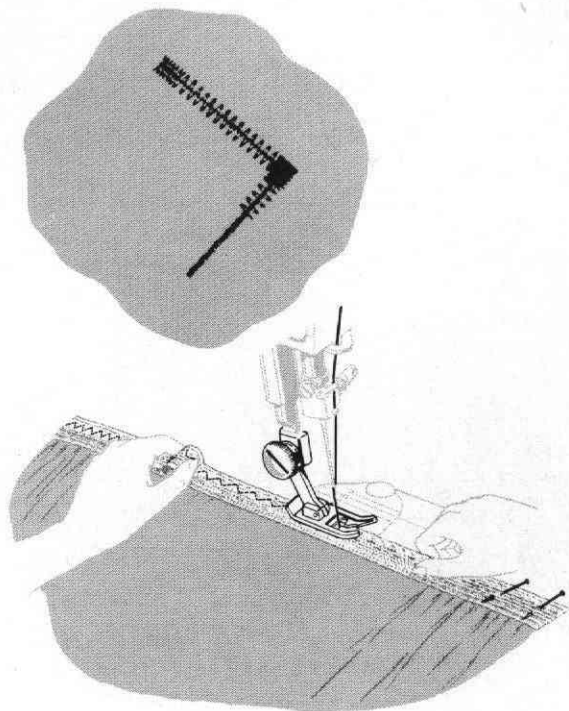

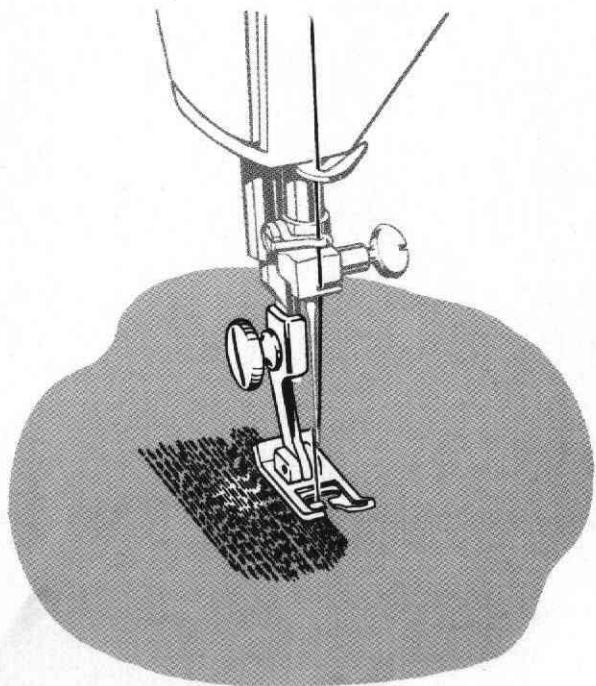
**DARNING**

Worn or torn areas on household textiles and clothing can be darned effortlessly and quickly with little practice. Set machine for straight stitching, adjust Stitch Length Regulator for desired stitch length, and turn Pressure Regulating Dial to "D".

Place portion to be darned under the presser foot. Lower presser bar and start stitching, alternately drawing fabric *gently* away from you and then *gently* pulling fabric toward you. Continue this forward and backward motion until area to be darned is filled with parallel lines of stitching. For reinforcement or additional strength, cover area with crosswise lines of stitching. Open areas require an underlay. Baste underlay in place before darning.



## THE ZIPPER FOOT

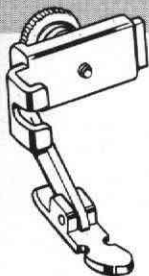

This foot is designed to facilitate the placement of stitching close to a raised edge. The hinged feature of this foot insures even feeding over pins, heavy layers of fabric or cross seams. It is attached to the machine in place of the regular presser foot, and may be adjusted to either the right or left side of the needle. Straight stitch or zigzag settings may be used.

### APPLICATIONS

Zipper Insertions  
Corded Seams

Tubular Cording  
Slip Cover Welting

**Preparation.** Secure the zipper foot to the presser bar in place of the regular presser foot. Adjustment to the right or left of the needle is made by loosening the thumb screw at the back.

Check the position of the foot by lowering the needle into the side notch, making sure it clears the foot. Lock it into position by tightening the thumb screw.

## ZIPPER INSERTION

STITCH WIDTH: **STR**  
NEEDLE POSITION: **CENTER**  
THROAT PLATE: GENERAL PURPOSE  
ZIPPER FOOT

Many different types of zippers are available for everything you sew. There are several satisfactory methods for insertion. Detailed sewing instructions are included in zipper packaging. For any method used, the Zipper Foot enables you to form an even line of stitching close to the zipper.

When the zipper is to the right of the needle—

- Adjust the Zipper Foot to the left of the needle.

When the zipper is to the left of the needle—

- Adjust the Zipper Foot to the right of the needle.

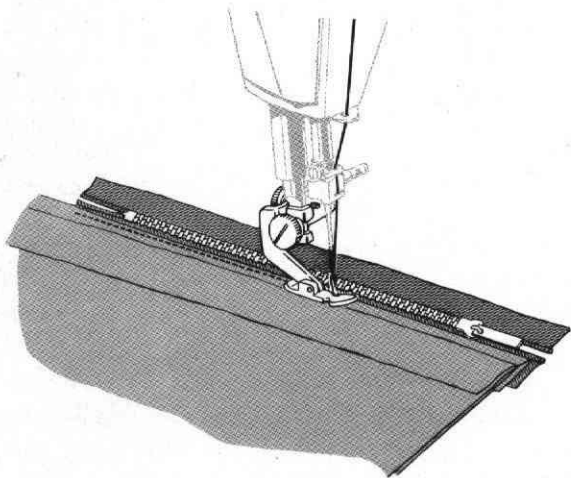

## BLIND STITCHED ZIPPER INSERTION

FASHION DISC: BLIND STITCH (8)  
 STITCH WIDTH:  $2\frac{1}{2}$  OR 3  
 NEEDLE POSITION: CENTER  
 THROAT PLATE: GENERAL PURPOSE  
 STITCH LENGTH: 12  
 ZIPPER FOOT

Blind stitching the final step of a zipper insertion results in a fine finish that is almost invisible and comparable to hand sewing. Particularly suitable for chiffons, sheers, velvets and all delicate fabrics where top stitching would be too harsh.

Allow a  $\frac{7}{8}$ " seam allowance. Start the insertion in the regular way but omit final step.

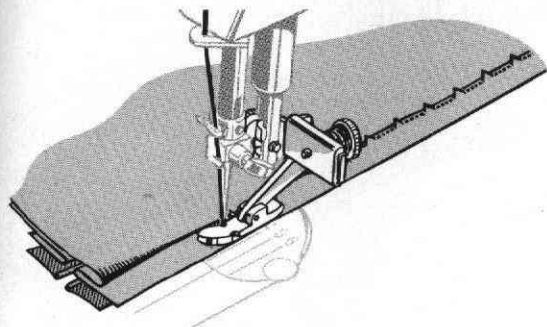

Work from the right side of the garment and pin the front of the zipper tape into position.

Roll the work over finger to ease fabric and pin through all thicknesses. Baste about  $\frac{3}{8}$ " from seam line to provide guide for blind stitching. Remove pins.

Set stitch and adjust zipper foot to the right side of the needle.

Turn garment inside out. Place zipper tape over feed of machine and turn back the front section of garment to line of basting, creating a soft fold. Position work so that the straight line of stitching is made through front seam allowance and zipper tape, and the sideward stitch pierces a few threads of the fold. Lower presser bar and stitch slowly. Remove bastings. Press.

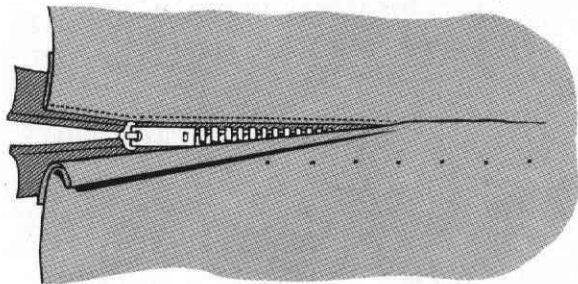

## CORDED WELTING

STITCH WIDTH: **STR**NEEDLE POSITION: **CENTER**THROAT PLATE: GENERAL PURPOSE OR  
STRAIGHT STITCH

ZIPPER FOOT

Cable cord comes in a variety of sizes and, when covered with a firmly woven fabric, makes a welting that is an excellent seam finish.

This welting is prepared in advance and then stitched into the seam. Cut a true bias strip  $1\frac{1}{4}$  inches wide, plus three times the width of the cord, of either self or contrasting fabric. Sew strips together on the lengthwise grain to obtain desired length.

Adjust zipper foot to the left side of the needle. Encase the cord in the bias strip, raw edges even. Lower presser bar. Stitch close to the cord, applying gentle tension to bias strip in front and back of the zipper foot. Use a stitch length slightly longer than for regular seaming. Do not crowd the stitching against the cord.

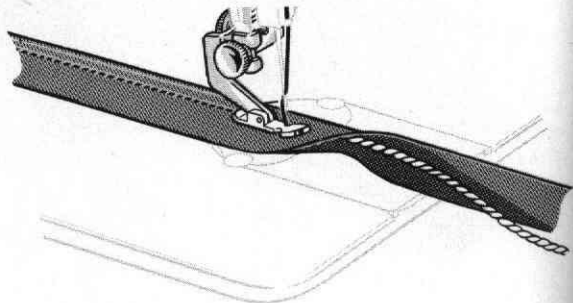
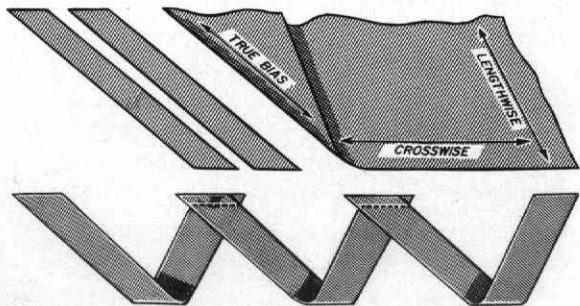

## CORDED SEAMS

STITCH WIDTH: **STR**

NEEDLE POSITION: **CENTER**

THROAT PLATE: GENERAL PURPOSE OR  
STRAIGHT STITCH

ZIPPER FOOT

The corded seam is a professional treatment for slip covers, children's clothes, blouses and lingerie. When cording a seam the zipper foot is usually adjusted to the right of the needle so that the bulk of the work will fall to the left.

Attach the welting to the right side of a single seam edge, with the same stitch length used to

make the welting ([page 66](#)). Guide the edge of the foot next to the cord, but do not crowd.

Place the attached welting over the second seam edge, and pin or baste together.

Keep the first stitching uppermost as a guide and position the seam under needle. Stitch, this time crowding the foot against the cord.

This method produces evenly joined seam edges and tightly set welting.

Curved seams are corded as easily as straight seams, except that a shorter stitch length is used. Since the seam allowance of the welting is bias, it is not difficult to shape it to the seam.

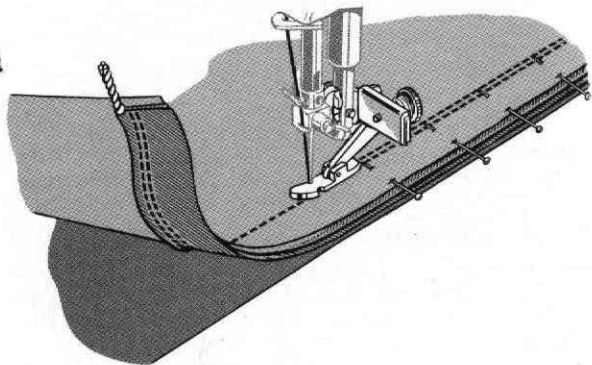
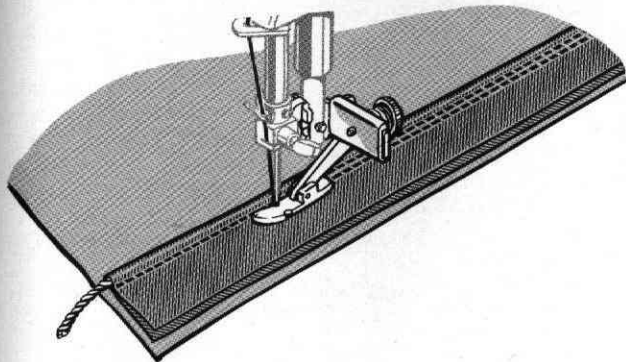

## THE SEAM GUIDE

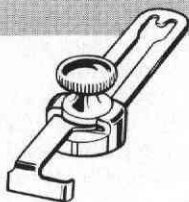

The seam guide aids in attaining uniformity of seam width. It provides for stitching to be spaced at any distance between  $\frac{1}{8}$ " to  $1\frac{1}{4}$ " from the edge of the fabric.

## APPLICATIONS

Seams  
Top Stitching

Blind Stitching  
Decorative Stitching

The attachment is used in connection with a presser foot.

It is secured to the bed of the machine in either of the threaded holes to the right of the needle.

## SEAMS

To guide seam stitching straight and parallel to the edge of the fabric, adjust the attachment for proper seam width. Align the guide with the presser foot. Adjust the machine for straight stitching.

Pin seam edges and baste if necessary. Hand basting can be eliminated on easy-to-handle fabrics. Place pins with the points toward the seam edge so they nip into the fabric at the stitching line. The hinged presser foot will ride freely over the points. Guide the fabric edges lightly against the guide while stitching.

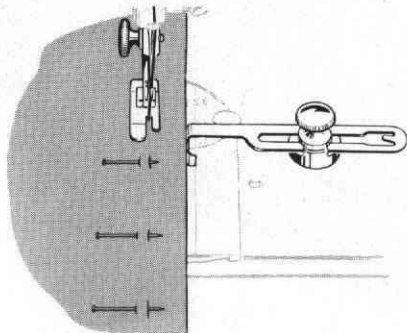

## SEAMS (Cont'd)

Curved seams require additional treatment in handling. A shorter stitch will provide greater elasticity and strength. Set the attachment at an angle so that the end closest to the needle acts as a guide.

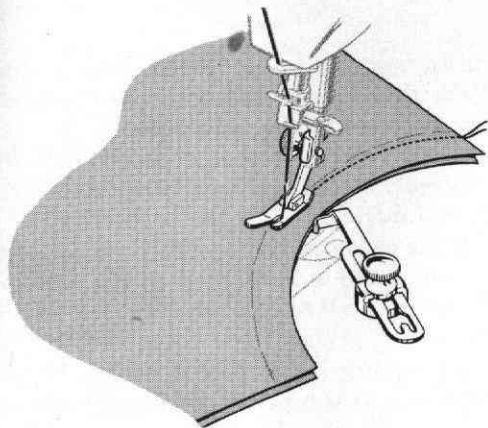

## TOP STITCHING

A practical, simple way to accent lines of a garment is to place single or multiple rows of stitching along collars, lapels, facing edges, pockets, sleeves, etc. A tailored effect can be achieved with straight stitching or an interesting, decorative touch can be obtained by using any of the attractive stitch patterns. Rows of stitching can be accurately spaced with the aid of the seam guide.

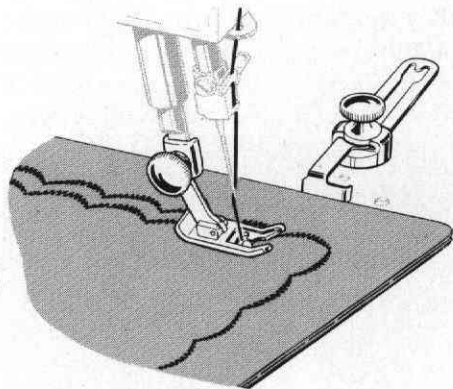

## BLIND STITCHED HEMS

FASHION DISC: BLIND STITCH ⑧  
 STITCH WIDTH: 2 - 5  
 NEEDLE POSITION: **CENTER**  
 STITCH LENGTH: 10 - 20  
 PRESSER FOOT: GENERAL PURPOSE  
 THROAT PLATE: GENERAL PURPOSE  
 SEAM GUIDE

Blind stitching provides a durable hem finish that is almost invisible and comparable to hand sewing.

Mark, turn and press hem in the usual way. Baste a guide line  $\frac{1}{4}$ " from the top of the hem edge.

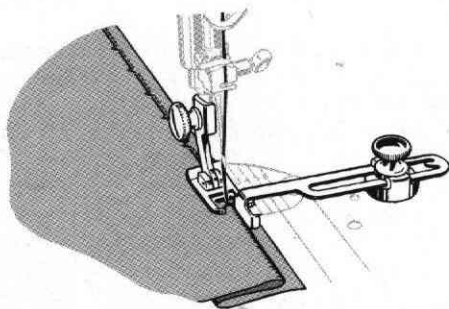

Place the hem edge over the feed of the machine, turn back the bulk of the fabric to the line of basting, thereby creating a soft fold.

Position the work so that straight stitches are made on the hem edge and sideward stitches pierce the fold.

Adjust the seam guide over the right toe of the presser foot until it rests next to the soft fold. While stitching, feed the fold against the flat of the guide.

When stitching is completed, swing the seam guide out of position before raising presser foot.

A test sample should be made to determine stitch width and stitch length for weight and texture of fabric used.

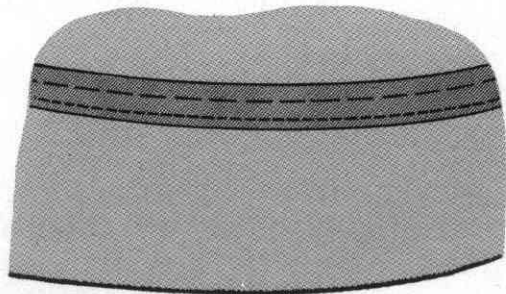



## THE FOOT HEMMER



The narrow hemmer forms and stitches a perfectly turned hem without basting or pressing. It is attached to the machine in place of the regular presser foot.

### APPLICATIONS

Fine Hems  
Edging Ruffles  
Hemmed Seams

Hemming with Lace  
Lingerie Finishes

STITCH WIDTH: **STR**  
NEEDLE POSITION: **CENTER**  
THROAT PLATE: **GENERAL PURPOSE**  
FOOT HEMMER

### HEMMING

Crease a double  $\frac{1}{8}$ " fold for about 2 inches along the edge of the fabric to be hemmed. Draw the bobbin and needle threads under the hemmer.

Place the fabric under the foot and stitch the creased fold for several stitches. Hold the thread ends in the left hand and guide the raw edge in front of the hemmer evenly into the scroll. Sew slowly, still holding thread ends until the hem is well started.

Soft fabrics will enter the scroll best with the foot down; firm, crisp materials with the foot raised.

Even feeding is essential to good hemming. The same width of fabric must be kept in the scroll of the hemmer at all times. A little practice will result in perfectly formed hems.

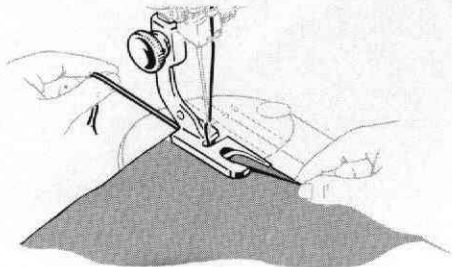

## HEMMED SEAMS

STITCH WIDTH: **STR**  
 NEEDLE POSITION: **CENTER**  
 THROAT PLATE: STRAIGHT STITCH  
 FOOT HEMMER

A hemmed seam is applied where a fine narrow seam is appropriate. Allow a scant  $\frac{1}{4}$ " seam allowance. With both sides of fabric together, place upper layer  $\frac{1}{8}$ " to left of lower layer. Insert two fabric edges into hemmer and proceed as for plain hem.

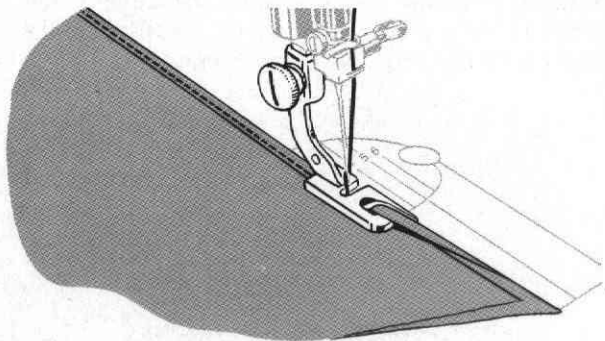

## DECORATIVE HEMS

FASHION DISCS: ALL  
 STITCH WIDTH: **2 THRU 4**  
 NEEDLE POSITION: **CENTER**  
 THROAT PLATE: GENERAL PURPOSE  
 FOOT HEMMER

Narrow hem edges can be turned and decorated in one operation using the foot hemmer and a stitch pattern. This time-saving finish is especially suited to ruffle edges and aprons.

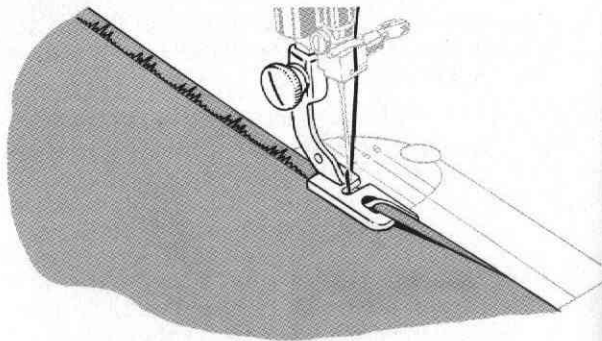

## HEMMING WITH LACE

FASHION DISC: ZIGZAG ①  
 STITCH WIDTH: 3  
 NEEDLE POSITION: CENTER  
 THROAT PLATE: GENERAL PURPOSE  
 FOOT HEMMER

Lace edgings can be applied with the Foot Hemmer to trim lingerie hems, children's clothes, etc.

**Lace Applied Over Hem.** Fold and start the hem in the usual way. Starting about 1" down from the end of the lace, place the selvage under the needle and lower needle to hold lace firmly. Raise the foot slightly and slip the lace under the back portion of the foot, without disturbing the position of the fabric. Stitch slowly, guiding the fabric with the right hand, the lace with the left. Take care not to stretch the lace.

**Lace Applied Under Hem.** When using lace underneath the fold of a hem, the procedure is the same as when making a hemmed seam. Slip the lace in from the left as you would the second piece of fabric. This method is used where a neat finish is desired on both sides of the material.

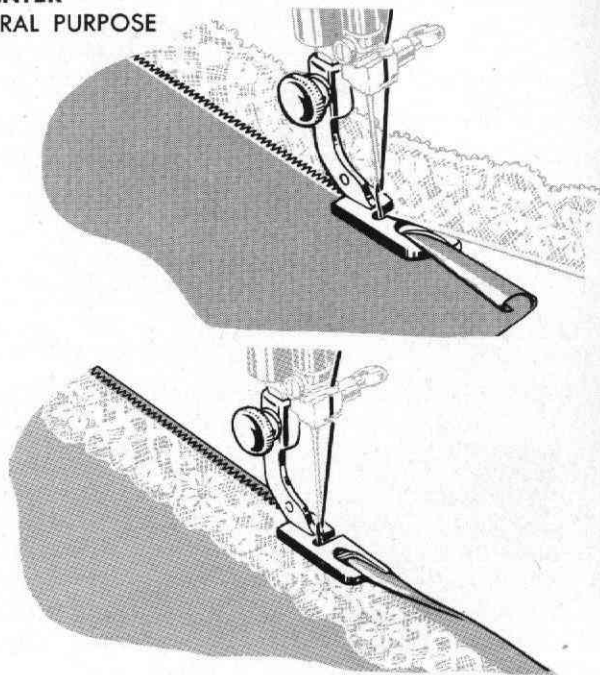

## MULTI-SLOTTED BINDER

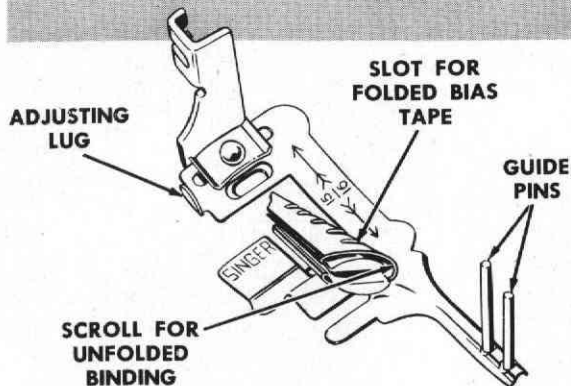

FASHION DISCS: ALL  
 STITCH WIDTH: STR THRU 5  
 NEEDLE POSITION: CENTER  
 THROAT PLATE: GENERAL PURPOSE

The multi-slotted binder is used to apply commercial binding as well as self-fabric bias to an unfinished edge. This colorful trim is attractive when applied to children's wear, aprons and household textiles. It is a practical finish for seam edges that ravel and for making bound seams.

Commercial single fold bias tape is inserted from the right into the slot at the wide end of the scroll. Unfolded bias  $\frac{15}{16}$ " wide is inserted into the opening at the end of the scroll.

Cut binding diagonally and pull through the scroll until evenly folded edges are under the needle. Free length of binding is held between the guide pins.

Insert the edge to be bound into the center of the scroll. Position stitching by moving the scroll portion of the binding to the right or left by means of the adjusting lug.

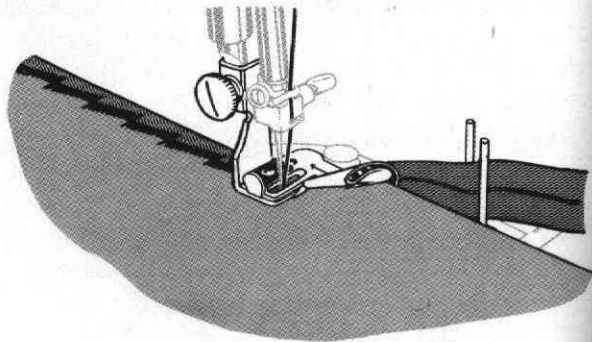

**MULTI-SLOTTED BINDER (Cont'd)**

Curved edges require slightly different fabric handling from straight edges. Inside curves are straightened as they are fed into the binder. If fabric is soft and has a tendency to stretch, reinforce the edge with a single row of stitching before binding.

Outside curves tend to lead away from the center slot of the scroll and should be guided so that a full seam width is taken at the needle point. Do not attempt to pull or straighten fabric into the full length of the scroll.

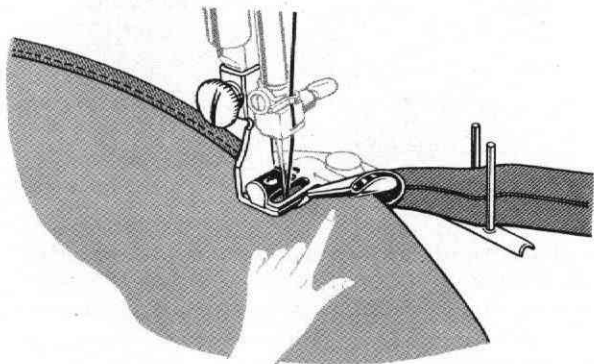
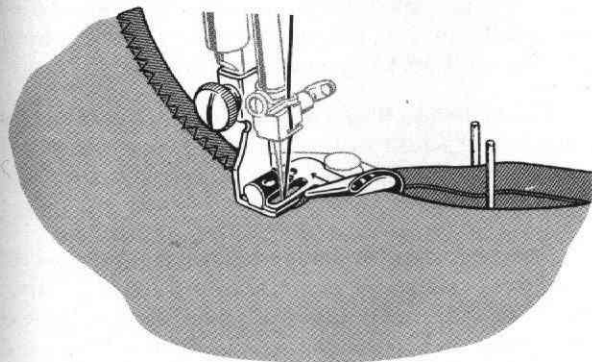

## THE RUFFLER

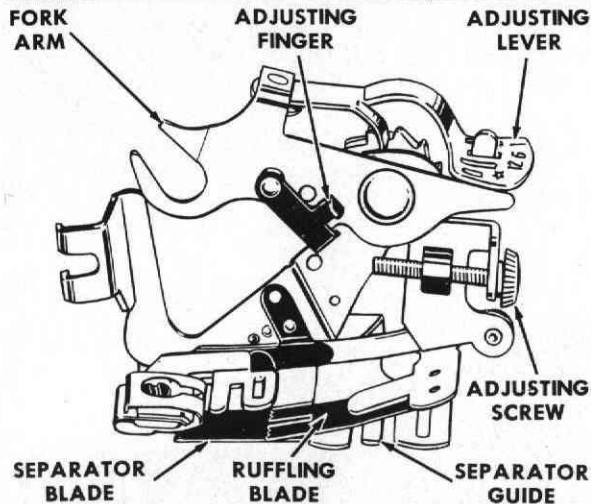

This attachment offers a simple and effective way to make gathered and pleated ruffles. Ruffles may be made separately or made and applied at the same time. The ruffler is attached to the machine in place of the regular presser foot and is used with a straight stitch setting only.

STITCH WIDTH: **STR**  
 NEEDLE POSITION: **CENTER**  
 THROAT PLATE: **STRAIGHT STITCH**  
 RUFFLER

### Adjusting Points

The **adjusting lever** sets the ruffler for **gathers or pleats**. The Number 1 space setting is for gathers and places fullness at every stitch. Numbers 6 and 12 are space settings for pleats, spacing them 6 or 12 stitches apart. The star is for straight stitching and is used when grouping gathers or pleats.

The **adjusting finger** is used only for **pleating** and affects the width of the pleat. It is thrown out of action by bringing it out of contact with the adjusting screw.

The **adjusting screw** regulates the **fullness of gathers or pleats**. When turned inward to its limit with the adjusting finger in place, the attachment is set for its deepest pleat. When turned outward to its limit, with the adjusting finger out of action, the ruffler gives only a hint of fullness.

## THE RUFFLER (Cont'd)

### Activating Parts

The ruffling blade and the separator blade are of blue steel and hold the material to be gathered between them. The ruffling blade forms the gathers or pleats by carrying the fabric to the needle according to the spacing and fullness to which the ruffler is adjusted. The separator guide is slotted to guide seam edges evenly and to separate the ruffle strip from the material to which the ruffle is attached.

### Preparation

- Raise needle to its highest point.
- Locate ruffler on presser bar with fork arm over needle clamp screw. Securely tighten both presser bar and needle clamp screws.

### Gathering

- Set adjusting lever on Number 1 setting and throw adjusting finger out of action.
- Turn adjusting screw for amount of fullness desired and set stitch length to space fullness. Turn screw in for more fullness; turn out for less fullness.

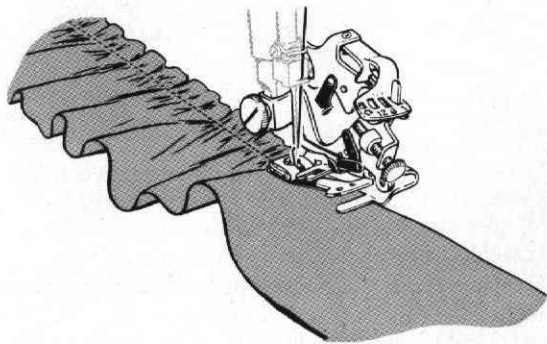

## THE RUFFLER (Cont'd)

Length of sewing machine stitch also affects ruffle fullness. Since a given attachment setting puts an equal amount of fullness into each stitch regardless of its length, shortening the stitch (more stitches to the inch) makes ruffle fuller; lengthening the stitch (fewer stitches to the inch) makes it less full. For fine, closely spaced gathering, use a short stitch and an outward adjustment of adjusting screw. For deeper, less closely spaced gathering, turn adjusting screw inward and use a medium stitch length.

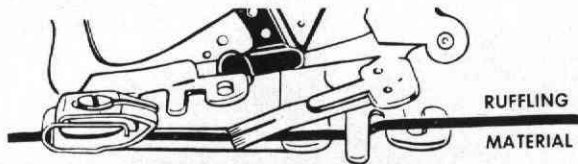

- Insert material to be gathered between blue blades and through first separator guide.
- Draw material to back of needle.
- Lower presser bar and stitch.

Fabric texture influences performance of ruffler as well as results. Soft fabrics, cut on crosswise grain, are best adapted for gathering ruffles. Always test stitch length and ruffler setting on a scrap of self-fabric before proceeding with the actual work.

### Attaching Ruffle

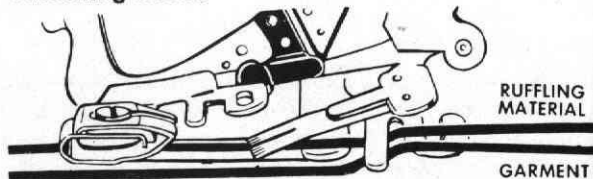

- Place ruffle strip between two blue blades and through first separator guide.
- Place material to which ruffle is to be attached between separator blade and feed of machine.
- Proceed as for plain gathering.

Right sides of fabric are placed together when the seam is to fall to the inside.

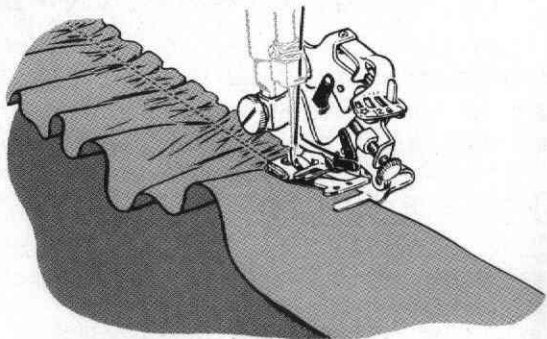



## THE RUFFLER (Cont'd)

### Pleating

- Move adjusting lever to desired space setting for pleats either 6 or 12 stitches apart.
- Set stitch length.

For deepest pleat, activate adjusting finger and turn adjusting screw inward to its maximum setting. For smaller pleats, turn adjusting screw outward.

A short stitch places pleats more closely together; a long stitch separates the pleats for a greater distance.

- Insert fabric to be pleated between blue blades and into first separator guide.
- Lower presser bar and stitch.

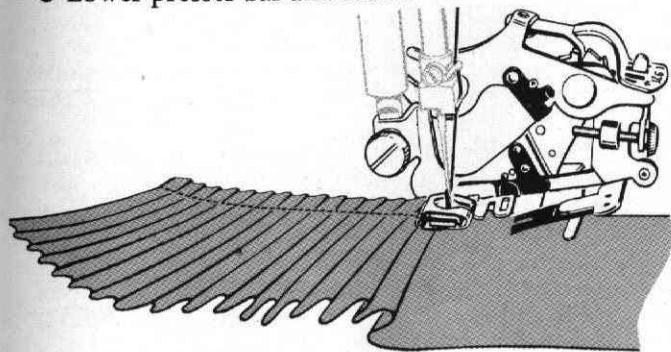

Crisp fabrics cut on the crosswise grain form the sharpest pleats. Glazed fabrics handle best if the glazed side is downward and the soft backing is next to the ruffler blade.

### Group Pleating

By using the star setting (straight stitching) alternately with 6 or 12 space setting, pleats are formed in groups. Even spacing between groups is accomplished by counting the number of stitches.

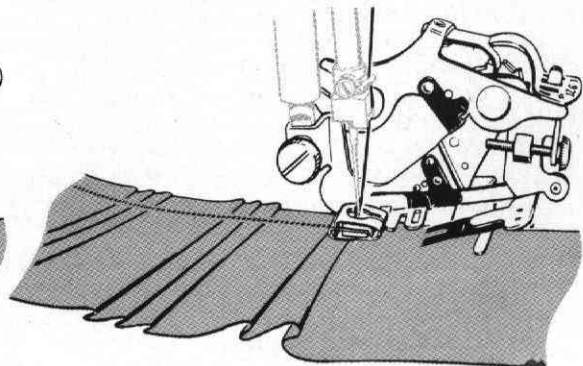

## FREE MOTION WORK DARNING

STITCH WIDTH: **STR**  
 NEEDLE POSITION: **CENTER**  
 THROAT PLATE: STRAIGHT STITCH (RAISED)  
 PRESSER FOOT: NONE  
 STITCH LENGTH: ABOVE 20

Household linens, children's clothes and knit wear of all kinds can be repaired with the darning stitch.

### Procedure

- Trim ragged edges from area to be darned. Center worn section in embroidery hoops.
- Remove presser foot and raise throat plate.
- Position work under needle and lower presser bar to engage tension. Hold needle thread loosely with left hand, turn hand wheel over and draw bobbin thread up through fabric. Hold both thread ends and lower needle into fabric.
- Outline area to be darned with running stitches for reinforcement. Place stitches  $\frac{1}{4}$ " from edge of open area.
- Stitch across opening, moving hoops under needle at a slight angle from lower left to upper right. Keep lines of stitching closely spaced and even in length.

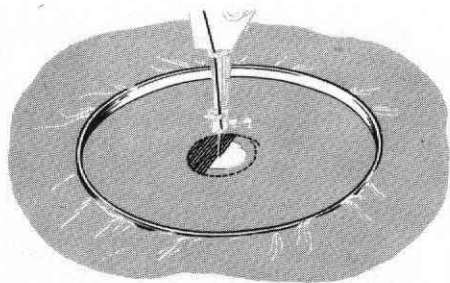

- When opening is filled, turn work 90° and continue stitching until darn is completed.
- Run machine at moderate speed and control hoops with a steady continuous movement. Slow movement of hoops will produce a short stitch; more rapid movement lengthens the stitch.

Fairly long stitches are best for knit and tricot fabrics; short stitches are best for cottons and linens as they approximate weave of fabric and are strong enough to withstand many launderings.

Darning and embroidery foot (available for separate purchase) provides a close control of stitch and fabric and aids in handling of difficult materials.

## FREE MOTION WORK MONOGRAMS

FASHION DISC: ZIGZAG (O)  
 STITCH WIDTH: 2 - 5  
 NEEDLE POSITION: CENTER  
 THROAT PLATE: GENERAL PURPOSE (RAISED)  
 PRESSER FOOT: NONE  
 STITCH LENGTH: ABOVE 20

Script lettering can be effectively accomplished with the zigzag stitch, when the free motion principle is employed.

- Trace or mark lettering on right side of fabric.
- Place work in embroidery hoops large enough to encompass entire design. Be sure fabric is held taut.
- Remove presser foot and raise throat plate.
- Position work under needle and lower presser bar to engage tension. Bring bobbin thread up through fabric at start of design. Hold both thread ends to start stitching.
- Move hoops slowly, following outline of lettering. Maintain an even rate of speed so that stitches are uniformly placed.

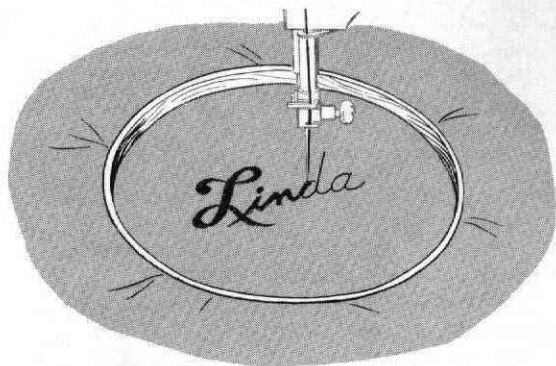

Slow movement of hoops produces a close satin stitch; more rapid movement lengthens the stitch and results in an open effect.

Shading stitches from wide to narrow is controlled by the angle at which work is placed and moved under needle.

A test sample should always be made before proceeding with the actual work to determine stitch setting and spacing. Some fabrics may require addition of an underlay of crisp lawn or organdy.

## FREE MOTION WORK EMBROIDERY

FASHION DISC: ZIGZAG ①

STITCH WIDTH: 2 - 5

NEEDLE POSITION: CENTER

THROAT PLATE: GENERAL PURPOSE (RAISED)

PRESSER FOOT: NONE

STITCH LENGTH: ABOVE 20

Of special interest to those with artistic ability, free motion machine embroidery has many applications to clothing and household linens. Many lovely effects comparable to hand embroidery can be achieved.

Original free hand sketches as well as transfer patterns may be used as guides for stitching.

Prepare the machine and proceed as for free motion script lettering ([page 81](#)).

To achieve a dimensional effect, stitches should be laid to conform to the contour of the design. Smooth effects result when outlines are filled using a slow steady hoop movement; irregular textures when a fast side-to-side motion is employed.

Stitch Width settings are varied to accommodate the size of the area to be covered within a specific design. A test sample will help you determine the method and setting best suited to your purpose.

Placement of bar tacks in sequence can be used to form spraylike leaves and flowers. This technique adds variety and lightness to many designs.

Leaves and petals formed in this manner carry the thread from one bar tack to the next. This carrying thread adds to the attractiveness of the design, while eliminating tying-off of thread ends.

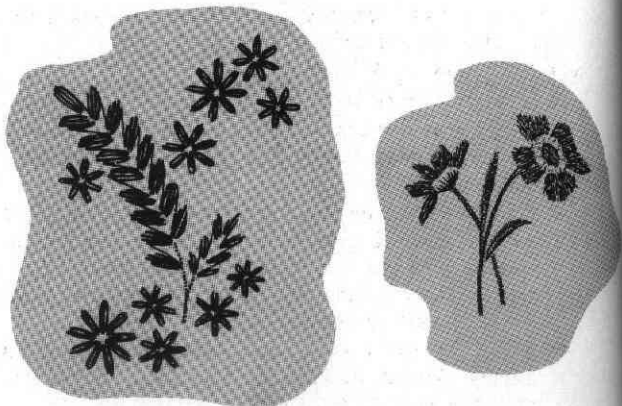

## FASHION\* AIDS

Available for separate purchase at your local SINGER SEWING CENTER

### DARNING AND EMBROIDERY ATTACHMENT

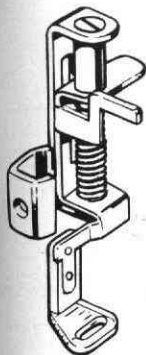

Fabrics that require skillful handling may be darned and embroidered with expert results when the Darning and Embroidery Foot is used.

This attachment is an aid to all who desire perfection in free motion embroidery and applique work.

The foot firmly holds the fabric as the needle enters and rises from the work, while fully revealing the line of design to be followed.

### THE GATHERING FOOT

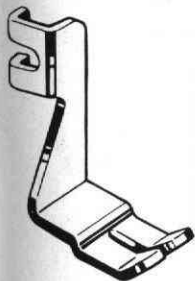

Single or multiple rows of shirring can be quickly and expertly placed with this attachment. Evenly spaced shirring is insured as this foot is designed to lock fullness into each stitch. The amount of fullness is very simply controlled by stitch length and degree of tension.

Use straight stitch setting only.

### THE EDGE STITCHER



This attachment, used with the straight stitch setting, has slotted guides which regulate placement of stitching at edge of fabric.

Among its many applications are the joining and insertion of lace, tucking from pin width to 1/4", French seaming and seam piping, facing and seam finishing.

### THE TUCKER

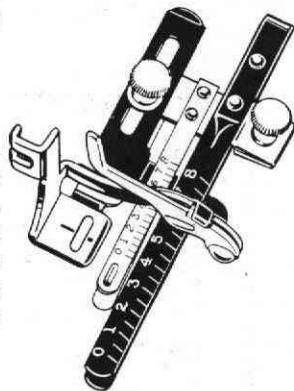

Since the beauty of tucking lies in explicit accuracy, the Tucker will contribute greatly to the attractiveness of this work.

Tucks up to 1" may be stitched and marked in one operation.

Two adjustable scales are provided to gauge tuck width and spacing.

Use either straight or decorative stitch setting.

## ADDITIONAL FASHION DISCS

The following additional FASHION Discs are available for purchase at your local SINGER SEWING CENTER.



2 SCALLOP



3 SOLID DIAMOND



4 SOLID SCALLOP



12 DOMINO



13 FAGOTING



14 COMB



15 THUNDERBIRD



16 SHAG



17 CURLICUE



18 SOLID PYRAMID



19 BLOCK



20 WALLS OF TROY



21 CHEVRON



## TO REPLACE STITCH PATTERN PLATE COVER

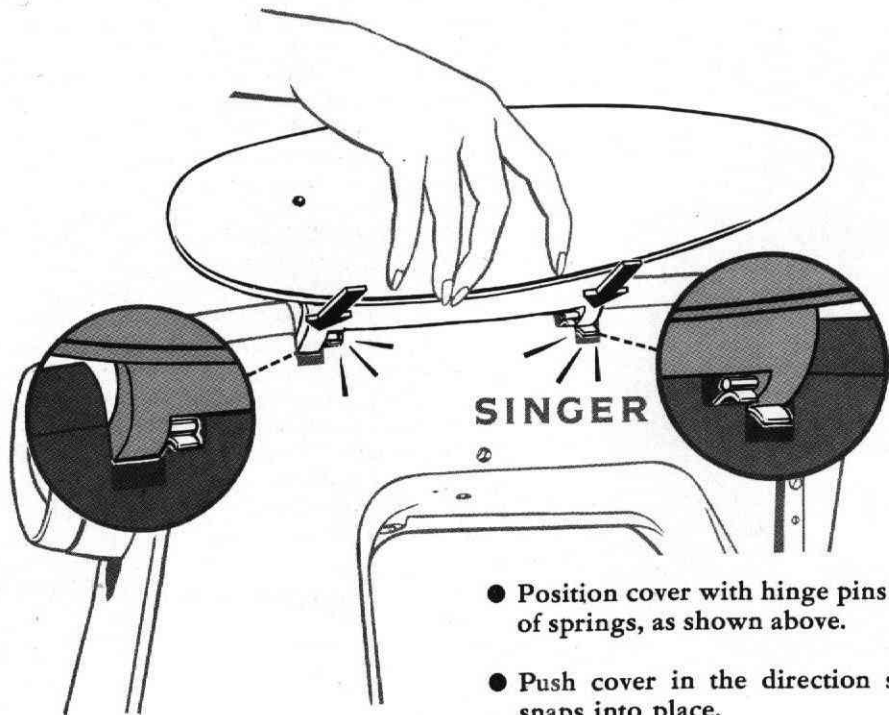

- Position cover with hinge pins resting on top of springs, as shown above.
- Push cover in the direction shown until it snaps into place.

## TO CLEAN THE MACHINE

Your sewing machine was built to exacting standards of precision and workmanship. Its performance depends on the care and treatment it receives when in use and before storing it away.

When in regular use, the machine should be cleaned periodically to remove the lint and fluff which may have accumulated around the working parts. To clean the bobbin case area, see instructions for removing and replacing bobbin case on **pages 87 and 88**. Oil the machine after each cleaning as instructed on **pages 89, 90 and 91**.

If the machine is to be stored away for an indefinite period of time, a thorough brush-cleaning to remove all traces of lint and fluff, followed by swabbing of all exposed parts with a lint-free brush saturated with SINGER\* Oil, is necessary to protect the machine against rust damage. The areas that should be cleaned and covered with a protective coat of oil are shown in the illustration at the left.

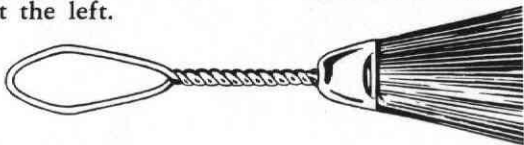
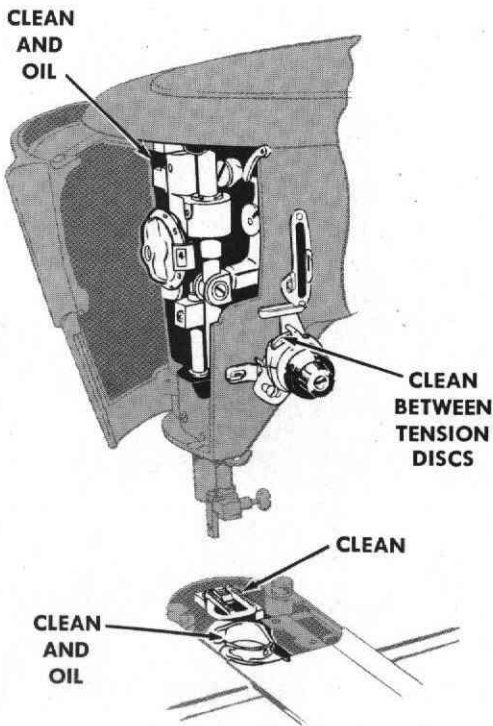



## TO REMOVE THE BOBBIN CASE

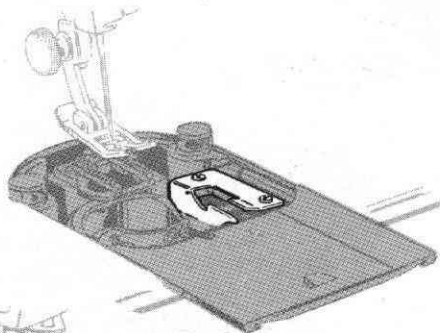
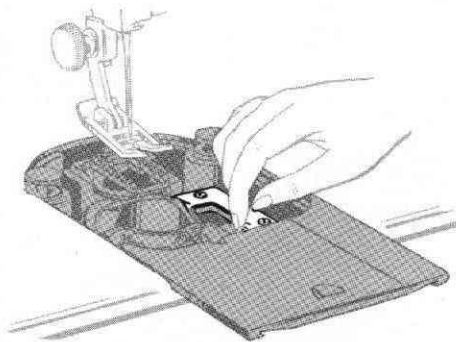

To clean hook raceway, remove bobbin case as follows:

1. Remove throat plate (see **page 15**) and open slide plate (see **page 12**).
2. Unlock bobbin case by lifting and pulling holder to right as shown.
3. Remove bobbin case from machine.
4. Remove all lint, fluff, loose thread ends or any other foreign matter which might clog the machine.

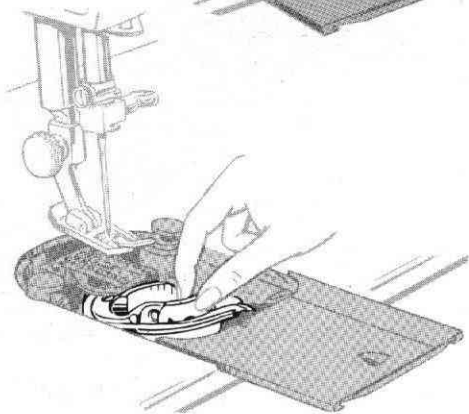

## TO REPLACE THE BOBBIN CASE

POSITIONING  
STUD

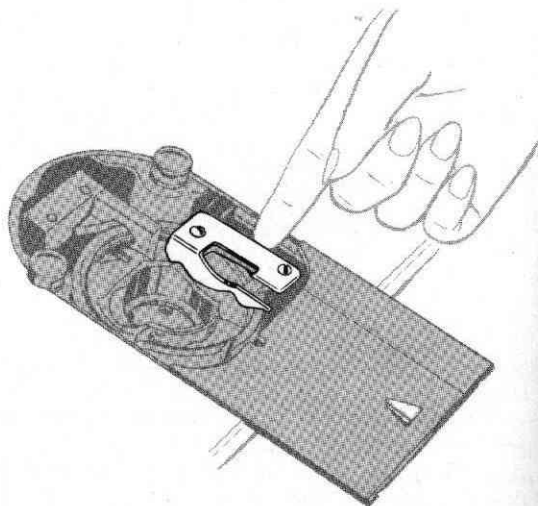
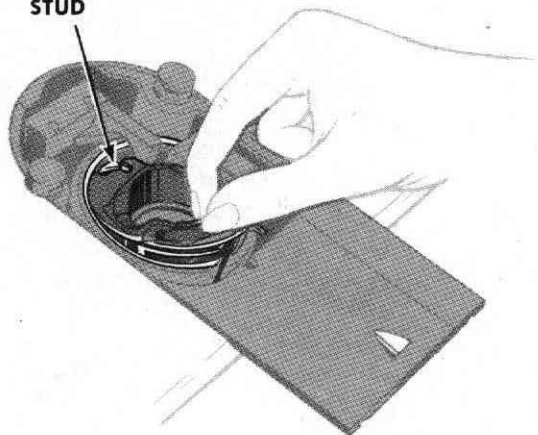

5. Replace bobbin case so that groove under tension spring fits on hook raceway and fork of case straddles positioning stud.
6. Push bobbin case holder to left as shown until it snaps down into lock position.
7. Close bed slide and replace throat plate.

## TO LUBRICATE THE MACHINE

To keep your machine in top running condition, use SINGER\* Oil and SINGER\* Lubricant. Both are quality products especially prepared for sewing machines, and should always be used in the care of your 503.

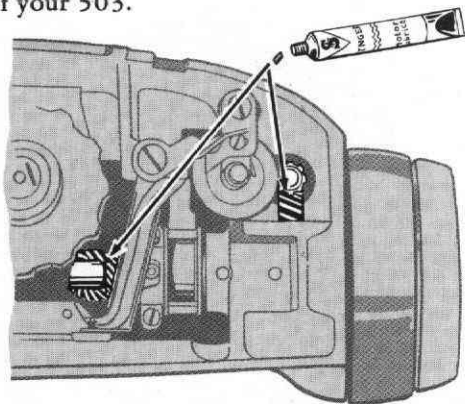
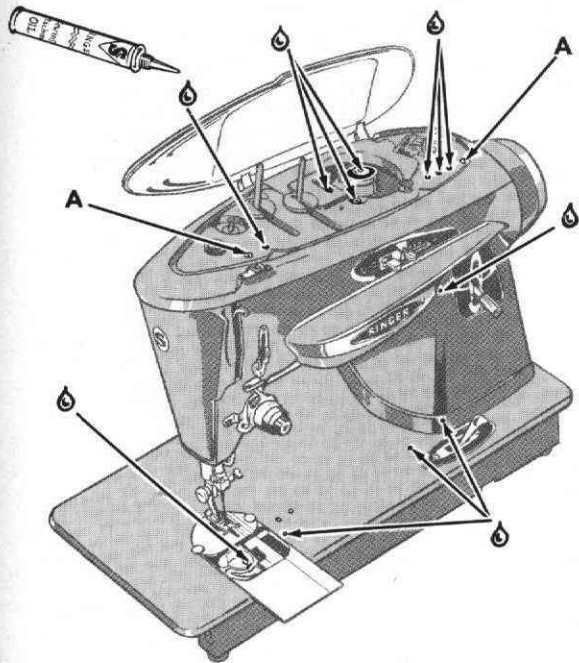

Clean the machine periodically as instructed on **page 86**.

Apply a drop of oil to each place indicated. Remove screws **A** and lift off arm top cover. Apply a small amount of lubricant to the gears as shown.

A tube of this lubricant can be purchased at your SINGER SEWING CENTER.

**NEVER APPLY OIL TO THESE GEARS.**

## TO LUBRICATE THE MACHINE (Cont'd)

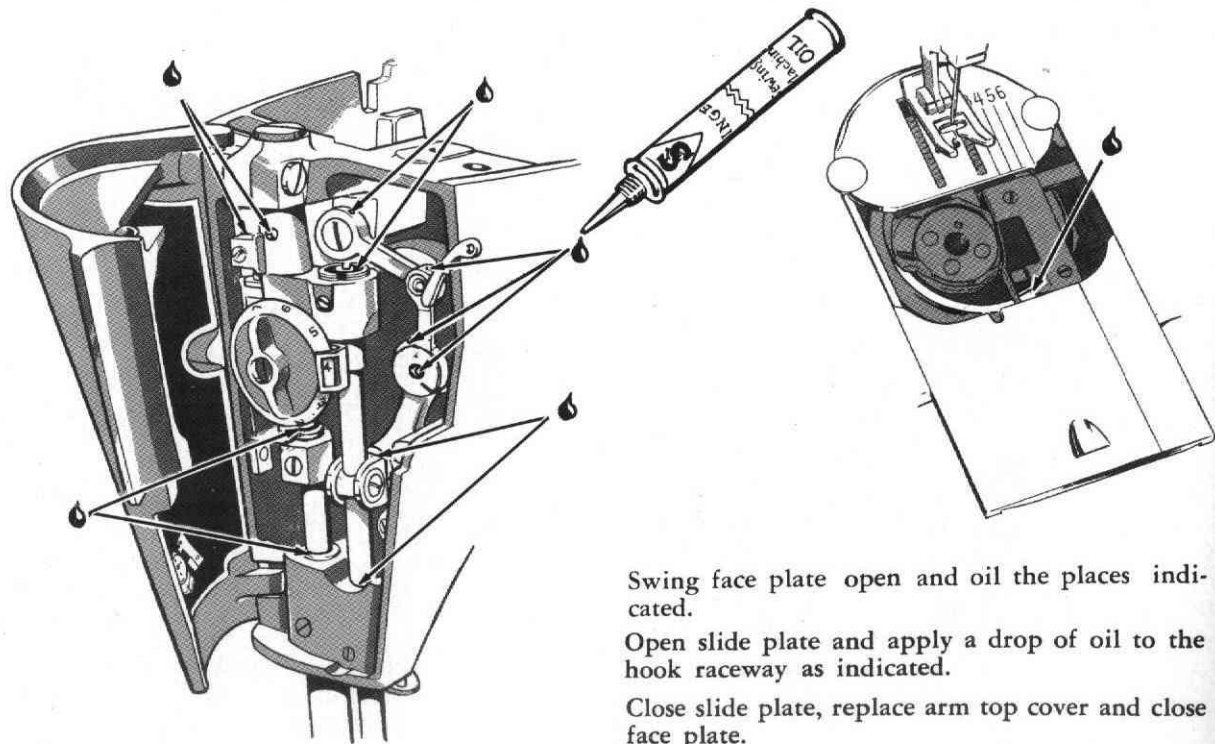

Swing face plate open and oil the places indicated.

Open slide plate and apply a drop of oil to the hook raceway as indicated.

Close slide plate, replace arm top cover and close face plate.

## TO LUBRICATE THE MACHINE (Cont'd)

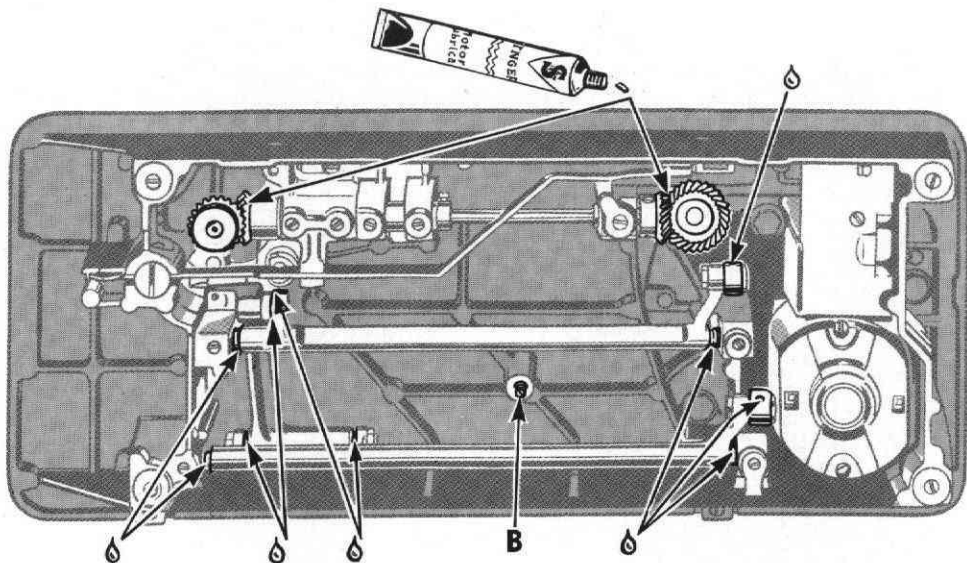

Tilt machine back and remove thumb nut from screw **B**, being careful not to lose felt washer, and remove cover from underside of machine.

Oil each of places indicated by arrows and occasionally apply a small quantity of lubricant to teeth of gears as shown.

Replace bottom cover.

**THE MOTOR REQUIRES NO LUBRICATION.**

## ELECTRICAL INFORMATION

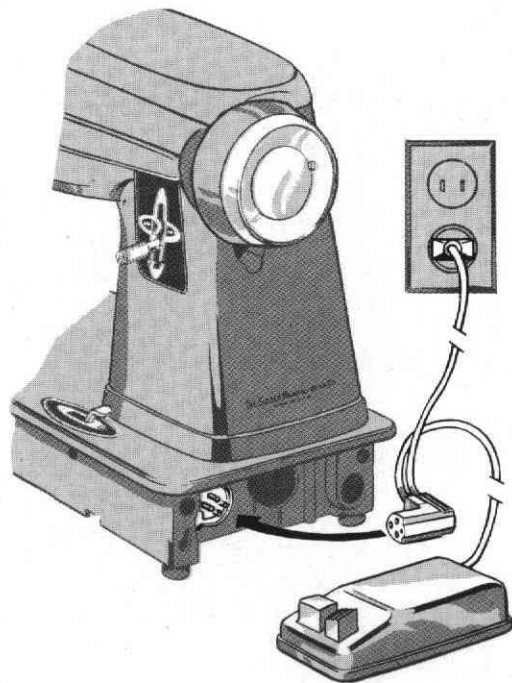

The **SINGER\* Electric Motor** in your sewing machine is furnished for operation on an alternating current of 110-120 volts, 25 to 75 cycles, or on 110-120 volts direct current. Special motors can be provided through your **SINGER SEWING CENTER** for direct or alternating current for any voltage between 95 and 145.

**Before Inserting Electric Plug,** be sure that the voltage and the number of cycles stamped on the four-pin terminal receptacle are within the range marked on your electric meter installed by your power company.

**Electrical Connections for Machine.** Push four-pin terminal plug on four-pin receptacle at right end of bed and connect plug at other end of cord to the electrical outlet.

**Speed Controller.** The speed of the machine is regulated by the amount of pressure on the pedal of the foot controller or the knee lever.

## LIGHT

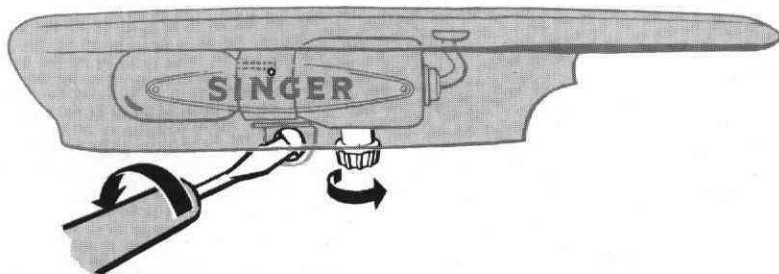

The light is turned "on" or "off" by the light switch.

**To Remove Bulb.** Remove screw which fastens lamp shade to machine and remove lamp shade.

Do not attempt to unscrew bulb. Press it into socket and at same time turn bulb over in direction shown to unlock bulb pin.

**To Replace Bulb.** Press new bulb into socket with bulb pin entering slot of socket and turn it over in direction shown to lock bulb pin in position. Replace lamp cover and securely fasten it in position with the lamp shade screw.

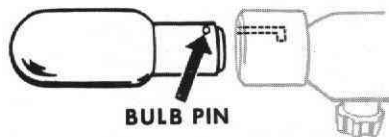

BULB PIN

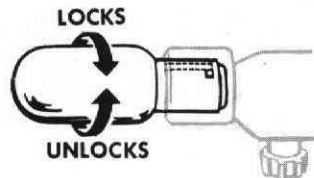

LOCKS

UNLOCKS

## INDEX

	PAGE		PAGE
Applique .....	46-47	Cording	
Attachments		Seams .....	67
Button Sewing Foot .....	54-55	Welting .....	66
Foot Hemmer .....	71-73	Couching .....	53
General Purpose Foot .....	56-62	Darning .....	62
Multi-slotted Binder .....	74-75	Darning, Free Motion Work .....	80
Ruffler .....	76-79	Darning and Embroidery Attachment .....	83
Seam Guide .....	68-70	Darts .....	59-60
Special Purpose Foot .....	42-53	Interfacing .....	60
Zipper Foot .....	63-67	Single Thread .....	59
Binding .....	74-75	Decorative Hems .....	72
Blanket Binding, Replacing of .....	60	Edge Stitcher .....	83
Blind Stitching		Elastic	
Hems .....	70	Application of Band .....	61
Zipper Insertion .....	65	Girdle Mending .....	61
Bobbin		Electrical Information .....	92-93
Preparation for Stitching .....	25	Light .....	93
Removing .....	12	Motor .....	92
Thread Tension .....	21	Embroidery, Free Motion Work .....	82
Winding .....	10-11	Fabric, Thread, Needle and Stitch Length	
Bobbin Case		Chart .....	6
Removal and Replacement .....	87-88	Fabrics, Guiding and Supporting .....	28
Threading .....	13	FASHION Aids .....	83
Border Designs .....	50-51	FASHION Discs .....	32-34
Buttonholes .....	42-45	Additional .....	84
Corded .....	45	Removal and Replacement of .....	34
Button Sewing .....	54-55	Features .....	3
Chart for Fabric, Thread, Needle and		Filler Cord, Threading of .....	45
Stitch Length .....	6	Finishes, Seam .....	58
Cleaning the Machine .....	86-88	Foot Hemmer .....	71-73
Corded Applique .....	47	Decorative Hems .....	72
Corded Buttonholes .....	45	Hemmed Seams .....	72



## INDEX (Con't)

	PAGE		PAGE
Hemming with Lace .....	73	Needle, Thread, Fabric and Stitch	
Free Motion Work .....	80-82	Length Chart .....	6
Darning .....	80	Needle Thread Tension	
Embroidery .....	82	Satin Stitching .....	31
Monograms .....	81	Straight Stitching .....	20
Gathering .....	77-78	Needle Threading	
Gathering Foot .....	83	Single .....	8-9
General Purpose Foot, Applications of .....	56-62	Two .....	38
Guiding and Supporting Fabric .....	28	Oiling .....	89-91
Hemmed Seams .....	72	Pleating .....	79
Hemming with Lace .....	73	Prepare to Sew .....	25
Hems		Pressure Adjustments .....	17
Blind Stitched .....	70	Principal Parts of Machine .....	5
Decorative .....	72	Removal and Replacement of Bobbin .....	12
Interfacing Darts .....	60	Removal and Replacement of Bobbin Case .....	87-88
Knit Fabric Seams .....	57	Removal and Replacement of FASHION Discs .....	34
Lace		Removal and Replacement of Throat Plate .....	15
Applique .....	47	Reverse Stitching	
Edging and Insertion .....	53 and 73	Application .....	26-27
Length of Stitch, Regulating .....	16	Regulation .....	16
Light Bulb, Replacement of .....	93	Ruffler .....	76-79
Lubricating .....	89-91	Attaching Ruffle .....	78
Mending .....	61	Gathering .....	77-78
Monograms, Free Motion Work .....	81	Pleating .....	79
Monograms and Motifs .....	48-49	Satin Stitching	
Motor .....	92	Stitch Length Adjustment .....	30
Multi-slotted Binder .....	74-75	Tension Adjustment .....	31
Needle Insertion .....	7 and 37	Seam Finishes .....	58
Needle Position Selector		Seam Guide .....	68-70
Operation of .....	18	Blind Stitched Hems .....	70
Two-Needle Setting .....	40	Seams .....	68
Zigzag Setting .....	36	Top Stitching .....	69

## INDEX (Con't)

	PAGE		PAGE
Seams		Thread, Needle, Fabric and Stitch	
Corded	67	Length Chart	6
Flat Felled	57	Threading	
Knit Fabric	57	Bobbin Case	13
Lingerie	56	Filler Cord	45
Sheer Fabrics	52	Single Needle	8-9
Straight	26-27	Two Needle	38
Supporting and Guiding	28	Throat Plate	
Sheer Fabric Seams	52	Changing	15
SINGER Service	4	Positions	14
Single Thread Darts	59	Straight Stitch	24
Special Purpose Foot, Applications of	42-53	Zigzag Stitch	29
Stitch Length		Top Stitching	69
Regulator	16	Tucker	83
Satin Stitch Adjustment	30	Two Needles	
Stitch Length, Fabric, Thread and Needle		Illustrations of Work	41
Chart	6	Insertion	37
Stitch Pattern Chart, Replacement of	85	Straight Stitching	39
Stitch Patterns		Threading	38
Basic FASHION Discs	33	Zigzag Stitching	40
Additional FASHION Discs	84	Welting	66
Stitch Width Selector		Winding a Bobbin	10-11
Control of Width	35	Zigzag Stitching	
Operation	19	Control of Width	35
Two Needle Settings	39-40	Equipment	29
Straight Stitching		FASHION Discs	33
Equipment and Settings	22-24	Needle Positions	36
Left and Right Needle Position	23	Operation	32
Seams	26-27	Stitch Length Adjustment	30
Two Needles	39	Tension Adjustment	31
Tension Adjustments		Two Needles	40
Bobbin Thread	21	Zipper Foot	63-67
Needle Thread	20	Welting and Corded Seams	66-67
Satin Stitching	31	Zipper Insertion	64-65

**To all whom it may concern:**

The improper placing or renewal of the trademark "**SINGER**" or any other of the trademarks of The Singer Manufacturing Company (all of which are duly Registered Trademarks) on any machine that has been repaired, rebuilt, reconditioned, or altered in any way whatsoever outside a SINGER factory or an authorized SINGER agency is forbidden.

## For your protection

SINGER Sewing Machines are sold and serviced wherever you see the famous SINGER and Red "S" Trademarks. When your machine needs servicing call your SINGER SEWING CENTER to be sure of warranted SINGER parts and service. See address in the classified telephone directory.

S I N G E R   S E W I N G   M A C H I N E   C O M P A N Y