

COMMERCIAL DURAPOST

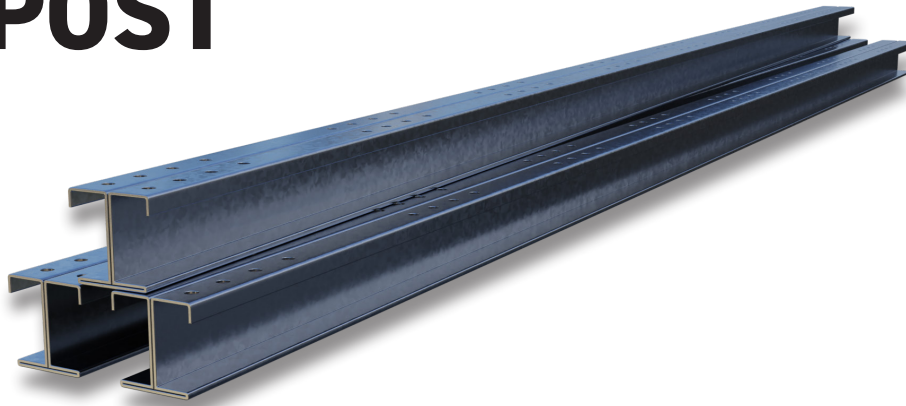

DESCRIPTION

DuraPost is a patented cold rolled galvanised steel (DX51D Z275NA-C) fence post system manufactured to EN 10346. Lightweight yet stronger and more durable than traditional fence posts, DuraPost offers a maintenance free fence post solution for commercial applications.

Made with 2.5mm steel compared to the 1.5mm thick classic version, the commercial DuraPost offers superior strength for higher fencing applications. The post is available in 2.4m, 3.0m, 3.4m, 4.0m and 5.0m lengths making it scalable for fencing projects up to 4m above the ground.

All powder coatings are salt spray tested to 1,000 hours to BS 3900F4, impact resistance to BS 3900E3, scratch resistance to BS 3900E2, and humidity minimum to 1,000 hours to BS3900F2.



Image: a 2.4m high hit and miss timber panel between two galvanised Commercial DuraPosts

FINISHES

Commercial DuraPost comes Galvanised as a standard finish. Other RAL finishes are available to order including the standard DuraPost colours: Anthracite Grey (RAL 7016), Sepia Brown (RAL 8014), Olive Grey (RAL 7002)

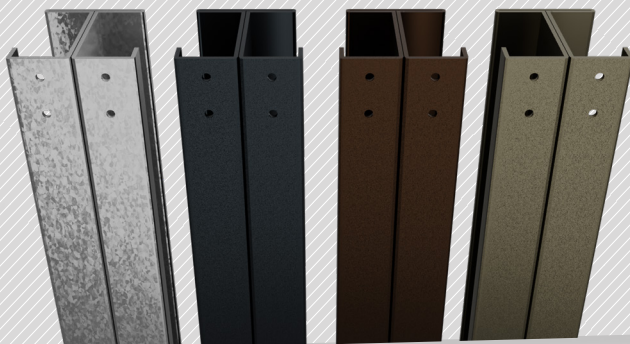

DURABILITY TESTED

DuraPost has been durability tested to EN 1794-1-2018 with wind speeds of up to 90mph (static load tested to 1,000kg/10,000N). Tests were carried out on 3.0m Posts, 2.4m above ground, with 1.8m centres.



Important: If you increase the height - to maintain the same load you need to decrease the centres. A minimum length of 600mm is recommended below the ground for a 2.4m post. This depth should increase accordingly as longer posts are used.

PATENTED



REGISTERED COMMUNITY DESIGN

- 005518057-001
- 006429171-001

DURAPOST POWDER COATING

Powder coating is mainly used for the coating and protection of metals. Polyester powder coating is a type of coating that is applied as a free-flowing dry powder.

Unlike conventional liquid paint which is delivered via an evaporating solvent, powder coating is typically applied electrostatically and then cured under heat or with ultraviolet light. The powder is a thermoset polymer, which is used to create a hard finish that is tougher than conventional paint. Polyester Powder Coatings offer durable decorative finishes in a wide range of colours, textures and gloss levels. They are formulated to provide maximum corrosion resistance, colour stability and gloss retention. They are suitable for interior and exterior use and entirely T.G.I.C free (triglycidyl isocyanurate crosslinkers).

All items are coated in accordance with BS-13438.

Our powders have certificated industry standard approval which are available on request.

Pre-Treatment

To ensure the best adhesion for coatings, all products undergo an eight-stage extensive pre-treatment process. As part of this process DuraPost use the premier brand for surface technology and process solutions that create competitive advantages across the industrial manufacturing marketplace.

Trusted for reliability, sustainability and proven results, our processes deliver superior operational efficiency. DuraPost use the latest conversion coating technologies that perform well on all standard substrates of steel, zinc and aluminium. They significantly reduce the environmental impact, while their corrosion performance meets metal finishing specifications for powder coated metal substrates.

Tested

All powder coatings are salt spray test to 1,000 hours to BS 3900F4, impact resistance to BS 3900E3, scratch resistance to BS 3900E2, and humidity minimum 1,000 hours to BS3900F2.



STORAGE SPACE AND WEIGHT

Manufactured in lengths of 2.4m, 3.0m, 3.4m, 4.0m and 5.0m all DuraPost fence posts come palletised. The patent design provides a high strength but low weight solution.

Fence Posts	Weight Per Post	Pallet Quantities
2.4	16.55 kg	75
3.0	20.69 kg	60
3.4	23.45 kg	55
4.0	27.58 kg	45
5.0	34.47 kg	35

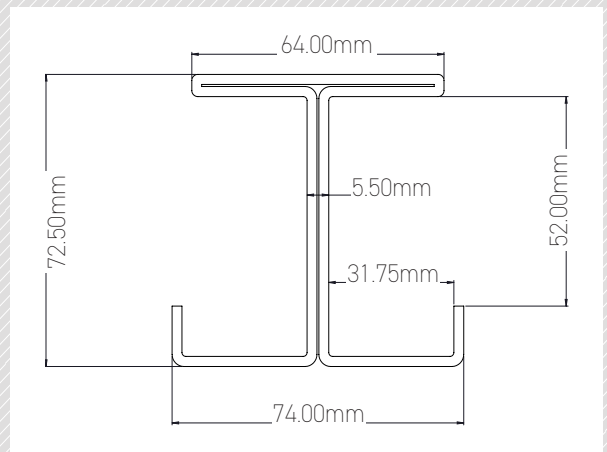

2.4m

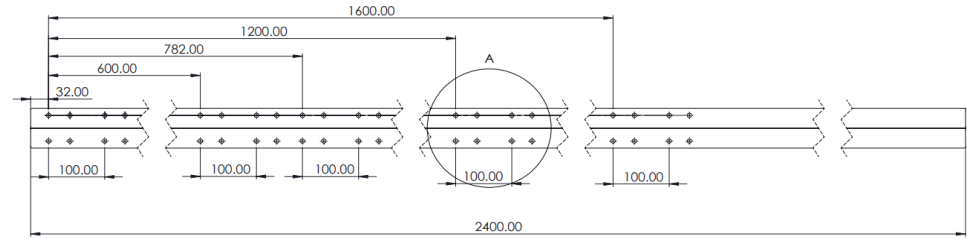
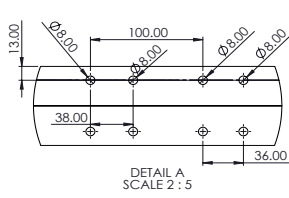

3.0m

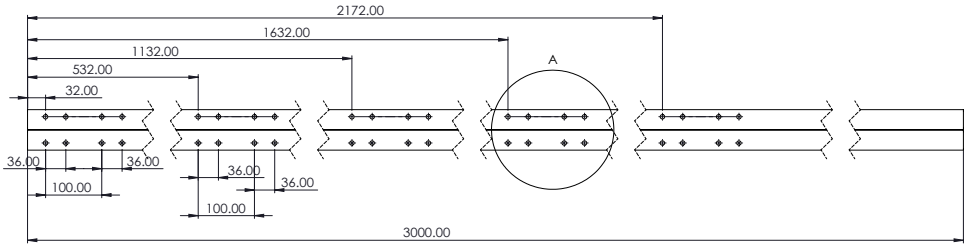
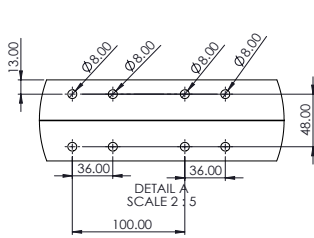

3.4m

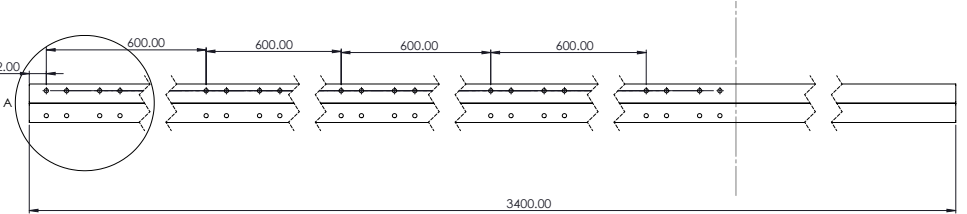
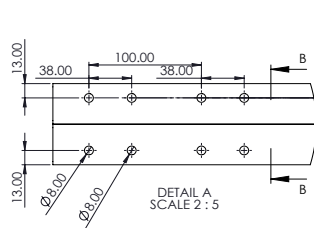

4.0m

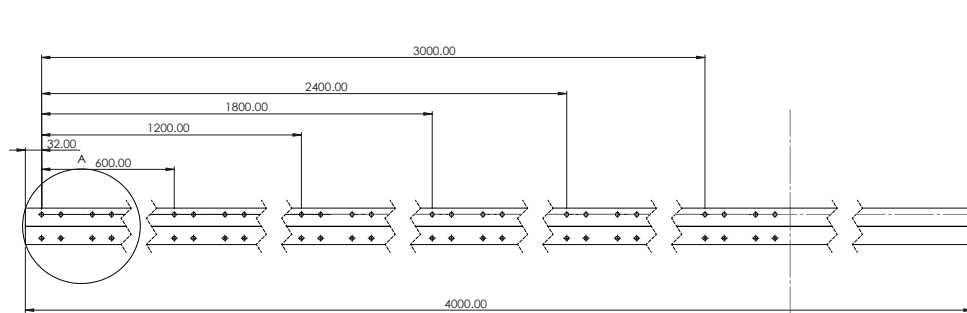
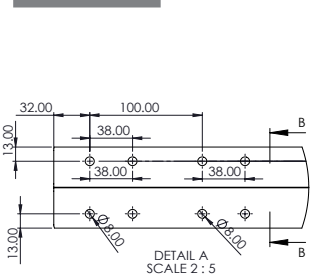

5.0m

