

TABLE OF CONTENTS

1	Before driving	Information on the hybrid system (hybrid vehicle) and adjusting and operating features such as door locks, mirrors, and steering column.
2	When driving	Driving, stopping and safe-driving information.
3	Interior features	Air conditioning and audio systems, as well as other interior features for a comfortable driving experience.
4	Maintenance and care	Cleaning and protecting your vehicle, performing do-it-yourself maintenance, and maintenance information.
5	When trouble arises	What to do if the vehicle needs to be towed, gets a flat tire, or is involved in an accident.
6	Vehicle specifications	Detailed vehicle information.
	Index	Alphabetical listing of information contained in this manual.

1 Before driving

**1-1. Hybrid system
(hybrid vehicle)**

Hybrid system features 48
 Hybrid system precautions ... 52
 Energy monitor/
 consumption screen 57
 Hybrid vehicle driving tips 62

1-2. Key information

Keys 64

**1-3. Opening, closing and
locking the doors**

Smart entry & start system ... 69
 Push-button start system 94
 Wireless remote control 105
 Side doors..... 114
 Back door..... 119

**1-4. Adjustable components
(seats, mirrors, steering
wheel)**

Front seats 124
 Rear seats 127
 Head restraints 131
 Seat belts 133
 Steering wheel 140
 Anti-glare inside rear
 view mirror 141
 Outside rear view mirrors.... 144

**1-5. Opening and closing
the windows**

Power windows 147

1-6. Refueling

Opening the fuel tank
 cap 151

1-7. Theft deterrent system

Engine immobilizer/
 immobilizer system 155
 Double locking system 163

1-8. Safety information

Correct driving posture 165
 SRS airbags 167
 Airbag manual on-off
 system 178
 Child restraint systems 182
 Installing child restraints 191

2 When driving

2-1. Driving procedures

Driving the vehicle	202
Engine (ignition) switch (except hybrid vehicle [vehicles without a smart entry & start system]).....	222
Engine (ignition) switch (except hybrid vehicle [vehicles with a smart entry & start system]).....	226
Engine (ignition) switch (hybrid vehicle [vehicles without an electronic key]).....	236
Power (ignition) switch (hybrid vehicle [vehicles with an electronic key])	241
EV drive mode (hybrid vehicle)	248
Hybrid transmission	250
Multidrive	253
Multi-mode manual transmission	258
Manual transmission.....	263
Turn signal lever	267
Parking brake.....	269
Horn	270

2-2. Instrument cluster

Gauges and meters.....	271
Indicators and warning lights.....	276
Multi-information display	284

2-3. Operating the lights and wipers

Headlight switch	291
Fog light switch	300
Windshield wiper and washer	302
Rear window wiper and washer	307

2-4. Using other driving systems

Cruise control	309
Speed limiter	313
Stop & Start system	316
Driving assist systems.....	324
Hill-start assist control (hybrid vehicle).....	330
Diesel particulate filter system.....	332

2-5. Driving information

Cargo and luggage.....	334
Winter driving tips.....	336
Trailer towing (hybrid vehicle).....	340
Trailer towing (except hybrid vehicle [except for South Africa])	341

1

2

3

4

5

6

3 Interior features

3-1. Using the air conditioning system and defogger

Manual air conditioning system 354
 Automatic air conditioning system 361
 Power heater 370
 Rear window and outside rear view mirror defoggers..... 372

3-2. Using the audio system

Audio system types..... 374
 Using the radio..... 379
 Using the CD player..... 383
 Playing back MP3 and WMA discs..... 388
 Operating an iPod..... 394
 Operating a USB memory... 402
 Optimal use of the audio system 409
 Using the AUX port 411
 Using the steering wheel audio switches 412

3-3. Using the interior lights

Interior lights list 415
 • Personal lights 416
 • Interior light 416

3-4. Using the storage features

List of storage features..... 418
 • Glove box..... 419
 • Cup holders..... 420
 • Bottle holders 422

3-5. Other interior features

Sun visors 423
 Vanity mirrors 424
 Clock 426
 Outside temperature display 427
 Portable ashtray 428
 Cigarette lighter..... 429
 Power outlet 430
 Seat heaters 432
 Armrest..... 434
 Panoramic roof shade 435
 Assist grips..... 436
 Floor mat 437
 Luggage compartment features 439

4 Maintenance and care

4-1. Maintenance and care

- Cleaning and protecting the vehicle exterior 444
- Cleaning and protecting the vehicle interior 449

4-2. Maintenance

- Maintenance requirements 452

4-3. Do-it-yourself maintenance

- Do-it-yourself service precautions 455
- Hood 460
- Positioning a floor jack 462
- Engine compartment 465
- 12-volt battery (hybrid vehicle) 484
- Tires 490
- Tire inflation pressure 494
- Wheels 496
- Air conditioning filter 498
- Wireless remote control/ electronic key battery 501
- Checking and replacing fuses 506
- Light bulbs 531

5 When trouble arises

5-1. Essential information

- Emergency flashers 548
- If your vehicle needs to be towed 549
- If you think something is wrong 559
- Fuel pump shut off system (except hybrid vehicle [gasoline engine only]) 560

5-2. Steps to take in an emergency

- If a warning light turns on or a warning buzzer sounds... 561
- If you have a flat tire (vehicles with a spare tire) 578
- If you have a flat tire (vehicles with an emergency tire puncture repair kit) 591
- If the engine will not start (except hybrid vehicle) 616
- If the hybrid system will not start (hybrid vehicle) 619
- If the shift lever cannot be shifted from P (vehicles with a hybrid transmission or a Multidrive) 621
- If the shift lever cannot be shifted (vehicles with a multi-mode manual transmission) 622

1

2

3

4

5

6

If you lose your keys 623

If the electronic key does not operate properly 624

If the vehicle battery is discharged (except hybrid vehicle) 629

If the vehicle's 12-volt battery is discharged (hybrid vehicle) 636

If your vehicle overheats (except hybrid vehicle)..... 642

If your vehicle overheats (hybrid vehicle) 646

If you run out of fuel and the engine stalls (diesel engine only) 651

If the vehicle becomes stuck 654

If your vehicle has to be stopped in an emergency 657

6 Vehicle specifications

6-1. Specifications

Maintenance data (fuel, oil level, etc.)..... 660

Fuel information 686

6-2. Customization

Customizable features 689

Index

Abbreviation list..... 694

Alphabetical index 695

What to do if... 705

1

2

3

4

5

6

3-door models (except hybrid vehicle)

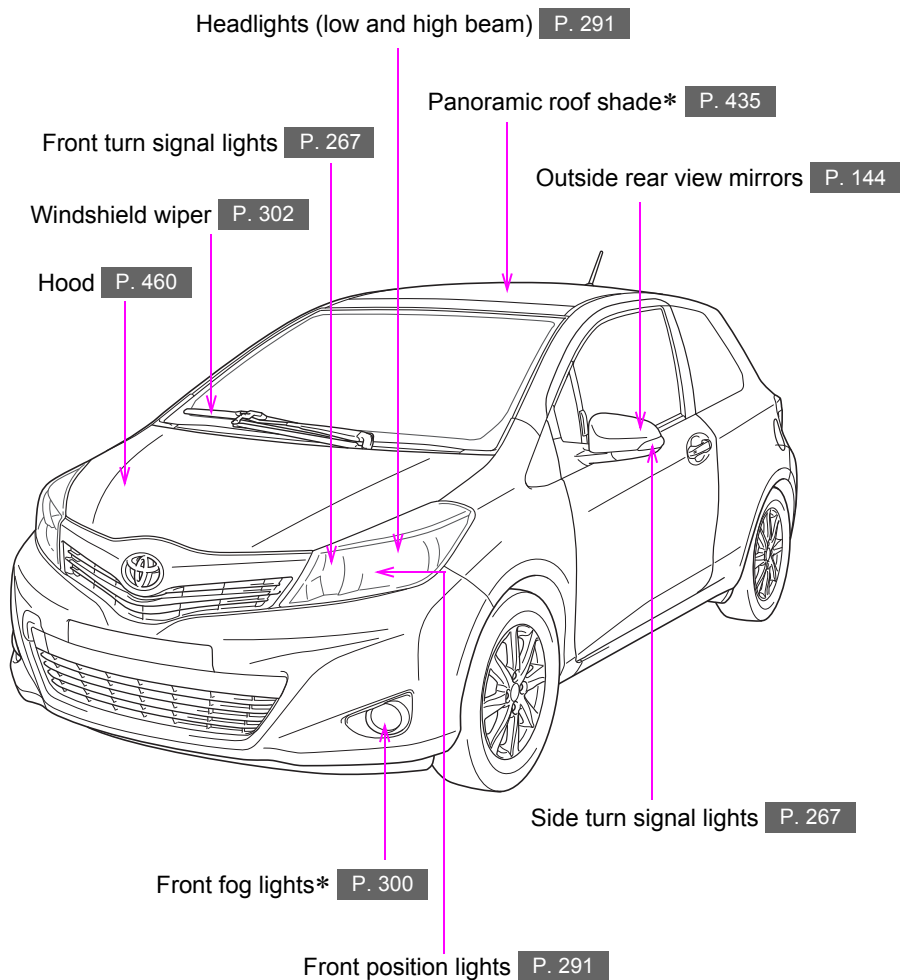

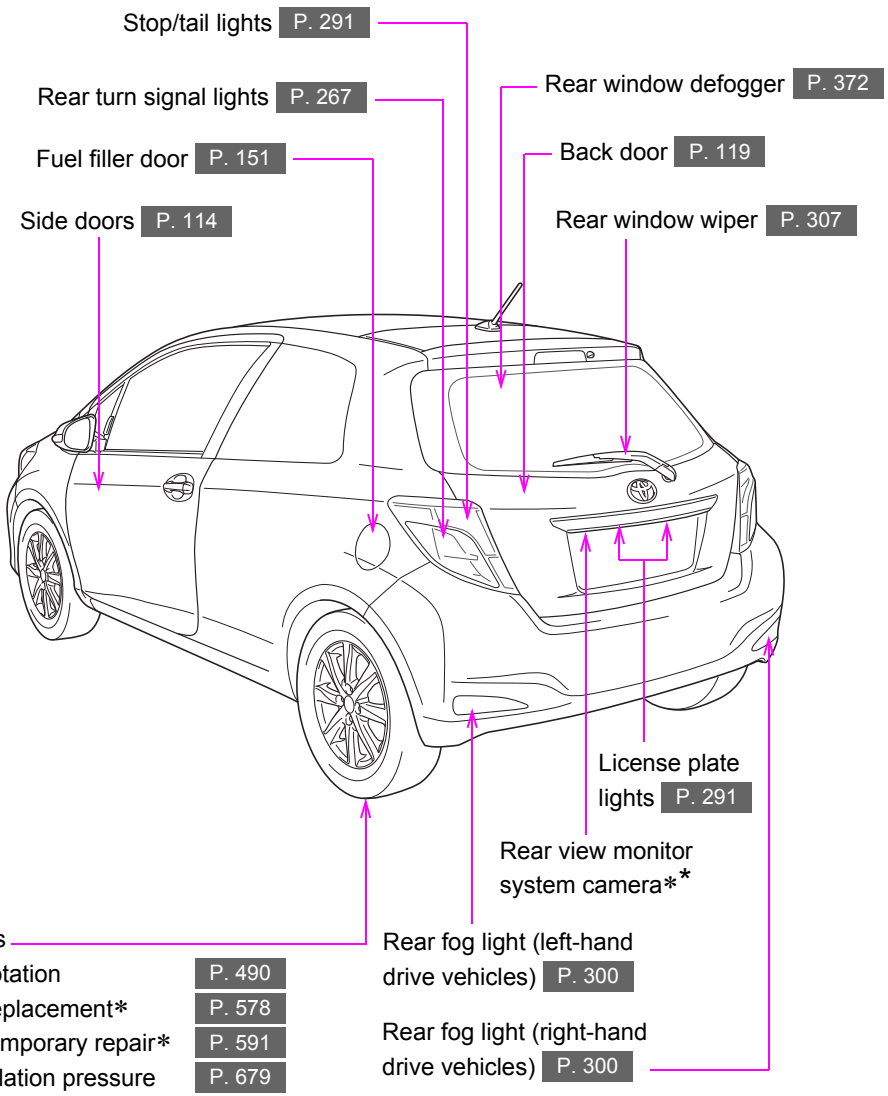

*: If equipped

*: Refer to “touch screen” Owner’s Manual”.

5-door models (except hybrid vehicle)

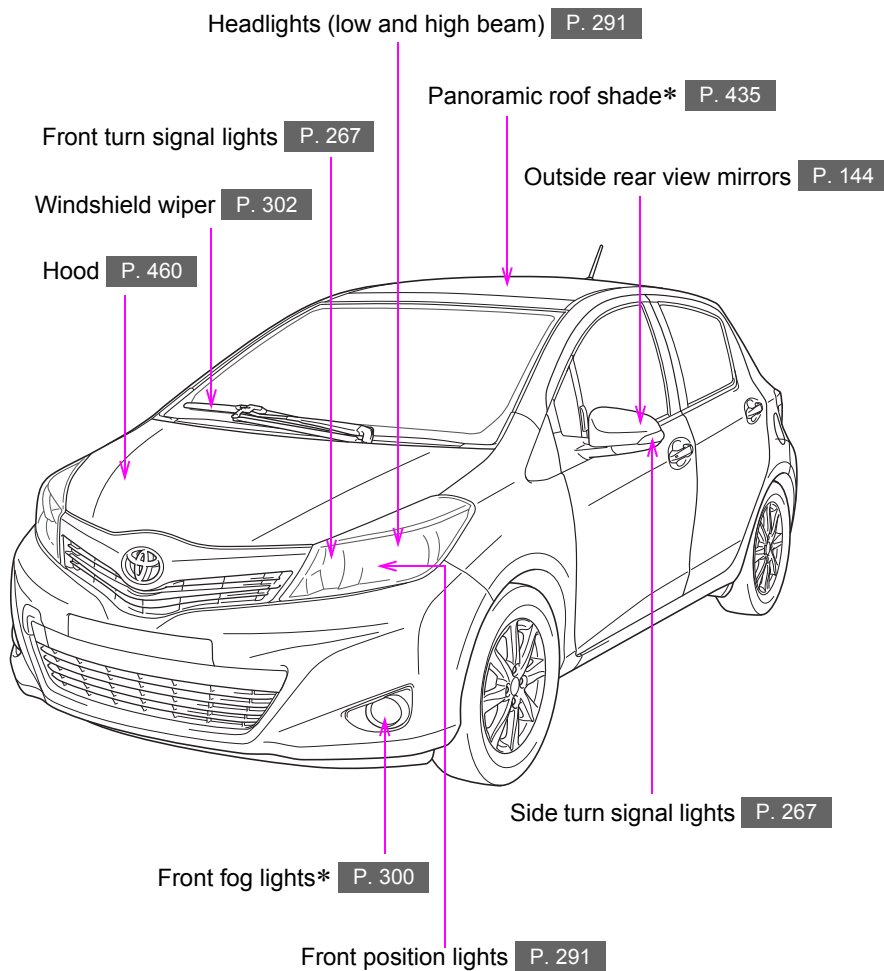

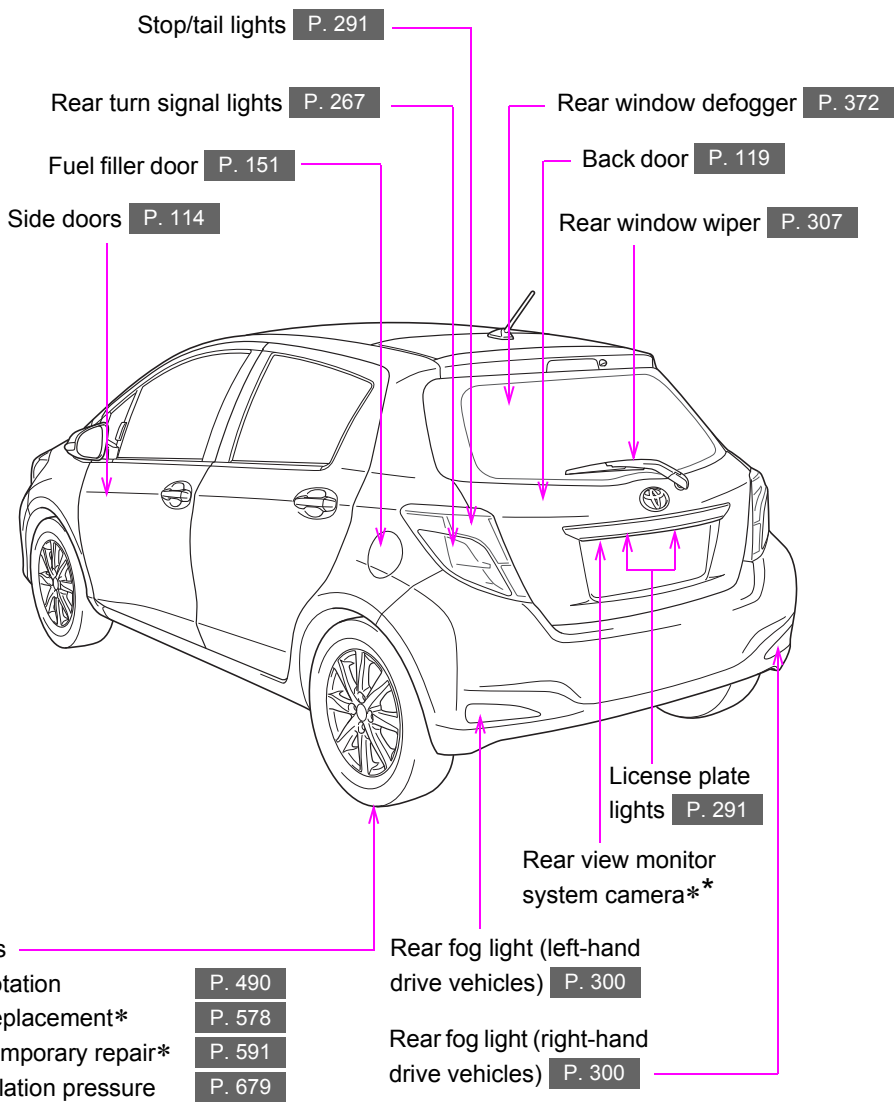

*: If equipped

** : Refer to “touch screen” Owner’s Manual”.

5-door models (hybrid vehicle)

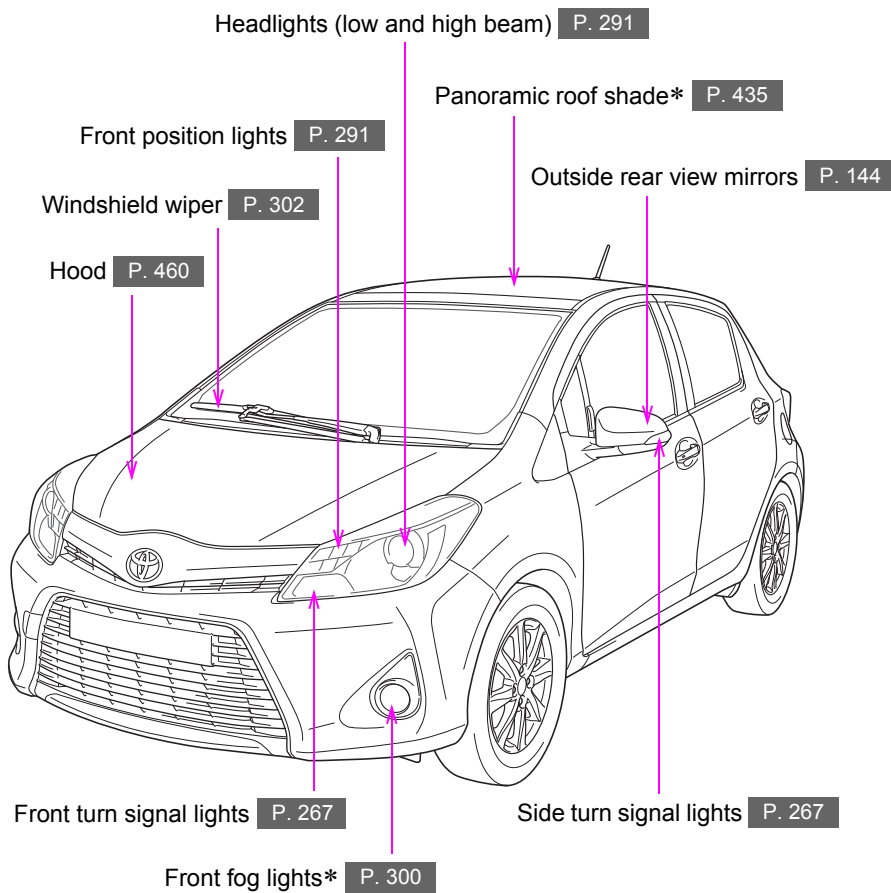

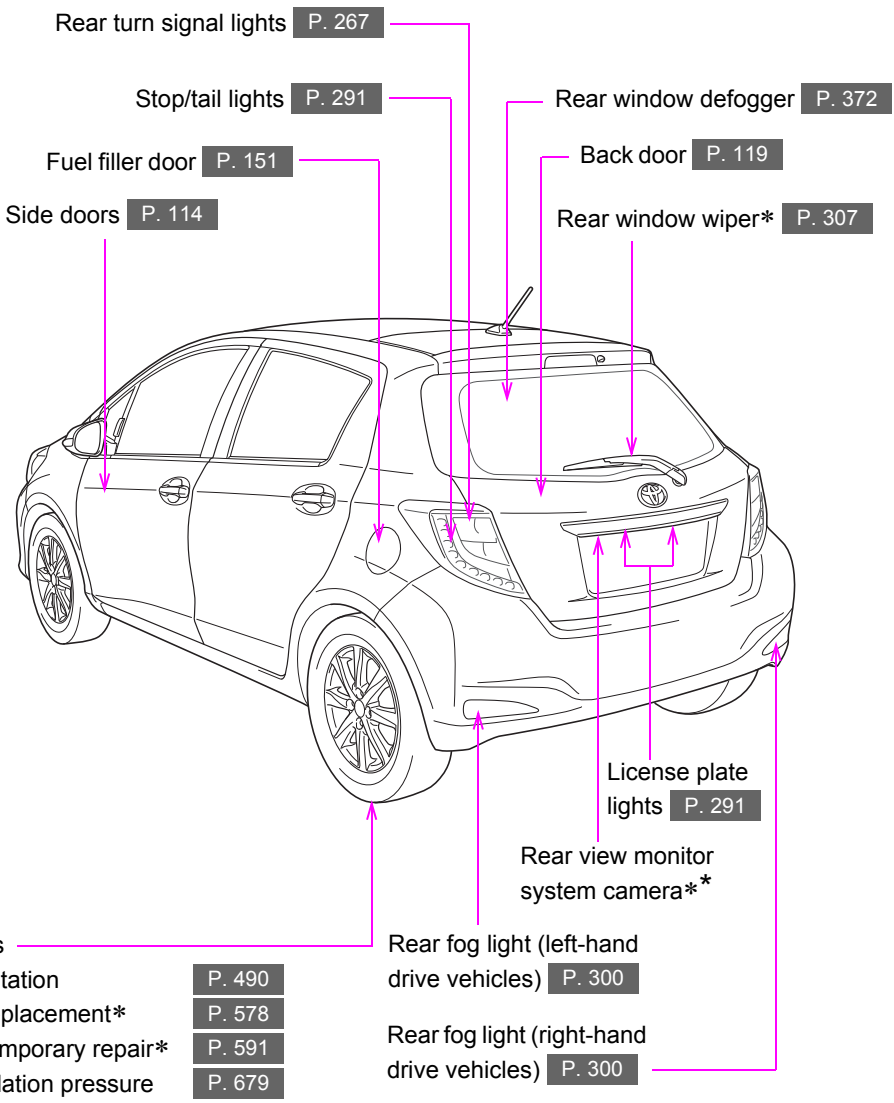

*: If equipped
 **: Refer to “touch screen” Owner’s Manual”.

3-door models (except hybrid vehicle)

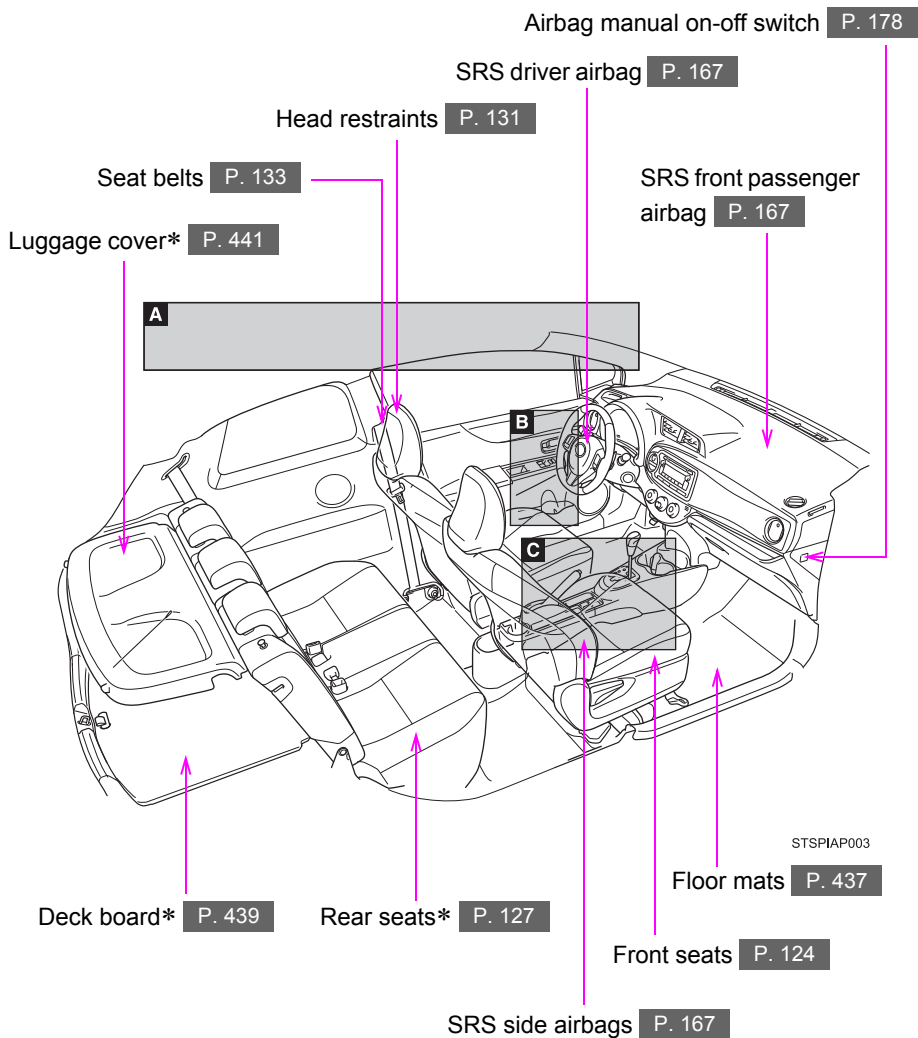

5-door models

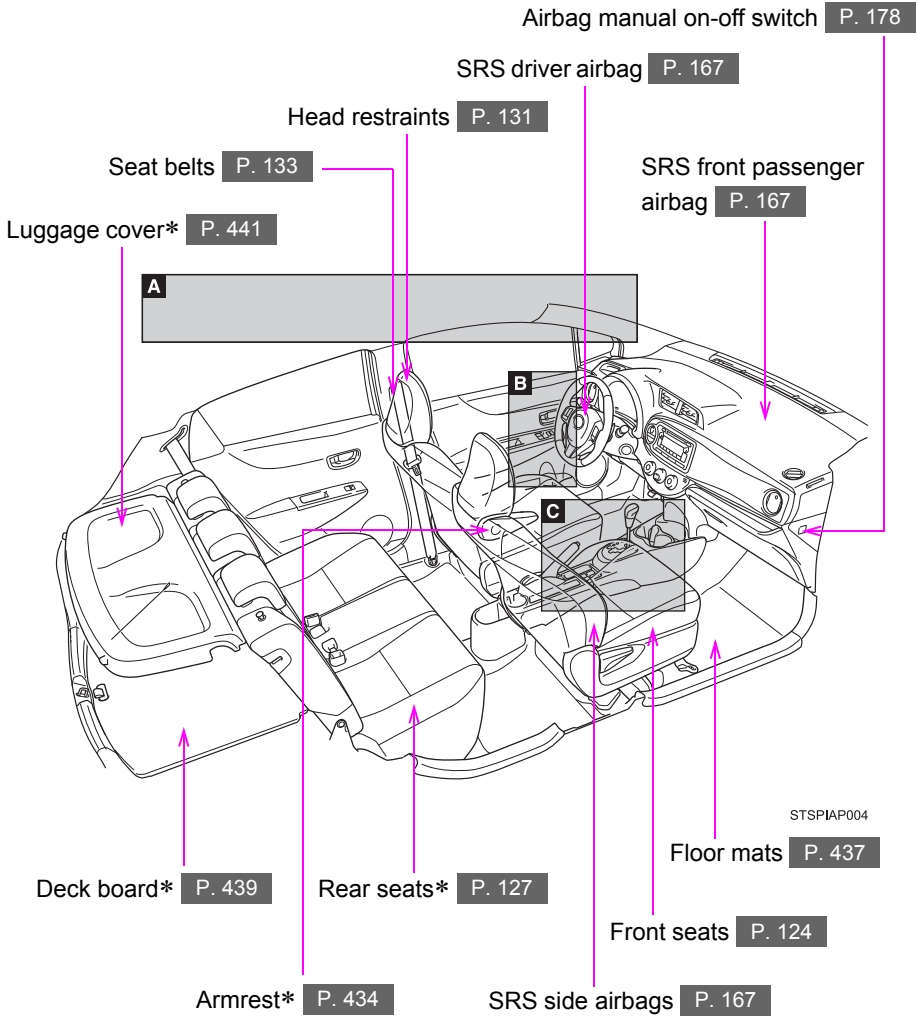

*: If equipped

A

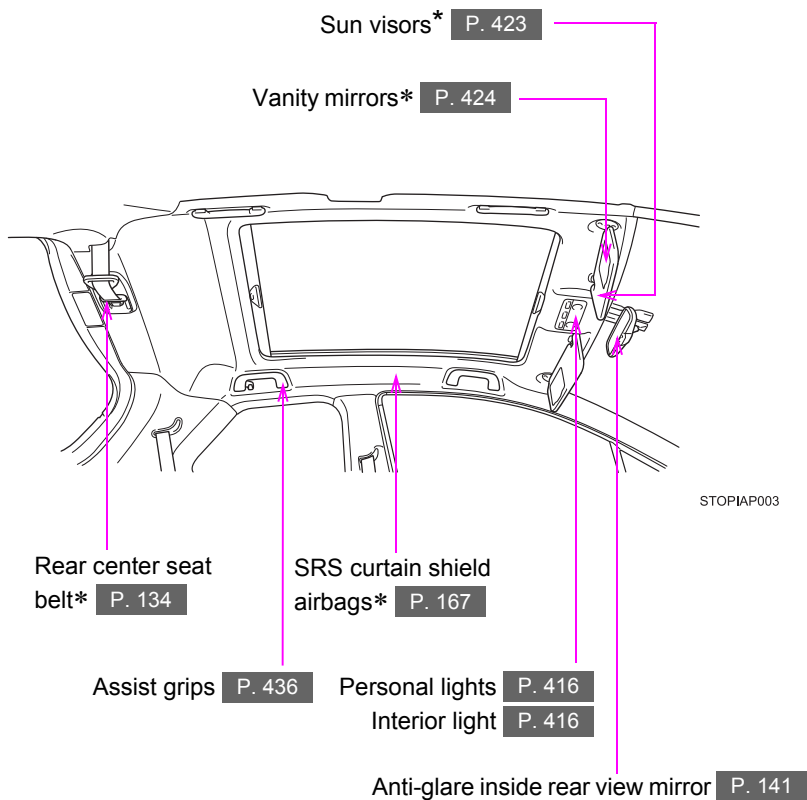

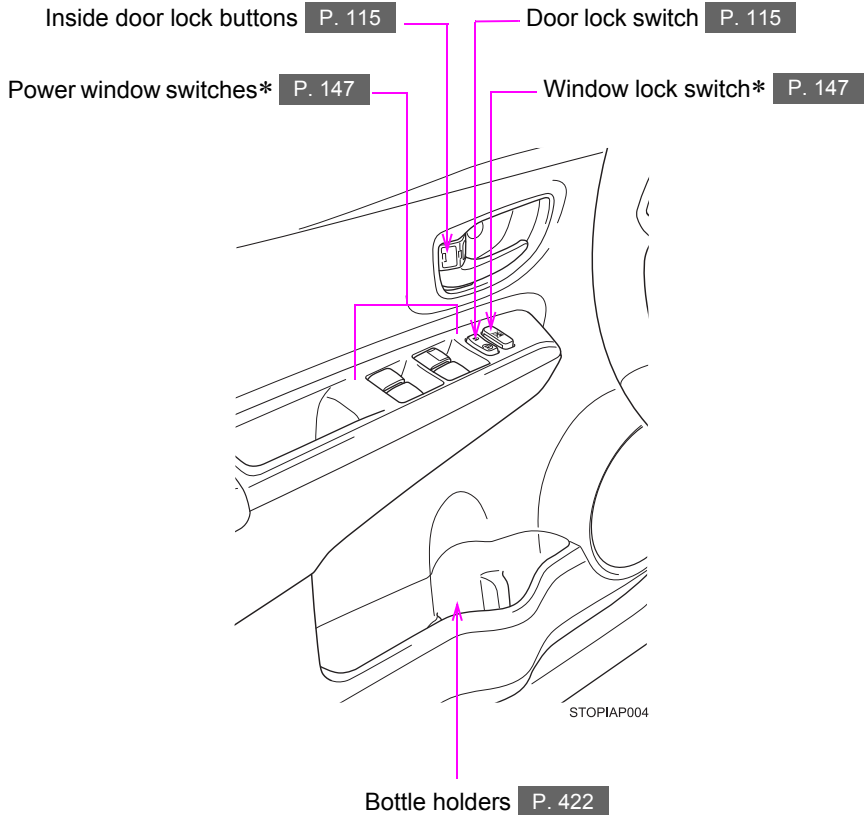
B

*: If equipped

*: NEVER use a rearward facing child restraint on a seat protected by an ACTIVE AIRBAG in front of it, DEATH or SERIOUS INJURY to the CHILD can occur. (→P. 198)



C

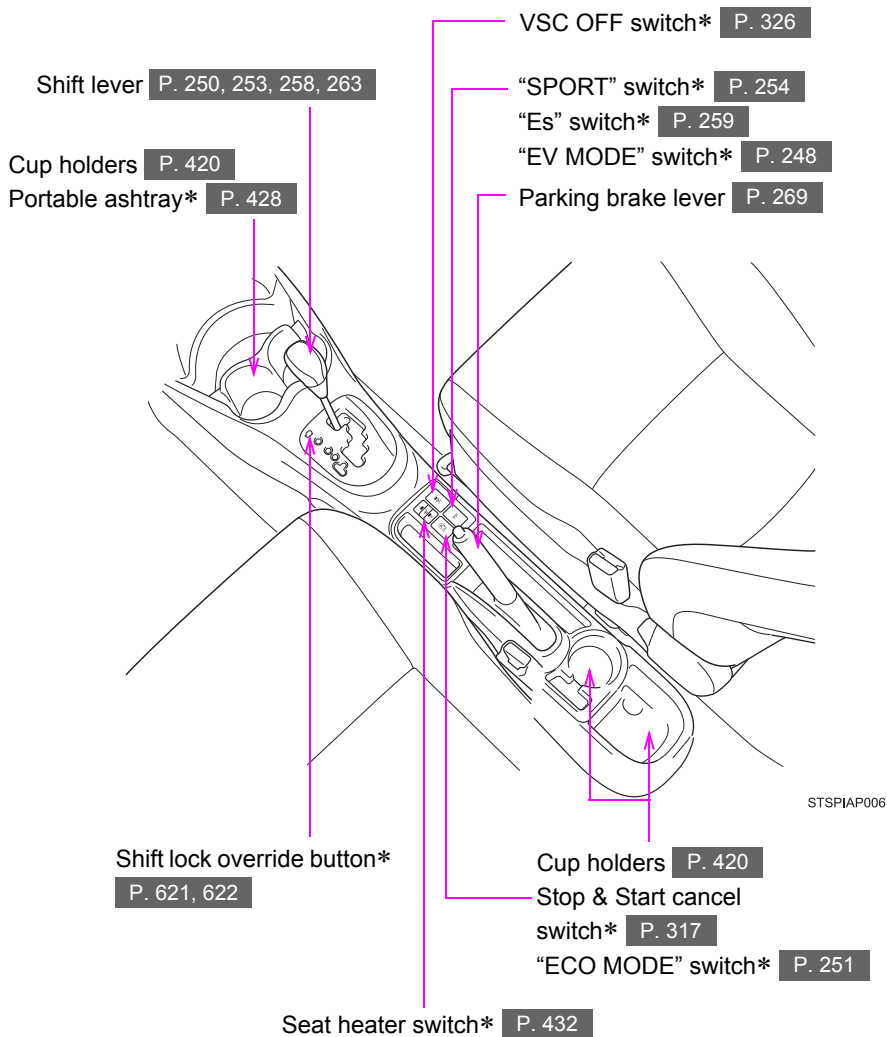

*: If equipped

Gauges and meters P. 271

Multi-information display P. 284

AUX port and USB port*

P. 394, 402, 411

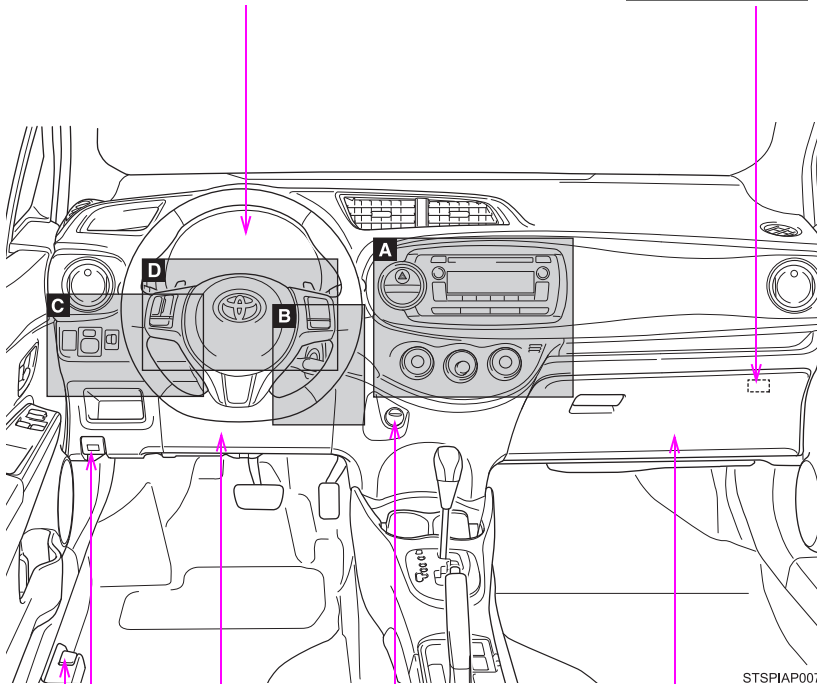

Cigarette lighter* P. 429

Power outlet* P. 430

SRS driver knee airbag* P. 167

Glove box P. 419

Hood lock release lever P. 460

Fuel filler door opener P. 151

*: If equipped

A

Vehicles with a manual air conditioning system

"PASSENGER AIR BAG" indicator P. 178

Emergency flasher switch P. 548

Audio system* P. 374
"touch screen"*

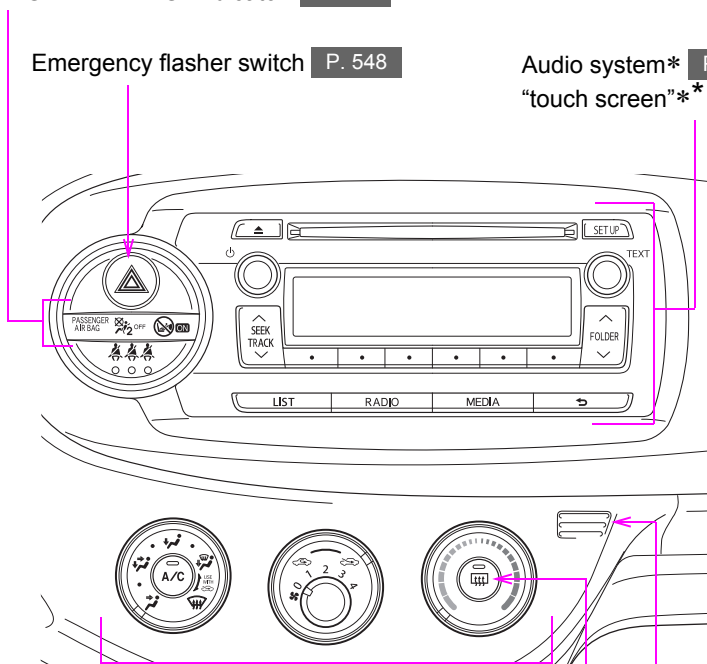

Air conditioning system P. 354

Microphone**

Rear window defogger switch*/
rear window defogger and outside
rear view mirror defoggers switch* P. 372

STSPIAP008

A

Vehicles with an automatic air conditioning system

“PASSENGER AIR BAG” indicator P. 178

Emergency flasher switch P. 548

Audio system* P. 374
“touch screen”*

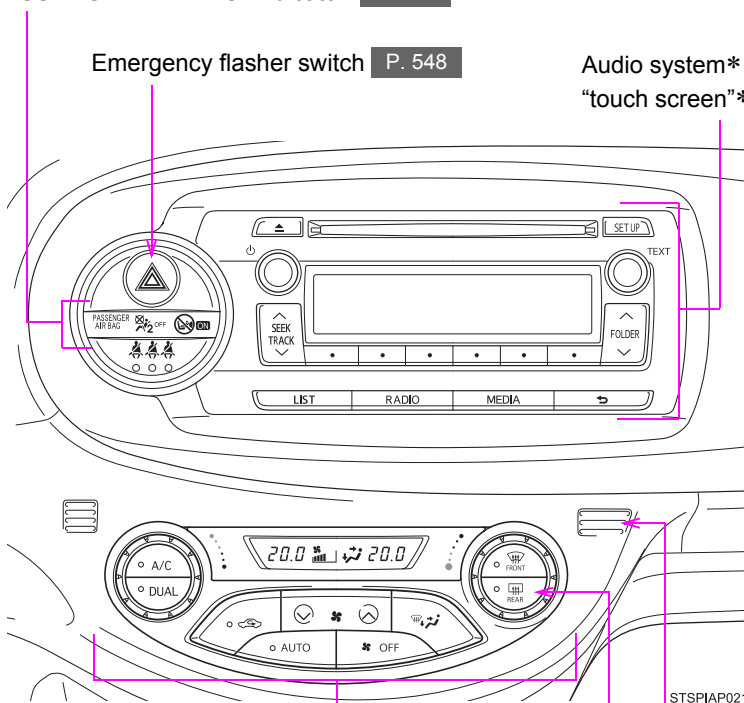

Air conditioning system P. 361

Microphone**

Rear window defogger switch*/
rear window defogger and outside rear
view mirror defoggers switch* P. 372

*: If equipped

*: Refer to ““touch screen” Owner’s Manual”.

B

Except hybrid vehicle

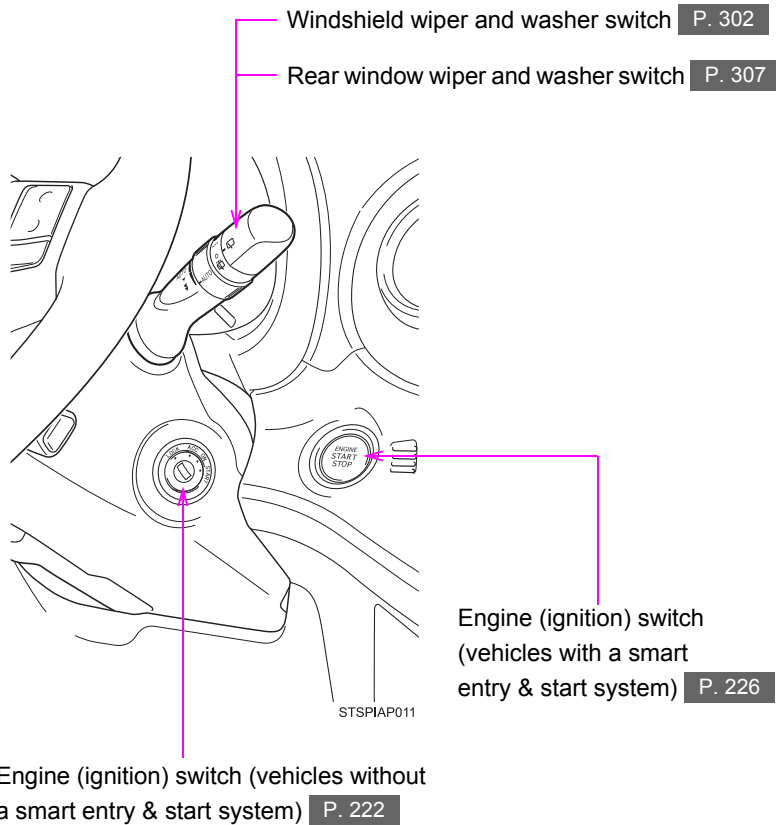

B

Hybrid vehicle

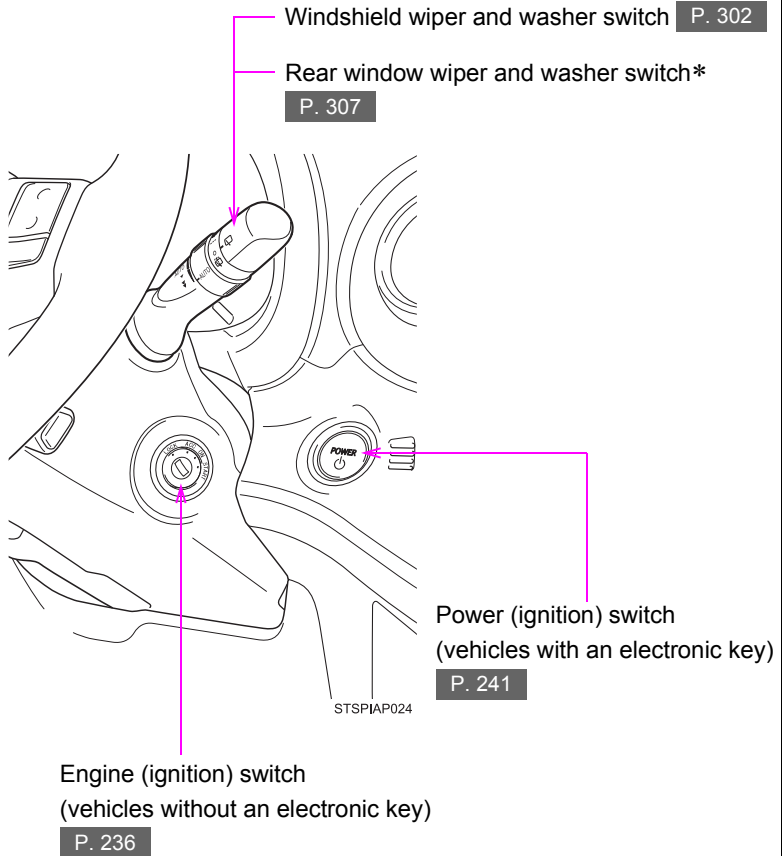

*: If equipped

C

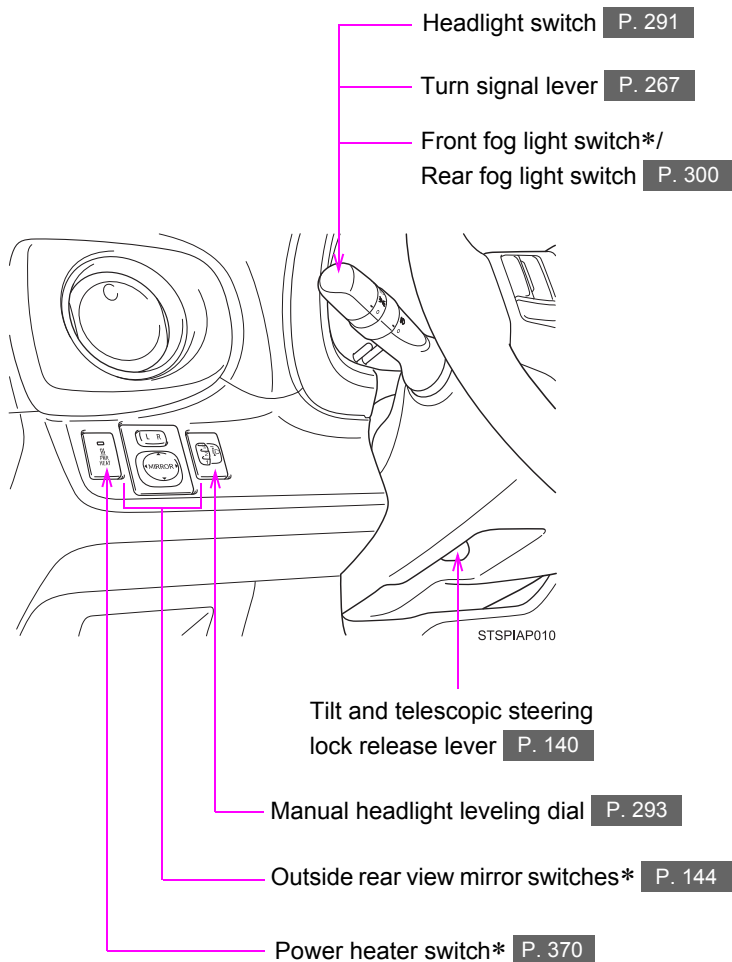

D

Paddle shift switches*

P. 255, 256, 259, 260

Audio switches** P. 412

Telephone switch**

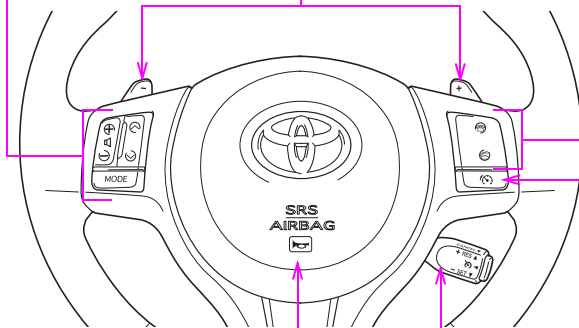

STSPIAP009

Horn P. 270

Cruise control switch*

P. 309, 313

Speed limiter switch* P. 313

*: If equipped

*: Refer to ""touch screen" Owner's Manual".

3-door models (except hybrid vehicle)

Airbag manual on-off switch P. 178

SRS driver airbag P. 167

Head restraints P. 131

SRS front passenger
airbag P. 167

Seat belts P. 133

Luggage cover* P. 441

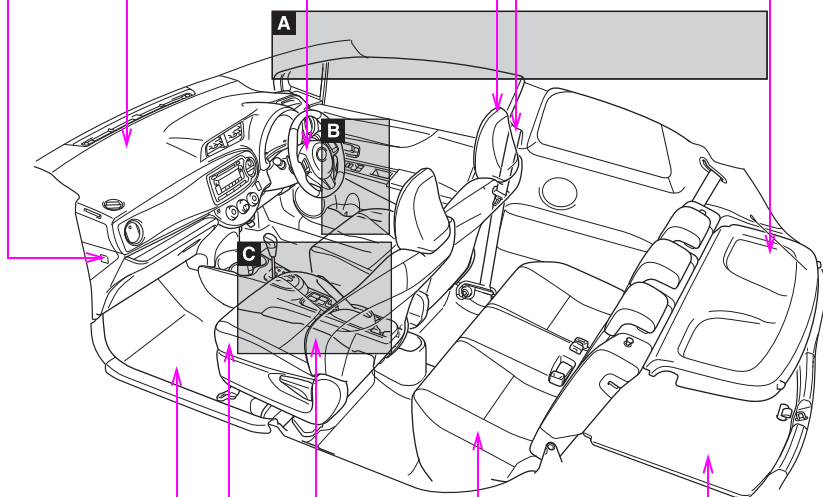

STSPIAP012

Floor mats P. 437

Front seats P. 124

Rear seats* P. 127

Deck board* P. 439

SRS side airbags P. 167

5-door models

Airbag manual on-off switch P. 178

SRS driver airbag P. 167

Head restraints P. 131

SRS front passenger
airbag P. 167

Seat belts P. 133

Luggage cover* P. 441

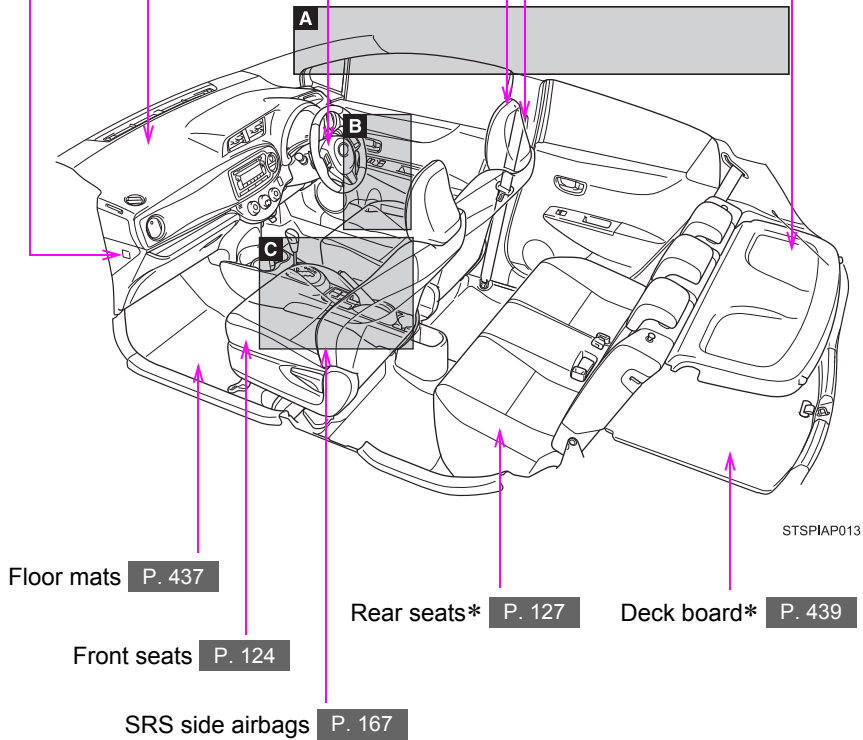

STSPIAP013

Floor mats P. 437

Rear seats* P. 127

Deck board* P. 439

Front seats P. 124

SRS side airbags P. 167

*: If equipped

A

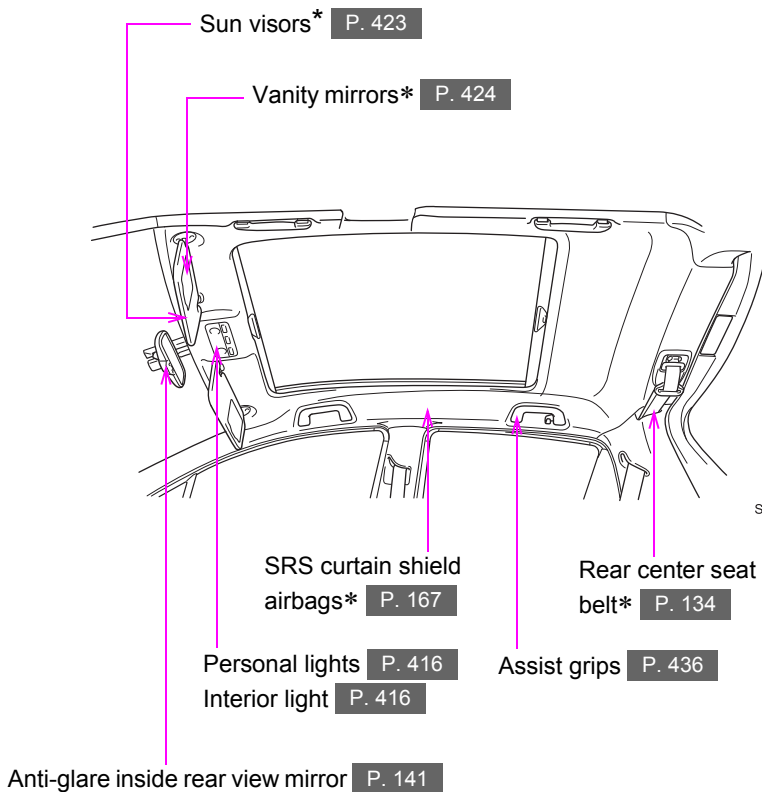

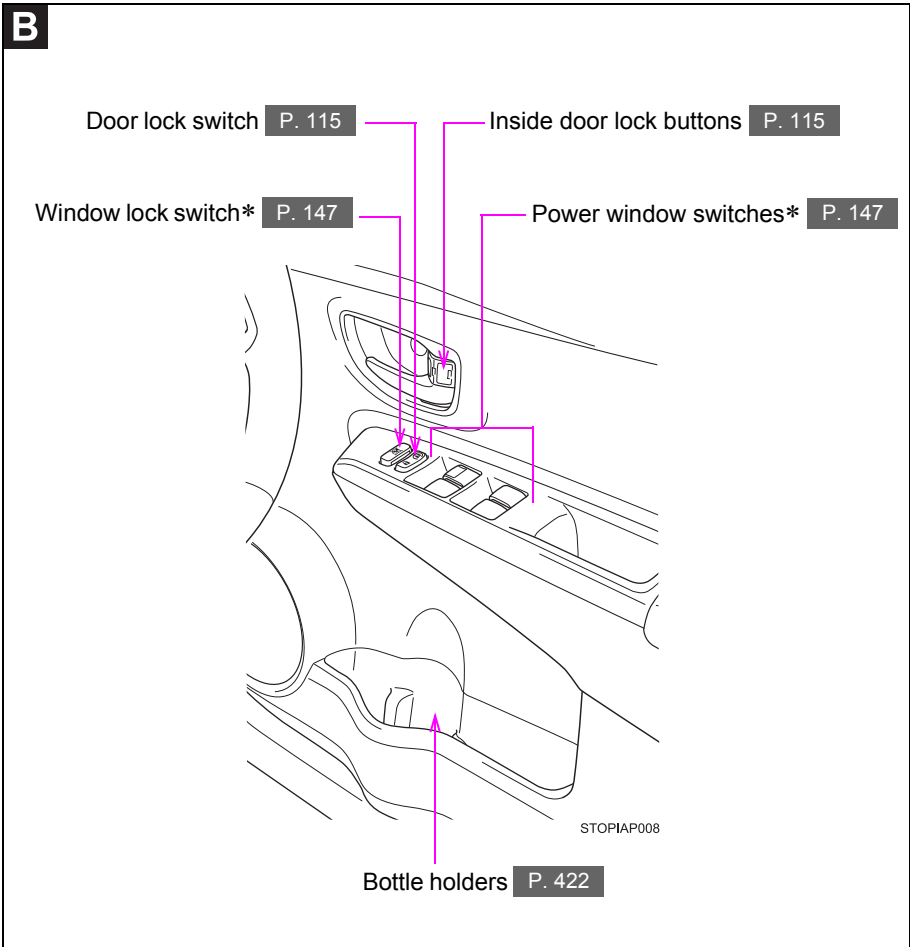
B

*: If equipped

*: NEVER use a rearward facing child restraint on a seat protected by an ACTIVE AIRBAG in front of it, DEATH or SERIOUS INJURY to the CHILD can occur. (→P. 198)



C

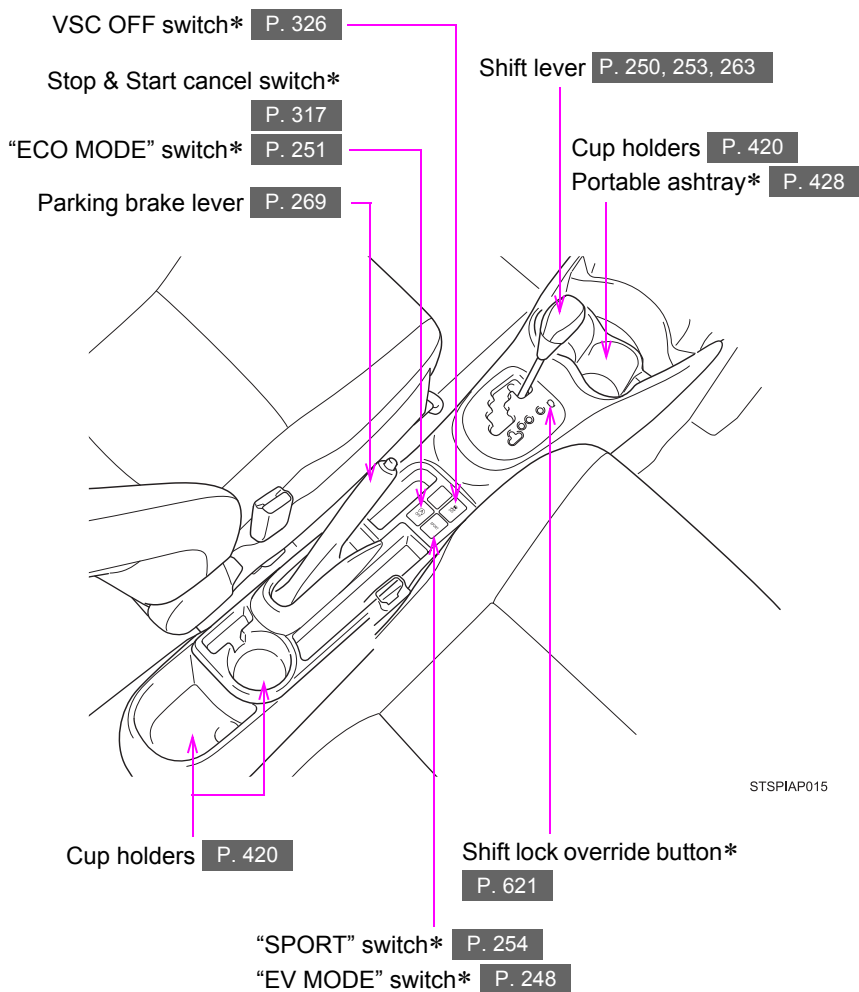

*: If equipped

AUX port and USB port*
P. 394, 402, 411

Gauges and meters P. 271
Multi-information display P. 284

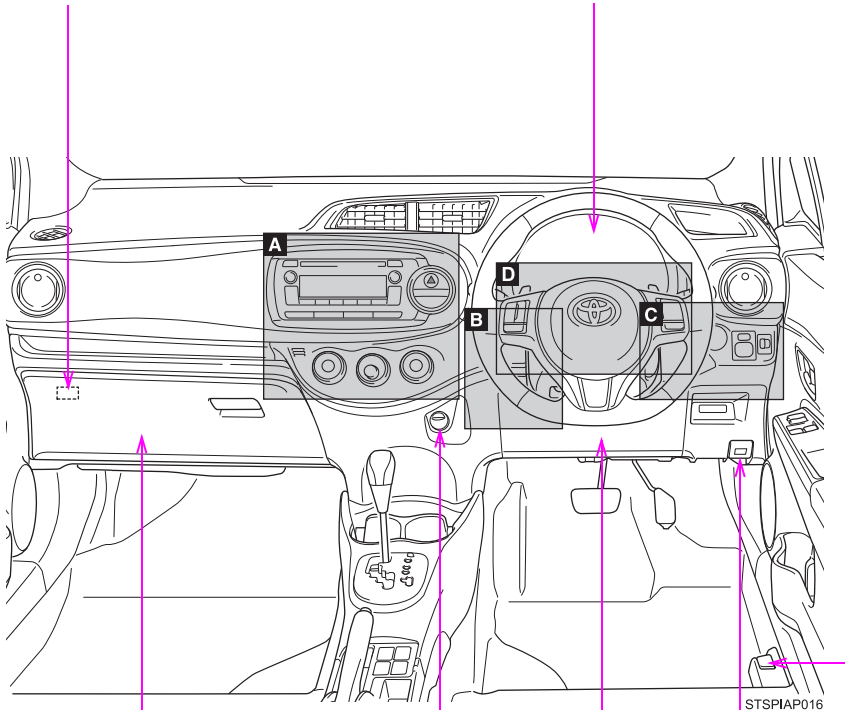

Glove box P. 419

Cigarette lighter* P. 429

Power outlet* P. 430

SRS driver knee airbag* P. 167

Hood lock release lever P. 460

Fuel filler door opener P. 151

*: If equipped

A

Vehicles with a manual air conditioning system

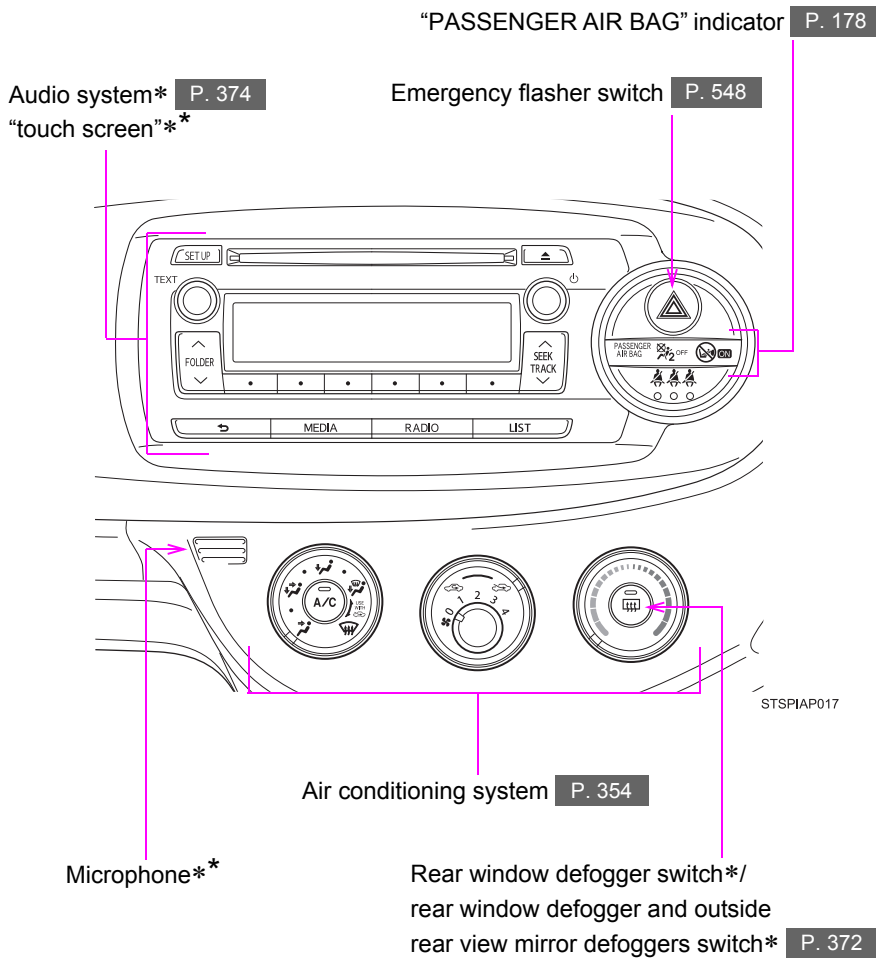

A

Vehicles with an automatic air conditioning system

“PASSENGER AIR BAG” indicator P. 178

Audio system* P. 374

Emergency flasher switch P. 548

“touch screen”**

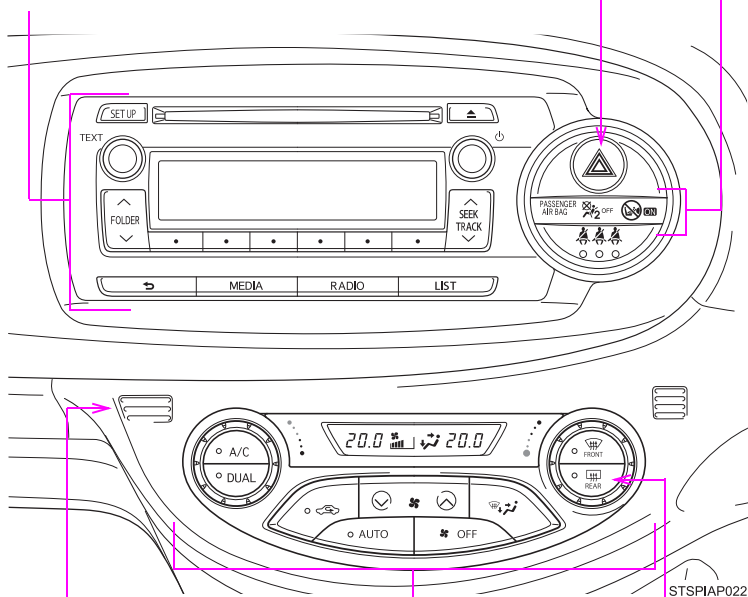

Air conditioning system P. 361

Microphone**

Rear window defogger switch*/
rear window defogger and outside
rear view mirror defoggers switch* P. 372

*: If equipped

** : Refer to “touch screen” Owner’s Manual”.

B

Headlight switch P. 291

Turn signal lever P. 267

Front fog light switch*/

Rear fog light switch P. 300

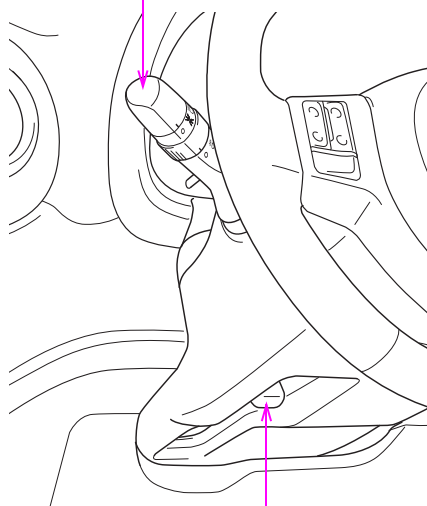

STSPIAP019

Tilt and telescopic steering lock release lever P. 140

C

Except hybrid vehicle

Windshield wiper and washer switch

P. 302

Rear window wiper and washer switch

P. 307

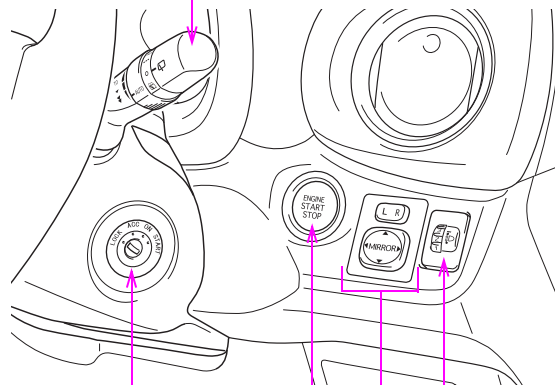

STSPIAP020

Engine (ignition) switch
(vehicles without a smart
entry & start system) P. 222

Engine (ignition) switch (vehicles with
a smart entry & start system) P. 226

Outside rear view mirror switches* P. 144

Manual headlight leveling dial P. 293

*: If equipped

C

Hybrid vehicle

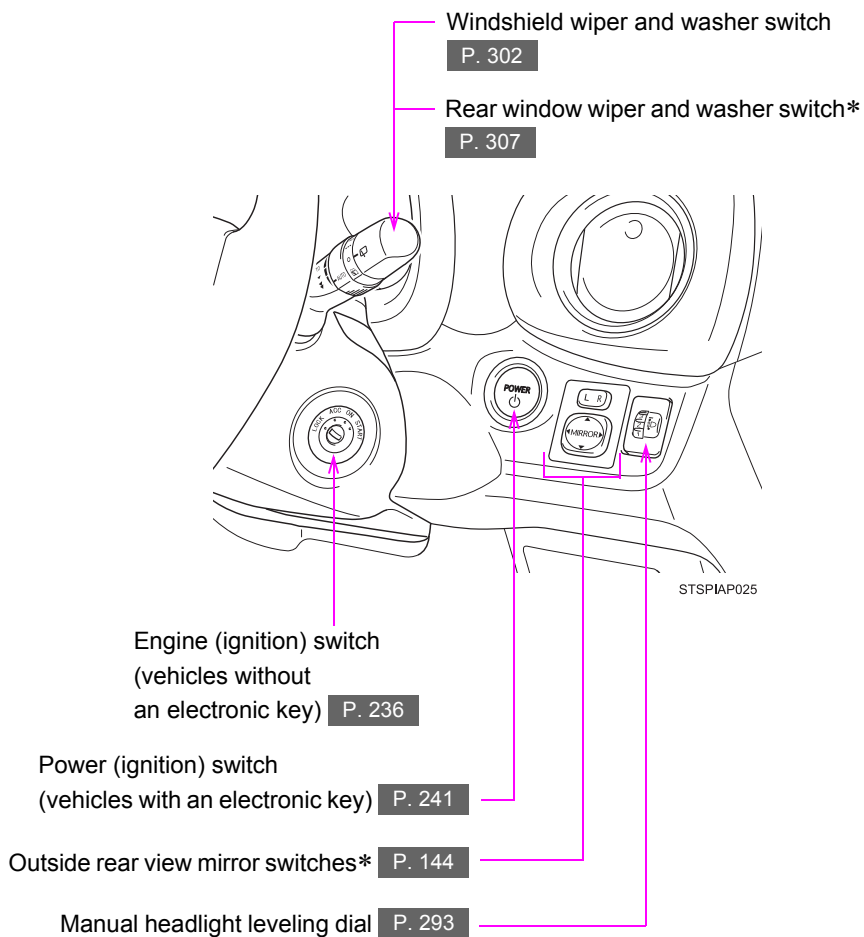

D

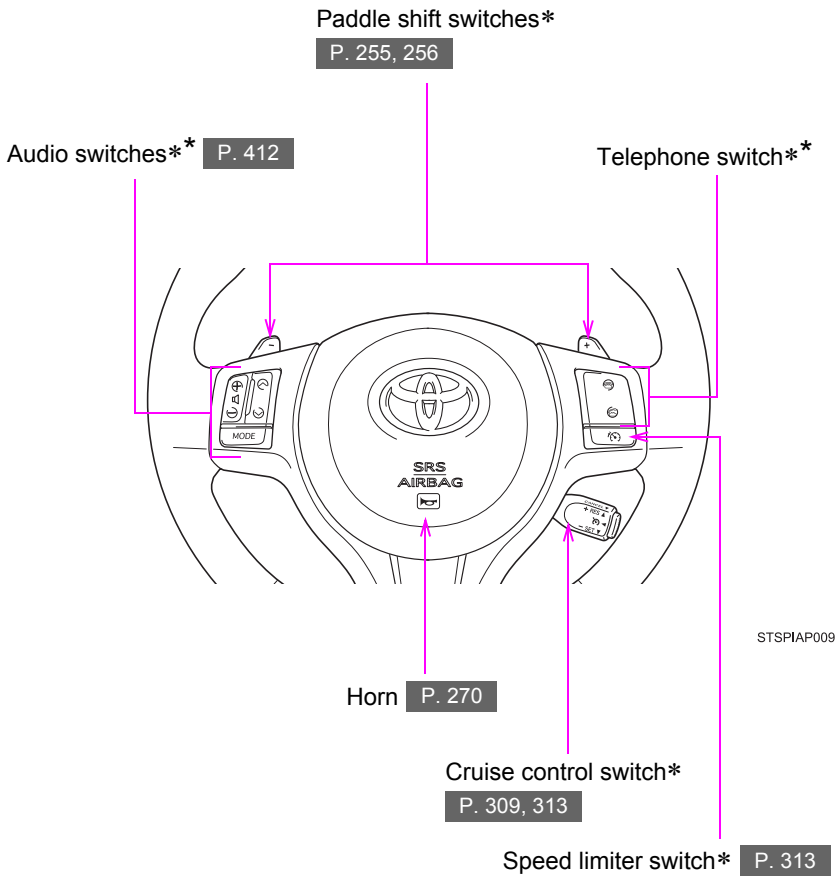

*: If equipped
*: Refer to "touch screen" Owner's Manual".

For your information

Main Owner's Manual

Please note that this manual applies to all models and all equipment, including options. Therefore, you may find some explanations for equipment not installed on your vehicle.

All specifications provided in this manual are current at the time of printing. However, because of the Toyota policy of continual product improvement, we reserve the right to make changes at any time without notice.

Depending on specifications, the vehicle shown in the illustrations may differ from your vehicle in terms of equipment.

Accessories, spare parts and modification of your Toyota

Both genuine Toyota and a wide variety of other spare parts and accessories for Toyota vehicles are currently available on the market. Should it be determined that any of the genuine Toyota parts or accessories supplied with the vehicle need to be replaced, Toyota recommends that genuine Toyota parts or accessories, be used to replace them. Other parts or accessories of matching quality can also be used. Toyota cannot accept any liability or guarantee spare parts and accessories which are not genuine Toyota products, nor for replacement or installation involving such parts. In addition, damage or performance problems resulting from the use of non-genuine Toyota spare parts or accessories may not be covered under warranty.

Installation of an RF-transmitter system (except hybrid vehicle)

The installation of an RF-transmitter system in your vehicle could affect electronic systems such as:

- Multiport fuel injection system/sequential multiport fuel injection system
- Cruise control system (if equipped)
- Anti-lock brake system
- SRS airbag system
- Seat belt pretensioner system

Be sure to check with any authorized Toyota dealer or repairer, or another duly qualified and equipped professional for precautionary measures or special instructions regarding installation of an RF-transmitter system.

Further information regarding frequency bands, power levels, antenna positions and installation provisions for the installation of RF-transmitters is available on request at any authorized Toyota dealer or repairer, or another duly qualified and equipped professional.

Installation of an RF-transmitter system (hybrid vehicle)

The installation of an RF-transmitter system in your vehicle could affect electronic systems such as:

- Multiport fuel injection system/sequential multiport fuel injection system
- Cruise control system (if equipped)
- Anti-lock brake system
- SRS airbag system
- Seat belt pretensioner system

Be sure to check with any authorized Toyota dealer or repairer, or another duly qualified and equipped professional for precautionary measures or special instructions regarding installation of an RF-transmitter system.

Further information regarding frequency bands, power levels, antenna positions and installation provisions for the installation of RF-transmitters is available on request at any authorized Toyota dealer or repairer, or another duly qualified and equipped professional.

High voltage parts and cables on the hybrid vehicles emit approximately the same amount of electromagnetic waves as the conventional gasoline powered vehicles or home electronic appliances despite of their electromagnetic shielding.

Unwanted noise may occur in the reception of the RF-transmitter.

Vehicle data recordings

Your Toyota is equipped with several sophisticated computers that will record certain data, such as:

- Engine speed
- Electric motor speed (traction motor speed)*
- Accelerator status
- Brake status
- Vehicle speed
- Shift position (except manual transmission)
- Hybrid battery (traction battery) status*

The recorded data varies according to the vehicle grade level and options with which it is equipped. Furthermore, these computers do not record conversations, sounds or pictures.

● Data usage

Toyota may use the data recorded in these computers to diagnose malfunctions, conduct research and development, and improve quality.

Toyota will not disclose the recorded data to a third party except:

- With the consent of the vehicle owner or with the consent of the lessee if the vehicle is leased
- In response to an official request by the police, a court of law or a government agency
- For research purposes where the data is not tied to a specific vehicle or vehicle owner

*: If equipped

Event data recorder

This vehicle is equipped with an event data recorder (EDR). The main purpose of an EDR is to record, in certain crash or near crash-like situations, such as an air bag deployment or hitting a road obstacle, data that will assist in understanding how a vehicle's systems performed. The EDR is designed to record data related to vehicle dynamics and safety systems for a short period of time, typically 30 seconds or less.

The EDR in this vehicle is designed to record such data as:

- How various systems in your vehicle were operating;
- How far (if at all) the driver was depressing the accelerator and/or brake pedal; and,
- How fast the vehicle was traveling.

These data can help provide a better understanding of the circumstances in which crashes and injuries occur.

NOTE: EDR data are recorded by your vehicle only if a non-trivial crash situation occurs; no data are recorded by the EDR under normal driving conditions and no personal data (e.g., name, gender, age, and crash location) are recorded. However, other parties, such as law enforcement, could combine the EDR data with the type of personally identifying data routinely acquired during a crash investigation.

To read data recorded by an EDR, special equipment is required, and access to the vehicle or the EDR is needed. In addition to the vehicle manufacturer, other parties, such as law enforcement, that have the special equipment, can read the information if they have access to the vehicle or the EDR.

● Disclosure of the EDR data

Toyota will not disclose the data recorded in an EDR to a third party except when:

- An agreement from the vehicle's owner (or the lessee for a leased vehicle) is obtained
- In response to an official request by the police, a court of law or a government agency
- For use by Toyota in a law suit

However, if necessary, Toyota may:

- Use the data for research on vehicle safety performance
- Disclose the data to a third party for research purposes without disclosing information about the specific vehicle or vehicle owner

Scrapping of your Toyota

The SRS airbag and seat belt pretensioner devices in your Toyota contain explosive chemicals. If the vehicle is scrapped with the airbags and seat belt pretensioners left as they are, this may cause an accident such as fire. Be sure to have the systems of the SRS airbag and seat belt pretensioner removed and disposed of by a qualified service shop or by any authorized Toyota dealer or repairer, or another duly qualified and equipped professional, before you scrap your vehicle.



Your vehicle contains batteries and/or accumulators. Do not discard them into the environment but cooperate with separate collection (Directive 2006/66/EC).

 **CAUTION**

■ **General precautions while driving**

Driving under the influence: Never drive your vehicle when under the influence of alcohol or drugs that have impaired your ability to operate your vehicle. Alcohol and certain drugs delay reaction time, impair judgment and reduce coordination, which could lead to an accident that could result in death or serious injury.

Defensive driving: Always drive defensively. Anticipate mistakes that other drivers or pedestrians might make and be ready to avoid accidents.

Driver distraction: Always give your full attention to driving. Anything that distracts the driver, such as adjusting controls, talking on a cellular phone or reading can result in a collision with resulting death or serious injury to you, your occupants or others.

■ **General precaution regarding children's safety**

Never leave children unattended in the vehicle, and never allow children to have or use the key.

Children may be able to start the vehicle or shift the vehicle into neutral. There is also a danger that children may injure themselves by playing with the cigarette lighter, the windows, the panoramic roof shade, or other features of the vehicle. In addition, heat build-up or extremely cold temperatures inside the vehicle can be fatal to children.

 **CAUTION**

■ **Hybrid battery (traction battery)**

Never resell, hand over or modify the hybrid battery. To prevent accidents, hybrid batteries that have been removed from a disposed vehicle are collected through any authorized Toyota dealer or repairer, or another duly qualified and equipped professional. Do not dispose of the battery yourself.

Unless the battery is properly collected, the following may occur, resulting in death or serious injury:

- The hybrid battery may be illegally disposed of or dumped, and someone may touch a high voltage part, resulting in an electric shock.
- The hybrid battery is intended to be used exclusively with your hybrid vehicle. If the hybrid battery is used outside of your vehicle or modified in any way, accidents such as electric shock, heat generation, smoke generation, an explosion and electrolyte leakage may occur.

When reselling or handing over your vehicle, the possibility of an accident is extremely high because the person receiving the vehicle may not be aware of these dangers.

■ **Disposal of the hybrid battery (traction battery)**

If your vehicle is disposed of without the hybrid battery having been removed, there is a danger of serious electric shock if high voltage parts, cables and their connectors are touched. In the event that your vehicle must be disposed of, the hybrid battery must be disposed of by any authorized Toyota dealer or repairer, or another duly qualified and equipped professional. If the hybrid battery is not disposed of properly, it may cause electric shock that can result in death or serious injury.

Symbols used throughout this manual

Cautions & Notices

CAUTION

This is a warning against something which, if ignored, may cause death or serious injury to people. You are informed about what you must or must not do in order to reduce the risk of death or serious injury to yourself and others.

NOTICE

This is a warning against something which, if ignored, may cause damage to the vehicle or its equipment. You are informed about what you must or must not do in order to avoid or reduce the risk of damage to your Toyota and its equipment.

Symbols used in illustrations



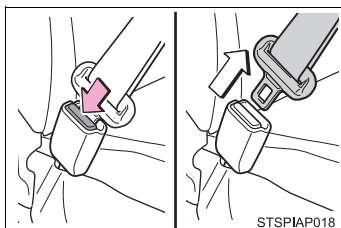

Safety symbol

The symbol of a circle with a slash through it means “Do not”, “Do not do this”, or “Do not let this happen”.



Arrows indicating operations

-  Indicates the action (pushing, turning, etc.) used to operate switches and other devices.
-  Indicates the outcome of an operation (e.g. a lid opens).

1-1. Hybrid system (hybrid vehicle)	
Hybrid system features	48
Hybrid system precautions	52
Energy monitor/ consumption screen	57
Hybrid vehicle driving tips	62
1-2. Key information	
Keys	64
1-3. Opening, closing and locking the doors	
Smart entry & start system	69
Push-button start system	94
Wireless remote control	105
Side doors	114
Back door	119
1-4. Adjustable components (seats, mirrors, steering wheel)	
Front seats	124
Rear seats	127
Head restraints	131
Seat belts	133
Steering wheel	140
	Anti-glare inside rear view mirror
	141
	Outside rear view mirrors
	144
1-5. Opening and closing the windows	
Power windows	147
1-6. Refueling	
Opening the fuel tank cap	151
1-7. Theft deterrent system	
Engine immobilizer/ immobilizer system	155
Double locking system	163
1-8. Safety information	
Correct driving posture	165
SRS airbags	167
Airbag manual on-off system	178
Child restraint systems	182
Installing child restraints ...	191

1-1. Hybrid system (hybrid vehicle)

Hybrid system features

Hybrid vehicle has characteristics different from conventional vehicles. Be sure you are closely familiar with the characteristics of your vehicle, and operate with care.

The hybrid system combines the use of a gasoline engine and an electric motor (traction motor) according to driving conditions, improving fuel efficiency and reducing exhaust emissions.

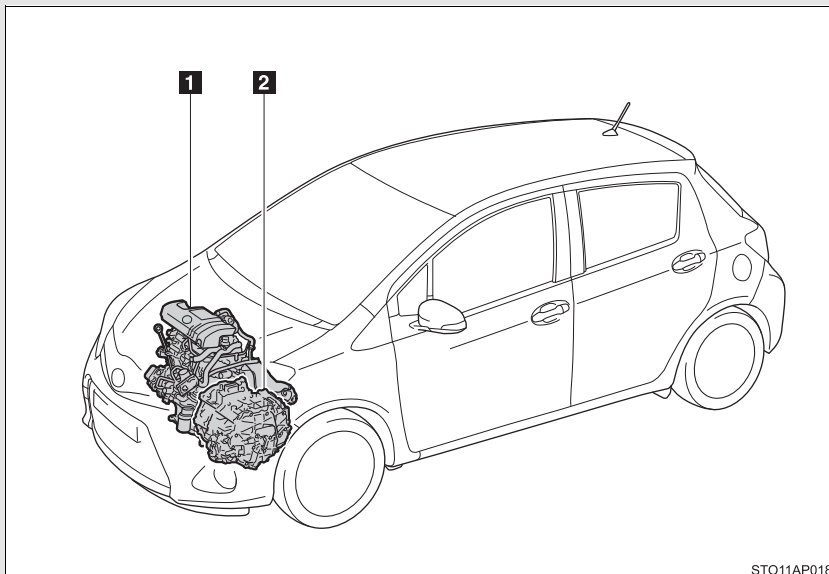

STO11AP018

- 1** Gasoline engine
- 2** Electric motor (Traction motor)

■ When stopped/during start off

The gasoline engine stops* when the vehicle is stopped. During start off, the electric motor (traction motor) drives the vehicle. At slow speeds or when traveling down a gentle slope, the engine is stopped* and the motor is used.

*: However, when the hybrid battery (traction battery) needs to be charged or while the engine is being warmed up, the gasoline engine may not stop automatically. (→P. 50)

■ During normal driving

The gasoline engine is predominantly used. The electric motor (traction motor) charges the hybrid battery (traction battery) as necessary.

■ When accelerating sharply

The power of the hybrid battery (traction battery) is added to that of the gasoline engine via the electric motor (traction motor).

■ When braking (regenerative braking)

The electric motor (traction motor) charges the hybrid battery (traction battery).

■ Regenerative braking

In the following situations, kinetic energy is converted to electric energy and deceleration force can be obtained in conjunction with the recharging of the hybrid battery (traction battery).

- The accelerator pedal is released.
- The brake pedal is depressed with the shift lever in D or B.

■ EV indicator

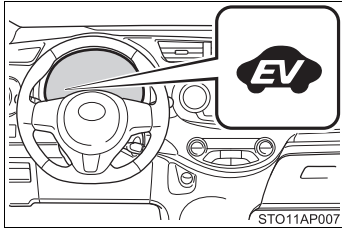

The EV indicator comes on when driving the vehicle using only the electric motor (traction motor).

The EV indicator can be activated or deactivated. (→P. 290)

■ Conditions in which the gasoline engine may not stop

The gasoline engine starts and stops automatically. However, it may not stop automatically in the following conditions:

- During gasoline engine warm-up
- During hybrid battery (traction battery) charging
- When the temperature of the hybrid battery (traction battery) is high or low
- When the heater is switched on

■ Charging the hybrid battery (traction battery)

- As the gasoline engine charges the hybrid battery (traction battery), the battery does not need to be charged from an outside source. However, if the vehicle is left parked for a long time the hybrid battery will slowly discharge. For this reason, be sure to drive the vehicle at least once every few months for at least 30 minutes or 16 km (10 miles). If the hybrid battery becomes fully discharged and you are unable to jump-start the vehicle with the 12-volt battery, contact any authorized Toyota dealer or repairer, or another duly qualified and equipped professional.
- If the shift lever is in N, the hybrid battery (traction battery) will not be charged. Always put the shift lever in P when the vehicle is stopped. When driving in heavy traffic, operate the vehicle with the shift lever in D or B to avoid discharging the battery.

■ Charging the 12-volt battery

→P. 636

■ After the 12-volt battery has discharged or has been changed or removed

The gasoline engine may not stop even if the vehicle is running on the hybrid battery (traction battery). If this continues for a few days, contact any authorized Toyota dealer or repairer, or another duly qualified and equipped professional.

■ Sounds and vibrations specific to a hybrid vehicle

There may be no engine sounds or vibration even though the vehicle is able to move. For safety, apply the parking brake and make sure to shift the shift lever to P when parked.

The following sounds or vibrations may occur when the hybrid system is operating and are not a malfunction:

- Motor sounds may be heard from the engine compartment.
- Sounds may be heard from the hybrid battery (traction battery) under the rear seats when the hybrid system starts or stops.
- Sounds from the hybrid system may be heard when the back door is open.
- Sounds may be heard from the transmission when the gasoline engine starts or stops, when driving at low speeds, or during idling.
- Engine sounds may be heard when accelerating sharply.
- Sounds may be heard due to regenerative braking when the brake pedal is depressed and accelerator is loosened.
- Vibration may be felt when the gasoline engine starts or stops.
- Cooling fan sounds may be heard from the air intake vent on the side of the lower part of the rear left seats.

■ Maintenance, repair, recycling, and disposal

Contact any authorized Toyota dealer or repairer, or another duly qualified and equipped professional regarding maintenance, repair, recycling and disposal. Do not dispose of the vehicle yourself.

1-1. Hybrid system (hybrid vehicle) Hybrid system precautions

Take care when handling the hybrid system, as it contains a high voltage system (about 520 V at maximum) as well as parts that become extremely hot when the hybrid system is operating. Obey the caution labels attached to the vehicle.

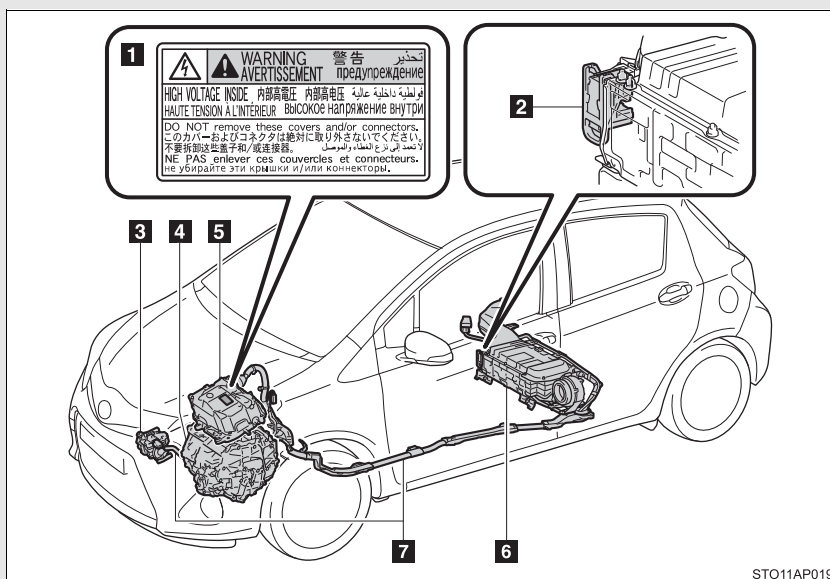

STO11AP019

- 1** Caution label
- 2** Service plug
- 3** Air conditioning compressor
- 4** Electric motor (traction motor)
- 5** Power control unit with DC/DC converter
- 6** Hybrid battery (traction battery)
- 7** High voltage cables (orange)

Hybrid battery air vent

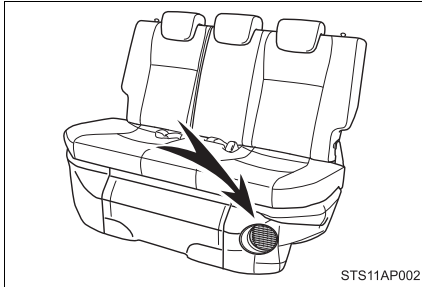

There is an air intake vent on the side of the lower part of the rear left seat for the purpose of cooling the hybrid battery (traction battery). If the vent becomes blocked, the hybrid battery (traction battery) may overheat, leading to a reduction in hybrid battery output.

Emergency shut off system

When a certain level of impact is detected by the impact sensor, the emergency shut off system blocks off the high voltage current and stops the fuel pump to minimize the risk of electrocution and fuel leakage. If the emergency shut off system activates, your vehicle will not restart. To restart the hybrid system, contact any authorized Toyota dealer or repairer, or another duly qualified and equipped professional.

■ If a warning light comes on, or the 12-volt battery is disconnected

The hybrid system may not start. In that case, try to start the system again. If the “READY” indicator does not come on, contact any authorized Toyota dealer or repairer, or another duly qualified and equipped professional.

■ Running out of fuel

When the vehicle has run out of fuel and the hybrid system cannot be started, refuel the vehicle with at least enough gasoline to make the low fuel level warning light (→P. 566) go off. If there is only a small amount of fuel, the hybrid system may not be able to start. (The minimum amount of fuel to add to make the low fuel level warning light go out is about 7.0 L [1.8 gal., 1.5 Imp. gal.] when the vehicle is on a level surface. This value may vary when the vehicle is on a slope.)

■ **Electromagnetic waves**

- High voltage parts and cables on the hybrid vehicles incorporate electromagnetic shielding, and therefore emit approximately the same amount of electromagnetic waves as conventional gasoline powered vehicles or home electronic appliances.
- Your vehicle may cause sound interference in some third party-produced radio parts.

■ **Hybrid battery (traction battery)**

The hybrid battery (traction battery) has a limited service life. The lifespan of the hybrid battery (traction battery) can change in accordance with driving style and driving conditions.

■ **Declaration of conformity**

This model conforms to hydrogen emissions according to regulation ECE100 (Battery electric vehicle safety).

⚠ CAUTION

■ **High voltage precautions**

The vehicle has high voltage DC and AC systems as well as a 12-volt system. DC and AC high voltage is very dangerous and can cause severe burns and electric shock that may result in death or serious injury.

- Never touch, disassemble, remove or replace the high voltage parts, cables or their connectors.
- The hybrid system will become hot after starting as the system uses high voltage. Be careful of both the high voltage and the high temperature, and always obey the caution labels attached to the vehicle.

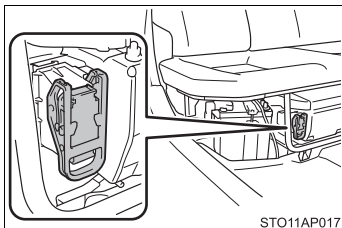

- The service plug is installed in the hybrid battery (traction battery). The service plug is used only when the vehicle is serviced and is subject to high voltage. Never touch the service plug, as a mistake in handling can lead to an electric shock.

 **CAUTION****■ Road accident cautions**

If your vehicle is involved in an accident, observe the following precautions to reduce the risk of death or serious injury:

- Stop the vehicle in a safe place to prevent subsequent accidents, shift the shift lever to P, apply the parking brake, and turn the hybrid system off. (→P. 237, 242)
- Do not touch the high voltage parts, cables or connectors.
- If electric wires are exposed inside or outside your vehicle, an electric shock may occur. Never touch exposed electric wires.
- If a fluid leak occurs, do not touch the fluid as it may be strong alkaline electrolyte from the hybrid battery (traction battery). If it comes into contact with your skin or eyes, wash it off immediately with a large amount of water or, if possible, boric acid solution. Seek immediate medical attention.
- If a fire occurs in the hybrid vehicle, leave the vehicle as soon as possible. Never use a fire extinguisher that is not meant for electric fires. Using even a small amount of water may be dangerous.
- If your vehicle needs to be towed, do so with front wheels raised. If the wheels connected to the electric motor (traction motor) are on the ground when towing, the motor may continue to generate electricity. This may cause an electricity leakage leading to a fire. (→P. 549)
- Carefully inspect the ground under the vehicle. If you find that liquid has leaked onto the ground, the fuel system may have been damaged. Leave the vehicle as soon as possible and contact any authorized Toyota dealer or repairer, or another duly qualified and equipped professional.

■ Nickel-metal hydride battery

Your vehicle contains a sealed nickel-metal hydride battery. If disposed of improperly, it is hazardous to the environment and there is a risk of severe burns and electrical shock that may result in death or serious injury.

 NOTICE

■ Hybrid battery air vent

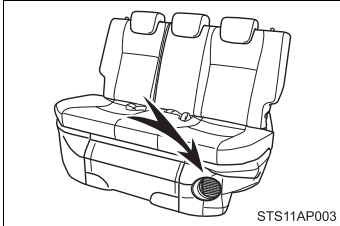

- Do not put foreign objects over or in front of the air vent. The hybrid battery (traction battery) may overheat and be damaged.
- Clean the air vent regularly to prevent the hybrid battery (traction battery) from overheating.
- Do not wet or allow foreign substances to enter the air vent as this may cause a short circuit and damage the hybrid battery (traction battery).
- Do not carry large amounts of water such as water cooler bottles in the vehicle. If water spills onto the hybrid battery (traction battery), the battery may be damaged.

1-1. Hybrid system (hybrid vehicle)

Energy monitor/consumption screen*

You can view the status of your hybrid system on the “touch screen”.

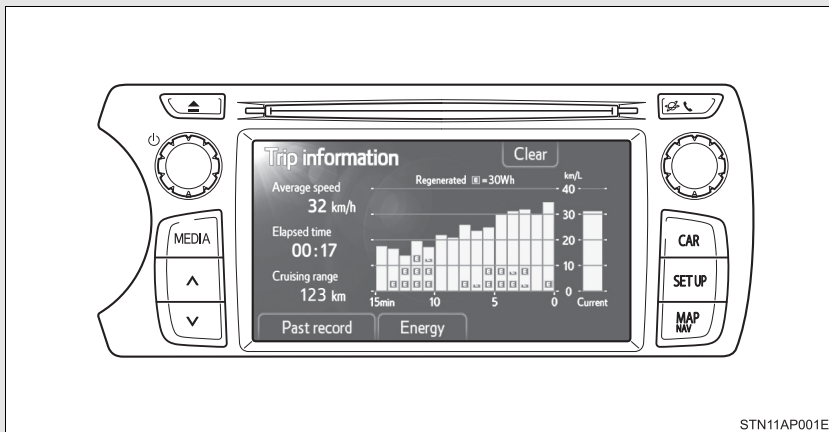

1

Before driving

*: If equipped

Energy monitor

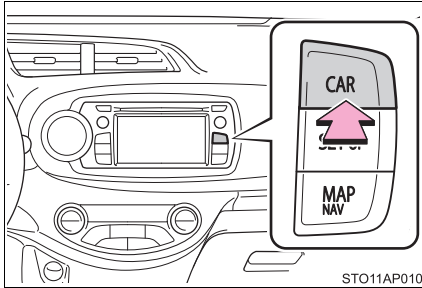

Press “CAR”.

If the “Trip information” or “Past record” screen is displayed, touch “Energy”.

	“touch screen”
When the vehicle is powered by the electric motor (traction motor)	
When the vehicle is powered by the gasoline engine	
When the vehicle is powered by both the gasoline engine and the electric motor (traction motor)	

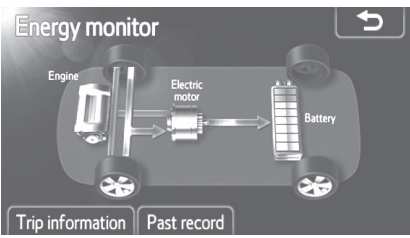
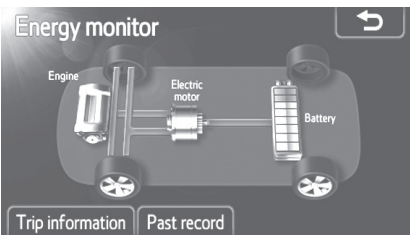
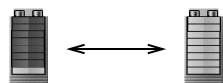
"touch screen"	
<p>When the vehicle is charging the hybrid battery (traction battery)</p>	 <p>The screen displays a top-down view of the vehicle chassis. The 'Engine' is on the left, the 'Electric motor' is in the center, and the 'Battery' is on the right. A thick arrow points from the engine to the electric motor, and another thick arrow points from the electric motor to the battery, indicating energy flow. A return arrow icon is in the top right. At the bottom are 'Trip information' and 'Past record' buttons.</p>
<p>When there is no energy flow</p>	 <p>The screen displays the same top-down view of the vehicle chassis. The 'Engine', 'Electric motor', and 'Battery' are labeled. No arrows are present between them, indicating no energy flow. A return arrow icon is in the top right. At the bottom are 'Trip information' and 'Past record' buttons.</p>
<p>Hybrid battery (traction battery) status</p>	<p style="display: flex; justify-content: space-around;"> Low Full </p>  <p>The indicator shows two battery icons. The left one is partially filled and labeled 'Low'. The right one is fully filled and labeled 'Full'. A double-headed arrow connects the two icons.</p>

These images are examples only, and may vary slightly from actual conditions.

Trip information screen

Press “CAR”. (→P. 58)

If the “Energy monitor” or “Past record” screen is displayed, touch “Trip information”.

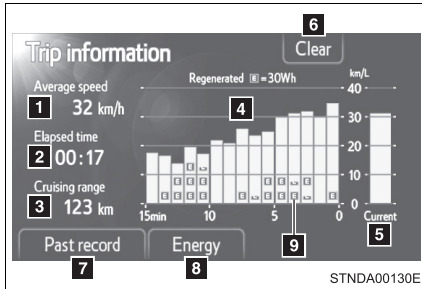

- 1 Average vehicle speed
- 2 Elapsed time
- 3 Cruising range
- 4 Fuel consumption in the past 15 minutes
- 5 Current fuel consumption
- 6 Reset the trip information data
- 7 “Past record” screen appears
- 8 “Energy monitor” screen appears
- 9 Regenerated energy in the past 15 minutes

One symbol indicates 30 Wh.
Up to 5 symbols are shown.

The image is example only, and may vary slightly from actual conditions.

Past record screen

Press “CAR”. (→P. 58)

If the “Energy monitor” or “Trip information” screen is displayed, touch “Past record”.

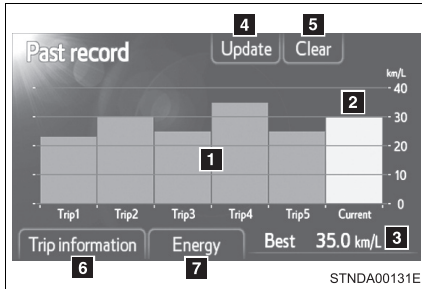

- 1 Previous fuel economy record
- 2 Current fuel economy
- 3 Best recorded fuel economy
- 4 Update the past record data
- 5 Reset the past record data
- 6 “Trip information” screen appears
- 7 “Energy monitor” screen appears

The image is example only, and may vary slightly from actual conditions.

Resetting the consumption data

Selecting “Clear” on the “Trip information” screen will reset the fuel consumption and the regenerated energy for the past 15 minutes. Selecting “Clear” on the “Past record” screen will reset the past records and best past fuel consumption. Selecting “Yes” on the following screen will confirm resetting of all the data.

1-1. Hybrid system (hybrid vehicle)

Hybrid vehicle driving tips

For economical and ecological driving, pay attention to the following points:

■ Using Eco drive mode

→P. 251

■ Use of Hybrid System Indicator

Eco-friendly driving is possible by keeping the indicator needle of Hybrid System Indicator within Eco area. (→P. 274)

■ When braking the vehicle

Make sure to operate the brakes gently and in good time. A greater amount of electrical energy can be retained when slowing down.

■ Delays

Repeated acceleration and deceleration, as well as long waits at traffic lights, will lead to bad fuel consumption. Check traffic reports before leaving and avoid delays as much as possible. When encountering a delay, gently release the brake pedal to allow the vehicle to move forward slightly while avoiding overuse of the accelerator pedal. Doing so can help control excessive gasoline consumption.

■ Highway driving

Control your speed and keep at a constant speed. Also, before stopping at a toll booth or similar, allow plenty of time to release the accelerator and gently apply the brakes. A greater amount of electrical energy can be retained when slowing down.

■ Air conditioning

Use the air conditioning only when necessary. Doing so can help control excessive gasoline consumption.

In summer: In high temperatures, use the recirculated air mode. Doing so will help to reduce the burden on the air conditioner and reduce fuel consumption as well.

In winter: Because the gasoline engine will not automatically cut out until the gasoline engine and the interior of the vehicle are warm, it will consume fuel. Also, fuel consumption can be improved by avoiding overuse of the heater such as setting the temperature too high.

■ **Checking tire inflation pressure**

Make sure to check the tire inflation pressure frequently. Improper tire inflation pressure can cause poor fuel consumption.

Also, as snow tires can cause large amounts of friction, their use on dry roads can lead to poor fuel consumption. Use a tire that is appropriate for the season.

■ **Luggage**

Carrying heavy luggage can lead to poor fuel consumption. Avoid carrying unnecessary luggage. Installing a large roof rack can also cause poor fuel consumption.

■ **Warming up before driving**

Since the gasoline engine starts up and cuts out automatically when cold, warming up the engine is unnecessary. Moreover, frequently driving short distances will cause the engine to repeatedly warm up, which can lead to poor fuel consumption.

1-2. Key information

Keys

The following keys are provided with the vehicle.

Vehicles without a smart entry & start system or a push-button start system (type A)

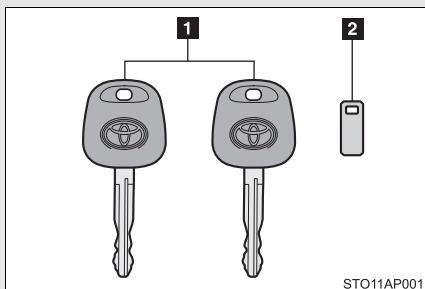

- 1** Keys
- 2** Key number plate

Vehicles without a smart entry & start system or a push-button start system (type B)

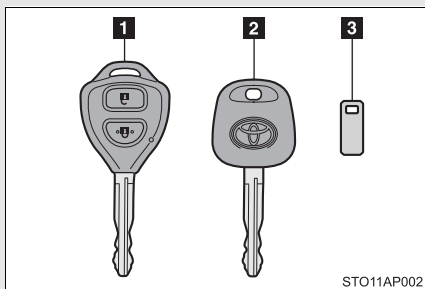

- 1** Key (with a wireless remote control function)
Operating the wireless remote control function (→P. 105)
- 2** Key (without a wireless remote control function)
- 3** Key number plate

Vehicles without a smart entry & start system or a push-button start system (type C)

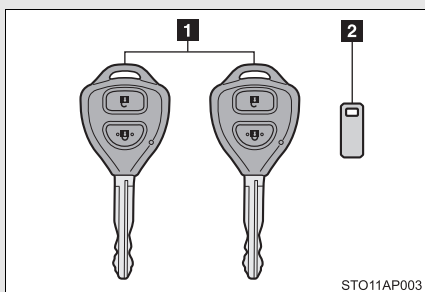

- 1** Keys
Operating the wireless remote control function (→P. 105)
- 2** Key number plate

Vehicles with a smart entry & start system (type A)

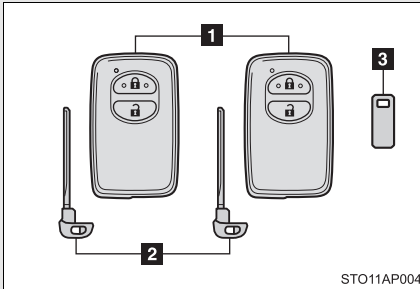

1 Electronic keys

- Operating the smart entry & start system (→P. 69)
- Operating the wireless remote control function (→P. 105)

2 Mechanical keys

3 Key number plate

Vehicles with a smart entry & start system (type B)

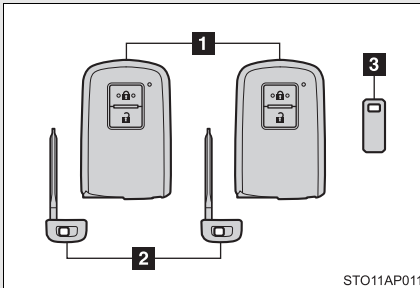

1 Electronic keys

- Operating the smart entry & start system (→P. 69)
- Operating the wireless remote control function (→P. 105)

2 Mechanical keys

3 Key number plate

Vehicles with a push-button start system

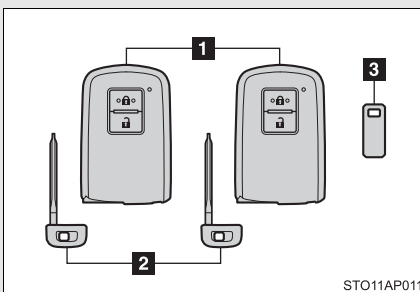

1 Electronic keys

- Operating the push-button start system (→P. 94)
- Operating the wireless remote control function (→P. 105)

2 Mechanical keys

3 Key number plate

Using the mechanical key (vehicles with a smart entry & start system or a push-button start system)

Type A

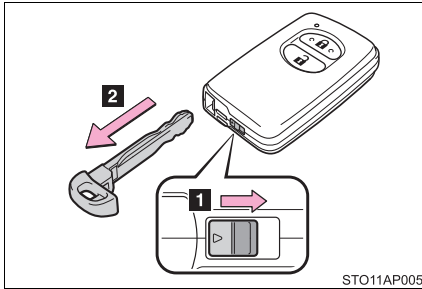

To take out the mechanical key, slide the release knob and take the key out.

After using the mechanical key, store it in the electronic key. Carry the mechanical key together with the electronic key. If the electronic key battery is depleted or the entry function does not operate properly, you will need the mechanical key. (→P. 624)

Type B

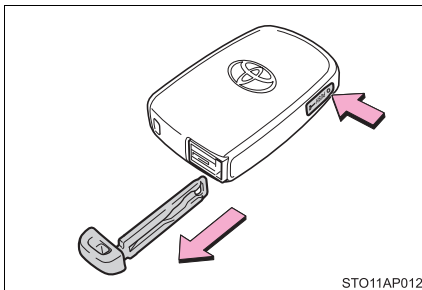

To take out the mechanical key, push the release button and take the key out.

After using the mechanical key, store it in the electronic key. Carry the mechanical key together with the electronic key. If the electronic key battery is depleted or the entry function does not operate properly, you will need the mechanical key. (→P. 624)

■ Key number plate

Keep the plate in a safe place such as your wallet, not in the vehicle. In the event that a key (vehicles without a smart entry & start system or a push-button start system) or a mechanical key (vehicles with a smart entry & start system or a push-button start system) is lost, a new key can be made by any authorized Toyota dealer or repairer, or another duly qualified and equipped professional using the key number plate. (→P. 623)

■ When riding in an aircraft

When bringing a key with wireless remote control function onto an aircraft, make sure you do not press any buttons on the key while inside the aircraft cabin. If you are carrying the key in your bag etc., ensure that the buttons are not likely to be pressed accidentally. Pressing a button may cause the key to emit radio waves that could interfere with the operation of the aircraft.

NOTICE

■ To prevent key damage

Observe the following:

- Do not drop the keys, subject them to strong shocks or bend them.
- Do not expose the keys to high temperatures for a long period of time.
- Do not get the keys wet or wash them in an ultrasonic washer etc.
- Vehicles with a smart entry & start system or a push-button start system:
Do not attach metallic or magnetic materials to the keys or place the keys close to such materials.
- Do not disassemble the keys.
- Do not attach a sticker or anything else to the surface of the key.
- Vehicles with a smart entry & start system or a push-button start system:
Do not place the keys near objects that produce magnetic fields, such as TVs, audio systems, induction cookers, or medical electrical equipment, such as low-frequency therapy equipment.

 NOTICE

■ **Carrying the electronic key on your person (vehicles with a smart entry & start system or a push-button start system)**

Carry the electronic key 10 cm (3.9 in.) or more away from electric appliances that are turned on. Radio waves emitted from electric appliances within 10 cm (3.9 in.) of the electronic key may interfere with the key, causing the key to not function properly.

■ **In case of a smart entry & start system or a push-button start system malfunction or other key-related problems (vehicles with a smart entry & start system or a push-button start system)**

Take your vehicle with all the electronic keys provided with your vehicle to any authorized Toyota dealer or repairer, or another duly qualified and equipped professional.

■ **When a vehicle key is lost (vehicles with a smart entry & start system or a push-button start system)**

If the key remains lost, the risk of vehicle theft increases significantly. Visit any authorized Toyota dealer or repairer, or another duly qualified and equipped professional immediately with all remaining electronic keys that was provided with your vehicle.

1-3. Opening, closing and locking the doors Smart entry & start system*

The following operations can be performed simply by carrying the electronic key on your person, for example in your pocket.
(The driver should always carry the electronic key.)

Except hybrid vehicle

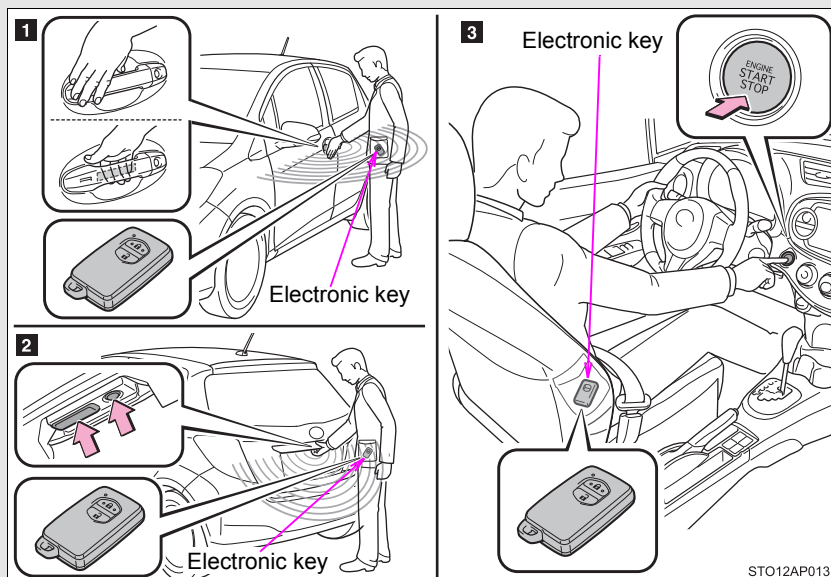

- 1 Unlocks and locks the side doors (→P. 71)
- 2 Unlocks and locks the back door (→P. 72)
- 3 Starts the engine (→P. 226)

Hybrid vehicle

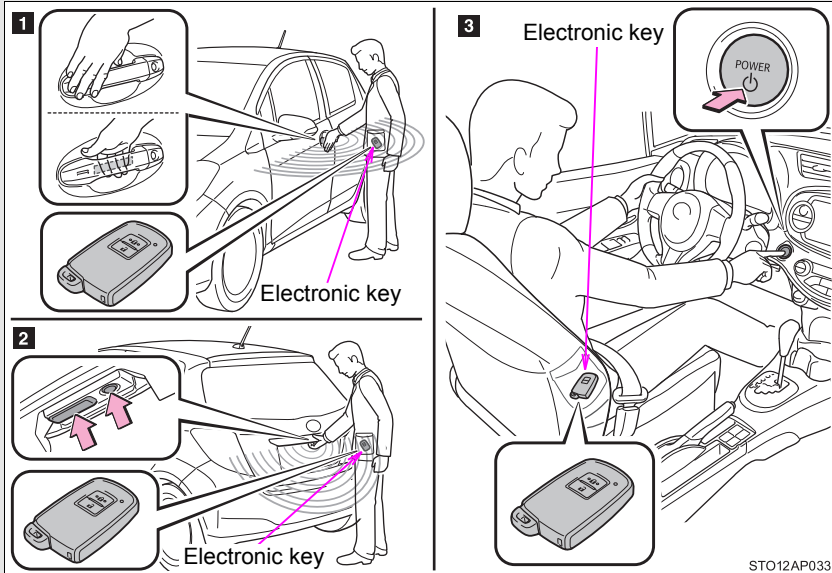

1 Unlocks and locks the side doors (→P. 71)

2 Unlocks and locks the back door (→P. 72)

3 Starts the hybrid system (→P. 241)

Unlocking and locking the side doors (front door handles only)

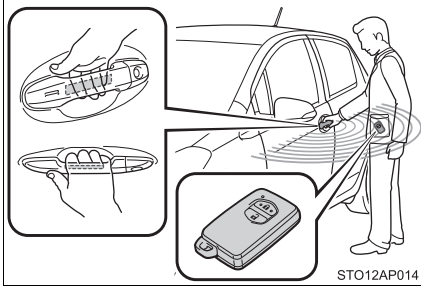

Grip the handle to unlock the doors.

Make sure to touch the sensor on the back of the handle.

The doors cannot be unlocked for 3 seconds after the doors are locked.

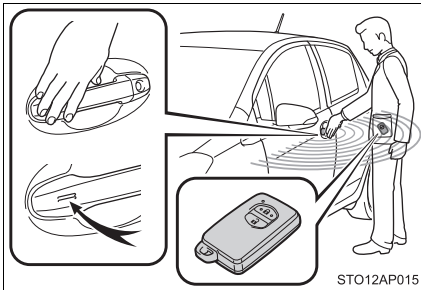

Touch the lock sensor (the indentation on the side of the door handle) to lock the doors.

Unlocking and locking the back door

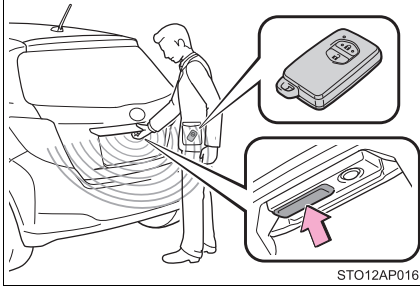

Press the button to unlock the door.

The door cannot be unlocked for 3 seconds after the door is locked.

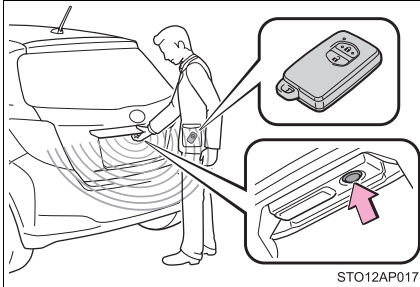

Press the button to lock the door.

Antenna location and effective range

■ Antenna location

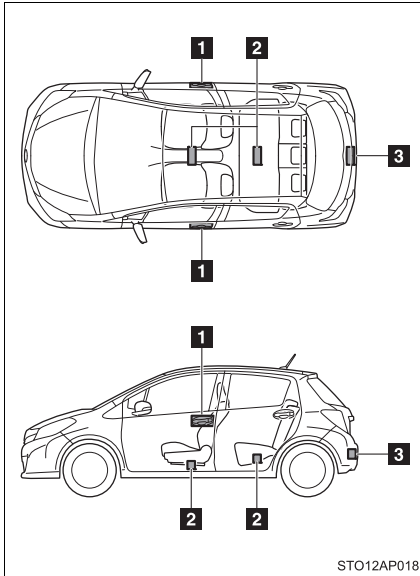

- 1** Antennas outside the cabin
- 2** Antennas inside the cabin
- 3** Antenna outside the luggage compartment

1

Before driving

■ **Effective range (areas within which the electronic key is detected)**

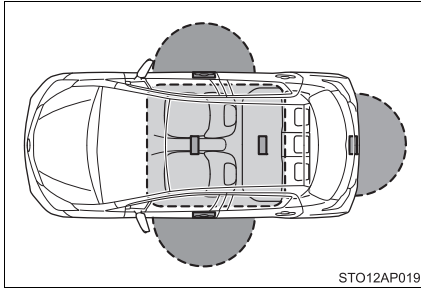

- When locking or unlocking the doors

The system can be operated when the electronic key is within about 0.7 m (2.3 ft.) either of the outside front door handles and back door. (Only the doors detecting the key can be operated.)

- Except hybrid vehicle: When starting the engine or changing “ENGINE START STOP” switch modes

Hybrid vehicle: When starting the hybrid system or changing “POWER” switch modes

The system can be operated when the electronic key is inside the vehicle.

■ Operation signals

The emergency flashers flash to indicate that the doors have been locked/unlocked. (Locked: once; Unlocked: twice)

■ When the door cannot be locked by the lock sensor

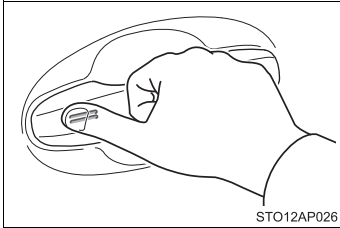

Use your thumb to push the lock sensor.

■ Alarms and warning indicators

A combination of exterior and interior alarms as well as warning lights are used to prevent theft of the vehicle and unforeseeable accidents resulting from erroneous operation. Take appropriate measures for the warning light that comes on. (→P. 571)

The following table describes circumstances and correction procedures when only alarms are sounded.

Alarm	Situation	Correction procedure
Exterior alarm sounds once for 5 seconds	An attempt was made to lock the doors using the smart entry & start system while the electronic key was still inside the vehicle.	Retrieve the electronic key from the vehicle and lock the doors again.
	An attempt was made to lock the vehicle while a door was open.	Close all of the doors and lock the doors again.

1-3. Opening, closing and locking the doors

Alarm		Situation	Correction procedure
Interior alarm pings once and exterior alarm sounds once for 5 seconds		An attempt was made to lock either front door by opening a door and putting the inside lock button into the lock position, then closing the door by pulling on the outside door handle with the electronic key still inside the vehicle.	Retrieve the electronic key from the vehicle and lock the doors again.
Interior alarm pings once and exterior alarm sounds once for 5 seconds (on some models)		An attempt was made to lock the doors other than using the smart entry & start system while the electronic key was still inside the vehicle.	Retrieve the electronic key from the vehicle and lock the doors again.
Interior alarm sounds continuously	Except hybrid vehicle	The “ENGINE START STOP” switch was turned to ACCESSORY mode while the driver’s door was open (or the driver’s door was opened while the “ENGINE START STOP” switch was in ACCESSORY mode).	Turn the “ENGINE START STOP” switch off and close the driver’s door.
	Hybrid vehicle	The “POWER” switch was turned to ACCESSORY mode while the driver’s door was open (or the driver’s door was opened while the “POWER” switch was in ACCESSORY mode).	Turn the “POWER” switch off and close the driver’s door.

Alarm	Situation	Correction procedure
Interior alarm sounds continuously*	The driver's door was opened while any shift position other than P was selected without turning off the "ENGINE START STOP" switch.	Shift the shift lever to P.

*: Vehicles with a Multidrive only

■ Security feature

If a door is not opened within approximately 30 seconds after the vehicle is unlocked, the security feature automatically locks the vehicle again. (However, depending on the location of the electronic key, the key may be detected as being in the vehicle. In this case, vehicle may be unlocked.)

■ Battery-saving function

The battery-saving function will be activated in order to prevent the electronic key battery and the vehicle battery from being discharged while the vehicle is not in operation for a long time.

- In the following situations, the smart entry & start system may take some time to unlock the doors.
 - The electronic key has been left in an area of approximately 2 m (6 ft.) of the outside of the vehicle for 10 minutes or longer.
 - The smart entry & start system has not been used for 5 days or longer.
- If the smart entry & start system has not been used for 14 days or longer, the doors cannot be unlocked at any doors except the driver's door. In this case, take hold of the driver's door handle, or use the wireless remote control or the mechanical key, to unlock the doors.

■ Conditions affecting operation

The smart entry & start system uses weak radio waves. In the following situations, the communication between the electronic key and the vehicle may be affected, preventing the smart entry & start system, wireless remote control and engine immobilizer system from operating properly.

(Way of coping: →P. 624)

- When the electronic key battery is depleted
- Near a TV tower, electric power plant, gas station, radio station, large display, airport or other facility that generates strong radio waves or electrical noise
- When the electronic key is in contact with, or is covered by the following metallic objects
 - Cards to which aluminum foil is attached
 - Cigarette boxes that have aluminum foil inside
 - Metallic wallets or bags
 - Coins
 - Hand warmers made of metal
 - Media such as CDs and DVDs
- When other wireless key (that emit radio waves) is being used nearby
- When carrying the electronic key together with the following devices that emit radio waves
 - A portable radio, cellular phone, cordless phone or other wireless communication device
 - Another vehicle's electronic key or a wireless key that emits radio waves
 - Personal computers or personal digital assistants (PDAs)
 - Digital audio players
 - Portable game systems
- If window tint with a metallic content or metallic objects are attached to the rear window
- When the electronic key is placed near a battery charger or electronic devices

■ Notes for the entry function

- Even when the electronic key is within the effective range (detection areas), the system may not operate properly in the following cases:
 - The electronic key is too close to the window or outside door handle, near the ground, or in a high place when the doors are locked or unlocked.
 - The electronic key is on the instrument panel, luggage cover (if equipped) or floor, or in the door pockets, glove box, accessory box of the instrument panel, or in/near the front cup holder when:
 - Except hybrid vehicle: the engine is started or “ENGINE START STOP” switch modes are changed.
 - Hybrid vehicle: the hybrid system is started or “POWER” switch modes are changed.
- Do not leave the electronic key on top of the instrument panel or near the door pockets when exiting the vehicle. Depending on the radio wave reception conditions, it may be detected by the antenna outside the cabin and the door will become lockable from the outside, possibly trapping the electronic key inside the vehicle.
- As long as the electronic key is within the effective range, the doors may be locked or unlocked by anyone.
- Even if the electronic key is not inside the vehicle, it may be possible to start the engine (except hybrid vehicle) or hybrid system (hybrid vehicle) if the electronic key is near the window.
- The doors may unlock if a large amount of water splashes on the door handle, such as in the rain or in a car wash when the electronic key is within the effective range. (The door will automatically be locked after approximately 30 seconds if the doors are not opened and closed.)
- Gripping the door handle when wearing a glove may not unlock the door.
- If the wireless remote control is used to lock the doors when the electronic key is near the vehicle, there is a possibility that the door may not be unlocked by the entry function. (Use the wireless remote control to unlock the doors.)
- A sudden approach to the effective range or door handle may prevent the doors from being unlocked. In this case, return the door handle to the original position and check that the doors unlock before pulling the door handle again.

■ **Notes for locking the doors**

- Touching the door lock sensor while wearing gloves may delay or prevent lock operation. Remove the gloves and touch the lock sensor again.
- On hybrid vehicle, when the lock operation is performed using the lock sensor, recognition signal will be shown up to two consecutive times. After this, no recognition signals will be given.
- If the door handle becomes wet while the electronic key is within the effective range, the door may lock and unlock repeatedly. Place the key in a position 2 m (6 ft.) or more separate from the vehicle while the vehicle is being washed. (Take care to ensure that the key is not stolen.)
- If the electronic key is inside the vehicle and a door handle becomes wet during a car wash, a buzzer will sound outside the vehicle. To turn off the alarm, lock all the doors.
- The lock sensor may not work properly if it comes into contact with ice, snow, mud, etc. Clean the lock sensor and attempt to operate it again.

■ **Notes for the unlocking function**

- A sudden approach to the effective range or door handle may prevent the doors from being unlocked. In this case, return the door handle to the original position and check that the doors unlock before pulling the door handle again.
- Gripping the door handle when wearing a glove may not unlock the door. Remove the gloves and touch the sensor on the back of the handle again.
- If the door handle becomes wet while the electronic key is within the effective range, the door may lock and unlock repeatedly. Place the key in a position 2 m (6 ft.) or more separate from the vehicle while the vehicle is being washed. (Take care to ensure that the key is not stolen.)
- If there is another electronic key in the detection area, it may take slightly longer to unlock the doors after the door handle is gripped.

■ **When the vehicle is not driven for extended periods**

- To prevent theft of the vehicle, do not leave the electronic key within 2 m (6 ft.) of the vehicle.
- The smart entry & start system can be deactivated in advance. (→P. 689)

■ Security feature

If a door is not opened within approximately 30 seconds after the vehicle is unlocked, the security feature automatically locks the vehicle again.

■ To operate the system properly

Make sure to carry the electronic key when operating the system. Do not get the electronic key too close to the vehicle when operating the system from the outside of the vehicle.

Depending on the position and holding condition of the electronic key, the key may not be detected correctly and the system may not operate properly. (The alarm may go off accidentally, or the door lock prevention function may not operate.)

■ If the smart entry & start system does not operate properly

- Locking and unlocking the doors: Use the mechanical key. (→P. 624)
- Starting the engine (except hybrid vehicle) or the hybrid system (hybrid vehicle): →P. 625, 627

■ Electronic key battery depletion

- The standard battery life is 1 to 2 years.
- If the battery becomes low, an alarm will sound in the cabin when the engine (except hybrid vehicle) or the hybrid system (hybrid vehicle) stops. (→P. 571)
- As the electronic key always receives radio waves, the battery will become depleted even if the electronic key is not used. The following symptoms indicate that the electronic key battery may be depleted. Replace the battery when necessary. (→P. 501)
 - The smart entry & start system or the wireless remote control does not operate.
 - The detection area becomes smaller.
 - The LED indicator on the key surface does not turn on.
- To avoid serious deterioration, do not leave the electronic key within 1 m (3 ft.) of the following electrical appliances that produce a magnetic field:
 - TVs
 - Personal computers
 - Cellular phones, cordless phones and battery chargers
 - Recharging cellular phones or cordless phones
 - Induction cookers
 - Table lamps

■ **When the electronic key battery is fully depleted**

→P. 501

■ **If the smart entry & start system has been deactivated in a customized setting**

● Locking and unlocking the doors: Use the wireless remote control or mechanical key. (→P. 105, 624)

● Starting the engine and changing “ENGINE START STOP” switch modes (except hybrid vehicle): →P. 625

● Starting the hybrid system and changing “POWER” switch mode (hybrid vehicle): →P. 627

● Stopping the engine (except hybrid vehicle): →P. 229

● Stopping the hybrid system (hybrid vehicle): →P. 242

■ **Customization that can be configured at any authorized Toyota dealer or repairer, or another duly qualified and equipped professional**

Settings (e. g. smart entry & start system) can be changed.

(Customizable features: →P. 689)

■ Certification for the smart entry & start system (except hybrid vehicle)



R&TTE Declaration of Conformity

We,

Manufacturer's name: Valeo Security Systems
 Manufacturer's address: 76, rue Auguste Perret
 F-96046 Créteil - France

hereby declare under our sole responsibility that the products:

Product name:	Model No.:
Smart Key	A02TAA
Smart Tuner	A02RAA
Engine Switch	A02IAA
Power Smart ECU	A02SAA

to which this declaration relates, comply with the essential protection requirements of R&TTE Directive (1999/5/ EC)
 The products are compliant with the following standards and/or normative documents:

- Radio matters: EN 300 220-1 V2.3.1 (2010-02), EN 300 220-2 V2.3.1 (2010-02)
 EN 300 330-1 V 1.7.1 (2010-02), EN 300 330-2 V1.5.1 (2010-02)
- EMC: EN 301 489-1 V1.8.1 (2008-04), EN 301 489-3 V1.4.1 (2002-08)
- Electrical Safety: EN 60950-1 (2006) + A11(2009)

CE marking:

CE 0682

Signature:

Jérôme Hugot
 Approval Engineer

Date: March 22, 2011

1-3. Opening, closing and locking the doors

<p>Valeo Security Systems tímto prohlašuje, že tento A02TAA, A02RAA, A02SAA & A02IAA je ve shodě se základními požadavky a dalšími příslušnými ustanoveními směrnice 1999/5/ES.</p>
<p>Undertegnede Valeo Security Systems erklærer herved, at følgende udstyr A02TAA, A02RAA, A02SAA & A02IAA overholder de væsentlige krav og øvrige relevante krav i direktiv 1999/5/EF.</p>
<p>Hiermit erklärt Valeo Security Systems, dass sich das Gerät A02TAA, A02RAA, A02SAA & A02IAA in Übereinstimmung mit den grundlegenden Anforderungen und den übrigen einschlägigen Bestimmungen der Richtlinie 1999/5/EG befindet.</p>
<p>Käesolevaga kinnitab Valeo Security Systems seadme A02TAA, A02RAA, A02SAA & A02IAA vastavust direktiivi 1999/5/EÜ põhinõuetele ja nimetatud direktiivist tulenevatele teistele asjakohastele sätetele.</p>
<p>Hereby, Valeo Security Systems declares that this A02TAA, A02RAA, A02SAA & A02IAA is in compliance with the essential requirements and other relevant provisions of Directive 1999/5/EC.</p>
<p>Por medio de la presente Valeo Security Systems declara que A02TAA, A02RAA, A02SAA & A02IAA cumple con los requisitos esenciales y cualesquiera otras disposiciones aplicables o exigibles de la Directiva 1999/5/CE.</p>
<p>ΜΕ ΤΗΝ ΠΑΡΟΥΣΑ Valeo Security Systems ΔΗΛΩΝΕΙ ΟΤΙ A02TAA, A02RAA, A02SAA & A02IAA ΣΥΜΜΟΡΦΩΝΕΤΑΙ ΠΡΟΣ ΤΙΣ ΟΥΣΙΩΔΕΙΣ ΑΠΑΙΤΗΣΕΙΣ ΚΑΙ ΤΙΣ ΛΟΙΠΕΣ ΣΧΕΤΙΚΕΣ ΔΙΑΤΑΞΕΙΣ ΤΗΣ ΟΔΗΓΙΑΣ</p>
<p>Par la présente Valeo Security Systems déclare que les appareils A02TAA, A02RAA, A02SAA & A02IAA sont conformes aux exigences essentielles et aux autres dispositions pertinentes de la directive 1999/5/CE.</p>
<p>Con la presente Valeo Security Systems dichiara che questo A02TAA, A02RAA, A02SAA & A02IAA è conforme ai requisiti essenziali ed alle altre disposizioni pertinenti stabilite dalla direttiva 1999/5/CE.</p>
<p>Ar šo Valeo Security Systems deklarē, ka A02TAA, A02RAA, A02SAA & A02IAA atbilst Direktīvas 1999/5/EK būtiskajām prasībām un citiem ar to saistītajiem noteikumiem.</p>
<p>Šiuo Valeo Security Systems deklaruoja, kad šis A02TAA, A02RAA, A02SAA & A02IAA atitinka esminius reikalavimus ir kitas 1999/5/EB Direktyvos nuostatas.</p>
<p>Hierbij verklaart Valeo Security Systems dat het toestel A02TAA, A02RAA, A02SAA & A02IAA in overeenstemming is met de essentiële eisen en de andere relevante bepalingen van richtlijn 1999/5/EG.</p>

Hawnhekk, Valeo Security Systems , jiddikjara li dan A02TAA, A02RAA, A02SAA & A02IAA jikkonforma mal-htigijiet essenzjali u ma provvedimenti ohrajn relevanti li hemm fid-Dirrettiva 1999/5/EC.
Alulírott, Valeo Security Systems nyilatkozom, hogy a A02TAA, A02RAA, A02SAA & A02IAA megfelel a vonatkozó alapvető követelményeknek és az 1999/5/EC irányelv egyéb előírásainak.
Niniejszym Valeo Security Systems oświadcza, że A02TAA, A02RAA, A02SAA & A02IAA jest zgodny z zasadniczymi wymogami oraz pozostałymi stosownymi postanowieniami Dyrektywy 1999/5/EC.
Valeo Security Systems declara que este A02TAA, A02RAA, A02SAA & A02IAA está conforme com os requisitos essenciais e outras disposições da Directiva 1999/5/CE.
Valeo Security Systems izjavlja, da je ta A02TAA, A02RAA, A02SAA & A02IAA v skladu z bistvenimi zahtevami in ostalimi relevantnimi določili direktive 1999/5/ES.
Valeo Security Systems tímto vyhlasuje, že A02TAA, A02RAA, A02SAA & A02IAA splňa základné požiadavky a všetky príslušné ustanovenia Smernice 1999/5/ES.
Valeo Security Systems vakuuttaa täten että A02TAA, A02RAA, A02SAA & A02IAA tyyppinen laite on direktiivin 1999/5/EY oleellisten vaatimusten ja sitä koskevien direktiivin muiden ehtojen mukainen.
Härmed intygar Valeo Security Systems att denna A02TAA, A02RAA, A02SAA & A02IAA står i överensstämmelse med de väsentliga egenskapskrav och övriga relevanta bestämmelser som framgår av direktiv 1999/5/EG.
Hér með lýsir Valeo Security Systems yfir því að A02TAA, A02RAA, A02SAA & A02IAA er í samræmi við grunnkröfur og aðrar kröfur, sem gerðar eru í tilskipun 1999/5/EC.
Ovim ,Valeo Security Sytems, izjavluje da ovaj A02TAA, A02RAA, A02SAA & A02IAA je usklađen sa bitnim zahtjevima i drugim relevantnim odredbama Direktive 1999/5/EC.
Valeo Security Systems erklærer herved at udstyret A02TAA, A02RAA, A02SAA & A02IAA er i samsvar med de grunnleggende krav og øvrige relevante krav i direktiv 1999/5/EF.

■ **Certification for the smart entry & start system (hybrid vehicle)**

“Hereby, TRCZ s.r.o., declares that this B94UM is in compliance with the essential requirements and other relevant provisions of Directive 1999/5/EC.”



R&TTE Declaration of Conformity

We,

Manufacturer's Name: TRCZ s.r.o.

Manufacturer's Address: Prumyslova 1165, 41002, Lovosice, Czech Republic

hereby declare under our sole responsibility that the product:

Product Name: Tuner

Product Model: B94UM

to which this declaration relates is in conformity with the essential requirements and other relevant requirements of the R&TTE Directive (1999/5/EC). The product is compliant with the following standards and/or other normative documents:

Safety: EN60950-1

EMC: EN301 489-1 & -3

Spectrum: EN300 220-2

Supplementary information:

* CE mark	
* Member states intended for use	EU and EFTA
* Member states with restrictive use	None

Date:

25 April 2011

Signature:

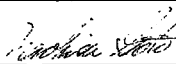

Position of the signatory:

Naohisa Goto
Vice President

"Hereby, TRCZ s.r.o., declares that this B94UM is in compliance with the essential requirements and other relevant provisions of Directive 1999/5/EC."

"Ovim, TRCZ s.r.o., izjavljuje da ovaj B94UM je usklađen sa bitnim zahtjevima i drugim relevantnim odredbama Direktive 1999/5/EC."

1

Before driving

“Hereby, TRCZ s.r.o., declares that this BA7EQ is in compliance with the essential requirements and other relevant provisions of Directive 1999/5/EC.”



R&TTE Declaration of Conformity

We,

Manufacturer's Name: TRCZ s.r.o.

Manufacturer's Address: Prumyslova 1165, 41002, Lovosice, Czech Republic

hereby declare under our sole responsibility that the product:

Product Name: Electronic Key

Product Model: BA7EQ

to which this declaration relates is in conformity with the essential requirements and other relevant requirements of the R&TTE Directive (1999/5/EC). The product is compliant with the following standards and/or other normative documents:

Safety: EN60950-1

EMC: EN301 489-1 & -3

Spectrum: EN300 220-2, EN300 330-2

Supplementary information:

* CE mark	
* Member states intended for use	EU and EFTA
* Member states with restrictive use	None

Date:

25 April 2011

Signature:

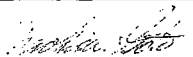

Position of the signatory:

Naohisa Goto
Vice President

"Hereby, TRCZ s. r. o., declares that this BA7EQ is in compliance with the essential requirements and other relevant provisions of Directive 1999/5/EC."

"Ovim, TRCZ s. r. o., izjavljuje da ovaj BA7EQ je usklađen sa bitnim zahtjevima i drugim relevantnim odredbama Direktive 1999/5/EC."

1

Before driving

TOYOTA

TOYOTA MOTOR CORPORATION

1, TOYOTA-CHO, TOYOTA, AICHI, 471-8571, JAPAN TEL: +81-565-28-2121

R&TTE Declaration of Conformity

We,

Manufacturer's Name: TOYOTA MOTOR CORPORATION
Manufacturer's Address: 1, Toyota -cho, Toyota, Aichi, 471-8572, Japan

hereby declare under our sole responsibility that the product:

Product Name: LF Oscillator
Product Model: TMLF10-16

to which this declaration relates is in conformity with the essential requirements and other relevant requirements of the R&TTE Directive (1999/5/EC). The product is compliant with the following standards and/or other normative documents:

-Health & safety requirements: EN 60950-1
-EMC requirements: EN 301 489-01 & EN 301 489-03
-Effective uses of radio spectrum: EN 300 330-2

Supplementary information:

* CE mark	
* Member states intended for use	EU and EFTA

Date: June 17, 2011

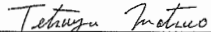
Signature: 
Tetsuya Matsuo

<p>Hereby, Toyota Motor Corporation, declares that this TMLF10-16 is in compliance with the essential requirements and other relevant provisions of Directive 1999/5/EC.</p>
<p>Toyota Motor Corporation vakuuttaa täten että TMLF10-16 tyyppinen laite on direktiivin 1999/5/EY oleellisten vaatimusten ja sitä koskevien direktiivin muiden ehtojen mukainen.</p>
<p>Hierbij verklaart Toyota Motor Corporation dat het toestel TMLF10-16 in overeenstemming is met de essentiële eisen en de andere relevante bepalingen van richtlijn 1999/5/EG.</p>
<p>Par la présente Toyota Motor Corporation déclare que l'appareil TMLF10-16 est conforme aux exigences essentielles et aux autres dispositions pertinentes de la directive 1999/5/CE.</p>
<p>Härmed intygar Toyota Motor Corporation att denna TMLF10-16 står i överensstämmelse med de väsentliga egenskapskrav och övriga relevanta bestämmelser som framgår av direktiv 1999/5/EG.</p>
<p>Undertegnede Toyota Motor Corporation erklærer herved, at følgende udstyr TMLF10-16 overholder de væsentlige krav og øvrige relevante krav i direktiv 1999/5/EF.</p>
<p>Hiermit erkläre Toyota Motor Corporation, dass sich das Gerät TMLF10-16 in Übereinstimmung mit den grundlegenden Anforderungen und den übrigen einschlägigen Bestimmungen der Richtlinie 1999/5/EG befindet.</p>
<p>ΜΕ ΤΗΝ ΠΑΡΟΥΣΑ Toyota Motor Corporation ΔΗΛΩΝΕΙ ΟΤΙ ΤΜΛF10-16 ΣΥΜΜΟΡΦΩΝΕΤΑΙ ΠΡΟΣ ΤΙΣ ΟΥΣΙΩΔΕΙΣ ΑΠΑΙΤΗΣΕΙΣ ΚΑΙ ΤΙΣ ΛΟΙΠΕΣ ΣΧΕΤΙΚΕΣ ΔΙΑΤΑΞΕΙΣ ΤΗΣ ΟΔΗΓΙΑΣ 1999/5/ΕΚ.</p>
<p>Con la presente Toyota Motor Corporation dichiara che questo TMLF10-16 è conforme ai requisiti essenziali ed alle altre disposizioni pertinenti stabilite dalla direttiva 1999/5/CE.</p>
<p>Por medio de la presente Toyota Motor Corporation declara que el TMLF10-16 cumple con los requisitos esenciales y cualesquiera otras disposiciones aplicables o exigibles de la Directiva 1999/5/CE.</p>
<p>Toyota Motor Corporation declara que este TMLF10-16 está conforme com os requisitos essenciais e outras disposições da Directiva 1999/5/CE.</p>
<p>Hawnhekk, Toyota Motor Corporation, jiddikjara li dan TMLF10-16 jikkonforma mal-ftigijiet essenzjali u ma provvedimenti oħrajn rilevanti li hemm fid-Dirrettiva 1999/5/EC.</p>
<p>Käesolevaga kinnitab Toyota Motor Corporation seadme TMLF10-16 vastavust direktiivi 1999/5/EÜ põhinõuetele ja nimetatud direktiivist tulenevatele teistele asjakohastele sätetele.</p>

1-3. Opening, closing and locking the doors

Alulírott, Toyota Motor Corporation nyilatkozom, hogy a TMLF10-16 megfelel a vonatkozó alapvető követelményeknek és az 1999/5/EC irányelv egyéb előírásainak.
Toyota Motor Corporation týmto vyhlasuje, že TMLF10-16 spĺňa základné požiadavky a všetky príslušné ustanovenia Smernice 1999/5/ES.
Toyota Motor Corporation tímto prohlašuje, že tento TMLF10-16 je ve shodě se základními požadavky a dalšími příslušnými ustanoveními směrnice 1999/5/ES.
Toyota Motor Corporation izjavlja, da je ta TMLF10-16 v skladu z bistvenimi zahtevami in ostalimi relevantnimi določili direktive 1999/5/ES.
Šiuo Toyota Motor Corporation deklaruoja, kad šis TMLF10-16 atitinka esminius reikalavimus ir kitas 1999/5/EB Direktyvos nuostatas.
Ar šo Toyota Motor Corporation deklarē, ka TMLF10-16 atbilst Direktīvas 1999/5/EK būtiskajām prasībām un citiem ar to saistītajiem noteikumiem.
Niniejszym Toyota Motor Corporation oświadcza, że TMLF10-16 jest zgodny z zasadniczymi wymogami oraz pozostałymi stosownymi postanowieniami Dyrektywy 1999/5/EC.
Hér með lýsir Toyota Motor Corporation yfir því að TMLF10-16 er í samræmi við grunnkröfur og aðrar kröfur, sem gerðar eru í tilskipun 1999/5/EC.
Toyota Motor Corporation erklærer herved at udstyret TMLF10-16 er i samsvar med de grunnleggende krav og øvrige relevante krav i direktiv 1999/5/EF.
С настоящето, Toyota Motor Corporation, декларира, че TMLF10-16 е в съответствие със съществените изисквания и другите приложими разпоредби на Директива 1999/5/EC.
Prin prezenta, Toyota Motor Corporation, declară că aparatul TMLF10-16 este în conformitate cu cerințele esențiale și cu alte prevederi pertinente ale Directivei 1999/5/CE.
Ovim, Toyota Motor Corporation, izjavljuje da ovaj TMLF10-16 je usklađen sa bitnim zahtjevima i drugim relevantnim odredbama Direktive 1999/5/EC.

■ **Certification for the smart entry & start system electronic key (vehicles sold in South Africa)**

Except hybrid vehicle

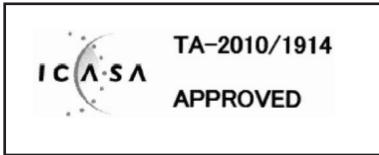

1

Before driving

⚠ CAUTION

■ **Caution regarding interference with electronic devices**

- People with implanted pacemakers or cardiac defibrillators should maintain a reasonable distance between themselves and the smart entry & start system antennas. (→P. 73)

The radio waves may affect the operation of such devices. If necessary, the entry function can be disabled. Ask any authorized Toyota dealer or repairer, or another duly qualified and equipped professional for details, such as the frequency of radio waves and timing of emitting the radio waves. Then, consult your doctor to see if you should disable the entry function.

- Users of any electrical medical device other than implanted pacemakers and implanted cardiac defibrillators should consult the manufacturer of the device for information about its operation under the influence of radio waves.

Radio waves could have unexpected effects on the operation of such medical devices.

Ask any authorized Toyota dealer or repairer, or another duly qualified and equipped professional for details on disabling the entry function.

1-3. Opening, closing and locking the doors

Push-button start system*

Starting and stopping the hybrid system can be performed simply by carrying the electronic key on your person, for example in your pocket. (→P. 241)

(The driver should always carry the electronic key.)

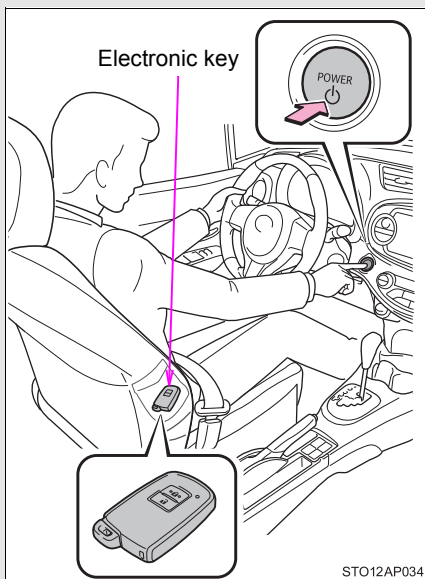

*: If equipped

Antenna location and effective range

■ Antenna location

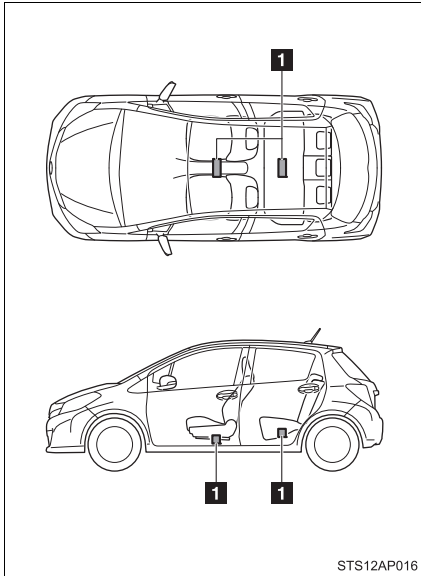

1 Antenna inside the cabin

■ Effective range (areas within which the electronic key is detected)

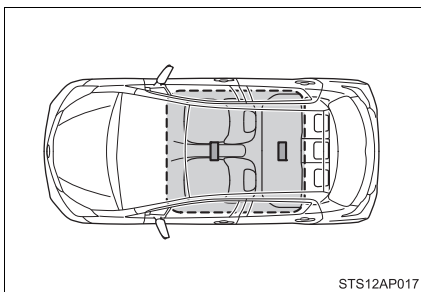

When starting the hybrid system or changing "POWER" switch modes

The system can be operated when the electronic key is inside the vehicle.

■ Alarms and warning indicators

A combination of exterior and interior alarms are used to prevent theft of the vehicle and unforeseeable accidents resulting from erroneous operation. Take appropriate measures for the warning light that comes on. (→P. 571)

The following table describes circumstances and correction procedures when only alarms are sounded.

Alarm	Situation	Correction procedure
Exterior alarm sounds once for 5 seconds	An attempt was made to lock the vehicle while a door is open	Close all of the doors and lock the doors again

■ Conditions affecting operation

→P. 78

■ Note for the push-button start system

- Even when the electronic key is within the effective range (detection areas), the system may not operate properly.

For example, the electronic key is on the instrument panel, luggage cover, floor or in the glove box when the hybrid system is started or “POWER” switch modes are changed.

- Even if the electronic key is not inside the vehicle, it may be possible to start the hybrid system if the electronic key is near the window.

■ To operate the system properly

Make sure to carry the electronic key when operating the system.

Depending on the position and holding condition of the electronic key, the key may not be detected correctly and the system may not operate properly. (The alarm may go off accidentally, or the door lock prevention may not function.)

■ If the push-button start system does not operate properly

→P. 627

■ Electronic key battery depletion

→P. 81

■ When the electronic key battery is fully depleted

→P. 501

■ Customization

Settings (e.g. push-button start system) can be changed.
(Customizable features →P. 689)

⚠ CAUTION**■ Caution regarding interference with electronic devices**

- People with implanted pacemakers or cardiac defibrillators should keep away from the push-button start system antennas. (→P. 95)

The radio waves may affect the operation of such devices. If necessary, the push-button start system can be disabled. Ask any authorized Toyota dealer or repairer, or another duly qualified and equipped professional for details, such as the frequency of radio waves and timing of emitting the radio waves. Then, consult your doctor to see if you should disable the push-button start system.

- Users of any electrical medical device other than implanted pacemakers and implanted cardiac defibrillators should consult the manufacturer of the device for information about its operation under the influence of radio waves. Radio waves could have unexpected effects on the operation of such medical devices.

Ask any authorized Toyota dealer or repairer, or another duly qualified and equipped professional for details on disabling the push-button start system.

■ **Certification**

“Hereby, TRCZ s.r.o., declares that this B94UM is in compliance with the essential requirements and other relevant provisions of Directive 1999/5/EC.”



R&TTE Declaration of Conformity

We,

Manufacturer's Name: TRCZ s.r.o.

Manufacturer's Address: Prumyslova 1165, 41002, Lovosice, Czech Republic

hereby declare under our sole responsibility that the product:

Product Name: Tuner

Product Model: B94UM

to which this declaration relates is in conformity with the essential requirements and other relevant requirements of the R&TTE Directive (1999/5/EC). The product is compliant with the following standards and/or other normative documents:

Safety: EN60950-1

EMC: EN301 489-1 & -3

Spectrum: EN300 220-2

Supplementary information:

* CE mark	
* Member states intended for use	EU and EFTA
* Member states with restrictive use	None

Date:

25 April 2011

Signature:

Position of the signatory:

Naohisa Goto
Vice President

"Hereby, TRCZ s.r.o., declares that this B94UM is in compliance with the essential requirements and other relevant provisions of Directive 1999/5/EC."

"Ovim, TRCZ s.r.o., izjavljuje da ovaj B94UM je usklađen sa bitnim zahtjevima i drugim relevantnim odredbama Direktive 1999/5/EC."

1

Before driving

“Hereby, TRCZ s.r.o., declares that this BA7EQ is in compliance with the essential requirements and other relevant provisions of Directive 1999/5/EC.”



R&TTE Declaration of Conformity

We,

Manufacturer's Name: TRCZ s.r.o.

Manufacturer's Address: Prumyslova 1165, 41002, Lovosice, Czech Republic

hereby declare under our sole responsibility that the product:

Product Name: Electronic Key

Product Model: BA7EQ

to which this declaration relates is in conformity with the essential requirements and other relevant requirements of the R&TTE Directive (1999/5/EC). The product is compliant with the following standards and/or other normative documents:

Safety: EN60950-1

EMC: EN301 489-1 & -3

Spectrum: EN300 220-2, EN300 330-2

Supplementary information:

* CE mark	
* Member states intended for use	EU and EFTA
* Member states with restrictive use	None

Date:

25 April 2011

Signature:

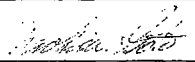

Position of the signatory:

Naohisa Goto
Vice President

"Hereby, TRCZ s. r. o., declares that this BA7EQ is in compliance with the essential requirements and other relevant provisions of Directive 1999/5/EC."

"Ovim, TRCZ s. r. o., izjavljuje da ovaj BA7EQ je usklađen sa bitnim zahtjevima i drugim relevantnim odredbama Direktive 1999/5/EC."

1

Before driving

TOYOTA

TOYOTA MOTOR CORPORATION

1, TOYOTA-CHO, TOYOTA, AICHI, 471-8571, JAPAN TEL: +81-565-28-2121

R&TTE Declaration of Conformity

We,

Manufacturer's Name: TOYOTA MOTOR CORPORATION
Manufacturer's Address: 1, Toyota -cho, Toyota, Aichi, 471-8572, Japan

hereby declare under our sole responsibility that the product:

Product Name: LF Oscillator
Product Model: TMLF10-16

to which this declaration relates is in conformity with the essential requirements and other relevant requirements of the R&TTE Directive (1999/5/EC). The product is compliant with the following standards and/or other normative documents:

-Health & safety requirements: EN 60950-1
-EMC requirements: EN 301 489-01 & EN 301 489-03
-Effective uses of radio spectrum: EN 300 330-2

Supplementary information:

* CE mark	
* Member states intended for use	EU and EFTA

Date: June 17, 2011

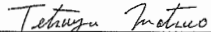
Signature: 
Tetsuya Matsuo

<p>Hereby, Toyota Motor Corporation, declares that this TMLF10-16 is in compliance with the essential requirements and other relevant provisions of Directive 1999/5/EC.</p>
<p>Toyota Motor Corporation vakuuttaa täten että TMLF10-16 tyyppinen laite on direktiivin 1999/5/EY oleellisten vaatimusten ja sitä koskevien direktiivin muiden ehtojen mukainen.</p>
<p>Hierbij verklaart Toyota Motor Corporation dat het toestel TMLF10-16 in overeenstemming is met de essentiële eisen en de andere relevante bepalingen van richtlijn 1999/5/EG.</p>
<p>Par la présente Toyota Motor Corporation déclare que l'appareil TMLF10-16 est conforme aux exigences essentielles et aux autres dispositions pertinentes de la directive 1999/5/CE.</p>
<p>Härmed intygar Toyota Motor Corporation att denna TMLF10-16 står i överensstämmelse med de väsentliga egenskapskrav och övriga relevanta bestämmelser som framgår av direktiv 1999/5/EG.</p>
<p>Undertegnede Toyota Motor Corporation erklærer herved, at følgende udstyr TMLF10-16 overholder de væsentlige krav og øvrige relevante krav i direktiv 1999/5/EF.</p>
<p>Hiermit erklärt Toyota Motor Corporation, dass sich das Gerät TMLF10-16 in Übereinstimmung mit den grundlegenden Anforderungen und den übrigen einschlägigen Bestimmungen der Richtlinie 1999/5/EG befindet.</p>
<p>ΜΕ ΤΗΝ ΠΑΡΟΥΣΑ Toyota Motor Corporation ΔΗΛΩΝΕΙ ΟΤΙ ΤΜΛΦ10-16 ΣΥΜΜΟΡΦΩΝΕΤΑΙ ΠΡΟΣ ΤΙΣ ΟΥΣΙΩΔΕΙΣ ΑΠΑΙΤΗΣΕΙΣ ΚΑΙ ΤΙΣ ΛΟΙΠΕΣ ΣΧΕΤΙΚΕΣ ΔΙΑΤΑΞΕΙΣ ΤΗΣ ΟΔΗΓΙΑΣ 1999/5/ΕΚ.</p>
<p>Con la presente Toyota Motor Corporation dichiara che questo TMLF10-16 è conforme ai requisiti essenziali ed alle altre disposizioni pertinenti stabilite dalla direttiva 1999/5/CE.</p>
<p>Por medio de la presente Toyota Motor Corporation declara que el TMLF10-16 cumple con los requisitos esenciales y cualesquiera otras disposiciones aplicables o exigibles de la Directiva 1999/5/CE.</p>
<p>Toyota Motor Corporation declara que este TMLF10-16 está conforme com os requisitos essenciais e outras disposições da Directiva 1999/5/CE.</p>
<p>Hawnhekk, Toyota Motor Corporation, jiddikjara li dan TMLF10-16 jikkonforma mal-htigijiet essenzjali u ma provvedimenti oħrajn rilevanti li hemm fid-Dirrettiva 1999/5/EC.</p>
<p>Käesolevaga kinnitab Toyota Motor Corporation seadme TMLF10-16 vastavust direktiivi 1999/5/EÜ põhinõuetele ja nimetatud direktiivist tulenevatele teistele asjakohastele sätetele.</p>

1-3. Opening, closing and locking the doors

<p>Alulírott, Toyota Motor Corporation nyilatkozom, hogy a TMLF10-16 megfelel a vonatkozó alapvető követelményeknek és az 1999/5/EC irányelv egyéb előírásainak.</p>
<p>Toyota Motor Corporation tímto vyhlasuje, že TMLF10-16 spĺňa základné požiadavky a všetky príslušné ustanovenia Smernice 1999/5/ES.</p>
<p>Toyota Motor Corporation tímto prohlašuje, že tento TMLF10-16 je ve shodě se základními požadavky a dalšími příslušnými ustanoveními směrnice 1999/5/ES.</p>
<p>Toyota Motor Corporation izjavlja, da je ta TMLF10-16 v skladu z bistvenimi zahtevami in ostalimi relevantnimi določili direktive 1999/5/ES.</p>
<p>Šiuo Toyota Motor Corporation deklaruoja, kad šis TMLF10-16 atitinka esminius reikalavimus ir kitas 1999/5/EB Direktyvos nuostatas.</p>
<p>Ar šo Toyota Motor Corporation deklarē, ka TMLF10-16 atbilst Direktīvas 1999/5/EK būtiskajām prasībām un citiem ar to saistītajiem noteikumiem.</p>
<p>Niniejszym Toyota Motor Corporation oświadcza, że TMLF10-16 jest zgodny z zasadniczymi wymogami oraz pozostałymi stosownymi postanowieniami Dyrektywy 1999/5/EC.</p>
<p>Hér með lýsir Toyota Motor Corporation yfir því að TMLF10-16 er í samræmi við grunnkröfur og aðrar kröfur, sem gerðar eru í tilskipun 1999/5/EC.</p>
<p>Toyota Motor Corporation erklærer herved at utstyret TMLF10-16 er i samsvar med de grunnleggende krav og øvrige relevante krav i direktiv 1999/5/EF.</p>
<p>С настоящето, Toyota Motor Corporation, декларира, че TMLF10-16 е в съответствие със съществените изисквания и другите приложими разпоредби на Директива 1999/5/EC.</p>
<p>Prin prezenta, Toyota Motor Corporation, declară că aparatul TMLF10-16 este în conformitate cu cerințele esențiale și cu alte prevederi pertinente ale Directivei 1999/5/CE.</p>
<p>Ovim, Toyota Motor Corporation, izjavljuje da ovaj TMLF10-16 je usklađen sa bitnim zahtjevima i drugim relevantnim odredbama Direktive 1999/5/EC.</p>

1-3. Opening, closing and locking the doors

Wireless remote control*

The wireless remote control can be used to lock and unlock the vehicle.

Vehicles without a smart entry & start system or a push-button start system

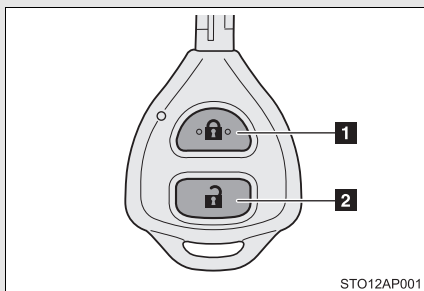

- 1** Locks all the doors
- 2** Unlocks all the doors

Vehicles with a smart entry & start system (type A)

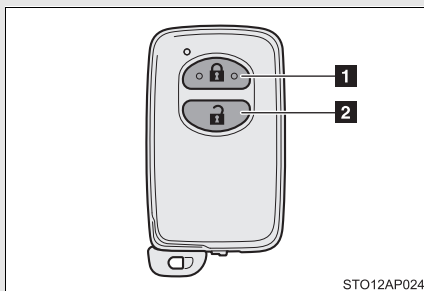

- 1** Locks all the doors
- 2** Unlocks all the doors

Vehicles with a smart entry & start system (type B)

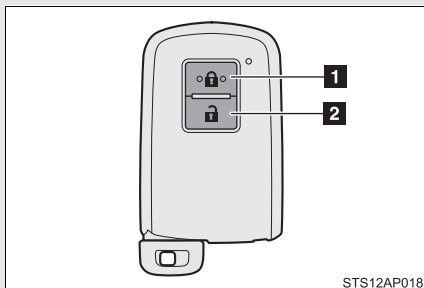

- 1** Locks all the doors
- 2** Unlocks all the doors

*: If equipped

Vehicles with a push-button start system

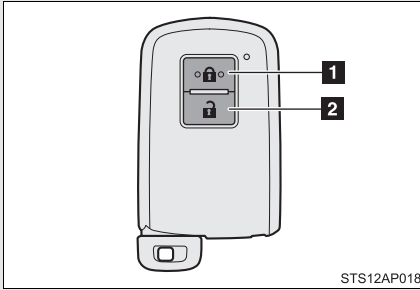

- 1** Locks all the doors
- 2** Unlocks all the doors

■ Operation signals

The emergency flashers flash to indicate that the doors have been locked/unlocked. (Locked: once; Unlocked: twice)

■ Door lock buzzer (vehicles with a smart entry & start system or a push-button start system)

If an attempt to lock the doors is made when a door is not fully closed, a buzzer sounds continuously. Fully close the door to stop the buzzer, and lock the vehicle once more.

■ Security feature

If a door is not opened within approximately 30 seconds after the vehicle is unlocked, the security feature automatically locks the vehicle again.

■ Conditions affecting operation

Vehicles without a smart entry & start system or a push-button start system

The wireless remote control function may not operate normally in the following situations:

- When the wireless key battery is depleted
- Near a TV tower, electric power plant, gas station, radio station, large display, airport or other facility that generates strong radio waves or electrical noise
- When carrying a portable radio, cellular phone or other wireless communication devices

- When the wireless key is in contact with, or is covered by a metallic object
- When other wireless key (that emit radio waves) is being used nearby
- If window tint with a metallic content or metallic objects are attached to the rear window

Vehicles with a smart entry & start system or a push-button start system

→P. 78

■ If the wireless remote control does not operate properly (vehicles with a smart entry & start system or a push-button start system)

Locking and unlocking the doors: Use the mechanical key. (→P. 624)

■ Key battery depletion

If the wireless remote control function does not operate, the battery may be depleted. Replace the battery when necessary. (→P. 501)

■ Electronic key battery depletion

→P. 81

■ When the key battery is fully depleted

→P. 501

■ Confirmation of the registered key number (vehicles with a smart entry and start system or a push-button start system)

The number of keys already registered to the vehicle can be confirmed. Ask any authorized Toyota dealer or repairer, or another duly qualified and equipped professional for details.

■ Customization that can be configured at any authorized Toyota dealer or repairer, or another duly qualified and equipped professional

Settings (e.g. wireless remote control system) can be changed.
(Customizable features →P. 689)

■ **Certification for wireless remote control (vehicles without a smart entry & start system or a push-button start system)**

Except hybrid vehicle



Valeo Security Systems

R&TTE Declaration of Conformity

We,

Manufacturer's name: Valeo Security Systems
Manufacturer's address: 76, rue Auguste Perret
F-96046 Créteil - France

hereby declare under our sole responsibility that the products:

Product name:	Model No.:
RF Key (Transmitter)	0603A1-A
RF Receiver	A03RAA

to which this declaration relates, comply with the essential protection requirements of R&TTE Directive (1999/5/ EC). The products are compliant with the following standards and/or normative documents:

- Radio matters: EN ETSI 300 220-1 V2.3.1 (2010-02), EN ETSI 300 220-2 V2.3.1 (2010-02)
- EMC: EN ETSI 301 489-1 V1.8.1 (2008-04), ETSI EN 301 489-3 V1.4.1 (2002-08)
- Electrical Safety: EN 60950-1: 2006/A11:2009/A1:2010

CE marking:



Signature:

Jerome Hugot
Approval Engineer

Date: 31-Jan-11

Valeo Security Systems tímto prohlašuje, že tento 0603A1-A & A03RAA je ve shodě se základními požadavky a dalšími příslušnými ustanoveními směrnice 1999/5/ES.
Undertegnede Valeo Security Systems erklærer herved, at følgende udstyr 0603A1-A & A03RAA overholder de væsentlige krav og øvrige relevante krav i direktiv 1999/5/EF.
Hiermit erklärt Valeo Security Systems, dass sich das Gerät 0603A1-A & A03RAA in Übereinstimmung mit den grundlegenden Anforderungen und den übrigen einschlägigen Bestimmungen der Richtlinie 1999/5/EG befindet.
Käesolevaga kinnitab Valeo Security Systems seadme 0603A1-A & A03RAA vastavust direktiivi 1999/5/EÜ põhinõuetele ja nimetatud direktiivist tulenevatele teistele asjakohastele sätetele.
Hereby, Valeo Security Systems declares that this 0603A1-A & A03RAA is in compliance with the essential requirements and other relevant provisions of Directive 1999/5/EC.
Por medio de la presente Valeo Security Systems declara que 0603A1-A & A03RAA cumple con los requisitos esenciales y cualesquiera otras disposiciones aplicables o exigibles de la Directiva 1999/5/CE.
ΜΕ ΤΗΝ ΠΑΡΟΥΣΑ Valeo Security Systems ΔΗΛΩΝΕΙ ΟΤΙ 0603A1-A & A03RAA ΣΥΜΜΟΡΦΩΝΕΤΑΙ ΠΡΟΣ ΤΙΣ ΟΥΣΙΩΔΕΙΣ ΑΠΑΙΤΗΣΕΙΣ ΚΑΙ ΤΙΣ ΛΟΙΠΕΣ ΣΧΕΤΙΚΕΣ ΔΙΑΤΑΞΕΙΣ ΤΗΣ ΟΔΗΓΙΑΣ
Par la présente Valeo Security Systems déclare que les appareils 0603A1-A & A03RAA sont conformes aux exigences essentielles et aux autres dispositions pertinentes de la directive 1999/5/CE.
Con la presente Valeo Security Systems dichiara che questo 0603A1-A & A03RAA è conforme ai requisiti essenziali ed alle altre disposizioni pertinenti stabilite dalla direttiva 1999/5/CE.
Ar šo Valeo Security Systems deklarē, ka 0603A1-A & A03RAA atbilst Direktīvas 1999/5/EK būtiskajām prasībām un citiem ar to saistītajiem noteikumiem.
Šiuo Valeo Security Systems deklaruoja, kad šis 0603A1-A & A03RAA atitinka esminius reikalavimus ir kitas 1999/5/EB Direktyvos nuostatas.
Hierbij verklaart Valeo Security Systems dat het toestel 0603A1-A & A03RAA in overeenstemming is met de essentiële eisen en de andere relevante bepalingen van richtlijn 1999/5/EG.

<p>Hawnhekk, Valeo Security Systems , jiddikjara li dan 0603A1-A & A03RAA jikkonforma mal-htigijiet essenzjali u ma provvedimenti oħrain relevanti li hemm fid-Dirrettiva 1999/5/EC.</p>
<p>Alulírótt, Valeo Security Systems nyilatkozom, hogy a 0603A1-A & A03RAA megfelel a vonatkozó alapvető követelményeknek és az 1999/5/EC irányelv egyéb előírásainak.</p>
<p>Niniejszym Valeo Security Systems oświadcza, że 0603A1-A & A03RAA jest zgodny z zasadniczymi wymogami oraz pozostałymi stosownymi postanowieniami Dyrektywy 1999/5/EC.</p>
<p>Valeo Security Systems declara que este 0603A1-A & A03RAA está conforme com os requisitos essenciais e outras disposições da Directiva 1999/5/CE.</p>
<p>Valeo Security Systems izjavlja, da je ta 0603A1-A & A03RAA v skladu z bistvenimi zahtevami in ostalimi relevantnimi določili direktive 1999/5/ES.</p>
<p>Valeo Security Systems týmto vyhlasuje, že 0603A1-A & A03RAA spĺňa základné požiadavky a všetky príslušné ustanovenia Smernice 1999/5/ES.</p>
<p>Valeo Security Systems vakuuttaa täten että 0603A1-A & A03RAA tyyppinen laite on direktiivin 1999/5/EY oleellisten vaatimusten ja sitä koskevien direktiivin muiden ehtojen mukainen.</p>
<p>Härmed intygar Valeo Security Systems att denna 0603A1-A & A03RAA står i överensstämmelse med de väsentliga egenskapskrav och övriga relevanta bestämmelser som framgår av direktiv 1999/5/EG.</p>
<p>Hér með lýsir Valeo Security Systems yfir því að 0603A1-A & A03RAA er í samræmi við grunnkröfur og aðrar kröfur, sem gerðar eru í tilskipun 1999/5/EC.</p>
<p>Ovim ,Valeo Security Systems, izjavlja da ovaj 0603A1-A & A03RAA je usklađen sa bitnim zahtjevima i drugim relevantnim odredbama Direktive 1999/5/EC.</p>
<p>Valeo Security Systems erklærer herved at udstyret 0603A1-A & A03RAA er i samsvar med de grundlæggende krav og øvrige relevante krav i direktiv 1999/5/EF.</p>



Hybrid vehicle**R&TTE Declaration of Conformity**

We,

Manufacturer's name: Valeo Security Systems
 Manufacturer's address: 76, rue Auguste Perret
 F-96046 Créteil - France

hereby declare under our sole responsibility that the products:

Product name:	Model No.:
RF Key (Transmitter)	0603A1-A
RF Receiver	A03RAA

to which this declaration relates, comply with the essential protection requirements of R&TTE Directive (1999/5/ EC).
 The products are compliant with the following standards and/or normative documents:

- Radio matters: EN 300 220-1 V2.3.1 (2010-02), EN 300 220-2 V2.3.1 (2010-02)
- EMC: EN 301 489-1 V1.8.1 (2008-04), EN 301 489-3 V1.4.1 (2002-08)
- Electrical Safety: EN 60950-1: 2006/A11:2009/A1:2010

CE marking:

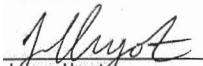

Signature:

 Jérôme Hugot
 Approval Engineer
 Date: 7-Nov-11

1-3. Opening, closing and locking the doors

<p>Valeo Security Systems tímto prohlašuje, že tento 0603A1-A & A03RAA je ve shodě se základními požadavky a dalšími příslušnými ustanoveními směrnice 1999/5/ES.</p>
<p>Undertegnede Valeo Security Systems erklærer herved, at følgende udstyr 0603A1-A & A03RAA overholder de væsentlige krav og øvrige relevante krav i direktiv 1999/5/EF.</p>
<p>Hiermit erklärt Valeo Security Systems, dass sich das Gerät 0603A1-A & A03RAA in Übereinstimmung mit den grundlegenden Anforderungen und den übrigen einschlägigen Bestimmungen der Richtlinie 1999/5/EG befindet.</p>
<p>Käesolevaga kinnitab Valeo Security Systems seadme 0603A1-A & A03RAA vastavust direktiivi 1999/5/EÜ põhinõuetele ja nimetatud direktiivist tulenevatele teistele asjakohastele sätetele.</p>
<p>Hereby, Valeo Security Systems declares that this 0603A1-A & A03RAA is in compliance with the essential requirements and other relevant provisions of Directive 1999/5/EC.</p>
<p>Por medio de la presente Valeo Security Systems declara que 0603A1-A & A03RAA cumple con los requisitos esenciales y cualesquiera otras disposiciones aplicables o exigibles de la Directiva 1999/5/CE.</p>
<p>ΜΕ ΤΗΝ ΠΑΡΟΥΣΑ Valeo Security Systems ΔΗΛΩΝΕΙ ΟΤΙ 0603A1-A & A03RAA ΣΥΜΜΟΡΦΩΝΕΤΑΙ ΠΡΟΣ ΤΙΣ ΟΥΣΙΩΔΕΙΣ ΑΠΑΙΤΗΣΕΙΣ ΚΑΙ ΤΙΣ ΛΟΙΠΕΣ ΣΧΕΤΙΚΕΣ ΔΙΑΤΑΞΕΙΣ ΤΗΣ ΟΔΗΓΙΑΣ 1999/5/ΕΚ.</p>
<p>Par la présente Valeo Security Systems déclare que les appareils 0603A1-A & A03RAA sont conformes aux exigences essentielles et aux autres dispositions pertinentes de la directive 1999/5/CE.</p>
<p>Con la presente Valeo Security Systems dichiara che questo 0603A1-A & A03RAA è conforme ai requisiti essenziali ed alle altre disposizioni pertinenti stabilite dalla direttiva 1999/5/CE.</p>
<p>Ar šo Valeo Security Systems deklarē, ka 0603A1-A & A03RAA atbilst Direktīvas 1999/5/EK būtiskajām prasībām un citiem ar to saistītajiem noteikumiem.</p>
<p>Šiuo Valeo Security Systems deklaruoja, kad šis 0603A1-A & A03RAA atitinka esminius reikalavimus ir kitas 1999/5/EB Direktyvos nuostatas.</p>
<p>Hierbij verklaart Valeo Security Systems dat het toestel 0603A1-A & A03RAA in overeenstemming is met de essentiële eisen en de andere relevante bepalingen van richtlijn 1999/5/EG.</p>

Hawnhekk, Valeo Security Systems , jiddikjara li dan 0603A1-A & A03RAA jikkonforma mal-htigijiet essenzjali u ma provvedimenti ohrain relevanti li hemm fid-Dirrettiva 1999/5/EC.
Alulírott, Valeo Security Systems nyilatkozom, hogy a 0603A1-A & A03RAA megfelel a vonatkozó alapvető követelményeknek és az 1999/5/EC irányelv egyéb előírásainak.
Niniejszym Valeo Security Systems oświadcza, że 0603A1-A & A03RAA jest zgodny z zasadniczymi wymogami oraz pozostałymi stosownymi postanowieniami Dyrektywy 1999/5/EC.
Valeo Security Systems declara que este 0603A1-A & A03RAA está conforme com os requisitos essenciais e outras disposições da Directiva 1999/5/CE.
Valeo Security Systems izjavlja, da je ta 0603A1-A & A03RAA v skladu z bistvenimi zahtevami in ostalimi relevantnimi določili direktive 1999/5/ES.
Valeo Security Systems tímto vyhlasuje, že 0603A1-A & A03RAA spĺňa základné požiadavky a všetky príslušné ustanovenia Smernice 1999/5/ES.
Valeo Security Systems vakuuttaa täten että 0603A1-A & A03RAA tyyppinen laite on direktiivin 1999/5/EY oleellisten vaatimusten ja sitä koskevien direktiivin muiden ehtojen mukainen.
Härmed intygar Valeo Security Systems att denna 0603A1-A & A03RAA står i överensstämmelse med de väsentliga ägenskapskrav och övriga relevanta bestämmelser som framgår av direktiv 1999/5/EG.
Hér með lýsir Valeo Security Systems yfir því að 0603A1-A & A03RAA er í samræmi við grunnkröfur og aðrar kröfur, sem gerðar eru í tilskipun 1999/5/EC.
Valeo Security Systems erklærer herved at udstyret 0603A1-A & A03RAA er i samsvar med de grundlæggende krav og øvrige relevante krav i direktiv 1999/5/EF.
Ovim ,Valeo Security Systems, izjavljuje da ovaj 0603A1-A & A03RAA je usklađen sa bitnim zahtjevima i drugim relevantnim odredbama Direktive 1999/5/EC.



1-3. Opening, closing and locking the doors

Side doors

The vehicle can be locked and unlocked using the entry function, wireless remote control, key or door lock switch.

■ **Entry function (vehicles with a smart entry & start system)**

→P. 71

■ **Wireless remote control (if equipped)**

→P. 105

■ **Keys (vehicles without a smart entry & start system or a push-button start system)**

Turning the key operates the doors as follows:

Driver's door

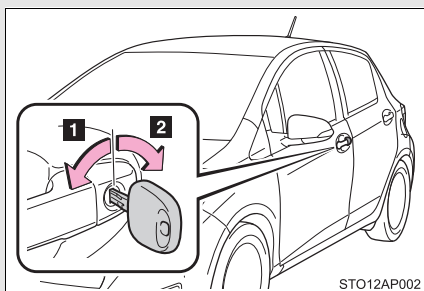

1 Locks all the doors

2 Unlocks all the doors

Front passenger's door (vehicles with a key cylinder)

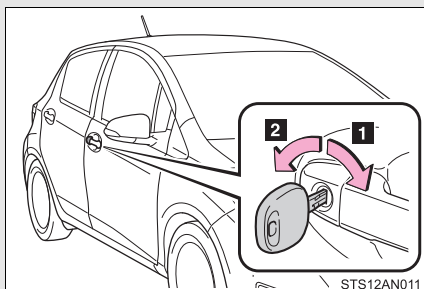

1 Locks the door

2 Unlocks the door

■ Electronic keys (vehicles with a smart entry & start system or a push-button start system)

The doors can also be locked and unlocked with the mechanical key. (→P. 624)

■ Door lock switch

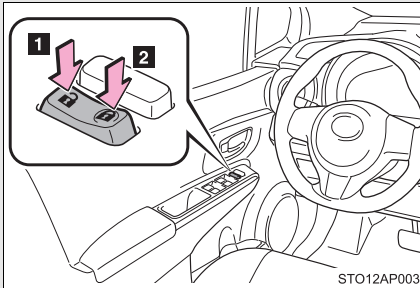

1 Unlocks all the doors

2 Locks all the doors

■ Inside door lock buttons

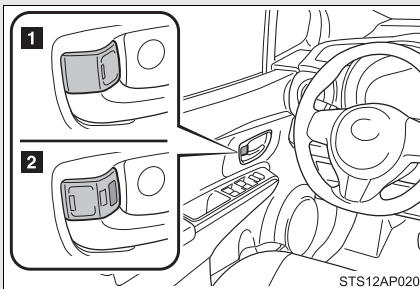

1 Locks the door

2 Unlocks the door

The front doors can be opened by pulling the inside handle even if the lock button is in the lock position.

Locking the front doors from the outside without a key

STEP 1 Move the inside door lock button to the lock position.

STEP 2 Close the door while pulling the door handle.

Vehicles without a smart entry & start system or a push-button start system (hybrid vehicle)

The door cannot be locked if the key is in the engine switch.

Vehicles with a smart entry & start system or a push-button start system (hybrid vehicle)

Except hybrid vehicle: The door cannot be locked if the “ENGINE START STOP” switch is in ACCESSORY or IGNITION ON mode, or the electronic key is left inside the vehicle.

Hybrid vehicle: The door cannot be locked if the “POWER” switch is in ACCESSORY or ON mode, or the electronic key is left.

The key may not be detected correctly and the door may be locked.

Rear door child-protector lock (5-door models only)

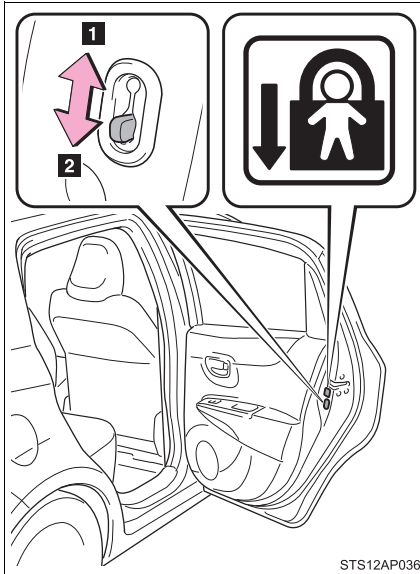

The door cannot be opened from inside the vehicle when the lock is set.

1 Unlock

2 Lock

These locks can be set to prevent children from opening the rear doors. Push down on each rear door switch to lock both rear doors.

1

Before driving

■ Impact detection door lock release system

In the event that the vehicle is subject to a strong impact, all the doors are unlocked. Depending on the force of the impact or the type of accident, however, the system may not operate.

■ Using the mechanical key (vehicles with a smart entry & start system or a push-button start system)

The doors can also be locked and unlocked with the mechanical key. (→P. 624)

■ If a wrong key is used (if equipped)

The key cylinder rotates freely to isolate inside mechanism.

■ If the smart entry & start system has been deactivated in a customized setting (vehicles with a smart entry & start system)

Use the wireless remote control or mechanical key. (→P. 105, 624)

 CAUTION

■ **To prevent an accident**

Observe the following precautions while driving the vehicle.

Failing to do so may result in a door opening and an occupant falling out, resulting in death or serious injury.

- Always use a seat belt.

- Ensure that all the doors are properly closed.

- Do not pull the inside handle of the doors while driving.

The doors may be opened and the passengers are thrown out of the vehicle and it may result in serious injury or death.

Be especially careful for the front doors, as the doors may be opened even if the inside lock buttons are in locked position.

- Set the rear door child-protector locks when children are seated in the rear seats.

1-3. Opening, closing and locking the doors

Back door

The back door can be locked/unlocked and opened by the following procedures.

■ Locking and unlocking the back door

Keys (from the back door: vehicles with a back door key cylinder)

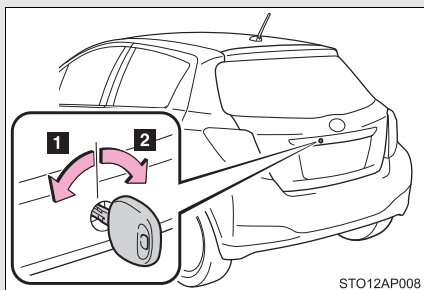

1 Unlocks all the doors

2 Locks all the doors

Keys (from the driver's door)

→P. 114

Wireless remote control (if equipped)

→P. 105

Door lock switch

→P. 115

Entry function (vehicles with a smart entry & start system)

→P. 71

■ Opening the back door from outside the vehicle

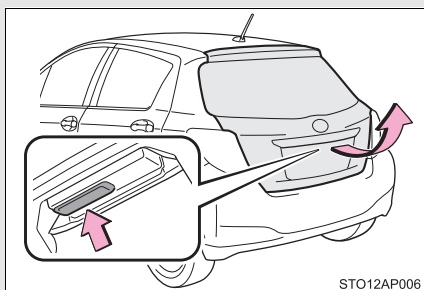

Raise the back door while pushing up the back door opener switch.

The back door cannot be closed immediately after the back door opener switch is pushed.

When closing the back door

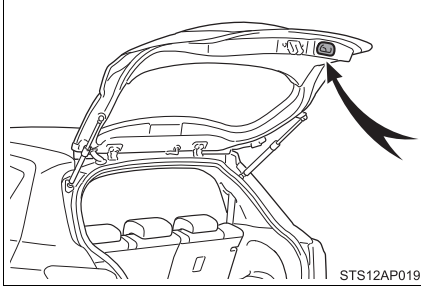

Lower the back door using the back door handle, and make sure to push the back door down from the outside to close it.

■ Luggage compartment light

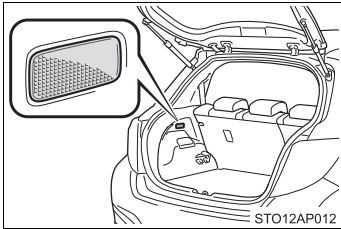

The luggage compartment light turns on when the back door is opened.

■ If the smart entry & start system has been deactivated in a customized setting (vehicles with a smart entry & start system)

Use the wireless remote control or mechanical key. (→P. 105, 624)

 **CAUTION****■ Caution while driving**

- Keep the back door closed while driving.
If the back door is left open, it may hit near-by objects while driving or luggage may be unexpectedly thrown out, causing an accident.
In addition, exhaust gases may enter the vehicle, causing death or a serious health hazard. Make sure to close the back door before driving.
- Before driving the vehicle, make sure that the back door is fully closed. If the back door is not fully closed, it may open unexpectedly while driving, causing an accident.
- Never let anyone sit in the luggage compartment. In the event of sudden braking or a collision, they are susceptible to death or serious injury.

■ When children are in the vehicle

Observe the following precautions.

Failure to do so may result in death or serious injury.

- Do not allow children to play in the luggage compartment.
If a child is accidentally locked in the luggage compartment, they could have heat exhaustion or other injuries.
- Do not allow a child to open or close the back door.
Doing so may cause the back door to move unexpectedly, or cause the child's hands, head, or neck to be caught by the closing back door.

⚠ CAUTION

■ Operating the back door

Observe the following precautions.

Failure to do so may cause parts of the body to be caught, resulting in death or serious injury.

- Remove any heavy loads, such as snow and ice, from the back door before opening it. Failure to do so may cause the back door to suddenly shut again after it is opened.
- When opening or closing the back door, thoroughly check to make sure the surrounding area is safe.
- If anyone is in the vicinity, make sure they are safe and let them know that the back door is about to open or close.
- Use caution when opening or closing the back door in windy weather as it may move abruptly in strong wind.

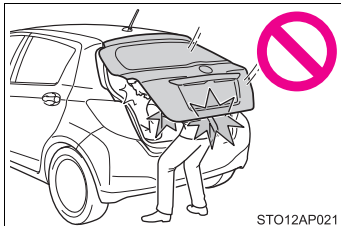

- The back door may suddenly shut if it is not opened fully. It is more difficult to open or close the back door on an incline than on a level surface, so beware of the back door unexpectedly opening or closing by itself. Make sure that the back door is fully open and secure before using the luggage compartment.

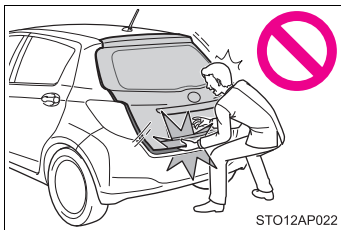

- When closing the back door, take extra care to prevent your fingers etc. from being caught.
- When closing the back door, make sure to press it lightly on its outer surface. If the back door handle is used to fully close the back door, it may result in hands or arms being caught.

⚠ CAUTION

- Do not pull on the back door damper stay to close the back door, and do not hang on the back door damper stay. Doing so may cause hands to be caught or the back door damper stay to break, causing an accident.
- If a bicycle carrier or similar heavy object is attached to the back door, it may suddenly shut again after being opened, causing someone's hands, head or neck to be caught and injured. When installing an accessory part to the back door, using a genuine Toyota part is recommended.

⚠ NOTICE

■ Back door damper stays

The back door is equipped with damper stays that hold the back door in place.

Observe the following precautions.

Failure to do so may cause damage to the back door damper stay, resulting in malfunction.

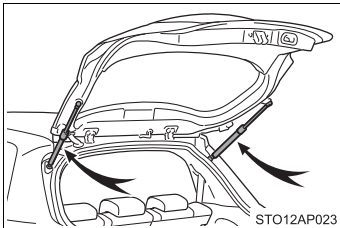

- Do not attach any foreign objects, such as stickers, plastic sheets, or adhesives to the damper stay rod.
- Do not touch the damper stay rod with gloves or other fabric items.
- Do not attach any accessories other than genuine Toyota parts to the back door.
- Do not place your hand on the damper stay or apply lateral forces to it.

1-4. Adjustable components (seats, mirrors, steering wheel)

Front seats

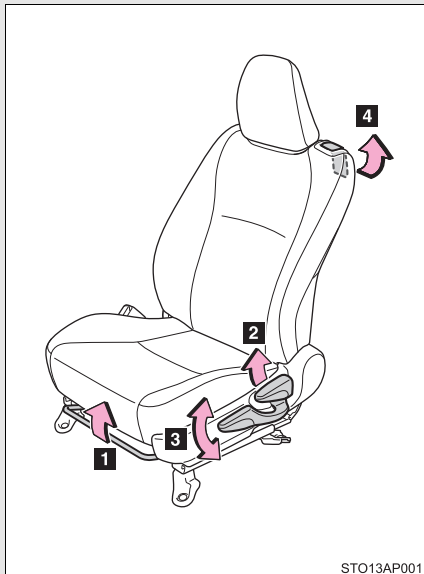

- 1** Seat position adjustment lever
- 2** Seatback angle adjustment lever
- 3** Vertical height adjustment lever (if equipped)
- 4** Seatback lock release lever (3-door models only)

STO13AP001

Moving front passenger's seat for rear seat entry (3-door models only)**■ Getting in the vehicle**

For easy access to the rear seat, use the seatback lock release lever. When the seatback lock release lever is used, the seat's original position is memorized, so the seat may be returned to that original position. However, if the seatback angle adjustment lever is used, the seat will not return to its original position.

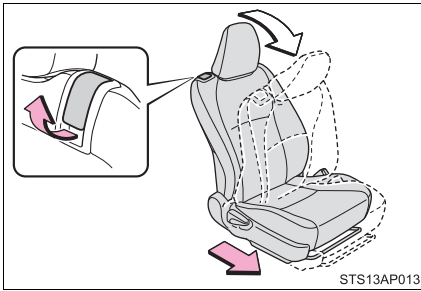

Lift the seatback lock release lever.

The seatback will fold forward, and the seat's slide lock will be released.

Move the seat all the way forward.

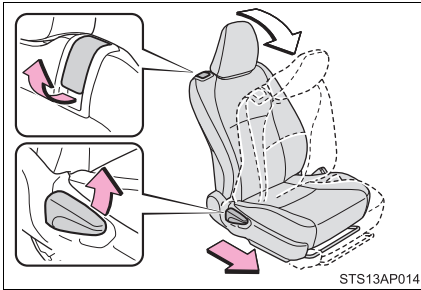
■ Getting out of the vehicle

Lift the seatback lock release lever or seatback angle adjustment lever.

The seatback will fold forward, and the seat's slide lock will be released.

Move the seat all the way forward.

■ **After passengers have entered the vehicle (3-door models only)**

Slide the seat backward and then lift the seatback. The seat will be set and locked to its previous position automatically. If the seat cannot be slid back to the previous position due to the rear passenger or luggage, the seat will be locked in that position, disabling the seat position memory system.

To recall the previous position, lift the seatback lock release lever after removing the luggage, or after having the passenger get out or sit properly so that the seat can be slid back to the previous position. However, if you slide the seat further backwards than previous position using the seat position adjustment lever, the memory of previous position will be overwritten.

 **CAUTION**

■ **Seat adjustment**

- Be careful that the seat does not hit passengers or luggage.
- To reduce the risk of sliding under the lap belt during a collision, do not recline the seat more than necessary.
If the seat is too reclined, the lap belt may slide past the hips and apply restraint forces directly to the abdomen, or your neck may contact the shoulder belt, increasing the risk of death or serious injury in the event of an accident.
Adjustments should not be made while driving as the seat may unexpectedly move and cause the driver to lose control of the vehicle.
- After adjusting the seat, make sure that the seat is locked in position.
- Never allow anyone to touch seatback lock release levers while the vehicle is moving.
- If anyone is in the vicinity, make sure they are clear of the seat back path and let them know that the seat is about to move.

■ **After returning the seatback to the upright position**

Make sure the seatback is securely locked by pushing it forward and rearward. Failure to do so may result in death or serious injury.

1-4. Adjustable components (seats, mirrors, steering wheel)

Rear seats*

The seatbacks of the rear seats can be folded down.

STEP 1 Stow the rear seat belt buckles as shown.

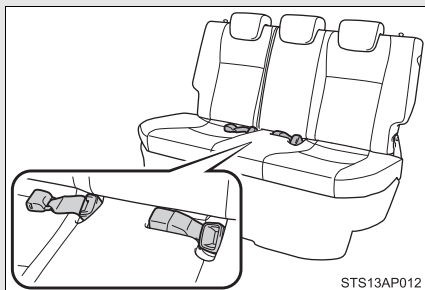

STEP 2 Stow the seat belts.

Center

→P. 134

Outside

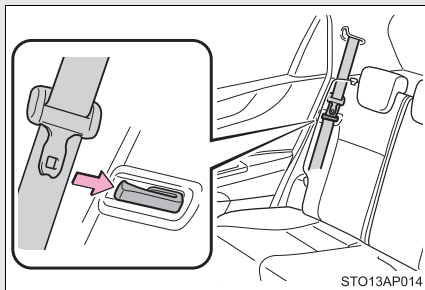

Use the seat belt hangers to prevent the belts from being tangled.

*: If equipped

1-4. Adjustable components (seats, mirrors, steering wheel)

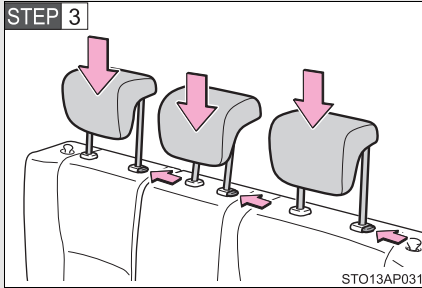

Lower the head restraints to the lowest position.

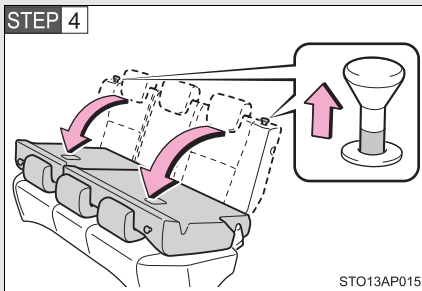

Pull the seatback lock release knob and fold the seatback down.

Each seatback may be folded separately.

⚠ CAUTION

■ When folding the rear seatbacks down

Observe the following precautions. Failure to do so may result in death or serious injury.

- Do not fold the seatbacks down while driving.
- Stop the vehicle on level ground, set the parking brake and shift the shift lever to P (vehicles with a hybrid transmission or a Multidrive), E, M or R (vehicles with a multi-mode manual transmission) or N (vehicles with a manual transmission).
- Do not allow anyone to sit on a folded seatback or in the luggage compartment while driving.
- Do not allow children to enter the luggage compartment.
- Do not allow anyone sit on the rear center seat if the rear right seat is folded down, as the seat belt buckle for the rear center seat belt is then concealed under the folded seat and cannot be used.
- Be careful not to catch your hand when folding the rear seatbacks.
- Depending on the position of the front seat, it may interfere when trying to fold down the rear seatbacks. If this happens, adjust the position of the front seat.

■ After returning the rear seatback to the upright position

Observe the following precautions. Failure to do so may result in death or serious injury.

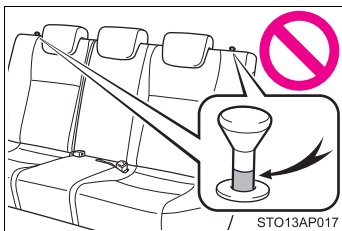

- Make sure that the seatback is securely locked in position by lightly pushing it back and forth. If the seatback is not securely locked, the red marking will be visible on the seatback lock release knob. Make sure that the red marking is not visible.

- Check that the seat belts are not twisted or caught in the seatback.

 NOTICE

■ **Stowing the seat belts**

The seat belts and the buckles must be stowed before you fold down the rear seatbacks.

1-4. Adjustable components (seats, mirrors, steering wheel)

Head restraints

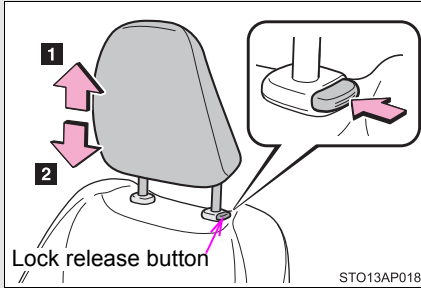

1 Up

Pull the head restraint up.

2 Down

Push the head restraint down while pushing the lock release button.

■ Removing the head restraints

Front and rear center head restraints

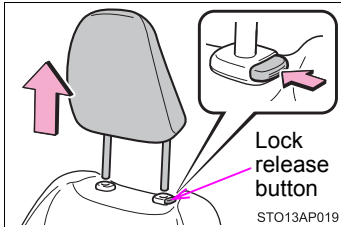

Pull the head restraint up while pressing the lock release button.

Rear outside head restraints

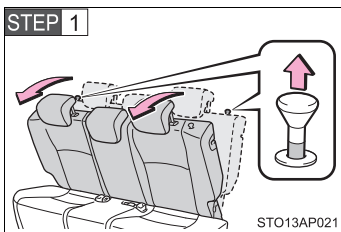

Pull the lock release knob and fold down the seatback until it reaches the position where the head restraints can be removed.

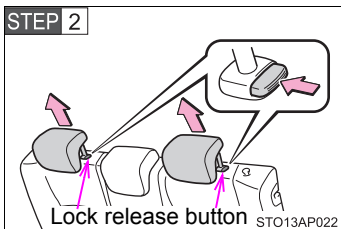

Pull the head restraint up while pushing the lock release button.

■ Adjusting the height of the front seat head restraints

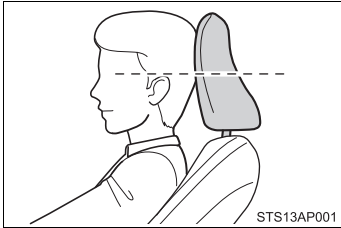

Make sure that the head restraints are adjusted so that the center of the head restraint is closest to the top of your ears.

■ Adjusting the rear seat head restraints

Always raise the head restraint one level from the stowed position when using.

⚠ CAUTION

■ Head restraint precautions

Observe the following precautions regarding the head restraints. Failure to do so may result in death or serious injury.

- Use the head restraints designed for each respective seat.
- Adjust the head restraints to the correct position at all times.
- After adjusting the head restraints, push down on them and make sure they are locked in position.
- Do not drive with the head restraints removed.

1-4. Adjustable components (seats, mirrors, steering wheel)

Seat belts

Make sure that all occupants are wearing their seat belts before driving the vehicle.

■ Correct use of the seat belts

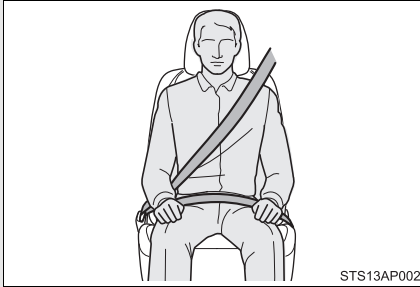

- Extend the shoulder belt so that it comes fully over the shoulder, but does not come into contact with the neck or slide off the shoulder.
- Position the lap belt as low as possible over the hips.
- Adjust the position of the seatback. Sit up straight and well back in the seat.
- Do not twist the seat belt.

■ Fastening and releasing the seat belt

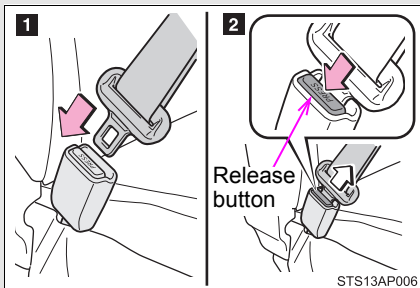

- 1** To fasten the seat belt, push the plate into the buckle until a click sound is heard.
- 2** To release the seat belt, press the release button.

Rear center seat belt

The rear center seat belt is a 3-point type restraint with 2 buckles. Both seat belt buckles must be correctly located and securely latched for proper operation.

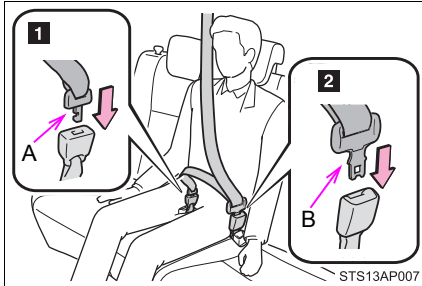

Make sure that the buckle **1** is securely latched ready for use of the center seat belt.

- 1** Matches the tab with hooked end (tab "A").
- 2** Matches the tab with concave end (tab "B").

■ Release method

The rear center seat belt can be completely released only when necessary such as when folding down the rear seat.

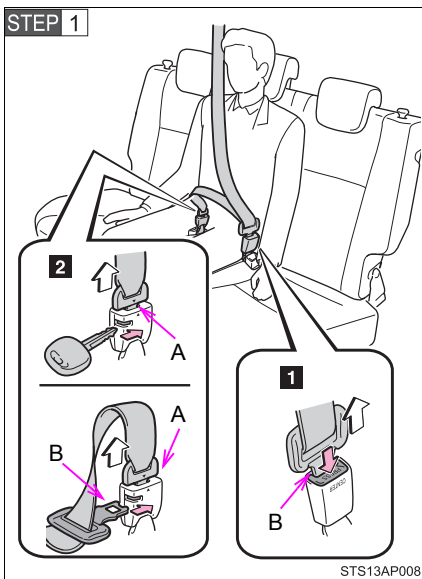

- 1** To release the tab "B", press the release button.
- 2** To release the tab "A", insert the key or tab "B" into the hole on the buckle.

Retract the belt slowly when releasing and stowing the seat belt.

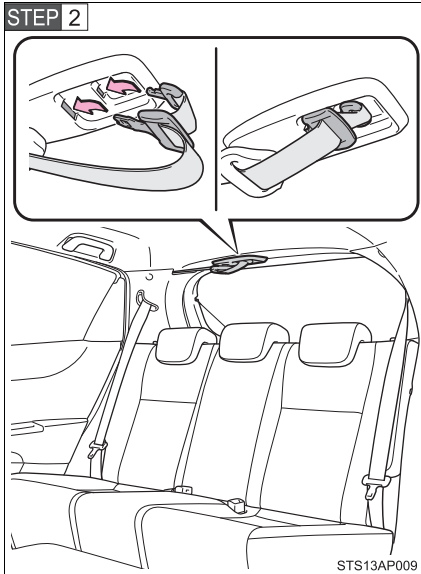

Stow the seat belt tabs in the cover set in the roof as shown.

■ **Extracting the belt**

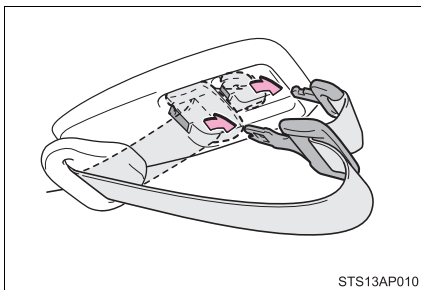

Remove the tabs from the cover.

Seat belt pretensioners (front seats)

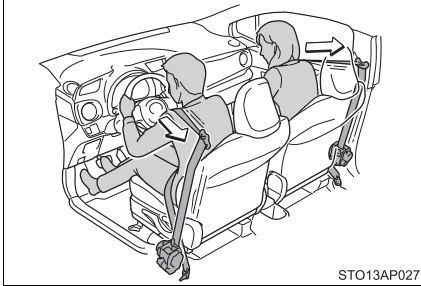

The pretensioner helps the seat belt to quickly restrain the occupant by retracting the seat belt when the vehicle is subjected to certain types of severe frontal collision.

The pretensioner does not activate in the event of a minor frontal impact, a side impact, a rear impact or a vehicle rollover.

■ Emergency locking retractor (ELR)

The retractor will lock the belt during a sudden stop or on impact. It may also lock if you lean forward too quickly. A slow, easy motion will allow the belt to extend so that you can move around fully.

■ Child seat belt usage

The seat belts of your vehicle were principally designed for persons of adult size.

- Use a child restraint system appropriate for the child, until the child becomes large enough to properly wear the vehicle's seat belt. (→P. 182)
- When the child becomes large enough to properly wear the vehicle's seat belt, follow the instructions on P. 133 regarding seat belt usage.

■ Replacing the belt after the pretensioner has been activated

If the vehicle is involved in multiple collisions, the pretensioner will activate for the first collision, but will not activate for the second or subsequent collisions.

■ Seat belt regulations

If seat belt regulations exist in the country where you reside, please contact any authorized Toyota dealer or repairer, or another duly qualified and equipped professional for seat belt replacement or installation.

⚠ CAUTION

Observe the following precautions to reduce the risk of injury in the event of sudden braking, sudden swerving or an accident.

Failure to do so may cause death or serious injury.

■ Wearing a seat belt

- Ensure that all passengers wear a seat belt.
- Always wear a seat belt properly.
- Each seat belt should be used by one person only. Do not use a seat belt for more than one person at once, including children.
- Toyota recommends that children be seated in the rear seat and always use a seat belt and/or an appropriate child restraint system.
- To achieve a proper seating position, do not recline the seat more than necessary. The seat belt is most effective when the occupants are sitting up straight and well back in the seats.
- Do not wear the shoulder belt under your arm.
- Always wear your seat belt low and snug across your hips.

■ Pregnant women

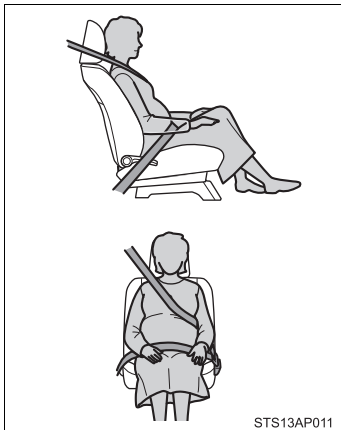

Obtain medical advice and wear the seat belt in the proper way. (→P. 133)

Women who are pregnant should position the lap belt as low as possible over the hips in the same manner as other occupants. Extend the shoulder belt completely over the shoulder and position the belt across the chest. Avoid belt contact over the rounding of the abdominal area.

If the seat belt is not worn properly, not only the pregnant woman, but also the fetus could suffer death or serious injury as a result of sudden braking or a collision.

■ People suffering illness

Obtain medical advice and wear the seat belt in the proper way. (→P. 133)

 **CAUTION**

■ **When children are in the vehicle**

Do not allow children to play with the seat belt. If the seat belt becomes twisted around a child's neck, it may lead to choking or other serious injuries that could result in death.

If this occurs and the buckle cannot be unfastened, scissors should be used to cut the belt.

■ **Seat belt pretensioners**

- Do not place anything, such as a cushion, on the front passenger's seat. The seat belt pretensioner for the front passenger's seat may not activate in the event of a collision.
- If the pretensioner has activated, the SRS warning light will come on. In that case, the seat belt cannot be used again and must be replaced at any authorized Toyota dealer or repairer, or another duly qualified and equipped professional.

■ **Seat belt damage and wear**

- Do not damage the seat belts by allowing the belt, plate, or buckle to be jammed in the door.
- Inspect the seat belt system periodically. Check for cuts, fraying, and loose parts. Do not use a damaged seat belt until it is replaced. Damaged seat belts cannot protect an occupant from death or serious injury.
- Ensure that the belt and plate are locked and the belt is not twisted. If the seat belt does not function correctly, immediately contact any authorized Toyota dealer or repairer, or another duly qualified and equipped professional.
- Replace the seat assembly, including the belts, if your vehicle has been involved in a serious accident, even if there is no obvious damage.
- Do not attempt to install, remove, modify, disassemble or dispose of the seat belts. Have any necessary repairs carried out by any authorized Toyota dealer or repairer, or another duly qualified and equipped professional. Inappropriate handling of the pretensioner may prevent it from operating properly, resulting in death or serious injury.

⚠ CAUTION

■ When using the rear center seat belt



- Do not use the rear center seat belt with either buckle released.

Fastening only one of the buckles may result in death or serious injury in case of sudden braking or a collision.

- Do not allow anyone sit on the rear center seat if the rear right seat is folded down, as the seat belt buckle for the rear center seat belt is then concealed under the folded seat and cannot be used.

1-4. Adjustable components (seats, mirrors, steering wheel)

Steering wheel

The steering wheel can be adjusted to a comfortable position.

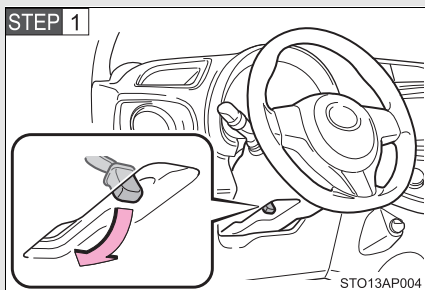

Hold the steering wheel and push the lever down.

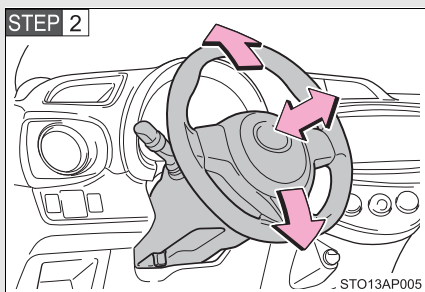

Adjust to the ideal position by moving the steering wheel horizontally and vertically.

After adjustment, pull the lever up to secure the steering wheel.

CAUTION

■ Caution while driving

Do not adjust the steering wheel while driving. Doing so may cause the driver to mishandle the vehicle and cause an accident, resulting in death or serious injury.

■ After adjusting the steering wheel

Make sure that the steering wheel is securely locked. Otherwise, the steering wheel may move suddenly, possibly causing an accident, and resulting in death or serious injury.

1-4. Adjustable components (seats, mirrors, steering wheel) Anti-glare inside rear view mirror

The rear view mirror's position can be adjusted to enable sufficient confirmation of the rear view in accordance with the driver's seating posture.

Adjusting the height of rear view mirror (vehicles with an auto anti-glare inside rear view mirror)

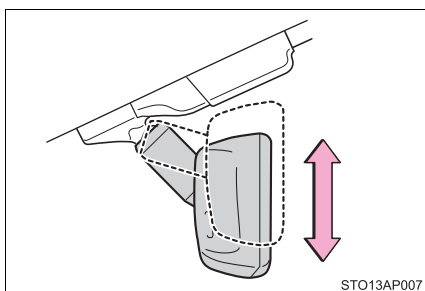

Adjust the height of the rear view mirror by moving it up and down.

Anti-glare function

Vehicles with a manual anti-glare inside rear view mirror

Reflected light from the headlights of vehicles behind can be reduced by operating the lever.

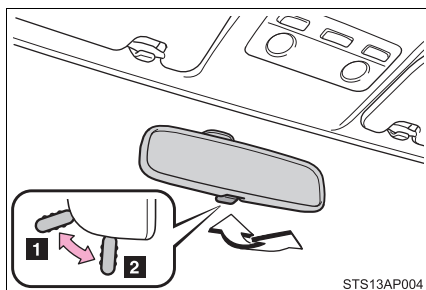

- 1 Normal position
- 2 Anti-glare position

Vehicles with an auto anti-glare inside rear view mirror

Responding to the level of brightness of the headlights of vehicles behind, the reflected light is automatically reduced.

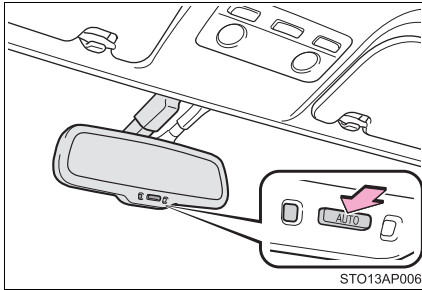

Changing automatic anti-glare function mode

ON/OFF

When the automatic anti-glare function is in ON mode, the indicator illuminates.

Except hybrid vehicle

Vehicles without a smart entry & start system:

The function will set to ON mode each time the engine switch is turned to the "ON" position. Pressing the button turns the function to OFF mode. (The indicator also turns off.)

Vehicles with a smart entry & start system:

The function will set to ON mode each time the "ENGINE START STOP" switch is turned to IGNITION ON mode. Pressing the button turns the function to OFF mode. (The indicator also turns off.)

Hybrid vehicle

Vehicles without an electronic key:

The function will set to ON mode each time the engine switch is turned to the "ON" position. Pressing the button turns the function to OFF mode. (The indicator also turns off.)

Vehicles with an electronic key:
The function will set to ON mode each time the "POWER" switch is turned to ON mode. Pressing the button turns the function to OFF mode. (The indicator also turns off.)

■ **To prevent sensor error (vehicles with an auto anti-glare inside rear view mirror)**

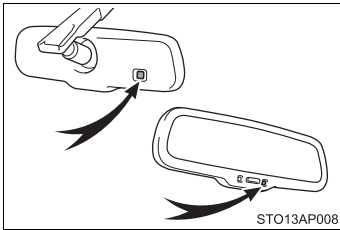

To ensure that the sensors operate properly, do not touch or cover them.

⚠ CAUTION

■ **Caution while driving**

Do not adjust the position of the mirror while driving. Doing so may lead to mishandling of the vehicle and cause an accident, resulting in death or serious injury.

1-4. Adjustable components (seats, mirrors, steering wheel)

Outside rear view mirrors

Mirror angle can be adjusted.

Vehicles with a manually adjustable type

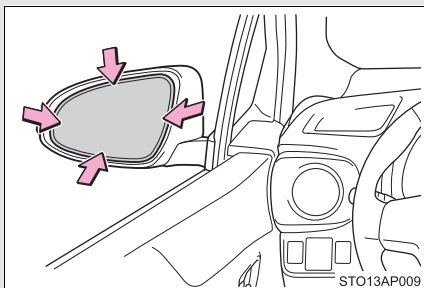

Adjust the mirror up, down, in or out by pushing the mirror surface.

Vehicles with a power-adjustable type

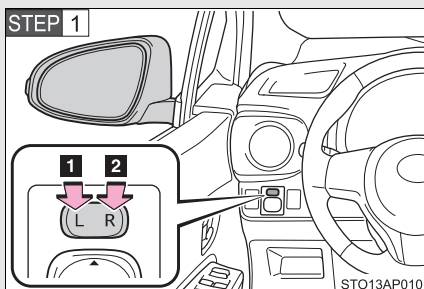

To select a mirror to adjust, press the switch.

- 1** Left
- 2** Right

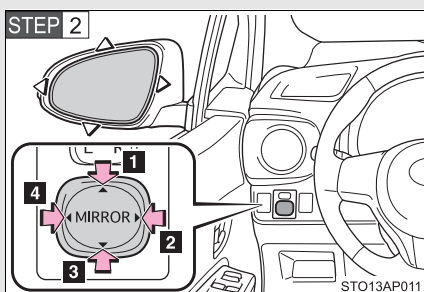

To adjust the mirror, press the switch.

- 1** Up
- 2** Right
- 3** Down
- 4** Left

Folding the mirrors

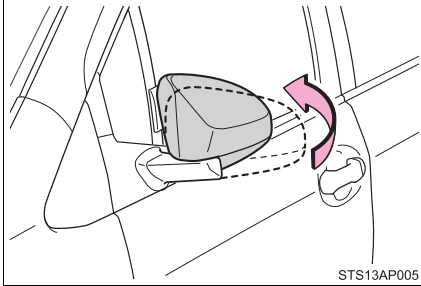

Push the mirror back in the direction of the vehicle's rear.

1

Before driving

■ Mirror operating conditions (vehicles with power-adjustable type)

Except hybrid vehicle

Vehicles without a smart entry & start system:

The engine switch is in the "ACC" or "ON" position.

Vehicles with a smart entry & start system:

The "ENGINE START STOP" switch is in ACCESSORY or IGNITION ON mode.

Hybrid vehicle

Vehicles without an electronic key:

The engine switch is in the "ACC" or "ON" position.

Vehicles with an electronic key:

The "POWER" switch is in ACCESSORY or ON mode.

■ When the mirrors are fogged up (vehicles with outside rear view mirror defoggers)

The outside rear view mirrors can be cleared using the mirror defoggers.

Turn on the rear window defogger to turn on the outside rear view mirror defoggers. (→P. 372)

 CAUTION

■ **When driving the vehicle**

Observe the following precautions while driving.

Failure to do so may result in loss of control of the vehicle and cause an accident, resulting in death or serious injury.

- Do not adjust the mirrors while driving.
- Do not drive with the mirrors folded.
- Both the driver and passenger side mirrors must be extended and properly adjusted before driving.

■ **When a mirror is moving (vehicles with power-adjustable type)**

To avoid personal injury and mirror malfunction, be careful not to get your hand caught by the moving mirror.

■ **When the mirror defoggers are operating (vehicles with outside rear view mirror defoggers)**

Do not touch the rear view mirror surfaces, as they can become very hot and burn you.

1-5. Opening and closing the windows

Power windows*

The power windows can be opened and closed using the switches.

Operating the switch moves the windows as follows:

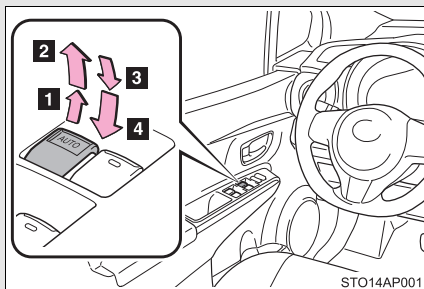

- 1 Closing
- 2 One-touch closing (driver's side only)*
- 3 Opening
- 4 One-touch opening (driver's side only)*

*: To stop the window partway, operate the switch in the opposite direction.

Window lock switch

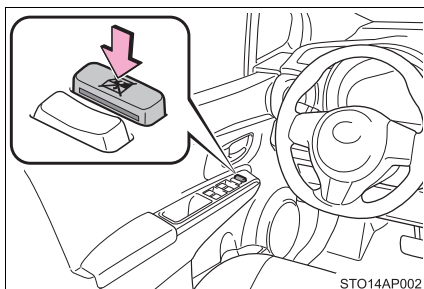

Press the switch down to lock the passenger window switches.

Use this switch to prevent children from accidentally opening or closing a passenger window.

*: If equipped

■ **The power windows can be operated when**

Except hybrid vehicle

Vehicles without a smart entry & start system:

The engine switch is in the “ON” position.

Vehicles with a smart entry & start system:

The “ENGINE START STOP” switch is in IGNITION ON mode.

Hybrid vehicle

Vehicles without an electronic key:

The engine switch is in the “ON” position.

Vehicles with an electronic key:

The “POWER” switch is in ON mode.

■ **Operating the power windows after turning the engine (except hybrid vehicle) or hybrid system (hybrid vehicle) off**

Except hybrid vehicle

Vehicles without a smart entry & start system:

The power windows can be operated for approximately 45 seconds even after the engine switch is turned to the “ACC” or “LOCK” position. They cannot, however, be operated once either front door is opened.

Vehicles with a smart entry & start system:

The power windows can be operated for approximately 45 seconds even after the “ENGINE START STOP” switch is turned to ACCESSORY mode or turned off. They cannot, however, be operated once either front door is opened.

Hybrid vehicle

Vehicles without an electronic key:

The power windows can be operated for approximately 45 seconds even after the engine switch is turned to the “ACC” or “LOCK” position. They cannot, however, be operated once either front door is opened.

Vehicles with an electronic key:

The power windows can be operated for approximately 45 seconds even after the “POWER” switch is turned to ACCESSORY mode or turned off. They cannot, however, be operated once either front door is opened.

■ **Jam protection function (driver’s side only)**

If an object becomes caught between the window and the window frame, window travel is stopped and the window is opened slightly.

■ When the power window does not close normally

If the jam protection function is operating abnormally and a window cannot be closed, perform the following operations using the power window switch on the driver's door.

- Except hybrid vehicle (vehicles without a smart entry & start system):
After stopping the vehicle, the window can be closed by holding the power window switch in the one-touch closing position while the engine switch is turned to the "ON" position.
- Except hybrid vehicle (vehicles with a smart entry & start system):
After stopping the vehicle, the window can be closed by holding the power window switch in the one-touch closing position while the "ENGINE START STOP" switch is turned to IGNITION ON mode.
- Hybrid vehicle (vehicles without an electronic key):
After stopping the vehicle, the window can be closed by holding the power window switch in the one-touch closing position while the engine switch is turned to the "ON" position.
- Hybrid vehicle (vehicles with an electronic key):
After stopping the vehicle, the window can be closed by holding the power window switch in the one-touch closing position while the "POWER" switch is turned to ON mode.
- If the window still cannot be closed even by carrying out the operation explained above, initialize the function by performing the following procedure.

STEP 1 Hold the power window switch in the one-touch closing position. Continue holding the switch for a further 6 seconds after the window has closed.

STEP 2 Hold the power window switch in the one-touch opening position. Continue holding the switch for a further 2 seconds after the window has opened completely.

STEP 3 Hold the power window switch in the one-touch closing position once again. Continue holding the switch for a further 2 seconds after the window has closed.

If you release the switch while the window is moving, start again from the beginning.

If the window continues to close but then re-open slightly even after performing the above procedure correctly, have the vehicle inspected by any authorized Toyota dealer or repairer, or another duly qualified and equipped professional.

 **CAUTION**

■ **Closing the windows**

Observe the following precautions.

Failure to do so may result in death or serious injury.

- Check to make sure that all passengers do not have any part of their body in a position where it could be caught when a window is being operated.
- Do not allow children to operate the power windows.
Closing a power window on someone can cause serious injury, and in some instances, even death.

■ **Jam protection function (driver's side only)**

- Never use any part of your body to intentionally activate the jam protection function.
- The jam protection function may not work if something gets caught just before the window fully closes.

1-6. Refueling

Opening the fuel tank cap

Perform the following steps to open the fuel tank cap:

■ Before refueling the vehicle

- Except hybrid vehicle (vehicles without a smart entry & start system):
Turn the engine switch off and ensure that all the doors and windows are closed.
- Except hybrid vehicle (vehicles with a smart entry & start system):
Turn the “ENGINE START STOP” switch off and ensure that all the doors and windows are closed.
- Hybrid vehicle (vehicles without an electronic key):
Turn the engine switch off and ensure that all the doors and windows are closed.
- Hybrid vehicle (vehicles with an electronic key):
Turn the “POWER” switch off and ensure that all the doors and windows are closed.
- Confirm the type of fuel. (→P. 152)

■ Opening the fuel tank cap

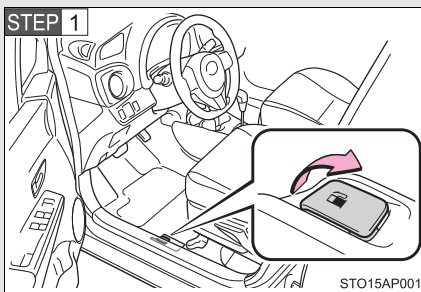

Pull up the opener to open the fuel filler door.

STEP 2

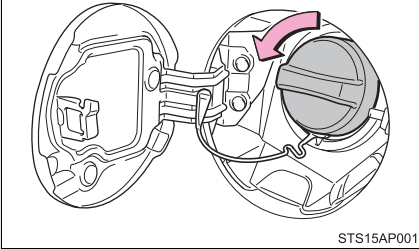

Turn the fuel tank cap slowly to open.

Closing the fuel tank cap

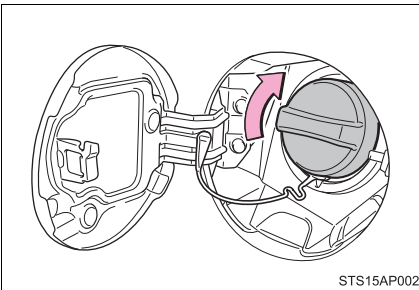

After refueling, turn the fuel tank cap until you hear a click. Once the cap is released, it will turn slightly in the opposite direction.

■ **Fuel types**

Gasoline engine

EU area:

Unleaded gasoline conforming to European standard EN228, Research Octane Number of 95 or higher

Except EU area:

Unleaded gasoline, Research Octane Number of 95 or higher

Diesel engine

EU area:

Diesel fuel conforming to European standard EN590

Except EU area:

Diesel fuel that contains 50 ppm or less of sulfur and has a cetane number of 48 or higher

■ Use of ethanol blended gasoline in a gasoline engine

Toyota allows the use of ethanol blended gasoline where the ethanol content is up to 10%. Make sure that the ethanol blended gasoline to be used has a Research Octane Number that follows the above.

⚠ CAUTION**■ When refueling the vehicle**

Observe the following precautions while refueling the vehicle. Failure to do so may result in death or serious injury.

- After exiting the vehicle and before opening the fuel door, touch an unpainted metal surface to discharge any static electricity. It is important to discharge static electricity before refueling because sparks resulting from static electricity can cause fuel vapors to ignite while refueling.
- Always hold the grips on the fuel tank cap and turn it slowly to remove it. A whooshing sound may be heard when the fuel tank cap is loosened. Wait until the sound cannot be heard before fully removing the cap. In hot weather, pressurized fuel may spray out the filler neck and cause injury.
- Do not allow anyone that has not discharged static electricity from their body to come close to an open fuel tank.
- Do not inhale vaporized fuel.
Fuel contains substances that are harmful if inhaled.

 **CAUTION**

- Do not smoke while refueling the vehicle.
Doing so may cause the fuel to ignite and cause a fire.
- Do not return to the vehicle or touch any person or object that is statically charged.
This may cause static electricity to build up, resulting in a possible ignition hazard.

■ **When refueling**

Observe the following precautions to prevent fuel overflowing from the fuel tank:

- Securely insert the fuel nozzle into the fuel filler neck
- Stop filling the tank after the fuel nozzle automatically clicks off
- Do not top off the fuel tank

■ **When replacing the fuel cap**

Do not use anything but a genuine Toyota fuel tank cap designed for your vehicle. Doing so may cause a fire or other incident which may result in death or serious injury.

 **NOTICE**

■ **Refueling**

Do not spill fuel during refueling.
Doing so may damage the vehicle, such as causing the emission control system to operate abnormally or damaging fuel system components or the vehicle's painted surface.

1-7. Theft deterrent system

Engine immobilizer/immobilizer system

The vehicle's keys have built-in transponder chips that prevent the engine (except hybrid vehicle) or hybrid system (hybrid vehicle) from starting if a key has not been previously registered in the vehicle's on-board computer.

Never leave the keys inside the vehicle when you leave the vehicle.

Engine immobilizer system (except hybrid vehicle)

Vehicles without a smart entry & start system: The system begins operating after the key has been removed from the engine switch. The system is canceled after the registered key has been inserted into the engine switch.

Vehicles with a smart entry & start system: The system begins operating after the "ENGINE START STOP" switch has been turned off. The system is canceled after the "ENGINE START STOP" switch has been turned to ACCESSORY or IGNITION ON mode.

Immobilizer system (hybrid vehicle)

Vehicles without an electronic key: The system begins operating after the key has been removed from the engine switch. The system is canceled after the registered key has been inserted into the engine switch.

Vehicles with an electronic key: The system begins operating after the "POWER" switch has been turned off. The system is canceled after the "POWER" switch has been turned to ACCESSORY or ON mode.

■ **System maintenance**

The vehicle has a maintenance-free type engine immobilizer/immobilizer system.

■ **Conditions that may cause the system to malfunction**

- If the grip portion of the key is in contact with a metallic object
- If the key is in close proximity to or touching a key to the security system (key with a built-in transponder chip) of another vehicle

■ Certification for the engine immobilizer system (except hybrid vehicle)

“Hereby, TRCZ s.r.o., declares that this RI-37BTY is in compliance with the essential requirements and other relevant provisions of Directive 1999/5/EC.”



R&TTE Declaration of Conformity

We,

Manufacturer's Name: TRCZ s.r.o.

Manufacturer's Address: Prumyslova 1165, 410 02, Lovosice, Czech Republic

hereby declare under our sole responsibility that the product:

Product Name: Immobilizer

Product Model: RI-37BTY

to which this declaration relates is in conformity with the essential requirements and other relevant requirements of the R&TTE Directive (1999/5/EC). The product is compliant with the following standards and/or other normative documents:

Safety: EN60950-1
EMC: EN301 489-1 & -3
Spectrum: EN300 330-2

Supplementary information:

* CE mark	
* Member states intended for use	EU and EFTA
* Member states with restrictive use	None

Date:

6 September 2010

Signature:



Position of the signatory:

Yasuo Miyake
Plant manager

<p>Hereby, TRCZ s.r.o., declares that this RI-37BTY is in compliance with the essential requirements and other relevant provisions of Directive 1999/5/EC.</p>
<p>TRCZ s.r.o. vakuuttaa täten että RI-37BTY tyyppinen laite on direktiivin 1999/5/EY oleellisten vaatimusten ja sitä koskevien direktiivin muiden ehtojen mukainen.</p>
<p>Hierbij verklaart TRCZ s.r.o. dat het toestel RI-37BTY in overeenstemming is met de essentiële eisen en de andere relevante bepalingen van richtlijn 1999/5/EG.</p>
<p>Par la présente TRCZ s.r.o. déclare que l'appareil RI-37BTY est conforme aux exigences essentielles et aux autres dispositions pertinentes de la directive 1999/5/CE.</p>
<p>Härmed intygar TRCZ s.r.o. att denna RI-37BTY står i överensstämmelse med de väsentliga egenskapskrav och övriga relevanta bestämmelser som framgår av direktiv 1999/5/EG.</p>
<p>Undertegnede TRCZ s.r.o. erklærer herved, at følgende udstyr RI-37BTY overholder de væsentlige krav og øvrige relevante krav i direktiv 1999/5/EF.</p>
<p>Hiermit erklärt TRCZ s.r.o., dass sich das Gerät RI-37BTY in Übereinstimmung mit den grundlegenden Anforderungen und den übrigen einschlägigen Bestimmungen der Richtlinie 1999/5/EG befindet.</p>
<p>ΜΕ ΤΗΝ ΠΑΡΟΥΣΑ TRCZ s.r.o. ΔΗΛΩΝΕΙ ΟΤΙ RI-37BTY ΣΥΜΜΟΡΦΩΝΕΤΑΙ ΠΡΟΣ ΤΙΣ ΟΥΣΙΩΔΕΙΣ ΑΠΑΙΤΗΣΕΙΣ ΚΑΙ ΤΙΣ ΛΟΙΠΕΣ ΣΧΕΤΙΚΕΣ ΔΙΑΤΑΞΕΙΣ ΤΗΣ ΟΔΗΓΙΑΣ 1999/5/ΕΚ.</p>
<p>Con la presente TRCZ s.r.o. dichiara che questo RI-37BTY è conforme ai requisiti essenziali ed alle altre disposizioni pertinenti stabilite dalla direttiva 1999/5/CE.</p>
<p>Por medio de la presente TRCZ s.r.o. declara que el RI-37BTY cumple con los requisitos esenciales y cualesquiera otras disposiciones aplicables o exigibles de la Directiva 1999/5/CE.</p>
<p>TRCZ s.r.o. declara que este RI-37BTY está conforme com os requisitos essenciais e outras disposições da Directiva 1999/5/CE.</p>
<p>Hawnhekk, TRCZ s.r.o., jiddikjara li dan RI-37BTY jikkonforma mal-ħtiġijiet essenzjali u ma provvedimenti oħrajn relevanti li hemm fid-Dirrettiva 1999/5/EC.</p>
<p>Käesolevaga kinnitab TRCZ s.r.o. seadme RI-37BTY vastavust direktiivi 1999/5/EÜ põhinõuetele ja nimetatud direktiivist tulenevatele teistele asjakohastele sätetele.</p>

Alulírott, TRCZ s.r.o. nyilatkozom, hogy a RI-37BTY megfelel a vonatkozó alapvető követelményeknek és az 1999/5/EC irányelv egyéb előírásainak.
TRCZ s.r.o. týmto vyhlasuje, že RI-37BTY spĺňa základné požiadavky a všetky príslušné ustanovenia Smernice 1999/5/ES.
TRCZ s.r.o. tímto prohlašuje, že tento RI-37BTY je ve shodě se základními požadavky a dalšími příslušnými ustanoveními směrnice 1999/5/ES.
TRCZ s.r.o. izjavlja, da je ta RI-37BTY v skladu z bistvenimi zahtevami in ostalimi relevantnimi določili direktive 1999/5/ES.
Šiuo TRCZ s.r.o. deklaruoja, kad šis RI-37BTY atitinka esminius reikalavimus ir kitas 1999/5/EB Direktyvos nuostatas.
Ar šo TRCZ s.r.o. deklarē, ka RI-37BTY atbilst Direktīvas 1999/5/EK būtiskajām prasībām un citiem ar to saistītajiem noteikumiem.
Niniejszym TRCZ s.r.o. oświadcza, że RI-37BTY jest zgodny z zasadniczymi wymogami oraz pozostałymi stosownymi postanowieniami Dyrektywy 1999/5/EC.
Hér með lýsir TRCZ s.r.o. yfir því að RI-37BTY er í samræmi við grunnkröfur og aðrar kröfur, sem gerðar eru í tilskipun 1999/5/EC.
TRCZ s.r.o. erklærer herved at utstyret RI-37BTY er i samsvar med de grunnleggende krav og øvrige relevante krav i direktiv 1999/5/EF.
С настоящето, TRCZ s.r.o., декларира, че RI-37BTY е в съответствие със съществените изисквания и другите приложими разпоредби на Директива 1999/5/EC.
Prin prezenta, TRCZ s.r.o., declară că aparatul RI-37BTY este în conformitate cu cerințele esențiale și cu alte prevederi pertinente ale Directivei 1999/5/CE.
Ovim, TRCZ s.r.o., izjavljuje da ovaj RI-37BTY je usklađen sa bitnim zahtjevima i drugim relevantnim odredbama Direktive 1999/5/EC.

■ Certification for the immobilizer system (hybrid vehicle)

TOYOTA

TOYOTA MOTOR CORPORATION

1, TOYOTA-CHO, TOYOTA, AICHI, 471-8571 (Head Office)
or 471-8572 (Research & Development Group) JAPAN
TEL.: +81-565-28-2121

R&TTE Declaration of Conformity

We,

Manufacturer's Name: TOYOTA MOTOR CORPORATION
Manufacturer's Address: 1, Toyota -cho, Toyota, Aichi, 471-8572, Japan

hereby declare under our sole responsibility that the product:

Product Name: Immobilizer
Product Model: TMIMB-3

to which this declaration relates is in conformity with the essential requirements and other relevant requirements of the R&TTE Directive (1999/5/EC). The product is compliant with the following standards and/or other normative documents:

- Health & safety requirements: EN 60950-1
- EMC requirements EN 301 489-01 & EN 301 489-03
- Effective uses of radio spectrum: EN 300 330-2

Supplementary information:

* CE mark	
* Member states intended for use	EU and EFTA

Date: March 23, 2010

Signature: 
Tetsuya Matsuo

<p>Hereby, Toyota Motor Corporation, declares that this TMIMB-3 is in compliance with the essential requirements and other relevant provisions of Directive 1999/5/EC.</p>
<p>Toyota Motor Corporation vakuuttaa täten että TMIMB-3 tyyppinen laite on direktiivin 1999/5/EY oleellisten vaatimusten ja sitä koskevien direktiivin muiden ehtojen mukainen.</p>
<p>Hierbij verklaart Toyota Motor Corporation dat het toestel TMIMB-3 in overeenstemming is met de essentiële eisen en de andere relevante bepalingen van richtlijn 1999/5/EG.</p>
<p>Par la présente Toyota Motor Corporation déclare que l'appareil TMIMB-3 est conforme aux exigences essentielles et aux autres dispositions pertinentes de la directive 1999/5/CE.</p>
<p>Härmed intygar Toyota Motor Corporation att denna TMIMB-3 står i överensstämmelse med de väsentliga egenskapskrav och övriga relevanta bestämmelser som framgår av direktiv 1999/5/EG.</p>
<p>Undertegnede Toyota Motor Corporation erklærer herved, at følgende udstyr TMIMB-3 overholder de væsentlige krav og øvrige relevante krav i direktiv 1999/5/EF.</p>
<p>Hiermit erkläre Toyota Motor Corporation, dass sich das Gerät TMIMB-3 in Übereinstimmung mit den grundlegenden Anforderungen und den übrigen einschlägigen Bestimmungen der Richtlinie 1999/5/EG befindet.</p>
<p>ΜΕ ΤΗΝ ΠΑΡΟΥΣΑ Toyota Motor Corporation ΔΗΛΩΝΕΙ ΟΤΙ ΤΜΙΜΒ-3 ΣΥΜΜΟΡΦΟΝΕΤΑΙ ΠΡΟΣ ΤΙΣ ΟΥΣΙΩΔΕΙΣ ΑΠΑΙΤΗΣΕΙΣ ΚΑΙ ΤΙΣ ΛΟΙΠΕΣ ΣΧΕΤΙΚΕΣ ΔΙΑΤΑΞΕΙΣ ΤΗΣ ΟΔΗΓΙΑΣ 1999/5/ΕΚ.</p>
<p>Con la presente Toyota Motor Corporation dichiara che questo TMIMB-3 è conforme ai requisiti essenziali ed alle altre disposizioni pertinenti stabilite dalla direttiva 1999/5/CE.</p>
<p>Por medio de la presente Toyota Motor Corporation declara que el TMIMB-3 cumple con los requisitos esenciales y cualesquiera otras disposiciones aplicables o exigibles de la Directiva 1999/5/CE.</p>
<p>Toyota Motor Corporation declara que este TMIMB-3 está conforme com os requisitos essenciais e outras disposições da Directiva 1999/5/CE.</p>
<p>Hawnhekk, Toyota Motor Corporation, jiddikjara li dan TMIMB-3 jikkonforma mal-htigijiet essenzjali u ma provvedimenti oħrajn relevanti li hemm fid-Dirrettiva 1999/5/EC.</p>
<p>Käesolevaga kinnitab Toyota Motor Corporation seadme TMIMB-3 vastavust direktiivi 1999/5/EÜ põhinõuetele ja nimetatud direktiivist tulenevatele teistele asjakohastele sätetele.</p>

Alulírott, Toyota Motor Corporation nyilatkozik, hogy a TMIMB-3 megfelel a vonatkozó alapvető követelményeknek és az 1999/5/EC irányelv egyéb előírásainak.
Toyota Motor Corporation tímto vyhlasuje, že TMIMB-3 splňa základné požiadavky a všetky príslušné ustanovenia Smernice 1999/5/ES.
Toyota Motor Corporation tímto prohlašuje, že tento TMIMB-3 je ve shodě se základními požadavky a dalšími příslušnými ustanoveními směrnice 1999/5/ES.
Toyota Motor Corporation izjavlja, da je ta TMIMB-3 v skladu z bistvenimi zahtevami in ostalimi relevantnimi določili direktive 1999/5/ES.
Šiuo Toyota Motor Corporation deklaruoja, kad šis TMIMB-3 atitinka esminius reikalavimus ir kitas 1999/5/EB Direktyvos nuostatas.
Ar šo Toyota Motor Corporation deklarē, ka TMIMB-3 atbilst Direktīvas 1999/5/EK būtiskajām prasībām un citiem ar to saistītajiem noteikumiem.
Niniejszym Toyota Motor Corporation oświadcza, że TMIMB-3 jest zgodny z zasadniczymi wymogami oraz pozostałymi stosownymi postanowieniami Dyrektywy 1999/5/EC.
Hér með lýsir Toyota Motor Corporation yfir því að TMIMB-3 er í samræmi við grunnkröfur og aðrar kröfur, sem gerðar eru í tilskipun 1999/5/EC.
Toyota Motor Corporation erklærer herved at utstyret TMIMB-3 er i samsvar med de grunnleggende krav og øvrige relevante krav i direktiv 1999/5/EF.
Ovim, Toyota Motor Corporation, izjavlja da ovaj TMIMB-3 je usklađen sa bitnim zahtjevima i drugim relevantnim odredbama Direktive 1999/5/EC.

NOTICE

■ To ensure the system operates correctly

Do not modify or remove the system. If modified or removed, the proper operation of the system cannot be guaranteed.

1-7. Theft deterrent system

Double locking system*

Unauthorized access to the vehicle is prevented by disabling the door unlocking function from both the interior and exterior of the vehicle.

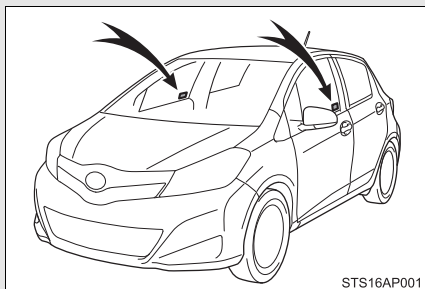

Vehicles employing this system have labels on the window glass of both front doors.

1

Before driving

Setting the double locking system

Except hybrid vehicle (vehicles without a smart entry & start system):
Turn the engine switch off, have all the passengers exit the vehicle and ensure that all the doors are closed.

Except hybrid vehicle (vehicles with a smart entry & start system):
Turn the "ENGINE START STOP" switch off, have all the passengers exit the vehicle and ensure that all the doors are closed.

Hybrid vehicle (vehicles without an electronic key):
Turn the engine switch off, have all the passengers exit the vehicle and ensure that all the doors are closed.

Hybrid vehicle (vehicles with an electronic key):
Turn the "POWER" switch off, have all the passengers exit the vehicle and ensure that all the doors are closed.

Using the entry function (vehicles with a smart entry & start system):
Touch the sensor area on the outside door handle twice within 5 seconds.

Using the wireless remote control:
Press  twice within 5 seconds.

*: If equipped

Canceling the double locking system

Using the entry function (vehicles with a smart entry & start system):
Hold either front outside door handle or push up the back door opener switch.

Using the wireless remote control: Press  .

CAUTION

Double locking system precaution

Never activate the double locking system when there are people in the vehicle because all the doors cannot be opened from inside the vehicle.

1-8. Safety information

Correct driving posture

Drive with a good posture as follows:

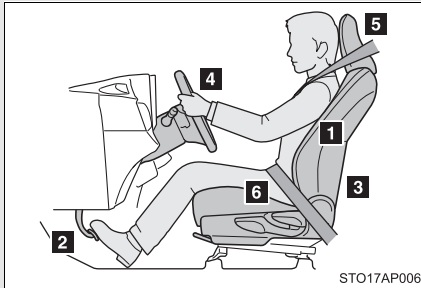

- 1** Sit upright and well back in the seat. (→P. 124)
- 2** Adjust the position of the seat forward or backward to ensure the pedals can be reached and easily depressed to the extent required. (→P. 124)
- 3** Adjust the seatback so that the controls are easily operable. (→P. 124)
- 4** Adjust the tilt and telescopic positions of the steering wheel downward so the air-bag is facing your chest. (→P. 140)
- 5** Lock the head restraint in place with the center of the head restraint closest to the top of your ears. (→P. 131)
- 6** Wear the seat belt correctly. (→P. 133)

 **CAUTION**

■ **While driving**

- Do not adjust the position of the driver's seat.
Doing so could cause the driver to lose control of the vehicle.
- Do not place a cushion between the driver or passenger and the seatback.
A cushion may prevent correct posture from being achieved, and reduce the effectiveness of the seat belt and head restraint, increasing the risk of death or serious injury to the driver or passenger.
- Do not place anything under the front seats.
Objects placed under the front seats may become jammed in the seat tracks and stop the seat from locking in place. This may lead to an accident, resulting in death or serious injury. The adjustment mechanism may also be damaged.

■ **Adjusting the seat position**

- Take care when adjusting the seat position to ensure that other passengers are not injured by the moving seat.
- Do not put your hands under the seat or near the moving parts to avoid injury.
Fingers or hands may become jammed in the seat mechanism.

1-8. Safety information

SRS airbags

The SRS airbags inflate when the vehicle is subjected to certain types of severe impacts that may cause significant injury to the occupants. They work together with the seat belts to help reduce the risk of death or serious injury.

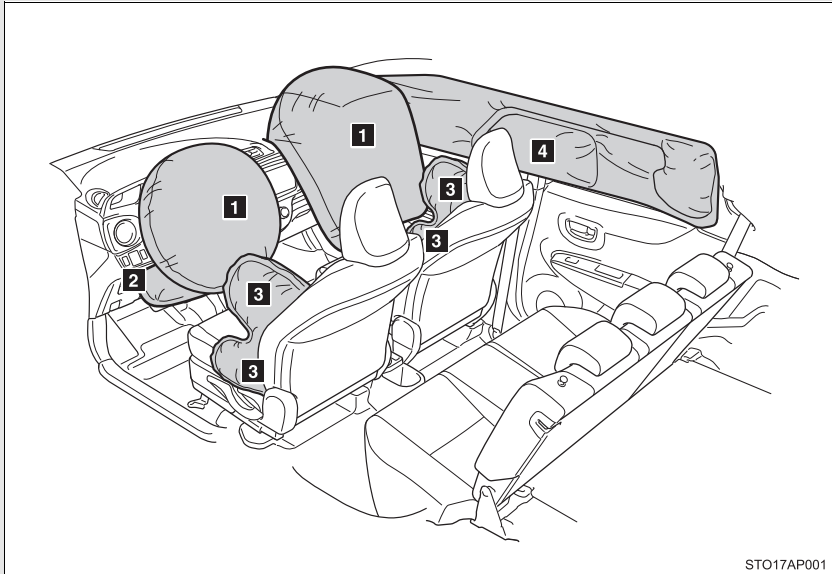

STO17AP001

SRS front airbags

- 1** SRS driver airbag/front passenger airbag
Can help protect the head and chest of the driver and front passenger from impact with interior components
- 2** SRS driver knee airbag (if equipped)
Can help provide driver protection

SRS side and curtain shield airbags

- 3** SRS side airbags
Can help protect the torso of the front seat occupants
- 4** SRS curtain shield airbags (if equipped)
Can help protect primarily the head of occupants in the outer seats

SRS airbag system components

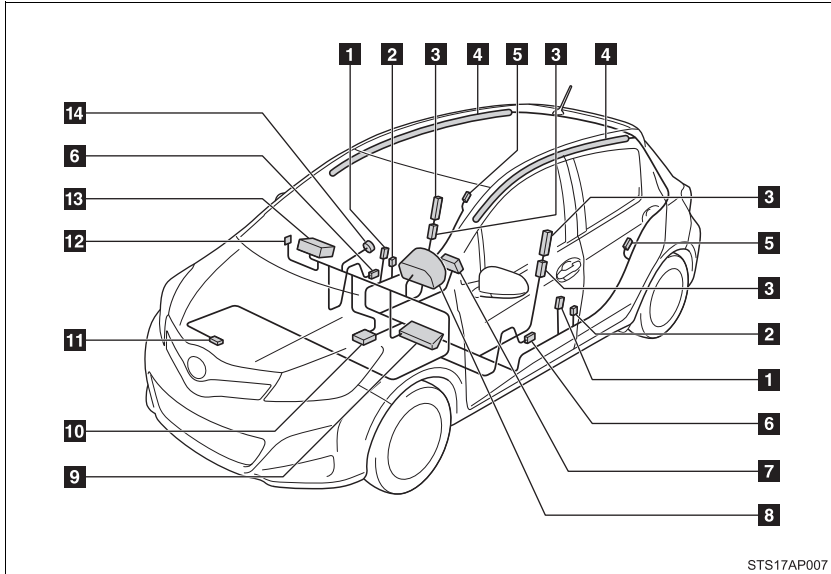

STS17AP007

- | | |
|--|---|
| 1 Seat belt pretensioners and force limiters | 7 Driver airbag |
| 2 5-door models: Side impact sensors (front) | 8 SRS warning light |
| 3 Side airbags | 9 Driver knee airbag (if equipped) |
| 4 Curtain shield airbags (if equipped) | 10 Airbag sensor assembly |
| 5 Side impact sensors (rear) (if equipped) | 11 Front impact sensor |
| 6 3-door models: Side impact sensors (front door) | 12 Airbag manual on-off switch |
| | 13 Front passenger airbag |
| | 14 "PASSENGER AIR BAG" indicator |

The main SRS airbag system components are shown above. The SRS airbag system is controlled by the airbag sensor assembly. As the airbags deploy, a chemical reaction in the inflators quickly fills the airbags with non-toxic gas to help restrain the motion of the occupants.

■ If the SRS airbags deploy (inflate)

- Bruising and slight abrasions may result from contact with a deploying (inflating) SRS airbag.
- A loud noise and white powder will be emitted.
- Vehicles without SRS curtain shield airbags: Parts of the airbag module (steering wheel hub, airbag cover and inflator) as well as the front seats may be hot for several minutes. The airbag itself may also be hot.
- Vehicles with SRS curtain shield airbags: Parts of the airbag module (steering wheel hub, airbag cover and inflator) as well as the front seats, parts of the front and rear pillars, and roof side rails, may be hot for several minutes. The airbag itself may also be hot.
- The windshield may crack.

■ SRS airbag deployment conditions (SRS front airbags)

- The SRS front airbags will deploy in the event of an impact that exceeds the set threshold level (the level of force corresponding to an approximately 20 - 30 km/h [12 - 18 mph] frontal collision with a fixed wall that does not move or deform).

However, this threshold velocity will be considerably higher in the following situations:

- If the vehicle strikes an object, such as a parked vehicle or sign pole, which can move or deform on impact
 - If the vehicle is involved in an underride collision, such as a collision in which the front of the vehicle “underrides”, or goes under, the bed of a truck
- Depending on the type of collision, it is possible that only the seat belt pretensioners will activate.

■ SRS airbag deployment conditions (SRS side airbags and SRS curtain shield airbags [if equipped])

The SRS side and curtain shield airbags will deploy in the event of an impact that exceeds the set threshold level (the level of force corresponding to the impact force produced by an approximately 1500 kg [3300 lb.] vehicle colliding with the vehicle cabin from a direction perpendicular to the vehicle orientation at an approximate speed of 20 - 30 km/h [12 - 18 mph]).

■ **Conditions under which the SRS airbags may deploy (inflate), other than a collision**

The SRS front airbags may also deploy if a serious impact occurs to the underside of your vehicle. Some examples are shown in the illustration.

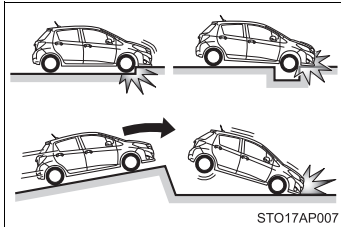

- Hitting a curb, edge of pavement or hard surface
- Falling into or jumping over a deep hole
- Landing hard or falling

■ **Types of collisions that may not deploy the SRS airbags (SRS front airbags)**

The SRS front airbags do not generally inflate if the vehicle is involved in a side or rear collision, if it rolls over, or if it is involved in a low-speed frontal collision. But, whenever a collision of any type causes sufficient forward deceleration of the vehicle, deployment of the SRS front airbags may occur.

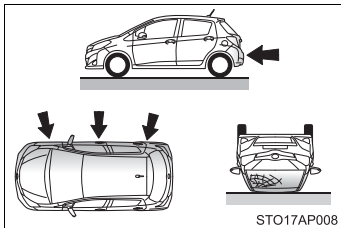

- Collision from the side
- Collision from the rear
- Vehicle rollover

■ Types of collisions that may not deploy the SRS airbags (SRS side airbags and SRS curtain shield airbags [if equipped])

The SRS side and curtain shield airbags may not activate if the vehicle is subjected to a collision from the side at certain angles, or a collision to the side of the vehicle body other than the passenger compartment.

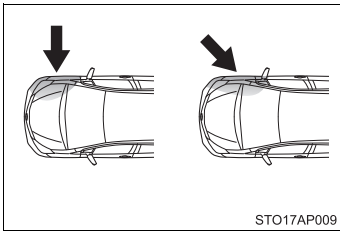

- Collision from the side to the vehicle body other than the passenger compartment
- Collision from the side at an angle

The SRS side and curtain shield airbags do not generally inflate if the vehicle is involved in a frontal or rear collision, if it rolls over, or if it is involved in a low-speed side collision.

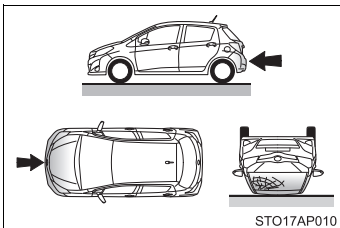

- Collision from the front
- Collision from the rear
- Vehicle rollover

■ When to contact any authorized Toyota dealer or repairer, or another duly qualified and equipped professional

In the following cases, the vehicle will require inspection and/or repair. Contact any authorized Toyota dealer or repairer, or another duly qualified and equipped professional as soon as possible.

- Any of the SRS airbags have been inflated.

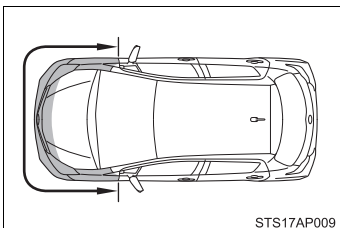

- The front of the vehicle is damaged or deformed, or was involved in an accident that was not severe enough to cause the SRS front airbags to inflate.

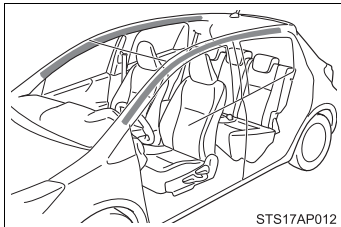
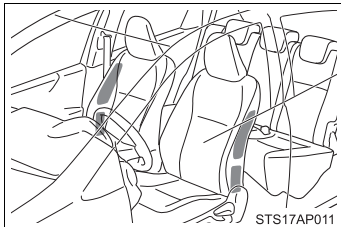
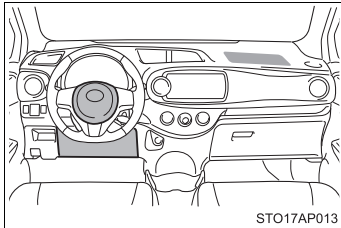
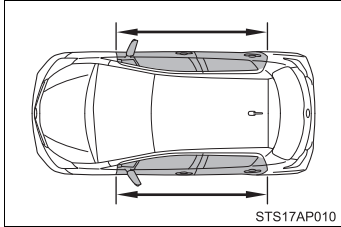

- A portion of a door is damaged or deformed, or the vehicle was involved in an accident that was not severe enough to cause the SRS side airbags and SRS curtain shield airbags (if equipped) to inflate.

- Vehicles without a SRS driver knee airbag: The pad section of the steering wheel or dashboard near the front passenger airbag is scratched, cracked, or otherwise damaged.

- Vehicles with a SRS driver knee airbag: The pad section of the steering wheel, dashboard near the front passenger airbag or lower portion of the instrument panel is scratched, cracked, or otherwise damaged.

- The surface of the seats with the side airbag is scratched, cracked, or otherwise damaged.

- Vehicles with SRS curtain shield airbags: The portion of the front pillars, rear pillars or roof side rail garnishes (padding) containing the curtain shield airbags is inside scratched, cracked, or otherwise damaged.

⚠ CAUTION**■ SRS airbag precautions**

Observe the following precautions regarding the SRS airbags. Failure to do so may cause death or serious injury.

- The driver and all passengers in the vehicle must wear their seat belts properly.

The SRS airbags are supplemental devices to be used with the seat belts.

- The SRS driver airbag deploys with considerable force, and can cause death or serious injury especially if the driver is very close to the airbag.

Since the risk zone for the driver's airbag is the first 50 - 75 mm (2 - 3 in.) of inflation, placing yourself 250 mm (10 in.) from your driver airbag provides you with a clear margin of safety. This distance is measured from the center of the steering wheel to your breastbone. If you sit less than 250 mm (10 in.) away now, you can change your driving position in several ways:

- Move your seat to the rear as far as you can while still reaching the pedals comfortably.
- Slightly recline the back of the seat. Although vehicle designs vary, many drivers can achieve the 250 mm (10 in.) distance, even with the driver seat all the way forward, simply by reclining the back of the seat somewhat. If reclining the back of your seat makes it hard to see the road, raise yourself by using a firm, non-slippery cushion, or raise the seat if your vehicle has that feature.
- If your steering wheel is adjustable, tilt it downward. This points the airbag toward your chest instead of your head and neck.

The seat should be adjusted as recommended above, while still maintaining control of the foot pedals, steering wheel, and your view of the instrument panel controls.

- The SRS front passenger airbag also deploys with considerable force, and can cause death or serious injury especially if the front passenger is very close to the airbag. The front passenger seat should be as far from the airbag as possible with the seatback adjusted, so the front passenger sits upright.

⚠ CAUTION

■ SRS airbag precautions

- Improperly seated and/or restrained infants and children can be killed or seriously injured by a deploying airbag. An infant or child who is too small to use a seat belt should be properly secured using a child restraint system. Toyota strongly recommends that all infants and children be placed in the rear seats of the vehicle and properly restrained. The rear seats are safer for infants and children than the front passenger seat. (→P. 182)

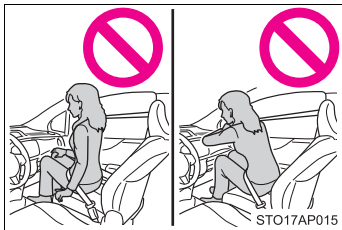

- Do not sit on the edge of the seat or lean against the dashboard.

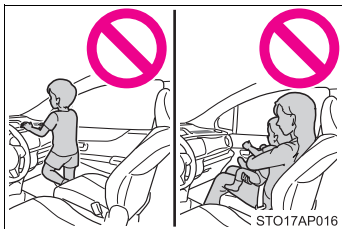

- Do not allow a child to stand in front of the SRS front passenger airbag unit or sit on the knees of a front passenger.
- Do not allow the front seat occupants to hold items on their knees.



- Vehicles without SRS curtain shield airbags: Do not lean against the front door.
- Vehicles with SRS curtain shield airbags: Do not lean against the door, the roof side rail or the front, side and rear pillars.

⚠ CAUTION

■ SRS airbag precautions

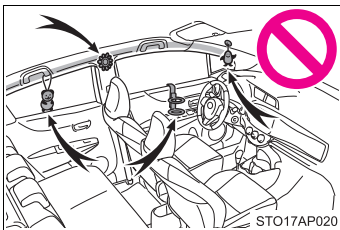
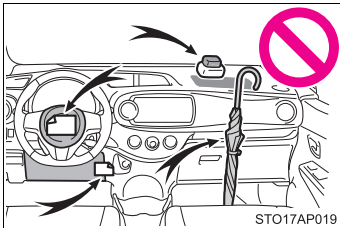

- Do not allow anyone to kneel on the passenger seat toward the door or put their head or hands outside the vehicle.
- Vehicles without a SRS driver knee airbag: Do not attach anything to or lean anything against areas such as the dashboard or steering wheel pad. These items can become projectiles when the SRS driver and front passenger airbags deploy.
- Vehicles with a SRS driver knee airbag: Do not attach anything to or lean anything against areas such as the dashboard, steering wheel pad and lower portion of the instrument panel. These items can become projectiles when the SRS driver, front passenger and driver knee airbags deploy.
- Vehicles without SRS curtain shield airbags: Do not attach anything to areas such as a door, windshield glass and side door glass.
- Vehicles with SRS curtain shield airbags: Do not attach anything to areas such as a door, windshield glass, side door glass, front or rear pillar, roof side rail and assist grip. (Except for the speed limit label →P. 599, 606)

▲ CAUTION

■ SRS airbag precautions

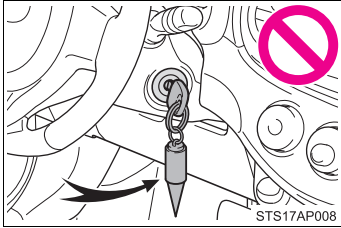

- Vehicles with a SRS driver knee airbag, but do not use a smart entry & start system or a push-button start system: Do not attach any heavy, sharp or hard objects such as keys and accessories to the key. The objects may restrict the SRS driver knee airbag inflation or be thrust into the driver's seat area by the force of the deploying airbag, thus causing a danger.
- Vehicles with SRS curtain shield airbags: Do not hang coat hangers or other hard objects on the coat hooks. All of these items could become projectiles and may cause death or serious injury, should the SRS curtain shield airbags deploy.
- Vehicles with a SRS driver knee airbag: If a vinyl cover is put on the area where the SRS driver knee airbag will deploy, be sure to remove it.
- Do not use seat accessories which cover the parts where the SRS side airbags inflate as they may interfere with inflation of the airbags. Such accessories may prevent the side airbags from activating correctly, disable the system or cause the side airbags to inflate accidentally, resulting in death or serious injury.
- Do not strike or apply significant levels of force to the area of the SRS airbag components.
Doing so can cause the SRS airbags to malfunction.
- Do not touch any of the component parts immediately after the SRS airbags have deployed (inflated) as they may be hot.
- If breathing becomes difficult after the SRS airbags have deployed, open a door or window to allow fresh air in, or leave the vehicle if it is safe to do so. Wash off any residue as soon as possible to prevent skin irritation.
- Vehicles without SRS curtain shield airbags: If the areas where the SRS airbags are stored, such as the steering wheel pad, are damaged or cracked, have them replaced by any authorized Toyota dealer or repairer, or another duly qualified and equipped professional.

 **CAUTION****■ SRS airbag precautions**

- Vehicles with SRS curtain shield airbags: If the areas where the SRS airbags are stored, such as the steering wheel pad and front and rear pillar garnishes, are damaged or cracked, have them replaced by any authorized Toyota dealer or repairer, or another duly qualified and equipped professional.

■ Modification and disposal of SRS airbag system components

Do not dispose of your vehicle or perform any of the following modifications without consulting any authorized Toyota dealer or repairer, or another duly qualified and equipped professional. The SRS airbags may malfunction or deploy (inflate) accidentally, causing death or serious injury.

- Installation, removal, disassembly and repair of the SRS airbags
- Repairs, modifications, removal or replacement of the steering wheel, instrument panel, dashboard, seats or seat upholstery, front, side and rear pillars or roof side rails
- Repairs or modifications of the front fender, front bumper, or side of the occupant compartment
- Installation of snow plows, winches, etc. to the front grille (bull bars, or kangaroo bar etc.)
- Modifications to the vehicle's suspension system
- Installation of electronic devices such as an RF-transmitter and CD players

1-8. Safety information

Airbag manual on-off system

This system deactivates the front passenger airbag.

Only deactivate the airbags when using a child restraint system on the front passenger seat.

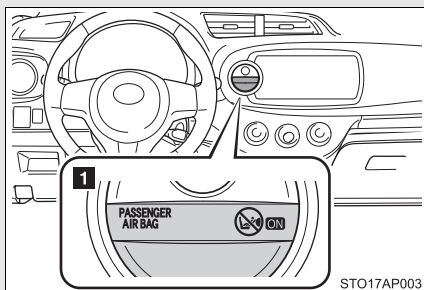

1 “PASSENGER AIR BAG” indicator

Except hybrid vehicle

Vehicles without a smart entry & start system:

This indicator light turns on when the airbag system is on (only when the engine switch is in the “ON” position).

Vehicles with a smart entry & start system:

This indicator light turns on when the airbag system is on (only when the “ENGINE START STOP” switch is in IGNITION ON mode).

Hybrid vehicle

Vehicles without an electronic key:

This indicator light turns on when the airbag system is on (only when the engine switch is in the “ON” position).

Vehicles with an electronic key:

This indicator light turns on when the airbag system is on (only when the “POWER” switch is in ON mode).

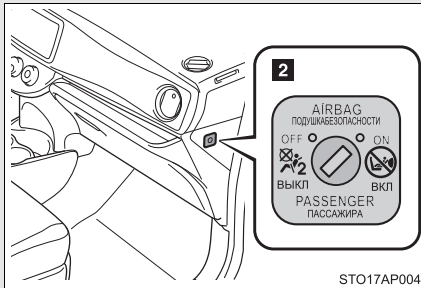

2 Airbag manual on-off switch

Deactivating the front seat passenger airbag

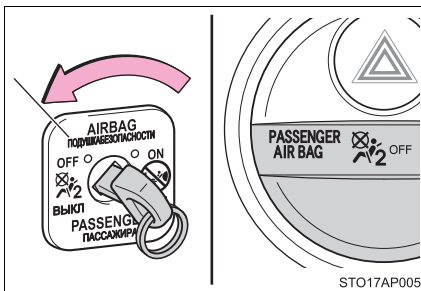

Except hybrid vehicle

Vehicles without a smart entry & start system:

Insert the key into the cylinder and turn to the “OFF” position.

The “OFF” indicator light turns on (only when the engine switch is in the “ON” position).

Vehicles with a smart entry & start system:

Insert the mechanical key into the cylinder and turn to the “OFF” position.

The “OFF” indicator light turns on (only when the “ENGINE START STOP” switch is in IGNITION ON mode).

Hybrid vehicle

Vehicles without an electronic key:

Insert the key into the cylinder and turn to the “OFF” position.

The “OFF” indicator light turns on (only when the engine switch is in the “ON” position).

Vehicles with an electronic key:
Insert the mechanical key into the cylinder and rotate to the “OFF” position.

The “OFF” indicator light turns on (only when the “POWER” switch is in ON mode).

■ **“PASSENGER AIR BAG” indicator information**

If any of the following problems occur, it is possible that there is a malfunction in the system. Have the vehicle inspected by any authorized Toyota dealer or repairer, or another duly qualified and equipped professional.

- Neither “ON” nor “OFF” comes on.
- The indicator light does not change when the airbag manual on-off switch is switched to “ON” or “OFF”.

 **CAUTION****■ When installing a child restraint system**

For safety reasons, always install a child restraint system in a rear seat. In the event that the rear seat cannot be used, the front seat can be used as long as the airbag manual on-off system is set to “OFF”.

If the airbag manual on-off system is left “ON”, the strong impact of the airbag deployment (inflation) may cause serious injury or even death.

■ When a child restraint system is not installed on the front passenger seat

Ensure that the airbag manual on-off system is set to “ON”.

If it is left “OFF”, the airbag may not deploy in the event of an accident, which may result in serious injury or even death.

1-8. Safety information

Child restraint systems

Toyota strongly urges the use of child restraint systems.

Points to remember

Studies have shown that installing a child restraint on a rear seat is much safer than installing one on the front passenger seat.

- Choose a child restraint system that suits your vehicle and is appropriate to the age and size of the child.
- For installation details, follow the instructions provided with the child restraint system.
General installation instructions are provided in this manual.
(→P. 191)
- If child restraint system regulations exist in the country where you reside, please contact any authorized Toyota dealer or repairer, or another duly qualified and equipped professional for the child restraint system installation.
- Toyota recommends that you use a child restraint system which conforms to the regulation ECE No.44.

Types of child restraints

Child restraint systems are classified into the following 5 groups according to the regulation ECE No.44:

Group 0:Up to 10 kg (22 lb.) (0 - 9 months)

Group 0⁺:Up to 13 kg (28 lb.) (0 - 2 years)

Group I:9 to 18 kg (20 to 39 lb.) (9 months - 4 years)

Group II:15 to 25 kg (34 to 55 lb.) (4 years - 7 years)

Group III:22 to 36 kg (49 to 79 lb.) (6 years - 12 years)

In this owner's manual, the following 3 types of popular child restraint systems that can be secured with the seat belts are explained:

Baby seat

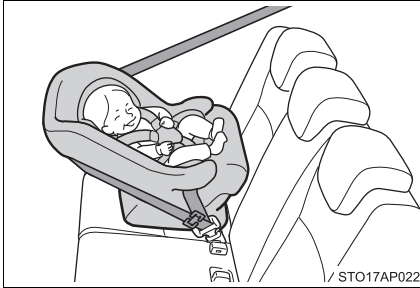

Equal to Group 0 and 0⁺ of ECE No.44

Child seat



Equal to Group 0⁺ and I of ECE No.44

Junior seat



Equal to Group II and III of ECE No.44

Child restraint system suitability for various seating positions

Information provided in the table shows your child restraint system suitability for various seating positions.

Seating position Mass groups	Front passenger seat		Rear seat	
	Airbag manual on-off switch			
	ON	OFF	Outside	Center
0 Up to 10 kg (22 lb.) (0 - 9 months)	X Never put	L1, L2, L3	U	L1, L2
0+ Up to 13 kg (28 lb.) (0 - 2 years)	X Never put	L1, L2, L3	U	L1, L2
I 9 to 18 kg (20 to 39 lb.) (9 months - 4 years)	Rear-facing — X Never put	UF*1	U	L4*2
	Forward-facing — UF*1			
II, III 15 to 36 kg (34 to 79 lb.) (4 - 12 years)	UF*1	UF*1	U	L5*2, L6*2

Key of letters inserted in the above table:

- U: Suitable for “universal” category child restraint system approved for the use in this mass group.
- UF: Suitable for forward-facing “universal” category child restraint system approved for the use in this mass group.
- L1: Suitable for “TOYOTA G 0+, BABYSAFE” (0 to 13 kg [0 to 28 lb.]) approved for the use in this mass group.
- L2: Suitable for “TOYOTA G 0+, BABYSAFE PLUS” (0 to 13 kg [0 to 28 lb.]) approved for the use in this mass group.
- L3: Suitable for “TOYOTA G 0+, BABYSAFE PLUS with SEAT BELT FIXATION, BASE PLATFORM” (0 to 13 kg [0 to 28 lb.]) approved for the use in this mass group.
- L4: Suitable for “TOYOTA DUO+” (without ISOFIX, 9 to 18 kg [20 to 39 lb.]) approved for the use in this mass group.
- L5: Suitable for “TOYOTA KID” (15 to 36 kg [34 to 79 lb.]) approved for the use in this mass group.
- L6: Suitable for “TOYOTA KIDFIX” (15 to 36 kg [34 to 79 lb.]) approved for the use in this mass group.
- X: Not suitable seat position for children in this mass group.
- *1: Adjust the front seat back to the most upright position. Move the front seat cushion to the fully rearward.
- *2: When you use a child restraint system in this position, remove the head restraint.

The child restraint systems mentioned in the table may not be available outside of the EU area. Other child restraint systems which is different from the systems mentioned in the table can be used, but the suitability of the systems must be carefully checked with the child restraint system manufacturer concerned and the seller of those seats.

**Child restraint system suitability for various seating positions
(with ISOFIX rigid anchors)**

Information provided in the table shows your child restraint system suitability for various seating positions.

Mass groups	Size class	Fixture	Vehicle ISOFIX positions
			Rear outside
Carrycot	F	ISO/L1	X
	G	ISO/L2	X
		(1)	X
Group 0 Up to 10 kg (22 lb.)	E	ISO/R1	IL1* ¹
		(1)	X
Group 0 ⁺ Up to 13 kg (28 lb.)	E	ISO/R1	IL1* ¹
	D	ISO/R2	X
	C	ISO/R3	X
		(1)	X
Group I* ³ 9 to 18 kg (20 to 39 lb.)	D	ISO/R2	X
	C	ISO/R3	X
	B	ISO/F2	IUF* ²
	B1	ISO/F2X	IUF* ²
	A	ISO/F3	IUF* ²
		(1)	X
Group II 15 to 25 kg (34 to 55 lb.)		(1)	X
Group III 22 to 36 kg (49 to 79 lb.)		(1)	X

- (1) For the CRS which do not carry the ISO/XX size class identification (A to G), for the applicable mass group, the car manufacturer shall indicate the vehicle specific ISOFIX child restraint system(s) recommended for each position.

Key of letters inserted in the above table:

IUF: Suitable for ISOFIX forward-facing child restraints systems of universal category approved for the use in this mass group.

IL1: Suitable for "TOYOTA G 0+, BABYSAFE PLUS with ISO-FIX FIXATION, BASE PLATFORM" (0 to 13 kg [0 to 28 lb.]) approved for the use in this mass group.

X: ISOFIX position not suitable for ISOFIX child restraint systems in this mass group and/or this size class.

*1: If the child seat is installed behind a front seat equipped with height adjuster and the front seat is adjusted below middle height position, then adjust the front seat head restraint to the highest position.

*2: When you use a child restraint system in this position, remove the head restraint.

*3: Toyota recommend to use "TOYOTA DUO+" (with ISOFIX and TOP TETHER, 9 to 18 kg [20 to 39 lb.]) approved for the use in this mass group. When using this child seat, adjust it to the most reclined position.

The child restraint systems mentioned in the table may not be available outside of the EU area. Other child restraint systems different from the systems mentioned in the table can be used, but the suitability of the systems must be carefully checked with the child restraint system manufacturer and retailer.

■ **When installing the child restraint system on the front passenger seat**

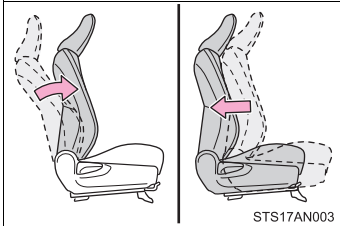

When you have to use a child restraint system on the front passenger seat, adjust the following:

- The seatback to the most upright position
- The seat as far back as possible

■ **Selecting an appropriate child restraint system**

- Use a child restraint system appropriate for the child until the child becomes large enough to properly wear the vehicle's seat belt.
- If the child is too large for a child restraint system, sit the child on a rear seat and use the vehicle's seat belt. (→P. 133)

⚠ CAUTION

■ **Using a child restraint system**

The use of a child restraint system not suitable for the vehicle may not properly secure the infant or child. It may result in death or serious injury (in the event of sudden braking or an accident).

■ **Child restraint precautions**

- For effective protection in automobile accidents and sudden stops, a child must be properly restrained, using a seat belt or child restraint system depending on the age and size of the child. Holding a child in your arms is not a substitute for a child restraint system. In an accident, the child can be crushed against the windshield, or between you and the vehicle's interior.
- Toyota strongly urges the use of a proper child restraint system that conforms to the size of the child, installed on the rear seat. According to accident statistics, the child is safer when properly restrained in the rear seat than in the front seat.

 CAUTION**■ Child restraint precautions**

- Never use a rear-facing child restraint system on the front passenger seat when the airbag manual on-off switch is on. (→P. 178)
In the event of an accident, the force of the rapid inflation of the front passenger airbag can cause death or serious injury to the child.
- A forward-facing child restraint system may be installed on the front passenger seat only when it is unavoidable. A child restraint system that requires a top tether strap should not be used in the front passenger seat since there is no top tether strap anchor for the front passenger seat. Adjust the seatback as upright as possible and always move the seat as far back as possible because the front passenger airbag could inflate with considerable speed and force. Otherwise, the child may be killed or seriously injured.
- Vehicles without SRS curtain shield airbags: Do not allow the child to lean his/her head or any part of his/her body against the door or the area of the seat from which the SRS side airbags deploy even if the child is seated in the child restraint system. It is dangerous if the SRS side airbags inflate, and the impact could cause death or serious injury to the child.
- Vehicles with SRS curtain shield airbags: Do not allow the child to lean his/her head or any part of his/her body against the door or the area of the seat, front and rear pillars or roof side rails from which the SRS side airbags or SRS curtain shield airbags deploy even if the child is seated in the child restraint system. It is dangerous if the SRS side airbags and curtain shield airbags inflate, and the impact could cause death or serious injury to the child.
- Make sure you have complied with all installation instructions provided by the child restraint manufacturer and that the system is properly secured. If it is not secured properly, it may cause death or serious injury to the child in the event of a sudden stop, sudden swerve or an accident.

 **CAUTION**

■ **When children are in the vehicle**

Do not allow children to play with the seat belt. If the seat belt becomes twisted around a child's neck, it may lead to choking or other serious injuries that may result in death.

If this occurs and the buckle cannot be unfastened, scissors should be used to cut the belt.

■ **When the child restraint system is not in use**

- Keep the child restraint system properly secured on the seat even if it is not in use. Do not store the child restraint system unsecured in the passenger compartment.
- If it is necessary to detach the child restraint system, remove it from the vehicle or store it securely in the luggage compartment. This will prevent it from injuring passengers in the event of a sudden stop, sudden swerve or accident.

1-8. Safety information

Installing child restraints

Follow the child restraint system manufacturer's instructions. Firmly secure child restraints to the seats using a seat belt or ISOFIX rigid anchors. Attach the top strap when installing a child restraint.

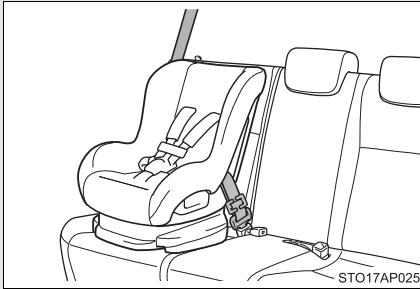

Seat belts (An ELR belt requires a locking clip.)

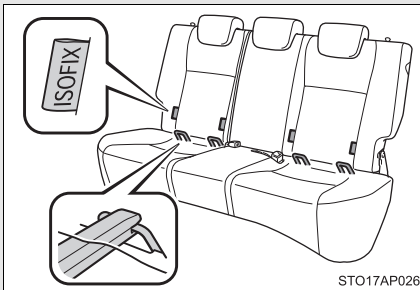

Vehicles with rear seats:
ISOFIX rigid anchors
(ISOFIX child restraint system)

Lower anchors are provided for outside rear seats. (Tags displaying the location of the anchors are attached to the seats.)

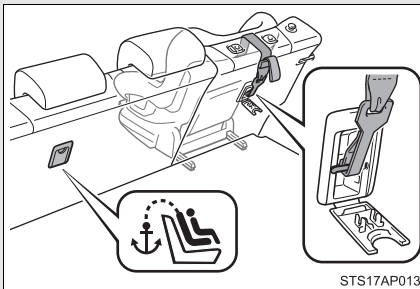

Vehicles with rear seats:
Anchor brackets (for the top strap)

Anchor brackets are provided for outside rear seats.

Installing child restraints using a seat belt

■ Rear facing — Baby seat/child seat

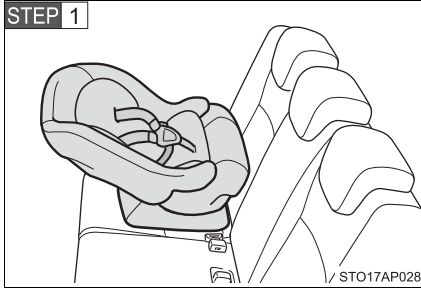

Place the child restraint system on the rear seat facing the rear of the vehicle.

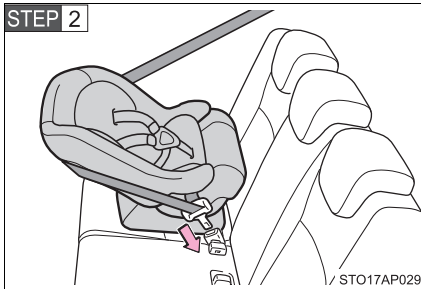

Run the seat belt through the child restraint system and insert the plate into the buckle. Make sure that the belt is not twisted.

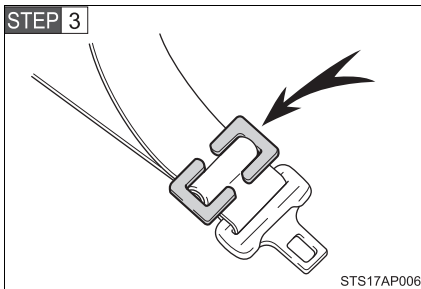

Install a locking clip near the tab of the lap and shoulder belt by inserting the lap and shoulder webbing through the recesses of the locking clip. Buckle the belt again. If the belt has any slack, release the buckle and reinstall the locking clip.

■ Forward facing — Child seat

STEP 1 Remove the head restraint. (→P. 131)

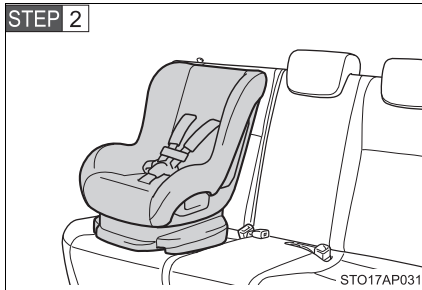

Place the child restraint system on the seat facing the front of the vehicle.

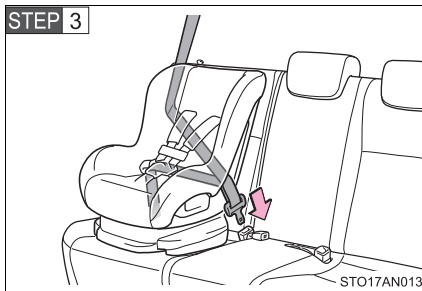

Run the seat belt through the child restraint system and insert the plate into the buckle. Make sure that the belt is not twisted.

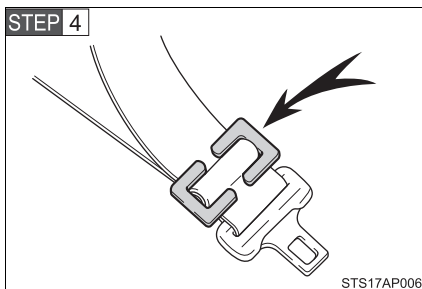

Install a locking clip near the tab of the lap and shoulder belt by inserting the lap and shoulder webbing through the recesses of the locking clip. Buckle the belt again. If the belt has any slack, release the buckle and reinstall the locking clip.

■ Junior seat

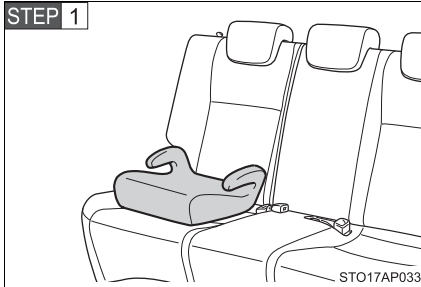

Place the child restraint system on the seat facing the front of the vehicle.

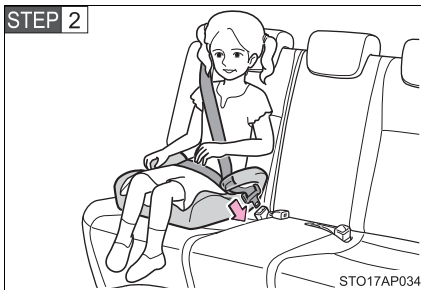

Sit the child in the child restraint system. Fit the seat belt to the child restraint system according to the manufacturer's instructions and insert the plate into the buckle. Make sure that the belt is not twisted.

Check that the shoulder belt is correctly positioned over the child's shoulder and that the lap belt is as low as possible.
(→P. 133)

Removing a child restraint installed with a seat belt

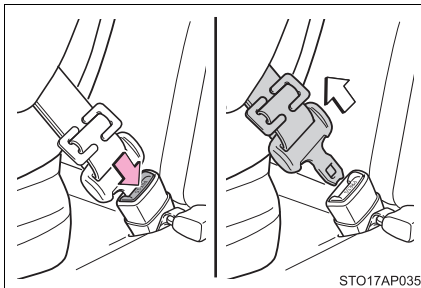

Push the buckle release button and fully retract the seat belt.

Installation with ISOFIX rigid anchors (ISOFIX child restraint system) (vehicles with rear seats)

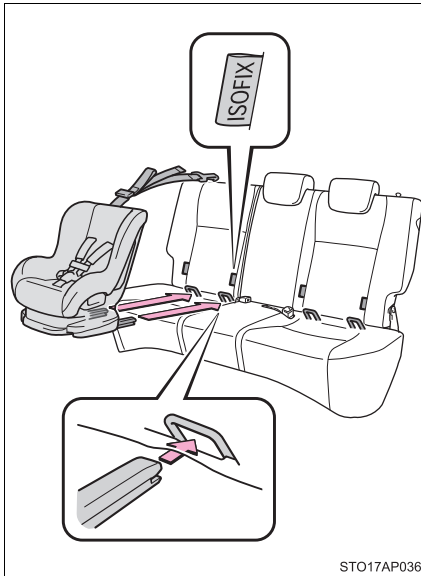

STEP 1 Widen the gap between the seat cushion and seatback slightly.

STEP 2 Latch the buckles onto the anchors.

If the child restraint has a top strap, the top strap should be latched onto the anchor bracket.

1

Before driving

Child restraint systems with a top strap (vehicles with rear seats)

STEP 1 Vehicles with a luggage cover: Remove the luggage cover. (→P. 441)

STEP 2 Remove the head restraint. (→P. 131)

STEP 3 Secure the child restraint system using a seat belt or ISOFIX rigid anchors.

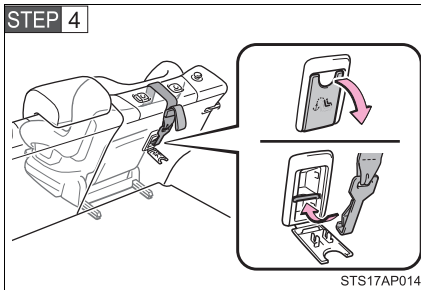

Open the anchor bracket cover, latch the hook onto the anchor bracket and tighten the top strap.

Make sure the top strap is securely latched.

STEP 5 Vehicles with a luggage cover: Reinstall the luggage cover.

■ When installing a child restraint system using a seat belt

You need a locking clip to install the child restraint system using a seat belt. Follow the instructions provided by the manufacturer of the system. If your child restraint system does not provide a locking clip, you can purchase the following item from any authorized Toyota dealer or repairer, or another duly qualified and equipped professional:

Locking clip for child restraint system
(Part No. 73119-22010)

⚠ CAUTION

■ When installing a child restraint system

Follow the directions given in the child restraint system installation manual and fix the child restraint system securely in place.

If the child restraint system is not correctly fixed in place, the child or other passengers may be seriously injured or even killed in the event of sudden braking, sudden swerving or an accident.

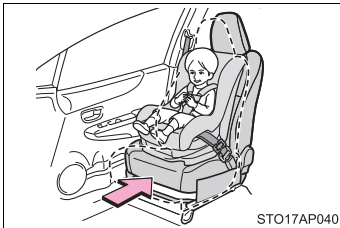
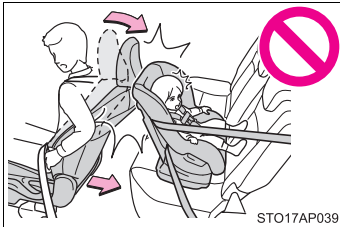

- If the driver's seat interferes with the child restraint system and prevents it from being attached correctly, attach the child restraint system to the right-hand rear seat (left-hand drive vehicles) or the left-hand rear seat (right-hand drive vehicles).
- Adjust the front passenger seat so that it does not interfere with the child restraint system.
- When installing a forward-facing child restraint system on the front passenger seat, move the seat as far back as possible. Failure to do so may result in death or serious injury if the airbags deploy (inflate).

⚠ CAUTION

■ When installing a child restraint system

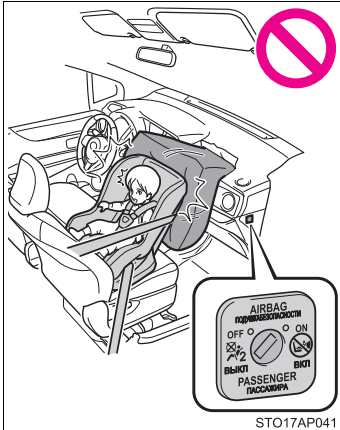

- Never use a rear-facing child restraint system on the front passenger seat when the airbag manual on-off switch is on. (→P. 178)

The force of the rapid inflation of the front passenger airbag can cause death or serious injury to children in the event of an accident.

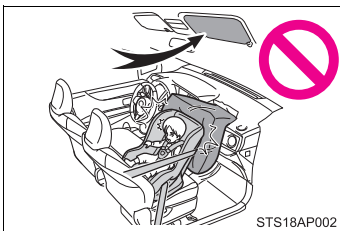

- There is a label(s) on the passenger side sun visor, indicating it is forbidden to attach a rear-facing child restraint system to the front passenger seat.

Details of the label(s) are shown in the illustration below.



STS18AP001

⚠ CAUTION

■ When installing a child restraint system

- If child restraint system regulations exist in the country where you reside, please contact any authorized Toyota dealer or repairer, or another duly qualified and equipped professional for the child restraint system installation.
- When a junior seat is installed, always ensure that the shoulder belt is positioned across the center of the child's shoulder. The belt should be kept away from the child's neck, but not so that it could fall off the child's shoulder. Failure to do so may result in death or serious injury in the event of sudden braking, sudden swerving or an accident.
- Ensure that the belt and plate are securely locked and the seat belt is not twisted.
- Shake the child restraint system left and right, and forward and backward to ensure that it has been securely installed.
- After securing a child restraint system, never adjust the seat.
- Follow all installation instructions provided by the child restraint system manufacturer.
- When a child restraint system with a top strap is installed, do not install the head restraint. The head restraint may interfere with the top strap preventing secure installation of the child restraint system.
- Make sure to properly store the removed head restraint in a secure place when you use the child restraint system on the rear seat.



- When using the right side seat for the child restraint system, do not sit in the center seat. Seat belt function may be impaired, such as being positioned overly high or loose-fitting, which may result in death or serious injury in the event of sudden braking or an accident.

 CAUTION

■ **To correctly attach a child restraint system to the anchors**

When using the lower anchors, be sure that there are no foreign objects around the anchors and that the seat belt is not caught behind the child restraint system. Make sure the child restraint system is securely attached, or it may cause death or serious injury to the child or other passengers in the event of sudden braking, sudden swerve or an accident.

2-1. Driving procedures

Driving the vehicle	202
Engine (ignition) switch (except hybrid vehicle [vehicles without a smart entry & start system]).....	222
Engine (ignition) switch (except hybrid vehicle [vehicles with a smart entry & start system]).....	226
Engine (ignition) switch (hybrid vehicle [vehicles without an electronic key]).....	236
Power (ignition) switch (hybrid vehicle [vehicles with an electronic key])...	241
EV drive mode (hybrid vehicle)	248
Hybrid transmission	250
Multidrive	253
Multi-mode manual transmission	258
Manual transmission.....	263
Turn signal lever	267
Parking brake	269
Horn	270

2-2. Instrument cluster

Gauges and meters	271
Indicators and warning lights	276
Multi-information display...	284

2-3. Operating the lights and wipers

Headlight switch.....	291
Fog light switch	300
Windshield wiper and washer	302
Rear window wiper and washer	307

2-4. Using other driving systems

Cruise control.....	309
Speed limiter	313
Stop & Start system	316
Driving assist systems	324
Hill-start assist control (hybrid vehicle)	330
Diesel particulate filter system	332

2-5. Driving information

Cargo and luggage	334
Winter driving tips	336
Trailer towing (hybrid vehicle)	340
Trailer towing (except hybrid vehicle [except for South Africa]).....	341

2-1. Driving procedures

Driving the vehicle

The following procedures should be observed to ensure safe driving:

■ Starting the engine (except hybrid vehicle) or hybrid system (hybrid vehicle)

→P. 222, 226, 236, 241

■ Driving

Vehicles with a hybrid transmission or a Multidrive

STEP 1 With the brake pedal depressed, shift the shift lever to D.
(→P. 250, 253)

STEP 2 Release the parking brake. (→P. 269)

STEP 3 Gradually release the brake pedal and gently depress the accelerator pedal to accelerate the vehicle.

Vehicles with a multi-mode manual transmission

STEP 1 With the brake pedal depressed, shift the shift lever to E or M. (→P. 258)

When shifting the shift lever to E: Make sure that the display of the gear position indicator shows E.

When shifting the shift lever to M: Make sure that the display of the gear position indicator shows 1.

STEP 2 Release the parking brake. (→P. 269)

STEP 3 Gradually release the brake pedal and gently depress the accelerator pedal to accelerate the vehicle.

Vehicles with a manual transmission

STEP 1 While depressing the clutch pedal, shift the shift lever to 1.
(→P. 263)

STEP 2 Release the parking brake. (→P. 269)

STEP 3 Gradually release the clutch pedal. At the same time, gently depress the accelerator pedal to accelerate the vehicle.

■ Stopping

Vehicles with a hybrid transmission or a Multidrive

STEP 1 With the shift lever in D, depress the brake pedal.

Vehicles with a Multidrive and a Stop & Start system: If the Stop & Start system is enabled, depressing the brake pedal will stop the engine. (→P. 316)

STEP 2 If necessary, set the parking brake.

If the vehicle is to be stopped for an extended period of time, shift the shift lever to P. (→P. 250, 253)

Vehicles with a multi-mode manual transmission

STEP 1 With the shift lever in E or M, depress the brake pedal.

STEP 2 If necessary, set the parking brake.

If the vehicle is to be stopped for an extended period of time, shift the shift lever to N. (→P. 258)

Vehicles with a manual transmission

STEP 1 While depressing the clutch pedal, depress the brake pedal.

STEP 2 If necessary, set the parking brake.

If the vehicle is to be stopped for an extended period of time, shift the shift lever to N. (→P. 263)

Vehicles with a Stop & Start system: If the Stop & Start system is enabled, shifting the shift lever to N and releasing the clutch pedal will stop the engine. (→P. 316)

■ Parking the vehicle

Vehicles with a hybrid transmission

STEP 1 With the shift lever in D, depress the brake pedal.

STEP 2 Set the parking brake. (→P. 269)

STEP 3 Shift the shift lever to P. (→P. 250)

If parking on a hill, block the wheels as needed.

STEP 4 Vehicles without an electronic key:

Turn the engine switch to the “LOCK” position to stop the hybrid system.

Vehicles with an electronic key:

Press the “POWER” switch to stop the hybrid system.

STEP 5 Lock the door, making sure that you have the electronic key on your person.

Vehicles with a Multidrive

STEP 1 With the shift lever in D, depress the brake pedal.

STEP 2 Set the parking brake. (→P. 269)

STEP 3 Shift the shift lever to P. (→P. 253)

If parking on a hill, block the wheels as needed.

STEP 4 Vehicles without a smart entry & start system:

Turn the engine switch to the “LOCK” position to stop the engine.

Vehicles with a smart entry & start system:

Press the “ENGINE START STOP” switch to stop the engine.

STEP 5 Lock the door, making sure that you have the key on your person.

Vehicles with a multi-mode manual transmission

- STEP 1** With the shift lever in E or M, depress the brake pedal.
- STEP 2** Set the parking brake. (→P. 269)
- STEP 3** Shift the shift lever to E, M or R. (→P. 258)
If parking on a hill, block the wheels as needed.
- STEP 4** Vehicles without a smart entry & start system: Turn the engine switch to the “LOCK” position to stop the engine.
Vehicles with a smart entry & start system: Press the “ENGINE START STOP” switch to stop the engine.
Make sure that the display of the gear position indicator shows 1 or R.
- STEP 5** Lock the door, making sure that you have the key on your person.

Vehicles with a manual transmission

- STEP 1** While depressing the clutch pedal, depress the brake pedal.
- STEP 2** Set the parking brake. (→P. 269)
- STEP 3** Shift the shift lever to N. (→P. 263)
If parking on a hill, shift the shift lever to 1 or R and block the wheels as needed.
- STEP 4** Vehicles without a smart entry & start system: Turn the engine switch to the “LOCK” position to stop the engine.
Vehicles with a smart entry & start system: Press the “ENGINE START STOP” switch to stop the engine.
- STEP 5** Lock the door, making sure that you have the key on your person.

Starting off on a steep uphill

Vehicles with a hybrid transmission or a Multidrive

- STEP 1** Firmly set the parking brake with the brake pedal depressed, and then shift the shift lever to D.
- STEP 2** Release the brake pedal and gently depress the accelerator pedal.
- STEP 3** Release the parking brake.

Vehicles with a multi-mode manual transmission

- STEP 1** With the brake pedal depressed, firmly set the parking brake and shift the shift lever to E or M.
When shifting the shift lever to E: Make sure that the display of the gear position indicator shows E.
When shifting the shift lever to M: Make sure that the display of the gear position indicator shows 1.

- STEP 2** Gently depress the accelerator pedal.
- STEP 3** Release the parking brake.

Vehicles with a manual transmission

- STEP 1** With the parking brake firmly set and the clutch pedal fully depressed, shift the shift lever to 1.
- STEP 2** Lightly depress the accelerator pedal at the same time as gradually releasing the clutch pedal.
- STEP 3** Release the parking brake.

■ Driving in the rain

- Drive carefully when it is raining, because visibility will be reduced, the windows may become fogged-up, and the road will be slippery.
- Drive carefully when it starts to rain, because the road surface will be especially slippery.
- Refrain from high speeds when driving on an expressway in the rain, because there may be a layer of water between the tires and the road surface, preventing the steering and brakes from operating properly.

■ Engine speed while driving (except manual transmission)

In the following conditions, the engine speed may become high while driving. This is due to automatic up-shifting control or down-shifting implementation to meet driving conditions. It does not indicate sudden acceleration.

Except hybrid vehicle

- The vehicle is judged to be driving uphill or downhill
- When the accelerator pedal is released
- When the brake pedal is depressed while sport mode (vehicle with a Multidrive) or Easy sports (Es) mode (vehicles with a multi-mode manual transmission) is selected

Hybrid vehicle

- The vehicle is judged to be driving uphill or downhill
- When the accelerator pedal is released

■ Breaking in your new Toyota

To extend the life of the vehicle, observing the following precautions is recommended:

Except hybrid vehicle

- For the first 300 km (186 miles):
Avoid sudden stops.
- For the first 800 km (500 miles):
Do not tow a trailer.
- For the first 1000 km (621 miles):
 - Do not drive at extremely high speeds.
 - Avoid sudden acceleration.
 - Do not drive continuously in low gears.
 - Do not drive at a constant speed for extended periods.

Hybrid vehicle

- For the first 300 km (186 miles):
Avoid sudden stops.
- For the first 1600 km (994 miles):
 - Do not drive at extremely high speeds.
 - Avoid sudden acceleration.
 - Do not drive at a constant speed for extended periods.

■ Idling time before stopping the engine (diesel engine)

To prevent damage to the turbocharger, allow the engine to idle immediately after high-speed driving or driving up a hill.

Driving condition		Idling time
Normal city driving		Not necessary
High-speed driving	Constant speed of approx. 80 km/h (50 mph)	Approximately 20 seconds
	Constant speed of approx. 100 km/h (63 mph)	Approximately 1 minute
Steep hill driving or continuous driving at 100 km/h (63 mph) or more (race track driving etc.)		Approximately 2 minutes

■ Eco-friendly driving (vehicles with a Multidrive)

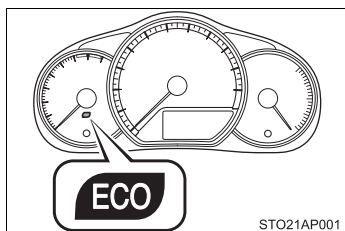

During Eco-friendly acceleration operation (Eco driving), Eco Driving Indicator Light will turn on. When the accelerator pedal is depressed excessively, and when the vehicle is stopped, the light turns off.

Eco Driving Indicator Light will not operate in the following conditions:

- The shift lever is in anything other than D.
- The driving mode is set to sport mode.
- The paddle shift switch is operated while the shift lever in D.
- The vehicle speed is approximately 130 km/h (80 mph) or higher.

Eco Driving Indicator Light can be activated or deactivated. (→P. 289)

■ Operating your vehicle in a foreign country

Comply with the relevant vehicle registration laws and confirm the availability of the correct fuel. (→P. 667)

■ For efficient use (Hybrid vehicle)

- Shift the shift lever to D when driving.
In the N position, the gasoline engine operates but electricity cannot be generated. The hybrid battery (traction battery) will discharge, requiring unnecessary engine power to recharge.
- Drive your vehicle smoothly.
Avoid abrupt acceleration and deceleration. Gradual acceleration and deceleration will make more effective use of the electric motor (traction motor) without having to use gasoline engine power.
- Avoid repeated acceleration.
Repeated acceleration consumes hybrid battery (traction battery) power, resulting in poor acceleration. Battery power can be restored by driving with the accelerator pedal slightly released.
- Shift the shift lever to P when parking.
In the N position, the hybrid battery (traction battery) does not recharge. Leaving the shift lever in the N position for an extended period of time may discharge the hybrid battery. The vehicle cannot run if the hybrid battery is discharged.

 CAUTION

■ **When starting the vehicle**

On vehicles with a hybrid transmission, always keep your foot on the brake pedal while stopped with the hybrid system operating. This prevents the vehicle from creeping.

On vehicles with a Multidrive, always keep your foot on the brake pedal while stopped with the engine running. This prevents the vehicle from creeping.

On vehicles with a multi-mode manual transmission, always keep your foot on the brake pedal while stopped with the engine running. This prevents the vehicle from moving unexpectedly.

■ **When driving the vehicle**

- Do not drive if you are unfamiliar with the location of the brake and accelerator pedals to avoid depressing the wrong pedal.
 - Accidentally depressing the accelerator pedal instead of the brake pedal will result in sudden acceleration that may lead to an accident that could result in death or serious injury.
 - When backing up, you may twist your body around, leading to a difficulty in operating the pedals. Make sure to operate the pedals properly.
 - Make sure to keep a correct driving posture even when moving the vehicle only slightly. This allows you to depress the brake and accelerator pedals properly.
 - Depress the brake pedal using your right foot. Depressing the brake pedal using your left foot may delay response in an emergency, resulting in an accident.
- On hybrid vehicles, the driver should pay extra attention to pedestrians when the vehicle is powered only by the electric motor (traction motor). Because there is no engine noise, the pedestrians may misjudge the vehicle's movement.

 CAUTION

- Do not drive the vehicle over or stop the vehicle near flammable materials. The exhaust system and exhaust gases can be extremely hot. These hot parts may cause a fire if there is any flammable material nearby.
- On vehicles with a hybrid transmission, do not let the vehicle roll backward while the shift lever is in a driving position, or roll forward while the shift lever is in R. Doing so may result in an accident or damage to the vehicle.
- On vehicles with a Multidrive or a multi-mode manual transmission, do not let the vehicle roll backward while the shift lever is in a driving position, or roll forward while the shift lever is in R. Doing so may cause the engine to stall or lead to poor brake and steering performance, resulting in an accident or damage to the vehicle.
- If the smell of exhaust is noticed inside the vehicle, open the windows and check that the back door is closed. Large amounts of exhaust in the vehicle can cause driver drowsiness and an accident, resulting in death or a serious health hazard. Have the vehicle inspected immediately by any authorized Toyota dealer or repairer, or another duly qualified and equipped professional immediately.
- On vehicles with a hybrid transmission or a Multidrive, do not shift the shift lever to P while the vehicle is moving. Doing so can damage the transmission and may result in a loss of vehicle control.
- Do not shift the shift lever to R while the vehicle is moving forward. Doing so can damage the transmission and may result in a loss of vehicle control.
- Do not shift the shift lever to D (vehicles with a hybrid transmission or a Multidrive), E (vehicles with a multi-mode manual transmission) or 1 (vehicles with a manual transmission) while the vehicle is moving backward. Doing so can damage the transmission and may result in a loss of vehicle control.

 CAUTION

- Except hybrid vehicle: Shifting the shift lever to N while the vehicle is moving will disengage the engine from the transmission. Engine braking is not available when N is selected.
- Hybrid vehicle: Shifting the shift lever to N while the vehicle is moving will disengage the hybrid system. Engine braking is not available with the hybrid system disengaged.
- Except hybrid vehicle: During normal driving, do not turn off the engine. Turning the engine off while driving will not cause loss of steering or braking control, but the power assist to these systems will be lost. This will make it more difficult to steer and brake, so you should pull over and stop the vehicle as soon as it is safe to do so.
However, in the event of an emergency, such as if it becomes impossible to stop the vehicle in the normal way: →P. 657
- Hybrid vehicle: During normal driving, do not turn off the hybrid system. Turning the hybrid system off while driving will not cause loss of steering or braking control, but the power assist to these systems will be lost. This will make it more difficult to steer and brake, so you should pull over and stop the vehicle as soon as it is safe to do so.
However, in the event of an emergency, such as if it becomes impossible to stop the vehicle in the normal way: →P. 657
- Use engine braking (downshift [except hybrid vehicle] or shift position B [hybrid vehicle]) to maintain a safe speed when driving down a steep hill. Using the brakes continuously may cause the brakes to overheat and lose effectiveness. (→P. 251, 254, 258)
- When stopped on an inclined surface, use the brake pedal and parking brake to prevent the vehicle from rolling backward or forward and causing an accident.
- Do not adjust the positions of the steering wheel, the seat, or the inside or outside rear view mirrors while driving.
Doing so may result in a loss of vehicle control that can cause accidents, resulting in death or serious injury.
- Always check that all passengers' arms, heads or other parts of their body are not outside the vehicle, as this may result in death or serious injury.

 **CAUTION****■ When driving on slippery road surfaces**

- Sudden braking, acceleration and steering may cause tire slippage and reduce your ability to control the vehicle, resulting in an accident.
- Sudden acceleration, engine braking due to shift changing, or changes in engine speed could cause the vehicle to skid, resulting in an accident.
- After driving through a puddle, lightly depress the brake pedal to make sure that the brakes are functioning properly. Wet brake pads may prevent the brakes from functioning properly. If the brakes on only one side are wet and not functioning properly, steering control may be affected, resulting in an accident.

■ When shifting the shift lever (vehicles with a hybrid transmission, a Multidrive or a multi-mode manual transmission)

Be careful not to shift the shift lever with the accelerator pedal depressed. Shifting the shift lever to a gear other than P (vehicles with a hybrid transmission or a Multidrive only) or N may lead to unexpected rapid acceleration of the vehicle that may cause an accident and result in death or serious injury.

■ If you hear a squealing or scraping noise (brake pad wear indicators)

Have the brake pads checked and replaced by any authorized Toyota dealer or repairer, or another duly qualified and equipped professional as soon as possible.

Rotor damage may result if the pads are not replaced when needed.

It is dangerous to drive the vehicle when the wear limits of the brake pads and/or those of the brake discs are exceeded.

 CAUTION

■ **When the vehicle is stopped**

- **Except hybrid vehicle:** Do not race the engine.
If the vehicle is in any gear other than P (vehicles with a Multidrive only) or N, the vehicle may accelerate suddenly and unexpectedly, causing an accident.
- **Hybrid vehicle:** Do not depress the accelerator pedal unnecessarily.
If the vehicle is in any gear other than P or N, the vehicle may accelerate suddenly and unexpectedly, causing an accident.
- **Except hybrid vehicle:** Do not leave the vehicle with the engine running for a long time.
If such a situation cannot be avoided, park the vehicle in an open space and check that exhaust fumes do not enter the vehicle interior.
- **Hybrid vehicle:** Do not leave the vehicle with the hybrid system on for a long time.
If such a situation cannot be avoided, park the vehicle in an open space and check that exhaust fumes do not enter the vehicle interior.
- **On vehicles with a Multidrive or a multi-mode manual transmission,** in order to prevent accidents due to the vehicle rolling away, always keep depressing the brake pedal while the engine is running, and apply the parking brake as necessary.
- **On vehicles with a hybrid transmission,** in order to prevent accidents due to the vehicle rolling away, always keep depressing the brake pedal while the “READY” indicator is on. Apply the parking brake as necessary.
- **If the vehicle is stopped on an incline,** in order to prevent accidents caused by the vehicle rolling forward or backward, always depress the brake pedal and securely apply the parking brake as needed.
- **Avoid revving or racing the engine.**
Running the engine at high speed while the vehicle is stopped may cause the exhaust system to overheat, which could result in a fire if combustible material is nearby.

 CAUTION**■ When the vehicle is parked**

- Do not leave glasses, cigarette lighters, spray cans, or soft drink cans in the vehicle when it is in the sun.
Doing so may result in the following:
 - Gas may leak from a cigarette lighter or spray can, and may lead to a fire.
 - The temperature inside the vehicle may cause the plastic lenses and plastic material of glasses to deform or crack.
 - Soft drink cans may fracture, causing the contents to spray over the interior of the vehicle, and may also cause a short circuit in the vehicle's electrical components.
- Do not leave cigarette lighters in the vehicle. If a cigarette lighter is in a place such as the glove box or on the floor, it may be lit accidentally when luggage is loaded or the seat is adjusted, causing a fire.
- Do not attach adhesive discs to the windshield or windows. Do not place containers such as air fresheners on the instrument panel or dashboard. Adhesive discs or containers may act as lenses, causing a fire in the vehicle.
- Do not leave a door or window open if the curved glass is coated with a metallized film such as a silver-colored one. Reflected sunlight may cause the glass to act as a lens, causing a fire.
- On vehicles with a hybrid transmission, always apply the parking brake, shift the shift lever to P, stop the hybrid system and lock the vehicle. Do not leave the vehicle unattended while the hybrid system is operating. Sound or shuddering may not be noticed even when the hybrid vehicle is ready to drive (when the "READY" indicator is illuminated).
- On vehicles with a Multidrive, always apply the parking brake, shift the shift lever to P, stop the engine and lock the vehicle. Do not leave the vehicle unattended while the engine is running.

 CAUTION

- On vehicles with a multi-mode manual transmission, always apply the parking brake, shift the shift lever to E, M or R, stop the engine and lock the vehicle.
Do not leave the vehicle unattended while the engine is running.
- Except hybrid vehicle: Do not touch the exhaust pipes while the engine is running or immediately after turning the engine off.
Doing so may cause burns.
- Hybrid vehicle: Do not touch the exhaust pipes or the rear bumper diffusers while the hybrid system is operating or immediately after turning the hybrid system off.
Doing so may cause burns.
- Except hybrid vehicle: Do not leave the engine running in an area with snow build-up, or where it is snowing. If snowbanks build up around the vehicle while the engine is running, exhaust gases may collect and enter the vehicle. This may lead to death or a serious health hazard.
- Hybrid vehicle: Do not leave the hybrid system operating in an area with snow build-up, or where it is snowing. If snowbanks build up around the vehicle while the hybrid system is operating, exhaust gases may collect and enter the vehicle. This may lead to death or a serious health hazard.
- On vehicles with a multi-mode manual transmission, do not turn off the engine until 1st or reverse is engaged properly and completely. Confirm that the gear is engaged by viewing the gear position indicator.
Parking the vehicle without a gear engaged may cause the vehicle to move result in an accident.

 **CAUTION****Exhaust gases**

Exhaust gases include harmful carbon monoxide (CO), which is colorless and odorless. Inhaling exhaust gases may lead to death or a serious health hazard.

- **Except hybrid vehicle:** If the vehicle is in a poorly ventilated area, stop the engine. In a closed area, such as a garage, exhaust gases may collect and enter the vehicle. This may lead to death or a serious health hazard.
- **Hybrid vehicle:** If the vehicle is in a poorly ventilated area, stop the hybrid system. In a closed area, such as a garage, exhaust gases may collect and enter the vehicle. This may lead to death or a serious health hazard.
- The exhaust system should be checked occasionally. If there is a hole or crack caused by corrosion, damage to a joint or abnormal exhaust noise, be sure to have the vehicle inspected and repaired by any authorized Toyota dealer or repairer, or another duly qualified and equipped professional. Failure to do so may allow exhaust gases to enter the vehicle, resulting in death or a serious health hazard.

When taking a nap in the vehicle

- **Except hybrid vehicle:** Always turn the engine off. Otherwise, if you accidentally move the shift lever or depress the accelerator pedal, this could cause an accident or fire due to engine overheating. Additionally, if the vehicle is parked in a poorly ventilated area, exhaust gases may collect and enter the vehicle, leading to death or a serious health hazard.
- **Hybrid vehicle:** Always turn the hybrid system off. Otherwise, if you accidentally move the shift lever or depress the accelerator pedal, this could cause an accident or fire due to hybrid system overheating. Additionally, if the vehicle is parked in a poorly ventilated area, exhaust gases may collect and enter the vehicle, leading to death or a serious health hazard.

 CAUTION

■ **When braking**

- When the brakes are wet, drive more cautiously.
Braking distance increases when the brakes are wet, and this may cause one side of the vehicle to brake differently than the other side. Also, the parking brake may not securely hold the vehicle.
- If the brake actuator (hybrid vehicle) or brake booster (except hybrid vehicle) does not operate, do not follow other vehicles closely and avoid hills or sharp turns that require braking.
In this case, braking is still possible, but the brake pedal should be depressed more firmly than usual. Also, the braking distance will increase.
- Do not pump the brake pedal if the engine stalls.
Each push on the brake pedal uses up the reserve for the power-assisted brakes.
- Except hybrid vehicle: The brake system consists of 2 individual hydraulic systems; if one of the systems fails, the other will still operate. In this case, the brake pedal should be depressed more firmly than usual and the braking distance will increase. If this happens, do not continue to drive the vehicle. Have your brakes fixed immediately.
- Hybrid vehicle: The brake system consists of 2 individual hydraulic systems; if one of the systems fails, the others will still operate. In this case, the brake pedal should be depressed more firmly than usual and the braking distance will increase. If this happens, do not continue to drive the vehicle. If the brake system warning light (red indicator) comes on together with the buzzer sound while driving, immediately stop the vehicle in a safe place and contact any authorized Toyota dealer or repairer, or another duly qualified and equipped professional.

 NOTICE

■ **When driving the vehicle**

Vehicles with a hybrid transmission or a Multidrive

- Do not depress the accelerator and brake pedals at the same time during driving, as this may restrain driving torque.
- Do not use the accelerator pedal or depress the accelerator and brake pedals at the same time to hold the vehicle on a hill.

Vehicles with a multi-mode manual transmission

- Do not depress the accelerator and brake pedals at the same time during driving, as this may restrain driving torque.
- Do not use the accelerator pedal or starting assist system to hold the vehicle on a hill.
Doing so may damage the clutch.

Vehicles with a manual transmission

- Do not depress the accelerator and brake pedals at the same time during driving, as this may restrain driving torque.
- Do not shift gears unless the clutch pedal is fully depressed. After shifting, do not release the clutch pedal abruptly. Doing so may damage the clutch, transmission and gears.
- Observe the following to prevent the clutch from being damaged.
 - Do not rest your foot on the clutch pedal while driving.
Doing so may cause clutch trouble.
 - Do not use any gears other than the 1st gear when starting off and moving forward.
Doing so may damage the clutch.
 - Do not use the clutch to hold the vehicle when stopping on an uphill grade.
Doing so may damage the clutch.
- Do not shift the shift lever to R when the vehicle is still moving. Doing so may damage the clutch, transmission and gears.

 NOTICE

■ **When parking the vehicle (vehicles with a hybrid transmission or a Multidrive)**

Always shift the shift lever to P. Failure to do so may cause the vehicle to move or the vehicle may accelerate suddenly if the accelerator pedal is accidentally depressed.

■ **Avoiding damage to vehicle parts**

- Do not turn the steering wheel fully in either direction and hold it there for an extended period of time.
Doing so may damage the power steering motor.
- When driving over bumps in the road, drive as slowly as possible to avoid damaging the wheels, underside of the vehicle, etc.
- Diesel engine only: Make sure to idle the engine immediately after high-speed driving or hill climbing. Stop the engine only after the turbocharger has cooled down.
Failure to do so may cause damage to the turbocharger.

■ **If you get a flat tire while driving**

A flat or damaged tire may cause the following situations. Hold the steering wheel firmly and gradually depress the brake pedal to slow down the vehicle.

- It may be difficult to control your vehicle.
- The vehicle will make abnormal sounds or vibrations.
- The vehicle will lean abnormally.

Information on what to do in case of a flat tire (→P. 578, 591)

 NOTICE**■ When encountering flooded roads**

Do not drive on a road that has flooded after heavy rain etc. Doing so may cause the following serious damage to the vehicle:

- Engine stalling
- Short in electrical components
- Engine damage caused by water immersion

In the event that you drive on a flooded road and the vehicle is flooded, be sure to have any authorized Toyota dealer or repairer, or another duly qualified and equipped professional check the following:

- Brake function
- Except hybrid vehicle: Changes in quantity and quality of engine oil, transmission fluid, etc.
- Hybrid vehicle: Changes in quantity and quality of oil and fluid used for the engine, hybrid transmission, etc.
- Lubricant condition for the bearings and suspension joints (where possible), and the function of all joints, bearings, etc.

2-1. Driving procedures



Engine (ignition) switch (except hybrid vehicle [vehicles without a smart entry & start system])

■ Starting the engine

Vehicles with a Multidrive

- STEP 1** Check that the parking brake is set.
- STEP 2** Check that the shift lever is set in P.
- STEP 3** Firmly depress the brake pedal.
- STEP 4** Turn the engine switch to the “START” position to start the engine.

Vehicles with a multi-mode manual transmission

- STEP 1** Check that the parking brake is set.
- STEP 2** Firmly depress the brake pedal, shift the shift lever to N. (→P. 258)
- STEP 3** Turn the engine switch to “ON” position.
The  indicator turns on.
- STEP 4** After the  indicator light goes out, turn the engine switch to the “START” position to start the engine.

Vehicles with a manual transmission (gasoline engine)

- STEP 1** Check that the parking brake is set.
- STEP 2** Check that the shift lever is set in N.
- STEP 3** Firmly depress the clutch pedal.
- STEP 4** Turn the engine switch to the “START” position to start the engine.

Vehicles with a manual transmission (diesel engine)

- STEP 1** Check that the parking brake is set.
- STEP 2** Check that the shift lever is set in N.
- STEP 3** Firmly depress the clutch pedal.
- STEP 4** Turn the engine switch to the “ON” position.

The  indicator turns on.

- STEP 5** After the  indicator light goes out, turn the engine switch to the “START” position to start the engine.

■ Changing the engine switch positions

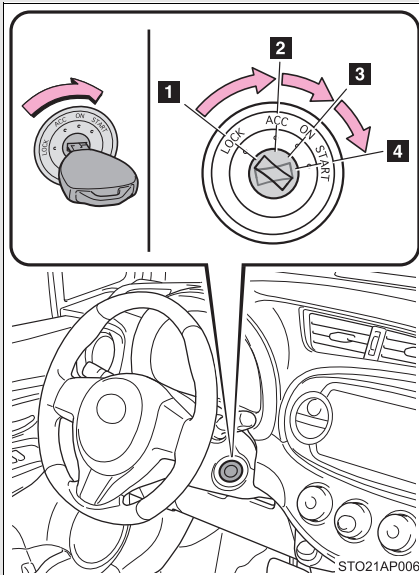

1 “LOCK”

The steering wheel is locked and the key can be removed. (Vehicles with a Multidrive: The key can be removed only when the shift lever is in P.)

2 “ACC”

Some electrical components such as the audio system can be used.

3 “ON”

All electrical components can be used.

4 “START”

For starting the engine.

■ **Turning the key from “ACC” to “LOCK”**

STEP 1 Shift the shift lever to P (vehicles with a Multidrive), E, M or R (vehicles with a multi-mode manual transmission) or N (vehicles with a manual transmission). (→P. 253, 258, 263)

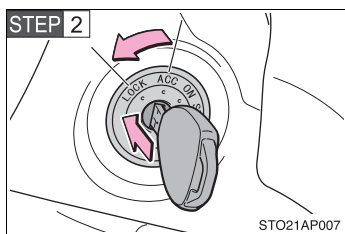

Push in the key and turn it to the “LOCK” position.

■ **If the engine does not start**

The engine immobilizer system may not have been deactivated. (→P. 155)
Contact any authorized Toyota dealer or repairer, or another duly qualified and equipped professional.

■ **When the steering lock cannot be released**

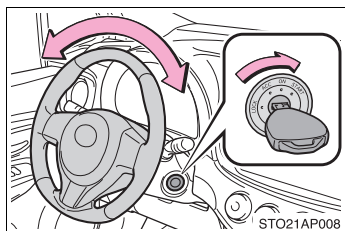

When starting the engine, the engine switch may seem stuck in the “LOCK” position. To free it, turn the key while turning the steering wheel slightly left and right.

■ **Key reminder function**

A buzzer sounds if the driver’s door is opened while the engine switch is in the “ACC” or “LOCK” position to remind you to remove the key.

 CAUTION**■ When starting the engine**

Always start the engine while sitting in the driver's seat. Do not depress the accelerator pedal while starting the engine under any circumstances. Doing so may cause an accident resulting in death or serious injury.

■ Caution when driving

Do not turn the engine switch to the "LOCK" position while driving. If, in an emergency, you must turn the engine off while the vehicle is moving, turn the engine switch only to the "ACC" position to stop the engine. An accident may result if the engine is stopped while driving. (→P. 657)

 NOTICE**■ To prevent battery discharge**

Do not leave the engine switch in the "ACC" or "ON" position for long periods of time without the engine running.

■ When starting the engine

- Do not crank the engine for more than 30 seconds at a time. This may overheat the starter and wiring system.
- Do not race a cold engine.
- If the engine becomes difficult to start or stalls frequently, have your vehicle checked by any authorized Toyota dealer or repairer, or another duly qualified and equipped professional immediately.

2-1. Driving procedures

Engine (ignition) switch (except hybrid vehicle [vehicles with a smart entry & start system])

Performing the following operations when carrying the electronic key on your person starts the engine or changes “ENGINE START STOP” switch modes.

■ Starting the engine

Vehicles with a Multidrive

STEP 1 Check that the parking brake is set.

STEP 2 Check that the shift lever is set in P.

If the shift lever is not set in P, the engine may not be started.
(→P. 253)

STEP 3 Firmly depress the brake pedal.

The smart entry & start system indicator light (green) will turn on.
If the indicator light does not turn on, the engine cannot be started.

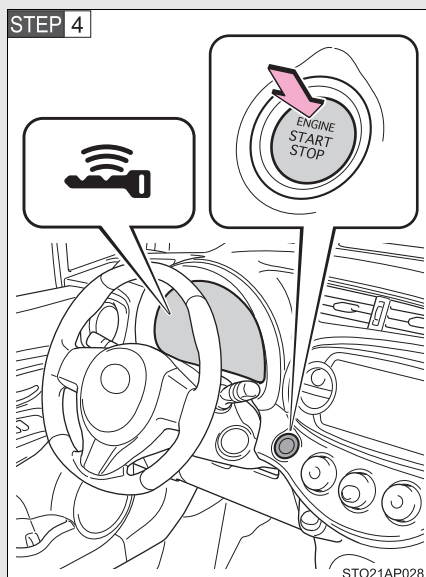

Press the “ENGINE START STOP” switch.

The engine will crank until it starts or for up to 30 seconds, whichever is less.

Continue depressing the brake pedal until the engine is completely started.

The engine can be started from any “ENGINE START STOP” switch mode.

Vehicles with a multi-mode manual transmission

STEP 1 Check that the parking brake is set.

STEP 2 Firmly depress the brake pedal, press the “ENGINE START STOP” switch once and shift the shift lever to N. (→P. 258)

The smart entry & start system indicator light (green) will turn on. If the indicator light does not turn on, the engine cannot be started.

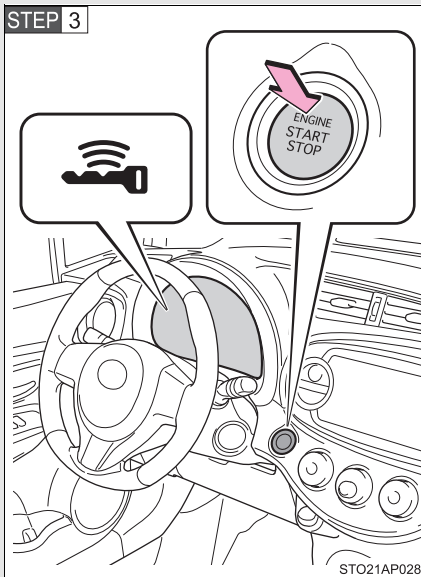

Press the “ENGINE START STOP” switch.

The engine will crank until it starts or for up to 30 seconds, whichever is less.

Continue depressing the brake pedal until the engine is completely started.

The  indicator turns on. The engine will start after the indicator light goes out.

The engine can be started from any “ENGINE START STOP” switch mode.

Vehicles with a manual transmission

STEP 1 Check that the parking brake is set.

STEP 2 Check that the shift lever is set in N.

STEP 3 Firmly depress the clutch pedal.

The smart entry & start system indicator light (green) will turn on. If the indicator light does not turn on, the engine cannot be started.

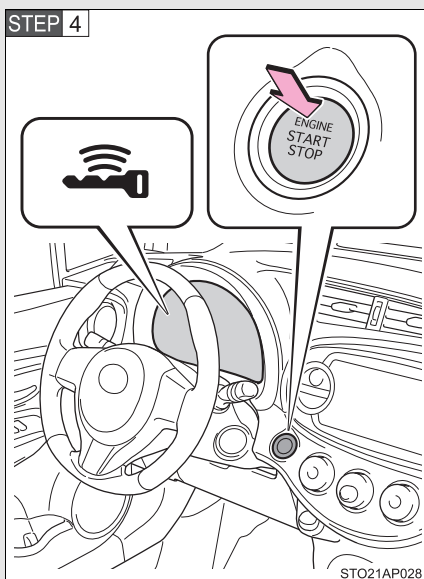

Press the “ENGINE START STOP” switch.

The engine will crank until it starts or for up to 30 seconds, whichever is less.

Continue depressing the clutch pedal until the engine is completely started.

Diesel engine only: The  indicator turns on. The engine will start after the indicator light goes out.

The engine can be started from any “ENGINE START STOP” switch mode.

■ Stopping the engine

Vehicles with a Multidrive

- STEP 1** Stop the vehicle.
- STEP 2** Shift the shift lever to P.
- STEP 3** Set the parking brake. (→P. 269)
- STEP 4** Release the brake pedal.
- STEP 5** Press the “ENGINE START STOP” switch.
- STEP 6** Check that the smart entry & start system indicator light (green) is off.

Vehicle with a multi-mode manual transmission

- STEP 1** Stop the vehicle.
- STEP 2** Shift the shift lever to E, M or R.
- STEP 3** Set the parking brake. (→P. 269)
- STEP 4** Release the brake pedal.
- STEP 5** Press the “ENGINE START STOP” switch.
- STEP 6** Check that the smart entry & start system indicator light (green) is off.

Vehicle with a manual transmission

- STEP 1** While depressing the clutch pedal, stop the vehicle.
- STEP 2** Shift the shift lever to N.
- STEP 3** Set the parking brake. (→P. 269)
- STEP 4** Release the clutch pedal.
- STEP 5** Press the “ENGINE START STOP” switch.
- STEP 6** Check that the smart entry & start system indicator light (green) is off.

■ Changing “ENGINE START STOP” switch mode

Modes can be changed by pressing the “ENGINE START STOP” switch with the brake pedal (except vehicles with a manual transmission) or clutch pedal (vehicles with a manual transmission) released. (The mode changes each time the switch is pressed.)

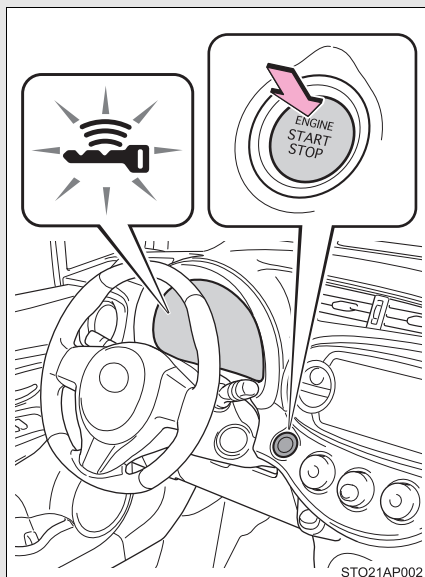

Off*

The emergency flashers can be used.

The smart entry & start system indicator light (green) is off.

ACCESSORY mode

Some electrical components such as the audio system can be used.

The smart entry & start system indicator light (green) flashes slowly.

IGNITION ON mode

All electrical components can be used.

The smart entry & start system indicator light (green) flashes slowly.

*:Vehicles with a Multidrive: If the shift lever is in a position other than P when turning off the engine, the “ENGINE START STOP” switch will be turned to ACCESSORY mode, not to off.

When stopping the engine with the shift lever in a position other than P (vehicles with a Multidrive)

If the engine is stopped with the shift lever in a position other than P, the “ENGINE START STOP” switch will not be turned off but instead be turned to ACCESSORY mode. Perform the following procedure to turn the switch off:

- STEP 1** Check that the parking brake is set.
- STEP 2** Shift the shift lever to P.
- STEP 3** Check that the smart entry & start system indicator light (green) flashes slowly and then press the “ENGINE START STOP” switch once.
- STEP 4** Check that the smart entry & start system indicator light (green) is off.

■ Auto power off function

Vehicles with a Multidrive

If the vehicle is left in ACCESSORY or IGNITION ON mode (the engine is not running) for more than an hour with the shift lever in P, the “ENGINE START STOP” switch will automatically turn off. However, this function cannot entirely prevent battery discharge. Do not leave the vehicle with the “ENGINE START STOP” switch in ACCESSORY or IGNITION ON mode for long periods of time when the engine is not running.

Vehicle with a multi-mode manual transmission and manual transmission

If the vehicle is left in ACCESSORY or IGNITION ON mode (the engine is not running) for more than an hour, the “ENGINE START STOP” switch will automatically turn off. However, this function cannot entirely prevent battery discharge. Do not leave the vehicle with the “ENGINE START STOP” switch in ACCESSORY or IGNITION ON mode for long periods of time when the engine is not running.

■ Electronic key battery depletion

→P. 81

■ **Conditions affecting operation**

→P. 78

■ **Notes for the entry function**

→P. 79

■ **If the engine does not start**

The engine immobilizer system may not have been deactivated. (→P. 155)
Contact any authorized Toyota dealer or repairer, or another duly qualified and equipped professional.

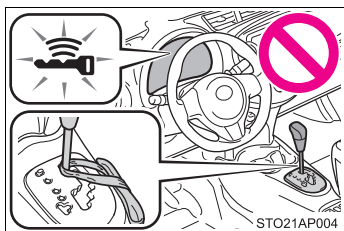

Vehicles with a Multidrive: Check that the shift lever is securely set in P. The engine may not start if the shift lever is displaced out of P. The smart entry & start system indicator light (green) will flash quickly.

■ **Steering lock**

After turning the “ENGINE START STOP” switch off and opening and closing the doors, the steering wheel will be locked due to the steering lock function. Operating the “ENGINE START STOP” switch again automatically cancels the steering lock.

■ **When the steering lock cannot be released**

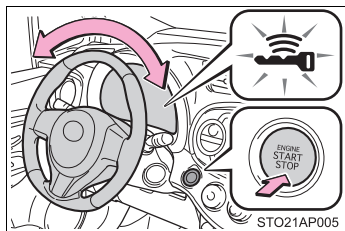

The smart entry & start system indicator light (green) will flash quickly.

Vehicles with a Multidrive

Check that the shift lever is set in P. Press the “ENGINE START STOP” switch while turning the steering wheel left and right.

Vehicles with a multi-mode manual transmission and manual transmission

Press the “ENGINE START STOP” switch while turning the steering wheel left and right.

■ Steering lock motor overheating prevention

To prevent the steering lock motor from overheating, the motor may be suspended if the engine is turned on and off repeatedly in a short period of time. In this case, refrain from operating the engine. After about 10 seconds, the steering lock motor will resume functioning.

■ When the smart entry & start system indicator light flashes in yellow

The system may be malfunctioning. Have the vehicle inspected by any authorized Toyota dealer or repairer, or another duly qualified and equipped professional immediately.

■ If the electronic key battery is depleted

→P. 501

■ Operation of the “ENGINE START STOP” switch

When operating the “ENGINE START STOP” switch, one short, firm press is enough. If the switch is pressed improperly, the engine may not start or the “ENGINE START STOP” switch mode may not change. It is not necessary to press and hold the switch.

■ If the smart entry & start system has been deactivated in a customized setting

→P. 689

 CAUTION

■ **When starting the engine**

Always start the engine while sitting in the driver's seat. Do not depress the accelerator pedal while starting the engine under any circumstances. Doing so may cause an accident resulting in death or serious injury.

■ **Caution while driving**

If engine failure occurs while the vehicle is moving, do not lock or open the doors until the vehicle reaches a safe and complete stop. Activation of the steering lock in this circumstance may lead to an accident, resulting in death or serious injury.

■ **Stopping the engine in an emergency**

If you want to stop the engine in an emergency while driving the vehicle, press and hold the "ENGINE START STOP" switch for more than 3 seconds, or press it briefly 3 times or more in succession. (→P. 657)

However, do not touch the "ENGINE START STOP" switch while driving except in an emergency. Turning the engine off while driving will not cause loss of steering or braking control, but the power assist to these systems will be lost. This will make it more difficult to steer and brake, so you should pull over and stop the vehicle as soon as it is safe to do so.

 NOTICE**■ To prevent battery discharge**

- Do not leave the “ENGINE START STOP” switch in ACCESSORY or IGNITION ON mode for long periods of time without the engine running.
- If the smart entry & start system indicator light (green) is illuminated, the “ENGINE START STOP” switch is not off. When exiting the vehicle, always check that the “ENGINE START STOP” switch is off.
- On vehicles with a Multidrive, do not stop the engine when the shift lever is in a position other than P. If the engine is stopped in another shift lever position, the “ENGINE START STOP” switch will not be turned off but instead be turned to ACCESSORY mode. If the vehicle is left in ACCESSORY mode, battery discharge may occur.

■ When starting the engine

- Do not race a cold engine.
- If the engine becomes difficult to start or stalls frequently, have your vehicle checked by any authorized Toyota dealer or repairer, or another duly qualified and equipped professional immediately.

■ Symptoms indicating a malfunction with the “ENGINE START STOP” switch

If the “ENGINE START STOP” switch seems to be operating somewhat differently than usual, such as the switch sticking slightly, there may be a malfunction. Contact any authorized Toyota dealer or repairer, or another duly qualified and equipped professional immediately.

2-1. Driving procedures

Engine (ignition) switch (hybrid vehicle [vehicles without an electronic key])

■ Starting the hybrid system

STEP 1 Check that the parking brake is set.

STEP 2 Check that the shift lever is set in P.

STEP 3 Firmly depress the brake pedal.

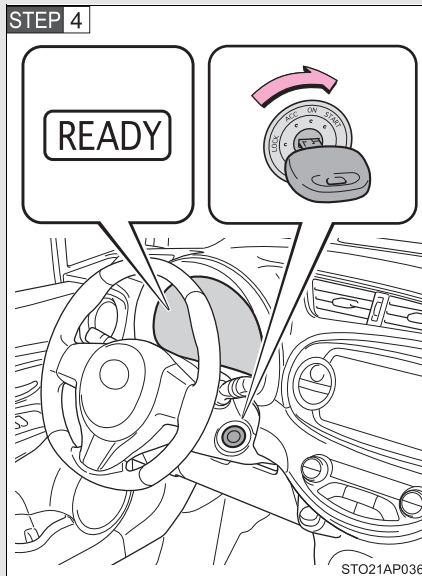

Turn the engine switch to the “START” position to start the hybrid system.

Continue depressing the brake pedal until the hybrid system is completely started.

STEP 5 Check that the “READY” indicator is on.

If the “READY” indicator changes from a flashing light to a solid light and a beep sound, the hybrid system is starting normally.

The vehicle will not move when the “READY” indicator is off.

The vehicle can move when the “READY” indicator is on even if the engine is stopped. (The gasoline engine starts or stops automatically in accordance with the state of the vehicle.)

■ Stopping the hybrid system

- STEP 1** Stop the vehicle completely.
- STEP 2** Shift the shift lever to P. (→P. 250)
- STEP 3** Set the parking brake. (→P. 269)
- STEP 4** Turn the engine switch to the “LOCK” position to stop the hybrid system.
- STEP 5** Slowly release the brake pedal and check that the “READY” indicator is off.

■ Changing the engine switch positions

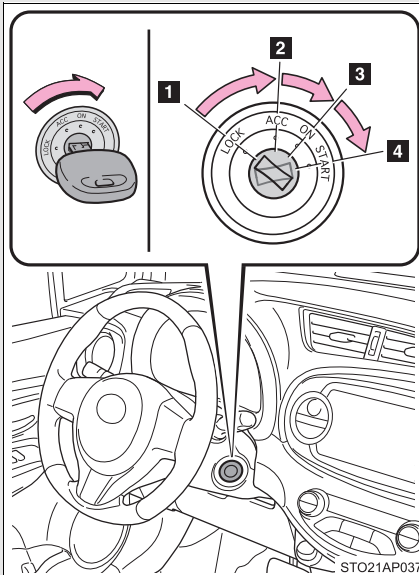

1 “LOCK”

The steering wheel is locked and the key can be removed. (The key can be removed only when the shift lever is in P.)

2 “ACC”

Some electrical components such as the audio system can be used.

3 “ON”

All electrical components can be used.

4 “START”

For starting the hybrid system.

When stopping the hybrid system with the shift lever in a position other than P

If the hybrid system is stopped with the shift lever in a position other than P, the engine switch will not be turned off but instead be turned to “ACC”. Perform the following procedure to turn the hybrid system off:

- STEP 1** Check that the parking brake is set.
- STEP 2** Shift the shift lever to P. (→P. 250)
- STEP 3** Turn the engine switch to the “LOCK” position to stop the hybrid system.

Turning the key from “ACC” to “LOCK”

- STEP 1** Shift the shift lever to P. (→P. 250)

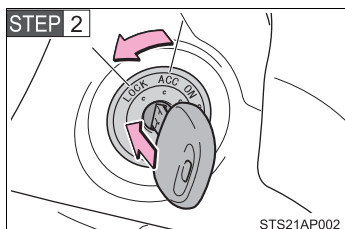

Push in the key and turn it to the “LOCK” position.

Sounds and vibrations specific to a hybrid vehicle

→P. 51

When the ambient temperature is low, such as during winter driving conditions

It may take time until the “READY” indicator comes on.

If the hybrid system does not start

The immobilizer system may not have been deactivated. (→P. 155)

Contact any authorized Toyota dealer or repairer, or another duly qualified and equipped professional.

■ When the steering lock cannot be released

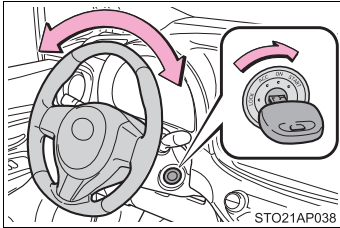

When starting the hybrid system, the engine switch may seem stuck in the “LOCK” position. To free it, turn the key while turning the steering wheel slightly left and right.

■ If the “READY” indicator does not come on

If the “READY” indicator does not come on when you turning the engine switch to the “START” position with the shift lever in P and the brake pedal depressed, contact any authorized Toyota dealer or repairer, or another duly qualified and equipped professional immediately.

■ If the hybrid system is malfunctioning

→P. 562, 564

■ Key reminder function

A buzzer sounds if the driver’s door is opened while the engine switch is in the “ACC” or “LOCK” position to remind you to remove the key.

⚠ CAUTION

■ When starting the hybrid system

Always start the hybrid system while sitting in the driver’s seat. Do not depress the accelerator pedal while starting the hybrid system under any circumstances.

Doing so may cause an accident resulting in death or serious injury.

■ Caution when driving

Do not turn the engine switch to the “LOCK” position while driving. If, in an emergency, you must turn the hybrid system off while the vehicle is moving, turn the engine switch only to the “ACC” position to stop the hybrid system. An accident may result if the hybrid system is stopped while driving.

(→P. 657)

 NOTICE

■ **To prevent 12-volt battery discharge**

Do not leave the engine switch in the “ACC” or “ON” position for long periods of time without the hybrid system on.

■ **When starting the hybrid system**

If the hybrid system becomes difficult to start, have your vehicle checked by any authorized Toyota dealer or repairer, or another duly qualified and equipped professional immediately.

2-1. Driving procedures

Power (ignition) switch (hybrid vehicle [vehicles with an electronic key])

Performing the following operations when carrying the electronic key on your person starts the hybrid system or changes “POWER” switch modes.

■ Starting the hybrid system

STEP 1 Check that the parking brake is set.

STEP 2 Check that the shift lever is set in P.

If the shift lever is not set in P, the hybrid system may not be started. (→ P. 250)

STEP 3 Firmly depress the brake pedal.

The smart entry & start system indicator light (green) will turn on. If the indicator light does not turn on, the hybrid system cannot be started.

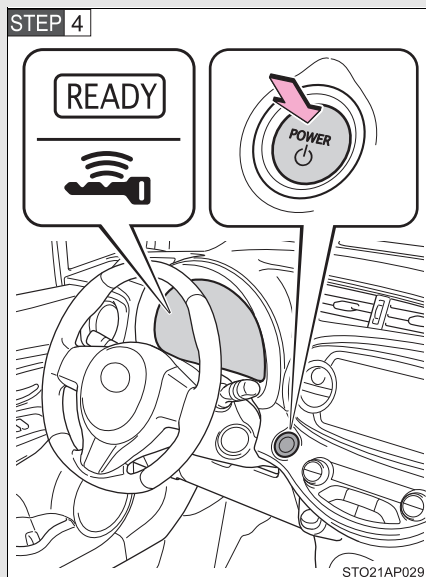

Press the “POWER” switch.

Continue depressing the brake pedal until the hybrid system is completely started.

The hybrid system can be started from any “POWER” switch mode.

STEP 5 Check that the “READY” indicator is on.

If the “READY” indicator changes from a flashing light to a solid light and a beep sound, the hybrid system is starting normally.

The vehicle will not move when the “READY” indicator is off.

The vehicle can move when the “READY” indicator is on even if the engine is stopped. (The gasoline engine starts or stops automatically in accordance with the state of the vehicle.)

■ Stopping the hybrid system

STEP 1 Stop the vehicle completely.

STEP 2 Shift the shift lever to P.

STEP 3 Set the parking brake. (→P. 269)

STEP 4 Press the “POWER” switch.

STEP 5 Slowly release the brake pedal and check that the “READY” indicator is off.

■ Changing “POWER” switch modes

Modes can be changed by pressing the “POWER” switch with brake pedal released. (The mode changes each time the switch is pressed.)

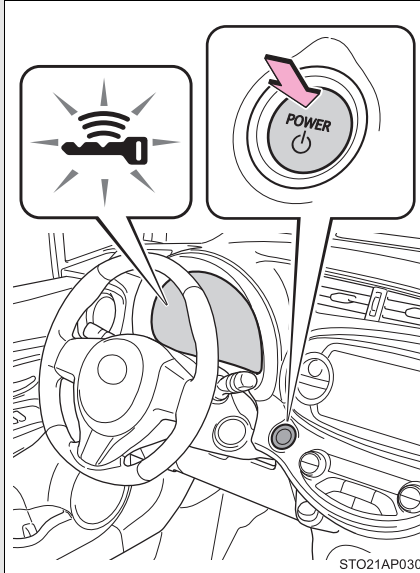

Off*

The emergency flashers can be used.

The smart entry & start system indicator light (green) is off.

ACCESSORY mode

Some electrical components such as the audio system can be used.

The smart entry & start system indicator light (green) flashes slowly.

ON mode

All electrical components can be used.

The smart entry & start system indicator light (green) flashes slowly.

*: If the shift lever is in a position other than P when turning off the hybrid system, the “POWER” switch will be turned to ACCESSORY mode, not to off.

When stopping the hybrid system with the shift lever in a position other than P

If the hybrid system is stopped with the shift lever in a position other than P, the “POWER” switch will not be turned off but instead be turned to ACCESSORY mode. Perform the following procedure to turn the switch off:

- STEP 1** Check that the parking brake is set.
 - STEP 2** Shift the shift lever to P.
 - STEP 3** Check that the smart entry & start system indicator light (green) flashes slowly and then press the “POWER” switch once.
 - STEP 4** Check that the smart entry & start system indicator light (green) is off.
-

■ **Auto power off function**

When the shift lever is in P, if the vehicle is left in ACCESSORY or ON mode with the hybrid system not operating for more than 20 minutes (ACCESSORY mode) or one hour (ON mode), the “POWER” switch will automatically turn off. However, this function cannot entirely prevent 12-volt battery discharge. Do not leave the vehicle with the “POWER” switch in ACCESSORY or ON mode for long periods of time when the hybrid system is not operating.

■ **Sounds and vibrations specific to a hybrid vehicle**

→P. 51

■ **Electronic key battery depletion**

→P. 81

■ **When the ambient temperature is low, such as during winter driving conditions**

It may take time until the “READY” indicator comes on.

■ **Conditions affecting operation**

→P. 78

■ Notes for the entry function

→P. 79

■ If the hybrid system does not start

The immobilizer system may not have been deactivated. (→P. 155)
Contact any authorized Toyota dealer or repairer, or another duly qualified and equipped professional.

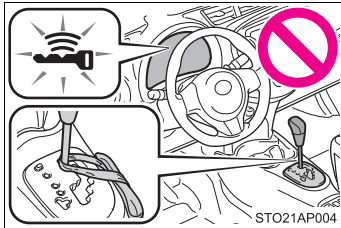

Check that the shift lever is securely set in P. The hybrid system may not start if the shift lever is displaced out of P. The smart entry & start system indicator light (green) will flash quickly.

■ Steering lock

After turning the “POWER” switch off and opening and closing the doors, the steering wheel will be locked due to the steering lock function. Operating the “POWER” switch again automatically cancels the steering lock.

■ When the steering lock cannot be released

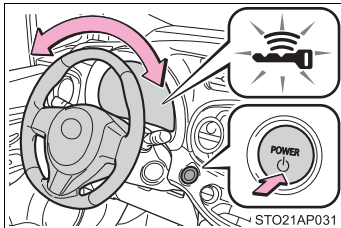

The smart entry & start system indicator light (green) will flash quickly.

Check that the shift lever is set in P. Press the “POWER” switch while turning the steering wheel left and right.

■ Steering lock motor overheating prevention

To prevent the steering lock motor from overheating, the motor may be suspended if the hybrid system is turned on and off repeatedly in a short period of time. In this case, refrain from operating the hybrid system. After about 10 seconds, the steering lock motor will resume functioning.

■ **If the “READY” indicator does not come on**

If the “READY” indicator does not come on when you press the “POWER” switch with the shift lever in P and the brake pedal depressed, contact any authorized Toyota dealer or repairer, or another duly qualified and equipped professional immediately.

■ **If the hybrid system is malfunctioning**

→P. 562, 564

■ **If the electronic key battery is depleted**

→P. 501

■ **Operation of the “POWER” switch**

- When operating the “POWER” switch, one short, firm press is enough. If the switch is pressed improperly, the hybrid system may not start or the “POWER” switch mode may not change. It is not necessary to press and hold the switch.
- If attempting to restart the hybrid system immediately after turning the “POWER” switch off, the hybrid system may not start in some cases. After turning the “POWER” switch off, please wait a few seconds before restarting the hybrid system.

■ **If the smart entry & start system or the push-button start system has been deactivated in a customized setting**

→P. 689

 **CAUTION**

■ **When starting the hybrid system**

Always start the hybrid system while sitting in the driver’s seat. Do not depress the accelerator pedal while starting the hybrid system under any circumstances.

Doing so may cause an accident resulting in death or serious injury.

■ **Caution while driving**

If a hybrid system failure occurs while the vehicle is moving, do not lock or open the doors until the vehicle reaches a safe and complete stop. Doing so may cause activation of the steering lock which may lead to an accident, resulting in death or serious injury.

 **CAUTION**
■ Stopping the hybrid system in an emergency

If you want to stop the hybrid system in an emergency while driving the vehicle, press and hold the “POWER” switch for more than 3 seconds, or press it briefly 3 times or more in succession. (→P. 657)

However, do not touch the “POWER” switch while driving except in an emergency. Turning the hybrid system off while driving will not cause loss of steering or braking control, but the power assist to these systems will be lost. This will make it more difficult to steer and brake, so you should pull over and stop the vehicle as soon as it is safe to do so.

 **NOTICE**
■ To prevent 12-volt battery discharge

- Do not leave the “POWER” switch in ACCESSORY or ON mode for long periods of time without the hybrid system on.
- If the smart entry & start system indicator light (green) is illuminated, the “POWER” switch is not off. When exiting the vehicle, always check that the “POWER” switch is off.
- Do not stop the hybrid system when the shift lever is in a position other than P. If the hybrid system is stopped in another shift lever position, the “POWER” switch will not be turned off but instead be turned to ACCESSORY mode. If the vehicle is left in ACCESSORY mode, 12-volt battery discharge may occur.

■ When starting the hybrid system

If the hybrid system becomes difficult to start, have your vehicle checked by any authorized Toyota dealer or repairer, or another duly qualified and equipped professional immediately.

■ Symptoms indicating a malfunction with the “POWER” switch

If the “POWER” switch seems to be operating somewhat differently than usual, such as the switch sticking slightly, there may be a malfunction. Contact any authorized Toyota dealer or repairer, or another duly qualified and equipped professional immediately.

2-1. Driving procedures

EV drive mode (hybrid vehicle)

In EV drive mode, the electric motor (traction motor), powered by the hybrid battery (traction battery), is used to drive the vehicle.

This mode allows you to drive in residential areas early in the morning and late at night, or in indoor parking lots etc. without concern for noises and exhaust gas emissions.

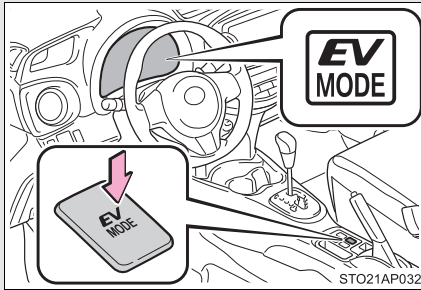

Turns EV drive mode on/off

When EV drive mode is turned on, the EV drive mode indicator will come on. Pressing the switch when in EV drive mode will return the vehicle to normal driving (using the gasoline engine and electric motor [traction motor]).

■ Switching to EV drive mode when the gasoline engine is cold

If the hybrid system is started while the gasoline engine is cold, the gasoline engine will start automatically after a short period of time in order to warm up. In this case, you will become unable to switch to EV drive mode. After the hybrid system has started and the “READY” indicator has illuminated, press the EV drive mode switch before the gasoline engine starts to switch to EV drive mode.

■ Situations in which EV drive mode cannot be turned on

It may not be possible to turn EV drive mode on in the following situations. If it cannot be turned on, a buzzer will sound.

- The temperature of the hybrid system is high.
The vehicle has been left in the sun, driven on a hill, driven at high speeds, etc.
- The temperature of the hybrid system is low.
The vehicle has been left in temperatures lower than about 0°C (32°F) for a long period of time etc.
- The gasoline engine is warming up.

- The hybrid battery (traction battery) is low.
 - When the low traction battery indicator light came on.
 - When the amount of remaining hybrid battery (traction battery) charge displayed on the “touch screen” is low. (→P. 58)
- Vehicle speed is high.
- The accelerator pedal is depressed firmly or the vehicle is on a hill etc.
- The windshield defogger is in use.

■ Automatic cancelation of EV drive mode

When driving in EV drive mode, the gasoline engine may automatically restart in the following situations. When EV drive mode is canceled, a buzzer will sound and the EV drive mode indicator will flash and go off.

- The hybrid battery (traction battery) becomes low. (→P. 58, 564)
- Vehicle speed becomes high.
- The accelerator pedal is depressed firmly or the vehicle is on a hill etc.

■ Possible driving distance when driving in EV drive mode

In EV drive mode, it is possible to drive up to about 2 km (1.3 miles) if driving at a speed of about 45 km/h (28 mph) or less.

(The distance that is possible depends on the hybrid battery [traction battery] level and driving conditions.)

■ Fuel economy

Your vehicle is designed to achieve the best possible fuel economy during normal driving (using the gasoline engine and electric motor [traction motor]). Driving in EV drive mode more than necessary may lower fuel economy.

CAUTION

■ Caution while driving

When driving in EV drive mode, pay special attention to the area around the vehicle. Because there is no engine noise, pedestrians, people riding bicycles or other people and vehicles in the area may not be aware of the vehicle starting off or approaching them, so take extra care while driving.

2-1. Driving procedures

Hybrid transmission*

Select a shift position appropriate for the driving conditions.

■ Shifting the shift lever

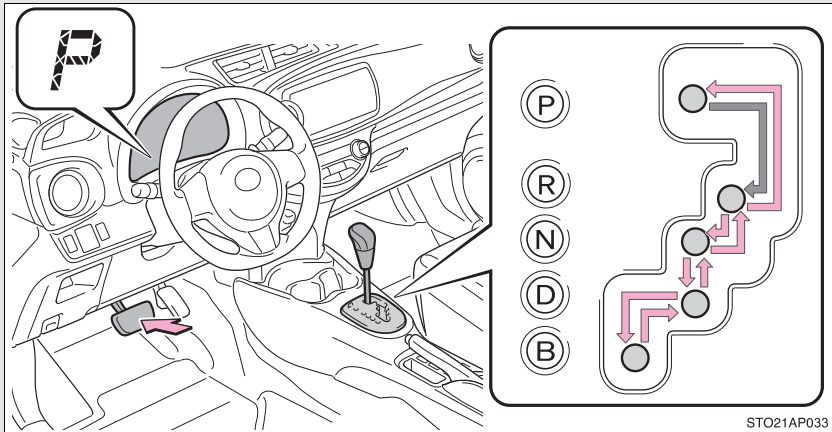

← Vehicles without an electronic key

While the engine switch is in the “ON” position, move the shift lever with the brake pedal depressed.

When shifting from P to another position; from D to R or P; or from R to P, D or B; ensure that the brake pedal is being depressed and the vehicle is stationary.

Vehicles with an electronic key

While the “POWER” switch is in ON mode, move the shift lever with the brake pedal depressed.

When shifting from P to another position; from D to R or P; or from R to P, D or B; ensure that the brake pedal is being depressed and the vehicle is stationary.

*: If equipped

■ Shift position purpose

Shift position	Function
P	Parking the vehicle/starting the hybrid system
R	Reversing
N	Neutral
D	Normal driving*
B	Position for engine braking

*: To improve fuel efficiency and reduce noises, set the shift lever in the D position for normal driving.

■ Selecting Eco drive mode

Suitable for improving the fuel economy, because the torque corresponding to the accelerator pedal depression amount can be generated more smoothly than it is in normal conditions and the operation of the air conditioning system (heating/cooling) will be minimized.

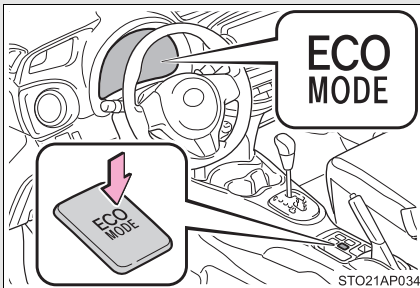

Eco drive mode

When Eco drive mode is turned on, the “ECO MODE” indicator will come on.

Pressing the “ECO MODE” switch again turns Eco drive mode off.

■ **Operation of the air conditioning system in Eco drive mode**

Eco drive mode controls the heating/cooling operations and fan speed of the air conditioning system to enhance fuel efficiency. (→P. 366) To improve air conditioning performance, adjust the temperature setting or fan speed, or turn off Eco drive mode.

■ **When in heavy traffic**

If the shift lever is in N, the hybrid battery (traction battery) will not be charged. To help prevent the battery from discharging, avoid putting the shift lever in N for an extended period of time.

■ **If the shift lever cannot be shifted from P**

→P. 621

 **CAUTION**

■ **When driving on slippery road surfaces**

Do not accelerate or shift gears suddenly.
Sudden changes in engine braking may cause the vehicle to spin or skid, resulting in an accident.

Select a shift position appropriate for the driving conditions.

■ Shifting the shift lever

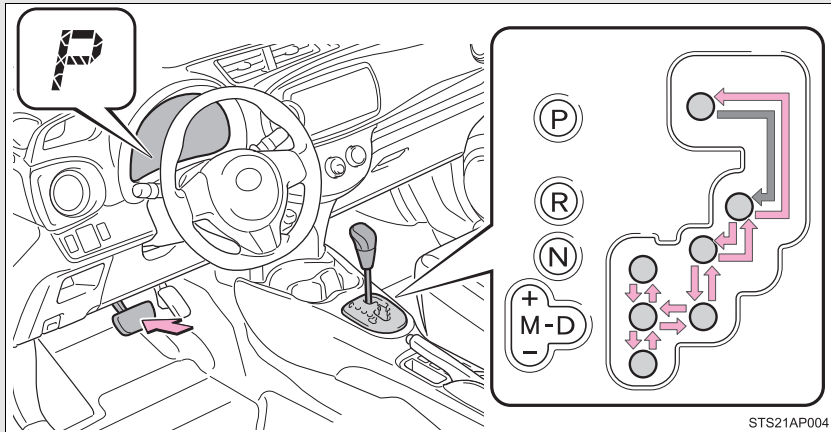

← Vehicles without a smart entry & start system

While the engine switch is in the “ON” position, move the shift lever with the brake pedal depressed.

When shifting the shift lever between P and D, make sure that the vehicle is completely stopped.

Vehicles with a smart entry & start system

While the “ENGINE START STOP” switch is in IGNITION ON mode, move the shift lever with the brake pedal depressed.

When shifting the shift lever between P and D, make sure that the vehicle is completely stopped.

■ Shift position purpose

Shift position	Function
P	Parking the vehicle/starting the engine
R	Reversing
N	Neutral
D	Normal driving ^{*1}
M	7-speed sport sequential shiftmatic mode driving ^{*2} (→P. 255)

*1: To improve fuel consumption and reduce noises, set the shift lever in the D position for normal driving.

*2: Selecting gear step using the M position achieves suitable engine braking forces by operating shift lever.

■ Selecting a driving mode

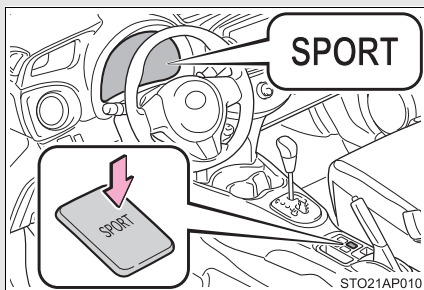

Press the switch.

For powerful acceleration and driving in mountainous regions.

The “SPORT” indicator will come on.

Press the switch once more to return the normal mode.

Changing gear steps in 7-speed sport sequential shiftmatic mode

Shift the shift lever to the M position and operate the shift lever or paddle shift switch.

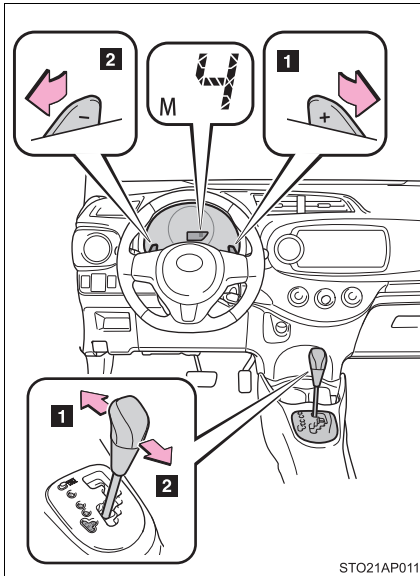

1 Upshifting

2 Downshifting

The gear step changes once every time the shift lever or paddle shift switch is operated.

The selected gear step, from 1 to 7, will be displayed in the multi-information display.

However, even when in the M position, the gear steps will be automatically changed if the engine speed is too high, or too low.

■ Gear step functions

- You can choose from 7 levels of engine braking force.
- A lower gear step will provide greater engine braking force than a higher gear step, and the engine speed will also increase.

Temporally gear steps selection mode in the D position

To drive in temporary gear steps selection mode, operate the “-” and “+” paddle shift switch. The gear steps can then be selected by operating the “-” and “+” paddle shift switches. By selecting gear step using paddle shift switches, you can control engine braking forces.

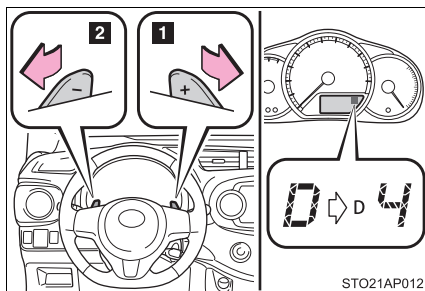

1 Upshifting

2 Downshifting

The gear step changes once every time the paddle shift switch is operated.

The selected gear step, from 1 to 7, will be displayed in the multi-information display

■ Gear step functions

→P. 255

■ Deactivation of the temporarily gear steps selection mode in the D position

In the following situations, temporarily gear steps selection mode in the D position will be deactivated:

- When the vehicle comes to a stop
- If the accelerator pedal is depressed for more than a certain period of time in one gear step
- When the “+” paddle shift switch is held down for a period of time

■ When driving with the cruise control activated (if equipped)

Even when performing the following actions with the intent of enabling engine braking, engine braking will not activate because cruise control will not be canceled.

- While driving in D or 7-speed sport sequential shiftmatic mode, downshifting to 6, 5, or 4. (→P. 255)
- When switching the driving mode to sport mode while driving in D position. (→P. 254)

■ When the vehicle comes to a stop with the shift lever in the M position

- The transmission will automatically downshift to M1 once the vehicle is stopped.
- After a stop, the vehicle will start off in M1.
- When the vehicle is stopped, the transmission is set at M1.

■ If the shift lever cannot be shifted from P

→P. 621

■ If the “M” indicator flashes or a buzzer beeps after shifting the shift lever to M

This may indicate a malfunction in the Multidrive system. Have the vehicle inspected by any authorized Toyota dealer or repairer, or another duly qualified and equipped professional immediately.

(In this situation, the transmission will operate in the same manner as when the shift lever is in D.)

■ Downshift restriction warning buzzer (vehicles with a 7-speed sport sequential shiftmatic mode)

To help ensure safety and driving performance, downshifting operation may sometimes be restricted. In some circumstances, downshifting may not be possible even when the shift lever or paddle shift switches are operated. (A buzzer will sound twice.)

CAUTION

■ When driving on slippery road surfaces

Do not accelerate or shift gear steps suddenly.

Sudden changes in engine braking may cause the vehicle to spin or skid, resulting in an accident.

2-1. Driving procedures

Multi-mode manual transmission*

Select a shift position appropriate for the driving conditions.

■ Shifting the shift lever

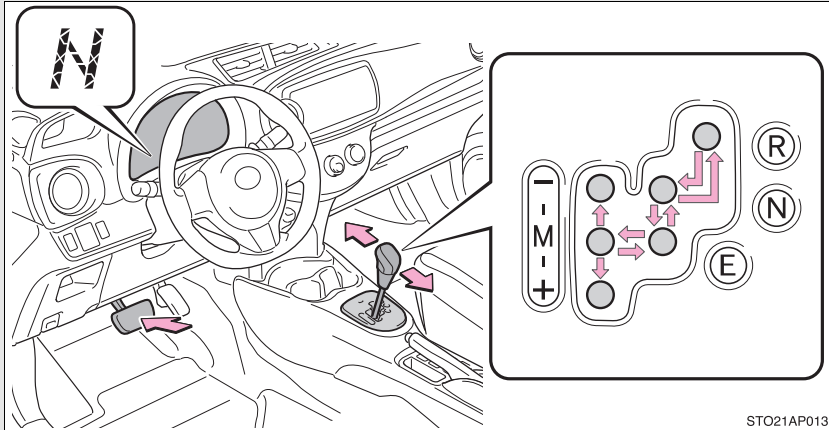

■ Shift position purpose

Shift position	Function
R	Reversing
N	Neutral or starting the engine
E	Easy (E) mode driving ^{*1}
M	Manual (M) mode driving ^{*2} (→P. 259)

*1: The most appropriate gear is automatically selected upon an operation of the accelerator pedal and vehicle speed.

*2: A gear must be selected manually. However, the gear may automatically be changed down optimally according to vehicle speed.

*: If equipped

■ Selecting Easy sports (Es) mode (when the shift lever is in E only)

Es mode can be selected for superior driving performance and to achieve a feeling of faster acceleration than in E mode.

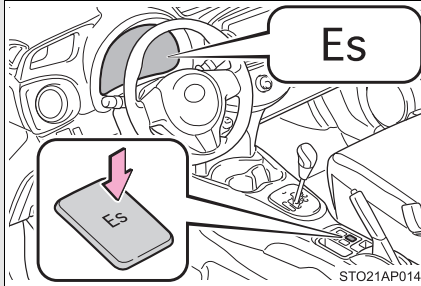

Turn Easy sports (Es) mode on/off

To improve fuel economy, cancel Es mode for ordinary driving.

Changing gears in M mode

When shift lever is in the M position, the shift lever or paddle shift switches can be operated as follows:

Shift lever

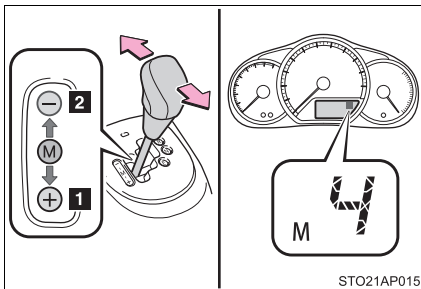

1 Upshifting

2 Downshifting

Shifting operation may be restricted depending on the vehicle speed.

Paddle shift switches

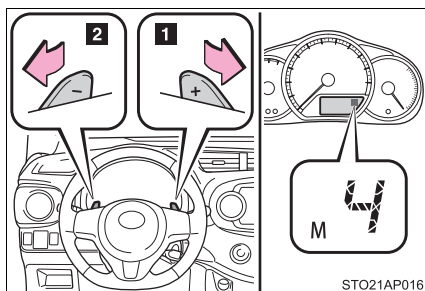

1 Upshifting

2 Downshifting

Shifting operation may be restricted depending on the vehicle speed.

Changing gears in E or Es mode

When the E or Es mode is selected, the paddle shift switches can be used as follows to select a gear temporarily.

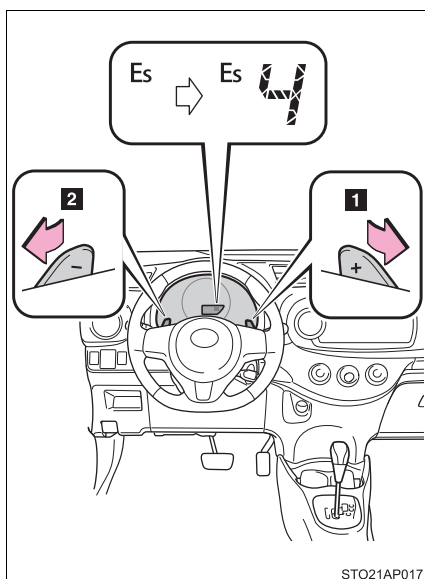

1 Upshifting

2 Downshifting

The gear will be displayed.

To return to E or Es mode, the “+” paddle shift switch must be held down for a period of time.

Shifting operation may be restricted depending on the vehicle speed.

■ Maximum allowable speeds

Observe the following maximum allowable speeds in each gear.

Gear	Maximum speed km/h (mph)
1	43 (27)
2	80 (50)
3	117 (73)
4	158 (98)
5	—

■ Es mode automatic deactivation

Es mode is automatically deactivated if the “ENGINE START STOP” switch (vehicles with a smart entry & start system) or the engine switch (vehicles without a smart entry & start system) is turned off after driving in Es mode.

■ If the shift lever cannot be shifted

- With the shift lever in N
Depress the brake pedal to shift the shift lever. If the shift lever cannot be shifted with your foot on the brake, there may be a problem with the shift lock system. (→P. 622)
- With the shift lever in a position other than N
→P. 622

■ If the driver's door is opened when the shift lever is in a position other than N and the engine is running

A buzzer will sound. Close the driver's door.

■ If the parking brake is set when the shift lever is in a position other than N with engine running

- When the driver's door is opened
A buzzer will sound and the gear position will automatically change to N in 10 seconds.
- When the driver's door is closed
A buzzer will sound and the gear position will automatically change to N in 90 seconds.

■ **If the “M” indicator does not come on even after shifting the shift lever to M**

This may indicate a malfunction in the multi-mode manual transmission system. Have the vehicle inspected by any authorized Toyota dealer or repairer, or another duly qualified and equipped professional immediately.

(In this situation, the transmission will operate in the same manner as when the shift lever is in E.)

■ **If the “N” indicator is flashing**

● When shifting the shift lever

Shift the shift lever to N. Wait a few seconds and shift the shift lever to the desired position.

● When the engine is turned off

Vehicles without a smart entry & start system: Turn the engine switch to the “ON” position. Depress the brake pedal and shift the shift lever to N, and then to the desired position.

Vehicles with a smart entry & start system: Turn the “ENGINE START STOP” switch to IGNITION ON mode. Depress the brake pedal and shift the shift lever to N, and then to the desired position.

If the indicator still flashes after the above operations, shift the shift lever to N and start the engine. Then, shift the shift lever to the desired position.

■ **If the “N” indicator is flashing and warning buzzer is beeping**

Shift the shift lever to N, and then to E, M or R.

■ **Reverse warning buzzer**

When shifting into R, a buzzer will sound to inform the driver that the shift lever is in R.

■ **Downshift restriction warning buzzer (in E mode [when the paddle shift switches are operated] or M mode)**

To help ensure safety and driving performance, downshifting operation may sometimes be restricted. In some circumstances, downshifting may not be possible even when the shift lever or paddle shift switches are operated. (A buzzer will sound twice.)

2-1. Driving procedures

Manual transmission*

■ Shifting the shift lever

Vehicles with a 5-speed transmission

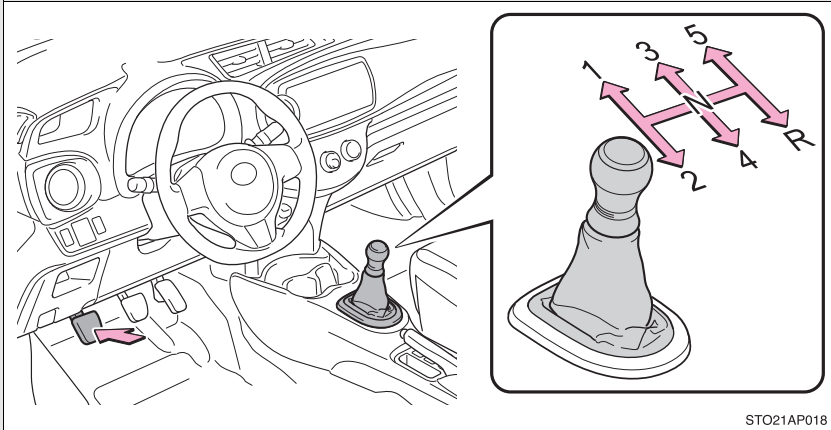

Fully depress the clutch pedal before operating the shift lever, and then release it slowly.

If it is difficult to shift in reverse, shift the shift lever to N, release the clutch pedal momentarily, and then try again.

Vehicles with a 6-speed transmission

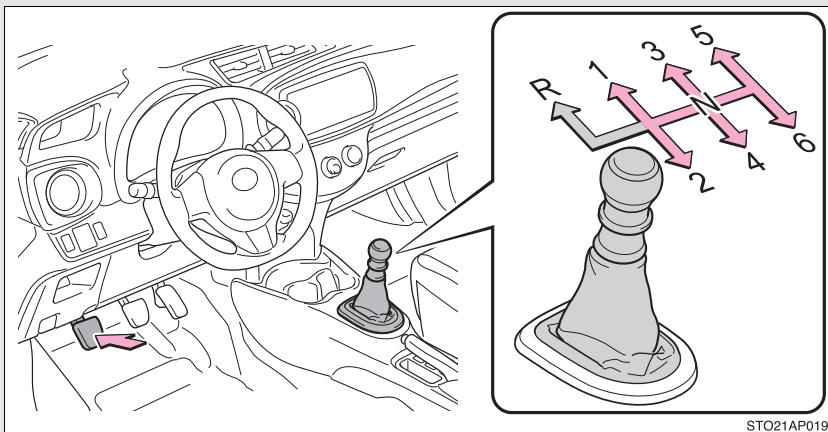

Fully depress the clutch pedal before operating the shift lever, and then release it slowly.

■ Shifting the shift lever to R (vehicles with a 6-speed transmission)

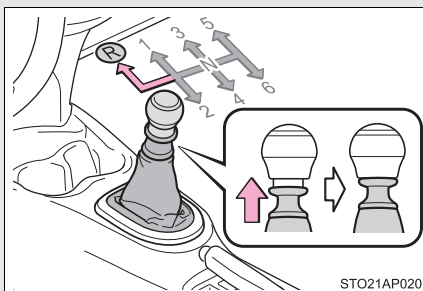

Shift the shift lever to R while lifting up the ring section.

Gear Shift Indicator

The Gear Shift Indicator is a guide to help the driver achieve improved fuel economy and reduced exhaust emissions within limits of engine performance.

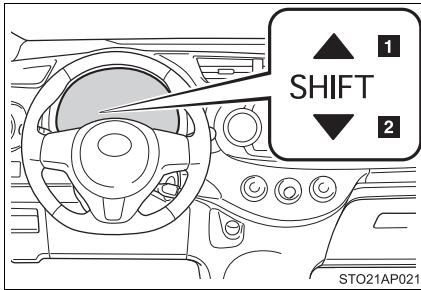

- 1 Upshifting
- 2 Downshifting

2

When driving

■ Gear Shift Indicator display

The Gear Shift Indicator may not be displayed when your foot is placed on the clutch pedal.

■ Maximum downshifting speed

Observe the downshifting speeds in the following table to prevent over-revving the engine.

Shift position	Maximum speed km/h (mph)		
	1KR-FE engine	1NR-FE engine	1ND-TV engine
1	45 (28)	46 (29)	43 (27)
2	84 (52)	85 (53)	80 (50)
3	123 (76)	124 (77)	117 (73)
4	157 (98)	158 (98)	158 (98)

⚠ CAUTION

■ **Gear Shift Indicator display**

Refer to the display while considering actual traffic and road conditions. Failure to exercise judgment may lead to an accident.

⚠ NOTICE

■ **To prevent damage to the transmission (vehicles with a 6-speed transmission)**

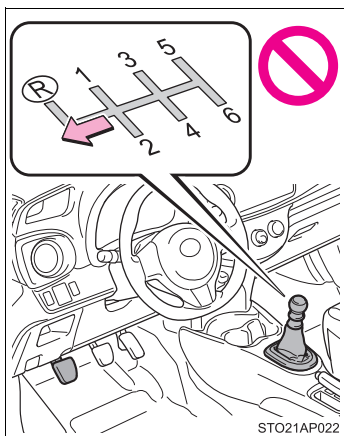

- Do not shift the shift lever to R without depressing the clutch pedal.

- Do not lift up the ring section except when shifting the lever to R.
- Shift the shift lever to R only when the vehicle is stationary.

2-1. Driving procedures

Turn signal lever

The turn signal lever can be used to show the following intentions of the driver:

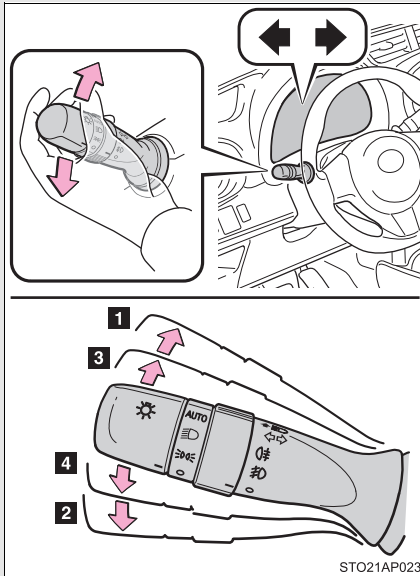

1 Right turn

2 Left turn

3 Lane change to the right
(push and hold the lever partway)

The right hand signals will flash until you release the lever.

4 Lane change to the left
(push and hold the lever partway)

The left hand signals will flash until you release the lever.

■ Turn signals can be operated when

Except hybrid vehicle

Vehicles without a smart entry & start system:

The engine switch is in the "ON" position.

Vehicles with a smart entry & start system:

The "ENGINE START STOP" switch is in IGNITION ON mode.

Hybrid vehicle

Vehicles without an electronic key:

The engine switch is in the "ON" position.

Vehicles with an electronic key:

The "POWER" switch is in ON mode.

■ **If the indicator flashes faster than usual**

Check that a light bulb in the front or rear turn signal lights has not burned out.

2-1. Driving procedures

Parking brake

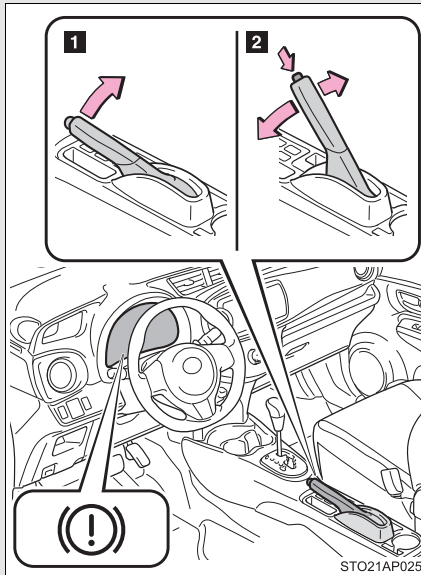

1 To set the parking brake, fully pull the parking brake lever while depressing the brake pedal.

2 To release the parking brake, slightly raise the lever and lower it completely while pressing the button.

2

When driving

■ Usage in winter time

→P. 336

⚠ NOTICE

■ Before driving

Fully release the parking brake.

Driving the vehicle with the parking brake set will lead to brake components overheating, which may affect braking performance and increase brake wear.

2-1. Driving procedures

Horn

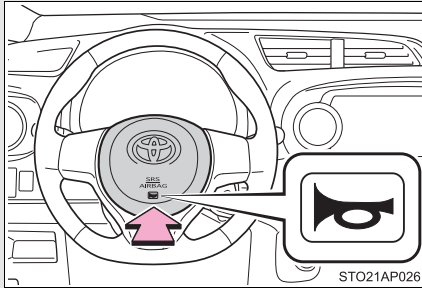

To sound the horn, press on or close to the  mark.

■ After adjusting the steering wheel

Make sure that the steering wheel is securely locked.

The horn may not sound if the steering wheel is not securely locked.

(→P. 140)

2-2. Instrument cluster

Gauges and meters

Except hybrid vehicle

Vehicles without a tachometer (type A):

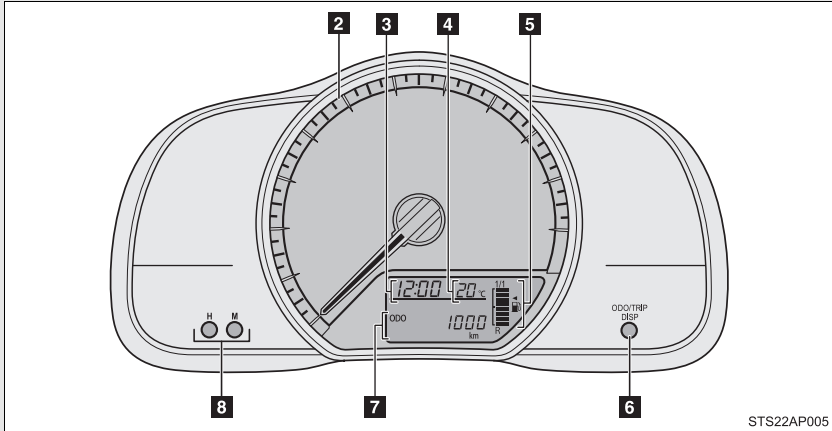

Vehicles without a tachometer (type B):

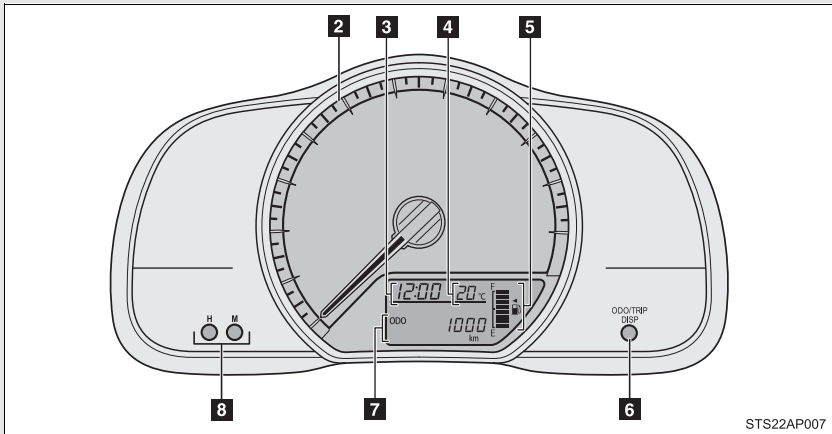

Vehicles with a tachometer (type A):

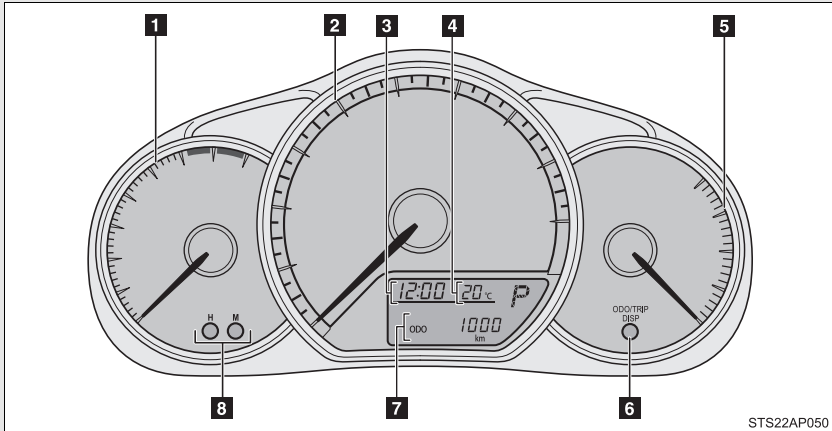

Vehicles with a tachometer (type B):

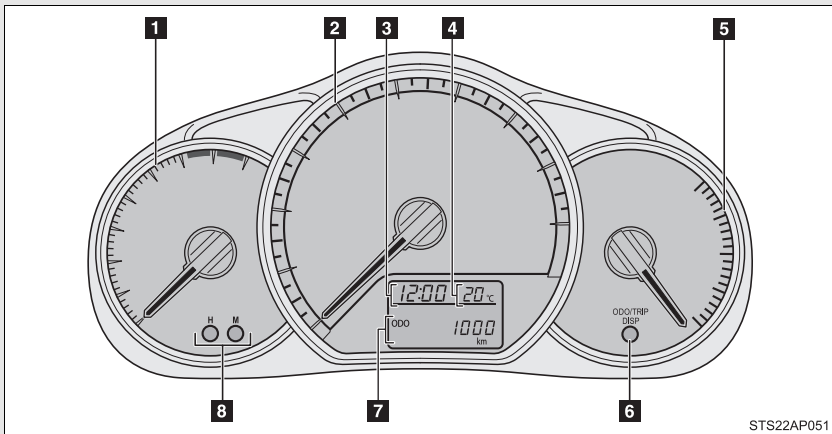

Hybrid vehicle

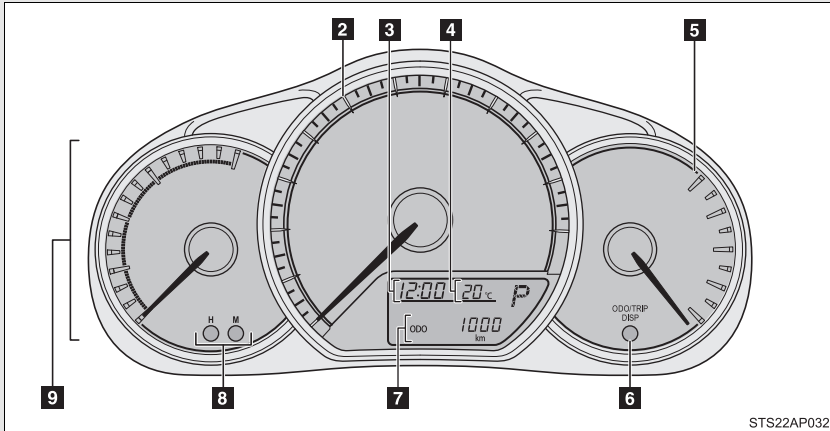

STS22AP032

1 Tachometer

Displays the engine speed in revolutions per minute.

2 Speedometer

Displays the vehicle speed.

3 Clock

→P. 426

4 Outside temperature display

→P. 427

5 Fuel gauge

Displays the quantity of fuel remaining in the tank.

6 Display change button

→P. 285

7 Odometer, trip meter and multi-information display

→P. 284

8 Clock adjusting buttons

→P. 426

9 Hybrid System Indicator

Displays hybrid system power output and regenerative level

■ **The meters and display operate when**

Except hybrid vehicle

Vehicles without a smart entry & start system:

The engine switch is in the “ON” position.

Vehicles with a smart entry & start system:

The “ENGINE START STOP” switch is in IGNITION ON mode.

Hybrid vehicle

Vehicles without an electronic key:

The engine switch is in the “ON” position.

Vehicles with an electronic key:

The “POWER” switch is in ON mode.

■ **Hybrid System Indicator**

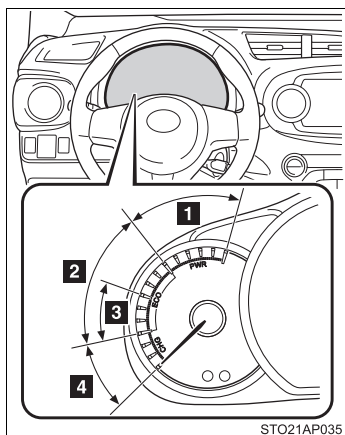

1 Power area

Shows that the driving power is more than the upper limit of Eco driving.

2 Eco area

Shows that the vehicle is driven Eco-friendly.

3 Hybrid Eco area

Shows that the vehicle is driven in a condition that promotes frequent motor-only operation. (When the vehicle is operating with low driving load, such as when driving slowly, using Hybrid Eco area leads Eco-friendly driving.)

4 Charge area

Shows regenerative charging.

- By keeping the indicator needle within Eco area, more Eco-friendly driving can be achieved.
- Charge area indicates regeneration* status. Regenerated energy will be used to charge the battery.

*:When used in this manual, “regeneration” refers to the conversion of energy created by the movement of the vehicle into electrical energy.

 NOTICE**■ To prevent damage to the engine and its components**

- Vehicles with a tachometer: Do not let the indicator needle of the tachometer enter the red zone, which indicates the maximum engine speed.
- The engine may be overheating if the high engine coolant temperature warning light flashes or turns on. In this case, immediately stop the vehicle in a safe place, and check the engine after it has cooled completely. (→P. 642, 646)

2-2. Instrument cluster

Indicators and warning lights

The indicators and warning lights on the instrument cluster and center panel inform the driver of the status of the vehicle's various systems.

For the purpose of explanation, the following illustration displays all indicators and warning lights illuminated.

Except hybrid vehicle

Instrument cluster (vehicles without a tachometer type A):

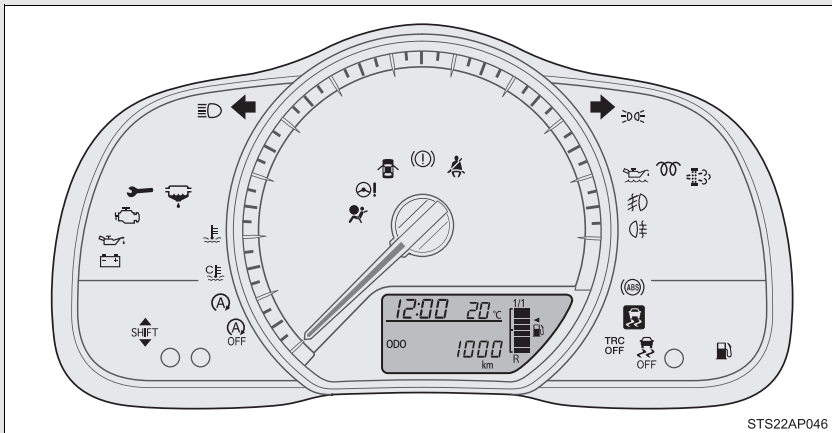

Instrument cluster (vehicles without a tachometer type B):

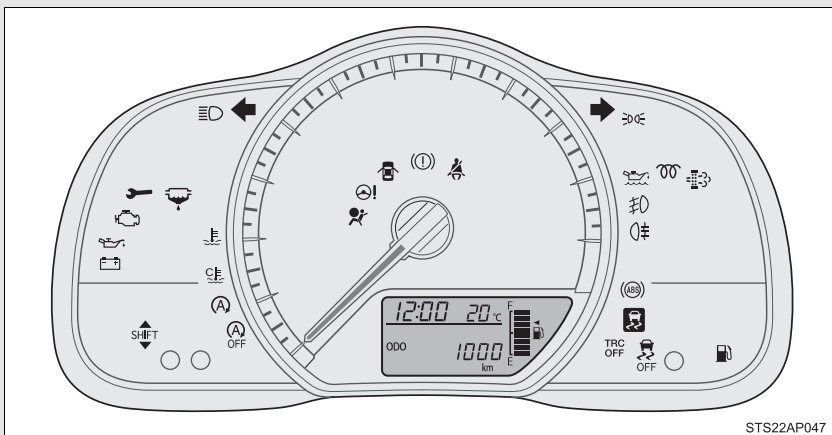

Instrument cluster (vehicles with a tachometer type A):

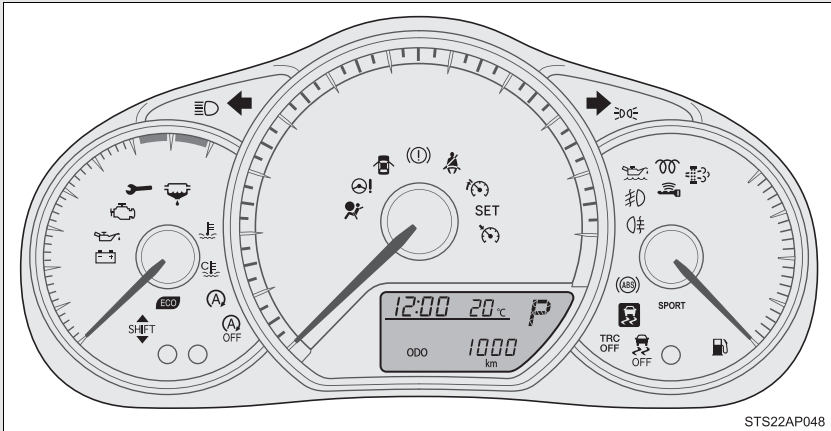

Instrument cluster (vehicles with a tachometer type B):

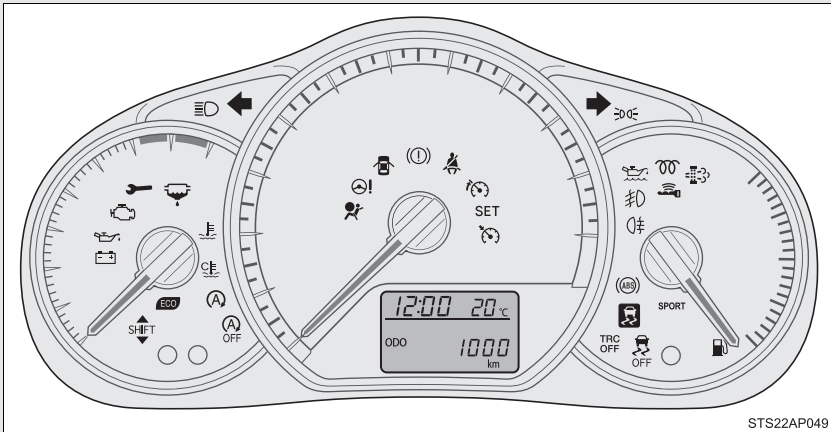

Hybrid vehicle

Instrument cluster:

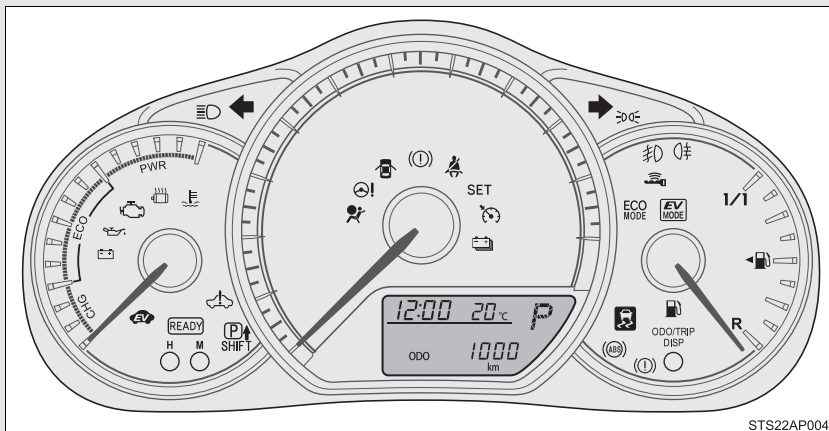

Center panel (left-hand drive vehicles)

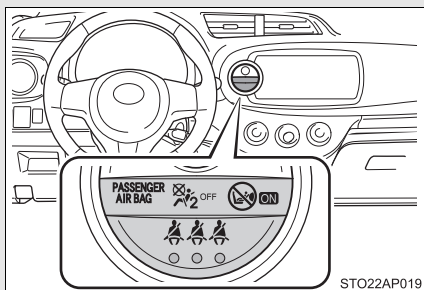

Center panel (right-hand drive vehicles)

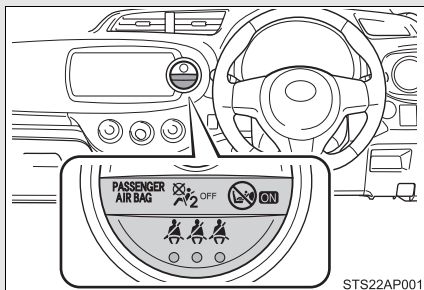

■ Indicators

The indicators inform the driver of the operating state of the vehicle's various systems.



Turn signal indicator
(→P. 267)



Headlight high beam indicator (→P. 293)



(if equipped)

Tail light indicator
(→P. 291)



(if equipped)

Front fog light indicator
(→P. 301)



Rear fog light indicator
(→P. 300, 301)



(if equipped)

Smart entry & start system indicator
(→P. 226, 241)



*3

Low engine coolant temperature indicator



(diesel engine)

Engine preheating indicator (→P. 222, 226)



(if equipped)

*1

Eco Driving Indicator Light (→P. 208)



(vehicles with a hybrid transmission)

Shift position indicator
(→P. 250)



(vehicles with a Multidrive)

Shift position and gear step position indicators
(→P. 253)



(vehicles with a multi-mode manual transmission)

Shift position and gear position indicators
(→P. 258)



(vehicles with a Multidrive)

"SPORT" indicator
(→P. 254)



(vehicles with a manual transmission)

*1

Gear Shift Indicator
(→P. 265)



(if equipped)

Cruise control indicator
(→P. 309)



(if equipped)

"SET" indicator
(→P. 309)



(if equipped)

Speed limiter indicator
(→P. 313)



(if equipped)

*1

Stop & Start indicator
(→P. 316)

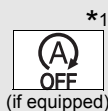

Stop & Start cancel indicator (→P. 317)

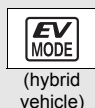

EV drive mode indicator (→P. 248)

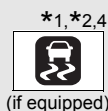

Slip indicator (→P. 325)

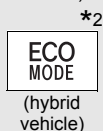

“ECO MODE” indicator (→P. 251)

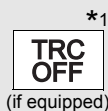

“TRC OFF” indicator (→P. 326)



EV indicator (→P. 50)

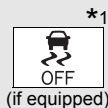

VSC OFF indicator (→P. 326)



Driving ready indicator (→P. 236, 241)



“PASSENGER AIR BAG” indicator (→P. 178)

*1: Except hybrid vehicle: These lights turn on when the engine switch is turned to the “ON” position (vehicles without a smart entry & start system) or the “ENGINE START STOP” switch is turned to IGNITION ON mode (vehicles with a smart entry & start system) to indicate that a system check is being performed. They will turn off after the engine is started, or after a few seconds. There may be a malfunction in a system if a light does not come on, or if the lights do not turn off. Have the vehicle inspected by any authorized Toyota dealer or repairer, or another duly qualified and equipped professional.

*2: Hybrid vehicle: These lights turn on when the engine switch is turned to the “ON” position (vehicles without an electronic key) or the “POWER” switch is turned to ON mode (vehicles with an electronic key) to indicate that a system check is being performed. They will turn off after the hybrid system on, or after a few seconds. There may be a malfunction in a system if a light does not come on, or if the lights do not turn off. Have the vehicle inspected by any authorized Toyota dealer or repairer, or another duly qualified and equipped professional.

*3: The light turns on when the engine coolant temperature is low.

*4: The light flashes to indicate that the system is operating.

■ **Warning lights**

Warning lights inform the driver of malfunctions in any of the vehicle’s systems. (→P. 561)

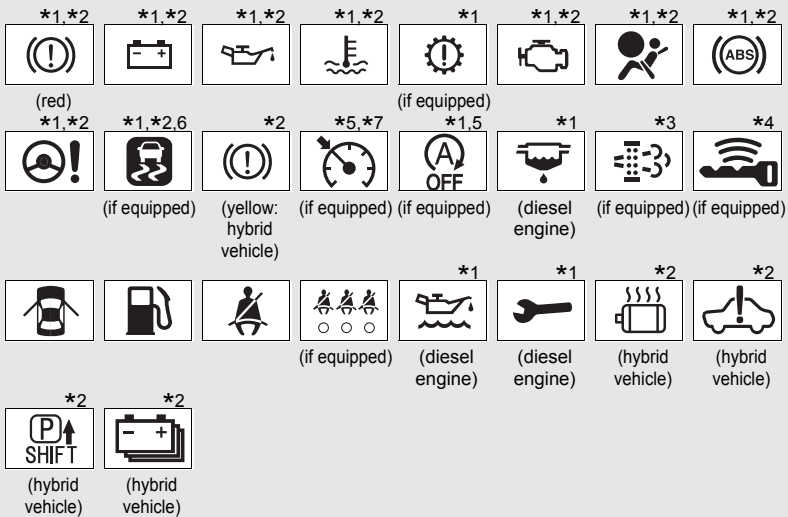

- *1: Except hybrid vehicle: These lights turn on when the engine switch is turned to the “ON” position (vehicles without a smart entry & start system) or the “ENGINE START STOP” switch is turned to IGNITION ON mode (vehicles with a smart entry & start system) to indicate that a system check is being performed. They will turn off after the engine is started, or after a few seconds. There may be a malfunction in a system if a light does not come on, or if the lights do not turn off. Have the vehicle inspected by any authorized Toyota dealer or repairer, or another duly qualified and equipped professional.
- *2: Hybrid vehicle: These lights turn on when the engine switch is turned to the “ON” position (vehicles without an electronic key) or the “POWER” switch is turned to ON mode (vehicles with an electronic key) to indicate that a system check is being performed. They will turn off after the hybrid system on, or after a few seconds. There may be a malfunction in a system if a light does not come on, or if the lights do not turn off. Have the vehicle inspected by any authorized Toyota dealer or repairer, or another duly qualified and equipped professional.
- *3: These lights turn on when the engine switch is turned to the “ON” position (vehicles without a smart entry & start system) or the “ENGINE START STOP” switch is turned to IGNITION ON mode (vehicles with a smart entry & start system) to indicate that a system check is being performed. They will turn off after the engine is started, or after a few seconds.
- *4: The light flashes in yellow to indicate a malfunction. The light flashes quickly in green to indicate that the steering lock has not been released.
- *5: Except hybrid vehicle: The light flashes to indicate a malfunction.
- *6: The light turns on to indicate a malfunction.
- *7: Hybrid vehicle: The light comes in yellow to indicate a malfunction.

 CAUTION**■ If a safety system warning light does not come on**

Should a safety system light such as the ABS and SRS warning light not come on when you start the engine (except hybrid vehicle) or hybrid system (hybrid vehicle), this could mean that these systems are not available to help protect you in an accident, which could result in death or serious injury. Have the vehicle inspected by any authorized Toyota dealer or repairer, or another duly qualified and equipped professional immediately if this occurs.

2-2. Instrument cluster

Multi-information display

The multi-information display presents the driver with a variety of driving-related data.

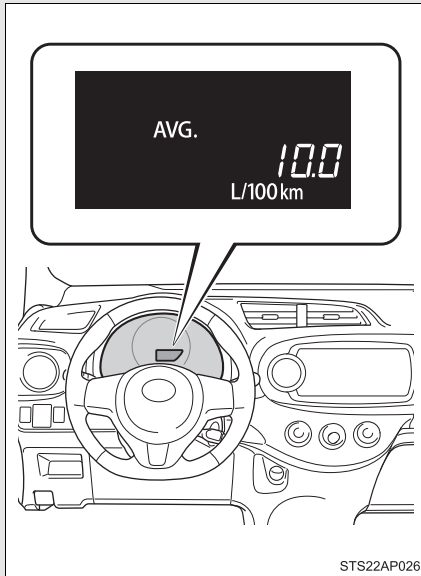

- Odometer (→P. 285)
- Trip meter (→P. 286)
- Stop & Start system operation time (if equipped) (→P. 286)
- Stop & Start system total operation time (if equipped) (→P. 287)
- Trip information (→P. 285)
Displays driving range, fuel consumption and other cruising-related information.
- Instrument panel light control (→P. 289)
- Eco Driving Indicator Light customization (except hybrid vehicle [if equipped]) (→P. 289)
- EV indicator customization (hybrid vehicle) (→P. 290)

Changing the display

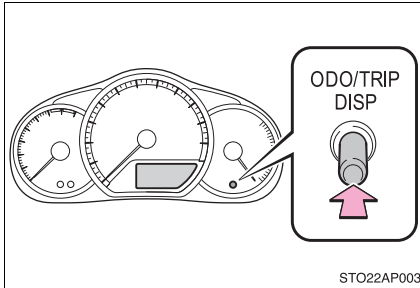

Items displayed can be switched by pressing the display change button.

Display items

■ Odometer

Type A



Displays the total distance the vehicle has been driven.

Type B



■ Trip meter

Type A



Displays the distance the vehicle has been driven since the meter was last reset. Trip meters A and B can be used to record and display different distances independently.

Pressing and holding the display change button will reset the trip meter that is currently displayed.

Type B



Type C



■ Stop & Start system operation time (if equipped)

Type A



Displays the amount of time the engine was stopped due to operation of the Stop & Start system during the current trip.

Vehicles without a smart entry & start system:

Type B



From the engine switch in the “ON” position to the engine switch in the “LOCK” position.

Vehicles with a smart entry & start system:

From the “ENGINE START STOP” switch in IGNITION ON mode to the “ENGINE START STOP” switch off.

■ Stop & Start system total operation time (if equipped)

Type A

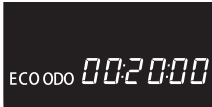

Displays the total amount of time that the engine has been stopped due to operation of the Stop & Start system since the system was last reset.

Press and hold the button to reset.

Type B



■ Instantaneous fuel consumption

Type A



Displays instantaneous fuel consumption.

Type B



■ Average fuel consumption

Type A

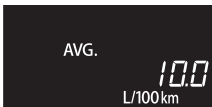

Displays the average fuel consumption since the function was reset.

- The function can be reset by pressing and holding the display change button when the average fuel consumption is displayed.
- Use the displayed average fuel consumption as a reference.

Type B



■ Driving range

Type A



Type B



Displays the estimated maximum distance that can be driven with the quantity of fuel remaining.

- This distance is computed based on your average fuel consumption. As a result, the actual distance that can be driven may differ from that displayed.
- When only a small amount of fuel is added to the tank, the display may not be updated.

Except hybrid vehicle

Vehicles without a smart entry & start system:

When refueling, turn the engine switch to the “LOCK” position. If the vehicle is refueled without turning the engine switch to the “LOCK” position, the display may not be updated.

Vehicles with a smart entry & start system:

When refueling, turn the “ENGINE START STOP” switch off. If the vehicle is refueled without turning the “ENGINE START STOP” switch off, the display may not be updated.

Hybrid vehicle

Vehicles without an electronic key:

When refueling, turn the engine switch to the “LOCK” position. If the vehicle is refueled without turning the engine switch to the “LOCK” position, the display may not be updated.

Vehicles with an electronic key:

When refueling, turn the “POWER” switch off. If the vehicle is refueled without turning the “POWER” switch off, the display may not be updated.

■ Average vehicle speed

Type A



Displays the average vehicle speed since the engine (except hybrid vehicle) or the hybrid system (hybrid vehicle) was started or the function was reset.

Type B



The function can be reset by pressing and holding the display change button when the average vehicle speed is displayed.

■ Instrument panel light control



Displays the brightness of the instrument panel lights when the headlight switch is on.

Pressing and holding the button will adjust brightness of the instrument panel lights.

Eco Driving Indicator Light customization (except hybrid vehicle [if equipped])



Eco Driving Indicator Light can be activated or deactivated by pressing the display change button when the Eco Driving Indicator Light customization display is displayed.



To change the Eco Driving Indicator Light customization display, display the odometer and press and hold the display change button until the display changes.

EV indicator customization (hybrid vehicle)



EV indicator can be activated or deactivated by pressing the display change button when the EV indicator customization display is displayed.



To change the EV indicator customization display, display the odometer and press and hold the display change button until the display changes.

■ When disconnecting and reconnecting battery (except hybrid vehicle) or 12-volt battery (hybrid vehicle) terminals

The following information data will be reset:

- Stop & Start system total operation time (if equipped)
- Average fuel consumption
- Driving range
- Average vehicle speed

NOTICE

■ The multi-information display at low temperatures

Allow the interior of the vehicle to warm up before using the liquid crystal information display. At extremely low temperatures, the information display monitor may respond slowly, and display changes may be delayed.



Headlight switch

The headlights can be operated manually or automatically.

Turning the end of the lever turns on the lights as follows:

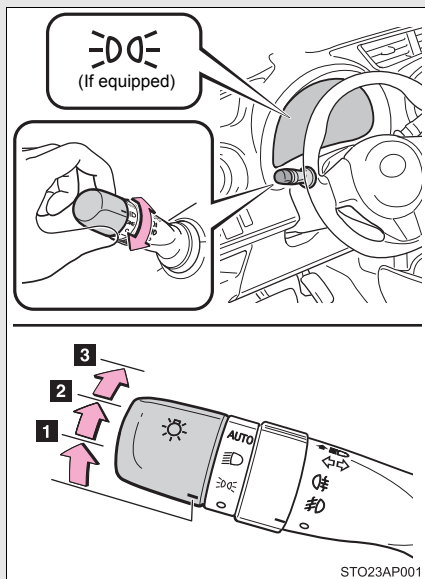
Except hybrid vehicle



- 1**  The front position, tail, license plate and instrument panel lights turn on.
- 2**  The headlights and all the lights listed above turn on.
- 3** **AUTO** (If equipped) Vehicles without a smart entry & start system: The headlights, front position lights and so on turn on and off automatically (when the engine switch is in the "ON" position.)
Vehicles with a smart entry & start system: The headlights, front position lights and so on turn on and off automatically (when the "ENGINE START STOP" switch is in IGNITION ON mode.)

Hybrid vehicle

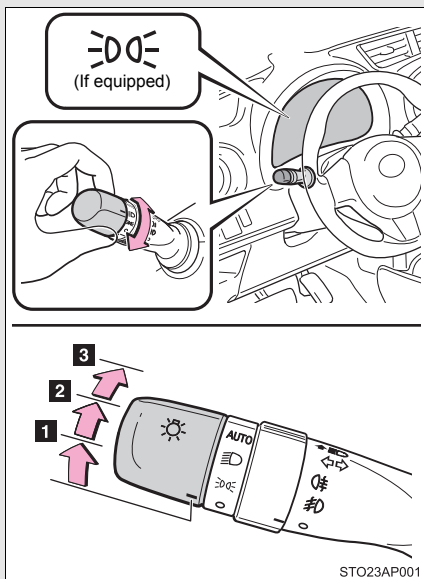

1  The front position, tail, license plate and instrument panel lights turn on.

2  The headlights and all the lights listed above turn on.

3 **AUTO** (If equipped) Vehicles without an electronic key: The headlights, front position lights, daytime running lights and so on turn on and off automatically (when the engine switch is in the "ON" position).

Vehicles with an electronic key: The headlights, front position lights, daytime running lights and so on turn on and off automatically (when the "POWER" switch is in ON mode).

Turning on the high beam headlights

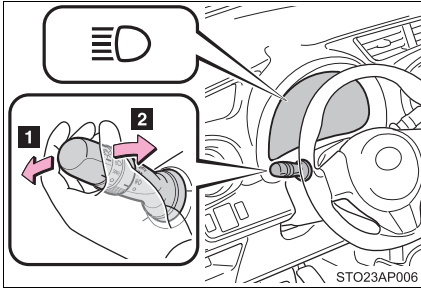

1 With the headlights on, push the lever away from you to turn on the high beams.

Pull the lever toward you to the center position to turn the high beams off.

2 Pull the lever toward you and release it to flash the high beams once.

You can flash the high beams with the headlights on or off.

Manual headlight leveling dial

The level of the headlights can be adjusted according to the number of passengers and the loading condition of the vehicle.

Left-hand drive vehicles

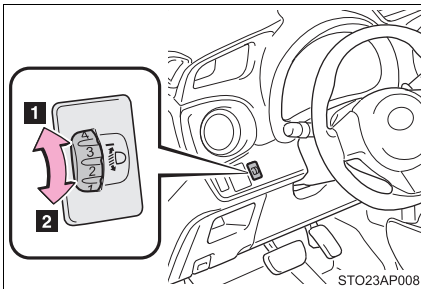

1 Raises the level of the headlights

2 Lowers the level of the headlights

Right-hand drive vehicles

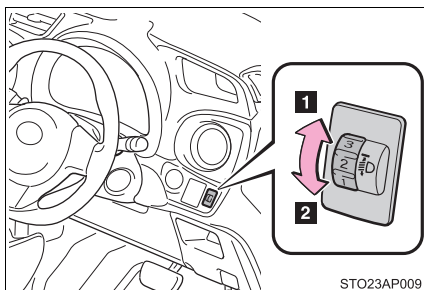

- 1** Raises the level of the headlights
- 2** Lowers the level of the headlights

■ Guide to dial settings

Vehicle category M1*

Loading condition	Control switch position
Driver only or Driver + one passenger in the front seat	0
All passengers	1.5
All passengers + full luggage loading to the luggage room.	2
Driver + full luggage loading to the luggage room	4

Vehicle category N1*

Loading condition	Control switch position
Driver only or Driver + one passenger in the front seat	0
Driver + full luggage loading to the luggage room	3.5

*: To distinguish the vehicle category, ask any authorized Toyota dealer or repairer, or another duly qualified and equipped professional.

■ Daytime running light system

Except hybrid vehicle (if equipped)

To make your vehicle more visible to other drivers, the headlights and tail lights turn on automatically whenever the engine is started. Daytime running lights are not designed for use at night.

Hybrid vehicle

To make your vehicle more visible to other drivers, the daytime running lights turn on automatically when the parking brake lever is released, if hybrid system is operating. (However, these lights will dim when the headlight switch is operated manually or the automatic headlight system turns on the tail lights.) Daytime running lights are not designed for use at night.

■ Headlight control sensor (if equipped)

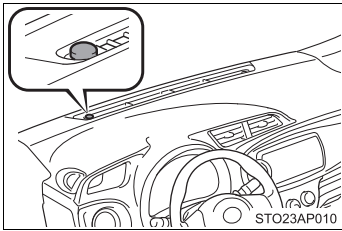



The sensor may not function properly if an object is placed on the sensor, or anything that blocks the sensor is affixed to the windshield.



Doing so interferes with the sensor detecting the level of ambient light and may cause the automatic headlight system to malfunction.

■ Automatic light off system (if equipped)



Except hybrid vehicle



Vehicles without a smart entry & start system:

- When the light switch is in  or  : The headlights and front fog lights turn off automatically when the engine switch is turned to the "LOCK" position.
- When the light switch is in **AUTO** : The headlights and all the lights turn off automatically when the engine switch is turned to the "LOCK" position.

To turn the lights on again, turn the engine switch to the "ON" position, or turn the light switch off once and then back to  or  .



Vehicles with a smart entry & start system:



- When the light switch is in  or  : The headlights and front fog lights turn off automatically when the “ENGINE START STOP” switch is turned off.
- When the light switch is in **AUTO** : The headlights and all the lights turn off automatically when the “ENGINE START STOP” switch is turned off.

To turn the lights on again, turn the “ENGINE START STOP” switch to IGNITION ON mode, or turn the light switch off once and then back to  or  .



Hybrid vehicle



Vehicles without an electronic key:

- When the light switch is in  or  : The headlights and front fog lights turn off automatically when the engine switch is turned to the “LOCK” position.
- When the light switch is in **AUTO** : The headlights and all the lights turn off automatically when the engine switch is turned to the “LOCK” position.

To turn the lights on again, turn the engine switch to the “ON” position, or turn the light switch off once and then back to  or  .

Vehicles with an electronic key:

- When the light switch is in  or  : The headlights turn off automatically if the “POWER” switch is turned to ACCESSORY mode or turned off and the driver’s door is opened.
- When the light switch is in **AUTO** : The headlights and tail lights turn off automatically if the “POWER” switch is turned to ACCESSORY mode or turned off and the driver’s door is opened.

To turn the lights on again, turn the “POWER” switch to ON mode, or turn the light switch off once and then back to  or  .

■ Light reminder buzzer

Except hybrid vehicle

Vehicles without a smart entry & start system:

With the key removed from the engine switch, if the driver door is opened while the lights are turned on, a buzzer will sound.

Vehicles with a smart entry & start system:

With the “ENGINE START STOP” switch turned off, if the driver door is opened while the lights are turned on, a buzzer will sound.

Hybrid vehicle

Vehicles without an electronic key:

With the key removed from the engine switch, if the driver door is opened while the lights are turned on, a buzzer will sound.

Vehicles with an electronic key:

A buzzer sounds when the “POWER” switch is turned off or turned to ACCESSORY mode and the driver’s door is opened while the lights are turned on.

■ Battery-saving function

In all conditions following below, the headlights and the other remaining lights will go off automatically after 20 minutes in order to prevent the vehicle battery from being discharged:

- Except hybrid vehicle: The engine switch is in the “LOCK” position (vehicle without a smart entry & start system) or the “ENGINE START STOP” switch is in off (vehicle with a smart entry & start system).
- Hybrid vehicle: The engine switch is in the “ACC” or the “LOCK” position (vehicles without an electronic key) or the “POWER” switch in turned to ACCESSORY mode or turned off (vehicles with an electronic key).
- The headlights and/or tail lights are on.
- The light switch is in  or AUTO.

This function will be canceled in any of the following situations:

- Except hybrid vehicle: When the engine switch is turned to the “ON” position (vehicle without a smart entry & start system) or the “ENGINE START STOP” switch is turned to IGNITION ON mode (vehicle with a smart entry & start system).
 - Hybrid vehicle: When the engine switch is turned to the “ON” position (vehicles without an electronic key) or the “POWER” switch is turned to ON mode (vehicles with an electronic key).
 - When the light switch is operated.
 - When the door is opened or closed.
- **Turning on the low beam headlights when the vehicle is parked in dark areas**

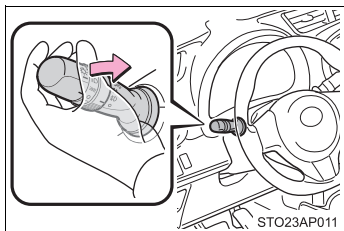

Turn off the engine (except hybrid vehicle) or hybrid system (hybrid vehicle) with the light switch in **auto** or off, and pull the light switch toward you and release it. The low beam headlights will turn on for about 30 seconds to light up the area around the vehicle.

The lights are turned off in the following situations.

Except hybrid vehicle

- Vehicles without a smart entry & start system:
The engine switch is turned to the “ON” position.
- Vehicles with a smart entry & start system:
The “ENGINE START STOP” switch is turned to IGNITION ON mode.
- The light switch is turned on.
- The light switch is pulled toward you and then released.

Hybrid vehicle

- Vehicles without an electronic key:
The engine switch is turned to the “ON” position.
- Vehicles with an electronic key:
The “POWER” switch is turned to ON mode.
- The light switch is turned on.
- The light switch is pulled toward you and then released.

■ **Customization that can be configured at any authorized Toyota dealer or repairer, or another duly qualified and equipped professional**

Settings (e.g. light sensor sensitivity) can be changed.
(Customizable features →P. 689)

 NOTICE

■ **To prevent battery discharge (except hybrid vehicle)**

Do not leave the lights on longer than necessary when the engine is not running.

■ **To prevent 12-volt battery discharge (hybrid vehicle)**

Do not leave the lights on longer than necessary when the hybrid system is off.

2-3. Operating the lights and wipers

Fog light switch

The fog lights secure excellent visibility in difficult driving conditions, such as in rain and fog.

■ Rear fog light switch

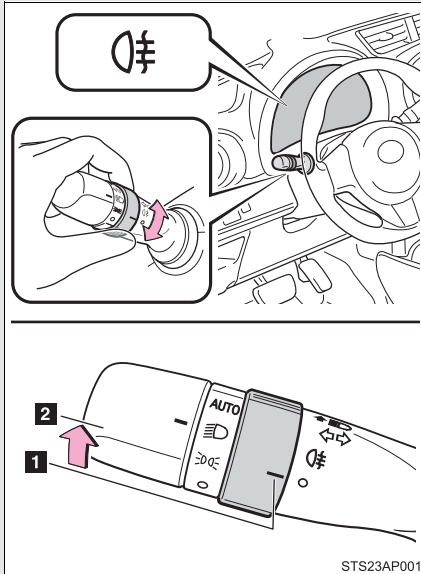

1 Turns the rear fog light off

2 Turns the rear fog light on

Releasing the switch ring returns it to the original position.

Operating the switch ring again turns the light off.

■ Front and rear fog light switch (if equipped)

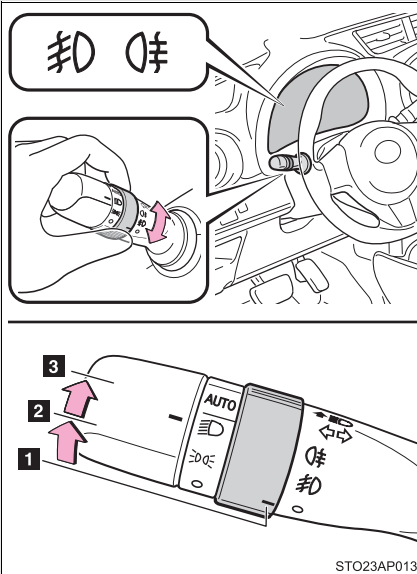

- 1 Turns the front and rear fog lights off
- 2 Turns the front fog lights on
- 3 Turns both front and rear fog lights on

Releasing the switch ring returns it to .

Operating the switch ring again turns only the rear fog lights off.

2

When driving

■ Fog lights can be used when

Vehicles with a rear fog light switch

The headlights are turned on.

Vehicles with front and rear fog light switch

Front fog lights: The headlights or front position lights are turned on.

Rear fog lights: The front fog lights are turned on.

2-3. Operating the lights and wipers

Windshield wiper and washer

Intermittent windshield wiper (if equipped)

The wiper operation is selected by moving the lever as follows:

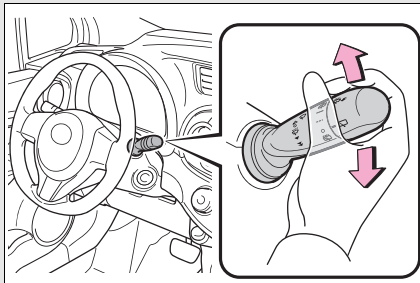

1 Intermittent windshield wiper operation

2 Low speed windshield wiper operation

3 High speed windshield wiper operation

4 Temporary operation

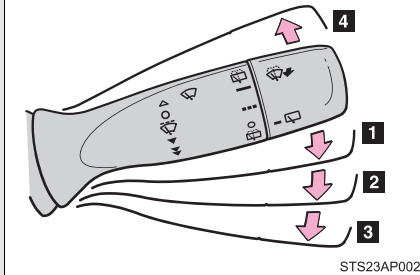

STS23AP002

5 Washer/wiper dual operation

The wiper will automatically operate a couple of times after the washer squirts.

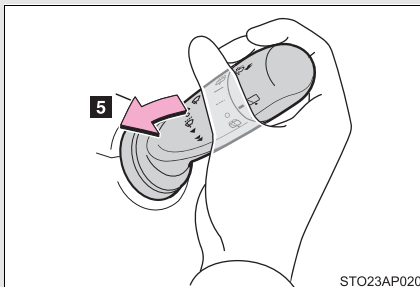

STO23AP020

Rain-sensing windshield wiper (if equipped)

When “AUTO” is selected, the wiper will operate automatically when the sensor detects falling rain. The system automatically adjusts wiper timing in accordance with rain volume and vehicle speed.

When “AUTO” is selected, the sensor sensitivity can be adjusted as follows by turning the switch ring:

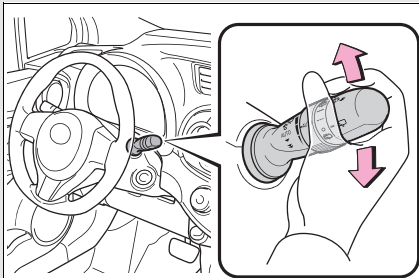

- 1** Rain-sensing wiper operation (“AUTO”)
- 2** Low speed wiper operation
- 3** High speed wiper operation
- 4** Temporary operation

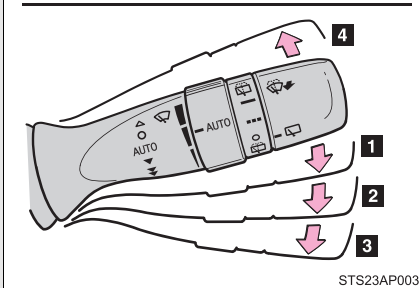

STS23AP003

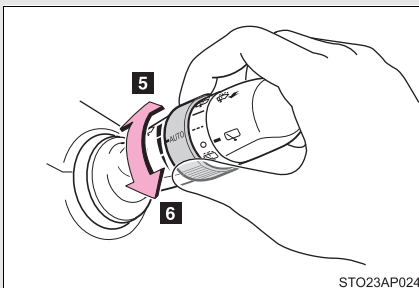

STO23AP024

- 5** Increases the sensitivity
- 6** Decreases the sensitivity

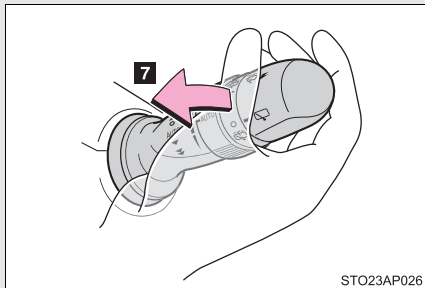

7 Washer/wiper dual operation

The wiper will automatically operate a couple of times after the washer squirts.

(After operating several times, the wiper operate one more time after a short delay to prevent dripping.)

■ The windshield wiper and washer can be operated when

Except hybrid vehicle

Vehicles without a smart entry & start system:

The engine switch is in the “ON” position.

Vehicles with a smart entry & start system:

The “ENGINE START STOP” switch is in IGNITION ON mode.

Hybrid vehicle

Vehicles without an electronic key:

The engine switch is in the “ON” position.

Vehicles with an electronic key:

The “POWER” switch is in ON mode.

■ Raindrop sensor (vehicles with a rain-sensing windshield wiper)

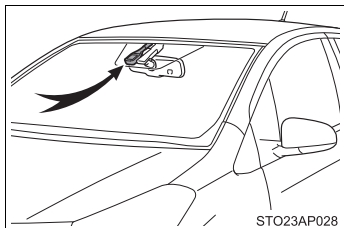

- The raindrop sensor judges the amount of raindrops.

An optical sensor is adopted. It may not operate properly when sunlight from the rising or setting of the sun intermittently strikes the windshield, or if bugs etc. are present on the windshield.

Vehicles without a smart entry & start system

- If the wiper switch is turned to the “AUTO” position while the engine switch is in the “ON” position, the wiper will operate once to show that “AUTO” mode is activated.
- When the sensor sensitivity ring is turned toward high while in “AUTO” mode, the wiper will operate once to indicate that the sensor sensitivity is enhanced.
- If the temperature of the raindrop sensor is 90°C (194°F) or higher, or -15°C (5°F) or lower, automatic operation may not occur. In this case, operate the wiper in any mode other than “AUTO”.

Vehicles with a smart entry & start system or a push-button start system

- Except hybrid vehicle: If the wiper switch is turned to the “AUTO” position while the “ENGINE START STOP” switch is in IGNITION ON mode, the wiper will operate once to show that “AUTO” mode is activated.
- Hybrid vehicle: If the wiper switch is turned to the “AUTO” position while the “POWER” switch is in ON mode, the wiper will operate once to show that “AUTO” mode is activated.
- When the sensor sensitivity ring is turned toward high while in “AUTO” mode, the wiper will operate once to indicate that the sensor sensitivity is enhanced.
- If the temperature of the raindrop sensor is 90°C (194°F) or higher, or -15°C (5°F) or lower, automatic operation may not occur. In this case, operate the wiper in any mode other than “AUTO”.

■ If no windshield washer fluid sprays

Check that the washer nozzles are not blocked if there is washer fluid in the windshield washer fluid reservoir.

 CAUTION

■ **Caution regarding the use of windshield wiper in “AUTO” mode (vehicles with a rain-sensing windshield wiper)**

The windshield wiper may operate unexpectedly if the sensor is touched or the windshield is subject to vibration in “AUTO” mode. Take care that your fingers etc. do not become caught in the windshield wiper.

■ **Caution regarding the use of washer fluid**

When it is cold, do not use the washer fluid until the windshield becomes warm. The fluid may freeze on the windshield and cause low visibility. This may lead to an accident, resulting in death or serious injury.

 NOTICE

■ **When the windshield is dry**

Do not use the wiper, as they may damage the windshield.

■ **When the washer fluid tank is empty**

Do not operate the switch continually as the washer fluid pump may over-heat.

■ **When a nozzle becomes blocked**

In this case, contact any authorized Toyota dealer or repairer, or another duly qualified and equipped professional.

Do not try to clear it with a pin or other object. The nozzle will be damaged.

2-3. Operating the lights and wipers

Rear window wiper and washer*

The wiper operation is selected by moving the lever as follows:

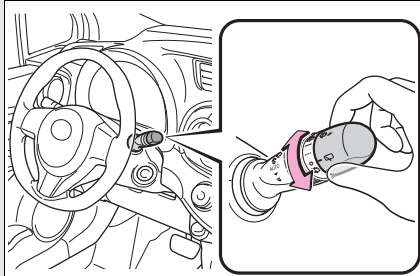

- 1** Intermittent window wiper operation
- 2** Normal window wiper operation
- 3** Washer/wiper dual operation
- 4** Washer/wiper dual operation

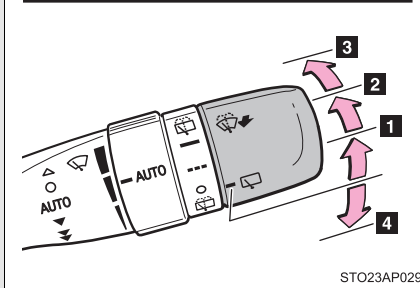

STO23AP029

The wiper will automatically operate a couple of times after the washer squirts.

■ **The rear window wiper and washer can be operated when**

Except hybrid vehicle

Vehicles without a smart entry & start system:

The engine switch is in the “ON” position.

Vehicles with a smart entry & start system:

The “ENGINE START STOP” switch is in IGNITION ON mode.

Hybrid vehicle

Vehicles without an electronic key:

The engine switch is in the “ON” position.

Vehicles with an electronic key:

The “POWER” switch is in ON mode.

■ **If no washer fluid sprays**

Check that the washer nozzle is not blocked if there is washer fluid in the washer fluid reservoir.

 **NOTICE**

■ **When the rear window is dry**

Do not use the wiper, as it may damage the rear window.

■ **When the washer fluid tank is empty**

Do not operate the switch continually as the washer fluid pump may over-heat.

■ **When a nozzle becomes blocked**

In this case, contact any authorized Toyota dealer or repairer, or another duly qualified and equipped professional.

Do not try to clear it with a pin or other object. The nozzle will be damaged.

2-4. Using other driving systems

Cruise control*

Use the cruise control to maintain a set speed without depressing the accelerator pedal.

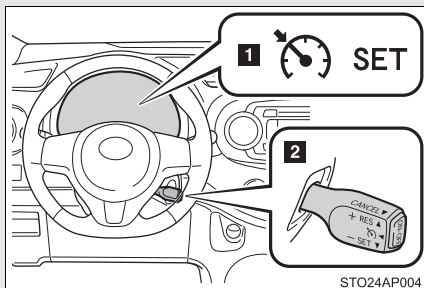

1 Indicators

2 Cruise control switch

■ Setting the vehicle speed

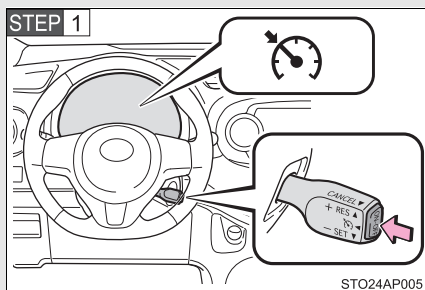

Press the “ON-OFF” button to activate the cruise control.

Cruise control indicator will come on.

Press the button again to deactivate the cruise control.

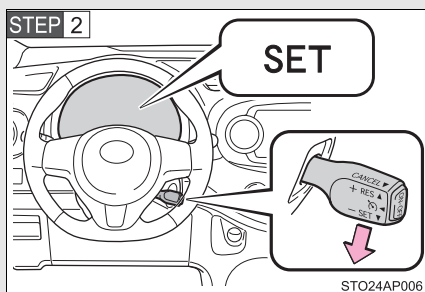

Accelerate or decelerate the vehicle to the desired speed, and push the lever down to set the speed.

“SET” indicator will come on.

The vehicle speed at the moment the lever is released becomes the set speed.

*: If equipped

■ Adjusting the set speed

To change the set speed, operate the lever until the desired set speed is obtained.

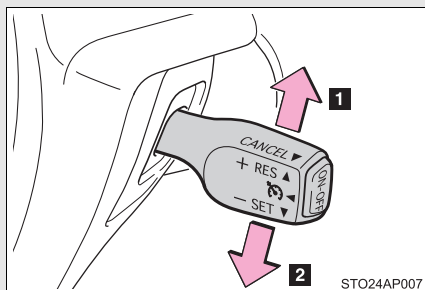

1 Increases the speed

2 Decreases the speed

Fine adjustment: Momentarily move the lever in the desired direction.

Large adjustment: Hold the lever in the desired direction.

The set speed will be increased or decreased as follows:

Fine adjustment: By approximately 1.6 km/h (1 mph) each time the lever is operated.

Large adjustment: The set speed can be increased or decreased continually until the lever is released.

■ Canceling and resuming the constant speed control

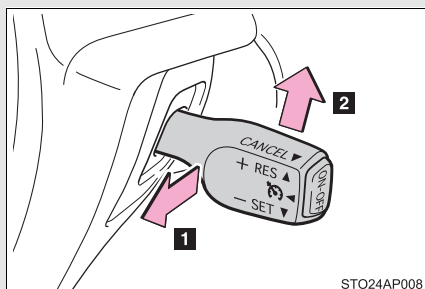

1 Pulling the lever toward you cancels the constant speed control.

The speed setting is also canceled when the brakes are applied or the clutch pedal (manual transmission only) is depressed.

2 Pushing the lever up resumes the constant speed control.

Resuming is available when the vehicle speed is more than approximately 40 km/h (25 mph).

■ Cruise control can be set when

- Vehicles with a hybrid transmission: The shift lever is in D.
- Vehicles with a Multidrive: The shift lever is in the D or range 4 or higher of M has been selected.
- Vehicles with a paddle shift switch: Range 4 or higher has been selected by using the paddle shift.
- Vehicle speed is above approximately 40 km/h (25 mph).

■ Accelerating after setting the vehicle speed

- The vehicle can be accelerated normally. After acceleration, the set speed resumes.
- Even without canceling the cruise control, the set speed can be increased by first accelerating the vehicle to the desired speed and then pushing the lever down to set the new speed.

■ Automatic cruise control cancelation

Cruise control will stop maintaining the vehicle speed in any of the following situations.

- Actual vehicle speed falls more than approximately 16 km/h (10 mph) below the preset vehicle speed.
At this time, the memorized set speed is not retained.
- Actual vehicle speed is below approximately 40 km/h (25 mph).
- VSC is activated (if equipped).
- Speed limiter is activated (if equipped).

■ If the cruise control indicator light flashes (except hybrid vehicle)

Press the “ON-OFF” button once to deactivate the system, and then press the button again to reactivate the system.

If the cruise control speed cannot be set or if the cruise control cancels immediately after being activated, there may be a malfunction in the cruise control system. Have the vehicle inspected by any authorized Toyota dealer or repairer, or another duly qualified and equipped professional.

■ **If the cruise control indicator light comes in yellow (hybrid vehicle)**

Press the “ON-OFF” button once to deactivate the system, and then press the button again to reactivate the system.

If the cruise control speed cannot be set or if the cruise control cancels immediately after being activated, there may be a malfunction in the cruise control system. Have the vehicle inspected by any authorized Toyota dealer or repairer, or another duly qualified and equipped professional.

 **CAUTION**

■ **To avoid operating the cruise control by mistake**

Switch the cruise control off using the “ON-OFF” button when not in use.

■ **Situations unsuitable for cruise control**

Do not use cruise control in any of the following situations.

Doing so may result in loss of control and could cause an accident resulting in death or serious injury.

- In heavy traffic
- On roads with sharp bends
- On winding roads
- On slippery roads, such as those covered with rain, ice or snow
- On steep hills
Vehicle speed may exceed the set speed when driving down a steep hill.
- When your vehicle is towing a trailer

2-4. Using other driving systems

Speed limiter*

The desired maximum speed can be set using the cruise control switch. The speed limiter prevents vehicle speed from exceeding the set speed.

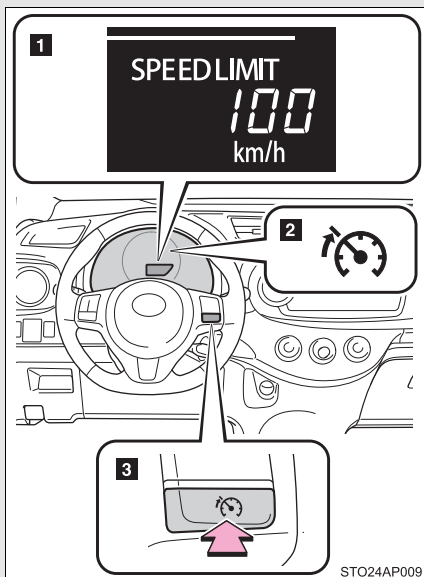

- 1 Display
- 2 Indicator
- 3 Speed limiter switch

■ Setting the vehicle speed

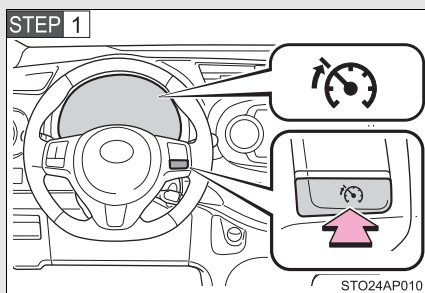

Press the speed limiter switch to activate the speed limiter.

Speed limiter indicator will come on.

Press the switch again to deactivate the speed limiter.

*: If equipped

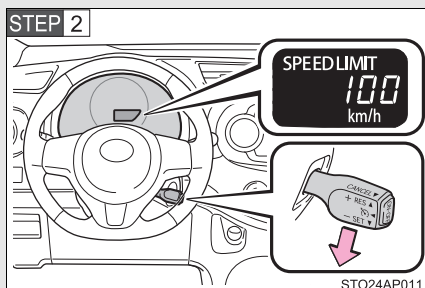

Accelerate or decelerate the vehicle to the desired speed, and push the lever down to set the speed.

The vehicle speed at the moment the lever is released becomes the set speed.

■ Adjusting the set speed

To change the set speed, operate the lever until the desired set speed is obtained.

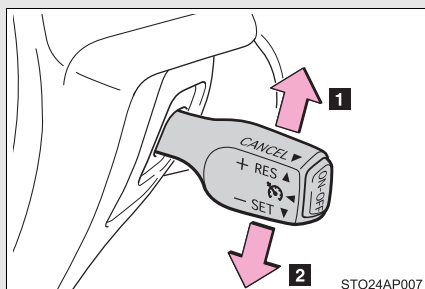

1 Increases the speed

2 Decreases the speed

Fine adjustment: Momentarily move the lever in the desired direction.

Large adjustment: Hold the lever in the desired direction.

Fine adjustment: By approximately 1 km/h (0.6 mph) each time the lever is operated

Large adjustment: By approximately 5 km/h (3.1 mph) for each 0.75 seconds the lever is held

■ Canceling and resuming the speed limiter

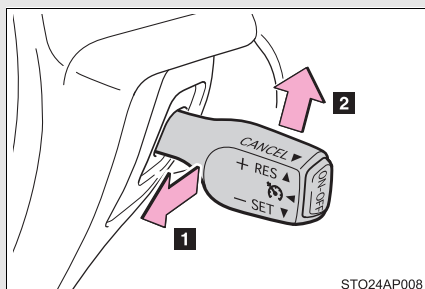

1 Pulling the lever toward you cancels the speed limiter.

2 Pushing the lever up resumes the speed limiter.

■ Speed limiter can be set when

The speed limiter can be set at any vehicle speed. However, if the speed limiter is set while the vehicle speed is below 30 km/h (18 mph), the speed limiter will be set to 30 km/h (18 mph).

■ Exceeding the set speed

In the following situation, the vehicle speed exceeds the set speed and multi-information display characters will flash:

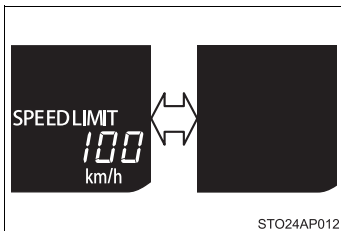

- When fully depressing the accelerator pedal
- When driving down a hill way

■ Automatic speed limiter cancelation

The set speed is automatically canceled when the cruise control is activated.

⚠ CAUTION

■ To avoid operating the speed limiter by mistake

Switch the speed limiter off using the speed limiter switch when not in use.

■ Situations unsuitable for the speed limiter

Do not use the speed limiter in either of the following situations. Doing so may result in loss of control and could cause a serious or fatal accident.

- On slippery roads, such as those covered with rain, ice and snow
- On steep hills
- When your vehicle is towing a trailer

2-4. Using other driving systems

Stop & Start system*

Vehicles with a Multidrive:

The Stop & Start system stops and restarts the engine according to the brake pedal and shift lever operation for stopping and starting the vehicle.

Vehicles with a manual transmission:

The Stop & Start system stops and restarts the engine according to the clutch pedal operation for stopping and starting the vehicle.

■ Stopping the engine

Vehicles with a Multidrive

STEP 1 While driving in D or M, depress the brake pedal fully, and stop the vehicle.

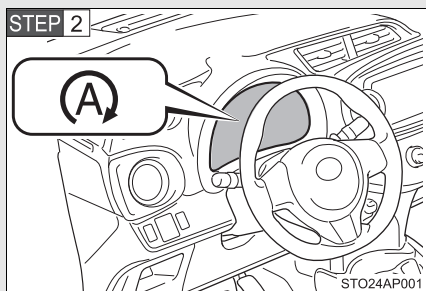

The engine will stop and the Stop & Start indicator will come on.

When the shift lever is in N or P, the engine will remain stopped without depressing the brake pedal.

Vehicles with a manual transmission

STEP 1 With the clutch pedal fully depressed, stop the vehicle. Then shift the shift lever to N.

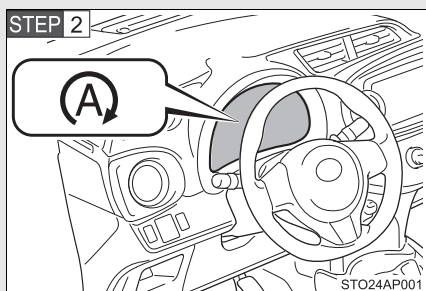

Release the clutch pedal.

The engine will stop and the Stop & Start indicator will come on.

*: If equipped

■ Restarting the engine

Vehicles with a Multidrive

Release the brake pedal. When the shift lever is in N or P, depress brake pedal and shift the shift lever to D or M.

The engine will restart. The Stop & Start indicator will go off.

Vehicles with a manual transmission

Check that the shift lever is in N and depress the clutch pedal.

The engine will restart. The Stop & Start indicator will go off. (In this situation, releasing the clutch pedal will not stop the engine again.)

Disabling the Stop & Start system

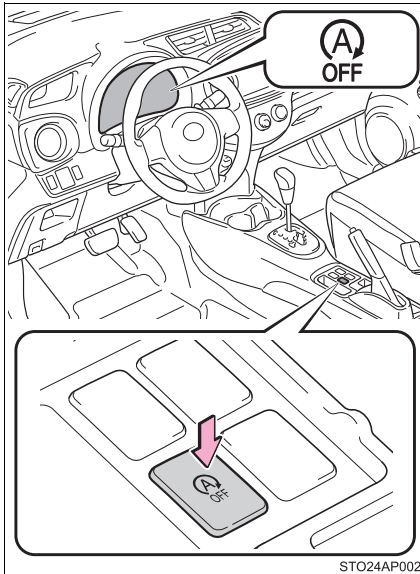

Press the Stop & Start cancel switch to disable the Stop & Start system.

The stop & start cancel indicator will come on.

The engine will not stop at each stop when the brake pedal (vehicles with a Multidrive) or clutch pedal (vehicles with a manual transmission) is depressed to stop the engine (→P. 316).

Pressing the switch again to re-enable the Stop & Start system.

■ **If the Stop & Start cancel switch is pressed while the vehicle is stopped**

- When the engine is stopped by the Stop & Start system, pressing the Stop & Start cancel switch will restart the engine.
From the next time the vehicle is stopped (after Stop & Start system has been turned off), the engine will not be stopped.
 - With the Stop & Start system disabled, pressing the Stop & Start cancel switch will re-enable the system but not stop the engine.
From the next time the vehicle is stopped (after Stop & Start system has been turned on), the engine will be stopped.
-

■ **Operating conditions**

- The Stop & Start system is operational when all of the following conditions are met:
 - The engine is adequately warmed up.
 - The battery is sufficiently charged.
 - The driver's door is closed.
 - Vehicles with a Multidrive: The driver's seat belt is fastened.
 - The hood is closed.
 - The accelerator pedal is not being depressed.
 - The shift lever is not in R.
- In the following circumstances the engine may not be stopped by the Stop & Start system. This is not a malfunction of the Stop & Start system.
 - Engine coolant temperature or transmission fluid temperature is too low or too high.
 - The air conditioning system is being used when the vehicle interior temperature is extremely high such as after the vehicle was parked under the hot sun.
 - Vehicles with an automatic air conditioning system only: The windshield defogger is being used.
 - The battery is not sufficiently charged, or is undergoing a periodic recharge.
 - Due to traffic or other circumstances the vehicle is stopped repeatedly, resulting in the amount of time the engine is stopped by the Stop & Start system to become excessively high.
 - The brake pedal is not depressed firmly.

- The vehicle is stopped on a steep hill.
- The brake booster vacuum is low.
- A large amount of electricity is being used.
- At high altitude.

When the above conditions improve, the Stop & Start system will stop and restart the engine from the next time the vehicle is stopped.

- In the following situations, the engine may start even without the brake pedal being released (vehicles with a Multidrive) or clutch pedal being depressed (vehicles with a manual transmission).

- The brake pedal is pumped or strongly depressed.
- The air conditioning system is being used or turned on.
- Vehicles with an automatic air conditioning system only: The windshield defogger is turned on.
- The battery is not sufficiently charged.
- The vehicle starts to roll on an incline.
- Vehicles with a Multidrive: The hood is opened when the shift lever is in N or P.
- The accelerator pedal is depressed.
- A large amount of electricity is being used.
- Vehicles with a Multidrive: The driver's door is opened.
- Vehicles with a Multidrive: The driver's seat belt is unfastened.

- In the following situations, it may take longer than normal for the Stop & Start system to activate.

- The battery is discharged.
- After the battery terminals have been disconnected and reconnected after a battery replacement, etc.
- The engine coolant temperature is low.

■ Automatic reactivation of the Stop & Start system

Vehicles without a smart entry & start system:

Even if the Stop & Start system is disabled by the Stop & Start cancel switch, it will be automatically re-enabled once the engine switch is turned to the "LOCK" position then to the "START" position.

Vehicles with a smart entry & start system:

Even if the Stop & Start system is disabled by the Stop & Start cancel switch, it will be automatically re-enabled once the "ENGINE START STOP" switch is turned off then the engine is started.

■ **The Stop & Start system protection feature**

Vehicles without a smart entry & start system:

When an excessively loud sound is being projected by the audio system, the audio system may be automatically cut off in order to maintain power for the Stop & Start system function.

If this occurs, turning the engine switch to the “LOCK” position then to the “ACC” or “ON” position re-enables the audio system.

Vehicles with a smart entry & start system:

When an excessively loud sound is being projected by the audio system, the audio system may be automatically cut off in order to maintain power for the Stop & Start system function.

If this occurs, turning the “ENGINE START STOP” switch off then to ACCESSORY mode or IGNITION ON mode re-enables the audio system.

■ **Steering wheel operation**

When the engine is stopped by the Stop & Start system, the steering wheel may become heavier than when driving.

■ **Hood**

If the hood is opened while the engine is stopped by the Stop & Start system, the engine cannot be restarted by the Stop & Start system or by the automatic engine start function. Restart the engine with the engine switch operation. (→P. 222, 226)

Vehicles with a Multidrive: If the hood is opened while the engine is stopped by the Stop & Start system and the shift lever is in N or P, the engine will restart.

■ **Hill-start assist control (vehicles with a Multidrive)**

- On a steep uphill grade, the vehicle may roll backward after hill-start assist control is released. In this situation, apply the parking brake and operate the brake pedal when putting the vehicle in motion.
- This system operates on flat surfaces as well as steep grades.
- When the engine is stopped due to Stop & Start system operation, the force required to depress the brake pedal may change, but this is not a malfunction.

■ **When to use the Stop & Start system**

Use the Stop & Start system when stopping the vehicle temporarily at red lights, intersections, etc. When stopping the vehicle for a longer period of time, turn off the engine completely.

■ Stop & Start system warning buzzer



If the engine is stopped by the Stop & Start system and either of the following actions is performed, a buzzer will sound and the Stop & Start indicator will flash (vehicles with a Multidrive), or a buzzer will sound (vehicles with a manual transmission). This indicates that the engine is only stopped by the Stop & Start system, not that the engine has been turned off completely.

- Vehicles with a Multidrive: The driver's door is opened when the shift lever is in D or M.
- Vehicles with a Multidrive: The shift lever is shifted into a position other than N or P with the brake pedal released.
- Vehicles with a manual transmission: The shift lever is shifted into a position other than N with the clutch pedal released.

■ If the Stop & Start cancel indicator light continues to flash

The Stop & Start system may be malfunctioning. Contact any authorized Toyota dealer or repairer, or another duly qualified and equipped professional.

■ If the windshield is fogged up while the engine is stopped by the Stop & Start system

- Vehicles with an automatic air conditioning system
 - Turn the windshield defogger on. (The engine will start due to the automatic engine start function.) (→P. 363)
 - Vehicles with a manual air conditioning system
 - Vehicles with a Multidrive: Restart the engine by releasing the brake pedal (when the shift lever is in D or M) or depress the brake pedal and shift the shift lever to D or M (when the shift lever is in N or P) (→P. 317), or by pressing the Stop & Start cancel switch, and then set the air outlet selector dial to . (→P. 355)
 - Vehicles with a manual transmission: Restart the engine by depressing the clutch pedal (→P. 317), or by pressing the Stop & Start cancel switch, and then set the air outlet selector dial to . (→P. 355)
- If the windshield fogs up frequently, press the Stop & Start cancel switch to deactivate the system.

■ **The Stop & Start system operation time and Stop & Start system total operation time display**

→P. 286, 287

■ **Replacing battery**

The installed battery is specific to the Stop & Start system. It should only be replaced with a battery of identical type and rating.

Ask any authorized Toyota dealer or repairer, or another duly qualified and equipped professional for further details.

 **CAUTION**

■ **When the Stop & Start system is operating**

● Keep the shift lever in N and apply the brake pedal or parking brake for safety while the engine is stopped due to the Stop & Start system (while the Stop & Start indicator is on).

Unexpected accidents may occur due to the automatic engine start function.

● Do not leave the vehicle while the engine is stopped due to the Stop & Start system (while the Stop & Start indicator is on).

Unexpected accidents may occur due to the automatic engine start function.

● Ensure that the engine is not stopped by the Stop & Start system while the vehicle is in a poorly ventilated area. The engine may restart due to the automatic engine start function, causing exhaust gases to collect and enter the vehicle and resulting in death or a serious health hazard.

 NOTICE**■ To ensure the system operates correctly**

If any one of the following situations occurs, the Stop & Start system may not operate correctly, thus, please have your vehicle checked by any authorized Toyota dealer or repairer, or another duly qualified and equipped professional.

- While the driver's seat belt is fastened, the driver's and front passenger's seat belt reminder light flashes.
- Even when the driver's seat belt is not fastened, the driver's and front passenger's seat belt reminder light remains off.
- Even when the driver's door is closed, the open door warning light comes on, or the interior light comes on when the interior light switch is in the door position.
- Even when the driver's door is opened, the open door warning light does not come on, or the interior light does not come on when the interior light switch is in the door position.

2-4. Using other driving systems

Driving assist systems

To help enhance driving safety and performance, the following systems operate automatically in response to various driving situations. Be aware, however, that these systems are supplementary and should not be relied upon too heavily when operating the vehicle.

■ **ABS (Anti-lock Brake System)**

Helps to prevent wheel lock when the brakes are applied suddenly, or if the brakes are applied while driving on a slippery road surface

■ **Brake assist**

Generates an increased level of braking force after the brake pedal is depressed when the system detects a panic stop situation

■ **VSC (Vehicle Stability Control) (if equipped)**

Helps the driver to control skidding when swerving suddenly or turning on slippery road surfaces

■ **TRC (Traction Control) (if equipped)**

Helps to maintain drive power and prevent the drive wheels from spinning when starting the vehicle or accelerating on slippery roads

■ **Hill-start assist control**

Except hybrid vehicle (vehicles with a Stop & Start system and a Multidrive)

Helps to prevent the vehicle from rolling backward when the brake pedal is released to restart the engine

Hybrid vehicle

→P. 330

■ **EPS (Electric Power Steering)**

Employs an electric motor to reduce the amount of effort needed to turn the steering wheel

When the TRC/VSC systems are operating (except hybrid vehicle)

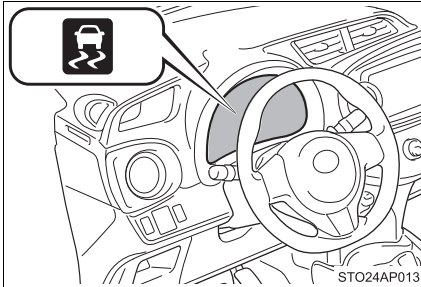

The slip indicator light flashes to indicate that the TRC/VSC systems have been engaged.

When the TRC/VSC/ABS/hill-start assist control systems are operating (hybrid vehicle)

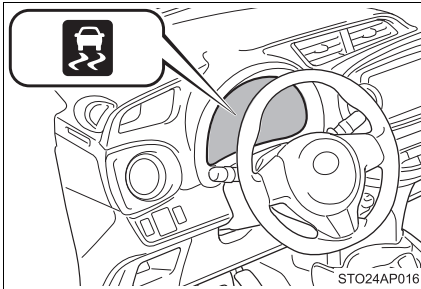

The slip indicator light will flash while the TRC/VSC/ABS/hill-start assist control systems are operating.

The stop lights and high mounted stoplight turn on when the hill-start assist control system is operating.

Disabling the TRC/VSC systems (except hybrid vehicle)

If the vehicle gets stuck in fresh snow or mud, the TRC/VSC systems may reduce power from the engine to the wheels. You may need to turn the system off to enable you to rock the vehicle in order to free it.

■ Turning off the TRC system only

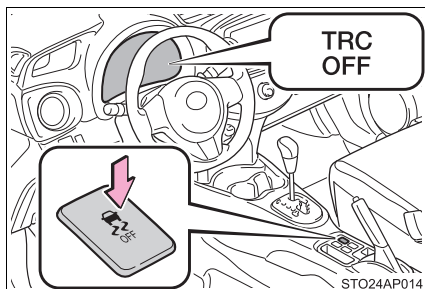

To turn the TRC system off, quickly press and release the button.

The "TRC OFF" indicator light will come on.

Press the button again to turn the system back on.

■ Turning off both TRC and VSC systems

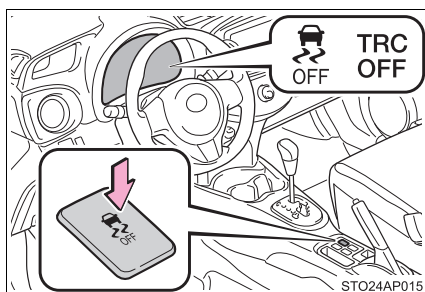

To turn the TRC and VSC systems off, press and hold the button for more than 3 seconds while the vehicle is stopped.

The "TRC OFF" indicator light and VSC OFF indicator light will come on.

Press the button again to turn the systems back on.

■ **Hill-start assist control operation conditions (except hybrid vehicle)**

- The shift lever is in D or M.
- The brake pedal is not depressed.

■ **When the “TRC OFF” indicator light comes on even if the VSC OFF switch has not been pressed (except hybrid vehicle)**

TRC and hill-start assist control cannot be operated. Contact any authorized Toyota dealer or repairer, or another duly qualified and equipped professional.

■ **Sounds and vibrations caused by the ABS, brake assist, TRC and VSC systems**

- A sound may be heard from the engine compartment when the brake pedal is depressed repeatedly, when the engine is started or just after the vehicle begins to move. This sound does not indicate that a malfunction has occurred in any of these systems.
- Any of the following conditions may occur when the above systems are operating. None of these indicates that a malfunction has occurred.
 - Vibrations may be felt through the vehicle body and steering.
 - A motor sound may be heard after the vehicle comes to a stop.
 - The brake pedal may pulsate slightly after the ABS is activated.
 - The brake pedal may move down slightly after the ABS is activated.

■ **EPS operation sound**

When the steering wheel is operated, a motor sound (whirring sound) may be heard. This does not indicate a malfunction.

■ **Reactivation of the TRC/VSC systems after turning off the engine (except hybrid vehicle)**

Even after the TRC/VSC systems have been turned off, turning the engine off and then on again will automatically reactivate the TRC/VSC systems.

■ **Reactivation of the TRC system linked to vehicle speed (except hybrid vehicle)**

When only the TRC system is turned off, the TRC system will turn on when vehicle speed increases. However, when both TRC and VSC systems are turned off, the systems will not turn on even when vehicle speed increases.

■ **Reduced effectiveness of the EPS system**

The effectiveness of the EPS system is reduced to prevent the system from overheating when there is frequent steering input over an extended period of time. The steering wheel may feel heavy as a result. Should this occur, refrain from excessive steering input or stop the vehicle and turn the engine (except hybrid vehicle) or hybrid system (hybrid vehicle) off. The EPS system should return to normal within 10 minutes.

■ **If the slip indicator comes on**

It may indicate a malfunction in the driving assist systems. Contact any authorized Toyota dealer or repairer, or another duly qualified and equipped professional.

 **CAUTION**

■ **The ABS does not operate effectively when**

- The limits of tire gripping performance have been exceeded (such as excessively worn tires on a snow covered road).
- The vehicle hydroplanes while driving at high speed on wet or slick roads.

■ **Stopping distance when the ABS is operating may exceed that of normal conditions**

The ABS is not designed to shorten the vehicle's stopping distance. Always maintain a safe distance from the vehicle in front of you, especially in the following situations:

- When driving on dirt, gravel or snow-covered roads
- When driving with tire chains
- When driving over bumps in the road
- When driving over roads with potholes or roads with uneven surfaces

■ **TRC may not operate effectively when**

Directional control and power may not be achievable while driving on slippery road surfaces, even if the TRC system is operating.

Do not drive the vehicle in conditions where stability and power may be lost.

■ **Hill-start assist control does not operate effectively when**

Do not overly rely on the hill-start assist control. The hill-start assist control may not operate effectively on steep inclines and roads covered with ice.

 **CAUTION****■ When the VSC is activated**

The slip indicator light flashes. Always drive carefully. Reckless driving may cause an accident. Exercise particular care when the indicator light flashes.

■ When the TRC/VSC systems are turned off (except hybrid vehicle)

Be especially careful and drive at a speed appropriate to the road conditions. Do not turn the TRC/VSC systems off unless necessary, as these are the systems to ensure vehicle stability and driving force by automatically controlling braking and engine outputs.

■ Replacing tires

Make sure that all tires are of the specified size, brand, tread pattern and total load capacity. In addition, make sure that the tires are inflated to the recommended tire inflation pressure level.

The ABS, TRC and VSC systems will not function correctly if different tires are installed on the vehicle.

Contact any authorized Toyota dealer or repairer, or another duly qualified and equipped professional for further information when replacing tires or wheels.

■ Handling of tires and the suspension

Using tires with any kind of problem or modifying the suspension will affect the driving assist systems, and may cause a system to malfunction.

2-4. Using other driving systems

Hill-start assist control (hybrid vehicle)

Assists with starting off and temporarily maintains braking power even if the foot is removed from the brake pedal when starting off on an incline or a slippery slope.

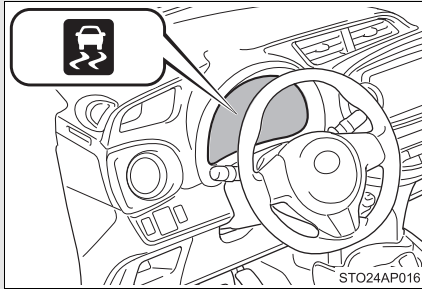

To engage hill-start assist control, further depress the brake pedal when the vehicle is stopped completely.

A buzzer will sound once to indicate the system is activated. The slip indicator will also start flashing.

■ Hill-start assist control operating conditions

- The system operates in the following situations:
 - The shift lever is in a position other than P.
 - The parking brake is not applied.
 - The accelerator pedal is not depressed.
- Hill-start assist control cannot be operated while the slip indicator light is illuminated.

■ Hill-start assist control

- While hill-start assist control is operating, the brakes remain automatically applied after the driver releases the brake pedal. The stop lights and the high mounted stoplight turn on.
- Hill-start assist control operates for about 2 seconds after the brake pedal is released.
- If the slip indicator does not flash and the buzzer does not sound when the brake pedal is further depressed, slightly reduce the pressure on the brake pedal (do not allow the vehicle to roll backward) and then firmly depress it again. If the system still does not operate, check that the operating conditions explained above have been met.

■ Hill-start assist control buzzer

- When hill-start assist control is activated, the buzzer will sound once.
- In the following situations, hill-start assist control will be canceled and the buzzer will sound twice.
 - No attempt is made to drive the vehicle within approximately 2 seconds of releasing the brake pedal.
 - The shift lever is moved to P.
 - The parking brake is applied.
 - The brake pedal is depressed again.
 - The brake pedal has been depressed for more than approximately 3 minutes.
- If a buzzer other than the hill-start assist control buzzer is sounding, the hill-start assist control buzzer may not sound.

■ If the slip indicator comes on

It may indicate a malfunction in the system. Contact any authorized Toyota dealer or repairer, or another duly qualified and equipped professional.

⚠ CAUTION**■ Hill-start assist control**

- Do not overly rely on hill-start assist control. Hill-start assist control may not operate effectively on steep inclines and roads covered with ice.
- Unlike the parking brake, hill-start assist control is not intended to hold the vehicle stationary for an extended period of time. Do not attempt to use hill-start assist control to hold the vehicle on an incline, as doing so may lead to an accident.

2-4. Using other driving systems

Diesel particulate filter system*

When the deposit collected by the filter reaches a predetermined amount, it is automatically cleaned.

■ Cleaning the DPF catalytic converter

Cleaning the DPF catalytic converter is performed as necessary in accordance with driving conditions.

■ Equipment characteristics

The DPF system has the following characteristics:

- Idle speed increases during cleaning
- The smell of the exhaust gas changes
- When starting the engine, white-colored steam (water vapor) may be expelled during cleaning
- Acceleration performance may degrade during cleaning

■ Replacing the engine oil

→P. 469

*: If equipped

 **CAUTION****■ Exhaust pipe**

Do not touch the exhaust pipe during cleaning, as the exhaust pipe and exhaust gases will become particularly hot. Also, make sure that there are no people or flammable materials near the exhaust pipe while the vehicle is stopped.

Failure to do so may cause injury by burning or a fire.

 **NOTICE****■ To prevent the DPF system from failing**

- Do not use fuel other than the specified type
- Do not use engine oil other than the recommended type
- Do not modify the exhaust pipe

2-5. Driving information

Cargo and luggage

Take notice of the following information about storage precautions, cargo capacity and load:

- Stow cargo and luggage in the luggage compartment whenever possible.
- Be sure all items are secured in place.
- To maintain vehicle balance while driving, position luggage evenly within the luggage compartment.
- For better fuel economy, do not carry unnecessary weight.

CAUTION

■ Things that must not be carried in the luggage compartment

The following things may cause a fire if loaded in the luggage compartment:

- Receptacles containing gasoline
- Aerosol cans

■ Storage precautions

Observe the following precautions.

Failure to do so may result in death or serious injury.

- Stow cargo and luggage in the luggage compartment whenever possible.
- Do not stack anything in the luggage compartment higher than the seatbacks.
Such items may be thrown about and possibly injure people in the vehicle in the event of sudden braking or in an accident.
- Do not place cargo or luggage in or on the following locations as the item may get under the clutch, brake or accelerator pedal and prevent the pedals from being depressed properly, block the driver's vision, or hit the driver or passengers, causing an accident:
 - At the feet of the driver
 - On the front passenger or rear seats (when stacking items)
 - On the luggage cover
 - On the instrument panel
 - On the dashboard

 CAUTION

- Secure all items in the occupant compartment, as they may shift and injure someone during sudden braking, sudden swerving or an accident.
- Vehicles with a rear seat: When you fold down the rear seats, long items should not be placed directly behind the front seats.
- Never allow anyone to ride in the luggage compartment. It is not designed for passengers. They should ride in their seats with their seat belts properly fastened. Otherwise, they are much more likely to suffer death or serious bodily injury, in the event of sudden braking, sudden swerving or an accident.

■ Load and distribution

- Do not overload your vehicle.
- Do not apply loads unevenly.
Improper loading may cause deterioration of steering or braking control which may cause death or serious injury.

2-5. Driving information

Winter driving tips

Carry out the necessary preparations and inspections before driving the vehicle in winter. Always drive the vehicle in a manner appropriate to the prevailing weather conditions.

■ Pre-winter preparations

- Use fluids that are appropriate to the prevailing outside temperatures.
 - Engine oil
 - Engine coolant
 - Washer fluid
 - Power control unit coolant (hybrid vehicle)
- Except hybrid vehicle: Have a service technician inspect the condition of the battery.
- Hybrid vehicle: Have a service technician inspect the condition of the 12-volt battery.
- Have the vehicle fitted with four snow tires or purchase a set of tire chains for the front tires.

Ensure that all tires are the same size and brand, and that their wear level is not noticeably different with each other. Also make sure that chains match the size of the tires.

■ Before driving the vehicle

Perform the following according to the driving conditions:

- Do not try to forcibly open a window or move a wiper that is frozen. Pour warm water over the frozen area to melt the ice. Wipe away the water immediately to prevent it from freezing.
- To ensure proper operation of the climate control system fan, remove any snow that has accumulated on the air inlet vents in front of the windshield.

- Check for and remove any excess ice or snow that may have accumulated on the exterior lights, vehicle's roof, chassis, around the tires or on the brakes.
- Remove any snow or mud from the bottom of your shoes before getting in the vehicle.

■ **When driving the vehicle**

Accelerate the vehicle slowly, keep a safe distance between you and the vehicle ahead, and drive at a reduced speed suitable to road conditions.

■ **When parking the vehicle (in the winter time or in the cold latitudes)**

Park the vehicle and move the shift lever to P (vehicles with a hybrid transmission or a Multidrive), E, M or R (vehicles with a multi-mode manual transmission), and 1 or R (vehicles with a manual transmission) without setting the parking brake. The parking brake may freeze up, preventing it from being released. If necessary, block the wheels to prevent inadvertent sliding or creeping.

Selecting tire chains

Use the correct tire chain size when mounting the tire chains.
Chain size is regulated for each tire size.

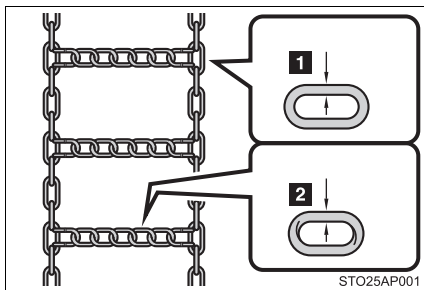

1 Side chain

Except 175/65R14 tires: 3 mm
(0.12 in.) in diameter

175/65R14 tires: 4 mm (0.16
in.) in diameter

2 Cross chain

Except 175/65R14 tires: 4 mm
(0.16 in.) in diameter

175/65R14 tires: 5 mm (0.20
in.) in diameter

Regulations on the use of tire chains

Regulations regarding the use of tire chains vary depending on location and type of road. Always check local regulations before installing chains.

■ Tire chain installation

Observe the following precautions when installing and removing chains:

- Install and remove tire chains in a safe location.
- Install tire chains on the front tires only. Do not install tire chains on the rear tires.
- Install tire chains on front tires as tightly as possible. Retighten chains after driving 0.5 — 1.0 km (1/4 — 1/2 mile).
- Install tire chains following the instructions provided with the tire chains.
- If wheel ornaments are used, they will be scratched by the chain band, so remove the ornaments before putting on the chains.

 CAUTION**■ Driving with snow tires**

Observe the following precautions to reduce the risk of accidents. Failure to do so may result in a loss of vehicle control and cause death or serious injury.

- Use tires of the specified size.
- Maintain the recommended level of air pressure.
- Do not drive at speeds in excess of the speed limit or the speed limit specified for the snow tires being used.
- Use snow tires on all, not just some wheels.
- Do not use tires of noticeably different wear level.

■ Driving with tire chains

Observe the following precautions to reduce the risk of accidents. Failure to do so may result in the vehicle being unable to be driven safely, and may cause death or serious injury.

- Do not drive in excess of the speed limit specified for the tire chains being used, or 50 km/h (30 mph), whichever is lower.
- Avoid driving on bumpy road surfaces or over potholes.
- Avoid sudden acceleration, abrupt steering, sudden braking and shifting operations that cause sudden to engine braking.
- Slow down sufficiently before entering a curve to ensure that vehicle control is maintained.

2-5. Driving information

Trailer towing (hybrid vehicle)

Toyota does not recommend towing a trailer with your vehicle. Toyota also does not recommend the installation of a tow hitch or the use of a tow hitch carrier for a wheelchair, scooter, bicycle, etc. Your vehicle is not designed for trailer towing or for the use of tow hitch mounted carriers.



2-5. Driving information

Trailer towing (except hybrid vehicle [except for South Africa])

Your vehicle is designed primarily as a passenger carrying vehicle. Towing a trailer will have an adverse effect on handling, performance, braking, durability, and fuel consumption. Your safety and satisfaction depend on the proper use of correct equipment and cautious driving habits. For your safety and the safety of others, do not overload the vehicle or trailer.

To tow a trailer safely, use extreme care and drive the vehicle in accordance with the trailer's characteristics and operating conditions.

Toyota warranties do not apply to damage or malfunction caused by towing a trailer for commercial purposes.

Ask your local authorized Toyota dealer or repairer, or another duly qualified and equipped professional, for further details before towing, as there are additional legal requirements in some countries.

■ Weight limits

Check the allowable towing capacity, GVM (Gross Vehicle Mass), MPAC (Maximum Permissible Axle Capacity), and permissible drawbar load before towing. (→P. 660)

■ Towing hitch/bracket

Toyota recommends the use of the Toyota hitch/bracket for your vehicle. Other products of a suitable nature and comparable quality may also be used.

Important points regarding trailer loads

■ Total trailer weight and permissible drawbar load

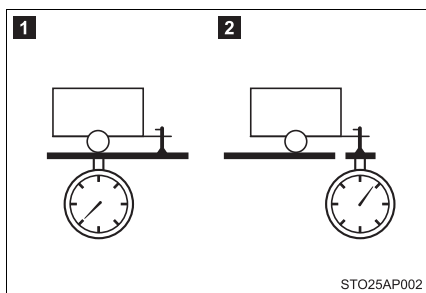

1 Total trailer weight

Weight of the trailer itself plus the trailer load should be within the maximum towing capacity. Exceeding this weight is dangerous. (→P. 660)

When towing a trailer, use a friction coupler or friction stabilizer (sway control device).

2 Permissible drawbar load

Allocate the trailer load so that the drawbar load is greater than 25 kg (55.1 lb.) or 4% of the towing capacity. Do not let the drawbar load exceed the indicated weight. (→P. 660)

■ Information tag (manufacturer's label)

Type A

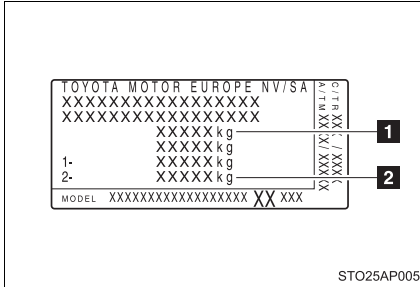

- 1 Gross vehicle mass
- 2 Maximum permissible rear axle capacity

Type B

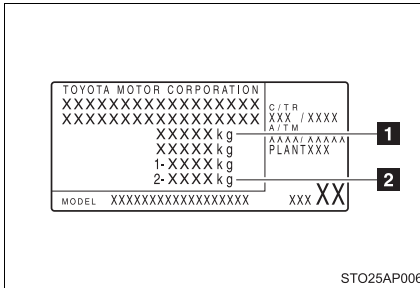

- 1 Gross vehicle mass
- 2 Maximum permissible rear axle capacity

■ Gross vehicle mass

Vehicle category M1 models*:

The combined weight of the driver, passengers, luggage, towing hitch, total curb mass and drawbar load should not exceed the gross vehicle mass by more than 100 kg (220.5 lb.). Exceeding this weight is dangerous.

Vehicle category N1 models*:

The combined weight of the driver, passengers, cargo, towing hitch, total curb mass and drawbar load must not exceed the gross vehicle mass. Exceeding this weight is dangerous.

■ Maximum permissible rear axle capacity

Vehicle category M1 models*:

The weight borne by the rear axle should not exceed the maximum permissible rear axle capacity by 15% or more. Exceeding this weight is dangerous.

Vehicle category N1 models*:

The weight borne by the rear axle should not exceed the maximum permissible rear axle capacity. Exceeding this weight is dangerous.

The values for towing capacity were derived from testing conducted at sea level. Take note that engine output and towing capacity will be reduced at high altitudes.

CAUTION

■ When the gross vehicle mass limit or maximum permissible axle capacity is exceeded (vehicle category M1 models*)

Do not exceed the established speed limit for towing a trailer in built-up areas or 100 km/h (62 mph), whichever is lower.

Failing to observe this precaution may lead to an accident causing death or serious injury.

*: To distinguish the vehicle category, ask any authorized Toyota dealer or repairer, or another duly qualified and equipped professional.

Installation positions* for the towing hitch/bracket and hitch ball

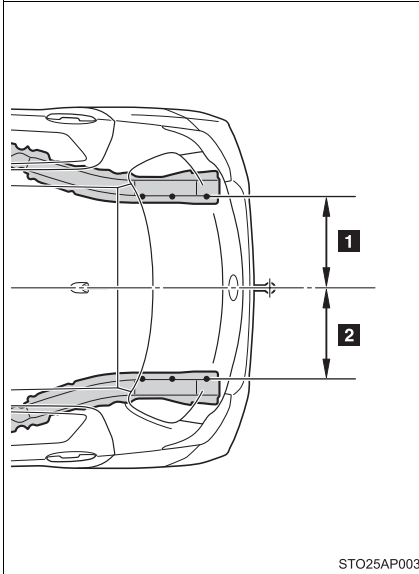

1 434 mm (17.1 in.)

2 434 mm (17.1 in.)

*: Gross vehicle mass and standard tire size

To distinguish the vehicle category, ask any authorized Toyota dealer or repairer, or another duly qualified and equipped professional.

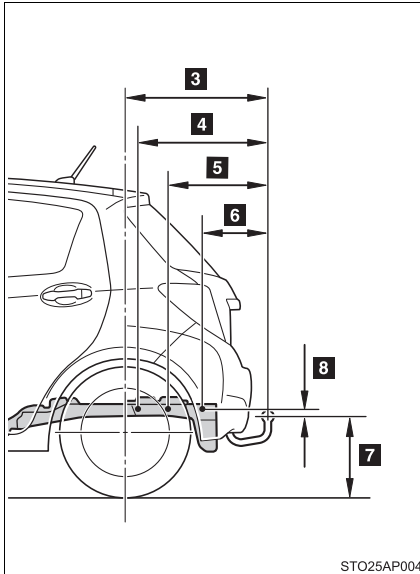

3 655 mm (25.8 in.)

4 602 mm (23.7 in.)

5 468 mm (18.4 in.)

6 313 mm (12.3 in.)

7 397 mm (15.6 in.)

8 26.2 mm (1.0 in.)

STO25AP004

■ Tire information

- Ensure that your vehicle's tires are properly inflated. Adjust the tire pressure to the recommended pressure. (→P. 679)
- Increase the air pressure of the trailer tires in accordance with the total trailer weight and according to the values recommended by the manufacturer of your trailer.

■ Trailer lights

Check that the turn signal lights and stoplights are operating correctly every time you hitch up the trailer. Directly wiring up to your vehicle may damage the electrical system and stop the lights from functioning correctly.

■ Break-in schedule

Toyota recommends that vehicles fitted with new power train components should not be used for towing trailers for the first 800 km (500 miles).

■ Safety checks before towing

- Check that the maximum load limit for the towing hitch/bracket and hitch ball is not exceeded. Bear in mind that the coupling weight of the trailer will add to the load exerted on the vehicle. Also make sure that the total load exerted on the vehicle is within the range of the weight limits. (→P. 342)
- Ensure that the trailer load is secure.
- Supplementary outside rear view mirrors should be added to the vehicle if the traffic behind cannot be clearly seen with standard mirrors. Adjust the extending arms of these mirrors on both sides of the vehicle so that they always provide maximum visibility of the road behind.

■ Maintenance

- Maintenance must be performed more frequently when using the vehicle for towing due to the greater weight burden placed on the vehicle compared to normal driving.
- Retighten all bolts securing the hitching ball and bracket after towing for approximately 1000 km (600 miles).

 NOTICE

■ **When the rear bumper strengthening material is aluminum**

Ensure the steel bracket part does not come directly in contact with that area.

When steel and aluminum come into contact, there is a reaction similar to corrosion, which will weaken the section concerned and may result in damage. Apply a rust inhibitor to parts that will come in contact when attaching a steel bracket.

Guidance

Your vehicle will handle differently when towing a trailer. In order to avoid accident, death or serious injury, keep the following in mind when towing:

■ **Checking connections between trailer and lights**

Stop the vehicle and check the operation of the connection between the trailer and lights after driving for a brief period as well as before starting off.

■ **Practicing driving with a coupled trailer**

- Get the feel for turning, stopping and reversing with the trailer coupled by practicing in an area with no or light traffic.
- When reversing with a coupled trailer, hold the section of the steering wheel nearest to you and rotate clockwise to turn the trailer left or counterclockwise to turn it right. Always rotate a little at a time to prevent steering error. Have someone guide you when reversing to lessen the risk of an accident.

■ Increasing vehicle-to-vehicle distance

At a speed of 10 km/h (6 mph), the distance to the vehicle running ahead of you should be equivalent to or greater than the combined length of your vehicle and trailer. Avoid sudden braking that may cause skidding. Otherwise, the vehicle may spin out of control. This is especially true when driving on wet or slippery road surfaces.

■ Sudden acceleration/steering input/cornering

Executing sharp turns when towing may result in the trailer colliding with your vehicle. Decelerate well in advance when approaching turns and take them slowly and carefully to avoid sudden braking.

■ Important points regarding turning

The wheels of the trailer will travel closer to the inside of the curve than the wheels of the vehicle. To make allowance for this, take the turns wider than you would normally do.

■ Important points regarding stability

Vehicle movement resulting from uneven road surfaces and strong crosswinds will affect handling. The vehicle may also be rocked by passing buses or large trucks. Frequently check behind when moving alongside such vehicles. As soon as such vehicle movement occurs, immediately start to decelerate smoothly by slowly applying the brakes. Always steer the vehicle straight ahead while braking.

■ Passing other vehicles

Consider the total combined length of your vehicle and trailer and ensure that the vehicle-to-vehicle distance is sufficient before executing lane changes.

■ **Transmission information**

Vehicles with a Multidrive and multi-mode manual transmission:

To maintain engine braking efficiency, when using engine braking, do not use the transmission in D. Transmission shift gear position must be in 4 in the M mode. (→P. 253, 258)

Vehicles with a manual transmission:

To maintain engine braking efficiency, when using engine braking, do not use the transmission in 5 and 6 (vehicles with a 6-speed manual transmission) gear. (→P. 263)

■ **If the engine overheats**

Towing a loaded trailer up a long, steep incline in temperatures exceeding 30°C (85°F) may result in the engine overheating. If the high engine coolant temperature warning light flashes or comes on, turn the air conditioning off immediately, leave the road and stop the vehicle in a safe place. (→P. 642)

■ **When parking the vehicle**

Always place wheel chocks under the wheels of both the vehicle and trailer. Firmly set the parking brake and shift the shift lever to P for Multidrives, E, M or R for multi-mode manual transmissions, and 1 or R for manual transmissions.

 **CAUTION**

Follow all the instructions described in this section. Failure to do so could cause an accident resulting in death or serious injury.

■ Trailer towing precautions

When towing, make sure that none of the weight limits are exceeded.
(→P. 342)

■ Vehicle speed in towing

Observe the legal maximum speeds for trailer towing.

■ Before descending hills or long declines

Reduce speed and downshift. However, never downshift suddenly while descending steep or long downhill grades.

■ Operation of the brake pedal

Do not hold the brake pedal depressed often or for long periods of time. Doing so may result in the brake overheating or reduce braking effects.

■ To avoid accident or injury

- Vehicles with a cruise control: Do not use cruise control when you are towing.
- Vehicles with a compact spare tire: Do not tow a trailer when the compact spare tire is installed on your vehicle.
- Vehicles with an emergency tire puncture repair kit: Do not tow a trailer when the tire installed is repaired with the emergency tire puncture repair kit.

3-1. Using the air conditioning system and defogger

Manual air conditioning system	354
Automatic air conditioning system	361
Power heater	370
Rear window and outside rear view mirror defoggers	372

3-2. Using the audio system

Audio system types	374
Using the radio	379
Using the CD player	383
Playing back MP3 and WMA discs.....	388
Operating an iPod.....	394
Operating a USB memory.....	402
Optimal use of the audio system	409
Using the AUX port.....	411
Using the steering wheel audio switches	412

3-3. Using the interior lights

Interior lights list.....	415
• Personal lights	416
• Interior light.....	416

3-4. Using the storage features

List of storage features	418
• Glove box	419
• Cup holders	420
• Bottle holders.....	422

3-5. Other interior features

Sun visors	423
Vanity mirrors.....	424
Clock.....	426
Outside temperature display	427
Portable ashtray.....	428
Cigarette lighter	429
Power outlet.....	430
Seat heaters	432
Armrest	434
Panoramic roof shade.....	435
Assist grips	436
Floor mat.....	437
Luggage compartment features.....	439

3-1. Using the air conditioning system and defogger Manual air conditioning system*

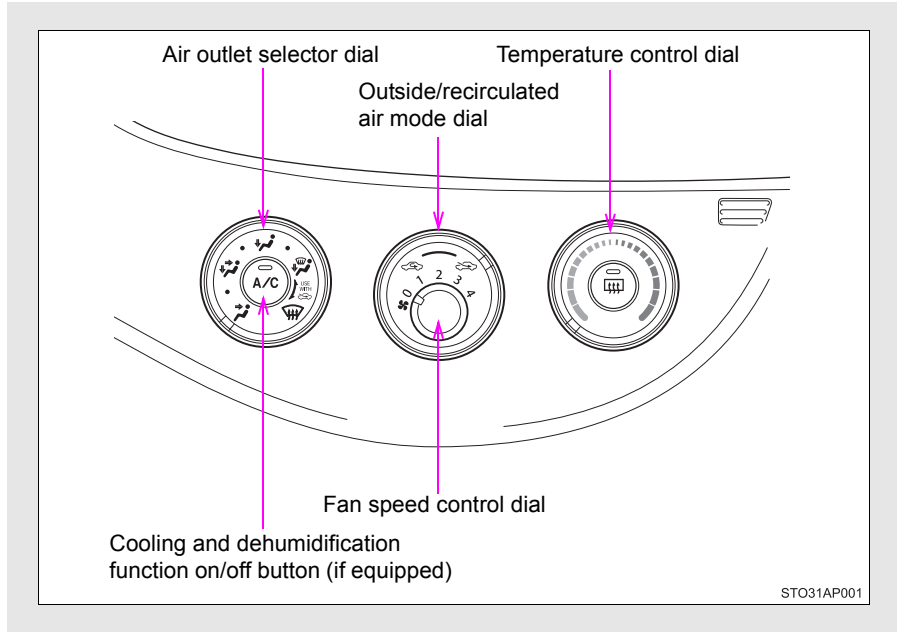

*: If equipped

Adjusting the settings

STEP 1 To adjust the fan speed, turn the fan speed control dial clockwise (increase) or counterclockwise (decrease).

Turning the dial to “0” turns off the fan.

STEP 2 Vehicles without a cooling and dehumidification function on/off button:

Turn the temperature control dial clockwise to increase the temperature.

Vehicles with a cooling and dehumidification function on/off button:

To adjust the temperature setting, turn the temperature control dial clockwise (warm) or counterclockwise (cool).

If  is not pressed, the system will blow ambient temperature air or heated air.

STEP 3 To select the air outlets, set the air outlet selector dial to the desired position.

The positions between the air outlet selectors shown below can also be selected for more delicate adjustment.

Defogging the windshield

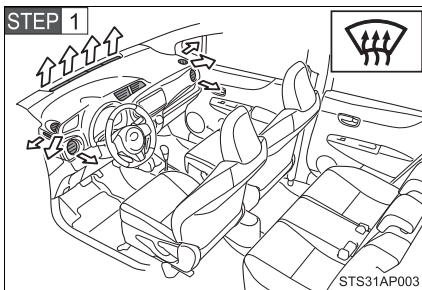

Set the air outlet selector dial to  position.

Set the outside/recirculated air mode dial to outside mode if recirculated air mode is used.

STEP 2 Perform the following operations accordingly:

- To adjust the fan speed, turn the fan speed control dial.
- To adjust the temperature setting, turn the temperature control dial.
- If the dehumidification function is not operating, press



to operate the dehumidification function.

To defog the windshield and the side windows early, turn the air flow and temperature up.

Air outlets and air flow

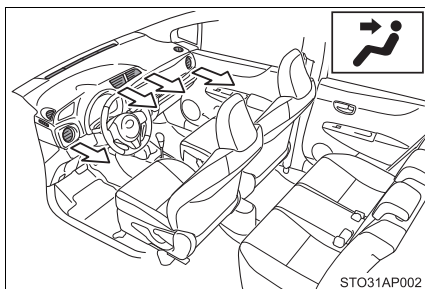

Air flows to the upper body.

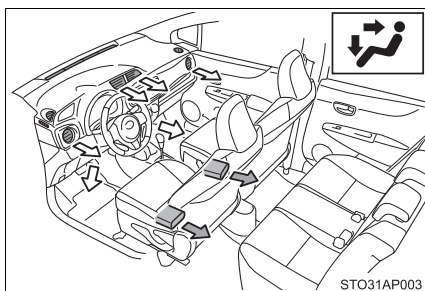

Air flows to the upper body and feet.

← : Some models

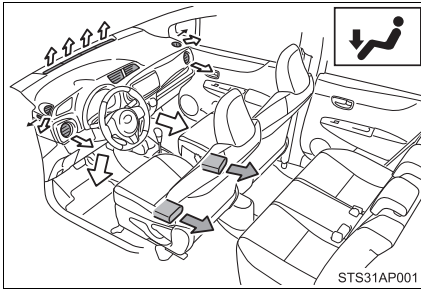

Air flows mainly to the feet.

← : Some models

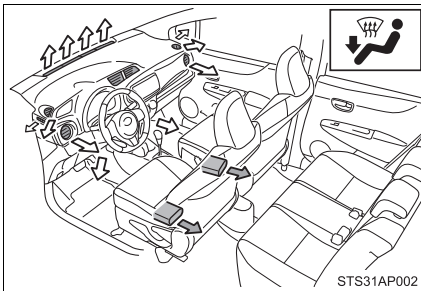



Air flows to the feet and the windshield defogger operates.

Use the outside/recirculated air mode dial at  (outside air mode).

← : Some models

Switching between outside air and recirculated air modes

Turn the outside/recirculated air mode dial to  (outside air mode) or  (recirculated air mode).

Adjusting the position of and opening and closing the air outlets

Center outlets

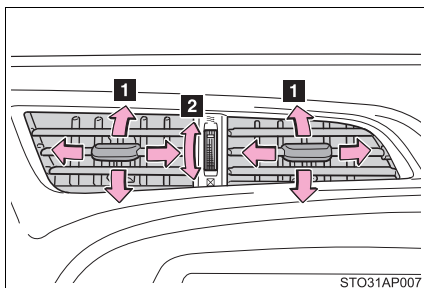

STO31AP007

1 Direct air flow to the left or right, up or down.

2 Turn the knob to open or close the vent.

Right and left side outlets

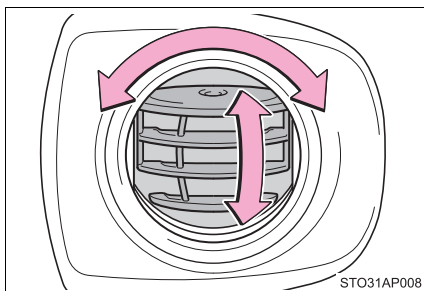

STO31AP008

Direct air flow to the left or right, up or down.

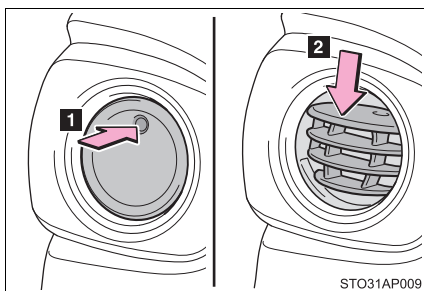

STO31AP009

1 Open the vent.

2 Close the vent.

■ Fogging up of the windows

- The windows will easily fog up when the humidity in the vehicle is high.

Turning  on will dehumidify the air from the outlets and defog the windshield effectively.

- If you turn  off, the windows may fog up more easily.
- The windows may fog up if the recirculated air mode is used.

■ Outside/recirculated air mode

When driving on dusty roads such as tunnels or in heavy traffic, set the outside/recirculated air mode dial to the recirculated air mode. This is effective in preventing outside air from entering the vehicle interior. During cooling operation, setting the recirculated air mode will also cool the vehicle interior effectively.

■ When the indicator light on goes off by itself (vehicles with a cooling and dehumidification function on/off button)

Press  to turn off the dehumidification function and turn it on again.

There may be a problem in the air conditioning system if the indicator light goes off again. Turn the air conditioning system off and have it inspected by any authorized Toyota dealer or repairer, or another duly qualified and equipped professional.

■ When the outside temperature falls to nearly 0°C (32°F) (vehicles with a cooling and dehumidification function on/off button)

The dehumidification function may not operate even when  is pressed.

■ **Air conditioning odors**

- During use, various odors from inside and outside the vehicle may enter into and accumulate in the air conditioning system. This may then cause odor to be emitted from the vents.
- To reduce potential odors from occurring:
It is recommended that the air conditioning system be set to outside air mode prior to turning the vehicle off.

■ **An odor comes from the air conditioning system due to the Stop & Start system operation (vehicles with a Stop & Start system)**

When the engine is stopped due to the Stop & Start system, an odor caused by moisture may be detected. This does not indicate a malfunction.

■ **Air conditioning filter**

→P. 498

 **CAUTION**

■ **To prevent the windshield from fogging up**

Do not use  during cool air operation in extremely humid weather. The difference between the temperature of the outside air and that of the windshield can cause the outer surface of the windshield to fog up, blocking your vision.

 **NOTICE**

■ **To prevent battery discharge**

Do not leave the air conditioning system on longer than necessary when the engine is stopped.

3-1. Using the air conditioning system and defogger

Automatic air conditioning system*

Air outlets and fan speed are automatically adjusted according to the temperature setting.

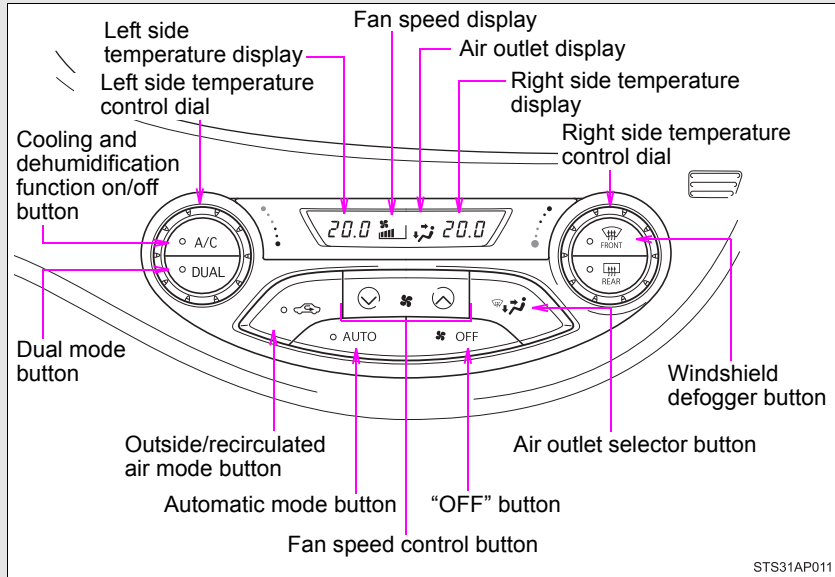





Using the automatic mode

STEP 1 Press .

Air outlets and fan speed are automatically adjusted according to the temperature setting.

*: If equipped

STEP 2 Turn  clockwise to increase the temperature and turn  counterclockwise to decrease the temperature.

When  is pressed (the indicator on  is on) or  is turned, the temperature for the driver side and front passenger side can be adjusted separately.



STEP 3 Press .



The cooling and dehumidification function turns on and off each time  is pressed.

Adjusting the settings manually

STEP 1 To adjust the fan speed, press “^” on  to increase the fan speed and “v” to decrease the fan speed.

Press  to turn the fan off.

STEP 2 To adjust the temperature setting, turn  clockwise to increase the temperature and turn  counterclockwise to decrease the temperature.

When  is pressed (the indicator on  is on) or  is turned, the temperature for the driver side and front passenger side can be adjusted separately.

If  is not pressed, the system will blow ambient temperature air or heated air.

STEP 3 To change the air outlets, press .

The air outlets used are switched each time  is pressed.

Defogging the windshield

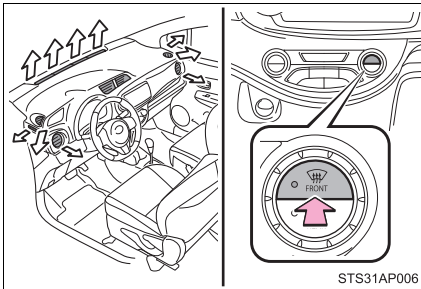

Press .

The dehumidification function operates and fan speed increases.

Set the outside/recirculated air mode button to the outside air mode if the recirculated air mode is used. (It may switch automatically.) To defog the windshield and the side windows early, turn the air flow and temperature up.

To return to the previous mode,

press  again when the windshield is defogged.

Air outlets and air flow

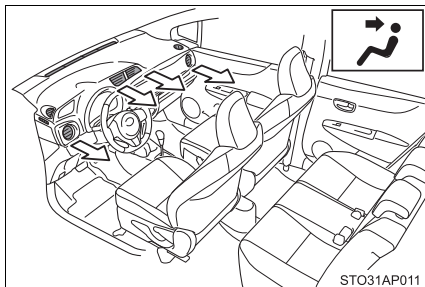

Air flows to the upper body.

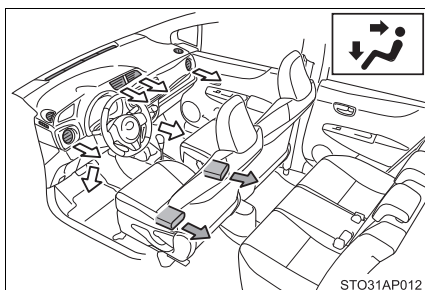

Air flows to the upper body and feet.

← : Some models

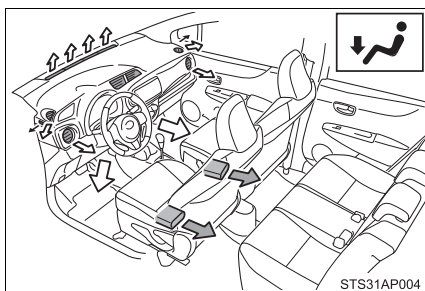

Air flows mainly to the feet.

← : Some models

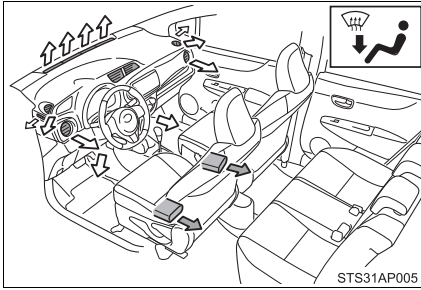

Air flows to the feet and the windshield defogger operates.

← : Some models

Switching between outside air and recirculated air modes

Press .

The mode switches between outside air mode (the indicator is off) and recirculated air mode (the indicator is on) each time the button is pressed.

Adjusting the position of and opening and closing the air outlets

Center outlets

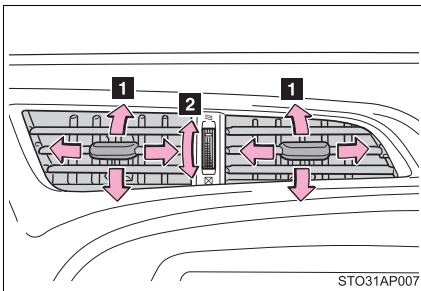

- 1** Direct air flow to the left or right, up or down.
- 2** Turn the knob to open or close the vent.

Right and left side outlets

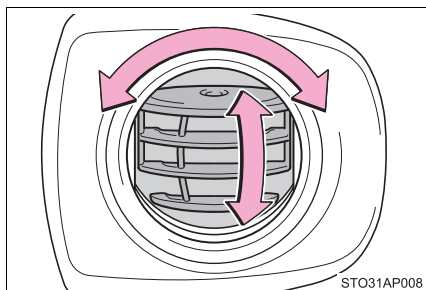

Direct air flow to the left or right, up or down.

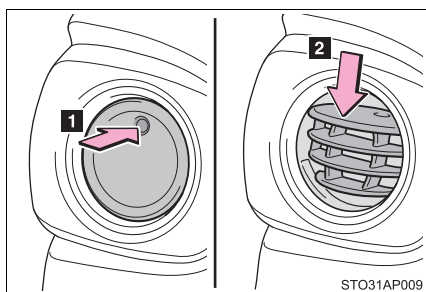

1 Open the vent.

2 Close the vent.

■ Operation of the air conditioning system in Eco drive mode (hybrid vehicle)

In Eco drive mode, the air conditioning system is controlled as follows to prioritize fuel efficiency:

- Heating/cooling capacity is restricted.
- Outside/recirculated air mode automatically switch depending on the temperature setting or the inside temperature.
- Fan speed restricted when automatic mode is selected.

To improve air conditioning performance, perform the following operations:

- Adjust the fan speed or the setting temperature.
- Turn off Eco drive mode.

■ Customization

The air conditioning control of Eco drive mode can be changed to the same setting as that used in normal drive mode.
(Customizable features→P. 689)

■ Using the automatic mode

Fan speed is adjusted automatically in accordance with the temperature setting and the ambient conditions.

Therefore, the fan may stop for a while until warm or cool air is ready to flow immediately after  is pressed.

■ Fogging up of the windows

- The windows will easily fog up when the humidity in the vehicle is high.

Turning  on will dehumidify the air from the outlets and defog the windshield effectively.

- If you turn  off, the windows may fog up more easily.
- The windows may fog up if the recirculated air mode is used.

■ Outside/recirculated air mode

- When driving on dusty roads such as tunnels or in heavy traffic, set the outside/recirculated air mode button to the recirculated air mode. This is effective in preventing outside air from entering the vehicle interior. During cooling operation, setting the recirculated air mode will also cool the vehicle interior effectively.
- Outside/recirculated air mode may automatically switch depending on the temperature setting or the inside temperature.

■ When the outside temperature falls to nearly 0°C (32°F)

The dehumidification function may not operate even when  is pressed.

■ **When the indicator light on  goes off by itself**

Press  to turn off the dehumidification function and turn it on again.

There may be a problem in the air conditioning system if the indicator light goes off again. Turn the air conditioning system off and have it inspected by any authorized Toyota dealer or repairer, or another duly qualified and equipped professional.

■ **Air conditioning odors**

- During use, various odors from inside and outside the vehicle may enter into and accumulate in the air conditioning system. This may then cause odor to be emitted from the vents.
- To reduce potential odors from occurring:
 - It is recommended that the air conditioning system be set to outside air mode prior to turning the vehicle off.
 - The start timing of the blower may be delayed for a short period of time immediately after the air conditioning system is started in AUTO mode.

■ **An odor comes from the air conditioning system due to the Stop & Start system operation (vehicles with a Stop & Start system)**

When the engine is stopped due to the Stop & Start system, an odor caused by moisture may be detected. This does not indicate a malfunction.

■ **Air conditioning filter**

→P. 498

 **CAUTION**

■ **To prevent the windshield from fogging up**

Do not use  during cool air operation in extremely humid weather. The difference between the temperature of the outside air and that of the windshield can cause the outer surface of the windshield to fog up, blocking your vision.

 NOTICE

■ **To prevent battery discharge (except hybrid vehicle)**

Do not leave the air conditioning system on longer than necessary when the engine is stopped.

■ **To prevent 12-volt battery discharge (hybrid vehicle)**

Do not leave the air conditioning system on longer than necessary when the hybrid system is off.

3-1. Using the air conditioning system and defogger

Power heater*

This feature is used to keep the cabin warm in cold conditions.

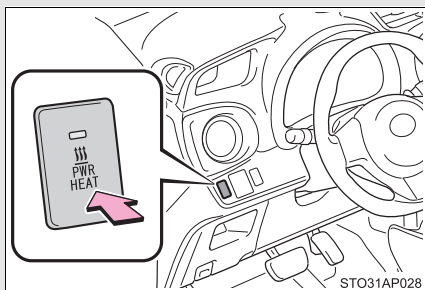

Turns the power heater on/off

The power heater turns on about 25 seconds after the button is pressed, and takes about another 85 seconds to warm up.

■ Power heater can be operated when

The engine is running.

■ Normal characteristics of power heater operation

The following cases do not indicate a malfunction:

- When the power heater is turned on or off, some white smoke and a slight odor may be emitted from the power heater exhaust that is located under the floor.
- When the power heater is used under extremely cold conditions, vapor may be visible from its exhaust.
- When the power heater is turned off, you may hear a sound in the engine compartment for about 2 minutes until the power heater turns off completely.

■ After the heater is turned off

We recommend not restarting the heater for 10 minutes after you turn it off. Otherwise, a noise may be heard as the heater ignites.

■ When refueling your vehicle

The engine must be turned off. Turning the engine off turns the power heater off.

*: If equipped

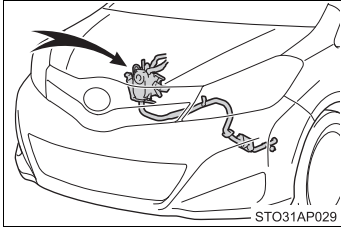
⚠ CAUTION**■ To prevent burns or damage to your vehicle**

- Do not touch the heater or its exhaust pipe as they are hot. You may burn yourself.
- Keep flammable items such as fuel away from the heater and its exhaust pipe, as this may cause a fire.

⚠ NOTICE**■ To prevent damage to your vehicle**

- Do not turn the heater on and off repeatedly in 5 minute intervals as this can shorten the life of the heater components. If the engine must be turned on and off repeatedly within short intervals (such as when the vehicle is being used for delivery purposes), turn the heater off.
- Do not modify or open the heater without consulting any authorized Toyota dealer or repairer, or another duly qualified and equipped professional, as this may cause a heater malfunction or a fire.
- Be careful not to splash or spill liquid directly on the heater or on the heater fuel pump, as this may cause the heater to malfunction.
- Keep the intake and exhaust pipes of the heater free from water, snow, ice, mud, etc. If the pipes become clogged, this can cause the heater to malfunction.
- If you notice anything unusual, such as a fluid leak, smoke and poor operation, turn off the heater and have your vehicle checked by any authorized Toyota dealer or repairer, or another duly qualified and equipped professional.

3-1. Using the air conditioning system and defogger Rear window and outside rear view mirror defoggers*

Defoggers are used to defog the rear window, and to remove rain-drops, dew and frost from the outside rear view mirrors.

Vehicles with a manual air conditioning system

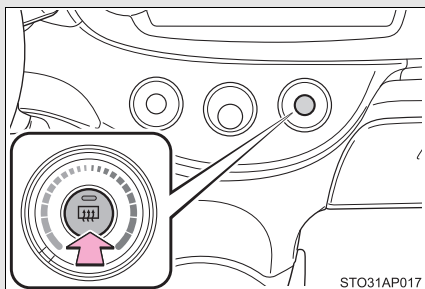

Turns the defoggers on/off

The defoggers will automatically turn off after approximately 15 minutes.

Vehicles with an automatic air conditioning system

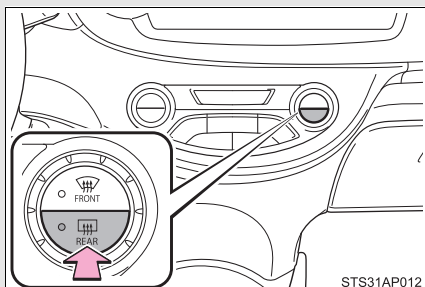

Turns the defoggers on/off

Except hybrid vehicle: The defoggers will automatically turn off the operation time. The operation time is between 15 minutes and 1 hour depending on the ambient temperature and vehicle speed.

Hybrid vehicle: The defogger will automatically turn off after approximately 15 minutes.

*: If equipped

■ The defoggers can be operated when**Except hybrid vehicle**

Vehicles without a smart entry & start system:

The engine switch is in the “ON” position.

Vehicles with a smart entry & start system:

The “ENGINE START STOP” switch is in IGNITION ON mode.

Hybrid vehicle

Vehicles without an electronic key:

The engine switch is in the “ON” position.

Vehicles with an electronic key:

The “POWER” switch is in ON mode.

■ The outside rear view mirror defoggers (if equipped)

Turning the rear window defogger on will turn the outside rear view mirror defoggers on.

⚠ CAUTION**■ When the outside rear view mirror defoggers (if equipped) are on**

Do not touch the outside surface of the rear view mirrors, as they can become very hot and burn you.

3-2. Using the audio system

Audio system types*

Vehicles with a “touch screen”

Owners of models equipped with a “touch screen” should refer to the “touch screen” Owner’s Manual.

The illustrations below is for left-hand drive vehicles. Some button positions are reversed for right-hand drive vehicles.

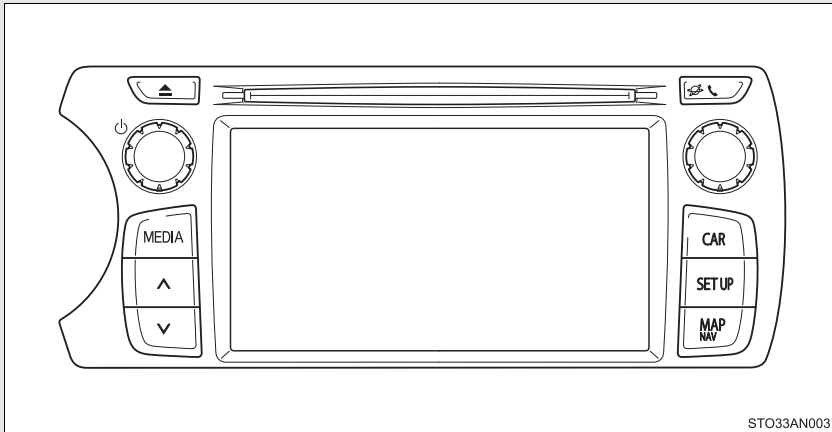

*: If equipped

Vehicles without a “touch screen”

CD player and AM/FM radio

The illustration below is for left-hand drive vehicles. Some button positions are reversed for right-hand drive vehicles.

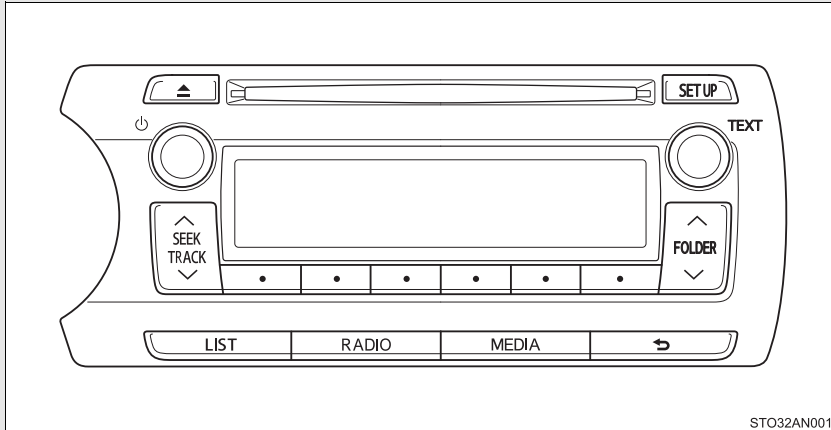

Title	Page
Using the radio	P. 379
Using the CD player	P. 383
Playing back MP3 and WMA discs	P. 388
Operating an iPod	P. 394
Operating a USB memory	P. 402
Optimal use of the audio system	P. 409
Using the AUX port	P. 411
Using the steering wheel audio switches	P. 412

■ **Using cellular phones**

Interference may be heard through the audio system's speakers if a cellular phone is being used inside or close to the vehicle while the audio system is operating.

■ Certification for the Bluetooth® (vehicles with a “touch screen”)

FUJITSU TEN LIMITED
 Engineering Management Department
 Design Management Division
 Products Management Group

FUJITSU TEN

2-28, Goshō-dori 1-chome, Hyogo-ku, Kobe, 652-8510, Japan
 Tel.: +81.78-682-2031 Fax: +81.78-671-7160

DECLARATION of CONFORMITY

We, FUJITSU TEN LIMITED of the above address, hereby declare, at our sole responsibility, that the following product conforms to the Essential Requirements of the Radio and Telecommunications Terminal Equipment Directive 1999/5/EC in accordance with the tests conducted to the appropriate requirements of the relevant standards, as listed herewith.

Product Name:	CD Receiver with Bluetooth and Display	
Model Number:	FT0017A	
Reference Standards:	<u>Radio :</u> EN 300 328 V1.7.1(2006-10) <u>EMC :</u> EN 301 489-1 V1.8.1(2008-04) EN 301 489-17 V2.1.1(2009-05) <u>Safety :</u> EN 60065 2002+A1:2006+A11:2008	

Supplementary Information:

CE Mark	
Member states intend for use	EU and EFTA
Member states with restrictive use	None

Signature: 
 Takao KAMAI

Position: Department General Manager
 Engineering Management Department
 Design Management Division
 Products Management Group

Date of issue: 27 May 2010
 Place of issue: Kobe, Japan

The latest “DECLARATION of CONFORMITY” (DoC) is available at the address stated in the DoC.

Ovim ,FUJITSU TEN LIMITED, izjavljuje da ovaj FT0017A je usklađen sa bitnim zahtjevima idrugim relevantnim odredbama Direktive 1999/5/EC.

■ **About Bluetooth® (vehicles with a “touch screen”)**



The Bluetooth word mark and logos are owned by the Bluetooth SIG, Inc. and any use of such marks by Fujitsu Ten Limited is under license. Other trademarks and trade names are those of their respective owners.

 **NOTICE**

■ **To prevent battery discharge (except hybrid vehicle)**

Do not leave the audio system on longer than necessary when the engine is stopped.

■ **To prevent 12-volt battery discharge (hybrid vehicle)**

Do not leave the audio system on longer than necessary when the hybrid system is off.

■ **To avoid damaging the audio system**

Take care not to spill drinks or other fluids over the audio system.

3-2. Using the audio system

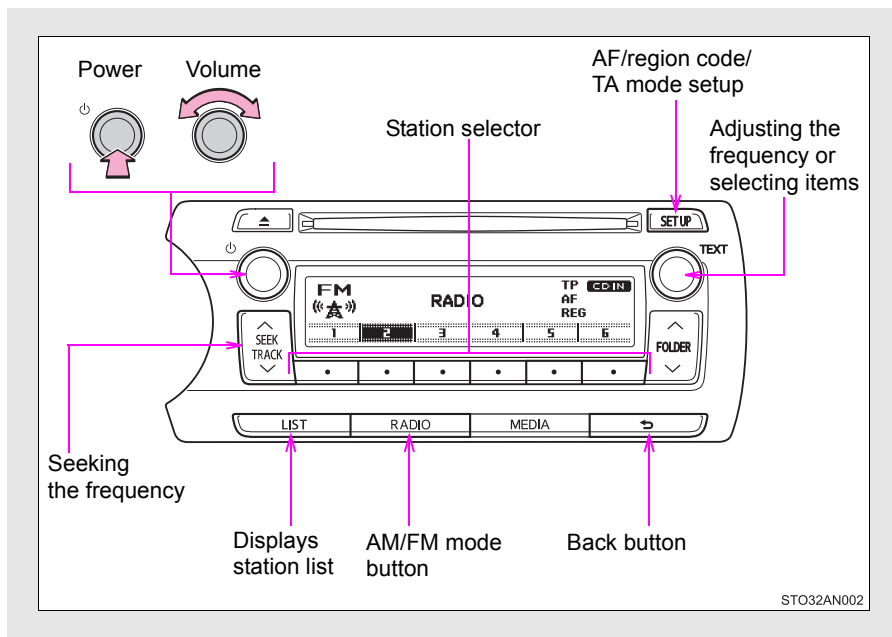

Using the radio*



Setting station presets

STEP 1 Search for desired stations by turning  or pressing “^” or

“v” on .

STEP 2 Press and hold the button (from  [1] to  [6]) the station is to be set to until you hear a beep.

*: If equipped

Using the station list

■ Updating the station list

STEP 1 Press  .

The station list will be displayed.

STEP 2 Press  (UPDATE) to update the list.

“Updating” is displayed while the searching is in process, and then available stations will be listed on the display.

To cancel the updating process, press  .

■ Selecting a station from the station list

STEP 1 Press  .

The station list will be displayed.

STEP 2 Turn  to select a station.

STEP 3 Press  to tune in the station.

To return to the previous display, press  .

RDS (Radio Data System)

This feature allows your radio to receive station.

■ Listening to stations of the same network

STEP 1 Press  .

STEP 2 Turn  to “RADIO” and press  .

STEP 3 Turn  as corresponds to the desired mode: “FM AF” or “Region code”.

STEP 4 Press  to select “ON” or “OFF”.

FM AF ON mode: The station among those of the same network with strong reception is selected.

Region code ON mode: The station among those of the same network with strong reception and broadcasting the same program is selected.

■ Traffic information

STEP 1 Press .

STEP 2 Turn  to “RADIO” and press .

STEP 3 Turn  to “FM TA” mode.

STEP 4 Press  to select “ON” or “OFF”.

TP mode: The system automatically switches to traffic information when a broadcast with a traffic information signal is received.

The station returns to the previous one when the traffic information ends.

TA mode: The system automatically switches to traffic information when a broadcast with a traffic information signal is received. In FM modes, the system will be mute unless traffic information is being broadcast.

The audio system returns to the previous mode when the traffic information ends.

■ **EON (Enhanced Other Network) system (for traffic announcement function)**

If the RDS station (with EON data) you are listening to is not broadcasting a traffic information program and the audio system is in the TA (traffic announcement) mode, the radio will be switched automatically to a station broadcasting a traffic information program in the EON AF list when traffic information begins.

■ **When the battery (except hybrid vehicle) or 12-volt battery (hybrid vehicle) is disconnected**

Stations presets are erased.

■ **Reception sensitivity**

- Maintaining perfect radio reception at all times is difficult due to the continually changing position of the antenna, differences in signal strength and surrounding objects, such as trains, transmitters, etc.
- The radio antenna is mounted on the rear roof. The antenna can be removed from the base by turning it.

■ **Digital Audio Broadcast (DAB) radio**

The optional radio antenna and tuner are necessary for the use of Digital Audio Broadcast (DAB) radio.

 NOTICE

■ **To prevent damage, remove the antenna in the following cases.**

- The antenna will touch the ceiling of a garage.
- A cover will be put on the roof.

3-2. Using the audio system Using the CD player*

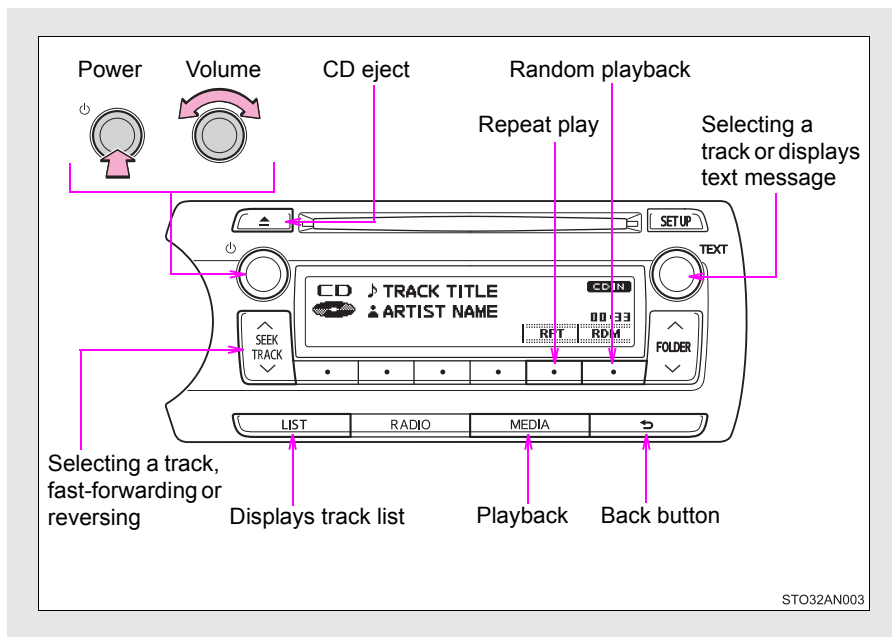



Loading CDs

Insert a CD.

Ejecting CDs

Press  and remove the CD.

Selecting a track

Turn  or press “^” to move up or “v” to move down using  until the desired track number is displayed.

*: If equipped

Selecting a track from a track list

STEP 1 Press  .

The track list will be displayed.

STEP 2 Turn and press  to select a track.

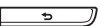
To return to the previous display, press  or  .

Fast-forwarding and reversing tracks

To fast-forward or reverse, press and hold “^” or “v” on  .

Random playback

Press  (RDM).

To cancel, press  (RDM) again.

Repeat play

Press  (RPT).

To cancel, press  (RPT) again.

Switching the display

Press  .

Track title, Artist name and CD title are shown on the display.

To return to the previous display, press  or  .

■ Display

Up to 24 characters can be displayed.

Depending on the contents recorded, the characters may not be displayed properly or may not be displayed at all.

■ Error messages

“ERROR”: This indicates a problem either in the CD or inside the player.

“CD CHECK”: The CD may be dirty, damaged or inserted up-side down.

“WAIT”: Operation has stopped due to a high temperature inside the player. Wait for a while and then press . If the CD still cannot be played back, contact any authorized Toyota dealer or repairer, or another duly qualified and equipped professional.

■ Discs that can be used

Discs with the marks shown below can be used.

Playback may not be possible depending on recording format or disc features, or due to scratches, dirt or deterioration.



CDs with copy-protect features may not be used.

■ CD player protection feature

To protect the internal components, playback is automatically stopped when a problem is detected while the CD player is being used.

■ If a CD is left inside the CD player or in the ejected position for extended periods

The CD may be damaged and may not play properly.

■ Lens cleaners

Do not use lens cleaners. Doing so may damage the CD player.

⚠ CAUTION

■ Certification for the CD player

This product is a class I laser product.

- Do not open the cover of the player or attempt to repair the unit yourself. Refer servicing to qualified personnel.
- Laser power: No hazardous

⚠ NOTICE

■ CDs and adapters that cannot be used

Do not use the following types of CDs or 8 cm (3 in.) CD adapters or Dual Disc.

Doing so may damage the CD player and/or the CD insert/eject function.

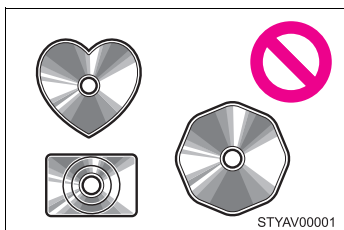

- CDs that have a diameter that is not 12 cm (4.7 in.)

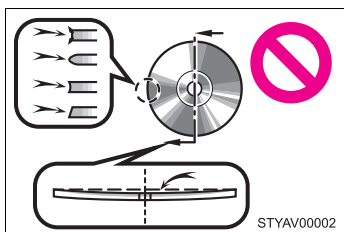

- Low-quality and deformed CDs

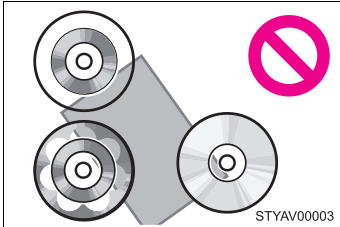
 NOTICE

- CDs with a transparent or translucent recording area

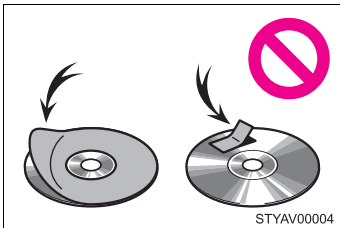

- CDs that have had tape, stickers or CD-R labels attached to them, or that have had the label peeled off

■ CD player precautions

Failure to follow the precautions below may result in serious damage to the CDs or the player itself.

- Do not insert anything other than CDs into the CD slot.
- Do not apply oil to the CD player.
- Store CDs away from direct sunlight.
- Never try to disassemble any part of the CD player.

3-2. Using the audio system

Playing back MP3 and WMA discs*

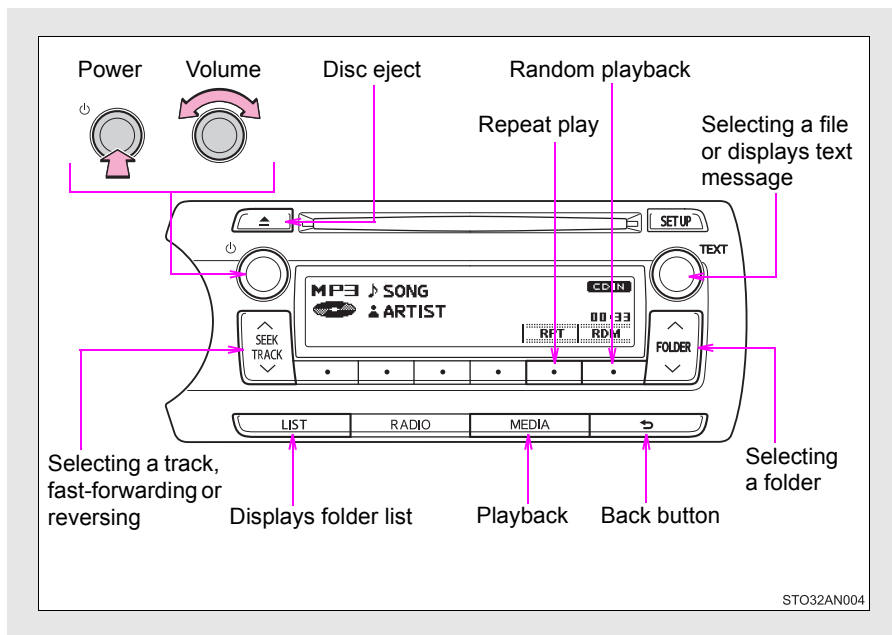

Loading and ejecting MP3 and WMA discs

→P. 383

Selecting a folder

■ Selecting folders one at a time

Press “^” or “v” on  to select the desired folder.

*: If equipped

■ Selecting a folder and file from folder list

STEP 1 Press  .

The folder list will be displayed.

STEP 2 Turn and press  to select a folder and a file.

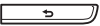

To return to the previous display, press  .

To exit, press  .

■ Returning to the first folder

Press and hold “√” on  until you hear a beep.

Selecting files

Turn  or press “∧” or “√” on  to select the desired file.

Fast-forwarding and reversing files

To fast-forward or reverse, press and hold “∧” or “√” on  .

Random playback

Pressing  (RDM) changes modes in the following order:
Folder random → Disc random → Off

Repeat play

Pressing  (RPT) changes modes in the following order:
File repeat → Folder repeat* → Off

*: Available except when RDM (random playback) is selected

Switching the display

Press  .

Track title, Artist name and Album title (MP3 only) are shown on the display.

To return to the previous display, press  or  .

■ Display

Up to 24 characters can be displayed.

Depending on the contents recorded, the characters may not be displayed properly or may not be displayed at all.

■ Error messages

“ERROR”: This indicates a problem either in the CD or inside the player.

“CD CHECK”: The CD may be dirty, damaged or inserted up-side down.

“NO SUPPORT”: This indicates that the MP3/WMA file is not included in the CD.

■ Discs that can be used

Discs with the marks shown below can be used.

Playback may not be possible depending on recording format or disc features, or due to scratches, dirt or deterioration.



■ CD player protection feature

To protect the internal components, playback is automatically stopped when a problem is detected while the CD player is being used.

■ If a CD is left inside the CD player or in the ejected position for extended periods

The CD may be damaged and may not play properly.

■ Lens cleaners

Do not use lens cleaners. Doing so may damage the CD player.

■ MP3 and WMA files

MP3 (MPEG Audio LAYER3) is a standard audio compression format.

Files can be compressed to approximately 1/10 of their original size by using MP3 compression.

WMA (Windows Media Audio) is a Microsoft audio compression format.

This format compresses audio data to a size smaller than that of the MP3 format.

There is a limit to the MP3 and WMA file standards and to the media/formats recorded by them that can be used.

● MP3 file compatibility

- Compatible standards
MP3 (MPEG1 LAYER3, MPEG2 LSF LAYER3)
- Compatible sampling frequencies
MPEG1 LAYER3: 32, 44.1, 48 (kHz)
MPEG2 LSF LAYER3: 16, 22.05, 24 (kHz)
- Compatible bit rates (compatible with VBR)
MPEG1 LAYER3: 64, 80, 96, 112, 128, 160, 192, 224, 256, 320 (kbps)
MPEG2 LSF LAYER3: 64, 80, 96, 112, 128, 144, 160 (kbps)
- Compatible channel modes: stereo, joint stereo, dual channel and monaural

● WMA file compatibility

- Compatible standards
WMA Ver. 7, 8, 9
- Compatible sampling frequencies
32, 44.1, 48 (kHz)
- Compatible bit rates (only compatible with 2-channel playback)
Ver. 7, 8: CBR 48, 64, 80, 96, 128, 160, 192 (kbps)
Ver. 9: CBR 48, 64, 80, 96, 128, 160, 192, 256, 320 (kbps)

● Compatible media

Media that can be used for MP3 and WMA playback are CD-Rs and CD-RWs.

Playback in some instances may not be possible, depending on the status of the CD-R or CD-RW. Playback may not be possible or the audio may jump if the disc is scratched or marked with fingerprints.

● Compatible disc formats

The following disc formats can be used.

- Disc formats: CD-ROM Mode 1 and Mode 2
CD-ROM XA Mode 2, Form 1 and Form 2
- File formats: ISO9660 Level 1, Level 2, (Romeo, Joliet)
MP3 and WMA files written in any format other than those listed above may not play correctly, and their file names and folder names may not be displayed correctly.

Items related to standards and limitations are as follows.

- Maximum directory hierarchy: 8 levels
- Maximum length of folder names/file names: 32 characters
- Maximum number of folders: 192 (including the root)
- Maximum number of files per disc: 255

● File names

The only files that can be recognized as MP3/WMA and played are those with the extension .mp3 or .wma.

● Multi-sessions

As the audio system is compatible with multi-sessions, it is possible to play discs that contain MP3 and WMA files. However, only the first session can be played.

● ID3 and WMA tags

ID3 tags can be added to MP3 files, making it possible to record the track title, artist name, etc.

The system is compatible with ID3 Ver. 1.0, 1.1, and Ver. 2.2, 2.3 ID3 tags. (The number of characters is based on ID3 Ver. 1.0 and 1.1.)

WMA tags can be added to WMA files, making it possible to record the track title and artist name in the same way as with ID3 tags.

● MP3 and WMA playback

When a disc containing MP3 or WMA files is inserted, all files on the disc are first checked. Once the file check is finished, the first MP3 or WMA file is played. To make the file check finish more quickly, we recommend you do not write in any files other than MP3 or WMA files or create any unnecessary folders.

If the discs contain a mixture of music data and MP3 or WMA format data, only music data can be played.

● Extensions

If the file extensions .mp3 and .wma are used for files other than MP3 and WMA files, they will be mistakenly recognized and played as MP3 and WMA files. This may result in large amounts of interference and damage to the speakers.

● Playback

- To play MP3 files with steady sound quality, we recommend a fixed bit rate of 128 kbps and a sampling frequency of 44.1 kHz.
- CD-R or CD-RW playback may not be possible in some instances, depending on the characteristics of the disc.
- There is a wide variety of freeware and other encoding software for MP3 and WMA files on the market, and depending on the status of the encoding and the file format, poor sound quality or noise at the start of playback may result. In some cases, playback may not be possible at all.
- When files other than MP3 or WMA files are recorded on a disc, it may take more time to recognize the disc and in some cases, playback may not be possible at all.
- Microsoft, Windows, and Windows Media are the registered trademarks of Microsoft Corporation in the U.S. and other countries.



NOTICE

■ **CDs and adapters that cannot be used (→P. 386)**

■ **CD player precautions (→P. 387)**

3-2. Using the audio system

Operating an iPod*

Connecting an iPod enables you to enjoy music from the vehicle speakers.

■ Connecting an iPod

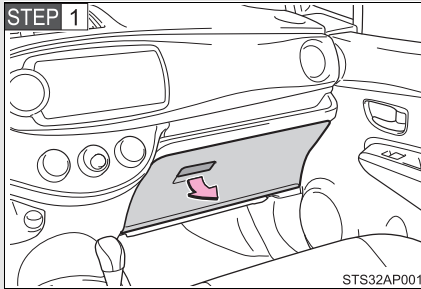

Pull up the lever to open the glove box.

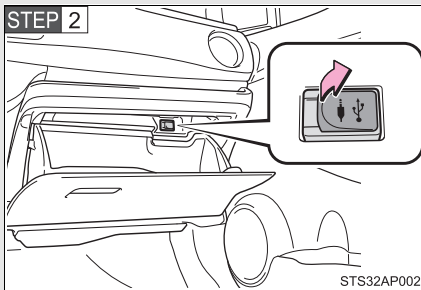

Open the cover and connect an iPod using an iPod cable.

Turn on the power of the iPod if it is not turned on.

STEP 3 Close the glove box and press .

*: If equipped

■ Control panel

The illustration below is for left-hand drive vehicles. Some button positions are reversed for right-hand drive vehicles.

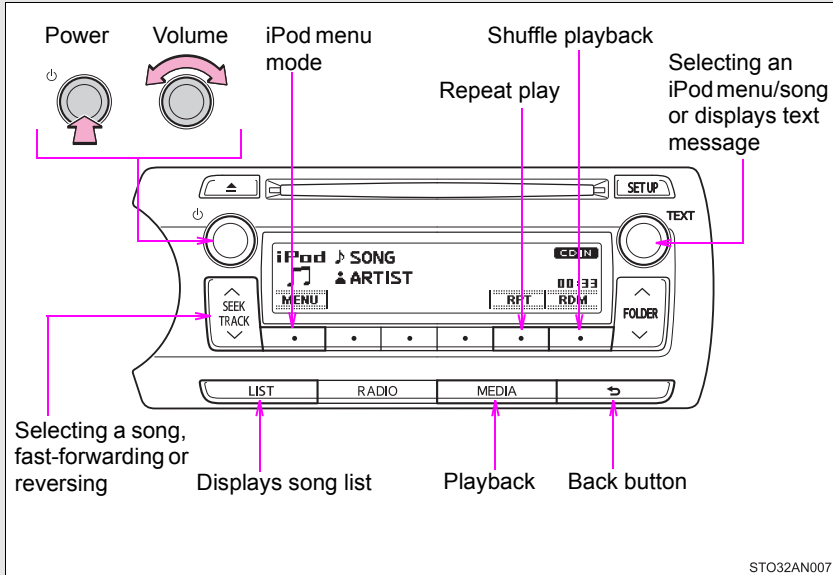

Selecting a play mode

STEP 1 Press (MENU) to select iPod menu mode.

STEP 2 Turning clockwise changes the play mode in the following order:

“Playlists” → “Artists” → “Albums” → “Songs” → “Podcasts”
 → “Genres” → “Composers” → “Audiobooks”

STEP 3 Press to select the desired play mode.

■ Play mode list

Play mode	First selection	Second selection	Third selection	Fourth selection
“Playlists”	Playlists select	Songs select	-	-
“Artists”	Artists select	Albums select	Songs select	-
“Albums”	Albums select	Songs select	-	-
“Songs”	Songs select	-	-	-
“Podcasts”	Podcasts select	Episodes select	-	-
“Genres”	Genre select	Artists select	Albums select	Songs select
“Composers”	Composers select	Albums select	Songs select	-
“Audiobooks”	Audiobooks select	-	-	-

■ Selecting a list

STEP 1 Turn  to display the first selection list.

STEP 2 Press  to select the desired item.

Pressing the knob changes to the second selection list.

STEP 3 Repeat the same procedure to select the desired item.

To return to the previous selection list, press  .

Selecting songs

Turn  or press “^” or “v” on  to select the desired song.

Selecting a song from the song list

STEP 1 Press .

The song list will be displayed.

STEP 2 Turn  to select a song.

STEP 3 Press  to play the song.

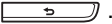
To return to the previous display, press .

Fast-forwarding and reversing songs

To fast-forward or reverse, press and hold “^” or “v” on .

Shuffle playback

Pressing  (RDM) changes modes in the following order:
Track shuffle → Album shuffle → Off

Repeat play

Press  (RPT).

To cancel, press  (RPT) again.

Switching the display

Press  .

Track title, Artist name and Album title are shown on the display.

To return to the previous display, press  or  .

Adjusting sound quality and volume balance

STEP 1 Press  to enter iPod menu mode.

STEP 2 Turning  changes sound modes. (→P. 409)

■ About iPod

- Apple is not responsible for the operation of this device or its compliance with safety and regulatory standards.
- iPod is a trademark of Apple Inc., registered in the U.S. and other countries.

■ iPod functions

- When an iPod is connected and the audio source is changed to iPod mode, the iPod will resume play from the same point in which it was last used.
- Depending on the iPod that is connected to the system, certain functions may not be available. If a function is unavailable due to a malfunction (as opposed to a system specification), disconnecting the device and reconnecting it once again may resolve the problem.
- While connected to the system, the iPod cannot be operated with its own controls. It is necessary to use the controls of the vehicle's audio system instead.

■ iPod problems

To resolve most problems encountered when using your iPod, disconnect your iPod from the vehicle iPod connection and reset it.

For instructions on how to reset your iPod, refer to your iPod Owner's Manual.

■ Display

→P. 385

■ Error messages

“ERROR”: This indicates a problem in the iPod or its connection.

“NO SONGS”: This indicates that there is no music data in the iPod.

“NO PLAYLISTS”: This indicates that some available songs are not found in a selected playlist.

“UPDATE YOUR IPOD”: This indicates that the version of the iPod is not compatible. Upgrade your iPod software to the latest version.

■ Compatible models

Model	Generation	Software version
iPod	5th generation	Ver. 1.3.0 or higher
iPod nano	1st generation	Ver. 1.3.1 or higher
	2nd generation	Ver. 1.1.3 or higher
	3rd generation	Ver. 1.1.3 or higher
	4th generation	Ver. 1.0.4 or higher
	5th generation	Ver. 1.0.1 or higher
iPod touch	1st generation	Ver. 3.1.2 or higher
	2nd generation	Ver. 3.1.2 or higher
	Late 2009 (8 GB)	Ver. 3.1.2 or higher
	Late 2009 (32 GB/64 GB)	Ver. 3.1.2 or higher
iPod classic	1st generation	Ver. 1.1.2 or higher
	2nd generation (120 GB)	Ver. 2.0.1 or higher
	Late 2009 (160 GB)	Ver. 2.0.3 or higher
iPhone	1st generation (iPhone)	Ver. 3.1.2 or higher
	2nd generation (iPhone 3G)	Ver. 3.1.2 or higher
	3rd generation (iPhone 3GS)	Ver. 3.1.2 or higher
	4th generation (iPhone 4)	Ver. 4.0.0 or higher

Depending on differences between models or software version etc., some models listed above might be incompatible with this system.

iPod 4th generation and earlier models are not compatible with this system.

iPod mini, iPod shuffle and iPod photo are not compatible with this system.

Items related to standards and limitations are as follows:

- Maximum number of lists in device: 9999
- Maximum number of songs in device: 65535
- Maximum number of songs per list: 65535

 CAUTION**■ Caution while driving**

Do not connect iPod or operate the controls.

 NOTICE**■ To prevent damage to iPod**

- Do not leave iPod in the vehicle. The temperature inside the vehicle may become high, resulting in damage to the iPod.
- Do not push down on or apply unnecessary pressure to the iPod while it is connected as this may damage the iPod or its terminal.
- Do not insert foreign objects into the port as this may damage the iPod or its terminal.

3-2. Using the audio system

Operating a USB memory*

Connecting a USB memory enables you to enjoy music from the vehicle speakers.

■ Connecting a USB memory

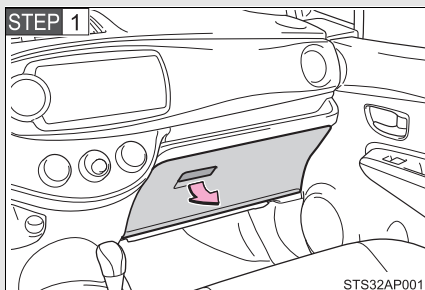

Pull up the lever to open the glove box.

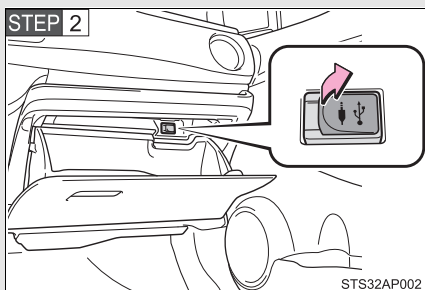

Open the cover and connect a USB memory.

Turn on the power of the USB memory if it is not turned on.

STEP 3 Close the glove box and press MEDIA .

*: If equipped

■ Control panel

The illustration below is for left-hand drive vehicles. Some button positions are reversed for right-hand drive vehicles.

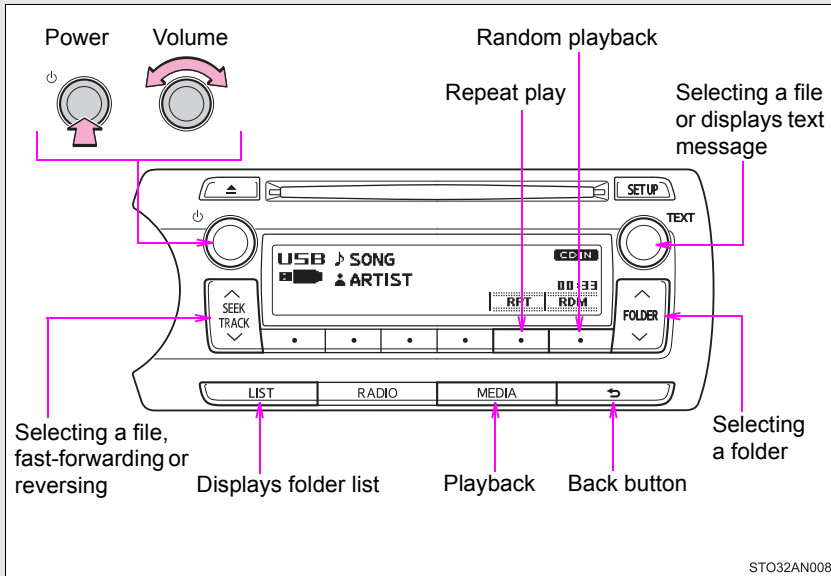

Selecting a folder

■ Selecting folders one at a time

Press “^” or “v” on  to select the desired folder.

■ Selecting a folder and file from folder list

STEP 1 Press  .

The folder list will be displayed.

STEP 2 Turn and press  to select a folder and a file.



To return to the previous display, press  .

To exit, press  .

■ Returning to the first folder

Press and hold “√” on  until you hear a beep.

Selecting files

Turn  or press “^” or “√” on  to select the desired file.

Fast-forwarding and reversing files

To fast-forward or reverse, press and hold “^” or “√” on  .

Random playback

Pressing  (RDM) changes modes in the following order:
Folder random → Disc random → Off

Repeat play

Pressing  (RPT) changes modes in the following order:
File repeat → Folder repeat* → Off

*: Available except when RDM (random playback) is selected

Switching the display

Press  .

Track title, Artist name and Album title (MP3 only) are shown on the display.

To return to the previous display, press  or  .

■ USB memory functions

- Depending on the USB memory that is connected to the system, the device itself may not be operable and certain functions may not be available. If the device is inoperable or a function is unavailable due to a malfunction (as opposed to a system specification), disconnecting the device and reconnecting it once again may resolve the problem.
- If the USB memory still does not begin operation after being disconnected and reconnected, format the memory.

■ Display

→P. 385

■ Error messages

“ERROR”: This indicates a problem in the USB memory or its connection.

“NO MUSIC”: This indicates that no MP3/WMA files are included in the USB memory.

■ USB memory

- Compatible devices

USB memory that can be used for MP3 and WMA playback

● Compatible device formats

The following device formats can be used:

- USB communication formats: USB2.0 FS (12 mbps)
- File formats: FAT16/32 (Windows)
- Correspondence class: Mass storage class

MP3 and WMA files written in any format other than those listed above may not play correctly, and their file names and folder names may not be displayed correctly.

Items related to standards and limitations are as follows:

- Maximum directory hierarchy: 8 levels
- Maximum number of folders in a device: 999 (including the root)
- Maximum number of files in a device: 9999
- Maximum number of files per folder: 255

● MP3 and WMA files

MP3 (MPEG Audio LAYER 3) is a standard audio compression format.

Files can be compressed to approximately 1/10 of their original size using MP3 compression.

WMA (Windows Media Audio) is a Microsoft audio compression format.

This format compresses audio data to a size smaller than that of the MP3 format.

There is a limit to the MP3 and WMA file standards that can be used and to the media/formats on which the files are recorded.

● MP3 file compatibility

- Compatible standards
MP3 (MPEG1 AUDIO LAYERII, III, MPEG2 AUDIO LAYERII, III, MPEG2.5)
- Compatible sampling frequencies
MPEG1 AUDIO LAYERII, III: 32, 44.1, 48 (kHz)
MPEG2 AUDIO LAYERII, III: 16, 22.05, 24 (kHz)
MPEG2.5: 8, 11.025, 12 (kHz)
- Compatible bit rates (compatible with VBR)
MPEG1 AUDIO LAYERII, III: 32-320 (kbps)
MPEG2 AUDIO LAYERII, III: 32-160 (kbps)
MPEG2.5: 32-160 (kbps)
- Compatible channel modes: stereo, joint stereo, dual channel and monaural

- WMA file compatibility

- Compatible standards
WMA Ver. 9
- Compatible sampling frequencies
HIGH PROFILE 32, 44.1, 48 (kHz)
- Compatible bit rates
HIGH PROFILE 32-320 (kbps, VBR)

- File names

The only files that can be recognized as MP3/WMA and played are those with the extension .mp3 or .wma.

- ID3 and WMA tags

ID3 tags can be added to MP3 files, making it possible to record the track title, artist name, etc.

The system is compatible with ID3 Ver. 1.0, 1.1, and Ver. 2.2, 2.3, 2.4 ID3 tags. (The number of characters is based on ID3 Ver. 1.0 and 1.1.)

WMA tags can be added to WMA files, making it possible to record the track title and artist name in the same way as with ID3 tags.

- MP3 and WMA playback

- When a device containing MP3 or WMA files is connected, all files in the USB memory are checked. Once the file check is finished, the first MP3 or WMA file is played. To make the file check finish more quickly, we recommend that you do not include any files other than MP3 or WMA files or create any unnecessary folders.
- When the USB memory is connected and the audio source is changed to USB memory mode, the USB memory will start playing the first file in the first folder. If the same device is removed and reinserted (and the contents have not been changed), the USB memory will resume play from the same point in which it was last used.

- Extensions

If the file extensions .mp3 and .wma are used for files other than MP3 and WMA files, they will be skipped (not played).

● Playback

- To play MP3 files with steady sound quality, we recommend a fixed bit rate of at least 128 kbps and a sampling frequency of 44.1 kHz.
- There is a wide variety of freeware and other encoding software for MP3 and WMA files on the market, and depending on the status of the encoding and the file format, poor sound quality or noise at the start of playback may result. In some cases, playback may not be possible at all.
- Microsoft, Windows, and Windows Media are registered trademarks of Microsoft Corporation in the U.S.A. and other countries.

 CAUTION

■ **Caution while driving**

Do not connect USB memory or operate the controls.

 NOTICE

■ **If the glove box cannot be fully closed**

Depending on the size and shape of the USB memory that is connected to the system, the glove box may not close fully. In this case, do not try to forcibly close the glove box, as this may damage the USB memory or the terminal, etc. Remove the USB memory, and use a different USB memory with a size and shape that allows the glove box to close fully when connected to the system.

■ **To prevent damage to USB memory**

- Do not leave USB memory in the vehicle. The temperature inside the vehicle may become high, resulting in damage to the player.
- Do not push down on or apply unnecessary pressure to the USB memory while it is connected as this may damage the USB memory or its terminal.
- Do not insert foreign objects into the port as this may damage the USB memory or its terminal.

3-2. Using the audio system

Optimal use of the audio system*

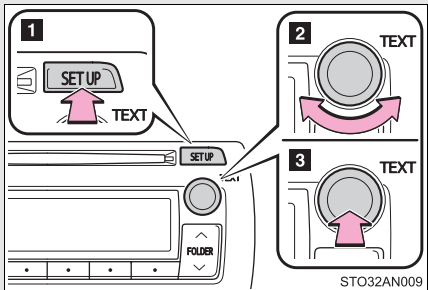

1 Displays the current mode

2 Changes the following setting

- Sound quality and volume balance (→P. 410)

The sound quality and balance setting can be changed to produce the best sound.

- Automatic Sound Levelizer on/off (→P. 410)

3 Selecting the mode

Using the audio control function

■ Changing sound quality modes

STEP 1 Press  .

STEP 2 Turn  to select “Sound Setting”.

STEP 3 Press  .

STEP 4 Turn  as corresponds to the desired mode.

“BASS”, “TREBLE”, “FADER”, “BALANCE”, or “ASL”

STEP 5 Press  .

*: If equipped

■ Adjusting sound quality

Turning  adjusts the level.

Sound quality mode	Mode displayed	Level	Turn to the left	Turn to the right
Bass*	“BASS”	-5 to 5	Low	High
Treble*	“TREBLE”	-5 to 5		
Front/rear volume balance	“FADER”	R7 to F7	Shifts to rear	Shifts to front
Left/right volume balance	“BALANCE”	L7 to R7	Shifts to left	Shifts to right

*: The sound quality level is adjusted individually in each audio mode.

■ Adjusting the Automatic Sound Levelizer (ASL)

When ASL is selected, turning  to the right changes the amount of ASL in the order of LOW, MID and HIGH.

Turning  to the left turns ASL off.

ASL automatically adjusts the volume and tone quality according to vehicle speed.

3-2. Using the audio system

Using the AUX port*

This port can be used to connect a portable audio device and listen to it through the vehicle's speakers.

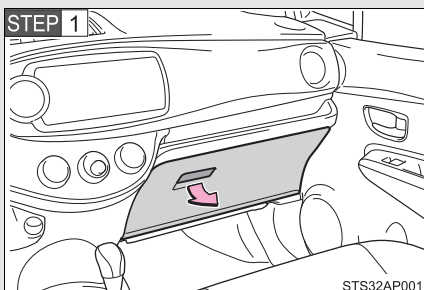

Pull up the lever to open the glove box.

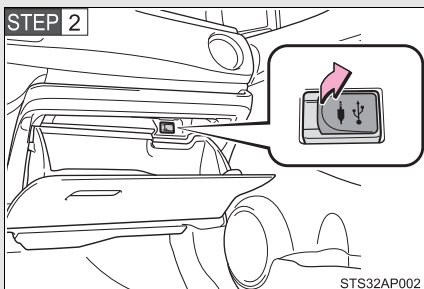

Open the cover and connect the portable audio device.

STEP 3 Close the glove box and press  until "AUX" is displayed.

■ Operating portable audio devices connected to the audio system

The volume can be adjusted using the vehicle's audio controls. All other adjustments must be made on the portable audio device itself.

■ When using a portable audio device connected to the power outlet

Noise may occur during playback. Use the power source of the portable audio device.

*: If equipped

3-2. Using the audio system

Using the steering wheel audio switches*

Some audio features can be controlled using the switches on the steering wheel.

Operation may differ depending on the type of audio system or navigation system. For details, refer to the manual provided with the audio system or navigation system.

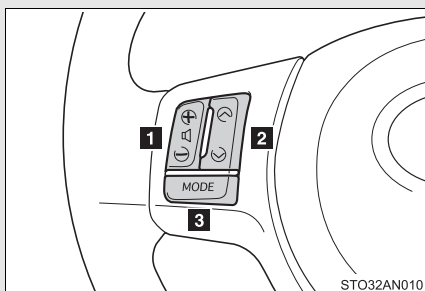



- 1** Volume
- 2** Radio mode: Select radio stations
CD mode: Select tracks and files (MP3 and WMA)
iPod mode: Selects a song
USB memory mode: Selects a file and folder
- 3** Power on, select audio source

Turning on the power

Press  when the audio system is turned off.

Changing the audio source

Press  when the audio system is turned on. The audio source changes as follows each time  is pressed. If a mode cannot be used, it will be skipped.

AM→FM→CD mode→iPod or USB memory mode*→AUX*

*: If equipped

*: If equipped

Adjusting the volume

Press “+” on  to increase the volume and “-” to decrease the volume.

Hold down “+” or “-” on  to continue increasing or decreasing the volume.

Silencing a sound

Press and hold .

To cancel, press and hold  again.

Selecting a radio station

STEP 1 Press  to select the radio mode.

STEP 2 Press “^” or “v” on  to select a preset station.

To scan for receivable stations, press and hold “^” or “v” on  until you hear a beep.

Selecting a track/file or song

STEP 1 Press  to select CD, iPod or USB memory mode.

STEP 2 Press “^” or “v” on  to select the desired track/file or song.

Selecting a folder (MP3 and WMA or USB memory)

STEP 1 Press  to select CD or USB memory mode.

STEP 2 Press and hold “^” or “v” on  until you hear a beep.

 CAUTION

■ **To reduce the risk of an accident**

Exercise care when operating the audio switches on the steering wheel.

3-3. Using the interior lights

Interior lights list

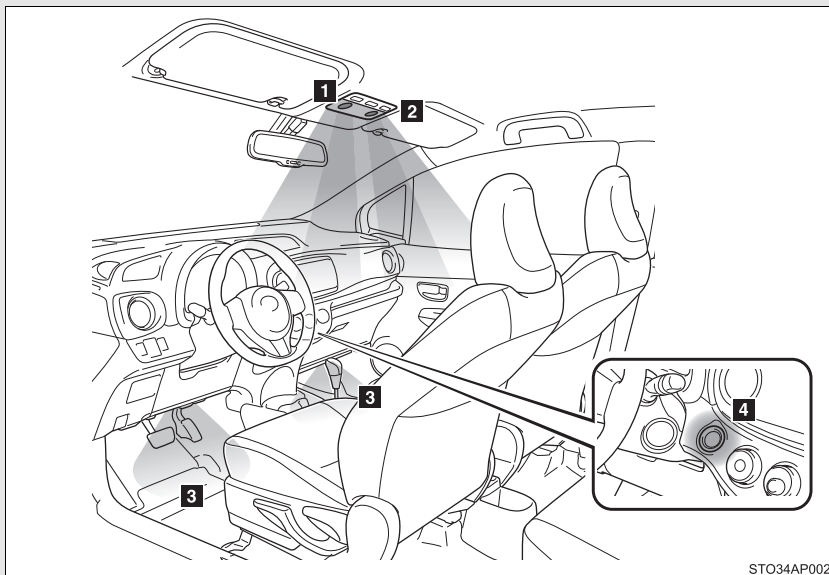

1 Interior light (→P. 416)

2 Personal lights (→P. 416)

3 Footwell lights (if equipped)

4 Except hybrid vehicle (vehicles with a smart entry & start system):

“ENGINE START STOP” switch light

Hybrid vehicle (vehicles with an electronic key):

“POWER” switch light

Personal lights

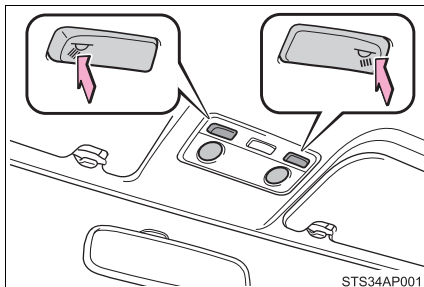

Turns the lights on/off

Interior light

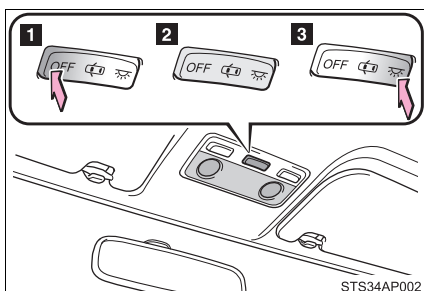

1 Turns the lights off

2 Turns the lights on/off linked to door position

3 Turns the lights on

■ Illuminated entry system

Except hybrid vehicle

Vehicles without a smart entry & start system:

The lights automatically turn on/off according to the engine switch position, whether the doors are locked/unlocked, and whether the doors are opened/closed.

Vehicles with a smart entry & start system:

The lights automatically turn on/off according to “ENGINE START STOP” switch mode, the presence of the electronic key, whether the doors are locked/unlocked, and whether the doors are opened/closed.

Hybrid vehicle

Vehicles without an electronic key:

The lights automatically turn on/off according to the engine switch position, whether the doors are locked/unlocked, and whether the doors are opened/closed.

Vehicles with an electronic key:

The lights automatically turn on/off according to “POWER” switch mode, the presence of the electronic key, whether the doors are locked/unlocked, and whether the doors are opened/closed.

■ To prevent battery discharge (except hybrid vehicle)**Type A**

If the following lights remain on when the door is not fully closed, the lights will go off automatically after 20 minutes:

- Interior light (when the switch is in the door position)
- “ENGINE START STOP” switch light
- Footwell lights

Type B

● The following lights will go off automatically after 20 minutes:

- Personal/interior lights
- Luggage compartment light
- Footwell lights

● If the “ENGINE START STOP” switch light remain on when the door is not fully closed, the light will go off automatically after 20 minutes.

■ To prevent 12-volt battery discharge (hybrid vehicle)

If the following lights remain on when the door is not fully closed, the lights will go off automatically after 20 minutes:

- Interior light (when the switch is in the door position)
- “POWER” switch light
- Footwell lights

■ Customization that can be configured at any authorized Toyota dealer or repair, or another duly qualified and equipped professional

Settings (e.g. the time elapsed before lights turn off) can be changed.
(Customizable features →P. 689)

3-4. Using the storage features

List of storage features

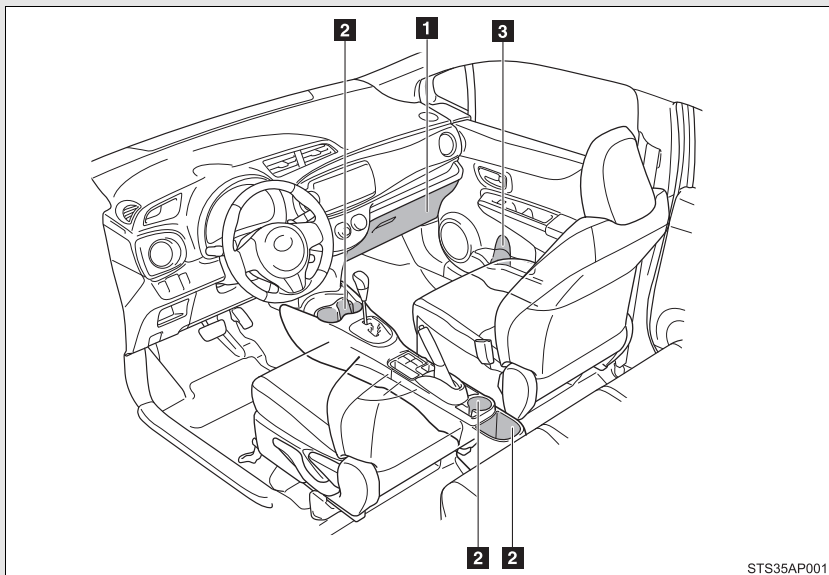

- 1** Glove box
- 2** Cup holders
- 3** Bottle holders

⚠ CAUTION

■ Items that should not be left in the storage spaces

Do not leave glasses, lighters or spray cans in the storage spaces, as this may cause the following when cabin temperature becomes high:

- Glasses may be deformed by heat or cracked if they come into contact with other stored items.
- Lighters or spray cans may explode. If they come into contact with other stored items, the lighter may catch fire or the spray can may release gas, causing a fire hazard.

Glove box

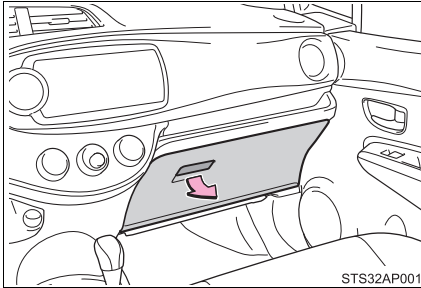

Pull up the lever to open the glove box.

Owner's Manual storage inside the glove box

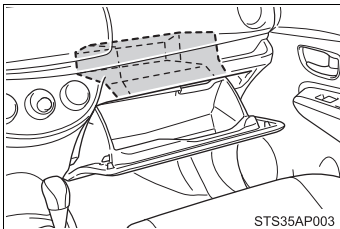

Inside the glove box, there is a compartment at the top that can be used to store the Owner's Manual.

Using the glove box vent (if equipped)

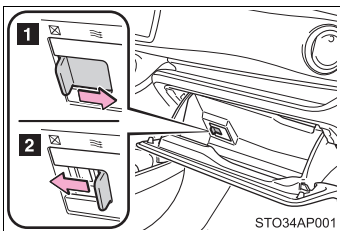

Air from the air conditioning system can be distributed into the glove box by opening and closing the vent.

- 1** Open
- 2** Close

The air is conditioned the same as the air for the passenger side vent.

Perishable items should not be put in the box.

⚠ CAUTION**■ Caution while driving**

Keep the glove box closed. In the event of sudden braking or sudden swerving, an accident may occur due to an occupant being struck by the open glove box or the items stored inside.

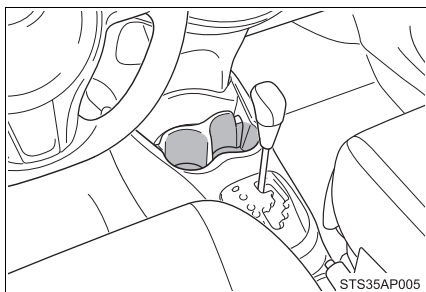
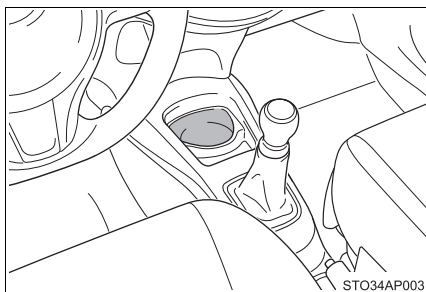
Cup holders**Front (Type A)****Front (Type B)**

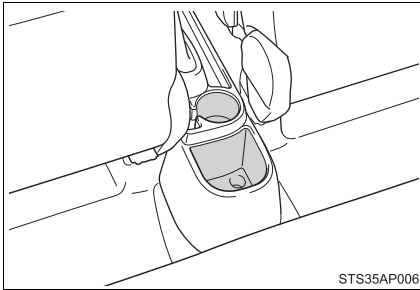
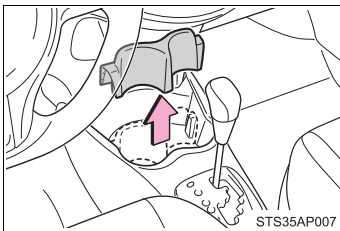
Rear**■ Removing the separator (type A only)**

Pull the separator up.

⚠ CAUTION**■ Items unsuitable for the cup holder**

Do not place anything other than cups or aluminum cans in the cup holders. Other items may be thrown out of the holders in the event of an accident or sudden braking, causing injury. If possible, cover hot drinks to prevent burns.

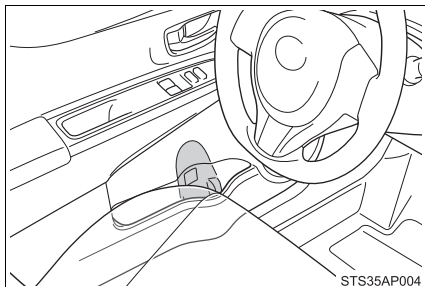
Bottle holders**■ When using the bottle holder**

- When storing a bottle, close the cap.
- The bottle may not be stored depending on its size or shape.

▲ CAUTION**■ Items unsuitable for the bottle holder**

Do not place anything other than a bottle in the bottle holders. Other items may be thrown out of the holders in the event of an accident or sudden braking and cause injury.

▲ NOTICE**■ Items that should not be stowed in the bottle holders**

Put the cap on before stowing a bottle. Do not place open bottles in the bottle holders, or glasses and paper cups containing liquid. The contents may spill and glasses may break.

3-5. Other interior features

Sun visors

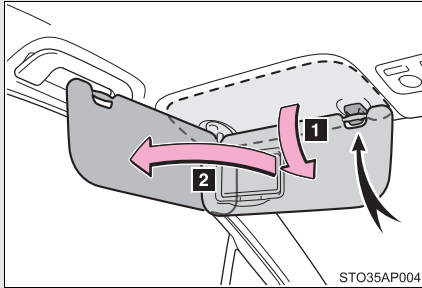

1 To set the visor in the forward position, flip it down.

2 To set the visor in the side position, flip down, unhook, and swing it to the side.

3-5. Other interior features

Vanity mirrors*

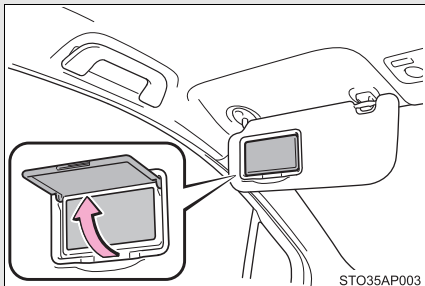

Open the cover.

■ Vanity lights (if equipped)

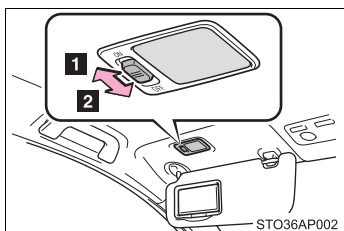

1 Turns the lights on

2 Turns the lights off

■ Vanity lights can be used when

Except hybrid vehicle

Vehicles without a smart entry & start system:

The engine switch is in the “ACC” or “ON” position.

Vehicles with a smart entry & start system:

The “ENGINE START STOP” switch is ACCESSORY or IGNITION ON mode.

Hybrid vehicle

Vehicles without an electronic key:

The engine switch is in the “ACC” or “ON” position.

Vehicles with an electronic key:

The “POWER” switch is in ACCESSORY or ON mode.

*: If equipped

 NOTICE

■ **To prevent battery discharge (except hybrid vehicle [vehicles with vanity lights])**

Do not leave the vanity lights on for extended periods while the engine is off.

■ **To prevent 12-volt battery discharge (hybrid vehicle [vehicles with vanity lights])**

Do not leave the lights on longer than necessary when the hybrid system is off.

3-5. Other interior features

Clock

The clock can be adjusted by pressing the buttons.

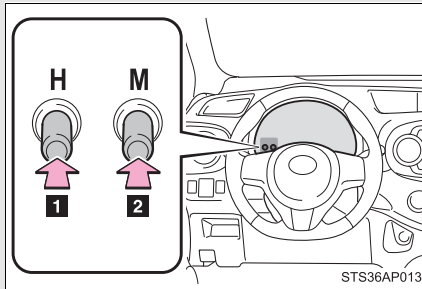

- 1** Adjusts the hours
- 2** Adjusts the minutes

■ The clock is displayed when

Except hybrid vehicle

Vehicles without a smart entry & start system:

The engine switch is in the "ON" position.

Vehicles with a smart entry & start system:

The "ENGINE START STOP" switch is in IGNITION ON mode.

Hybrid vehicle

Vehicles without an electronic key:

The engine switch is in the "ON" position.

Vehicles with an electronic key:

The "POWER" switch is in ON mode.

■ When disconnecting and reconnecting battery terminals

The clock data will be reset.

3-5. Other interior features

Outside temperature display

The temperature display shows temperatures within the range of -40°C (-40°F) and 50°C (122°F).

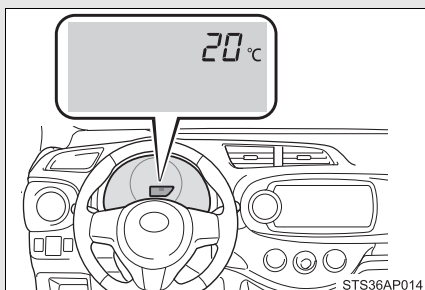

■ The outside temperature is displayed when

Except hybrid vehicle

Vehicles without a smart entry & start system:
The engine switch is in the "ON" position.

Vehicles with a smart entry & start system:
The "ENGINE START STOP" switch is in IGNITION ON mode.

Hybrid vehicle

Vehicles without an electronic key:
The engine switch is in the "ON" position.

Vehicles with an electronic key:
The "POWER" switch is in ON mode.

■ Display

In the following situations, the correct outside temperature may not be displayed, or the display may take longer than normal to change:

- When the vehicle is stopped, or moving at low speeds (less than 25 km/h [16 mph])
- When the outside temperature has changed suddenly (at the entrance/exit of a garage, tunnel, etc.)

■ When "--" or "E" is displayed

The system may be malfunctioning. Take your vehicle to any authorized Toyota dealer or repairer, or another duly qualified professional.

3-5. Other interior features

Portable ashtray*

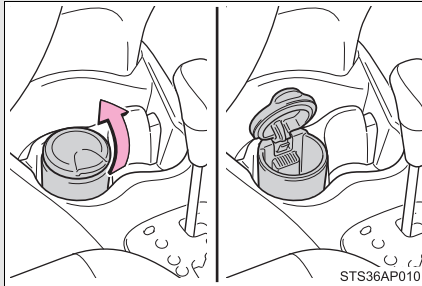

The ashtray can be installed in a cup holder. (→P. 420)

⚠ CAUTION

■ When not in use

Keep the ashtray closed. In the event of sudden braking, an accident may occur due to an occupant being struck by the open ashtray or ash flying out.

■ To prevent fire

- Fully extinguish matches and cigarettes before putting them in the ashtray, then make sure the ashtray is fully closed.
- Do not place paper or any other type of flammable object in the ashtray.

*: If equipped

3-5. Other interior features

Cigarette lighter*

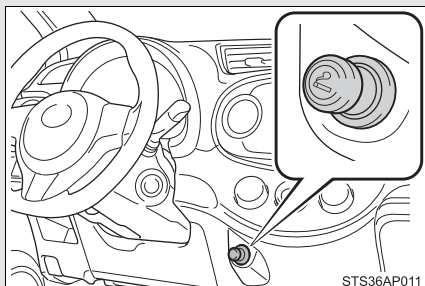

Push the cigarette lighter.

The cigarette lighter will pop up when it is ready for use.

■ The cigarette lighter can be used when

Except hybrid vehicle

Vehicles without a smart entry & start system:

The engine switch is in the “ACC” or “ON” position.

Vehicles with a smart entry & start system:

The “ENGINE START STOP” switch is in ACCESSORY or IGNITION ON mode.

Hybrid vehicle

Vehicles without an electronic key:

The engine switch is in the “ACC” or “ON” position.

Vehicles with an electronic key:

The “POWER” switch is in ACCESSORY or ON mode.

⚠ CAUTION

■ To avoid burns or fires

- Do not touch the metal parts of the cigarette lighter.
- Do not hold the cigarette lighter down. It could overheat and cause a fire.
- Do not insert anything other than the cigarette lighter provided into the cigarette lighter outlet. Doing so may deform the outlet and make the cigarette lighter pop out of the outlet or become difficult to take out.

*: If equipped

3-5. Other interior features

Power outlet*

The power outlet can be used for 12 V accessories that run on less than 10 A.

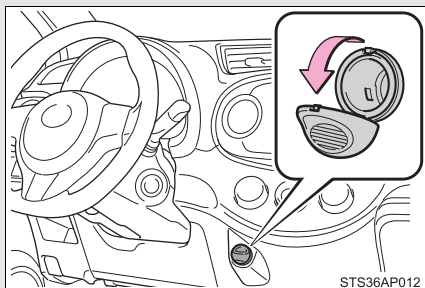

■ The power outlet can be used when

Except hybrid vehicle

Vehicles without a smart entry & start system:

The engine switch is in the “ACC” or “ON” position.

Vehicles with a smart entry & start system:

The “ENGINE START STOP” switch is in ACCESSORY or IGNITION ON mode.

Hybrid vehicle

Vehicles without an electronic key:

The engine switch is in the “ACC” or “ON” position.

Vehicles with an electronic key:

The “POWER” switch is in ACCESSORY or ON mode.

*: If equipped

 NOTICE**■ To avoid damaging the power outlet**

Close the power outlet lid when the power outlet is not in use. Foreign objects or liquids that enter the power outlet may cause a short circuit.

■ To prevent blown fuse

Do not use an accessory that uses more than 12 V 10 A.

■ To prevent battery discharge (except hybrid vehicle)

Do not use the power outlet longer than necessary when the engine is not running.

■ To prevent 12-volt battery discharge (hybrid vehicle)

Do not use the power outlet longer than necessary when the hybrid system is off.

3-5. Other interior features

Seat heaters*

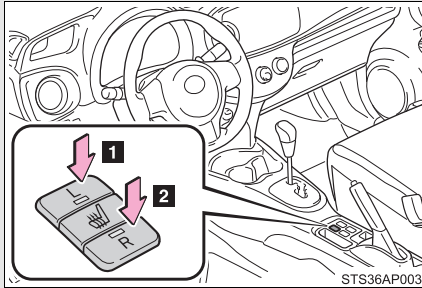

- 1 Heats the left front seat
- 2 Heats the right front seat

The indicator light comes on.

■ The seat heaters can be used when

Except hybrid vehicle

Vehicles without a smart entry & start system:

The engine switch is in the "ON" position.

Vehicles with a smart entry & start system:

The "ENGINE START STOP" switch is in IGNITION ON mode.

Hybrid vehicle

Vehicles without an electronic key:

The engine switch is in the "ON" position.

Vehicles with an electronic key:

The "POWER" switch is in ON mode.

■ When not in use

Turn the seat heater off.

*: If equipped

 CAUTION**■ Burns**

- Use caution when seating the following persons in a seat with the seat heater on to avoid the possibility of burns:
 - Babies, small children, the elderly, the sick and the physically challenged
 - Persons with sensitive skin
 - Persons who are fatigued
 - Persons who have taken alcohol or drugs that induce sleep (sleeping drugs, cold remedies, etc.)
- Do not cover the seat with anything when using the seat heater. Using the seat heater with a blanket or cushion increases the temperature of the seat and may lead to overheating.
- Do not use the seat heater more than necessary. Doing so may cause minor burns or overheating.

 NOTICE**■ To prevent seat heater damage**

Do not put heavy objects that have an uneven surface on the seat and do not stick sharp objects (needles, nails, etc.) into the seat.

■ To prevent battery discharge (except hybrid vehicle)

Turn the seat heaters off when the engine is not running.

■ To prevent 12-volt battery discharge (hybrid vehicle)

Do not use the power outlet longer than necessary when the hybrid system is off.

3-5. Other interior features

Armrest*

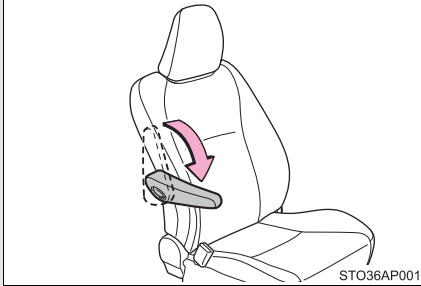

Fold down the armrest for use.

NOTICE

■ To prevent damage to the armrest

Do not apply too much load on the armrest.

*: If equipped

3-5. Other interior features

Panoramic roof shade*

The panoramic roof shade can be opened and closed manually.

■ Opening the panoramic roof shade

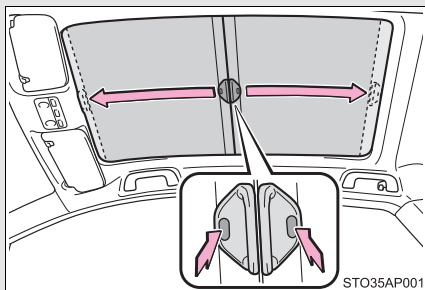

Pushing the tabs will release the lock, and the shade can be opened.

■ Closing the panoramic roof shade

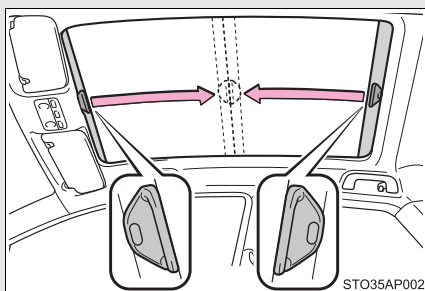

Pull the tabs to the lock position to close the shade.

3-5. Other interior features

Assist grips

An assist grip installed on the ceiling can be used to support your body while sitting on the seat.

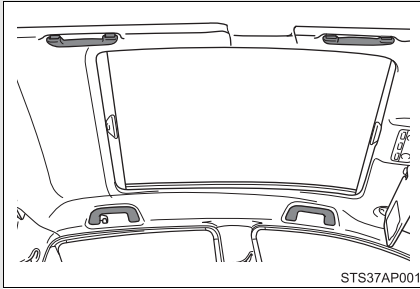

CAUTION

■ Assist grip

Do not use the assist grip when getting in or out of the vehicle or rising from your seat.

NOTICE

■ To prevent damage to the assist grip

Do not hang any heavy object or put a heavy load on the assist grip.

3-5. Other interior features

Floor mat

Use only floor mats designed specifically for vehicles of the same model and model year as your vehicle. Fix them securely in place onto the carpet.

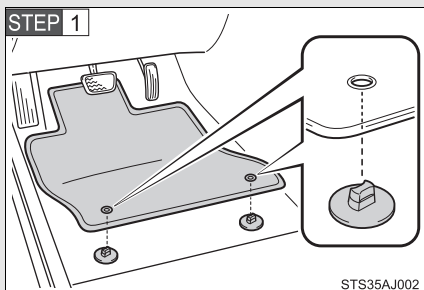

Insert the retaining hooks (clips) into the floor mat eyelets.

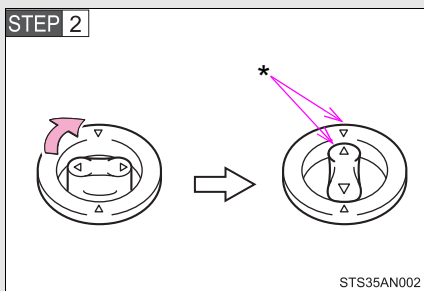

Turn the upper knob of each retaining hook (clip) to secure the floor mats in place.

*: Always align the Δ marks.

The shape of the retaining hooks (clips) may differ from that shown in the illustration.

⚠ CAUTION

Observe the following precautions.

Failure to do so may cause the driver's floor mat to slip, possibly interfering with the pedals while driving. An unexpectedly high speed may result or it may become difficult to stop the vehicle, leading to a serious accident.

■ When installing the driver's floor mat

- Do not use floor mats designed for other models or different model year vehicles, even if they are Toyota Genuine floor mats.
- Only use floor mats designed for the driver's seat.
- Always install the floor mat securely using the retaining hooks (clips) provided.
- Do not use two or more floor mats on top of each other.
- Do not place the floor mat bottom-side up or upside-down.

■ Before driving

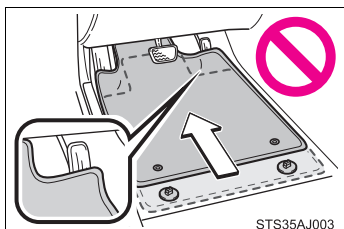

- Check that the floor mat is securely fixed in the correct place with all the provided retaining hooks (clips). Be especially careful to perform this check after cleaning the floor.
- With the engine (except hybrid vehicle) or hybrid system (hybrid vehicle) stopped and the shift lever in P (vehicles with a hybrid transmission or a Multidrive) or N (vehicles with a multi-mode manual transmission or manual transmission), fully depress each pedal to the floor to make sure it does not interfere with the floor mat.

3-5. Other interior features

Luggage compartment features

■ Deck board (if equipped)

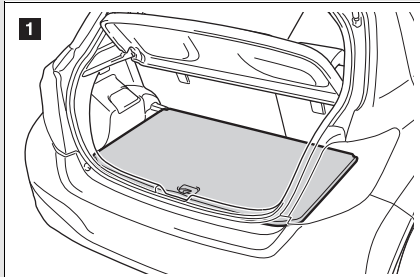

1 Upper position

2 Lower position

The lower position can be used when the deck board is placed on the luggage floor cover.

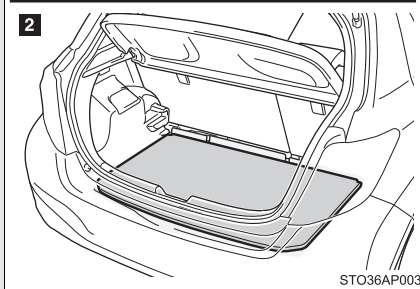

STO36AP003

■ Auxiliary box (if equipped)

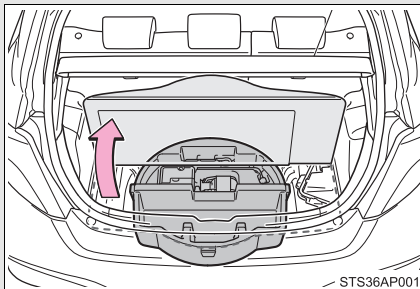

STS36AP001

Lift the deck board and the luggage floor cover.

Removing the deck board

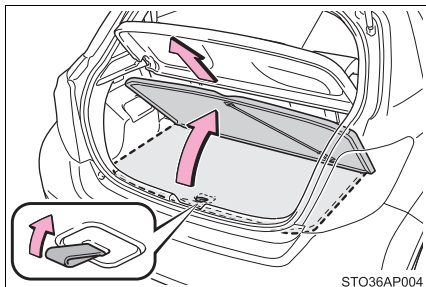

Lift the deck board and pull it toward you to remove it.

Securing the deck board

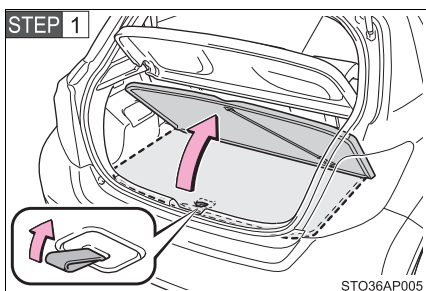

Lift the deck board up.

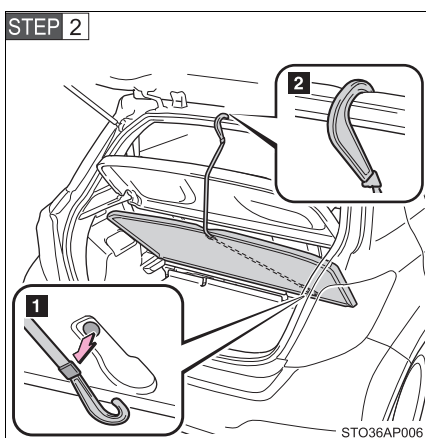

- 1 Remove the hook on the back-side of the deck board.
- 2 Attach the hook to the upper edge of the back door opening as shown.

■ Removing the luggage cover

The luggage cover can be removed by the following procedure:

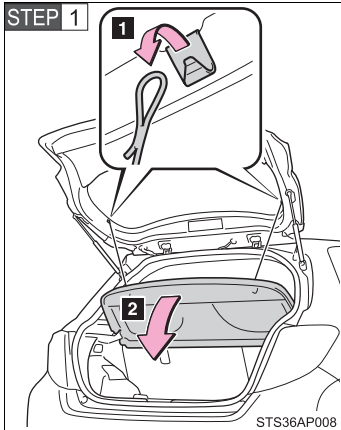

- 1 Unhook the cords.
- 2 Return the luggage cover to horizontal position.

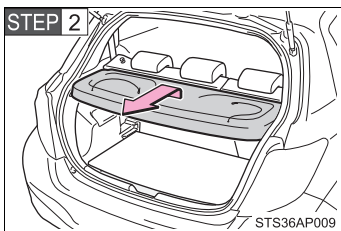

Lift the luggage cover and pull it forward.

⚠ CAUTION

■ When operating the deck board

Do not place anything on the deck board when operating the board. Otherwise, your fingers may be caught or an accident may result causing injuries.

4-1. Maintenance and care
Cleaning and protecting
the vehicle exterior 444
Cleaning and protecting
the vehicle interior 449

4-2. Maintenance
Maintenance
requirements..... 452

4-3. Do-it-yourself maintenance
Do-it-yourself service
precautions 455
Hood 460
Positioning a floor jack..... 462
Engine compartment..... 465
12-volt battery
(hybrid vehicle) 484
Tires..... 490
Tire inflation pressure 494
Wheels 496
Air conditioning filter 498
Wireless remote
control/electronic key
battery..... 501
Checking and replacing
fuses 506
Light bulbs 531

4-1. Maintenance and care

Cleaning and protecting the vehicle exterior

Perform the following to protect the vehicle and maintain it in prime condition:

- Working from top to bottom, liberally apply water to the vehicle body, wheel wells and underside of the vehicle to remove any dirt and dust.
- Wash the vehicle body using a sponge or soft cloth, such as a chamois.
- For hard-to-remove marks, use car wash soap and rinse thoroughly with water.
- Wipe away any water.
- Wax the vehicle when the waterproof coating deteriorates.

If water does not bead on a clean surface, apply wax when the vehicle body is cool.

■ Automatic car washes

- Fold the mirrors and remove the antenna before washing the vehicle. Start washing from the front of the vehicle. Make sure to re-install the antenna and extend the mirrors before driving.
- Brushes used in automatic car washes may scratch the vehicle surface and harm your vehicle's paint.
- Vehicles with a rear spoiler: In certain automatic car washes, the rear spoiler may interfere with machine operation. This may prevent the vehicle from being cleaned properly or result in damage to the rear spoiler.

■ High pressure car washes

- Do not allow the nozzles of the car wash to come within close proximity of the window and door borders, and high mounted stoplight.
- Before using the car wash, check that the fuel filler door on your vehicle is closed properly.

■ When using a car wash (vehicles with a smart entry & start system)

If the door handle becomes wet while the electronic key is within the effective range, the door may lock and unlock repeatedly. Place the key in a position 2 m (6 ft.) or more separate from the vehicle while the vehicle is being washed. (Take care to ensure that the key is not stolen.)

■ Aluminum wheels (if equipped)

- Remove any dirt immediately by using a neutral detergent. Do not use hard brushes or abrasive cleaners. Do not use strong or harsh chemical cleaners.

Use the same mild detergent and wax as used on the paint.

- Do not use detergent on the wheels when they are hot, for example after driving for long distance in the hot weather.
- Wash detergent from the wheels immediately after use.
- To preserve the wheels luster, do not allow hot water, such as from steam cleaning, to contact them directly.

■ Bumpers

Do not scrub with abrasive cleaners.

⚠ CAUTION

■ When cleaning the windshield (vehicles with a rain-sensing windshield wiper)

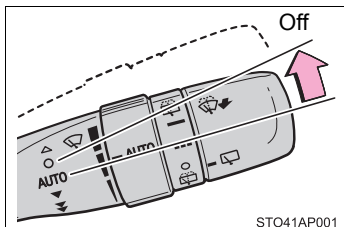

Set the wiper switch to off.

If the wiper switch is in “AUTO”, the wiper may operate unexpectedly in the following situations, and may result in hands being caught or other serious injuries and cause damage to the wiper blades.

- When the upper part of the windshield where the raindrop sensor is located is touched by hand
- When a wet rag or similar is held close to the raindrop sensor
- If something bumps against the windshield
- If you directly touch the raindrop sensor body or if something bumps into the raindrop sensor

■ When washing the vehicle

Do not apply water to the inside of the engine compartment. Doing so may cause the electrical components etc. to catch fire.

■ Precautions regarding the exhaust pipe

Exhaust gasses cause the exhaust pipe to become quite hot.

When washing the vehicle, be careful not to touch the pipe until it has cooled sufficiently, as touching a hot exhaust pipe can cause burns.

 NOTICE**■ To prevent paint deterioration and corrosion on the body and components (aluminum wheels etc.)**

- Wash the vehicle immediately in the following cases:
 - After driving near the sea coast
 - After driving on salted roads
 - If coal tar or tree sap is present on the paint surface
 - If dead insects, insect droppings or bird droppings are present on the paint surface
 - After driving in an area contaminated with soot, oily smoke, mine dust, iron powder or chemical substances
 - If the vehicle becomes heavily soiled with dust or mud
 - If liquids such as benzene and gasoline are spilled on the paint surface
- If the paint is chipped or scratched, have it repaired immediately.
- To prevent the wheels from corroding, remove any dirt and store in a place with low humidity when storing the wheels.

■ Cleaning the exterior lights

- Wash carefully. Do not use organic substances or scrub with a hard brush. This may damage the surfaces of the lights.
- Do not apply wax to the surfaces of the lights. Wax may cause damage to the lenses.

■ Antenna installation and removal precautions

- Before driving, ensure that the antenna is installed.
- When the antenna is removed, such as before entering an automatic car wash, make sure to store it in a suitable place so as not to lose it. Also, before driving, make sure to reinstall the antenna in its original position.

■ When using an automatic car wash (vehicles with a rain-sensing windshield wiper)

Set the wiper switch to the off position.

If the wiper switch is in "AUTO", the wiper may operate and the wiper blade may be damaged.

 NOTICE

■ **To prevent damage to the antenna**

Remove the antenna in the following situations:

- When the antenna will touch the ceiling of a garage or other such places
- When a car cover is to be used to cover the vehicle

Cleaning and protecting the vehicle interior

The following procedures will help protect your vehicle's interior and keep it in top condition:

■ Protecting the vehicle interior

Remove dirt and dust using a vacuum cleaner. Wipe dirty surfaces with a cloth dampened with lukewarm water.

■ Cleaning the leather areas

- Remove dirt and dust using a vacuum cleaner.
- Wipe off any excess dirt and dust with a soft cloth dampened with diluted detergent.

Use a diluted water solution of approximately 5% neutral wool detergent.

- Wring out any excess water from the cloth and thoroughly wipe off all remaining traces of detergent.
- Wipe the surface with a dry, soft cloth to remove any remaining moisture. Allow the leather to dry in a shaded and ventilated area.

■ Cleaning the synthetic leather areas

- Remove loose dirt using a vacuum cleaner.
- Apply a mild soap solution to the synthetic leather using a sponge or soft cloth.
- Allow the solution to soak in for a few minutes. Remove the dirt and wipe off the solution with a clean, damp cloth.

■ **Caring for leather areas**

Toyota recommends cleaning the interior of the vehicle at least twice a year to maintain the quality of the vehicle's interior.

■ **Shampooing the carpets**

There are several commercial foaming-type cleaners available. Use a sponge or brush to apply the foam. Rub in overlapping circles. Do not use water. Wipe dirty surfaces and let them dry. Excellent results are obtained by keeping the carpet as dry as possible.

■ **Seat belts**

Clean with mild soap and lukewarm water using a cloth or sponge. Also check the belts periodically for excessive wear, fraying or cuts.

 **CAUTION**

■ **Water in the vehicle**

- **Except hybrid vehicle:** Do not splash or spill liquid in the vehicle. Doing so may cause electrical components etc. to malfunction or catch fire.
- **Hybrid vehicle:** Do not splash or spill liquid in the vehicle, such as on the floor, in the hybrid battery (traction battery) air vents, and in the rear seat. Doing so may cause the hybrid battery, electrical components, etc. to malfunction or catch fire.
- **Do not get any of the SRS components or wiring in the vehicle interior wet.** (→P. 168)
An electrical malfunction may cause the airbags to deploy or not function properly, resulting in death or serious injury.

■ **Cleaning the interior (especially instrument panel)**

Do not use polish wax or polish cleaner. The instrument panel may reflect off the windshield, obstructing the driver's view and leading to an accident, resulting in death or serious injury.

 NOTICE**■ Cleaning detergents**

- Do not use the following types of detergent, as they may discolor the vehicle interior or cause streaks or damage to painted surfaces:
 - Non-seat portions: Organic substances such as benzene or gasoline, alkaline or acidic solutions, dye, and bleach
 - Seats: Alkaline or acidic solutions, such as thinner, benzene, and alcohol
- Do not use polish wax or polish cleaner. The instrument panel's or other interior part's painted surface may be damaged.

■ Preventing damage to leather surfaces

Observe the following precautions to avoid damage to and deterioration of leather surfaces:

- Remove any dust or dirt from leather surfaces immediately.
- Do not expose the vehicle to direct sunlight for extended periods of time. Park the vehicle in the shade, especially during summer.
- Do not place items made of vinyl, plastic, or containing wax on the upholstery, as they may stick to the leather surface if the vehicle interior heats up significantly.

■ Water on the floor

Do not wash the vehicle floor with water.

Vehicle systems such as the audio system may be damaged if water comes into contact with electrical components such as the audio system above or under the floor of the vehicle. Water may also cause the body to rust.

■ Cleaning the inside of the rear window

- Do not use glass cleaner to clean the rear window, as this may cause damage to the rear window defogger heater wires. Use a cloth dampened with lukewarm water to gently wipe the window clean. Wipe the window in strokes running parallel to the heater wires.
- Be careful not to scratch or damage the heater wires.

Maintenance requirements

To ensure safe and economical driving, day-to-day care and regular maintenance are essential. Toyota recommends the following maintenance:

■ Scheduled maintenance

Scheduled maintenance should be performed at specified intervals according to the maintenance schedule.

For full details of your maintenance schedule, refer to the “Toyota Service Booklet” or “Toyota Warranty Booklet”.

■ Do-it-yourself maintenance

What about do-it-yourself maintenance?

Many of the maintenance items are easy to do yourself if you have a little mechanical ability and a few basic automotive tools.

Note, however, that some maintenance tasks require special tools and skills. These are best performed by qualified technicians. Even if you are an experienced do-it-yourself mechanic, we recommend that repairs and maintenance be conducted by any authorized Toyota dealer or repairer, or another duly qualified and equipped professional. Any authorized Toyota dealer or repairer will keep a record of maintenance, which could be useful should you ever require Warranty Service. Should you choose to select a qualified and equipped professional other than an authorized Toyota repairer to service or maintain your vehicle, we recommend that you request that a record of maintenance be kept.

■ Where to go for the maintenance service?

In order to maintain your vehicle in the best possible condition, Toyota recommends that all repairs and service operations be carried out by authorized Toyota dealers or repairers or other duly qualified and equipped professionals. For repairs and services covered by your warranty, please visit an authorized Toyota dealer or repairer, who will use genuine Toyota parts in repairing any difficulties you may encounter. There can also be advantages in utilizing authorized Toyota dealers or repairers for non-warranty repairs and services, as members of the Toyota network will be able to expertly assist you with any difficulties you may encounter.

Your Toyota dealer or repairer, or another duly qualified and equipped professional will perform all of the scheduled maintenance on your vehicle reliably and economically due to their experience with Toyota vehicles.

■ Does your vehicle need repairs?

Be on the alert for changes in performance and sounds, and visual tip-offs that indicate service is needed. Some important clues are:

- Engine misses, stumbling, or pinging
- Appreciable loss of power
- Strange engine noises
- A fluid leak under the vehicle (However, water dripping from the air conditioning system after use is normal.)
- Change in exhaust sound (This may indicate a dangerous carbon monoxide leak. Drive with the windows open and have the exhaust system checked immediately.)
- Flat-looking tires, excessive tire squeal when cornering, uneven tire wear
- Vehicle pulls to one side when driving straight on a level road
- Strange noises related to suspension movement
- Loss of brake effectiveness, spongy feeling brake pedal or clutch pedal (vehicles with a manual transmission), pedal almost touches the floor, vehicle pulls to one side when braking
- Engine coolant temperature continually higher than normal

If you notice any of these clues, take your vehicle to any authorized Toyota dealer or repairer, or another duly qualified and equipped professional as soon as possible. Your vehicle may need adjustment or repair.

 CAUTION

■ **If your vehicle is not properly maintained**

Improper maintenance could result in serious damage to the vehicle and possible serious injury or death.

■ **Handling of the battery (except hybrid vehicle)**

Battery posts, terminals and related accessories contain lead and lead compounds which are known to cause brain damage. Wash your hands after handling. (→P. 479)

■ **Handling of the 12-volt battery (hybrid vehicle)**

12-volt battery posts, terminals and related accessories contain lead and lead compounds which are known to cause brain damage. Wash your hands after handling. (→P. 484)

4-3. Do-it-yourself maintenance

Do-it-yourself service precautions

If you perform maintenance by yourself, be sure to follow the correct procedures as given in these sections.

Items	Parts and tools
Battery condition (except hybrid vehicle) (→P. 479)	<ul style="list-style-type: none">• Warm water• Baking soda• Grease• Conventional wrench (for terminal clamp bolts)• Distilled water
12-volt battery condition (hybrid vehicle) (→P. 484)	<ul style="list-style-type: none">• Grease• Conventional wrench (for terminal clamp bolts)
Engine coolant level (except hybrid vehicle) (→P. 475)	<ul style="list-style-type: none">• “Toyota Super Long Life Coolant” or a similar high quality ethylene glycol-based non-silicate, non-amine, non-nitrite and non-borate coolant with long-life hybrid organic acid technology. “Toyota Super Long Life Coolant” is pre-mixed with 50% coolant and 50% deionized water.• Funnel (used only for adding coolant)
Engine/power control unit coolant level (hybrid vehicle) (→P. 476)	<ul style="list-style-type: none">• “Toyota Super Long Life Coolant” or a similar high quality ethylene glycol-based non-silicate, non-amine, non-nitrite and non-borate coolant with long-life hybrid organic acid technology. “Toyota Super Long Life Coolant” is pre-mixed with 50% coolant and 50% deionized water.• Funnel (used only for adding coolant)

Items	Parts and tools
Engine oil level (→P. 469)	<ul style="list-style-type: none"> • “Toyota Genuine Motor Oil” or equivalent • Rag or paper towel • Funnel (used only for adding engine oil)
Fuses (→P. 506)	<ul style="list-style-type: none"> • Fuse with same amperage rating as original
Light bulbs (→P. 531)	<ul style="list-style-type: none"> • Bulb with same number and wattage rating as original • Phillips-head screwdriver • Flathead screwdriver • Wrench
Radiator, condenser and inter-cooler (→P. 478)	—
Tire inflation pressure (→P. 494)	<ul style="list-style-type: none"> • Tire pressure gauge • Compressed air source
Washer fluid (→P. 482)	<ul style="list-style-type: none"> • Water or washer fluid containing antifreeze (for winter use) • Funnel (used only for adding water or washer fluid)

 **CAUTION**

The engine compartment contains many mechanisms and fluids that may move suddenly, become hot, or become electrically energized. To avoid death or serious injury, observe the following precautions:

■ **When working on the engine compartment:**

- On hybrid vehicles, make sure that the engine switch is in the “LOCK” position (vehicles without an electronic key) or the “POWER” switch off (vehicles with an electronic key) and the “READY” indicator are both off.
- Keep hands, clothing and tools away from the moving fan and engine drive belt.
- Be careful not to touch the engine, power control unit (hybrid vehicle), radiator, exhaust manifold, etc. right after driving as they may be hot. Oil and other fluids may also be hot.
- Do not leave anything that may burn easily, such as paper and rags, in the engine compartment.
- Do not smoke, cause sparks or expose an open flame to fuel or the battery. Fuel and battery fumes are flammable.
- Be extremely cautious when working on the battery. It contains poisonous and corrosive sulfuric acid.
- Take care because brake fluid can harm your hands or eyes and damage painted surfaces. If fluid gets on your hands or in your eyes, flush the affected area with clean water immediately.
If you still experience discomfort, consult a doctor.

 **CAUTION**

■ **When working near the electric cooling fan or radiator grille**

Except hybrid vehicle

Vehicles without a smart entry & start system:

Be sure the engine switch is in the “LOCK” position.

With the engine switch in the “ON” position, the electric cooling fan may automatically start to run if the air conditioning is on and/or the coolant temperature is high. (→P. 478)

Vehicles with a smart entry & start system:

Be sure the “ENGINE START STOP” switch is off.

With the “ENGINE START STOP” switch in IGNITION ON mode, the electric cooling fan may automatically start to run if the air conditioning is on and/or the coolant temperature is high. (→P. 478)

Hybrid vehicle

Vehicles without an electronic key:

Be sure the engine switch is in the “LOCK” position.

With the engine switch in the “ON” position, the electric cooling fan may automatically start to run if the air conditioning is on and/or the coolant temperature is high. (→P. 478)

Vehicles with an electronic key:

Be sure the “POWER” switch is off.

With the “POWER” switch in ON mode, the electric cooling fan may automatically start to run if the air conditioning is on and/or the coolant temperature is high. (→P. 478)

■ **Safety glasses**

Wear safety glasses to prevent flying or falling material, fluid spray, etc. from getting in your eyes.

 NOTICE**■ If you remove the air cleaner filter**

Driving with the air cleaner filter removed may cause excessive engine wear due to dirt in the air.

■ If the fluid level is low or high

It is normal for the brake fluid level to go down slightly as the brake pads wear or when the fluid level in the accumulator is high.

If the reservoir needs frequent refilling, it may indicate a serious problem.

4-3. Do-it-yourself maintenance

Hood

Release the lock from the inside of the vehicle to open the hood.

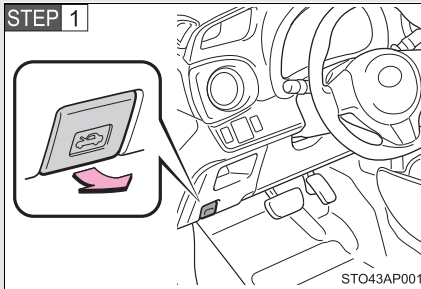

Pull the hood lock release lever.

The hood will pop up slightly.

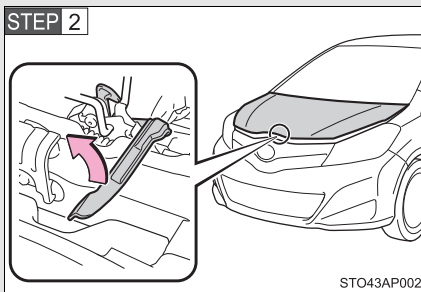

Pull up the auxiliary catch lever and lift the hood.

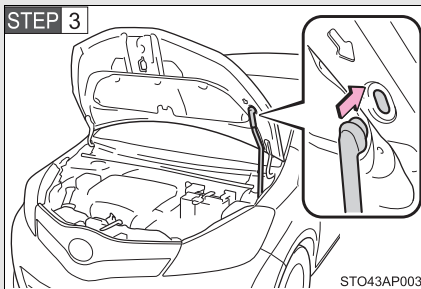

Hold the hood open by inserting the supporting rod into the slot.

 CAUTION**■ Pre-driving check**

Check that the hood is fully closed and locked.

If the hood is not locked properly, it may open while the vehicle is in motion and cause an accident, which may result in death or serious injury.

■ After installing the support rod into the slot

Make sure the rod supports the hood securely from falling down on to your head or body.

 NOTICE**■ When closing the hood**

Be sure to return the support rod to its clip before closing the hood. Closing the hood without returning the support rod properly could cause the hood to bend.

4-3. Do-it-yourself maintenance

Positioning a floor jack

When raising your vehicle with a floor jack, position the jack correctly. Improper placement may damage your vehicle or cause injury.

Front

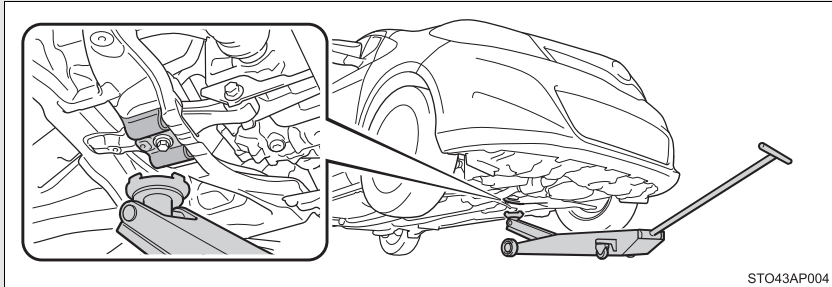

Rear

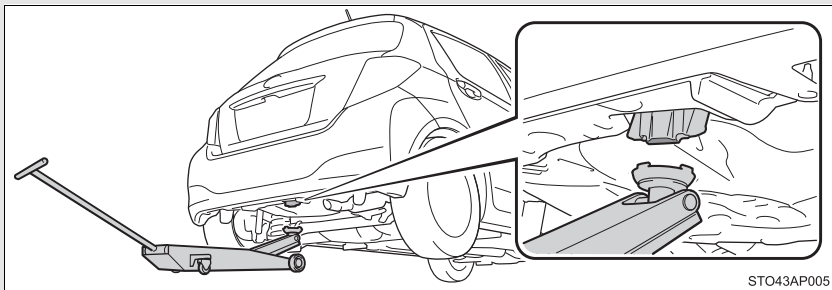

⚠ CAUTION

■ When raising your vehicle

Make sure to observe the following precautions to reduce the possibility of death or serious injury:

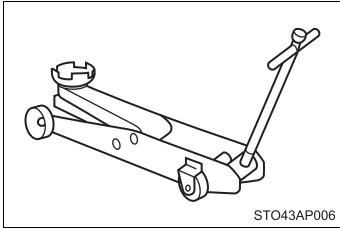

- Lift up the vehicle using a floor jack such as the one shown in the illustration.

- When using a floor jack, follow the instructions of the manual provided with the jack.
- Do not use the jack that was supplied with your vehicle.
- Do not put any part of your body underneath the vehicle when it is supported only by the floor jack.
- Always use floor jack and/or automotive jack stands on a solid, flat, level surface.
- Do not start the engine (except hybrid vehicle) or hybrid system (hybrid vehicle) while the vehicle is supported by the floor jack.
- Stop the vehicle on level, firm ground, firmly set the parking brake and shift the shift lever to P (vehicles with a hybrid transmission or a Multidrive), E, M or R (vehicles with a multi-mode manual transmission) or R (vehicles with a manual transmission).

⚠ CAUTION

- Make sure to set the floor jack properly at the jack point.
Raising the vehicle with an improperly positioned floor jack will damage the vehicle and may cause the vehicle to fall off the floor jack.

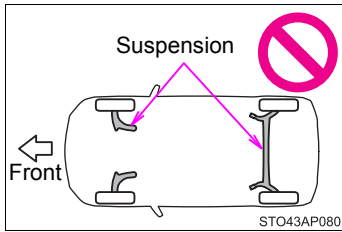

- Do not jack the vehicle at the suspension. The suspension may be damaged.

- Do not raise the vehicle while someone is in the vehicle.
- When raising the vehicle, do not place any object on top of or underneath the floor jack.

4-3. Do-it-yourself maintenance

Engine compartment

1KR-FE engine

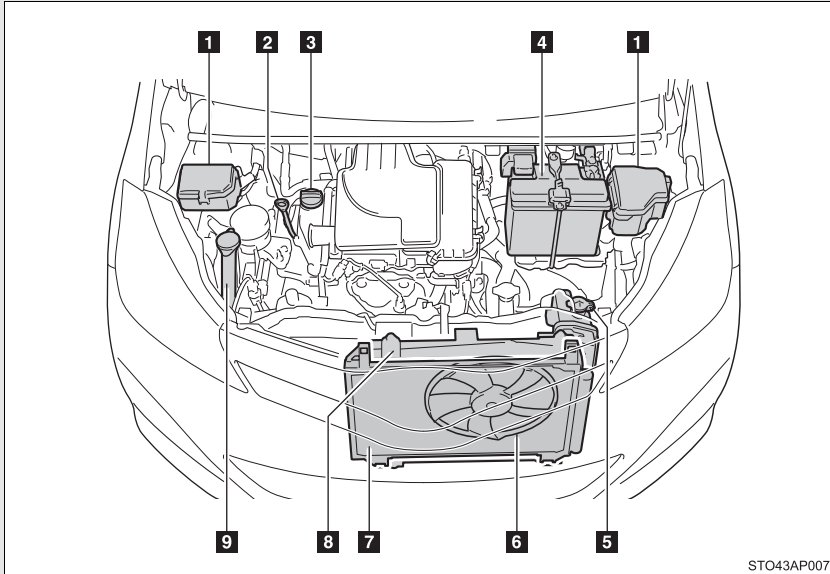

STO43AP007

- | | |
|--|---|
| 1 Fuse boxes (→P. 506) | 5 Engine coolant reservoir (→P. 475) |
| 2 Engine oil level dipstick (→P. 469) | 6 Electric cooling fan |
| 3 Engine oil filler cap (→P. 471) | 7 Condenser (→P. 478) |
| 4 Battery (→P. 479) | 8 Radiator (→P. 478) |
| | 9 Washer fluid tank (→P. 482) |

1NR-FE engine

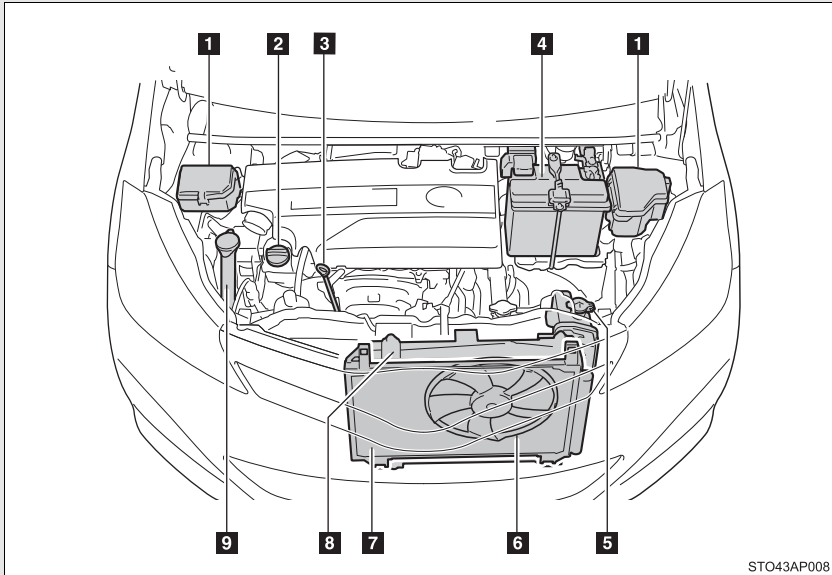

STO43AP008

- | | |
|--|---|
| 1 Fuse boxes (→P. 506) | 5 Engine coolant reservoir (→P. 475) |
| 2 Engine oil filler cap (→P. 471) | 6 Electric cooling fan |
| 3 Engine oil level dipstick (→P. 469) | 7 Condenser (→P. 478) |
| 4 Battery (→P. 479) | 8 Radiator (→P. 478) |
| | 9 Washer fluid tank (→P. 482) |

1ND-TV engine

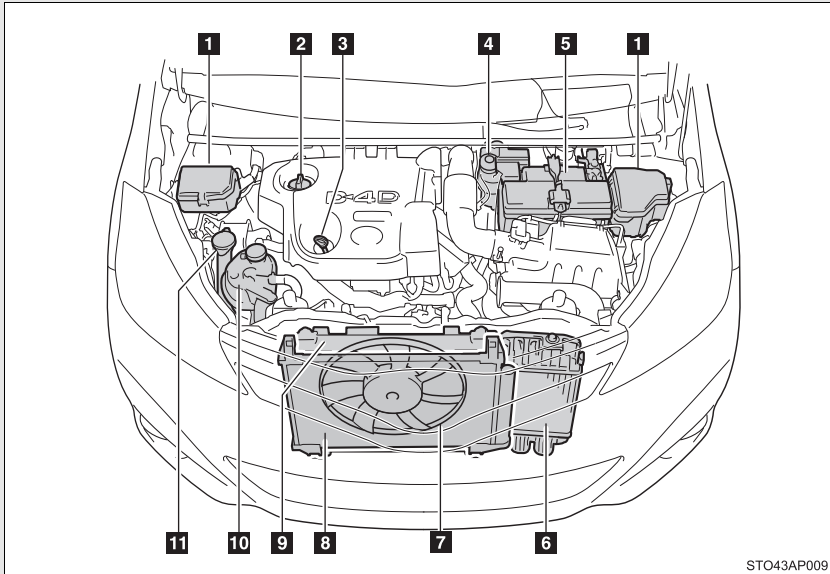

STO43AP009

- | | | | |
|------------------------------------|-----------|------------------------------------|-----------|
| 1 Fuse boxes | (→P. 506) | 6 Intercooler | (→P. 478) |
| 2 Engine oil filler cap | (→P. 471) | 7 Electric cooling fan | |
| 3 Engine oil level dipstick | (→P. 469) | 8 Condenser | (→P. 478) |
| 4 Fuel filter | (→P. 483) | 9 Radiator | (→P. 478) |
| 5 Battery | (→P. 479) | 10 Engine coolant reservoir | (→P. 475) |
| | | 11 Washer fluid tank | (→P. 482) |

1NZ-FXE engine

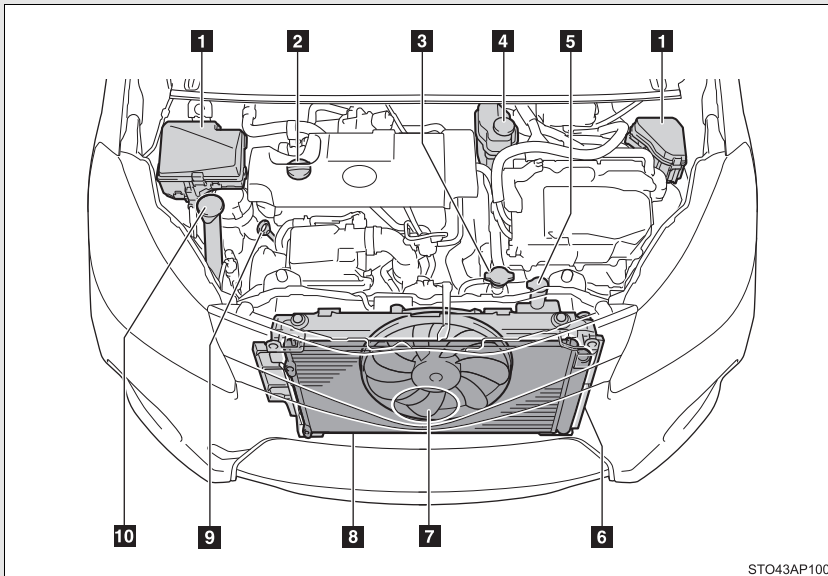

STO43AP100

- | | |
|--|---|
| 1 Fuse boxes (→P. 506) | 6 Engine/power control
coolant radiator (→P. 478) |
| 2 Engine oil filler cap
(→P. 471) | 7 Electric cooling fan |
| 3 Engine coolant radiator cap | 8 Condenser (→P. 478) |
| 4 Power control unit
coolant reservoir (→P. 476) | 9 Engine oil level dipstick
(→P. 469) |
| 5 Engine coolant reservoir
(→P. 476) | 10 Washer fluid tank (→P. 482) |

Engine oil

With the engine at operating temperature and turned off, check the oil level on the dipstick.

■ Checking the engine oil

STEP 1 Except hybrid vehicle

Gasoline engine: Park the vehicle on level ground. After warming up the engine and turning it off, wait more than 5 minutes for the oil to drain back into the bottom of the engine.

Diesel engine: Park the vehicle on level ground. After warming up the engine and turning it off, wait more than 5 minutes for the oil to drain back into the bottom of the engine.

Hybrid vehicle

Park the vehicle on level ground. After warming up the engine and turning off the hybrid system, wait more than 5 minutes for the oil to drain back into the bottom of the engine.

STEP 2 Holding a rag under the end, pull the dipstick out.

1KR-FE engine

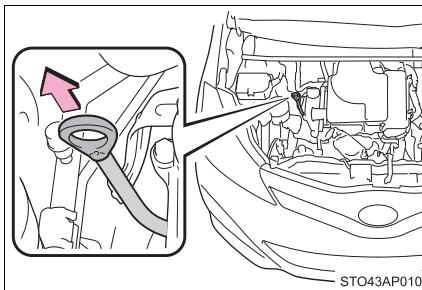

1NR-FE engine

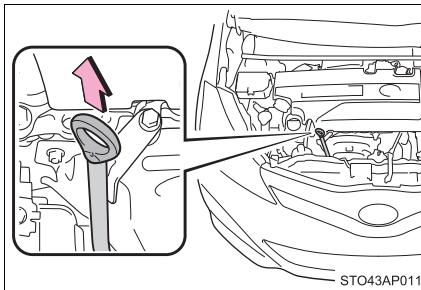

1ND-TV engine

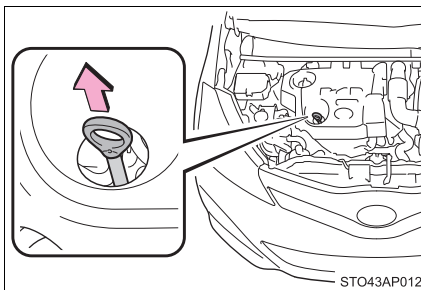

1NZ-FXE engine

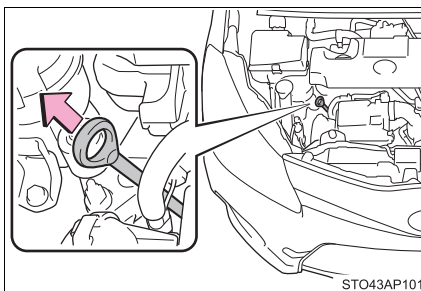

STEP 3 Wipe the dipstick clean.

STEP 4 Reinsert the dipstick fully.

STEP 5 Holding a rag under the end, pull the dipstick out and check the oil level.

Flat dipstick

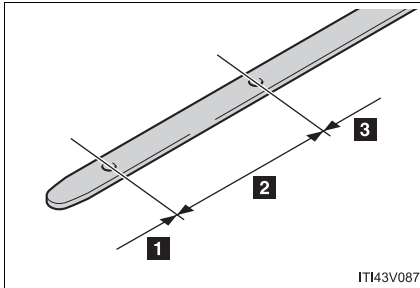

- 1** Low
- 2** Normal
- 3** Excessive

The shape of the dipstick may differ depending on the type of vehicle or engine.

Non-flat dipstick

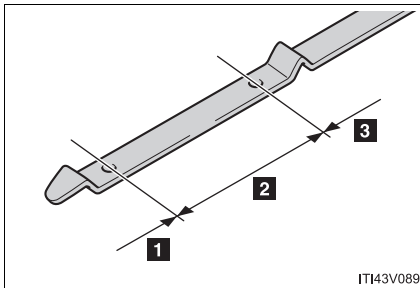

- 1** Low
- 2** Normal
- 3** Excessive

The shape of the dipstick may differ depending on the type of vehicle or engine.

STEP 6 Wipe the dipstick and reinsert it fully.

■ Adding engine oil

If the oil level is below or near the low level mark, add engine oil of the same type as that already in the engine.

1KR-FE engine

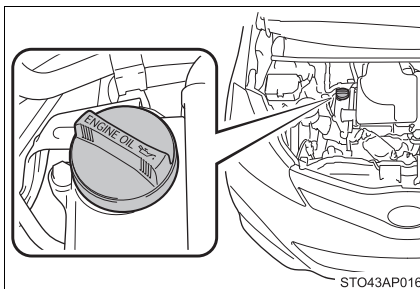

1NR-FE engine

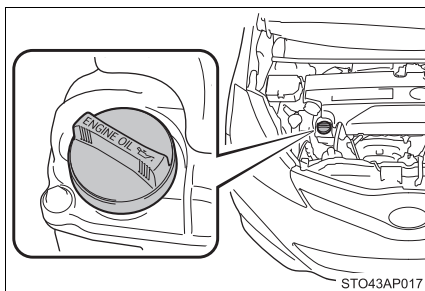

1ND-TV engine

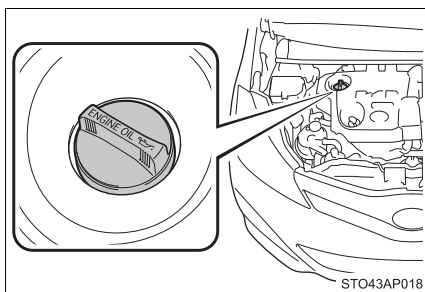

1NZ-FXE engine

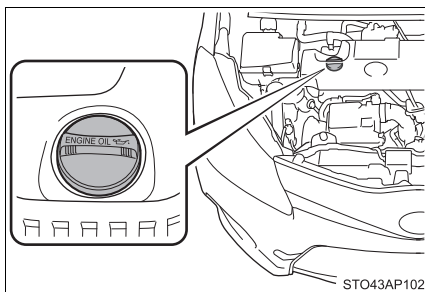

Make sure to check the oil type and prepare the items needed before adding oil.

Engine oil selection	→P. 670
Oil quantity (Low → Full)	1.5 L (1.6 qt., 1.3 Imp. qt.)
Item	Clean funnel

STEP 1 Remove the oil filler cap by turning it counterclockwise.

STEP 2 Add engine oil slowly, checking the dipstick.

STEP 3 Install the oil filler cap by turning it clockwise.

■ Engine oil consumption

A certain amount of engine oil will be consumed while driving. In the following situations, oil consumption may increase, and engine oil may need to be refilled in between oil maintenance intervals.

- When the engine is new, for example directly after purchasing the vehicle or after replacing the engine
- If low quality oil or oil of an inappropriate viscosity is used
- When driving at high engine speeds or with a heavy load, when towing (except hybrid vehicle [except for South Africa]), or when driving while accelerating or decelerating frequently
- When leaving the engine idling for a long time, or when driving frequently through heavy traffic

■ **After changing the engine oil (diesel engine only)**

The engine oil maintenance data should be reset. Perform the following procedures:

STEP 1 Switch the display to the trip meter “A” when the engine is running. (→P. 285)

STEP 2 Vehicles without a smart entry & start system:
Turn the engine switch to the “LOCK” position.
Vehicles with a smart entry & start system:
Turn the “ENGINE START STOP” switch off.

STEP 3 Vehicles without a smart entry & start system:
While pressing the display change button (→P. 285), turn the engine switch to the “ON” position (do not start the engine because reset mode will be canceled). Continue to press and hold the button until the trip meter displays “000000”.

Vehicles with a smart entry & start system:
While pressing the display change button (→P. 285), turn the “ENGINE START STOP” switch to the IGNITION ON mode (do not start the engine because otherwise the reset mode will be canceled). Continue to press and hold the button until the trip meter displays “000000”.

 **CAUTION**

■ **Used engine oil**

- Used engine oil contains potentially harmful contaminants which may cause skin disorders such as inflammation and skin cancer, so care should be taken to avoid prolonged and repeated contact. To remove used engine oil from your skin, wash thoroughly with soap and water.
- Dispose of used oil and filters only in a safe and acceptable manner. Do not dispose of used oil and filters in household trash, in sewers or onto the ground. Call any authorized Toyota dealer or repairer, or another duly qualified and equipped professional, service station or auto parts store for information concerning recycling or disposal.
- Do not leave used engine oil within the reach of children.

 NOTICE

■ To prevent serious engine damage

Check the oil level on a regular basis.

■ When replacing the engine oil

- Be careful not to spill engine oil on the vehicle components.
- Avoid overfilling, or the engine could be damaged.
- Check the oil level on the dipstick every time you refill the vehicle.
- Be sure the engine oil filler cap is properly tightened.

■ Engine oil (vehicles with a DPF system*)

Using an engine oil other than ACEA C2 may damage the catalytic converter.

*:To determine whether or not your vehicle has a DPF system, contact any authorized Toyota dealer or repairer, or another duly qualified and equipped professional.

Engine coolant (except hybrid vehicle)

The coolant level is satisfactory if it is between the “FULL” and “LOW” lines on the reservoir when the engine is cold.

Gasoline engine

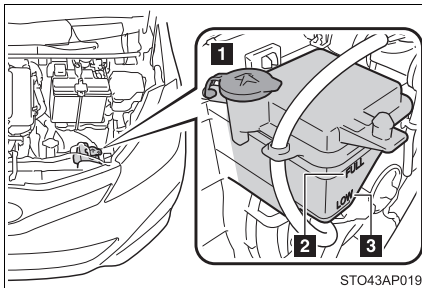

1 Reservoir cap

2 “FULL” line

3 “LOW” line

If the level is on or below the “LOW” line, add coolant up to the “FULL” line. (→P. 674)

Diesel engine

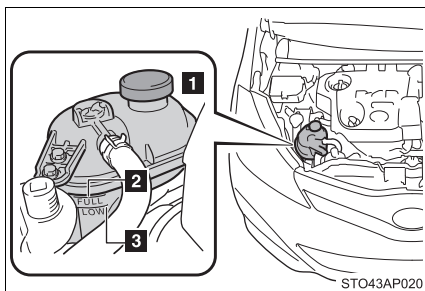

- 1 Reservoir cap
- 2 "FULL" line
- 3 "LOW" line

If the level is on or below the "LOW" line, add coolant up to the "FULL" line. (→P. 674)

Coolant (hybrid vehicle)

Engine coolant reservoir

The coolant level is satisfactory if it is between the "FULL" and "LOW" lines on the reservoir when the engine is cold.

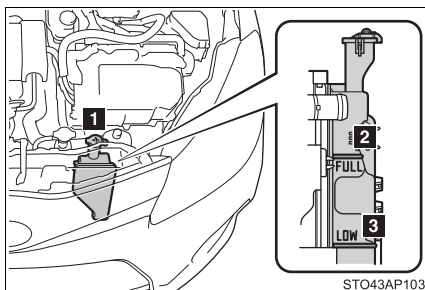

- 1 Reservoir cap
- 2 "FULL" line
- 3 "LOW" line

If the level is on or below the "LOW" line, add coolant up to the "FULL" line. (→P. 674)

Power control unit coolant reservoir

The coolant level is satisfactory if it is between the "F" and "L" lines on the reservoir when the hybrid system is cold.

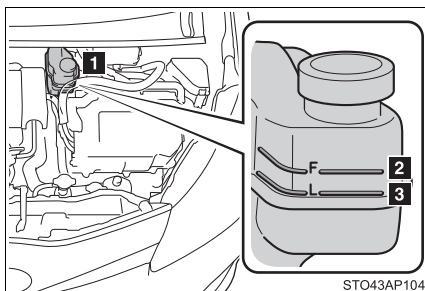

- 1 Reservoir cap
- 2 "F" line
- 3 "L" line

If the level is on or below the "L" line, add coolant up to the "F" line. (→P. 674)

■ Coolant selection

Only use “Toyota Super Long Life Coolant” or a similar high quality ethylene glycol based non-silicate, non-amine, non-nitrite, and non-borate coolant with long-life hybrid organic acid technology.

“Toyota Super Long Life Coolant” is a mixture of 50% coolant and 50% deionized water. (Minimum temperature: -35°C [-31°F])

For more details about engine coolant, contact any authorized Toyota dealer or repairer, or another duly qualified and equipped professional.

■ If the coolant level drops within a short time of replenishing

Except hybrid vehicle: Visually check the radiator, hoses, engine coolant reservoir cap, drain cock and water pump.

Hybrid vehicle: Visually check the radiator, hoses, engine/power control unit coolant reservoir caps, drain cock and water pump.

If you cannot find a leak, have any authorized Toyota dealer or repairer, or another duly qualified and equipped professional, test the cap and check for leaks in the cooling system.

CAUTION

■ When the engine is hot (except hybrid vehicle)

Do not remove the radiator cap (gasoline engine), or the engine coolant reservoir cap (diesel engine).

The cooling system may be under pressure and may spray hot coolant if the cap is removed, causing serious injuries, such as burns.

■ When the hybrid system is hot (hybrid vehicle)

Do not remove the engine/power control unit coolant reservoir caps.

The cooling system may be under pressure and may spray hot coolant if the cap is removed, causing serious injuries, such as burns.

 NOTICE

■ **When adding coolant**

Coolant is neither plain water nor straight antifreeze. The correct mixture of water and antifreeze must be used to provide proper lubrication, corrosion protection and cooling. Be sure to read the antifreeze or coolant label.

■ **If you spill coolant**

Be sure to wash it off with water to prevent it from damaging parts or paint.

Radiator, condenser and intercooler

Check the radiator, condenser and intercooler and clear away any foreign objects.

If any of the above parts are extremely dirty or you are not sure of their condition, have your vehicle inspected by any authorized Toyota dealer or repairer, or another duly qualified and equipped professional.

 CAUTION

■ **When the engine is hot (except hybrid vehicle)**

Do not touch the radiator, condenser or intercooler as they may be hot and cause serious injuries, such as burns.

■ **When the hybrid system is hot (hybrid vehicle)**







Do not touch the radiator or condenser as they may be hot and cause serious injuries, such as burns.

Battery (except hybrid vehicle)

Check the battery as follows:

■ Caution symbols

The meanings of each caution symbol on the top of the battery are as follows:

	No smoking, no naked flames, no sparks		Battery acid
	Shield eyes		Note operating instructions
	Keep away from children		Explosive gas

■ Battery exterior

Make sure that the battery terminals are not corroded and that there are no loose connections, cracks, or loose clamps.

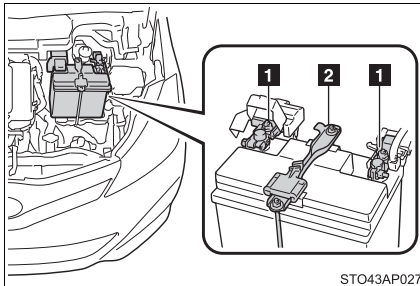

1 Terminals

2 Hold-down clamp

■ **Before recharging**

When recharging, the battery produces hydrogen gas which is flammable and explosive. Therefore, observe the following before recharging:

- If recharging with the battery installed on the vehicle, be sure to disconnect the ground cable.
- Make sure the power switch on the charger is off when connecting and disconnecting the charger cables to the battery.

■ **After recharging/reconnecting the battery (vehicles with a smart entry & start system)**

- Unlocking the doors using the smart entry & start system may not be possible immediately after reconnecting the battery. If this happens, use the wireless remote control or the mechanical key to lock/unlock the doors.
- Start the engine with the “ENGINE START STOP” switch in ACCESSORY mode. The engine may not start with the “ENGINE START STOP” switch turned off. However, the engine will operate normally from the second attempt.
- The “ENGINE START STOP” switch mode is recorded by the vehicle. If the battery is reconnected, the vehicle will return the “ENGINE START STOP” switch mode to the status it was in before the battery was disconnected. Make sure to turn off the engine before disconnect the battery. Take extra care when connecting the battery if the “ENGINE START STOP” switch mode prior to discharge is unknown.

If the engine will not start even after multiple attempts, contact any authorized Toyota dealer or repairer, or another duly qualified and equipped professional.

 **CAUTION****■ Chemicals in the battery**

Batteries contain poisonous and corrosive sulfuric acid and may produce hydrogen gas which is flammable and explosive. To reduce the risk of death or serious injury, take the following precautions while working on or near the battery:

- Do not cause sparks by touching the battery terminals with tools.
- Do not smoke or light a match near the battery.
- Avoid contact with eyes, skin and clothes.
- Never inhale or swallow electrolyte.
- Wear protective safety glasses when working near the battery.
- Keep children away from the battery.

■ Where to safely charge the battery

Always charge the battery in an open area. Do not charge the battery in a garage or closed room where there is insufficient ventilation.

■ How to recharge the battery

Only perform a slow charge (5 A or less). The battery may explode if charged at a quicker rate.

■ Emergency measures regarding electrolyte

- If electrolyte gets in your eyes
Flush your eyes with clean water for at least 15 minutes and get immediate medical attention. If possible, continue to apply water with a sponge or cloth while traveling to the nearest medical facility.
- If electrolyte gets on your skin
Wash the affected area thoroughly. If you feel pain or burning, get medical attention immediately.
- If electrolyte gets on your clothes
It can soak through clothing on to your skin. Immediately take off the clothing and follow the procedure above if necessary.
- If you accidentally swallow electrolyte
Drink a large quantity of water or milk. Get emergency medical attention immediately.

 NOTICE

■ **When recharging the battery**

Never recharge the battery while the engine is running. Also, be sure all accessories are turned off.

Washer fluid

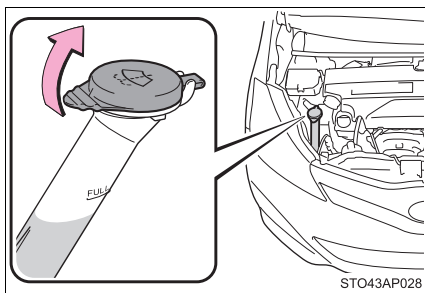

If the washer fluid level is less than “FULL” line, add washer fluid to “FULL” line.

 CAUTION

■ **When adding washer fluid**

Do not add washer fluid when the engine is hot or running (except hybrid vehicle) or the hybrid system is hot or operating (hybrid vehicle) as washer fluid contains alcohol and may catch fire if spilled on the engine etc.

 NOTICE

■ **Do not use any fluid other than washer fluid**

Do not use soapy water or engine antifreeze instead of washer fluid. Doing so may cause streaking on the vehicle’s painted surfaces.

■ **Diluting washer fluid**

Dilute washer fluid with water as necessary. Refer to the freezing temperatures listed on the label of the washer fluid bottle.

Fuel filter (diesel engine only)

You may drain the fuel filter yourself. However, as the operation is difficult, we recommend having it drained by any authorized Toyota dealer or repairer, or another duly qualified and equipped professional. Even if you decide to drain it yourself, contact any authorized Toyota dealer or repairer, or another duly qualified and equipped professional.

The water in the fuel filter needs to be drained if the fuel filter warning light comes on. (→P. 564)

- STEP 1** Vehicles without a smart entry & start system:
Turn the engine switch to the “LOCK” position.
- Vehicles with a smart entry & start system:
Turn the “ENGINE START STOP” switch off.

- STEP 2** Place a small tray under the drain plug to catch the water and any fuel that comes out.

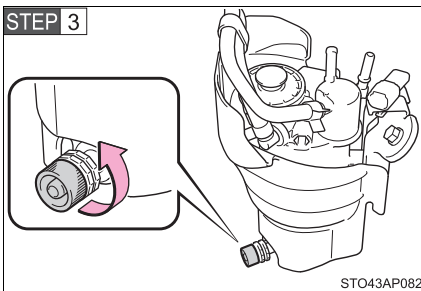

Turn the drain plug counterclockwise about 2 to 2 1/2 turns.

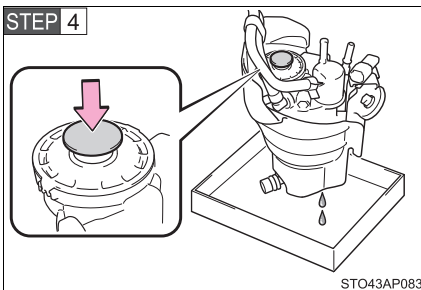

Operate the priming pump until fuel begins to run out.

- STEP 5** After draining, tighten the drain plug by hand.

4-3. Do-it-yourself maintenance

12-volt battery (hybrid vehicle)

■ Location

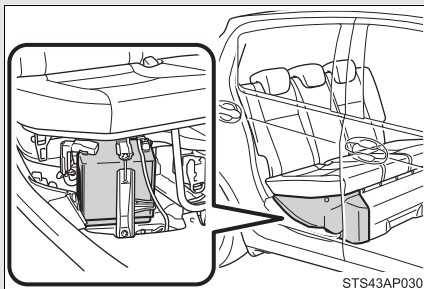

The 12-volt battery is located under the rear right seat.

■ Removing the 12-volt battery cover

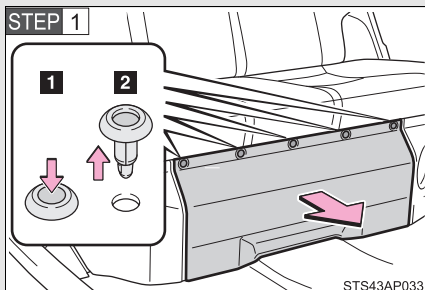

Remove the cover after removing the clips.

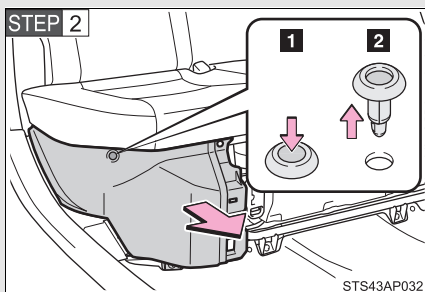

Remove the cover after removing the clip.

■ Exterior

Make sure that the 12-volt battery terminals are not corroded and that there are no loose connections, cracks, or loose clamps.

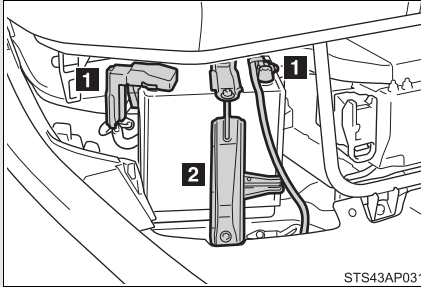

1 Terminals

2 Hold-down clamp

■ Installing the 12-volt battery cover

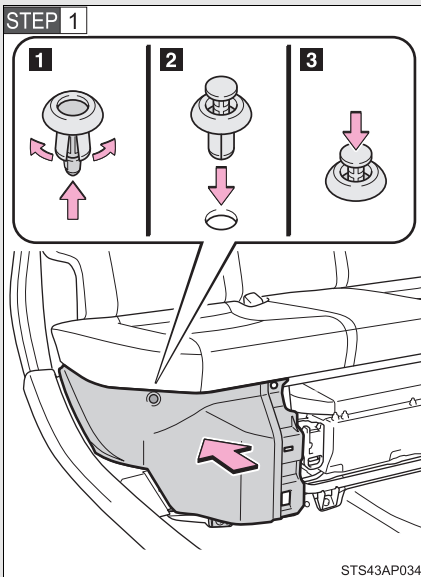



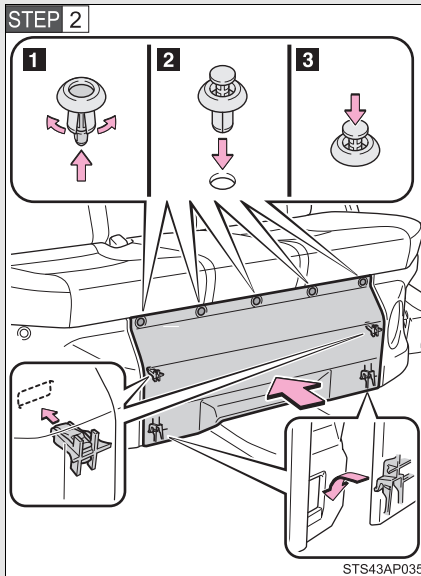



Install the cover with the clip.



Install the cover with the clips.

■ Caution symbols

The meanings of each caution symbol on the top of the battery are as follows:

	No smoking, no naked flames, no sparks		Battery acid
	Shield eyes		Note operating instructions
	Keep away from children		Explosive gas

■ Before recharging

When recharging, the 12-volt battery produces hydrogen gas which is flammable and explosive. Therefore, observe the following precautions before recharging:

- If recharging with the 12-volt battery installed on the vehicle, be sure to disconnect the ground cable.
- Make sure the power switch on the charger is off when connecting and disconnecting the charger cables to the 12-volt battery.

■ When disconnecting the 12-volt battery terminals

Always disconnect the negative (-) terminal first.

■ After recharging/reconnecting the 12-volt battery

- Unlocking the doors using the smart entry & start system may not be possible immediately after reconnecting the 12-volt battery. If this happens, use the wireless remote control or the mechanical key to lock/unlock the doors.
- Vehicles with an electronic key: Start the hybrid system with the “POWER” switch in ACCESSORY mode. The hybrid system may not start with the “POWER” switch turned off. However, the hybrid system will operate normally from the second attempt.
- Vehicles with an electronic key: The “POWER” switch mode is recorded by the vehicle. If the 12-volt battery is reconnected, the vehicle will return the “POWER” switch mode to the status it was in before the 12-volt battery was disconnected. Make sure to turn off the power before disconnect the 12-volt battery. Take extra care when connecting the 12-volt battery if the “POWER” switch mode prior to discharge is unknown.

If the system will not start even after multiple attempts, contact any authorized Toyota dealer or repairer, or another duly qualified and equipped professional.

 CAUTION

■ **Chemicals in the 12-volt battery**

The 12-volt battery contains poisonous and corrosive sulfuric acid and may produce hydrogen gas which is flammable and explosive. To reduce the risk of death or serious injury, take the following precautions while working on or near the 12-volt battery:

- Do not cause sparks by touching the 12-volt battery terminals with tools.
- Do not smoke or light a match near the 12-volt battery.
- Avoid contact with eyes, skin and clothes.
- Never inhale or swallow electrolyte.
- Wear protective safety glasses when working near the 12-volt battery.
- Keep children away from 12-volt battery.

■ **Where to safely charge the 12-volt battery**

Always charge the 12-volt battery in an open area. Do not charge the 12-volt battery in a garage or closed room where there is insufficient ventilation.

■ **When disconnecting the 12-volt battery terminals**

Always disconnect the negative (-) terminal first. If the positive (+) terminal is disconnected first and touches a surrounding metal surface sparks will be produced, possibly starting a fire. It could also result in an electric shock or serious injury.

■ **How to recharge the 12-volt battery**

Only perform a slow charge (3.5 A or less). The 12-volt battery may explode if charged at a quicker rate.

 **CAUTION****■ Emergency measures regarding electrolyte**

- If electrolyte gets in your eyes
Flush your eyes with clean water for at least 15 minutes and get immediate medical attention. If possible, continue to apply water with a sponge or cloth while traveling to the nearest medical facility.
- If electrolyte gets on your skin
Wash the affected area thoroughly. If you feel pain or burning, get medical attention immediately.
- If electrolyte gets on your clothes
It can soak through clothing on to your skin. Immediately take off the clothing and follow the procedure above if necessary.
- If you accidentally swallow electrolyte
Drink a large quantity of water or milk. Get emergency medical attention immediately.

■ When replacing the 12-volt battery

Use a 12-volt battery designed for this vehicle. Failure to do so may cause gas (hydrogen) to enter the passenger compartment, causing a fire or explosion.

For replacement of the 12-volt battery, contact any authorized Toyota dealer or repairer, or another duly qualified and equipped professional.

 **NOTICE****■ When recharging the 12-volt battery**

Never recharge the 12-volt battery while the hybrid system is operating. Also, be sure all accessories are turned off.

4-3. Do-it-yourself maintenance

Tires

Replace or rotate tires in accordance with maintenance schedules and treadwear.

■ Checking tires

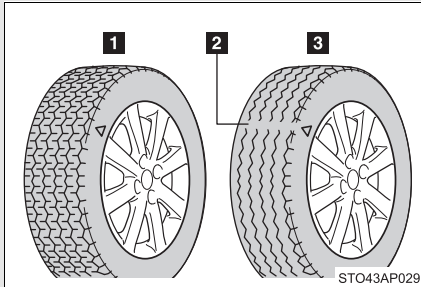

- 1 New tread
- 2 Treadwear indicator
- 3 Worn tread

The location of treadwear indicators is shown by the “TWI” or “Δ” marks, etc., molded on the sidewall of each tire.

Check spare tire condition and pressure if not rotated.

■ Tire rotation

Vehicles with a spare tire of different wheel type from the installed tires or an emergency tire puncture repair kit

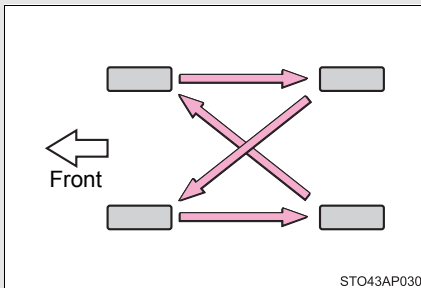

Rotate the tires in the order shown.

To equalize tire wear and help extend tire life, Toyota recommends that tire rotation is carried out approximately every 10000 km (6000 miles).

Vehicles with a spare tire of the same wheel type as the installed tires

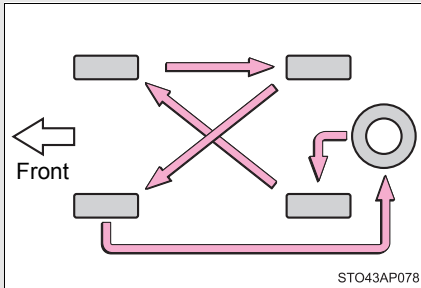

Rotate the tires in the order shown.

To equalize tire wear and help extend tire life, Toyota recommends that tire rotation is carried out approximately every 10000 km (6000 miles).

■ When to replace your vehicle's tires

Tires should be replaced if:

- You have tire damage such as cuts, splits, cracks deep enough to expose the fabric, and bulges indicating internal damage
- A tire goes flat repeatedly or cannot be properly repaired due to the size or location of a cut or other damage

If you are not sure, consult with any authorized Toyota dealer or repairer, or another duly qualified and equipped professional.

■ Tire life

Any tire over 6 years old must be checked by a qualified technician even if it has seldom or never been used or damage is not obvious.

■ Low profile tires (vehicles with 195/50R16 tires)

Generally, low profile tires will wear more rapidly and tire grip performance will be reduced on snowy and/or icy roads when compared to standard tires. Be sure to use snow tires or tire chains on snowy and/or icy roads and drive carefully at a speed appropriate for road and weather conditions.

■ If the tread on snow tires wears down below 4 mm (0.16 in.)

The effectiveness of the tires as snow tires is lost.

 CAUTION

■ When inspecting or replacing tires

Observe the following precautions to prevent accidents.

Failure to do so may cause damage to parts of the drive train as well as dangerous handling characteristics, which may lead to an accident resulting in death or serious injury.

- Do not mix tires of different makes, models or tread patterns.
Also, do not mix tires of remarkably different treadwear.
- Do not use tire sizes other than those recommended by Toyota.
- Do not mix differently constructed tires (radial, bias-belted or bias-ply tires).
- Do not mix summer, all season and snow tires.
- Do not use tires that have been used on another vehicle.
Do not use tires if you do not know how they were used previously.
- Vehicles with a compact spare tire: Do not tow if your vehicle has a compact spare tire installed.

 NOTICE**■ Driving on rough roads**

Take particular care when driving on roads with loose surfaces or potholes. These conditions may cause losses in tire inflation pressure, reducing the cushioning ability of the tires. In addition, driving on rough roads may cause damage to the tires themselves, as well as the vehicle's wheels and body.

■ Low profile tires (vehicles with 195/50R16 tires)

Low profile tires may cause greater damage than usual to the tire wheel when sustaining impact from the road surface. Therefore, pay attention to the following:

- Be sure to use proper tire inflation pressure. If tires are under-inflated, they may be damaged more severely.
- Avoid potholes, uneven pavement, curbs and other road hazards. Failure to do so may lead to severe tire and wheel damage.

■ If tire inflation pressure of each tire becomes low while driving

Do not continue driving, or your tires and/or wheels may be ruined.

4-3. Do-it-yourself maintenance

Tire inflation pressure

Make sure to maintain proper tire inflation pressure. Tire inflation pressure should be checked at least once per month. However, Toyota recommends that tire inflation pressure be checked once every two weeks. (→P. 679)

■ Effects of incorrect tire inflation pressure

Driving with incorrect tire inflation pressure may result in the following:

- Reduced fuel efficiency
- Reduced driving comfort and tire life
- Reduced safety
- Damage to the drive train

If a tire needs frequent inflating, have it checked by any authorized Toyota dealer or repairer, or another duly qualified and equipped professional.

■ Instructions for checking tire inflation pressure

When checking tire inflation pressure, observe the following:

- Check only when the tires are cold.
If your vehicle has been parked for at least 3 hours or has not been driven for more than 1.5 km or 1 mile, you will get an accurate cold tire inflation pressure reading.
- Always use a tire pressure gauge.
The appearance of the tire can be misleading. In addition, tire inflation pressure that is even just a few pounds off can affect ride quality and handling.
- Do not reduce tire inflation pressure after driving. It is normal for tire inflation pressure to be higher after driving.
- Never exceed the vehicle capacity weight.
Passengers and luggage weight should be placed so that the vehicle is balanced.

 **CAUTION****■ Proper inflation is critical to save tire performance**

Keep your tires properly inflated. Otherwise, the following conditions may occur and result in an accident causing death or serious injury:

- Excessive wear
- Uneven wear
- Poor handling
- Possibility of blowouts resulting from overheated tires
- Poor sealing of the tire bead
- Wheel deformation and/or tire separation
- A greater possibility of tire damage from road hazards

 **NOTICE****■ When inspecting and adjusting tire inflation pressure**

Be sure to put the tire valve caps back on.

Without the valve caps, dirt or moisture could get into the valve and cause air leakage, which could result in an accident. If the caps are lost, replace them as soon as possible.

Wheels

If a wheel is bent, cracked or heavily corroded, it should be replaced. Otherwise, the tire may separate from the wheel or cause a loss of handling control.

■ Wheel selection

When replacing wheels, care should be taken to ensure that they are equivalent to those removed in load capacity, diameter, rim width and inset*.

Replacement wheels are available at any authorized Toyota dealer or repairer, or another duly qualified and equipped professional.

*: Conventionally referred to as "offset".

Toyota does not recommend using the following:

- Wheels of different sizes or types
- Used wheels
- Bent wheels that have been straightened

■ Aluminum wheel precautions (if equipped)

- Use only Toyota wheel nuts and wrenches designed for use with your aluminum wheels.
- When rotating, repairing or changing your tires, check that the wheel nuts are still tight after driving 1600 km (1000 miles).
- Be careful not to damage the aluminum wheels when using tire chains.
- Use only Toyota genuine balance weights or equivalent and use a plastic or rubber hammer when balancing your wheels.

■ When removing the wheel ornament (if equipped)

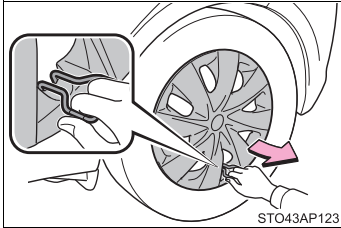

Remove the wheel ornament using the wheel cap clip.

▲ CAUTION

■ When replacing wheels

- Do not use wheels that are a different size from those recommended in the Owner's Manual, as this may result in a loss of handling control.
- Never use an inner tube in a leaking wheel which is designed for a tubeless tire. Doing so may result in an accident, causing death or serious injury.

■ When installing the wheel nuts

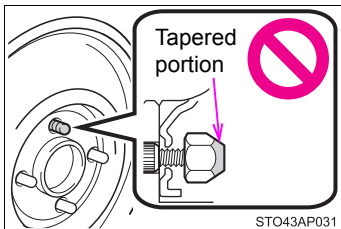

- Be sure to install the wheel nuts with the tapered ends facing inward. Installing the nuts with the tapered ends facing outward can cause the wheel to break and eventually cause the wheel to come off while driving, which could lead to an accident resulting in death or serious injury.

- Never use oil or grease on the wheel bolts or wheel nuts. Oil and grease may cause the wheel nuts to be excessively tightened, leading to bolt or disc wheel damage. In addition, the oil or grease can cause the wheel nuts to loosen and the wheel may fall off, causing an accident and resulting in death or serious injury. Remove any oil or grease from the wheel bolts or wheel nuts.

4-3. Do-it-yourself maintenance

Air conditioning filter

The air conditioning filter must be changed regularly to maintain air conditioning efficiency.

■ Replacement method

STEP 1 Except hybrid vehicle

Vehicles without a smart entry & start system:

The engine switch is in the "LOCK" position.

Vehicles with a smart entry & start system:

The "ENGINE START STOP" switch is off.

Hybrid vehicle

Vehicles without an electronic key:

The engine switch is in the "LOCK" position.

Vehicles with an electronic key:

The "POWER" switch is off.

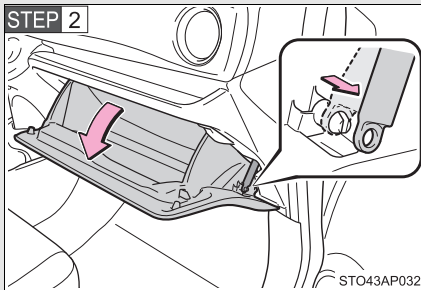

Open the glove box. Slide off the damper.

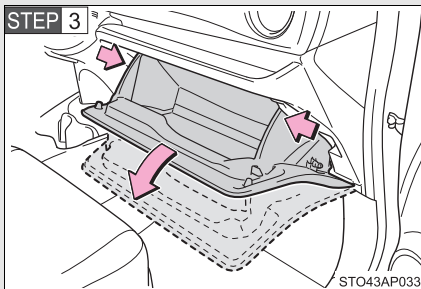

Push in each side of the glove box to disconnect the upper claws.

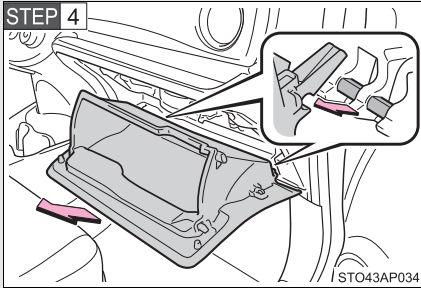

Pull out the glove box and disconnect the lower claws.

STEP 5 Remove the filter cover.

Left hand drive vehicles

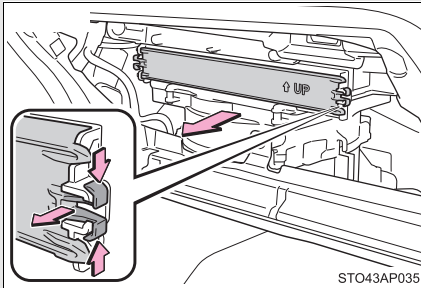

Right hand drive vehicles

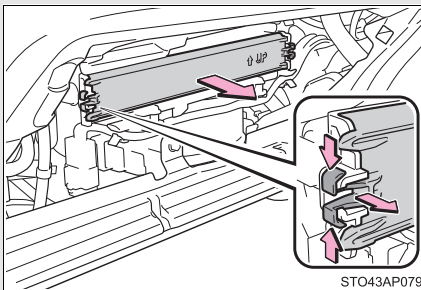

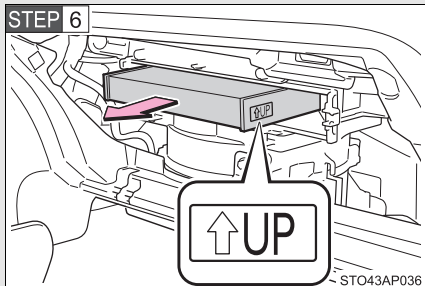

Remove the air conditioning filter and replace it with a new one.

The “↑UP” marks shown on the filter should be pointing up.

■ Checking interval

Inspect and replace the air conditioning filter according to the maintenance schedule. In dusty areas or areas with heavy traffic flow, early replacement may be required. (For scheduled maintenance information, please refer to the “Toyota Service Booklet” or “Toyota Warranty Booklet”.)

■ If air flow from the vents decreases dramatically

The filter may be clogged. Check the filter and replace if necessary.

⚠ NOTICE

■ When using the air conditioning system

Make sure that a filter is always installed.
Using the air conditioning system without a filter may cause damage to the system.

4-3. Do-it-yourself maintenance

Wireless remote control/electronic key battery

Replace the battery with a new one if it is depleted.

■ You will need the following items:

- Flathead screwdriver
- Lithium battery CR2016 (vehicles without a smart entry & start system or a push-button start system), or CR2032 (vehicles with a smart entry & start system or a push-button start system)

■ Replacing the wireless remote control battery

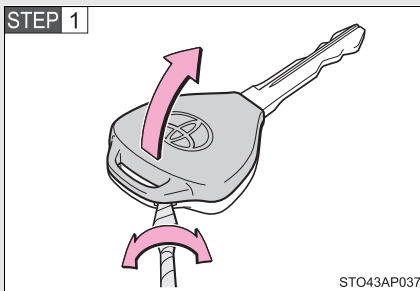

Remove the cover.

To prevent damage to the key, cover the tip of the screwdriver with a tape.

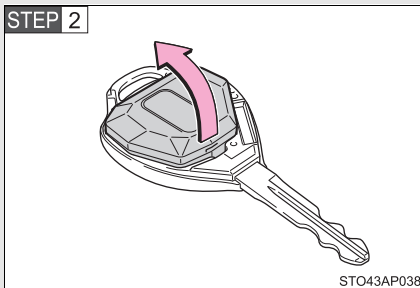

Remove the module.

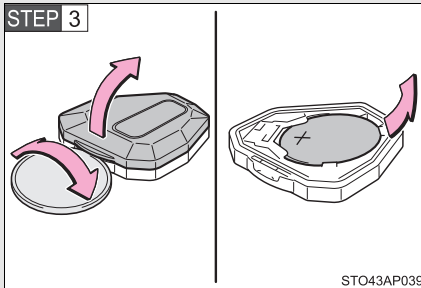

Remove the battery cover and the depleted battery.

Insert a new battery with the “+” terminal facing up.

■ Replacing the electronic key battery

Type A

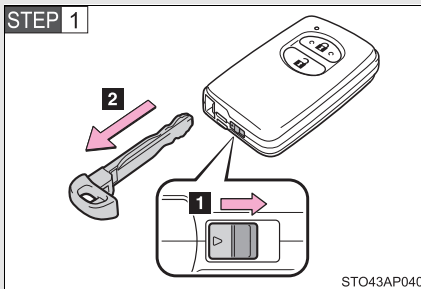

Take out the mechanical key.

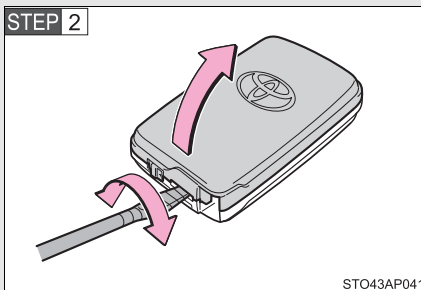

Remove the cover.

To prevent damage to the key, cover the tip of the screwdriver with a tape.

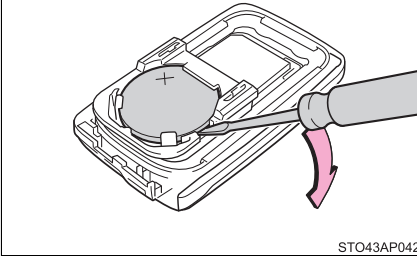
STEP 3

Remove the depleted battery.

Insert a new battery with the “+” terminal facing up.

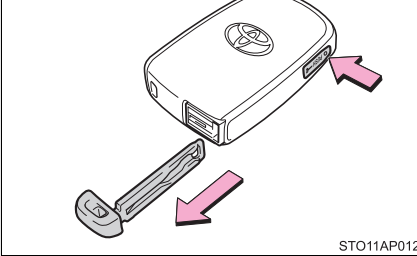
Type B**STEP 1**

Take out the mechanical key.

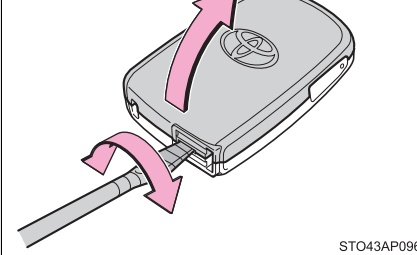
STEP 2

Remove the cover.

To prevent damage to the key, cover the tip of the screwdriver with a tape.

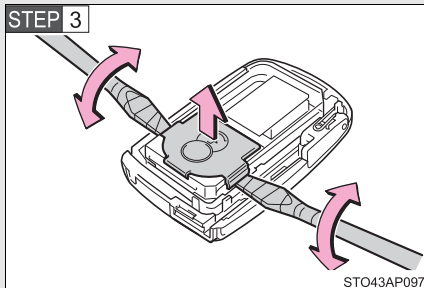

Remove the battery cover.

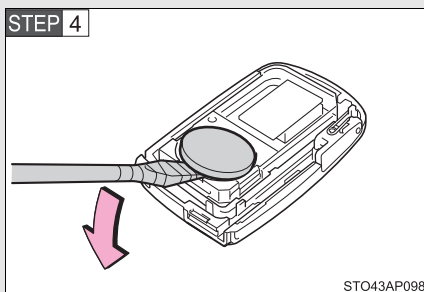

Remove the depleted battery.

Insert a new battery with the "+" terminal facing up.

■ **Use a CR2016 (vehicles without a smart entry & start system or a push-button start system) or CR2032 (vehicles with a smart entry & start system or a push-button start system) lithium battery**

- Batteries can be purchased at any authorized Toyota dealer or repairer, or another duly qualified and equipped professional, local electrical appliance shops or camera stores.
- Replace only with the same or equivalent type recommended by the manufacturer.
- Dispose of used batteries according to local laws.

■ **If the key battery is depleted**

The following symptoms may occur:

- The smart entry & start system (if equipped), push-button start system (if equipped) and wireless remote control will not function properly.
- The operational range will be reduced.

 CAUTION**■ Removed battery and other parts**

These parts are small and if swallowed by a child, they can cause choking. Keep away from children. Failure to do so could result in death or serious injury.

■ Certification for the lithium battery

RISK OF EXPLOSION IF BATTERY IS REPLACED BY AN INCORRECT TYPE. DISPOSE OF USED BATTERIES ACCORDING TO THE INSTRUCTIONS

 NOTICE**■ For normal operation after replacing the battery**

Observe the following precautions to prevent accidents:

- Always work with dry hands.
Moisture may cause the battery to rust.
- Do not touch or move any other component inside the remote control.
- Do not bend either of the battery terminals.

4-3. Do-it-yourself maintenance

Checking and replacing fuses

If any of the electrical components do not operate, a fuse may have blown. If this happens, check and replace the fuses as necessary.

STEP 1 Except hybrid vehicle

Vehicles without a smart entry & start system:

Turn the engine switch is in the “LOCK” position.

Vehicles with a smart entry & start system:

Turn the “ENGINE START STOP” switch off.

Hybrid vehicle

Vehicles without an electronic key:

Turn the engine switch is in the “LOCK” position.

Vehicles with an electronic key:

Turn the “POWER” switch off.

STEP 2 Open the fuse box cover.

Except hybrid vehicle

Engine compartment (type A fuse box):

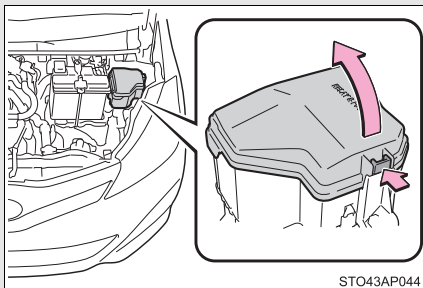

STO43AP044

Push the tab in and lift the lid off.

Engine compartment (type B fuse box):

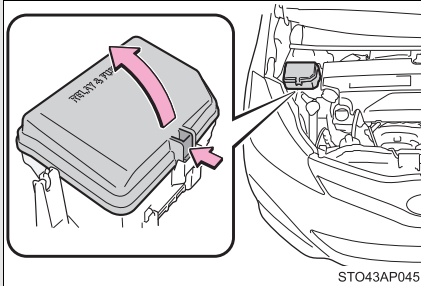

Push the tab in and lift the lid off.

Engine compartment (type C fuse box for the left-hand drive vehicles):

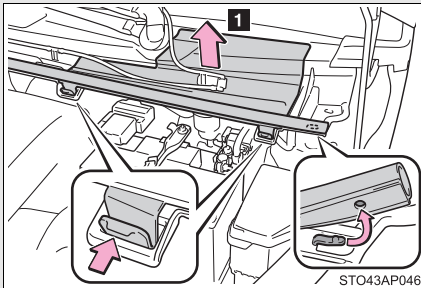

1 Pull the rubber strip on the edge to unhook it from the cover, and then push the tabs in and lift the cover off.

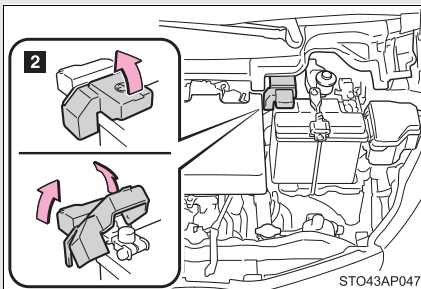

2 Remove the battery terminal cover and then the fuse box cover.

Engine compartment (type C fuse box for the right-hand drive vehicles):

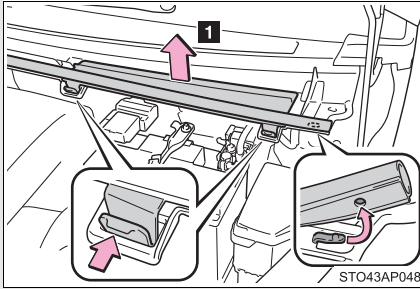

1 Pull the rubber strip on the edge to unhook it from the cover, and then push the tabs in and lift the cover off.

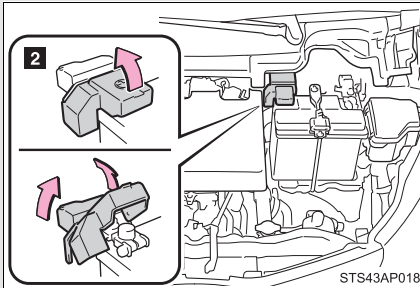

2 Remove the battery terminal cover and then the fuse box cover.

Under the instrument panel (left-hand drive vehicles):

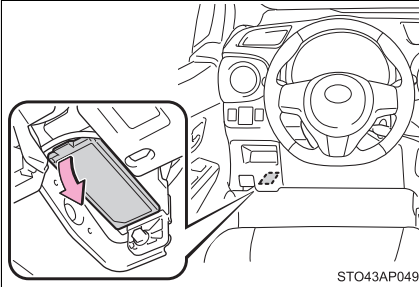

Remove the lid.

Under the instrument panel (right-hand drive vehicles):

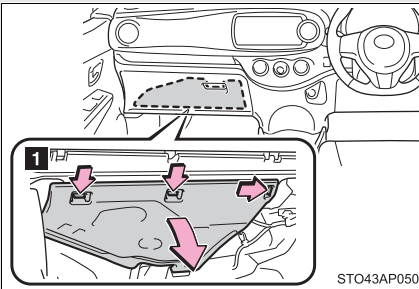

1 Remove the cover.

Do not pull off the cover using excessive force as it is attached to the footwell light.

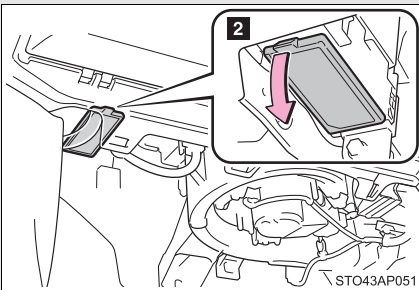

2 Remove the lid.

Hybrid vehicle

Engine compartment (type A fuse box):

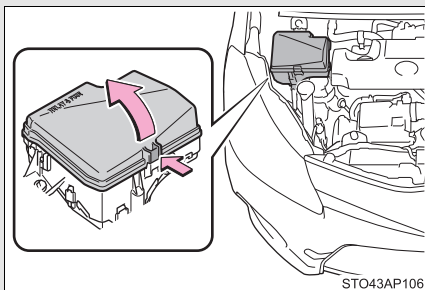

Push the tab in and lift the lid off.

Engine compartment (type B fuse box):

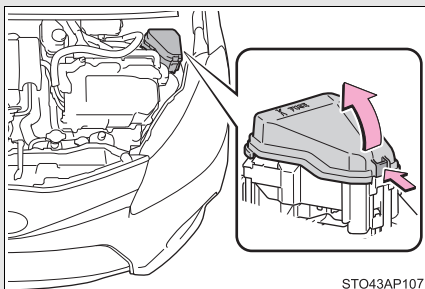

Push the tab in and lift the lid off.

Under the instrument panel (left-hand drive vehicles):

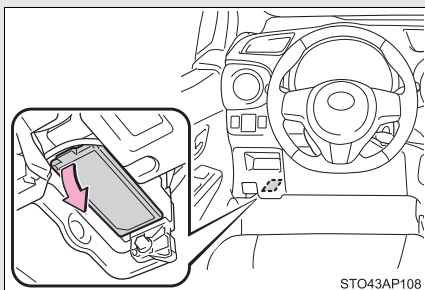

Remove the lid.

Under the instrument panel (right-hand drive vehicles):

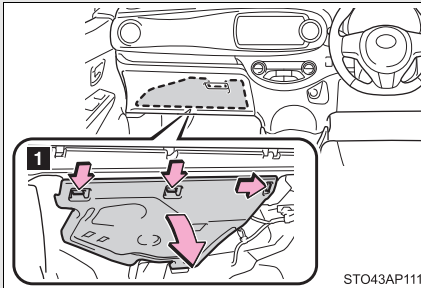

1 Remove the cover.

Do not pull off the cover using excessive force as it is attached to the footwell light.

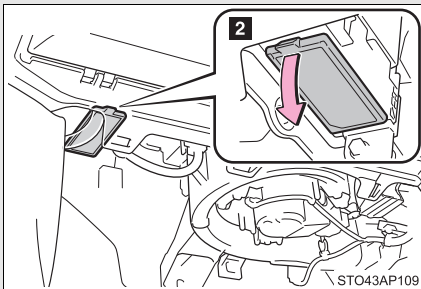

2 Remove the lid.

STEP 3 After a system failure, see “Fuse layout and amperage ratings” (→P. 515, 523) for details about which fuse to check.

STEP 4 Remove the fuse.

Except hybrid vehicle

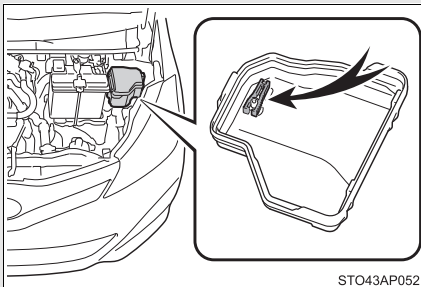

Only type A fuse can be removed using the pullout tool.

The pullout tool is located on the back of the type A fuse box cover.

Hybrid vehicle

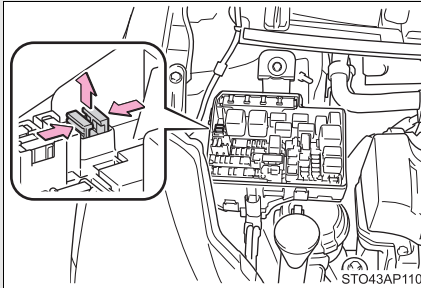

Only type A fuse can be removed using the pullout tool.

STEP 5 Check if the fuse is blown.

Type A

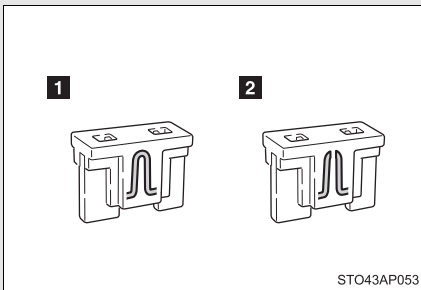

1 Normal fuse

2 Blown fuse

Replace the blown fuse with a new fuse of an appropriate amperage rating. The amperage rating can be found on the fuse box lid.

Type B

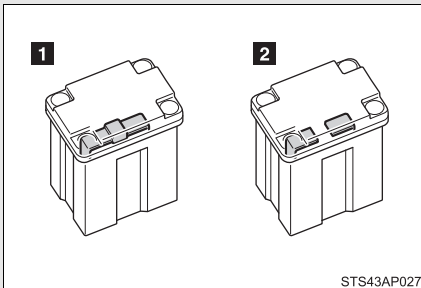

1 Normal fuse

2 Blown fuse

Replace the blown fuse with a new fuse of an appropriate amperage rating. The amperage rating can be found on the fuse box lid.

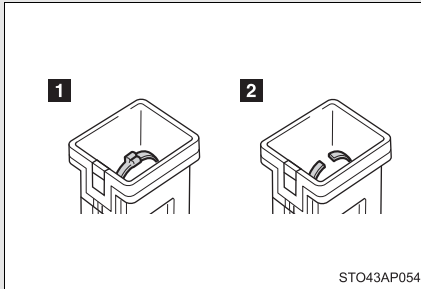
Type C**1** Normal fuse**2** Blown fuse

Replace the blown fuse with a new fuse of an appropriate amperage rating. The amperage rating can be found on the fuse box lid.

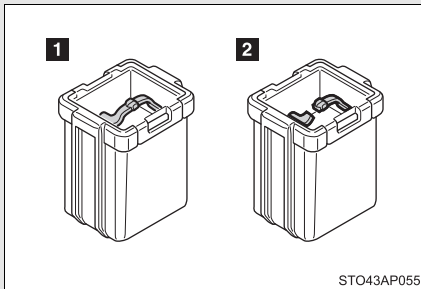
Type D**1** Normal fuse**2** Blown fuse

Replace the blown fuse with a new fuse of an appropriate amperage rating. The amperage rating can be found on the fuse box lid.

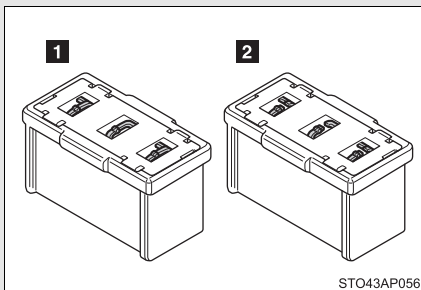
Type E**1** Normal fuse**2** Blown fuse

Replace the blown fuse with a new fuse of an appropriate amperage rating. The amperage rating can be found on the fuse box lid.

Type F

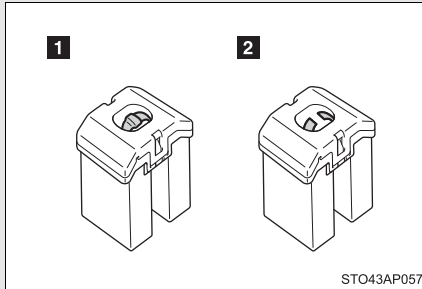

1 Normal fuse

2 Blown fuse

Replace the blown fuse with a new fuse of an appropriate amperage rating. The amperage rating can be found on the fuse box lid.

Type G

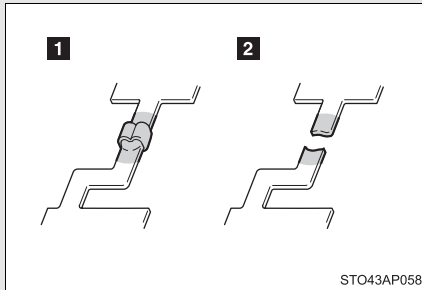

1 Normal fuse

2 Blown fuse

Contact any authorized Toyota dealer or repairer, or another duly qualified and equipped professional.

Fuse layout and amperage ratings (except hybrid vehicle)

Engine compartment (type A fuse box)

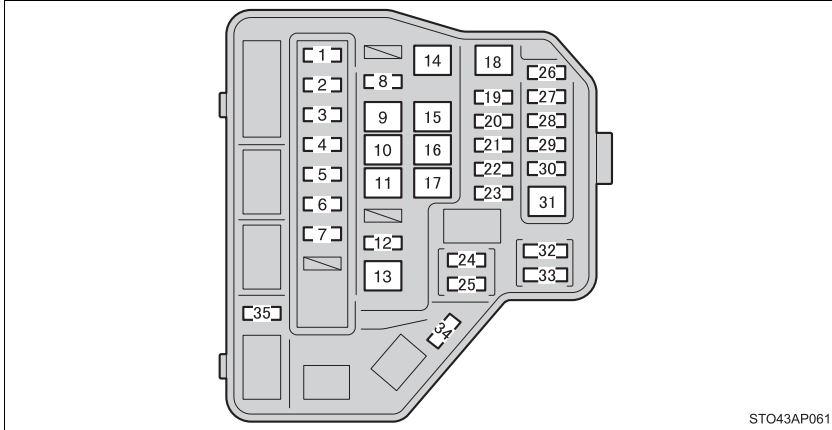

Fuse		Ampere	Circuit
1	EFI MAIN* ¹	20 A	Multiport fuel injection system/ sequential multiport fuel injection system, EFI NO.2, EFI NO.3
	ECD MAIN* ²	30 A	Multiport fuel injection system/ sequential multiport fuel injection system, EFI NO.2, EFI NO.3
2	EFI NO.3	7.5 A	Multiport fuel injection system/ sequential multiport fuel injection system
3	HORN	10 A	Horn
4	EFI NO.2	10 A	Stop & Start system, multiport fuel injection system/sequential multi- port fuel injection system

Fuse		Ampere	Circuit
5	IG2	10 A	Smart entry & start system, multiport fuel injection system/sequential multiport fuel injection system, multi-mode manual transmission, SRS airbag system, steering lock system, stop lights, Stop & Start system
6	IGN	15 A	Multiport fuel injection system/sequential multiport fuel injection system
7	MET	7.5 A	Gauge and meters, Stop & Start system
8	PWR HTR* ²	25 A	Power heater, multiport fuel injection system/sequential multiport fuel injection system
9	EPS	50 A	Electric power steering
10	ABS NO.2	30 A	ABS, VSC
11	DEF	30 A	Rear window defogger, ID/UP, MIR-HTR
12	SPARE	10 A	Spare fuse
13	PTC	80 A	PTC heater, outside rear view mirror defogger
14	HTR	40 A	Air conditioning system
15	H-LP CLN	30 A	—
16	RDI FAN	30 A	Electric cooling fan
17	ABS NO.1	50 A	ABS, VSC
18	BBC* ³	40 A	Stop & Start system
19	ST	30 A	Starting system
20	AMP	15 A	Audio system
21	D/L NO.2	25 A	Power door lock
22	D.C.C.	30 A	DOME, ECU-B NO.1

Fuse		Ampere	Circuit
23	STR LOCK	20 A	Steering lock system
24	ECU-B NO.1	5 A	Main body ECU, smart entry & start system, VSC*4
25	DOME	15 A	Interior lights, audio system, VSC*4
26	ETCS	10 A	Multiport fuel injection system/ sequential multiport fuel injection system
27	HAZ	10 A	Turn signal lights
28	AM2	7.5 A	Multiport fuel injection system/ sequential multiport fuel injection system, smart entry & start system, stop & start system, starting system, multi-mode manual transmission
29	ECU-B NO.2	5 A	Gauge and meters, power door lock, wireless remote control, Stop & Start system, smart entry & start system, multi-mode manual transmission, air conditioning system
30	ALT-S	7.5 A	—
31	R/I	50 A	EFI MAIN, ECD MAIN, EFI NO.2, EFI NO.3, IG2, IGN, MET, HORN
32	SPARE	20 A	Spare fuse
33	SPARE	30 A	Spare fuse
34	MIR-HTR	10 A	Outside rear view mirror defogger
35	ID/UP	7.5 A	Multiport fuel injection system/ sequential multiport fuel injection system

*1: Gasoline engine

*2: Diesel engine

*3: Vehicles with a 1NR-FE engine equipped with a Stop & Start system

*4: On some models

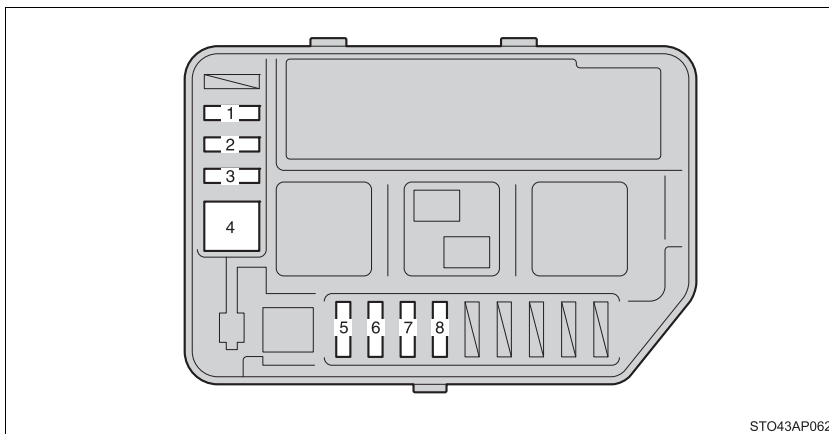
Engine compartment (type B fuse box)

Fuse		Ampere	Circuit
1	EU-DRL	15 A	—
2	S-HORN	10 A	—
3	H-LP MAIN	7.5 A	Headlights
4	MMT	50 A	Multi-mode manual transmission
5	H-LP RH HI	10 A	Right-hand headlight (high beam)
6	H-LP LH HI	10 A	Left-hand headlight (high beam), gauge and meters
7	H-LP RH LO	10 A	Right-hand headlight (low beam)
8	H-LP LH LO	10 A	Left-hand headlight (low beam), manual headlight leveling dial

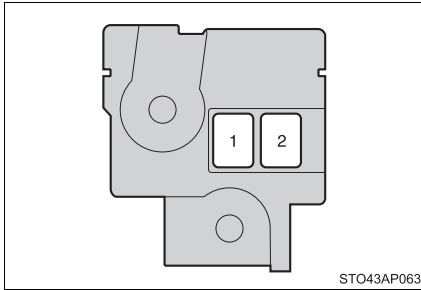
Engine compartment (gasoline engine type C fuse box)

Fuse		Ampere	Circuit
1	ALT	120 A	EPS, ABS NO.2, DEF, PTC, HTR, RDI FAN, ABS NO.1, TAIL NO.2, PANEL, DOOR R/R, DOOR P, ECU-IG NO.1, ECU-IG NO.2, A/C, GAUGE, WASHER, WIPER, WIPER RR, P/W, DOOR R/L, DOOR, CIG, ACC, D/L, OBD, FOG RR, STOP, AM1, FOG FR, D-D/L, SHADE, S-HTR
2	MAIN	80 A	BBC, ST, D/L NO.2, D.C.C., STR LOCK, ETCS, HAZ, AM2, ECU-B NO.2, R/I, H-LP MAIN, H-LP RH HI, H-LP LH HI, H-LP RH LO, H-LP LH LO, AMP

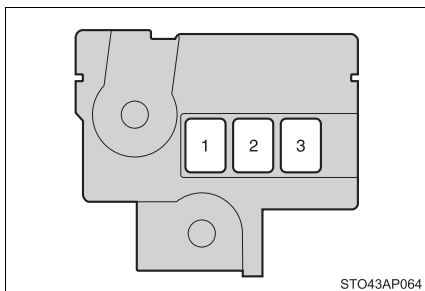
Engine compartment (diesel engine type C fuse box)

Fuse		Ampere	Circuit
1	ALT	120 A	PWR HTR, EPS, ABS NO.2, DEF, PTC, HTR, RDI FAN, ABS NO.1, TAIL NO.2, PANEL, DOOR R/R, DOOR P, ECU-IG NO.1, ECU-IG NO.2, A/C, GAUGE, WASHER, WIPER, WIPER RR, P/W, DOOR R/L, DOOR, CIG, ACC, D/L, OBD, FOG RR, STOP, AM1, FOG FR, D-D/L, SHADE, S-HTR
2	MAIN	80 A	ST, D/L NO.2, D.C.C., STR LOCK, ETCS, HAZ, AM2, ECU-B NO.2, R/I, H-LP MAIN, H-LP RH HI, H-LP LH HI, H-LP RH LO, H-LP LH LO, MMT
3	GLOW DC/DC	80 A	Engine glow system

Under the instrument panel

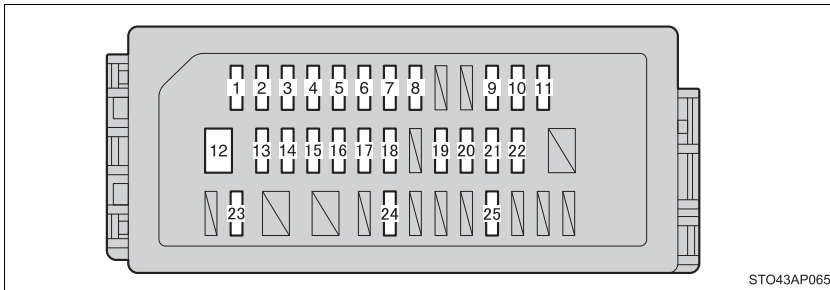

Fuse		Ampere	Circuit
1	TAIL NO.2	10 A	Front position lights, tail lights, license plate lights, front fog lights, rear fog light, multiport fuel injection system/sequential multiport fuel injection system, gauge and meters
2	PANEL	5 A	Gauge and meters, instrument panel lights, switch illumination
3	DOOR R/R	20 A	Power windows
4	DOOR P	20 A	Power windows
5	ECU-IG NO.1	5 A	Electric cooling fan, rear window defogger, electric power steering, main body ECU, windshield wipers, VSC
6	ECU-IG NO.2	5 A	ABS, VSC, Stop & Start system
7	A/C	7.5 A	Air conditioning system, power heater, rear window defogger, outside rear view mirror defoggers
8	GAUGE	10 A	Back-up lights, shift lock control system, rear seat belt reminder lights, auto anti-glare inside rear view mirror, multidrive, audio system, multiport fuel injection system/sequential multiport fuel injection system, rain sensor

Fuse		Ampere	Circuit
9	WASHER	15 A	Windshield washer
10	WIPER	20 A	Windshield wipers
11	WIPER RR	15 A	Rear window wiper
12	P/W	30 A	Power windows
13	DOOR R/L	20 A	Power windows
14	DOOR	20 A	Power windows
15	CIG	15 A	Power outlets
16	ACC	5 A	Main body ECU, outside rear view mirrors, audio system, Stop & Start system, shift lock control system
17	D/L	25 A	Power door lock system
18	OBD	7.5 A	On-board diagnosis system
19	FOG RR	7.5 A	Rear fog light, gauge and meters
20	STOP	7.5 A	Multiport fuel injection system/ sequential multiport fuel injection system, smart entry & start system, ABS, VSC, stop lights, high mounted stoplight, shift lock control system
21	AM1	7.5 A	Starting system
22	FOG FR	7.5 A	Front fog lights, gauge and meters
23	D-D/L	25 A	D-D/L
24	SHADE	25 A	—
25	S-HTR	15 A	Seat heaters

Fuse layout and amperage ratings (hybrid vehicle)

Engine compartment (type A fuse box)

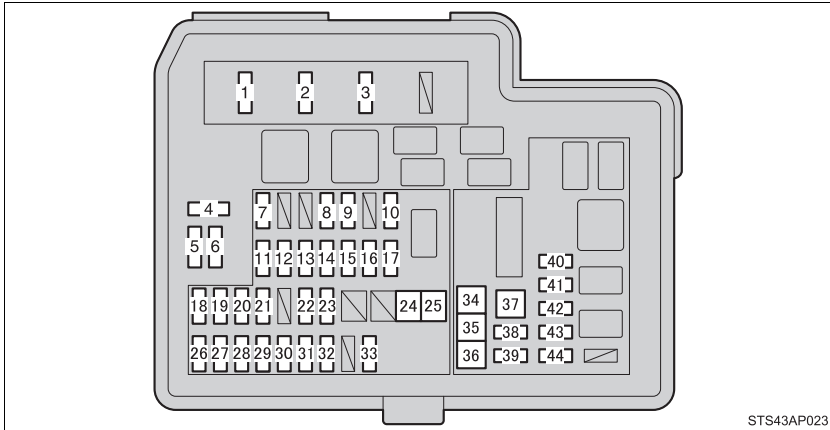

STS43AP023

Fuse	Amperage	Circuit
1	20 A	EFI MAIN
2	10 A	HORN
3	30 A	IG2
4	5 A	SPARE
5	7.5 A	SPARE
6	30 A	SPARE
7	10 A	EFI NO.2
8	10 A	H-LP RH-LO
9	10 A	H-LP LH-LO
10	7.5 A	FOG FR NO.2

Fuse		Ampere	Circuit
11	IG2 NO.2	10 A	Smart entry & start system, push-button start system, multiport fuel injection system/sequential multiport fuel injection system, SRS air-bag system, steering lock system, stop lights
12	DOME	15 A	Audio system, main body ECU, personal lights, foot well lights
13	ECU-B NO.1	5 A	Main body ECU, smart entry & start system
14	METER	7.5 A	Gauge and meters
15	IGN	15 A	Multiport fuel injection system/sequential multiport fuel injection system
16	H-LP RH-HI	5 A	Right-hand headlight (high beam)
17	H-LP LH-HI	5 A	Left-hand headlight (high beam), gauge and meters
18	D/L NO.2	25 A	Power door lock
19	HAZ	10 A	Emergency flashers
20	ETCS	10 A	Multiport fuel injection system/sequential multiport fuel injection system
21	ABS NO.1	20 A	Brake system
22	ENG W/PMP	30 A	Multiport fuel injection system/sequential multiport fuel injection system
23	H-LP-MAIN	20 A	H-LP LH-LO, H-LP RH-LO, H-LP LH-HI, H-LP RH-HI
24	ABS MTR NO.1	30 A	Brake system
25	P/I	50 A	EFI-MAIN, HORN, IG2

Fuse		Ampere	Circuit
26	ECU-B NO.2	5 A	Air conditioning system, gauge and meters, smart entry & start system, push-button start system
27	AM2	7.5 A	Start system
28	DRL	7.5 A	Daytime running lights
29	STRG LOCK	20 A	Starter system
30	ABS NO.2	7.5 A	Brake system
31	AMP	15 A	Audio system
32	IGCT-MAIN	30 A	IGCT NO.2, IGCT NO.3, IGCT NO.4, PCU, BATT FAN
33	D/C CUT	30 A	DOME, ECU-B NO.1
34	PTC HTR NO.1	30 A	No circuit
35	PTC HTR NO.2	30 A	No circuit
36	FAN	30 A	Electric cooling fan
37	PTC HTR NO.3	30 A	No circuit
38	DEF	25 A	MIR HTR, rear window defogger
39	MIR HTR	10 A	Outside rear view mirror defogger
40	BATT FAN	10 A	Battery cooling fan
41	IGCT NO.2	10 A	Hybrid system
42	IGCT NO.4	10 A	Hybrid system
43	PCU	10 A	Hybrid system
44	IGCT NO.3	10 A	Hybrid system

Engine compartment (type B fuse box)

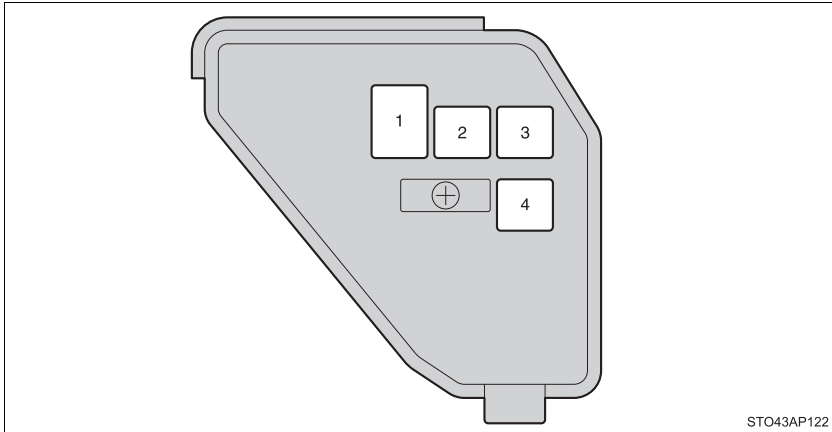

Fuse		Ampere	Circuit
1	DC/DC	100 A	Hybrid system
2	ABS MTR NO.2	30 A	Brake system
3	HTR	40 A	Air conditioning system
4	EPS	50 A	Electric power steering system

Under the instrument panel

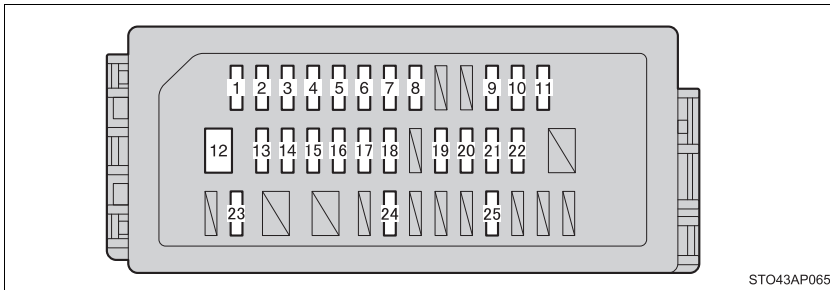

Fuse		Ampere	Circuit
1	TAIL NO.2	10 A	Front position lights, tail lights, license plate lights
2	PANEL	5 A	Instrument panel lights, manual headlight leveling dial, gauge and meters
3	DOOR R/R	20 A	Power window
4	DOOR P	20 A	Power window
5	ECU-IG NO.1	5 A	Rear window defogger, main body ECU, brake system, vehicle stability control system, shift lock control system, audio system, windshield wipers
6	ECU-IG NO.2	5 A	Electric power steering system
7	A/C	7.5 A	Air conditioning system
8	GAUGE	10 A	Back-up lights, shift lock control system, rear seat belt reminder lights, auto anti-glare inside rear view mirror, hybrid transmission, audio system, multiport fuel injection system/sequential multiport fuel injection system, rain sensor
9	WASHER	15 A	Windshield wipers and washer
10	WIPER	20 A	Windshield wipers and washer
11	WIPER RR	15 A	Rear window wiper

	Fuse	Ampere	Circuit
12	P/W	30 A	Power windows
13	DOOR R/L	20 A	Power windows
14	DOOR	20 A	Power windows
15	CIG	15 A	Power outlets
16	ACC	5 A	Main body ECU, audio system, outside rear view mirrors, shift lock control system, vanity lights
17	D/L	25 A	Power door lock system
18	OBD	7.5 A	On-board diagnosis system
19	FOG RR	7.5 A	Rear fog light, gauge and meter
20	STOP	7.5 A	Starter system, shift lock control system, brake system, stop lights, high mounted stoplight
21	AM1	7.5 A	No circuit
22	FOG FR	15 A	Front fog lights, gauge and meters
23	D-D/L	25 A	D-D/L
24	SHADE	25 A	—
25	S-HTR	15 A	Seat heaters

■ After a fuse is replaced

- If the lights do not turn on even after the fuse has been replaced, a bulb may need replacement. (→P. 531)
- If the replaced fuse blows again, have the vehicle inspected by any authorized Toyota dealer or repairer, or another duly qualified and equipped professional.

■ If there is an overload in a circuit

The fuses are designed to blow, protecting the wiring harness from damage.

■ When replacing light bulbs

Toyota recommends that you use genuine Toyota products designed for this vehicle. Because certain bulbs are connected to circuits designed to prevent overload, non-genuine parts or parts not designed for this vehicle may be unusable.

■ When reinstalling the cover (type C fuse box cover only)

Left hand drive vehicles

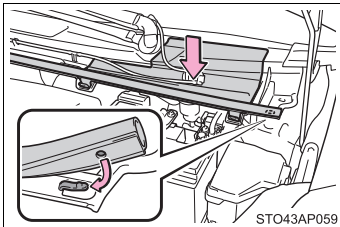

Reinstall the cover, and then hook the rubber strip's groove onto the cover.

Right hand drive vehicles

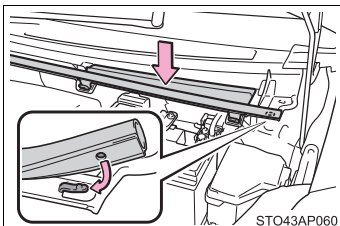

 CAUTION

■ **To prevent system breakdowns and vehicle fire**

Observe the following precautions.

Failure to do so may cause damage to the vehicle, and possibly a fire or injury.

- Never use a fuse of a higher amperage rating than that indicated, or use any other object in place of a fuse.
- Always use a genuine Toyota fuse or equivalent.
Never replace a fuse with a wire, even as a temporary fix.
- Do not modify the fuses or fuse boxes.

■ **Fuse box near the power control unit (hybrid vehicle)**

Never check or replace the fuses as there are high voltage parts and wiring near the fuse box.

Doing so may cause electric shock, resulting in death or serious injury.

 NOTICE

■ **Before replacing fuses**

Have the cause of electrical overload determined and repaired by any authorized Toyota dealer or repairer, or another duly qualified and equipped professional as soon as possible.

4-3. Do-it-yourself maintenance

Light bulbs

You may replace the following bulbs by yourself. The difficulty level of replacement varies depending on the bulb. As there is a danger that components may be damaged, we recommend that replacement is carried out by any authorized Toyota dealer or repairer, or another duly qualified and equipped professional.

For more information about replacing other light bulbs, contact any authorized Toyota dealer or repairer, or another duly qualified and equipped professional.

■ Preparing for light bulb replacement

Check the wattage of the light bulb to be replaced. (→P. 684)

■ Front bulb locations

Except hybrid vehicle

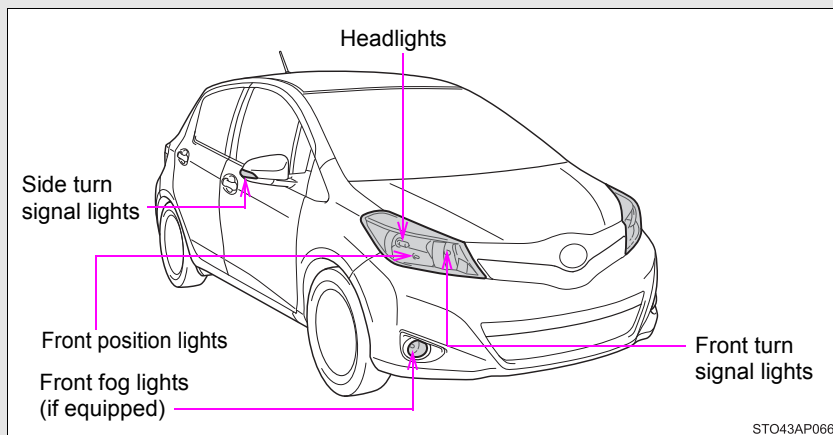

Hybrid vehicle

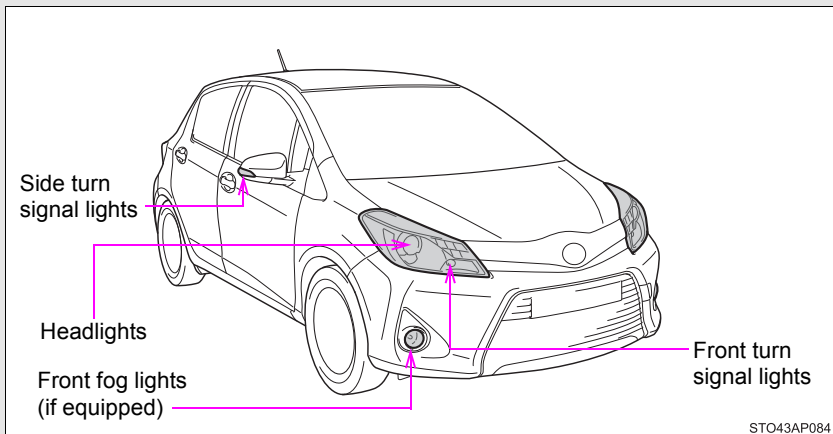

■ Rear bulb locations

Type A

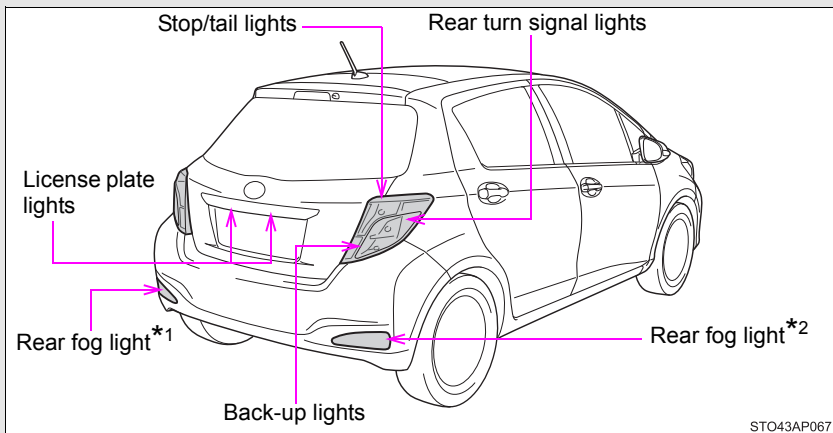

*1: Left-hand drive vehicles

*2: Right-hand drive vehicles

Type B

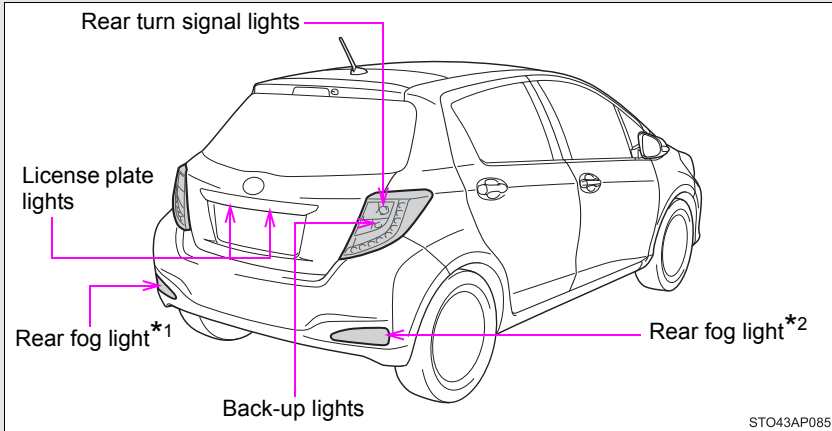

STO43AP085

*1: Left-hand drive vehicles

*2: Right-hand drive vehicles

Replacing light bulbs

■ Headlights (except hybrid vehicle)

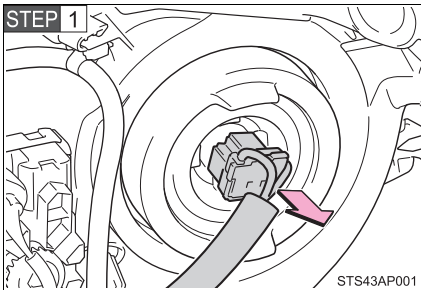

Unplug the connector.

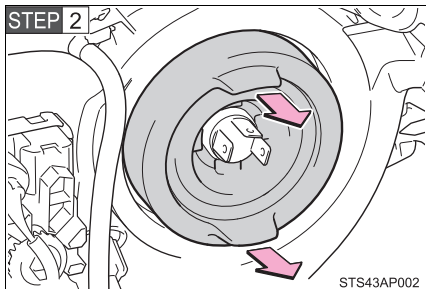

Remove the rubber cover.

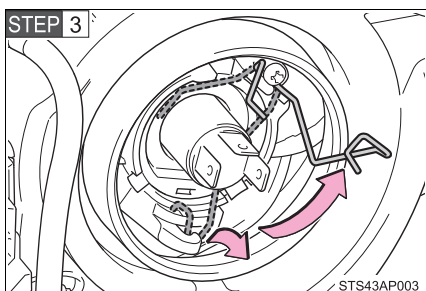

Release the bulb retaining spring.

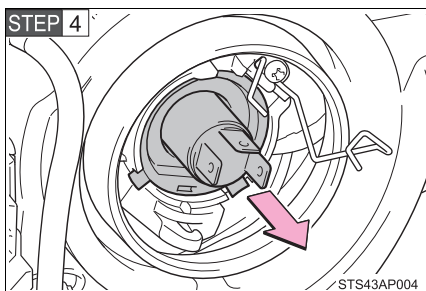

Remove the bulb.

To install a new bulb, align the tabs of the bulb with the cutouts of the mounting hole.

STEP 5 When installing, reverse the steps listed.

■ Headlights (hybrid vehicle)

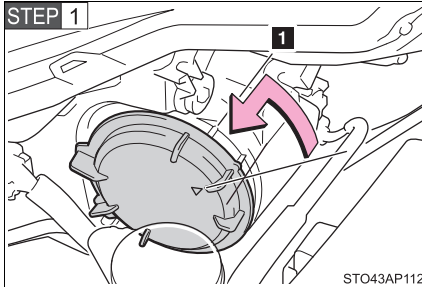

Turn the cover to the open position and remove it.

1 Open position

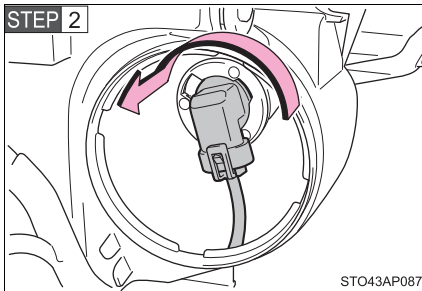

Turn the bulb base counterclockwise.

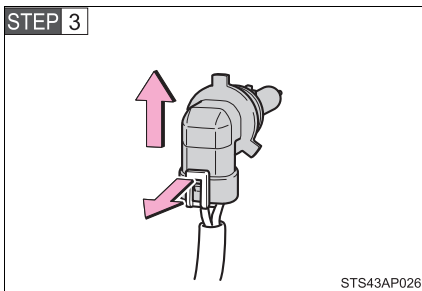

Unplug the connector while pulling the lock release.

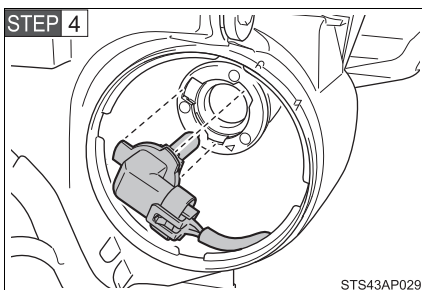

Replace the light bulb, and install the bulb base.

Align the 3 tabs on the light bulb with the mounting, and insert.

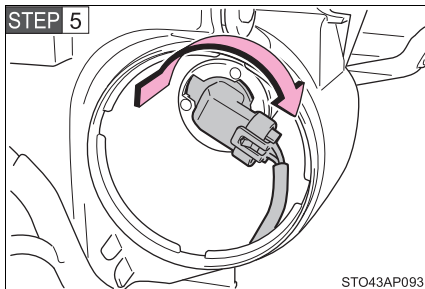

Turn and secure the bulb base.

Shake the bulb base gently to check that it is not loose, turn the headlights, on once and visually confirm that no light is leaking through the mounting.

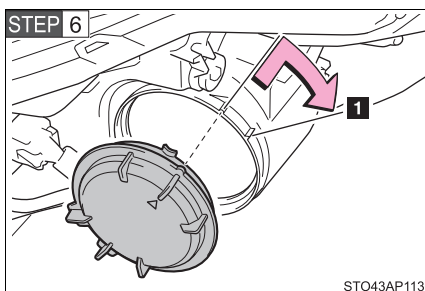

Install and turn the cover to the closed position.

1 Closed position

The illustrations show the removal of a headlight from a right-hand drive vehicle.

■ Front fog lights (if equipped)

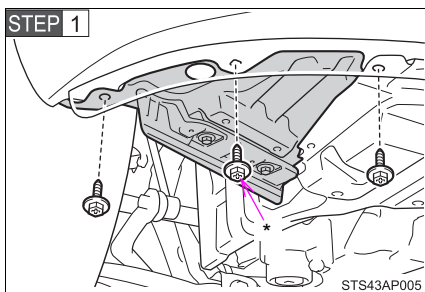

Vehicles without a front spoiler

Remove the 2 screws.

Vehicles with a front spoiler

Remove the 3 screws.

The front spoiler will come off on that side when the screws are removed.

*: Vehicles with a front spoiler only

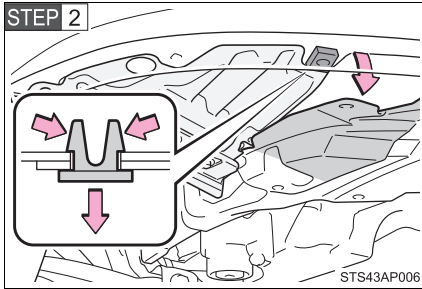

Remove the grommet.

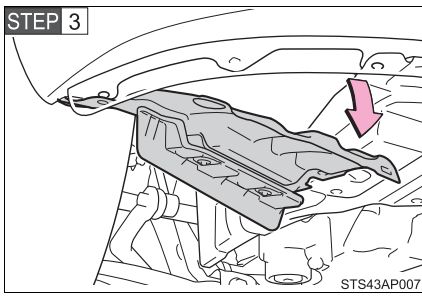

Partly remove the fender liner.

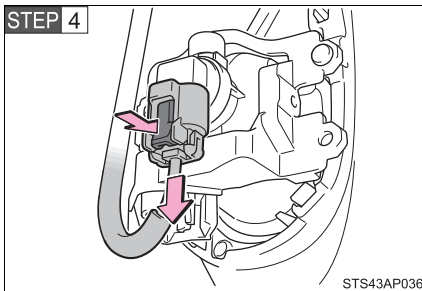

Unplug the connector while depressing the lock release.

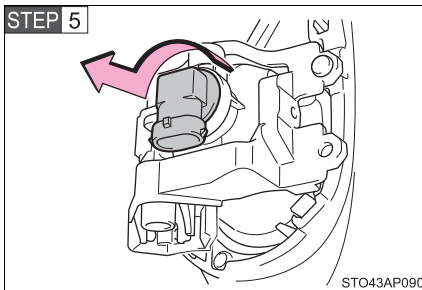

Turn the bulb base counterclockwise.

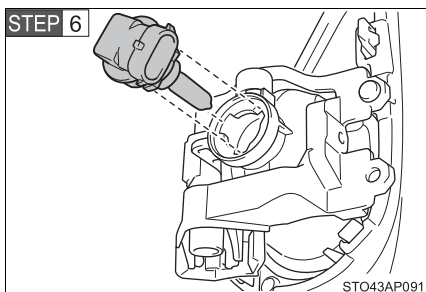

Install a new bulb.

Align the 3 tabs on the light bulb with the mounting, and insert.

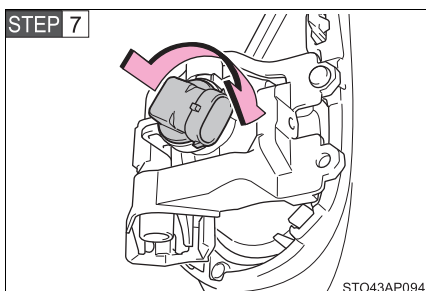

Turn and secure the bulb. Install the connector.

Shake the bulb base gently to check that it is not loose, turn the front fog light, on once and visually confirm that no light is leaking through the mounting.

STEP 8 When installing the fender liner, install by conducting **STEP 3** with the directions reversed.

■ **Front position lights (except hybrid vehicle)**

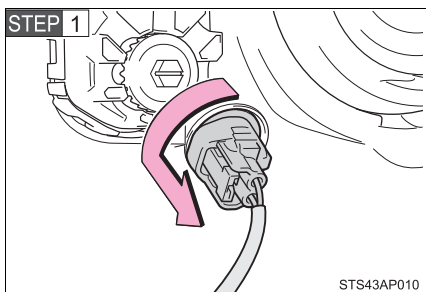

Turn the bulb base counterclockwise.

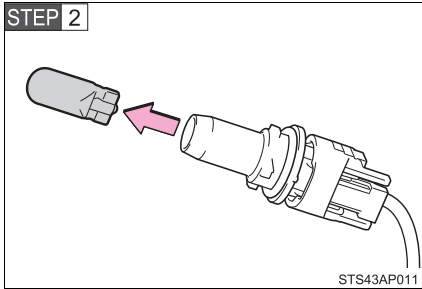

Remove the light bulb.

STEP 3 When installing, reverse the steps listed.

■ Front turn signal lights

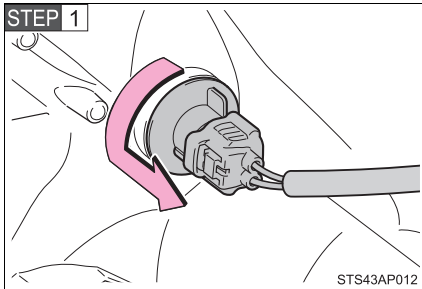

Turn the bulb base counterclockwise.

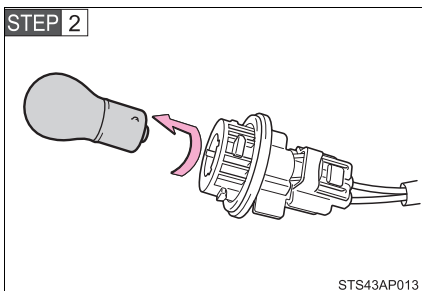

Remove the light bulb.

STEP 3 When installing, reverse the steps listed.

■ Side turn signal lights

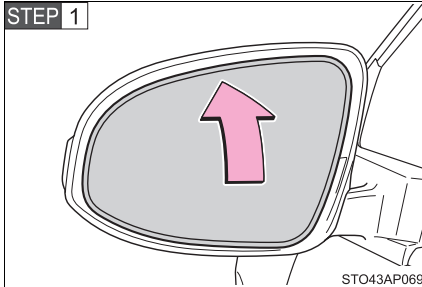

Depress the mirror.

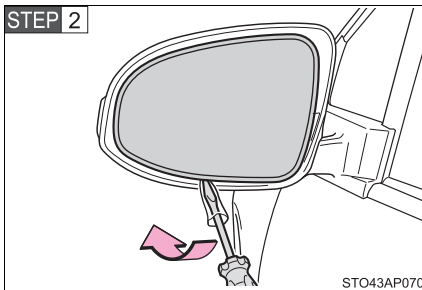

Remove the mirror.

To prevent damaging the vehicle, wrap the screwdriver with a tape.

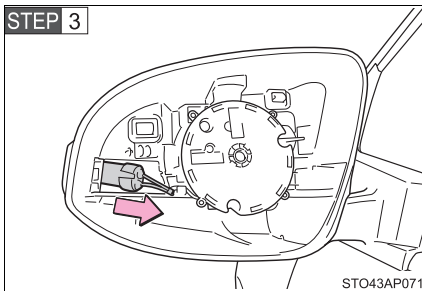

Remove the bulb base.

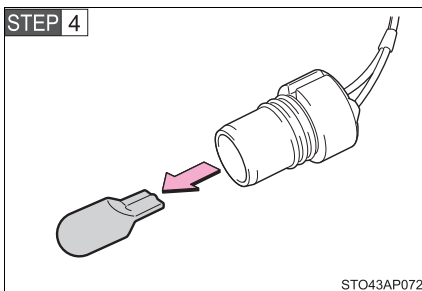

Remove the light bulb.

STEP 5 When installing, reverse the steps listed.

■ Back-up lights, stop/tail lights and rear turn signal lights

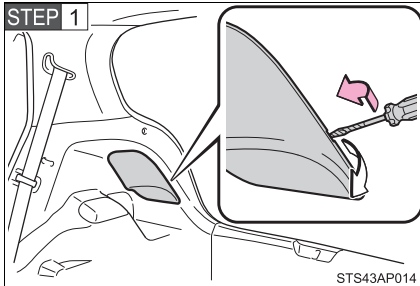

Open the back door and remove the cover.

To prevent damaging the vehicle, wrap the screwdriver with a tape.

STEP 2 Turn the bulb base counterclockwise.

Type A

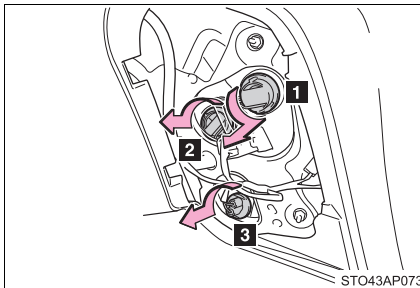

- 1** Stop/tail light
- 2** Rear turn signal light
- 3** Back-up light

Type B

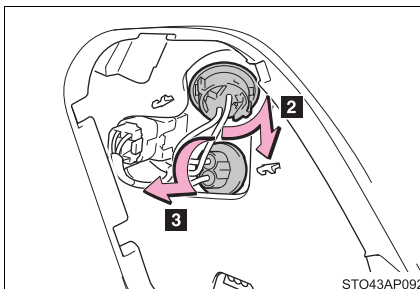

- 2** Rear turn signal light
- 3** Back-up light

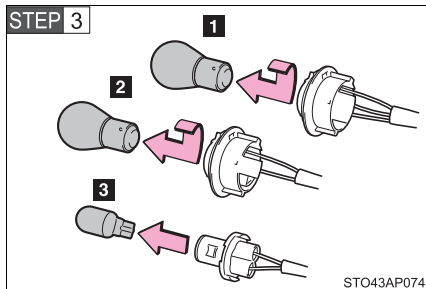

Remove the light bulb.

- 1 Stop/tail light
- 2 Rear turn signal light
- 3 Back-up light

STEP 4 When installing, reverse the steps listed.

■ Rear fog light

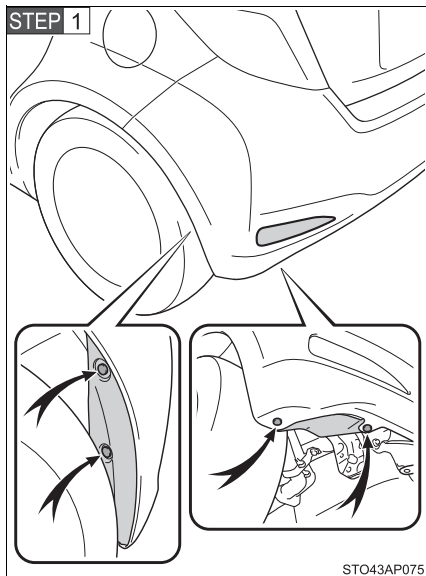

Remove the clips and remove the cover.

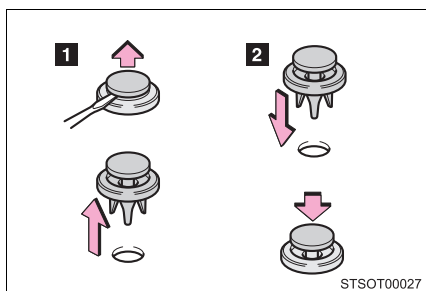

- 1 Remove the clips.
- 2 Insert the clips.

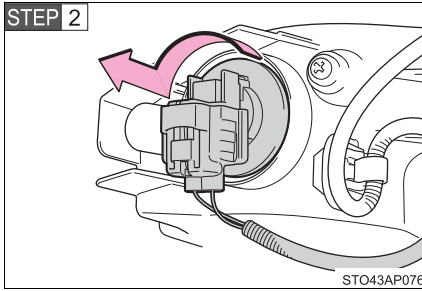

Turn the bulb base counterclockwise.

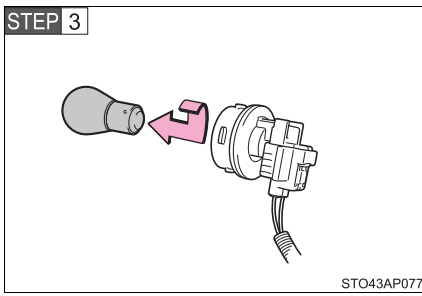

Remove the light bulb.

STEP 4 When installing, reverse the steps listed.

■ License plate lights

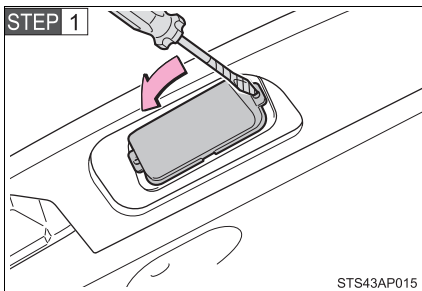

Remove the cover.

Insert a properly sized screwdriver into the hole of the cover, and pry off the cover as shown in the illustration.

To prevent damaging the vehicle, wrap the screwdriver with a tape.

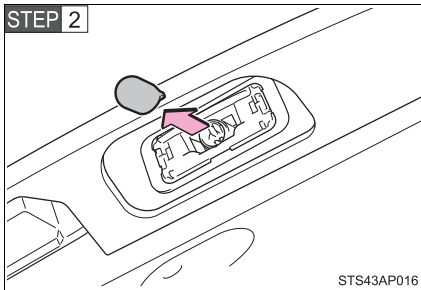

Remove the light bulb.

STEP 3 When installing, reverse the steps listed.

■ Replacing the following lights

If any of the lights listed below has burnt out, have it replaced by any authorized Toyota dealer or repairer, or another duly qualified and equipped professional.

- Front position lights and daytime running lights (LED type)
- Stop/tail lights (LED type)
- High mounted stoplight

■ LED lights

The front position lights and daytime running lights (LED type), stop/tail lights (LED type) and high mounted stoplight consists of a number of LEDs. If any of the LEDs burn out, take your vehicle to any authorized Toyota dealer or repairer, or another duly qualified and equipped professional to have the light replaced.

If one or more LEDs in a stop light burn out, your vehicle may not conform to local laws (ECE).

■ Condensation build-up on the inside of the lens

Contact any authorized Toyota dealer or repairer, or another duly qualified and equipped professional for more information in the following situations. Temporary condensation build-up on the inside of the headlight lens does not indicate a malfunction.

- Large drops of water have built up on the inside of the lens.
- Water has built up inside the headlight.

■ When replacing light bulbs

→P. 529

CAUTION

■ Replacing light bulbs

- Turn off the lights. Do not attempt to replace the bulb immediately after turning off the lights.
The bulbs become very hot and may cause burns.
- Do not touch the glass portion of the light bulb with bare hands. Hold the bulb by the plastic or metal portion.
If the bulb is scratched or dropped, it may blow out or crack.
- Fully install light bulbs and any parts used to secure them. Failure to do so may result in heat damage, fire, or water entering the headlight unit. This may damage the headlights or cause condensation to build up on the lens.

■ To prevent damage or fire

Make sure bulbs are fully seated and locked.

5-1. Essential information

- Emergency flashers 548
- If your vehicle needs to be towed 549
- If you think something is wrong 559
- Fuel pump shut off system (except hybrid vehicle [gasoline engine only]).... 560

5-2. Steps to take in an emergency

- If a warning light turns on or a warning buzzer sounds..... 561
- If you have a flat tire (vehicles with a spare tire) 578
- If you have a flat tire (vehicles with an emergency tire puncture repair kit)..... 591
- If the engine will not start (except hybrid vehicle).... 616
- If the hybrid system will not start (hybrid vehicle) 619
- If the shift lever cannot be shifted from P (vehicles with a hybrid transmission or a Multidrive)..... 621
- If the shift lever cannot be shifted (vehicles with a multi-mode manual transmission) 622

- If you lose your keys 623
- If the electronic key does not operate properly 624
- If the vehicle battery is discharged (except hybrid vehicle) 629
- If the vehicle's 12-volt battery is discharged (hybrid vehicle) 636
- If your vehicle overheats (except hybrid vehicle).... 642
- If your vehicle overheats (hybrid vehicle) 646
- If you run out of fuel and the engine stalls (diesel engine only) 651
- If the vehicle becomes stuck 654
- If your vehicle has to be stopped in an emergency 657

5-1. Essential information

Emergency flashers

The emergency flashers are used to warn other drivers when the vehicle has to be stopped in the road due to a breakdown, etc.

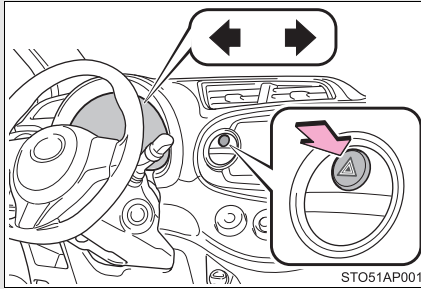

Press the switch.

All the turn signal lights will flash. To turn them off, press the switch once again.

■ Emergency flashers

- Except hybrid vehicle: If the emergency flashers are used for a long time while the engine is not operating, the battery may discharge.
- Hybrid vehicle: If the emergency flashers are used for a long time while the hybrid system is not operating (while the “READY” indicator is not illuminated), the 12-volt battery may discharge.

5-1. Essential information

If your vehicle needs to be towed

If towing is necessary, we recommend having your vehicle towed by any authorized Toyota dealer or repairer, or another duly qualified and equipped professional, such as a commercial towing service, using a lift-type truck or flatbed truck.

Use a safety chain system for all towing, and abide by all state/provincial and local laws.

Before towing

The following may indicate a problem with your transmission. Contact any authorized Toyota dealer or repairer, or another duly qualified and equipped professional before towing.

Except hybrid vehicle

- The engine is running but the vehicle will not move.
- The vehicle makes an abnormal sound.

Hybrid vehicle

- The hybrid system is operating but the vehicle will not move.
- The vehicle makes an abnormal sound.

Emergency towing

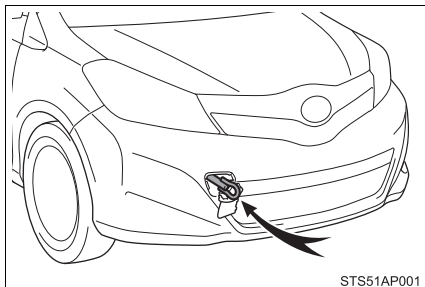

If a tow truck is not available in an emergency, your vehicle may be temporarily towed using a cable or chain secured to the emergency towing eyelet. Except hybrid vehicle: This should only be attempted on hard surfaced roads for short distances at low speeds.

Hybrid vehicle: This should only be attempted on hard surfaced roads for short distances, such as distances required to load onto a lift-type truck or flatbed truck, at under 30 km/h (18 mph).

A driver must be in the vehicle to steer and operate the brakes. The vehicle's wheels, drive train, axles, steering and brakes must be in good condition.

Installing towing eyelet

Except hybrid vehicle

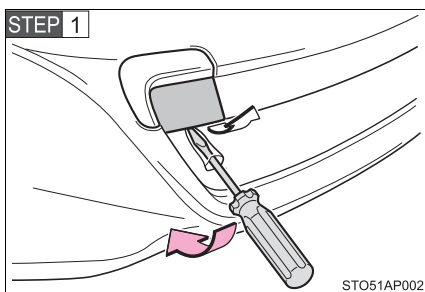

Remove the eyelet cover using a flathead screwdriver.

To protect the bodywork, place a rag between the screwdriver and the vehicle body as shown in the illustration.

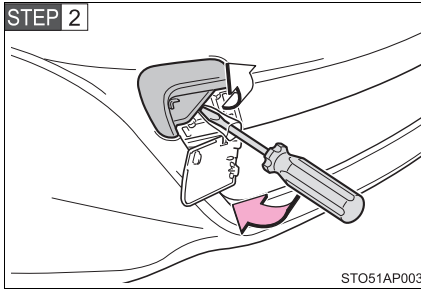

Remove the eyelet cover using a flathead screwdriver.

To protect the bodywork, place a rag between the screwdriver and the vehicle body as shown in the illustration.

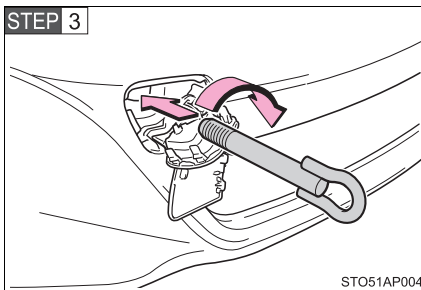

Insert the towing eyelet into the hole and tighten partially by hand.

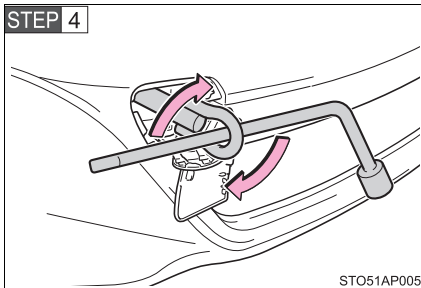

Tighten down the towing eyelet securely using a wheel nut wrench* or hard metal bar.

*: If a wheel nut wrench is not equipped, a wheel nut wrench can be purchased at any authorized Toyota dealer or repairer, or another duly qualified and equipped professional.

Hybrid vehicle

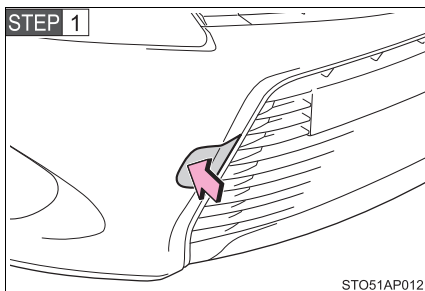

Push the eyelet cover and then open it.

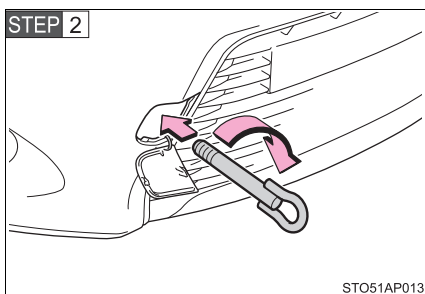

Insert the towing eyelet into the hole and tighten partially by hand.

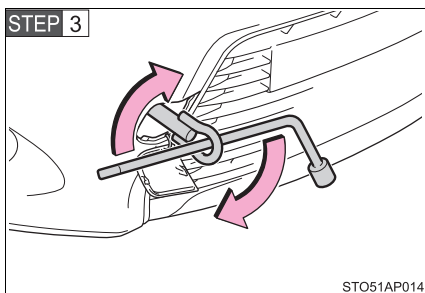

Tighten down the towing eyelet securely using a wheel nut wrench* or hard metal bar.

*: If a wheel nut wrench is not equipped, a wheel nut wrench can be purchased at any authorized Toyota dealer or repairer, or another duly qualified and equipped professional.

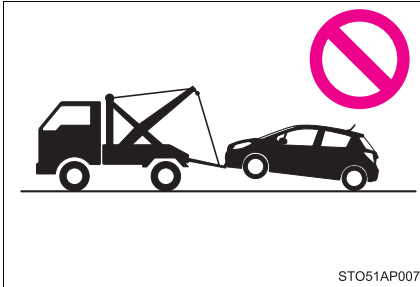
Towing with a sling-type truck

Do not tow with a sling-type truck to prevent body damage.

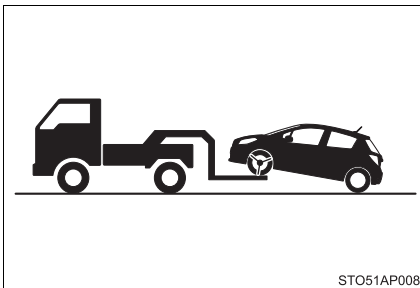
Towing with a wheel-lift type truck**From the front**

Release the parking brake.

From the rear

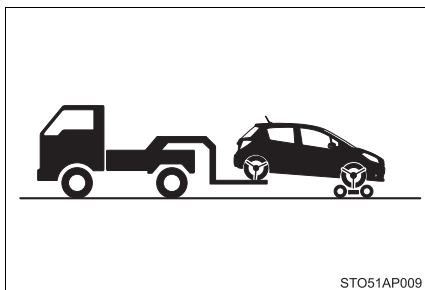

Vehicles with a hybrid transmission or a Multidrive: Use a towing dolly under the front wheels.

Vehicles with a multi-mode manual transmission or a manual transmission: We recommend using a towing dolly under the front wheels.

Vehicles without a smart entry & start system: When not using a towing dolly, turn the engine switch to the “ON” position (vehicles with a multi-mode manual transmission) or the “ACC” position (vehicles with a manual transmission) and shift the shift lever to N.

Vehicles with a smart entry & start system: When not using a towing dolly, turn the “ENGINE START STOP” switch to IGNITION ON mode (vehicles with a multi-mode manual transmission) or ACCESSORY mode (vehicles with a manual transmission) and shift the shift lever to N.

Using a flatbed truck

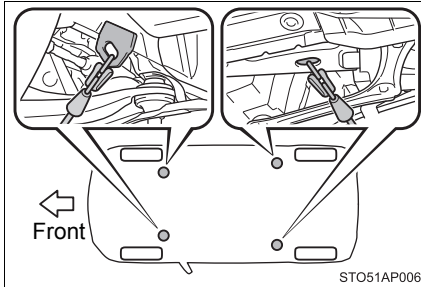

If your Toyota is transported by a flatbed truck, it should be tied down at the locations shown in the illustration.

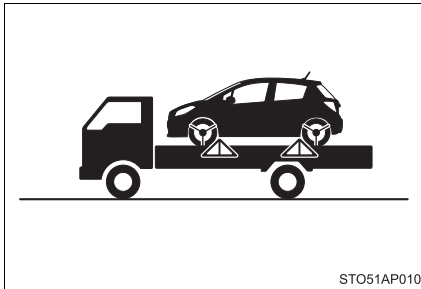

If you use chains or cables to tie down your vehicle, the angles shaded in black must be 45°.

Do not overly tighten the tie downs or the vehicle may be damaged.

■ **Before emergency towing**

STEP 1 **Except hybrid vehicle**

Vehicles without a smart entry & start system: Turn the engine switch to the “ACC” (engine off) or “ON” (engine running) position.

Vehicles with a smart entry & start system: Turn the “ENGINE START STOP” switch to ACCESSORY (engine off) or IGNITION ON (engine running) mode.

Hybrid vehicle

Vehicles without an electronic key: Turn the engine switch to the “ACC” (hybrid system off) or “ON” (hybrid system operating) position.

Vehicles with an electronic key: Turn the “POWER” switch to ACCESSORY (hybrid system off) or ON (hybrid system operating) mode.

STEP 2 Shift the shift lever to N.

STEP 3 Release the parking brake.

■ **Emergency towing eyelet location**

→P. 578, 592

 **CAUTION**
■ Caution while towing

- Use extreme caution when towing the vehicle.
Avoid sudden starts or erratic driving maneuvers which place excessive stress on the emergency towing eyelet and the cable or chain. Always be cautious of the surroundings and other vehicles while towing.
- Except hybrid vehicle (vehicles without a smart entry & start system): Do not turn the engine switch to the “LOCK” position.
Except hybrid vehicle (vehicles with a smart entry & start system): Do not turn the “ENGINE START STOP” switch off.
Doing so will lock the steering wheel and prevent operation, possibly causing an accident and resulting in death or serious injury.
- Hybrid vehicle (vehicles without an electronic key): Do not turn the engine switch to the “LOCK” position.
Hybrid vehicle (vehicles with an electronic key): Do not turn the “POWER” switch off.
This may lead to accidents because the steering wheel will be locked and you will not be able to operate the steering wheel.
- Except hybrid vehicle: If the engine is not running, the power assist for the brakes and steering will not function, making steering and braking more difficult.
- Hybrid vehicle: If the hybrid system is off, the power assist for the brakes and steering will not function, making steering and braking more difficult.

■ Installing towing eyelet to the vehicle

Make sure that towing eyelet is installed securely.
If not securely installed, towing eyelet may come loose during towing. This may lead to accidents that cause serious injury or even death.

 NOTICE

- **To prevent causing serious damage to the transmission when towing using a wheel-lift type truck (vehicles with a hybrid transmission or a Multidrive)**

Never tow this vehicle from the rear with the front wheels on the ground.

- **To prevent causing serious damage to the Stop & Start system when towing (vehicles with a Stop & Start system)**

Never tow this vehicle with four wheels on the ground. Use a flatbed truck, or lift up front or rear of the vehicle by using a wheel-lift type truck.

- **To prevent damage to the vehicle when towing using a wheel-lift type truck (vehicles with a hybrid transmission or a Multidrive)**

When raising the vehicle, ensure adequate ground clearance for towing at the opposite end of the raised vehicle. Without adequate clearance, the vehicle could be damaged while being towed.

- **To prevent damage to the vehicle when towing using a wheel-lift type truck (vehicles with a multi-mode manual transmission or a manual transmission)**

- Vehicles without a smart entry & start system: Do not tow the vehicle from the rear when the engine switch is in the “LOCK” position or the key is removed. The steering lock mechanism is not strong enough to hold the front wheels straight.

- Vehicles with a smart entry & start system: Do not tow the vehicle from the rear when the “ENGINE START STOP” switch is off. The steering lock mechanism is not strong enough to hold the front wheels straight.

- When raising the vehicle, ensure adequate ground clearance for towing at the opposite end of the raised vehicle. Without adequate clearance, the vehicle could be damaged while being towed.

- **To prevent body damage when towing with a sling-type truck**

Do not tow with a sling-type truck, either from the front or rear.

- **To prevent causing serious damage to the transmission in emergency towing**

Never tow a vehicle from the rear with four wheels on the ground. This may cause serious damage to the transmission.

If you think something is wrong

If you notice any of the following symptoms, your vehicle probably needs adjustment or repair. Contact any authorized Toyota dealer or repairer, or another duly qualified and equipped professional as soon as possible.

■ Visible symptoms

- Fluid leaks under the vehicle
(Water dripping from the air conditioning after use is normal.)
- Flat-looking tires or uneven tire wear
- High engine coolant temperature warning light flashes or comes on
- Except hybrid vehicle: Low engine coolant temperature indicator comes on or does not come on continuously

■ Audible symptoms

- Changes in exhaust sound
- Excessive tire squeal when cornering
- Strange noises related to the suspension system
- Except hybrid vehicle: Pinging or other noises related to the engine
- Hybrid vehicle: Pinging or other noises related to the hybrid system

■ Operational symptoms

- Engine missing, stumbling or running roughly
- Appreciable loss of power
- Vehicle pulls heavily to one side when braking
- Vehicle pulls heavily to one side when driving on a level road
- Loss of brake effectiveness, spongy feeling, pedal almost touches the floor

5-1. Essential information

Fuel pump shut off system (except hybrid vehicle [gasoline engine only])

To minimize the risk of fuel leakage when the engine stalls or when an airbag inflates upon collision, the fuel pump shut off system stops the supply of fuel to the engine.

Follow the procedure below to restart the engine after the system is activated.

Vehicles without a smart entry & start system:

STEP 1 Turn the engine switch to the “ACC” or “LOCK” position.

STEP 2 Restart the engine.

Vehicles with a smart entry & start system:

STEP 1 Turn the “ENGINE START STOP” switch to ACCESSORY mode or turn it off.

STEP 2 Restart the engine.



NOTICE

■ Before starting the engine

Inspect the ground under the vehicle.

If you find that fuel has leaked onto the ground, the fuel system has been damaged and is in need of repair. Do not restart the engine.

5-2. Steps to take in an emergency

If a warning light turns on or a warning buzzer sounds...

Calmly perform the following actions if any of the warning lights comes on or flashes. If a light comes on or flashes, but then goes off, this does not necessarily indicate a malfunction in the system. However, if this continues to occur, have the vehicle inspected by any authorized Toyota dealer or repairer, or another duly qualified and equipped professional.

Stop the vehicle immediately. Continuing to drive the vehicle may be dangerous.

The following warning indicates a possible problem in the brake system. Immediately stop the vehicle in a safe place and contact any authorized Toyota dealer or repairer, or another duly qualified and equipped professional.





Warning light	Warning light/Details
 (Red indicator [*])	Brake system warning light and warning buzzer <ul style="list-style-type: none">• Low brake fluid• Malfunction in the brake system This light also comes on when the parking brake is not released. If the light turns off after the parking brake is fully released, the system is operating normally.

^{*}: Parking brake engaged warning buzzer:

The buzzer sounds to indicate that the parking brake is still engaged (with the vehicle having reached a speed of 5 km/h [3 mph]).

Stop the vehicle immediately.

- The following warnings indicate the possibility of damage to the vehicle that may lead to an accident. Immediately stop the vehicle in a safe place and contact any authorized Toyota dealer or repairer, or another duly qualified and equipped professional.

Warning light	Warning light/Details
	<p>Charging system warning light Indicates a malfunction in the vehicle's charging system.</p>
	<p>Low engine oil pressure warning light Indicates that the engine oil pressure is too low.</p>
 <p>(Flashes or comes on)</p>	<p>High engine coolant temperature warning light Indicates that the engine is overheating. (→P. 642, 646)</p> <ul style="list-style-type: none"> • Flashes: Engine is overheating. Drive carefully. • Comes on: Engine is overheated. Stop the vehicle.
	<p>Hybrid system warning light and warning buzzer (hybrid vehicle) Indicates a malfunction in the hybrid system.</p>

- The following warning indicates the possibility of damage to the vehicle that may lead to an accident. Immediately stop the vehicle in a safe place and take the specified steps to correct the suspected problem.

Warning light	Warning light/Details	Correction procedure
 (Comes on) (if equipped)	Multi-mode manual transmission warning light Indicates a malfunction in the multi-mode manual transmission system.	Have the system checked by any authorized Toyota dealer or repairer, or another duly qualified and equipped professional.
	Multi-mode manual transmission warning light (warning buzzer) Indicates a malfunction in the multi-mode manual transmission system and that the clutch has become hot due to excessive load.	Pull over and shift the shift lever to N. Wait for about 15 minutes for the clutch to cool down. Have the system checked by any authorized Toyota dealer or repairer, or another duly qualified and equipped professional.

- Immediately stop the vehicle in a safe place and take the specified steps to correct the suspected problem.



Warning light	Warning light/Details	Correction procedure
 (Flashes) (if equipped)	Heat clutch warning light (warning buzzer) Indicates that the clutch has become hot, but does not indicate a malfunction in the multi-mode manual transmission system.	Pull over and shift the shift lever to N. Wait for about 15 minutes for the clutch to cool down.









■ To prevent the clutch from overheating

- Do not use the accelerator pedal or starting assist system to hold the vehicle on a hill.
- On an uphill incline, observe the following whenever possible:
 - Maintain a safe distance from the vehicle ahead and avoid unnecessary starting off and stopping.
 - Avoid using E mode on an uphill slope. This will help to avoid unnecessary gear changes.

Have the vehicle inspected immediately.





Failure to investigate the cause of the following warnings may lead to the system operating abnormally and possibly cause an accident. Have the vehicle inspected by any authorized Toyota dealer or repairer, or another duly qualified and equipped professional immediately.



Warning light	Warning light/Details
	<p>Malfunction indicator lamp Indicates a malfunction in:</p> <ul style="list-style-type: none"> • The hybrid system (hybrid vehicle); • The hybrid transmission control system (if equipped); • The electronic engine control system; • The electronic throttle control system; • The electronic Multidrive control system (if equipped); • The electronic multi-mode manual transmission control system (if equipped); • The emission control system; or • The DPF catalytic converter (if equipped).
	<p>SRS warning light Indicates a malfunction in:</p> <ul style="list-style-type: none"> • The SRS airbag system; or • The seat belt pretensioner system.

Warning light	Warning light/Details
	<p>ABS warning light Indicates a malfunction in:</p> <ul style="list-style-type: none"> • The ABS; or • The brake assist system.
	<p>Electric power steering warning light (warning buzzer) Indicates a malfunction in the EPS system.</p>
	<p>Slip indicator light (if equipped) Indicates a malfunction in:</p> <ul style="list-style-type: none"> • The VSC system; • The TRC system; or • Hill-start assist control.
 <p>(yellow indicator)</p>	<p>Brake system warning light (hybrid vehicle) Indicates a malfunction in:</p> <ul style="list-style-type: none"> • The regenerative brake system; or • The electronically controlled brake system.
 <p>(Flashes or yellow indicator)</p>	<p>Cruise control indicator light (if equipped) Indicates a malfunction in the cruise control system.</p> <ul style="list-style-type: none"> • Except hybrid vehicle: The light flashes to indicate a malfunction. • Hybrid vehicle: The light comes in yellow to indicate a malfunction.
 <p>(Flashes)</p>	<p>Stop & Start cancel indicator light (if equipped) Indicates a malfunction in the Stop & Start system.</p>
	<p>Fuel filter warning light (diesel engine only) Indicate that the amount of accumulated water in the fuel filter has reached the specified level. (→P. 483)</p>
 <p>(Flashes in yellow for 15 seconds.)</p>	<p>Smart entry & start system indicator light (If equipped) Indicates a malfunction in the smart entry & start system.</p>
	<p>Low traction battery indicator light (hybrid vehicle) Indicates that the hybrid battery (traction battery) is low.</p>

Follow the correction procedures.

After taking the specified steps to correct the suspected problem, check that the warning light goes off.

Warning light	Warning light/Details	Correction procedure
	Open door warning light (warning buzzer)*¹ Indicates that a door is not fully closed.	Check that all the doors are closed.
	Low fuel level warning light Except hybrid vehicle Gasoline engine: Indicates that remaining fuel is about 5.8 L (1.5 gal., 1.3 Imp. gal.) or less. Diesel engine: Indicates that remaining fuel is about 6.4 L (1.7 gal., 1.4 Imp. gal.) or less. Hybrid vehicle Indicates that remaining fuel is about 5.2 L (1.4 gal., 1.1 Imp. gal.) or less.	Refuel the vehicle.
 (On the instrument cluster)	Driver's and front passenger's seat belt reminder light (warning buzzer)*² Warns the driver and front passenger to fasten their seat belts.	Fasten the seat belt.
 (On the center panel)	Rear passengers' seat belt reminder lights (warning buzzer)*² (if equipped) Warns the rear passengers to fasten their seat belts.	Fasten the seat belt.

Warning light	Warning light/Details	Correction procedure
	<p>Low engine oil level warning light (diesel engine only) Indicates that engine oil level is low.</p>	<p>Check the level of engine oil, and add if necessary.</p>
	<p>Hybrid system overheat warning light and warning buzzer (hybrid vehicle) Indicates that the hybrid system has overheated. This light may come on when driving under severe operating conditions. (For example, when driving up a long steep hill.)</p>	<p>Stop and check. (→P. 646)</p>
	<p>P position request indicator light (hybrid vehicle) An attempt was made to start the hybrid system</p>	<p>Shift the shift lever to P.</p>
	<p>P position request indicator light and warning buzzer (hybrid vehicle)</p> <ul style="list-style-type: none"> • Indicates that the driver's door was opened with the shift lever in N, D or B. • Indicates that the hybrid battery (traction battery) power has dropped because a long period of time has elapsed after shifting the shift lever to N. 	<ul style="list-style-type: none"> • Shift the shift lever to P. • Shift the shift lever to P and restart the hybrid system when starting the vehicle.

Warning light	Warning light/Details	Correction procedure
	<p>DPF system warning light (diesel engine with a DPF system)</p> <ul style="list-style-type: none"> • Indicates that the DPF catalytic converter needs to be cleaned due to repeated short trips and/or low-speed driving. • Indicates that the amount of accumulated deposits in the DPF catalytic converter has reached the specified level. 	<p>To clean the DPF catalytic converter, drive the vehicle at a speed of 65 km/h (40 mph) or greater for 20 to 30 minutes as much as possible until the DPF system warning light turns off.*³</p> <p>Do not turn off the engine as much as possible until the DPF system warning light turns off.</p> <p>If it is not possible to drive the vehicle at speeds of 65 km/h (40 mph) or greater, or the DPF system warning light does not turn off even after driving for more than 30 minutes, have the vehicle inspected by any authorized Toyota dealer or repairer, or another duly qualified and equipped professional.</p>

Warning light	Warning light/Details	Correction procedure
 (Flashes)	<p>Engine oil change reminder light (diesel engine only)</p> <p>Indicates that the engine oil is scheduled to be changed.</p> <ul style="list-style-type: none"> • Vehicles without a DPF system*4: Flashes approximately 35000 km (22000 miles) after the engine oil is changed. (The indicator will not work properly unless the oil maintenance data has been reset). • Vehicles with a DPF system*4: Flashes approximately 14500 km (9000 miles) after the engine oil is changed. (→P. 576) (The indicator will not work properly unless the oil maintenance data has been reset). 	<p>Check the engine oil, and change if necessary. After changing the engine oil, the oil change system should be reset. (→P. 474)</p>

Warning light	Warning light/Details	Correction procedure
 (Comes on)	<p>Engine oil change reminder light (diesel engine only)</p> <p>Indicates that the engine oil should be changed.</p> <ul style="list-style-type: none"> • Vehicles without a DPF system*4: Comes on approximately 40000 km (25000 miles) after the engine oil is changed (and the oil maintenance data has been reset). • Vehicles with a DPF system*4: Comes on approximately 15000 km (9300 miles) after the engine oil is changed (and the oil maintenance data has been reset). 	<p>Check and change the engine oil and oil filter by any authorized Toyota dealer or repairer, or another duly qualified and equipped professional. After changing the engine oil, the oil change system should be reset. (→P. 474)</p>

*1: Open door warning buzzer:

A buzzer will sound if the vehicle reaches a speed of 5 km/h (3 mph) or more with any door open.

*2: Driver's and passengers seat belt reminders:

The driver's and passengers seat belt buzzer sounds to alert the driver and passengers that their seat belt is not fastened. The buzzer sounds for 30 seconds after the vehicle has reached a speed of at least 20 km/h (12 mph). Then, if the seat belt is still unfastened, the buzzer will sound in a different tone for 90 more seconds.

*3: The DPF system warning light may not turn off when the engine oil change reminder light is on. In this event, have the vehicle inspected by any authorized Toyota dealer or repairer, or another duly qualified and equipped professional.



*4: To determine whether or not your vehicle has a DPF system, contact any authorized Toyota dealer or repairer, or another duly qualified and equipped professional.





Follow the correction procedures. (vehicles with a smart entry & start system or push-button start system)

After taking the specified steps to correct the suspected problem, check that the warning light goes off.

Interior buzzer	Exterior buzzer	Warning light	Warning light/Details	Correction procedure
Continuous	Continuous	 (Flashes in yellow)	<p>Smart entry & start system indicator light (vehicles with a hybrid transmission or a Multidrive)</p> <p>Except hybrid vehicle The electronic key was carried outside the vehicle and the driver's door was opened and closed while any shift position other than P was selected without turning off the "ENGINE START STOP" switch.</p> <p>Hybrid vehicle The electronic key was carried outside the vehicle and the driver's door was opened and closed while any shift position other than P was selected without turning off the "POWER" switch.</p>	<ul style="list-style-type: none"> • Change the shift position to P. • Bring the electronic key back into the vehicle.

Interior buzzer	Exterior buzzer	Warning light	Warning light/Details	Correction procedure
Once	3 times	 (Flashes in yellow)	<p>Smart entry & start system indicator light</p> <p>Except hybrid vehicle Vehicles with a Multidrive: The electronic key was carried outside the vehicle and the driver's door was opened and closed while the shift position P was selected without turning off the "ENGINE START STOP" switch.</p> <p>Vehicles with a multi-mode manual transmission or a manual transmission: The electronic key was carried outside the vehicle and a door other than the driver's door was opened and closed while the "ENGINE START STOP" switch was in a mode other than off.</p> <p>Hybrid vehicle The electronic key was carried outside the vehicle and the driver's door was opened and closed while the shift position P was selected without turning off the "POWER" switch.</p>	<p>Except hybrid vehicle Turn the "ENGINE START STOP" switch off or bring the electronic key back into the vehicle.</p> <p>Hybrid vehicle Turn the "POWER" switch off or bring the electronic key back into the vehicle.</p>

Interior buzzer	Exterior buzzer	Warning light	Warning light/Details	Correction procedure
Once	3 times	 (Flashes in yellow)	<p>Smart entry & start system indicator light</p> <p>Except hybrid vehicle Indicates that a door other than the driver's door has been opened and closed with the "ENGINE START STOP" switch in any mode other than off and the electronic key outside of the detection area.</p> <p>Hybrid vehicle Indicates that a door other than the driver's door has been opened and closed with the "POWER" switch in any mode other than off and the electronic key outside of the detection area.</p>	Confirm the location of the electronic key.
Once	Continuous (5 seconds)	 (Flashes in yellow)	<p>Smart entry & start system indicator light</p> <p>Except hybrid vehicle An attempt was made to exit the vehicle with the electronic key and lock the doors without first turning the "ENGINE START STOP" switch off.</p> <p>Hybrid vehicle (vehicles with a smart entry & start system only) An attempt was made to exit the vehicle with the electronic key and lock the doors without first turning the "POWER" switch off.</p>	<p>Except hybrid vehicle Turn the "ENGINE START STOP" switch off and lock the doors again.</p> <p>Hybrid vehicle Turn the "POWER" switch off and lock the doors again.</p>

Interior buzzer	Exterior buzzer	Warning light	Warning light/Details	Correction procedure
Once	—	 (Flashes in yellow for 15 seconds.)	Smart entry & start system indicator light Indicates that the electronic key is not present when attempting to start the engine.	Confirm the location of the electronic key.
9 times	—	 (Flashes in yellow)	Smart entry & start system indicator light An attempt was made to drive when the regular key was not inside the vehicle.	Confirm that the electronic key is inside the vehicle.
Once	—	 (Flashes in yellow for 15 seconds.)	Smart entry & start system indicator light Indicates that the electronic key battery is low.	Replace the battery. (→P. 501)
Once	—	 (Flashes quickly in green for 15 seconds.)	Smart entry & start system indicator light Indicates that the steering lock has not been released.	Release the steering lock. (→P. 232)

Interior buzzer	Exterior buzzer	Warning light	Warning light/Details	Correction procedure
Once	—	 (Flashes in yellow for 30 seconds.)	<p>Smart entry & start system indicator light Except hybrid vehicle</p> <ul style="list-style-type: none"> • When the doors were unlocked with the mechanical key and then the “ENGINE START STOP” switch was pressed, the electronic key could not be detected in the vehicle. • The electronic key could not be detected in the vehicle even after the “ENGINE START STOP” switch was pressed two consecutive times. <p>Hybrid vehicle</p> <ul style="list-style-type: none"> • When the doors were unlocked with the mechanical key and then the “POWER” switch was pressed, the electronic key could not be detected in the vehicle. • The electronic key could not be detected in the vehicle even after the “POWER” switch was pressed two consecutive times. 	<p>Except hybrid vehicle Except vehicles with a manual transmission: Touch the electronic key to the “ENGINE START STOP” switch while depressing the brake pedal. Vehicles with a manual transmission: Touch the electronic key to the “ENGINE START STOP” switch while depressing with the clutch pedal.</p> <p>Hybrid vehicle Touch the electronic key to the “POWER” switch while depressing the brake pedal.</p>

■ **Passenger detection sensor and passenger seat belt reminder**

- If luggage is placed on a passenger seat, the passenger detection sensor may cause the warning light to flash even if a passenger is not sitting in the seat.
- If a cushion is placed on the seat, the sensor may not detect a passenger, and the warning light may not operate properly.

■ **Electric power steering warning light (warning buzzer)**

Except hybrid vehicle: When the battery charge becomes insufficient or the voltage temporarily drops, the electric power steering system warning light may come on and the warning buzzer may sound.

Hybrid vehicle: When the 12-volt battery charge becomes insufficient or the voltage temporarily drops, the electric power steering system warning light may come on and the warning buzzer may sound.

■ **If the malfunction indicator lamp comes on while driving**

For some models, the malfunction indicator lamp will come on if the fuel tank becomes completely empty. If the fuel tank is empty, refuel the vehicle immediately. The malfunction indicator lamp will go off after several trips.

If the malfunction indicator lamp does not go off, contact any authorized Toyota dealer or repairer, or another duly qualified and equipped professional as soon as possible.

■ **If the engine oil change reminder light flashes (diesel engine with a DPF system)**

Repeated short trips and/or low-speed driving may cause the oil to degrade sooner than usual, regardless of the actual distance driven. If this happens, the engine oil change reminder light will flash.

■ **Engine oil change reminder light comes on (diesel engine only)**

Vehicles without a DPF system:

Replace the engine oil and oil filter when the engine oil change reminder light does not come on even if you have driven over 40000 km (25000 miles) after the engine oil was changed.

There is a possibility that the engine oil change reminder light has been illuminated when you have driven less than 40000 km (25000 miles) based on a usage or driving condition.

Vehicles with a DPF system:

Replace the engine oil and oil filter when the engine oil change reminder light does not come on even if you have driven over 15000 km (9300 miles) after the engine oil was changed.

There is a possibility that the engine oil change reminder light has been illuminated when you have driven less than 15000 km (9300 miles) based on a usage or driving condition.

CAUTION

■ **When the electric power steering system warning light comes on**

The steering wheel may become extremely heavy.

If the steering wheel becomes heavier than usual when operating, hold firmly and operate using more force than usual.

■ **When driving to clean the DPF catalytic converter**

When driving, pay sufficient attention to weather, road conditions, terrain and traffic conditions, and be sure to observe traffic laws and/or regulations. Failure to do so may cause an unexpected accident, resulting in death or serious injury.

NOTICE

■ **If the fuel filter warning light comes on (diesel engine only)**

Never drive the vehicle with the warning light on. Continued driving with water accumulated in the fuel filter will damage the fuel injection pump.

■ **When the DPF system warning light comes on (diesel engine with a DPF system)**

If the DPF system warning light is left on without performing cleaning, after an additional 100 to 300 km (62 to 187 miles), the malfunction indicator lamp may come on. If this happens, have the vehicle inspected by any authorized Toyota dealer or repairer, or another duly qualified and equipped professional immediately.

5-2. Steps to take in an emergency

If you have a flat tire (vehicles with a spare tire)

Remove the flat tire and replace it with the spare tire provided.

■ Before jacking up the vehicle

- Stop the vehicle on a hard, flat surface.
- Set the parking brake.
- Vehicles with a hybrid transmission or a Multidrive: Shift the shift lever to P.
- Vehicles with a multi-mode manual transmission: Shift the shift lever to M, E or R.
- Vehicles with a manual transmission: Shift the shift lever to R.
- Stop the engine (except hybrid vehicle) or hybrid system (hybrid vehicle).
- Turn on the emergency flashers.

■ Location of the spare tire, jack and tools

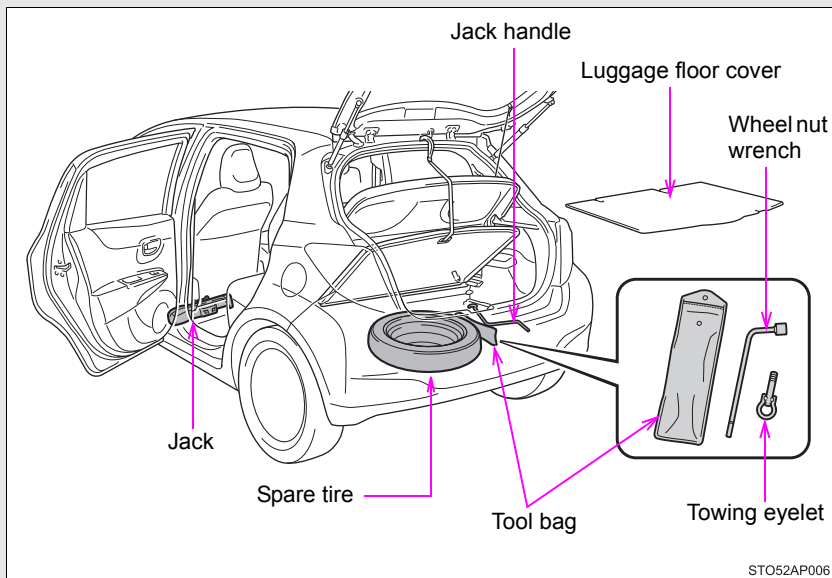

Taking out the jack

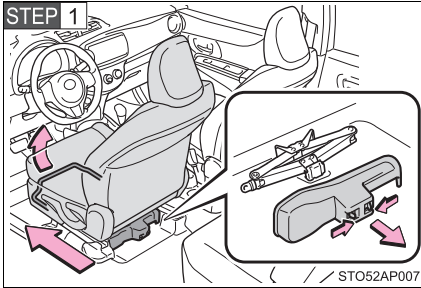

Move the front left seat to the front most position and remove the cover.

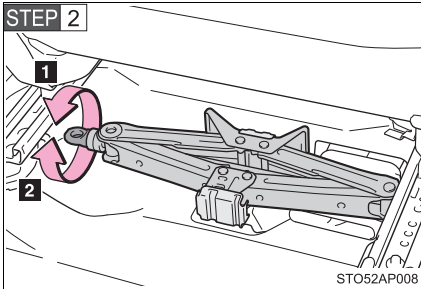

Take out the jack.

- 1 For tightening
- 2 For loosening

Taking out the spare tire

Vehicles with a compact spare tire

STEP 1 Vehicles with a deck board: Lift the deck board and attach the hook. (→P. 440)

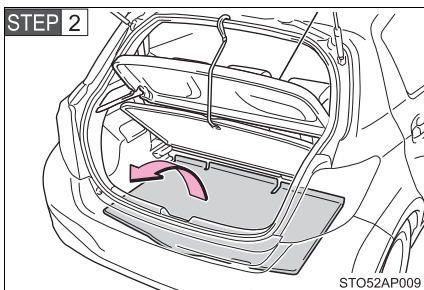

Remove the luggage floor cover.

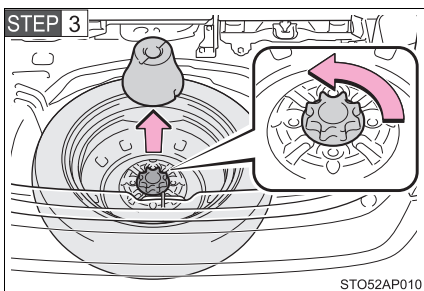

Remove the spare wheel cushion, then loosen the center fastener.

Vehicles with a full-size spare tire

STEP 1 Lift the deck board and attach the hook. (→P. 440)

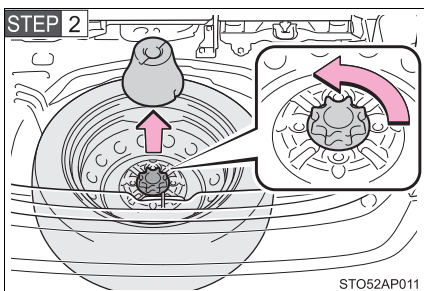

Remove the spare wheel cushion, then loosen the center fastener.

Replacing a flat tire

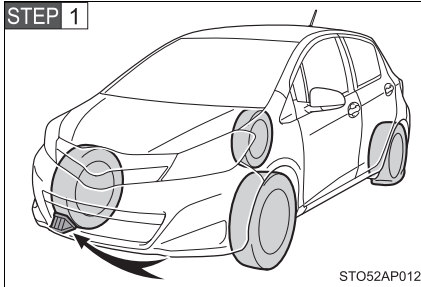

Chock the tires.

Flat tire		Wheel chock positions
Front	Left-hand side	Behind the rear right-hand side tire
	Right-hand side	Behind the rear left-hand side tire
Rear	Left-hand side	In front of the front right-hand side tire
	Right-hand side	In front of the front left-hand side tire

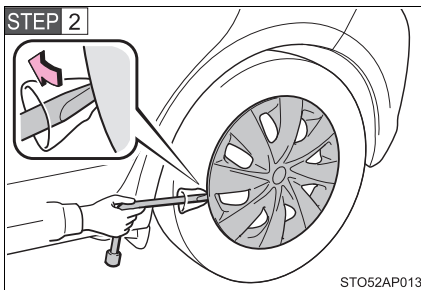

Vehicles with a steel wheel:
Remove the wheel ornament using the wrench.

To protect the wheel ornament, place a rag between the wrench and the wheel ornament, as shown in the illustration.

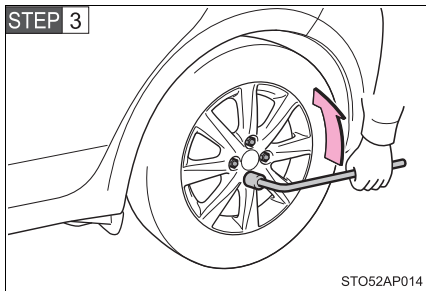

Slightly loosen the wheel nuts (one turn).

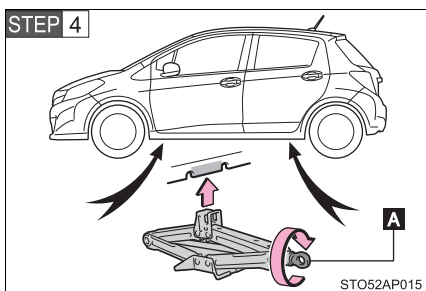

Turn the tire jack portion "A" by hand until the notch of the jack is in contact with the jack point.

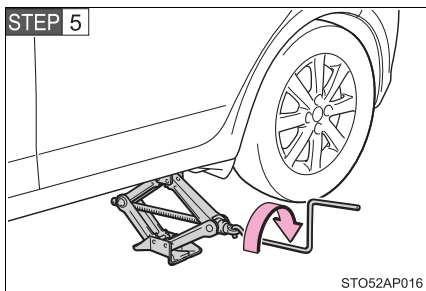

Raise the vehicle until the tire is slightly raised off the ground.

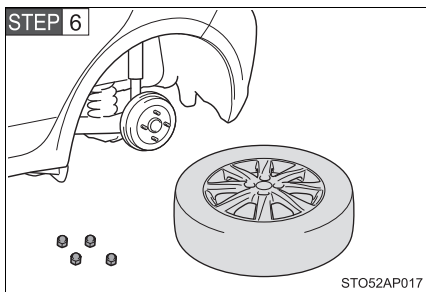

Remove all the wheel nuts and the tire.

When resting the tire on the ground, place the tire so that the wheel design faces up to avoid scratching the wheel surface.

Installing the tire

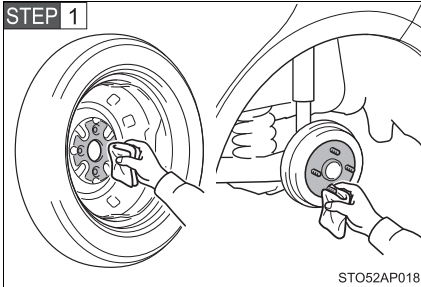

Remove any dirt or foreign matter from the wheel contact surface.

If foreign matter is on the wheel contact surface, the wheel nuts may loosen while the vehicle is in motion, causing the tire to come off.

STEP 2 Install the tire and loosely tighten each wheel nut by hand by approximately the same amount.

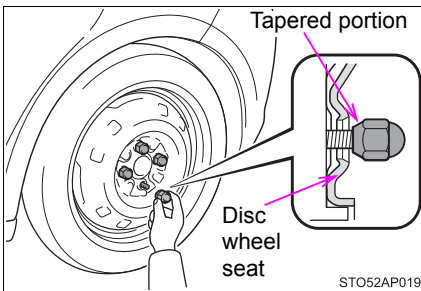

When replacing a steel wheel with a steel wheel (including a compact spare tire), tighten the wheel nuts until the tapered portion comes into loose contact with the disc wheel seat.

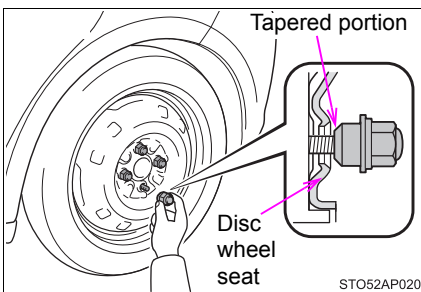

When replacing an aluminum wheel with a compact spare tire, tighten the wheel nuts until the tapered portion comes into loose contact with the disc wheel seat.

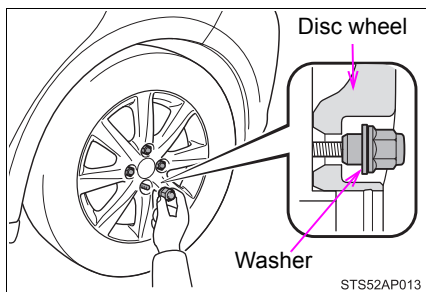

When replacing an aluminum wheel with an aluminum wheel, turn the wheel nuts until the washers come into contact with the disc wheel.

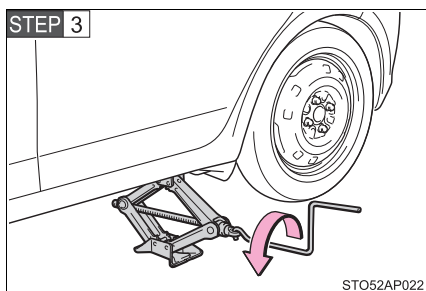

Lower the vehicle.

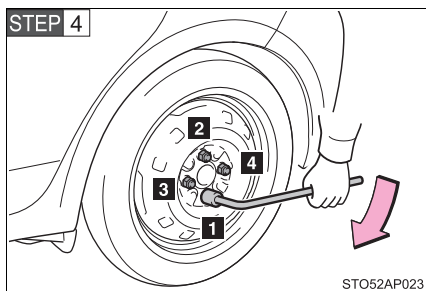

Firmly tighten each wheel nut two or three times in the order shown in the illustration.

Tightening torque:

103 N·m (10.5 kgf·m, 76 ft·lbf)

Do not use other tools or any additional leverage other than your hands, such as a hammer, pipe or your foot.

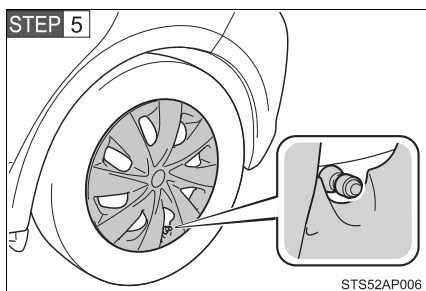

Vehicles with steel wheels (except compact spare tire):
Reinstall the wheel ornament.

Align the cutout of the wheel ornament with the valve stem as shown.

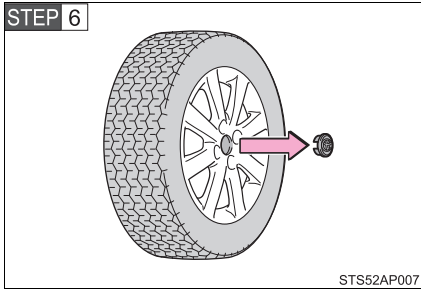

Vehicles with aluminum wheels:
Remove the center wheel ornament by pushing from the reverse side.

Be careful not to lose the wheel ornament.

STEP 7 Stow the flat tire, tire jack and all tools.

■ The compact spare tire

- The compact spare tire is identified by the label “TEMPORARY USE ONLY” on the tire sidewall.
Use the compact spare tire temporarily, and only in an emergency.
- Make sure to check the tire inflation pressure of the compact spare tire.
(→P. 679)

■ If you have a flat front tire on a road covered with snow or ice

Install the compact spare tire on one of the rear wheels of the vehicle. Perform the following steps and fit tire chains to the front tires:

STEP 1 Replace a rear tire with the compact spare tire.

STEP 2 Replace the flat front tire with the tire removed from the rear of the vehicle.

STEP 3 Fit tire chains to the front tires.

■ Certification for the jack



Manufacturer's Declaration of Conformity

Manufacturer:

Kawasaki Industrial Co., Ltd.
4618 Mukaijima Shimada, Shizuoka, Japan

The EU Directives covered by this Declaration

2006/42/EC Machinery Directive

The product covered by this declaration

JACK SUB-ASSY,PANTOGRAPH

model

0.8ton , 1.1ton , 1.35ton , 1.5ton

The basis on which conformity is being declared

The product identified above complies with the requirements of
the Machinery Directive
Directive above by meeting following standards

JIS D 8103

The technical documentation required to demonstrate that the product
meets the requirement the Machinery Directive has been compiled by
the signatory below and is available for inspection by the relevant
enforcement authorities.

A sample of the product has been tested by the manufacturer

Technical File No: KSF-201-00-01

The CE mark was first applied in:2010

Done at Shizuoka, Japan

Signature:

A handwritten signature in black ink, appearing to read 'Koji Kawasaki', written over a horizontal line.

Koji Kawasaki

PRESIDENT ,Kawasaki Industrial Co., Ltd.

Date of Issue: 25 December.2009



Manufacturer's Declaration of Conformity

Manufacturer :

ARIKAN KRİKO A.Ş
Organize Sanayi Bölgesi 2.Cd.26110 ESKİŞEHİR / TURKEY

The EU Directives covered by this Declaration

2006 / 42 / EC Machinery Directive

The product covered by this declaration

JACK SUB-ASSY. PANTOGRAPH
model
0.8 ton , 1.1 ton

The basis on which conformity is being declared

The product identified above complies with the requirements of
the Machinery Directive
Directive above by meeting following standards

857 – ISO 8720

The technical documentation required to demonstrate that the product
meets the requirement the Machinery Directive has been compiled by
the signatory below and is available for inspection by the relevant
enforcement authorities.

A sample of the product has been tested by the manufacturer

Technical File No :2010-TOYOTA JACK-ISO8720-1

The CE mark was first applied in:2010

Done at Shizuoka , Japan

Ahmet ARIKAN
General Manager

Signature :

Date of Issue : 24.08.2010

 CAUTION

■ **When using the compact spare tire**

- Remember that the compact spare tire provided is specifically designed for use with your vehicle. Do not use your compact spare tire on another vehicle.
- Do not use more than one compact spare tire simultaneously.
- Replace the compact spare tire with a standard tire as soon as possible.
- Avoid sudden acceleration, abrupt steering, sudden braking and shifting operations that cause sudden engine braking.

■ **When storing the compact spare tire**

Be careful not to catch fingers or other body parts between the compact spare tire and the body of the vehicle.

■ **When the compact spare tire is attached**

The vehicle speed may not be correctly detected, and the following systems may not operate correctly:

- ABS
- Brake assist
- VSC (if equipped)
- TRC (if equipped)
- Cruise control (if equipped)
- Navigation system (if equipped)

■ **Speed limit when using the compact spare tire**

Do not drive at speeds in excess of 80 km/h (50 mph) when a compact spare tire is installed on the vehicle.

The compact spare tire is not designed for driving at high speeds. Failure to observe this precaution may lead to an accident causing death or serious injury.

 **CAUTION****■ Using the tire jack**

Improper use of the tire jack may cause the vehicle to suddenly fall off the jack, leading to death or serious injury.

- Do not use the tire jack for any purpose other than replacing tires or installing and removing tire chains.
- Only use the tire jack that comes with this vehicle for replacing a flat tire. Do not use it on other vehicles, and do not use other tire jacks for replacing tires on this vehicle.
- Always check that the tire jack is securely set to the jack point.
- Do not put any part of your body under the vehicle while it is supported by the jack.
- Do not start or run the engine (except hybrid vehicle) or hybrid system (hybrid vehicle) while your vehicle is supported by the jack.
- Do not raise the vehicle while someone is inside.
- When raising the vehicle, do not put an object on or under the jack.
- Do not raise the vehicle to a height greater than that required to replace the tire.
- Use a jack stand if it is necessary to get under the vehicle.

Take particular care when lowering the vehicle to ensure that no one working on or near the vehicle may be injured.

 **CAUTION**

■ **Replacing a flat tire**

- Do not touch the disc wheels or the area around the brakes immediately after the vehicle has been driven.
After the vehicle has been driven the disc wheels and the area around the brakes will be extremely hot. Touching these areas with hands, feet or other body parts while changing a tire, etc. may result in burns.
- Failure to follow these precautions could cause the wheel nuts to loosen and the tire to fall off, resulting in death or serious injury.
 - Have the wheel nuts tightened with a torque wrench to 103 N·m (10.5 kgf·m, 76 ft·lbf) as soon as possible after changing wheels.
 - When installing a tire, only use wheel nuts that have been specifically designed for that wheel.
 - If there are any cracks or deformations in the bolt screws, nut threads or bolt holes of the wheel, have the vehicle inspected by any authorized Toyota dealer or repairer, or another duly qualified and equipped professional.
 - When installing the wheel nuts, be sure to install them with the tapered ends facing inward. (→P. 497)

 **NOTICE**

■ **Do not drive the vehicle with a flat tire**

Do not continue driving with a flat tire.

Driving even a short distance with a flat tire can damage the tire and the wheel beyond repair.

■ **Be careful when driving over bumps with the compact spare tire installed on the vehicle**

The vehicle becomes lower when driving with the compact spare tire compared to when driving with standard tires. Be careful when driving over uneven road surfaces.

■ **Driving with tire chains and the compact spare tire**

Do not fit tire chains to the compact spare tire.

Tire chains may damage the vehicle body and adversely affect driving performance.

5-2. Steps to take in an emergency

If you have a flat tire (vehicles with an emergency tire puncture repair kit)

A puncture caused by a nail or screw passing through the tire tread can be repaired temporarily using the emergency tire puncture repair kit. (The kit contains a bottle of sealant. The sealant can be used only once to temporarily repair one tire without removing the nail or screw from the tire.) Depending on the damage, this kit cannot be used to repair the tire. (→P. 595)

After temporarily repairing the tire with the kit, have the tire repaired or replaced by any authorized Toyota dealer or repairer, or another duly qualified and equipped professional. Repairs conducted using the emergency tire puncture repair kit are only a temporary measure. Have the tire repaired and replaced as soon as possible.

■ Before repairing the tire

- Stop the vehicle in a safe place on a hard, flat surface.
- Set the parking brake.
- Vehicles with a hybrid transmission or a Multidrive: Shift the shift lever to P.
- Vehicles with a multi-mode manual transmission and manual transmission: Shift the shift lever to N.
- Stop the engine (except hybrid vehicle) or hybrid system (hybrid vehicle).
- Turn on the emergency flashers.

■ Location of the emergency tire puncture repair kit

Type A

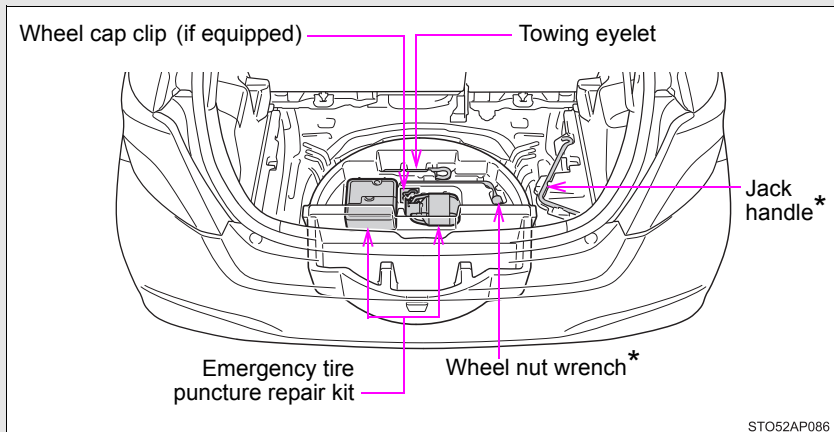

Type B

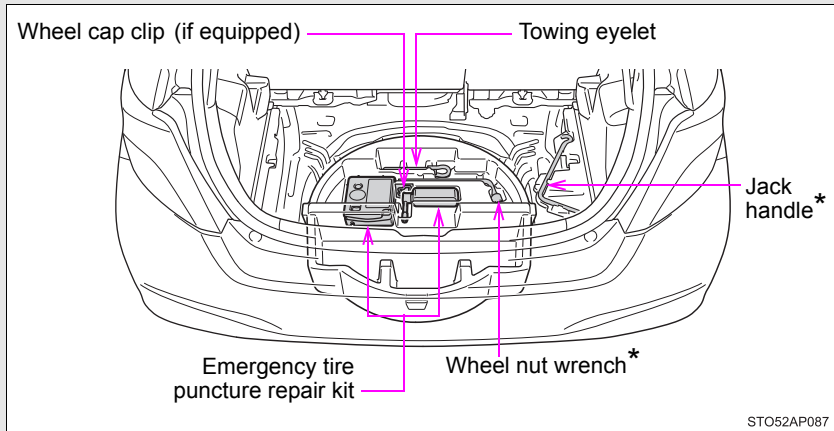

*: Use of the jack, jack handle and wheel nut wrench. (if equipped)
(→P. 578)

A jack, jack handle and wheel nut wrench can be purchased at any authorized Toyota dealer or repairer, or another duly qualified and equipped professional.

Emergency tire puncture repair kit components

Type A

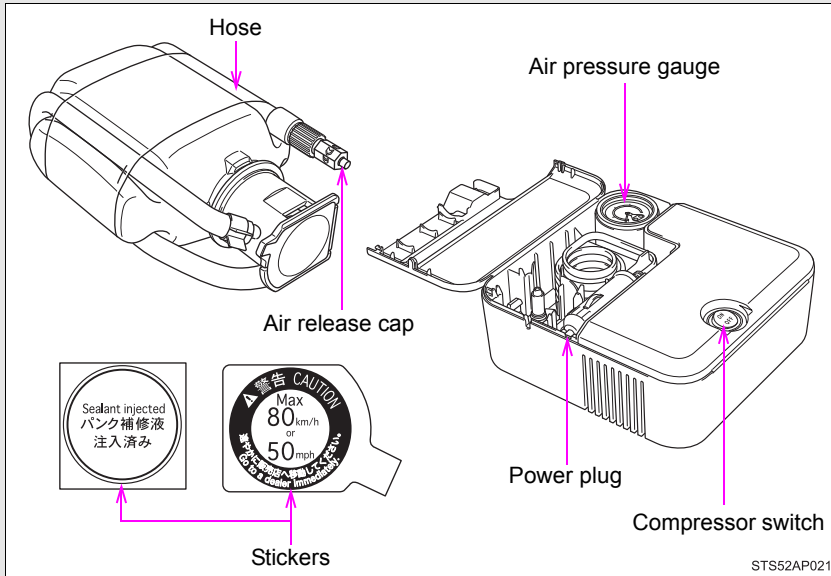

Type B

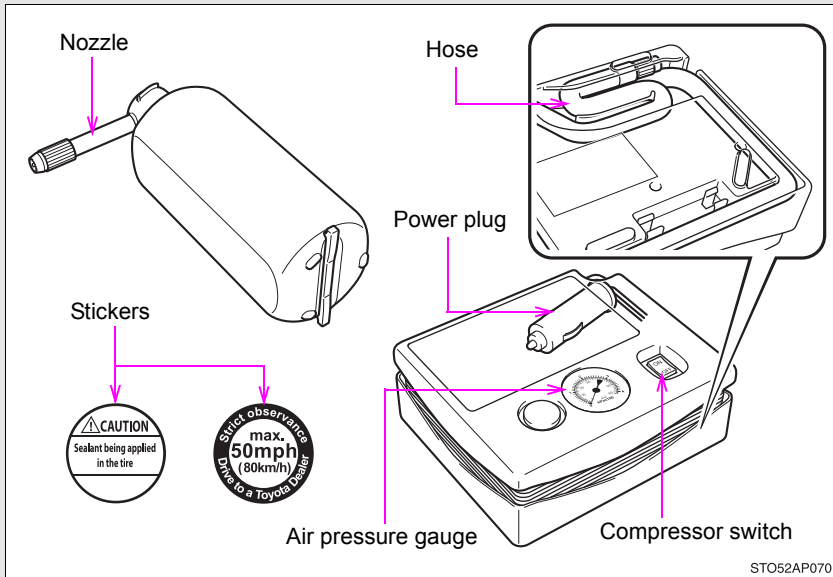

STO52AP070

Before performing emergency repair

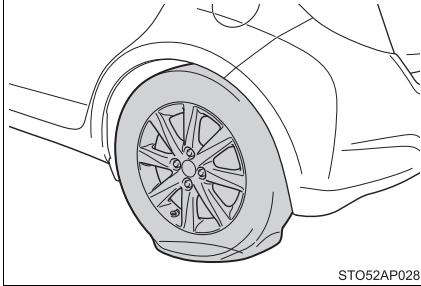

Check the degree of the tire damage.

- Do not remove the nail or screw from the tire. Removing the object may widen the opening and prevent emergency repair with the repair kit.
- To avoid sealant leakage, move the vehicle until the area of the puncture, if known, is positioned at the top of the tire.

■ **In the following cases, the tire cannot be repaired with the emergency tire puncture repair kit. Contact any authorized Toyota dealer or repairer, or another duly qualified and equipped professional.**

- When the tire is damaged due to driving without sufficient air pressure
- When there are any cracks or damage at any location on the tire, such as on the side wall, except the tread
- When the tire is visibly separated from the wheel
- When the cut or damage to the tread is 4 mm (0.16 in.) long or more
- When the wheel is damaged
- When two or more tires have been punctured
- When more than 2 sharp objects such as nails or screws have passed through the tread on a single tire
- When the sealant has expired

Taking out the emergency tire puncture repair kit

Vehicles without a deck board

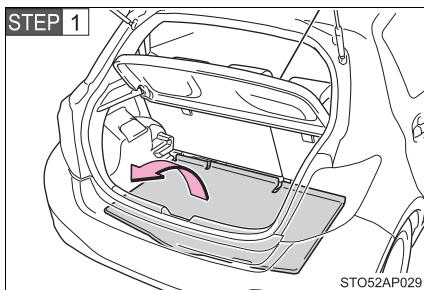

Remove the luggage floor cover.

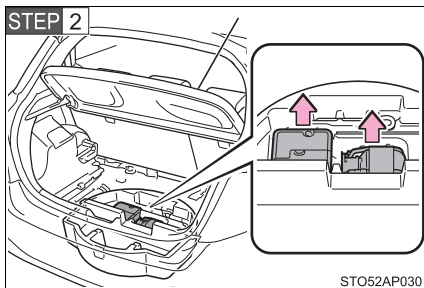

Take out the emergency tire puncture repair kit.

Vehicles with a deck board

STEP 1 Lift the deck board and attach the hook. (→P. 440)

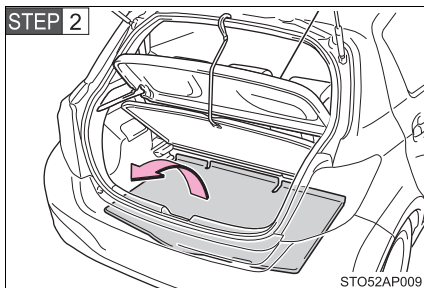

Remove the luggage floor cover.

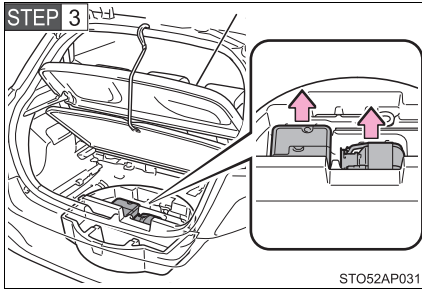

Take out the emergency tire puncture repair kit.

Emergency repair method (type A)

STEP 1 Take out the repair kit from the tool box.

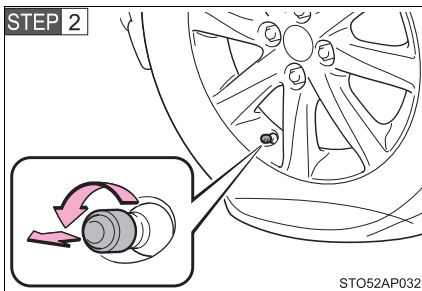

Remove the valve cap from the valve of the punctured tire.

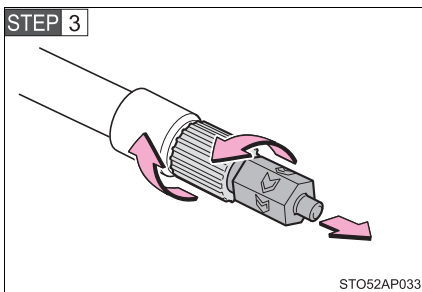

Remove the protective film from the bottle and extend the hose. Remove the air release cap from the hose.

Attach the sticker enclosed with the bottle on the specified locations. (See **STEP 9**.)

You will use the air release cap again. Therefore keep it in a safe place.

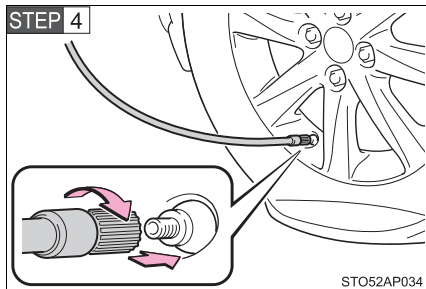

Connect the hose to the valve.

Screw the end of the hose clockwise as far as possible.

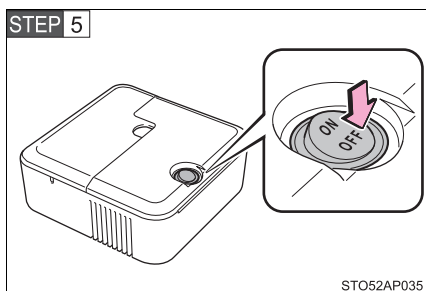

Make sure that the compressor switch is off.

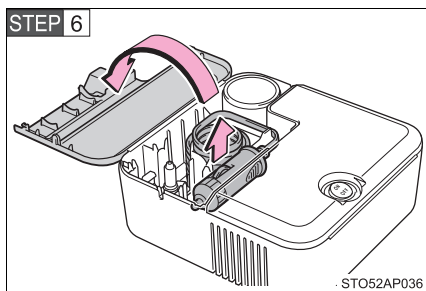

Remove the power plug from the compressor.

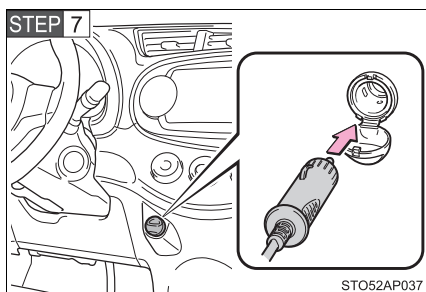

Connect the power plug to the power outlet socket or cigarette lighter socket. (→P. 429, 430)

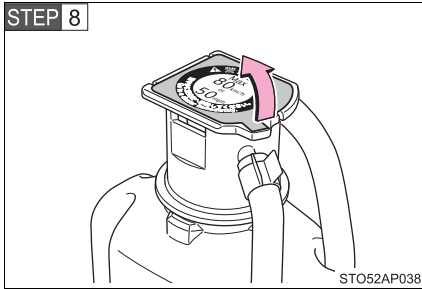

Remove the sticker.

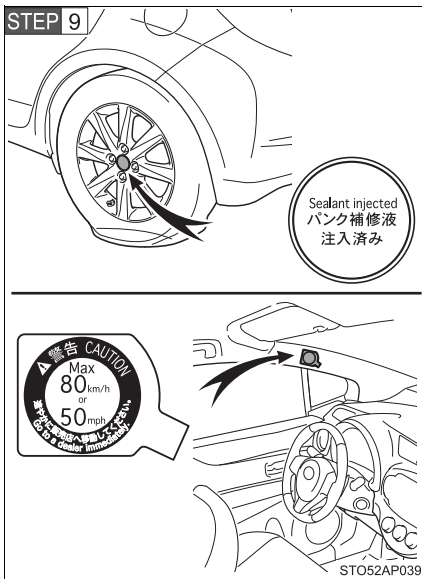

Attach the 2 stickers as shown.

Remove any dirt and moisture from the wheel before attaching the label. If it is impossible to attach the label, make sure to tell any authorized Toyota dealer or repairer, or other duly qualified and equipped professional when you have them repair and replace the tire that sealant is injected.

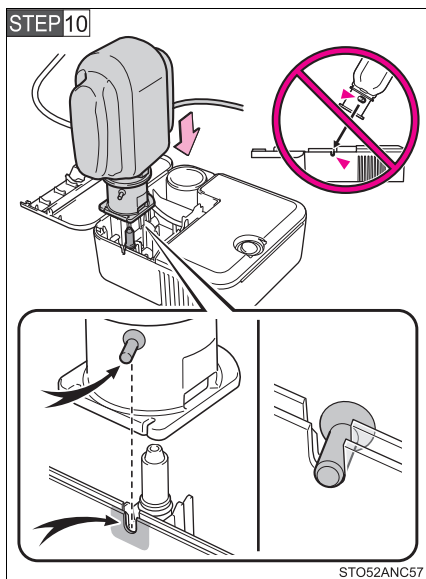

Connect the bottle to the compressor.

As shown in the illustration, insert the bottle vertically into the compressor to connect making sure that the claw on the bottle's neck is hooked onto the cutout of the compressor case.

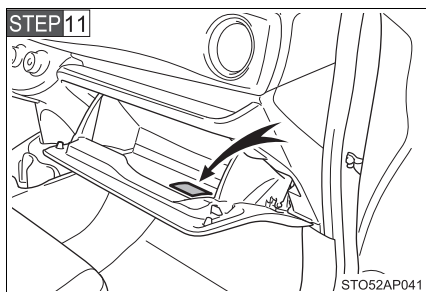

Check the specified tire inflation pressure.

Tire inflation pressure is specified on the label in the glove box. (→P. 679)

STEP 12 Start the vehicle's engine (except hybrid vehicle) or hybrid system (hybrid vehicle).

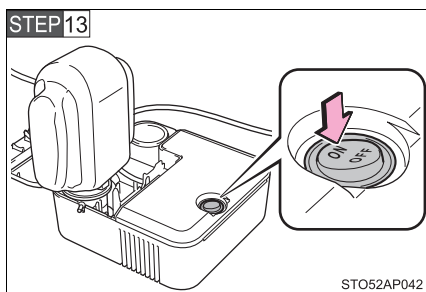

To inject the sealant and inflate the tire, turn the compressor switch on.

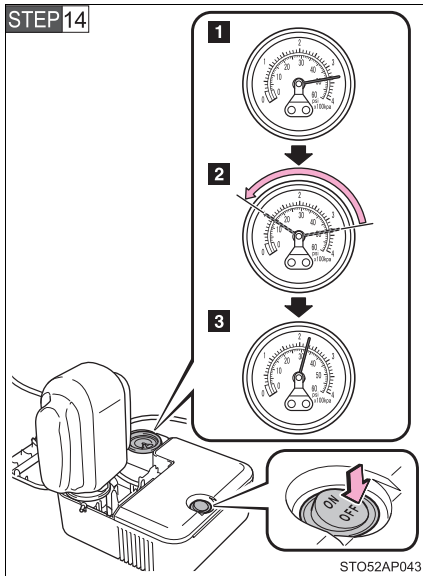

Inflate the tire until the specified air pressure is reached.

- 1** The sealant will be injected and the pressure will surge and then gradually decrease.
- 2** The air pressure gauge will display the actual tire inflation pressure about 1 minute (5 minutes at low temperature) after the switch is turned on.
- 3** Inflate the tire until the specified air pressure.

- Turn the compressor switch off and then check the tire inflation pressure. Being careful not to over inflate, check and repeat the inflation procedure until the specified tire inflation pressure is reached.
- If the tire inflation pressure is still lower than the specified point after inflation for 35 minutes with the switch on, the tire is too damaged to be repaired. Turn the compressor switch off and contact any authorized Toyota dealer or repairer, or another duly qualified and equipped professional.
- If the tire inflation pressure exceeds the specified air pressure, let out some air to adjust the tire inflation pressure.
(→P. 611, 679)

STEP 15 With the compressor switch off, disconnect the hose from the valve on the tire and then pull out the power plug from the power outlet socket or cigarette lighter socket.

Some sealant may leak when the hose is removed.

STEP 16 Install the valve cap onto the valve of the emergency repaired tire.

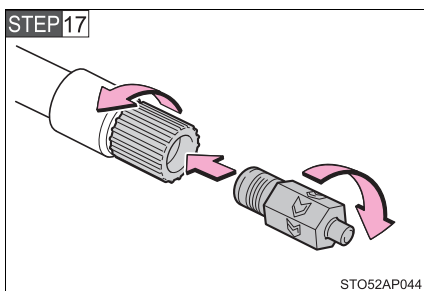

Attach the air release cap to the end of the hose.

If the air release cap is not attached, the sealant may leak and the vehicle may get dirty.

STEP 18 Temporarily store the bottle in the luggage compartment while it is connected to the compressor.

STEP 19 To spread the liquid sealant evenly within the tire, immediately drive safely for about 5 km (3 miles) below 80 km/h (50 mph).

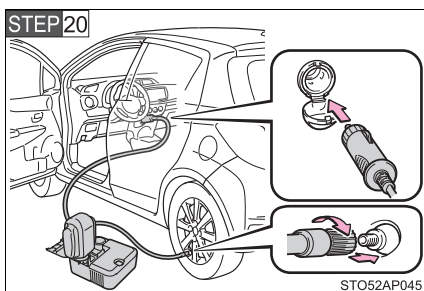

After driving for about 5 km (3 miles), stop your vehicle in a safe place on a hard, flat surface and remove the air release cap from the hose before reconnecting the repair kit.

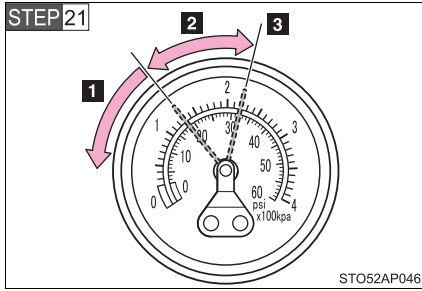

Turn the compressor switch on and wait for an approximately 5 seconds, and then turn it off. Check the tire inflation pressure.

- 1** If the tire inflation pressure is under 130 kPa (1.3 kgf/cm² or bar, 19 psi): The puncture cannot be repaired. Contact any authorized Toyota dealer or repairer, or another duly qualified and equipped professional.
- 2** If the tire inflation pressure is 130 kPa (1.3 kgf/cm² or bar, 19 psi) or higher, but less than the specified air pressure: Proceed to **STEP 22**.
- 3** If the tire inflation pressure is the specified air pressure (→P. 679): Proceed to **STEP 23**.

STEP 22 Turn the compressor switch on to inflate the tire until the specified air pressure is reached. Drive for about 5 km (3 miles) and then perform **STEP 20**.

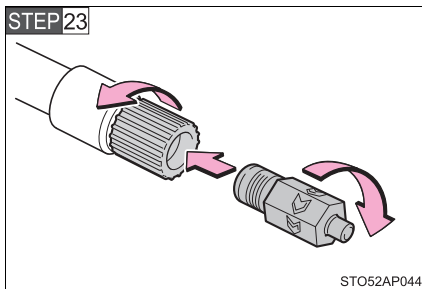

Attach the air release cap to the end of the hose.

If the air release cap is not attached, the sealant may leak and the vehicle may get dirty.

STEP 24 Store the bottle in the luggage compartment while it is connected to the compressor.

STEP 25 Taking precautions to avoid sudden braking, sudden acceleration and sharp turns, drive carefully at under 80 km/h (50 mph) to the nearest authorized Toyota dealer or repairer, or another duly qualified and equipped professional for tire repair or replacement.

Emergency repair method (type B)

STEP 1 Take out the repair kit from the tool box.

When taking out the bottle from the original bag, do not tear or discard the bag.

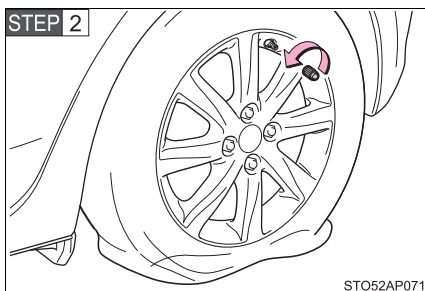

Remove the valve cap from the valve of the punctured tire.

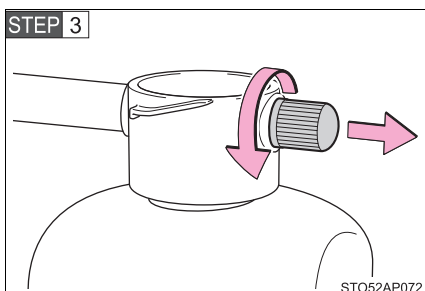

Remove the cap from the bottle.

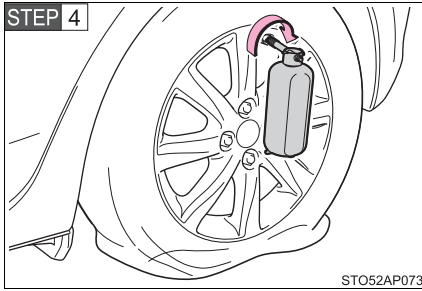

Connect the nozzle to the valve.

Screw the end of the nozzle clockwise as far as possible.

The bottle should hang vertically without contacting the ground. If the bottle does not hang vertically, move the vehicle so that the tire valve is located properly.

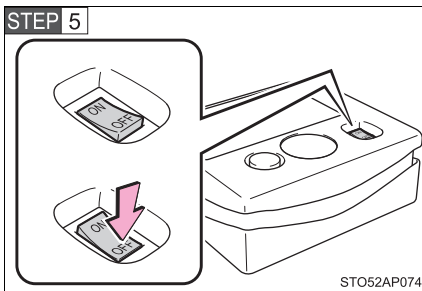

Make sure that the compressor switch is off.

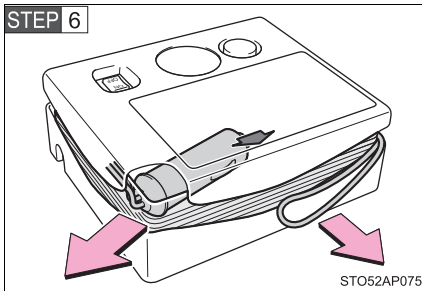

Remove the power plug from the compressor.

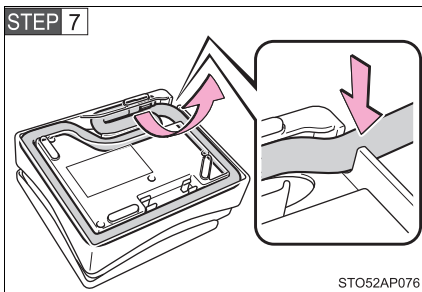

Pull the hose out from the compressor.

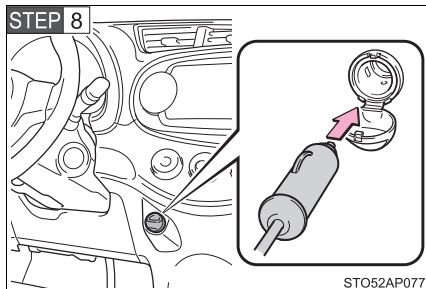

Connect the power plug to the power outlet socket or cigarette lighter socket. (→P. 429, 430)

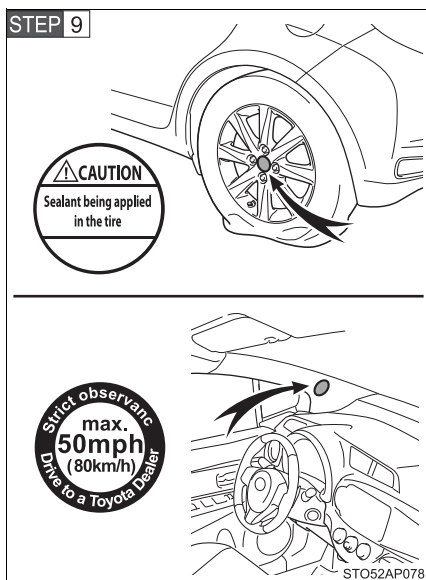

Attach the 2 stickers as shown.

Remove any dirt and moisture from the wheel before attaching the label. If it is impossible to attach the label, make sure to tell any authorized Toyota dealer or repairer, or other duly qualified and equipped professional when you have them repair and replace the tire that sealant is injected.

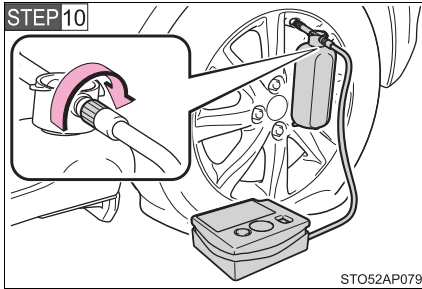

Connect the bottle to the compressor.

Screw the end of the nozzle clockwise as far as possible.

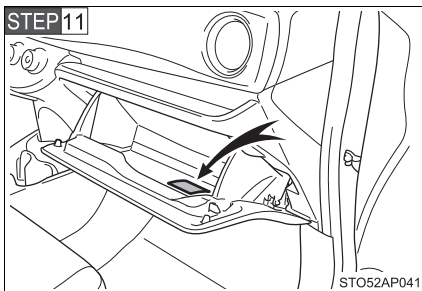

Check the specified tire inflation pressure.

Tire inflation pressure is specified on the label in the glove box. (→P. 679)

STEP 12 Start the vehicle's engine (except hybrid vehicle) or hybrid system (hybrid vehicle).

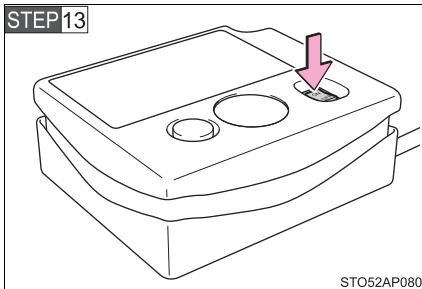

To inject the sealant and inflate the tire, turn the compressor switch on.

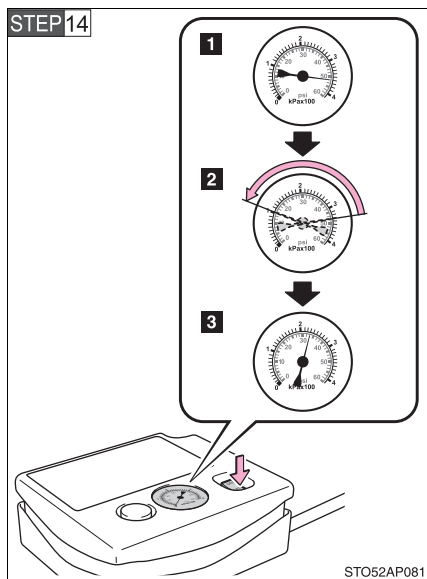

Inflate the tire until the specified air pressure is reached.

1 The sealant will be injected and the pressure will surge and then gradually decrease.

2 The air pressure gauge will display the actual tire inflation pressure about 1 minute (5 minutes at low temperature) after the switch is turned on.

3 Inflate the tire until the specified air pressure.

- If the tire inflation pressure is still lower than the specified point after inflation for 35 minutes with the switch on, the tire is too damaged to be repaired. Turn the compressor switch off and contact any authorized Toyota dealer or repairer, or another duly qualified and equipped professional.
- If the tire inflation pressure exceeds the specified air pressure, let out some air to adjust the tire inflation pressure. (→P. 611, 679)

STEP 15 With the compressor switch off, disconnect the nozzle from the valve on the tire and then pull out the power plug from the power outlet socket or cigarette lighter.

Some sealant may leak when the hose is removed.

STEP 16 Install the valve cap onto the valve of the emergency repaired tire.

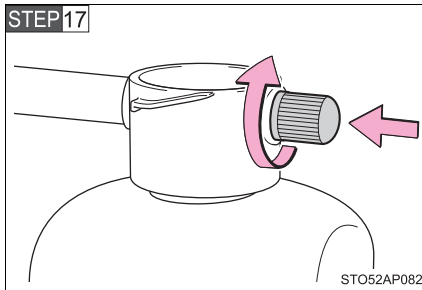

Disconnect the hose from the bottle and attach the cap to the bottle.

Place the bottle in the original bag and zip it.

STEP 18 Temporarily store the bottle and compressor in the luggage compartment.

STEP 19 To spread the liquid sealant evenly within the tire, immediately drive safely for about 5 km (3 miles) below 80 km/h (50 mph).

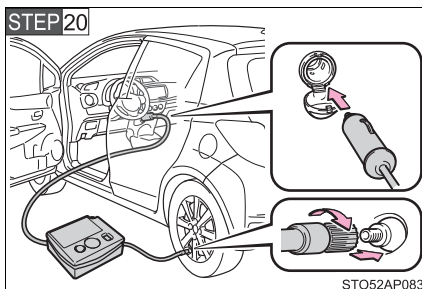

After driving for about 5 km (3 miles), stop your vehicle in a safe place on a hard, flat surface and connect the compressor.

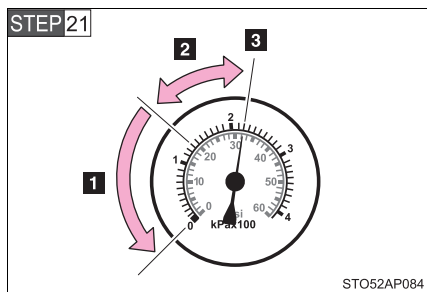

Turn the compressor switch on and wait for an approximately 5 seconds, and then turn it off. Check the tire inflation pressure.

1 If the tire inflation pressure is under 130 kPa (1.3 kgf/cm² or bar, 19 psi): The puncture cannot be repaired. Contact any authorized Toyota dealer or repairer, or another duly qualified and equipped professional.

2 If the tire inflation pressure is 130 kPa (1.3 kgf/cm² or bar, 19 psi) or higher, but less than the specified air pressure: Proceed to **STEP22**.

3 If the tire inflation pressure is the specified air pressure (→P. 679): Proceed to **STEP23**.

STEP22 Turn the compressor switch on to inflate the tire until the specified air pressure is reached. Drive for about 5 km (3 miles) and then perform **STEP20**.

STEP23 Store the compressor in the luggage compartment.

STEP24 Taking precautions to avoid sudden braking, sudden acceleration and sharp turns, drive carefully at under 80 km/h (50 mph) to the nearest authorized Toyota dealer or repairer, or another duly qualified and equipped professional for tire repair or replacement.

■ **If the tire is inflated to more than the specified air pressure (type A)**

STEP 1 Disconnect the hose from the valve.

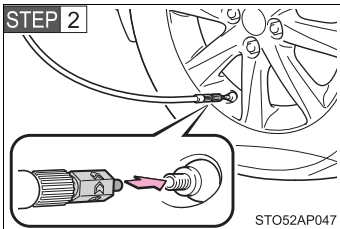

Install the air release cap to the end of the hose and push the protrusion on the air release cap into the tire valve to let some air out.

STEP 3 Disconnect the hose from the valve, remove the air release cap from the hose and then reconnect the hose.

STEP 4 Turn the compressor switch on and wait for several seconds, and then turn it off. Check that the air pressure indicator shows the specified air pressure.

If the air pressure is under the designated pressure, turn the compressor switch on again and repeat the inflation procedure until the specified air pressure is reached.

■ **If the tire is inflated to more than the specified air pressure (type B)**

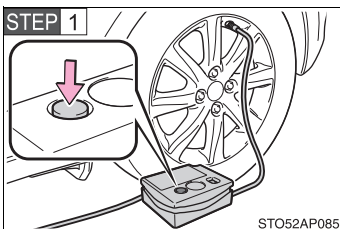

Press the button to let some air out.

STEP 2 Check that the air pressure indicator shows the specified air pressure.

If the air pressure is under the designated pressure, turn the compressor switch on again and repeat the inflation procedure until the specified air pressure is reached.

■ **The valve of a tire that has been repaired**

After a tire is repaired with the emergency tire puncture repair kit, the valve should be replaced.

■ **Note for checking the emergency tire puncture repair kit**

Check the sealant expiry date occasionally.

The expiry date is shown on the bottle. Do not use sealant whose expiry date has already passed. Otherwise, repairs conducted using the emergency tire puncture repair kit may not be performed properly.

■ **Emergency tire puncture repair kit**

- The sealant stored in the emergency tire puncture repair kit can be used only once to temporarily repair a single tire. If the sealant has been used and needs to be replaced, purchase a new bottle at any authorized Toyota dealer or repairer, or another duly qualified and equipped professional. The compressor is reusable.
- The sealant can be used when the outside temperature is from -30°C (-22°F) to 60°C (140°F).
- The repair kit is exclusively designed for size and type of tires originally installed on your vehicle. Do not use it for tires that a different size than the original ones, or for any other purposes.
- The sealant has a limited lifespan. The expiry date is marked on the bottle. The bottle of sealant should be replaced with a new bottle before the expiry date. Contact any authorized Toyota dealer or repairer, or another duly qualified and equipped professional for replacement.
- If the sealant gets on your clothes, it may stain.
- If the sealant adheres to a wheel or the surface of the vehicle body, the stain may not be removable if it is not cleaned at once. Immediately wipe away the sealant with a wet cloth.
- During operation of the repair kit, a loud operation noise is produced. This does not indicate a malfunction.
- Do not use to check or to adjust the tire pressure.

 **CAUTION**

■ **Do not drive the vehicle with a flat tire**

Do not continue driving with a flat tire.

Driving even a short distance with a flat tire can damage the tire and the wheel beyond repair.

Driving with a flat tire may cause a circumferential groove on the side wall. In such a case, the tire may explode when using a repair kit.

■ **Caution while driving**

- Store the repair kit in the luggage room.

Injuries may result in the event of an accident or sudden braking.

- The repair kit is exclusively only for your vehicle.

Do not use repair kit on other vehicles, which could lead to an accident causing death or serious injury.

- Do not use repair kit for tires that are different size than the original ones, or for any other purpose. If the tires have not been completely repaired, it could lead to an accident causing death or serious injury.

■ **Precautions for use of the sealant**

- Ingesting the sealant is hazardous to your health. If you ingest sealant, consume as much water as possible, and then immediately consult a doctor.

- If sealant gets in eyes or adheres to skin, immediately wash it off with water. If discomfort persists, consult a doctor.

■ **When fixing the flat tire**

- Stop your vehicle in a safe and flat area.

- Do not touch the wheels or the area around the brakes immediately after the vehicle has been driven.

After the vehicle has been driven, the wheels and the area around the brakes may be extremely hot. Touching these areas with hands, feet or other body parts may result in burns.

- To avoid risk of burst or severe leakage, do not drop or damage the bottle. Visually inspect the bottle before use. Do not use a bottle with shock, crack, scratch, leakage or any other damage. In such case, immediately replace.

 CAUTION

- Connect the valve and hose securely with the tire installed on the vehicle. If the hose is not properly connected to the valve, air leakage may occur as sealant may be sprayed out.
- If the hose comes off the valve while inflating the tire, there is a risk that the hose will move abruptly due to air pressure.
- After inflation of the tire has completed, the sealant may splatter when the hose is disconnected or some air is let out of the tire.
- Follow the operation procedure to repair the tire. If the procedures not followed, the sealant may spray out.
- Keep back from the tire while it is being repaired, as there is a chance of it bursting while the repair operation is being performed. If you notice any cracks or deformation of the tire, turn off the compressor switch and stop the repair operation immediately.
- The repair kit may overheat if operated for a long period of time. Do not operate the repair kit continuously for more than 40 minutes.
- Parts of the repair kit become hot during operation. Be careful when handling the repair kit during and after operation. Do not touch the metal part around the connecting area between the bottle and compressor. It will be extremely hot.
- Do not attach the vehicle speed warning sticker to an area other than the one indicated. If the sticker is attached to an area where an SRS airbag is located, such as the pad of the steering wheel, it may prevent the SRS airbag from operating properly.

■ **Driving to spread the liquid sealant evenly**

Observe the following precautions to reduce the risk of accidents. Failing to do so may result in a loss of vehicle control and cause death or serious injury.

- Drive the vehicle carefully at a low speed. Be especially careful when turning and cornering.
- If the vehicle does not drive straight or you feel a pull through the steering wheel, stop the vehicle and check the following.
 - Tire condition. The tire may have separated from the wheel.
 - Tire inflation pressure. If the tire inflation pressure is 130 kPa (1.3 kgf/cm² or bar, 19 psi) or less, the tire may be severely damaged.

 NOTICE**■ When performing an emergency repair**

- A tire should only be repaired with the emergency tire puncture repair kit if the damage is caused by a sharp object such as nail or screw passing through the tire tread.

Do not remove the sharp object from the tire. Removing the object may widen the opening and disenable emergency repair with the repair kit.

- The repair kit is not waterproof. Make sure that the repair kit is not exposed to water, such as when it is being used in the rain.
- Do not put the repair kit directly onto dusty ground such as sand at the side of the road. If the repair kit vacuums up dust etc., a malfunction may occur.

■ Precautions for the emergency tire puncture repair kit

- The repair kit power source should be 12 V DC suitable for vehicle use. Do not connect the repair kit to any other source.
- If gasoline splatters on the repair kit, the repair kit may deteriorate. Take care not to allow gasoline to contact it.
- Place the repair kit in a storage to prevent it from being exposed to dirt or water.
- Store the repair kit in the luggage room out of reach of children.
- Do not disassemble or modify the repair kit. Do not subject parts such as the air pressure indicator to impacts. This may cause a malfunction.

5-2. Steps to take in an emergency

If the engine will not start (except hybrid vehicle)

If the engine will not start even though correct starting procedures are being followed (→P. 222, 226), consider each of the following points:

■ **The engine will not start even though the starter motor operates normally.**

One of the following may be the cause of the problem:

- There may not be sufficient fuel in the vehicle's tank.
Gasoline engine: Refuel the vehicle.
Diesel engine: (→P. 651)
- The engine may be flooded. (gasoline engine)
Try to restart the engine again following correct starting procedures. (→P. 222, 226)
- There may be a malfunction in the engine immobilizer system.
(→P. 155)

■ **The starter motor turns over slowly, the interior lights and headlights are dim, or the horn does not sound or sounds at a low volume.**

One of the following may be the cause of the problem:

- The battery may be discharged. (→P. 629)
- The battery terminal connections may be loose or corroded.

■ **The starter motor does not turn over. (vehicles with a smart entry & start system)**

The engine starting system may be malfunctioning due to an electrical problem such as an open circuit or a blown fuse. However, an interim measure is available to start the engine.
(→P. 617)

■ **The starter motor does not turn over, the interior lights and headlights do not turn on, or the horn does not sound.**

One of the following may be the cause of the problem:

- One or both of the battery terminals may be disconnected.
- The battery may be discharged. (→P. 629)
- There may be a malfunction in the steering lock system (vehicles with a smart entry & start system).

Contact any authorized Toyota dealer or repairer, or another duly qualified and equipped professional if the problem cannot be repaired, or if repair procedures are unknown.

Emergency start function (vehicles with a smart entry & start system)

When the engine does not start, the following steps can be used as an interim measure to start the engine if the “ENGINE START STOP” switch is functioning normally:

Vehicles with a Multidrive

STEP 1 Set the parking brake.

STEP 2 Shift the shift lever to P.

STEP 3 Turn the “ENGINE START STOP” switch to ACCESSORY mode.

STEP 4 Push and hold the “ENGINE START STOP” switch for about 15 seconds while depressing the brake pedal firmly.

Even if the engine can be started using the above steps, the system may be malfunctioning. Have the vehicle inspected by any authorized Toyota dealer or repairer, or another duly qualified and equipped professional.

Vehicles with a multi-mode manual transmission

STEP 1 Set the parking brake.

STEP 2 Put the shift lever in N.

STEP 3 Turn the “ENGINE START STOP” switch to ACCESSORY mode.

STEP 4 Push and hold the “ENGINE START STOP” switch for about 15 seconds while depressing the brake pedal firmly.

Even if the engine can be started using the above steps, the system may be malfunctioning. Have the vehicle inspected by any authorized Toyota dealer or repairer, or another duly qualified and equipped professional.

Vehicles with a manual transmission

STEP 1 Set the parking brake.

STEP 2 Put the shift lever in N.

STEP 3 Turn the “ENGINE START STOP” switch to ACCESSORY mode.

STEP 4 Push and hold the “ENGINE START STOP” switch for about 15 seconds while depressing the brake pedal and clutch pedal firmly.

Even if the engine can be started using the above steps, the system may be malfunctioning. Have the vehicle inspected by any authorized Toyota dealer or repairer, or another duly qualified and equipped professional.

5-2. Steps to take in an emergency

If the hybrid system will not start (hybrid vehicle)

Reasons for the hybrid system not starting vary depending on the situation. Check the following and perform the appropriate procedure:

■ **The hybrid system will not start even though the correct starting procedure is being followed. (→P. 236, 241)**

One of the following may be the cause of the problem:

- Vehicles with an electronic key: The electronic key may not be functioning properly. (→P. 627)
- There may not be sufficient fuel in the vehicle's tank. Refuel the vehicle. (→P. 151)
- There may be a malfunction in the immobilizer system. (→P. 155)
- There may be a malfunction in the steering lock system.
- The hybrid system may be malfunctioning due to an electrical problem such as an open circuit or a blown fuse. However, depending on the type of malfunction, an interim measure is available to start the hybrid system. (→P. 620)

■ **The interior lights and headlights are dim, or the horn does not sound or sounds at a low volume.**

One of the following may be the cause of the problem:

- The 12-volt battery may be discharged. (→P. 636)
- The 12-volt battery terminal connections may be loose or corroded.

■ **The Interior lights and headlights do not turn on, or the horn does not sound.**

One of the following may be the cause of the problem:

- One or both of the 12-volt battery terminals may be disconnected.
- The 12-volt battery may be discharged. (→P. 636)

Contact any authorized Toyota dealer or repairer, or another duly qualified and equipped professional if the problem cannot be repaired, or if repair procedures are unknown.

Emergency start function (vehicles with an electronic key)

When the hybrid system does not start, the following steps can be used as an interim measure to start the hybrid system if the “POWER” switch is functioning normally:

STEP 1 Shift the shift lever to P.

STEP 2 Set the parking brake.

STEP 3 Turn the “POWER” switch to ACCESSORY mode.

STEP 4 Press and hold the “POWER” switch for about 15 seconds while depressing the brake pedal firmly.

Even if the hybrid system can be started using the above steps, the system may be malfunctioning. Have the vehicle inspected by any authorized Toyota dealer or repairer, or another duly qualified and equipped professional.

5-2. Steps to take in an emergency

If the shift lever cannot be shifted from P (vehicles with a hybrid transmission or a Multidrive)

If the shift lever cannot be shifted with your foot on the brake pedal, there may be a problem with the shift lock system (a system to prevent accidental operation of the shift lever). Have the vehicle inspected by any authorized Toyota dealer or repairer, or another duly qualified and equipped professional immediately.

The following steps may be used as an emergency measure to ensure that the shift lever can be shifted:

STEP 1 Set the parking brake.

STEP 2 **Except hybrid vehicle**

Vehicles without a smart entry & start system:

Turn the engine switch to the “ACC” position.

Vehicles with a smart entry & start system:

Turn the “ENGINE START STOP” switch to ACCESSORY mode.

Hybrid vehicle

Vehicles without an electronic key:

Turn the engine switch to the “ACC” position.

Vehicles with an electronic key:

Turn the “POWER” switch to ACCESSORY mode.

STEP 3 Depress the brake pedal.

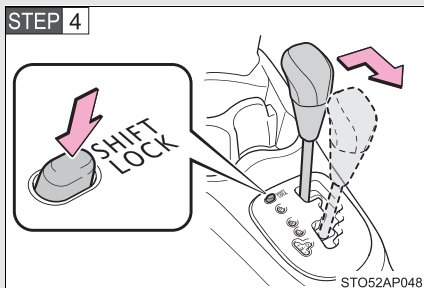

Press the shift lock override button.

The shift lever can be shifted while the button is pressed.

5-2. Steps to take in an emergency

If the shift lever cannot be shifted (vehicles with a multi-mode manual transmission)

If the shift lever cannot be shifted with your foot on the brake pedal, there may be a problem with the shift lock system (a system to prevent accidental operation of the shift lever). Have the vehicle inspected by any authorized Toyota dealer or repairer, or another duly qualified and equipped professional immediately.

The following steps may be used as an emergency measure to ensure that the shift lever can be shifted:

STEP 1 Set the parking brake.

STEP 2 Vehicles without a smart entry & start system:

Turn the engine switch to the “ON” position.

Vehicles with a smart entry & start system:

Turn the “ENGINE START STOP” switch to IGNITION ON mode.

STEP 3 Depress the brake pedal.

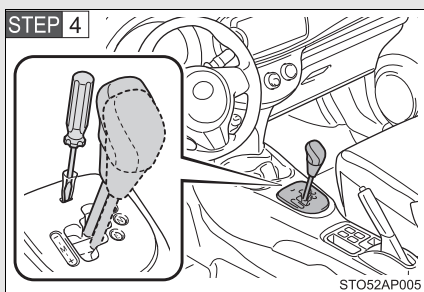

Press the shift lock override button with a flathead screwdriver or equivalent.

The shift lever can be shifted while the button is pressed.

5-2. Steps to take in an emergency

If you lose your keys

New genuine Toyota keys can be made by any authorized Toyota dealer or repairer, and another duly qualified and equipped professional using the other key and the key number stamped on your key number plate.

5-2. Steps to take in an emergency

If the electronic key does not operate properly*

If communication between the electronic key and vehicle is interrupted (→P. 78) or the electronic key cannot be used because the battery is depleted, the smart entry & start system and wireless remote control cannot be used. In such cases, the doors can be opened and the engine (except hybrid vehicle) or hybrid system (hybrid vehicle) can be started by following the procedure below.

Unlocking and locking the doors

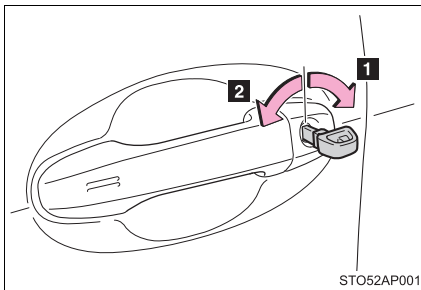

Use the mechanical key (→P. 66) in order to perform the following operations:

- 1** Unlocks all the doors
- 2** Locks all the doors

*: If equipped

Starting the engine (except hybrid vehicle)

Vehicles with a Multidrive

STEP 1 Ensure that the shift lever is in P and firmly depress the brake pedal.

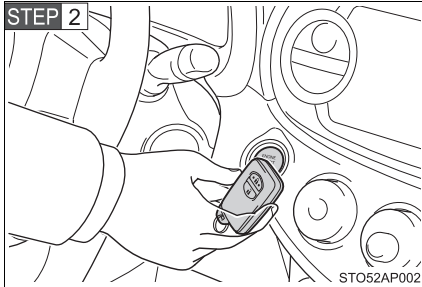

Touch the Toyota emblem side of the electronic key to the “ENGINE START STOP” switch.

The “ENGINE START STOP” switch will turn to IGNITION ON mode.

When the smart entry & start system is deactivated in customization setting, the “ENGINE START STOP” switch will turn to ACCESSORY mode.

STEP 3 Firmly depress the brake pedal and check that the smart entry & start system indicator light (green) turns on.

STEP 4 Press the “ENGINE START STOP” switch.

In the event that the “ENGINE START STOP” switch still cannot be operated, contact any authorized Toyota dealer or repairer, or another duly qualified and equipped professional.

Vehicles with a multi-mode manual transmission

STEP 1 Ensure that the shift lever is in N and firmly depress the brake pedal.

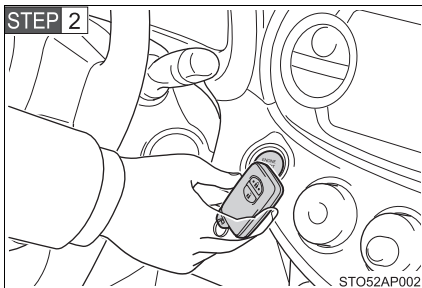

Touch the Toyota emblem side of the electronic key to the “ENGINE START STOP” switch.

The “ENGINE START STOP” switch will turn to IGNITION ON mode.

When the smart entry & start system is deactivated in customization setting, the “ENGINE START STOP” switch will turn to ACCESSORY mode.

STEP 3 Firmly depress the brake pedal and check that the smart entry & start system indicator light (green) turns on.

STEP 4 Press the “ENGINE START STOP” switch.
In the event that the “ENGINE START STOP” switch still cannot be operated, contact any authorized Toyota dealer or repairer, or another duly qualified and equipped professional.

Vehicles with a manual transmission

STEP 1 Ensure that the shift lever is in N and depress the clutch pedal.

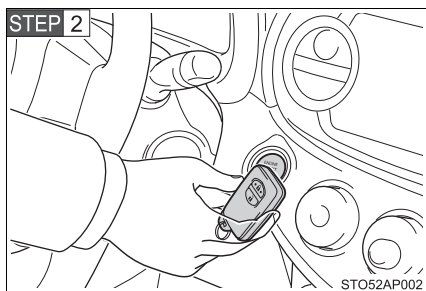

Touch the Toyota emblem side of the electronic key to the “ENGINE START STOP” switch.

The “ENGINE START STOP” switch will turn to IGNITION ON mode.

When the smart entry & start system is deactivated in customization setting, the “ENGINE START STOP” switch will turn to ACCESSORY mode.

STEP 3 Firmly depress the clutch pedal and check that the smart entry & start system indicator light (green) turns on.

STEP 4 Press the “ENGINE START STOP” switch.
In the event that the “ENGINE START STOP” switch still cannot be operated, contact any authorized Toyota dealer or repairer, or another duly qualified and equipped professional.

Starting the hybrid system (hybrid vehicle)

STEP 1 Ensure that the shift lever is in P and firmly depress the brake pedal.

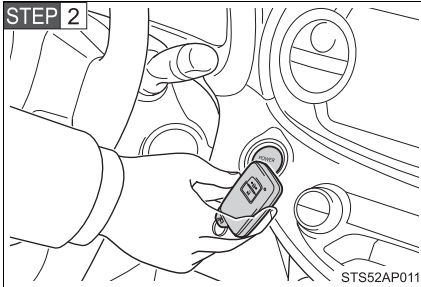

Touch the Toyota emblem side of the electronic key to the “POWER” switch.

The “POWER” switch will turn to ON mode.

If any of the doors is opened or closed while the key is being touched to the switch, an alarm will sound to indicate that the start function cannot detect the electronic key.

When the smart entry & start system is deactivated in customization setting, the “POWER” switch will turn to ACCESSORY mode.

STEP 3 Firmly depress the brake pedal and check that the smart entry & start system indicator light (green) turns on.

STEP 4 Press the “POWER” switch.

In the event that the hybrid system still cannot be operated, contact any authorized Toyota dealer or repairer, or another duly qualified and equipped professional.

■ Stopping the engine (except hybrid vehicle)

Vehicles with a Multidrive: Shift the shift lever to P and press the “ENGINE START STOP” switch as you normally do when stopping the engine.

Except vehicles with a Multidrive: Shift the shift lever to N and press the “ENGINE START STOP” switch as you normally do when stopping the engine.

■ Stopping the hybrid system (hybrid vehicle)

Shift the shift lever to P and press the “POWER” switch as you normally do when stopping the hybrid system.

■ **Replacing the key battery**

As the above procedure is a temporary measure, it is recommended that the electronic key battery be replaced immediately when the battery is depleted. (→P. 501)

■ **Changing “ENGINE START STOP” switch modes (except hybrid vehicle)**

● Vehicles with a Multidrive or multi-mode manual transmission: Release the brake pedal and press the “ENGINE START STOP” switch in **STEP 3** above. (→P. 625, 626)

The engine does not start and modes will be changed each time the switch is pressed. (→P. 230)

● Vehicles with a manual transmission: Release the clutch pedal and press the “ENGINE START STOP” switch in **STEP 3** above. (→P. 626)

The engine does not start and modes will be changed each time the switch is pressed. (→P. 230)

■ **Changing “POWER” switch modes (hybrid vehicle)**

Release the brake pedal and press the “POWER” switch in **STEP 3** above. (→P. 627)

The hybrid system does not start and modes will be changed each time the switch is pressed. (→P. 243)

■ **If the doors cannot be locked or unlocked by the smart entry & start system**

Lock and unlock the doors by the mechanical key or wireless remote control.

■ **When the electronic key does not work properly**

Make sure that the smart entry & start system has not been deactivated in the customization setting. If it is off, turn the function on.

(Customizable features →P. 689)

5-2. Steps to take in an emergency

If the vehicle battery is discharged (except hybrid vehicle)

The following procedures may be used to start the engine if the vehicle's battery is discharged.

You can also call any authorized Toyota dealer or repairer, or another duly qualified and equipped professional.

If you have a set of jumper (or booster) cables and a second vehicle with a 12-volt battery, you can jump start your vehicle by following the steps below.

STEP 1 Open the hood. (→P. 460)

STEP 2 Connect the jumper cables according to the following procedure:

1KR-FE engine

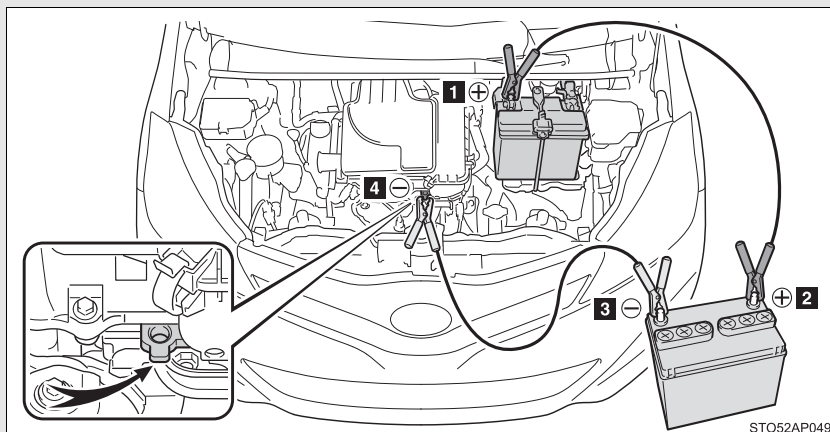

- 1** Connect a positive jumper cable clamp to the positive (+) battery terminal on your vehicle.
- 2** Connect the clamp on the other end of the positive cable to the positive (+) battery terminal on the second vehicle.
- 3** Connect a negative cable clamp to the negative (-) battery terminal on the second vehicle.
- 4** Connect the clamp at the other end of the negative cable to a solid, stationary, unpainted metallic point away from the battery and any moving parts as shown in the illustration.

1NR-FE engine

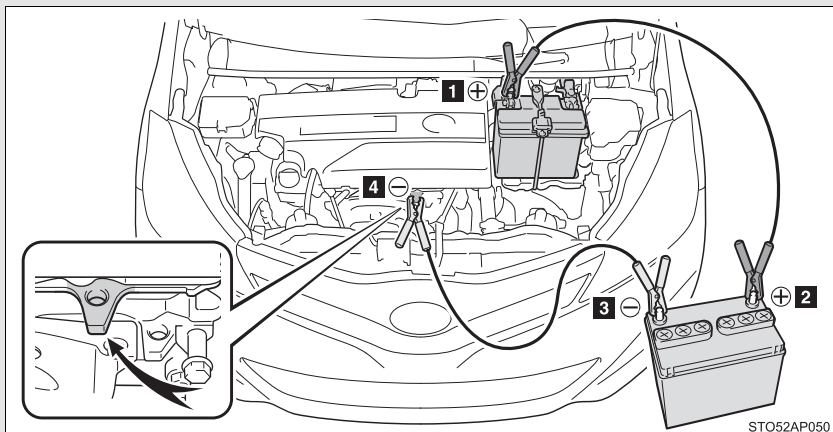

- 1** Connect a positive jumper cable clamp to the positive (+) battery terminal on your vehicle.
- 2** Connect the clamp on the other end of the positive cable to the positive (+) battery terminal on the second vehicle.
- 3** Connect a negative cable clamp to the negative (-) battery terminal on the second vehicle.
- 4** Connect the clamp at the other end of the negative cable to a solid, stationary, unpainted metallic point away from the battery and any moving parts as shown in the illustration.

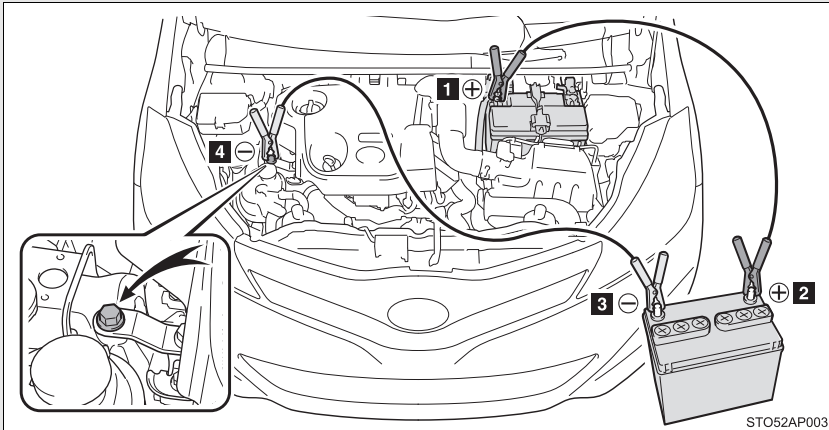
1ND-TV engine

STO52AP003

- 1** Connect a positive jumper cable clamp to the positive (+) battery terminal on your vehicle.
 - 2** Connect the clamp on the other end of the positive cable to the positive (+) battery terminal on the second vehicle.
 - 3** Connect a negative cable clamp to the negative (-) battery terminal on the second vehicle.
 - 4** Connect the clamp at the other end of the negative cable to a solid, stationary, unpainted metallic point away from the battery and any moving parts as shown in the illustration.
- STEP 3** Start the engine of the second vehicle. Increase the engine speed slightly and maintain at that level for approximately 5 minutes to recharge the battery of your vehicle.
- STEP 4** Vehicles with a smart entry & start system: Open and close any of the doors with the “ENGINE START STOP” switch turned off.

STEP 5 Vehicles without a smart entry & start system: Maintain the engine speed of the second vehicle and turn the engine switch to the “ON” position, then start the vehicle’s engine.

Vehicles with a smart entry & start system: Maintain the engine speed of the second vehicle and turn the “ENGINE START STOP” switch to IGNITION ON mode, then start the vehicle’s engine.

STEP 6 Once the vehicle’s engine has started, remove the jumper cables in the exact reverse order from which they were connected.

Once the engine starts, have the vehicle inspected at any authorized Toyota dealer or repairer, or another duly qualified and equipped professional as soon as possible.

■ Starting the engine when the battery is discharged (vehicles with a Multidrive)

The engine cannot be started by push-starting.

■ To prevent battery discharge

- Turn off the headlights and the audio system while the engine is off.
- Turn off any unnecessary electrical components when the vehicle is running at a low speed for an extended period, such as in heavy traffic.

■ Charging the battery

The electricity stored in the battery will discharge gradually even when the vehicle is not in use, due to natural discharge and the draining effects of certain electrical appliances. If the vehicle is left for a long time, the battery may discharge, and the engine may be unable to start. (The battery recharges automatically during driving.)

■ Precautions when the battery is discharged (vehicles with a smart entry & start system)

- In some cases, it may not be possible to unlock the doors using the smart entry & start system when the battery is discharged. Use the wireless remote control or the mechanical key to lock or unlock the doors.
- The engine may not start on the first attempt after the battery has recharged but will start normally after the second attempt. This is not a malfunction.
- The “ENGINE START STOP” switch mode is memorized by the vehicle. When the battery is reconnected, the system will return to the mode it was in before the battery was discharged. Before disconnecting the battery, turn the “ENGINE START STOP” switch off.
If you are unsure what mode the “ENGINE START STOP” switch was in before the battery discharged, be especially careful when reconnecting the battery.

 CAUTION

■ **Avoiding battery fires or explosions**

Observe the following precautions to prevent accidentally igniting the flammable gas that may be emitted from the battery:

- Make sure each jumper cable is connected to the correct terminal and that it is not unintentionally in contact with any other than the intended terminal.
- Do not allow the + and - clamps of the jumper cables to come into contact with each other.
- Do not smoke, use matches, cigarette lighters or allow open flame near the battery.

■ **Battery precautions**

The battery contains poisonous and corrosive acidic electrolyte, while related parts contain lead and lead compounds. Observe the following precautions when handling the battery:

- When working with the battery, always wear safety glasses and take care not to allow any battery fluids (acid) to come into contact with skin, clothing or the vehicle body.
- Do not lean over the battery.
- In the event that battery fluid comes into contact with the skin or eyes, immediately wash the affected area with water and seek medical attention. Place a wet sponge or cloth over the affected area until medical attention can be received.
- Always wash your hands after handling the battery support, terminals, and other battery-related parts.
- Do not allow children near the battery.

■ **To prevent damage to the vehicle**

Do not pull- or push-start the vehicle as the three-way catalytic converter (gasoline-powered vehicles) or catalytic converter (diesel-powered vehicles) may overheat and become a fire hazard.

 NOTICE**■ When handling jumper cables**

When connecting the jumper cables, ensure that they do not become entangled in the cooling fan or belt.

5-2. Steps to take in an emergency

If the vehicle's 12-volt battery is discharged (hybrid vehicle)

The following procedures may be used to start the hybrid system if the vehicle's 12-volt battery is discharged.

You can also call any authorized Toyota dealer or repairer, or another duly qualified and equipped professional.

If you have a set of jumper (or booster) cables and a second vehicle with a 12-volt battery, you can jump start your vehicle by following the steps below.

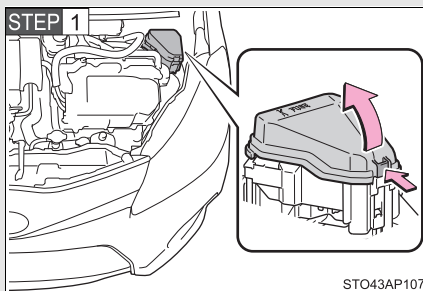

Open the hood and remove the fuse box cover.

Push the tab in and lift the cover off.

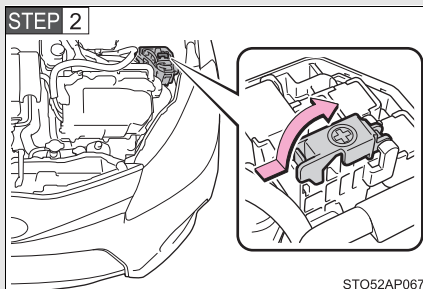

Open the exclusive jump starting terminal cover.

Push the tab in and open the cover.

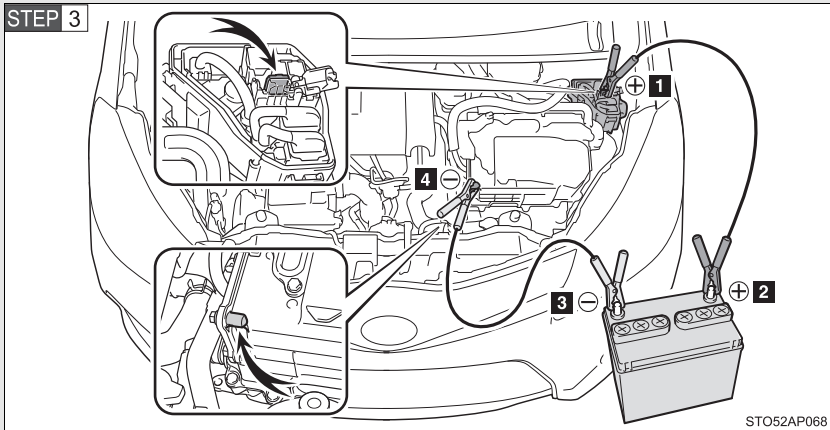

Connect the jumper cables according to the following procedure:

- 1** Connect a positive jumper cable clamp to the exclusive jump starting terminal on your vehicle.
 - 2** Connect the clamp on the other end of the positive cable to the positive (+) battery terminal on the second vehicle.
 - 3** Connect a negative cable clamp to the negative (-) battery terminal on the second vehicle.
 - 4** Connect the clamp at the other end of the negative cable to a solid, stationary, unpainted metallic point away from the exclusive jump starting terminal and any moving parts, as shown in the illustration.
- STEP 4** Start the engine of the second vehicle. Increase the engine speed slightly and maintain that level for approximately 5 minutes to recharge the 12-volt battery of your vehicle.
- STEP 5** Open and close any of the doors of your vehicle with the engine switch (vehicles without an electronic key) or “POWER” switch (vehicles with an electronic key) off.

STEP 6 Maintain the engine speed of the second vehicle and start the hybrid system of your vehicle by turning the engine switch (vehicles without an electronic key) to “ON” position or “POWER” switch (vehicles with an electronic key) to ON mode.

STEP 7 Make sure the “READY” indicator comes on. If the indicator does not come on, contact any authorized Toyota dealer or repairer, or another duly qualified and equipped professional.

STEP 8 Once the hybrid system has started, remove the jumper cables in the exact reverse order from which they were connected.

STEP 9 Close the exclusive jump starting terminal cover, and reinstall the fuse box cover to its original position.

When installing, first hook the fuse box cover onto the two rear tabs.

Once the hybrid system starts, have the vehicle inspected at any authorized Toyota dealer or repairer, or another duly qualified and equipped professional as soon as possible.

■ **Starting the hybrid system when the 12-volt battery is discharged**

The hybrid system cannot be started by push-starting.

■ **To prevent 12-volt battery discharge**

- Turn off the headlights and the audio system while the hybrid system is off.
- Turn off any unnecessary electrical components when the vehicle is running at a low speed for an extended period, such as in heavy traffic.

■ **Precautions when the 12-volt battery is discharged**

- In some cases, it may not be possible to unlock the doors using the smart entry & start system immediately after the 12-volt battery has been disconnected and reconnected. Use the wireless remote control or the mechanical key to lock or unlock the doors.

- The hybrid system may not start on the first attempt after the 12-volt battery has recharged but will start normally after the second attempt. This is not a malfunction.
- Vehicles with an electronic key: The “POWER” switch mode is memorized by the vehicle. When the 12-volt battery is reconnected, the system will return to the mode it was in before the 12-volt battery was discharged. Before disconnecting the 12-volt battery, turn the “POWER” switch off.
If the “POWER” switch was in ACCESSORY or ON mode before the 12-volt battery was discharged, the audio system and/or air conditioning system may operate when the 12-volt battery is reconnected.

■ Charging the 12-volt battery

The electricity stored in the 12-volt battery will discharge gradually even when the vehicle is not in use, due to natural discharge and the draining effects of certain electrical appliances. If the vehicle is left for a long time, the 12-volt battery may discharge, and the hybrid system may be unable to start. (The 12-volt battery recharges automatically while the hybrid system is operating.)

CAUTION

■ Avoiding 12-volt battery fires or explosions

Observe the following precautions to prevent accidentally igniting the flammable gas that may be emitted from the 12-volt battery:

- Make sure each jumper cable is connected to the correct terminal and that it is not unintentionally in contact with anything other than the intended terminal.
- Do not allow the other end of the jumper cable connected to the “+” terminal to come into contact with any other parts or metal surfaces in the area, such as brackets or unpainted metal.
- Do not allow the + and - clamps of the jumper cables to come into contact with each other.
- Do not smoke, use matches, cigarette lighters or allow open flame near the 12-volt battery.

 CAUTION

■ **After recharging the 12-volt battery**

Have the 12-volt battery inspected at any authorized Toyota dealer or repairer, or another duly qualified and equipped professional as soon as possible.

If the 12-volt battery is deteriorating, continued use may cause the 12-volt battery to emit a malodorous gas, which may be detrimental to the health of passengers.

■ **When replacing the 12-volt battery**

→P. 489

■ **12-volt battery precautions**

The 12-volt battery contains poisonous and corrosive acidic electrolyte, while related parts contain lead and lead compounds. Observe the following precautions when handling the 12-volt battery:

- When working with the 12-volt battery, always wear safety glasses and take care not to allow any battery fluids (acid) to come into contact with skin, clothing or the vehicle body.
- Do not lean over the 12-volt battery.
- In the event that battery fluid comes into contact with the skin or eyes, immediately wash the affected area with water and seek medical attention. Place a wet sponge or cloth over the affected area until medical attention can be received.
- Always wash your hands after handling the battery support, terminals, and other battery-related parts.
- Do not allow children near the 12-volt battery.

 NOTICE**■ When handling jumper cables**

When connecting the jumper cables, ensure that they do not become entangled in the cooling fan or belt.

■ Exclusive jump starting terminal

The exclusive jump starting terminal is to be used when charging the 12-volt battery from another vehicle in an emergency. It cannot be used to jump start another vehicle.

5-2. Steps to take in an emergency

If your vehicle overheats (except hybrid vehicle)

The following may indicate that your vehicle is overheating.

- The high engine coolant temperature warning light (→P. 562) comes on or flashes, or a loss of engine power is experienced. (For example, the vehicle speed does not increase.)
- Steam comes out from under the hood.

Correction procedures

STEP 1 Stop the vehicle in a safe place and turn off the air conditioning system, and then stop the engine.

STEP 2 If you see steam:

Carefully lift the hood after the steam subsides.

If you do not see steam:

Carefully lift the hood.

STEP 3 After the engine has cooled down sufficiently, inspect the hoses and radiator core (radiator) for any leaks.

Gasoline engine

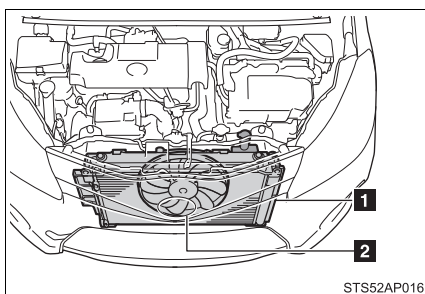

1 Radiator

2 Cooling fan

If a large amount of coolant leaks, immediately contact any authorized Toyota dealer or repairer, or another duly qualified and equipped professional.

Diesel engine

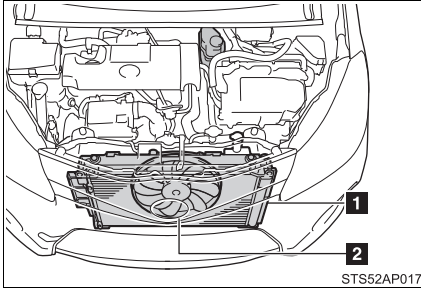

- 1 Radiator
- 2 Cooling fan

If a large amount of coolant leaks, immediately contact any authorized Toyota dealer or repairer, or another duly qualified and equipped professional.

STEP 4 The coolant level is satisfactory if it is between the “FULL” and “LOW” lines on the reservoir.

Gasoline engine

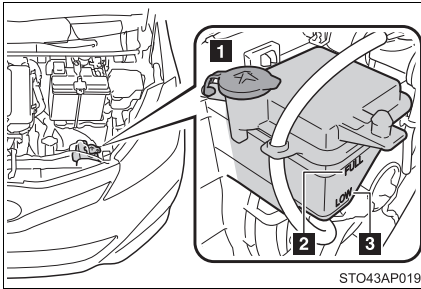

- 1 Reservoir
- 2 “FULL” line
- 3 “LOW” line

Diesel engine

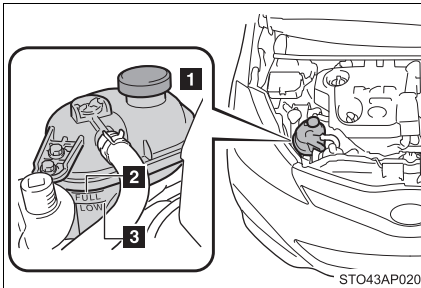

- 1 Reservoir
- 2 “FULL” line
- 3 “LOW” line

STEP 5 Add coolant if necessary.

Water can be used in an emergency if coolant is unavailable.

Gasoline engine

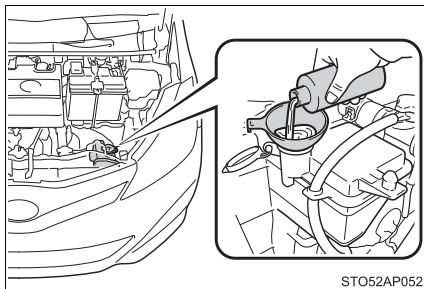

Diesel engine

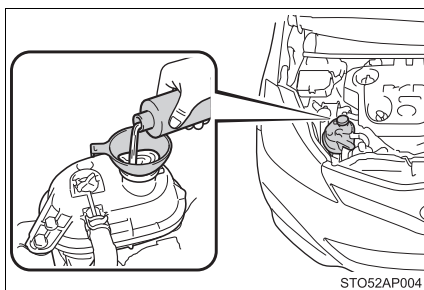

STEP 6 Start the engine and turn the air conditioning system on to check that the radiator cooling fan operates and to check for coolant leaks from the radiator or hoses.

The fan operates when the air conditioning system is turned on immediately after a cold start. Confirm that the fan is operating by checking the fan sound and air flow. If it is difficult to check these, turn the air conditioning system on and off repeatedly. (The fan may not operate in freezing temperatures.)

STEP 7 If the fan is not operating:

Stop the engine immediately and contact any authorized Toyota dealer or repairer, or another duly qualified and equipped professional.

If the fan is operating:

Have the vehicle inspected at the nearest authorized Toyota dealer or repairer, or another duly qualified and equipped professional.

 **CAUTION****To prevent an accident or injury when inspecting under the hood of your vehicle**

- If steam is seen coming from under the hood, do not open the hood until the steam has subsided. The engine compartment may be very hot, causing serious injuries such as burns.
- Keep hands and clothing (especially a tie, a scarf or a muffler) away from the fan and belts. Failure to do so may cause the hands or clothing to be caught, resulting in serious injury.
- Do not loosen the radiator cap, or the coolant reservoir cap while the engine and radiator are hot.
Serious injury, such as burns, may result from hot coolant and steam released under pressure.

 **NOTICE****When adding engine coolant**

Wait until the engine has cooled down before adding engine coolant. When adding coolant, do so slowly. Adding cool coolant to a hot engine too quickly can cause damage to the engine.

To prevent damage to the cooling system

Observe the following precautions:

- Avoid contaminating the coolant with foreign matter (such as sand or dust etc.).
- Do not use commercially available coolant additives.

5-2. Steps to take in an emergency

If your vehicle overheats (hybrid vehicle)

The following may indicate that your vehicle is overheating.

- The high engine coolant temperature warning light (→P. 562) comes on or flashes, or a loss of hybrid system power is experienced. (For example, the vehicle speed does not increase.)
- The hybrid system overheat warning light (→P. 567) comes on.
- Steam comes out from under the hood.

Correction procedures

■ If the high engine coolant temperature warning light comes on or flashes

STEP 1 Stop the vehicle in a safe place and turn off the air conditioning system, and then stop the hybrid system.

STEP 2 If you see steam:

Carefully lift the hood after the steam subsides.

If you do not see steam:

Carefully lift the hood.

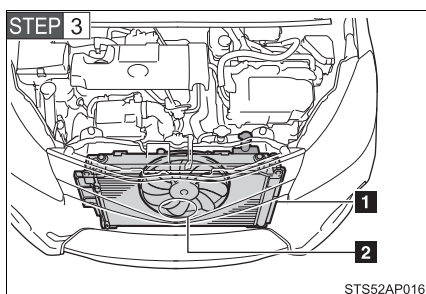

After the hybrid system has cooled down sufficiently, inspect the hoses and radiator core (radiator) for any leaks.

- 1** Radiator
- 2** Cooling fan

If a large amount of coolant leaks, immediately contact any authorized Toyota dealer or repairer, or another duly qualified and equipped professional.

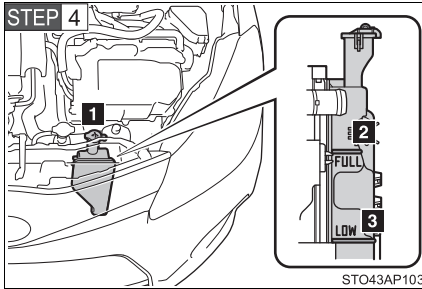

The coolant level is satisfactory if it is between the “FULL” and “LOW” lines on the reservoir.

- 1** Reservoir
- 2** “FULL” line
- 3** “LOW” line

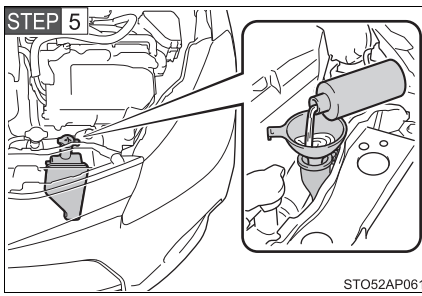

Add coolant if necessary.

Water can be used in an emergency if coolant is unavailable.

STEP 6 Start the hybrid system and turn the air conditioning system on to check that the radiator cooling fan operates and to check for coolant leaks from the radiator or hoses.

The fan operates when the air conditioning system is turned on immediately after a cold start. Confirm that the fan is operating by checking the fan sound and air flow. If it is difficult to check these, turn the air conditioning system on and off repeatedly. (The fan may not operate in freezing temperatures.)

STEP 7 If the fan is not operating:

Stop the hybrid system immediately and contact any authorized Toyota dealer or repairer, or another duly qualified and equipped professional.

If the fan is operating:

Have the vehicle inspected at the nearest authorized Toyota dealer or repairer, or another duly qualified and equipped professional.

■ **If the hybrid system overheat warning light comes on**

STEP 1 Stop the vehicle in a safe place.

STEP 2 Stop the hybrid system and carefully lift the hood.

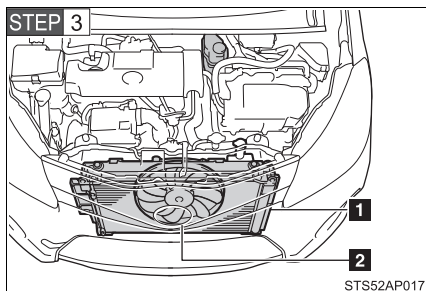

After the hybrid system has cooled down, inspect the hoses and radiator core (radiator) for any leaks.

- 1** Radiator
- 2** Cooling fan

If a large amount of coolant leaks, immediately contact any authorized Toyota dealer or repairer, or another duly qualified and equipped professional.

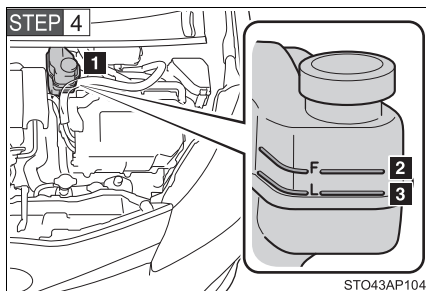

The coolant level is satisfactory if it is between the "F" and "L" lines on the reservoir.

- 1** Reservoir
- 2** "F" line
- 3** "L" line

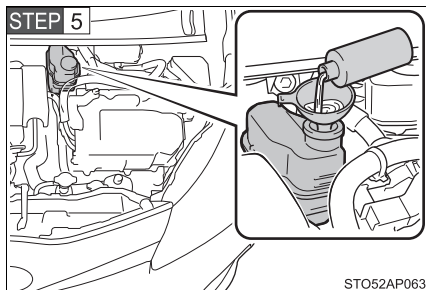

Add coolant if necessary.

Water can be used in an emergency if coolant is unavailable.

STEP 6 Start the hybrid system and check for the hybrid system over-heat warning light.

If the warning light does not go off:

Stop the hybrid system and contact any authorized Toyota dealer or repairer, or another duly qualified and equipped professional.

If the warning light goes off:

Have the vehicle inspected at the nearest authorized Toyota dealer or repairer, or another duly qualified and equipped professional.

 **CAUTION**

■ To prevent an accident or injury when inspecting under the hood of your vehicle

- If steam is seen coming from under the hood, do not open the hood until the steam has subsided. The engine compartment may be very hot, causing serious injuries such as burns.
- Check that the “READY” indicator is off.
- On hybrid vehicles, the gasoline engine may automatically start, or the cooling fan may suddenly operate even if the gasoline engine stops. Do not touch or approach rotating parts such as the fan, which may lead to fingers or clothing (especially a tie, a scarf or a muffler) getting caught, resulting in serious injury.
- Do not loosen the coolant reservoir cap while the hybrid system and radiator are hot.
Serious injuries, such as burns, may result from hot coolant and steam released under pressure.

 NOTICE

■ **When adding engine/power control unit coolant**

Wait until the hybrid system has cooled down before adding engine/power control unit coolant.

When adding coolant, do so slowly. Adding cool coolant to a hot hybrid system too quickly can cause damage to the hybrid system.

■ **To prevent damage to the cooling system**

Observe the following precautions:

- Avoid contaminating the coolant with foreign matter (such as sand or dust etc.)
- Do not use commercially available coolant additives

5-2. Steps to take in an emergency

If you run out of fuel and the engine stalls (diesel engine only)

If you run out of fuel and the engine stalls:

STEP 1 Refuel your vehicle.

STEP 2 Pull the rubber strip on the edge to unhook it from the cover, and then push the tabs in and lift the cover off.

Left-hand drive vehicles

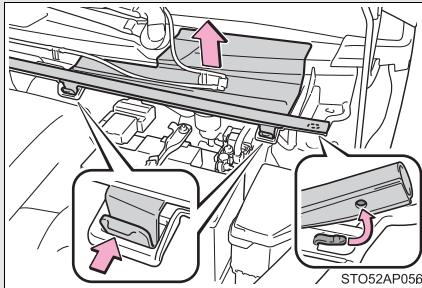

Right-hand drive vehicles

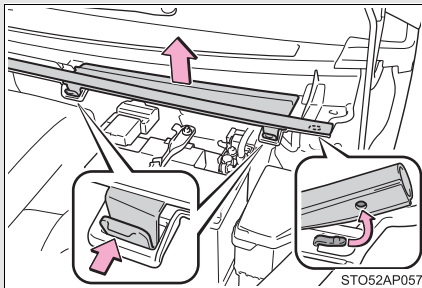

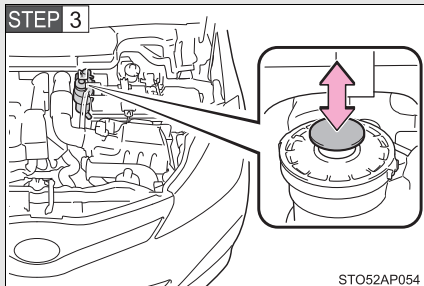

To bleed the fuel system, operate the priming pump until you feel more resistance.

STEP 4 Reinstall the cover, and then hook the rubber strip's groove onto the cover.

Left-hand drive vehicles

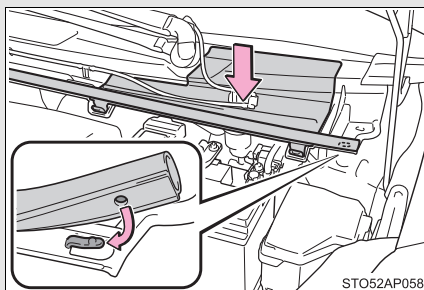

Right-hand drive vehicles

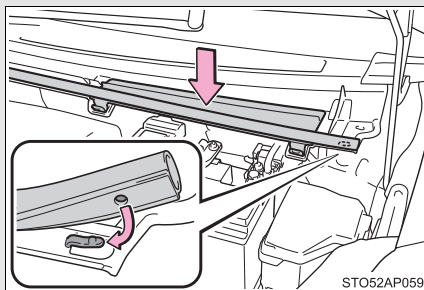

STEP 5 Start the engine. (→P. 222, 226)

If the engine does not start after the above steps have been performed, wait for 10 seconds and then try steps 3 and 5 again. If the engine still does not start, contact any authorized Toyota dealer or repairer, or another duly qualified and equipped professional.

After starting the engine, depress the accelerator pedal lightly until the engine runs smoothly.

 **NOTICE****■ When restarting the engine**

- Do not crank the engine before refueling and operating the priming pump. This may damage the engine and fuel system.
- Vehicles without a smart entry & start system: Do not crank the engine for more than 30 seconds at a time. This may overheat the starter and wiring system.

5-2. Steps to take in an emergency If the vehicle becomes stuck

Carry out the following procedures if the tires spin or the vehicle becomes stuck in mud, dirt or snow:

- STEP 1** Vehicles with a hybrid transmission or a Multidrive: Stop the engine (except hybrid vehicle) or hybrid system (hybrid vehicle). Set the parking brake and shift the shift lever to P. Vehicles with a multi-mode manual transmission or a manual transmission: Stop the engine. Set the parking brake and shift the shift lever to N.
- STEP 2** Remove the mud, snow or sand from around the front wheels.
- STEP 3** Place wood, stones or some other material under the front wheels to help provide traction.
- STEP 4** Restart the engine (except hybrid vehicle) or hybrid system (hybrid vehicle).
- STEP 5** Vehicles with a hybrid transmission or a Multidrive: Shift the shift lever to the D or R and carefully apply the accelerator to free the vehicle.
Vehicles with a multi-mode manual transmission: Shift the shift lever to E, M or R and carefully apply the accelerator to free the vehicle.
Vehicles with a manual transmission: Shift the shift lever to 1 or R and carefully apply the accelerator to free the vehicle.

■ When it is difficult to free the vehicle

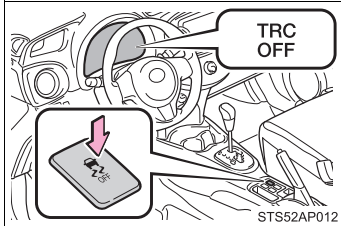

Press the button to turn off TRC.

■ Emergency hooks

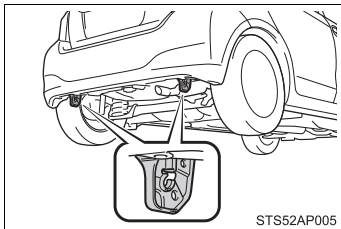

When your vehicle becomes stuck and cannot move, the emergency hooks are used for another vehicle to pull your vehicle out in an emergency. Your vehicle is not designed to tow another vehicle.

⚠ CAUTION

■ When attempting to free a stuck vehicle

If you choose to push the vehicle back and forth to free it, make sure the surrounding area is clear to avoid striking other vehicles, objects or people. The vehicle may also lunge forward or lunge back suddenly as it becomes free. Use extreme caution.

■ When shifting the shift lever

Be careful not to shift the shift lever with the accelerator pedal depressed. This may lead to unexpected rapid acceleration of the vehicle that may cause an accident resulting in death or serious injury.

 NOTICE

■ **To avoid damage to the transmission and other components**

- Avoid spinning the front wheels and depressing the accelerator pedal more than necessary.
- If the vehicle remains stuck even after these procedures are performed, the vehicle may require towing to be freed.

5-2. Steps to take in an emergency

If your vehicle has to be stopped in an emergency

Only in an emergency, such as if it becomes impossible to stop the vehicle in the normal way, stop the vehicle using the following procedure:

STEP 1 Steadily step on the brake pedal with both feet and firmly depress it.

Do not pump the brake pedal repeatedly as this will increase the effort required to slow the vehicle.

STEP 2 Shift the shift lever to N.

If the shift lever is shifted to N

STEP 3 After slowing down, stop the vehicle in a safe place by the road.

STEP 4 Stop the engine (except hybrid vehicle) or hybrid system (hybrid vehicle).

If the shift lever cannot be shifted to N

STEP 3 Keep depressing the brake pedal with both feet to reduce vehicle speed as much as possible.

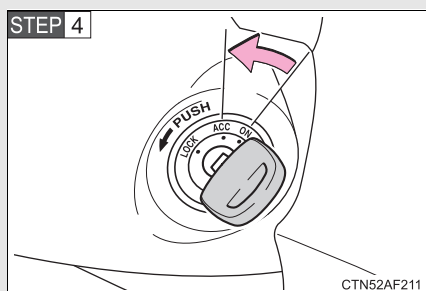

Except hybrid vehicle (vehicles without a smart entry & start system): Stop the engine by turning the engine switch to the “ACC” position.

Hybrid vehicle (vehicles without an electronic key): Stop the hybrid system by turning the engine switch to the “ACC” position.

STEP 4

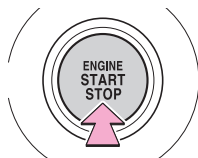

Press and hold for 3 seconds or more, or press briefly 3 times or more

CTY52AD212

Except hybrid vehicle (vehicles with a smart entry & start system): To stop the engine, press and hold the “ENGINE START STOP” switch for 3 consecutive seconds or more, or press it briefly 3 times or more in succession.

STEP 4

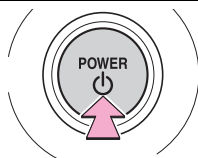

Press and hold for 3 seconds or more, or press briefly 3 times or more

CTY52AD214

Hybrid vehicle (vehicles with an electronic key): To stop the hybrid system, press and hold the “POWER” switch for 3 consecutive seconds or more, or press it briefly 3 times or more in succession.

STEP 5 Stop the vehicle in a safe place by the road.

⚠ CAUTION

■ If the engine has to be turned off while driving (except hybrid vehicle)

- Power assist for the brakes and steering wheel will be lost, making the brake pedal harder to depress and the steering wheel heavier to turn. Decelerate as much as possible before turning off the engine.
- Vehicles without a smart entry & start system: Never attempt to remove the key, as doing so will lock the steering wheel.

■ If the hybrid system has to be turned off while driving (hybrid vehicle)

- Power assist for the brakes and steering wheel will be lost, making the brake pedal harder to depress and the steering wheel heavier to turn. Decelerate as much as possible before turning off the hybrid system.
- Vehicles without an electronic key: Never attempt to remove the key, as doing so will lock the steering wheel.

Vehicle specifications

6

6-1. Specifications

Maintenance data (fuel, oil level, etc.).....	660
Fuel information	686

6-2. Customization

Customizable features	689
-----------------------------	-----

6-1. Specifications

Maintenance data (fuel, oil level, etc.)

Dimensions and weights

Except hybrid vehicle

Overall length		3885 mm (153.0 in.)
Overall width		1695 mm (66.7 in.)
Overall height*1		1510 mm (59.4 in.) 1520 mm (59.8 in.)*2
Wheelbase		2510 mm (98.8 in.)
Tread	Front	1485 mm (58.5 in.)*3 1470 mm (57.9 in.)*4 1460 mm (57.5 in.)*5
	Rear	1470 mm (57.9 in.)*3 1460 mm (57.5 in.)*4 1450 mm (57.1 in.)*5
Gross vehicle mass	1KR-FE engine	1430 kg (3153 lb.)
	1NR-FE engine	Vehicles with a Multidrive 1480 kg (3263 lb.) Vehicles with a manual transmission 1470 kg (3241 lb.)
	1ND-TV engine	Vehicles with a multi-mode manual transmission 1530 kg (3373 lb.) Vehicles with a manual transmission 1525 kg (3362 lb.)
Maximum permissible axle capacity	Front	1KR-FE engine 825 kg (1819 lb.) 1NR-FE engine 850 kg (1874 lb.) 1ND-TV engine 895 kg (1973 lb.)
	Rear	825 kg (1819 lb.)
Drawbar load		50 kg (110 lb.)

Towing capacity (except South Africa)	Vehicles with a brake	1KR-FE engine 750 kg (1653 lb.) 1NR-FE engine 900 kg (1984 lb.) 1ND-TV engine 1050 kg (2315 lb.)
	Vehicles without a brake	550 kg (1213 lb.)

*1: Unladen vehicles

*2: Vehicles with rough road package

*3: 175/65R14, 175/70R14 or 175/65R15 tires

*4: 185/60R15 tires

*5: 195/50R16 tires

Hybrid vehicle

Overall length		3905 mm (153.7 in.)
Overall width		1695 mm (66.7 in.)
Overall height* ¹		1510 mm (59.4 in.) 1520 mm (59.8 in.)* ²
Wheelbase		2510 mm (98.8 in.)
Tread	Front	1485 mm (58.5 in.)* ³ 1470 mm (57.9 in.)* ⁴ 1460 mm (57.5 in.)* ⁵
	Rear	1470 mm (57.9 in.)* ³ 1460 mm (57.5 in.)* ⁴ 1450 mm (57.1 in.)* ⁵
Gross vehicle mass		1565 kg (3450 lb.)
Maximum permissible axle capacity	Front	895 kg (1973 lb.)
	Rear	825 kg (1819 lb.)

*1: Unladen vehicles

*2: Vehicles with rough road package

*3: 175/65R15 tires

*4: 185/60R15 tires

*5: 195/50R16 tires

Vehicle identification

■ Vehicle identification number

The vehicle identification number (VIN) is the legal identifier for your vehicle. This is the primary identification number for your Toyota. It is used in registering the ownership of your vehicle.

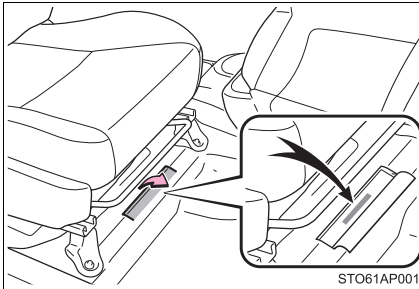

This number is stamped under the right-hand front seat.

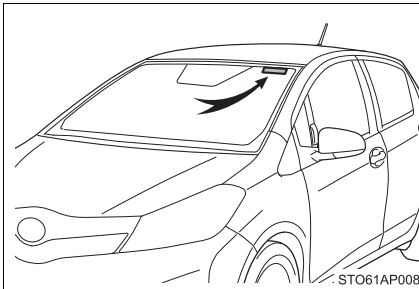

For South Africa: This number is also stamped on the top left of the windshield glass.

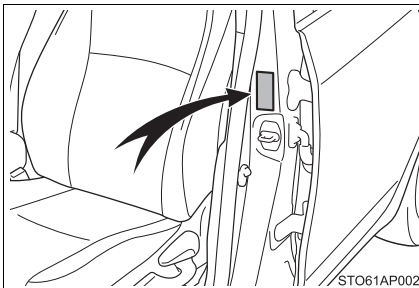

This number is also on the manufacturer's label on the left-hand side center pillar.

■ **Engine number**

The engine number is stamped on the engine block as shown.

1KR-FE engine

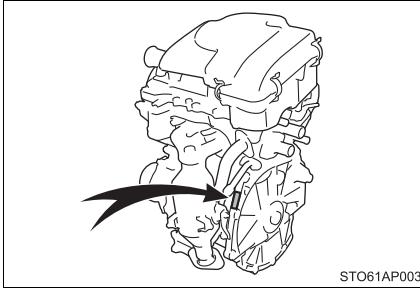

1NR-FE engine

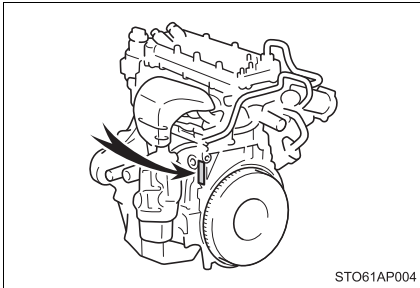

1ND-TV engine

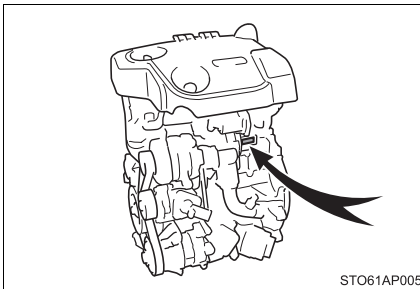

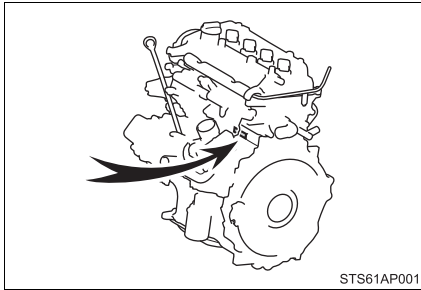
1NZ-FXE engine**Engine****Gasoline engine**

Model	1KR-FE, 1NR-FE and 1NZ-FXE
Type	1KR-FE engine 3-cylinder in line, 4-cycle, gasoline 1NR-FE engine 4-cylinder in line, 4-cycle, gasoline 1NZ-FXE engine 4-cylinder in line, 4-cycle, gasoline
Bore and stroke	1KR-FE engine 71.0 × 84.0 mm (2.79 × 3.30 in.) 1NR-FE engine 72.5 × 80.5 mm (2.85 × 3.17 in.) 1NZ-FXE engine 75.0 × 84.7 mm (2.95 × 3.33 in.)
Displacement	1KR-FE engine 998 cm ³ (60.9 cu.in.) 1NR-FE engine 1329 cm ³ (81.1 cu.in.) 1NZ-FXE engine 1497 cm ³ (91.3 cu.in.)

<p>Valve clearance (engine cold)</p>	<p>1KR-FE engine Intake: 0.145 — 0.235 mm (0.006 — 0.009 in.) Exhaust: 0.275 — 0.365 mm (0.011 — 0.014 in.)</p> <p>1NR-FE engine Automatic adjustment</p> <p>1NZ-FXE engine Intake: 0.15 — 0.25 mm (0.006 — 0.010 in.) Exhaust: 0.25 — 0.35 mm (0.010 — 0.014 in.)</p>
<p>Drive belt tension</p>	<p>1KR-FE engine 9.0 — 11.0 mm (0.35 — 0.43 in.)* Vehicles without an air conditioning system:</p> <div data-bbox="523 581 950 867" style="border: 1px solid black; padding: 5px; text-align: center;"> <p>Generator Water pump Crankshaft</p> <p style="text-align: right; font-size: small;">STO61AP006</p> </div> <p>Vehicles with an air conditioning system:</p> <div data-bbox="523 915 950 1201" style="border: 1px solid black; padding: 5px; text-align: center;"> <p>Generator Water pump Air conditioning compressor Crankshaft</p> <p style="text-align: right; font-size: small;">STO61AP007</p> </div> <p>1NR-FE engine Automatic adjustment</p>

*: Drive belt deflection with 98 N (10 kgf, 22 lbf) thumb force (used belt)

Diesel engine

Model	1ND-TV
Type	4-cylinder in line, 4-cycle, diesel
Bore and stroke	73.0 × 81.5 mm (2.87 × 3.21 in.)
Displacement	1364 cm ³ (83.2 cu.in.)
Valve clearance (engine cold)	Intake: 0.11 — 0.17 mm (0.004 — 0.007 in.) Exhaust: 0.14 — 0.20 mm (0.006 — 0.008 in.)
Drive belt tension	Automatic adjustment

NOTICE

■ Drive belt type (diesel engine)

The high strength drive belt is used for the generator side drive belt. When replacing the drive belt, use Toyota genuine drive belt or equivalent high strength drive belt. If the high strength drive belt is not used, durability of the belt may become less than expected. The high strength drive belt is a belt with Aramid core which has higher strength compared to usually available belts with PET or PEN core.

Fuel

Gasoline engine

Fuel type	EU area: Unleaded gasoline conforming to European standard EN228 only Except EU area: Unleaded gasoline only
Research octane number	95 or higher
Fuel tank capacity (Reference)	1KR-FE and 1NR-FE engines 42 L (11.1 gal., 9.2 Imp. gal.) 1NZ-FXE engine 36 L (9.5 gal., 7.9 Imp. gal.)

Diesel engine

Fuel type	EU area: Diesel fuel conforming to European standard EN590 Except EU area: Diesel fuel that contains 50 ppm or less of sulfur
Cetane number	48 or higher
Fuel tank capacity (Reference)	42 L (11.1 gal., 9.2 Imp. gal.)

Electric motor (Traction motor)

Type	Permanent magnet motor
Maximum output	45 kW
Maximum torque	169 N·m (17.2 kgf·m, 125 ft·lbf)

Hybrid battery (Traction battery)

Type	Nickel-Metal hydride battery
Voltage	7.2 V/module
Capacity	6.5 Ah (3HR)
Quantity	20 modules
Overall voltage	144 V

Lubrication system

Oil capacity (Drain and refill — reference*)	
With filter	1KR-FE engine 3.1 L (3.3 qt., 2.7 Imp. qt.) 1NR-FE engine 3.4 L (3.6 qt., 3.0 Imp. qt.) 1ND-TV engine 3.9 L (4.1 qt., 3.4 Imp. qt.) 1NZ-FXE engine 3.7 L (3.9 qt., 3.3 Imp. qt.)
Without filter	1KR-FE engine 2.9 L (3.1 qt., 2.6 Imp. qt.) 1NR-FE engine 3.2 L (3.4 qt., 2.8 Imp. qt.) 1ND-TV engine 3.5 L (3.7 qt., 3.1 Imp. qt.) 1NZ-FXE engine 3.4 L (3.6 qt., 3.0 Imp. qt.)

*: The engine oil capacity is a reference quantity to be used when changing the engine oil. Warm up and turn off the engine (except hybrid vehicle) or warm up the engine and turn off the hybrid system (hybrid vehicle), wait more than 5 minutes, and check the oil level on the dipstick.

■ Engine oil selection

“Toyota Genuine Motor Oil” is used in your Toyota vehicle. Toyota recommends the use of approved “Toyota Genuine Motor Oil”. Another motor oil of matching quality can also be used.

Gasoline engines

Oil grade:

0W-20, 5W-20, 5W-30 and 10W-30:

API grade SL “Energy-Conserving”, SM “Energy-Conserving”, SN “Resource-Conserving” or ILSAC multigrade engine oil

15W-40 and 20W-50:

API grade SL, SM or SN multigrade engine oil

Recommended viscosity (SAE):

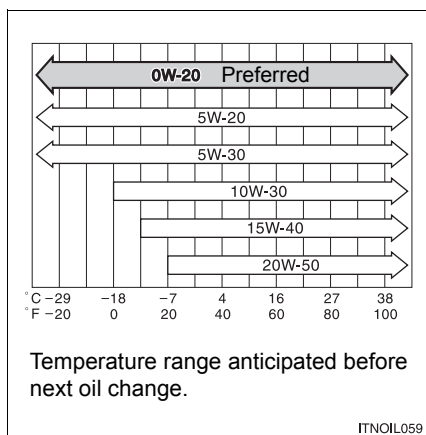

SAE 0W-20 is filled into your Toyota vehicle at manufacturing, and the best choice for good fuel economy and good starting in cold weather.

If SAE 0W-20 oil is not available, SAE 5W-30 oil may be used. However, it should be replaced with SAE 0W-20 at the next oil change.

If you use SAE 10W-30 or a higher viscosity engine oil in extremely low temperatures, the engine may become difficult to start, so SAE 5W-30 or lower viscosity engine oil is recommended.

Oil viscosity (0W-20 is explained here as an example):

- The 0W in 0W-20 indicates the characteristic of the oil which allows cold startability. Oils with a lower value before the W allow for easier starting of the engine in cold weather.
- The 20 in 0W-20 indicates the viscosity characteristic of the oil when the oil is at high temperature. An oil with a higher viscosity (one with a higher value) may be better suited if the vehicle is operated at high speeds, or under extreme load conditions.

How to read oil container labels:

Either or both API registered marks are added to some oil containers to help you select the oil you should use.

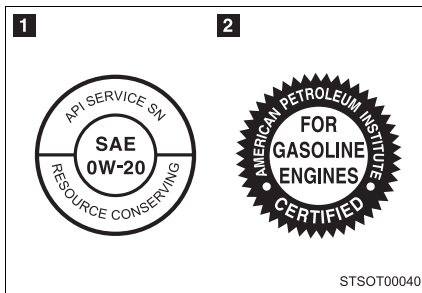

1 API Service Symbol

Top portion: The oil quality designation by API (American Petroleum Institute) (SN)

Center portion: The SAE viscosity grade (SAE 0W-20)

Lower portion: “Resource-Conserving” means that the oil has fuel saving and environmental protection capabilities.

2 ILSAC Certification Mark

The ILSAC (International Lubricant Standardization and Approval Committee) Certification Mark is displayed on the front of the container.

Diesel engine vehicles without a DPF system*

Oil grade: ACEA C2, B1, API CF-4 or CF

(You may also use API CE or CD.)

Recommended viscosity (SAE):

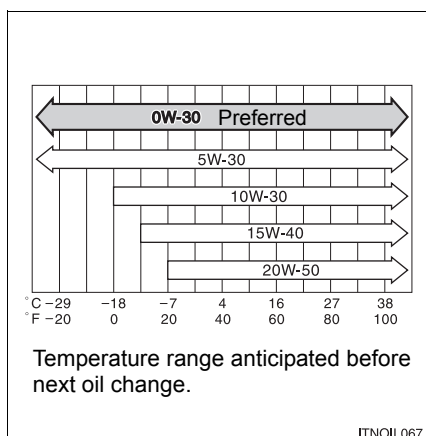

SAE 0W-30 is filled into your Toyota vehicle at manufacturing, and the best choice for good fuel economy and good starting in cold weather.

If you use SAE 10W-30 or a higher viscosity engine oil in extremely low temperatures, the engine may become difficult to start, so SAE 5W-30 or 0W-30 engine oil is recommended.

Oil viscosity (0W-30 is explained here as an example):

- The 0W in 0W-30 indicates the characteristic of the oil which allows cold startability. Oils with a lower value before the W allow for easier starting of the engine in cold weather.
 - The 30 in 0W-30 indicates the viscosity characteristic of the oil when the oil is at high temperature. An oil with a higher viscosity (one with a higher value) may be better suited if the vehicle is operated at high speeds, or under extreme load conditions.
- *: To determine whether or not your vehicle has a DPF system, contact any authorized Toyota dealer or repairer, or another duly qualified and equipped professional.

Diesel engine vehicles with a DPF system*

Oil grade: ACEA C2

NOTICE

Using engine oil other than ACEA C2 may damage the catalytic converter.

Recommended viscosity (SAE):

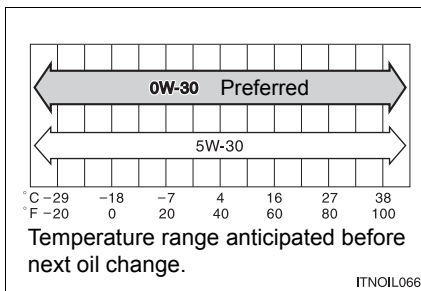

SAE 0W-30 is filled into your Toyota vehicle at manufacturing, and the best choice for good fuel economy and good starting in cold weather.

Oil viscosity (0W-30 is explained here as an example):

- The 0W in 0W-30 indicates the characteristic of the oil which allows cold startability. Oils with a lower value before the W allow for easier starting of the engine in cold weather.
- The 30 in 0W-30 indicates the viscosity characteristic of the oil when the oil is at high temperature. An oil with a higher viscosity (one with a higher value) may be better suited if the vehicle is operated at high speeds, or under extreme load conditions.

*: To determine whether or not your vehicle has a DPF system, contact any authorized Toyota dealer or repairer, or another duly qualified and equipped professional.

Cooling system

Capacity (Reference)	1KR-FE engine	4.5 L (4.8 qt., 4.0 Imp. qt.)
	1NR-FE engine	Vehicles with a Multidrive 4.8 L (5.1 qt., 4.2 Imp. qt.) Vehicles with a manual transmission 4.6 L (4.9 qt., 4.0 Imp. qt.)
	1ND-TV engine	Vehicles without a power heater 4.5 L (4.8 qt., 4.0 Imp. qt.) Vehicles with a power heater 4.9 L (5.2 qt., 4.3 Imp. qt.)
	1NZ-FXE engine	Gasoline engine 4.5 L (4.8 qt., 4.0 Imp. qt.) Power control unit 1.6 L (1.7 qt., 1.4 Imp. qt.)
Coolant type	Use either of the following: <ul style="list-style-type: none"> • “Toyota Super Long Life Coolant” • A similar high-quality ethylene glycol-based non-silicate, non-amine, non-nitrite, and non-borate coolant with long-life hybrid organic acid technology Do not use plain water alone.	

Ignition system (gasoline engine only)

Spark plug Make	1KR-FE engine DENSO SK16HR11 1NR-FE engine DENSO SC20HR11 1NZ-FXE engine DENSO FK16R-A8
Gap	1KR-FE and 1NR-FE engines 1.1 mm (0.043 in.) 1NZ-FXE engine 0.8 mm (0.031 in.)

NOTICE

Iridium-tipped spark plugs

Use only iridium-tipped spark plugs. Do not adjust the spark plug gap.

Electrical system

Battery (except hybrid vehicle)/ 12-volt battery (hybrid vehicle)	
Open voltage* at 20°C (68°F):	12.6 — 12.8 V Fully charged 12.2 — 12.4 V Half charged 11.8 — 12.0 V Discharged (*: Voltage checked 20 minutes after the engine and all the lights turned off)
Charging rates	5 A max.

Hybrid transmission

Fluid capacity*	3.3 L (3.5 qt., 2.9 Imp. qt.)
Fluid type	Toyota Genuine ATF WS

*: The fluid capacity is a reference quantity. If replacement is necessary, contact any authorized Toyota dealer or repairer, or another duly qualified and equipped professional.

NOTICE

■ Transmission fluid type

Using transmission fluid other than “Toyota Genuine ATF WS” may cause deterioration in shift quality, locking up of the transmission accompanied by vibration, and ultimately damage to the vehicle’s transmission.

Multidrive

Fluid capacity*	6.4 L (6.8 qt., 5.6 Imp. qt.)
Fluid type	Toyota Genuine CVT Fluid FE

*: The fluid capacity is the quantity of reference. If replacement is necessary, contact any authorized Toyota dealer or repairer, or another duly qualified and equipped professional.

NOTICE

■ Multidrive fluid type

Using Multidrive fluid other than “Toyota Genuine CVT Fluid FE” may cause deterioration in shift quality, locking up of your transmission accompanied by vibration, and ultimately damage the transmission of your vehicle.

Manual transmission

Gear oil capacity (Reference)	1KR-FE engine 1.7 L (1.8 qt., 1.5 Imp. qt.) 1NR-FE and 1ND-TV engines 2.4 L (2.5 qt., 2.1 Imp. qt.)
Gear oil type	Use either of the following: <ul style="list-style-type: none"> • “TOYOTA Genuine Manual Transmission Gear Oil LV” • Other gear oil that meets API GL-4 and SAE 75W specifications

NOTICE

Manual transmission gear oil

Please be aware that depending on the particular characteristics of the gear oil used or the operating conditions, idle sound, shift feeling and/or fuel efficiency may be different or affected. Toyota recommends to use “TOYOTA Genuine Manual Transmission Gear Oil LV” to achieve optimal performance.

Clutch

Pedal free play	5 — 15 mm (0.2 — 0.6 in.)
Fluid type	SAE J1704 or FMVSS No.116 DOT 4

Brakes

Except hybrid vehicle

Pedal clearance* ¹	Left-hand drive vehicles	Gasoline engines	Vehicles with a rear drum brake 83 mm (3.27 in.) Min. Vehicles with a rear disc brake 79 mm (3.11 in.) Min.
		Diesel engines	Vehicles with a rear drum brake 81 mm (3.19 in.) Min. Vehicles with a rear disc brake 78 mm (3.07 in.) Min.
	Right-hand drive vehicles	Gasoline engines	Vehicles with a rear drum brake 76 mm (2.99 in.) Min. Vehicles with a rear disc brake 74 mm (2.91 in.) Min.
		Diesel engines	Vehicles with a rear drum brake 75 mm (2.95 in.) Min. Vehicles with a rear disc brake 73 mm (2.87 in.) Min.
Pedal free play		1 — 6 mm (0.04 — 0.24 in.)	
Parking brake lever travel* ²		Vehicles with a rear drum brake 5 — 7 clicks Vehicles with a rear disc brake 4 — 6 clicks	
Fluid type		SAE J1704 or FMVSS No.116 DOT 4	

Hybrid vehicle

Pedal clearance* ¹	70 mm (2.8 in.)
Pedal free play	1 — 6 mm (0.04 — 0.24 in.)
Parking brake lever travel* ²	4 — 6 clicks
Fluid type	SAE J1704 or FMVSS No.116 DOT 4

*1: Minimum pedal clearance when depressed with a force of 300 N (31 kgf, 67.4 lbf) while the engine is running

*2: Parking brake lever travel when pulled up with a force of 200 N (20.4 kgf, 45.0 lbf)

Steering

Free play	Less than 30 mm (1.2 in.)
-----------	---------------------------

Tires and wheels**Type A**

Tire size	175/65R14 82T	
Tire inflation pressure (Recommended cold tire inflation pressure)	Front wheel kPa (kgf/cm ² or bar, psi)	Rear wheel kPa (kgf/cm ² or bar, psi)
	220 (2.2, 32)	220 (2.2, 32)
Wheel size	14 × 5J	
Wheel nut torque	103 N·m (10.5 kgf·m, 76 ft·lbf)	

Type B

Tire size	175/65R14 82T, T125/70D15 95M (compact spare)	
Tire inflation pressure (Recommended cold tire inflation pressure)	Front wheel kPa (kgf/cm ² or bar, psi)	Rear wheel kPa (kgf/cm ² or bar, psi)
	220 (2.2, 32)	220 (2.2, 32)
Tire inflation pressure (compact spare) (Recommended cold tire inflation pressure)	420 kPa (4.2 kgf/cm ² or bar, 60 psi)	
Wheel size	14 × 5J, 15 × 4B (compact spare)	
Wheel nut torque	103 N·m (10.5 kgf·m, 76 ft·lbf)	

Type C

Tire size	175/70R14 84S, T125/70D16 96M (compact spare)*	
Tire inflation pressure (Recommended cold tire inflation pressure)	Front wheel kPa (kgf/cm ² or bar, psi)	Rear wheel kPa (kgf/cm ² or bar, psi)
	250 (2.5, 36)	240 (2.4, 35)
Tire inflation pressure (compact spare) (Recommended cold tire inflation pressure)	420 kPa (4.2 kgf/cm ² or bar, 60 psi)	
Wheel size	14 × 5J, 16 × 4T (compact spare)*	
Wheel nut torque	103 N·m (10.5 kgf·m, 76 ft·lbf)	

*: Vehicles without an emergency tire puncture repair kit.

Type D

Tire size	175/65R15 84H, T125/70D16 96M (compact spare)*1	
Tire inflation pressure (Recommended cold tire inflation pressure)	Front wheel kPa (kgf/cm ² or bar, psi)	Rear wheel kPa (kgf/cm ² or bar, psi)
	Standard tire pressure: 230 (2.3, 33) ECO tire pressure*2: 250 (2.5, 36)	Standard tire pressure: 220 (2.2, 32) ECO tire pressure*2: 240 (2.4, 35)
Tire inflation pressure (compact spare) (Recommended cold tire inflation pressure)	420 kPa (4.2 kgf/cm ² or bar, 60 psi)	
Wheel size	15 × 5J, 16 × 4T (compact spare)*1	
Wheel nut torque	103 N·m (10.5 kgf·m, 76 ft·lbf)	

*1: Vehicles without an emergency tire puncture repair kit.

*2: For some models, ECO tire pressure is shown on the tire pressure label.
(→P. 600)
“For optimizing fuel economy, ECO tire pressure is recommended.
Tire pressure affects traveling comfort, road noise and steering characteristics.”

Type E

Tire size	185/60R15 84H		
Tire inflation pressure (Recommended cold tire inflation pressure)	Vehicle speed	Front wheel kPa (kgf/cm ² or bar, psi)	Rear wheel kPa (kgf/cm ² or bar, psi)
	160 km/h (99 mph) or less	220 (2.2, 32)	220 (2.2, 32) 200 (2.0, 29)*
	More than 160 km/h (99 mph)	240 (2.4, 35) 230 (2.3, 33)*	220 (2.2, 32) 200 (2.0, 29)*
Wheel size	15 × 5 1/2J		
Wheel nut torque	103 N·m (10.5 kgf·m, 76 ft·lbf)		

*: Hybrid vehicle

Type F

Tire size	185/60R15 84H, T125/70D15 95M (compact spare)		
Tire inflation pressure (Recommended cold tire inflation pressure)	Vehicle speed	Front wheel kPa (kgf/cm ² or bar, psi)	Rear wheel kPa (kgf/cm ² or bar, psi)
	160 km/h (99 mph) or less	220 (2.2, 32)	220 (2.2, 32)
	More than 160 km/h (99 mph)	240 (2.4, 35)	220 (2.2, 32)
Tire inflation pressure (compact spare) (Recommended cold tire inflation pressure)	420 kPa (4.2 kgf/cm ² or bar, 60 psi)		
Wheel size	15 × 5 1/2J, 15 × 4B (compact spare)		
Wheel nut torque	103 N·m (10.5 kgf·m, 76 ft·lbf)		

Type G

Tire size	195/50R16 84V, T125/70D16 96M (compact spare)*		
Tire inflation pressure (Recommended cold tire inflation pressure)	Vehicle speed	Front wheel kPa (kgf/cm ² or bar, psi)	Rear wheel kPa (kgf/cm ² or bar, psi)
	160 km/h (99 mph) or less	220 (2.2, 32)	200 (2.0, 29)
	More than 160 km/h (99 mph)	240 (2.4, 35)	210 (2.1, 30)
Tire inflation pressure (compact spare) (Recommended cold tire inflation pressure)	420 kPa (4.2 kgf/cm ² or bar, 60 psi)		
Wheel size	16 × 6J, 16 × 4T (compact spare)*		
Wheel nut torque	103 N·m (10.5 kgf·m, 76 ft·lbf)		

*: Vehicles without an emergency tire puncture repair kit.

Light bulbs

Except hybrid vehicle

	Light Bulbs	W	Type
Exterior	Headlights	60/55	A
	Front fog lights (if equipped)	19	B
	Front position lights	5	C
	Front turn signal lights	21	F
	Side turn signal lights	5	D
	Back-up lights	16	C
	Rear fog light	21	G
	Stop/tail lights	21/5	G
	License plate lights	5	C
	Rear turn signal lights	21	F
Interior	Vanity lights (if equipped)	5	E
	Personal lights/interior light	5	C
	Luggage compartment light	5	E

A: H4 halogen bulbs

B: H16 halogen bulbs

C: Wedge base bulbs (clear)

D: Wedge base bulbs (amber)

E: Double end bulbs

F: Single end bulbs (amber)

G: Single end bulbs (clear)

Hybrid vehicle

	Light Bulbs	W	Type
Exterior	Headlights	55	A
	Front fog lights (if equipped)	19	B
	Front turn signal lights	21	F
	Side turn signal lights	5	D
	Back-up lights	16	C
	Rear fog light	21	G
	Stop/tail lights	21/5	G
	License plate lights	5	C
	Rear turn signal lights	21	F
Interior	Vanity lights (if equipped)	5	E
	Personal lights/interior light	5	C
	Luggage compartment light	5	E

A: HIR2 halogen bulbs

B: H16 halogen bulbs

C: Wedge base bulbs (clear)

D: Wedge base bulbs (amber)

E: Double end bulbs

F: Single end bulbs (amber)

G: Single end bulbs (clear)

6-1. Specifications

Fuel information

Gasoline engine

EU area:

Your vehicle must use only unleaded gasoline conforming to European standard EN228.

For optimum engine performance, select unleaded gasoline with a Research Octane Number of 95 or higher.

Except EU area:

Your vehicle must use only unleaded gasoline.

For optimum engine performance, select unleaded gasoline with a Research Octane Number of 95 or higher.

Diesel engine

EU area:

Your vehicle must use only diesel fuel conforming to European standard EN590.

Except EU area:

Your vehicle must use only diesel fuel that contains 50 ppm or less of sulfur and has a cetane number of 48 or higher.

■ Fuel tank opening for unleaded gasoline (gasoline engine)

To help prevent incorrect fueling, your vehicle has a fuel tank opening that only accommodates the special nozzle on unleaded fuel pumps.

■ If you plan to drive in foreign countries (diesel engine)

Low sulfur diesel fuel may not be available, so please check the availability with your distributor.

■ If your engine knocks

- Consult any authorized Toyota dealer or repairer, or another duly qualified and equipped professional.
- You may occasionally notice light knocking for a short time while accelerating or driving uphill. This is normal and there is no need for concern.

NOTICE

■ Notice on fuel quality (gasoline engine)

- Do not use improper fuels. If improper fuels are used, the engine will be damaged.
- Do not use leaded gasoline.
Leaded gasoline will cause the three-way catalytic converter to lose its effectiveness and the emission control system to function improperly.
- EU area: Bioethanol fuel sold under names such as “E50” or “E85” and fuel containing a large amount of ethanol should not be used. The use of these fuels will damage the vehicle’s fuel system. In case of any doubt, ask any authorized Toyota dealer or repairer, or another duly qualified and equipped professional.
- Except EU area: Bioethanol fuel sold under names such as “E50” or “E85” and fuel containing a large amount of ethanol should not be used. Your vehicle can use gasoline mixed with 10% max ethanol. The use of fuel with more than 10% ethanol content (E10) will damage the vehicle’s fuel system. You must ensure that refueling is carried out only from a source where fuel specification and quality can be guaranteed. In case of any doubt, ask any authorized Toyota dealer or repairer, or another duly qualified and equipped professional.

 NOTICE

■ **Notice on fuel quality (diesel engine)**

- Do not use improper fuels. If improper fuels are used, the engine will be damaged.
- Do not use a fuel that contains more than 50 ppm of sulfur.
Use of such a high sulfur fuel may damage the engine.
- EU area: FAME (Fatty Acid Methyl Ester) fuel sold under names such as “B30” or “B100” and fuel containing a large amount of FAME should not be used. The use of these fuels will damage the vehicle’s fuel system. In case of any doubt, ask any authorized Toyota dealer or repairer, or another duly qualified and equipped professional.
- Except EU area: FAME (Fatty Acid Methyl Ester) fuel sold under names such as “B30” or “B100” and fuel containing a large amount of FAME should not be used. Your vehicle can use diesel mixed with 5% max biodiesel FAME (B5). The use of fuel with more than 5% FAME content (B5) will damage the vehicle’s fuel system. You must ensure that refueling is carried out only from a source where fuel specification and quality can be guaranteed. In case of any doubt, ask any authorized Toyota dealer or repairer, or another duly qualified and equipped professional.

6-2. Customization

Customizable features

Your vehicle includes a variety of electronic features that can be personalized to suit your preferences. Programming these preferences requires specialized equipment and may be performed by any authorized Toyota dealer or repairer, or another duly qualified and equipped professional.

Some function settings are changed simultaneously with other functions being customized. Contact any authorized Toyota dealer or repairer, or another duly qualified and equipped professional for further details.

Customizable Features

- 1** Vehicles with “touch screen”: Settings that can be changed using the “touch screen”
(For further information on customizing settings using the “touch screen”, refer to the ““touch screen” Owner’s Manual”.)
- 2** Settings that can be changed by any authorized Toyota dealer or repairer, or another duly qualified and equipped professional for further details

Definition of symbols: O = Available, — = Not available

Item	Function	Default setting	Customized setting	1	2
Smart entry & start system (→P. 69)	Smart entry & start system	ON	OFF	O	O
	Operation signal (Emergency flashers)	ON	OFF	—	O
	Time elapsed before automatic door lock function is activated if door is not opened after being unlocked	30 seconds	60 seconds	—	O
			120 seconds	—	O
Open door warning function (when locking the vehicle)	ON	OFF	—	O	

Item	Function	Default setting	Customized setting	1	2
Smart entry & start system (→P. 69)	Number of permissible times of continuous smart lock (hybrid vehicle)	Twice	Unlimited	—	O
Push-button start system (→P. 94)	Push-button start system	ON	OFF	—	O
Wireless remote control (→P. 105)	Wireless remote control (hybrid vehicle)	ON	OFF	—	O
	Operation signal (Emergency flashers)	ON	OFF	—	O
	Time elapsed before automatic door lock function is activated if door is not opened after being unlocked	30 seconds	60 seconds	—	O
	120 seconds				
Automatic light control system (→P. 291)	Light sensor sensitivity	Level 3	Level 1 to 5	O	O
Lights (→P. 291)	Daytime running light system (if equipped)	ON	OFF	O	O
	Time that the low beam headlights are on when the vehicle is parked	30 seconds	60 seconds	—	O
			90 seconds		
120 seconds					

Item	Function	Default setting	Customized setting	1	2
Illumination (→P. 415)	Time elapsed before the interior lights turn off	15 seconds	7.5 seconds	—	○
			30 seconds	—	○
	Operation when the doors are unlocked	ON	OFF	—	○
	Except hybrid vehicle: Operation after the engine switch (vehicles without a smart entry & start system) or “ENGINE START STOP” switch (vehicles with a smart entry & start system) is turned off Hybrid vehicle: Operation after the engine switch (vehicles without an electronic key) or the “POWER” switch (vehicles with an electronic key) is turned off	ON	OFF	—	○
	Operation when you approach the vehicle with the electronic key on your person*	ON	OFF	—	○
	Footwell lighting	ON	OFF	—	○
Automatic air conditioning system (→P. 361)	Air conditioning control of Eco drive mode	ON	OFF	—	○

*: Vehicles with a smart entry & start system

Index

Abbreviation list	694
Alphabetical index.....	695
What to do if... ..	705

Abbreviation list

Abbreviation/Acronym list

ABBREVIATIONS	MEANING
A/C	Air Conditioning
ABS	Anti-lock Brake System
ACC	Accessory
CRS	Child Restraint System
DPF	Diesel Particulate Filter system
ECO	Economy/Ecology
ECU	Electronic Control Unit
EDR	Event Data Recorder
ELR	Emergency Locking Retractor
EPS	Electric Power Steering
EV	Electric Vehicle
GVM	Gross Vehicle Mass
LED	Light Emitting Diode
MPAC	Maximum Permissible Axle Capacity
PEN	Polyethylene Naphthalate
PET	Polyethylene Terephthalate
PTC	Positive Temperature Coefficient
RDS	Radio Data System
SRS	Supplemental Restraint System
TRC	Traction Control
TWI	Treadwear Indicator
VIN	Vehicle Identification Number
VSC	Vehicle Stability Control

A

- A/C**..... 354, 361
- ABS** 324
- Air conditioning filter** 498
- Air conditioning system**
 - Air conditioning filter..... 498
 - Automatic air conditioning system 361
 - Manual air conditioning system 354
- Airbags**
 - Airbag manual on-off system 178
 - Airbag operating conditions 169
 - Airbag precautions for your child 174
 - Airbag warning light 564
 - Curtain shield airbag operating conditions 169
 - Curtain shield airbag precautions 173
 - General airbag precautions... 173
 - Locations of airbags..... 167
 - Modification and disposal of airbags..... 177
 - Proper driving posture... 165, 173
 - Side airbag operating conditions 169
 - Side airbag precautions 173
 - SRS airbags..... 167
- Antenna** 382
- Anti-lock brake system** 324
- Armrest**..... 434
- Ashtray** 428
- Assist grips** 436
- Audio input**..... 411

- Audio system**
 - Antenna 382
 - Audio input..... 411
 - AUX port 411
 - CD player..... 383
 - iPod..... 394
 - MP3/WMA disc 388
 - Optimal use..... 409
 - Portable music player 411
 - Radio 379
 - Steering wheel audio switch 412
 - Type..... 374
 - USB memory 402
- Automatic air conditioning system**..... 361
- Automatic light control system**..... 291
- AUX port**..... 411
- Auxiliary box** 439

B

- Back door**..... 119
- Back-up lights**
 - Replacing light bulbs..... 531
 - Wattage 684
- Battery**
 - Checking..... 479, 484
 - If the vehicle has a discharged battery..... 629
 - If the vehicle has a discharged 12-volt battery 636
 - Preparing and checking before winter..... 336
- Bluetooth® audio***
- Bluetooth® phone***
- Bottle holders** 422

*: Refer to “touch screen” Owner’s Manual”.

C

Brake
 Fluid 678
 Parking brake 269
Brake assist 324
Break-in tips 207
Brightness control
 Instrument panel light
 control 289

Care
 Exterior 444
 Interior 449
 Seat belts 450
CD player 383
Chains 336
Child-protectors 117
Child restraint system
 Baby seats, definition 182
 Baby seats, installation 191
 Child seats, definition 182
 Child seats, installation 191
 Installing CRS with ISOFIX
 rigid anchors 195
 Installing CRS with seat
 belts 192
 Installing CRS with top
 straps 196
 Junior seats, definition 182
 Junior seats, installation 191

Child safety
 Airbag precautions 173
 Battery precautions 481, 634
 Child-protectors 117
 Child restraint system 182
 How your child should wear
 the seat belt 136
 Installing child restraints 191
 Power window lock switch ... 147
 Power window precautions ... 150
 Removed key battery
 precautions 505
 Seat belt precautions 137
 Seat heater
 precautions 433
 12-volt battery
 precautions 488, 640
Cigarette lighter 429
Cleaning
 Exterior 444
 Interior 449
 Seat belts 450
Clock 426
Condenser 478
Cooling system
 Engine overheating 642
 Hybrid system overheating ... 646
Cruise control
 Cruise control 309
 Indicator 309
Cup holders 420
Curtain shield airbags 167
Customizable features 689

D

- Daytime running light system** 295
- Deck board** 439
- Defogger**
 - Rear window 372
 - Side mirror 372
- Dimension** 660
- Display**
 - Trip information 284
- Do-it-yourself maintenance** 455
- Doors**
 - Back door 119
 - Door glasses 147
 - Door lock 69, 105, 114
 - Double locking system 163
 - Side doors 114
 - Side mirrors 144
- Double locking system** 163
- DPF**
 - Diesel Particulate Filter system 332
 - Warning light 566
- Driver's seat belt reminder light** 566
- Driving**
 - Break-in tips 207
 - Correct posture 165
 - Procedures 202
 - Winter driving tips 336

E

- Electric power steering** 324
- Electronic key**
 - If the electronic key does not operate properly 624
 - Replacing the battery 501
- Emergency flashers**
 - Switch 548
- Emergency, in case of**
 - If the electronic key does not operate properly 624
 - If the engine will not start 616
 - If the hybrid system will not start 619
 - If the shift lever cannot be shifted 622
 - If the shift lever cannot be shifted from P 621
 - If the vehicle has a discharged battery 629
 - If the vehicle has a discharged 12-volt battery 636
 - If the warning buzzer sounds 561
 - If the warning light turns on 561
 - If you have a flat tire 578, 591
 - If you lose your keys 623
 - If you run out of fuel and the engine stalls 651
 - If you think something is wrong 559
 - If your vehicle becomes stuck 654
 - If your vehicle has to be stopped in an emergency 657
 - If your vehicle needs to be towed 549
 - If your vehicle overheats 642, 646

Emergency tire puncture repair kit 591

Engine

- Compartment 465
- Engine switch 222, 226, 236
- Hood 460
- How to start the engine 222, 226
- How to start the hybrid system 236, 241
- Identification number 663
- If the engine will not start 616
- If the hybrid system will not start 619
- If you run out of fuel and the engine stalls 651
- Ignition switch 222, 226, 236, 241
- Overheating 642, 646
- “POWER” switch 241

Engine coolant

- Capacity 674
- Checking 475
- Preparing and checking before winter 336

Engine immobilizer system 155

Engine oil

- Capacity 669
- Checking 469
- Preparing and checking before winter 336

Engine/power control unit coolant

- Capacity 674
- Checking 476
- Preparing and checking before winter 336

“ENGINE START STOP” switch light 415

EPS 324

EV drive mode 248

Event data recorder 41

Exclusive jump starting terminal 636

F

Floor mat 437

Fluid

- Washer 482

Fog lights

- Replacing light bulbs 531
- Switch 300
- Wattage 684

Front fog lights

- Replacing light bulbs 531
- Switch 300
- Wattage 684

Front passenger’s seat belt reminder light 566

Front position lights

- Replacing light bulbs 531
- Switch 291
- Wattage 684

Front seats

- Adjustment 124

Front turn signal lights

- Replacing light bulbs 531
- Switch 267
- Wattage 684

Fuel

- Capacity 667
- Fuel gauge 271
- Fuel pump shut off system 560
- Gas station information 712
- If you run out of fuel and the engine stalls 651
- Information 686
- Refueling 151
- Type 667

Fuel door 151

Fuel filler door 151

Fuel filter 483

Fuel pump shut off system 560
 Fuses 506

G Gas station information 712
 Gauges..... 271
 Gear Shift Indicator 265
 Glove box 419

H Hazard lights
 Switch 548
 Head restraints
 Adjusting 131
 Headlights
 Replacing light bulbs..... 531
 Switch 291
 Wattage..... 684

Heaters
 Seat heaters..... 432
 Side mirror 372

Hill-start assist control..... 324

Hood..... 460

Horn 270

Hybrid system
 Emergency shut off system..... 53
 Engine switch..... 236
 Energy monitor/
 consumption screen 57
 High voltage components 52
 How to start the hybrid
 system 236, 241
 Hybrid System Indicator..... 274
 If the hybrid system will
 not start..... 619
 Overheat 646
 “POWER” switch 241

Hybrid transmission 250

I Identification
 Engine..... 664
 Vehicle..... 663

Ignition
 switch 222, 226, 236, 241

Illuminated entry system 415

Immobilizer system 155

Indicator lights..... 276

Inside rear view mirror 141

Intercooler 478

Interior light
 Interior light 415
 Switch 415
 Wattage 684

J Jack
 Positioning a floor jack..... 462
 Vehicle-equipped
 jack 578

Jack handle 578, 592

K Keyless entry 69, 105
Keys

 Electronic key 64
 Engine switch..... 222, 226, 236
 If the electronic key does
 not operate properly 624
 If you lose your keys 623
 Ignition
 switch 222, 226, 236, 241
 Key number 64
 Keyless entry 69, 105
 Keys..... 64
 Mechanical key 64
 “POWER” switch..... 241
 Wireless remote control
 key..... 105

Knee airbag..... 167

L

License plate lights
 Replacing light bulbs 531
 Wattage 684

Light bulbs
 Replacing 531
 Wattage 684

Lights
 Emergency flasher switch 548
 Fog light switch 300
 Hazard light switch 548
 Headlight switch 291
 Interior light switch 416
 Luggage compartment
 light 120
 Personal light switch 416
 Replacing light bulbs 531
 Turn signal lever 267
 Vanity lights 424
 Wattage 684

**Lock steering
 column 224, 232, 239, 245**

Luggage cover 441

M

Maintenance
 Do-it-yourself maintenance ... 455
 Maintenance data 660
 Maintenance requirements ... 452

**Manual air conditioning
 system 354**

**Manual headlight leveling
 dial 293**

Manual transmission
 Gear Shift Indicator 265
 Manual transmission 263

Meter
 Instrument panel light
 control 289
 Meters 271

Mirrors
 Inside rear view mirror 141
 Side mirror heater 372
 Side mirrors 144
 Vanity mirrors 424

MP3 disc 388

Multidrive
 If the shift lever cannot
 be shifted from P 621
 Multidrive 253

**Multi-information
 display 284**

**Multi-mode manual
 transmission**
 Easy (E) mode 260
 Easy sports (Es)
 mode 259, 260
 If the shift lever cannot be
 shifted 622
 Manual (M) mode 259
 Multi-mode manual
 transmission 258

O

Odometer 271

Oil
 Engine oil 469

Opener
 Back door 119
 Fuel filler door 151
 Hood 460

Outside rear view mirrors
 Adjusting and folding 144

**Outside temperature
 display 427**

Overheating, Engine 642

**Overheating, Hybrid
 system 646**

P	Panoramic roof shade	435
	Parking brake	269
	Personal lights	
	Personal lights	415
	Switch	416
	Wattage.....	684
	Portable ashtray	428
	Power heater	370
	Power outlet	430
	“POWER” switch light	415
	Power windows	147
	Push-button start system	94
	Push-button start system	
	Antenna location	95
R	Radiator	478
	Radio	379
	RDS (Radio Data System)	380
	Rear fog light	
	Replacing light bulbs.....	531
	Switch	300
	Wattage.....	684
	Rear seat	
	Adjustment.....	127
	Folding down.....	127
	Rear turn signal lights	
	Replacing light bulbs.....	531
	Wattage.....	684
	Rear view monitor system*	
	Rear window defogger	372
	Rear window wiper	307
	Replacing	
	Electronic key battery.....	501
	Fuses	506
	Key battery.....	501
	Light bulbs.....	531
	Tires	578
	Wireless remote control	
	battery.....	501

S	Seat belts	
	Adjusting the seat belt	133
	Child restraint system	
	installation	191
	Cleaning and maintaining	
	the seat belts.....	450
	Emergency Locking	
	Retractor (ELR).....	136
	How to wear your seat belt ...	133
	How your child should wear	
	the seat belt.....	136
	Pregnant women,	
	proper seat belt use.....	137
	Reminder light.....	566
	Seat belt pretensioners.....	136
	Seat heaters	432
	Seats	
	Adjustment.....	124, 127
	Adjustment precautions	126
	Child seats/child restraint	
	system installation.....	191
	Cleaning.....	449
	Head restraint	131
	Properly sitting in the seat ...	165
	Rear seat adjustment.....	127
	Rear seat adjustment	
	precaution.....	129
	Seat heaters	432
	Service reminder	
	indicators	276
	Shift lever	
	Hybrid transmission	250
	If the shift lever cannot	
	be shifted.....	622
	If the shift lever cannot	
	be shifted from P	621
	Manual transmission.....	263
	Multidrive	253
	Multi-mode manual	
	transmission	258

*: Refer to “touch screen” Owner’s Manual”.

Shift lock system 621, 622

Side airbags 167

Side mirrors
 Adjusting and folding..... 144

Side turn signal lights
 Replacing light bulbs..... 531
 Wattage..... 684

Smart entry & start system
 Antenna location 73
 Entry function 69
 Starting the engine..... 226
 Starting the hybrid system 241

Spare tire
 Inflation pressure 679
 Storage location 578

Spark plug 675

Specifications 660

Speed limiter 313

Speedometer 271

Steering
 Column lock
 release..... 224, 232, 239, 245

Steering wheel
 Adjustment..... 140
 Audio switches..... 412

Stop & Start cancel switch..... 317

Stop & Start system..... 316

Stop & Start system
 operation time..... 286

Stop & Start system total
 operation time..... 287

Stop lights
 Replacing light bulbs..... 531
 Wattage..... 684

Storage feature 418

Storage precautions 334

Stuck
 If your vehicle becomes
 stuck 654

Sun visors 423

Sunshade
 Panoramic roof 435

Switch
 Airbag manual on-off
 switch 178
 Emergency flasher switch..... 548
 Engine switch..... 222, 226, 236
 “Es” switch 259
 Fog light switch 300
 Hazard light switch..... 548
 Ignition
 switch 222, 226, 236, 241
 Light switches 291
 Power door lock switch 115
 “POWER” switch..... 241
 Power window switch..... 147
 “SPORT” switch 254
 Stop & Start cancel switch 317
 Window lock switch..... 147
 Wiper and washer 302, 307

T **Tachometer** 271

Tail lights
 Replacing light bulbs..... 531
 Switch 291
 Wattage 684

Telephone switch*

Theft deterrent system
 Double locking system..... 163
 Engine immobilizer system ... 155
 Immobilizer system 155

Tire inflation pressure 494

Tires
 Chains..... 336
 Checking..... 490
 If you have a flat tire 578, 591
 Inflation pressure 494, 679
 Replacing..... 578
 Rotating tires..... 490
 Size..... 679
 Snow tires 336

Spare tire 578

Tools 578, 592

Total load capacity 660

Towing

 Emergency towing 550

 Trailer towing 340, 341

Traction control 324

Transmission shift switches 259, 260

TRC 324

Trip information 284

Trip meter 271

Turn signal lights

 Replacing light bulbs 531

 Switch 267

 Wattage 684

V

Vanity lights

 Vanity lights 424

 Wattage 684

Vanity mirrors 424

Vehicle data recordings 40

Vehicle identification number 663

Vehicle stability control 324

VSC 324

W

Warning buzzers

 Brake system 561

 Clutch 562

 Electric power steering system 564

 Hybrid system 562

 Hybrid system overheat 566

 Multi-mode manual transmission 562

 P position request indicator light 566

 Seat belt reminder 566

Warning lights

 Anti-lock brake system 564

 Brake assist system 564

 Brake system 561

 Charging system 562

 Clutch 562

 Cruise control indicator light 564

 DPF system 566

 Electric power steering 564

 Electronic engine control system 564

 Engine oil maintenance 566

 Fuel filter 564

 High engine coolant temperature 562

 Hybrid system 562

 Hybrid system overheat 566

 Low engine oil level 566

 Low engine oil pressure 562

 Low fuel level 566

 Low traction battery 564

 Malfunction indicator lamp 564

 Multi-mode manual transmission 562

 Open door 566

 P position request indicator light 566

 Pretensioners 564

 Seat belt reminder light 566

 Slip indicator light 564

 Smart entry & start system 564, 571

 SRS airbags 564

 Stop & Start indicator light 564

Washer

 Checking 482

 Preparing and checking before winter 336

 Switch 302, 307

*: Refer to “touch screen” Owner’s Manual”.

Washing and waxing	444
Weight.....	660
Wheels	496
Window glasses	147
Window lock switch.....	147
Windows	
Power windows	147
Rear window defogger	372
Washer.....	302, 307
Windshield wiper	302
Wireless remote control key	
Locking/Unlocking.....	105
Replacing the battery	501
Wireless remote control	105
WMA disc.....	388

What to do if...

What to do if...

A tire punctures

P. 578
P. 591

If you have a flat tire

The engine does not start
(except hybrid vehicle)

P. 616

If the engine will not start

P. 651

If you run out of fuel and the engine stalls (diesel engine only)

P. 155

Engine immobilizer system

P. 629

If the vehicle battery is discharged

P. 624

If the electronic key does not operate properly

The hybrid system does not start
(hybrid vehicle)

P. 619

If the hybrid system will not start

P. 155

Immobilizer system

P. 636

If the vehicle's 12-volt battery is discharged

P. 624

If the electronic key does not operate properly

The shift lever cannot be moved out

P. 621

If the shift lever cannot be shifted from P

P. 622

If the shift lever cannot be shifted

The high engine coolant temperature warning light flashes or comes on

P. 642

If your vehicle overheats (except hybrid vehicle)

Steam can be seen coming from under the hood

The high engine coolant temperature warning light flashes or comes on

The hybrid system overheat warning light comes on

Steam can be seen coming from under the hood

P. 646

If your vehicle overheats (hybrid vehicle)

The key is lost

P. 623 If you lose your keys

The battery runs out
(except hybrid vehicle)

P. 629 If the vehicle battery is discharged

The 12-volt battery runs out
(hybrid vehicle)

P. 636 If the vehicle's 12-volt battery is discharged

The doors cannot be locked

P. 114 Side doors

P. 119 Back door

P. 624 If the electronic key does not operate properly

P. 69 Smart entry & start system

The vehicle is stuck in
mud or sand

P. 654 If the vehicle becomes stuck

A warning light or indicator light
comes on

P. 561 If a warning light turns on or a warning buzzer sounds...

■ Instrument cluster

Except hybrid vehicle

Vehicles without a tachometer (type A):

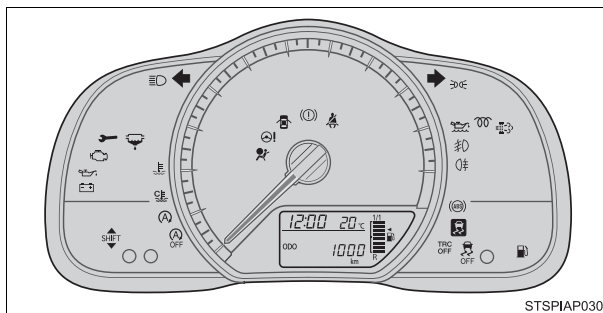

Vehicles without a tachometer (type B):

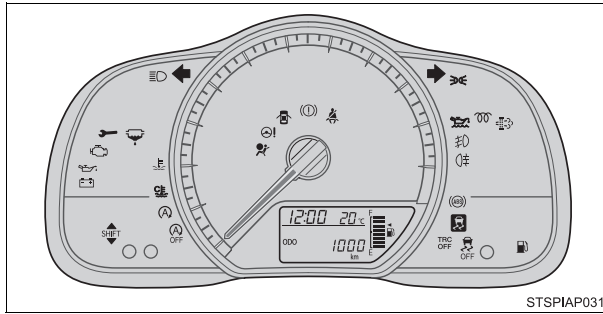

Vehicles with a tachometer (type A):

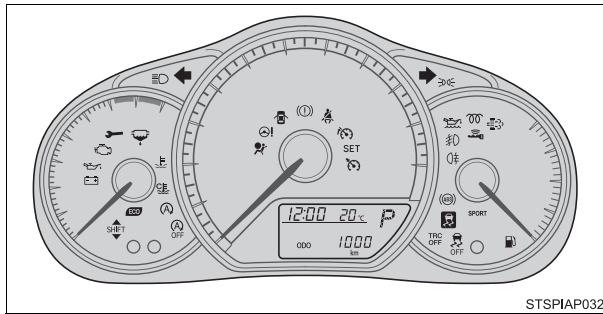

Vehicles with a tachometer (type B):

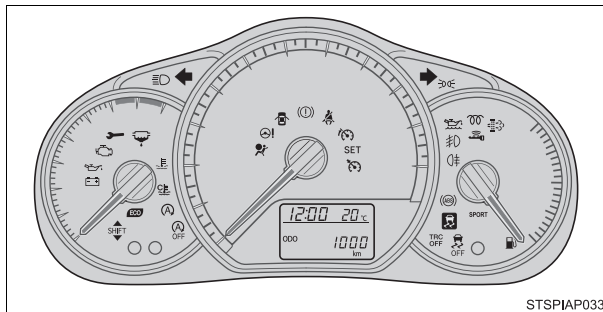

Hybrid vehicle

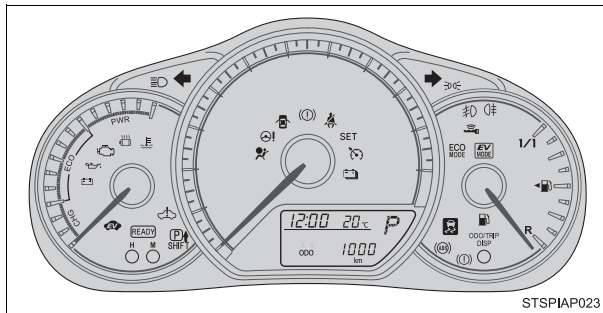

■ Center panel



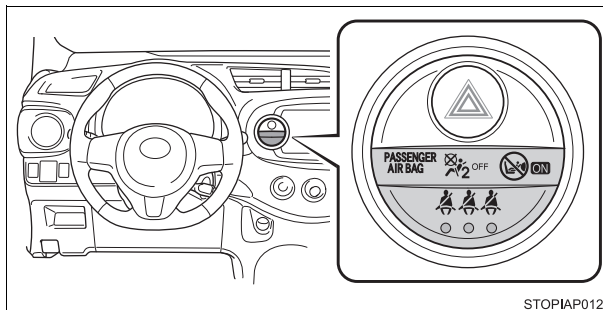



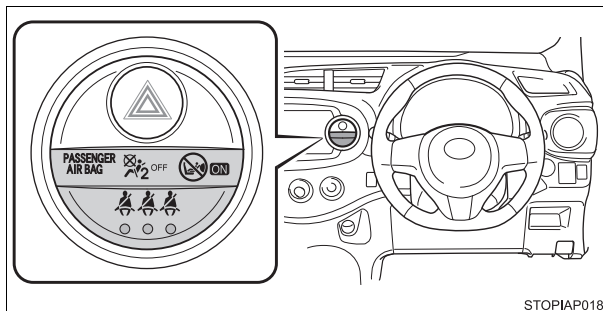













Left-hand drive vehicles



Right-hand drive vehicles



■ Warning lights

	Brake system warning light (red indicator) P. 561		Electric power steering warning light P. 565
	Charging system warning light P. 562		Slip indicator light* ¹ P. 565
	Low engine oil pressure warning light P. 562		Brake system warning light (yellow indicator) P. 565
	High engine coolant temperature warning light P. 562		Cruise control indicator light* ² P. 565
	Hybrid system warning light P. 562		Stop & Start cancel indi- cator light* ³ P. 565
	Multi-mode manual transmission warning light* ¹ P. 563		Fuel filter warning light P. 565
	Heat clutch warning light* ³ P. 563		Smart entry & start system indicator light P. 565, 571
	Malfunction indicator lamp P. 564		Low traction battery indicator light P. 565
	SRS warning light P. 564		Open door warning light P. 566
	ABS warning light P. 565		Low fuel level warning light P. 566

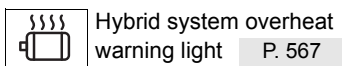
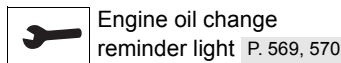
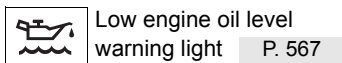
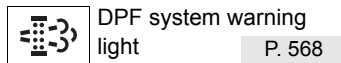
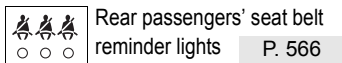
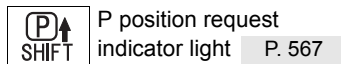
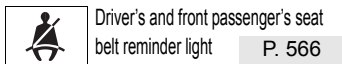

*1: The light turns on to indicate a malfunction.

*2: Except hybrid vehicle: The light flashes to indicate a malfunction.

Hybrid vehicle: The light comes in yellow to indicate a malfunction.

*3: The light flashes to indicate a malfunction.



GAS STATION INFORMATION

Auxiliary catch lever
P. 460

Fuel filler door
P. 151

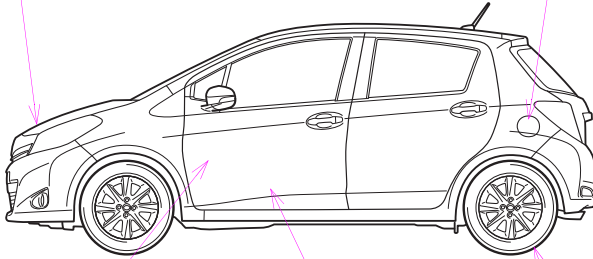

STOPIAP013

Hood lock release lever
P. 460

Fuel filler door opener
P. 151

Tire inflation pressure
P. 679

Fuel tank capacity (Reference)	1KR-FE, 1NR-FE and 1ND-TV engines 42 L (11.1 gal., 9.2 Imp. gal.) 1NZ-FXE engine 36 L (9.5 gal., 7.9 Imp. gal.)
Fuel type	P. 667
Cold tire inflation pressure	P. 679
Engine oil capacity (Drain and refill — reference)	P. 669
Engine oil type	P. 670