

— AR-15 SPECIAL ISSUE! —

FIREARMS NEWS[®]

GUN SALES, REVIEWS, & INFORMATION

JUNE 2020 | ISSUE 11

SPRINGFIELD ARMORY EDGE EVAC

— COMPACT & CAPABLE!

THE GEISSELE 'SUPER DUTY' PHILOSOPHY

A LOOK AT THIS RIFLE
AS WELL AS THE
MAN BEHIND IT!

BRAVO COMPANY PISTOL UPPER IN .300 BLACKOUT

LUTH-AR BALLISTIC SYNERGY

THE ULTIMATE DIY
FRANKENGUN BUILD
FOR COMPETITION
AND HOME DEFENSE

GOING RETRO

A COLT AR-15 SP1 FROM 1966

SIG'S M400 TREAD RIFLE

▼ AIMPOINT MICRO H-2

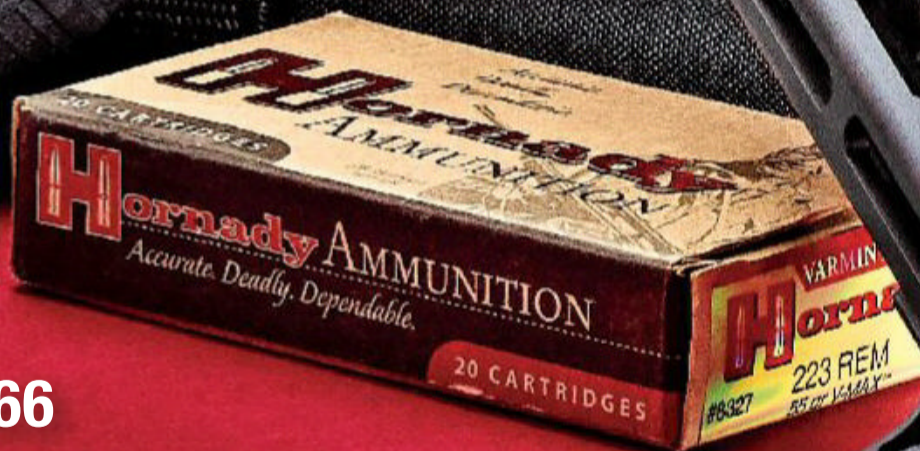

TRAIN AT HOME WITH YOUR OWN GUN

Introducing the ALL NEW

ELMS



EXPERT LASER MARKSMAN SYSTEM



- FREE APP DOWNLOAD FOR YOUR ANDROID OR IPHONE
- THE MOST ACCURATE DRY - FIRE TRAINING PRODUCT AVAILABLE
- TRAIN IN THE COMFORT OF YOUR HOME WHILE USING YOUR OWN GUN
- 2020 LAS VEGAS SHOT SHOW FAN FAVORITE

"Very impressed! Easy, accurate and simple to use."

ANDREW G., ATLANTA, GA

"By far the best laser training cartridge"

DAVIN S., PLANO, TX



Available Calibers
9MM *10MM
.45ACP *.380ACP
.40S&W *.38SUPER
 *.223

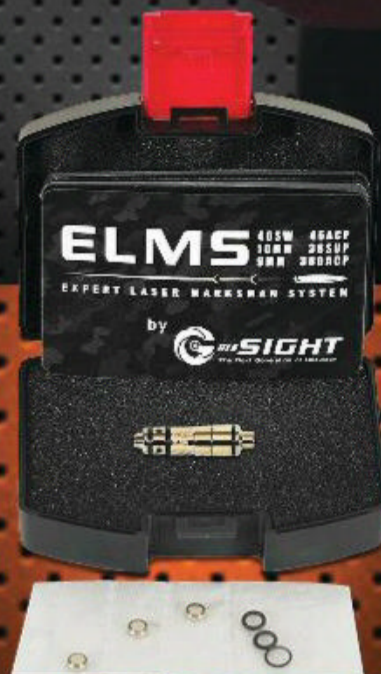

TIM LARKIN

Former US Military Intelligence Officer



9MM LASER CARTRIDGE

g-sight.com

*Available in Gen2 - ELMS (Gen3) in Summer 2020

PERFORMANCE WHEN IT MATTERS MOST



Performance
Center®
by Smith & Wesson®

▶▶▶ VISIT YOUR LOCAL DEALER TO SEE THE COMPLETE
PERFORMANCE CENTER® M&P M2.0™ PISTOL LINE-UP

PRO SERIES® IS USED UNDER LICENSE.



M&P®45 SHIELD™
NIGHT SIGHTS
3.3" BARREL

M&P®9 SHIELD™
OPTICS READY
PORTED BARREL & SLIDE
4.0" BARREL

M&P®9 PRO SERIES®
5.0" BARREL

M&P®9
PORTED BARREL & SLIDE
5.0" BARREL

M&P®40 PRO SERIES®
OPTICS READY
4.25" BARREL

M&P®9
OPTICS READY and PORTED BARREL & SLIDE
5.0" BARREL

Follow Us!



/smithwessoncorp

M2.0®



All inquiries for
Advertising, Editorial:
1-800-521-2885, ext. 5064
2 News Plaza, 3rd Floor
Peoria, IL 61614

PLACING AN AD

Advertisers will furnish **FIREARMS NEWS** with copy legibly printed or typewritten on one side of the paper only. Please leave a margin of at least 1" on all sides. Classified ad copy can be submitted on disk, e-mailed to firearmsnews@outdoorsg.com, through www.firearmsnews.com, or picked up from your web site.

Contact the Art Director before submitting electronic display advertising.

Due care and diligence is used in checking advertising copy for accuracy, but the Publisher makes no warranty, express or implied. Advertisers and **FIREARMS NEWS** are not responsible for typographical errors, mistakes or misprints.

All ads received too late for the current issue will be inserted in the following issue, unless you qualify the submission of the ad. Existing ad copy may be substituted if new copy fails to arrive by the specified date.

Advertising is credit card, check or money order in advance. If uncertain as to the cost of your ad, submit it and we will advise the amount to be remitted, and we will refund any overage.

Artwork is kept in our files for 13 months and then destroyed. Reproduction quality is not guaranteed.

FIREARMS NEWS reserves the right to omit any ads that in its opinion are objectionable.

In addition, **FIREARMS NEWS** will no longer accept ads offering the following items for sale: Plans, videos or books for converting semi-automatic firearms into full-automatic firearms.

Sound suppressor plans, and videos. Plans or formulas for making explosives, booby traps, etc.

Lock picks, Slim-Jims, etc. and lock picking instructions.

Also, items related to the above.

If in doubt about your ad, call us.

AD DEADLINE DATES

ISSUE	DEADLINE	ISSUE	DEADLINE
Vol. 74 - Issue 13	May 22	Vol. 74 - Issue 16	July 13
Vol. 74 - Issue 14	June 8	Vol. 74 - Issue 17	July 27
Vol. 74 - Issue 15	June 29	Vol. 74 - Issue 18	Aug. 10

NOTE: ALL ad space MUST be reserved and art materials MUST be received BEFORE the above DEADLINE DATES!

COMPLAINTS AGAINST ADVERTISERS

We want **FIREARMS NEWS** readers to receive prompt, friendly service from our advertisers. If you have experienced bad service from a **FIREARMS NEWS** advertiser, you may submit a complaint in writing to **FIREARMS NEWS**, Dept. CL, 2 News Plaza, 3rd Floor, Peoria, IL 61614. You can e-mail to firearmsnews@outdoorsg.com or fax to (309) 679-5476. We do not accept complaints by telephone. Note that **FIREARMS NEWS** is not a law enforcement agency and cannot investigate complaints. We will contact the advertiser on your behalf, and a continuing pattern of complaints can cost an advertiser its advertising privileges.

SUBSCRIPTION INQUIRIES

BE AWARE THAT FIREARMS NEWS ONLY ACCEPTS SUBSCRIPTION REQUESTS FROM AUTHORIZED AGENTS! WE MAY NOT HONOR REQUESTS FROM UNAUTHORIZED AGENTS, AND YOU THEREFORE MAY LOSE YOUR MONEY IF YOU BUY FROM AN UNAUTHORIZED AGENT. If you are offered a subscription to **FIREARMS NEWS**, please call 1-800-345-6923 to determine if the agent is authorized. For more information on subscription scams, please visit www.ftc.gov.

To change your address: Call our toll-free customer service number or E-mail us with your new address **6 to 8 weeks before** your move. **If you receive a bill after you've paid:** Our letters probably crossed in the mail. Please disregard any bill or renewal notice you receive soon after mailing your payment or order. (If you continue to receive notices, please let us know.)

If your issue is damaged or missing: Call our toll-free number or E-mail us. We'll replace the issue or extend your subscription, whichever you prefer. Remember, **FIREARMS NEWS** is published 24 times a year.

Toll-Free Subscription Number

1-800-345-6923

Outside U.S.; call 386-447-6318

E-mail: sgncustserv@cdfsulfillment.com

FIREARMS NEWS®

An Outdoor Sportsman Group® Publication

PUBLISHER

Mike Schoby

EDITORIAL EDITOR

Vincent L. DeNiro

FIELD EDITORS:

Senior Field Editor

David Fortier

Gunsmithing

Gus Norcross

Historic Military Arms

Paul Scarlata

Hunting

Rikk Rambo

Machine Guns & Tactics

Leroy Thompson

Movie Guns

Dr. Will Dabbs

NFA & Airguns

Patrick Sweeney

Pistols

James Tarr

Columnists

Mark Chestnut, David Codrea, Jim Grant,

Jeff Knox, Vin Suprunowicz

DESIGN

SENIOR ART DIRECTOR

Bill Smalley

ASSISTANT ART DIRECTOR

Ashley N. Honea

ASSISTANT ART DIRECTOR

Mark Kee

PRODUCTION

PRODUCTION MANAGER

Terry Boyer

ADVERTISING

ADVERTISING DIRECTOR

Pat Bentzel (East Region) (717) 695-8095

patrick.bentzel@outdoorsg.com

ADVERTISING SALES MANAGER

Mark Thiffault (720) 630-9863

mark.thiffault@outdoorsg.com

ACCOUNT EXECUTIVE, AD SALES

Brendan Vorobiev (734) 800-6666

CLASSIFIED ADVERTISING REPRESENTATIVE

Sue Fitch (309) 679-5064

Western Region

Hutch Looney & Associates

email: hutch@hlooney.com

NATIONAL AD SALES

Account Director – Detroit Office

Kevin Donley (248) 798-4458

National Account Executive – Chicago Office

Carl Benson (312) 955-0496

Direct Response Advertising/Non-Endemic

Anthony Smyth (914) 693-8700



PRESIDENT & CHIEF EXECUTIVE OFFICER

Jim Liberatore

CHIEF OPERATING OFFICER, PUBLISHING & BRANDED MEDIA

Mike Carney

EVP, GROUP PUBLISHER & OPERATIONS

Derek Sevcik

VP, CONSUMER MARKETING

Peter Watt

VP, MANUFACTURING

Deb Daniels

SENIOR DIRECTOR, PRODUCTION

Connie Mendoza

DIRECTOR, PUBLISHING TECHNOLOGY

Kyle Morgan

SENIOR CREATIVE DIRECTOR

Tim Neher

DIGITAL

Editorial Director, Fishing Jeff Simpson

Digital Editor, Hunting Drew Pellman

For questions regarding digital editions, please contact digitalsupport@outdoorsg.com

MEDIA

outdoorsg.com

TELEVISION

outdoorchannel.com

thesportsmanchannel.com

worldfishingnetwork.com

HUNTING

bowhunter.com

bowhuntingmag.com

gundogmag.com

petersenshunting.com

northamericanwhitetail.com

wildfowlmag.com

FISHING

bassfan.com

floridasportsman.com

flyfisherman.com

gameandfishmag.com

in-fisherman.com

SHOOTING

gunsandammo.com

handguns.com

rifleshooter.com

shootingtimes.com

firearmsnews.com

Firearms News (USPS Periodicals Permit 23130) is published 24 times a year. Semimonthly January through December by OUTDOOR SPORTSMAN GROUP, 1040 6th Ave., 12th Floor, New York, NY 10018-4618. Periodical postage paid at New York, NY and at additional mailing offices. **POSTMASTER:** Send address change (Form 3579) to *Firearms News*, P.O. Box 37539, Boone, IA 50037-0539. Return undeliverable Canadian addresses to: 500 Rt. 46 East Clifton, NJ 07011. Canada Post Publications Mail-Agreement No. 41405030.

To know when your subscription expires: Check the printed address label on the magazine cover. The date your subscription expires appears to the right of your name and address. Allow 6-8 weeks after renewing for the label to reflect your new expiration date.

Occasionally, our subscriber list is made available to reputable firms offering goods and services that we believe would be of interest to our readers. If you prefer to be excluded, please send your current address label and a note requesting to be excluded from these promotions to: Outdoor Sportsman Group – 1040 6th Ave, 12th Floor, New York, NY 10018-3703 Attn: Privacy Coordinator, or email your label information and note to privacycoordinator@outdoorsg.com

Copyright 2020 by Outdoor Sportsman Group®

All Rights Reserved. No part of this book may be reproduced without written permission.

FIREARMS NEWS® is a registered trademark of Outdoor Sportsman Group® in the United States.

The Publisher and authors make no representations or warranties regarding the accuracy, completeness or timeliness of the information

contained in this publication. Any reliance or use of the information is solely at your own risk, and the authors and Publisher disclaim any and all liability relating thereto. Any prices given in this issue were suggested prices at the press time and are subject to change. Some advertisements in this magazine may concern products that are not legally for sale to California residents or residents in other jurisdictions.

PRINTED IN THE U.S.A.



THE RUGER-57™

FUN TO SHOOT. COOL TO OWN.



The all new Ruger-57™ is just plain cool. Brought to you by the company that revolutionized the innovation of rugged, reliable firearms that the average American can afford, the Ruger-57™ is our most cutting-edge platform yet. Chambered in the high performance and low-recoiling 5.7x28mm caliber, this ergonomic, smooth shooting and accurate pistol is as full-featured as they come.



[RUGER.COM/RUGER57](https://www.ruger.com/ruger57)



CONTENTS

8 PRODUCT SHOWCASE



12 SPRINGFIELD ARMORY EDGE EVAC WINS!

The Contest is Over.
Patrick Sweeney

24 THE GEISSELE 'SUPER DUTY' PHILOSOPHY

A Look at this Rifle as well as the
Man Behind It.
James Tarr

38 BRAVO COMPANY PISTOL UPPER IN .300 BLACKOUT

Keeping Up with the Joneses
— Build What You Need
Patrick Sweeney

50 THE RISING TIDE

SIG's M400 TREAD Rifle
James Tarr

58 LUTH-AR BALLISTIC SYNERGY

The Ultimate DIY Frankengun for
Competition and Home Defense
Will Dabbs, MD

68 THE 1966 COLT AR-15 SP1

Brothers by a Different Mother
Will Dabbs, MD

80 SUBVERSIVE MACHINE GUN RULING WILL GUT SECOND AMENDMENT IF UPHELD

David Codrea

DISPLAY ADS

A	J
AERO Precision, LLC 21	J&G Sales LTD.....83-85
Air-Ordnance, LLC 45	L
American Gun Craft 102	L&S Supply 104
American Tactical, Inc. 112	M
AMG International Armory 105	M&A Parts 71
AR15MOLD.COM 102, 106	N
B	Newsmax 53
Black Hills Ammunition, Inc. 35	Nextten Stauer, LLC..... 49
Bob Hayley 104	O
Bob's Gun Shop 107	Outdoor Sportsman Group.....65, 82
Bravo Company USA	R
..... 10, 11, 14, 15, 41	Rapidfire Triggers, Inc.
Buffalo Arms Company 103 102, 104, 105, 106, 108
C	Recon Ordnance 75
CBRPS, LLC 107	Ruben Mendiola, Jr.....105, 109
CDNN Sports..... 73	S
Centerfire Systems, Inc..... 107	S&K Scope Mounts 102
Crosscut Saw Co. 107	Sabot Designs, LLC..... 102
D	Sarco, Inc.77, 87-101
D.B. Stewart Enterprises, LLC 103	Saxet Trade Shows 109
Davidson's..... 111	SI-CLO Mfg / Hybrid, Inc 45
Denver 45..... 104	Smith Wesson, Inc..... 3
E	Stocky's LLC..... 37
Electric Metering Corporation..... 37	Sturm, Ruger & Co., Inc.5
Evenheat Kiln Co..... 108	T
Everest 61	Truglo, Inc.7
F	U
First Samco, Inc..... 37	Uintah Precision..... 35
G	UltiMAK41
G-Sight Solutions, LLC 2	W
GovMint..... 41	Walther Arms, Inc. 29
H	Wiley & Sons, Inc..... 108
Handi Racker 103	
Harbor Freight Tools 66	
Hornady Mfg Co Natl..... 31, 103	



facebook.com/
FirearmsNewsMag



twitter.com/
FirearmsNewsMag



instagram.com/
firearmsnews



WHEN BRIGHTNESS COUNTS[®]



TFX[™] PRO
PROFESSIONAL-GRADE
TRITIUM + FIBER-OPTIC
XTREME DAY/NIGHT SIGHTS



TFX[™]
TRITIUM + FIBER-OPTIC
XTREME DAY/NIGHT SIGHTS



TRITIUM PRO
PROFESSIONAL-GRADE
HANDGUN NIGHT SIGHTS



TRITIUM
HANDGUN NIGHT SIGHTS

TRUGLO[®]
TACTICAL

WWW.TRUGLO.COM



BATTLELINK MINIMALIST PISTOL STABILIZER BY MFT!

The Battlelink Minimalist Pistol Stabilizer is a slide-on replacement designed to be held and operated with one hand, counterbalancing muzzle weight and stabilizing the pistol against the shooter's forearm. Sleek and comfortable along all planes eliminating any snag hazards and abrasive areas resulting in a comfortable interface. Compatible with a standard Milspec carbine receiver extension/buffer tube, the set screw locates into the buffer tube plunger hole. Sling slots and a Quick Detach Sling mounting point positioned in the rear. A Forearm Strap can be added. The upper section provides an enhanced cheek weld. Available in Black and Scorched Dark Earth, MSRP of \$44.99.



Warning: This product is subject to all applicable federal, state and local laws and regulations. It is the purchaser's obligation to check for compliance before purchasing. Modifying or redesigning the Stabilizer may be subject to NFA regulation and is not recommended.

For more information, visit MissionFirstTactical.com

MFT'S BATTLELINK EXTREME DUTY MINIMALIST STOCK

The Battlelink Extreme Duty Minimalist Stock is a slide-on replacement for a collapsible buttstock. Building on our popular minimalist platform, we recognized the need for a more robust stock capable of withstanding long-term abuse delivered by larger caliber firearms such as tactical shotguns of 12 gauge or 7.62x51 AR-10 while remaining nimble enough for use on a 5.56. The angled, non-slip rubberized removable buttpad allows for faster presentation. Multiple sling slots with a single point mount and Quick Detach Sling mounting point positioned in the rear. Comes equipped with a single MLOK connection point, and the upper section provides an enhanced cheek weld. Available in Black and Scorched Dark Earth, MSRP of \$69.99

Mission First Tactical Battlelink Extreme Duty Minimalist Stocks are built for hard shooting and extreme treatment and shooting conditions and come with a Lifetime Warranty.

For more information, visit MissionFirstTactical.com.



SBA4™ PISTOL STABILIZING BRACE®



Designed for all platforms capable of accepting a mil-spec carbine receiver extension, the SBA4™ Pistol Stabilizing Brace® is 5-position adjustable and features an integral, ambidextrous QD sling socket. The SBA4 greatly enhances usability by adding a third point of contact for stabilization and includes a 7075 mil-spec carbine receiver extension and an adjustable nylon strap. Like all SB Tactical® braces, the SBA4 is US veteran designed and proudly manufactured in the USA. MSRP: \$169.99

For more info please visit: SB-Tactical.com/product/sba4/

PROTECT YOUR AR RIFLES WITH THE IRON CLASP CASE FROM CEDAR MILL!

The Iron-Clasp™ Cam-Latch™ case combines toughness and practicality with dependability. It's built from heavy-duty DS2Tek™ resin and is lined with two plush layers of Pick and Pluck Foam with endless customization options. The hinges and clasps are stainless steel. MSRP is \$139.99

For more info please visit CedarMillFirearms.com



KEEP THAT BRASS FROM HITTING YOUR BUDDY ON THE FIRING LINE!

A new alternative to traditional brass catchers that is designed to provide military, law enforcement and performance-focused shooters with a lightweight and easy to attach alternative device for training sessions. Kinetic Energy Tools is solving problems and limitations that brass catchers have not been able to address — heat resistance, easy installation, light weight,



non-intrusive capacity maximum, and high quality. Consistently blocks spent ammo from flying away from the shooter. 100% made in the U.S.A. Only \$32.99

For more information, visit KineticEnergyTools.com

SHOWCASE

THORSDEN CUSTOMS® PICATINNY BUFFER TUBE ADAPTER

The growing popularity of vertical 1913 picatinny railed weapons like the new Ruger PC Charger® has triggered a surge in pistol brace and SBR conversions. The Thorsden Customs Picatinny Buffer Tube Adapter is an essential part of that process. It provides a highly functional and attractive transition from your vertical 1913 rail to any AR-15 style buffer tube for brace or stock installations. Unlike other buffer tube adapters, a hidden clamping mechanism keeps the stock perfectly aligned with the centerline of the firearm while leaving a sleek, clean look. MSRP is \$42.99

For more info please visit: ThorsdenCustoms.com



THE ENHANCED AR BY ATAC DEFENSE



Our enhancement modifications make this rifle fast to operate and a dream to shoot. Enhancements include: ambi safety, ambi mag release with oversized mag button, oversized bolt release, oversized ambi charging handle, muzzle brake, and nickel boron coated bolt carrier group, MFT minimalist stock and MFT engage grip. ADER 5.56 AR - \$1299.00

Contact ATAC Defense at (601) 963-0600 or visit AtacDefense.com

LOVE ARS AND WANT A 12-GAUGE SHOTGUN? LEGACY SPORTS HAS JUST WHAT YOU ARE LOOKING FOR WITH THE CITADEL BOSS 25!



TWO NEW CERAKOTE Models have been added to the CITADEL BOSS 25 semiauto 12-gauge shotgun lineup (based on the popular AR platform). FDE – (Flat Dark Earth) and TACTICAL GREY models now compliment the already popular semiauto that is full of some great features that is truly a versatile shotgun that is capable of home defense, recreational and 3-Gun Competition use. The CITADEL BOSS 25 is built from the ground up to be a user-friendly, work-horse shotgun that will perform under the harshest of conditions. MSRP \$639

For more information about the CITADEL BOSS 25 lineup and the rest of the LSI product line or to request a FREE 2020 catalog, please call (775) 828-0555 or visit: LegacySports.com

LEUPOLD ANNOUNCES NEW BLACK RING VERSION OF FREEDOM RED DOT SIGHT WITH BULLET DROP COMPENSATOR

A tubular red dot sight built for performance and versatility, the new RDS is available in two models: One features capped precision ¼-MOA click adjustments. The other a precision exposed BDC (Bullet Drop Compensator) elevation turret that ships with measurements out to 500 yards for standard 55-grain .223 Rem. ammunition. The RDS is designed to install easily with an included mount that sits at the optimal height for use on AR-style rifles. A 34mm main tube allows the RDS to be mounted using any appropriately-sized rings.



The Freedom RDS features a 1-MOA dot reticle that's supported by Leupold's battery-saving Motion Sensor Technology (MST), which puts the sight into a battery-saving standby mode after five minutes of inactivity. When the MST detects motion, it instantly activates the sight so it's ready when you are. A manual mode allows the sight to shut off when not in use. Eight illumination settings are available, making the dot easily visible in low-light conditions or the mid-day sun. On the RDS's medium setting, you get up to 1,000 hours of battery life – which, thanks to its MST, truly equals 1,000 usable hours.

The scratch-resistant lenses feature Leupold's Twilight Red Dot System, which delivers standard color consistency and premium lens clarity. The RDS features 80-MOA of adjustment in both elevation and windage. It measures at under 5.5 inches and weighs less than 7 ounces. The ultra-lightweight construction disperses recoil energy, making the RDS the toughest red dot in its class. Waterproof, fog proof, and guaranteed to perform for life, the Freedom RDS is backed by Leupold's Lifetime Guarantee.

For more information on Leupold products, please visit Leupold.com

JARD AR SET TRIGGER SYSTEM – 13-OUNCE PULL!

The JARD AR Set Trigger System (patent pending) brings bolt action accuracy to the AR platform. It's unlike any other AR trigger on the market, featuring set functionality otherwise only found in select bolt action triggers. The set function allows the user to push the blade of the trigger forward for a trigger pull weight of just 13 oz., allowing for little to no impediment of shot accuracy produced from trigger pull. This trigger capability significantly enhances the user's ability for accurate fire when precision shooting. Regular trigger pull weight without engaging the set function is approximately 4 lbs. The JARD AR Set Trigger System comes preassembled within a drop-in housing milled from billet aircraft grade aluminum. MSRP \$220 (Plus \$7.45 S&H).

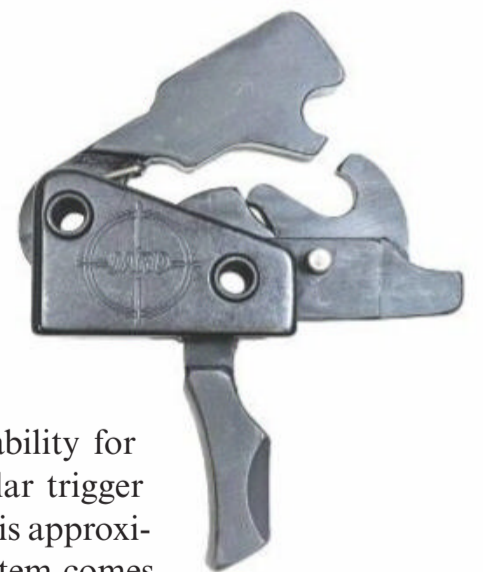

For more info please call JARD at (712) 324-7409 or visit JardInc.com



- Trijicon AccuPoint TR24G 1-4x24 Rifle Scope \$1,099.00
- BCM® Diamondhead Folding Rear Sight \$119.00
- BCM® KMR-A15 KeyMod Rail Handguard 15 Inch \$199.95
- BCMGUNFIGHTER™ QD End Plate \$16.95
- BCMGUNFIGHTER™ Stock \$55.95
- GEARWARD Ranger Band 20-Pak \$10.00
- BCMGUNFIGHTER™ Grip Mod 0 \$25.95
- American Defense RECON X Scope Mount \$189.95
- BCM® Diamondhead Folding Front Sight \$99.00
- BCMGUNFIGHTER™ KMSM KeyMod QD Sling Mount \$17.95
- BCMGUNFIGHTER™ Vertical Grip Mod 3 \$18.95
- BCMGUNFIGHTER™ Compensator Mod 0 \$89.95
- BCM® Low Profile Gas Block \$44.95
- BCM® A2X Flash Suppressor \$34.95



B5 Systems SOPMOD Bravo Stock \$58.00

Blue Force Gear VCAS Sling \$59.95



BCM® PNT™ Trigger Assembly
Polished - Nickel - Teflon
\$65.95

Wilson Combat Tactical Trigger \$269.95



Inforce WML-HSP \$129.00

Trijicon TA31RCO-M4 ACOG 4x32 \$1,422.05

Aimpoint PRO Patrol Rifle Optic \$441.00



BCM® KMR-A KeyMod Free Float Rail Handguards

Same as the fantastic original KMR Handguards but machined from aircraft aluminum!

BCM 9 Inch KMR-A9	\$176.95
BCM 10 Inch KMR-A10	\$179.95
BCM 13 Inch KMR-A13	\$189.95
BCM 15 Inch KMR-A15	\$199.95

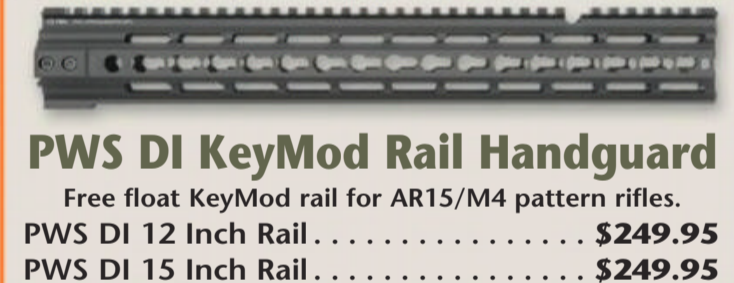

PWS DI KeyMod Rail Handguard

Free float KeyMod rail for AR15/M4 pattern rifles.

PWS DI 12 Inch Rail	\$249.95
PWS DI 15 Inch Rail	\$249.95



PWS KeyMod Polymer Bipod Adapter \$23.95



Daniel Defense SLiM Rail Handguard

Slim, Light, Modular KeyMod free float handguard.

DD SLiM Rail 12.0	\$265.00
DD SLiM Rail 15.0	\$265.00



Daniel Defense KeyMod Bipod Adapter \$48.00



Daniel Defense KeyMod 1 O'Clock Offset Rail Assembly \$40.00



BCM GUNFIGHTER™ KeyMod 1-Inch Ring Light Mount

For 1" diameter lights **\$39.95**



BCM GUNFIGHTER™ KeyMod Modular Scout Light Mount

For SureFire Scout Light **\$39.95**



BCM GUNFIGHTER™ KeyMod Modular Light Mount

For 1913 mounted lights **\$39.95**



Arisaka Inline KeyMod Scout Mount \$37.00

Arisaka Ring KeyMod 1" Light Mount \$45.00



Thorntail KeyMod Offset Adaptive Light Mounts

Thorntail 1.030 Mount **\$70.00**

Thorntail M3M6 1913 Mount **\$50.00**



Arson Machine Company KeyMod Light Mounts

Scout M600 Mount **\$48.00**

1" Ring Mount **\$44.00**

- Midwest Industries Folding Front Sight \$79.95
- Midwest Industries ERS BUIS \$93.95
- GEARWARD Ranger Band 20-Pak \$10.00
- BattleComp 1.5 \$155.00
- BCMGUNFIGHTER™ 1913 Modular Light Mount, KeyMod \$39.95
- BCMGUNFIGHTER™ KMSM KeyMod QD Sling Mount \$17.95
- BCMGUNFIGHTER™ KAG Kinesthetic Angled Grip, KeyMod \$18.95
- BCM® KMR-A13 KeyMod Rail Handguard 13 Inch \$189.95
- BCM® PNT™ Trigger \$65.95
- BCMGUNFIGHTER™ QD End Plate \$16.95
- BCMGUNFIGHTER™ Stock \$55.95
- BCMGUNFIGHTER™ Grip Mod 3 \$17.95
- TangoDown ARC MK2 30 Round Mag \$19.48
- BCM® Polymer Trigger Guard \$6.95
- PWS FSC556 Tactical Compensator \$94.95

BCMGUNFIGHTER™
Comp Mod 0 - 556
Threaded 1/2x28 for 5.56 AR15 platform
\$89.95

Comp Mod 1 - 556
Threaded 1/2x28 for 5.56 AR15 platform
\$94.95

IWC KeyMod QD RL Sling Mount
Accepts heavy duty or standard QD swivels
\$17.00

IWC KeyMod Hand Stop
Mount-N-Slot design **\$34.95**

BCM® KeyMod Picatinny Rail Sections
Mil-Std 1913 rails, Nylon Rails available in Black, Flat Dark Earth and Foliage Green.

- Nylon Rail, 3 Inch **\$8.95**
- Nylon Rail, 4 Inch **\$11.95**
- Nylon Rail, 5.5 Inch **\$14.95**
- Aluminum Rail, 3 Inch, Black **\$19.95**
- Aluminum Rail, 4 Inch, Black **\$24.95**
- Aluminum Rail, 5.5 Inch, Black **\$29.95**

PWS KeyMod Picatinny Rail

- Polymer Rail, 5 Slot **\$11.95**
- Aluminum Rail, 5 Slot **\$28.95**

BCMUNFIGHTER™ Enhanced Lower Parts Kit
BCM® PNT™ Trigger Assembly, BCM® Mod 3 Grip, BCM® Trigger Guard, and Mil-Spec hardware kit.
BCMUNFIGHTER™ ELPK, semi-auto. . . . **\$119.95**

BCMUNFIGHTER™ KAG Kinesthetic Angled Grip
Uses a biomechanically efficient forward rake, small profile, textured front and back for positive engagement. Impact resistant polymers, available in Black, Flat Dark Earth, Foliage Green and Wolf Gray.

- KAG-KM, KeyMod Version **\$18.95**
- KAG-1913, Picatinny Rail Version. **\$19.95**

BCM® KeyMod Rail Panel Kits
In Black, Flat Dark Earth, Foliage Green and Wolf Gray.
5.5 Inch Rail Panels, 5-Pack **\$9.95**

Vltor Carbine EMOD Stock \$119.65

VTAC MK2 Wide Sling \$44.95

BCMGUNFIGHTER™ VG MOD 3
Low-profile length for increased mobility and decreased "snag". Made in the U.S.A. from impact resistant polymers, available in Black, Flat Dark Earth, Foliage Green and Wolf Gray.

- VG-KM-MOD-3, KeyMod Version. **\$18.95**
- VG-1913-MOD-3, Picatinny Version **\$19.95**

Aimpoint Comp M4S
Red dot sight, fully NVD compatible, with QRP2 Picatinny Rail Mount
\$889.00

EOTech HOLOgraphic Weapon Sights

- Model 512 **\$429.00**
- Model 552 **\$529.00**



By Patrick Sweeney
Cover and lead photo by Mike Anschuetz

The contest? The most compact AR-15 pistol. Until now, we have been limited to the length of the buffer tube, because you have to have a buffer tube for function, or it isn't really an AR-15. Springfield Armory has made serious contenders in this regard, like their Saint Edge pistol with the telescoping arm brace. That one ends up being a shade over twenty-four inches long.

Adding a folding buffer tube with an arm brace let them get the length down to about nineteen inches, but it took one more step to make their entire package so compact you might not recognize it as an AR-15 pistol: a takedown barrel assembly.

SPRINGFIELD ARMORY EDGE EVAC WINS!

THE CONTEST IS OVER.

OK, the Springfield Armory Saint Edge EVAC (with a name almost longer than the pistol) is one seriously compact setup. In a world of compact AR-15 pistols, it throws down the gauntlet, and declares no-one else will beat this. Springfield has sought out the best additions to the already excellent Saint line, to make the Edge EVAC beat all the others.

At first glance, it appears to be just another AR-15 pistol variant, with a blunt-nosed handguard, and a plain tube with metal loop as the brace.

Let's unpack this, from back to front.

[Cont. to page 16]



RESOLUTE

PROFESSIONAL GRADE WEAPONRY®

BRAVOCOMPANYMFG.COM

BCM GUN FIGHTER™



BCMGUNFIGHTER™ Pistol Grip

- Reduced grip angle keeps wrist in line for improved trigger control
- Hinged Trap Door interior storage with water resistant rubber gasket
- Mod 0 similar to A1/A2 backstrap, Mod 1 with high rise backstrap
- Mod 2 up to 1/4 inch wider with interchangeable backstraps/inserts
- Mod 3 up to 1/4 inch wider with high rise backstrap/extended insert
- All Mods available in Black, Flat Dark Earth, Foliage Green, Wolf Gray

BCMGUNFIGHTER Pistol Grips Prices start at **\$17.95**



BCMGUNFIGHTER™ Stock

- Over a year in design, specifically engineered geometry, with no weak links. New patent pending latch reinvents the interface with the receiver extension, providing superior strength.
- Simple modular, snag free design utilizes only 5 parts and 1 screw
- 2 ambidextrous sling mounting options including QD swivel socket
- Color matched rubber buttpad for secure shoulder placement
- Available in Black, Flat Dark Earth, Foliage Green and Wolf Gray

BCMGUNFIGHTER Stock **\$55.95**



BCMGUNFIGHTER™ Vertical Grip

- Forward angle increases rigidity of the forearm, provides more natural wrist angle
- Featuring an aggressive texture, and generous storage volume
- Cross bolt designed to work with improvised tools
- Reversible clamp for fastener setup on either side
- Made in the U.S.A. from high quality, impact resistant polymers
- Available in Black, Flat Dark Earth, Foliage Green and Wolf Gray

BCMGUNFIGHTER VG - Screw Mount . . . **\$20.00**



BCMGUNFIGHTER™ Vertical Grip -Short

- Low-profile length for increased mobility and decreased "snag" factor
- Forward angle increases rigidity of the forearm, provides more natural wrist angle
- Aggressive texture, generous storage volume
- Made in the U.S.A. from high quality, impact resistant polymers
- Available in Black, Flat Dark Earth, Foliage Green and Wolf Gray

BCMGUNFIGHTER VG-S - Short, Screw Mount Version . . . **\$35.95**

BCMGUNFIGHTER VG-S-KM - Short, KeyMod Version **\$39.95**



BCMGUNFIGHTER™ VG

- Low-profile length for increased mobility and decreased "snag" factor
- The forward angle increases the rigidity of the forearm, while providing a more natural wrist angle
- Can be mounted in reverse angle to increase control when grabbing handguard and grip
- Flat sides with aggressive texture give better control to the shooter
- Anchor and bolt system offers a simple and robust design, while maintaining a light-weight 1.9 ounces
- Made in the U.S.A. from high quality, impact resistant polymers
- Available in Black, Flat Dark Earth, Foliage Green and Wolf Gray

BCMGUNFIGHTER VG-KM-MOD-3 - KeyMod Version **\$18.95**

BCMGUNFIGHTER VG-1913-MOD-3 - Picatinny Rail Version . . **\$19.95**



BCMGUNFIGHTER™ KAG Kinesthetic Angled Grip

- Forward rake gives positive retention when using "C-clamp" method of handguard support, works as a rest for supported firing positions
- Slight angle without bulk adds just the right amount of strain relief to the wrist without substantially increasing the girth of the handguard
- Small profile, textured front and back for positive engagement
- Innovative patent pending attachment method allows for robust clamping and alignment with minimal hardware and accessory size
- Made in the U.S.A. from high quality, impact resistant polymers
- Available in Black, Flat Dark Earth, Foliage Green and Wolf Gray

BCMGUNFIGHTER KAG-KM - KeyMod Version **\$18.95**

BCMGUNFIGHTER KAG-1913 - Picatinny Rail Version **\$19.95**



All pricing is subject to change without notice. Please see our website for current pricing.

Hartland, WI U.S.A. / Toll Free: 1-877-BRAVO CO (1-877-272-8626) / Fax: 262-367-0989 / BravoCompanyMFG.com



Recoil is mild, accuracy is great, reliability is 100%, and it all fits into an incredibly small transport case. Does life get any better than this?



The Springfield Armory Edge EVAC is an ultra-compact AR-15 pistol that has all the features, and breaks apart as well.

[Cont. from page 13]

On the back is the Gear Head Works Tailhook Mod 1 arm brace, which is an oval aluminum brace. You use it by unclipping the lever (there's a button for that) and hinging the lever down. You can then hook the lever under your forearm, and viola, you can one-hand-shoot the AR-15 pistol. But, there's more. The Tailhook Mod 1 is light weight, with only a few

ounces to call its own. And Gear head Works incorporates a QD sling swivel socket as well.

The Gear Head Works Tailhook Mod 1 arm brace buffer tube is screwed into a Law Tactical folding receiver plate. There's a button there, also. You press the button, and the arm brace hinges to the left, and stops once it is parallel to the receiver, on the left side. As a

result, most of the extra length the buffer tube adds to the overall of the pistol, disappears. The package, of course, becomes twice as wide, but width isn't the problem when we are trying to discreetly transport an essential emergency tool.

Now, the Law Tactical folding adapter is not without its costs. First of all, in order to be robust enough



The Gear head Works Tailhook has a button to unlock the brace.



When you fold the brace down, it stops at a right angle to other half.



To use the brace, hook the horizontal part of the brace under your forearm, and you can now shoot the AR-15 pistol.



The Law Tactical folder has a hinge that is on the left side, down below the tube axis, and out of the way.



The Law Tactical folder adds some weight, and adds some bulk. Both are small prices to pay for the ability to fold.

to withstand the use we will be putting it to, it has to be made of steel. Law Tactical does this right, by making it out of 4140 steel. No low-carbon, Chinese “alloy” here, but it does add ten ounces to the overall of your AR-15 pistol. They designed it with the hinge mechanism as low-profile as possible, and tucked it down out of the way on the left-hand side.

When you unfold it, the Law Tactical adapter automatically locks in the open position. No need to press a lock button, or turn a lever, or anything like that.

The adapter, when open, still retains the buffer and its spring, so you don't have parts flying when you open it. And this also allows you to use your standard, or favorite, buffer weight and spring setup. The EVAC ships with an “H” buffer and standard spring inside of the Gear head Works arm brace tube. Good choice.

There's a setscrew, to make sure the LAW adapter doesn't loosen from its fit to the lower receiver. There's a QD sling swivel socket, for them that wants that kind of sling setup. And, should your adapter show wear with use, you can adjust the hinge tension, so it won't flop around on you.

It also comes with a bolt carrier extension. The Edge EVAC needs something to fill the gap created by adding the hinged adapter, and the extension does just that. It also adds a couple of ounces (of the ten-plus

TAKEDOWN FIREARMS

Takedown firearms have a long history, even if they have never been common. Obviously the classic side-by-side double shotgun is a takedown, but that is a special case. The other takedowns were the Winchester lever actions that had a takedown system built in. Some of the Browning shotguns could be readily taken down, and of course, most pumps, when you remove the barrel, become a lot more compact.

The classic, and desired, takedown system was one where the rifle or shotgun was literally taken down in half, right at the front of the receiver. And then it was stored in a case called a “leg o'mutton” case, because of its shape. I saw a few of those when working as a gunsmith, but they were mostly a first half of the 20th century and earlier item. My father knew of them. Before WWII, he'd go hunting by simply walking down to the Warren Avenue route of the Detroit trolley system, and taking the trolley west to the end, the edge of Detroit. From there a short walk got him into the country, and he could go hunting. (Now, it is all suburban housing, for fifteen miles to the West of where he stepped off the trolley.)



When my father was growing up, Detroit was the wealthiest city in the country, perhaps the world. (By per Capita income.) Had some other country done this to us, their Capital city would be a glowing sheet of radioactive glass. But we did it to ourselves.

A takedown system allowed you to transport a less-bulky setup. Not that anyone would be alarmed at seeing a rifle or shotgun on the trolley. But it took up less room in a leg o'mutton case.

Now, the standard transport system is a bag for a laptop, notebook or other electronics, so we adapt. And the EVAC lets us adapt to the new common case size. **FN**



To fold the Law Tactical, you have to press the unlocking button.



The Springfield sights are held onto the receiver by means of a torx screw. A T15 is the correct size, should you need to move the sights.



The muzzle brake does a good job of dampening felt recoil, and a great job of not being an onerous burden to others on the firing line.



You can see the retained buffer and spring on the left, and the carrier extension protruding from the receiver, on the right.



Large or small aperture as the default, Springfield gives you the choice.



Not too shabby for a short-barreled AR-15 pistol, and a "mere" 4X scope. (Yes, there are four bullet holes in there.)

added in the completed build) but the weight acts as an extra bit of weight to the "H" buffer in the build, making recoil a bit softer.

And yes, you can fire the EVAC with the buffer tube folded. It is a single-shot in that mode, and you can't even cycle the action to get the next round up the spout, but you can shoot it.

In the middle, Springfield has used their own Saint receiver set. The upper is a flat-top M4 configuration, with forward assist and ejector pyramid. It is forged, given a Type III hardcoat anodized finish and dyed black. Inside, it has M4 feed ramps.

The bolt is made of Carpenter 158, the classic and accepted mil-spec steel. The bolt is also magnetic particle inspected after being proofed. The carrier is the heavy, M16 style, and it is given a Melonite treatment for extra durability and ease of cleaning. The carrier group is cycled when you need to load by means of the Springfield Midsize-Edge charging handle. The carrier has, of course, the forward assist ratchets machined into it, in case you want to use the FA in your handling. Me, I prefer to eject a recalcitrant cartridge, rather than hammer it in deeper. But that's just me, and I applaud Springfield for giving us the choice.

The lower is the Saint sculpted lower, machined from billet aluminum with the magazine well relieved for hand room on inserting or removing a magazine. The selector is ambidextrous, and the Reptilia CQG

pistol grip rests behind the straight-blade trigger. Underneath the trigger, Springfield has elected to go with an integral trigger guard bar, curved for access with a gloved hand. Inside the lower, Springfield has installed their Accu-Tite tension system. This is an adjustable setscrew in the lower, one that bears up against the rear lug of the upper when the receiver set is closed. It takes up any play that might exist in the fit of the lowers. If, over time and hard use, your Edge EVAC gets to feeling a little bit wobbly, you can tighten it up with a judicious adjustment of the tensioning screw.

The trigger is the SA match system, with a flat trigger blade, and the internals are given a low-friction plating of Nickel Boron. The trigger Springfield chose is a single-stage, for extreme durability, and the Nickel-boron coating allows them to produce a clean, crisp and not-heavy trigger pull.

On top of the upper receiver assembly, Springfield has installed their own excellent folding back-up sights. These are spring-loaded, and pop up when you press the unlock button on the left side. They lock in the upright position, so they won't get accidentally folded down if you bump them against something. Of course, they are sights, so if you hit them hard enough

you can break them, so don't. You have to press the unlock button to fold them, not a big deal. I only had one complaint, and even I have to admit it is a minor one: whoever mounted the sights on the EVAC sent to me, bolted the rear sight not in the last slot available. And since Springfield wisely uses torx-headed screws as the attachment system, I had to dig into the toolkit to find the properly-fitting torx wrench. (A size T15 by the way)

Another good detail of the Springfield sights is that the rear sight can be folded with either the small or the large aperture as the default size. I prefer to have the large as the default, and sights that make me flip to the small, just to fold the sights, are not my happy sights. The Springfield gives you both options.



To take down the EVAC, lock the bolt back and then pull down the locking latch.

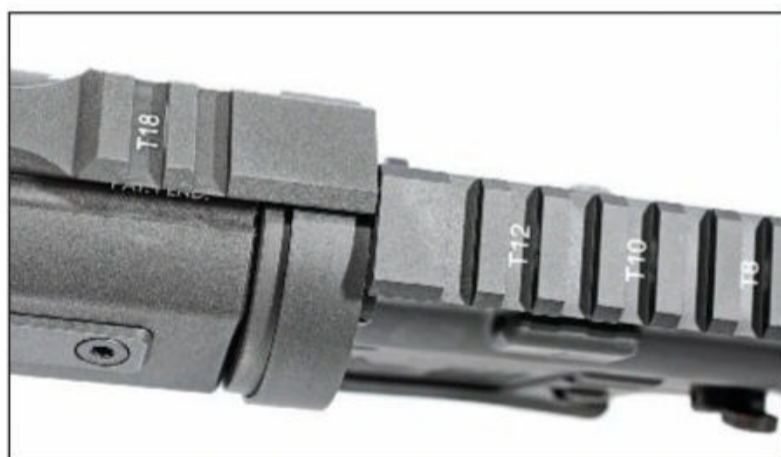

Then rotate the forward half clockwise until it stops.

The barrel on the Edge EVAC is seven and a half inches long, and composed of 416 stainless steel that has been given a Melonite surface treatment. This is the newest thing in barrels (well, a few years along at this point) and provides the corrosion and wear resistance of a chrome-lined bore, without the extra dimensional problems, and wear problems, that chrome-plating bring with it. Springfield lists the chambering as “5.56” so I just had to drop my M-Guns 223/556? gauge in there. Yep, a 5.56 it is, so no fears of using



The handguard has the top rail machined off behind the front sight location, so you can more-easily wrap your hand around it.

honest-to-goodness 5.56 ammo in it. Not that you could ream the leade if it weren't, what with it being a Melonite-d barrel. Reamers just slip off of, and get dulled, by a Melonite treated surface.

The gas system is, obviously a pistol-length direct-impingement design, with the gas block pinned to the barrel. Again, good on Springfield for not depending on setscrews here.

The twist rate is one turn in seven inches, so you can count on the barrel properly stabilizing the heaviest normal bullets found in the AR-15.

The stubby barrel is given a proprietary muzzle brake. Now, when I read “7.5 inches” and “muzzle brake” I was prepared for the usual range-test-buffet of awfulness, vis-à-vis muzzle blast. A barrel that short is blasty enough on its own, but adding a muzzle brake? So when it came time to do the chrono work, I doubled up: I wore both plugs and muffs. Well, I needn't have. Springfield did their homework here, and while the muzzle brake does take the oomph out of recoil, it also re-directs the blast forward, and not to the sides. Well, it may be somewhat to the sides, but I didn't have anyone else on the range when I was testing, so I can't ask them. It didn't blast back at me, and when I was under a covered firing line, it wasn't the usual echo chamber. So, well done Springfield.



The folded EVAC, with the forward half taken down. Can you get a more-compact package than this?

HOW FAST IS FAST ENOUGH?

Short barrels lose speed. There's no way around it. I'm sure Sir Isaac Newton, once he got over the shock of smokeless powder, self-loading rifles, and the lack of powdered wigs, would grasp the situation quickly.

So, how slow is too slow? After all, we're talking muzzle velocities that are just over 2,000 fps, after all. That's where bullet design comes in. My contact at Hornady tells me they specifically tested in, and loaded for, SBRs, to develop their special SBR load. And shooting tells me they got that part right. The bullet they use will expand down to 1,950 fps. Of course, the speeds you get out of a 7.5" barrel aren't what you'd get out of an 11.5" barrel.

The 11.5" velocity keeps the 75 grain Interlock up over 1,950 fps to 100 yards. From a 7.5" barrel, you aren't going to be getting 1,950 past 50 yards, but the number of gunfights any of us might be in, in a non-military contact, past 50 yards, is miniscule. So I'm not worried. **FN**



Mission First Tactical not only offers reliable magazines, but you can have them with artwork on them as well.

The handguard is the Springfield hexagonal tube free-float handguard, with MLoc slots, and the top rail sculpted off in-between the front sight position and the upper receiver. This does limit the amount of gear you can mount, but really, how much would

you want to add, on something this compact? Springfield adds a hand stop on the end of the handguard, a good thing for those of us who have long arms, or those who insist on shooting with the left arm almost straight.

The neatest thing about the EVAC system is the takedown. Yes, takedown. Springfield made their free-float handguard from the Saint fit the Pantheon-Dolos System takedown assembly, and as a result, you have an AR pistol that folds at one end and comes apart at the other.

The process is simple. Remove the magazine. Lock the bolt to the rear. Pull the two-ledged tab on the bottom of the handguard away from the bore axis of the pistol. Now give the handguard, and the assembled parts that are attached, a partial turn clockwise (as seen from the shooter's point of view) and then pull the forward half forward and off of the receiver.

You'll see the barrel extension and the gas tube protruding from the rear plate of the Pantheon-Dolos System takedown assembly.

Re-assembly is just as easy. Line up the gas tube with the gas tube hole in the front of the receiver. Press the handguard/barrel assembly into the receiver, lining up the barrel extension, and push together until you have the front half fully inserted. Once all the way in, rotate counter-clockwise. You'll hear the ratchet system doing its thing, and once the handguard stops, with the top rails lined up, you are done. Press the locking latch back up towards the bore and you're ready.

Test-firing posed a few new situations. First, what optics? A pistol like this just cries out for a red-dot optic, something so compact you hardly notice it until you need it. But, testing any firearm at 100 yards, using a 1X red-dot is more a test of the shooter than the firearm. There are maybe a dozen shooters in the country who can wring all the accuracy possible out of a firearm, at 100 yards, with a red-dot optic. Every-

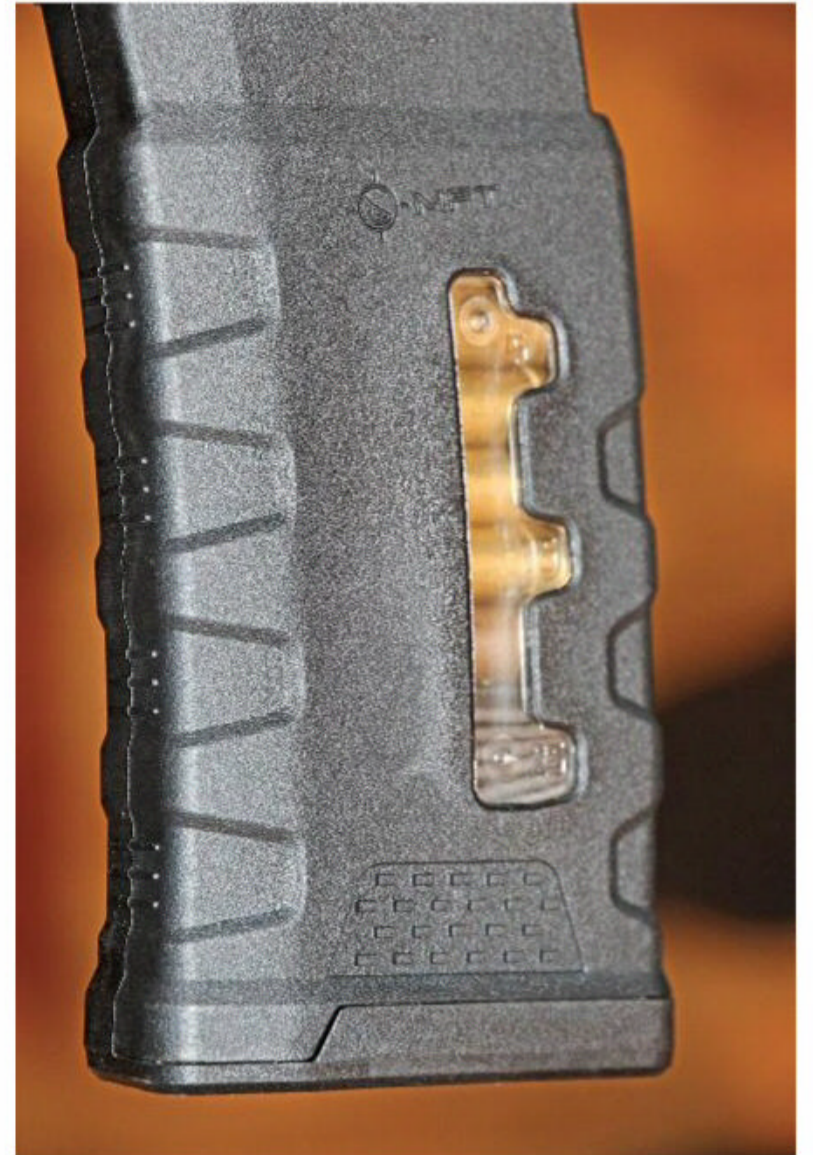

With aggressive sculpting and a see-through window, MFT magazines are loaded with features.

one else is either kidding themselves, or lying to you. But, I need something compact, in keeping with the idea and approach of the EVAC.

As I'm looking through the optics locker, I see my ACOG. Perfect. The quick-detach levers allow me to clamp it right on, no need to fuss around, and once I get it set for eye relief, I'm good to go.

For magazines, the EVAC is shipped with a Magpul 20-round magazine, which is as compact as the pistol itself. But I need more than just one mag, so I tossed some Mission First Tactical (MissionFirstTactical.com) mags into the gear bag, and had no complaints by the time I was done. The 20-round magazine is no longer than the Reptilia CQG pistol grip, so if you are

[Cont. to page 22]

TRIJICON ACOG

The Acog is all over US military small arms. It is a compact, 3.5X or 4X optic, with the reticle illuminated by means of a fiber optic, or fiber optic and battery setup. As an ultra-durable optic, it finally brought magnified optics into standard use as a military aiming system.

The Bindon Aiming concept (Glyn Bindon came by our gun club several times to show his new optics, back in the 1980s) is simply to use the bright illuminated center of the reticle, at speed, and at close range, instead of trying to figure out what you're seeing, at 3.5X or 4X. Keep both eyes open, and hose.

When I was at the Trijicon factory a few years ago, my guide walked me past a waist-high small-dumpster sized carton, filled with used Acogs. "What are these?" "Military returns for exchange." I had a moment to consider, and I said "You have a carton full of gold bars here. People will pay extra for a used, certified, surplus Acog, that may well have been to Iraq or Afghanistan, and back."

With a smile and a sigh, he told me: "The contract specifically says that anything that can't be re-built to new specs has to be destroyed."

Jesus wept. **FN**



The iron sights fold, and you pop them up by pressing the lock button. The built-in spring does the rest.



M4E1
MIL-SPEC

ENHANCING THE AR15 STANDARD

M4E1 LOWER RECEIVER

AERO
PRECISION **A**

25 YEARS
FOUNDED IN 1994

MORE IS BETTER

If you want a set of backup sights (and I do) then folding is the way to go. One thing Springfield did was make their folding sights relatively non-proprietary. As in, the front sight can be swapped out. So, in the interests of adding versatility, you might be interested in a Tritium front sight blade. XS Sights has a Tritium-insert front sight that replaces the existing post. They even include a front sight adjustment tool, in case you don't have one. (Or can't find any of the three to four you know you already own.)



The XS Sights Trijicon front blade for an AR-15, complete with the supplied front sight tool.



Since it is a blade, you can only adjust it in full-revolution amounts. Not a big problem, as problems of the world come.

The vial rides in a blade, and the vial is a vertical line, albeit a short one. It rides in a white panel on the front of the blade. Now, you have to remember that when you make a change like this, you are dealing with a blade, which means you adjust one full rotation. You may have to settle for your daylight iron sight zero being off a bit at 100 yards. The worst it can be is an inch and a half off at 100 yards, and that would be out of an M4gery carbine with its short sight radius. A full-sized rifle would be off an inch at most.

Truthfully, the majority of ARs out there are off an inch in their zero just because it is a lot of work to get the irons more dialed-in than that.

So, with the XS Sight Tritium Stripe front sight, you get an extra measure of insurance, a way to keep going, if things get really bad. **FN**



The Edge EVAC taken down and tucked into the transport case, which is so compact it is not obviously a firearms or skateboard bag.



With an EVAC in the case (and some magazines as well) and a coffee beverage, one is well-fortified for the day's work.

CHRONOGRAPH AND ACCURACY DATA

Ammunition	Bullet weight (gr.)	Velocity	Es	sD	Accuracy, Ave & best
Black Hills FMJ	55	2,168	71	25.9	1.85" / 1.55"
Hornady Interlock SP	75	2,012	8	3.3	1.7" / 1.5"
Federal Premium BTHP	69	2,047	39	14.1	1.6" / 1.2"

Accuracy results are averages of 3, 5-shot groups at 100 yards off a Caldwell Hydrosled shooting rest. Velocities are averages of 10 shots measured on a Labrador chronograph set to read 15 feet from the muzzle.

[Cont. from page 20]

transporting in a case, that's the magazine you'd want first up. But on the reload, go for the 30s.

As far as ammo is concerned, I just hit the highlights. I opted for a load that has shown consistent accuracy over time, and across various AR firearms, the Federal Premium 68 grain BTHP. I added the Hornady 5.56 SBR Black load, because I have found it to be a really soft-shooting and consistent load. And I added some plain old (but top-notch) 55 grain FMJ-BT, from Black Hills, because that's the kind of ammo that most shooters will be putting downrange most of the time. They all worked just fine, and the accuracy was very good, when you consider we're using a barrel that is just over one-third the length of the original system.

The gas system of the EVAC, being a pistol system, and with the gas port mere inches ahead of the chamber, ran like a top. Combined with the muzzle brake, the EVAC was pleasant to shoot, not at all what I had expected, as I mentioned earlier.

The Edge EVAC that arrived here came in a regular black Springfield-badged rifle case, appropriate for an AR-15 pistol, or an SBR. There's also a transport case (the one I got came separately) that holds the EVAC when it is fully dismounted. It has no markings on it, and if you were to walk down the average city street with it slung over your shoulder, it would appear to anyone looking as just a notebook case, with some extra space for cords, etc.

Now, just because it is a takedown pistol doesn't mean you have to take it down. If you want to use a

slightly larger case, you can leave the front half on the pistol, and the folded package is eighteen inches long. So, instead of it disassembled, and in a notebook bag, you can leave it assembled, fold it, and tuck it into a messenger bag. This is America, after all, you have options. Pick one and practice.

Now, putting it together from take-down is not a super-speedy operation. As a test, I started with the various parts on the bench, and timed myself to see how long it took to get it together. The trick here is simple; you use your left hand to hold the charging handle back (once you've unfolded the buffer tube to its locked position) and use your right hand to insert and rotate the forward half assembly. Spending time to lock the bolt back is just adding time. As a range process, fine, but in an emergency you'll want to save time, so practice.

Even fumbling, it was easy to get the forward half inserted, turned and locked, in under five seconds. Then, slap in a magazine and work the charging handle, and you are ready for emergency problem solving.

So, in the end, what do we have here? Besides the winner in "the most compact AR-15 pistol" contest, we have a high-scoring entrant in the "coolest AR-15 of any kind" contest. It is also a potentially very useful defensive tool, as well as one heck of a fun firearm for a day of just getting in some trigger time.

Springfield may see this as heresy, but I'm already poking at the muzzle brake and its mounting system, to see if I can take it off and install a suppressor. Of



The Springfield Edge EVAC comes apart much like your regular AR-15, with one difference: you have to push out both pins and pull the upper forward off of the lower. The carrier extension, required for the LAW Tactical folder, won't allow the action to hinge open if you just push the rear pin across. A small thing, but you'll get used to it quickly.

course, the problem will be finding one that can withstand the uncorking pressure of a 7.5" barrel, but that's a different problem.

In a world full of emergency tools to choose from, the Springfield Armory Edge EVAC should be high on your list, if not at the top of it. **FN**

SPECIFICATIONS **SPRINGFIELD ARMORY** **EDGE EVAC AR-15 PISTOL**

Type:	Self-loading, gas-operated pistol
Caliber:	5.56
Capacity:	30+1 round
Barrel:	7.5"
Length:	18" folded, 26.5" extended
Weight:	7 lbs. 3 oz.
Trigger:	4 lbs.
Finish:	Parkerized steel, anodized aluminum
MSRP:	\$1,949
Contact:	Springfield Armory, Springfield-Armory.com, (800) 680-6686

STOP WRITING TO THE ATF

It is a given that our illustrious editor is going to receive a bunch of letters admonishing me about having the arm brace of the Edge EVAC against my shoulder. "Don't taunt the ATF like that." Or, "Don't give the anti-gunners any more ammunition against us. I've got a clue for you: the anti's don't need any more. They'll just make it all up, anyway.

As for the ATF, every time the question comes up, someone suggests writing to the ATF, asking if it really, truly, actually, honestly, is not a doubleplus-ungoodthoughtcrime to occasionally or incidentally put the arm brace against your shoulder. It doesn't matter to some guy at your gun club that there is/was/always will be a card or letter in the box with the arm brace, a copy of the ATF letter, saying it is OK. No, they are going to write to the ATF and "settle the matter, once and for all."

Please, stop. Just stop.

A longtime friend of mine, who has spent his entire life in law enforcement, has a saying that is relevant: "If it wasn't written down, it never happened." The ATF wrote it down. They issued the letter. It is true. If they issue a letter on a subject, and they get no mail on the subject, as far as they are concerned, the matter is solved.

If, however, if they get a letter, two, ten, fifty, a week back on a subject, they clearly have to re-think this one. Or someone will suggest that since it wasn't clear the first time, they should re-clarify it. Dear god,

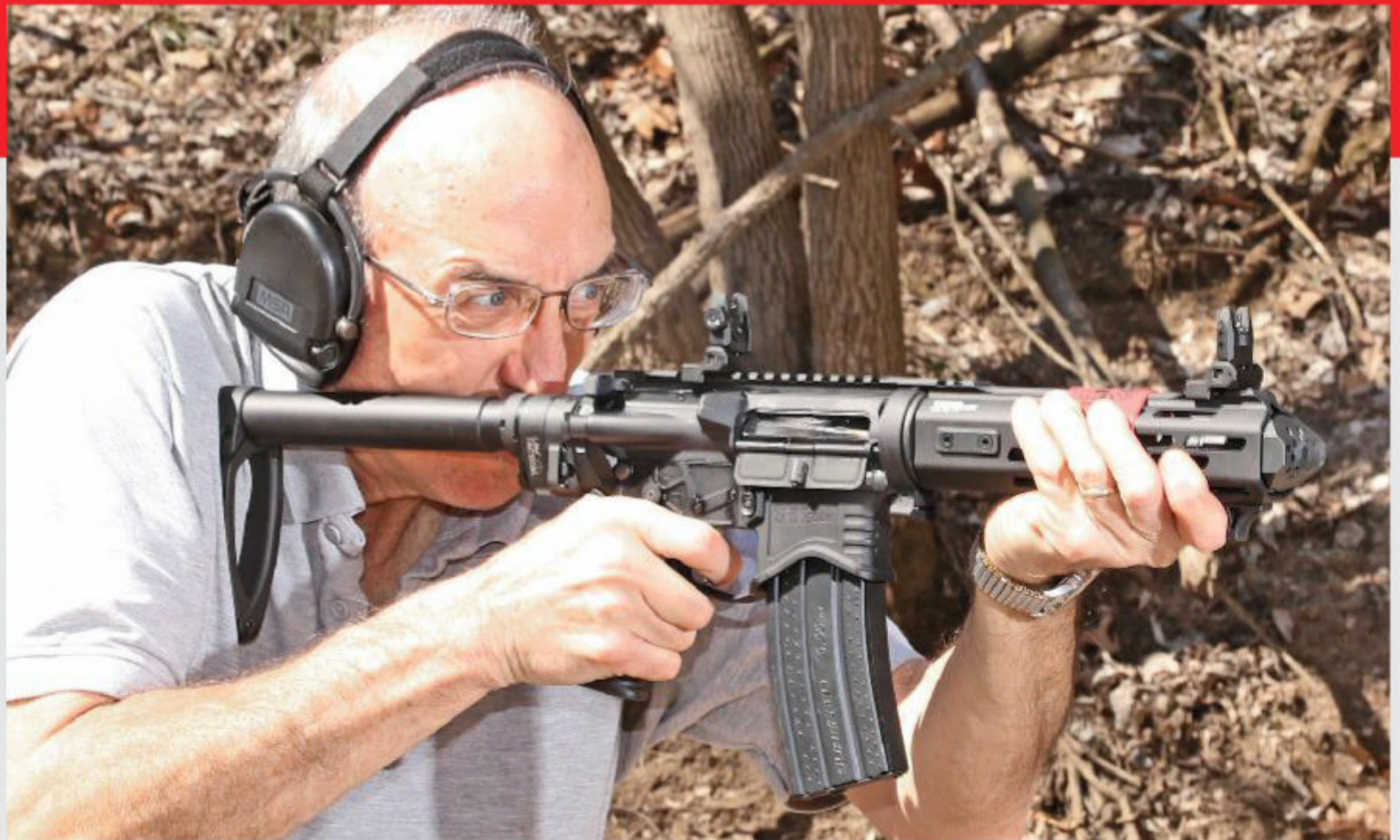

Stop writing the Editor, and the ATF, complaining about things. You're just making trouble.

no. Leave the subject alone. Stop writing them, or they will think they have to make it "clearer."

And while we're at it, stop writing the ATF asking how long your application for your suppressor is going to take. You are just delaying everyone when you do that.

When your letter arrives, someone has to open it, read it, see who has your application, and then walk it over to that examiner and hand it to them. That examiner then has to stop what they are doing, paw through the pile of applications, find yours, estimate

how long until they get to it, and then write you a letter back.

For god's sake, stop it.

None of the people involved can be processing applications while they deal with your pointless, time-wasting, annoying letter.

If you want to know how long it takes, there are no end of online forums where people have reported how long it is taking at the moment.

If you're going to waste time, waste your own, not the examiner's time. You're just delaying us all. **FN**



For cost to value, Tarr believes Geissele's new Super Duty rifles are the best on the market. This is a 16-inch version with OD Green anodizing.

Geissele Automatics is one of those companies whose impact on the firearms market is much larger than their sales would indicate. Thirteen years ago, Bill Geissele was making AR-15 triggers in his mother's basement; currently Geissele triggers are found in just about every rifle fielded by U.S. Special Forces. Geissele rails, triggers, and scope mounts can be found on everything from SOCOM M4s to the new HK G28 DMR. Geissele parts have been specified by the United States Army Special Operations Command (USASOC) for the new M4 Upper Receiver Group — Improved. And Geissele just secured the rights from Barrett to produce the M240 LW and M240LWS machine guns for the U.S. military. Geis-

sele Automatics makes just about every accessory you can think of for AR-15s including, now, complete rifles, and their workforce (including sister companies ALG Defense and Abraham and Moses Knives) now numbers over two hundred.

For this article I secured a sample of their Super Duty 16" Rifle, but in addition to a review of the rifle itself I wanted to detail how one small company in eastern Pennsylvania now seems to be the go-to factory and R&D department for U.S. Special Operations.

I've spoken to Bill Geissele at length several times about his company's history, and visited the Geissele Automatics facility. To understand the products, and the company, you also have to understand Bill Geis-

sele philosophy, which is best described as "I can make that better."

Folks, it ain't bragging if you can do it.

Let's start with Geissele's new rifle, and expand from there:

While talking to Bill Geissele several things become very clear: 1. He's a perfectionist, and 2. He makes products for two reasons: either because someone asks him to, or because he sees a problem with an existing product and wants to fix it.

"We have a donation program for the cops around here," Bill Geissele told me. *"Any police officer that comes into the shop with their gun we completely trick it out with Geissele*

THE GEISSELE 'SUPER DUTY' PHILOSOPHY

By James Tarr



**A LOOK AT THIS RIFLE AS WELL
AS THE MAN BEHIND IT.**

stuff for free. That goes for all local and federal LE stationed in the area. What we find is they're bringing us all these really cheap guns that don't run. Even in our own guns, to test our triggers, we've had rifles with problems. I've been so dissatisfied with the stuff out there, extractors that have a hook that is too shallow, a bolt stem over a thousandth under tolerance, you name it. We just decided to fix it all."

This was the impetus for Geissele to begin making complete rifles, first for police officers, and then for the commercial market. Geissele's Super Duty rifles are the company's top-of-the-line model, available in four different anodized colors — Luna Black, OD

Green, Grey, or DDC (Geissele's Desert Dirt Color, their version of FDE). Geissele shipped me an OD Green model to test.

This rifle starts with a cold hammer forged, chrome-lined barrel with a 1:7" twist and button rifling. It has a mag phosphate finish and is tipped with a Surefire SF3P flash hider which sports Geissele's Nanoweapon coating (more on that in a bit). This barrel has a somewhat lightweight profile and offers Geissele's "Super mid-length" gas system. What's that? It's slightly longer than a mid-length, but not as long as a rifle-length gas system.

BG: *Instead of dealing with standard lengths that you can just buy, we optimized the*

gas system length for each barrel. Optimized it using high speed video. We found a carbine length gas system works fine for 10–11" barrels, mid-length is great for 14.5", and for a 16-inch we optimized it with our Super Mid-length, which is about an inch longer than a standard mid-length gas system. It's a tremendously smooth shooting barrel, smooth recoiling and very reliable.

This and all the barrels found in Geissele's rifles are made by Geissele in-house. When I first visited their facility in 2018, they had just installed their barrel-making machinery and were still getting it up to speed, and had just over one hundred employees.



Designed to be better than the standard in just about every way, Geissele's Super Duty rifle is their top of the line model, and just about every metal piece on the rifle is made in-house by Geissele.



Now they're not just making barrels but complete firearms, and have two hundred employees.

BG: *The material comes in as a raw blank and we turn it into a rifle barrel. He have a forge. The only thing we're not doing in-house is the chrome lining. I'm very happy with the accuracy, we worked with them for over a year and half, making a lot of changes, before I was happy with how they shot. With factory 77-grain ammo, like Black Hills' Mk 262, it'll do about 1 MOA, plus or minus .1. With other*

common ammo, M193/green tip, the barrels will do 1.5-2 MOA. I'm very happy with how it shoots with regular ammunition.

We magnetic particle inspect every barrel. I think very few people mag particle their barrels. We had to have consultants come in and train our people how to do it, it takes a long time. MPing a barrel is not straightforward. First you have to get the proof rounds and you've got to proof it. Then when you MP it not only do you use the oil with fluorescent

Bill Geissele in his office in 2018, cradling one of the first Super Duty LE rifles which are sold only to law enforcement officers at a crazy discount. A full commercial line of Super Duty rifles soon followed.

The very first receiver for a Geissele Super Duty rifle (check out the serial number). And yes, Geissele is making their own lower receivers, they are not just having their name stuck on lowers made by someone else, as so many companies do.





carrier on the outside but you've also got to have a very special high-powered UV bore-scope that costs almost twenty grand.

The barrel free floats inside a 15-inch Geissele Mk16 Super Modular Rail. The Mk16 is a relatively new product for Geissele, and it was created for the USA-SOC (United States Army Special Operations Command) URG-I (Upper Receiver Group — Improved) project, which Geissele was deeply involved with. The URG-I is an entirely new upper receiver assembly meant to provide improved reliability, durability, and accuracy over the original M4 carbine top end, in addition to superior ergonomics, and the military specced both a Geissele handguard (the Mk16) and Airborne charging handle for this kit.

Offering a full-length MIL STD 1913 along the top, the Mk16 rail has M-LOK attachment slots all around. Geissele is known for making some of the strongest handguards in the industry, and compared to some of their previous offerings the MK16 is somewhat slim and light, but uses the same very beefy precision-machined Geissele barrel nut.

BG: *This was meant to be a rail for the warfighter, and it was a bit of an interactive design process. Those guys told me they wanted a slimmer rail, with M-LOK attachments all around, and they wanted a specific length — 13.5". A lot of these soldiers are 3-gun shoot-*

ers, and gun guys, and knew exactly what they wanted. For this Super Duty Rifle the rail has been extended to 15 inches.

The Mk16 has four tabs which interface with the receiver to prevent the handguard from rotating, and the disassembly screws are captive, so you can't lose any hardware if you need to remove the handguard. There are QD sockets machined at the rear of the handguard at the upper 45s for sling mounting.

Underneath the handguard you'll see Geissele's stainless steel Super Compact Gas Block, which is pinned in place (in addition to having set screws for an additional level of security) in what they call their "bombproof installation." If you look close at the top rear of the Geissele gas block, you'll see a stainless-steel pin set into a notch cut into the top of the barrel.

BG: *I don't feel that lining up a gas block with dimples and set screws is acceptable.*

Screws don't line anything up. They have clearance. If there wasn't any clearance, the screw wouldn't work. So, it is not an alignment system, but people expect that to line up their gas system with the upper receiver perfectly.

I don't like that, and I don't think that's right. We take every barrel, and we have a special fixture that works off an alignment dowel in the barrel extension. We get that exactly vertical and we put that small keyway right near the gas block, and our gas block has a small key that fits into that. That aligns our gas block perfectly with the upper receiver, and the set screws lock it into place, but they don't align it, the stainless-steel key pin does that. Then we put the cross-pin in the gas block as a bombproof installation. I'm very much into that gas block being aligned perfectly because a gas tube that's off to the side is gonna cause wear to the gas tube quickly, and when that starts to wear you're going to get blow-by and your gun isn't going to be reliable.

At the rear of the barrel is the bolt carrier group, and there Geissele has seen fit to improve over the



Geissele's first foray into firearms was being involved in the Upper Receiver Group — Improved project for the US Army's Special Operations Command. This is the end result, and the Geissele Airborne charging handle and Mk16 rail are part of the specs. The mid-length gas system on the URG-I was specifically chosen to provide longer bolt life when shooting the military's new high pressure M855A1.



In the Super Duty rifle you'll see Geissele's stainless steel Super Gas Block which has a tiny indexing pin at the rear which fits into a slot they've machined into the top of the barrel for perfect alignment.

standard AR-15/M-16 design as well. Inside this and every other Super Duty rifle is the Reliability Enhanced Bolt Carrier Group (REBCG).

BG: *Military guys tell me their bolts are breaking, they're only lasting 2,000–3,000 rounds (of the new high-pressure M855A1 ammo), so I decided to make this super bolt, the Geissele Stressproof Bolt. The bolt is actually constructed of a special steel, Carpenter 158 with ESR (electro-slag remelt) that makes the steel much cleaner and gives it a much higher fatigue life. We call it Carpenter 158 Plus. Carpenter steel is just down the road from us and we work very closely with them. I had to order 20,000 pounds of this stuff, but they cooked it special for me. The secret in the new bolt isn't just the kind of steel, but how it's manufactured.*

BG: *Our bolt is made from a forging. All other bolts are made from bar stock, most places take a length of steel rod and cut off pieces to make their bolts. We take a piece of steel and smash it between two dies and that aligns the grain flow, so the bolt is stronger, especially around the lugs. Most people aren't willing to do that, but we're willing to do things the hard way to get the best product.*

So many companies out there say they high pressure mag particle test their bolts, but they don't test every one, they just batch test, maybe one out of 500, but they mark each bolt as if it's been tested. That's what you're getting out there, and people don't realize they're getting snookered. We do every one.

You'll see the extractor is a different color from the bolt itself. The extractor is another Carpenter alloy, a special stainless steel called Carpenter 465. It is an extremely difficult alloy to machine. It is very popular in tools for orthopedic surgery, that steel will never shatter when it is put under stress, only deform. That makes it extremely strong and tough. Geissele expects this bolt to have five times the life of a standard bolt.

The cam pin is constructed of an advanced medical steel known as H13 which is also given a Nanoweapon coating. The coating combined with the new head slows down the cam pin wear in the upper receiver. It

The barrel is tipped with the very effective Surefire SF3P flash hider. Supplied for testing with the rifle (but not standard) are Geissele's new BUIS iron sights.



Geissele's Mk16 rail is held in place by two bolts. The barrel nut is beefy, but the rail is relatively slender for a Geissele product. Note the checkered receiver pin, which is also stainless and nitrided.

is also stronger so that cam pin should be are less.

As I mentioned above, the Surefire flash hider had been given a Nanoweapon coating as well. Bill Geissele had been in search of a "super" coating for his internal parts, and found it with DSL — Durable Solid Lubricant, developed by the U.S. Army. DSL is actually a PECVD (plasma-enhanced chemical vapor deposition) coating. Geissele calls it their Nanoweapon coating. It is applied in-house by Geissele's own coating company, NCC (Nano Composite Coatings). The bolt carrier, cam pin, and gas key on the SD BCG are coated with Nanoweapon.

BG: *We went to the scientists who developed the coating and they designed a special machine for us to apply it. It is extremely corrosion resistant, extremely slick, and extremely hard. It wears at a very slow rate. We have a carrier with 13,000 rounds through it and people can't tell the difference between it and brand new. It rejects carbon, so all your dirt and fouling will pretty much just wipe off. The Nanoweapon coating goes into the bore of the carrier so it doesn't need to be chrome-lined. You'll notice how smooth those gas rings run and that is due to the Nanoeapon coating.*

In addition to all of the above, the patented REBCG carrier has extended rails. The extended rails prevent the carrier from tilting inside the receiver, which helps a lot with reliability. Behind the bolt is Geissele's Super 42 braided wire buffer spring and their H2 buffer to soak up even more recoil.

Geissele's new Super Duty Bolt Carrier Group will be sold in combination with their Super 42 braided wire buffer spring and buffer as their Reliability Enhancement Kit (REK). Both come standard in the Super Duty rifle.



The Geissele Reliability Enhanced Bolt Carrier Group has been improved in just about every way, from the steel in the bolt to how it is made, the improved steel in the extractor and cam pins, and the Nanoweapon coating on everything.

The upper and lower receivers are 7075 T6 aluminum and built to Mil-Spec, with the standard, familiar case deflector and forward assist. The upper receiver has M4 feed ramps. While the upper and lower receivers themselves aren't fancy, just about every part in them has been upgraded over the standard G.I. offerings.

A huge improvement is the Geissele Airborne charging handle. This bilateral model has latches larger and much easier to use than the one-sided G.I. type, yet the handle is not so wide that it will catch on a soldier's webgear. The right-side lever does not stick out past the forward assist.

As he mentioned above, Bill Geissele has been sorely disappointed in the quality of AR-15 parts, and that includes all of the lower receiver components. This rifle comes with Geissele's Ultra-Duty Lower

[Cont. to page 30]



THE PERFORMANCE LEADER.



— *NEW* —
Q4 STEEL FRAME

Walther continues their tradition of superiority with a handgun designed specifically for those who only buy the best and nothing less. This is the ultimate representation of high-class performance in a concealed carry package that just can't be found anywhere else.

WaltherArms.com

© 2020 Walther Arms, Inc. | All Rights Reserved.



Here you see just a few of the upgrades from MilSpec — the receiver pins are checkered, stainless steel, and nitrided, the safety is bilateral with swappable levers, the Airborne charging handle is bilateral and oversized, and the pistol grip comes from B5 Systems.



The oversized trigger guard is Geissele's Ultra Precision Trigger Guard, CNC machined from billet aluminum and anodized to match the receiver. You'll spot the Geissele 'G' on the bottom.



Every Geissele Super Duty rifle comes with the B5 Systems' Enhanced SOPMOD Stock with compartments for spare batteries or bolts.



Super Duty rifles come with Geissele's Maritime bolt release, great if you're wearing gloves or a left-hander. Exclusive to these rifles is the SSA-E X trigger, with a bow halfway between a traditional curved bow and a straight trigger, with a 3.5-pound two-stage pull.

[Cont. from page 28]

Parts Kit. Key components are made from stainless steel, heat treated, then nitrided.

For a bolt catch you've got Geissele's oversized Maritime Bolt Catch, which has larger, checkered surface areas. It is much easier to use (especially when locking the bolt back) while wearing gloves or if you're a left-hander. The receiver pins and magazine release feature the same kind of aggressive checkering as the bolt catch, for a very nice matching look.

The safety is Geissele's Super Configurable Safety, which is a bilateral model. As it comes from the factory the right-side safety lever is shorter, and it doesn't hit your trigger finger when being disengaged. If you happen to be a southpaw, you can swap the levers. The oversized trigger guard is Geissele's Ultra Precision Trigger Guard, CNC machined from billet aluminum and anodized to match the receiver. You'll spot the Geissele 'G' on the bottom.

Exclusive to the new Super Duty 16" Rifle is the brand new SSA-E X with Lighting Bow trigger. This nanocoated, two-stage trigger features a wide body and bow shape halfway between a traditional curved bow and a flat-face trigger. It provides a two-stage, 3.5-pound pull and has no more parts than a standard G.I.-style trigger.

Black, Grey, and DDC rifles come equipped with the standard A2 pistol grip. The OD Green model I received comes with B5 Systems' Type 23 P-Grip, which has more material under the web of your hand, very aggres-

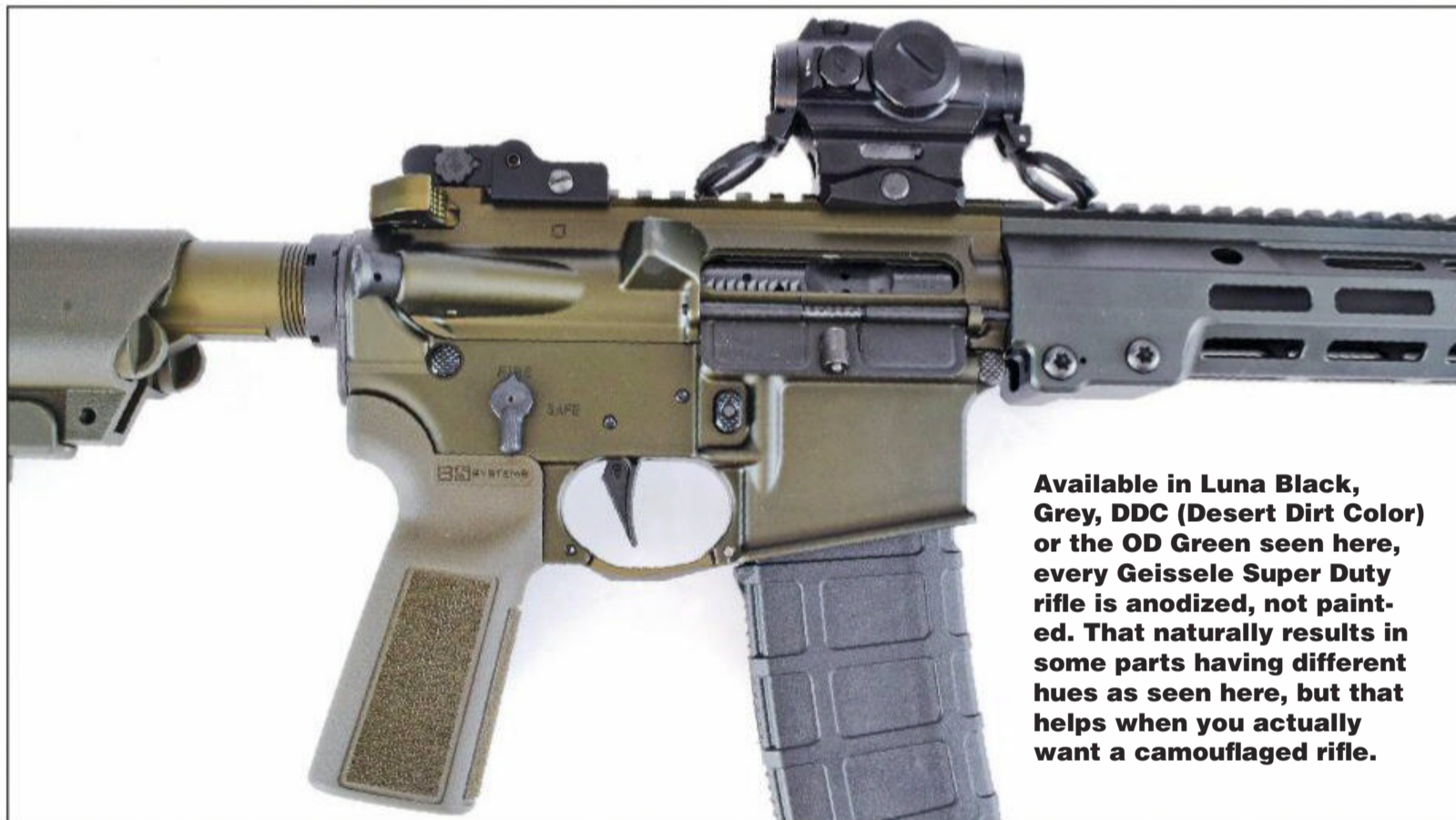

Available in Luna Black, Grey, DDC (Desert Dirt Color) or the OD Green seen here, every Geissele Super Duty rifle is anodized, not painted. That naturally results in some parts having different hues as seen here, but that helps when you actually want a camouflaged rifle.

sive texturing, and a more vertical angle. Every color rifle ships with B5's Enhanced SOPMOD stock which has two storage compartments which fit batteries and/or spare bolts. It also has a non-slip rubber buttpad. The buttstocks are all in matching colors to the rifle, except for the Grey rifle, which ships with a black stock.

This rifle is not supplied with any sights, but for testing Geissele sent me a set of their Folding BUIS sights. These aluminum-bodied sights are like most Geissele products — not fancy, but solid, functional,

and tough enough for combat. As in, I'm pretty sure I could bang on them with a hammer and while afterward they wouldn't be pretty, they'd still work. Flip them up by hand, and they lock in place. To unlock them, you push sideways on the body of the sight itself, there are no small buttons to break or get clogged with dirt. A set of these sights retails for \$200.

A trip to the range provided absolutely no surprises — the Super Duty rifle was soft-shooting, and with most ammo it averaged 1-2 MOA. The Surefire flash

[Cont. to page 32]

Load	Bullet Weight (gr)	Velocity	SD	Avg Group
.223 REMINGTON				
Hornady V-Max	55	2930	29	1.46
Wolf FMJ	55	2903	28	1.94
Federal Fusion SP	62	2777	23	1.07
Black Hills OTM	77	2623	33	1.19
5.56 NATO				
Frontier Ammo FMJ	55	2955	37	1.88

Accuracy results are the averages of four five-shot groups at 100 yards from a sandbag rest. Velocities are averages of ten shots measured with an Oehler Model 35P 12 feet from the muzzle.

800-338-3220 | HORNADYSECURITY.COM



RAPiD® SAFE READY VAULT™



Touch free entry uses patented RFID technology to unlock the safe faster than keypads or biometrics.

Metal interior peg walls with patented gun racks offer flexible storage.



Heavy-duty steel housing and five hardened locking lugs provide confident protection.



Patented dual-purpose gun racks accommodate up to 8 long guns and 14 handguns by utilizing the space between barrels.



Control all your RAPiD® Safes with the same RFID tag.



Bill Geissele standing in front of a machine bought through government surplus. This machine sands smooth the surface of steel plates that will become Abraham and Moses knives, a sister company run by his sons.

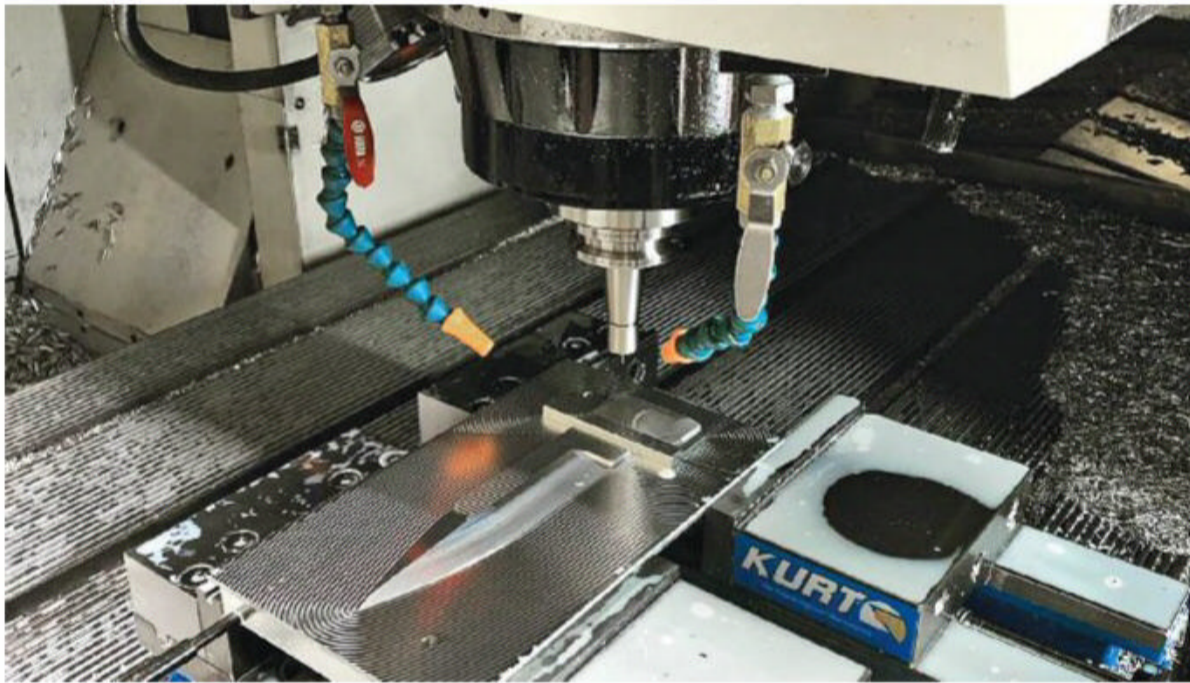

A milling machine hard at work at Abe and Moe knives inside the Geissele factory.



Tarr in front of the control panel of a 7-axis CNC machine in the Geissele factory. Or an espresso maker. He honestly has no idea.



Bill Geissele standing in front of an old-school Okuma Milling machine which just celebrated its 27th birthday.

[Cont. from page 30]

hider is very effective, but if you wanted to run this rifle in competition a good muzzle brake would totally kill what little recoil there is, and you would not have to swap out the trigger, the SSA-E X is fast, light, and crisp.

For everything but accuracy testing I topped this rifle with SIG's ROMEO 4T red dot. This is a very interesting piece that's been adopted by some serious warfighters — check out the sidebar.

My range time was once again affected negatively by this strange climate change event which seems to happen every year around December in Michigan, resulting in not just colder temperatures but sometimes, actually, snow. Where's global warming when you need it? Still, I had a great time pounding USPSA silhouettes out to 100 yards just about as fast as I could pull the trigger, and clanging a few pieces of steel here and there.

Because Geissele makes just about every part on this gun and you don't have to pay for a middle-man, I feel this rifle provides a remarkable value. Out of any other company it would cost twice as much, and still be worth every penny. While it really isn't

a sub-MOA match rifle on the accuracy side, when it comes to reliability I would stack this rifle up against any AR made by any other company, no matter the cost.

Now, for a bit of history. If you're not sure how Geissele Automatics came to be, it all started with one trigger, the Hi-Speed National Match.

BG: *I had been shooting High Power for years, Service Rifle, shooting an A2. And at that time there were no good triggers. They would always go south. I tried everything.*

I started looking at the Milazzo-Krieger and was told it requires gunsmith installation. It literally took me a day to install, it was a nightmare. But I learned how it worked, figured out how to make it run, and my friends would bring me their triggers to get them tuned up.

Then one day I said I wonder if I can make a trigger that's better than this. And that's what I decided to do. I took everything out there, all the positive stuff from every design, and put it into my trigger, which was the Hi-Speed.

In 2004 I went to Camp Perry, a month after I met my now wife Amy. I brought my triggers with me including one in my gun. I was shooting very good, and was squadded with Lance Dement from the AMU (Army Marksmanship Unit). Afterward I showed him my trigger, and he told me to show it to the guys at the AMU trailer, which has a mobile machine shop in it. Gene Clark, the head gunsmith of the AMU, checked it out and liked that it used a full-power hammer spring.

While I was there the Commander of the AMU came up, examined my trigger, and he said that's just what we need. What I wound up doing was giving the Commander one of my triggers and he put it in his gun and he finished out the rest of his stage with my trigger. Five months later they called me up and asked to buy six triggers from me, and that was my first military sale, January 2005.

What I didn't know was that the AMU is the R&D shop for the part of the Army that does a lot of the doctrine. The Infantry Board

SIG ROMEO4T

Over the past ten years or so SIG Sauer has expanded into just about every firearms-related market segment. One line of their products that doesn't get much attention is their electro-optics. I think there's two good reasons for this — their initial efforts at optics kinda sucked (that's a technical gunwriter term) and they don't seem to market them well.



SIG has a number of versions of their ROMEO4 red dot, but the ROMEO4T is built to military specs, comes with everything you see here, and offers you four reticle options. Which is why it was adopted by SFOD-D "Delta Force" and other high-speed units.

Their current optics, however, do not disappoint. As perhaps the best example of this, I give you the SIG ROMEO4T. Now, I will be the first to admit SIG has caused problems for themselves because there are currently four versions of the ROMEO4, and there used to be more. Not all ROMEO4s are created equal, but SIG does a poor job explaining those differences and why, even though the 4T costs nearly twice as much as the 4DR, it's worth it.

Short answer — the ROMEO4T is built so tough, with such great features, that SFOD-D (otherwise known as Delta Force) recently adopted it. This was not announced, but I know people who know people. The SpecOps community is like a small town, everybody knows everybody's business, which leads me to this tidbit....You know that SAS trooper who went all Die Hard on the terrorists inside the hotel in Nairobi a year ago? Not only is his official nickname Obi-Wan Nairobi, but the optic spotted on his carbine was a SIG

[Cont. to page 34]



Just thought it was a very cool image, off Geissele's Instagram.



This clock is an exact copy of the clock found in the headquarters of a very elite military unit, showing the time zones where their troops are deployed. Bill Geissele has it and several others mounted around the facility to remind his employees that the products they make help save American lives.

is down the street, and wanted the AMU to build them .308 gas guns so they could evaluate the concept of a semi-auto sniper rifle. The AMU built 6 AR-10-type rifles on Armalite receivers and these were the first SASS rifles. Proof-of-concept SASS, and that gun had my trigger in them, that's what they wanted those six triggers for.

At this point Bill Geissele was in his late thirties, and had seen more of the world than most veteran spec-ops troops in one of the most interesting career paths I've seen....

BG: *When I was fifteen and living in rural New Jersey there was a guy in our church who owned a one-man-band machine shop. He taught me just about everything I know when it comes to machining.*

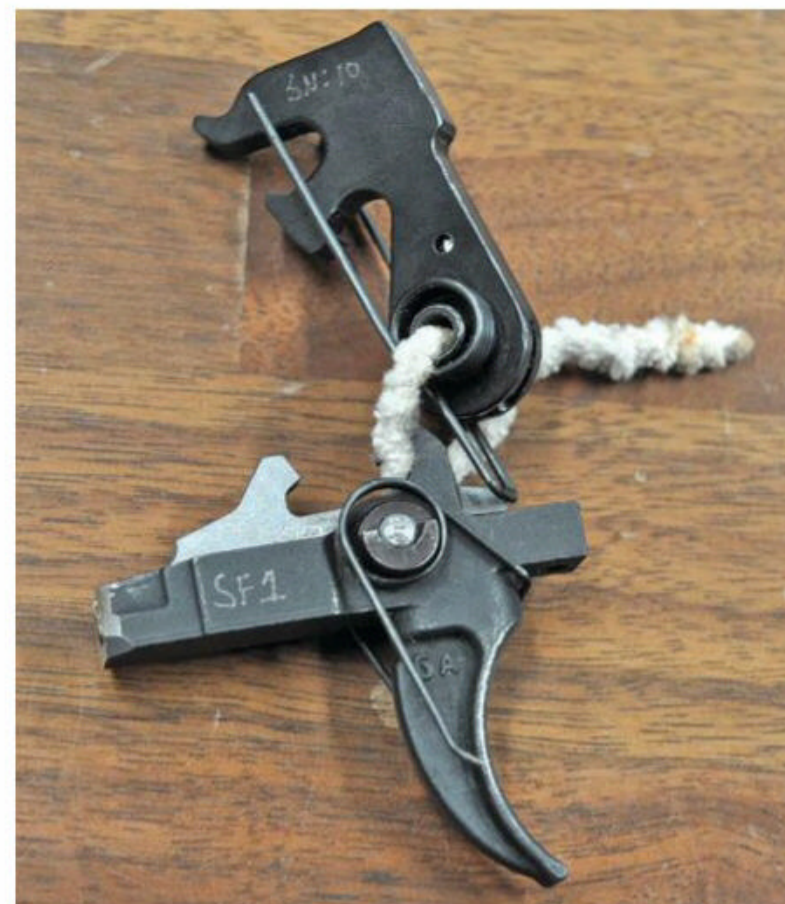

The very first SSF trigger prototype made by hand by Bill Geissele from one of his Hi-Speed triggers for an unnamed elite military unit.



A 3D-printed prototype of Geissele's first rail design, for the HD 416. Note the "NOT FOR COMBAT USE" etched on it.

I decided I wanted to be an engineer and started going to community college. I worked and went to school part time at night. I got a job at a big machine shop in Chester PA. They did a lot of big work, paper mill equipment, huge industrial pieces. All the machines were gigantic and I worked in their field service dept. After two years of doing this I ended up getting a job in the mining industry. As I interviewed with all the engineers and management people, they only had one question for



Bill Geissele is an avid collector of surplus military vehicles, and the lot behind the factory is strewn with them. Photo with yours truly.

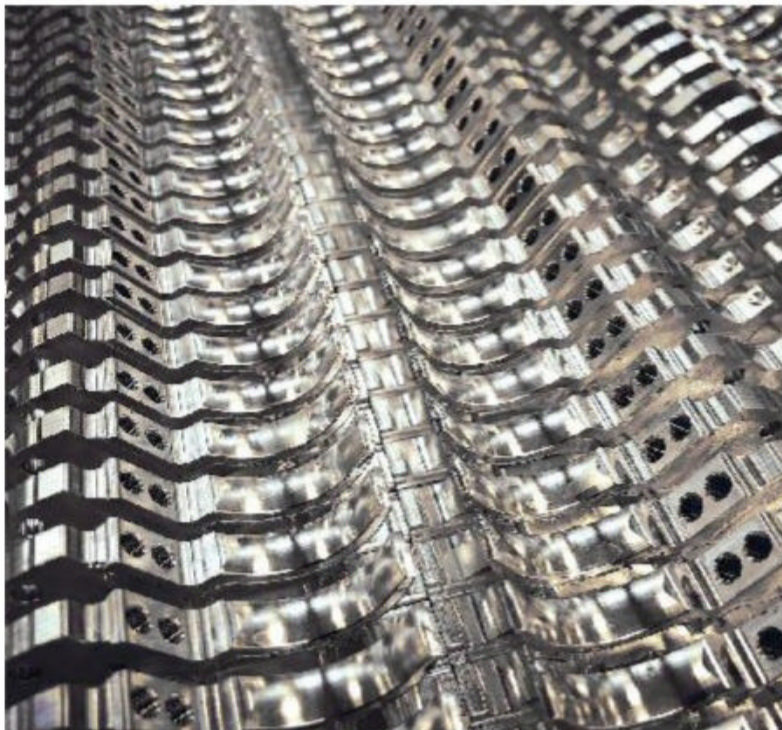

Hundreds of Geissele's new trigger for the Remington 700, in the white.



Freshly machined Geissele rails, in the white, waiting for assembly.



A selection of Geissele's Airborne charging handles.



Two bins full of Airborne charging handles at the Geissele factory, done in their DDC anodizing, which stands for Desert Dirt Color.

me: Can you travel? I didn't have a family, so travelling was no problem.

The company sent me all over the US and world to work on mining equipment. I went to Canada, all over South America, Southeast

Asia, Australia, Indonesia, China. I worked at a lithium mine in Chile in the middle of the Atacama Desert, back when mining lithium was brand new. You're on your own, you need to fix it, you've got to figure it out, usually

[Cont. to page 36]

[Cont. from page 33]

ROME04T. Don't think that wasn't noticed. This sight is also being used by several federal law enforcement agencies.

Okay, so why are Premium Ninja MultiCam Deathstalker types running the ROME04T? Let's look at the specs.

First, this is a non-magnified LED-illuminated red dot, and in size and shape could be compared to the Aimpoint Micro. The housing is 7075 aluminum. The battery compartment is on the right, and the rubberized brightness control buttons are on the left side of the body. The 4T has an IPX-8 waterproof rating, which means it can withstand 30 minutes of submersion at 66 feet (20 meters).

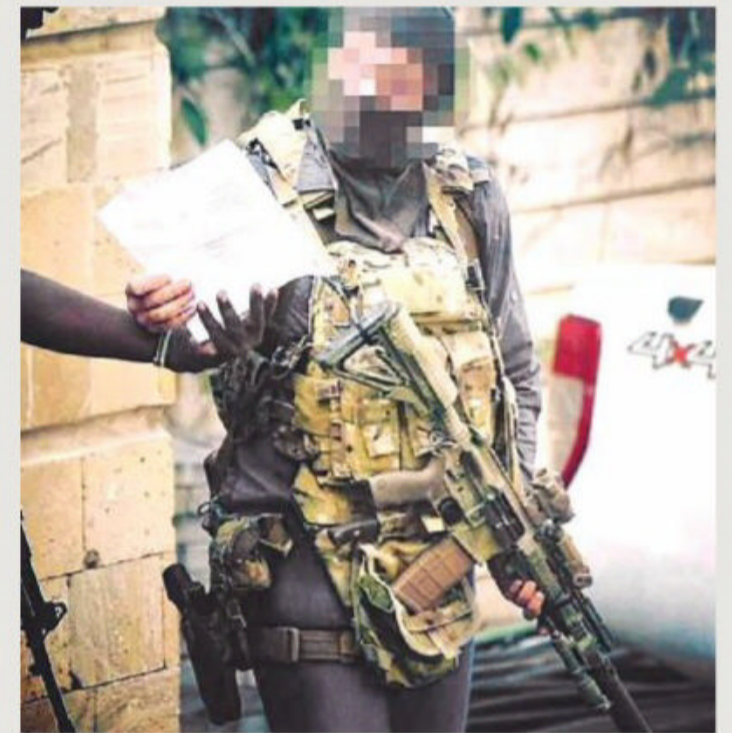

The SAS trooper seen here who went all Die Hard on the terrorists inside the hotel in Nairobi a year ago? Not only is his official nickname Obi-Wan Nairobi, but the optic spotted on his L119A2 carbine was a SIG ROME04T.



It is powered by one CR2032 battery (provided), but also has a solar panel atop it. The two combined can provide up to 50,000 hours of continuous use at a medium setting. Combined with SIG's MOTAC (motion-activated illumination control that shuts it down or powers it up depending on movement) the battery life can be extended to 100,000 hours. There are 10 daytime and two night vision brightness settings.

As it comes from the factory the 4T is on a flat-top AR mount that puts it at co-witness height. It wears see-through flip-up lens covers front and rear. Also supplied with the sight — a spare flip-up lens cover, a honeycomb kill flash for the front lens, low- and medium-height M1913 mounts, a rubber bikini lens cover, an adjustment tool, and a nice box with slots for all of the above bits and pieces.

I haven't even gotten to what I think is the best part — this optic gives you the option of two different center reticles, with four different reticle

[Cont. to page 36]



UINTAHPRECISION.COM   



**TRUE BOLT ACTION
AR10 / AR15
RIFLES & UPPERS**

*To pull off something big,
you have to pull off something small.
Over and Over again.*

Perfect rounds are crafted, one by one. In machines, calibrated to a hair, then a breath. With components, sourced from the best across the country. We sweat every detail. Rework every imperfection. Move a millimeter at a time. That's what we signed up for when we set out to make the best ammunition on Earth.



WWW.BLACK-HILLS.COM

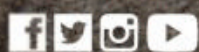

**TO LOCATE A DEALER NEAR YOU,
PLEASE CALL 800.568.6625**

[Cont. from page 34]

options apiece, however SIG does a horrible job explaining them. Let me try —

First, you have to choose between a Circle-Dot or a CirclePlex. If you choose the dot, you get a 1 MOA center dot for your four reticle options. With the Plex, you get a small crosshair. Now, for your four different reticles:

There's the 1 MOA dot (or plex), a circle dot/plex, a dot/plex with holdovers, and a circle dot/plex with holdovers. The circle dot reticle should be familiar to anyone who has used an EOTech HWS. The outer ring has hashmarks at 3, 6, 9, and 12 o'clock, and has a diameter roughly the height of a bad guy 100 yards away, so it can be used for rough range estimation. The "hold-overs" are simply three additional dots below the center one for holdovers on distance shooting. Hold down both brightness adjustment buttons to cycle through the reticle options.

The SOR43031 model, which is what I tested (circle dot, in black), is their most popular model. As it came from the factory (flattop co-witness mount and flip-up covers attached) and battery installed, it weighed 6.9 ounces, which is an ounce less than the factory published specs. Black models of the ROMEO4T are \$719.99, and the FDE model is \$749.99. **FN**

[Cont. from page 34]

working with people who don't speak English, and there were no cell phones. I'd go into places and nobody could speak English. I learned how to pantomime and act out so people could understand me.

I worked a very long job in Russia up near the Arctic Circle and earned enough money to take time off from the job to finish up my bachelor's degree in mechanical engineering. I went back to the company and ran the department I had started in.

Eventually the company came to me and asked me to become a field service manager for the country of Chile. I saw that if I did this I could make good money, but I wouldn't be able to come back home to the US that much, and my mom was getting older. If I went to Chile I knew I'd end up getting married to a girl down there. My life would be down there. I was 35 at the time, and I decided not to do it.

I got a design engineer job in the railway industry June 2001, and moved back in with my mother, who'd become ill. I designed components for track. Now all of a sudden, I'm in design engineering, I'm using 3D CAD. Within six months of being there I solved a design problem that had stumped the railway industry for 25 years and got a patent out of it. I learned later that product saved our company, although nobody ever told me at the time, and I eventually realized the company wasn't going to take care of me.

Enter the Geissele Hi-Speed National Match Trigger, and his first six-unit sale to the U.S. military. And word started getting around.

BG: *At this point I'm making triggers in my basement, actually my mom's basement, by hand. I still had my railroad day job. The company insisted everybody take an hour lunch. So, I would quick eat lunch, drive over to one of the idle factories in this big industrial park and sleep in the parking lot. Every day in my car I got twenty minutes' sleep and would have my wife call me to wake me up. I worked the rest of the afternoon, left work at five, got home, ate dinner, napped on the couch until 7:30, and then would work until one or two in the morning on triggers.*

I worked every Saturday and Sunday. I was chronically sleep deprived, but this is what it took for me to do this business.

During my tour of Geissele's facility in 2018 (which is a former pottery factory of all things) I wasn't allowed to photograph most of the place due to ITAR issues. As I was shown around the facility I observed that every piece made by Geissele was hand-inspected at every step of the manufacturing process from CNC machine to final assembly.

For lunch, we met up with Bill Geissele's wife Amy and headed to the Purple Meteor Canteen, the in-house café helmed by a local chef, where every employee gets a free breakfast and lunch, the java is from Black Rifle Coffee Company, and the TVs are tuned to One America News Network, which I'd never even heard of until then. It's the little things like that which make an impression, like every female Geissele employee getting fresh flowers on her desk every Monday.

BG: *In 2006 I got calls from the guys in the Army. They said they got my name from Gene Clark, and asked if I made triggers for an automatic weapon. I said I don't, but I can.*

While I hadn't made any yet I had designed the SSA the summer of 2006. It was designed to be a non-adjustable combat trigger. I worked and made prototype select-fire triggers for these people, who wouldn't identify themselves. That trigger became the SSF. These Army guys came to visit me in my basement shop in my little row house, toting big gun cases, and they had to walk past my washer and dryer to get to my work space, but they didn't bat an eye.

They pulled out a bunch of guns including M4s, HK416s, and a SCAR. You have to remember at this time, I'd heard about a SCAR, but I'd never seen one. And they adopted my trigger. It led to a long and fruitful relationship with this organization.

Geissele declined to identify the specific Army unit he was working with, but at that point in history there really was only one Spec-Ops unit that was fielding SCARs and HK416s, and they are considered the top of the food chain. It was their adoption of his triggers — and word getting out about that — that put Geissele Automatics on the map.

BG: *I was talking to one of the program managers at Fort Bragg and he mentioned that they needed a new rail for their HK416s. We got into the rail business by making rails for them because nobody else wanted to do it. Once we did it, one of the guys said, "You should make a rail for an M4," ... and the business just started moving along.*

I was down at Fort Bragg, talking, and one thing led to another and the Super Precision Scope Mount came about in the exact same way. It was built for them, at their request.

The firearms industry is filled with geniuses and idiots, nice people and horrible people. Bill Geissele isn't just a design genius, he is genuinely is one of the nicest people you'd ever want to meet. And humble. His wife has the nice office in the building; Bill's desk, on the other hand, was rescued from a neighboring business' Dumpster. Seriously.

Geissele Automatics is far from tapped out. In addition to being thrilled to work on the new M240LW/LWS weapon system with the military, Geissele and Surefire have teamed up on a project designed to modernize the AR-15/M-16/M4 from the inside out. I suspect the best it yet to come.

James Tarr is a longtime contributor to *Firearms News* and other firearms publications. He is also the author of several books, including *CARNIVORE*, which was featured on *The O'Reilly Factor*. His current novel, *Splashback*, is available now through Amazon and Barnes & Noble. **FN**

SPECIFICATIONS GEISSELE SUPER DUTY RIFLE 16"

Caliber:	5.56 NATO
Weight:	7 lbs, 1 oz
Overall Length:	34.0" (stock collapsed) 37.25" (stock extended)
Receiver:	Forged aluminum
Barrel:	16.0", CHF, chrome-lined, mid-length gas system, 1/7" twist
Gas block:	Geissele super compact
Muzzle Device:	SureFire SF3P
Stock:	B5 Systems Enhanced SOPMOD
Pistol Grip:	B5 Systems
Handguard:	15" Geissele Mk16
Charging handle:	Geissele Airborne
Trigger:	Geissele SSA-E X two-stage, 3.5 pounds (as tested)
Sights:	none, Geissele BUIS as tested
Accessories:	1 30-round magazine
MSRP:	\$1,599
Manufacturer:	Geissele Automatics, Geissele.com

CONCEALED CONFIDENCE™

FOBUSHOLSTER.COM

- Rapid Draw
- Innovative Active & Passive Retention
- Maximum Comfort & Concealability
- Durable Injection Molded Polymer
- Hundreds of Holsters and Mag Pouches



ISRAEL'S LEADING HOLSTER MANUFACTURER SINCE 1978

©2020.FOBUS International Ltd. All rights reserved. Company names other than FOBUS International Ltd. shown herein, and such other companies' respective product names, may be trademarks of such respective companies.

F R E E D O M

MSRP \$395.00 "R" Models



Great Silencer, Great Price

SILENCE... IS GOLDEN

3 RING SILENCER CORPORATION

www.3RingSilencer.com • (215) 949-8378

Amazing Upgrades At Affordable Prices



LRC™ Thumbhole

700 AccuBlocks® #1 Accuracy Upgrade

10 Min. Install



M50™ Adjustable

ONLY \$188

Aluminum Bedded!



Accublock™ Aluminum Bedding System

Great Upgrades For Resellers!



LRC™ Vertical Grip

LRC™ Sporter

Promo Code 188LRC (Or Call)

Genuine Remington 7/700™ BDL / CDL / VLS Stocks



BDL / CDL / VLS Varmints & Sporters

\$228 SALE

Choice of Many Colors

Standard or Magnum

EXPERT SERVICE

Stocky's

ph (561) 584-8500 America's Gunstock Specialists!

www.NewRifleStocks.com

INSTANT SHIPPING



**AR-15
pistols are
the new
hotness.
You have to
have one.**

BRAVO COMPANY PISTOL UPPER IN .300 BLACKOUT

Keeping Up with the Joneses — Build What You Need

By Patrick Sweeney

I regularly correspond with a group of people by means of a method so old it is almost archaic. Retro, even. Called an email digest, this one has for its members two essential requirements: that you be a Gunsite grad, and that you want to be in the group. Recently, one of the members attached a photo of his latest build. It was, simply, an AR-15 pistol, with folding arm brace, short barrel, and chambered in .300 Blackout.

Much discussion ensued, pertaining to handling, performance, terminal effectiveness, and the usefulness of bigger-than-.224" bullets on vehicles, glass and other chance obstacles. All the while, I'm thinking "that's a pretty cool setup, I wonder" and by the time we were done, it was an assignment.

OK, time for a bit of background, and explanation.

The .300 Blackout is the twin to the .300 Whisper, and yes, they can, in many firearms, be used interchangeably. The design constraints were simple, and for those who want to argue, go through the exercise yourself; first of all, it must use a standard AR-15/M16 bolt. It has to work in unmodified AR-15 magazines. It has to hold a full-weight .308" projectile in the right spot to fit the magazine and feed, and it needs as much case capacity as is possible, to allow for flexibility in loading ballistics.

If anyone comes up with a solution to those constraints, that isn't a clone of the Blackout or Whisper, let us know.

Once you have a subsonic thumper designed, then loading it with lighter bullets makes for a really useful and compact firearm. With 110- to 125-grain bullets, the .300 Blackout becomes a near-equal to the .30-30 and its loads with lighter bullets. Comparing favorably to the .30-30 is never a bad thing.

The AR-15 pistol part is easy: if you start with a lower receiver that has never had a stock on it, you can build it as a rifle, or as a handgun. This has always been the case, but the AR-15 pistol got new respect with the folks at SB Tactical when they came up with



The ultra-compact .300 Blackout AR-15 pistol, starting with a Bravo Company upper.



The SB Tactical SBA3 brace is a fine piece of gear, and my favorite arm brace.



Now that the world is virus-ridden, zombies are almost quaint. But this Mega Arms lower soldiers on, having spent all its time as a test-mule pistol.

the idea of the arm brace, allowing for actual one-handed aiming and firing of the AR-15.

After a little uncertainty in the beginning, the ATF has ruled that using a firearm in a manner that it was not originally designed for does not change its definition. If you think that is not logical, follow the logic of changing use to the end: handguns were originally designed to be fired with one hand. If changing the way they are used changes the definition, then we are no longer shooting a "handgun" when we shoot in the manner that Jeff Cooper championed. We would be shooting a "handgun."

The rational result is that an AR-15 pistol, if you happen to momentarily, inadvertently, or accidentally place the back end of the brace against your body while shooting, you have not changed the definition of the object.

For this project, I rang up SB Tactical, and they were kind enough to send me one of their SBA3 arm braces. The SBA3 fits onto a regular carbine buffer tube, and that is an aspect we must go into in some detail. As above, your lower receiver must not have ever had a stock on it. And there is an aspect of purchase that you also must attend to. When you pick up



Back when it seemed like zombies were an entertaining diversion, we had lots of options for markings. The paint on the lower is from an earlier project, when this was a test-mule pistol lower.



The Bravo Company upper, with their front sight, showing the pistol-length gas system.



BCM makes their rear sight so you get to choose which is the default; large or small aperture. I prefer large.

MISSION FIRST TACTICAL

MFT makes all kinds of AR accessories, but the one of interest here is one of their magazines. In the course of piling gear up for the range trip, I peered into the magazine bin and spotted an MFT mag. "Cool, add to the list." When I got to the range, I realized just which one of the MFT magazines I had grabbed. Some years ago, I did an article where I shot various AR-15 magazines with a shotgun. What I found out was that as long as it was birdshot, and I was 20 yards or more away, the magazines survived.

This MFT mag was one of the closer tests, and one lone pellet had dented the polymer tube just enough to bind the follower. So, back then, I simply

took the mag apart, reached in with a big sharp knife, and shaved off the dent. The mag has worked flawlessly ever since.

Lots of magazines survived the experience, and I continue to use them, when I encounter them in the magazine bin they happen to be in.

It was fun remembering that experiment, and to also remember that we live in a golden age of AR-15 magazines. They used to be expensive, fragile, temperamental, and closely guarded. If you had mags that worked, you didn't loan them, not to *anyone*. Today, finding reliable magazines is as easy as falling off a log. **FN**



The Mission First Tactical magazine I so heinously abused some years ago. Despite the shotgun pellet marks, it still works just fine.

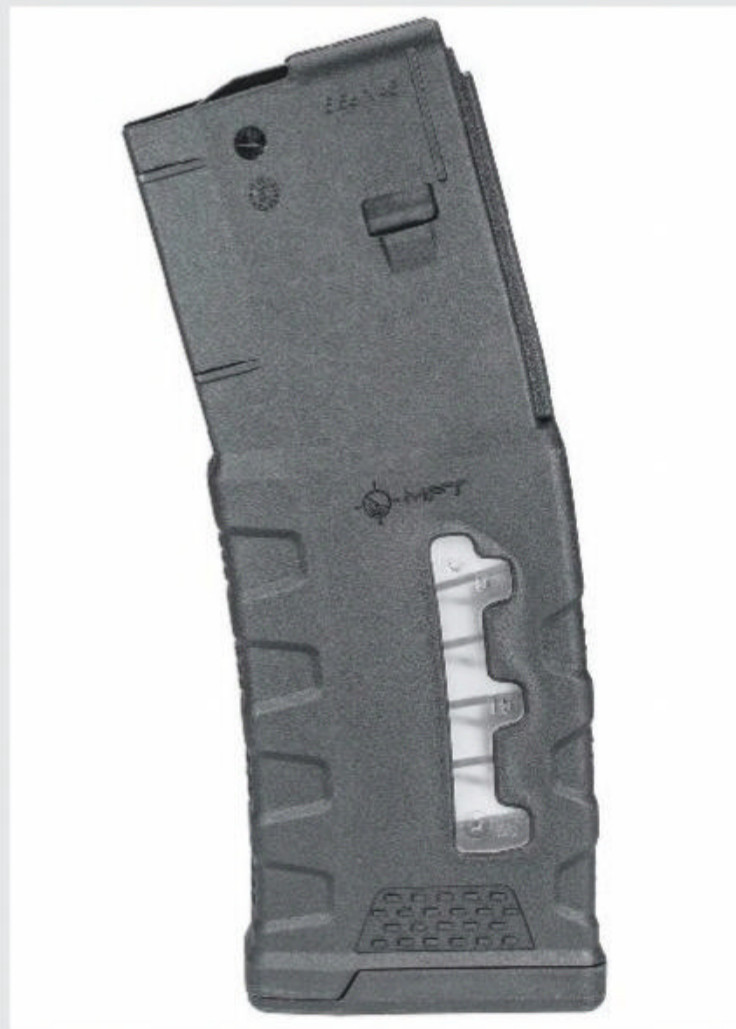

This is MFT's Extreme Duty Window 30-round magazine. If you want a beefy magazine which can take a ton of abuse, this is it.

your stripped lower at the gun shop, you'll have to fill out a form 4473. In section B, question 16 requires that it be identified as "handgun" "rifle" or "other." Either handgun or other are fine. If it leaves the shop having checked the 4473 as a declared rifle, the moment you put a barreled upper on it with a barrel less than sixteen inches, you have made an SBR. (Short-Barreled Rifle) It doesn't matter that you haven't put a stock (or any buffer tube at all) on it. It doesn't matter that your intention was from the beginning to make it a pistol.

You called it a rifle when you picked it up, and a rifle it will always be. So, don't make that mistake.

You can make a pistol a rifle, but not the other way around.

This particular lower is a Mega Arms made back when we were having fun contemplating the zombie apocalypse that was going to destroy civilization. (Now we've got a flu epidemic that is destroying the economy, and it doesn't seem like so much fun.) It arrived here as a bare lower, and I put a simple tube buffer on it, as an AR-15 pistol back in the days before arm braces were invented. Since it wasn't going to be anything exotic, I just dropped in a standard mil-spec trigger, hammer and such, and put a basic A2 pistol grip on it.

The initial build was an 11.5" 5.56 upper that had an A1 carry handle on it, because that's what I had. It later got separated, and the A1 upper went into a Retro build, while the pistol lower languished in the safe. (That's the life that some gun writer guns live: built and re-built.)

When it came time for this project, I took a Bravo upper in .300 Blackout that I had gotten for a different project, to match up with this lower. And therein we see the appeal of the AR-15 to many people: you can, as long as you pay attention to the legal and mechanical details, make your AR-15 pretty much whatever you want it to be.

The Bravo Company upper is not the only one they offer, not even just in .300 Blackout. But for this project, it was perfect, and Bravo attends to the details, so you won't have to.

OK, we're part of the way there. The upper, coming from Bravo as an assembled upper, needed no extra work on my part. (Thank you. Bravo, for making it

[Cont. to page 42]

Advanced Mounting Solutions Ultra-low, Forward Optic Mounts for M-14, M1A, Mini-14, M1 Carbine, AK, and M1 Garand

Patented, combat proven rail systems, optics,
stock kits & grips.

"Because Good People Need Better Weapons"



UltiMAK™ 2216 S. Main, Suite B2
Moscow, ID 83843
208-883-4734
www.ultimak.com
Enhanced Performance

Discovered! Unopened Bag of 138-Year-Old Morgan Silver Dollars

*Coin experts amazed by
"Incredible Opportunity"*

The Morgan Silver Dollar is the most popular vintage U.S. coin. The Silver Dollar of the Wild West, the Morgan went on countless adventures in dusty saddlebags across the nation. Finding a secret hoard of Morgans doesn't happen often—and when it does, it's a big deal.

How big? Here's consultant to the Smithsonian® Jeff Garrett:

"It's very rare to find large quantities of Morgan Silver Dollars, especially in bags that have been sealed... to find several thousand Morgan Silver Dollars that are from the U.S. Treasury Hoards, still unopened, is really an incredible opportunity." -Jeff Garrett

But where did this unique hoard come from? Read on...

Morgans from the New Orleans Mint

In 1859, Nevada's Comstock Lode was discovered, and soon its silver made its way to the fabled New Orleans "O" Mint. In 1882, some of that silver was struck into Morgan Silver Dollars, which employees then placed into canvas bags...

The U.S. Treasury Hoard

Fast-forward nearly 80 years. In the 1960s, the U.S. government opened its vaults and revealed a massive store of Morgan Silver Dollars including full, unopened bags of "fresh" 1882-O Morgan Silver Dollars. A number of bags were secured by a southern gentleman whose upbringing showed him the value of hard assets like silver. He stashed the unopened bags of "fresh" Morgans away, and there they stayed...

The Great Southern Treasury Hoard

That is, until another 50 years later, when the man's family finally decided to sell the coins still in their unopened bags which we secured, bag and all! We submitted the coins to respected third-party grading service Numismatic Guaranty Corporation (NGC), and they agreed to honor the southern gentleman by giving the coins the pedigree of the "Great Southern Treasury Hoard."



Actual size is 38.1 mm

- ✓ Historic Morgan Silver Dollars
- ✓ Minted in New Orleans
- ✓ Struck and bagged in 1882
- ✓ Unopened for 138 years
- ✓ 26.73 grams of 90% fine silver
- ✓ Hefty 38.1 mm diameter
- ✓ Certified Brilliant Uncirculated by NGC
- ✓ Certified "Great Southern Treasury Hoard" pedigree
- ✓ Limit five coins per household

These gorgeous 1882-O Morgans are as bright as the day they were struck and bagged 138 years ago. Coins are graded on a 70-point scale, with those graded at least Mint State-60 (MS60) often referred to as "Brilliant Uncirculated" or BU. Of all 1882-O Morgans struck, LESS THAN 1% have earned a Mint State grade. This makes these unopened bags of 1882-O Morgans extremely rare, certified as being in BU condition nearly unheard of for coins 138 years old.

Don't Miss Out—Order Now!

Regular 1882-O Morgans sell elsewhere for as much as \$133, and that's without the original brilliant shine these "fresh" 138-year-old coins have, without their special NGC hoard designation, and without their ability to tell their full, complete story from the Comstock Lode all the way to your collection.

Given the limited quantity of coins available from this historic hoard, we must set a strict limit of five coins per household. Call quickly to secure yours today as supplies are sure to sell out quickly!



1882-O Morgan Silver Dollar NGC Certified BU from the Great Southern Treasury Hoard — \$99 ea.

FREE SHIPPING on 2 or More!
Limited time only. Product total over \$149 before taxes (if any). Standard domestic shipping only. Not valid on previous purchases.

Call today toll-free for fastest service
1-888-324-9125

Offer Code MSH214-01
Please mention this code when you call

GovMint.com • 14101 Southcross Dr. W., Suite 175
Dept. MSH214-01, Burnsville, MN 55337



GovMint.com® is a retail distributor of coin and currency issues and is not affiliated with the U.S. government. The collectible coin market is unregulated, highly speculative and involves risk. GovMint.com reserves the right to decline to consummate any sale, within its discretion, including due to pricing errors. Prices, facts, figures and populations deemed accurate as of the date of publication but may change significantly over time. All purchases are expressly conditioned upon your acceptance of GovMint.com's Terms and Conditions (www.govmint.com/terms-conditions or call 1 800 721 0320); to decline, return your purchase pursuant to GovMint.com's Return Policy. © 2020 GovMint.com. All rights reserved.

BCMGUNFIGHTER™



Carbine Length

Mid-Length

BCMGUNFIGHTER™ PKMR Polymer KeyMod Rail Handguards

- Direct "drop-in" design replacement handguard for AR15's with mil-spec front sight base
- Natural ergonomics, slim, comfortable and lightweight, with an aggressively textured area for enhanced traction
- Featuring a reinforced KeyMod interface for durable accessory support with three, six-hole KeyMod mounting surfaces
- Aluminum heat shield reduces heat transfer to the handguard and shooters' hand
- Patent Pending design, made in the U.S.A.
- Will only fit round carbine-type handguard retaining cap
- Available in Black and Flat Dark Earth

BCMGUNFIGHTER™ PKMR
Carbine Length\$24.95
Mid-Length\$26.95



BravoCompanyMFG.com • Hartland, Wisconsin U.S.A.
Toll Free: 1-877-BRAVO CO (1-877-272-8626) • Fax: 262-367-0989
Pricing subject to change without notice. Please see website for current pricing.



Start with a bare lower or take the pistol buffer tube off of the lower. Do not ever use a lower that has ever had a stock on it. That is against the law.



The LAW Tactical folder adapter comes with the parts you need, you'll have to come up with a couple of allen wrench. No big deal, they are common sizes.



You start by disassembling the LAW Tactical adapter.

[Cont. from page 40]

easy.) The .300 Blackout upper uses a pistol-length gas system, which is pretty much a requirement if you expect your .300 to cycle with subsonic ammunition. They mark the upper as to caliber (always a wise thing to do when involved with the .300 in any capacity) and provide it with an ambidextrous charging handle.

The lower, I placed it flat on the bench, and used my Real Avid multi-tool to loosen the castle nut holding the plain buffer tube on. It was at this point that I remembered that I had been using the lower for several projects over the years. The paint on one side was a clue, but the big clue was that the castle nut had not been staked. Every castle nut here usually gets staked, but this one hadn't been. So clearly, even though I can't remember all the projects this went through, it had been built as a test-mule AR-15 pistol.

I then slipped it onto a lower holding fixture from Real Avid, and spun the castle nut back, unscrewed the buffer tube, and made sure I saved the buffer retainer and spring, and the rear takedown spring.

Then it was time to assemble the LAW Tactical Gen M3 folding stock adapter.

The adapter comes as an assembled hinge adapter, and the carrier adapter. You'll need a couple of allen wrenches, but they will be standard English (not metric, thank goodness) sizes, that you'll have on your allen wrench tool.

There are instructions, but just so you know the drill, and to add some data, I'll describe. You first have to take out the carrier retainer on the LAW adapter. On the bottom of the hinge assembly there's a small allen-head screw. Loosen and remove the screw, and pull the retainer off. Inside there is a spring and the carrier retainer. Pull those out and set them aside.

With the lower still in the holding block, press the hinge assembly against the lower, as if it were a retaining plate on a regular carbine stock assembly. You'll compress the rear takedown spring into its tunnel, and you want to nestle the raised part of the hinge into the recess machined in the lower. (Again, like a retaining plate.)

Now take the castle nut-looking threaded tube, and screw it into the hinge assembly from behind. The threads of the new nut engage the threads in the receiver, and this is what you will be using to hold the hinge assembly in place.

Once it is in place, use the provided wrench (a flat piece of mild steel) to tighten the nut. Make sure everything is still aligned, and the takedown spring is compressed into the tunnel, not pinched and flattened outside of it. The instructions say to tighten "until the wrench flexes" which I took to mean put some muscle into it. When I was done, I took a look at the wrench and realized I had bent it. The adapter hadn't seemed to notice. LAW Tactical makes some pretty stout gear.

Once tightened in place, make sure everything is properly aligned, and then tighten the lock nut that is on the right side of the adapter. You will notice that the new lock nut does not come forward far enough to trap the buffer retainer. That's because it will be re-installed on the adapter, not the lower receiver.

Now you stuff the carrier retainer back into the adapter, insert the spring that powers it, and re-install the retainer and screw for them.

Next you install the buffer tube onto the adapter as if it were a lower receiver. Keep the hinge assembly open, and then begin screwing the buffer tube into

TO PISTOL OR NOT TO PISTOL, THAT IS THE QUESTION

Another quirk in the law; if your AR-15 is, or has ever been, a rifle, it can only ever be a rifle. However, if you build it first as a pistol, and then get tired of it, or decide you need something else, you can take your pistol and make it a rifle.

Here's the process:

Separate the upper and lower. Either sell the upper and buy a new one, with a longer (at least 16 inches) barrel, or pull the barrel, sell/trade it, and acquire one of carbine or longer length.

Disassemble the arm brace from the lower, and sell or trade it. Install a proper stock on the lower. The lower is now a rifle lower, and cannot ever be made back into a pistol.

Why the elaborate process? Simple: if you simply swap out the arm brace for a stock, you now have the components to assemble an SBR, an SBR that just sits there, while you "get around to" making the upper a proper rifle upper. If you have one lower, with a stock, and two uppers, the new rifle, and the old pistol, you again, have an SBR.

So, if you are doing all this with just one lower, you have to make sure you never have on hand a set of parts that can be an SBR, or conversely, a

"pistol" lower with a carbine or rifle-length upper. Having an SBR without the permission slip is unlawful. Having a pistol with a long barrel makes the ATF grumpy.

And here's the easiest part; just get another lower. They are inexpensive enough that you can invest in a new lower for the new build. Just taking a quick look at prices at Brownells, to convert an AR-15 pistol into a carbine would cost at least \$180 for the barrel (if you swapped all the parts over) plus \$65 for a stock assembly, to make a carbine.

A new lower would add \$50 to \$75 to the build cost, on the lower end of the market. (You can easily spend over \$500 for a matched upper and lower receiver set. This is America, you have choices.)

As far as markings are concerned, don't worry. Yes, you can have a lower marked "pistol" if you want, but there's no requirement it be marked. And building a pistol-marked lower up as a carbine or rifle is not against the law.

Now, this is all according to Federal law and regs. Your state may have some other ideas on the subject, so make sure you know those before you get to building. **FN**



1
Insert the locking collar through the adapter.



2
And then press the adapter to the receiver. Tighten the locking collar until you flex the wrench. (I bent mine, probably a bit too much, that.) Don't worry about the buffer retainer, it goes into the adapter later.



3
You install the buffer retainer in the adapter as you are also installing the buffer tube.



The sole job now of the lower retaining plate is to provide a location you can use to stake the castle nut, once you complete the build.



The carrier adapter is a press-fit into the rear of the assembled carrier.



The carrier adapter uses a pair of rubber o rings to keep it inside of the carrier. While a minor shortcoming, I don't see any other way of doing this.

it. Once the buffer tube gets close enough, install the retainer and its spring, and hold them down while you continue to screw in the buffer tube. Stop once the tube traps the retainer, and the tube is properly aligned. Now press the receiver plate against the LAW adapter and spin the castle nut down to hold it. You don't need the receiver plate to capture the takedown spring, that's been done for you by the LAW adapter, but you will need a piece to stake, to hold the castle nut in place. That is the sole job now of the retaining plate.

Check everything for alignment, and then properly stake the castle nut into place.

Buffer assembly is as if nothing had been changed, except that you install the spring and buffer weight when the adapter is open, not closed.

The last part of the assembly is to install the carrier extension, and here I have to offer up just a bit of a grump with LAW Tactical. The carrier adapter is an extension that reaches across the gap created by the folder adapter. Without it, there would be an inch or so of dead space behind the carrier. The adapter has a pair of rubber o rings installed in it, and you simply press the adapter into the rear of the carrier. I can see the adapter falling out, if the folded pistol gets jostled, or something presses against the adapter from the side. Also, if you have one of the gelded Colt carriers, from back in the day when Colt was being obsequious to authority, then the adapter might not be as secure as you would like.

Having said that, and considering that most carriers are as hard as a tax auditors heart, I don't see how they could have done it any other way.

When you close the LAW folder, there's an engagement lug that pushes the carrier retainer to the side. When you open the retainer springs out, that's the spring you installed after you had bolted the adapter to the receiver. The folder locks in place when it is opened, so you don't have to worry about it folding on you when you need it. To fold, press the button on the right side, and hinge the buffer tube to the left.

An assembly or disassembly detail of the LAW folder is something you have to know. The carrier extension makes the carrier longer. That's obvious, right? But with the adapter installed, the action won't hinge open if you push just the rear takedown pin across. To take the completed pistol apart, you have to push both pins out, and then lift the action up in front and pull it forward out of and off of the lower.



To take the folded pistol apart, you have to press both takedown pins through, and then lift the upper away from the lower. It won't hinge open.



The Bravo/LAW folder AR-15 pistol ends up with the same number of parts as any other AR-15 pistol.



Folded, and with a magazine, the Bravo pistol doesn't take up much room.



The left side of the pistol, showing the vanilla-plain controls this test-mule pistol has had for some time, and the Aimpoint Micro T-1 that is likely to remain on this pistol forever now.



The ambidextrous charging handle from Bravo Company.

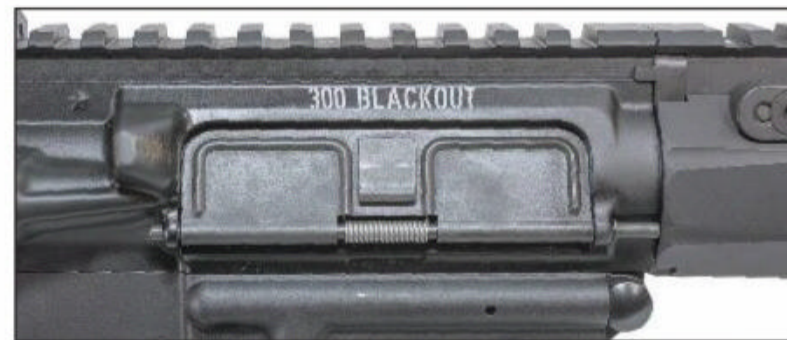

Bravo Company puts the caliber right there for you to see.

To re-assemble, the reverse, stuff the upper down and back into the lower, then push the front pin across, and then the rear.

Ok, so that leaves us with a completed AR-15 pistol, chambered in .300 Blackout. Now what? Well, first of all we have to have some way of aiming it. The Bravo Company upper came complete with their most-excellent folding BUIS. And every rifle should have back-up sights, even if they are the main sights. One detail of the Bravo sights I love is that the rear sight gives you the option of having the small or large aperture as the default one. I always want the large as my default, and hate rear sights that force me to use the small aperture as the default when folded. As much as I insist on having iron sights as an option (and think everyone should learn how to use them), I'll always go with optics as the first choice.

In this case, I went with two for the testing. The main setup would be an Aimpoint Micro. The ones I have are now old by the standards of red-dot sights. The newest Aimpoints I have are "only" T-1 and S-1 vintage, but they still work, and probably will continue to long after my nephews have inherited my gear. I use them with an Aimpoint riser and QD mount. Although, in all fairness, the world is awash in mounts, QD and otherwise, and risers and adapters for red-dot optics. The general quality is now so good you can hardly go wrong.

For general use (like as a defensive tool) I'd be happy with a red-dot like my Micros. But for accuracy testing, I recognize that I am the weak link here, and need magnification. So, I opted again for the Primary Arms SLx 1-6x24 ACSS-Raptor. This is a one-to-six-power scope with a First Focal Plane reticle, and a reticle with bullet drop compensation. Now, the Raptor has its reticle regulated for 5.56 ammunition. Which is a good thing if you are using a 5.56. In a .300 Blackout, the ranging isn't so useful, but then again, who uses a .300 Blackout past 100 yards? If I zero one inch high at 100 yards, I'm down not quite three inches at 200

[Cont. to page 46]

SILICONECLOTHS.COM

Personalized silicone gun cloths



Make a lasting impression with a soft flannel silicone gun cloth featuring your business logo and contact information. Your customers will think of you every time they pick it up.

Choose from a variety of fabric and ink colors at wholesale prices.

Mention this ad and get free shipping and press setup



Made in the U.S.A.

SI-CLO MFG. 1-800-560-1347

AIR ORDNANCE

made in U.S.A.

BELT FED



100 ROUND DRUM



CUSTOMIZABLE



FULLY AUTOMATIC .22

WITH 100 ROUNDS, IT SURE IS TOUGH TO MISS. THIS BELT FED, FULLY AUTOMATIC .22 PELLET GUN COMES IN A VARIETY OF DIFFERENT PACKAGES FROM BASIC GUN TO THE TACTICAL "ELITE" PACKAGE. FUN AT THE RANGE AND IN THE FIELD.

AIR ORDNANCE

800-671-1498

3518 ADAM CENTER ROAD
FORT WAYNE IN, 46806



It's time to BE READY!

All you have to do is read the headlines to know why people all over the country are thinking more about preparedness. Whether it's catastrophic weather, utility breakdowns, terrorist attack or the collapse of civil order, millions of Americans aren't willing just to hope for the best. They are taking more active measures to get ready for the times when stopping at the grocery store or the ATM won't be options. **BE READY!** addresses the skills and supplies they will need to survive.

ON NEWSSTANDS 06.23.20



The Daniel Defense muzzle device, to hold the DDWave suppressor.



The aluminum magazines from Surefeed are improved and refined from the originals they made for the government.

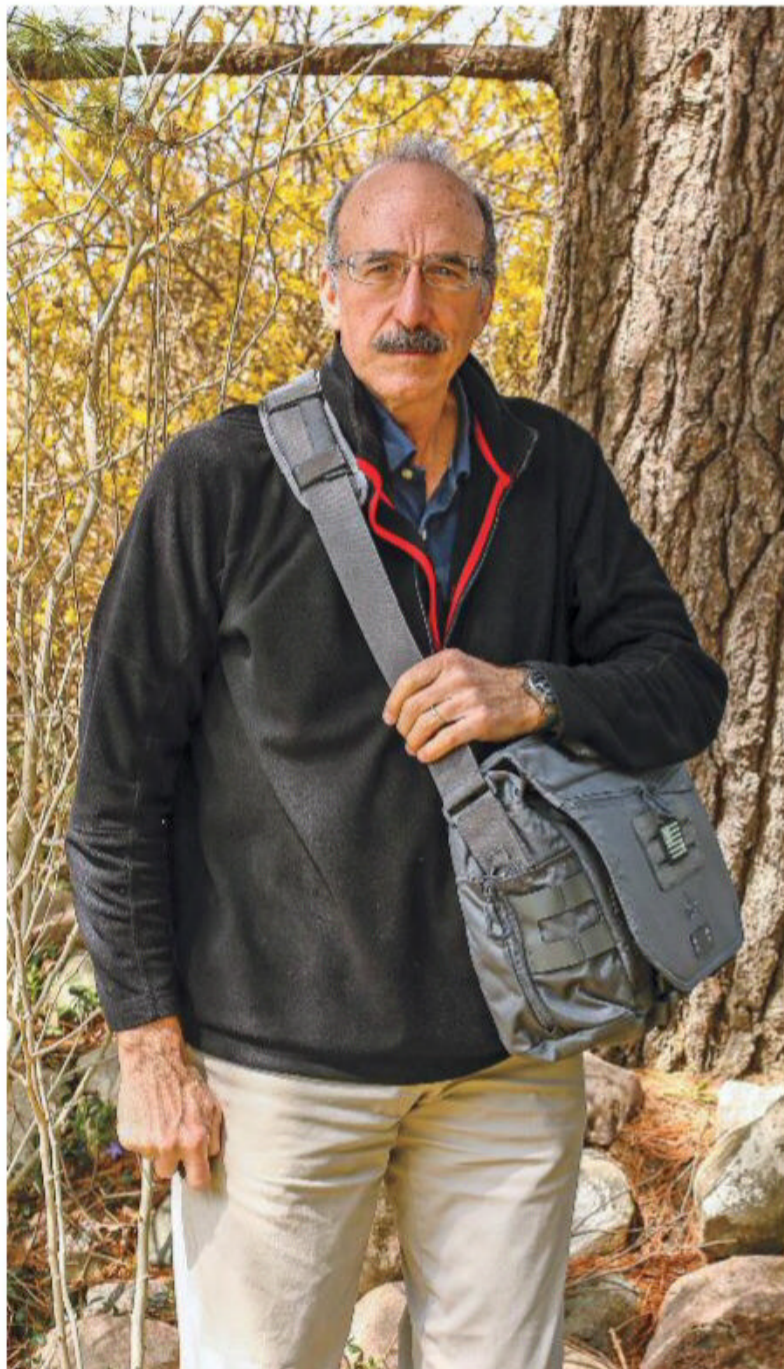

The author, and the Envoy-17, out for a day's work. Notebooks, pens and pencils, and a .300 Blackout pistol, all at the ready.

[Cont. from page 44]

yards. In a defensive situation, I am hard-pressed to find a defensive engagement or law enforcement incident much past 50 yards, let alone 200. Most incidents will be the length of a Buick, and some few would be across a small parking lot. If I take this pistol hunting, I'm not shooting at a deer past 150 yards in any case.

But the illuminated horseshoe of the Raptor, and the zooming aspect of the first focal plane, makes the 1-6x24 very useful on top of a .300 Blackout pistol.

I mounted the Primary Arms 1-6, as I usually do, in a bomb-proof scope mount. In this case, a Geissele Super Precision. Yes, I am mounting a \$400 scope in a \$350 mount, but I want a scope to be solidly attached. If I could weld them on, I'd be tempted to. (Welcome to the world of a gun writer)

For magazines I snatched a handful out of the magazine bin, and came up with the usual suspects: Mission First Tactical, Magpul and Surefeed. The first two are polymer, the last is aluminum, the company who has been making real-deal military-spec magazines for the government, for decades.

And finally, there is the matter of the muzzle. I could just stick with the regular A2 flash hider that came with the Bravo Company upper, but where's the fun in that? So, I took the flash hider off, and installed a mount for the Daniel Defense DDWave suppressor. The quick-attach system allows me to pack the pistol away with the suppressor off, and not take up any more room than needed. And if I need/want the suppressor, it is a matter of seconds to install it.

Transport of the Bravo-LAW pistol (I've got to come up with a name for this beastie) is a puzzlement until you notice how many people wander around town with backpacks, messenger bags and the like. Long-gone are the attaché cases of the 20th century. So, I rang up Vanquest, and talked over the likely possibilities. The one that was tops of the list was their ADDAX-25, a low-profile backpack. Alas, that one had all available samples locked up in a warehouse that wasn't being serviced, because, well, the Governor didn't deem it an "essential" service. Hey, some of us think it is essential.



The rear compartment of the Envoy 17, showing the mag carriers, two for a hi-cap 9mm pistol, and three for your .300 Blackout pistol.



The Bravo/LAW .300 pistol, folded and tucked into the Envoy 17.



Here is the zipper on the flap of the Envoy 17, opened showing access to the Bravo 300 Blackout inside.

A very, very close second choice was their Envoy 17, a messenger bag, so in short order one of those appeared on my doorstep.

Along with the ENVOY-17 they sent a selection of optional accessories; dividers and adapters to compartmentalize the interior. There are plenty of extra slots and pouches already in there, to stash everyday items, as well as the folded pistol, spare magazines or more, like a med kit. Pretty much, the limits are your imagination, wallet and how much weight you are willing to pack. The Envoy is lined in bright orange, so you can readily see your items inside, and don't have to go pawing through the interior to see what you are looking for. Also, the flap has a zipper on top, down its length. You don't have to rip the Velcro to open the flap, you can slide the zipper and reach into the bag that way.

This would also make a fabulous travel bag, as long as you were thorough in removing all the items that TSA might be grumpy about.

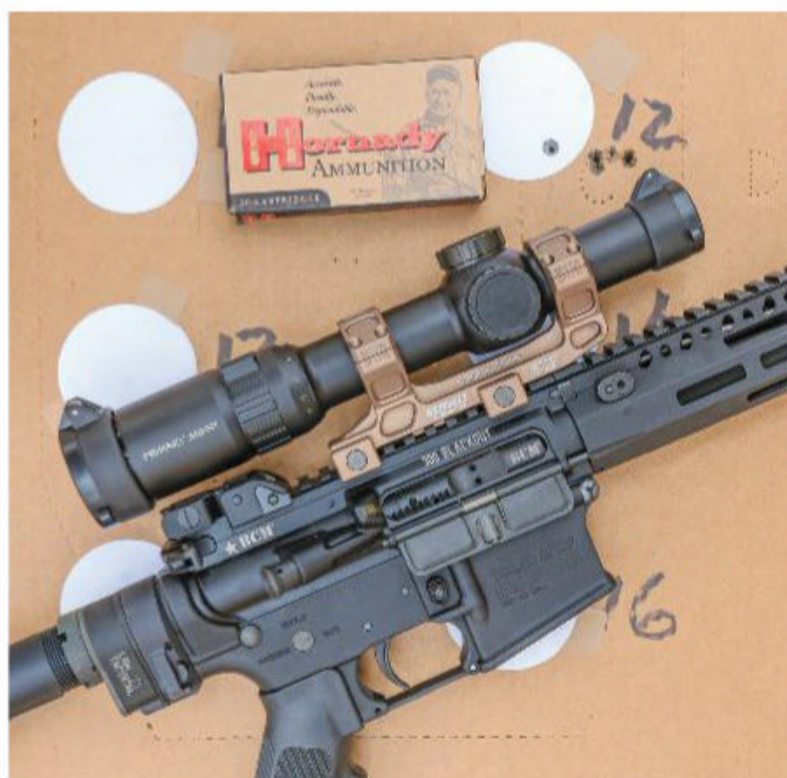

The Primary Arms Raptor optic is an excellent choice for an AR-15 pistol. A tad bulky, if you are going for the most-compact pistol possible, but very capable.



The hot setup for defense are the supersonic loads, like these. Left to right, Hornady V-Max, Barnes TAC-TX, SIG Short Barrel and Remington Accu-Tip.

One aspect of the Envoy 17, is that with this setup, and the Daniel Defense muzzle device, it is a tight fit. I have to work to get the pistol into place, and I might have to re-think my choice of mounts or suppressors for this pistol. For now, I'm sticking with them, but you may read about a change in the future.

For ammo, I swept an assortment off the shelf, both supersonic and subsonic.

On the supersonic front, I used Hornady 110 V-Max, not because it is the best self-defense load (it would suffer in barriers, but Hornady is up-front about that, it is a varmint bullet) but because it is

quite often the most accurate bullet, and load, in any given caliber. And so, it was here.

I added some Barnes TAC-TX, an all-copper bullet of 110 grains, and have an enviable reputation for barrier work and expansion in ballistic gel. Next up was another all-copper bullet, the SIG 120 grain Short-Barrel. The load is tuned for short barrels, like pistols, and SIG uses a blackened case to make it easy to sort out.

Last was a Remington load, their Accu-Tip 125 grain. It is no longer listed in the Remington lineup, which is a shame because it performed quite well.

CHRONOGRAPH AND ACCURACY DATA

Ammunition	Bullet Wt. (gr.)	Velocity (fps)	Es	sD	Ave. Group (in.)	Best Group (in.)
Hornady V-Max	110	2,103	57	26.2	1.2	1
Barnes TAC-TX	110	2,092	49	24.6	1.3	1.1
SIG HT	120	2,052	14	6.3	1.2	1
Remington Accutip	125	2,062	77	30.2	1	0.9
Gemtech subsonic*	187	893	125	52.5	2	1.75
SIG subsonic	220	902	69	26.8	2	1.5
Remington OTM	220	802	78	30.4	2.1	1.8
American Eagle sub	220	872	72	26.6	2.1	1.75

Accuracy results are averages of three five-shot groups at 100 yards off a Caldwell Hydrosled shooting rest. Velocities are averages of 10 shots measured on a Labradar chronograph set to read 15 feet from the muzzle, with the suppressor not installed.

* The Gemtech load did not reliably cycle the pistol with the suppressor off. However, with the suppressor on, the load lost 30 fps, but cycled the action 100%.

AMMO CHOICES

The original choice, the one we all got all excited about, were the various subsonics. Anything from a 200 to a 240 grain BTHP or match bullet, hurled at less than the speed of sound, got everyone's attention.

There were problems, however. First, we're talking performance that is on-par with a .45 ACP or .45 ACP+P. Not something to sneeze at, but not rifle-like performance. Second, the bullets were not designed to expand or fragment at those velocities. The ballistic gel testing I did all had the same results: the bullets would go 8-10-12 inches deep (depending on the bullet), and then turn sideways and exit the block to the sides, up or down.

Don't get me wrong, a 220 grain .308" bullet, going sideways, is going to have an effect. But there can be more. Barnes offers their TAC-TX, and Black Hills loads the Barnes TTSX, both all-copper bullets, to useful velocities. If you are looking for a defensive load, or a barrier-blind load, start there. Others, like SIG, offer all-copper bullets, but I have yet to slap them into gel in tests yet.

And as an interesting update to the subsonics, both SIG and Hornady now offer expanding subsonic loadings. These too will require barrier and gel tests to see how they perform, but if we can have it all; subsonics, expansion, barrier-blind, and accuracy, well, I'm buying a truckload of that. **FN**



The Black Hills 110 grain TTSX load expands to over .600", penetrates to just over eighteen inches, and runs like a champ.

For the subsonics, I grabbed SIG, Remington, American Eagle and Gemtech. Of the four, Gemtech is no longer made. It was offered for a short while, but when S&W bought Gemtech, the ammo didn't make the transition. Too bad, because it is very quiet and soft in recoil, but it has one interesting quirk. In a lot of firearms, it won't properly cycle the firearm unless there is a suppressor on board. And so it was with the Bravo Company LAW folder. Without the DDWave suppressor, the Gemtech ammo was a single shot. With the suppressor, it ran 100%, and locked open when empty.

For ammo, I opted to try both supersonic and subsonic loads, because you never know what you'll need for a defensive tool.

This pistol has just gotten a promotion. It will no longer be a built, re-built and re-re-built test-mule. That part of its service life is over. The Bravo upper, the SB Tactical arm brace and the LAW folder make

it such a useful combo that it is going to be this way going forward. From this point on, it undergoes a different process; it will have a set of magazines that it is tested with, and provides 100% reliability. (A lot easier today, but still a process I undertake.) I'll stake the parts that need staking, I'll paint-in the things that need painting. It will get its own optics set-up, and the irons and optics will be zeroed, and the load noted. And the load will be either a supersonic or a subsonic, because they can hit to sometimes wildly different points of impact.

I will seriously consider installing an upgraded trigger set, like one from Geissele, or LaRue.

Then the whole thing will get a paint job, and ride either in the rack, ready for work, or in the Envoy-17, ready for trouble.

It has found a purpose and station in life. Some other receiver gets moved up from the waiting shelf to "test mule" status. **FN**



An AR-15 pistol need not be a close-range plinking toy. It is fully capable of excellent accuracy, as demonstrated here. Bravo Company makes top-notch barrels, and Hornady makes great ammo.

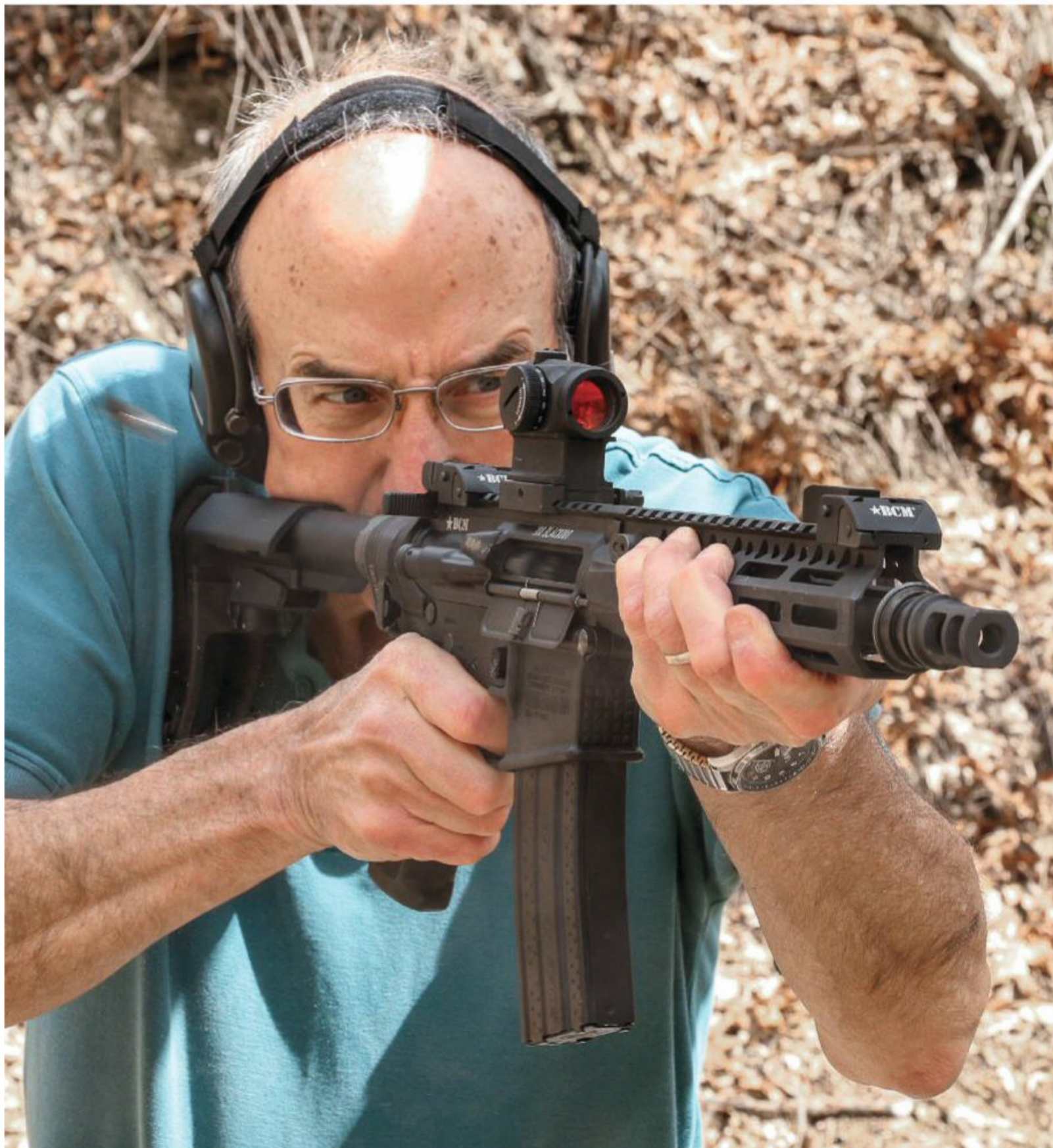

Low recoil, low muzzle blast, great accuracy, and performance on the other end. The .300 blackout is a great little cartridge.

**SPECIFICATIONS
ULTIMATE BRAVO AR PISTOL TRUCK GUN**

Type:	Self-loading, gas-operated pistol
Caliber:	.300 Blackout
Capacity:	30+1 round
Barrel:	8"
Length:	18" folded, 26.5" extended
Weight:	7 lbs. 3 oz.
Trigger:	4.5 lbs.
Finish:	Parkerized steel, anodized aluminum
Maker:	Bravo Company BravoCompanyMfg.com (877) 272-8626
	LAW Tactical LawTactical.com (267) 209-0529
	Your Workbench (you know your website and phone number)

SUPPLIERS

BravoCompanyMfg.com
Remington.com
SIGSauer.com
BarnesBullets.com
MissionFirstTactical.com
SureFeedMagazines.com
Aimpoint.com
PrimaryArms.com
Hornady.com
FederalPremium.com
Vanquest.com
Magpul.com
LawTactical.com
RealAvid.com
Brownells.com

**FREE \$99 Binoculars,
With Knife Purchase**
(see details)



Not shown
actual size.

*Limited
Collector's
Edition*

CAN YOU HANDLE IT?

The steel of ancient warriors unfolds from a beautiful Pakkawood handle at only \$99

Damascus steel is the stuff of ancient legend. Treasured by mighty warriors and made using a secret technique, Damascus steel was famed for its sharpness and durability, and was known to slice gun barrels in half and separate single strands of hair in two. The secretive, ancient forging technique mixed different steel alloys to form a supersteel, creating a rippled, wavy texture, which made Damascus steel instantly recognizable.

Can you handle such a blade? You definitely can, because the modern Damascus steel of the *Saga Blade*, complete with the signature rippled texture, unfolds from a striking Pakkawood handle. Pakkawood takes its strength from combining wood with other strength-magnifying materials to create a powerful and near-waterproof product. This mix of two masterful techniques is enhanced by engraved stainless steel at the bolster and handle end, delivering a *Saga Blade* worthy of the name for an epic price of only \$99.

But we don't stop there. While supplies last, we'll include a pair of \$99, 8x21 power compact binoculars and a genuine leather sheath **FREE** when you purchase the *Saga Damascus Blade*.

Your satisfaction is 100% guaranteed. Feel the knife in your hands, wear it on your hip, inspect the impeccable craftsmanship of Damascus steel. If you don't feel like we cut you a fair deal, send it back within 30 days for a complete refund of the item price.

"The most common aspects of Damascus steel knives that enthusiasts consider ideal are the aesthetics and high performance." — Knife Informer

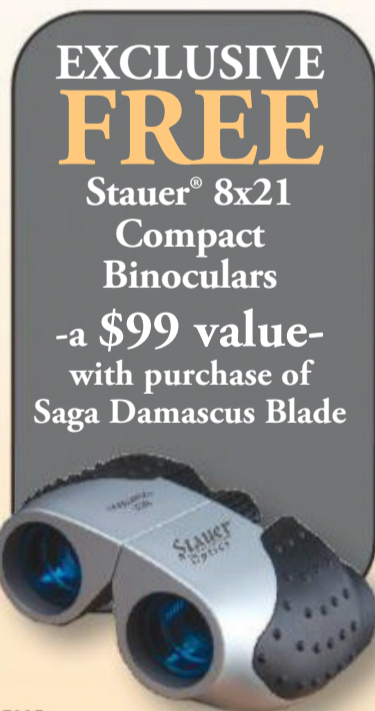

**EXCLUSIVE
FREE**

Stauer® 8x21
Compact
Binoculars
-a \$99 value-
with purchase of
Saga Damascus Blade

**What clients are saying about Stauer
Damascus knives...**



"Without a doubt, this knife will always hold a special place in my heart... because of its beauty, its craftsmanship and its obvious durability."

— J., Hawthorne, FL

Limited Reserves. You could pay well over \$1,000 for a folding Damascus steel pocket knife, but why would you when you can enjoy the superb craftsmanship of the *Saga Blade* for only \$99. Damascus steel blades are a lost art form that only a handful of artisan bladesmiths have mastered. These legendary blades take time to forge and only a few are crafted each month. Don't let this beauty slip through your fingers. Call today!

Saga Damascus Blade \$149*

Offer Code Price Only \$99 + S&P **Save \$50**

1-800-333-2045

Your Insider Offer Code: SDK118-01

You must use the insider offer code to get our special price.

Stauer®

14101 Southcross Drive W., Ste 155, Dept. SDK118-01
Burnsville, Minnesota 55337 www.stauer.com

*Discount is only for customers who use the offer code versus the listed original Stauer.com price.



Rating of A+



California residents please call 1-800-333-2045 regarding Proposition 65 regulations before purchasing this product.

- Modern Damascus steel blade 3"; overall 7"
- Pakkawood handle with stainless steel bolster & handle top; Leather pouch included

Stauer... *Afford the Extraordinary.*®



Designed to give you everything you want and need in an AR at a reasonable price, with an unusual name and a cool logo, the TREAD is the latest market entry from SIG.





THE By James Tarr

RISING TIDE

SIG's M400 TREAD Rifle



The path SIG Sauer has taken with their AR offerings to me is very reminiscent of Ruger's journey. Both companies started out making expensive, heavy AR-15s with all sorts of extra features, but it wasn't until they began selling a stripped-down lighter "M4-style" version that they saw huge jumps in sales. With Ruger, that came with their AR-556.

SIG was selling their M4-style M400 rifle quite a while ago, but it was their feature-laden but affordably priced M400 TREAD, introduced in late 2018, which breathed new life into the line and got a lot of attention — in addition to selling a lot of guns. SIG has since expanded the TREAD line with a pistol and a .308 version, but let's take a look at the original rifle, which I continue to believe is one of the two best AR-15s on the market priced under \$1,000.



The TREAD features many ambidextrous controls. Here you can see the ambi-mag release and bolt release.



The right-side safety lever is shorter, so it won't poke your trigger finger. At the rear of the receiver on both sides you'll see a QD sling swivel socket, which is a nice extra.



SIG's TREAD logo is a snake in the shape of the American flag. Tarr thinks it is very cool, but believes SIG should have etched it into the lower receiver as well.



The medium-light contour stainless steel barrel has a 5.56 NATO chamber, mid-length gas system, 1/8" twist, and is tipped by a three-prong flash hider from SIG.

SIG sells several AR-pattern rifles. Their flagship is the MCX Virtus, which is a piston-driven gun that has all sorts of bells and whistles. It is also very expensive and rather heavy. At the other end of the spectrum is SIG's M400 direct gas impingement AR. These rifles have offered a few upgrades over standard Mil-Spec, but have been priced somewhat higher than similar competing designs from other manufacturers, especially basic "economy" M4-style rifles.

SIG looked at what they were offering, compared it to the competition, and came up with the M400 TREAD, meant to offer far better than G.I. "M4" looks and performance at a very competitive price. The MSRP is just \$951, which means the TREAD will be on dealer shelves probably near or below \$850.

First, let's deal with the name. TREAD is a bit unusual, but less weird a name for an AR to me than the Springfield SAINT. If you're wondering where the name comes from look at the logo on the side of the aluminum handguard which is being used all over the marketing materials. The logo is a snake in the shape of the American flag, deliberately reminiscent of the "DON'T TREAD ON ME" Gadsden flag (1775) from the American Revolution. FYI, it was Benjamin Franklin who first used a snake as a symbol of the colonies in his "JOIN, or DIE" cartoon from 1754, so a snake logo has some serious freedom bona fides in this country. Many of the shirts and stickers SIG is selling have the TREAD logo in yellow or on a yellow background, deliberately mimicking the yellow field of the Gadsden flag.

Honestly, I'm surprised SIG doesn't put the cool TREAD logo on the lower receiver instead of or in addition to the handguard. I know this would cost a tiny bit extra, and this rifle is aimed at a specific price point, but that logo is very cool, and would look great etched into a lower. I'm not sayin', I'm just sayin'

The first thing about the TREAD that will catch your eye is the stainless steel barrel. Not only is the

slender 16-inch barrel stainless, it sports a 5.56 NATO chamber, 1:8 twist rifling, pinned gas block, and a mid-length gas system. If you know, you know. If you don't, let me put it this way ... if you were going to spec out an AR-15 barrel/gas system that you wanted to run reliably under adverse conditions, that could eat whatever ammo you fed it, and was as soft-shooting as possible, it would be exactly what you get with the TREAD.

The number of ARs on the market priced under \$1,000 with a stainless steel barrel is very, very, very low. Provided everything else (metallurgy, machining, etc.) is up to snuff, a stainless steel barrel is superior to other steels.

A 5.56 NATO chamber is a little bigger than the .223 Remington chamber, which in addition to safely allowing you to shoot the higher pressure 5.56 round has a little more room and is thought to provide a little extra reliability when the rifle gets dirty. The 1/8" twist seems to be the best to handle a wide range of bullet weights. And, finally, the mid-length gas system is considered to be optimum for reliability and reduced recoil in a 16-inch barrel. Pressures are lower than in the shorter carbine-length gas system and as

[Cont. to page 54]



The QD sling swivel sockets on the receiver are nice, but of more use would have been a better-than-GI charging handle. As seen here Tarr installed a SIG TREAD-branded ambi oversized charging handle and flip-up sight.



The TREAD features ambidextrous controls and QD sling swivel sockets on either side of the lower receiver at the rear. The pictogram selector markings are nice. Seen here is the standard GI-pattern charging handle.

Trump's Coming **BLITZ**

Are You Ready?

Buckle up — 2020 will be the political ride of your life!

Ever since he first announced his presidential quest — after coming down the escalator of New York's Trump Tower — the media, the establishment, and his critics in both parties belittled, demeaned, mocked, and even laughed at Donald Trump.

But the billionaire has had the last laugh and will again in 2020. And, as David Horowitz reveals in his just-released **BLITZ: Trump Will Smash the Left and Win**, Trump has been — and will continue to be — the Democrats' worst nightmare.

BLITZ reveals the attacks made against Trump have been the most brutal ever mounted against a sitting president of the United States.

Blinded by deep-seated hatred of his person and his policies, the left even desperately tried to oust Trump in a failed impeachment bid.

Horowitz shows that their very attacks — targeting a man whose mission has been to “Drain the Swamp” and “Make America Great Again” — backfired, turning Trump himself into a near martyr while igniting the fervor of his “base.”

In **BLITZ** you'll discover the left's

terrifying socialist agendas as you've never seen them before.

Trump's response? He's going to steamroll this opposition in November using the same playbook he has used to win before.

In **BLITZ** you will find shocking revelations:

✓ **The 9 biggest dangers to America the left poses — their agenda will blow your mind.**

✓ Show me the money: names of the billionaires and fat cats out to get Trump.

✓ **Why charter schools may prove to be a decisive issue and why the Democrats fear them.**

✓ How patriotism suddenly became “white nationalism” linking Trump to Hitler and the KKK.

✓ **Why Trump is at the nexus of the left's secularism and hate pushed against Christians.**

✓ Why every effort to demonize Trump and his supporters is backfiring.

✓ Obama's agenda: how the former president casts a much greater shadow over

Trump's political woes than you ever imagined.

★ **Hillary is not gone!** **BLITZ** shows the “revenge” role she plans for Trump.



DAVID HOROWITZ is not just any author. Once a radical liberal, he turned on his far-left friends when he saw their real motives. He soon became a noted conservative and author.

His *New York Times* bestseller **Big Agenda: President Trump's Plan to Save America**



was written *before Trump was elected* — so certain was Horowitz of Trump's victory.

Now, Horowitz is so certain Trump will win reelection in 2020, he's written **BLITZ**.

✓ **The Genius:** Trump's brilliant strategy has worked and will continue to work — why he'll be president again in 2021!

The effort to remove and destroy our duly elected president may be the greatest challenge America has faced since the Civil War, explains Horowitz.

For the first time **BLITZ** exposes the left's strategy to take down Trump, and how Trump not only beat them at their own game, but how he's turning the tables on them once and for all.

Buzz on **BLITZ**

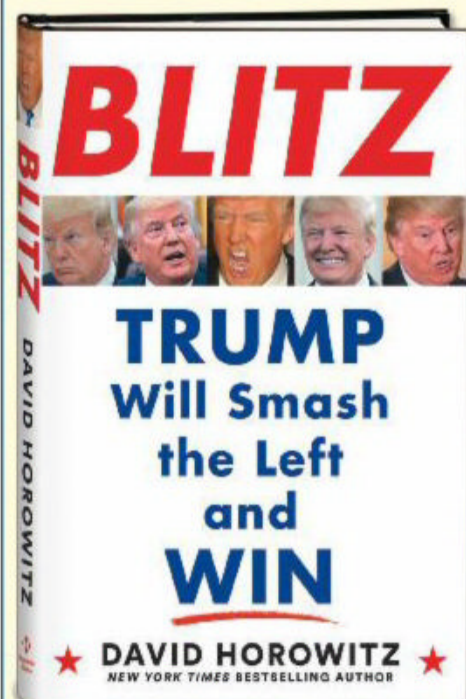

Donald Trump Jr.:



“If you're interested in debating deranged liberals with facts, you won't want to miss this latest book.”



Mark Levin:

“David Horowitz has written an indispensable book, *Blitz*, explaining why today's Democrats are so dangerous and why President Trump is their nemesis.”

FREE OFFER!

BLITZ retails for \$30 at bookstores everywhere, but Newsmax has an incredible FREE Offer!

Check it out today:

Online: Blitz711.com/Firearms

Toll-free: 1-800-307-1364

[Cont. from page 52]

a result the bolt moves slower, increasing bolt life and reducing felt recoil.

The barrel profile is generally what determines how heavy or light your AR is going to be. The barrel of the TREAD has a medium-light profile, and as a result the overall unloaded weight of the TREAD is six pounds nine ounces, even with the long (15-inch) aluminum handguard. SIG currently lists the weight of the TREAD on their website as seven pounds, but even with an empty magazine in place my sample only weighed six pounds thirteen ounces, so I'm guessing somebody used their Common Core math skills. With the stock fully extended the rifle balances over the front receiver pin, so it is not muzzle heavy. SIG's ARs have historically been overweight and overpriced, with bulky handguards. The TREAD has none of that.

The barrel is tipped with a three-prong flash hider of SIG's own design that seemed to be very effective. The barrel is free floated inside the long handguard. Before we talk about the handguard, let's talk about what's underneath it — SIG's Micro Gas Block. The stainless steel gas block on the TREAD is so fancy at first it looks like it might house an adjustment for the gas system, but the gas system isn't adjustable.

When I was younger I heard Larry Vickers (SFOD-D Delta Force veteran) say that any AR meant for defensive use should have a pinned gas block — as in the gas block is secured in place by a horizontal pin which actually goes through the barrel. At the time I pooh-poohed that idea, as I've shot a lot of rounds through great guns with gas blocks simply screwed in place, but as I have gotten older I see the wisdom in that statement. If an AR is going to have reliability issues, there's a huge chance it's because of a non-pinned gas block coming loose. While the handguard makes it tough to spot, the Micro Gas Block on the TREAD is in fact pinned in place, so whether you're just punching paper at the range or the Boogaloo kicks off the TREAD will handle it.

The narrow (1.75" x 1.5") fifteen-inch handguard is a new SIG design, proprietary to the TREAD. It has M-LOK attachment slots at 3, 6, 9 and 12 o'clock on the forward two-thirds of the handguard. If you want to mount a front sight on the handguard you'll have to first attach a rail section to the top of it near the muzzle, but SIG sells both rail sections and flip-up



To test its reliability Tarr used a wide variety of magazines. The magazine well on the TREAD was rather tight, and the Gen 1 Magpul PMag didn't drop free, but reliability with all magazines and ammunition was 100%.

sights. In fact, SIG sells all sorts of TREAD-branded accessories, but let me circle back around to those.

The lower receiver is where you'll see some serious changes from the GI specs, but done in a very smart, unobtrusive way. The TREAD features what everyone calls ambidextrous controls, and I'll use that term, but the more correct term is "bilateral" — ambidextrous means you can use both sides equally, bilateral means something has two sides.

First, the TREAD has an ambi safety, with the right-side lever being short enough that it didn't poke my trigger finger, a problem I have with most ambi-safety levers. The rifle also has an ambi-magazine release, with a pivoting lever on the left side, and an extended bolt release to make locking the bolt back a little bit easier.

Now we get to one of my few complaints about the gun: just ten percent of the population is left-handed,

but everyone who shoots an AR has to use the charging handle, so I don't know why SIG would equip the TREAD with improved ambi controls and then stick a single-sided and outdated GI-style charging handle in the gun. A flared magazine well would have been more useful to everyone as well. I mention that not only because I think a slightly flared magazine well is needed on the AR in general, but because the magazine well on the TREAD was noticeably tight. If this was my gun I would take a Dremel tool to the mag well opening just to increase the bevel there a bit.

There are big QD sling swivel sockets on either side of the lower receiver at the rear. There is a rubber tensioning device at the back of the lower receiver underneath the rear receiver pin to eliminate any play or rattle between the two receiver halves.

According to SIG, the TREAD is equipped with a "single stage polished/hard-coat trigger" and I wish



The TREAD wears a SIG-made pistol grip, oversize polymer trigger guard, and a Magpul SL-K stock on a six-position receiver extension that featured a castle nut properly staked in place.

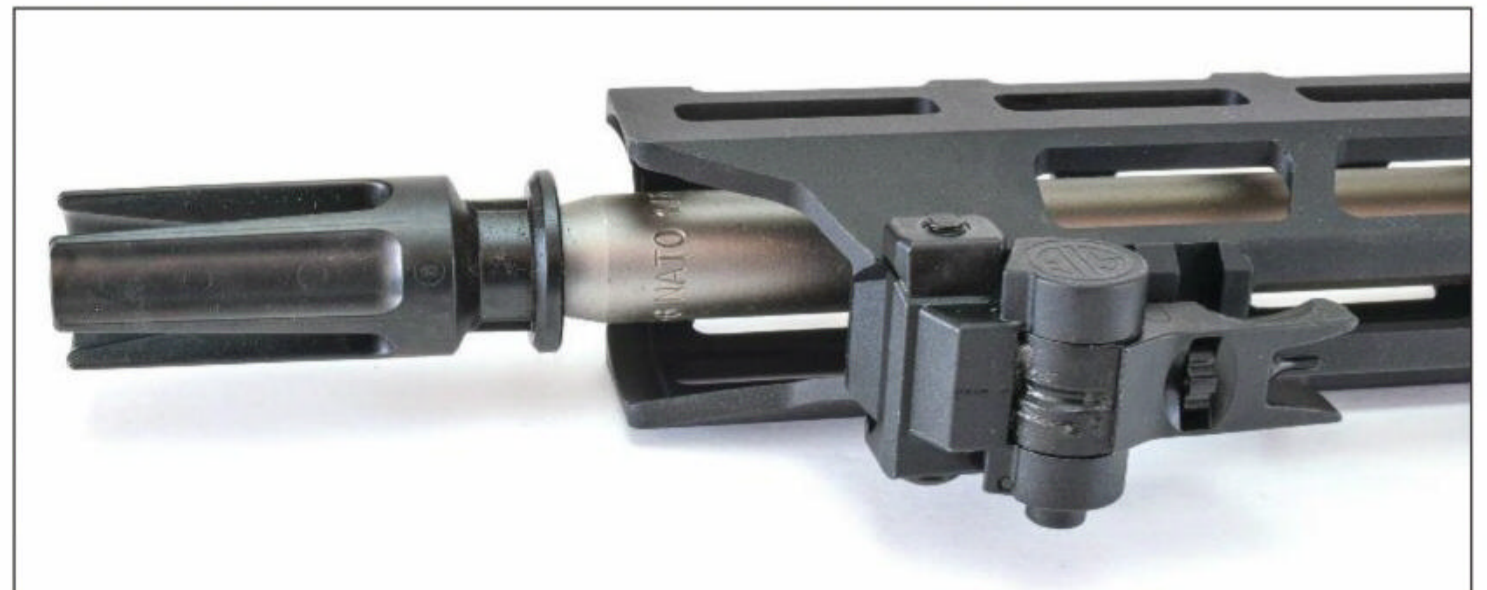

The caliber and barrel twist rate is marked on the barrel near the muzzle. Here Tarr has installed the alternate 15-inch SIG TREAD-branded handguard and flip-up sight on the rifle.



Using some of the many SIG TREAD-branded accessories, Tarr upgraded his rifle. He installed the more skeletonized 15-inch M-LOK handguard, handstop, flip-up sights, and ambi oversized charging handle.

I could say it provided a trigger pull as good as that sounds, but no. Trigger pull on my sample was seven pounds even, and a tiny bit gritty. A seven-pound trigger pull is great if you're using a heavy trigger pull as additional insurance against a negligent discharge, but it sucks if you know what you're doing or, you know, actually want to shoot tight groups at distance.

Think I'm a spoiled gunwriter and a trigger snob? Well, you're not wrong, but it's people who don't know any better who think a GI-style gritty six- or seven-pound trigger pull on an AR is A-OK. Those people who do know better replace those triggers. Example A: Geissele Automatics. Those "people who know better" (cough*Delta Force*cough) went to Bill Geissele and asked — begged — him to design a better trigger for their M4s, and thus the SSF trigger (with a crisp 4.5-pound pull) was born.

With all of that whining out of the way, I will say that putting in a better trigger would raise the price of the TREAD, probably significantly, and this is, among other things, a price point gun. I'm guessing SIG did everything they could to improve this rifle, while aiming for an MSRP under \$1,000. Luckily, the number of improved aftermarket triggers for the AR-15 platform is in the hundreds.

The provided stock on the TREAD is Magpul's newer SL-K, which has a reduced profile and a rubber butt pad. It rides on a six-position Mil-Spec buffer tube. I was pleased to see the castle nut, which holds the buffer tube firmly to the receiver, was properly staked in place.

The pistol grip is one of SIG's own design that mimics the A2 grip angle while providing a little more material under the web of your hand to promote proper placement of your finger on the trigger. The trigger guard is an oversized polymer piece. The rifle is supplied with one 30-round magazine, a Magpul Gen 2 PMag in the case of my sample.

The AR-15 is often described as "LEGOs for men" as it is possible to swap out every part on the gun — EVERY part — using just simple hand tools. This is, in fact, one of the great things about the design, its modularity. It's tough to find two people whose ARs are identical, as they are so easy to customize. Why does this matter when we're talking about a "factory" gun?

SIG seems to be pushing their "TREAD-branded" accessories and upgrades just as hard as they are the



Swapping out one SIG handguard for another requires only removing two hex-head bolts which secure the handguard to this barrel nut. The barrel's light profile is apparent.

rifle. Most of the photos of TREADs I see on SIG's website show the rifle sporting some of those accessories, such as triggers, muzzle devices, flip-up sights, ambi charging handle, vertical grips/handstops, and the aforementioned alternate aluminum handguards.

Under normal circumstances I would say that swapping out parts and accessories on an AR is the same from gun to gun, but in fact SIG has made things a little easier if you want to replace the provided handguard on the TREAD with one of their two alternate models.

Every SIG TREAD handguard uses the same barrel nut, and all you have to do to swap handguard is to remove two hex-head bolts securing the handguard to the barrel nut. Personally, I think the alternate 15-inch handguard with lightening cuts SIG sells as a TREAD factory accessory is the one they should have put on this rifle, as it is both more functional (more



SIG's gas block is so fancy at first you might think it is adjustable, but it is not. It is pinned in place for the utmost in durability and reliability. That blowback and discoloration on the gas tube is normal after you've put hundreds of rounds through a gun.

M-LOK slots) and has a more traditional appearance than the skinny factory standard handguard.

While I don't really care for the looks of the provided handguard it works just fine, and even as a whiny spoiled gunwriter the only minor complaint I have with the base rifle is the unimpressive trigger and old-school charging handle. Well, one more — I wish it came with iron sights, but yes, I know, those would cost additional money. Subscribing to the "everything that can go wrong will" philosophy, I believe every rifle intended for self-defense use should have backup irons no matter how reliable your optic of choice is.

For accuracy testing, I mounted a Trijicon Accupower 1-8X scope in a quick detach Midwest Industries mount, and the rifle did very well. Accuracy with just about every type of ammo I tried averaged between 1-2 MOA, and the biggest challenge was



SIG sells a number of TREAD-branded accessories for the rifle. Seen here are just a few — 13- and 15-inch skeletonized handguards, sights, a match trigger, ambi charging handle, muzzle brake, and more.

shooting up to the rifle's accuracy potential, because of the seven-pound trigger.

For up close speed work I mounted the SIG ROMEO4T optic on the gun, which I have previously reviewed in these pages. This small red dot is built to handle military grade abuse, and only adds a few ounces to the weight of the gun, unlike the Trijicon



A closer view of some of the SIG TREAD-branded accessories installed on the gun — the 15-inch skeletonized M-LOK handguard, the handstop, and the flip-up front sight. This handguard allows you to see the narrow barrel profile, which helps keep weight down.

1-8X scope and mount combo which adds 34 ounces. Although ... that weight helps to eliminate what little recoil there is, and that 8X magnification will allow you to use the rifle out to the limits of the cartridge's capability.

I grabbed an assortment of magazines from my basement for reliability testing. In addition to the provided Gen 2 Magpul PMag I used a Gen 1 PMag, a Lancer AWM, and a Colt aluminum magazine with a Magpul follower. I specifically grabbed a first-generation Magpul PMag as they are a little larger than the new ones, and as I mentioned the magazine well of the TREAD was tight. The Gen 1 PMag fit in the gun, but it did not drop free when empty no matter whether the bolt was closed or locked open.

Accuracy testing is necessary, but not exactly fun. Fun for me is practicing snapping the rifle up to my shoulder and seeing how fast I can hammer silhouettes at various urban distances, practicing my target

transitions (the lack of forward weight on this rifle made it easy to swing back and forth and stop the muzzle where I wanted to), and shooting off various improvised rests — 55-gallon plastic drums, walls, a knee, etc.

For the bulk of my range fun I used bulk-packed 5.56 NATO FMJ from Frontier Ammunition. A collaborative business partnership between Hornady and the Lake City ammunition plant (normally used to load government rifle ammo), Frontier ammo features Hornady bullets loaded into cases by the Lake City plant for budget-priced ammo.

I would like to point out that, for this article, I was getting myself reacquainted with this rifle. This rifle was sent to me quite some time ago, and was in fact used throughout the entire 2019 season of the *Handguns & Defensive Weapons* TV show on The Sportsman Channel, and we've been using it while filming the 2020 season as well. I and my co-host

27 WORDS BY YEHUDA REMER

Doing a little research on the Gadsden Flag and Benjamin Franklin's "JOIN, or DIE" cartoon for this article reminded me just how little American history children are being taught these days — or what they're being taught is just plain wrong.

If you want to do your part to combat this, with your children or grandchildren, I recommend picking up a copy of *27 Words, A Children's Guide to the Second Amendment*, by Yehuda Remer. Remer is a very politically active (Pro-2A) author and activist known as "The Pew Pew Jew", and *27 Words* is just one of the many children's books he's written. His illustrated books on gun safety for kids (including a coloring book) are so good they're carried by the Pro Shop at Gunsite, which should tell you all you need to know.

27 Words (which is the length of the amendment in question) explains both the meaning of the Second Amendment and the history behind it. It is thirty pages long and fully illustrated with modern and historical images, including colonists battling against the redcoats and modern American citizens carrying pistols

and shooting AR-15s. It is written for ages six to 10, and with full-color images on every page it will keep the interest of younger children if you want to read it to them.

However, unlike probably most of the history books shoved at kids in public school, you won't find any political correctness or revisionist history here.

Remer goes through the 27 words that separate the citizens of the United States from tyranny. He correctly defines what a militia is (among other things) and explicit states, "... the real reason why the Founding Fathers wrote the Second Amendment into the Constitution is because they wanted to make sure that if the government of the United States ever tried taking away citizens' rights, like the British did, the citizens would be able to protect themselves and fight for their freedoms."

27 Words is available from Amazon.com for \$14.95 in paperback and is also available digitally on Kindle. You can also purchase signed copies at ThePewPewJew.com for a few dollars more. **FN**

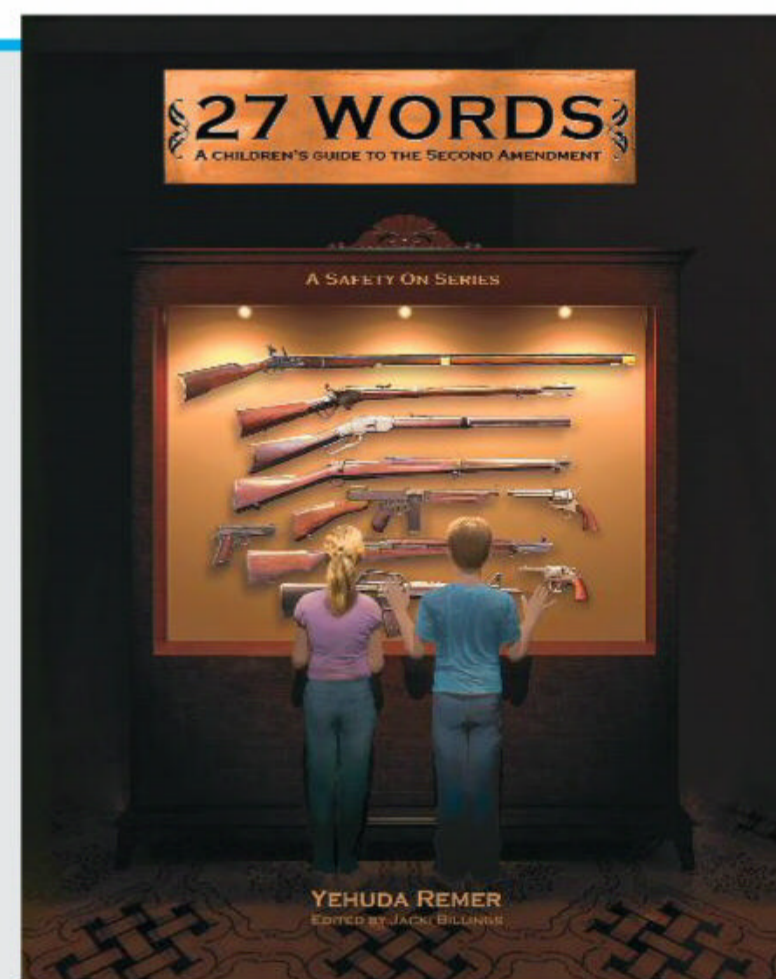

***27 Words* is a children's book which explains the meaning of and history behind the Second Amendment written by a very Pro-2A writer and activist.**



The TREAD upgraded with the SIG TREAD-branded accessories. The accessories Tarr chose make the TREAD “perfect” in his opinion — they provide added performance and improved looks, but combined have an MSRP of \$376, which is a significant bump.

SIG TREAD M400 RIFLE	
Caliber:	5.56 NATO
Weight:	6 lbs. 9 oz
Overall length:	32.5 in. (stock collapsed) 35.75 in. (stock fully extended)
Receiver:	Forged aluminum
Barrel:	16" stainless steel, mid length gas system, 1/8" twist
Muzzle Device:	SIG 3-prong flash hider
Stock:	Magpul SL-K
Pistol Grip:	SIG
Forend:	SIG 15-inch M-LOK
Trigger:	7.0 pounds (as tested)
Sights:	None
Accessories:	One 30-round magazine
MSRP:	\$951.00
Manufacturer:	SIG Sauer SigSauer.com

Rich Nance have put untold hundreds of rounds through this rifle at the legendary Gunsite (which is in the dusty high desert of Arizona), The Site training facility in northwest Illinois, and the private range run by Pendleton Safes in Georgia. I'm shocked it doesn't look worse than it does, and in

fact don't know how I've managed to keep it from getting scratched up.

In all that time, the rifle has never jammed, never malfunctioned in any way. And I have yet to clean or even lube it.

Long ago SIG sent me a box of their TREAD-branded accessories, and for this article I opted to install the ones I liked to fully customize the rifle, as I've decided that, whenever SIG gets around to asking for it back, I'm going to buy it (which should tell you how I feel about its value).

Exactly what accessories does SIG offer for the TREAD? 15- and 13-inch skeletonized M-LOK handguards, an all-metal flip-up sight set, ambidextrous oversize charging handle, two-stage match trigger with a flattish face, handstop kit, three-port muzzle brake, and vertical foregrip kit, at a minimum. I chose to install the 15-inch handguard, flip-up sights, handstop, and the ambi charging handle. You can see the result in the photos.

The accessories I chose I feel make the TREAD “perfect” — they provide added performance and (in my opinion) improved looks, but combined have an MSRP of \$376, which is a significant bump.

No honest review of the SIG TREAD would be complete without discussing the one rifle that I believe is the direct reason for the existence of the TREAD and several other new ARs, the Springfield Armory

Saint. When it was introduced three years ago the Saint offered an AR-pattern rifle that was significantly improved over a standard “M4-pattern” AR, sporting better than GI furniture and a mid-length gas system instead of the traditional carbine-length. Springfield wasn't the first company to do this, but the Saint was close to three hundred dollars less than any competing rifle from any other major manufacturer. And it had a huge impact on the market.

Ruger responded with their AR556 MPR, and SIG followed suit with the TREAD. It's said that a rising tide lifts all boats, and with companies struggling to reignite interest in the stagnant AR segment even with the coronavirus-related gun sales surge (most guns sold were handguns suited for CCW), the American consumer is the real winner.

Personally, I want every American to own an AR, so that when they come for one they have to come for us all, and there are few (if any) better choices for the money on the market today than the SIG TREAD.

James Tarr is a longtime contributor to Firearms News and other firearms publications. He is also the author of several books, including CARNIVORE, which was featured on The O'Reilly Factor. His brand-new novel, Dogsoldiers, is available now through Amazon and Barnes & Noble. FN

GALLERY OF GUNS[®].com

WANT A SIG TREAD M400 RIFLE?

Check out Davidson's Gallery of Guns at GalleryOfGuns.com!

Davidson's offers the GuaranteeD® Lifetime Replacement Warranty which backs all the firearms you buy through GalleryofGuns.com. It works like this: if anything ever goes wrong with any gun you buy with the Davidson's GuaranteeD® Lifetime Replacement Warranty, it will be replaced. If no replacement is available, it will be repaired at no charge to you. Simply return it to the retailer where you purchased it, pay for the return shipping and upon receipt Davidson's will ship the returning retailer a brand-new gun for you provided one is available. If a replacement is not available your firearm will be repaired for free. For complete warranty information please refer to the Guaranteed Warranty link found at the home page of GalleryofGuns.com **FN**

SIG TREAD M400 RIFLE				
Load	Bullet Weight	Velocity	SD	Avg Group
Black Hills TSX (5.56 NATO)	50	3021	30	1.93
Winchester 3-Gun FMJ	55	2814	31	2.12
Hornady V-Max	55	2898	40	1.37
Aguila FMJBT (5.56 NATO)	62	2779	27	2.08
Black Hills TMK (5.56 NATO)	77	2688	15	1.34

Accuracy results are the averages of four five-shot groups at 100 yards from a sandbag rest. Velocities are averages of ten shots measured with an Oehler Model 35P 12 feet from the muzzle.



Stuck inside because of coronavirus?
Why not build the ultimate home
defense rifle with parts from Luth-AR?
It's not hard and makes for
a great family project.

LUTH-AR

The Ultimate DIY
Frankengun for Competition
and Home Defense

BALLISTIC SYNERGY:

By Will Dabbs, MD

As I type these words, the entire planet seems to be on lockdown over the blasted coronavirus. With little else to do most Americans are busy gaining weight and binge-watching *Tiger King*. Here at *Firearms News* we thought it might be a good time to create something dark, sinister, and oily.

Given the peerless modularity of the AR15 rifle, my tasker was to do some shopping and build up the ideal defensive rifle from commercially-available components. This homebuilt DIY Frankengun gun should be optimized for both competition and home defense. We wanted a rifle that was reliable, accurate, versatile, and cool. As so often seems the case getting there was half the fun.

**Our custom-built
competition home
defender is greater than
the sum of its parts.**



Ballistic Philosophy

What must it have felt like when John, Paul, George, and Ringo first sat down together in London's Abbey Road Studios and recorded *Love Me Do* in September of 1962? Do you think they felt like they were about to become the greatest rock and roll band in the history of music, or were they just four scraggly beatniks grinding out some glorified noise?

Robert Norton Noyce was the archetypal uber-nerd who built his first homebuilt aircraft at age twelve. In 1959 when he invented the world's first monolithic integrated circuit, do you think he realized he was about to change every single thing about life on planet earth or was he just some geek who like to tinker?

Similarly, when Gene Stoner, Jim Sullivan, and Bob Fremont gathered round a piece of paper in 1956 to design the most modular firearm in human history, did they have any inkling as to where this thing might actually go? Did they suspect that gun nerds such as ourselves would someday be bodging these things together in our basements or were they just three gifted guys who liked to shoot?

Some folks seem to grasp their greatness, while others just muddle along. In the case of Stoner, Sullivan, and Fremont, that space age black rifle they designed back in the 1950's did indeed change the way the world made firearms. Just about every military weapon on the planet was influenced to one degree or another by that remarkable first black rifle.

Nowadays building your own AR15 rifle at home is both great fun and big business. Down here in the Deep South where I live, if you haven't built an AR with your kid before they leave for college you could be suspected of child abuse. Stoner's cool black gun is like Legos for grownups. By mixing and matching components you can build everything from a concealable Lilliputian pocket howitzer up to a long-range steel-thumping beast.

There are typically about 60,000 people at the SHOT Show every year. Each of those people represents a weapons company, gun shop, firearms magazine, or something similar. The scope of this remarkable undertaking amazes me with monotonous regularity.



That first AR-15, ably represented here by the contemporary Brownells BRN-Proto, changed everything about the way the world made guns.

With an entire industry from which to draw, here is how we skinned this cat.

The Best Place to Start is Typically the Beginning

While Gene Stoner and Company birthed the original chassis back in 1956, it was Randy Luth who really took America's black rifle to the next level. In 1993, Randy owned Essential Arms and was feeding the burgeoning market for barrels, receivers, and entrails necessary to build your own AR rifles at home. It seemed like there weren't but about five of us who were into such stuff back then, but this was of course before Al Gore really invented the Internet.

America was just developing a taste for such stuff, and Randy rode the wave. He started with pedestrian milspec parts and accessories. Then he milled the carrying handle off of an AR upper, bolted three lengths

of rail to the thing, and changed the entire world as we know it.

Randy chambered his neophyte custom AR rifles for scads of different calibers and was the first to convince the world that Stoner's black rifle could be used for hunting. A couple of other familiar companies built and sold later, Randy is now comfortably ensconced at the controls of Luth-AR, his premium black rifle parts company. Luth-AR produces some of the finest barrels, handguards, and MSR (Modern Sporting Rifle) components in the business.

We assembled everything on a Spike's Tactical lower because they make great receivers and I think the markings are comical. The stainless 16-inch heavy fluted barrel is precision bored and free-floated for optimal accuracy. The flutes cut down on unnecessary weight and enhance stiffness. Nobody makes them better.



Luth-AR (Luth-AR.com) supplied the complete upper as well as the lower components (buffer, bolt release, etc.), with the exception of the fire control parts and Bravo Company furniture.



Spike's Tactical makes some of the cleverest black rifle lowers on the market. Whatever suits your personality and mood can be found on their website.

The enlarged Luth-AR bolt release is fast and handy.



The triangular forearm is rugged and nicely ventilated.



The oversized Luth-AR safety is both easy to use and smooth.



The BCM Gunfighter collapsible stock is snag-free and all but indestructible.

An extended paddle bolt release makes running the gun at speed smooth and fast. The custom Luth-AR trigger guard maximizes the available finger space and mounts up without those pesky roll pins. The extended safety lever rides underneath your thumb for instant activation like it was born to be there.

The forearm sports a full-length triangular cross section that mimics Stoner's original design. Nothing interfaces with the human hand better. The forearm is festooned with KEYMOD slots as well as some milled bullet imagery that just looks cool. M-LOK is of course available as well. This keeps the weight down and increases the gun's innate awesome factor. The top aspect includes a full-length Picatinny rail for optics.

Dressing the Beast

Bravo Company USA does the furniture. Their BCM Gunfighter collapsible buttstock is the top of the heap in polymer black rifle near ends. The BCM Gunfighter sports smooth snag-free edges and

rugged lightweight construction. A soft rubber butt-pad excises whatever residual recoil such an optimized smoke pole might retain.

There are two broad sling mounting options to include bilateral QD swivel sockets. The modular VBOST (Vehicle Borne Operations Sling Tab) keeps the sling snug against the stock when not in use so you don't inadvertently strangle yourself when you have to egress a vehicle in a rush. The simple modular design only has five parts and one screw. It is also available in four different colors for anyone who wishes to color coordinate their tactical weaponry.

The BCM Gunfighter Grip (GFG) Mod 1 is the perfect way to grab your rifle. A hinged trap door storage compartment sports a water-resistant rubber gasket. The smooth modular insert closes the gap behind the grip to best accommodate the human form. The surface texture enhances control without being uncomfortable. The GFG also offers a more oblique angle between the grip and bore when compared to milspec offerings.

Back in the Dark Ages when I wore the uniform, we were taught to turn 90 degrees away from our target and run our rifles with our strong-side elbow jutting out at a jaunty angle. Nowadays, everybody wears body armor, and we do things a bit differently. These days, we square off against our target and tuck the strong-side elbow in tight. This puts more armor

[Cont. to page 62]

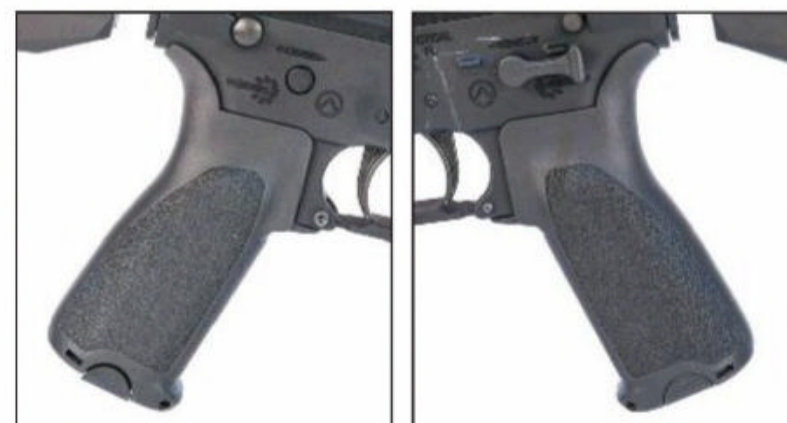

The BCM Gunfighter Grip is tough, comfortable, and effective.



**GEAR UP
TODAY!**

everest.com

[#calibermember](https://twitter.com/calibermember)



Whether for competition, LE, or home defense, we train to run our rifles with the strong elbow tucked in tight. The BCM Gunfighter Grip from Bravo Company USA helps you keep your elbow where it should be.



The Leupold VX-R 1.25-4x20mm combat gunsight is compact, lightweight, and versatile.



The Leupold VX-R 1.25-4x20mm gunsight is easy to run, even in a rush.

[Cont. from page 60]

toward the threat, reduces the possibility of snagging that elbow while on the move, and enhances control. The oblique angle of the GFG tends to push the strong-side elbow down where it should be.

Tactical Glass

You can't sit at the cool kids' table at your local range unless you have something electronic and sparkly perched atop your favorite black rifle these days. The Leupold VX-R 1.25-4x20mm combat gunsight strikes the perfect balance between precision and speed. Featuring beautiful flawless glass along with the cool-guy stuff you want without the fluff you don't, the VX-R 1.25-4x20mm gunsight optimizes this tactical hotrod.

This crystal clear optic includes a red illuminated FireDot reticle and a baseline 1.25X magnification for up close engagements at bad breath range. At minimal magnification and with the FireDot ignited the scope is the equal of the best close combat red dots on the market. Instantly spin the optic up to 4X if your targets are out there a ways. The sight is remarkably lightweight yet milspec rugged.

Of course the thing is water and fogproof. This is a top-tier Leupold combat sight, not some cheesy airsoft crap. The scope features a 30mm main tube, a 3:1 zoom ratio, and easy-to-use 1/4 MOA finger click capped turrets. Motion Sensor Technology wakes the illuminated reticle up when it moves.



The latest Magpul PMAG is Uncle Sam's M4 magazine. That makes it the best on the planet.

Magpul Magic

Magpul went from humble beginnings to become arguably the most agile and innovative tactical solutions supplier on the planet. Their handgrips, slings, sights, and handguards set the standard the world over. Don't just take my word for it. Uncle Sam just bought himself an absolute buttload of PMAGs.



The Magpul AFG adorned with a little cool grippy stuff from Talon Grips puts your weak hand in the perfect spot for optimal control.

Magpul PMAGs are what convinced the world that polymer AR magazines were cool. Featuring a long-life USGI-spec stainless steel lift spring, a four-way anti-tilt follower, constant-curve internal geometry, and simple tool-free disassembly, the PMAG sets the bar. A scant flare to the baseplate makes the PMAG easy to grab, and an over-travel stop built into the



The Silent Legion Complete Multi-Caliber Kit orbits around a versatile titanium suppressor appropriate for a variety of applications.



The Silent Legion Complete Multi-Caliber Kit comes with four different mounting solutions. Their QD flash suppressor mounts offer maximum versatility.

spine keeps the mag from poking too deep. Rugged bilateral transparent windows help you keep track of rounds remaining at a glance. U.S. Army Rangers, Special Forces, SEALs, and Marines can't tear these things up. They work just fine for the rest of us as well.

The Magpul AFG (Angled Fore Grip) interfaces with your natural body mechanics to provide a firm and comfortable grip on your favorite tactical firearm. The AFG mounts to any standard Picatinny rail and keeps your support hand high and around the center-line of the bore. Mounting the AFG toward the distal end of the rifle lets you drive the gun like you mean it.

Talon Grips offers rugged adhesive gun grips for most anything that shoots. Custom cut for each application, these applique grips are easy to apply and a perfect fit. I opted for the grippiest sort for my Magpul AFG, and it locks your hand in place tighter than politicians grab other people's money.

The Sound of Silence

Sound suppressors used to be expensive, mysterious, and rare. Nowadays they are found everywhere free men and women shoot. In addition to enhancing control and accuracy, a decent can just makes you a friendlier shooter. These harmless firearm accessories should really be sold through coin-operated vending machines at your local range.

Despite all their undeniable benefits, the government persists in just regulating the living heck out of these things. That means an onerous \$200 transfer tax and an interminable wait to process the forms. No kidding, my last Form 4 took nearly a year. The Silent Legion response to this sticky quandary is the Complete Multi-Caliber Kit.

The Silent Legion Complete Multi-Caliber Kit consists of a 16-ounce tank-tough high-efficiency titanium sound suppressor, four different mounts, and a disassembly tool. Direct thread inserts come in 1/2x28 and 5/8x24 for both 5.56mm and .30-caliber applications. Two different QD flash suppressors interface with the same two platforms. By mixing and matching mounts you can use a single registered can for anything from .22LR up to .300 Win Mag.

This Silent Legion suppressor is only 7.5 inches long and remarkably efficient. Also, unlike many



The Streamlight Protac Rail Mount HL-X Laser Long Gun Light is precise, powerful, and tough while remaining reasonably priced.



The Streamlight HL-X puts out 1,000 lumens to burn through the darkness.

rifle-grade sound suppressors, this can is rated for short-barreled applications. I use my Silent Legion suppressor on all my .223 rifles as well as my Springfield Armory SOCOM16 .308. Mounting and dismounting the device on the QD flash hider mounts involves nothing more than pressing in against spring pressure and twisting.

Piercing the Darkness

The Streamlight Protac Rail Mount HL-X Laser Long Gun Light includes a hardened red laser sight and a 1000-lumen white light illuminator bright enough to burn your skin off. The HL-X weighs a bit shy of eleven ounces and feeds off of a pair of CR123A Lithium batteries or a Lithium-Ion rechargeable battery pack. The HL-X comes with a rugged, easy-to-use mount and two tailcap switches.

The extended remote features momentary and constant operation and is designed to be easily controlled in hard dark. The push-button tail switch has separate switches for the light and laser and is also easily distinguished by feel alone. The HL-X is as tough as Chuck Norris' beard and reasonably priced. You could spend more on a top-tier tactical illuminator, but you could just put your money in a tidy pile and set fire to it if that's your thing. The Streamlight HL-X is professional illumination for LE, military, and civilian tactical applications that doesn't break the bank.

Trigger Time

I mounted up a Hiperfire modular drop-in trigger. These guys have taken the humble AR trigger into the Information Age. Their fire control units are easy to install and let you customize the personality of your rifle into your ballistic soul mate. Quite literally anything you could imagine in the way of refined custom AR triggers awaits you on their website.

With all the cool-guy stuff in place this rifle is undeniably hefty. Gene Stoner's original weighed about 6.5 pounds. Fully accessorized this customized room-clearing monster is closer to eleven. Before you recoil in disgust at that number, let's think this through.

This is not the gun you want if you are about to do a thirty-click recce through the Hindu Kush. This is

[Cont. to page 67]

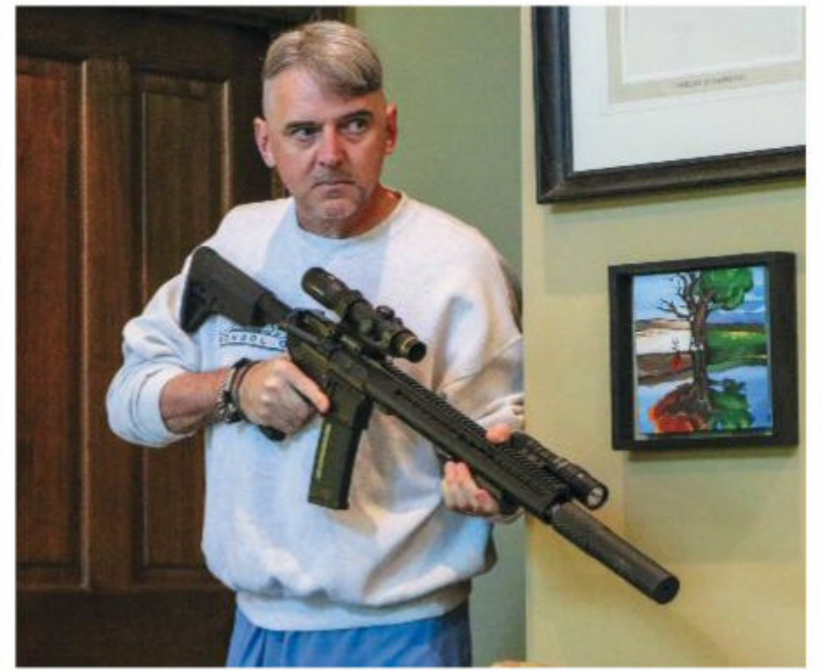

The resulting Frankengun is a home defending monster.



Hiperfire triggers come in a bewildering array of configurations and compartments. They allow you to tune your rifle to your particular personality.



Whether up close or out a ways, these 100-meter groups show that our DIY home defender Luth-AR 5.56mm Frankengun shoots plenty straight.

LUTH-AR FRANKENGUN		
Load	Group Size (in.)	Velocity (fps)
Inceptor SRR 35gr Frangible	2.5	3,329
Hornady 53gr V-Max	0.9	3,057
SIG SAUER 77-gr OTM	2.1	2,368
Federal Fusion 62gr FMJ	1.1	2,821
Federal Premium 69-gr BTHP	0.8	2,597

Group size is best four of five shots measured center to center fired from a Lead Sled at 100 meters. Velocity is the average of three shots fired across a Caldwell Ballistic Chronograph oriented ten feet from the muzzle.

THE BEST GUN ENTHUSIAST SHOWS EVER MADE. ONLY ON MY**OUTDOOR**TV.



**10,000+ Exclusive Shows.
Best-In-Class Content.**

Watch the best hunting, fishing and shooting shows ever made. Exclusive, premium content added weekly. **MyOutdoorTV** is available on all your favorite devices — stream or download to watch anytime, anywhere.

**MYOUTDOORTV.
NOW EVERYWHERE.**

Apple TV App Store

XBOX Google Play

amazon fireTV Roku

MOTV
MYOUTDOORTV®
MYOUTDOORTV.COM

**START YOUR
FREE TRIAL**

HARBOR FREIGHT

QUALITY TOOLS AT RIDICULOUSLY LOW PRICES

Shop When You Need To Online & In-Store

SUPER COUPON

U.S. GENERAL

BIGGER • STRONGER • MORE STABLE SERIES 2

30", 5 Drawer Mechanic's Cart

★★★★★ (1,453)

\$199⁹⁹

- 15,000 cu. in. of storage
- 700 lb. capacity
- Heavy duty locking casters

~~\$239⁹⁹~~

Save \$630



YOUR CHOICE OF 7 COLORS



Use Online & In-Store

Item 64033, 64722, 64031, 64721, 64059, 64720, 56429
40714375 **LIMIT 1** - Coupon valid through 8/9/20

NOW
GOOD THRU AUGUST 9

SAVE 94%

Swivel Lens Headlamp

★★★★★ (4,103)



WOW! 89¢

~~\$2.89~~

LIMIT 3

Compare to Energizer EDB32EH \$15.98

Item 63598/61319/64073/64145/45807 shown

Use Online & In-Store

40715514 **LIMIT 3** - Coupon valid through 8/9/20

SUPER COUPON

20% OFF

ANY SINGLE ITEM*

Use Online & In-Store



40426268

Limit 1 coupon per customer per day. Save 20% on any 1 item purchased. *Cannot be used with other discount, coupon or any of the following items or brands: Inside Track, Club membership, Extended Service Plan, gift card, open box item, 3 day Parking Lot Sale, compressors, floor jacks, power stations, sales, storage cabinets, chests or carts, trailers, welders, Admiral, Ames, Atlas, Bauer, Central Machinery, Cobra, CoverPro, Daytona, Diamondback, Earthquake, Fischer, Hercules, Icon, Jupiter, Lynxx, Poulan, Predator, Tailgator, Viking, Vulcan, Zurich. Not valid on prior purchases. Non-transferable. Original coupon must be presented. Valid through 8/9/20.

SUPER COUPON

.50 Cal Metal Ammo Can

★★★★★ (1,726)

\$10⁹⁹

~~\$13⁹⁹~~

Save 56%



Compare to Game Winner FSGWHE1030 \$24.99

Item 63750, 56810/63181 shown

Use Online & In-Store

40715788 **LIMIT 3** - Coupon valid through 8/9/20

SUPER COUPON

7 ft. 4" x 9 ft. 6" All Purpose/Weather Resistant Tarp

★★★★★ (1,970)

\$2⁹⁹

~~\$4⁹⁹~~

Save 65%



Compare to Blue Hawk 8G8X10-Y \$8.78

Item 69115/69121, 69129/69137, 69249/877 shown

Use Online & In-Store

40721507 **LIMIT 4** - Coupon valid through 8/9/20

SUPER COUPON

PITTSBURGH 130 Piece Tool Kit with Case

★★★★★ (3,484)

\$29⁹⁹

~~\$39⁹⁹~~

Save 54%

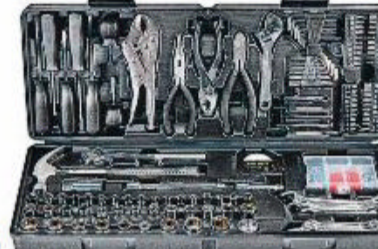

Compare to Anvil A13THOS \$66.39

Item 68998/63248, 64080, 64263/63091 shown

Use Online & In-Store

40722798 **LIMIT 3** - Coupon valid through 8/9/20

SUPER COUPON

Heavy Duty Foldable Aluminum Sports Chairs

★★★★★ (4,509)

\$19⁹⁹

~~\$29⁹⁹~~

Save 50%



Compare to Coleman 635394 \$39.99

Item 63066/62314 shown, Item 56719
40723452 **LIMIT 3** - Coupon valid through 8/9/20

SUPER COUPON

drillmaster 4-1/2" Angle Grinder

★★★★★ (5,805)

\$9⁹⁹

~~\$14⁹⁹~~

Save 44%



Compare to Performax 2411-1 \$17.99

Item 69645, 60625 shown

Use Online & In-Store

40727449 **LIMIT 4** - Coupon valid through 8/9/20

SUPER COUPON

8" Hunting Knife with Survival Kit

★★★★★ (941)

\$6⁹⁹

~~\$9⁹⁹~~

Save 53%



Compare to Whetstone 25-87612 \$14.92

Item 61733, 61501/90714 shown

Use Online & In-Store

40728891 **LIMIT 4** - Coupon valid through 8/9/20

SUPER COUPON

HaulMaster 18" x 12" Mover's Dolly

★★★★★ (5,759)

\$7⁹⁹

~~\$10⁹⁹~~

Save 65%



Compare to Buffalo Tools HDFOOLLY \$22.99

Item 60497/62399, 63095/63096, 63097/63098 shown

Use Online & In-Store

40736332 **LIMIT 4** - Coupon valid through 8/9/20

SUPER COUPON

WARRIOR 29 Piece Titanium Drill Bit Set

★★★★★ (4,679)

\$10⁹⁹

~~\$18⁹⁹~~

Save 83%



Compare to Dewalt DW1369 \$68.14

Item 5889/62281, 61637 shown

Use Online & In-Store

40736870 **LIMIT 3** - Coupon valid through 8/9/20

SUPER COUPON

Apache Weatherproof Protective Rifle Cases

★★★★★ (579)

\$114⁹⁹

~~\$149⁹⁹~~

Save \$155



Compare to Pelican DOUBLE RIFLE \$269.99

Item 56862, 64520

Use Online & In-Store

40738941 **LIMIT 1** - Coupon valid through 8/9/20

SUPER COUPON

HARDY Mechanics Gloves

★★★★★ (274)

\$4⁹⁹

~~\$5⁴⁹~~

Save 66%



Compare to Valeo 25521 \$14.99

Item 62434, 62426, 62433, 62432, 62429, 64179, 62428, 64178 shown

Use Online & In-Store

40740146 **LIMIT 4** - Coupon valid through 8/9/20

SUPER COUPON

UNION 10 Gun Electronic Security Safe

★★★★★ (155)

\$279⁹⁹

~~\$329⁹⁹~~

Save \$284



Compare to Stack-on SS-16-MB-E \$564.57

Item 64008/64011 shown

Use Online & In-Store

40748363 **LIMIT 1** - Coupon valid through 8/9/20

SUPER COUPON

CENTRAL PNEUMATIC 3 Gallon, 100 PSI Oil-Free Air Compressors

★★★★★ (3,708)

\$39⁹⁹

~~\$54⁹⁹~~

Save 59%



Compare to Hot Dog Item 69269 97080 shown

Item 61615/60637, 95275 shown

Use Online & In-Store

40751387 **LIMIT 3** - Coupon valid through 8/9/20

SUPER COUPON

PREDATOR 4375w Max. Starting Extra Long Life Gas Powered Generator

★★★★★ (249)

\$349⁹⁹

~~\$379⁹⁹~~

Save \$1,719



Compare to Honda EM4000SX \$2,069

Item 63963/63962 shown, Item 63960/63961, California Only

Use Online & In-Store

40765951 **LIMIT 1** - Coupon valid through 8/9/20

SUPER COUPON

Safety Glasses

★★★★★ (1,096)

\$1²⁹

~~\$1⁹⁹~~

Save 78%



Compare to 3M 90552-00000B \$5.96

Item 66822, Smoke Lens Item 66823, Yellow Lens Item 66823, Clear Lens Item 63851/99762 shown

Use Online & In-Store

40768849 **LIMIT 4** - Coupon valid through 8/9/20

SUPER COUPON

THUNDERBOLT solar 100w Solar Panel Kit

★★★★★ (733)

\$189⁹⁹

~~\$199⁹⁹~~

Save \$102



Compare to Windynation SOK-100WP-P30L \$292.44

Item 63585

Use Online & In-Store

40774292 **LIMIT 1** - Coupon valid through 8/9/20

SUPER COUPON

WARRIOR 4-1/2" Flap Disks

★★★★★ (815)

\$2⁹⁹

~~\$4⁴⁹~~

Save 62%



Compare to Diablo DCX-045080N01F \$7.97

Item 61500/67639, 69604 shown, 60 GRIT 69602/67637, 120 GRIT 69604/67636

Use Online & In-Store

40785928 **LIMIT 4** - Coupon valid through 8/9/20

1,000+ Stores Nationwide • HarborFreight.com

*Original coupon only. No use on prior purchases after 30 days from original purchase or without original receipt. Valid through 8/9/20.

At Harbor Freight Tools, the "Compare to" price means that the specified comparison, which is an item with the same or similar function, was advertised for sale at or above the "Compare to" price by another national retailer in the U.S. within the past 90 days. Prices advertised by others may vary by location. No other meaning of "Compare to" should be implied. For more information, go to HarborFreight.com or see store associate.



Our home-built hotrod started out as a pile of parts yet shoots like a laser and corners like a Bugatti.

[Cont. from page 64]

the weapon you grab to go spank your friends at the local range. This rifle would also be great company while you wander about to see why the dog won't shut up at three o'clock in the morning. Balance of probability none of us will be humping the Hindu Kush any time soon. That other stuff closer to home, however, remain very real possibilities.

The center of gravity ends up right at the open spot in the forearm, so toting the weapon comes naturally. The combination of a soft-shooting round and the gun's not insubstantial mass make this system essentially recoilless. Lock the piece into your shoulder and drive it like you mean it and this thing will put the holy smackdown on anything that needs shooting. Whether the threat is three hundred meters distant or across the room, this custom high efficiency threat remover will reliably blast what ails you.

Day or night, out a ways or at bad breath range, this custom-built DIY close combat Frankengun is drawn to trouble like a monkey on a Funyun. Fast, slick, capable, and cool, this custom rifle will make you competitive on the range or help secure your hacienda against life's nastier bits. The satisfaction that comes from having built the thing myself is also not insubstantial.

Anybody with a clean criminal record, a functional credit card, and even a modicum of mechanical aptitude can build one of these guns. Now get to it. *Tiger King* will still be there when you're done. **FN**



The modular nature of Gene Stoner's legendary black rifle lets us build the ultimate home defense and competition rifle at home.

LUTH-AR FRANKENGUN

Caliber:	5.56x45mm
Overall Length:	38.25/41.5 inches Collapsed/Extended
Barrel Length:	16 inches
Operating System:	Direct Gas Impingement
Weight:	11 pounds
Furniture:	Bravo Company USA
Feed System:	30-round Magpul PMAG
Optic:	Leupold VX-R 1.25-4x20mm
Suppressor:	Silent Legion

SOURCES FOR GREAT PARTS AND ACCESSORIES MENTIONED

Luth-AR.com
SpikesTactical.com
BravoCompanyUSA.com
Leupold.com
Magpul.com
SilentLegion.com
TalonGrips.com
HiperFire.com



Brothers by a Different Mother

THE 1966 COLT AR-15 SP1

By Will Dabbs, MD

I made my grand entrance into the world on a chilly Mississippi day in February of 1966. At six and one-half pounds and full of noise and energy, I was a force with which to be reckoned. The planet might never be the same.

At roughly the same time across the country in Hartford, Connecticut, another noisy violent creation first drew breath. This rowdy child also weighed about 6.5 pounds and showed up comparably ready to spew chaos. The convoluted trajectories that ultimately brought us together make for a fascinating tale.

In the Beginning ...

The modern black gun phenomenon all began in 1963 with those first few Colt SP1 AR-15 rifles. Prior to that time you could order M1 Carbines and 1911 pistols through the mail. Genuine full auto machine-guns were both ubiquitous and cheap as well. However, the AR-15 changed everything. With its rakish lines and space age materials science the AR-15 altered mankind's perception of the tactical firearm.

1966 was a weird time in American history. The War in Vietnam was just starting to go sideways, and the Age of Aquarius was about to turn American culture inside out. Amidst all this pervasive grooviness a certain Colt rifle and I drew our first breaths.

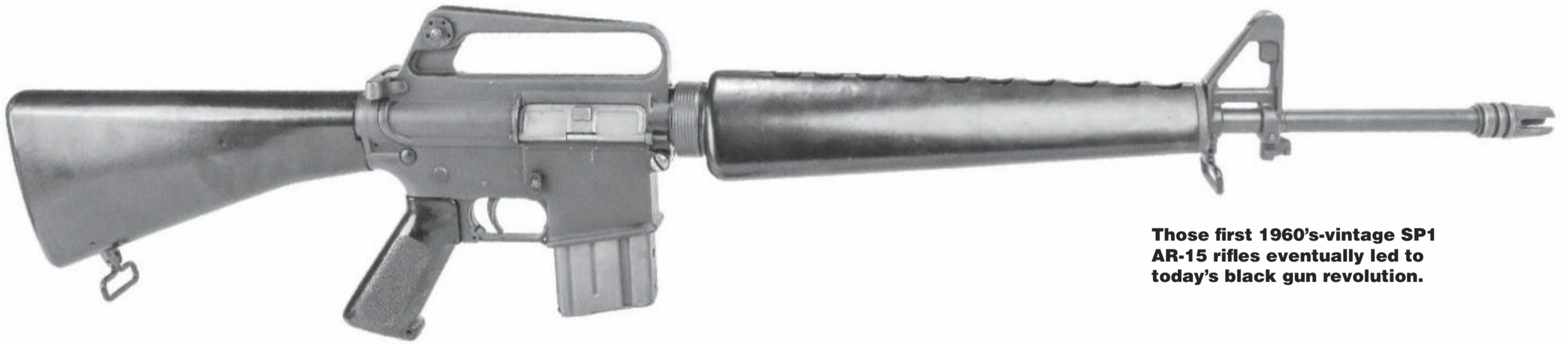

Those first 1960's-vintage SP1 AR-15 rifles eventually led to today's black gun revolution.

Interestingly, as was the case with the Colt Single Action Army, the American public got to buy Gene Stoner's uber-awesome black gun before the Big Green Machine did. The Army didn't make its first serious purchase of those early XM16E1 rifles until March of 1965. Though civilian production didn't really become a thing until 1964, Colt did sell 2,400 SP1 AR-15's that year. Interestingly, Colt's first military sale of AR-15's was to Malaya in September of 1959.

The development of the AR-15 is foundational dogma in our little world. Gene Stoner, Jim Sullivan, Bob Fremont, and a few others developed the AR-15 in 1956 as an offshoot of the larger 7.62x51mm AR10. Stoner himself developed the .223 round that became the 5.56x45mm cartridge as well.

The AR-15 was the product of the ArmaLite Company. ArmaLite was a tiny little subsidiary of Fairchild Aviation. However, ArmaLite was a research and development concern, not a manufacturing facility. In 1959, ArmaLite sold the rights to the AR-15 to Colt. Colt moved the charging handle from inside the carrying handle to the more familiar spot at the back of the receiver and titled the gun the Colt 601.

Details

Those first civilian-legal SP1 AR-15 rifles differed slightly from their military counterparts. AR-15 stood for ArmaLite Rifle, while SP1 was the Colt abbreviation for Sporter. The civilian AR-15 was obviously semiauto only, where the M16 was selective fire.

Additionally, for some reason the forward pivot pin on the SP1 AR-15 was a two-headed screw rather than the more familiar pushpin on the military rifles. Incidentally, those very early forward pushpins were not positively retained in the receiver.

An in-depth study of AR-15 development can and has filled volumes. We will just hit the high points here. The SP1 evolved through a bewildering variety

[Cont. to page 72]



American civilians actually got their hands on Gene Stoner's revolutionary black rifle before the US Army did. Colt sold the semiauto SP1 AR-15 to the public for more than a year before the Big Army bought their first XM16E1's. This XM177 Carbine version was a common fixture in Vietnam in the late 1960's.

superb hunting partner... Colt's new AR-15 Sporter

With Colt's new AR-15 Sporter you're ready for a new hunting adventure.

The AR-15 Sporter weighs only six pounds. It's .223 cal., 55-grain bullet has a muzzle velocity of 3,100 fps. Every AR-15 Sporter is factory-targeted at 100 yards.

If you're a hunter, camper or collector, you'll want the AR-15 Sporter. At any Registered Colt Dealer. \$189.50

Colt's Firearms Hartford, Connecticut

Colt Industries Inc
Colt Firearms Division



M&A PARTS INC. / WWW.MAPARTSINC.COM



964 Donata Ct. / Lake Zurich, IL 60047 / Tel: 847-550-8246 / Fax: 847-550-0654



Hours: 9:00 AM to 5:00 PM CST. Most orders shipped within 24 hours. Send certified check or money order, add approximate shipping. All federal, state and local laws must be adhered to. Illinois residents add 7.75% sales tax. All prices and specifications are subject to change without notice.



CHECK OUR WEBSITE FOR WEEKLY SALES AND NEW PRODUCTS !!!

COMPLETE KITS

Add our Kit to your stripped lower receiver to complete your rifle.

All kits are assembled, head-spaced & test fired.

CAR Kits



Mil-Spec Forged Flattop T-Marked Upper

Barrel with M4 Feed Ramps / A2 Flash Hider
Mil-Spec Forged F-Marked FSB / A2 Sight Post

CAR Handguards w/Heatshield / Collapsible CAR Stock

5.56mm / 16 Inch Chrome-Moly 1:9	\$475.00
5.56mm / 16 Inch Chrome Lined 1:9 or S.S. 1:8	\$520.00
300BLK 16 Inch Chrome-Moly 1:8	\$475.00
7.62x39mm / 16 Inch Chrome-Moly 1:10	\$525.00
9mm / 16 Inch Chrome-Moly 1:10 w/ Colt Mag Block	\$695.00
9mm / 16 Inch Chrome-Moly 1:10 for Glock Style Mags	\$525.00
458 SOCOM / 16 Inch Chrome-Moly 1:14	\$845.00

Mid-Length Kits



Mil-Spec Forged Flattop T-Marked Upper

Barrel with M4 Feed Ramps / A2 Flash Hider

Mil-Spec Forged F-Marked Front Sight Base / A2 Sight Post

Mid-Length Handguards w/Heatshield / Collapsible CAR Stock

5.56mm / 16 Inch Chrome-Moly 1:9	\$475.00
5.56mm / 16 Inch Chrome Lined 1:9 or S.S. 1:8	\$520.00
5.56mm / 16 Inch Chrome-Moly LtWt 1:9 or 1:7	\$475.00
5.56mm / 16 Inch Chrome Lined LtWt 1:9 or 1:7	\$520.00

M4 Style Kits



Mil-Spec Forged Flattop T-Marked Upper

Barrel with M4 Feed Ramps / A2 Flash Hider

Mil-Spec Forged F-Marked Front Sight Base / A2 Sight Post

M4 Handguards w/Heatshield / Collapsible CAR Stock

5.56mm / 14.5 or 16 Inch Chrome-Moly 1:9	\$495.00
5.56mm / 14.5 or 16 Inch Chrome Lined 1:9 or S.S. 1:8	\$540.00
5.56mm / 14.5 or 16 Inch Chrome-Moly 1:7	\$495.00
5.56 / 14.5 or 16 Inch Chrome Lined 1:7	\$540.00
6.8 SPC II 16 Inch Chrome-Moly 1:10	\$525.00

CAR Lightweight Kits



Mil-Spec Forged Flattop T-Marked Upper

Ltwt Bbl w/M4 Feed Ramps / A2 Flash Hider

Mil-Spec Forged F-Marked FSB / A2 Sight Post

CAR Handguards w/Heatshield / Collapsible CAR Stock

5.56mm / 16 Inch Chrome-Moly 1:9	\$475.00
5.56mm / 16 Inch Chrome-Moly 1:9	\$475.00
5.56mm / 16 Inch Chrome Lined 1:9	\$520.00
5.56mm / 16 Inch Chrome Lined 1:7	\$520.00

Commando Kits



Shown with optional RRA Entry Stock

Mil-Spec Forged Flattop T-Marked Upper

Barrel with M4 Feed Ramps / A2 Flash Hider

Mil-Spec Forged F-Marked FSB / A2 Sight Post

CAR Handguards w/Heatshield / Collapsible CAR Stock

5.56mm / 11.5 Inch Chrome-Moly 1:9	\$475.00
5.56mm / 11.5 Inch Chrome Lined 1:9 or 1:7	\$520.00
300B0 / 10.5 Inch Chrome-Moly 1:8	\$475.00
7.62x39 / 11.5 Inch Chrome Lined 1:10	\$565.00

Pistol Kits



Mil-Spec Forged Flattop T-Marked Upper

Barrel with M4 Feed Ramps / A2 Flash Hider

Picatinny Rail Gas Block Front Sight

Base Aluminum Free Float Tube / Pistol Recoil Buffer

5.56mm / 7 or 11.5 Inch Chrome-Moly 1:9	\$495.00
5.56mm / 11.5 Inch Chrome Lined 1:9	\$540.00
300B0/ 8 or 10.5 inch Chrome-Moly 1:8	\$495.00
9mm / 4 or 10.5 Inch Chrome-Moly 1:10 w/ Colt Mag Block	\$695.00
9mm / 4 or 10.5 Inch Chrome-Moly 1:10 for Glock Style Mags	\$525.00

20 Inch Rifle Kit



Mil-Spec Forged Flattop T-Marked Upper

Barrel with M4 Feed Ramps / A2 Flash Hider

Mil-Spec Forged F-Marked FSB / A2 Sight Post

Rifle Handguards w/Heatshield / A2 Trapdoor Stock

5.56mm / 20 Inch Chrome-Moly 1:9	\$495.00
5.56mm / 20 Inch Chrome-Moly 1:9 LtWt	\$515.00
5.56mm / 20 Inch Chrome Lined 1:9 or 1:7	\$540.00
5.56mm / 20 Inch Stainless Steel 1:8	\$540.00
5.56mm / 20 Inch DCM Stainless Steel 1:8	\$975.00

16 Inch Varmint Kit



Mil-Spec Forged Flattop T-Marked Upper

Varmint Barrel with M4 Feed Ramps

Picatinny Rail Gas Block Front Sight Base

Aluminum Free Float Tube / A2 Trapdoor Stock

5.56mm / 16 Inch Stainless Steel 1:8	\$515.00
With optional Fluted Barrel	\$575.00
With optional Versa-Pod Bipod	add \$85.00

20 or 24 Inch Varmint Kit



Mil-Spec Forged Flattop T-Marked Upper

Aluminum Free Float Tube

Varmint Barrel with M4 Feed Ramps
Picatinny Gas Block
Sight Base

5.56mm / 20 Inch Stainless Steel 1:8	\$540.00
With optional Fluted Barrel	\$590.00
Shown with optional Versa-Pod Bipod	add \$85.00

KITS OPTIONS & UPGRADES

BUTTSTOCKS

A2 Trapdoor or Car Stock	No Charge w/o kit \$85.00
M4 Stock (Standard with M4 Kit)	add \$25.00 w/o kit \$60.00
Magpul MOE Rifle Stock	add \$55.00 w/o kit \$65.00
Magpul PRS Stock	add \$210.00 w/o kit \$245.00
Magpul UBR Stock	add \$160.00 w/o kit \$180.00
Magpul ACS Stock	add \$60.00 w/o kit \$75.00
Magpul CTR Stock	add \$45.00 w/o kit \$55.00
Magpul MOE Stock	add \$30.00 w/o kit \$35.00
ACE Skeleton Stock	add \$60.00 w/o kit \$75.00
ACE M4 SOCOM Stock	add \$135.00 w/o kit \$155.00
Luth-AR	MBA-1 \$135.00 MBA-3 \$150.00
Rock River Arms Operator Stock	add \$95.00 w/o kit \$110.00
Troy Battle Ax CQB Stock	add \$135.00 w/o kit \$155.00
Troy SOCC Airborne Stock	add \$170.00 w/out kit \$195.00

LOWER PARTS / GRIPS

Rock River Arms NM Two Stage Trigger	add \$80.00 w/o kit \$110.00
Geissele SSA Trigger	add \$245.00 w/o kit \$275.00
KE Arms Drop In Trigger	add \$135.00 w/o kit \$165.00
Hogue Pistol Grip	add \$15.00 w/o kit \$20.00
ERGO SureGrip	add \$20.00 w/o kit \$25.00
ERGO Deluxe Tactical Grip	add \$50.00 w/o kit \$60.00
Magpul MOE Grip	add \$15.00 w/o kit \$20.00
Magpul MOE+ or MOE K+ Grip	add \$20.00 w/o kit \$24.00
Rock River Arms Winter Trigger Guard	add \$10.00 w/o kit \$15.00
Magpul Enhanced Trigger Guard	add \$15.00 w/o kit \$20.00
Magpul Enhanced Mag Release	\$18.00
Magpul BAD Lever	\$27.00
KE Arms Ambi Selector	add \$30.00 w/o kit \$35.00
Mil-Spec AR15 Ambi Selector	add \$20.00 w/o kit \$25.00
Mil-Spec M16 Ambi Selector	\$35.00

CHARGING HANDLES / CARRIERS / HANDGUARDS

Tactical Charging Handle Latch	add \$10.00 w/o kit \$15.00
PR Big Latch	add \$15.00 w/o kit \$20.00
Ambi Charging Handle	add \$50.00 w/o kit \$65.00
BCM Ambi Charging Handle	add \$65.00 w/o kit \$75.00
Chrome Carrier Group Assembly	add \$30.00 w/o kit \$130.00
Nickel Boron Carrier Group Assy	add \$55.00 w/o kit \$155.00
Diamondhead VRS T or X	10" \$160.00 13.5" \$185.00 15" \$195.00
2 Piece Car Quad Rail (Imported)	add \$25.00 w/o kit \$35.00
Carbine 7" Free Float Quad Rail	add \$35.00 w/out kit \$45.00
M&A Keymod or M-Lok 7"	\$60.00 9" \$75.00 12" \$95.00 15" \$110.00
Magpul MOE CAR/Mid	add \$25.00 w/o kit \$35.00
Troy Alpha or M-Lok 7"	\$150.00 9 or 11" \$175.00 15" \$190.00
Troy Alpha w/ Integrated Flip Up Front Sight 11 or 13"	\$235.00
YHM Diamond Quad 7" Car	\$130.00 9" Mid \$155.00 15" \$170.00

GAS BLOCKS / FRONT & REAR SIGHTS

Low Profile GB .750 Alum	add \$0.00/ Steel add \$25.00
Single Rail GB .750 Alum	add \$0.00/ Steel add \$35.00
Quad Rail Block .750 or .936 Steel	add \$65.00 w/o kit \$80.00
Rock River Gas Block Flip-Up Front Sight	\$85.00
Magpul Polymer Front Sight	add \$45.00 PRO \$75.00
YHM Flip-Up Rear Sight	.9680 \$95.00 5010 \$110.00
YHM Flip-Up Front Sight. Gas or Rail Height	\$75.00
Troy Flip-Up Front Sight. Rail Height	\$90.00
Magpul Polymer Flip-Up Rear Sight	\$55.00 PRO \$95.00
Mil-Spec Detachable Carry Handle	\$85.00
Diamondhead Poly Rear Sight	\$60.00/ Steel \$115.00
UTG or Amsport Imported Flip Rear Sight	\$30.00
A.R.M.S. #40 Flip-Up Rear Sight	\$110.00
Troy Flip-Up Rear Sight	\$110.00

Slings & Adaptors

	Ambi Lock Plate Loop \$10.00
Condor Bungee 1pt	\$40.00
Condor Bungee 2pt	\$40.00
Magpul .MS3 Sling	\$46.00
Magpul MS4 Sling	\$55.00
Magpul ASAP Plate	\$27.00
Magpul RSA Adapter	\$27.00
G.I Standard Sling	\$10.00
QD Lock Plate	\$20.00
Ambi Lock Plate, Loop Slip Over Tube Style	\$25.00
QD Sling Swivel, Heavy Duty	\$12.00
Ambi Lock Plate, For QD Swivel Slip Over Tube Style	\$20.00

Magazines

Brass Catcher	\$15.00
CMMG 22LR Conversion w/ Mag	\$185.00
CMMG 22LR 26rd Mag	\$25.00
CMMG SS Anti Tilt Follower or Braided Spring	\$4.00
G.I. Aluminum 30rd	\$16.00
FAL 20rd Metric	\$25.00
GI Green No Tilt Follower	\$1.25
Troy 30rd	\$13.00
HK91/G3 Alum	\$7.00
10 for	\$50.00
Magpul .308	20rd \$20.00 , 25rd \$23.00
Magpul 7.62x39 30rd	\$14.00
Magpul 5.56 40rd	\$20.00
Magpul 5.56 30rd	No Window \$14.00 , w/ Window \$17.00
Magpul 5.56 10 or 20rd	\$14.00

Flash Hider / Misc.

G.I. A1 or A2 Flash Hider	\$8.00
Noveske PIG KX5	\$185.00
Smith Ent. Vortex	\$65.00
Troy Midvil Flash Hider	\$45.00
YHM 28A	\$35.00
Crush Washer	\$2.00
Field Repair Kit	\$35.00
Brass Catcher	\$15.00
Gas Ring (set of 3)	\$2.00
Lower Spring Kit	\$9.00
Lower Pin & Detent Kit	\$15.00
M&A T-shirt (Skull w/ Logo \$ Smoking M4)	\$12.00
Misc Parts Kits Fal STG, Romanian AK, Sten III	See Website
Misc Parts for the 1911, M1 Carbine, Garand and M1A	See Website
Rifle Cases, Mag Pouches, Flashlights & Mounts	See Website

Maintenance/Tools

A1 or A2 Sight Tool	\$7.00
AR15/M16 Tech Manual	\$5.00
Armor Wrench	\$20.00
Box of 1000 Patches .223	\$7.00
Bore Guide	\$25.00
Broken Shell Extractor	\$10.00
Buttstock Cleaning Kit	\$15.00
CAR Spanner Wrench 3pt	\$10.00
Chamber Blocking Device	\$3.00
Chamber Cleaning Stars	\$10.00
Gas Tube Cleaner 50pk	\$9.00
Handguard Removal Tool	\$12.00
Military Sniper Manual	\$5.00
Lower Receiver Vice Block	\$20.00
Upper Receiver Vice Clamp	\$25.00

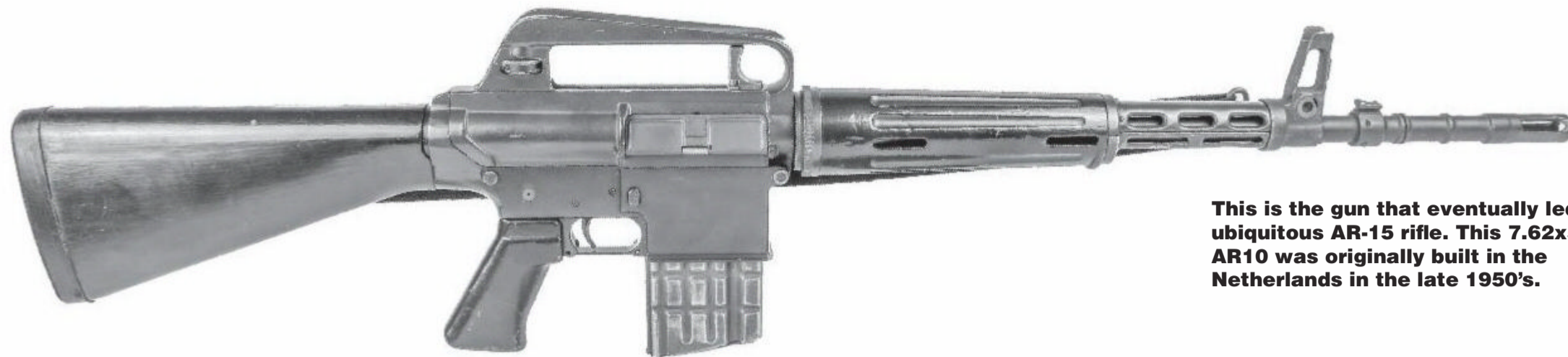

This is the gun that eventually led to the ubiquitous AR-15 rifle. This 7.62x51mm AR10 was originally built in the Netherlands in the late 1950's.



The original ArmaLite AR-15 sported a trigger-shaped charging handle located within the carrying handle. Colt moved this appendage back to the more familiar spot in the back of the upper receiver for ease of manufacturing. This Brownells BRN-Proto is a splendid representation of those uber-rare early ArmaLite guns.

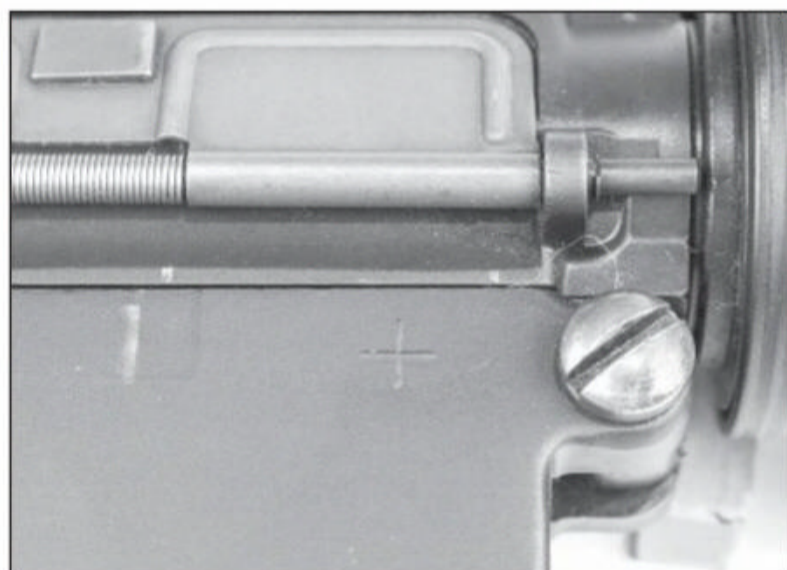

SP1 AR-15 rifles used a two-headed screw to hold the two receiver halves in place. I have no idea the significance of that little "plus" sign on the side of the receiver, but geeks like me care deeply about it.

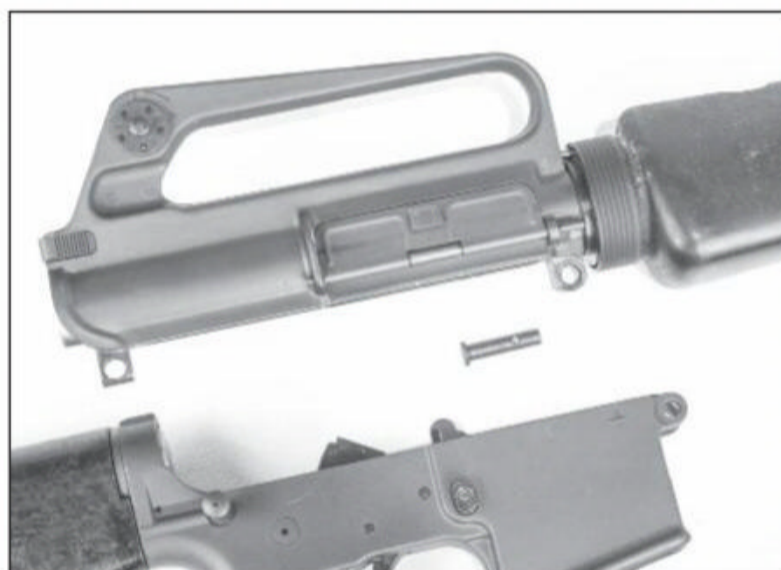

The Colt Model 601 and 602 military rifles used a removable forward pivot pin with a built-in detent. This looks like something that would be easy to lose in the field.



The earliest SP1 AR-15 rifles lacked a forward assist device, had their buffer tubes secured with a roll pin, and sported the little "plus" sign on the side of their lower receivers. The magazine catch was also left unprotected against accidental manipulation.



The early pivoting rear sling swivel is shown on the left. The later fixed version was supposedly incorporated to make the gun more effective when used in the butt stroke. Wouldn't Pelosi and Schumer have a field day with that evil feature today?

[Cont. from page 70]

of arcane characteristics between 1963 and 1978. Those very early guns had slab-sided lowers without a fenced magazine release, a dedicated roll pin through the back of the receiver to stake the buffer tube in place, and a little Plus sign on the right aspect of the lower receiver. The upper receivers lacked the forward assist device of the later Army versions. Early USAF rifles lacked this appendage as well.

Production ranges by serial number can be accessed online. I recall seeing these guns for sale in our neighborhood Gibson's department store back in the late 1970's new for \$200. That would be around \$700 today.

Early rifles sported floppy pivoting rear sling swivels. Later versions were fixed at a forward angle. When

[Cont. to page 74]



The early model solid buttstock is shown on the right. Later versions had a trapdoor storage compartment for a cleaning kit or a few emergency M&M's.

25,000,000 AR15



AMERICA'S LARGEST FIREARMS LIQUIDATOR

PARTS LIQUIDATION

DPMS-BUSHMASTER-REMINGTON WE BOUGHT THEIR PARTS



PRICES START AT
\$249⁹⁹

COMPLETE UPPERS



PRICES START AT
\$299⁹⁹

GUN PARTS BUILDS



PRICES START AT
\$199⁹⁹

COMPLETE LOWERS



223 LOWER RECEIVERS



308 LOWER RECEIVERS



223 M4 BARRELS



308 BARRELS



TARGET BARRELS



MIL-SPEC STOCKS



FLIP-UP SIGHTS



HANDGUARDS



BUSHMASTER OPTICS



FLASH SUPPRESSORS



AMBI SAFETY & MAG RELEASES



CARRY HANDLES



CLEANING KITS



5.56 BOLT CARRIER ASSEMBLIES



308 BOLT CARRIER ASSEMBLIES



200,000 MAGAZINES



TARGET TRIGGERS



ARMORER'S TOOLS

Order online WWW.CDNNSPORTS.COM or by phone 800-588-9500

PRICES SUBJECT TO CHANGE

NO FEES
FOR USING YOUR CREDIT CARD

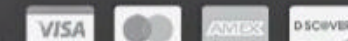



AR-15 flash suppressors evolved through three major variations in the early days. The duckbill on the right equipped the earliest guns. The solid birdcage type began service in 1967. The standard three-prong fell in between.



My 1966-vintage SP1 sports the early three-pronged flash suppressor. While this design made for a handy prying tool, it caught badly on wait-a-minute vines in the jungles of Vietnam.

[Cont. from page 72]

first I learned the storied art of the bayonet, courtesy Uncle Sam, I was told this was to enhance the effectiveness of the butt stroke. Who knows if that was true or not.

Those early buttstocks were solid without the cleaning kit storage compartment. Early flash suppressors consisted of three prongs open on the far end. The closed birdcage version came later after combat reports from Vietnam disclosed a tendency of the open sort to catch on brush and vines. Colt switched to the closed design for its military M16A1 rifles in January of 1967. Apparently the three-prong versions were used on civilian SP1 guns until they ran out. These open flash suppressors were handy for twisting the wire off of ammunition and C-Ration crates, however.

Diving Deep into the Weeds – The Edgewater Buffer

The earliest SP1 AR-15 rifles came equipped with what is known in the biz as an Edgewater buffer. I have been told that these buffers were so named because of their association with the Edgewater Arsenal, an entity that purportedly dates back to the First World War. The Edgewater Buffer is a relatively complex contrivance consisting of a separate headpiece that reciprocates ever so slightly on the body of the device. It is also shockingly lightweight when first you heft it.

When I initially removed the buffer from this rifle, I thought it was made of plastic. It really is that flimsy. This was one of several reasons why the earliest M16 rifles suffered from an unacceptably high rate of fire. The addition of the later one-piece solid weighted buffer reduced wear on the guns and slowed the cyclic



The elusive Edgewater buffer equipped the earliest SP1 AR-15 rifles.



The headpiece on the Edgewater buffer actually reciprocates very slightly. The entire unit is almost unnaturally lightweight.



The Edgewater buffer, shown here alongside the later one-piece sort, was relatively complex to manufacture and less effective than the later sort.

Diving Even Deeper into the Weeds – The SERIAL 66's

On early Colt SP1 AR-15's the serial number is depicted "SER. SP 12345." Colt 601 M16 rifles sported numbers that began with the word "SERIAL" done in a slightly different font. At some point in the SP1 AR-15 production run between serial number 7642 and number 8085 the engraving machine on the

[Cont. to page 76]

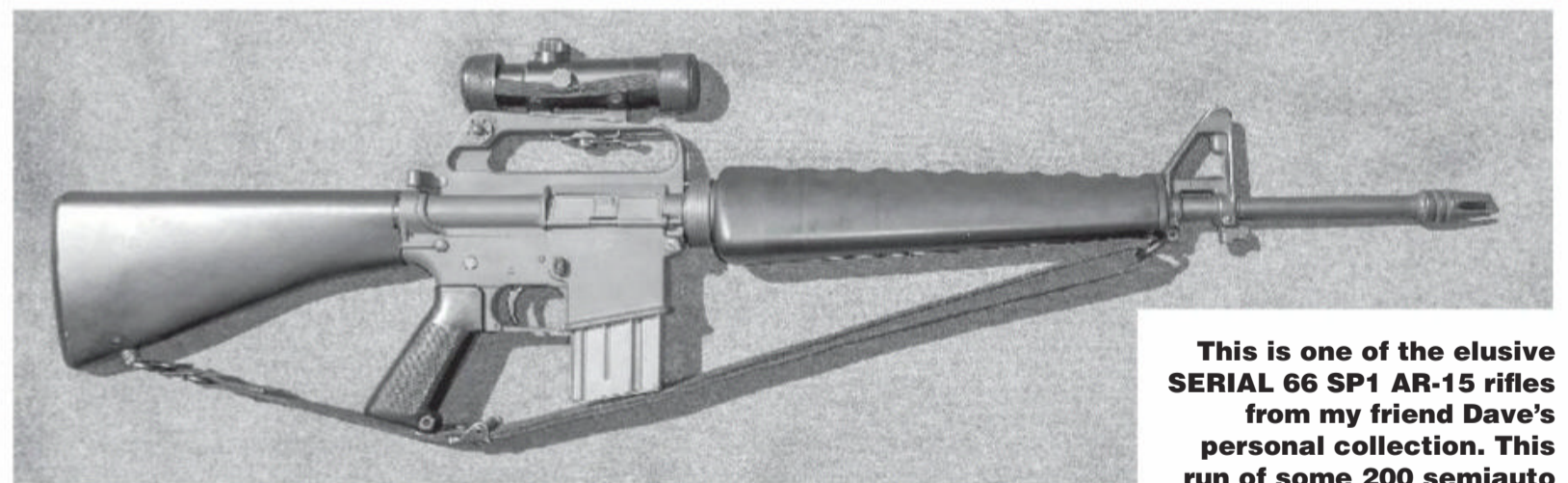

This is one of the elusive SERIAL 66 SP1 AR-15 rifles from my friend Dave's personal collection. This run of some 200 semiauto guns have an increased value due to a temporary manufacturing problem at the Colt plant.

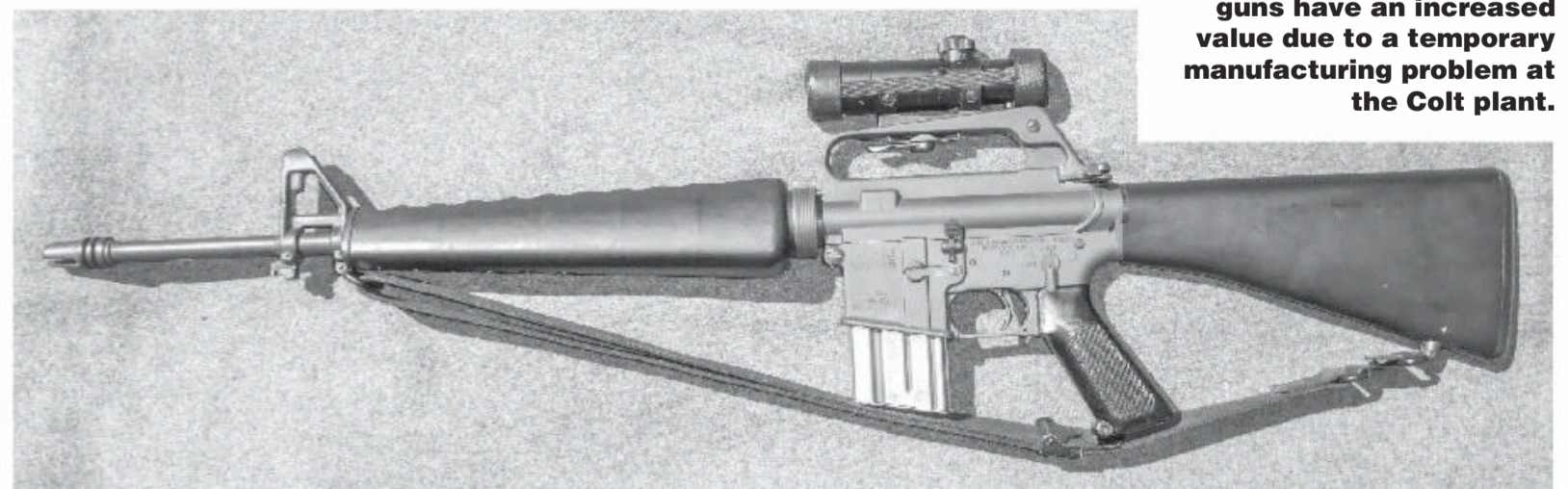

RECON ORDNANCE COMPANY



P.O. Box 829 • Fond du Lac, WI 54936 • 920-922-1515 VC • 920-922-0737 FAX

STEEL REPLACEMENT MAGAZINES

For the SWD M-11 9MM SMG

- 60 rounders \$99.00
- Over 18,000 sold—Supplies running low
- Guaranteed for fit and function in the SWD M-11 9mm SMG & Semi auto



\$29.00 30 Rounders

VZ61 SEMI-AUTOMATIC RECEIVER



with S/A selector lever
\$295.00

VZ61 SCORPION PARTS KIT

VZ61 Scorpion Parts kit with Barrel, Beautiful condition. As pictured includes cut receiver, Original ready to shoot barrel, one ten round magazine, 2 twenty round mags, all in leather pouch and holster.



\$375.00
Plus shipping

MODEL 74 CHINESE FLAMETHROWER

- Brand new, complete, never demilled.
- In wooden chest.
- Google for more info.
- A few available.



\$2995.00
Plus shipping

.308 1919 A4

Semi Automatic

- U.S. GI Parts
- Includes mini belt loader
- Comes with Anti-Aircraft Tri-Pod
- Metal links and manual included
- Spare barrels available \$95.00
- Ships in hard case

Belt Loaders Available at **\$300**



\$3995.00
Plus shipping

Exact copy of U.S. 1919A4 LMG
-Requires only FFL-

CZ 26 PARTS KITS

Cal. 7.62X25

- As new guns, before being demilled as per BATF
- All kits come with (5) magazines, a mag pouch, a cleaning rod and a sling (no barrel)



\$159.00
Plus shipping

SCORPION PISTOL

CAL. 32 ACP (7.65mm)

- Hard case
- (1) 10rd magazine
- (2) 20rd magazine
- Holster & Mag. pouch
- Owners manual
- Both plastic & wood grips
- Folding stock assembly



Extra 20rd mags available for **\$25.00**

\$695.00
Plus shipping

Threaded barrel Guns Available at **\$795.00**

U.S.G.I. M3 TRI-POD

\$995.00
Plus shipping



FOR 50 CAL HB M.G.

Pintel and T&E available with purchase **\$300**

CZECH UK 59 COMPLETE

\$1400.00

PARTS KIT WITH TORCH CUT RECEIVER AS PER BATF

- We have barrels available for purchase.

Includes barrel. Scopes and tripods available.



DP-28 LMG

SEMI AUTO

Russian mainstay of WWII and the Cold War. In caliber 7.62x54R. Comes with (2) 47rd drum magazines.

Call us about California compliant models of this gun.



\$4995.00

Cleaning kit and sling included

STG-44 BARRELS, \$300. STG-44 OP RODS, \$500. WEBSITE: WWW.RECONORD.COM



WANT TO BUY



Machine Guns, Single Pieces or Collections, Military Rifles and Pistols. Top Dollar Paid!
FULL TIME CLASS III DEALER IN BUSINESS SINCE 1975



My traditional 1966-vintage SP1 has an "SER. SP" prefix ahead of the serial number.



The serial number on the rare SERIAL 66 rifles was engraved using the military machinery.

[Cont. from page 74]

SP1 line apparently broke. To maintain production the SP1 lowers were serialized on the same equipment used to number the military rifles.

This industrial hiccup resulted in a run of some two hundred or so civilian SP1 rifles that were produced in 1966 with the "SERIAL" prefix. These guns are referred to in our odd little community as SERIAL 66's and naturally command a premium as a result. This is one of the rarest AR-15 variants around and the hallmark of a truly refined collection. The fact

that I know this should also shed light onto why I have so few normal friends.

How Does One Come By a 1966-Vintage AR-15?

As a 54-year-old gun nerd born in 1966 I always felt a bit of a kinship with the old SP1 AR-15. I worked a full year as a janitor in a print shop to save up the cash to buy my first SP1 in Tenth Grade in 1982 for \$486. That works out to around \$1,300 today. Ouch.

Hunting rare AR-15 variants is a fairly rarefied art. In the days before Al Gore invented the Internet it would have been quite literally impossible. Nowadays, however, landing the elusive SERIAL 66 is theoretically possible but practically improbable. Online resources make establishing a value for a rare or unusual piece fairly straightforward, so it is tough to find a bargain these days.

I hunted this particular rifle for a couple of years, checking GunBroker every now and again and following auctions from a distance to see what the guns were actually bringing. Finding these old AR-15 rifles is not terribly difficult. Finding just the right example with just the right date range is a function of patience, resources, and luck. I saved my pennies for a while to make this one mine.

Practical Tactical

It is amazing how lithe and maneuverable these little rifles were before we started hanging so much junk off of them. I can see how grunts inured to the M14 and BAR would have been absolutely enraptured by this thing. To paw over this early SP1 AR-15 is to appreciate where it all began.

The smooth plastic furniture is undeniably slippery. However, I humped a rifle like this one through most of the planet's sundry hostile climates and did just

[Cont. to page 78]

CURIOUS RULES

If Stephen Hawking made it his life goal to master all the nuances of American firearms law I am convinced he would just head back to his lab empty-handed and confused. The myriad dicta that govern our quirky little sport are tough for me to follow, and I've been immersed in it since childhood.

You can buy a pocket pistol from your local gun emporium with nothing more than a clean record and a driver's license. However, cut the barrel on a three-foot-rifle down to fifteen inches, and you've created a short-barreled rifle good for ten years in the Big House. None of it really makes much sense. One of the more labyrinthine aspects of the American gun culture is the way we license firearms dealers.

The BATFE issues licenses to buy, sell, manufacture, collect, and import guns. On top of these sundry licenses you can also get a Special Occupational Tax that will allow you to deal in sound suppressors, machineguns, and short-barreled weapons without paying the individual transfer taxes governing such stuff. Amongst all this bewildering mass of administrative minutiae, however, there lurks something that is actually pretty simple and pretty cool.

The Curio and Relic Federal Firearms License is designed for the individual collector, costs a mere \$30 for three years, and is fairly easy to obtain. A lot of folks spend that on coffee in a week. You need to be fingerprinted at your local police department, but you don't need a storefront or other special facility. The C&R FFL is designed for collectors of old weapons. Every proper gun nerd should have one.

The C&R FFL is typically run out of your home. Once it comes back approved you can mail order antique weapons and have them shipped straight to your doorstep. Guns that are considered C&R eligible are those that are more than fifty years old. Each year a new batch of old weapons becomes eligible.

In recent years this has gotten more and more fascinating. Where previously C&R guns were centurians Peacemakers and WW2-era iron, nowadays a C&R FFL will land you much sexier stuff.

Rolling back fifty years obviously takes us to 1970 and renders any Title I guns made prior to that time C&R eligible. There are a few FN FAL and G3 variants that might qualify, but most of the pertinent iron will be these early AR-15's. However, with each passing year more and more guns make the list. In another decade things will get really interesting. **FN**

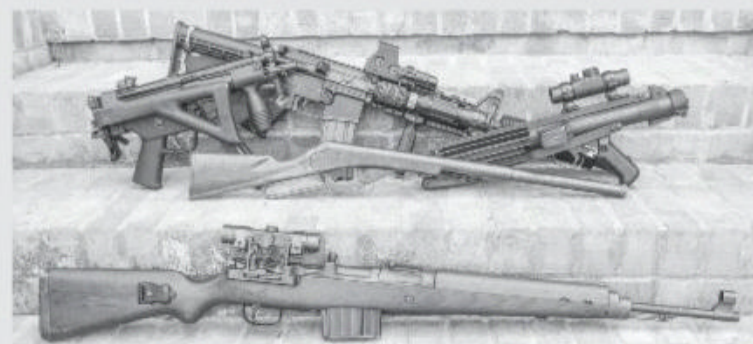

The befuddling rules governing firearms acquisition and ownership in America can be mightily confounding.



Previously C&R weapons were presumed to be such as this old Mauser Broomhandle. Nowadays, however, a C&R FFL will grant you access to even cooler stuff. Thanks to www.worldwarssupply.com for the neat replica gear.

SARCO, INC.

CALL
Us!

LET'S MAKE A DEAL

CALL
Us!

610.250.3960

AND ASK FOR CHOLLY, DAVE OR MARK

DAVE MICHELS

mgdave@sarcoinc.com
ext. 223

CHOLLY STEEN

PRESIDENT & CEO
csteen@sarcoinc.com

MARK DOTTEN

mdotten@sarcoinc.com
ext.224

www.SARCOINC.com

50 Hilton Street, Easton, PA 18042



EXTRA SURPLUS TO SELL??

MATERIAL SITTING AROUND ACCUMULATING ANOTHER YEAR OF DUST??

SARCO, one of the top 2 gun parts and general surplus dealers & importers in the U.S., is interested in your surplus material! Our primary interest is in gun parts, ammunition, ammo components, guns, cannon, aircraft, military vehicles, uniforms, field gear, etc. We are also interested in commercial firearms or parts, and surplus commercial inventory.

NO DEAL IS TOO BIG OR TOO SMALL !!

We will consider all offers and we assure you of our prompt and discreet attention to your offering. Mutually beneficial business is just a call away!

WE CAN SELL YOU SURPLUS AS WELL ! INQUIRE !!

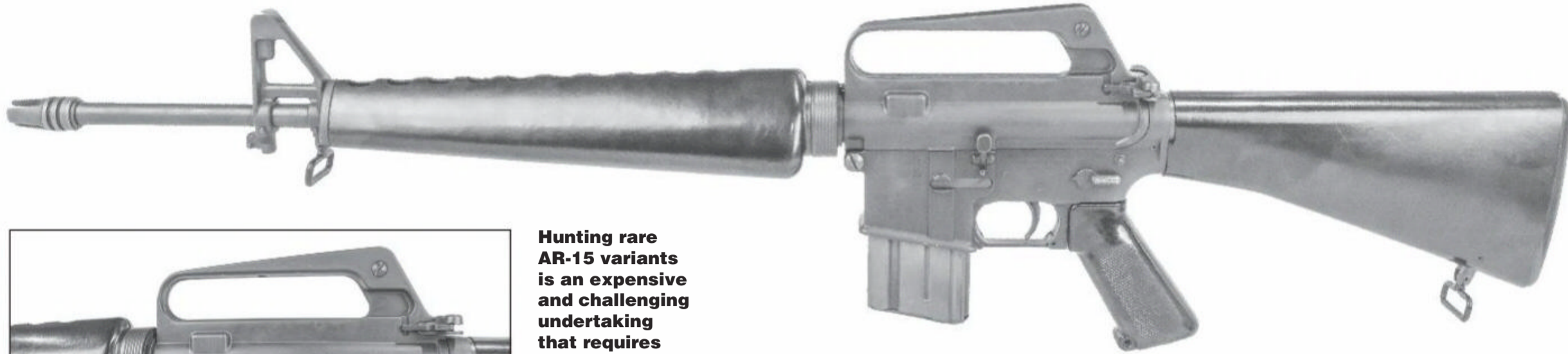

Hunting rare AR-15 variants is an expensive and challenging undertaking that requires patience, persistence, and cash.

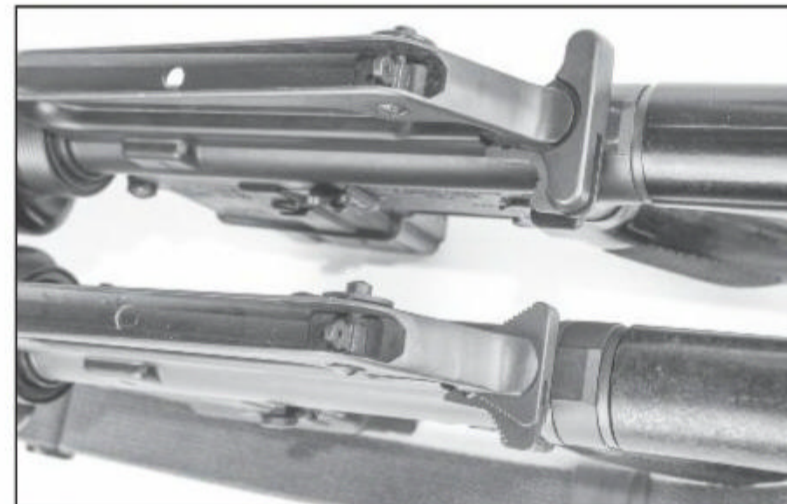

To the gun geek truly committed to his craft little things like variations in charging handle design are the stuff of which dreams are forged.

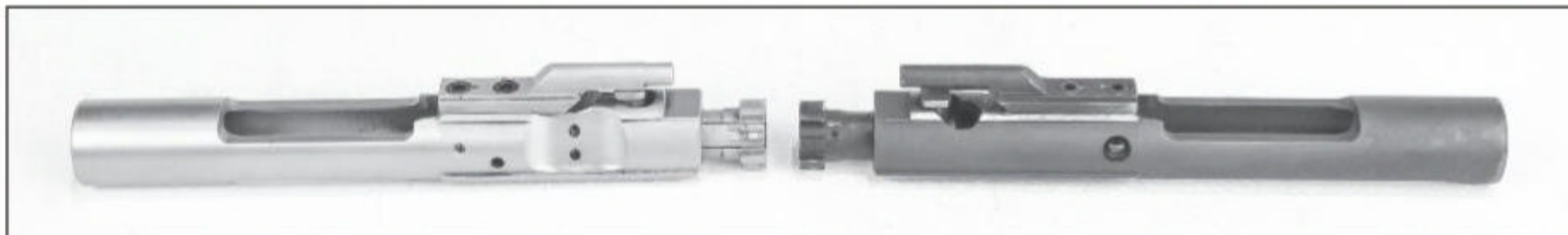

Really early AR-15 rifles had hard-chromed bolts and bolt carriers.

[Cont. from page 76]

fine with it. The triangular handguard in particular fits the hand beautifully well.

The ergonomics of the rifle set the standard for everything else and, amazingly, remain essentially unchanged despite half a century of aggressive mechanical evolution. This fact speaks to the remarkable prescience of Gene Stoner and his design team.

Despite the rifle's undeniably radical capabilities, there yet remain a few interesting throwbacks to a previous era. The sling swivels are on the absolute wrong side of the gun. Attaching the sling to the bottom works great on the parade ground but is fairly worthless in the field. I always tied a piece of 550 cord around the buttstock of mine with a loop on the top. I could then affix my sling to the loop and the front sight base and let the rifle ride in my right hand ready to use.

Given the rarity of this gun and the fact that it is all but unfired I was unwilling to burn a lot of ammo through it. However, I have a comparable parts gun that was up to the task. It ran everything I fed it from 55gr M193 ball up through SIG and Hornady 77gr Open Tip Match rounds without a hiccup. In my prime, I could reliably nail a helmet at 300 meters with open sights. Nowadays my tired eyes hamstring my efforts. However, the rifle is clearly capable of sub-two inch groups at a football field with a decent operator behind it.

Buy a Gun, Make a friend

Gun guys are almost without exception genuinely good folk. They're the sorts of people you'd get to watch your house while you're away on a trip. You'd be glad to loan them your pickup truck. I can't count the number of times I have sent money to some dude I've never met on the strength of an online classified ad for a gun. I've not been burned yet.

I bought this rifle via GunBroker from a gent named Dave who is just the nicest guy. Dave is a True Believer. At the apogee of his art Dave maintained an

unfired 64, an unfired 65, two 66's, one of which was the SERIAL sort, and a 67, 68, 69, 70, and 71 as well. It was under his gentle tutelage that I came to learn the nuances of the SERIAL tale. Like most of us, life intervened and he unloaded most of his collection over the past few years. I was blessed to be able to land his pedestrian 66.

Dave connected with a man who had formerly owned a gun shop and ended up with his two 1966 rifles as well as pre-production ArmaLite AR180, the 24th copy ever released to the public. Hearing tales

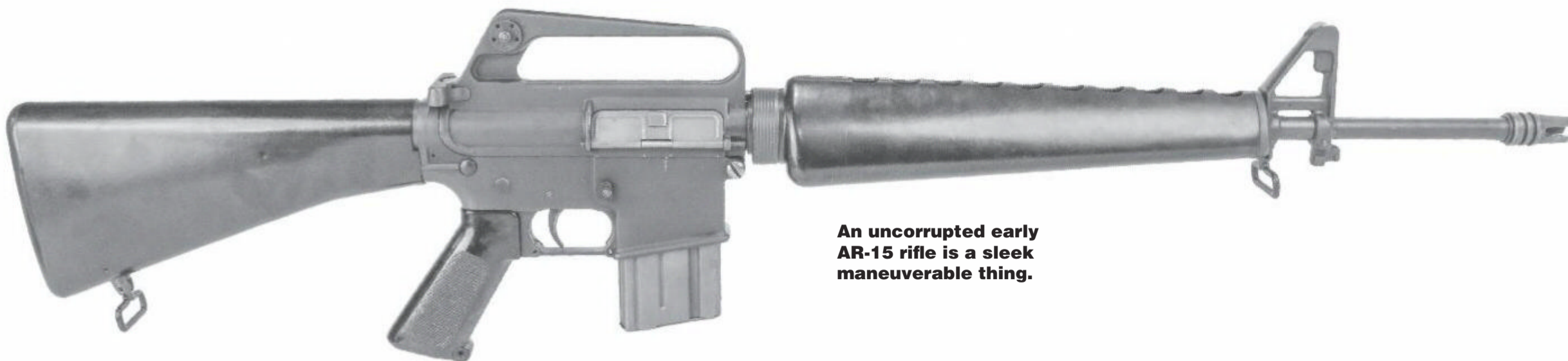

An uncorrupted early AR-15 rifle is a sleek maneuverable thing.



The black plastic furniture on these old 1960's-vintage rifles is undeniably slick, but I found that they worked just fine back in the day.



The modern direct gas impingement system all started here. The black plastic handguards sport aluminum heat shields and are unique to their respective sides of the rifle.



This surplus M16A1 parts gun is a beater stand-in for our rare original 1966-era SP1 AR-15.



I actually built this M16A1 rifle up using a GhostGunner milling machine and a Hydramatic 80% lower receiver. The end result is a semiauto spitting image of the Vietnam-era M16A1 right down to the receiver markings.

COLT SP1 AR-15

Caliber:	.223 Remington
Barrel Length:	20 inches
Overall Length:	39.5 inches
Weight:	6.37 pounds
Action:	Direct Gas Impingement
Feed:	20-round box magazine
Sights:	Front Post/Rear Flip-Adjustable Peep
Value:	\$1,000-\$3,000+ depending on condition, model, and production date



The community of folks who get into serious AR-15 collecting is fairly rarefied. M1 Carbine acolytes are comparably committed. However, I have found that most all dedicated gun nerds make simply capital friends.

about identifying and acquiring these old collectible guns is like crack cocaine for a guy like me. It is amazing what is lurking out there in the woodwork just waiting to be discovered.

Denouement

All this fuss over font sizes and sling swivels might strike you as insanely tedious. That is certainly my wife's perspective. The study of such stuff is no doubt confined to the First World and only tiny slices of it at that. However, it is an undeniably harmless pursuit, and it brings those of us who swim in it no end of enjoyment. If you're one of those who doesn't really care all that much, thanks for sticking with me to the end.

If you don't have your own C&R FFL (as described in the sidebar), I'd strongly suggest you get one. You don't end up on any watch lists (that I know of), and the BATF doesn't come visit your home or paw through your records. When you finally do throw in the towel and give up your license you just send them your acquisition records. BATFE likely stores them alongside the Ark of the Covenant in that big warehouse from the *Raiders of the Lost Ark* movie.

Time really does heal all wounds. With each passing year the pool of C&R eligible guns grows incrementally deeper. In my case I landed an SP1 AR-15 the same age as I am that the Brown Truck of Happiness shipped straight to my door.

How groovy is that? **FN**

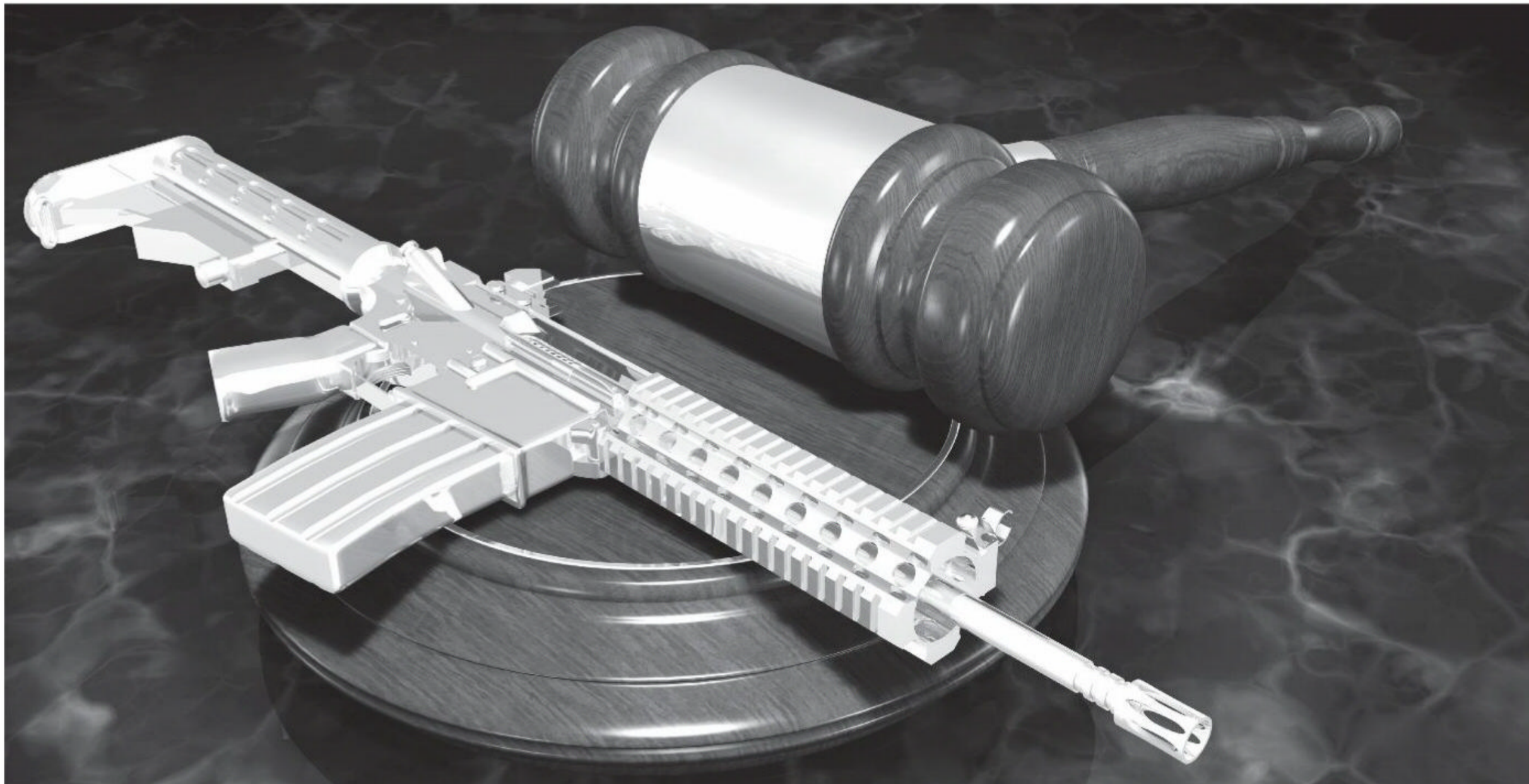

SUBVERSIVE MACHINE GUN RULING WILL GUT SECOND AMENDMENT IF UPHeld

By David Codrea

“A federal judge has found makers of assault rifles used by a gunman to indiscriminately shoot at concertgoers at the Route 91 Harvest Musical Festival in Las Vegas in 2017 must face a wrongful death claim by the family of one of the 58 people killed,” Courthouse News Service reports. “U.S. District Judge Andrew Gordon, a Barack Obama appointee, found in a 15-page order that Colt’s Manufacturing and other gun makers and dealers whose AR-15 rifles were used in the mass shooting could not dodge a lawsuit by one of the victim’s family.”

What happened to the Protection of Lawful Commerce in Arms Act, passed by the legislative branch of government, and signed by the executive?

Per the order, “The wrongful death and negligence per se claims are premised on the Parsons’ contention that the defendants manufactured and sold firearms that were designed to shoot automatically, rendering them illegal machine guns under federal and Nevada law.”

That’s clearly bunk, but bunk that conveniently advances the gun-grabber goal of banning semiautomatics. So how is it that one activist judge, with clear political leanings, can impose his will and over-

ride duly enacted law, and make a company liable for third-party abuses?

First off, we have our “leaders” to thank.

In the Beginning...

Let’s go back to how Judge Gordon got into a position where he could impose his treasonous agenda on his countrymen — and lest you think that’s too strong a word, note what the Founders considered “necessary to the security of a free State.” The judicial apparatchik knows exactly what he’s subverting, and he’s done it with calculated premeditation. Then again, we expect a snake to bite, so we need to go back to who besides Obama thought it would be a grand idea to put this one on the federal bench.

The system is geared to do that. By throwing softball questions that allow plenty of room for misrepresentation of actual positions, equivocation and weasel-wording, even a radical gun-grabber like Gordon can come across as moderate, reasonable, impartial, fair and respectful of precedent.

A report prepared by Congressional Research Service, a “think tank” established to inform our representatives on issues of import, notes that in judicial

confirmation hearings, nominees have been able to rely on an “out” giving them a pass on answering specific questions:

“In recent decades a recurring Senate issue has been what kinds of questions are appropriate for Senators to pose to a Supreme Court nominee appearing at hearings before the Senate Judiciary Committee. Particularly at issue has been whether, or to what extent, questions by committee members should seek out a nominee’s personal views on current legal or constitutional issues or on past Supreme Court decisions that have involved those issues. Usually, when Senators at confirmation hearings have asked Supreme Court nominees to comment on topical legal and constitutional issues, the nominees have firmly declined to do so. In those situations, the nominees typically have taken the position that answers to questions which convey their personal views would conflict with their obligation to avoid appearing to make commitments, or provide signals, as to how they would vote as a Justice on future cases.”

Think of one job you’ve ever applied for where you’d have gotten it if you decided to play coy with the hiring managers. While it may be “inappropriate” for a judge to weigh in on a specific case before confir-

mation — for legitimate reasons, including not having studied and evaluated all the particulars, evidence and precedents against the “supreme Law of the Land,” — there’s no reason why general principles of understanding should be off-limits. Such hearings are supposed to be, among other things, high-level employment interviews, not pre-coronation ceremonies.

As such, here are questions gun owner rights advocates should expect the representatives they enable and support to ask judicial candidates, things no American have any trouble answering:

What did the Founders mean by “A well regulated militia”? What did the Founder mean by “being necessary to the security of a free State”? What did the Founders mean by “the right of the people to keep and bear arms”? What did the Founders mean by “shall not be infringed”? How can past Supreme Court opinion specifying protected arms as those being “in common use at the time” not apply to the types of firearms needed for militia service?

Now that he’s ruled, how do you think Judge Gordon would answer?

The thing is, having been given a pass, Gordon was confirmed by voice vote in 2013. That’s when Harry Reid, the Democrat politician Wayne LaPierre called “a true champion of the Second Amendment,” was Senate Majority Leader. And considering the tangential relationship between Gordon’s ruling and an earlier legislative action on weapons of militia utility, it’s fair to note a voice vote a few decades earlier allowed the politicians to give themselves cover on the fraudulent “passage” of the Hughes Amendment ban on machineguns manufactured after May 19, 1986.

Facts Not in Evidence

So, what does all this have to do with manufacturer liability overriding PLCAA?

“Over the past decade, new devices called ‘bump stocks’ have been developed to enable reliable and continuous automatic fire by capitalizing on the AR-15’s recoil and removable stock,” Judge Gordon’s order asserts. “Videos available on the internet show the ease of installing a bump stock, and the Slide Fire bump stock can be installed with ‘nothing more than a screwdriver.’”

And what does that have to do with this case?

“On October 1, the shooter used the AR-15s equipped with bump stocks to fire 1,049 rounds in less than ten minutes, killing 58 people and injuring hundreds,” Gordon alleges. “One of the rounds hit Carrie Parsons in the shoulder. Carrie was transported to the hospital before succumbing to her wound.”

“The Parsons do not allege that this type of Colt AR-15 was used in the October 1 shooting,” Gordon adds in a footnote.

And as for facts not in evidence?

Michael Bloomberg-“seeded” website The Trace told us “A forensic firearms report performed by investigators shows further that the gunman used all but one of those bump stock-equipped rifles during his deadly attack. With the aid of the devices, the gunman unleashed a total of 1,049 rounds at the crowd below.” They were citing the Las Vegas Metropolitan Police Department report sections on “Evidence Recovery” and “Firearms Forensic Analysis.”

So that takes care of all reasonable doubt, right? Except for one inconvenient and as-yet unexplained truth that the government doesn’t want to answer any questions about and that the media doesn’t want to ask about: There has been no reported examination of the internal workings of those firearms.

“There are no external visual indicators (i.e. automatic sear pin hole) that the weapons have been converted into machineguns,” an ATF presentation on Las Vegas Recovered Weapons and Ammunition,” obtained through a Freedom of Information Act request declared. “However, on-scene ATF personnel were **not** allowed [emphasis in original] to physically examine the interior of the weapons for machinegun fire-control components or known machinegun conversion devices such as Drop-In-Auto Sears, Lightning Links, etc.”

ATF is saying in an official document that its experts don’t know if the firearms could have been internally modified to fire full auto.

ATF productions in response to the FOIA continued to create questions. It admits “the Firearms Enforcement Officer...has not yet been provided access to conduct a full examination.” Another page notes “the ATF FEO has not been able to conduct a full examination [of] them at this time.” Yet another page asserts, in all caps, “I CANNOT FURTHER COMMENT ON THE BUMP-FIRE TYPE DEVICES RECOVERED IN THIS CASE AT THIS TIME AS THE PROCESSING AND ASSESSMENT OF EVIDENCE ONGOING, INCLUDING WHETHER OR HOW THE FIREARMS WITH BUMP-STOCKS WERE USED//” (AGAIN WITH EMPHASIS ADDED).

To date, there has been no report showing the internals of the firearms were ever examined, by ATF’s Firearms Technology Branch or by any other law enforcement agency.

“There should be hundreds, if not thousands, of photos of firearms, their internal parts, and chamber photos to compare with photos of ejected cases that would support the claims made,” firearms designer and expert witness Len Savage, president of Historic Arms, LLC posits. “In this litigious world you know damned well the test firing of every firearm would have been video documented to prove the claims, with maybe even photos in each report for each firearm.”

“But none have ever been turned over in FOIA disclosures,” Savage observes. “Are we to believe they never opened the action nor photographed the internals of any firearm during their examination?”

So, what is it I’m trying to imply here? Hey, I’m merely repeating the government’s words. If anyone infers more into it, that could quickly be cleared up if those who have custody of the evidence wanted to give some straight answers.

But the bottom line is, ATF did not disclose that they had not examined the firearms prior to promulgating the rule banning “bump stocks.” And now that all previous rules and rationales have been thrown out the window, and they have been designated “machineguns” by the Trump administration, we find ourselves facing outrageous, politically-motivated absurdities like Gordon’s semi-auto ruling, which if upheld, spells nothing less than the “legal” evisceration of the Second Amendment.”

That’s the door NRA opened when Wayne LaPierre and the as-yet-to-be-purged Chris Cox issued a “joint statement” declaring “In Las Vegas, reports indicate that certain devices were used to modify the firearms involved. Despite the fact that the Obama administration approved the sale of bump fire stocks on at least two occasions, the National Rifle Association is calling on the Bureau of Alcohol, Tobacco, Firearms and Explosives (BATFE) to immediately review whether these devices comply with federal law. The NRA believes that devices designed to allow semi-automatic rifles to function like fully-automatic rifles should be subject to additional regulations.”

Once that door was opened and the signal had been sent that “the 800-pound gorilla” had his back on political fallout, who is surprised that a politician walked through it, and took more than was being willingly surrendered. After all, it’s not like “bump stock” owners aren’t a marginalized niche that could be thrown under the bus with minimal perceived repercussions as a matter of political expediency.

Is This the Hill to Die On?

That’s a question put to activists objecting to the Trumpstock ban by gun owners foolish enough to think it was “just” about such devices. Some get angry and obnoxious about it defending “stupid toys,” arguing we have bigger issues to confront, and not understanding that if they think this is just about bump stocks, they’re missing the point.

If the Supreme Court ultimately upholds the ban and President Trump gets away with this usurpation of undelegated power, guess what the Democrats will be able to pull the next time they take the White House. And as Judge Gordon’s ruling shows, they might not have to wait.

“In particular, one appellate judge was very concerned that, in the future, the ATF could choose to redefine “machine gun” as including all semiautomatic weapons that can be modified with a device like a bump stock,” Gun Owners of America alerted supporters in an update on its lawsuit against the ban. “Of course, this is exactly the point that GOA has made in its briefs to the court.

“If the ATF can claim that a bump stock can turn an AR-15 into a machine gun, then the same can be said about rubber bands or belt loops,” GOA elaborated. “Given the latter two items are found in every home in America, a future anti-gun president could use the doctrine of ‘constructive possession’ to justify a ban on all semi-automatic rifles in the country.

“Here’s the bottom line,” GOA concluded. “If bump stocks can be defined as ‘machine guns’ because they supposedly cause a semi-automatic to fire automatically, then, using the same line of reasoning, semi-automatics are machine guns too.”

Does anybody still have stupid questions about hills?

About David Codrea:

David Codrea is the winner of multiple journalist awards for investigating / defending the RKBA and a long-time gun owner rights advocate who defiantly challenges the folly of citizen disarmament. In addition to being a regular featured contributor for *Firearms News* and *AmmoLand Shooting Sports News*, he blogs at “The War on Guns: Notes from the Resistance,” and posts on Twitter: @dcodrea and Facebook. **FN**



YOU WERE BORN READY

YOU'RE A REAL SHOOTER.
THIS IS YOUR WEBSITE.

OUTDOORCHANNELPLUS.COM

THE MOST COMPREHENSIVE OUTDOOR WEBSITE EVER CREATED



Powered by America's premier outdoor media brands including *Firearms News* magazine.



J & G SALES

Dept. FN / 440 Miller Valley Road / Prescott, AZ 86301

All prices and specifications subject to change without notice

Hours: Mon - Fri: 8 am to 5:30 pm / Sat: 9 am to 3 pm MST • Fax: 928-445-9658

Order Online at:
www.jgsales.com

Order by Phone:
928-445-9650

Great Deals on Firearms, Ammo & Accessories at J&G Sales!
Call or visit www.jgsales.com for the latest pricing and availability on hard to find firearms, imported or domestic ammo and accessories.



**CURIO & RELIC
ELIGIBLE**

9x18 Makarov Czech CZ-82

Czech CZ-82 9x18 Makarov semi-auto, surplus sidearm featuring 3.9 inch barrel, black polycoat finish with plastic grips, and ambi safety. A very heavy duty and accurate pistol. Has polygonal rifling for long barrel life (rifling not visible, appears as smoothbore). The CZ-82 replaced the older CZ-52 and served the Czech military in the 1980's and 90's. It comes with one 12 round magazine and leather duty holster. In good condition with coated finish flaking off (sometimes significantly) and scratches on the grips. Holster condition or completeness varies. **C&R eligible. Add \$20.00 for Hand Select.**

Czech CZ-82 25-1885 **\$249.95**

Czech CZ-82 9x18 Makarov
Good condition but with chipped grips 25-1886 **\$199.95**

Czech CZ-82 9x18 12 Round Magazine
Military CZ magazines for the CZ-82 and CZ-83, work for both 9x18 and .380 ACP calibers. Blued steel double stack mags that hold twelve 9x18 rounds or thirteen .380 rounds. In good condition 4-565 **\$49.95**
With purchase of CZ-82 Pistol 4-565 **\$29.95**

9x18 Sellier & Bellot

95 Grain FMJ • Brass Case • Non-Corrosive • Boxer Primed
Box of 50 rounds 5-513 **\$15.95**
500 rounds **\$149.95**
1,000 rounds **\$279.90**



9x18 Makarov Brown Bear 94 Grain FMJ

Lacquered Steel Case

Berdan Primed, Non-Corrosive

Box of 50 Rounds 5-1088 **\$10.95**
500 Rounds **\$104.95**
500 Rounds **\$199.90**



.308 Caliber Malaysion Surplus

146 Grain FMJ

Brass Case
Berdan Primed
Non-Corrosive

Box of 40 Rounds 5-820 **\$16.90**
300 Rounds in Steel
.30 Cal Ammo Can **\$124.95**

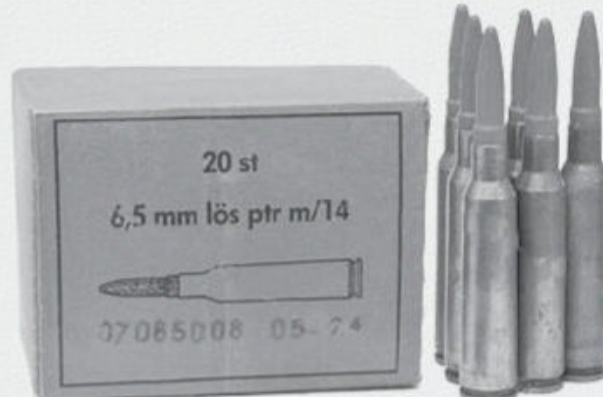

6.5x55mm Swedish M14 Blank

Wooden Projectile
Tarnished Brass Case
Berdan Primed

Box of 20 Rounds 5-2159 **\$2.50**
200 Rounds **\$19.98**
800 Rounds **\$59.60**
SALE! 4,800 Rounds **\$96.00**

Visit www.jgsales.com and sign up to receive our E-Mail Special Offers!

J & G SALES ORDER ONLINE AT WWW.JGSALES.COM
928.445.9650
 FIREARMS / AMMUNITION / ACCESSORIES 440 Miller Valley Road, Prescott, Arizona 86301

STAR BM 9mm PISTOL



see the various grades at jgsales.com

hand select and extra mag available

from \$149.95

WWW.JGSALES.COM

J & G SALES
 FIREARMS / AMMUNITION / ACCESSORIES

ORDER ONLINE AT WWW.JGSALES.COM

928.445.9650

440 Miller Valley Road, Prescott, Arizona 86301

You CAN reload easily
Order all your equipment online



**Presses and
 equipment,
 plus bullets
 and brass!**

**RCBS
 Lyman
 Hornady**

**Lee
 Sierra
 Nosler**

WWW.JGSALES.COM

THE 2020 *FIREARMS NEWS* **TREASURY** IS BACK.

**ON NEWSSTANDS
NOW!**

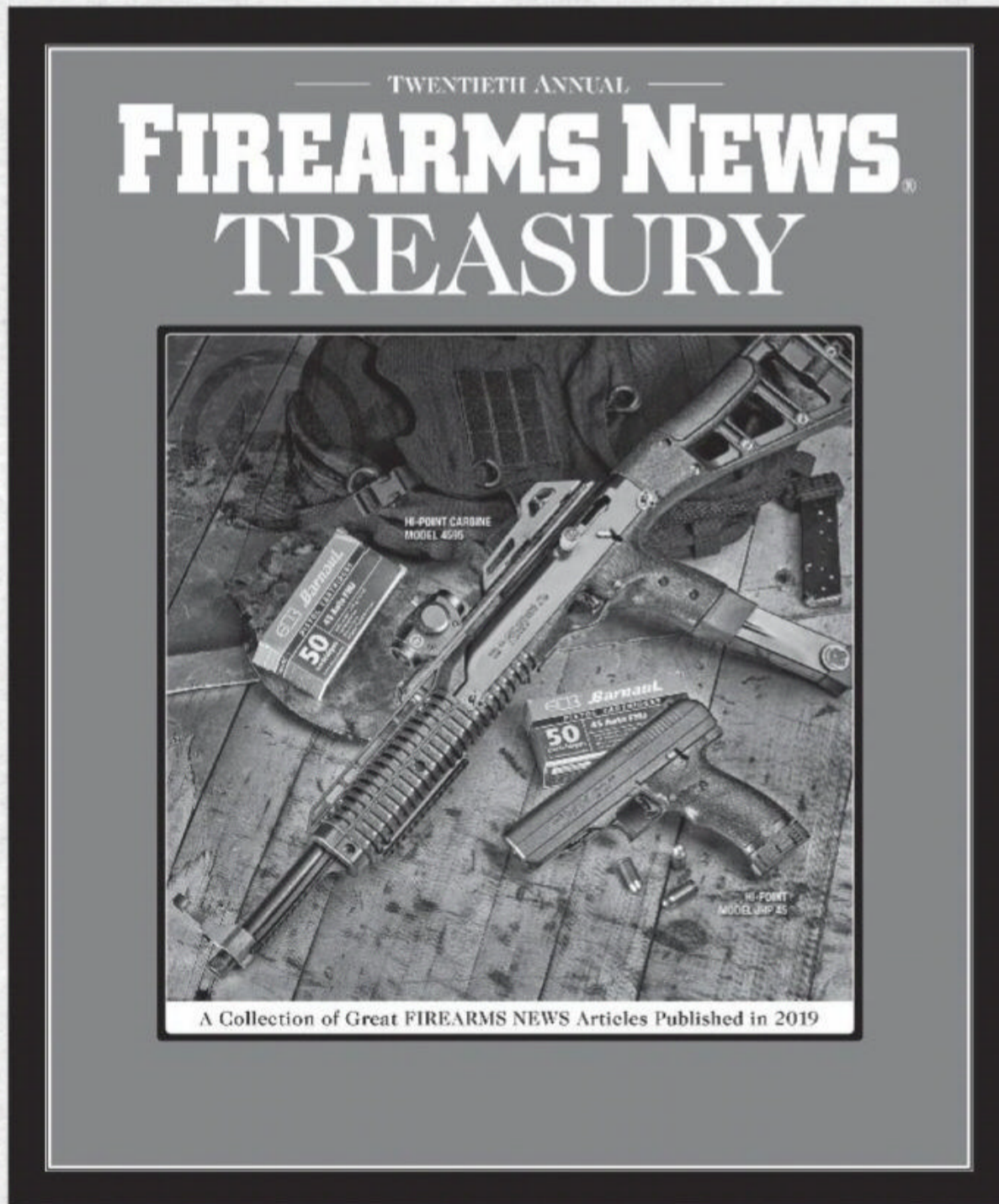

PACKED with some of the most popular stories of the year!

Don't wait — they'll go fast!

On sale at fine retailers like Barnes & Noble and Wal-Mart.

WW2 USMC CAMOUFLAGE (REVERSIBLE 'FROG' PATTERN)

MATERIAL

JUST IN !!

(Famous for use in WW2 Pacific, Korea, and the French Foreign Legion in Indochina) Hard to find, but Sarco has a limited roll of this material that is perfect for making repairs to your USMC WW2 items, creating new clothing, tents, backpacks, pouches, etc. Sold by the Meter. Actual size per meter runs @ 40"x 60", and longer continuous lengths can be purchased by the meter. Heavy herringbone pattern printed with jungle green on one side and beach/desert pattern on opposite side. Very Limited **\$25.00/per meter MISC885**

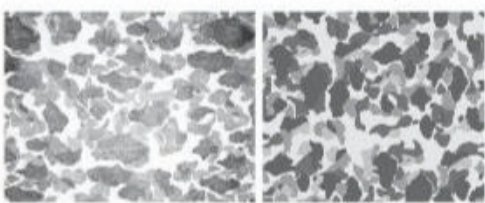

1970S RHODESIAN CAMOUFLAGE PATTERN MATERIAL

JUST IN !!

Famous grass pattern African Bush camouflage utilized by the Rhodesian Army and almost adopted by the U.S.M.C. ! Still extremely effective in the age of digital patterns, this grass pattern is natural and excellent at blurring flora & fauna at a distance. Sold by the Meter (@40")in length. Actual width measurement on this is 58 Inches. Continuous uncut lengths can be sold as long as the material lasts. Very Limited. New.

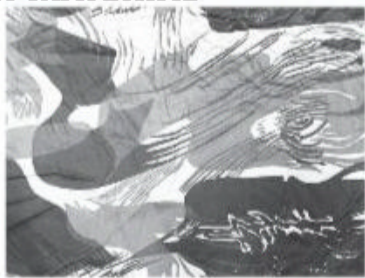

..... **\$23.00/per meter in length MISC894**

We Wish All Of Our Customers Good Health and Safety During These Times of Uncertainty



Sarco is here for you !

GERMAN HELMET 1889 PRUSSIAN KURASSIER, PICKELHAUBE

Beautiful Pre-WWI model military helmet made from steel with leather liner, brass scalloped chinstrap, cockades, steel spike and brass emblem. Inscription embossed on brass emblem translates from German as, 'With God for King and Country'. (Mit Gott Fur Koenig und Vaterland) **\$84.95 HLM012**



CHINESE GI SKS BANDOLIER WITH 20 STRIPPER CLIPS

Original military issue SKS Chest Bandolier with 10 ammo pouches. Used in excellent condition. **JUST IN !!** May have some minor lite stains, but washable. Comes with 20 original military SKS Stripper Clips too! **\$24.95 SKS103B**



POLICE NIGHT STICK

JUST IN !!

Made for Riot Police, this stick has a sure hold grip with 6 circumference inlets, hole for lanyard, and is over 24 inches long. Material- hard wood. Black. Surplus **\$18.00 MISC890**



JUST IN !! USMC HERRINGBONE KOREAN WAR ERA SHORT SLEEVE UTILITY SHIRT

Rugged Olive Drab short sleeve shirt for combat duty with breast pocket and two large Map pockets inset under the chest. Officers and NCOs loved these shirts and they fade wonderfully and take abuse of the rugged outdoors. Newly manufactured and made with USMC embossed buttons like the original shirts. Sizes available; Medium, Large, XL,2XL,3XL. Rare as 'hens teeth' these days, this might be your one chance to obtain one. Very limited **\$49.00 MISC868**



AR15 FLAT TOP UPPER COMPLETE PARTS SETS

Double time it and get these before they're gone..... Everything present in this Kit to make an AR15 type rifle except for the Lower Receiver. All parts included are new mfg parts. Sling and magazine are not included. Buttstock supplied is the telescoping 6 position M4 stock with correct buffer and spring and the 16" barrel is brand new and has the front sight assy. installed. We use the industry standard hammer/trigger pin with a diameter of .154"

Most Lower receivers use this size pin although there are some Colt mfg. lower receivers that use .170" pins which are not compatible with standard parts. The Upper Receiver is a flattop model and we offer it with and without the carry handle/rear sight configuration.



LOWEST PRICES ANYWHERE!!

BEST DEAL

- A. KIT w/ Flat top upper rec. w/ carry handle and rear sight **SALE!!** **\$375.00 \$399.95 AR150** (shown in picture)
- B. KIT w/ Flat top upper rec. without carry handle & rear sight **SALE!!** **\$349.00 \$379.95 AR224**

SARCO



50 Hilton Street, Easton PA 18042
610.250.3960
Fax: 610.438.2548

www.sarcoinc.com

Phones Open:
Mon - Fri, 8:30am - 5:00pm
Showroom Open:

Monday - Saturday, 10:00am - 5:00pm,
Friday til 8:00pm

1

NOW'S THE TIME!! BE THE FIRST TO KNOW ABOUT OUR DEALS !!!

Join Our **EMAIL BLAST** List Today By Texting **SARCO** to **22828** And Receive A **SPECIAL DISCOUNT !** By doing so, you'll get our latest email blast offers, sale items and notifications of new goodies coming in! **AND...** after you sign up, receive a **FREE** deck of authentic Cold War, Unissued & Illustrated **AIRCRAFT CARDS!** Just add them to your cart using part number **MISC168** and enter source code **EMAILBLAST** at check out to receive them for **FREE**. What are you waiting for?? **Get On The List!!**



18TH CENTURY ENGLISH CUTLASS

CIRCA—FRENCH & INDIAN AND AMERICAN REVOLUTION WARS

From 1750-1768 this sword was produced and became a standard arm of American and Crown forces during several Wars. Well liked for its compactness and maneuverability, and well-designed brass handle with guard and 23.5" blade. Marked with 'SH' with a running Fox as originally produced by the armorer Samuel Harvey. Comes with Leather scabbard with brass accents. Frequently referred to as the 'Bunker Hill Sword' for its use there..... **\$69.95 SWRD41**

WINCHESTER 70 RIGHT HAND SHORT ACTION STOCK / SYNTHETIC

New condition black synthetic stock with buttpad and swivel posts installed. Over-all length 29-3/4 inches. For Post 1964 models. Great Price!



JUST IN !!

\$49.95 STK427

FRENCH 1877 CANTEEN / WWI

French 2 Liter canteen was the mainstay implement for carting potable water and even wine for the French Army, from the disastrous Franco Prussian War through WWI. Unique design with air vent and carry strap and a green blue felt covering. New **\$49.95 MISC889**



JUST IN !!

REMINGTON GUN STOCK POMMEL CAPS

Original Remington pommel caps that we purchased from a Remington auction over 20 years ago. Priced right to move. Hard to find, so now's a great time to buy a replacement for that cracked pommel cap! .. **\$10.00 MISC892**



JUST IN !!

BLACK GUNSTOCK POMMEL CAPS

Purchased decades ago, these caps are perfect for restoring the cracked caps on old stocks. Smooth black oval shape is roughly 1-7/8"x 1-1/2" and @3/16" deep 3 pcs for **\$8.95 MISC891**



JUST IN !!

Super Sale on AR15 Rail Covers

4 pcs of rubberized 6-7/8" rail covers in Black for the best price of \$4.80 a set! (What a deal! Previous price was \$3.95 each!) 4 Black Rail Covers



\$4.80 LA017

SARCO'S M16 MULTIPLE MAGAZINE CARRIER

Secure metal clip holds two magazines for quick change firing and tactical applications. We've made thousands for the U.S. Govt.! See our web site for details **\$14.95**, or 4 for **\$45.80 AR203** (metal clip holder only)



SALE !! TAKE 20% OFF LISTED PRICE ON ALL TOOLS & FURNITURE IN THIS BOX SALE !!

AFFORDABLE 'AR' TOOLS & FURNITURE FOR EVERY WALLET!

- A. Picatinny Sling Swivel Mount - for adjustable placement of the sling, complete with rubberized swivel. Fits on picatinny rails **\$7.95 AR462**
- B. Rail Mounted Front Sight - steel sight, flip up style **\$13.95 AR131**
- C. Rail Mounted Rear Sight - Steel with adjustable windage and elevation in the A2 sight style. Clamps to rail mount..... **\$ 14.95 AR274**
- D. Vertical Grip, Full Size - 4-3/4" long clamps to picatinny rails. Tan..... **\$9.00 AR464T**
Black **\$9.00 AR464B**
Green **\$9.00 AR464G**

E. Compact Vertical Foregrip - 3-1/8" long in 3 colors:

- Tan..... **\$8.50 AR463T**
- Green **\$8.50 AR463G**
- Black..... **\$8.50 AR463B**

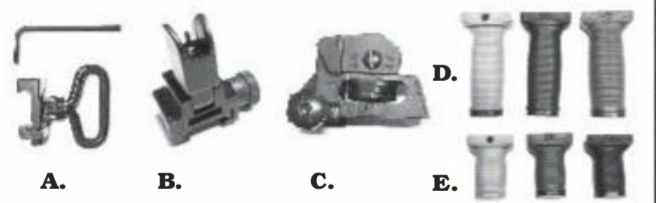

AR /M16 ARMORER'S KIT

Be ready when the time comes! Quality tool set for removal & installation of parts. Easily worth the cost just for the quality vise block set! INCLUDES - VISE BLOCK, DELTA WRENCH, TOOL BRUSH, BROKEN SHELL EXTRACTOR, BORE & CHAMBER BRUSHES, 1 SIGHT TOOL, CLEANING ROD SET \$91.50 value for just **\$49.95 \$59.95 AR373**



AR15/M16 UPPER RECEIVER VICE BLOCKS

To securely hold your upper firmly without damage to the upper or the barrel on barrel installation. Will work on any AR upper (receiver not included)..... **\$29.95 AR467**

M4 16" COMPLETE BARRELED FLAT TOP UPPER ASSEMBLIES

Comes w/ bolt & carrier assembly

We have done the hard work for you. These are fully assembled upper halves complete and ready to drop on to your complete lower. All parts made in the U.S.A! Includes Flat Top Upper, barrel assembly, complete bolt and carrier assembly, charging handle assembly, forward assist and ejection port cover assembly **\$270.00 \$295.00 AR013**

Add ons: Kit with carry handle, rear sight assembly **\$290.00 \$324.00 AR014**

Add ons: Lower parts kit and collapsible stock and carry handle **\$404.00 \$379.00 AR117**



VICTORIAN STYLE HANDCUFFS & LEG IRONS

Based on original Hiatt / Derby handcuffs & leg irons, these are steel and quite functional. You could still find yourself getting fastened to one or both of these if you get too rowdy drinking gin & tonics in Mombassa Used throughout the British Commonwealth and beyond. Gently antiqued in rust patina, they are heavy, rugged, and interesting curios of a bygone era. New.
Victorian handcuffs with key **\$19.95** MISC719
Victorian leg irons with key **\$24.95** MISC824
Set of handcuffs with leg irons **\$35.00** MISC849



M16/AR15 COMBINATION TOOL

Save time with this wrench assy. that will speed up your maintenance of the M16 / AR15 and CAR15 platforms. Built with 4140 powder coated steel, this will outlast your Rifle! **\$17.95** AR440
ON SALE!



M16A2 STOCK SET W/ HANDGUARDS, PISTOL GRIP AND BUFFER & SPRING

Complete 16 inch .223 'Wylde' barrel with 1 in 9 twist. Ready for installation. Complete with barrel nut, slip ring, waffle spring, handguard retainer, front sight assy, flash hider & front swivel **\$134.00** AR426

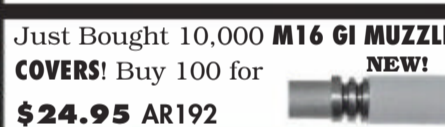

COMPLETE M4/AR15 16" BARREL

Complete 16 inch .223 'Wylde' barrel with 1 in 9 twist. Ready for installation. Complete with barrel nut, slip ring, waffle spring, handguard retainer, front sight assy, flash hider & front swivel **\$134.00** AR426



JUST BOUGHT 10,000 M16 GI MUZZLE COVERS! Buy 100 for

\$24.95 AR192



AR15 COMPLETE BOLT ASSEMBLY - SUPER SALE!!

Best deal around! Bolt with all associated parts. Reg. \$75.00 **\$34.95** ~~\$49.95~~ AR062



COLLAPSIBLE AR-15 CARBINE STOCK

• Six Positions • Precision machined Parts for Maximum Strength • Super Quality Aluminum Buffer • Includes complete stock assembly w/ buffer & recoil spring. • Reinforced grids Black
\$34.95, 3 for **\$94.50** AR145
SALE! \$28.95, 3 for **\$85.95**



ISRAELI NYLON DOUBLE GRENADE POUCH

Unissued pouch system with two compartments and adjustable flaps for use with different sized grenades. Loop on back and also British style belt hooks. **\$7.95** MISC877



DUTCH CAMOUFLAGED AMMUNITION POUCH

Nylon pouch with Velcro securing flap on front and two U.S. style fastening clips on back, allows for attachment to narrow and wide belts. New or like new condition. Dimensions @4"x4.5"x1.5". Perfect for a pack of .30-06 or 8mm ammo, smokes, pistol ammo, or any compact item **\$5.95** MISC878



U.S. CASUALTY PERSONAL EFFECTS BAG FROM VIETNAM ERA, ORIGINAL

Original OD cotton bag of a cylindrical design about 6" outer diameter and 6" high with a fabric label for identifying the personal effects of the soldier. These are unissued / new condition **\$5.95** each or 3 for **\$15.00** MISC879



See our website for M16 RETRO VIETNAM ERA TYPE PARTS

SIGHT ADJUSTING TOOL BACK IN STOCK!!
AR15/M16A2 SIGHT ADJUSTING TOOL 4 PRONG **\$4.90** AR158

Manufacturers...
Sarco has contracted thousands of reproduction line items in metal, wood, leather & canvas products from different vendors. We would be pleased to hear from new Manufacturing vendors who can offer their services. Contact Mark or Dave. Email at mdotten@sarcoinc.com or mgdave@sarcoinc.com

AR15 ACCESSORIES

Cleaning rod 4 pc. CLN030 **\$6.95**
Muzzle Cap (plastic) AR192 **\$1.50**
3 for **\$2.95**
Stripper clip guide STC005 **\$1.50**
Magazine dust covers AR199 3 for **\$2.00**
M16 G.I. cleaning "toothbrush" orig. G.I. issue. AR188 **\$2.00**
3 for **\$3.75**
SPECIAL one each of all 5 items above. AR321 **\$8.95**
M16A2 PEEL OFF FLASH HIDER WASHERS AR358 **\$7.95**
3 for **\$18.95**
AR DELTA RING REMOVAL TOOL Makes hand guard removal simple AR326 **\$8.95**

M4 AR15/M16 RECEIVER CARRYING HANDLE AND REAR SIGHT ASSEMBLY

Fits Flat Top Upper receiver with Picatinny Rail. Complete with M16A2 rear sight assembly. AR180
SPECIAL SALE! **\$29.95**, 3 for **\$84.95**

SPECIAL SALE ON UPPERS! BEST PRICE EVER! WE GOT A GOOD BUY!! AR FLAT TOP M4 UPPERS

Many choices to suit your needs.
A: Stripped flat top upper **\$39.95** AR196
B: Stripped Flat Top Upper with our complete A-4 carrying handle assy. (includes complete A2 rear sight assy) **\$60.00** AR202
C: Stripped flat top upper with M4 carry handle assy and also ejection port cover assy and forward assist assy **\$85.00** AR204

AR307	AR15/M16 Buttstock trapdoor hinge.....	\$4.00
AR119	AR15/M16 Butt Swivel A1/A2.....	\$4.00
AR056	AR15/M16 Butt Swivel Pin.....	\$1.00
AR118	AR15/M16 Butt Swivel Screw M16A2.....	\$2.85
AR002	AR15/M16 Charging Handle assy.....	\$16.95
AR188	AR15/M16 Cleaning Toothbrush, G.I.....	\$2.00 , 3 for \$3.75
AR104	AR15/M16 Disconnector Spring.....	\$1.00
AR178	AR15/M16 Early prong flash hider.....	\$12.50
AR036	AR15/M16 Ejection Port Cover.....	\$7.95
AR034	AR15/M16 Ejection Port Cover Snap ring.....	\$1.00
AR035	AR15/M16 Ejection Port Cover Spring.....	\$1.50
AR172	AR15/M16 Ejection port cover pin.....	\$2.75
AR067	AR15/M16 Ejector.....	\$3.00
AR066	AR15/M16 Ejector Pin.....	\$1.00
AR068	AR15/M16 Ejector Spring.....	\$1.00
AR064	AR15/M16 Extractor.....	\$10.95
AR063	AR15/M16 Extractor Pin.....	\$2.00
AR065	AR15/M16 Extractor Spring.....	\$1.00
AR059	AR15/M16 Firing Pin.....	\$7.95
AR058	AR15/M16 Firing Pin Retaining.....	\$2.00
AR011	AR15/M16 Flash Hider Washer.....	\$1.00
AR047	AR15/M16 Forward Assist Pin.....	\$1.00
AR048	AR15/M16 Forward Assist Spring.....	\$1.00
AR077	AR15/M16 Front and Rear Takedown Detent Spring.....	\$1.00
AR078	AR15/M16 Front and Rear Takedown Detent.....	\$1.00
AR079	AR15/M16 Front Pivot Pin.....	\$1.00
AR020	AR15/M16 Front Sight Detent.....	\$4.95
AR021	AR15/M16 Front Sight Detent Spring.....	\$2.00
AR024	AR15/M16 Front Swivel Pin.....	\$1.00
AR023	AR15/M16 Front Swivel Rivet.....	\$1.00
AR029	AR15/M16 Gas Tube 16" (Shorty).....	\$11.95
AR028	AR15/M16 Gas Tube 20" (Standard).....	\$13.50
AR027	AR15/M16 Gas Tube Pin.....	\$1.00
AR072	AR15/M16 Grip Screw & Washer.....	\$1.00
AR089	AR15/M16 Hammer Pin.....	\$1.50
AR093	AR15/M16 Hammer Spring.....	\$2.00
AR275	M16/M16A1 Handguard, new Colt (Right).....	\$14.95
AR025	AR15/M16 Handguard Cap (Triangular).....	\$6.95
AR033	AR15/M16 Handguard Slip Ring (G.I).....	\$7.50
AR030	AR15/M16 Handguard Snap Ring.....	\$2.50
AR031	AR15/M16 Handguard Spring.....	\$6.00
AR083	AR15/M16 Lower Receiver Extension.....	\$20.00
AR165	AR15/M16 Mag Carrier.....	\$7.50
AR109	AR15/M16 Magazine Catch.....	\$1.50
AR177	AR15/M16 Magazine Catch Button, metal.....	\$2.50
AR111	AR15/M16 Magazine Catch Spring.....	\$1.00
AR133	AR15/M16 Pin Kit.....	\$14.95 , 3/ \$39.95
AR043	AR15/M16 Rear Sight Aperture, Standard.....	\$5.00
AR040	AR15/M16 Rear Sight Detent Spring.....	\$1.00
AR038	AR15/M16 Rear Sight Drum.....	\$6.50
AR037	AR15/M16 Rear Sight Drum Pin.....	\$1.00
AR046	AR15/M16 Rear Sight Spring.....	\$1.00
AR041	AR15/M16 Rear Sight Windage Screw.....	\$7.50
AR115	AR15/M16 Rear Takedown Pin.....	\$5.75
AR050	AR15/M16 Round Forward Assist.....	\$14.75
AR130	AR15/M16 Rubberized Swivel front new.....	\$5.00
AR076	AR15/M16 Safety Detent.....	\$2.00
AR075	AR15/M16 Safety Detent Spring.....	\$1.00
AR095	AR15/M16 Sear Assembly.....	\$19.95
AR116	AR15/M16 Sear Spring.....	\$3.00
AR145	AR15/M16 Shorty Buttstock Assembly, high strength fiberglass w/ steel locking ring.....	\$39.95 , 3 for \$85.95
AR430	AR15/M16 Slip Ring A1 (early).....	\$20.00
AR134	AR15/M16 Spring Kit.....	\$12.95
AR032	AR15/M16 Top sling adapter.....	\$1.95
AR103	AR15/M16 Trigger Spring.....	\$2.00
AR176	AR15/M16 Triggerguard, aluminum.....	\$6.75
AR112	AR15/M16 Triggerguard Pin.....	\$1.00
AR006	AR15/M16A1 Birdcage Flash hider.....	\$6.95
AR085	AR15/M16A1 Buttcap Screw (Short).....	\$2.25
AR220	M16A1 Butt Swivel Screw.....	\$3.00
AR073	AR15/M16A1 Pistol Grip (Used).....	\$9.95
AR214	AR15/M16A2 Burst Trigger.....	\$15.00
AR143	AR15/M16A2 Buttstock Crnt Prod. Comes with buffer, spring & all hrdw milspec.....	\$54.95
AR007	AR15/M16A2 Flash hider.....	\$8.95
AR144	AR15/M16A2 New Buttstock (Current production) stripped.....	\$34.95
AR074	AR15/M16A2 Pistol Grip new.....	\$8.95
AR158	AR15/M16A2 Sight Tool (4 Prong).....	\$4.90
AR229	M16 Bolt Carrier.....	\$99.95
AR127	M16 Magazine 6 Oriltes w/ Carriers.....	\$59.95
SLNG099	M16 Single Point Sling, BLACK.....	\$17.95
SLNG100	M16 Single Point Sling, GREEN.....	\$17.95
SLNG101	M16 Single Point Sling, SCORCHED DARK EARTH.....	\$17.95
AR358	M16A2 Peel off flash hider washers. Used take off. Work fine.....	\$7.95
AR205	AR15/M16 chamber brush.....	\$3.95
AR141	M16 Original G.I. Buttstock, plus lower receiver extension, buffer and spring.....	\$59.95

AM136	223 (5.56) Dummy Rounds from Lake City - Original G.I. green tip.....	10 for \$8.95
AR098	AR Safety.....	\$10.95
AR100	AR15 Disconnector.....	\$9.95
AR092	AR15 Hammer (Semi auto).....	\$15.00
AR001	AR15 Lower Receiver Parts Kit (Semi-Auto).....	\$36.50 ea., 3 for \$99.00
AR102	AR15 Trigger (Semi-Auto).....	\$17.95
AR082	AR15/M16 Action Spring.....	\$4.00
AR120	AR15/M16 Action Spring (shorty style).....	\$4.00
AR032	AR15/M16 Barrel nut.....	\$7.50
AR060	AR15/M16 Bolt Cam Pin.....	\$6.00
AR071	AR15/M16 Bolt Carrier Key.....	\$13.50
AR070	AR15/M16 Bolt Carrier Key Screw.....	\$1.00
AR106	AR15/M16 Bolt Catch.....	\$7.50
AR105	AR15/M16 Bolt Catch Pin.....	\$1.00
AR107	AR15/M16 Bolt Catch Plunger.....	\$7.50
AR108	AR15/M16 Bolt Catch Spring.....	\$1.00
AR057	AR15/M16 Bolt gas rings, set of 3.....	\$3.00
AR149	223 cal bore brushes, bronze 10 for.....	\$8.95
AR080	AR15/M16 Buffer.....	\$12.95
AR081	AR15/M16 Buffer Short.....	\$12.95
AR087	AR15/M16 Buffer Retainer.....	\$2.00
AR088	AR15/M16 Buffer Retainer Spring.....	\$1.00
AR306	AR15/M16 Buttstock hinged trapdoor assy.....	\$9.95

AR15/M16 CLEANING KIT & ACCESSORY KIT

• Bore brush • Chamber brush
• Cleaning rod • Broken shell extractor
• Tooth brush • Stripper clip guide
• Oiler • Grenade launcher tool
• Muzzle cap • Grenade launcher Tension band
\$17.50, 3 for **\$49.95** AR240

M16 4 PIECE CLEANING ROD

29 1/2" long. Threaded **\$6.95** CLN030

M16A2 HANDGUARD SET COMPLETE WITH METAL LINER

CURRENT PRODUCTION **\$16.10** AR184

NEW M16A2 ROUND HANDGUARD SETS MILITARY PRODUCTION

Shortie length w/ liner **\$14.95** AR185

AR SHORTY BUTTSTOCK INSTALLATION WRENCH

Free Bonus - other end of wrench fits the 1911 barrel bushing **\$2.95** TOOL031

M203 RUBBERIZED TUBE GRIP W/O CLIPS

\$30.00 GRP139

M203 TOP HANDGUARD W/ METAL LINER \$60.00 M203009

AR15 LONG VENTILLATED FLASH SUPPRESSOR

Steel flash suppressor with standard threading for Govt./ Commercial 5.56/.223 barrels. 5.5 inches long **\$19.95** AR212

AR15 LONG SLOTTED FLASH HIDER

Steel flash hider similar to the Vietnam CAR-15 with standard threading for Govt./Commercial 5.56/.223 barrels 5.5 inches long **\$19.95** AR213

AR15 AND M16

SARCO www.sarcoinc.com

AR15 LOWER RECEIVER PARTS SET

Super price! Includes all parts shown except for the receiver. Comes with late model pistol grip and our hammer & trigger pin diameter is the industry standard at .154. Some Colt made guns use a .170 diameter which is not compatible with our parts **\$36.50** ea.
3 for **\$99.00** AR001



M16 ACCESSORY KIT - HEAVY DUTY

Cleaning toothbrush (GI) Silent sling, Front sight tool, Muzzle cover, Magazine dust covers (6), Plastic mag carriers (4) (Israeli G.I.), Broken shell extractor, Cleaning rod, Stripper guide, 2 Grenade launcher tension band (rare). Value \$83.50
Sarco Special Price **\$19.95** AR238

AR-15 TAPCO INTRAFUSE HANDGUARD SET

New sporting design makes these 6.5" handguards with 3 accessory rail covers, a convenient change of variety for your M4 style rifle. Color: black **\$29.95** AR420
CLOSE OUT! **\$9.95**
3 for **\$27.00**

M4 STOCK SET WITH HANDGUARDS & PISTOL GRIP

New M16A2 or M4 pistol grip **\$8.95** AR074

AR15/M16 BIPOD, NEW ORIGINAL U.S. G.I. METAL

Above Bipod with Pouch **\$29.95** AR297
Pouch only **\$5.95** AR324

5.56MM/.223 BROKEN SHELL EXTRACTOR

Brand new tool; made for removing stuck headless cases from the chamber of any .223/5.56mm rifle. We've never seen these offered before now **\$5.95** ea. BSE001
Our new BSE's work - others on the market don't fit. We learned the hard way!

COMPLETE BOLT CARRIER ASSEMBLED

FULL-AUTO (works well with semi-auto AR15)
\$99.95 AR263



AR-15 DUAL FRONT SIGHT TOOL

Two-in-One tool with dual functions to adjust both 4-prong and 5-prong front sights. Makes adjusting the front sight on your A1 and A2 a snap. **\$5.95**, 3 for **\$14.95** AR175

See our bayonet page 8 for M16 (M7) bayonets

M16 AUTO SEAR

Few only **\$19.95** AR095
Buy a replacement(s) for your legal M16. All NFA rules apply. **Note:** These go out of time with use.

AR15/M16 CHAMBER BRUSH

Original style **\$3.95** AR205

AR 16" BARREL GAS TUBES

Just got a shipment in. these have been tight **\$11.95** AR029

M16/AR15 EARLY 'DUCKBILL' FLASH HIDER

Early U.S. Advisors & Air Force 'Model O1' flash hidiers originally issued with the guns starting in 1963. These were succeeded by the standard GI 'prong' flash hider & later in 1969 by the 'birdcage' model. New mfg. **\$9.95** AR423

FLASH HIDERS

M16A2 **\$8.95** AR007

G.I. M16 RIFLE SLINGS

Late production **\$5.95** SLNG001



www.sarcoinc.com

50 Hilton Street, Easton PA 18042
610.250.3960
Fax: 610.438.2548

M14 PARTS & ACCESSORIES

M14 7.62 NATO CHAMBER BRUSHES

G.I. ratchet chamber brush originally made for use with the M14 rifle, but will work just as well in most 7.62mm NATO rifles, new \$2.95 or 3 for \$6.95 M14016

M14 FLASH HIDER PLIERS

Available once again. New condition. A necessity for your M14 ensemble \$16.50 ea. TOOL039



See our website for ITALIAN GARAND BARRELS

NEW!!! M14 BARRELS IN STOCK

Brand new .308 cal M14 Barrels made by one of the best U.S. barrel manufacturers \$175.00 ea. M14124



AVAILABLE AGAIN M14 FULL AUTO PARTS KITS

M14 Selector, Pin & Spring
M14 Selector Shaft
M14 Sear Release
M14 Connector Rod Full Auto
M14 Selector Lock \$75.00 M14014

M14 WALNUT STOCK

Nice Military rework... \$45.00 M14363

M14/M1A SIGHT PROTECTORS

Military style plastic snap-on covers to protect the front and rear sights and the flash hider muzzle of the M14/M1A rifle. New \$6.50 3 for \$17.95 M14022



M14 RIFLE CLEANING KIT

Kit consists of following items:
G.I. sectional cleaning rod, Rod handle/comboination tool, Ratchet chamber brush, .30 cal. bore brush
G.I. carrying pouch..... \$12.50 CLN070



M14 STRIPPER CLIPS

12 original clips for \$9.95 STC016

M14 SPECIAL ITEMS

- M14 Bolt stop G.I. \$22.95 M14091
- M14 Buttplateassy hinged, G.I. \$29.95 M14047
- M14 Connector rod G.I. \$19.95 3/ \$49.95 M14049
- M14 Firing Pin, original G.I. \$21.00 M14058
- M14 Front stock swivel set, new G.I. \$8.95 M14117
- M14 Handguard w/retaining clip, Fiberglass G.I. \$12.50 M14005
- M14 Handguard w/o retaining clip, Fiberglass \$9.95 HNGD13
- M14 Handguard, Walnut \$24.95 M14120
- M14 Op rod spring guide \$19.95 M14051
- M14 Recoil Spring, TRW Orig GI \$7.45 5/ \$29.95 \$49.95 M14052
- M14 Rear Sight Aperture, .052 NM \$41.50 M14127
- M14 Rear Sight Aperture, .059 NM \$41.50 M14364

M1 GARAND PART SETS

We can piece together a few M1 Garand parts sets - All but the receiver - The stock and handguard set will be our new stock set GRD278. Condition of all parts is from good to new. Most are G.I. Sorry, but these have to be \$730 as some Garand parts are getting tough to acquire and cost is high. .30-06 \$730.00 GRD380

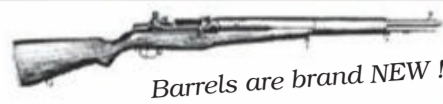

Barrels are brand NEW!

Just In !! NEW VARIATION OF THE .308 M1 GARAND KIT

Again, all parts but the receiver with an original Italian .308 barrel. This unit is 1/2 inch shorter than a standard Garand \$495.00 GRD387

M1 GARAND RIFLE 'LINED' JEEP SCABBARD

Marked improvement over the WW2 issue scabbard! Has the same outward appearance with brass guard for the charging handle and rich brown color with two leather straps and has been improved with a soft lining on the inside to protect your valuable investment from scratches and undue wear. Great for all sorts of similar sized rifles and works beautifully on horseback too! SALE! \$49.95 \$59.95 GRD382



LATE T-37 M1 GARAND SNIPER FLASH HIDER

\$34.50 GRD111

M1 GARAND OP ROD

.308 length - 1/2 inch shorter than standard. \$125.00 GRD175
Finally Back In Stock! We dug out a pile of Garand standard GI Op Rods..... \$175.00 GRD052



M1 GARAND ACCESSORY PACK

Terrific set of accessories for the Shooter or Reenactor! Made up of both original and reproduction items, the Pack includes the following items:
GARAND GUN CASE, GARAND CARTRIDGE BELT, MILITARY MANUAL, M10 CLEANING SET w/brush, CHAMBER BRUSH, SNIPER CHEEK PAD, GI BORE CLEANER, CLEANING ROD STOP, 3 EN-BLOC STRIPPER CLIPS, M15 G.L. SGT.CASE, PULL THRU ROD & CORD
ALSO: Your choice of 1907 Leather Sling or Canvas WW2 style sling. Specify when ordering. A Retail Value of over \$145.00 For Just. SALE! \$59.95 \$79.95 GRD329
A great gift for a Garand owner!

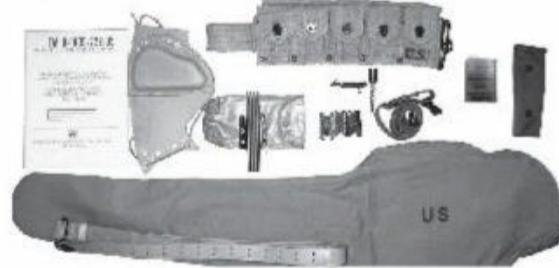

OUR LATEST FABULOUS BUY ON BARREL BLANKS!

All previous buys have been a sellout - most of these have been profiled so they are ready for your project.

NOTE: These are all first class production. LIMITED SUPPLY
NOTE: We even have .20cal blanks
NOTE: We are told that these blanks sell for up to \$200. These are ALL 1st class blanks. NO rejects, bloms or GD2.

Part #	Caliber	Length	Diameter	Profile	Twist	Material	Description	Price
BB056	375 Cal	26 inches	N/A	#3	1 12.	4140	Unfinished Profile Blank	\$59.95
BB058	35 Cal	26 inches	N/A	#3	1 14.	4140	Unfinished Profile Blank	\$59.95
BB059	7MM	24 inches	N/A	#1	1 9.5	4140	Unfinished Profile Blank	\$59.95
BB060	270 Cal	24 inches	N/A	#1 1/2	1 10.	4140	Unfinished Profile Blank	\$59.95
BB062	243 Cal	24 inches	N/A	#1 1/2	1 10.	4140	Unfinished Profile Blank	\$59.95
BB063	22Cal	24 inches	N/A	#1 1/2	1 14.	4140	Unfinished Profile Blank	\$59.95
BB064	8MM	24 inches	1.250 Dia		1 9.5	Stainless	Unfinished Blank	\$34.95
BB065	30 Cal	22 1/2 inch	1.175 Dia		1 10.	Stainless	Unfinished Blank	\$34.95
BB066	20 Cal	24 inches	1.250 Dia		1 12.	Stainless	Unfinished Blank	\$44.95
BB070	5.56 Cal	16 inches	1 Dia		1 10.	Stainless	Threaded & Chambered AR15	\$39.95
BB073	270 Cal	26 inches	N/A	#3	N/A	4140	Unfinished Profile Blank	\$59.95
BB074	22 Cal	26 inches	N/A	#2 1/2	1 14.	4140	Unfinished Profile Blank	\$59.95
BB075	243 Cal	26 inches	N/A	#2 1/2	1 10.	4140	Unfinished Profile Blank	\$59.95
BB079	5.56Cal	16.5 inches	.980 Turned		1 7.	4140	Hub Threaded & Chambered AR15	\$35.95
BB080	9mmCal	16.5 inches	.980 Turned		1 10.	Stainless	Hub Threaded & Chambered AR15	\$39.95
BB081	5.56Cal	20.5 inches	.812 Turned		1 8.	4140	Chamber Only Turned Blank	\$29.95
BB082	300 Blackout	16.5 inches			1 8.	Stainless	Chamber & threaded	\$49.95
BB083	458 Socom	18 inches	1.032 Dia		1 14.	stainless	Milled Finish Barrel Blank	\$59.95
BB084	10/22 Ruger	18.5 inches	.920 Turned			4140	Uncrowned	\$45.00
BB085	Mauser 25 06	26 inches		#3		4140		\$79.95
BB086	260 Rem AR15	22 inches				stainless	Extension, pins & gas holes	\$125.00
BB087	22RF	17 inches	.750 Dia		1 16.	4140	Turned Blank	\$49.95
BB089	308Cal	24 inches				stainless	Hub Threaded & Chambered AR10	\$49.95
BB090	308Cal	20 inches				stainless	Hub Threaded & Chambered AR10	\$49.95
BB091	9mm AR15	17 inches				4140	chambered with machine ext.	\$59.95

NEW ADDITIONS!!!

BB095	Barrel Blank 24.5" .17 Cal 1-9, 4140 1.032 dia	\$49.95
BB096	Barrel Blank 26.75" .17 cal, 1-9, 4140 1.250 dia	\$49.95
BB097	Barrel Blank 26.75" .17 cal, 1-9, SS 1.250 dia	\$49.95
BB098	10/22 Barrel Blank 18" 17 1-9 SS .920 dia needs finishing	\$49.95
BB099	Barrel Blank 25.5" .22 RF 1-16 4140, 1 dia	\$49.95
BB100	Barrel Blank 24.5" .243, 1-10, 4140, 1.20 dia	\$49.95
BB101	Barrel Blank 24.5" .25 cal 1-10 4140, 1.20 dia	\$49.95
BB102	Barrel Blank 21.5" .25 Cal 1-10, SS 1.312 dia	\$49.95
BB103	Barrel Blank 16.5" .264 cal 1-8 4140, 1.032 dia	\$49.95
BB104	Barrel Blank 18.5" .264, 1-8 SS 1.032 dia	\$49.95
BB105	Barrel Blank 26.75" .264, 1-8, 4140, 1.250 dia	\$49.95
BB106	Barrel Blank 26.5" .264, 4140, 1-8, 1 dia	\$49.95
BB107	Barrel Blank 21.75" .270, 1-10, 4140 1.2 dia	\$49.95
BB108	Barrel Blank 26.75" .270, 1-10, 4140, 1.312 dia	\$49.95
BB109	Barrel Blank 11" .30 cal 1-7 SS 1.032	\$49.95
BB110	Barrel Blank 9.5" .30 Cal 1-7, 4140 1.2 dia	\$49.95
BB111	Barrel Blank 11" .30 cal 1-8 SS 1.032	\$49.95
BB112	Barrel Blank 26.5" .30 Cal 4140 1-10 1.250 dia	\$49.95
BB113	Barrel Blank 22.5" .303 SS 1-10 1.312 dia	\$49.95
BB114	10/22 Barrel 18" 22Mag 1-16, SS .920 dia	\$49.95
BB115	10/22 Barrel 16.5" 22RF 1-16 Threaded Muzzle 1/2-28, SS .920 dia	\$49.95
BB116	10/22 Barrel 22RF 1-16 18" 4140 .920 dia	\$49.95
BB118	Barrel Blank 9" 12 GA, Smooth bore, SS, 1.312 dia	\$49.95
BB119	Barrel Blank 12GA 1-28 Rifled blank 4140 turned 1.125	\$49.95
BB120	Barrel Blank 26.5" 22 Cal 1-14, 4140 #3 contoured blank	\$49.95
BB121	Barrel Blank 24.5" 22 RF 1 16 4140, 1 dia	\$49.95
BB122	Barrel Blank 16.625" 22LR, 4140, 1 16, 1 dia	\$49.95
BB123	Barrel Blank 19" 45 70, 1 22 SS 1.312 dia	\$49.95
BB124	Barrel Blank 20.5" 5.56, 4140, 1 7, .815 dia	\$49.95
BB125	Barrel Blank 13" 5.56, 4140, 1 7, .98 dia	\$49.95
BB126	AR10 Barrel 18" 6.5 Creedmoor 1 8 SS, 1.190 dia hub, thread, chamber	\$49.95
BB127	77/22 Barrel 24" 22 RF 1 16 Bentz chamber, SS .920 dia	\$49.95
BB128	77/22 Barrel 24" 22 RF 1 16 Match chamber, SS .920 dia	\$49.95
BB129	Barrel Blank 17" 9mm 1 10 SS 1.032 dia	\$49.95
BB130	Barrel Blank 11" 9mm 1 10 SS 1.312 dia	\$49.95
BB131	Barrel Blank 12" 9mm, 4140, 1 10 1.20 dia	\$49.95
BB132	AR10 Barrel Blank 20.5 .243, 1-10 SS, 1.190 dia hub, thread, chamber	\$49.95
BB133	AR10 Barrel Blank 13.5" 308, SS 1-10 1.190 dia hub, thread, chamber	\$49.95
BB134	AR10 Barrel Blank 24" 6.5 Creedmoor 1-8 SS, 1.190 dia hub, thread, chamber	\$49.95
BB135	AR10 Barrel Blank 22" 6.5 Creedmoor 1-8, contoured, TM, SS, Hub, thread, chamber	\$49.95
BB136	AR15 Barre Blank 22" .224 Valkyrie 1-7 4140 TM, Contoured hub, thread, chamber	\$49.95
BB137	AR15 Barrel Blank 20" 450 Bushmaster 1-24, 4140 hub, thread, chamber	\$49.95
BB138	AR15 Barrel Blank 24" 5.56 1-7 SS, Bull, hub, thread, chamber, crowned	\$49.95
BB139	AR15 Barrel Blank 8.5" 5.7x28 1-7 SS	\$49.95
BB140	AR15 Barrel Blank 12" OTD, SS, Legend 1-12	\$49.95

New 'Barrel Blanks'

3 new 'barrel blanks' ready for your next project. Steel barrels, unfinished, with an O.D. of 1 inch, in the white and in 3 different calibers:
Barrel Blank, 17 Cal., 23" long..... \$39.95 BB076
Barrel Blank, 30 Cal., 18" long..... \$35.95 BB078

FINALLY BACK IN STOCK!!

WWII PATTERN WEB GARAND SLING

Just reproduced for U.S. complete with markings. OD with all proper metal fittings Beautiful. Proper for Springfield and Garand..... \$9.95 SLNG057



FOUND A FEW MORE M1C SNIPER RIFLE GRIFFIN & HOWE PATTERN MOUNT BASES

Parkerized - Complete with the 3 screws & 2 pins \$24.95 GRD285
We also have the pin & screw set for..... \$12.95 GRD327



M1 GARAND RIFLE (More on page 4!) 3

M1 GARAND CLEANING KIT SALE!!

Kit contains M10 cleaning rod, bore brush and a G.I. carrying pouch. CLN064 \$14.95 \$17.49
3 for \$39.95 \$49.50
Handle for M10 cleaning Rod for Garand Rifle - hard to find \$4.95 \$7.95
3 for \$14.00 \$22.50 CLN047
Orig G.I. M10 handles \$6.95 \$9.95 GRD281



NEW GI GARAND BUTTPLATES

We bought 'em 30-40 years ago. Found another small batch in the warehouse sort. Believe this is the end. \$40.00 \$44.95 GRD326
Conetta Mfr. While they last!



BRAND NEW M1 GARAND BARRELS

Currently produced in USA by a 30 Year Top Line Barrel MFG .30-06 barrels in stock!

Newly manufactured barrels ready to install on your M1 Garand Receiver. Made by one of the premier barrel manufacturers in the USA, these .30-06 caliber barrels are manufactured from 4140 steel with 4 groove rifling and a 1 in 10 twist. Beautiful high quality parkerized replacement barrels. Because they are made here in the US, they do not have the ungainly import barrel markings. A great chance to get rid of that 'Blue Sky' or other import marked barrel and also restore accuracy! Barrels should always be installed by a qualified gunsmith.

.30 06..... \$149.95 GRD157



M1D SCOPE MOUNT

Scope mounts for the M1D Garand Sniper rifle. These are for the 7/8" diameter M81 - M82 - M84 Scope. New condition \$74.00 GRD112



We still have a few ORIGINAL WW2 ERA GARAND STOCKS W/ MARKINGS.

See our website!

GARAND BROKEN SHELL EXTRACTORS

.30-06..... \$7.95 BSE006



Just In !! .30 CALIBER BRAND NEW RIFLE BARREL BLANKS

These are U.S. GI 1903A3 Springfield barrels that have had the front & backend cutoff. Perfect for your special project!..... \$19.95 3 for \$49.95 BB141

Overall length: approximately 46.5 cm, **Breech O.D:** 26.4 mm, **Muzzle O.D:** 17 mm



.30 CAL BARREL BLANKS

Cutoff front ends with @9"/- 1". Bore is rifled. Nice lands and grooves. Perfect for firearm projects \$9.95 3 for..... \$23.95 CRB204

CHECK OUR WEBSITE FOR A FULL LISTING OF M14 & M1 GARAND PARTS & ACCESSORIES!

SARCO

50 Hilton Street, Easton PA 18042
610.250.3960 Fax: 610.438.2548

www.sarcoinc.com

**We have 30 Different
Varations of Handguards -
See our website!**

ORIGINAL G.I. M1 GARAND BOLTS

Stripped
\$69.95 GRD070
Complete
\$89.95 GRD071

**One Month Only
Super Sale!**
USGI Original
Stripped Bolts
- VG cond.
\$49.95
3 for **\$134.95**



Go to our website for a complete selection of Garand bolts by maker and dash variation. We have sorted out 13 variations we even offer heat treat lots for serious collectors.

M1 GARAND FRONT & REAR SIGHT COVERS

Perfect for protecting your prized Match Sights installed on the rifle. Plastic covers slip on & off easily. Set of Front & Back covers
\$6.00 GRD114



A perfect reproduction of the **GRENAD LAUNCHING RUBBER BOOT** (slip on) for the Springfield and M1 Garand. Absolutely meticulously beautiful!! **\$34.50** MISC088



M1 STAINLESS STEEL GARAND OP ROD SPRINGS

The Best On The Market!
Just got a new fresh shipment made from G.I. blueprints. Replace your tired spring or put away a spare now! **Stainless Steel**
17-7 **\$7.95**
3 for **\$22.95** GRD171
Standard op rod Spring **\$5.95**
3 for **\$13.95** GRD059



M1 GARAND OPERATING ROD TIPS (pistons) Brand new, made to Government specs. Replace your worn piston - diameter .5265" (high end + .0005") Made of the proper 174PH steel. **SALE \$7.95 \$9.95**, 3 for **\$21.95 \$22.95** GRD211



WW2 ORIGINAL M1 GARAND BARRELS

These are decorator condition w/ poor bores. Few only **\$49.95** GRD330

SPECIAL M1D SNIPER COMBO SET

New G.I. Handguard
T-37 Flash hider **\$20.00**
Barrel Block **\$20.00**
Cheek Pad
Scope Mount
Value \$200.00. GRD145 **SPECIAL \$149.50**

BRAND NEW GARAND STOCK & HANDGUARD SETS IN WALNUT

The stocks are new walnut G.I. stocks that were .308 cal & we retrofitted them to .30-06. Fit is perfect for .30-06. There is a tiny hairline from the conversion that is visible. Handguards are new production walnut. Complete stock set (wood only) **\$69.95**
3 for **\$195.00** GRD278
We can also offer the stock alone which makes a great replacement for your CMP worn out drill rifle or regular Garand stock **\$49.95**
3 for **\$139.95**
20 for **\$749.95** GRD279

U.S. WW2 M7 GRENADE LAUNCHER

M7 Grenade Launchers now available! Connects quickly to the M1 Garand Rifle and locks in place with an attached clip. Great compliment to your collection and allows the Rifle Grenades to be mounted. We can offer the launcher on its own, and also with an original inert M11 Rifle Grenade at a savings from buying each item separately. Launcher new mfr.
M7 Grenade Launcher **\$69.95** RL020
M7 Grenade Launcher with M11 inert Rifle Grenade **\$99.95** RL021



JUST IN!!

WINCHESTER 97 TRENCH GUN BAYONET LUG & HEAT SHIELD W/ SCREWS

PLEASE NOTE: These will only fit original Winchester 97s with the correct grooves cut - If your barrel does not have the grooves cut for the screws, they will have to be machined. These will not fit reproduction Winchester 97s currently on the market. Will ONLY fit P14 & P17 bayonets
..... **\$129.00** W97058



M1 GARAND M82 SNIPER SCOPE

New precision 2.5x scope marked with Govt. part numbers, complete with sun shade and rubber eye cup. Perfect quality scope for making an M1D, M1C or O3A4 sniper rifle. Beautifully constructed and clinically accurate!
..... **\$260.00** SCP040



SPARE PIN & SPRING KIT FOR M1 GARAND

Clip latch spring **\$12.95** GRD219
Extractor spring & plunger
Hammer spring
Op rod spring
Clip latch pin

GARAND SNIPER LEATHER CHEEKPAD

Special new low price. GRD124
Exact repro with proper markings **\$18.95** 3 for **\$49.95**



.30 CAL BORE BRUSHES

Normal .30 cal bronze brushes
10/ **\$9.95**
20/ **\$17.98**
50/ **\$39.95**
100/ **\$69.95** CLN172
Stainless steel bore brush for cleaning those tough military bores. 5 for **\$8.95** CLN120

COMBO. New Style M3A1 TOOLS WITH CHAMBER BRUSH

The Latest and best.
A. Used G.I. **\$25.00** GRD134
B. Like new tool w/new brush **\$30.00** GRD138
C. Absolutely New G.I. WWII original tool in orig G.I. grease & G.I. package (no brush) **\$40.00** GRD165



WWII U.S. PATTERN CLEANING ROD CASES WITH WWII STYLE BELT HOOKS

These are nice as they have leather straps & edging - new - show some storage
For M1 Carbine rod ... **\$12.50** CLN117
For M1 Garand rod ... **\$12.50** CLN118
Special - 1 of each ... **\$21.95** CLN119

Available Again - Ratchet chamber brushes for the M1 Garand

..... **\$4.95**,
3 for **\$9.95**
TOOL044



M1 GARAND BLANK ADAPTER

GRD126 U.S. G.I. pattern, new
..... **\$7.95** 3 for **\$21.95**
For bulk pricing on Garand BFA's call Mark, Dave or Cholly

GARAND ACCESSORY KIT

- Perfect new leather sling
 - Orig. late oiler
 - Orig. combat cleaning throw
 - Cleaning brush
 - Front & rear sight cover
 - 10 - 8 shot clips
 - Orig. WWII accessory pouch
 - Cleaning rod buffer
 - G.I. type carrying case
- \$70.00 value \$49.95** GRD172

Orig. Brass oil & throng set, exc. condition. OIL015 **\$35.00**
Orig plastic oil & throng set, used exc. condition OIL016 **\$8.50**

M1C/M1D SNIPER PARTS

1. M1D rear handguard New G.I. original GRD031 **\$25.00**
2. T37 flash hider GRD111 **\$34.50**
3. M1D barrel block GRD113 **\$59.95**
4. M1D scope mount GRD112 **\$47.50**

M1 GARAND STYLE REAR SIGHT BASE...

For Your Next Project!
Originally designed for the M1 Garand rifle, this great little sight base is perfect for your next project. It allows you to actually add the superb and precise M1 Garand Rear Sight assy. components onto the weapon of your choice. Imagine having the ability to dial elevation and traverse measurements on a commercial or project rifle the same way you can on the Garand! With the same ease and precision that you don't find on most rifles. The base has a concave bottom with 2 mounting holes. Accepts the superior M1 Garand windage pinion & elevation aperture sold separately. Fits well on the Ruger 10-22 as well, but can be used on almost any project you come up with **\$19.95 ea.**, 3 for **\$17.50 ea.**, 10 for **\$15.00** MISC727



M1 GARAND LINED GUN COVERS

Olive drab & U.S. marked ... **\$22.95** GRD345



WW2 M1C GARAND RIFLE FLASH HIDER

M1C Garand Sniper Rifle flash hider as used in WW2, simply and quickly, attaches on the muzzle end & bayonet lug of the rifle. Hard to find item is finally available after more than a decade! Get one before they disappear again! Late mfr. **\$125.00** GRD388



4

M84 repro scope buyers from other sources- we have original G.I. unnumbered **M84 SCOPE DATA PLATES** from Libbey Owen Ford (the manufacturer) NOS. You can number your scope to your gun on an original date plate. M84 repro scope buyers from other sources - we have unnumbered M84 scope data plates. You can number your scope to your gun on this data plate **\$29.95** M84014

ITALIAN WW2 CARCANO RIFLE SLING

BACK IN STOCK!
New made, Italian WW2 brown leather sling is @54.5 inches long and comes complete with Italian Ordnance stamp and date. One end has adjusting buckle and the other end has two holes with stud **\$17.95** SLNG125



M1 GARAND REAR SIGHT PARTS - STANDARD & MATCH

- GRD094 Complete Rear Sight Assy, late model **\$64.95**
 - GRD084 Rear Sight Base **\$27.00**
 - GRD088 Rear Sight Aperture **\$10.00**
 - GRD348 Rear Sight Aperture, Match peep hole .059 **\$13.50**
 - GRD093 Rear Sight Aperture Cover **\$5.95**
 - GRD090 Windage Knob Assy **\$14.00**
 - GRD086 Elevating Pinion Assy, Yard graduations **\$24.95**
 - GRD363 Elevating Pinion Assy, Meter graduations **\$29.95**
- NATIONAL MATCH REAR SIGHT ITEMS**
GRD095 Complete National Match Rear Sight w/Hooded Cover, (Elevation pinion assy not included as it is the same as a standard Garand elevation pinion) **\$90.00**
- (When ordering, please specify which size aperture hole you would like - two Options shown several items down in this list.)
- GRD085 National Match Rear Sight Base **\$46.50**
 - GRD091 National Match Windage Knob **\$25.00**
 - GRD089 National Match Hooded Aperture (.052 hole) **\$41.50**
 - GRD154 National Match Hooded Aperture (.059 hole) **\$41.50**
- **Please Note - all sight parts above also work with the M14 too!**
• **Buyers Note - the aperture is made slightly 'oversized' to fit to your Sight Base. The fitting procedure is simple and instructions are included. See our web site for the instructions as an option.**
- 'EARLY' M1 GARAND SIGHT PARTS**
GRD182 Pinion, early stripped original **\$55.00**
GRD092 Windage Knob, G.I. original **\$25.00**
GRD189 Lock Bar, early rear sight **\$35.00**

FRONT HALF G.I. M1 GARAND RECEIVER

\$9.95, 3 for **\$24.95** GRD143
Neat paper weight!



M1 GARAND SET OF FRONT/REAR HANDGUARDS W/METAL, BIRCH

Select US GI, Used, Select Condition
\$39.95
GRD355



M1 GARAND CLIPS

New current production by G.I. contractor GRD275
5 for **\$9.95**
10 for **\$14.95**
20 for **\$24.95**
40 for **\$45.00**
Nice fresh spring tension in your clip
SPECIAL GARAND CLIPS
1.2 round clip for match shooters **\$8.00 ea.**
5 for **\$24.95** GRD131
2.5 round hunting clips
..... **\$8.00 ea.** 5 for **\$24.95** GRD130

M1 GARAND STOCK HARWARE SET

Complete set of M1 Garand Stock Hardware. Either new or excellent parts **\$39.95** GRD136

FRENCH FOREIGN LEGION BERET OF THE FAMED 2E REP PARATROOPER

Sarco has a very limited 'run' of wool Green Berets with the famed French Foreign Legion 2e REP badge.



A unit famed for fierce fighting, especially in Indochina and Algeria, but also a familiar sight on the frontiers where Mercenaries are operating. Three sizes available. Beret with Badge **\$29.95** HAT10
(U.S. sizes 7-1/4, 7-1/2, 7-3/4)

.30 CAL. ONE PIECE USGI CLEANING ROD

Finally have some more of these splendid original cleaning rods originally used in WW2 / Korean / Vietnam era garrison or barracks where they were in constant use **\$9.95 ea.**, 3 for **\$27.50** CLN113

GARAND PARTS

- GRD330 Barrel G.I. Orig WWII Dated, poor bore & some rust **\$49.95**
 - GRD002 Barrel "Clunker Grade" **\$20.00**
 - GRD071 Bolt (Complete) **This Month Only!** **\$62.95** ~~\$89.95~~
 - GRD070 Bolt (Stripped Used) **This Month Only!** **\$41.95** ~~\$59.95~~
- See our website for a complete offering of Collector Garand bolts
- CLN172 Bronze bore brush 30 cal
10/ **\$9.95**
100/ **\$69.95**
 - GRD198 Bullet Guide, milled, New **\$15.00**
 - GRD065 Bullet Guide, stamped, New **\$12.00**
 - GRD046 Butt Swivel **\$8.00**
 - GRD220 Buttplate Assy, brand new **\$24.95**
 - GRD043 Buttplate Screw Bottom (Long) **\$2.95**
 - GRD044 Buttplate Screw Upper (Small) **\$2.00**
 - GRD115 Carrying Case **\$14.95**
 - GRD021 Clip Ejector **\$4.95**
 - GRD081 Clip Latch **\$24.50**

- GRD082 Clip Latch Pin **\$3.35**
- GRD083 Clip Latch Spring **\$1.35**
- MISC630 Conversion op rod 'tip' (modifies .308 to .30-06) **\$8.25**
- GRD214 Danish contract Garand oiler **\$3.70**, 3 for **\$8.95**
- GRD076 Ejector **\$3.25**
- GRD077 Ejector Spring **\$1.50**
- GRD078 Ejector w/ Spring **\$4.95**
- GRD086 Elevation Pinion (Late Style) **\$29.95**
- GRD363 Elevating Pinion Assy, Meter graduations **\$29.95**
- GRD075 Extractor-current production **\$15.95**
- GRD310 Extractor G.I. **\$24.95**
- GRD079 Extractor Spring w/ Plunger **\$3.45**
- GRD074 Firing Pin orig G.I. **\$19.95**
- GRD186 Flash hider lock bracket G.I. M2 **\$25.00**
- GRD111 Flashider T-37 (Pronged) **\$34.50**
- GRD062 Follower Arm **\$24.95**
- GRD064 Follower Arm Pin **\$2.45**
- GRD068 Follower Assy **\$24.95**
- GRD061 Follower Rod **\$7.00**
- GRD066 Follower Slide **\$12.00**
- GRD109 Front Sight **\$12.00**
- GRD110 Front Sight Screw **\$1.25**
- GRD101 Gas Cylinder Lock w/Hump **\$26.00**

- GRD100 Gas Cylinder Lock (Used) **\$20.00**
- GRD286 Gage GI barrel diameter-gas cylinder .5991 **\$75.00**
- GRD016 Hammer **\$24.95**
- GRD015 Hammer Pin **\$2.00**
- GRD013 Hammer Spring **\$2.00**
- GRD014 Hammer Spring Plunger **\$4.00**
- GRD041 Handguard Band Rear **\$5.00**
- GRD039 Handguard Ferrule Front **\$6.00**
- GRD032 Handguard, Rear walnut w/o metal, good **\$20.00**
- GRD033 Handguard, Front walnut w/ metal, good **\$25.00**
- GRD040 Handguard Spacer Front **\$5.00**
- GRD089 Hooded Rear Sight Aperture National Match **\$39.95**
- GRD037 Lower Band **\$15.00**
- GRD038 Lower Band Pin **\$1.00**
- OIL002 Lubriplate pot, G.I. 3 for **\$3.95**
- CLN116 M10 cleaning rod handle **\$7.45**, 3 for **\$20.00**
- M84017 M84 Sniper Scope Cover, Orig **\$59.95**
- OIL035 Oiler, late plastic WWII, new **\$13.95**
- OIL015 Oiler, brass & throng set, exc **\$35.00**

- OIL016 Oiler, plastic & throng set, used, exc. **\$8.50**
- GRD052 Operating rod G.I. **\$175.00**
- GRD063 Op rod catch assy **\$30.00**
- GRD088 Rear Sight Aperture **\$10.00**
- GRD094 Rear Sight Assembly Late **\$64.95**
- GRD084 Rear Sight Base **\$25.00**
- GRD085 Rear Sight Base National Match **\$46.50**
- GRD093 Rear Sight Cover **\$5.95**
- GRD017 Safety **\$17.50**
- GRD112 Scope Mount M1D **\$47.50**
- GRD111 Sear **\$6.00**
- GRD114 Front & Rear Sight protective cover with muzzle can **\$6.00**
- SLNG024 Sling Repro WWII Leather, brass hook **\$16.95**
- SLNG025 Sling Repro WWII Leather, steel hook **\$16.95**
- GRD107 Stacking Swivel **\$8.00**
- GRD108 Stacking Swivel Screw, new **\$2.95**
- 5/ **\$11.95**
- GRD028 Garand stock for .308 NATO cal gun, new **\$49.95**
- GRD048 Stock Ferrule, new GI In the grease **\$15.00**

- GRD375 Stock Ferrule Assembly, New **\$20.00**
- GRD047 Stock Ferrule Stripped **\$10.00**
- GRD049 Stock Ferrule Swivel **\$6.00**
- GRD050 Stock Ferrule Swivel Screw **\$2.95**
- GRD027 Stock U.S. / G.I. Average, Used Condition, No Cracks **\$49.95**
- GRD024 Stock U.S. / G.I. Select, Used Cond **\$75.00**
- GRD323 Trigger forging, orig G.I. new **\$4.95**
- GRD009 Trigger & Sear Assembly **\$12.00**
- GRD019 Trigger Guard Milled **\$25.00**
- GRD020 Trigger Guard Stamped **\$16.50**
- GRD023 Trigger Housing Assembly **\$99.00**
- GRD022 Trigger Housing Stripped **\$39.95**
- GRD152 Trigger Housing, Win. Reparked Stripped **\$74.95**
- GRD008 Trigger Pin **\$2.00**
- GRD092 Windage Knob early original **\$55.00**
- GRD090 Windage Knob (Late Style) **\$12.00**
- GRD212 G.I. winter trigger in orig. pkg **\$19.95**

STILL LOWER PRICES ON ALL .45 AUTO KITS .45 AUTO

"BUILDERS KITS"

Put together your own .45 "Government" pistol with our Builder Kits. Several different kits available to best fit your needs. Our parts are standard M1911A1/ Pre-'70 Government type. Compare our prices and see how much you will save compared to the competition!

- #1. Builders Kit - All parts in the gun less frame and slide **\$149.95** or 3 for **\$429.95 C45095**
- #2. Builders Kit - All parts in the gun less frame, slide and barrel **\$119.95** or 3 for **\$349.95 C45096**
- #3. Builders Kit - All parts in the gun less frame. Kit includes one of our new current manufacture G.I. type slide (unmarked) **\$239.95 C45097** (Regular value \$300)
- #4. Builders Kit - All parts in the gun less frame. Kit includes one of our new current manufacture commercial slide (unmarked) **\$264.95 C45218**

Note: All gun parts may require some fitting and technical knowledge for assembly. If you are not knowledgeable seek professional assistance.

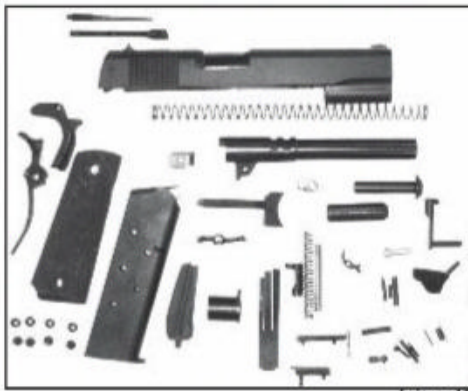

Military Model 1911 C45097



Commercial Model 1911 C45218

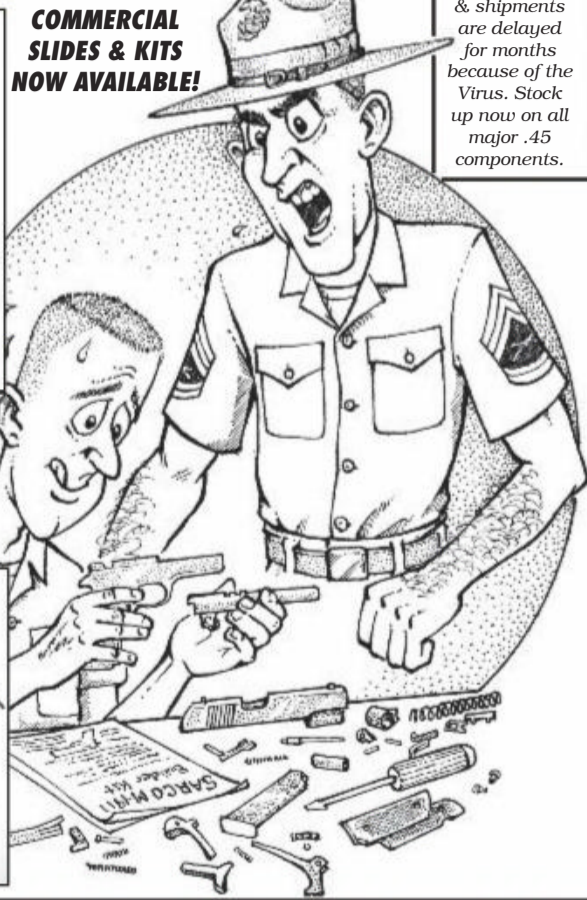

COMMERCIAL SLIDES & KITS NOW AVAILABLE!

Getting low!!! & shipments are delayed for months because of the Virus. Stock up now on all major .45 components.

5 INCH .45 ACP, NO RAMP, STAINLESS STEEL PARA ORDNANCE BARREL \$145.00 PAR1B (F500173) P-14



CHECK OUR WEBSITE FOR : PARA LDA Spring Kits #PARA312 PARA Put Away Kits #PARA311

Have 50 to 100 Special 1911 Slides on our website. Just came in! Have specially marked Para slides and also unmarked special and hard to get standard 1911 slides.

ROTO HAMMER FORGED 1911, 5" BARREL

Precise and consistent specs make these the barrel of choice for the 1911 pistol. These .45 cal. barrels are made in the USA and available at a Super price!..... **\$54.70 C45011**

MILITARY RIFLE SLINGS ORIGINAL & REPRO

- SING024 1907 WW I Sling (Brass Hardware) Repro..... **\$16.95**
- SING025 1907 WW II Sling (Steel Hardware) Repro..... **\$16.95**
- SING001 AR15/M16 Black Silent Sling... **\$5.95**
- SING002 AR15/M16 Padded Assault Sling **\$19.95**
- SING075 Chilean Mauser M1895 Carbine, fair, few only **\$14.95**
- BAR008 BAR Sling Repro **\$25.00**
- SING023 Egyptian Maadi AK sling **\$9.95**
- SING023 Egyptian Rashid Sling, Carbine **\$9.95**
- SING096 Enfield canvas, Black canvas ... **\$6.95**
- SING094 Enfield canvas, Olive Drab canvas **\$6.95**
- SING095 Enfield canvas, RAF Blue canvas **\$6.95**
- SING027 Japanese Arisaka Sling Type 38 Repro..... **\$17.50**
- SING008 Japanese Arisaka Sling Type 99, Leather w/steel hardware, brown, 1.5" wide..... **\$14.50**
- SING098 Japanese Naval, leather **\$13.00**
- SING093 Japanese Pacific WW2 Rubberized Canvas **\$19.00**
- SING012 La Corona 98/43 Sling (Spanish style) La Corona (Fair-Good)... **\$14.95**
- SING042 Lee Enfield #3 or #4 Sling WWI w/ Brass Stamp late production... **\$7.95**
- SING079 Lee Enfield Pattern 14 leather sling **\$12.95**
- SING006 M1/M2 Carbine Sling Khaki (Repro) **\$9.95**
- SING005 M1/M2 Carbine Sling O.D. (Repro) **\$7.95**
- M36032 Mas 36 & 36/51 Original, VG Cond, Rifle Sling **\$15.95**
- SING011 Mauser 98K Sling (WW II style) Repro **\$12.50**
- SING018 Mosin Dog Collar 91/30 Sling, New Mfr **\$12.95**
- SING103 Mosin Dog Collar 91/30 Sling, Original Russian **\$19.95**
- SING119 Mosin Nagant Leather Sling, new w/ brass buckle & loop **\$19.95**
- SING007 Russian SMG Sling PPSH41 **\$9.95**
- SING017 SKS Sling Tab, new leather **\$2.00**
- SING041 SKS Sling w/Leather Tabs New Orig **\$6.95**
- STN021 Sten Web Sling. Good cond. Needs cleaning. Few Only..... **\$9.95**
- SING034 Swedish Mauser Sling..... **\$11.95**
- SING038 Thompson WWII Khaki Sling... **\$18.95**
- SING061 Tokarev rifle, Original - Super Rare! **\$14.95**
- 3 for..... **\$34.95**
- SING020 UZI Original Sling w/leather loops **\$9.95**
- SING126 Yugoslavian K98, M48, M24 Rifle Sling **\$12.95**

ROCK ISLAND SLIDE & BARREL SETS

Rock Island Ultra 1911 Slide & Bull Barrel Combo, 10mm, 4.25" Barrel Type: Black Ramped BULL with link & pin / Front Sight: FIBER OPTIC / Front Sight Cut: DOVETAIL / Rear Sight: SNAG-FREE WEDGE / Rear Sight Cut: LPA / Finish: BLACK / Serration: REAR G.I. / Action Type: SINGLE / Front End: SCALLOPED **\$235.00 \$299.95 AC20**

Rock Island 1911 38 Super Slide & Bull Barrel Combo, .38cal, 5" Barrel Type: Ramped BULL with link & pin and Bushing / Front Sight: GI / Front Sight Cut: STAKE / Rear Sight: GI / Rear Sight Cut: DOVETAIL / Finish: BLACK / Serration: GI REAR / Action Type: SINGLE / Front End: SCALLOP CUT FRONT..... **\$250.00 \$304.95 AC23**



SALE !!

JUST IN!

1911 DOUBLE LEATHER MAGAZINE POUCH
Slips Onto Your Belt Traditional double leather magazine pouch as issued for WW2 Field Grade Officers not using a standard grommet style pistol belt. Holds 2 single stack standard 1911 magazines. Will last a lifetime! Fits belts up to 2.5 inches wide..... **\$7.50 C45431**



See our website for a big sale on our nice assortment of factory frame castings, others call **80% receivers!**

.45 SLIDE CASTINGS
Sizes 3" to 5"
Colt 1911/1911A1 .45 ACP.
See Our Website!!

SERIOUS ABOUT COMBAT SHOOTING? ROTO 4M COMPENSATED BARREL

DOD contractors have been buying up our Roto 4M barrels because they work! MODEL 1911 COMPENSATED BARRELS in 3 calibers will reduce recoil and speed your target acquisition especially during multiple shots. Takes a minute to install our barrel that comes with Barrel Bushing and permanently attached and ported Compensator. Also there is less weight on the muzzle end than with conventional screw on muzzle compensators. Most people comment on the change of performance, but also that it looks great too! Sold elsewhere for \$175-\$200, Sarcos price is **\$89.95 \$99.95**
Specify caliber when ordering: New, made in USA. **.38 cal C45024, .45 cal C45015, .400 corbon C45194**



'Cause we're such nice guys, take 25% off the listed price on these 80% frames...

80% LOWER FRAMES STEEL & ALUMINUM

1911 Series 80 single stack, single action, full size pistol frames available in either ordnance grade steel or lightweight aluminum! These are finished frames except for several features that are unfinished to comply with BATF directives classifying these as Non-Firearms in their present condition. Slide rails, hammer & sear pin holes, mainspring housing retaining pin, and ejector leg holes remain to be applied. Grip screw holes are drilled and tapped.
#500649 Extra Small Para Frame for 3" slide. Series 80, aluminum, Double stack, Single action..... **\$125.00 C45331**
#500675 Para LDA Officers length grip frame in steel with checkered front grip strap. Accepts 4.25" or smaller slide. Single stack and Double action..... **\$99.95 \$125.00**
3 for **\$249.95 C45332**
#500678 "Agent" extra small steel frame with checkered front strap. Single stack, Double action, and fits 3" slide **\$99.95 \$125.00**
3 for **\$249.95 C45333**
NOT FOR SALE IN NJ - See new change in law. Not for sale in PA until further notice.



SARCO www.sarcoinc.com **5**

G-3 ZF SCOPES & MOUNTS

Haven't had these in years! Original German military service ZF-1 and ZF-24 Sniper Scopes with original claw mounts for the G-3 Rifle. Manufactured by Hensoldt/Wetzlar, these scopes are premium quality and although used, are in excellent condition and come complete with green case, rubber eye pc. protectors, claw mount, filter eyepiece, accessory case and in the case of the ZF-24, a mounting plate to accept a reticle illuminator if needed. **NOTE: We can now offer a SECOND Version of the ZF-1 that has a see-through reticle that can be illuminated.** You can check our website for more info. & pictures.
ZF-1 Hensoldt/Wetzlar Sniper Scope package - Please specify if you prefer version 1 (w/o reticle) or version 2 (w/reticle) when ordering..... **\$495.00 \$695.00 SCP058**
ZF-24 Hensoldt/ Wetzlar Sniper Scope package..... **\$595.00 \$795.00 SCP059**



RAMPED 5" STANDARD BUSHING 1911 9MM BARRELS

Found a few in the back from our parts paradise! These are the Clark / Para Ord pattern. Each barrel comes with a free link & pin. Sold elsewhere from \$80-\$200, Our Special Price..... **\$69.95**
3 for **\$199.95 C45429**



NEW G.I. CLONE ROCK ISLAND ARMORY .45 1911 & 1911A1 BARRELS

The rifling is absolutely beautiful and the bore surface is very smooth. Made from ordnance steel..... **\$49.95**
3 for **\$143.50 C45202**



THREADED 1911 BARRELS

5-1/2 Inch. Brand new black oxide finished barrels in 3 calibers. Thread is standard .578x28 TPI.
9mm Model 1911 5-1/2" barrel..... **\$60.00 C45360**
.38 Super Model 1911 5-1/2" barrel **\$60.00 C45361**
.400 Corbon Model 1911 5-1/2" barrel **\$60.00 C45362**
.45 ACP model 1911, 5.5" barrel **\$65.00 C45321**



THREADED PROTECTION CAP FOR THREADED BARRELS

Barrels with .578x28 threads per inch **\$13.00 C45363**

OUTSTANDING ASSORTMENT OF QUALITY 1911 BARRELS

ROTO 4M HAMMER FORGED .45 ACP, 9MM & .38 SUPER

Build to precise tolerance by a special hammer forging process, these barrels are the best you can buy! The hammer forging forms the barrel around a precision mandrel and holds the tolerance to .0001". This is much better than the typical broached barrels found elsewhere Note: 5" & 6" .45 barrels are L.H. twist all others are R.H. twisted

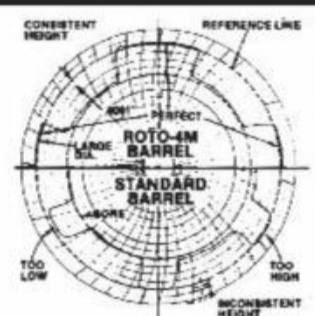

COMPARE THE ROTO-4M BARREL FOR ROUNDNESS AGAINST A STANDARD BROACHED BARREL FROM A WELL KNOWN MANUFACTURER. ALL ROTO-4M BARRELS ARE MADE IN THE USA.

Brand new extra length barrels for all Colt/1911/Government Model type automatic pistols. These barrels are made by the Special Roto 4M Hammer forge process which produces the most precise and consistent barrels for the best accuracy. Minor hand fitting may be necessary for some guns.

Barrels do not include link & pin. Link & pin available w/barrel purchase for additional \$5.00 C45281 Available in:

.400 Corbon Barrels	5" \$54.70 C45017
4 1/4" Commander.....	6" \$61.70 C45009
6"	7" \$65.70 C45018
STD 5".....	
.45 ACP	9MM LUGER
4 1/4" Comm \$54.70 C45010	4 1/4" Comm..... \$56.70 C45163
5" \$54.70 C45011	5" \$56.70 C45019
6" \$62.70 C45013	6" \$61.70 C45020
7" \$63.70 C45014	7" \$65.70 C45021
16" \$82.50 C45016	
.40 S&W 1911 5" BARREL \$56.70 C45277
.38 SUPER	
4 1/4" Comm..... \$54.70 C45164	Note: 9mm & .38's will not fit the .45 slide

NEW MANUFACTURE MODEL 1911 SLIDES AND SLIDE KITS

Beautiful new slides, precision machined from high quality steel and offered with front & rear sights. The military slide is the perfect 'drop on' replacement slide for your Government Model, manufactured with the improved beveled ejection port! 1911 Military Slide with Sights **\$124.95 C45160**
COMPLETE 1911 .45 SLIDE KIT (All Parts For Slide)
A complete set of the top half of a .45 Government model. Kit includes one of our new current manufacture slides (unmarked), barrel, firing pin, recoil spring parts, sights, extractor, link & pin, band bushing. Over \$198.00 worth of parts for only **\$174.95 C45092**



COMMERCIAL SLIDES ARE BACK IN STOCK!!

1911 .45 SERRATED SLIDE Best Quality Commercial .45 Slides - Special wide angled front and rear cocking serrations for easy grasping. Nice subdued blue finish with sand blasted inner serrations. Lowered beveled ejection port. Unmarked slide. With desirable snag-free rear sight. Also available as Complete Upper Commercial Slide Kit (refer to part # C45200) Note: Due to variations we have seen in frames & parts, slight fitting of ejectors extractors may be necessary **\$139.95 C45172**



.45 1911 COMPLETE COMMERCIAL SERRATED SLIDE KIT

A complete set of the top half of a .45 Commercial model. Kit includes one of our commercial .45 slides (part # C45172), barrel, firing pin, recoil spring parts, sights, extractor, link pin, band bushing
\$184.95 C45200 PLEASE NOTE: ALL our 1911 parts are for series 70 unless otherwise specified.



SARCO
www.sarcoinc.com

JUST FOUND FROM 45 YEARS AGO !!! JUST IN !!

BRAND NEW ORIGINAL COLT 1911 NICKEL PLATED 1911 THUMB SAFETY

A few only!! **\$65.00 each** C45432
We be DIGG'IN!!



Sarco has the goods to 'trick out' your 1911 pistol with a wood stock and accessories! Buy a complete set of parts to create a pistol with 16" .45 barrel, stock, holster and connecting parts or buy individual parts to help you create your own custom stock. We have two full sets to select from (Pictured items F & G above), which provide you everything needed for the conversion. Items A thru E can be purchased individually to help you with your own custom project.

- A. Lightweight 1911 Stock **\$49.95** C45402
- B. Standard 1911 Stock Assy **\$35.00** C45390
- C. 16 inch .45 ACP Barrel..... **\$82.50** C45016
- D. Mainspring for Wood Stock Connection **\$18.95** C45391
- E. 1911 Stock Building Hardware Kit - contains metal parts that will allow you to build your own custom stock and install the pistol to the stock. Contains slotted mainspring housing, 2 brackets with pair of screws and escutcheons, and knurled tightening screw **\$34.95** C45394
- F. Complete Lightweight 1911 Stock Rig - holster, 16" barrel, slotted mainspring housing, wood stock with metal hardware **\$164.95** C45428
- G. Complete Standard 1911 Stock Rig - holster, 16" barrel, slotted mainspring housing, wood stock with metal hardware **\$149.95** C45392
- H. Holster for Stock Rig (Pictured in the sets above) **\$45.00** C45393

(all NFA rules apply)

1911 Stock Rig Conversions
Funnest Way to Extend your 1911 Shooting to the Limit!

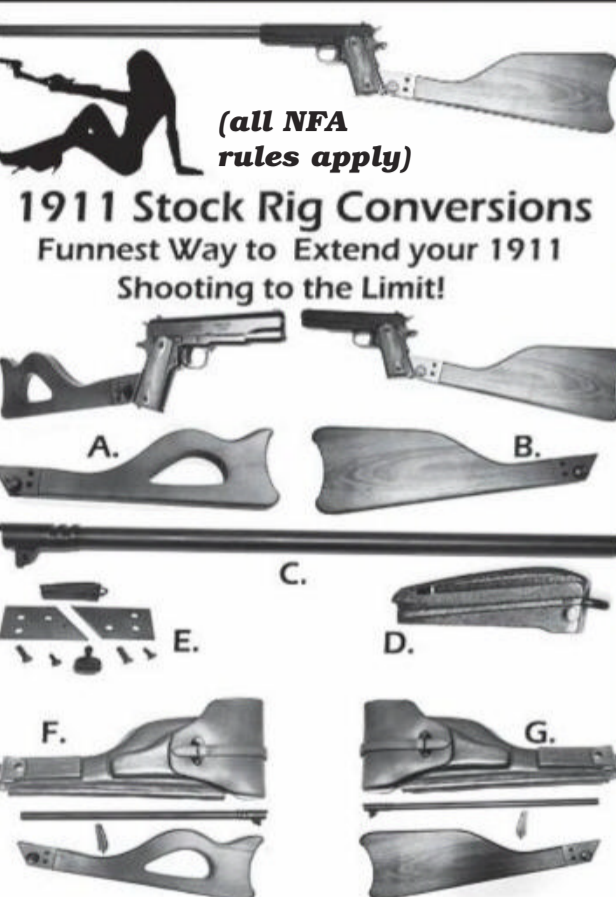

NEW HARDCASE FOR 6 PISTOLS JUST IN !!

with up to 6" barrels is foam padded and tabbed for padlocks. Will hold multiple small or compact pistols too (locks not included) ... **\$12.00** MISC887

Grade 1 Ballester Molina Barrel - 95%+ finish **\$59.95** BAL013
See our website for more Ballester Molina barrels and other parts!

1911 7RD .45 MAGAZINE, US GI ORIGINAL 1911 MAGAZINES

In very good condition released from the military decades ago. We purchased these long ago and lost track of them. Steel magazines are standard 7 rd, .45 caliber **\$14.95** C45369

INCREASE THE MAG CAPACITY ON YOUR REMINGTON 700 BDL TO 6 SHOTS

For .270 - .30-06 - 7mm mag & .264 no longer made. These have been hidden for years. **\$14.95**, 2 for **\$24.95** MISC119
The famous coyler clip

SPECIAL .45 COLT AUTO REPAIR PARTS KIT

Containing the following parts: 4 grip screws, 2 grip screw escutcheons, 2 mainsprings, plunger tube spring, sear spring, 2 ejector pins, 2 mag. catch springs, 1 firing pin stop, 2 firing pin springs, 4 hammer strut pins, 2 firing pins, 2 mainspring housing pins, 1 recoil spring. Regular \$37.00 SPECIAL..... **\$22.50** C45091

M1911 "DIAMOND" GRIPS

These brand new walnut grips are made in the original World War I style with the "Diamond" pattern checkering. Give your 45 Auto the classic look and feel of the original Colt 1911 design

- **\$13.95**/pr.
- 3/..... **\$36.50** GRP162



FULL PIN SET for Colt .45 Auto. All seven pins for the M1911. New

- **\$4.85**/ set.
- 10 sets for **\$38.50**
- 100 sets for **\$285.00** C45195

WIDE BEAUTIFUL GRIP SAFETY FOR 1911 .45 AUTO

Stop the pinch in the web of your hand (I used to get bloody) **\$16.50**, 3 for **\$49.95** C45079 (Note: These are for short rear tang frame. You can fit them to Std. frame)

.45 AUTO SPRING KIT One each of all 6 springs in a Colt .45. A \$13.25 value for only. Includes sear spring **\$7.75** ea. C45002. 10 sets for **\$65.00**. 100 sets for **\$450.00**

For Colt mfg revolver barrels, see our website.

STAINLESS STEEL 1911 PARTS

- C45150 Reverse recoil spring plug..... **\$6.95**
- C45312 Hammer pin..... **\$2.00**
- C45313 Mag catch lock..... **\$3.00**
- C45314 Mainspring Housing pin..... **\$2.00**

MODEL 1911, 9MM UPPER PARTS SET !

Finally In!! A great set of parts to help you complete a 9mm version of the venerable Model 1911 pistol. All parts are quality machined parts including a 10rd. 9mm magazine, both sights, firing pin assy, ramped barrel and extractor. This is for use with single stack, Model 1911 frames. The feed ramp will handle 9mm as well as it does with your .45 ACP ammunition! We include the 9mm/.38 Ejector which replaces your .45 Ejector in the Frame and also included is the correct 9mm mainspring. Awesome pack age deal beats the competition and makes it easier for you to send rounds down range!

..... **\$199.00** C45378

JUST IN... FOR YOUR MODEL 1911 PISTOL!

Model 1911, 8 round .45 ACP stainless steel magazine **\$15.95** RPM306

Model 1911, 15 round .45 ACP stainless steel magazine **\$17.95** RPM307

Model 1911, 15 round .45 ACP standard blued finish magazine **\$17.95** RPM308



.45 AUTO FRAME KIT

All parts to build a 1911A1 frame (except the frame itself). Includes trigger, hammer, grips, sear, mainspring, safety, etc., etc., (no slide stop) **\$89.95** ea. C45099

.45 BARREL BUSHING WRENCH

Free Bonus - Other end is an M16 shorty buttstock installation wrench.. **\$2.95** TOOL031



COLT 1911 STEEL MAINSPRING HOUSING

Housing is grooved for a sure grip 1911A1 style - nicely blued. With Lanyard Loop

- **\$16.50**
- 3 for **\$47.50** C45081
- Without Lanyard Loop **\$16.50**
- 3 for **\$47.50** C45171



MODEL 1911 FIRING PINS SALE ON EITHER ONE IN BULK!

Ravenous for firing pins? Sarco's Sale will satiate your appetite....Series 70 and Series 80 firing pins used in 9mm, 38 super, & 40 S&W..... available at a Bulk price...Saving you big \$\$\$\$.

- Series 70 Firing Pin - **\$8.95** ea. C45268
- Series 80 Firing Pin - **\$9.95** ea. C45301
- 5 for **\$5.00** Each
- 10 for..... **\$4.00** Each
- 50 for..... **\$3.00** Each
- 100 for..... **\$2.00** Each

.45 1911 FLAT MAINSPRING HOUSING, NEW

Brand new, flat (M1911 Style) steel housings, checkered nicely for a sure grip. Matt gray/black finish. These are nice!..... **\$13.50**, 3 for **\$37.50** C45082



NEW, ARMSCOR...45 Recoil Springs for the 1911 pistol rated at 16lbs

- **\$4.95** C45326

Mag Catch for wide body 1911 frames. Comes with release and spring..... **\$16.95** C45327

SARCO SPECIAL

Four of our famous 1911 .45 mags with 2 pouches (below) for only **\$20.95**, 2/**\$39.95** C45310

Two of our famous 1911 .45 mags plus a web mag pouch (below) for only **\$13.95** C45213

DOUBLE MAG POUCHES FOR COLT 1911 .45

Exact repro with WWII markings. We had these 2 years ago but got lost in the warehouse C45280

- **\$4.95**
- 3 for **\$11.95**



G.I. MARKED 1911 MAGAZINE

marked .45 ACP #1005 00 8694 MFR8R320

- **\$10.95**, 3 for **\$29.95** RPM155

WIDE SPUR HAMMER

Desirable M1911 type checkered wide spur hammers for the Colt .45 auto pistol. These are new, ready to install and upgrade your pistol. Heavily checkered (not grooved) wide spur provides a sure grip when thumb cocking or decocking. **\$12.50** C45054 (Comparable price \$23.00) Note: These are due in a month. Send order and get on the list



SARCO SPECIAL WORLD WAR I PATTERN .45 1911 MAGS WITH LANYARD LOOP

C45295 - 1911 mag with lanyard loop **\$11.95**

Buy 3 mags for **\$34.95** and get a free pistol lanyard for the mags.

These are rarely seen now a days. Best way to participate in fast combat shooting where you must drop and load mags quickly. Avoids damage to your dropped magazines. WWI Cavalry and vehicle crews would keep 2 or 3 mags on a lanyard for combat purposes! Original mags came with hemp twine so you could tie them to the lanyards individually. These magazines are made on the same automated machinery as our famous magazines shown above.

C45292 Recoil Spring Plug G.I. New **\$14.95**

C45126 Recoil Spring, High Speed **\$3.95**

C45138 Reverse Recoil Spring Plug..... **\$7.50**

C45074 Safety Plunger **\$1.45**

C45075 Safety Plunger Spring **\$1.75**

C45088 Screw Driver & Take Down Tool.. **\$4.95**

C45056 Sear **\$8.50**

C45057 Sear Pin **\$1.00**

C45051 Sear Spring..... **\$3.95**

C45160 Slide, Military **\$124.95**

C45092 Slide Kit, Military **\$174.95**

C45076 Slide Stop Plunger **\$1.45**

C45003 Slide Stop, Standard **\$12.00**

C45002 Spring Kit **\$7.75**

C45046 Thumb Safety..... **\$10.00**

C45365 Trigger Steel, 3 Hole..... **\$12.95**, 3 for **\$36.50**

C45148 Trigger, medium steel non-adjustable **\$11.95**

C45077 Tube Slide Stop & Safety Plunger **\$4.95**

1911 9MM 10RD MAGAZINE

For your 1911 chambered in 9mm Luger. Perfect for your 9mm Rock Island 1911 or other 1911 style pistol as replacement or additional magazines!..... **\$24.95** RPM269



A NEW WORLD OF 1911 .45 AUTO MAGS

SARCO HAS GONE TO EXTENSIVE LENGTHS TO DEVELOP A SUPERIOR 1911 .45 COMPETITOR MAGAZINE. We have sold probably 150,000 of our price busters, but we decided we need a new & better 1911 mag & we are very pleased with our new program. This is the results of over a year of product development.

Plus with all of the above a killer price **\$8.95** ea., 5 for **\$39.95** C45298

This is half the price of most reasonable .45 mags! OEM or Large Quantity Buyers Contact Holly or Dave at (610) 250-3960 ext. 223. Check our website for additional info & pictures of our fabulous tooling.

NOTE! AT LEAST \$1 UNDER ANY COMPETITOR

NEW VARIATIONS OF OUR 1911 .45 ACP MAGS - JUST IN THE DOOR

Stainless steel magazines

- **\$14.95**
- 3 for **\$40.00** RPM121



1911 .45 ACP 7rd MILITARY MARKED MAGAZINES

.45 ACP #1005-00-8694 MFR8R320

- **\$10.95**
- 3 for **\$29.95** RPM155



8 ROUND .45 MAGAZINE

New, blued steel magazine for all .45 ACP Government Model/M1911 type pistols. Base plate also acts as finger rest to improve your grip on the gun

- **\$16.95** ea. RPM319



MODEL 1911 9MM BUILDER KIT

Finally, a Model 1911 Builders Kit to allow you to assemble all parts onto your stripped single stack Model 1911 frame to create a 9mm pistol! Contains all of the internals including slide, ramped barrel, and all parts required for 9mm operation including a 9rd magazine. All parts newly precision made and ready for installation! Includes the traditional diamond cross hatched wood grips too!

Very Limited **\$245.00** C45381



FOUND IN WAREHOUSE!! ORIGINAL WWII G.I. COLT .45 AUTO COMPOSITION GRIPS

These were long ago taken off G.I. 1911A1's - when the guns were demilled. V.G. excellent condition **\$24.95** GRP131

Just a solution to your bad/broken CMP grips!



1911 SCREW & BUSHING SET

4 screws & 4 bushings **\$5.95** C45206

SUPER SPECIAL

All 3 kits of springs, pins & screws above for the 1911 Colt. Sale value is \$18.65. Super Sarco Value **\$14.95** for all 3 sets C45259

1911 .45 AUTO PISTOL PARTS

C45095	Auto Builders Kit (Less Frame & Slide) \$149.95
C45097	Auto Builders Kit (Less Frame)	\$229.95
C45096	Auto Builders Kit (Less Frame, Slide & Barrel)	\$119.95
C45099	Frame Kit	\$89.95
C45091	Auto Repair Parts Kit	\$22.50
C45374	Barrel, 5" 1911 Colt, .38 Super, new in the wrap	\$135.00
C45010	Barrel, 4 1/4" Commander, Roto, .45	\$54.70
C45017	Barrel, 5" Roto, .38	\$54.70
C45024	Barrel, 5" Roto, .38, w/Compensator	\$101.95
C45011	Barrel, 5", Roto, .45	\$54.70
C45015	Barrel, 5" Roto .45 w/Compensator	\$101.95
C45025	Barrel, 5" Roto, 400 Cor-Bon	\$56.70
C45019	Barrel, 5" Roto, 9mm	\$56.70
C45009	Barrel, 6" Roto, .38	\$61.70
C45013	Barrel, 6", Roto, .45	\$62.70
C45020	Barrel, 6" Roto, 9mm	\$61.70
C45018	Barrel, 7" Roto, .38	\$65.70
C45014	Barrel, 7" Roto, .45	\$63.70
C45021	Barrel, 7" Roto, 9mm	\$65.70
C45016	Barrel, 16" Roto	\$82.50
C45040	Barrel Bushing	\$6.50
C45087	Barrel Bushing Wear Gauge	\$19.95
C45085	Barrel Bushing Wrench	\$2.95
C45026	Barrel Link Pin	\$1.00
C45028	Barrel Link, #13, NM	\$8.95
C45027	Barrel Link, Std	\$4.95
C45098	.45 Cal. Bore Brush	\$1.25
C45251	Colt 1911 Cleaning Rod M4	\$6.95
C45045	Disconnecter	\$7.50
C45068	Ejector	\$4.75

C45067	Ejector Pin	\$1.00
C45030	Extractor	\$12.00
C45044	Firing Pin	\$4.95
C45301	Just in the door! Series 80, 9mm & .38 Super firing pins - Now available for 1911 pistols	\$5.95 , 3 for 14.95
C45029	Firing Pin Spring	\$1.75
C45043	Firing Pin Stop	\$4.25
C45032	Front Sight Al	\$5.00
C45079	Grip Safety, Wide Extended Parked (Note: These are for short rear tang frame. You can fit them to Std. frame)	\$16.50
C45078	Grip Safety, Long Tang	\$12.00
C45073	Grip Screw Bushing	\$1.00
GRP131	Grip Set, Plastic, GI, exc	\$24.95
GRP162	Grip Walnut, Diamond Style, new	\$13.95
C45052	Hammer Pin	\$1.00
C45056	Hammer Strut	\$3.50
C45055	Hammer Strut Pin	\$1.00
C45053	Hammer, Regular Spur	\$9.95
C45054	Hammer, Wide Spur	\$12.50
RPM155	Magazine, 1911 .45 ACP GI marked #1005-00-8694 MFR8R320	\$10.95 , 3 for \$29.95
RPM319	Magazine, 1911 .45 8rd, Blued	\$16.95
RPM158	Magazine, 1911 .45 Compact	\$24.95
C45060	Mag Catch	\$6.95
C45061	Mag Catch Extended	\$9.95
C45327	Mag Catch Wide Body, Armscor	\$16.95
C45062	Mag Catch Lock	\$2.00
C45063	Mag Catch Spring	\$1.00
C45094	Magazine Pouch	\$7.95
C45047	Main Spring	\$2.00
C45084	Main Spring Cap	\$1.25
C45083	Main Spring Cap Pin	\$1.00
C45059	Main Spring Housing Retainer Pin	\$1.40

C45082	Main Spring Housing, Flat (Checked) \$13.50
C45145	Main Spring Housing Flat & Grooved, Composite	\$8.75
C45081	Main Spring Housing, Steel w/loop	\$16.50
C45171	Main Spring Housing, Steel w/o loop	\$16.50
C45050	Main Spring Retainer	\$1.00
C45049	Main Spring, for Alum.Frame	\$1.25
C45001	Rear Sight	\$4.75
C45326	Recoil Spring, Armscor	\$4.95
C45036	Recoil Spring, Standard	\$2.75
C45037	Recoil Spring Guide	\$4.65
C45034	Recoil Spring Plug	\$4.00
C45039	Recoil Spring Plug, Commander length - FRESH OFF THE BOAT!	\$5.00
C45232	Recoil Spring Plug G.I. New	\$14.95
C45126	Recoil Spring, High Speed	\$3.95
C45138	Reverse Recoil Spring Plug	\$7.50
C45074	Safety Plunger	\$1.45
C45075	Safety Plunger Spring	\$1.75
C45088	Screw Driver & Take Down Tool	\$4.95
C45056	Sear	\$8.50
C45057	Sear Pin	\$1.00
C45051	Sear Spring	\$3.95
C45160	Slide, Military	\$124.95
C45092	Slide Kit, Military	\$174.95
C45076	Slide Stop Plunger	\$1.45
C45003	Slide Stop, Standard	\$12.00
C45002	Spring Kit	\$7.75
C45046	Thumb Safety	\$10.00
C45365	Trigger Steel, 3 Hole	\$12.95 , 3 for \$36.50
C45148	Trigger, medium steel non-adjustable	\$11.95
C45077	Tube Slide Stop & Safety Plunger	\$4.95

ENFIELD STRIPPER CLIPS

We just bought the last small quantity we know of. They are now dinosaurs. All new original. While they last!

\$3.00 ea
5 for **\$12.95 STC010**
10 in a pouch for **\$28.95 STC039**



ENFIELD STRIPPER CLIPS WITH POUCH / 10 PACK

Convenient military pouch with 10- .303 Enfield Stripper Clips, unissued. **\$28.95 STC039**

ENFIELD SMLE MKIII REAR HANDGUARD

New **\$34.95 LE3090**



See our website for ORIGINAL ENFIELD #5 JUNGLE CARBINE FOREND & HANDGUARDS!

#1 MK3 & #4 MK1 ENFIELD SPECIAL ITEMS

- LE3076 #1 MK3 Bolt, .22 LR cal, complete, super rare **\$150.00**
- LE3064 #1 MK3 Bolt, complete **\$99.95**
- LE3078 #1 MK3 Buttplate, brass, original **\$20.00**
- LE3074 #1 MK3 Buttstock, original G.I, brand new **\$39.95**
- LE3059 #1 MK3 Extractor spring **\$10.00**
- LE3075 #1 MK3 Safety Assy, complete **\$19.95**
- LE3095 #1 MK3 Sliding dust cover, Long Lee and Lee Medford, RARE - few only **\$100.00**
- SING079 #1 MK3 Sling, MLE-SMLE Pattern 14... Reproduction of the "Pattern 14" leather sling used for the SMLE (Short, Magazine Lee Enfield) starting in 1914 **\$9.95**
- LE3049 #1 MK3 Striker (firing pin) new original factory **\$20.00**
- LE4077 #4 MK1 Buttplate, brass, original, VG **\$20.00**
- LE4005 #4 MK1 Bolt head, original standard, brand new **\$26.50**
- LE4117 #4 MK1 Barrel, orig GOOD **\$65.00**
- LE4062 #4 MK1 Cleaning rod pull thru, original, new **\$2.95**, 3 for **\$6.95**
- LE4013 #4 MK4 Extractor spring **\$7.85**
- LE4063 #4 MK1 Safety Assy, complete **\$20.00**
- LE4096 #4 MK1 Scope Rings for the brass Israeli #32 scope, for the Israeli #4 Enfield sniper rifle (few only), original **\$59.95/set**
- LE4059 #4 MK1 Stock Set, new (stock & forend & 2 handguards) Original **\$149.50**
- LE4079 #4 MK1 Stock & Handguards Set, used **\$134.95**
- LE4111 #4 MK1 Swivel, Early **\$7.00**
- LE5001 #5 MK1 Buttstock Assembly for British Jungle Carbine-late production, includes buttplate assembly **\$39.95**

Now we have delightful #1 MKIII Complete Stock Sets

- Original refurbished buttstock
- Original new rear handguard
- New production forend
- Original front handguard

Bring your Enfield up to the delightful! **\$149.95 LE3091**

JUST IN !!!! Finally available ENFIELD #1 MK3 FORENDS!

(May require minor fitting)
Finally available.... Brand new stained Beech Forends to replace all of those ugly worn out Forends on the #1 MK3 Enfield Rifles. These forends are properly inletted on the inside and contoured evenly on the outside to provide your military Enfield #1 Mk3 Rifle the perfect profile & enhancement. Already stained a medium walnut color, they can be further darkened to match your handguards as needed. Best way to improve the silhouette and value of your Enfield! **\$85.00 LE3110**

SEE OUR WEBSITE... FOR 1000s OF ENFIELD PARTS & ACCESSORIES!!

ENFIELD RIFLE ID DISC
Engraved brass 1 inch diameter disc w/4 markings (proof marks and/or mfg names, dates, etc) which is fitted into the right side of the Lee Enfield Rifle stock **\$6.95 LE3084**



LEE ENFIELD RIFLE MAGAZINES
#1 MK3 Enfield Rifle Magazine
.303, 10 rd. capacity
\$29.95
\$40.00
RMO11



ENFIELD #4 MAG FOLLOWER AND SPRING!
Put one or more away for the future to protect against mag failures! **\$4.95 ea**, 3 for **\$12.95**
Limited Supply LE4119

Just dug out - A few original British brass oilers for British Enfield Rifles **\$21.75 OIL008**

BRITISH ENFIELD CANVAS SLING

We are now able to offer you 2 of the Wartime canvas slings used on the Lee Enfield Rifles as well as 1 post war issue sling. These are new made and all feature brass hardware and an accurate cotton weave.



Colors available: KAHKI w/ WWII INK
STAMP **SING044**
BLACK **SING096**
Your choice... **\$6.95 each**

LEE ENFIELD #1 MK3 AND #4 MK1 FIRING PIN REMOVAL TOOL

Vital tool necessary to strip a Lee Enfield bolt or replace a firing pin. Fits the .303 MKIII, No. 4 and No. 5 Enfields. Made of 1144 stress proof steel - we couldn't break one **\$8.95 LE3067**



BRAND NEW !!!! ORIGINAL #1 MK3 ENFIELD BARRELS!
Been sleeping for over 30 years in the warehouse! They have GI blue finish and are original! Like new! While they last **\$124.95 each**
or 3 for **\$299.95 LE3103**

COMPLETE SET OF #4 ENFIELD STOCK HARDWARE
Buttplate, bands, swivels, handguard ring, stock bolt and all related screws and washers. 17 parts **\$39.95 LE4103**
See our website for complete list of parts in kit

BRITISH ENFIELD ACCESSORY KIT
Sling, firing pin tool, oiler, field cleaning rod (pull through), and brush. Value \$22. Special **\$16.95 LE4061**



PARKER HALE NO. 4 ENFIELD TARGET/MATCH SIGHTS
w/o adjustable aperture **\$49.95 PH007**
See our website for details

ENFIELD #1 MK3 CANVAS RIFLE COVER (CASE) W/KHAKI SLING CARRY STRAP, WWII PATTERN
Made from heavy canvas material, this gun case's overall length is 46" and fits the Enfield #1 MKIII, #1 MKIV rifles and many other rifles. Beside the main compartment it has a smaller pouch originally used for a cleaning kit case. Has two sling hoops on the back for attaching a strap so you can carry it over the shoulder. We even include a khaki sling carry strap **\$16.95 LE3092**



BRITISH 9 POCKET CAVALRY BANDOLIER
New made 1903 era British/Australian Cavalry heavy duty leather bandolier held 90 rds. of Enfield ammunition. 40 more rounds of ammunition than the standard infantry bandolier, and frequently was also worn around the neck of the trooper's horse **\$45.00 MISC634**



BAYONETS See More On The Next Page!

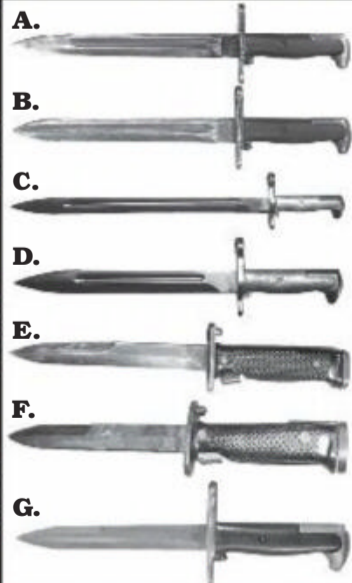

M1 GARAND BAYONETS

Sarco has a limited quantity of M1 Garand Bayonets in both original, and new/late production versions with blade lengths from 6.5 to @ 16 inches, sold with, and without scabbards.

A. **Original 10" Model 1943**, Unmodified Bayonet w/ late production US scabbard **\$74.95 BAY193**

B. **Original 10" Model M1905E1**, Modified Spear Point blade w/ late production US scabbard **\$74.95 BAY194**

DEAL: Buy 1 each of the above 2 bayonets w/scabbards \$140.00 BAY268

C. **Late production 16" Model 1943 bayonet & scabbard \$39.95 BAY182**

D. **Late production 10" Model 1943 bayonet & scabbard \$32.95 BAY183**

E. **Original M5A1 bayonet w/ M5A1 scabbard \$36.50 BAY189**

F. **ALSO.... We have RARE M5A1 Garand bayonets marked KM5A1 \$59.95 BAY020**

G. **Original Korean Army version of the 1943/ 1905 blade** shortened to their requirement of between 6.5-7" length. These were imported from the military by Arlington Ordnance years ago, and we have found a handful remaining in the warehouse. Complete with original Korean short scabbard **\$49.95 BAY240**

H. **Also have a few original Korean scabbards by themselves Used \$14.95 ea BAY135, Go to our website for a full listing!**

SPECIAL RARE COLLECTOR M1 GARAND BAYONETS. FEW ONLY AVAILABLE. SEE OUR WEBSITE.



BAYONET FROGS

- A. SWEDISH MAUSER original, fair condition **\$5.95 MSR258**
- B. JAPANESE ARISAKA late mfg, new, for Type 38 & Type 99 bayonets **\$9.95 BAY115**
- C. GERMAN K98 MAUSER late mfg, new, fits WWII K98 bayonets **\$9.95 MSR111**
- D. SWISS BAYONET FROG Swiss military frog as issued for the STGW 57 rifle bayonet. Also works with the K31 bayonets and many other similar style bayonets and scabbards **\$8.95 BAY272**

- E. ROMANIAN AK47 BAYONET FROG Original leather military frog in used/very good condition **\$7.95 AK060**
 - F. GERMAN 1898/05 WW1 FROG Excellent new made version of the German WW1 frog for bayonets. Perfect for our 'Butcher' and 'Pioneer' bayonets and with WW1 German markings **\$14.95 BAY290**
 - G. WW2 Enfield Canvas Frog For Spike Bayonets, new Mfr **\$7.95 BAY334**
- We have 4 leather historical bayonet Frogs for wearing on waist belts.

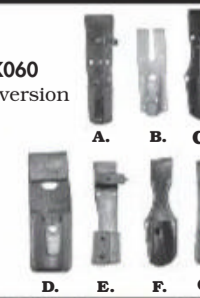

www.sarcoinc.com **SARCO** 7

SUPER FIND! ORIGINAL BRITISH ENFIELD BRASS OILERS!

Enfield collectors...we have been so fortunate to find about 100 original Enfield brass oilers in the mountain. Earl has been nice enough to sort out all of these into the original sources. Some we only have one of, while others we have a few. I can't believe he found 22 different variations! Take a look and satisfy your desires while they last - They were covered in 80 years of grease & grunge. He cleaned 'em up so he could read the markings. See our website for the various markings.



Project Lovers Special #4 ENFIELD GDI BARRELED RECEIVERS

Lets call 'em "Battlefield Relics" Will have flaws - these are the ones we didn't want to build. As-Is, no returns. 10 for **\$150.00**, 25 for **\$295.00**, 50 for **\$500.00 GUN717** - FFL Required

HARD TO FIND ORIGINAL BRITISH MILITARY #4 ENFIELD MKII FORENDS
\$110.00 LE4124

ORIGINAL EARLY ENFIELD SLOTTED REAR HANDGUARDS
Excellent - new
\$35.00 LE4065

BRITISH 1903 ENFIELD AMMUNITION BANDOLIER

Used just prior to WW1 through WW2 and beyond in British Commonwealth forces. Rugged leather combined with brass hardware to provide the soldier and easy method of lugging around ammo. Convenient to take to the range too!
\$38.00 MISC501



#4 MK1 RIFLE MAGAZINE

.303, 10 rd. capacity and broad arrow marked. We've worked on having these made accurately for over 2 years of development & testing. Exactly like the WW2 issue magazine! Extremely difficult to find on the market and we've been very challenged to keep originals in stock. Now all of our hard work to bring these to you can pay off and at an unbeatable price! **\$29.95 each**, 3 for **\$84.95**
10 for **\$229.95 RM61**



PLEASE NOTE: There are many variations in manufacture of #4 Enfield Rifles - Although we don't get any returns (like zero) we want to make you aware of this and we found at times some minor fitting may be needed.

ENFIELD #4 MKIT SNIPER RIFLE CHEEK PIECES

Just in the door! Complete with proper brass screws. Use to build your sniper rifle or also to create a high comb buttstock **\$34.95 LE4106**



NO.4 MK1 WW2 ACTION COVER

Canvas cover as issued during both World Wars. This action cover is newly manufactured in the correct weave, snaps, grommets, and leather tie down. Also comes with period markings. Perfect for completing your Enfield Rifle ensemble **\$14.95 LE4115**



NO.4 ENFIELD SPIKE BAYONET W/ SCABBARD

Excellent condition original WWII, fits all #4 Enfield Rifles. Standard MKII bayonet with MKI scabbard **\$17.95 BAY106**



BRITISH ENFIELD HOOKED QUILLION BAYONET

For the #1 Mk3 Lee Enfield Rifle, this steel bayonet comes with the early style hilt with "Hooked Quillion" which was the original 1907 bayonet issued with the rifle. Blade is 17" long with black finish & wood grips. Late manufacture. Limited **\$38.95 BAY244**



BLACK PLASTIC BAYONET GRIPS FOR U.S. 1943 10" & U.S. 1942 16" BAYONETS

Perfect grips for replacement of your broken or chipped bayonet grip panels. Pair of Grip panels **\$9.95 per pair BAY291**
Screw is available if needed. Special price if bought with grips **\$2.00 BAY163**



CMP GARAND M1 M1943 & M1 10" BLADE BAYONET REPAIR KITS

grips & screw, lever, latch button & spring. All the missing parts. These are nice repos - small quantity only. We will use most for our own bayonets. May require minor fitting - we easily fit 'em on our own bayo projects!
\$24.95 BAY199

SPRINGFIELD WOOD BAYONET GRIPS

New production, new condition wood grips for the M 1905 pattern bayonet as used on the M1903 Springfield rifle. Fix up or up-grade your old bayonets with these beautiful new grips. Heavily grooved for better holding, just like some originals we found and sent to the wood workers to copy. Nut included. Ready to fit on to your blade **\$9.95 per set**
or 3 sets for **\$24.95 GRP143**
Screw is available if needed. Special price if bought with grips **\$2.00 BAY163**

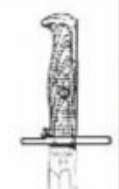

BAYONET GRIPS & SCREWS

- BAY164 Original Yugo '98 Mauser bayonet grip sets **\$5.95**, 3 for **\$14.95**
- LE3083 Original grips for Enfield #1MKIII (1907) bayonet **\$9.95**
- BAY163 Original new G.I. grip screws for 1903 Springfield & WWII Garand bayonet **\$3.95 ea.**, 4 for **\$10.00**
- BAY179 Original new grip set for the British #7 bayonet for the #4 Enfield **\$12.95**



www.sarcoinc.com
BAYONETS CONTINUED FROM PAGE 7

DANISH M8 SCABBARD BODIES

Original Danish military wood Scabbard bodies as used on M8 series scabbards for the M1, M14, Danish G3, & M16 bayonets. Nice wood grain with a hardening coat makes this the perfect replacement scabbard body for upgrading your M8 scabbard from a plastic fiberglass body. Scabbard body is 7 inches long and unissued.



..... **\$10.00 Each**
or 3 pcs. for **\$24.95 BAY356**

U.S. M4 CARBINE BAYONET & M8 SCABBARD JUST IN!!

Classic leather bound M4 bayonet handle with sharpened steel blade is the perfect complement for your M1 Carbine! Solid construction and simple to attach and wonderful as a hand fighting knife too. Very sharp leading edge! Blade length 6-5/8". New **\$49.95 BAY354**



ENFIELD #7 BAYONET

BACK IN STOCK !!!

Sarco has obtained some original #7 small parts in bulk and has had the bayonet blade newly manufactured so we can finally offer this very rare bayonet originally issued in 1945. While it fits the #4 rifle, it was chiefly made for the Sten Mk5 SMG. The blade has been manufactured with tempered steel with edge and the original classic 'Tufnel' fiber reinforced grips have been added. The grip is superior and more comfortable than probably any bayonet made up till 1945. Makes a very formidable fighting knife too! While it was exceptionally made, it suffered from finicky swivel catches and a muzzle ring that seemed out of place when used on Sten Guns. Nevertheless, these bayonets have never made it onto the world market place in suitable numbers and the originals command extremely high prices. Ours is first class, although like the original manufacturers like BSA, Elkington, R.O.F. Poole/ Newport, we too have not overcome the finicky catch system, but have improved the blade with an edge. Extremely Limited. New. Bayonet with steel scabbard **\$125.00 BAY349**



RARE FAL TUBULAR BAYONET

Bayonet w/ scabbard w/o belt connection **\$18.95 BAY171**
Bayonet w/o scabbard **\$9.95 BAY156**



South African R1 FAL bayonets coming soon - Inquire!

A. U.S. 1910 Springfield Leather Bound Scabbard with belt clip

..... **\$27.95 BAY347**



B. U.S. Springfield Canvas Bound Scabbard WW1 with belt hooks

..... **\$29.95 BAY266**



FRENCH FOREIGN LEGION PARATROOP KNIFE

Version modified from the British Sykes model and carried by Legion Paras throughout campaigns in Indochina, Algeria, Kolwezi, etc. Very light and a superior grip to the standard Sykes Fairbairn knife. High Carbon sharpened steel blade is blackened and adorned with low luster French Legion Para emblems. Blade @7" long. Overall length @12". Comes with Sykes style leather scabbard as used by the French. **\$59.95 BAY322**



1905 BAYONET PROJECT

Set of original and new made parts for assembling a 1905 bayonet. Years ago we had 2,000 blades manufactured and rewelded onto handles with great success, allowing us to sell 1905 bayonets again. Now we have a very limited group of these complete sets of parts remaining. The handles and hilts are from original U.S. bayonets that were demilled by the U.S. govt. Plastic grips and internal handle parts and blade are new mfg. Set of parts: **\$29.95 ea.**, or 8 for **\$199.99 BAY232**
*Add a scabbard for **\$12.95 ea.**, or 10 for **\$99.95 BAY233**

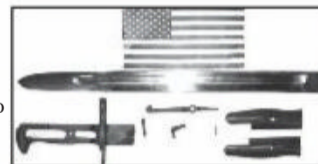

MOSIN 91/30 BAYONET

Exc condition **\$16.95 BAY019**
91/30 bayonet w/ Scabbard **\$32.00 BAY084**
MOSIN NAGANT 91/30 BAYO Exc w/New Scabbard, excellent condition **\$32.00 BAY084**
MOSIN NAGANT M91/30 & EARLY CARBINE BAYONET - Mosin short 11.5 inch **\$44.95 BAY261**
MOSIN NAGANT MODEL /44 / CARBINE BAYONET - 2 variations available in limited supplies:
A. Mosin 44 Bayonet w/Single Ear connection. 1945 & earlier **\$44.50 BAY262**
B. Mosin 44 Bayonet w/Double Ear connection **\$44.50 BAY263**

M16 BAYONETS

Sarco is pleased to offer a selection of original USGI, foreign military contract, and new mfg bayonets.
(Fits Galil, too)
A. **U.A.E. (United Arab Emirates) Contract M16 bayonet** with black synthetic scabbard. UAE emblem on handle and also on scabbard. New/unused **\$39.95 BAY237**
B. **Econo M7 bayonet w/ scabbard** - fits and looks like the M7 bayonet and scabbard. New condition **\$19.95 BAY229**
C. **New G.I. M16 bayonet** in original, G.I. packaging. Only A Few Left! **\$39.50 BAY172**



METAL BAYONET SCABBARD GRAB BAG

8

From decades of importing original military bayonets from overseas, we have accrued a 'mound' of metal scabbards which are not perfect, but may help you complete your bayonet collection where scabbards are missing. Some dings, some dents, some rust may appear as well as perhaps missing or damaged throats on some, but on the whole, an interesting group of metal scabbards that range anywhere from 8.5 inches to 19.5 inches long. Set of 10 scabbards, sold as is **\$49.95 BAY355**
(Picture shown is random set, and there may be variations in sets)



BACK IN STOCK!

INDIAN FAL BAYONET W/ SAWTEETH

Savage in length and scope, this 10.5 inch blade is longer than other FAL bayonets. Sporting a wood handle and cross serrated saw teeth, it fits the British L1A1 and Indian FAL rifles. Comes with steel scabbard **\$49.95 BAY330**



BACK IN STOCK!

1907 BRITISH SMLE BAYONET

Nice late manufacture, WW1 style British bayonet for the #1MK3 Enfield rifle, 2A Rifle in .308, and Lanchester SMG. Steel with wood handles and period markings **\$34.95 BAY348**



BACK IN STOCK!

BRITISH ENFIELD # 5 JUNGLE CARBINE BAYONET & SCABBARD

Our new manufacture #5 bayonet is well made and checked for fit on an original military Lug/Flash hider. Fits both the Enfield Jungle Carbine and the Sterling submachine gun **\$39.90 BAY145**



GERMAN MODEL 1898 PIONEER SAWBACK BAYONET & SCABBARD

The longest of the WW1 German bayonets primarily associated with the Pioneer troops and NCOs **\$75.00 BAY301**



GERMAN MODEL 1898 / 05 SAWBACK BAYONET & SCABBARD

Commonly referred to in the family of German Butcher Blades, this was a second variation to the non-sawback butcher blade bayonet that chiefly became to the mainstay of WW1 German bayonets. The 'sawback' blade makes it quite intimidating and was far stronger than the 1898 sawback. Our new made bayonet comes with markings on the ricasso and is complete with steel scabbard **\$69.95 BAY302**



U.S. MODEL M6, M14 BAYONET W/ M8A1 SCABBARD

Finally we have a small shipment of newly manufactured M14, Model M6 Bayonets which come with the M8A1 scabbard. Get one before they're gone again! **\$45.00 BAY324**



JAPANESE ARISAKA STEEL SCABBARD

See our website for details **\$16.95 BAY303**



JAPANESE TYPE 38 AND TYPE 99 PROPER HOOK QUILLION BAYONET WITH SCABBARD

..... **\$44.95 BAY178**



JAPANESE TYPE 100 & ARISAKA PARATROOPER BAYONET

BAYONET & SCABBARD for the WW2 Japanese Paratroop rifles, Type 100 SMG, and Type 99/38 rifles **\$75.00 BAY279**



VARIOUS COLLECTORS BAYONETS & ACCESSORIES

BAY043 Perfect reproduction leather scabbard for 1941 Johnson rifle bayonet. Almost sold out - can't tell from original **\$29.95**
BAY304 1891/M1938 Carcano Cavalry Carbine bayonet, original, steel **\$49.95**
BAY251 1891/M1938 Carcano Cavalry Carbine bayonet, new production **\$30.00**



JOHNSON M1941 BAYONET & SCABBARD

Finally back in stock after a long wait!!! Very rare steel Johnson Rifle bayonet and leather scabbard as issued to the U.S. Marines in WW2. Always been difficult to find, these are newly manufactured and identical to the original with a blade length of about 7.5". Used by select Marine units in WW2 and by 'Merks' invading Cuba at the Bay of Pigs. Very Limited **\$125.00 BAY024**



M1941 Johnson Scabbard
For collectors who have a Johnson bayonet without its scabbard, we have had some extra scabbards made up. New leather scabbard - Johnson M1941 **\$29.95 BAY043**

1918 U.S. TRENCH KNIFE MODEL

Developed by the American Expeditionary Force, this combat fighting knife was contracted to U.S. and French manufacturers. With over 1.2 million ordered, only about 119,000 were produced before the war ended. Handle of solid brass with a 6.5 inch blade. Our Mark 1 knife is the rarer version and is engraved with the 'Au Lion' cartouche on the ricasso. New **\$39.00 BAY333**
*Sold as a curio collector item and without scabbard.



*Check your local laws on 'knuckle knives' before ordering. Cannot ship to CA, IL, MI, VT, MO, TX, DE, MA, NY, NJ

ALLIED D-DAY FIGHTING KNIFE

Cruciform 7" blade was a sleek low profile sentry removal tool using the French Cruciform style blade. One of many specialized fighting knives used by allied troops during the D-Day invasion **\$24.95 BAY256**



M3 FIGHTING KNIFE M3 Knife w/ leather grip & M6 scabbard w/ WW2 markings. New **\$35.00 BAY331**
M6 leather scabbard (scabbard only) **\$14.95 BAY184**



U.S. 1917 BOLO KNIFE & SCABBARD

Made in substantial numbers during WW1 and in several variations from 1897 to 1917, we can offer this full tang, tempered version of the 1917 model complete with period markings on knife & cloth and leather bound scabbard. This is a real 'Chopper', meant to use both blade and heft to hack things apart from fire wood to the 'Hun' in the Trench. With a little care, it will last a lifetime! **\$99.95 BAY321**



FINALLY AVAILABLE

1917 Scabbard, U.S. **\$22.95 BAY278**



BRITISH SYKES FAIRBAIRN FIGHTING KNIFE W/ SCABBARD

British & Allied soldiers loved this knife which was specifically made for sentry removal and still to this day, serves with the SAS. Steel 7.5" long blade. Sykes Brass Handle Knife w/ Scabbard **\$24.95 BAY274**
Back in stock! Steel handle **\$24.95 BAY275**



BEAUTIFUL LATE PRODUCTION SCABBARDS FOR YOUR CMP AND COLLECTOR BAYONETS

M3 scabbard for 16" M1942 bayonet **\$18.95**, 3 for **\$45.00 BAY176**
10" Garand scabbard **\$12.95**, 3 for **\$34.95 BAY175**



INDIA PATTERN SCABBARD #1 MARK 3

..... **\$19.95 BAY131**



GERMAN BUTCHER SCABBARD, WW1

Steel replacement scabbard for the First World War German bayonet M1898 /05. This scabbard has been reproduced from an original and fits both the plain and 'sawtooth' variety blades. Scabbard only **\$18.95 BAY273**



WW1 GERMAN 'PIONEER' BAYONET SCABBARD

@23" Long. Scabbard only **\$19.95 BAY276**

M8A1 BAYONET SCABBARDS

M8A1 Scabbards to fit the following bayonets!
M5 & M5A1 Garand, M3 Trench Knife, M4 for M1 Carbine, M6 for M14 Rifle, M7 for M16
New Military Contract **\$19.95 ea BAY083**
Excellent used military contract **\$17.95 BAY191**
We have a small quantity of U.S. G.I. M8A1 scabbards, VG condition **\$19.95 BAY040**
(Call Cholly for bulk purchases on M8A1 scabbard BAY083)
Original G.I. new M8A1 scabbard. Just found a few in the warehouse from the old days.
Has original USGI scabbard body **\$24.95 BAY041**





50 Hilton Street, Easton PA 18042
610.250.3960 Fax: 610.438.2548

www.sarcoinc.com

M1 CARBINE PARTS

CRB090	Banana Clip Pouch	\$9.95
CRB023	Barrel Band 1st Model	\$14.95
CRB036	Barrel Band Retaining Spring	\$3.85
CRB025	Barrel Band w/Bayo Lug New, G.I. Parkerized	\$19.95
CRB093	Blank Adapter	\$9.95
CRB002	Bolt Assembly & Disassembly Tool	\$22.50
CRB096	Brass Deflector	\$8.95
CLN172	Bronze bore brush 30 cal	10/ \$9.95
CRB032	Buttplate (Used)	\$8.00
CRB031	Buttplate Screw	\$1.50
CRB094	Carrying Case	\$17.50

ORIGINAL WW2 TRAINING AIDS

Weapon Training Aids for 1919A4, BAR, Garand & M1 Carbine. Large Scale for Classroom Use.



Check our website!
Contact Dave for details at Ext.223.

M1 CARBINE MILLED REAR COMBAT SIGHT

Back in stock
\$29.95 CRB154

CRB028	Demilled Front Receiver M1/M2	\$12.50	CRB046	Hammer Pin	\$1.50
CRB067	Ejector	\$5.00	CRB041	Hammer Spring	\$2.50
CRB066	Ejector and Spring	\$6.75	CRB042	Hammer Spring Plunger	\$5.95
CRB068	Ejector Spring	\$1.50	CRB100	M1A1 Pistol Grip Current Production	\$19.95
CRB063	Extractor	\$17.00	CRB014	M2 Potbelly stock, used G.I. walnut	\$49.50
CRB065	Extractor Spring	\$1.25	CRB113	M3 Sniper Scope Battery Charging Rack. Charges 8-10 batteries. Orig new G.I. in crate can ship UPS (136#)	\$295.00
CRB064	Extractor Spring and Plunger	\$3.50	CRB056	Mag Catch	\$13.00
CRB069	Firing Pin	\$17.50	CRB058	Mag Catch Spring and Plunger	\$3.25
CRB080	Front sight	\$12.50	CRB057	Mag Catch, late w/mag support	\$13.00
CRB079	Front Sight Pin	\$1.25	CRB135	Mag Spring Put-Away New G.I. 15 rd	\$2.95
CRB175	Front Sight Removal Tool	\$29.95			
CRB082	Gas Piston	\$13.00			
CRB083	Gas Piston Nut	\$6.00			
HNGD06	Handguard, M3 carbine w/hole for M3 sniper scope	\$35.00			
CRB184	Handguard rivets	20 for \$5.00			
CRB044	Hammer	\$17.00			

M1 CARBINE PARTS & ACCESSORIES

OUR FAMOUS M1A1

PARATROOPER CARBINE STOCKS

THIS LOT ALMOST SOLD OUT & IT WILL BE MONTHS BEFORE THE NEXT ONE ARRIVES !!

This is a perfect and exact reproduction of the WWII M1A1 Paratrooper Stock. Each stock has a matching handguard, so your treasured carbine will look beautiful.
(See website for other M1A1 Stock Parts)



\$149.95
CRB098

This is absolutely the best quality available

(Gun Not Included)

Other Accessories Available: Carbine Stock Pouch \$9.45 CRB134
Sling and Oiler \$10.95 CRB088

Bulk buyers of this great stock, call Dave or Cholly.

Check our website for new 15 & 30 ROUND CARBINE MAGAZINES - In stock - GI pattern 15rd magazine \$11.95 CRB010
30rd magazine \$14.95 CRB008



Ordering instructions are in the ad or on our website

M1 CARBINE SLINGS AND OILERS

SLING AND OILER SET	\$10.95 ea.
50 sets for	\$349.50 (\$7.00/set)
100 sets for	\$599.00 (\$6.00/set)
CRB088	OILER ONLY \$4.95 ea.
50 for	\$149.50
100 for	\$275.00
OIL019	SLING ONLY \$7.95 ea.
50 for	\$300.00
100 for	\$350.00
SING005	Early WWII pattern Khaki color M1 Carbine sling \$9.95
SING006	

U.S. FLAG IN HEAVY DUTY COTTON

w/ Embroidered Stars
3x5 foot & will outlast most nylon flags



\$34.95 FLAG55

BETSY ROSS FLAG

Manufactured with heavy duty cotton layered with 13 embroidered Stars applied in a manner Betsy Ross would be proud of. Perfect for the Fourth of July or flying every day on your flag pole. A beautiful touch of traditional colonial Americana.



To be the Season to show your True Colors!!

\$34.95 FLAG56
(High quality, heavy duty cotton... Not cheap nylon or poly!)

FN49 PARTS

Sarco has a full line of FN49 parts in .30-06 & 8x57mm. Check our website.



M1 CARBINE SLIDE \$75.00
CRB015



M1 TRIGGER HOUSING \$75.00
CRB061



M2 TRIGGER HOUSING, G.I. \$85.00
CRB062

FN49 RIFLE CLEANING KIT

Original FN49 Rifle cleaning kits in the aluminum tube. Caps on both ends and brush combo 'pull thru' inserts easily. Difficult accessory to find these days. Can be stored inside the buttstock



\$12.95 CLN165

M1 CARBINE MAGAZINE DUST COVER

Original rubber dust covers back in stock after many years! These are G.I. and in excellent condition. They fit easily over the top feed area of the magazine.
5 pcs. for \$3.95,
10 pcs. for \$5.95,
25 pcs. for \$12.50 CRB095

ORIGINAL BOX OF 100 DUST COVERS

M1 Carbine fans will love this deal! Original G.I. cardboard box containing 100 pcs. of the rubber carbine dust cover \$19.95,
2 for \$34.95 CRB188

ROCKOLA T-3 CARBINE RECEIVERS ARE IN STOCK AGAIN!!

Last ones you'll see!! Check them out on our website or our gun ad in the 2nd issue of the month.

M1/M2 CARBINE BARREL BAND W/ BAYONET LUG (3RD MODEL)

GI, Parkerized, Original, G.I. \$24.95 ea., 10 for \$245.00 CRB025



We have a M1 Carbine straight stocks and M2 Carbine potbelly stocks available... Check our website!

FN49 FLASH HIDERS

Exact reproduction of the original- Just in the door after waiting 2 years \$24.95 FN49089



PISTOL & RIFLE STRIPPER CLIPS

	EA.	3 for	10 for
STC005	AR15/M16 Guide	\$1.50	\$3.50 \$9.95
STC003	Carcano (may have light pitting)	\$6.95	N/A N/A
STC034	Carcano, brass 6.5mm/7.35, 6rd	\$9.95	N/A N/A
STC009	6.5 Dutch Rifle	\$4.00	\$11.00 \$39.95
STC010	Enfield .303	\$3.00	\$8.25 5/\$12.25
STC039	Pack of 10 Enfield .303 stripper clips w/ pouch	\$28.95	
STC011	Steyr Hahn 9mm Auto for the 1911/1912	\$8.95	\$24.95 N/A
STC014	Mosin Nagant	N/A	\$2.35 \$7.50
STC016	M14	12 for \$9.95	
STC025	1903 Springfield, Brass, Original	\$4.00	\$10.00 \$30.00
STC029	1891 & 1909 Argentine	\$1.50	\$3.25 \$9.00
STC031	Mannlicher 7.65 pistol	\$6.50	\$18.00 \$49.95
STC013	'98 Mauser steel stripper clip	\$2.00	\$5.70 \$18.00
STC018	'93 Mauser brass	\$3.00	\$8.00 \$20.00
STC028	Orig. '98 Mauser brass, never seen before. Few only	\$3.00 ea.	
STC033	Replacement Mauser C-96 Broomhandle 8rd original military	N/A	N/A \$10.00
STC012	C96 Broomhandle, 10rd	\$5.95	N/A N/A
STC006	Rare 1896 Mannlicher	\$24.95	\$59.95
STC020	Swedish Mauser - Back In Stock!	N/A	\$5.00 N/A
STC024	SKS 10rd stripper clips	\$2.00	\$1.50 \$9.95
STC037	Pack of 10 SKS 10rd stripper clips w/ pouch	\$9.95	

Note: all above stripper clips are original except 91/30

UNIVERSAL 9MM STRIPPER CLIPS

1/2" wide 3-1/4" long holds 10 rds. Got a pile of 'em so cheap cheap! STC036
10 for \$9.95
50 for \$40.00
100 for \$60.00

T.V. WATCH'IN PROJECT

Same 9mm clips as above but some rust - easily cleanable: STC038
10 for \$5.95 500 for \$125.00
50 for \$19.95 1000 for \$195.00
100 for \$29.95

STYER HAHN 9MM AUTO STRIPPER CLIPS
For the 1911/1912 \$8.95, 3 for \$24.95 STC011

M1 CARBINE SPRING & PIN KIT

All the pins & springs in a M1 Carbine \$9.95,
3 for \$27.95 CRB173

M1 CARBINE DUAL CLIP HOLDER

\$5.95 CRB101

M1 CARBINE SPRING KIT

A put-away special: slide stop, recoil, extractor, ejector, sear, hammer trigger, & mag catch spring \$14.00 value. Only \$6.95.
3 for \$18.95 CRB137

WWII PATTERN M1 CARBINE CARRYING CASE - UNLINED

These are a very close copy of the World War II M1 carbine case. O.D. canvas with proper brass zipper and leather tabs. "US" marked. Carrying strap included. Will hold all M1 and M2 carbines. New condition.
Unlined Cover. \$14.95 ea,
3 for \$42.95 CRB094



M1 CARBINE REAR ADJUSTABLE SIGHTS

New condition \$17.50
CRB155



RARE G-41 HAMMER SPRING

Few only - these break \$9.95, 3 for \$17.95 G43069

ORIGINAL G-43 EAST GERMAN POLICE SLINGS

From late 40's/ early 50's, VG condition, Original \$12.95 SLNG110

G-43 RECOIL SPRING SET, THE LONG AND SHORT

Put one or more sets away for the future! Only \$8.95 a set, or 3 sets for \$23.95 G43073

G-43 RIFLE PARTS

1. Extractor \$24.95 ea. G43003
2. Cleaning rod \$14.95 ea. CLN015
3. Recoil Spring, front \$5.95 ea. G43007
4. Recoil Spring, rear \$5.95 ea. G43010
5. G43 front sight hoods new \$9.95 ea. G43040
6. New G43 exact repro hammer torsion spring \$9.95 G43023
7. New G43 exact repro trigger torsion spring \$9.95 G43029
8. Rare G 41 hammer spring few only these break \$9.95 G43069
9. G43 Rifle Sling \$24.95 SLNG110

G-43 RIFLE PARTS

G-43 SPRING SET

We finally completed this project all brand new live springs. Tune up your G-43 or keep a set as a "put away". These kits will run out. Old weak springs not only affect function but also take a toll on the hard parts in your gun. Springs are copied exactly from the originals. This kit is sold elsewhere for \$80.00 and are sold out there! Buy one for your gun & one to put away for when they're gone or go in business at \$14.95/set.
2 sets for \$28.95,
10 sets for \$140.00 G43067
1 front recoil spring 1 gas piston spring
1 hammer torsion spring 1 safety plunger spring
1 rear recoil spring 1 mag catch Torsion spring
1 trigger torsion spring

G-43 Canvas Bag Pouch (repro) w/2 new Mags \$103.95 G43056

G-43 Canvas Pouch by itself \$12.95 G43002

G-43 Leather Mag Pouch with 2 new 10rd mags \$103.95 G43061

G-43 10rd Magazine, New MFG - Well-made and tested, steel. Meticulously made identical to the original \$54.95 G43001



M1 CARBINE BANDS

First model barrel band assembly with swivel and screw. Perfect for restoration of an early WWII pattern carbine. New. Just bought a good deal on 1st model M1 Carbine barrel bands and will pass it on to you. Previously \$20-\$25 ea, now!! \$14.95, 3 for \$39.95 CRB023

M-1 CARBINE POUCHES & MAGAZINE SETS

Individual pouches for sale as well as combination sets with magazines. Every order with magazines gets a free original USGI rubber dust cover with each mag!

1. CARBINE STOCK POUCH holds 2 15 rd. magazines and slides onto the wood stock. New repro. With markings on front & back \$9.45 or 3 for \$24.95 CRB134 (pictured on Left)
2. CARBINE BELT POUCH holds 2 15 rd. magazines and slides onto belt. New, GI. \$8.00 CRB092
3. CARBINE BANANA CLIP POUCH holds 4 30rd. magazines. Slides onto belt \$9.95 or 3 for \$24.95 CRB090 (pictured on Right)
4. COMBO A: 2 15 rd. Magazines and Stock Pouch w/dust covers \$29.95 CRB191
5. COMBO B: 2 15 rd. Magazines and Belt Pouch w/dust covers \$28.95 CRB192
6. COMBO C: 4 30rd. Magazines and Banana Clip Pouch w/dust covers \$69.50 CRB193

Follow State & Local laws when ordering magazines



WWII M1 CARBINE LEATHER SCABBARD



These are truly Scarce as Hens Teeth! For whatever reason there are very few of these remaining on the collectors market so we have thoughtfully had them made from an original utilizing strong leather, brass cover and correct fasteners, and markings. This was used by Cavalry, on motorcycles, jeeps, half-tracks etc. Originally made for the full stock M-1 Carbine, it also fits similar sized firearms like the Ruger® 10/22® with the Sarco stock. Originals can fetch \$400-\$700. Sarco brings this quality leather item to you at the fabulous price of \$57.95 CRB189

M1 CARBINE G.I. COLLECTORS

Check our website for G.I. M1 sorted collectors parts! We have sorted a lot of G.I. parts - Some are really rare!!

Don't forget to visit www.SARCOINC.com for 1000's of Carbine Rifle items!

BACK IN STOCK !! VIKING & CELT NECK RINGS

Also known as the 'Viking Torque' - Worn by Celts and Norsemen recorded back as far as 1200 BC to 600 AD. Sometimes referred to as a neck Torc or Torque, these rings are worn on the base of the neck and were considered imbued with powers of independence for the free born, warrior status, and an earthly connection with deities. Worn by both women and men. We have two of the common types. One of brass and one of Copper antiqued. Your choice.....**\$29.95**

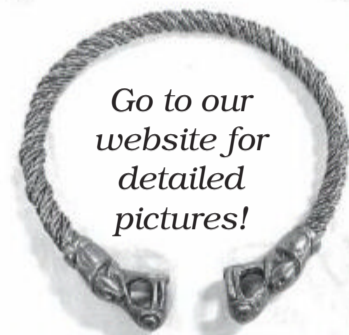

Go to our website for detailed pictures!

Brass Neck Ring MISC847
Copper Neck Ring MISC846
These are very popular and sell out FAST!
Don't wait to order yours!

NEW 1903A3 WALNUT HANDGUARDS

New, unstained..... **\$26.50** SPF377W

U.S. M1903 & 03A3 RIFLE PARTS

- SPF001 Band Front Sight 1903 **\$13.50**
- SPF002 Band Front Sight 1903A3 **\$12.00**
- SPF253 Band Lower, new GI blue 1903 **\$25.00**
- SPF011 Band Lower (milled) 1903 **\$20.00**
- SPF012 Band Lower w/Swivel (milled) 1903 **\$23.95**
- SPF014 Band Lower w/Swivel (stamped) 1903A3 **\$17.50**
- SPF018 Band Screw Upper Band 1903 **\$3.00**
- SPF019 Band Screw Upper Band 1903A3 **\$3.00**
- SPF263 Band & Hardware Set, milled 1903 **\$54.95**
- SPF265 Band & Hardware Set, 1903A3 **\$49.95**
- SPF003 Base rear sight (not sleeve) **\$12.00**
- SPF306 Bolt, smooth body, bent handle **\$125.00**
- SPF004 Bolt Late (complete) **\$42.00**
- SPF005 Bolt Late (stripped) **\$20.00**
- SPF008 Bolt Sleeve (stripped) **\$15.00**
- SPF009 Bolt Sleeve Lock **\$4.75**
- SPF010 Bolt Sleeve Lock Spring **\$1.75**
- SPF384 Bolt sleeve w/lock & spring **\$19.95**
- SPF308 Bolt smooth body, early straight handle, good cond. **\$140.00**

- SPF352 Bolt stripped & welded in firing pin hole 1903(A3) **\$3.95**, 5 for **\$14.95**
- SPF351 1901 era, Springfield bolt body, smooth, not heat treated **\$300.00**
- SPF357 Bolt R marked for early Remington 1941-42, stripped **\$65.00**
- SPF358 Bolt BF (Bonnie Forge) Springfield 1941 & 42, stripped, like new **\$45.00**
- CLN172 Bronze bore brush 30 cal. 10/ **\$9.95**
- SPF091 Butt Swivel (milled) 1903 **\$6.50**
- SPF061 Butt Swivel (stamped) 1903A3 **\$5.00**
- SPF016 Buttplate (milled) 1903(used) **\$20.00**
- SPF015 Buttplate (stamped) 1903A3 used **\$18.95**
- SPF121 Buttplate Milled fine checkered **\$35.00**
- SPF402 Buttplate milled, heavy (wide) checkering - unchecked trap **\$99.95**
- SPF020 Cutoff **\$8.50**
- SPF021 Cutoff Plunger **\$2.00**
- SPF023 Cutoff Screw **\$2.00**
- SPF024 Cutoff Spindle **\$3.50**
- SPF022 Cutoff Spring **\$1.50**

SPRINGFIELD RIFLE CASE, MODEL 1918

WWI canvas case with canvas flap, carry strap, and markings. Not many of these are found today, but this new mfr case is every bit as good. Great for the M1 Garand, too! 47 inches long **\$24.00** SPF392



SPRINGFIELD 1903 & 1903A3 'C' STOCKS

BEECH STOCK OPTIONS

- Beech C Stock w/ stain **\$139.95** SPF2765
- Beech C Stock w/o stain(natural) **\$129.95** SPF276
- To either Stock, add a New Handguard for **\$23.00**

Unstained (so you can stain to match your stock) Beech Handguard SPF377
Stained Beech Handguard SPF377S

Note: many of the currently produced military stocks are made of stained beech & finish up very nicely. The Beech stock that we sell also has a walnut stain and there is an economy in going this route and also in having a beautiful stock! We have sold thousands of Beech Stocks. Your choice. Note: Any stocks ordered with a 1903 handguard will receive a New, GI unstained 1903 handguard.

WALNUT STOCK OPTIONS

- Walnut C Stock w/ stain **\$159.95** SPF276WS
- Walnut C Stock w/o stain (natural) **\$149.95** SPF276W
- To either Stock, add a New Handguard for **\$25.00**

Unstained (so you can stain to match your stock) Walnut Handguard SPF377W
Stained Walnut Handguard SPF377WS

Beautiful new walnut or hardwood 'C' Stocks in several flavors to enhance your old 1903 Springfield series rifles. All stocks are sanded to USGI specification of 120 Grit for proper G.I. texture.

JUST A FEW - ORIGINAL G.I. SPRINGFIELD STRAIGHT FINGER

GROOVED STOCK - good condition, sanded & oiled **\$175.00** SPF406

BRAND NEW!! SPRINGFIELD 1903A3 BARRELS

High quality 4140, 4-groove barrels with shallow chamber (.044") to accommodate for receiver variations, extractor cut, front sight cut out for base, with a 1 in 10 twist. In the white and unmarked! **\$110.00** SPF387 (Very Limited Availability) Can be converted to an '03 barrel by adding an '03 rear sight sleeve!

SPF342 Die cast buttplate assemblies for 1903 Springfield - looks like a milled buttplate (new orig). Super rare! Collector's dream **\$39.95**

SPF309 Early '03 bolt stop, new orig. G.I. **\$16.00**

SPF028 Ejector **\$5.00**

SPF029 Ejector Pin **\$2.00**

SPF025 Extractor **\$14.95**

SPF027 Extractor Collar **\$10.00**

SPF026 Extractor w/ Hole **\$16.50**

SPF033 Floorplate (milled) 1903 **\$19.95**

SPF034 Floorplate Catch Assembly **\$8.75**

SPF031 Follower (milled) 1903 **\$7.00**

SPF030 Follower (stamped) 1903A3 **\$10.00**

SPF032 Follower Spring **\$4.00**

SPF036 Front Sight Base Pin **\$1.50**

SPF035 Front Sight Blade 1903 **\$6.00**

SPF333 Front sight blade 1903A3 **\$5.00**

SPF044 Front Sight Cover **\$12.95**

SPF093 Front Sight Key 1903A3 **\$2.25**

SPF037 Front Sight Pin **\$1.50**

SPF039 Front Sight Screw 1903 **\$2.75**

SPF038 Front Sight w/Stud 1903 **\$9.95**

HNGD01 Handguard 1903 (new G.I.) **\$14.95**

HNGD37 Handguard 1903 used cracked repairable 10/ **\$39.95**

HNGD02 Handguard, U.S. 1903A3 (new G.I.) **\$65.00**

SPF084 Handguard Clips (Two Packs) **\$3.85**

SPF043 Handguard Plastic (New) 1903A3 **\$15.00**

SPF049 Handguard Ring to Receiver 1903A3 **\$6.00**

SPF347 Lower band assy w/swivel, used orig Remington 1903 **\$47.50**

SPF349 Lower band screw, new 1903A3 **\$1.95**

SPF046 Mainspring **\$4.00**

COMPLETE HARDWARE SET FOR 1903A3 SPRINGFIELD

Same list as parts to the left only 1903A3 late pattern. Value \$55.00. Special **\$49.95** SPF265

1903 SPRINGFIELD LOW SCOPE SAFETY ASSY

\$16.50 SPF054

BORE CLEANING BRUSHES

.30 caliber brass bore brushes, new. **\$9.95**/10 • **\$39.95**/50 • **\$69.95**/100 CLN172

SPRINGFIELD STRIPPER CLIPS

Early brass WWI **\$4.00** ea, 5 for **\$14.95** STC025

1903 SPRINGFIELD GRENADE LAUNCHING BOOTS

A perfect reproduction of the grenade launching rubber boot (slip on) for the Springfield and M1 Garand. Absolutely meticulously beautiful!! **\$34.50** MISC088

See our website for 1903 Springfield Drill Rifle Barrels SPF271

EXTRA LONG REAR GUARD SCREWS FOR 1903A3 RECEIVERS

The standard guard screw only goes up part way in an A3 receiver. This screw fills the hole to make your rifle more attractive. Haven't had these for 20 years. The G.I. screws only engages a few threads. **\$3.95** ea, 3 for **\$9.95** SPF360

1903 & A3 SPRINGFIELD SPRING KIT

A put-away for the future all springs in the gun - bolt sleeve lock, main, cut-off, sear, floor plate catch, & magazine follow \$15.00 value - Only **\$4.45**, 3 for **\$11.45** SPF248

SPRINGFIELD RIFLE

OIL035 Oiler, late plastic WWII, new **\$13.95**

OIL015 Oil and Thong Set (Metal) **\$35.00**

OIL016 Oil and Thong Set (Plastic) Used **\$8.50**

SPF371 Rear sight, complete assembly w/base & windage screw (barrel ring not included), 1903. **\$74.95**

SPF094 Rear sight, complete without windage screw w/o barrel ring, VG to Exc, 1903 **\$69.95**

SPF294 Rear sight, G.I. used, 1903A3 **\$40.00**

SPF370 Rear sight, perfect repro, 1903A3 **\$29.95**

SPF273 Rear sight sleeve (around barrel), Orig/Late 1903. **\$60.00**

SPF143 Rear sight windage screw, 1903 **\$7.50**

SPF053 Safety Lock **\$8.00**

SPF054 Safety Low Scope Type **\$16.50**

SPF086 Screw Buttplate Large **\$2.95**

SPF085 Screw Buttplate Small **\$2.45**

SPF092 Screw Stacking Swivel 1903 **\$2.00**

SPF056 Screw Trigger Guard Front **\$3.00**

SPF057 Screw Trigger Guard Rear **\$3.00**

SPF074 Screwdriver Three Blade **\$9.95**

SPF055 Sear **\$7.50**

SPF087 Sear, Pederson Device **\$65.00**

SPF072 Sear Pin **\$2.00**

SPF062 Sear Spring **\$2.00**

SLNG067 Sling keeper, 1/4" for 1907 sling, orig, new GI. **\$5.95** ea, 2 for **\$9.95**

SPF013 Sling Swivel for Band (milled) 1903 **\$7.50**

SARCO www.sarcoinc.com 10

US KRAG & SPRINGFIELD KERR RIFLE SLING

Original complete with the 'NobuckL' sling hardware, correct weave, and khaki color. This was also originally used on the 1921 & 1928 Thompson SMG before they shortened it during the war. Long length of sling is @45", and short length is @14.5". New. **\$22.00** SLNG104



SPRINGFIELD RIFLE LEATHER KERR SLING

Expensive to make, this leather sling sported the brass Kerr 'NOBUCKL' system for their canvas slings from WW1 thru WW2. Fits loads of rifles and will last a lifetime of use. High quality and a classic! New **\$24.00** SLNG115



Note: Almost all of our Springfield parts are original, new G.I. bought 30-40 years ago

SPF067 Spring Band Retainer (milled) **\$14.50**

SPF066 Spring Band Retainer (stamped) **\$4.00**

SPF058 Stacking Swivel and Band (exact reproduction) 1903A3 **\$15.00**

SPF068 Stacking Swivel Used G.I. (milled) 1903 **\$9.50**

SPF366 Stacking swivel and band assembly, 1903A3 G.I. used **\$18.00**

SPF367 Stacking swivel 1903A3 G.I. new **\$6.00**

SPF335 1903A3 stamped replacement rear sight. Perfect for drill rifles **\$5.95**

3 for **\$14.95**

SPF113 Stock cross bolt & nut **\$9.65**

SPF090 Striker **\$7.40**

SPF052 Striker Rod **\$6.00**

SPF051 Striker Sleeve **\$3.00**

SPF076 Trigger Grooved **\$13.95**

SPF077 Trigger Pin **\$1.50**

SPF075 Trigger Plain **\$9.95**

SPF368 Trigger guard, 1903A3 used G.I. **\$32.00**

SPF382 Trigger guard, 1903A3-Reparked **\$36.00**

SPF117 Trigger Guard 1903 type, Milled **\$49.95**

SPF078 Trigger Guard 1903, Orig GI **\$95.00**

SPF079 Trigger Guard (stamped) 1903A3 **\$31.50**

SPF083 Upper Band (stamped) 1903A3 **\$16.00**

SPF081 Upper Band Used (milled) 1903 **\$26.00**

M1903 & 03-A3 "SPRINGFIELD" RIFLE KITS

These kits consist of every part of the "Springfield" rifle except the stock, receiver, and barrel assy. (w/ sight bases). Kits will have bolts, bands, stamped trigger guard, swivels, trigger, etc. Use these kits to build up to a rifle on your receiver or to rebuild an old '03. All parts are in new or like new condition. Note: Rear sight parts may be used G.I.

A. M1903 Parts Kit includes new handguard **\$159.95** ea. SPF127

B. M1903A3 Parts Kit **\$149.95** ea. SPF126

C. For a new G.I. 2 groove 03A3 barrel add **\$190.00** SPF080

D. Special on new '03A3 barrels if bought with an '03 or 'A3 kit (can also be converted to an '03 barrel with '03 kit by adding '03 rear sight sleeve) **\$100.00** SPF387

(price valid only if purchased with kit)

If you want an unfinished receiver casting in either kit, add \$19.95 SPF405 Not for sale in NJ

SPRINGFIELD 80% RECEIVER CASTINGS \$39.95 SPF405

Not for sale in NJ
Not for sale in PA until further notice

1903A3 SPRINGFIELD DRILL RIFLE BARRELS

These were removed from drill rifles & have their chambers welded or have a rod in the barrel with a small plug weld to hold it in. Front sight base not included **\$12.50** ea, 10 for **\$99.95**, 50 for **\$400.00** SPF270

BRAND NEW 1903A3 SPRINGFIELD REAR SIGHTS ASSEMBLIES

Forgot we had 'em **\$29.95**, 3 for **\$84.95** SPF370
Original G.I. A3 rear sight used VG **\$40.00** SPF294
Check our website for A3 Sight Parts Have all parts

NEW GI SPRINGFIELD BARRELS

M1903A3, New, G.I., 2 groove **\$189.95** SPF080
M1903A3, New, G.I., 4 groove **\$199.95** SPF130

See our website for all M1 & M2 .22 Springfield parts.

COMPLETE NEW SCREW SET FOR 1903 & 1903A3 SPRINGFIELD

Includes:
Upper band screw Rear guard screw
Front guard screw 3 Small buttplate and
Large buttplate screw swivel screws
Stacking swivel screw Cut off screw
Lower band screw
Note: the 1903 kit also includes the front sight screw (value \$23.00) SPF378 - screw set for 1903A3 **\$9.95**
(value \$26.00) SPF379 - screw set for 1903 **\$9.95**

See our website for a full listing of our 1903 Springfield Rear Sight Parts

SPRINGFIELD PUT AWAY KIT 1/2 PRICE!

Trigger, 2 sears, 1 milled follower, 2 ejector, 2 strikers, 1 mainspring, 2 trigger pins, 1/2 price special **\$15.80** SPF095

SPRINGFIELD RIFLE ACCESSORY SET

Canvas roll up pouch with original spare maintenance items to keep your Springfield Rifle running well. See our website for details! **\$34.95** SPF389

Chrome Springfield Parts - We have 30 different chromed Springfield parts. Very small quantities. Check our website for list. All parts are used off of drill rifle.

1903A3 PIN & SPRING KITS

All the pins & springs in a Springfield rifle - 03 & A3 included **\$9.95**, 3 for **\$24.95** SPF341

1903 & A3 SPRINGFIELD BUTTPLATE COLLECTION

See our website!

M1903 TRIGGER GUARDS MILLED (NOT STAMPED 03A3 TYPE)

Absolutely beautiful repro of 1903 Springfield milled trigger guard. Can't really tell from original. Replace the stamped 'A3 guard in your rifle with one of these beauties. Finished in matte black, stripped (no floorplate) **\$49.95** ea. SPF117. Complete assy - trigger guard with floorplate & catch assy **\$69.50** SPF343

1903A3 TRIGGER GUARD ASSEMBLIES

A brand new complete assembly - trigger guard + follower + spring + 2 screws - \$51 value **\$39.50** SPF375
Complete assembly, used surplus - \$51.50 value **\$39.50** SPF376
Trigger guard only, brand new **\$31.50** SPF079

SPRINGFIELD 1907 SLINGS, LEATHER - AS USED IN WWI & WWII

- 1. SLNG024 WWI Model 1907 Sling (w/ brass hardware and WWI date) **\$16.95** ea, 3 for **\$47.95**
- 2. SLNG025 WWII Model 1907 Sling (w/ steel hardware and WWII date) **\$16.95** ea, 3 for **\$47.95**

SPRINGFIELD HANDGUARDS

- Original G.I. walnut handguards. M1903, New, unissued **\$14.95** HNGD01
- 1903A3 used cracked repairable **\$59.95** SPF261
- 1903A3 plastic for drill rifle **\$15.00** SPF043
- 1903 handguard Type 2 (1910 to 1916) **\$150.00**
- 1903 handguard NM **\$100.00**

ORIGINAL MAUSER '98 AND OTHER MAUSER HANDGUARDS
 MSR216 M98/43 La Corona Handguard \$35.00
 HNGD55 M1912 Chilean Mauser Handguard \$35.00
 HNGD17 M1893 Spanish Mauser Handguard \$30.00
 HNGD34 M1908 Brazilian Mauser Handguard \$35.00
 HNGD36 CZEC VZ24 Mauser Handguard \$35.00

MAUSER "20" ROUND "TRENCH" MAGAZINE Check your local laws and/ or our website for mag restrictions

 \$49.95 MSR167

RARE FIND IN P-17 ENFIELD
 Just a handful from sorting P17 Front handguards with Winchester & Remington markings - good to VG cond.
 Winchester "W" \$75.00 P17045-W
 Remington "R" \$75.00 P17045-R

U.S.M1917 & BRITISH P-14 ENFIELD PARTS

- Almost all parts are new G.I.
- P14003 P14. Bolt Stripped.....\$32.00
 - P14002 P14 Bolt, complete.....\$99.95
 - P14004 P14 Extractor, original.....\$39.95
 - P14007 P14, Floorplate.....\$9.00
 - P14009 P14, Follower, Milled.....\$8.00
 - P14008 P14, Magazine Box.....\$11.50
 - P14010 P14, Speed Lock.....\$40.00
 - P14005 P14, Striker (Firing Pin).....\$20.00
 - P14006 P14, Triggerguard.....\$15.00
 - P17051 P17, Speed Lock.....\$39.95
 - P17016 Bolt Complete.....\$75.00
 - P17017 Bolt, stripped.....\$37.50
 - P17068 Bolt stop assy, 4 parts w/o ejector.....\$15.00
 - P17041 Buttplate Assembly.....\$14.95
 - P17040 Buttplate Screw Large.....\$3.50
 - P17056 Buttplate Swivel Screw.....\$4.00
 - P17012 Ejector, original.....\$17.50
 - P17043 Extractor.....\$24.50
 - P17034 Front guard screw.....\$3.50
 - P17036 Floorplate.....\$10.00
 - P17038 Follower Spring.....\$5.00
 - P17039 Follower, Milled.....\$12.00
 - P17006 Handguard Ring.....\$10.00
 - P17082 High speed firing pin spring.....\$4.95
 - P17054 Lower Band Assembly.....\$10.00
 - P17037 Magazine Box.....\$9.95
 - P17035 Rear Guard Screw.....\$3.50
 - P17004 Stacking Swivel.....\$9.50
 - P17052 Stacking Swivel Screw.....\$4.00
 - P17059 Stock.....\$195.00
 - P17018 Striker (Firing Pin).....\$18.00
 - P17031 Triggerguard.....\$20.00
 - P17053 Upper Band.....\$9.50
 - P17046 Rear handguard walnut new G.I.....\$40.00
 - P17047 Rear handguard walnut used G.I.....\$30.00
 - P17062 Rear handguard hardwood, new G.I.....\$30.00
 - P17063 Rear handguard hardwood, used G.I.....\$25.00
 - P17044 Front handguard walnut new G.I.....\$35.00
 - P17045 Front handguard walnut used G.I.....\$25.00
 - P17061 Front handguard hardwood, new G.I.....\$30.00
 - P17060 Front handguard hardwood used G.I.....\$20.00

P14 & P17 Handguards are interchangeable. Order under P17 part #s. See our website for all other P17 & P14 parts

BRAND NEW ORIGINAL 98 MAUSER STRAIGHT BODY STRIPPED BOLTS

Bought from the FN warehouse in Belgium. The original FN production. These came out of the FN Factory in a buy of left over parts in the warehouse. Unnumbered. Never in a gun..... \$49.95 MSR517
 Extra Special Our new '98 bolt with new extractor and new firing pin \$79.95 MSR518

MAUSER RIFLE BARRELS VARIOUS MODELS

1. Kar 88, 8x57, original used, with good bores, 17 1/2".....\$75.00 MSR096 with hand pick bores \$95.00 MSR097
2. Rare Argentine M1909 Engineers Carbine barrel - bores vary.....\$100.00 MSR512
3. 1908 Brazilian Barrels:
 Fair.....\$40.00 MSR659
 Good.....\$60.00 MSR107

MISC. 98 MAUSER ITEMS

1. Original Argentine SOM sniper scope w/base & leather case.....\$3495.00
2. Rare M98/43 La Corona Spanish muzzle cover.....\$9.95 MSR217
3. VZ24 Mauser new original stock disc \$4.95
 3 for.....\$12.50 MSR523
4. Original Israeli K98 grenade launcher, like new.....\$49.95 MSR575
5. Orig Yugoslav, 98 & M48 etc Mauser oiler.....\$4.95 MSR576
6. Rare original 1904 Portuguese Verguiero front sight cover, new.....\$9.95 MSR591

TOKAREV RIFLE & PISTOL PARTS

SVT-40 TOKAREV RIFLE SPARES PACK

Sarco has a new spares pack for the venerable SVT-40 Tokarev Rifle. These parts just came in and we can offer you an unbeatable deal on this parts package. Pack consists of Bolt with Extractor, Front End-gas housing & flash hider, Rear Sight-complete, Trigger Housing complete, and Piston Rod. Normally these parts would fetch \$350.00, but Sarco's special price is.....\$64.95, 3 for \$179.95 TOK089



TOKAREV TU-90 GRIPS
 Like new \$14.95, 3/ \$29.95
 GRP194 See our website for more Tokarev parts!



TOKAREV BARRELS IN 7.62X25 Original Used.
 VG clear rifling \$64.95 TOKP033



K98 MAUSER SPARE PARTS KIT

Been out of these for a while. Now's a great time to pick up a pack of these original parts before they are gone again! Contains: EJECTOR, FOLLOWER, MILLED, TRIGGER SEAR, SAFETY, FOLLOWER SPRING, SEAR SPRING, BOLT SLEEVE, FIRING PIN, FIRING PIN SPRING \$29.95 MSR370 VALUE \$65.00



'98 MAUSER SPORTER RIFLE PARTS

Steel hinged trigger guard assembly \$69.95 MSR326
 Single stage trigger (uses original sear).....\$14.95, 3 for \$39.95 MSR205
Note: Delightful single stage trigger assembly—this takes the historic 'creep' out of your trigger pull. It is interchangeable with your standard trigger. A must for all shooters looking to improve the performance of their Mauser 98.
Low scope safety - for scope mounting on 98 Mauser scoped Sporter. Fits & works on standard military bolt sleeve.....\$17.75 MSR162



'98K MAUSER ACCESSORY KIT

Cleaning rod. Our famous K98 Repro sling, front sight hood. Value \$55.00
 Sarco Special..... \$24.95 MSR365



K98 RIFLE STOCK DISC

Usually inserted in the right side of Mauser stocks in the 1930s and in Garrison rifles of the Home Guard through the early war years. Would ID mfg., date, serial #.....\$4.95 MSR596



K98 MAUSER HANDGUARD

Beautiful new hardwood hand-guard ready to replace that old worn out handguard!..... \$19.95 HNGD42



SEE OUR WEBSITE FOR THE FULL SELECTION OF '98 MAUSER PARTS

- MSR104 Band Retaining Spring, front GEW 98.....\$4.00
- MSR105 Band Retaining Spring, rear GEW 98.....\$4.00
- MSR106 Band Spring (98K).....\$7.00
- MSR107 Barrel, 1908 Brazilian style 7x57mm (30" large ring).....\$60.00
- MSR096 Barrel KAR88 Orig Used 8x57 17 1/2" small ring.....\$75.00
- MSR304 Barrel, Verguiero 8x57mm 23 3/4" Small Ring, New.....\$75.00
- MSR097 Barrel KAR88 Original (hand picked bores) 8 x 57MM 17 1/2" small ring.....\$95.00
- MSR114 Bolt (complete) turndown handle.....\$84.95
- MSR115 Bolt (stripped) turndown handle.....\$75.00
- MSR117 Bolt Sleeve (new).....\$12.00
- MSR118 Bolt Sleeve (used).....\$8.00
- MSR120 Bolt Stop (stripped).....\$7.00
- MSR121 Bolt Stop Assembly.....\$22.50
- MSR359 Bolt Stop for 1909 Argentine stripped.....\$14.95
- MSR434 Bolt Stop Screw, new.....\$2.50
- MSR122 Bolt Stop Spring.....\$12.00
- MSR404 Bolt stripped, straight handle.....\$43.50
- MSR123 Bolt, complete straight handle.....\$98.95
- MSR125 Buttplate (cupped) Israeli.....\$7.50
- MSR126 Buttplate (flat).....\$8.00
- MSR127 Buttplate Screw.....\$1.25
- CLN014 Cleaning Rod 12 1/2" M98/43.....\$12.95
- CLN025 Cleaning Rod 15" GEW 98.....\$12.50
- CLN018 Cleaning Rod 15" VZ24/G24(T).....\$13.50
- CLN013 Cleaning Rod early 10".....\$12.00
- CLN049 Cleaning Rod M93 17 1/4".....\$10.00
- CLN074 Cleaning Rod Stock Nut.....\$5.00
- MSR135 Cocking Piece.....\$7.00
- MSR136 Ejector.....\$5.00
- MSR138 Extractor.....\$19.95
- MSR139 Extractor Collar.....\$8.00
- MSR141 Firing Pin Spring.....\$3.75
- MSR143 Floorplate (used).....\$9.00
- MSR142 Floorplate new orig, unnumbered.....\$19.95
- MSR146 Follower (milled).....\$8.00
- MSR147 Follower (stamped, WWII).....\$17.50
- MSR148 Follower Spring.....\$4.00
- MSR151 Front Sight.....\$4.00
- MSR153 Front Sight Hood, 98K.....\$6.50
- MSR155 Front Sight Protector VZ24.....\$10.00
- MSR157 Guard Screw Bushing.....\$2.00
- MSR150 Guard Screw, Front (military).....\$4.00
- MSR158 Guard Screw Set (commercial) New.....\$6.95
- MSR158(A) Guard Screw Set (commercial) Used.....\$5.00
- MSR373 Guard Lock Screw Set, (military) new.....\$3.95
- MSR372 Guard Screw Set w/Lock Screws (military), Used.....\$9.75
- MSR159 Handguard, K98 (beechwood, used, orig) Good VG.....\$24.95
- MSR161 Handguard K98 laminated, original. Good-VG.....\$34.95
- HNGD34 Handguard 1908 Brazilian long rifle.....\$35.00
- MSR162 Low Scope Safety.....\$17.75
- MSR129 Lower sling swivel, detachable, 98 WWI GEW.....\$8.50
- MSR193 Parade sling loop swivel, original 98 WWI GEW.....\$4.00
- MSR415 Combination of MSR129 & MSR193.....\$9.95
- MSR175 Rear sight & handguard screw VZ24.....\$4.00
- MSR180 Rear Sight Sleeve.....\$15.00
- MSR185 Safety.....\$4.25
- MSR149 Screw, Front (commercial) New.....\$3.50
- SLNG010 Sling GEW 98 (WWI Style).....\$16.95
- STC013 Stripper Clips (8mm, 5 rd).....\$2.00
- MSR208 Trigger Guard Assy, milled military.....\$34.95
- MSR206 Trigger Guard stripped.....\$23.95

GERMAN MADE H&K DESIGN ADAPTABLE FLASH HIDER
 Proven design! 7.62mm (30cal) metric 15 x 1 right hand thread.....\$7.95
 3 for.....\$19.95 MISC795



GERMAN MAUSER RIFLE

WEEKLY FIND IN THE MINE! ORIGINAL NEW BROWNING DOUBLE AUTO FORENDS!
 FN Belgian made. Walnut checkered.....\$65.00 BDA482



EXTRA LONG LOCKING LUG MAUSER K98 BOLT
 To Solve 98 Mauser Headspace Problems - New Mauser '98 bolts FN made from years ago. These are new original bolts with extra length locking lugs to repair excess headspace guns. Been hiding for years. Stripped, brand new original FN.....\$79.95 MSR517L



Check our website for a fabulous assortment of '98 Mauser trigger guards over 35 variations - we had a big sort! Have over 30 varieties of Bolts, too!!

GERMAN WW2 MAUSER G33 /40 FRONT SIGHT HOOD \$24.95 MSR633



'98 MAUSER FRONT SIGHT COVERS Back Again!
 New condition.....\$6.50.
 3 for.....\$17.95 MSR153



MAUSER K98 SNIPER RIFLE SPECIAL EXTENDED SAFETY
 We have them for the first time! To go with your Mauser sniper rifle project. Others sell for \$69.95.....\$24.95 MSR574



MAUSER 98 SPORTER STOCK WITH BUTTPLATE

Our Hardwood Mauser Sporter Stocks are sold out - Now we have walnut sporter stocks with buttplate and nicely checkered pistol grip & forend. Of course a nice cheek piece - new condition from our Interarms bayonet years ago. Small lot only..... \$99.95 MSR662



Go to our website for the last of our true re-creation of the Mauser 98 WW2 Turret Scope mounts - almost sold out and we are not running them again because they are too expensive to manufacture!



98 MAUSER GUARD SCREW SET

- MSR372 - Military set w/lock screws used.....\$9.75
- MSR373 - Military guard lock screw set new.....\$3.95

MITCHELL ARMS .22 CALIBER PARTS AVAILABLE

Sarco has parts for the following 'Mitchell Arms' .22 cal rifles - Please check our website for details: M16A1/22 AK47/2 GALIL .22

98 MAUSER COMMERCIAL GUARD SCREW SETS

Commercial set, new.....\$6.95 MSR158

SARCO 11

www.sarcoinc.com
 610.250.3960

MAUSER PARTS & ACCESSORIES

See our website for thousands of K98 Parts!

BACK AGAIN!! NEW PRODUCTION '98 MAUSER FIRING PINS

We just produced these out of the best 4140 steel - The good news is that we redesigned the cocking piece knoches to fit multiple manufacturing variations of the cocking piece. For years we have suffered pins and cocking pieces that won't fit together and hours and hours of sorting for fit. Problem solved + a new 4140 pin.....\$22.50 MSR431



MAUSER STOCK MILITARY ISSUE

1. Israeli K98 handguard only.....\$24.95 MSR403
2. 1908 Brazilian Mauser long rifle stock, good cond.....\$65.00 MSR366
3. 1908 Brazilian Mauser long rifle stock - Select (very few only).....\$85.00 MSR366A
4. 1908 Brazilian Mauser long rifle stock w/ handguard, good cond.....\$75.00 MSR375
5. 1908 Brazilian Mauser long rifle stock w/ handguard - Select (very few only).....\$95.00 MSR375A
6. Steyr M1912 stock w/buttplate & bayo lug.....\$69.00 MSR548
7. Steyr 1912 Rifle Stock, good condition.....\$89.95 MSR549
8. VZ24 stock, new original.....\$69.95 VZ24001
9. VZ24 Stock original, used condition Good.....\$85.00 VZ24004
10. VZ24 handguard, used Good - VG.....\$38.00 HNGD36
11. VZ24 Stock & handguard set, Good.....\$110.00 MSR668
12. Yugoslav M48 Mauser Rifle Stock, good condition.....\$85.00 MSR669

Use above 1908 Mauser stocks to rework the 1908's with cracked stocks currently on the market.

NEW ARRIVALS! RARE '98 CONTRACT MAUSER SLINGS

Brazilian M1908 detachable Sling Swivel, For GEW 98 as well.....\$8.50 MSR324
 Proper parade sling loop for Brazilian 1908 to go with the butt swivel above.....\$4.00 MSR193
 Set of above MSR324 & MSR193, only.....\$9.95 MSR415
 Orig used Spanish Mauser Model 1893 & M1916 rifle sling.....\$12.95 SLNG058

98 MAUSER 8x57MM STRIPPER CLIPS

Steel 5rd.....\$2.00 STC013
 Original brass few only.....\$3.00 STC028

MAUSER 98K WWII STYLE SLING

New MFR.....\$14.95.
 3 for.....\$39.95
 10 for.....\$120.00 SLNG011

K98 MAUSER RIFLE COMPLETE HINGED TRIGGER GUARD SET (CASTINGS)

We got 'em! \$19.95 MSR626
 See our website!

M98 MAUSER BOLTS

Complete bolt assembly with firing pin, extraction, bolts sleeve, etc. Standard length '98 bolt, fits German 98K, Czech VZ24, Argentine '09, etc. Gew 98 style bolts. Good, original condition \$98.95 ea. MSR123



RHODESIAN SELOUS SCOUT RIFLE / SHOTGUN CASE

Heavy cotton gun bag very similar to the British rifle bag, but slightly shorter and in a mustard color. About 41" long. Large Rhodesian Selous Scout emblem stenciled on one side. These gun bags will hold some rifles, but were primarily used to hold Greener and Belgian Browning Shotguns in barracks, watchtowers, Eland Armored Cars etc.. **\$15.95 MISC394**



MAUSER SCHNELLFEUERER WOOD STOCK

Walnut, late production. Holds pistol with 20rd magazine. A tremendous rarity, we have been able to have the 'wide body' Mauser Schnellfeuerer stock made to carry and attach the Automatic pistol. This stock allows you to insert the gun in with the 20 rd. magazine attached which is different from the Mauser 712 standard stock. We have a very limited number in stock so act quickly because we may not be able to offer them again **\$275.00 MSR667**



SHOULDER HOLSTER FOR MODEL 712 SCHNELLFEUERER WOOD STOCK

For the rare Mauser C96 pistol 'version' that uses the 20rd. magazine, we have the leather holster for the stock that is designed to hold the entire locked & loaded Pistol with 20rd magazine attached **\$24.95 HOL193**



PROPER 8x57mm BORE BRUSHES

Bronze brush - 5 for **\$5.50 CLN124**
Stainless steel brush for cleaning those tough military bores 5 for **\$8.95 CLN121**

AVAILABLE AGAIN!! SWEDISH MAUSER HIGH FRONT SIGHTS

Specially made tall front sights so you can zero your rifle at 100 yards. Most of these rifles shoot very high at short range as their minimum sight setting is 300 meters. Use of our high sight blade will allow you to get accurate sightings at 100 yards. Made to look like the original sights. These sights install in the existing dovetail. Made in U.S.A., Blued steel, Milspec quality, Swedish M96 and M38 Tall Front Sight. Now back in stock. **\$13.95 MSR283**



PRECISION SWISS MILITARY CLEANING KIT

The 'Swiss Watch' of Rifle Cleaning Kits! Precision Swiss military cleaning kit is far above the quality of typical Military or Commercial cleaning kits. Probably will never see another kit of such quality combining steel and brass parts carefully machined and assembled with everything needed to care for the chamber, bore, and exterior of a firearm. 5 rods combine to handle barrels up to 31" in length. 2 bakelite containers of lubricant, 2 different style bore brushes, 1 chamber brush, bore mirror, cleaning jag, short style chamber cleaning handle and rod handle are packed conveniently in a water resistant rollup. Great for calibers .30 Cal. thru 8mm **\$14.95 CLN167**



NOTE: OUR KITS ARE COMPLETE! Others sell incomplete kits for less!

ABOUT HIGH CAPACITY MAGAZINES:

Although we try to stay abreast of current State gun laws, it is a herculean task with over 20,000 laws on the books. By ordering, you are stating that you are complying with your Local & State laws. Most States allow large capacity magazines. Some do not. If you are unsure on this issue, contact your Local or State law enforcement to confirm what is allowed. This is a partial list of States with some hi-capacity restrictions: NJ, NY, MA, MD, HI, KS, CO, CT, IL and various county laws therein including Chicago, D.C. CA residents - check your laws as they are changing.

ONLINE ORDERS

Go to www.sarcoinc.com
Its fast, secure & convenient!

PHONE ORDERS

Call (610) 250-3960
Phones opened M-F 8:30am-5pm EST. If possible, please have the part #'s of each item ready for our order takers. If you have any technical questions, they will connect you to the most appropriate department.

EMAIL ORDERS - info@sarcoinc.com

Include your name, full address (indicate if its commercial or residential) and contact info. Include part #'s of items and what ad you saw them in.

FAX ORDERS

610-438-2548 (order department)
610-250-3961 (showroom)
610-250-3962 (gunroom - fax all FFLs here)

MAIL ORDERS - SARCO, INC.

50 Hilton St, Easton PA 18042
When writing your check, please include \$9.50 for shipping, (\$12.50 for rifle stocks & barrels). Actual shipping cost is determined by the weight of the package. You will be contacted if amount included is insufficient or a refund is due. There is a \$25.00 fee for all returned checks.
See our page 29 in the 2nd issue of the month for FIREARMS Ordering Info.

Note About Shipping:

Sarco deals with a lot of material that is very difficult to find and much of the original wartime material undergoes refinishing, manipulation, and repair as needed. With this in mind, we are not Amazon... While our aspiration is to ship your order quickly, some items may take a little more time to prepare so please be patient! Most orders go out quickly.

SHIPPING

ALL ORDERS WILL BE RECEIVED, PROCESSED AND SHIPPED OUT OF OUR PENNSYLVANIA LOCATION.
MINIMUM SHIPPING AND HANDLING CHARGES START AT: \$9.50. Rifle Stocks and Barrels...\$12.50
Call for larger items on prepaid orders
* NJ residents please add 6.625% sales tax. Not all items available to NJ residents.
* PA residence please add 6% sales tax
All orders to Alaska and Hawaii shipped via US Mail, unless customer specifically requests Blue or Red Label UPS (not available for online orders). Employees not authorized to modify prices or conditions stated in this advertisement. **Most orders ship within 7-14 days**

CUSTOMER SERVICE:

info@sarcoinc.com

PARTS QUESTIONS:

parts@sarcoinc.com

MACHINE GUN QUESTIONS:

mgdave@sarcoinc.com

• We are forever adding pictures to our website, but we have a lot of stuff and it takes time. If you dont see a picture of something you need, email us. We'll add it to the website and reply back with the link!

Sarco only sells products to persons 18 years or older

SWEDISH MAUSER PARTS

Go to our website for a complete list of Swedish Mauser rifle parts

C96 MAUSER PISTOL REAR SIGHT ASSEMBLIES

Graduations from 0 to 14. Just found these in the warehouse. Original New in the grease. Not \$125.00! Only **\$75.00!! MSR665**



C-96 BROOMHANDLE STRIPPER CLIPS

Works with both .30 Mauser and 9mm Luger ammunition. The 8 round is an original military strip per clip. 8rd. C96 Clip. 10 for **\$10.00**
25 for **\$20.00**
50 for **\$35.00**
100 for **\$50.00 STC033**



MAUSER C96 BROOMHANDLE CLEANING ROD

\$7.95 CLN164



C96 MAUSER BROOMHANDLE STOCK & HARNESS

Well-made, beautifully crafted hardwood stock and leather holster. Pistol fitting connects quickly and the pistol can be stored in the wood stock and then inserted in the leather holster. Includes cleaning rod. Made famous during WWI. Stock & harness only. Comes with two 8rd stripper clips for a limited time. **\$149.95 MSR340**



MAUSER BROOMHANDLE (C96) PISTOL GRIPS

Available Again! Just got in 600 pair. Custom made WOOD grips to match the originals. Complete with escutcheons & grip screws. Immaculate copies in the many variations.
GRP125 C96 Mauser standard fine line early grips - 20 lines
GRP126 C96 Mauser standard fine line early grips with Red 9 - 20 lines
GRP121 C96 Mauser model 1930 grips - 11 lines
GRP122 C96 Mauser model 1930 grips with Red 9 - 11 lines
GRP123 Bolo (small grips) Mauser pistol with standard lines - 20 lines
GRP124 Bolo (small grips) Mauser pistol with standard lines and Red 9 - 20 lines **\$19.95** a pair, 3 for **\$54.95**



These grips are superb reproductions. Others may sell cheaper but I guess they know what their stuff is worth.

SWEDISH MAUSER RIFLE PARTS

- 1. MILITARY RIFLE OILER Swedish design double oilers, issued with all variants of Swedish Mauser rifles. **\$1.95 each MSR289**
- 2. CLEANING ROD EXTENSION **\$2.95 ea. MSR269**
3 for **\$6.95**
- 3. CLEANING ROD GUIDE new original **\$4.95 ea. MSR369**
3 for **\$11.95**
- 4. M1896 CLEANING ROD..... **\$10.00 CLN020**
- 5. M1938 CLEANING ROD **\$12.50 CLN021**
- 6. M1896 REAR SIGHT ASSY w/sleeve **\$25.00 MSR291**
- 7. SWEDE MODEL CG63 MATCH RIFLE. new original buttplate with crown over "C" crest 5 7/8 x 1 3/4" **\$14.95**
3 for **\$34.95 MSR263**
- 8. Swede Mauser FIRING PIN **\$19.95 MSR494**
- 9. SWEDISH LONG RIFLE MAUSER BOLTS M1896, M38 **\$49.95 MSR260**
- 10. SWEDISH MAUSER ACCESSORY KIT For the Swedish Mauser M1896 and M38 Rifles. Kit includes one each of the following items:

- Cleaning Rod (M96 only)
- Cleaning Brush
- 5 Stripper Clips
- Double Metal Oiler
- Cleaning Rod Guide
- Cleaning Rod Extension

Reg. \$60.00 SARCO PRICE SALE! **\$19.95 MSR253**



MAUSER 712 (SCHNELLFEUERER) WOOD STOCK

SARCO has a half dozen of the wood stocks specifically designed to hold the selective fire version of the C96 Mauser. Very difficult to find, and this is for the real pistol, not the air soft version. Late production/walnut. Get one while you can. Won't last long! Mauser 712 Wood Stock.... **\$150.00 MSR654**

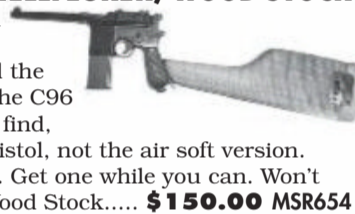

SWEDISH M96 AMMUNITION BANDOLIER

NEW **\$49.95 MSR632**



See our website for Collector Grade M96, CG63 & CG80 Mauser Bolts

See our website for Swedish Mauser Cleaning Rod Extensions #MSR644

LJUNGMAN AG-42 RIFLE OILER \$14.95 OIL038

SWEDISH LJUNGMAN RIFLE BARREL \$125.00 AG42010

~ Swedish Mauser Flash Hiders Are Coming! Inquire ~

NEW SWEDISH MAUSER FIRING PINS

\$19.95 MSR494

COMPLETE SWEDE BOLTS
The stripped bolts & bolt sleeves & extractors & firing pins are new unnumbered. Rest of parts are exc Complete straight bolt **\$129.95 SALE \$49.95**
3/\$134.50 MSR493

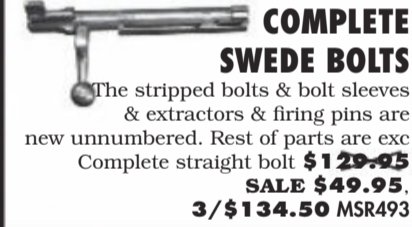

A NOTE ON SARCO GOODS

Many of Sarco's prices are below market price. Some too that this means Sarco sells lower quality... **Not True.** Sarco shops the world and the U.S. for deals and because of our buying power & 55 years of presence in the market, we are able to acquire good deals and pass the savings on to you. For example, we have over 20 vendors we buy AR parts from and are always shopping for the best price and quality.

FOR PARTS & ACCESSORIES

Visa and MasterCard accepted. Sorry no COD's.

ORDERING INSTRUCTIONS

Our ads in the Firearms News are catalogue prices and may not reflect any sales or higher pricing found on our website.

Prices are subject to change without notice. We are not responsible for typographical errors or misprints.

Over 95% of our inventory is listed in the Firearms News. We have to move items to our website to make room for new stuff. So if you don't see something, check www.sarcoinc.com or call us.

DISCLAIMER

Parts sold by Sarco should be installed only by a competent gunsmith. These products are sold as is and without a warranty. No liability is expressed or implied for damage or injury which may result from the improper installation or use of these products.

OUR GUARANTEE

Our guarantee is simple and easy to understand. If you are not satisfied with any item received from us you have 5 days to return it for a replacement or a refund of the advertised price. All returns must be accompanied by a letter WITH YOUR INVOICE NUMBER and explanation of the problem. Before returning anything, please see our guarantee on our website.

EASTON SHOWROOM VISIT

Showroom opened Mon-Sat 10am-5pm / Friday Opened til 8pm. For directions to the showroom, see website. In Stock Inventory - If you are planning on visiting the showroom, feel free to call ahead to make sure that we stock the item(s) that you need. Please give us a least a few days' notice before your visit in case we need to retrieve goods in from our other warehouses. Note that the prices in Firearms News are dealer prices and may not be the same prices as in our showroom.

ORDER PROBLEMS,

Damaged or Missing Packages

Call (610) 250-3960 and ask for Liz ext 208 or email lheisler@sarcoinc.com **BACKORDERS** Check the status of an existing Backorder, Call (610) 250-3960 or email: backorder@sarcoinc.com SARCO deals in modern as well as obsolete and hard to find merchandise and offers full & prompt refund on any cancelled backorders prior to ship. **WEBSITE Questions or Issues** Call (610) 250-3960 and ask to be transferred to the e-Commerce Department or email ecom@sarcoinc.com **INTERNATIONAL** Call (610)250-3960 and ask for Mike ext 210 or email international@sarcoinc.com

REGARDING LOCAL, CITY & STATE REGULATIONS

You warrant by ordering from Sarco Inc., that you are in compliance with the laws of your local, city and State regulations and that you are a legal adult without any legal restrictions in regards to your purchase. With 20,000 plus laws on the books it is difficult for us to know what laws may affect your purchase where you reside. Please check your local and State laws before ordering.

RETURNS

We offer a 5-day inspection period on all of our merchandise, except for special order items which are not refundable. Items that state they are sold "as-is" are not returnable.
• **PHONE ORDERS, EMAILED, FAXED OR MAILED-IN ORDERS:** You will need a Return Authorization Number to return something. Please email returns@sarcoinc.com or call (610) 250-3960 for a RT #. Feel free to check on the status of your return, credit or refund.
• **ONLINE ORDERS:** Please visit our website www.sarcoinc.com and click the Return Policy link. Fill out the printable form and mail it back with your package. Feel free to email our e-Comm department at ecom@sarcoinc.com to check on the status of your return or call (610) 250-3960 and ask to be transferred to the e-Commerce Department.
We do not refund any shipping cost unless the error/problem causing the return is our fault. Returns may be subject to a 10% restocking charge.





www.sarcoinc.com
610-250-3960



WANTED TO BUY!!! STRIPPERS!

Do you have a bunch of old strippers just hanging around? Well if so, sell them to us and we will put them to good use. We will make a cash or trade offer for stripper clips in good used condition. Offers only made on quantities of 100pcs and above. Contact Dave at Ext.130 or email mgdave@sarcoinc.com



STEEL TYPE 99 PROTECTIVE SHIELD

As used by Japanese forces during WW2. Complete with handle and monopod. New SALE!.....**\$80.00**
~~\$99.95~~ MISC443



ALMOST GONE!!

JAPANESE ARISAKA RIFLE PARTS FOR TYPE 38 & 99 - PLEASE SPECIFY WHEN ORDERING

- BAKELITE MUZZLE COVER..... **\$11.00** JAP9915
- TYPE 99 DUST COVER..... **\$19.95** JAP9903 **BACK IN!!**
- TYPE 38 DUST COVER Steel .. **\$19.95** JAP3811 *We've got these too!*
- FIRING PIN SPRING..... **\$5.00** JAP9905
- EXTRACTOR..... **\$40.00** JAP3801
- JAPANESE ARISAKA SLINGS**
- WWII JAPANESE NAVAL SLING FOR ARISAKA & VZ 24 RIFLES **\$14.95** SLNG098 **BACK IN!!**
- TYPE 99 'PACIFIC' RUBBERIZED CANVAS SLING Developed to resist mildew and create a lighter sling. Laminated just like the original w/ brass hardware and markings. Wartime use of 1942-45. Unlike our competitors, we have included the leather sling keeper which the others omit!..... **\$19.00** SLNG093
- TYPE 38 Leather Sling brass hardware, brown, 1 1/8" wide..... **\$17.50** SLNG027
- TYPE 99 Leather Sling w/steel hardware, brown, 1.5" wide..... **\$17.50** SLNG008

JAPANESE ARISAKA CLEANING RODS

- TYPE 99
- LONG ROD @29 3/16"..... **\$17.95** CLN044
- SHORT ROD 23 3/4"..... **\$14.95** CLN126
- LAST DITCH' TRANSITIONAL ROD @4 7/8"..... **\$12.00** CLN147
- ARISAKA TYPE 1 & 2 PARATROOPER ROD 21 1/2"..... **\$17.50** CLN046
- TYPE 38
- LONG ROD @29 1/4"..... **\$17.95** JAP3803
- SHORT ROD @23 1/4"..... **\$17.50** CLN148
- CARBINE @17"..... **\$19.95** CLN008
- TYPE 100 & ARISAKA PARATROOPER BAYONET \$75.00** BAY279
- BAYONET FROG Late mfg., new for Type 99 and Type 38 bayonets. Excellent reproduction..... **\$9.95** BAY115

Japanese Chrysanthemum Metal Hand Stamp

Metal hand stamp with an overall length of @ 3.25 inches and with an imprint diameter of 5/8 of an inch. Slightly concave embossing face. Perfect for marking WW2 military items with the classic emblem of the military Empire of the Sun! Good for leather, wood, copper, brass and other soft metals... **\$45.00** STAMP15

Toyada Automatic Loom Works WW2 Arsenal Stamp..... \$45.00 STAMP14

Note: Stamps are NON-Returnable unless damaged or incorrect in which case they will be exchanged for the correct one.

TYPE 99 MONOPOD Nice reproduction of the rifle monopod made in steel just like the original. Great way to complete your rifle since most monopods are missing from guns on the market..... **\$29.95** JAP9902



WW2 ARISAKA RIFLE 'PAPERWEIGHTS'

1 set of Cut Arisaka Receivers..... **\$9.95 each.**
or 5 sets for..... **\$38.95** JAP9918



BACK IN STOCK!!!

Japanese Type 99 Pacific Rubberized Canvas Sling
\$19.00 SLNG093



JAPANESE NAMBU TYPE 14 HOLSTER

Clam shell holster as used by Japanese forces in WWII. Very well made hard shell flap and tab with brass hardware
..... **\$40.00** HOL001



JAPANESE WW2 PARATROOPER BANDOLIER

Japanese Khaki bandolier (only)
\$27.95 MISC676

Japanese Khaki bandolier with 17 Brass stripper clips
\$39.95 MISC685



SKS RIFLE PARTS & ACCESSORIES

SKS PHENOLIC STOCK W/ FOREND

China's military machine under Mao, ramped up production of Phenolic or synthetic stocks during the late 60s when it became clear that the tensions along the Sino Soviet border were intensifying toward 'all-out war'. Wood was too precious to strip for the manufacture of millions of Chinese SKS rifles so synthetics were applied to AKs and SKSs alike. Good stocks are getting hard to find. We have a few dozen original SKS stocks w/forend. Some minor color blemishes, but overall very good..... **\$89.95** SKS100

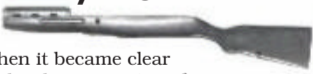

SKS CHINESE STOCK & HANDGUARD



used with metal and handguard.
Good condition **\$89.95** SKS090
Stock is cut for the Chinese spike bayonet.

SKS STRIPPER CLIPS WITH POUCH

These are ORIGINAL MILITARY ISSUE - Not the reproductions we hear complaints about. 10 SKS Strippers w/ Pouch (ammo not included)..... **\$14.95** STC037

SKS STRIPPER CLIPS (NO POUCH)

Original Chinese from 1980's. NOTE! These are original Chinese military from the 1980's! NOT the current Chinese production that many say don't work. Sarco price for quantity (ammo not included): STC024. 1 for..... **\$2.00**
10 for..... **\$13.95**
20 for..... **\$24.00**
50 for..... **\$45.00**
100 for..... **\$74.95**

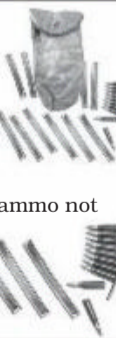

SKS Chinese bayonet blade stock..... \$98.00 SKS092

SKS Chinese Stock with handguard - with bayonet slot filled..... \$89.95 SKS094

SKS043 Accessory kit..... \$9.95	SKS013 Firing pin, new..... \$15.00	SKS036 Rear sight leaf spring, new..... \$4.00
SKS011 Bolt new..... \$45.00	SKS042 Front sight tool, "T" type..... \$3.95	SKS055 Rear sight leaf w/slide..... \$25.00
SKS093 Buttplate..... \$10.00	SKS048 Gas port cleaning tool..... \$2.95	SKS033 Rear sight leaf, new..... \$15.00
SKS072 Buttplate/rear swivel screw..... \$2.00	SKS007 Hold open latch..... \$8.00	SKS034 Rear sight slide, new..... \$6.00
SKS038 Buttplate trapdoor assembly, new..... \$5.00	OIL032 Oil bottle..... \$3.00	SKS016 Recoil spring, new..... \$8.00
SKS056 Buttstock anti rattle spring..... \$3.00	SKS002 Piston extension..... \$20.00	SKS071 Rear swivel..... \$8.00
CLN095 Cleaning jag..... \$2.50	SKS003 Piston return spring, new..... \$5.00	SKS041 Sight tool, "C" type..... \$9.95
CLN092 Cleaning rod..... \$12.00	SKS035 Rear sight button, new..... \$4.00	SLNG041 Sling, exc..... \$6.95
		STC024 Stripper clips..... 3/ \$4.50

JAPANESE ARISAKA

JAPANESE RISING SUN FLAG

Cotton 3'x5' flag with loop on top and cord on bottom like the original WW2 flags. Originally adopted by the Army, but later dominated for use by the Japanese Navy..... **\$18.00** FLAG12



WW2 JAPANESE ARMY CARTRIDGE BELT SET

Excellent quality leather belt and pouch set with bayonet frog as issued to Imperial Japanese Infantry. Very rugged, sturdy, high grade belt set with brass buckle. Consists of belt, 3 pouches and frog. Adjusts out to 46 inches SALE!..... **\$39.95** MISC489



JAPANESE WW2 TROPICAL ARMY HAT

Available in 4 sizes:
7-1/4",
7-1/2",
7-5/8",
7-3/4"
\$19.95 HAT07 **NEW!**



JAPANESE INFANTRYMAN'S OIL BOTTLE

Steel oil bottle with brass top as issued to infantry in order to keep their rifle operational. New..... **\$16.95** JAP9916



WW2 JAPANESE ARMY HELMET W/ NET

Steel helmet complete with suspension, chin strap, and helmet net as used by Japanese forces during WW2. Excellent quality and perhaps even better than the original. New made..... **\$54.95** HLM038



AK RIFLE PARTS & ACCESSORIES

13

AK 47 (AMD65 HUNGARIAN HANDGUARD)

Stamped steel handguard in excellent condition actually can work nicely for all sorts of AK and specialty gun projects. Strong and only 4.4 ounces! Original GI..... **\$12.50** HNGD54



JUST FOUND!

ORIGINAL MILITARY AK FIRE CONTROL PARTS SETS

Consists of hammer, trigger, disconnecter..... **SALE!! \$14.95**
3 for..... **\$39.95** AK067

Also found - Just a few...
ORIGINAL AK AUTO SEARS..... \$14.95 AK068



5 & 10rd WASR Magazines in 5.45 x 39 cal.

AVAILABLE NOW!

See Our Website!

REDDISH/BROWN AK-47 GRIP WITH LONG SCREW

Used in excellent shape. Reddish Brown Grip alone..... **\$22.95** GRP219
Reddish Brown Grip with Screw... **\$25.00** GRP223
Long grip Screw alone..... **\$3.00** AK080



BLACK AK-47 GRIP W/ COMPONENTS

Used excellent condition original AK parts: Black Grip alone..... **\$7.00** GRP220
Black Grip w/ screw, washer, bottom cap..... **\$16.95** GRP224
Screw & Washer for black grip..... **\$7.00** AK081
Bottom Cap for black AK grip..... **\$3.00** AK082



AK47 SLINGS

Khaki..... **\$6.95** SLNG033-TAN
Black..... **\$6.95** SLNG033-BLK



Only a half dozen remaining



WW2/Korean Era British Map Reader
Tactical Magnifying D-cell Operated Lighting w/ Grid
ORIGINAL !!!
Original British / Commonwealth tactical map reader with internal light, magnifier lens and 2 sets of grid lines for use with military geodetic mapping. Makes reading your position on a map under low light conditions very simple whether you need to plot your coordinates, provide a grid position, or call in Artillery. Uses 2 standard D cell batteries. Original, in Unissued in box!!! Extremely limited and probably won't see these again..... **\$69.95** MISC873

SKS/AK 'C' TYPE SIGHT TOOL

The original unbreakable carbon steel "C" tool. The "C" tool enables elevation and windage adjustments to the front sights of AKM, SKS, Galil, and similar semi-automatic rifles..... **\$9.95**
3 for..... **\$24.95** SKS041

More Parts Just in the Door...

- AK47 Disconnecter, GI used exc..... **\$7.00** AK069
- AK47 Hammer, full auto, GI used exc **\$8.95** AK070
- AK47 Muzzle bearing, round, GI used exc..... **\$4.50** AK071
- AK47 Rate reducer assy, GI used exc **\$5.00** AK072
- AK47 Sear spring, GI used exc..... **\$4.00** AK073
- AK47 Trigger single hook, GI used exc **\$9.95** AK074
- AK47 Trigger double hook, GI used exc..... **\$9.95** AK075
- AK47 Trigger Guard Assy. with catch GI used exc. **\$20.50** AK076
- Dust Cover..... **\$10.00** AK042
- Extractor gage (orig.)..... **\$19.95** AK036
- Blank Adapter..... **\$3.95** AK013
- Broken Shell Extractor for 7.62 x 39 Good for SKS & AK **\$2.99 ea.**
4 for ... **\$10.00** BSE020
- AK 3 PRONG FLASH HIDER - M16 pattern. Looks neat on gun..... **\$8.95,**
3 for..... **\$25.95** AK033
- AK47 MAGAZINE LOADER FOR LOADING & UNLOADING - Double thumb depressing levers. Makes the process easier..... **\$17.99** AK048

JUST IN! AK RIVET SETS

Complete set of the PROPER rivets needed to build an AK..... **\$9.95** AK051

Back In Stock! AK SEMI PARTS PACK
Correct parts for building an AK Semi Auto. Counts as 3 compliant parts under US Sec.922r. Made in the USA by High Standard..... **\$25.95** AK052

AK63 / AMD-65 COMPENSATOR

Steel flash hider/compensator for AK47 Rifles such as the AK-63, AMD-65, and similar AK47 variants with the same threaded muzzles. 2-7/8" long, 3.95 oz. weight, 14 x 1 left hand thread. Helps make the AK more controllable in automatic or fast semi firing. SALE!..... **\$8.95** ~~\$19.95~~ MISC562

AK STRAIGHT MAGAZINE POUCH

Excellent condition **\$4.00** AK064

HUNGARIAN AMD65 FOLDING BUTTSTOCK ASSEMBLY

Excellent condition AMD65 right side folding wire stock is exceptionally strong, low weight, and stable making it perfect for Hungarian AKs, and any project that you might have. Complete w/ trunnion assy. Very limited..... **\$57.00** AK077



STANDARD RPK M72 BIPODS

Just in the door, we have excellent condition Yugoslavian M72 series bipods. Perfect replacements and terrific for gun projects where a solid versatile bipod is required. M72 Bipod..... **\$27.00** AK078



SARCO LUGER PARTS

www.sarcoinc.com
See our website for OUR Original Luger Cleaning Kit (#CLN171)

LUGER SIDE PLATE ASSEMBLY... BACK IN STOCK!

Complete side plate with trigger lever and trigger lever pin installed!
Minor fitting required
..... **\$59.95 LGR067**

LUGER PUT AWAY OR SHOP KIT

Extractor, Ejector, Firing pin, Main-spring, Extractor spring, Firing pin spring, Locking bolt spring \$104.50 value - Sarco's Price
..... **\$69.95 LGR161** Stash It Now!

LUGER SPRING KIT

All the coil springs in a Luger - mainspring, trigger spring, firing pin spring & extractor spring.
..... **\$9.95**, 3 for **\$26.75 LGR138**

WE HAVE LUGER 'ARMY' & 'NAVY' WOOD MAGAZINE BOTTOMS - SEE OUR WEBSITE!

LUGER DRESS-UP SET

Get one of our Luger holsters, a pair of new checkered wood grips, and a new magazine loading tool. All 3 pieces, a \$58.00 value. Only **\$49.95/set LGR082**

LUGER ARTILLERY STOCK HOLSTER RIG

Exact reproduction of the Luger Artillery model leather holster rig used by German troops. Our Artillery holster rig includes the holster itself, cleaning rod, carrying strap, leather pieces to connect to a stock board, and 2 pocket magazine pouch which goes on the carry strap. We offer this set with a wood stock and without a wood stock:

1. Wood Stock with Black leather Artillery Holster Rig **\$129.95 LGR175**
2. Black Leather Artillery Holster Rig (without stock) - includes carry strap & magazine pouch..... **\$34.95 LGR176**

LGR170	1908 Trigger bar	\$45.00	LGR020	Firing Pin, beautiful & new	\$19.95 ea.
LGR044	ARMY LUGER WOOD BOTTOM.....	\$9.95 ea		3 for	\$49.95
	or 5 for	\$45.00	LGR022	Firing pin spring	\$3.00
LGR043	NAVY LUGER WOOD BOTTOM	\$9.95 ea	LGR023	Firing Pin Spring Guide.....	\$19.95
	or 3 for	\$27.95	LGR159	Full Spring Kit (new) - springs for: hold open latch, extractor, locking bolt recoil, sear bar, trigger mag catch, firing.....	\$44.50
LGR153	Breech bolt new, perfect current production.....	\$99.50		May require minor fitting of rails due to variation in receivers	
LGR048	Double mag pouch, Leather	\$9.95	LGR030	Grip screw	\$5.00
LGR087	Double mag pouch w/2 wood base mags (current production).....	\$56.50	LGR040	Hold open latch spring, new May require minor fitting due to variations in frame slot length	\$8.00
LGR146	Ejector, M1900 beautiful new production	\$67.50	LGR156	Locking bolt spring	\$12.00
LGR016	Ejector, late model, new production	\$29.95	LGR061	Mag catch spring	\$8.00
LGR145	Extractor, M1900 beautiful new production	\$67.50	LGR050	Mainspring (recoil)	\$4.50
LGR084	Extractor, new production	\$26.95	LGR072	Sear bar (trigger bar) spring, repro	\$8.00
LGR142	Extractor, new production - a wee bit narrow but works fine. Need cleaning up of the casting - dirt cheap	\$10.00	LGR149	Side Plate, Original, milled, in the white	\$49.00
LGR019	Extractor spring	\$2.00		Check our websites for more Original Luger parts	
LGR160	Extractor & Firing pin combo	\$44.50	LGR066	Side plate, stripped	\$36.50
			LGR062	Thumb safety, Late Orig	\$50.00
			LGR074	Trigger lever	\$19.95
			LGR073	Trigger lever pin repro	\$7.75

LUGER ARTILLERY BOARD STOCK WITH METAL

(stock may require final fitting)
..... **\$74.95 LGR157**

LUGER ATTACHING STOCK IRON

Sarco sells the metal part that allows you to attach a stock onto the Navy or Artillery Luger. This is newly machined and has all of the contours of the original military part. We have sold these on our own wooden stocks for years. Great for fixing a bad stock or for making your own custom fit Luger stock. Limited SALE..... **\$44.95 \$49.95 LGR148**

LUGER TOOL W/ EARLY MARKING

Just in, some Luger tools with the pre WW2 Eagle with drooping wings common on 1930s Lugers
..... **\$8.45 LGR180**

LUGER LOADING & DISASSEMBLY TOOL WITH WW2 MARKINGS

\$8.45 LGR068

LUGER GRIPS SPECIAL!!

Just made a large purchase of beautiful checkered wood grips for the ever-popular Luger pistol. These are the nicest looking reproduction grips we've seen. Sharp checkering, nice color, and properly finished edges make this a sure-fire winner. Due to variations in frames some minor fitting may be necessary. Dress up that old import Luger today GRP118 **Special of the month \$19.95, 3 for \$49.95**

NAVY LUGER STOCK

We are selling this hardwood Luger Navy Stock originally manufactured in Spain, without the attaching iron for the pistol, but with the metal data disc installed. These are the last of what we brought into Sarco in the late 1980s. Good for making your own custom luger stock with some ingenuity. May be blemishes.... **\$39.95 LGR187**

LUGER ARTILLERY SIGHT

Finally back in stock, but only a handful! Graduated leaf assy out to 800 yards. New mnfr.
..... **SALE! \$135.00 \$150.00 LGR077**

1936 BROWNING HI POWER HOLSTER / STOCK RIG

Leather combination of 'Sam Brown model belt' and holster to hold the 1935 Hi Power pistol and wood stock. Assembly includes leather belt (adjust between @39-46 inches), a mag pouch (hold 2 mags), cross strap, and leather holster which will hold the 1935 Hi Power pistol and the original style board stock in separate pouches. Wood stock or pistol not included **\$115.00 BHP077**

See our website for our LUGER SNAIL DRUM HOLSTER !!

BROWNING HI-POWER HOLSTER

Well-made copy of the holster as used by German forces after occupation of the Browning factories. Marked with German code and Waffen marks.
..... **\$24.95 HOL021**

KHAKI MILITARY STYLE CANVAS BELT W/ BLACK BUCKLE

JUST IN !!
Khaki web belt used by the military and perfect for casual wear!
Buckle is steel and overall length is 54" which allows you to cut it back to the actual size you need. We provide an extra brass 'lip' to place on the 'belt end' once you cut it back to the size you need
..... **\$8.95 MISC871**

OD MILITARY STYLE CANVAS BELT W/ BRASS BUCKLE

JUST IN !!
Olive Drab web belt used by the military and perfect for casual wear!
Buckle has sliding lock and overall length is 64" which allows you to cut it back to the actual size you need. We provide an extra brass 'lip' to place on the 'belt end' once you cut it back to the size you need.
..... **\$8.95 MISC870**

OD MILITARY STYLE CANVAS BELT W/ ANTIQUED BRASS BUCKLE

JUST IN !!
Olive Drab web belt used by the military and perfect for casual wear! Buckle has sliding lock and overall length is 54" which allows you to cut it back to the actual size you need. We provide an extra brass 'lip' to place on the 'belt end' once you cut it back to the size you need. Buckle is fashionably antiqued brass color.
..... **\$8.95 MISC869-GREEN**

KHAKI MILITARY STYLE CANVAS BELT W/ ANTIQUED BRASS BUCKLE

JUST IN !!
Khaki cotton web belt used by the military and perfect for casual wear! Buckle has sliding lock and overall length is 54" which allows you to cut it back to the actual size you need. We provide an extra brass 'lip' to place on the 'belt end' once you cut it back to the size you need. Buckle is fashionably antiqued brass color. **\$8.95 MISC869-TAN**

GALIL LOVERS

Do you need the attaching pin & spring for the detachable Galil bipods? We had 'em made as we needed them too. They don't exist! Have a few from over production **\$14.95/set GAL111**

Just Found from the old Colt Deal - ORIGINAL COLT POLICE POSITIVE FIRING PINS!

\$11.00 CPP11

MOSIN NAGANT 91 ACCESSORY KIT

\$28.95 N91052



MOSIN NAGANT RIFLE

SEE OUR WEBSITE FOR A FULL LIST OF ALL MODELS OF MOSIN PARTS & ACCESSORIES

ORIGINAL MOSIN M91/30 BAYONET
\$16.95 BAY019
MOSIN NAGANT 91/30 BAYO Exc w/ New Scabbard, excellent condition
\$32.00 BAY084
MOSIN NAGANT M91/30 & EARLY CARBINE BAYONET
Mosin short 11.5 inch
\$44.95 BAY261

MOSIN NAGANT 91 CLEANING KIT, ORIGINAL
\$9.95 N91051

1. Takedown tool
2. Cleaning Jag
3. Cleaning Rod Handle Set
4. Muzzle Cleaning Rod Guide
5. Hold All Pouch
6. Oiling Kit, Original

MOSIN NAGANT SUPER CLEANING KIT
Takedown tool, Cleaning Jag, Cleaning Rod Handle Set, Muzzle Cleaning Rod Guide, Hold All Pouch, Oiler, 2 ammo pouches and 10 stripper clips..... **\$26.50 N91056**

- ### Contains:
- 2 ammo pouches
 - 1 soft pouch
 - 1 sling
 - 1 oiler
 - 1 combo tool
 - 2 jags and a few assorted parts

MOSIN DOG COLLAR 91/30 SLINGS

Original Russian
\$19.95 SLNG103

MOSIN NAGANT LEATHER SLING

The leather Mosin Nagant sling was used early on in the issuance of the Model 91/30 rifles **\$19.95 SLNG119**

Mosin rifle stripper clips in stock again - 3 for \$2.35, 10 for \$7.50

STC014

MOSIN-NAGANT RIFLE ACCESSORIES

1. PAIR OF RUSSIAN AMMO POUCHES, original Mosin Nagant.. **\$9.95 N91045**
2. CLEANING ROD HANDLE Handle for cleaning rod issued on every rifle **\$4.95 CLN086**
3. FINNISH M28/30 new original handguard..... **\$24.95 N91041**
4. Original Finnish Mosin oiler (few only) **\$6.95 N91069**
5. FIRING PIN PROTRUSION GAGE & Screwdriver Tool **\$15.00 TOOL050**

MOSIN DOG COLLAR 91/30 SLINGS

We have been out for six months just found a new batch. New mnfr
\$12.95 SLNG018

JUST IN THE DOOR ORIGINAL SLINGS FOR MOSIN MODEL 38 & MODEL 44 CARBINE

We've been out for a year
..... **\$14.95 ea.**
3 for **\$34.95 SLNG060**

MOSIN NAGANT RIFLE PARTS

N91052	Accessory Kit M91	\$34.95	N91004	Firing pin	\$19.95
N91040	Ammo pouch	\$6.50	N91082	Follower Arm M91	\$7.50
N91086	Bolt body, Grade 2 pitted	\$29.95	N91041	Handguard, Finnish M28/30	\$14.95
N91084	Bolt Comp w/Extractor	\$59.95	N91020	Lower band 91/30	\$8.00
N91005	Bolt connector & guide bar	\$16.50	N91067	Lower mag Follower Spring	\$5.00
N91006	Bolt head	\$19.95	N91079	M39 Finnish Rear Sight Base Spring	\$10.00
N91087	Bolt Head w/ extractor	\$29.95	N91015	Mag follower assy w/ floorplate M91	\$18.00
N91033	Buttplate	\$7.95	N91016	Magazine floorplate	\$12.00
N91043	Cleaning Kit	\$4.95	N91050	Oiler, Original, Brass, Double Spout	\$3.95
N91051	Cleaning Kit Original M91	\$9.95	N91036	Rear sight leaf and slide assembly M1891/30 (type 4)	\$15.00
N91030	Cleaning rod, Carbine, 1907	\$16.95	N91037	Rear sight leaf M1891 (type 2)	\$13.00
N91029	Cleaning rod (model 91/30)	\$15.00	N91055	Rings Only for PU Scope Original	\$95.00
N91028	Cleaning rod handle	\$10.00	N91045	Pair of Russian Ammo Pouches	\$9.95
N91001	Cocking piece	\$15.00	N91081	Scabbard, leather w/belt loop and brass ball tip - 91 & 91/30	\$14.95
N91011	Ejector	\$14.00			
N91009	Ejector spring	\$12.00			
N91007	Extractor, generic	\$19.95			
N91080	Extractor, reproduction	\$19.95			
N91003	Firing pin spring	\$6.00			
N91078	Sniper Bolt, Comp w/ Extractor	\$159.95			
STC014	Stripper Clips M91 3 for	\$2.35			
	10 for	\$7.50			
N91025	Stock lug assembly	\$12.00			
N91056	Super Kit - Cleaning w/2 ammo pouch & 10 stripper clips	\$26.50			
N91057	Super Kit - Cleaning w/Bolt orig, 2 ammo pouch, 10 stripper clips	\$51.50			
N91066	Take down tool	\$3.95			
N91014	Trigger guard stripped	\$19.95			
N91013	Trigger spring & bolt stop	\$22.00			
N91012	Trigger	\$8.00			
N91062	Triggerguard & Magazine Assy Comp. Exc 100% blue	\$29.95			
N91018	Upper band 91/30	\$8.00			

ORIGINAL MOSIN RIFLE BOLTS

These bolts fit all Mosins including Dragoon, Cossack M1891 Rifle, M1907 Carbine 91/30 Rifle, M1938 & M44 Carbines, & Finnish models. Also fits Sniper but bolt not bent. Complete bolt w/extractor **\$59.95 \$89.95 N91084**

ALMOST GONE! Can you believe we started with 17,000?!



BROWNING HI POWER

FINALLY BACK IN STOCK!!!!
GET YOURS NOW BEFORE THEY'RE GONE AGAIN!!!

BROWNING HI-POWER WOOD STOCK
Brand New! **\$145.00**
NFA Rules Apply BHP055

Original FN Early Browning Hi Power Extractors few only! **\$49.95 BHP014**

F.N. HIGH POWER 9MM MAGAZINES

Brand new magazines. New commercial quality. 13 rd., blue Ea. **\$17.95**, 3 for **\$49.50**, RPM105 Browning Hi Power Magazine Loader..... **\$4.95 BHP072**

BROWNING HI-POWER GRIPS

Newly manufactured synthetic grips with the look of black wood grips. Panels are knurled like the original grips **\$19.95 GRP179**

SEE OUR WEB PAGE FOR EXTENSIVE HI POWER PARTS LISTING

BROWNING HI-POWER LANYARD RING & SCREW

& STUD ASSEMBLY New **\$19.95 BHP069**

FABULOUS CURRENT PRODUCTION

FN pattern wood Hi power Checkered grips. Just like previous FN production. Need minor fitting inside mag well **\$17.50**
3 for **\$44.50 GRP174**

HI POWER STOCK FROG

As used with the Inglis wood stock. Allows you to attach the wood stock to your belt. Canvas with metal clip just like the original **\$12.95 BHP076**

SARCO

PISTOL AND RIFLE MAGAZINES

WANTED TO BUY
up to 5 Grizzly .45 Winchester magazines.
Call and ask for Cholly, Dave or Mark!

STOCKS AND FORENDS

Seriously the best deal we have offered in a long time on wood for firearms under the mfg names such as Mossberg, Marlin, H&R, Savage, Ithaca, S&W, and Winchester. 15 different stock and forends at a fraction of the cost and with no duplicates. Total Value \$587.00, but Sarco's Special Price is 1 LOT (all 15 pieces) for..... **\$150.00** or buy 2 LOTS for..... **\$265.00! STK363**
This is a great opportunity for Gun Show sale items and if you sell 3 of the 15 items, you're out of it!
PLEASE NOTE: There is a \$20 Handling Fee on this item



Super Commercial Stock Deal...all brand new original stocks and forends!

BEST PRICE ANYWHERE !!!

GLOCK 17 - 17RD, 9MM MAGAZINE
Composite magazine holding 17 rds.
.....**\$11.99 RPM292**



MAS 49 & 49/56 MAGAZINE
Original 10 rd, 7.5mm French issue magazine. Sold out months ago, but a got a few more back in. Get 'em while you can!
.....**\$49.95 RM018**



See e-sarcoinc.com for extensive magazine listings

STAR 9MM SUPER MAGS
ORIGINAL MAGS FOR STAR MODELO SUPER 9MM LARGO.
\$29.95 RPM132

LORCIN .380 AUTO
Had no stock for years.
\$17.50, 3 for **\$44.95** RPM276



TOKAREV 7.62x54 RIFLE MAGAZINES
New Condition
.....**\$79.95** MISC053



COMPLETE SAVAGE 1905 (Original Body!) .32 AUTO MAG SALE!
\$30.00
~~\$40.00~~ RPM282



RASHEED RIFLE MAG - ORIGINAL!
Very Limited
\$100.00 RM40



HUNGARIAN FEG P9R/P9RK PISTOL MAGAZINES
Made for the Hungarian High Power clone P9R/P9RK pistol. New 10 rd. original replacement mags. These magazines DO NOT fit the FEG P9M or FEG P9. These do not fit FN or Canadian Hi Powers. Check your gun—No Returns. Sold elsewhere for \$25.00! SARCO price. **\$19.95** ea. RPM106

HUNGARIAN FEG AP-MBP PISTOL MAGAZINE
Original 8 rd. steel magazine in very good condition. 7.65mm. Hard to find so stock up now!
.....**\$29.95** RPM315



G43 RIFLE MAGAZINES
BACK IN STOCK!! **\$54.95** G43001

MAGAZINES FOR M16/AR15 USGI M261 CONVERSION KIT
We've got both the U.S. Army M261 magazine in steel (right), and the rare U.S. Air Force version 'Teflon' magazine (left). Army M261 .22 Magazine **\$24.95** M26120
Air Force .22 Magazine **\$75.00** RM44



CZ-52 PISTOL MAGAZINE
Steel CZ-52, 8rd magazine for 7.62x25mm Ammunition. Original CZ mag body! Get one now before they're gone again!
.....**\$17.50** CZ5202



DESTROYER CARBINE MAGS
\$7.95 ea, 10 for **\$50.00**, 25 for **\$79.50** RM004



ASTRA 400 MAGS
9mm Largo - original
\$24.95 3 for **\$64.95** RPM159

MAGAZINES FOR WINCHESTER .22 RIFLES
(Current production) for model 75, 52, etc.
\$19.95 RM002 - found a few more

RIFLE MAGAZINES

ITEM NUMBER	DESCRIPTION	PRICE
RM61	#4 MK1 .202 10rd.....	\$29.95
	3/.....	\$84.95
	10/.....	\$229.95
BRN003	BRNO .22 LR bolt action 10 shot mag, Original.....	\$39.95
RM004	Carbine Destroyer.....	\$6.95
RM64	CZ-452 Rifle 10rd Original, steel. Fits CZ-452 rifle and holds 10rds of 22LR. Also good for the Norinco JW-15 rifle. Excellent Condition.....	\$70.00
RM101	Franchi SPAS-15 mag.....	\$135.00
RM39	Joloar, Orig.....	\$60.00
RM43	KKW Mauser & MAS 45 .22 training rifle mag, Original.....	\$24.95
RM011	Lee Enfield MKIII 10 Round, Refurbished.....	\$29.95
RM012	Lee Enfield MKIII 10 Round, Early version w/follower retainer tab.....	\$42.95
RM001	.22 Hornet M4 survival rifle magazine, original.....	\$49.95
RM40	Rasheed, original.....	\$100.00
RM85	Swiss KE 7 Neuhausen LMG.....	\$9.95
RM58	VZ52 Rifle 7.62x45.....	\$64.95
RM72	VZ52 Rifle 7.62x39, 10rd Orig. Exc.....	\$75.00
VZ5801	VZ58 Rifle 7.62x39, 30rd.....	\$17.95, 4/\$70.00
RM002	Winchester M52.....	\$19.95

RPM035	CZ-Model 1936.....	\$26.00
RPM038	Mauser Model 1910.....	\$35.00
RPM037	Mauser WTP, New.....	\$28.00
RPM039	Ortgies.....	\$34.00
RPM040	Raven.....	\$21.95
RPM041	Sterling Model 300.....	\$26.00
RPM042	Unique.....	\$26.00
RPM043	Walther Model # 8.....	\$36.00
RPM044	Walther Model # 9.....	\$42.00
RPM045	Walther Model 2&5.....	\$28.00
RPM046	Webley Model 1906/1909 w/o Ejector.....	\$28.00

.32 CALIBER

RPM047	Astra Model 300/3000, Side Magazine Catch.....	\$26.00
RPM048	Bayard Model 1908.....	\$34.00
RPM049	Beretta Model 1919.....	\$34.00
RPM050	Beretta Model 1934.....	\$38.00
RPM051	Beretta Model 70 Puma.....	\$36.00
RPM053	Browning Model 1900.....	\$35.00
RPM054	Browning Model 1910.....	\$35.00
RPM055	Browning Model 1922.....	\$35.00
RPM263	1922 Browning German Marked.....	\$50.00
RPM056	Colt Model 1903.....	\$34.00
RPM057	CZ Model 1927.....	\$43.00
RPM058	Dreyse Model 1907.....	\$34.00
RPM059	Femaru Model 37.....	\$40.00
RPM193	French Mod 1935 A Long, 8rd. Orig.....	\$65.00
RPM170	French Mod 1935 S, 7rd, Orig.....	\$65.00
RPM060	Frommer Stop.....	\$36.00
RPM064	MAB Model D .32 ACP orig.....	\$22.95
RPM065	Mauser 1914, repro.....	\$47.00
RPM066	Mauser Model HSC.....	\$42.00
RPM067	Ortgies.....	\$36.00
RPM070	Sauer Model 38-H.....	\$46.00
RPM072	Steyr.....	\$28.00
RPM073	Walther Model #4.....	\$35.00
RPM075	Walther PP/PPKS, early flat side repro w/ finger rest.....	\$38.00
RPM076	Walther PPK.....	\$34.00
RPM078	Webley.....	\$30.00

.38 & .357 CALIBER

RPM079	Colt Model 1900 .38 Auto.....	\$38.00
RPM151	Colt .38 Super.....	\$29.00
RPM080	Llama .38 Super, Narrow Floorplate.....	\$30.00
RPM081	Llama Model 6 .38 Super.....	\$30.00
RPM082	Llama Model 8 .38 Super.....	\$30.00
RPM083	Star Model A .38 Super 9mm.....	\$38.00

.380 CALIBER

RPM084	Browning Model 1910.....	\$35.00
RPM085	Browning Model 1922.....	\$35.00
RPM088	Colt Pony (Star-Model D).....	\$38.00
RPM153	Colt Mustang.....	\$28.00
RPM089	CZ DA Model 1938.....	\$36.00
RPM090	CZ Model 1924.....	\$30.00
RPM091	Femaru P-37.....	\$40.00
RPM092	Frommer Stop.....	\$28.00
RPM093	H&K Model # 4.....	\$35.00
RPM094	Mauser HSC Reproduction.....	\$40.00

ITEM NUMBER	DESCRIPTION	PRICE
RPM095	Ortgies.....	\$36.00
RPM096	Remington Model 51.....	\$35.00
RPM097	Savage Model 1910/1917.....	\$36.00
RPM098	Walther PPK.....	\$32.00
RPM099	Walther PPK/S.....	\$27.00

8MM CALIBER

G43001 German G43 New MFG..... **\$54.95**

9MM CALIBER

RPM290	.22 TCM/9mm 17 round.....	\$32.99
RPM159	Astra Model 400.....	\$24.95
RPM101	Astra Model 600.....	\$36.00
RPM316	Beretta 92 FS, 10rd.....	\$19.95
RPM150	Beretta Brigadeer & Helwan.....	\$30.00
RPM105	Browning Hi-Power 13 Round, Blued (9mm Caliber).....	\$17.95
RPM106	Hungarian Hi-Power P9R.....	\$19.95
RPM107	Lahti Original SALE.....	\$7.95 \$20.00
RPM109	Radom.....	\$45.00
RPM110	S&W Model 39.....	\$26.00
RPM111	Star BM, BKM, BKS Starfire, Starlite.....	\$36.00
RPM152	Star Firestar.....	\$30.00
RPM114	Star Model B.....	\$35.00
RPM132	Star Super 9mm Largo (9x23).....	\$29.95
RPM112	Taurus Model 92.....	\$14.95
RPM102	Glisenti repro.....	\$60.00
P38079	Walther P38 1960 'banner marked' Military mag w/Nato stock #.....	\$39.95

40 S&W

RPM317 S&W Model 4053, 8rd..... **\$24.95**

.41 & .45 CALIBER

C45376	1911 Black Nickel Finish (.45cal).....	\$12.50
RPM307	1911 Stainless Steel 15 rd. (.45 ACP).....	\$17.95
RPM308	1911 Blued Steel 15 rd. (.45 ACP).....	\$17.95
RPM289	1911 Double Stack 13 round (.45 caliber).....	\$24.99
RPM309	1911 Drum (.45 caliber).....	\$64.95
RPM319	1911 .45 Cal 8rd, Blued Magazine.....	\$12.99
RPM158	.45 1911 Compact Magazine.....	\$24.95
RPM269	1911 9mm 10 Round Magazine.....	\$24.95
RPM119	Ballister Molina (.45 Caliber).....	\$5.95
RPM121	Colt Model 1911 Stainless Steel 7 round (.45 Caliber).....	\$14.95
	3/.....	\$40.00
RPM303	Desert Eagle 8rds.....	\$35.00
RPM266	Norwegian Model 1914 Original (.45 caliber) Rare, w/loop.....	\$65.00
RPM118	Star Model S.S. (.45 Caliber).....	\$38.00
RPM117	Star Model PD (.45 Caliber).....	\$42.00

RARE RIFLE STOCKS

MSR366	1908 Brazilian Mauser long rifle stock, good cond.....	\$85.00
MSR366A	1908 Brazilian Mauser long rifle stock - Select (very few only).....	\$99.00
MSR375	1908 Brazilian Mauser long rifle stock with handguard, good cond.....	\$105.00
MSR375A	1908 Brazilian Mauser long rifle stock with handguard - Select (very few only).....	\$120.00
BM59037	BM59 stock & handguard set, new in wrap SALE!.....	\$65.00 \$85.00
CC053	Carcano 38 stock - new, nice arsenal rework.....	\$99.50
FAL305	FAL/FALO stock & forend - RARE.....	\$250.00
FN49001	FN 1949 .30-06 cal stock, good condition - will rework well (we did one) - Complete with handguard set.....	\$99.95
FN49068	FN49 .30-06 stock.....	\$135.00
FN49078	FN49 .30-06 stock & handguards reworked in our shop (this is a reworked #4).....	\$159.95
HKR001	Hakim stock, new original used, very nice.....	\$195.00
M36058A	MAS 36/51 stock set w/all metal.....	\$125.00
STK345	Mossberg144 stock, used exc.....	\$45.00
STK385	Mossberg 42B military stock.....	\$36.50
STK339	Norinco JW15 .22 bolt action clip fed rifle stock, new original.....	\$34.95
P14012	P14 Enfield stock.....	\$200.00
P17059	P17 Enfield Stock Set - good cond.....	\$230.00
P17044	P17, Front handguard new walnut. Also fits P14.....	\$19.95
P17045	P17, Front handguard used walnut. Also fits P14.....	\$18.00
P17061	P17, Front handguard new hardwood. Also fits P14.....	\$34.50
P17060	P17, Front handguard used hardwood. Also fits P14.....	\$15.00
P17046	P17, Rear handguard new walnut. Also fits P14.....	\$32.00
P17047	P17, Rear handguard used walnut. Also fits P14.....	\$22.00
P17062	P17, Rear handguard new hardwood. Also fits P14.....	\$25.00
P17063	P17, Rear handguard used hardwood. Also fits P14.....	\$20.00
STK004	Remington 1934 military rifle stock, good.....	\$200.00
STK343	Remington 513T target rifle stock, used VG - low comb.....	\$29.95
STK341	Stevens 416 .22 TGT stock, VG used, orig.....	\$65.00
STK342	Stevens 416 .22 TGT stock w/buttplate, new orig.....	\$100.00
STK344	Winchester 75 TGT stock stripped, original, used.....	\$49.95
STK401	Winchester 75 TGT stock with all hardware, original - Good/VG condition.....	\$89.95
MSR669	Yugoslav M48 Mauser Rifle Stock, good condition.....	\$85.00

(Note: For special selection on Winchester 75 stocks, please add \$15)

Just in!
RARE SPAS-15 MAGAZINE
12 GA, 6 rounds, parkerized steel, new. Best price going
\$135.00 RM101

AK .22CAL LR (ORIGINAL EAST GERMAN) 15-20 ROUND MAGAZINE AK .22 cal mag extends from 15 to 20 rounds
SALE.....\$9.95 ~~\$15.00~~ AK006

BRAND NEW ORIGINAL TOKAREV MILITARY PISTOL MAGAZINES
Just in! SALE.... **\$9.95** ~~\$18.00~~, 3 for **\$26.95** ~~\$49.95~~ RPM160

BROWNING HI POWER
13 round - Super price.
.....**\$17.95**, 3 for ... **\$49.50** RPM105

AR15/M16 100RD DRUM
Front of drum is colored while the rear is clear to see remaining rounds. The package comes with a dust cover, a mag loader and a carrying case..... **\$115.00** AR383
Specify drum color when ordering:
Tan, w/black pouch
Green w/green pouch
Call for availability on Black drum w/black pouch (\$125.00) See our page 12 or our website for Hi Cap Mag restrictions

See our website for **PARA ORDNANCE MAGS!!**

TAURUS M92 & M99 9MM MAGAZINE
Super price
..... **\$14.95** ea, 3 for **\$42.95** RPM112

ORIGINAL TOKAREV PISTOL MAGAZINES 7.62x25
1. Standard mag for Chinese model 213 or Russian TT30 **SALE !!**
..... **\$9.95** ~~\$18.00~~ ea, 3 for .. **\$26.95** ~~\$49.50~~ TOK052
2. Pakistan Frontier Constabulary/ Security Service TT-30/TT-33 Tokarev magazine. 8rd. 7.62x25 Tokarev, New..... **\$18.00** ea, or 3 for **\$49.95** RPM322

There are many variations of RUBY - See our website to get the corrcrct magazine

LAHTI PISTOL MAGAZINES
Genuine Swedish surplus magazines for the 9mm Model 1940 Lahti Pistol. Excellent condition RPM107
SALE!!!..... **\$7.95** ea. 3/..... **\$19.95**

MAGAZINES FOR REMINGTON .22 RIFLES
New, blued steel replacement magazine for the 513T series of Rem. .22 rifles and all Rem series 500 rifles 5rd..... **\$19.95** RM058

Airguns For Sale S3000

AIRGUN REPAIR & SERVICE
 Factory authorized Crosman, Benjamin and Sheridan warranty service. We also repair Daisy, Beeman and many other makes of pellet and bb guns. No firearms. Most repairs \$65-\$100. We buy used airguns and parts. In business since 2005.
ACCURATE AIRGUNS LLC
 Ph: 360-656-5123
 Email: airguns@comcast.net
 Website: accurateairguns.com

A Miscellaneous For Sale S3100

AMF M1 Navy Trophy Rifle. .308
 Caliber. Approximately 5,000 survived. Looks unfired with box and some documents. \$13,500. Doug Oefinger 863-444-1849. No pictures.

Colt Named Model For Sale S3280

Colt 1918 B.A.R. serial number 1. Excellent condition. Original wood. No Bipod. Used as a display gun at Colt.

\$325,000. Serious inquiries only. Doug Oefinger 863-444-1849. No pictures.

Heckler & Koch (H&K) S3780 For Sale

California D.O.J. HK Model 94. Ex D.O.J. gun, refinished. \$6,500. Doug Oefinger 863-444-1849. No pictures.

Luger Handguns For Sale S4080

LUGERS, P-38'S.

Military Arms For Sale S4200

1903 A4 Sniper, Overall condition excellent. "W" stamped behind the trigger, came from the National Guard in the 1960's. \$7,500. Doug Oefinger 863-444-1849. No pictures.

www.StormWerkz.com
Small Arms Upgrades
Made in USA

1903 COLT U.S. property marked 32 and 380 cal. boxes with proper instruction sheet, paper and cleaning rod. \$39.95 plus postage. Ray 847-854-6608.

GOVERNMENT 1911 A-1 .45 cal. surplus Kraft boxes: Colt, Remington, ITHACA, US&S with wrapping paper. \$27.75 plus postage. Ray 847-854-6608.

BLUEPRINTS
 American 180, AN-M2, Austen,

INTRODUCING THE ALL NEW...

HELLFIRE STEALTH

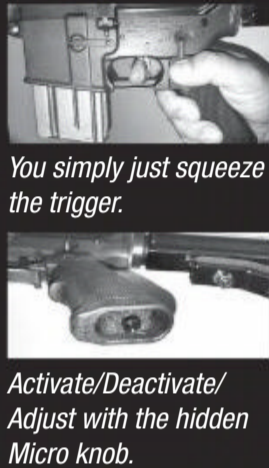
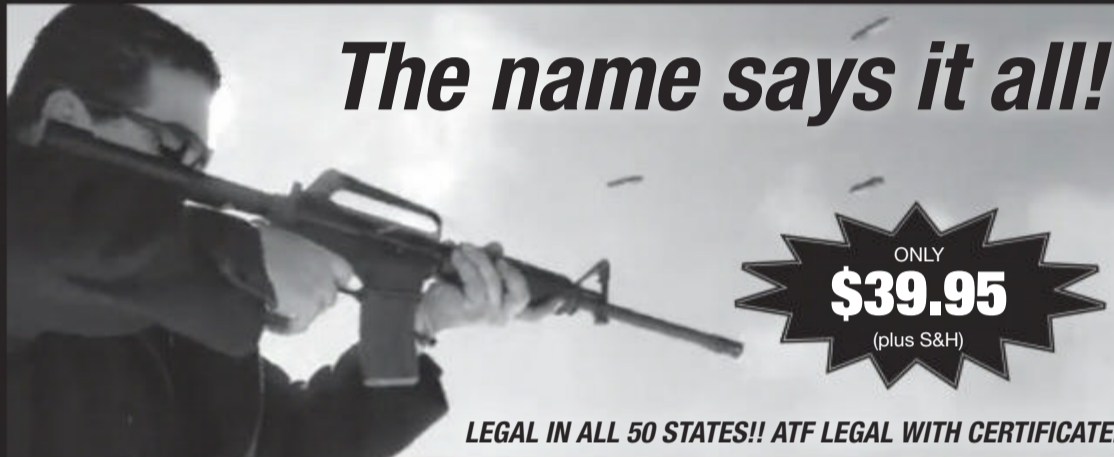

This incredible new system installs invisibly within your grip on any AR15 style rifle invisibly. It can be activated or deactivated in seconds. It legally allows you to pull your guns trigger at it's highest rate legally. It installs in minutes and nobody but you will know it's there. It features a micro-adjust for activation and deactivation. It looks absolutely built in. It is revolutionarily the best rapid fire system for these new volatile times. Get them now before new laws outlawing "Fast Shooting" arrive. This may very well be the best system ever devised for AR15 platforms. It is constructed of all Steel for a lifetime of reliability. The shooter always maintains control and single function of the trigger so you can fire single, double, bursts or empty mags and it is the only system that is 100% legal for now in all 50 states!

ONLY AT ROCKINLOCK.COM AND FIREQUEST.COM

AAO WWW.AAOMFG.COM
FOR MORE INFORMATION CALL US AT: (601) 514-0660



AR9 Dedicated Glock Magazine 80% lower with Last Round Bold Hold Open \$109.99



80% AR15 Lowers - .223/5.56 - Mil-Spec \$38.50



AR9 Dedicated S&W M&P Magazine 80% lower with Last Round Bold Hold Open \$109.99



Mil-Spec Lower Parts Kits \$42.00

We are a family owned and operated business that specializes in manufacturing innovative products for the 2A lifestyle.

Broom Handles, Nambus, Accessories, German, Japanese, War Relics. List \$2.
Hoffman,
4105 Stephanie,
Branch, MI 49402.
231-462-3594,
863-291-3594.

FLECHETTE SHOTGUN AMMO
 LONG RANGE - BORE SAFE - HIGH PERFORMANCE
 STEEL DARTS
 12 GA PATENTED SABOT HOLDS 19 NEW HEAT TREATED 8 GR FLECHETTES MV 1925 FPS 2 3/4" SHELL - CALL OR ORDER ONLINE
 12GA 10RDS 12GA 25 RDS 12GA 100RDS
 PRICE INCLUDES GROUND SHIPPING
SABOT DESIGNS LLC
 541-770-6047 10AM-5PM PST
 WWW.SABOTDESIGNS.COM

RUGER MINI-14 RANCH SCOPE MOUNT

The absolute best mount for the Ruger Mini-14 Ranch. Machined from solid bar stock & made in the USA.



S&K Scope Mounts

70 Swede Hollow Rd - Sugar Grove, PA 16350, 800-578-9862
 Email: comments@scopemounts.com

www.scopemounts.com

12 GAUGE PISTOLS



Your LEGAL-TO-OWN answer for the modern sawed-off double barrel shotgun.



209 Primer IGNITION ML | No license or FFL required, order direct

Check out our entire product line at

AMERICANGUNCRAFT.COM/products/
 Dealers-Distributors: Inquire about special resale programs

Berretta 38A, Bar, BMG 30, 50, Czech25, 383, FN-FAL, Hotchkiss, Kommando, Lanchester, Mac-10, Madsen, Mat-49 28-A1, M1A1, M3A1, M-16, M-37, M-203, MG-34, MP- 34, 38, 40, 41, Owen, PAF, PPSH-41, PPS-43, Reising, SIG-57, Sola, Star, Sten II & V, Sterling, Suomi, Swedish K, UD-42, Vickers, Vigneron, Yugo 49, 56. \$15 each or 2/\$25, Complete package \$125. MG-42 and M-14 are \$25 each. Make payment to: C. Shillig PO Box 25932, Colo. Springs, CO 80936 wmem1a1@gmail.com

Military/Automatic Arms For Sale S4220

AKM Underfolder Conversion Gun. \$25,000. Serious inquiries only. Doug Oefinger 863-444-1849. No pictures.

Aircraft Lewis Gun Reg. Live but welded together, blued, no magazine.

Granpa's Gun Parts
US Springfield Parts
Krag, 1903, Trapdoors,
Muskets & More!
www.granpasgunparts.com

Handi-Racker.com

The Safest Way to Rack Your Pistols

Load and unload
 Clear Jams
 Aids in disassembly
 Aids in assembly

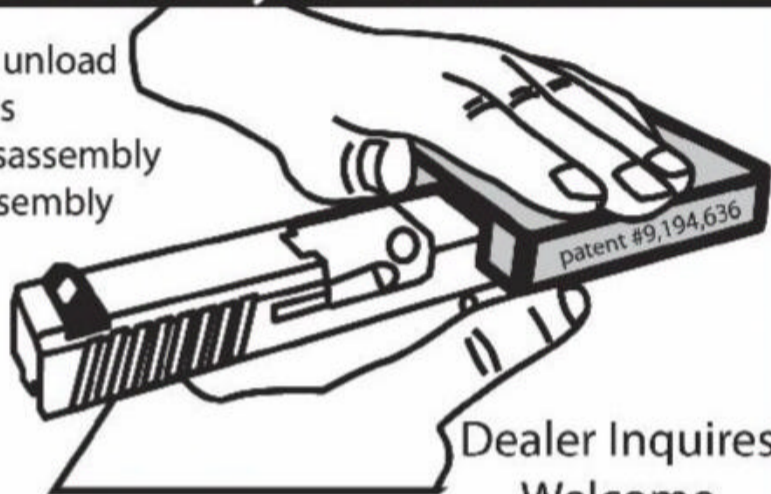

Dealer Inquires Welcome

MSRP was ~~\$29.99~~
 NOW only \$24.99

(515) 480-4905

We Have a Huge Selection of Old and Hard to Find Shooting Supplies and Accessories!

Holsters | Gun Cases
 Ammo | Reloading | Sights

Free Digital Catalog!



208 263-6953

8am - 4:30pm M - F PST
 660 Vermeer Court, Ponderay, ID 83852

WWW.BUFFALOARMS.COM

GET IN THE RELOADING REDZONE™

LOCK-N-LOAD® AP™ LOADER

The Lock-N-Load® AP™ is the easiest, ready-to-use reloading press you can buy. Lock-N-Load® technology allows you to stop loading, change dies and start loading another caliber in a matter of seconds. With a single pull of the handle, you can feel precision engineering at work with ultra-smooth indexing and quick-change die bushings. Reload up to 500 rounds per hour with the most efficient and advanced progressive reloading press available today.

- Patented Lock-N-Load® Die Bushing System
- Lock-N-Load® Powder Measure with Quick Change Metering Insert
- Case Activated Powder Drop
- Automatic Indexing
- Automatic Priming System
- Reliable EZ-Ject™ System



GET LOADED!

Purchase the AP™ and get FREE bullets!
 See hornady.com for details.



Hornady
Accurate. Deadly. Dependable.

Dies, bullets and cases not included

800.338.3220 | HORNADY.COM

Military/Automatic Arms S4220 For Sale

\$11,000. Doug Oefinger 863-444-1849. No pictures.

MP40 Good numbers matching with matching magazine painted black and appears to have never been blued. \$18,000. Doug Oefinger 863-444-1849. No pictures.

T161/M60 .308 caliber, excellent condition, C&R eligible. \$65,000. Doug

Oefinger 863-444-1849. No pictures.

CLASS II FULL AUTO DRILLING FIXTURES For MAK-90/AK-47 (w/ pins & bushing)--\$48.50 shipped or AR-15/M-16, M-11/9 & HK--\$33.50 shipped. All NFA Rules Apply. Order online at www.ftfindustries.com or mail to:

FTF Industries, Box 68, Hildebran, NC 28637 (cert. funds, M/C or Visa).

Colt M16-A1 Full Auto, Original Colt 3X Scope, Colt 5.56 Magazine,

Original NAM PM Manual. Florida Residents Only. Joel 772-285-3597. \$25,000.

CZ24 REPLACEMENT Receiver Tube Section w/template. 4130 tubing with correct OD & ID \$45.00 Shipping \$5.50

Keller Enterprises, PO Box 563, Safety Harbor, FL 34695. 727-726-2500 www.stenparts.com

PPSH41 RECEIVER Section \$50.00, PPS43 Receiver Section \$50.00,

PPS43S Trunnions \$30.00 Shipping \$11.50 Keller Enterprises, PO Box 563, Safety Harbor, FL 34695. 727-726-2500. www.stenparts.com

STEN MkII \$30, STEN MkIII \$35, Sterling \$35, Yugo 56 \$45; Receiver Tubes w/bonded templates made from 4130 Tubing. Correct OD/ID Shipping extra. Keller Enterprises, PO Box 563, Safety Harbor, FL 34695.

727-726-2500. www.stenparts.com

STEN MARK II, III, & V spring kits \$20, \$5 shipping **KELLER ENTERPRISE** PO BOX 563 Safety Harbor, FL 34695. 727-726-2500 www.stenparts.com

.50 BMG UPPERS, .50 BMG RIFLES www.SHTF50.com

STEN MARK II & III BARRELS, New Manufacture, Original Length \$45.00; AMD-65 extended muzzlebrakes AK74 style \$27.00, Shipping \$5.50 each. **KELLER ENTERPRISES,** PO Box 563, Safety Harbor, FL 34695. 727-726-2500. www.stenparts.com

DEPOT LEVEL Maintenance on your U.S. Military Machine Guns. Most M16, M60 and .50 cal. parts in stock. We can put your M18 or M20 recoilless rifle back together. Sub-cal units available. M60 Mil Spec Channels Parked \$150. Gunsmith 203-605-4578.

UNLEASH INCREDIBLE FIREPOWER WITH THE NEW HELL-FIRE GEN2™

- ◆ Installs quickly and easily
- ◆ Looks built in and part of your rifle
- ◆ Non Bumpfire Technology
- ◆ Can be shot firmly against shoulder
- ◆ Select fire Micro Adjust knob
- ◆ Can be fired with one hand for pistols
- ◆ Adjustable rate of fire-Up to 900 rpm
- ◆ ATF legal certificate
- ◆ Can be retrofit to most anything
- ◆ Made in USA-All Metal- Patent Pending



\$59.95

(plus S&H)



ALL NEW SNAP-ON VERSION ONLY \$34.95

ROCKINLOCK.COM ♦ FIREQUEST.COM ♦ (770) 249-2991

Tremendous Variety Of Custom Classic Cartridge Brass and Specially Cast Bullets



Whether it's a classic American, British or European metric caliber, we can supply new formed brass, specially cast bullets in almost any caliber. That includes Maynard types, as well as rimfire and pinfire cartridges! Need a 8.15x46R bullet with central driving band? We have them... along with .310 Cadet factory bullets and six-sided Metford bullets. We also offer reloading tools and dies.

If you want it we can make it!



This is a partial caliber list:

6mm Lee Navy	.32 Remington	8x60 RS	.401 WSL	.43 Egyptian	.45-120 Sharps
.25 Remington	8mm Kirtz	.33 Win.	.41 Colt	.44 Bull Dog	.50-70 Govt.
6.5x53R Dutch	8.15x46R	.351 WSL	.401 Herters	.44 Russian	.50-95 WCF
7.35 Italian	8mm Lebel	9mm Jap Rev.	.40-60 WCF	.45 Colt blank	.50-110 WCF
32 French Auto	8x50R Siamese	9mm Mannlicher	.40-65 WCF	455 Webley	.50 x 3/4"
.310 Cadet	8x52R Siamese	9.5mm Mannlicher	.40-82 WCF	.45-60 WCF	.56-46
.303 Savage	8x56 Mannlicher	.35 Win.	11mm French Rev.	.45-70 blank	.56-50
7.63 Mannlicher	8x57 R360	.38-56 WCF	.43 Spanish	.45-75 WCF	.56-52
.32 WSL	6x58 Sauer	4-in-1 blank	.43 Mauser	.45-90 WCF	.577 Snider

Bob Hayley

211 North River, PO Box 889, Seymour, TX 76380 Phone (940) 888-3352

M1 CARBINE PARTS

Download Our FREE Catalog!! www.bestcarbineparts.com

Carbine Barrels
Stock Pouches
Slings & Early Oilers
Stocks & Handguards
Type I Early Flip Sights

- *Type I, II Dog Leg Hammers
- *Flat & Round Bolts: \$95.00 & Up
- *Front Bands Type I, II & III
- *Front & Rear Sights
- *Swivels (All Mfgs.): \$18.00 & Up
- *Mag. Rel. Type I, II & III: \$32.00 & Up
- *M1A1 Recoil Plate Covers: \$65.00
- *M1A1 Butt Plate Springs: \$10.00
- *M1A1 Coil Springs (Pistol Grip): \$10.00
- *Type I Band Screws: \$7.50

*** Celebrating 30+ Years***

L&S SUPPLY, INC.

22211 Lofton Ave. N
Scandia, MN 55073

E-Mail: Issupply@spacestar.net

Or call: (651)773-9972

15 DAY 100% Satisfaction Guaranteed

!! FINALLY !! A 1911 PISTOL BEAVERTAIL JIG THAT WORKS!



BUY NOW AT:

1911denver45.com / Amazon / 303-210-2030

Miniatures, Replicas For Sale S4234

Gatling Guns made by Furrs Arms, 1/3 scale in 22 short. Models 1874 & 1883 on carriages. Both beautifully made museum pieces. Rare. Email for prices and pics; randyman@ncidata.com 509-826-5512.

Remington Rifles For Sale S4440

FOR SALE: 700 R5 Military .300 WIN Mag. Nightforce Scope 8-32x55. \$3,200 or Best Offer. 561-271-0721 for info.

Remington Rifles Wanted S4441

Buying Remington No. 1 Rolling Blocks & Hepburns in Long Range Creedmoors, Mid-Range, Short-Range and Schuetzen Target Models. 509-826-5512, randyman@ncidata.com

R Miscellaneous For Sale S4560

M55 Reising. Came from H&R in the 1980's. No metal on the wood stock. \$12,000. Doug Oefinger 863-444-1849. No pictures.

Accessories For Sale S5200

AMMO, Antique/Obsolete, in original boxes. Most American sporting calibers

including obsolete rimfires. NO lists, reloads, military/foreign. Ray Giles, RTG Sporting Collectibles LLC, 214-361-6577 www.rtgammo.com

Antiques S5270

SARCO, INC. -MIG 21 jet fighter cockpit section from the DDR (East German) Air Force. We have only one single-seater. ATF will not allow the import of military aircraft, so this is the end. Ours was saved from the smelter at the last possible minute. The single-seater will be missing the stick and maybe some instruments. The cockpit was cut out of existing planes that were phased out of service. **Single cockpit MIG - \$9000.00 MMP011.** Please call us at (610) 250-3960 to order

AMG INTERNATIONAL ARMORY
(All Military Gunsmithing)

Military Gunsmith
35 yrs. Experience

Former NATO Defense Contractor

Kit Building / Rebuild / Repair / Refinish
• FN-FAL • FN-49 • M-1 • Garand
• M-1 Carbine • British Enfields • M-1A
• AR-15 • 98's • O3's
• All U.S. and Foreign Rifles & Pistols Repaired and much more!

Full Mil-Spec Finishes Including:
Parkerizing, Manganese Phosphate, Polymer, Teflon, Porcelainized Enamel and Bluing.

Premium AK Builds and Other Custom Builds Available!

GUY SNELEN • email: guyamg@centurytel.net
Phone: 417.754.1097 • M-F 9AM-4PM CST

RUBEN MENDIOLA DEALERNFA, INC.

PO Box 566300, Miami, FL 33256-6300, 305-271-3436
TOLL FREE: 866-NFA-WANT (866-632-9268), FAX: 866-415-7066,
CELL: 786-256-6746 for pics or text, EMAIL: Ruben@dealernfa.com
HOURS: 8am-9pm Eastern, 7 days a week

!WANTED!

ALL TYPES OF QUALITY LEGAL MACHINE GUNS!



NO COLLECTION TOO LARGE! GENEROUS FINDER'S FEES GLADLY PAID!

Estate and Machine Gun Appraisals!
Before Selling Your Guns, Please Call Me To Make Sure You Are Getting The Most For Them!
CONSISTENTLY PROVIDING EXCELLENT AND DISCREET SERVICE & FAIRLY PRICED HIGH QUALITY MACHINE GUNS SINCE 1985!

Attorney Available for Trust or Estate Matters.

WE PAY UP FRONT

100% of the Agreed Price Before You Ship Your Guns!
You Will Never Have To Wait Until I Sell Your Guns in Order to Be Paid!
100% Risk, Worry & Hassle Free Transactions!
Avoid the Uncertainty of Consignment or Brokering!
Specializing in Investment Grade Transferable Machineguns
Specialist in Law Enforcement Purchases and Cashless Trades



www.dealernfa.com
ALWAYS PAYING TOP DOLLAR!

Introducing the "ALL NEW"

HYPERGAT TRIGGER SYSTEM

Fits most all Rifles and Pistols .22 to .50cal



"Bump-Firing"
"Slide-Firing"

No Technique required!

BEST of ALL No High Price!!

\$49.95

"FORCE MULTIPLYER" Complete with the "Hypergat" Trigger System.
Mounts easily- Does not obstruct trigger-600 to 1000 rpm
"Fully auto type Fire" - ATF Legal

THIS IS THE EASIEST BEST RAPID FIRE TRIGGER SYSTEM IN THE WORLD! IT IS THE ONLY SYSTEM THAT WORKS ON .22'S PERIOD.

Go to our website or Call 970-417-4860 and get yours today!!

See our AMAZING videos on our website!

WWW.HYPERGAT.NET

Antiques \$5270

this item. These are oversized items. Cockpit shipped via truck at our 55% discount. See pictures of the actual unit and read more by visiting our website www.E-Sarcoine.com.

Barrels For Sale \$5280

CORSON'S BARRELS 1000 New, Used, and Obsolete Shotgun Barrels.

Buy, Sell, Trade. 928-718-4282
Arizona. dccorson@citilink.net,
www.corsonsbarels.com

Clips & Magazines For Sale \$5380

VEPR & SAIGA METAL MAGAZINES U.S. Made.
Also, AK floor plates. See us at:
CSSPECS.COM
or Call 386-490-1102

Original Clips for Old Guns,

Collector & Unusual, No Modern,
I have the Hard-to-Find,
No Aftermarket, Buying
765-546-8314

Gun Parts For Sale \$5500

Charles Daly Miroku Shotgun Repairs.
Original Parts. Gunsmith with over
forty years experience with CDM
shotguns. We have 10,000 parts plus
12 other firearms manufacturers. B&C
Gunsmithing Call Monday-Thursday,

TACTICAL GLOCK ACCESSORIES

Everything you won't find just anywhere

New Hellfire
Legal Auto Fire
\$39.95

Glock Props
\$39.95

• Stocks **\$39.95**

• Arm Braces **\$49.95**

• Scopes **\$29.95**

• Hand Grips **\$19.95**

• Lasers **\$24.95**

• Pistol Lights **\$14.95**

Call 770-249-2991 or visit
www.rapidfiretriggers.net

ATAC DEFENSE

ATACDEFENSE.COM
(601) 963-0300

ADER 5.56 - ATAC DEFENSE ENHANCED RIFLE



AMBI SAFETY & AMBI MAG RELEASE WITH
OVERSIZED MAG BUTTON, LARGE AMBI
CHARGING HANDLE AND BOLT RELEASE,
MUZZLE BRAKE, NICKEL BORON COATED
C158 BOLT CARRIER GROUP, ENGAGE
HAND GRIP AND MINIMALIST STOCK

ADER - \$1299

ADBR 5.56 - ATAC DEFENSE BASIC RIFLE

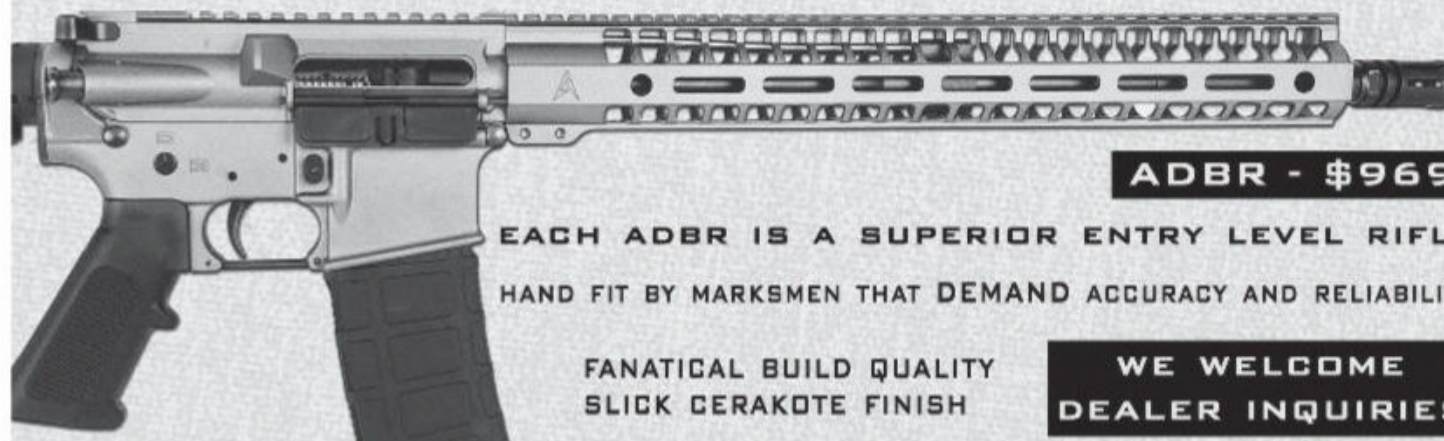

ADBR - \$969

EACH ADBR IS A SUPERIOR ENTRY LEVEL RIFLE
HAND FIT BY MARKSMEN THAT DEMAND ACCURACY AND RELIABILITY

FANATICAL BUILD QUALITY
SLICK GERAKOTE FINISH

**WE WELCOME
DEALER INQUIRIES**

ANYTIME ANYWHERE

DIGITAL ACCESS NOW INCLUDED WITH YOUR PAID SUBSCRIPTION!

ENJOY DIGITAL ACCESS ON YOUR PHONE, TABLET & MORE*



SUBSCRIBE TODAY AT

WWW.FIREARMSNEWS.COM

CURRENT SUBSCRIBERS GO TO MYMAGNOW.COM
AND SELECT "CREATE DIGITAL ACCOUNT"

*Digital Edition is available on updated iPad/iPhone, most Android devices, and the Microsoft Store for Windows

12 noon - 4pm,
928-854-8209.

ORIGINAL PRECISION
MANUFACTURER OF
LOCK DELETE
FOR S&W REVOLVERS
UNIVERSAL MOONCLIP
TOOL
MOONS DEMOONS RIM OR NON
RIM BRASS
MULTI-CAL 32 THRU 460 ALL
BRANDS
J.D. @ 480-305-3236
ORIGINALPRECISION.
COM

GUNSMITH'S Assortment: Screws,
springs, pins, 100 pieces, \$14.50 plus
\$5 shipping: Poppert's, Box 413,
Glenside, PA 19038.
www.PoppertsGunParts.com

COLT Lightning Springs. One each
of the following: Trigger spring, Hand
Spring, Strut Spring, Cyl stop spring,
Ejector spring, \$24.50 per set plus \$5
shipping.
Poppert's, Box 413, Glenside, PA
19038. www.PoppertsGunParts.com

GUN PARTS: You name it.
Professional service since 1965.
General Parts List, \$5. Traders Den,
1655 Olson Dr., Cook, MN 55723.
Mail order or by appointment only.
218-666-5083.

Gunsmith & Dealer Services **S5540**

Firearms Refinishing. No More Rust!
Parkerizing, Moly, Ceramic. Call 337-
230-4815, alomar.resources@cox.net

PMD Gunsmithing
Specializing in Firearm
Restoration
Rebluing, Stock Refinishing, and
Repair. Better than New!
www.pmdgunsmithing.com
Call 330-240-5960 to receive FREE
SHIPPING both ways with your
restoration project.

RICK'S PLACE
Master Gunsmith
Full Line Gunsmith Shop

CBRPS LLC.
AK
SKS
Saiga
Ruger
Remington
Mosin Nagant
Bullpup stock kits
www.cbrps.com

REPAIRS & RESTORATIONS
Metal & Wood Refinishing
Custom Barrels-Stocks-Grips-Guns
Choke Tube Installation/Removal
Barrels Threaded
Shotgun Barrel Straightening
Appraisals - FFL Transfers
Fire & Flood Insurance Claims
Bad@\$\$ Stuck Choke Tube
Removal Tool & Other
Custom Gunsmith Tools
More Services on Website
501-658-7347
rick@ricksplace.biz
www.ricksplace.biz

BARREL RELINING in .22 RF,
25-20, 32-20, 38-40, 44-40. Installing
the finest liners, manufactured by
Redman's. Professional Craftsmanship
Guaranteed. Established shop of 41
Years.
Redman's Rifling & Reboring,
189 Nichols, Omak, WA 98841.

CROSSCUT SAW COMPANY

THE FINEST IN PEOPLE POWERED GOODS
P.O. Box 7872, Seneca Falls, N.Y. 13148
315-568-5755
www.crosscutsaw.com
Quality Saws, Knives, and
Hard-to-Find Tools.
Catalog \$1 U.S. (\$3 Foreign)

MILLIONS OF GUN PARTS!!
WE NOW HAVE 300 MODELS ON THE WEB
VISA-MASTER-DISCOVER
Company Check or MO.
BOB'S GUN SHOP
P.O. Box 200
Royal, AR 71968
FAX 501-767-2750
www.gun-parts.com
gunparts@hsnp.com

STACKIN' EM DEEP AND SELLIN' EM CHEAP
CENTERFIRE SYSTEMS since 1992
GIVE US A CALL! IN-HOUSE CUSTOMER SERVICE REPS 6 DAYS A WEEK!

LOCK ORIGINAL FACTORY PARTS
OEM Factory GLOCK Very Good Condition, 40S&W Replacement Parts Kit **\$339.99** #KIT-G22
GUNSMITH'S Garage
1975 Original! Romanian AK 7.62x39mm Rifle Parts Kit with Wood Furniture **\$299.99** #KIT-AK33

FEAR-HIG SEMI-AUTO AR STYLE 12GA SHOTGUN Accepts ALL MKA-style Mags & Drums!
Includes: (2) 5rd mags, (4) chokes + case #SG0116 **\$399.99** compare to \$529.99

PPS43-C 7.62x25mm pistol **MADE IN POLAND**
★★★★★ PPS43-C 7.62x25mm Pistol with (3) FREE! 35rd Mags includes (1) 35rd magazine #PPS43-PS **\$419.99** compare to \$529.99

Over 100 Mags & Drums for Glock starting at **\$9.99**
50rd 9MM Drum for GLOCK Pistols #DRUM003 **\$69.99**
AR-15 223 100rd Drum **\$9.99**
40S&W/9MM/45ACP Hi-Cap Mags for Glock YOUR CHOICE **\$14.99**

Original - U.S. PALM AK30 30rd 7.62x39mm AK-47 TangoDown Polymer Magazine Date Stamped May 2015 #MAG0585 **\$21.99** compare to \$39.99
20 or 30 round AK-47 Magazines starting at **\$9.99**

Over 100 AK-47 HiCap Mags & Drums to choose from
75rd AK-47 Drum #DRUM005 **\$59.99**
40rd AK-47 Magazines #MAGAKA-KR40 **\$14.99**

COLT Authentic Parts
Vietnam Issue Colt AR .223 M16A1 Parts Kit unmarked #KIT-AR-COLF-D **\$249.99**

New Production Complete .45ACP M1911A1 Pistol Parts Kit **\$349.99** #KIT-191101

GEAR HUNTING TARGETS HOLSTERS FIREARMS MAGAZINES AMMUNITION OPTICS PARTS ACCESSORIES EAR&EYE PRO SURPLUS
M-F 9-6 Sat 9-2
800-950-1231 & CENTERFIRESYSTEMS.COM
and SO. MUCH. MORE...
PRICES & AVAILABILITY SUBJECT TO CHANGE WITHOUT NOTICE

Gunsmith & Dealer Services S5540

509-826-5512.
Prices & info www.redmansrifling.com

BROOMHANDLE BARREL RELINING
Broomhandles to 30 Mauser using

the finest liners. Rust bluing available. Guaranteeing the finest job around. Established shop of 41 years. Redman's Rifling & Reboring, 189 Nichols, Omak, WA 98841. 509-826-5512. Prices & Info: www.redmansrifling.com

REAMERRENTALS.COM ONLINE CATALOG

400+ Calibers Available. Call (800) 996-0426.

Gunsmith & Dealer Supplies S5560

BARREL LINERS: 17 Mach II, 22RF, 25-20, 32-20, 38-40, 44-40. Satisfaction Guaranteed. Prices & info on website at

www.redmansrifling.com

Gun Barrel Reboring Machine (hydraulically operated), tooling & training. This equipment is for reboring an existing barrel up to a bigger size. Not cheap but a rare opportunity. 509-429-6856.

Pratt & Whitney Sine Bar Rifling Machine. Call 509-429-6856.

SARCO, INC.- COMMERCIAL GUN STOCK LOTS FOR SHOW SALES! Fabulous opportunity to buy

new commercial stocks & forends for brand names like Mossberg, S&W, Ithaca, Marlin, H&R, Winchester, Savage, etc. **One lot of 15 Stocks & forends with no duplicates for \$150.+Sh. (STK363).** Sell 3 pcs and your out of it! Rest is profit. Multiple lots get better price! Great for gun show and store sales. Sarco Inc. **610.250.3960** or visit www.E-Sarcoinc.com for a vast wealth of goodies !!

Militaria For Sale S5700

NAZI, JAPANESE -- ITALIAN Daggers, Swords, Medals, Hats, Documents, Standards, etc. I buy collections, also interested in: Parts, Broken Daggers, Swords & Bayonets. Send \$2 for Large List. Since 1963. Mike Warren, P.O. Box 566, Bethpage, NY 11714.

SOVIET MILITARIA!

Trade & Buy. Send \$3 for Catalog. **RUSSIAN STORE** 7657 Winnetka Ave, Suite #203, Winnetka, CA 91306 818-999-1257 russianstoreinla@yahoo.com

Indian Relics - B.C.

\$1.00 for Color Catalog. Indian, P.O. Box 246 Independence, KY 41051

Militaria Wanted S5701

I Want to Buy Firearm and Militaria Collections. 605-321-4402, Leave Message. ds57110@live.com

Miscellaneous For Sale S5720

Ugly But Cheap! Prehistoric Authentic Indian Arrow Heads. Complete Undamaged. Found Lake Ozark Missouri. 21 For \$27.50. Makes Nice Display Frame. Indian Head Cent \$3.00; Silver Eagle, \$25.00. Satisfaction Guaranteed. Richard's 126-FN Honeysuckle, Eldon, MO 65026.

COINS OF WAR! Civil War Token VG+ \$24.95 each, 3 Different Nazi Coins \$4.95, 3 Different Coins of South Vietnam \$3.95. Free Price List. U.P.C.&C., P.O. Box 222, Hazelhurst WI 54531.

Reloading Components S5800 For Sale

BRASS
Once Fired Range Cleaned.
9mm. \$35/1000
40 S&W \$35/1000
223/556 \$80/1000
For Other Calibers Call Chuck. 623-341-9122. www.bremersbrass.com

RELOADERS
All Pistol & Rifle Calibers, Inspected & Polished. 817-834-5716 thbrassman@aol.com

SABOTS!
4,000 FPS out of your .30 caliber rifle? It's possible with our sabots! You can

THE ALL NEW "HELLFIRE RANCH™" RAPID FIRE TRIGGER SYSTEM FOR "NON-ASSAULT RIFLES". (PAT PEND.)



\$39.95
(plus S&H)

Snaps in place easily!

- Perfect for MINI-14, MINI-30, 10/22, and most Ranch Style Rifles with or without pistol grips.
- Goes ON and OFF in seconds.
- All Metal Construction.
- Allows for accurate aimed single shots, bursts, or emptying of magazines.
- Perfect for Varmints, Hog Shooting or Protection from any intrusion.
- Rapid Fire availability when you need it.
- ATF legal

INTRODUCING THE "MAGNABRACE™" ADJUSTABLE INSTANT ON/OFF OR PERMANENT PISTOL ARM BRACE. (PAT. PENDING.)



\$69.95
(plus S&H)

- Installs instantly via a super strong directional magnetic system with a 70 lb. pull strength.
- Can be permanently installed with 3m adhesive disc included that is as strong as a metal rivet.
- 3 position snap detent system for quick and positive adjustment.
- Mounts on AK pistols, Dracos, Macs, Uzi and a host of others.
- Adds accuracy and rapid fire controllability.
- Looks fabulous on the guns.
- Tough polymer metal construction with velcro arm strap.
- NFA legality card included.

CALL (770) 249-2992 or go to ROCKINLOCK.COM or FIREQUEST.COM and watch the videos and get yours today!

HEAT TREAT OVENS

Take control of your heat treating. Evenheat offers a full line of heat treat ovens for private and commercial shops. Prices start at \$730

evenheat
www.evenheat-kiln.com

PH: 969-853-2281 FAX: 969-856-4040

QUICK DRAW \$42.95

LOTS OF 24 RIGS VISA, MASTERCARD
WILEY'S, 7009 Co. Rd. 2120 WILLS POINT, TX 75169 1-903-848-7912-FAX-7922 www.wileysguns.com

TOOLED LEATHER - SUEDE LINED - FITS SINGLE ACTION

ASK FOR CAL. 22-38-357-44-45
ASK FOR SIZES: 32-44
FEATURES BROWN COLOR
LOW DROP ON HIP
BBL LENGTHS: 6" OR 7 1/2"

SELL OUT PRICES	24 RIGS \$42.95 EA.
12 RIGS \$44.95 EA.	6 RIGS \$46.95 EA.
4 RIGS \$48.95 EA.	2 RIGS \$52.95 EA.
1 RIG \$59.95 EA.	Plus Shipping

Like, comment and share all the latest news!

www.facebook.com/FirearmsNewsMag

Find us on

UNTAMED ADVENTURE

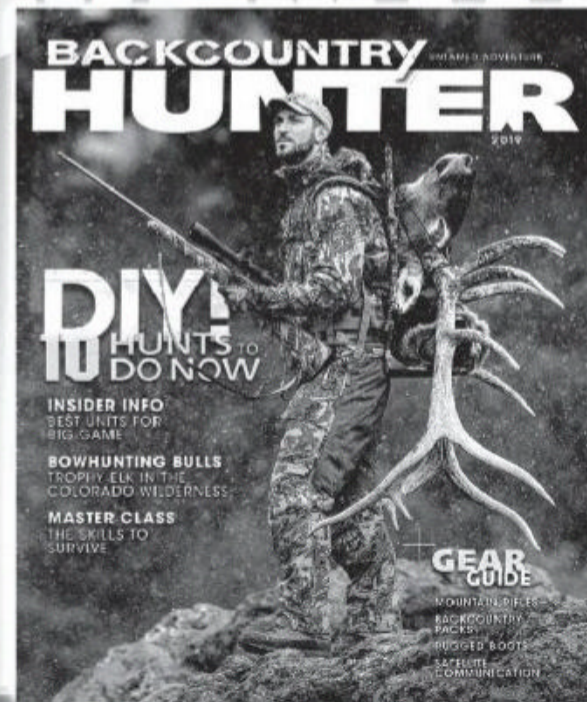

COMING TO A NEWSSTAND NEAR YOU!

LOG ON TO osgnewsstand.com

Also available for iPad, Android Tablets, Kindle & Nook

load and shoot .22 caliber bullets in any .30 caliber cartridge. Our six fluted design enables instantaneous separation of sabot from the bullet at the muzzle. Add \$5 for each order. Utah residents add 6.25% sales tax. No COD's or credit cards.

J&D Components
75 East 350 North, Orem Utah 84057
www.jdcomponents.com

POWDER, BRASS-BULLETS:
Powder: WC844 (223) Virgin surplus 159.00, 4+156.99, WC860-69.00, 4+64.00, SALE WC872-WC867 48.00 Surplus, Unfired Primed LC 223 from ammo 500-79.99, 1000-149.99; 223 LC military 60m, 45 Auto, Tumbled 1000-89.99, 308 LC Primed Unfired Brass, from ammo, 500-140.00; See web for other Military-Commercial Brass: New and Fired **BULLETS:** 308 IMI M-80 147gr. FMJ-500-89.00, Sierra 224-77gr. Special match 500-118.00, WOLF 224 55 FMJ 1000-79.99, Hornady 224 55gr. PSP-FMJ 94.99m, Federal 223 55 FMJ m193 - 94.99m; 223 M855 62 FMJ -124.99; 223-M856 tracer, Military Surplus-99.00m; 50 API Silver Unsized 289m, Sized 339m, 50 Tracer 279.00, sized 329.00 See web for complete 50 Bullet List, plus WW-Remington-Hornady Commercial Bullets:
see web for current Prices:
Brian McDonald
74880 Johnson Run Rd.
Kimbolton, OH 43749
9AM-5PM,
330-833-4360
Fax No. 740-492-0063
Web: PatsReloading.com

SARCO, INC. - FLECHETTE DARTS: 1 inch long military flechettes in stock. Sold in 2 oz. (#MISC288) and 1 lb. (#MISC307) packs. Original USGI. Sarco Inc., 610.250.3960. Visit www.E-Sarcoinc.com for a vast wealth of goodies !!

Reloading Equipment For Sale \$5820

ONCE FIRED Remington 3" Mag 12 or 20ga \$44.95/1000; Remington 12ga High Brass, New Type, Compression Formed, \$39.95/1000; Federal or Remington 3 1/2" 12ga Mag \$79.95/1000. All Prepaid up to zip 57300. Others: Add 10.00/1000. Bob Kase, 3475 Palmyra Rd, Marion, NY 14505.

Reloading Equipment Wanted \$5821

RELOADING EQUIPMENT & Gun related stuff WANTED! Attention Estates, Gun Shops, Collectors! Sell me your no longer used reloading equipment, casting, gunsmithing

equipment & tools. Presses, dies, molds, Stocks, grips and Misc. parts too. I buy the items left over after others buy the guns. Gladly travel for large collections.
Call Rick (330)806-4169 or email ricketts711@sbcglobal.net

Scopes, Rings & Bases For Sale \$5840

RIFLESCOPES
Browse Online Catalog at 4scopes.com
Get Free Shipping!

Stocks & Grips For Sale \$5860

Precision Gunstock Duplicating of any wood. Gunstock repair, custom, restoration, and checking. My pattern and wood or yours. Quality work, fair price, quick turnaround. 570-637-3004, leave message.

Surplus Gear For Sale \$5880

SARCO, INC. - FRENCH 73MM BAZOOKA: LRAC-50 bazooka as used by the post war French in Vietnam & Algeria. Never on the market before. Comes with shield and optics, deactivated to ATF specs. Very limited!
Sarco Inc., 610.250.3960
Visit www.E-Sarcoinc.com for a vast wealth of goodies !!

SARCO, INC. - RPG-2 ROCKETS (INERT) (#RL005): Original Vietnam era rockets with the warhead removed and replacement inert head installed. Great for completing your RPG launchers!
Sarco Inc. 610.250.3960
Visit www.E-Sarcoinc.com for a vast wealth of goodies !!

SARCO, INC. - WW2 VEHICLE RADIO SETS: SCR528 (#RAD04), SCR506 (#RAD02), & SCR508 (#RAD03) radio sets with mounting bases. Perfect for completing your military vehicle. Supplies are dwindling. Sarco Inc., Call Dave or Mark: 610.250.3960 or visit www.E-Sarco.com for a vast wealth of goodies !!

Gun Shows \$6150

ATLANTA, G.A. Jul. 17-18, Atlanta Antique Gun & International Military Show, IAMAW Local 709, Union Hall, 1032 S. Marietta Parkway, Marietta, Ga. Arms & Memorabilia of the Civil War, Indian Wars, WWI, WWII, etc. Info: **Carolina Trader Promotions, 704-282-1339**
www.TheCarolinaTrader.com

RUBEN MENDIOLA

DEALERNFA, INC. SINCE 1985

PO Box 566300, Miami, FL 33256-6300, 305-271-3436
TOLL FREE: 866-NFA-WANT (866-632-9268), FAX: 866-415-7066,
CELL: 786-256-6746 for pics or text, EMAIL: Ruben@dealernfa.com,
HOURS: 8am-9pm Eastern, 7 days a week

100s OF MACHINE GUNS ON SALE!!

Colt M16, M16A1, M16A2, 614, AR15 conversions, DIAS, Auto Links, all types and configurations. HK MP5, MP5K-PDW, HK33, G3, HK51, HK21, Sear, Double Push Pin & Registered Receiver Guns. HK Registered Machine Guns Sears.

Thompsons, Colt 21 & 28, WWII Savage & Bridgeport M1 & M1928 & Commercial Guns, Reisings, M2 Carbines, M3 Grease Guns, FNC, Ruger 556, AK47, MP40, MP44, Stens MKII, S&W 76, MK760, M10 45ACP & 9mm, M11 9mm & .380.

Maremont and Rock Island M60 & M60E6. Belt Fed 1919A4, 1917A1, Browning M2HB .50 Cal, FightLite MCR060 Belt Fed Uppers for AR15 or M16 Platforms.

Extremely Rare Museum Quality Very Early Presentation Colt 1918 BAR

Pre-May Sales Samples Available only to Dealers.

HK MP5, MP5K, HK33, HK53, Steyr AUGs, FN FAL, BAR, UZI Full Size & Mini, M3 Grease Guns, Thompson, Walther MPK & MPL, Beretta 93R LNIB & SC70, Restricted Post Sample: Glock 18

We are Always in the Market to Purchase Quality Machine Guns. We will never sell guns until they have been received and inspected. My staff and I welcome prospective clients to come and inspect the firearms they are interested in purchasing in our state of the art, high security facility. We are dedicated, full time dealers with a full-time staff. Every item we offer for sale is in stock and owned by us. We are not brokers, or a consignment store. We send every HK conversion to Terry Dyer for inspection and upgrade.

Please visit our website for the full list of inventory specials.



WE PROVIDE THE BEST QUALITY GUNS ON THE MARKET.

A Dealer You Can Trust!



www.dealernfa.com
ALWAYS PAYING TOP DOLLAR!

SAXET Gun Shows
JULY 4-5 // SAN ANTONIO, TX
SAN ANTONIO EVENT CENTER
AUGUST 1-2 // SAN ANTONIO EVENT CENTER—SAN ANTONIO, TX
AUGUST 8-9 // RICHARD M. BORCHARD REG'L FAIRGROUNDS—CORPUS CHRISTI, TX
AUGUST 15-16 // MCALLEN CONVENTION CENTER—MCALLEN, TX
SEPTEMBER 5-6 // SAN ANTONIO EVENT CENTER—SAN ANTONIO, TX
FOR MORE INFO: SAXETSHOWS.COM // 361.289.2256

INDEX CLASSIFIEDS

CLASSIFIED CATEGORIES

FIREARMS NEWS offers classified ads in more than 440 categories from airguns to Winchester. Both for sale and wanted categories are available. You can find the classifications at www.firearmsnews.com. Or call (800) 521-2885, ext. 5064.

FIREARMS NEWS is published by Outdoor Sportsman Group®.

Some of the common classifications are:

- Colt M1911 Semiauto Variants For Sale \$3300
- Fabrique Nationale (FN) For Sale \$3620
- Heckler & Koch (H&K) For Sale \$3780
- Military Arms For Sale..... \$4200
- Military Arms Wanted..... \$4201
- Military/Automatic Arms For Sale..... \$4220
- Military/Automatic Arms Wanted..... \$4221
- Remington Rifles For Sale..... \$4440
- SIG Handguns For Sale..... \$4640
- Taurus Handguns For Sale..... \$4840
- Winchester Rifles For Sale..... \$5080

Accessories, Knives, & Gunsmithing Services

- Accessories For Sale..... \$5200
- Accessories Wanted..... \$5201
- Ammunition For Sale..... \$5220

- Ammunition Wanted..... \$5221
- Appraisal Services..... \$5260
- Archery For Sale..... \$5240
- Archery Wanted..... \$5241
- Aviation For Sale..... \$5250
- Antiques..... \$5270

b

- Barrels For Sale..... \$5280
- Barrels Wanted..... \$5281
- Binoculars & Spotting Scopes For Sale..... \$5300
- Binoculars & Spotting Scopes Wanted \$5301
- Books & Magazines For Sale..... \$5320
- Books & Magazines Wanted..... \$5321

c

- Cartridge Collections For Sale \$5340
- Cartridge Collections Wanted \$5341
- Clips & Magazines For Sale \$5380
- Clips & Magazines Wanted..... \$5381
- Cowboy Action Accessories For Sale..... \$5390
- Cowboy Action Accessories Wanted..... \$5391
- Clubs & Organizations \$5420

e

- Education & Home Study..... \$5440
- Engravers..... \$5460

g

- Gun Cleaning Supplies..... \$5475
- Lists, Consignments & Collections For Sale \$5480
- Lists, Consignments & Collections Wanted \$5481
- Gun Parts For Sale..... \$5500
- Gun Parts Wanted..... \$5501
- Gun Safes For Sale..... \$5520

- Gun Safes Wanted \$5521
- Gun Shows \$6150
- Gunsmith & Dealer Services \$5540
- Gunsmith & Dealer Supplies \$5560

h

- Holsters For Sale \$5580
- Holsters Wanted \$5581
- Hunting Guides \$5600
- Hunting Supplies \$5620

k

- Knives & Bayonets For Sale \$5640
- Knives & Bayonets Wanted \$5641

l

- Lost & Stolen..... \$5660

m

- Metallic Sights For Sale \$5680
- Metallic Sights Wanted \$5681
- Militaria For Sale \$5700
- Militaria Wanted \$5701
- Miscellaneous For Sale..... \$5720
- Miscellaneous Wanted \$5721
- Muzzleloader Accessories For Sale..... \$5730
- Muzzleloader Accessories Wanted..... \$5731

p

- POR, Firearms & Miscellaneous..... \$5750
- Print, Stamps & Collectibles For Sale..... \$5760
- Print, Stamps & Collectibles Wanted..... \$5761

r

- Real Estate..... \$5770
- Reloading Components For Sale \$5800
- Reloading Components Wanted \$5801

- Reloading Equipment For Sale \$5820
- Reloading Equipment Wanted \$5821

s

- Sales & Auctions..... \$6120
- Scopes, Rings & Bases For Sale..... \$5840
- Scopes, Rings & Bases Wanted..... \$5841
- Scopes, Laser Sights For Sale..... \$5850
- Scopes, Laser Sights Wanted \$5851
- Services \$5852
- Shooting Events..... \$6140
- Stocks & Grips For Sale \$5860
- Stocks & Grips Wanted \$5861
- Surplus Gear For Sale..... \$5880
- Surplus Gear Wanted..... \$5881
- Swords For Sale..... \$5920
- Swords Wanted \$5921

t

- Taxidermy Services..... \$5940
- Taxidermy Supplies..... \$5960
- Targets For Sale..... \$5980
- Triggers For Sale \$5990
- Triggers Wanted \$5991

v

- Videos For Sale..... \$6000
- Videos Wanted..... \$6001

There are more than 400 other categories: check online or call to get them.

Category _____ PRINT ONE WORD PER SPACE - TWO WORDS FREE

1	2	3	4	5	6
7	8	9	10	11	12
13	14	15	16	17	18
19	20	21	22	23	24
25	26	27	28	FREE	FREE

Please use additional sheet of paper for larger ads.

MAIL completed form to: Firearms News, Dept. CL, 2 News Plaza, 3rd Floor, Peoria, IL 61614
or **EMAIL** ad and all information below to: FirearmsNews@outdoorsg.com

PLEASE INCLUDE FULL ADDRESS & PHONE NUMBER FOR OUR RECORDS

NAME _____
 ADDRESS _____
 CITY _____ STATE _____ ZIP _____
 DAYTIME PHONE _____
 METHOD OF PAYMENT: Check/Money Order Enclosed MC VISA AMEX DISCOVER
 CARD # _____ Exp. Date _____
 SIGNATURE _____

START DATE: _____

X 8pt plain @ 40¢ = _____
 X 8pt bold @ 80¢ = _____
 X 10pt bold @ \$1.00 = _____
 X 10pt bold caps @ \$1.60 = _____
 X 12pt bold @ \$1.80 = _____
 X 12pt bold caps @ \$2.20 = _____
 X _____ # of issue(s)
MINIMUM: \$4.00 \$ _____ **Total Due**

Continue running until notified & charge credit card monthly

**GALLERY
OF GUNS**.com[®]

1,000'S OF FIREARMS

**DAVIDSON'S
Guaranteed**
LIFETIME
REPLACEMENT

**ROCK SOLID
GUARANTEE**

NO HIDDEN FEES
-OR-
TRANSFER FEES



EXCLUSIVE FIREARMS
YOU WON'T FIND ANYWHERE ELSE!



(LIKE THIS ONE?)



FN America 509 with FDE Slide
#66-100600 • 9mm Luger • **17+1** & **24+1** • 4.5" Barrel

**GALLERY
OF GUNS**.com
SEARCH. FIND. BUY.

4

REASONS TO GET YOUR NEXT FIREARM
AT GALLERYOFGUNS.COM!



AMERICAN TACTICAL
**SHEDDING NEW LIGHT
ON A FAMILIAR PLATFORM**

NO OTHER BULLPUP PLATFORM IS LIKE

THE BULL-DOG

FREE SHIPPING

Use [FREESHIPBDOG0609](#) at check-out. Only at [AmericanTactical.us](#)
Expires 08.31.2020

ITEM ATIG12BDB

MSRP: **\$499**

NO OTHER BULLPUP
PLATFORM IS IN THIS PRICE RANGE!

A VERY TACTICAL SHOTGUN WITH UNIQUE PATENT PENDING FEATURES

- Gauge: 12 Gauge w/ 3" Chamber
- Barrel length 18.5"
- Overall shotgun length is 26"
- Includes One (1) 5-Round Magazine w/ Picatinny Cut-Out (Additional Mags available at \$34.95 each)
- Picatinny Rail System allows you to use an Extra Magazine as a Foregrip
- Mag attaches to Pic Rail Feature
- 3 Choke Tubes Included
- Removable Adjustable Open Sights
- Adjustable Cheek Rest
- Patent-Pending AR15-Style Charging Handle

Unlike similar types of firearms, the uppers are the serialized part of the weapon.

ONE PLATFORM MANY POSSIBILITIES!

When you buy one complete BULL-DOG semi-auto shotgun, you then will be able to purchase other uppers.

- 12GA Auto
- 20 GA Auto



Orders only valid online at [AmericanTactical.us](#). Quantities limited. Not responsible for printing errors. Sale subject to stock on hand. Prices subject to change without notice. ATI adheres to all state and federal regulations for all products and will ONLY transfer ownership of a firearm to individuals or agencies in possession of a valid Federal Firearms License (FFL). This means we cannot ship directly to you unless you are an FFL holder.

AMERICAN TACTICAL