



A

Towing Electrics



12N plug
Loose **012003A**
Singly or 20 per outer

Polybagged **012003B**
Singly or 12 per outer



12S plug
Loose **012014A**
Singly or 20 per outer

Polybagged **012014B**
Singly or 12 per outer



13 pin plug
Loose **012037A**
Singly or 20 per outer

Polybagged **012037B**
Singly or 12 per outer



Socket gasket
Polybagged **012047A**
Singly or 20 per outer



12N socket
With fog cut out
Loose **012025A**
Singly or 20 per outer

Polybagged **012025B**
Singly or 12 per outer



12S socket
Loose **012036A**
Singly or 20 per outer

Polybagged **012036B**
Singly or 12 per outer



13 pin socket
With fog cut out
Loose **012038A**
Singly or 20 per outer

Polybagged **012038B**
Singly or 12 per outer



Socket cover
Loose Black **012163A**
Loose Grey **012165**
Singly or 20 per outer



7 pin 12N plug to 13 pin socket mini adaptor
Polybagged **012044A**
Singly or 12 per outer



7 pin 12N plug to 13 pin socket mini adaptor
Polybagged **012054**
Singly or 12 per outer



13 pin plug to 7 pin 12N socket mini adaptor
Polybagged **012052**
Singly or 12 per outer



7 pin 12N & 12S plugs to 13 pin trailing socket
Polybagged **012041A**
Singly or 12 per outer



13 pin plug to 7 pin 12N & 12S trailing sockets
Polybagged **012042A**
Singly or 12 per outer

Towballs and accessories

A



AK270 coupling head
The AL-KO AK270 with soft touch grip and safety indicators for both engagement and wear. 2700kg max total weight with 120kg imposed load. Boxed with fitting kit including 35, 40 and 45mm spacers
007361A



AL-KO soft dock
For AK7, AK10/2 and AK252. Display box of 12
007159



Spacers
13mm **007040**
25mm **007051**



Drop plates
51mm **007007**
76mm **007018**
100mm adjustable **007029**



13 pin alignment tool
A simple tool to re-align the pins when the plug and socket have not separated correctly. Singly or 10 per outer
012050



High tensile bolts (2)
Singly or 10 per outer
45mm pair **007073**
65mm pair **007084**
75mm pair **007095**
100mm pair **007085**
Carded.
Singly or 10 per outer
Ring 55mm **014475**
Ring 75mm **014478**

Socket mounting plates
Manufactured from mild steel plate.
Singly or 25 per outer
Single **012087**
Double straight **012096**
Double 'T' **012105**



AL-KO towball kit
Extended necked towball includes 2 x 50mm nuts, bolts and spring washers
008003



Towball
50mm ball. 'E' approved.
Singly or 10 per outer
007062



Bump guard
With two socket mounting points.
Singly or 10 per outer
012109



Mini bump guard
Singly or 10 per outer
012110



AL-KO towball boot
Black plastic **008006**



Towball boot
Black plastic
Loose (50) **012191**
Packaged **014460**



W4 Cover-up
Tow ball cover with grease reservoir. Supplied in a display box of 20 pieces
012205



Ring towball cover
Chrome **014452**
Black **014455**



AL-KO soft ball
Supplied in a display box of 24
Red **012200**
Black **012201**
Blue **012202**



W4 Socket bolt set (3)
010515
10 per outer



AL-KO 7/13 Pin plug holder
Suitable for either 7 or 13 pin plugs **012060**



Plug and ball cover holder
012058
Singly or 10 per outer



Fenwicks towball cleaner
For dry degreasing of all metal parts
● Improves damping performance
● Reduces stabiliser pad squeal
● Fast, effective, deep cleaning action
200ml. 10 per outer
007064

Ring Towing accessories



Coiled cable kits
 Consists of a length of cable which extends to 1.2m and has a 7 pin plug on each end. Kit contains a 7 pin socket to mount on caravan A frame.
 12N **014310** 12S **014311**

Complete towing stand
 Ask your sales contact for details
014479



Combination relay
 Split charge relay for charging auxiliary battery & operating a refrigerator whilst towing. With automatic cut off **014405**



Audible relay
 Rear mounting sensor relay
014407



Metal plugs
 12N **014314**
 12S **014332**



Metal sockets
 12N **014315**
 12S **014330**



Socket cover
 Black **014457**



Towball covers
 Chrome **014452**
 Black **014455**



Towball boots
 Black with reflector **014465**
 Black **014460**



Twin socket
 Pre-wired with fog cut out **014395**



Socket plates
 Single **014445**
 Twin **014450**
 Singly or 10 per outer



High tensile bolts (2)
 55mm **014475**
 75mm **014478**
 Singly or 10 per outer



Trailer lamps
 Small square **014424**



Socket seal kit
 Singly or 10 per outer **014470**



12N Tester



7 core Black
 21 x 0.2mm
 100m roll **011542**

7 core Grey
 6 of 21 x 0.3mm and 1 of 35 x 0.3mm
 30m roll **011553**

13 Core Cable
 5 x 2.5mm & 8 x 1.5mm to ISO 11446
 3 meter **011554**
 5 meter **011555**

Relays



W4 Combi Master
 Combined fridge power supply and charging relay enabling the fridge to operate and an auxiliary battery to be charged whilst towing **014076**



ERL11 **ERL7**
Automotive relays
 12V 40A - Centre pin not used
ERL11
 12V 20/30A
ERL7

Plug / Socket Tester

Simple battery powered tool to allow you to test and identify issues with both the 12N socket on the towing vehicle and the 12N plug on the trailer. Identifies the colour of the wire causing the problem to make simple repairs easily achievable, and more complex problems less expensive at professional repair facilities. Singly or 20 per outer **012011**

Wheel rims

A



Prins LD1361 rim
4.5J x 13" 4 Stud **005016**
Prins LD1360 rim
5J x 13" 4 Stud **005004**



Prins LD1362 rim
4.5J x 13" - B + B **005038**



Trailer wheels & tyres
Wheel rim with 4 ply tyre
400-8" No cut out **005048**
500-10" **005050**



Alloy wheel bolt
STW M12R
005147



Alloy wheel lock nuts
M12 Set of 4
005148



Lemmerz rim
5.5J x 14" 4 stud **005020**



Lemmerz rim
5.5J x 14" 5 stud **005025**
6J x 15" 5 stud **005030**

Wheel Trims

Supplied boxed in a set of 4



Motorhome trims
15" Silver **006022**
16" Silver **006024**



Ring commercial wheel trims
16" Silver **006024**



Polus trims (4)
13" silver **006026**



Gyro trims (4)
14" silver **006027**



Ikon trims (4)
14" silver **006028**



Polar trims (4)
14" white **006029**



Nelux trims (4)
15" silver **006030**



Wheel cover protectors

Protect your investment by protecting your wheel and tyre from UV, wind and rain. Colours may change periodically. Sold individually
Single axle **007347A**
Twin axle **007348B**

Spare wheel accessories

AL-KO side lift jack

Can be fitted to all caravans manufactured after 1980. The jack is easy to position and operate and is supplied with mounting brackets which are bolted to the main chassis members immediately behind the wheel. The jack can also be used as an aid to levelling. Can be lowered to 85mm and raised to 375mm. The mounting bracket design ensures correct positioning and operation. **WARNING:** When in use the caravan must be attached to the towing vehicle.



AL-KO side lift jack 800kg

Maximum load 1600kg
Static load 800kg
Bagged **007364**
Boxed **007351**



AL-KO side lift jack 1000kg

Maximum load 2000kg
Static load 1000kg **007357**



Side lift jack bracket kit

Suitable for use only with AL-Ko Side Lift Jack or 2 Tonne Jack. Comprises of 2 x galvanised mounting brackets and fixing kit **007403**
Spare bracket ONLY **007402**

AL-KO spare wheel carriers

For AL-KO chassis with fixing holes. Check AL-KO technical brochure for wheel size compatibility. Telescopic action for easy wheel removal and replacement.

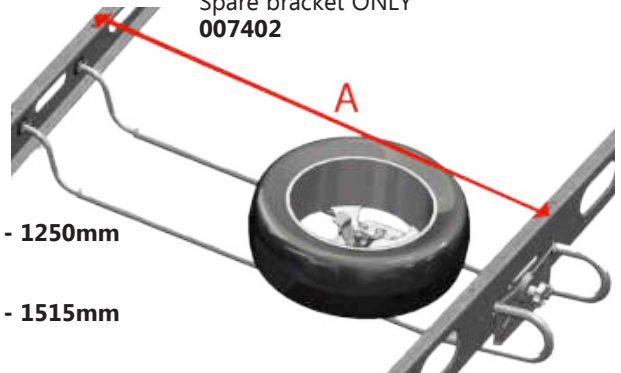

AL-KO part no. 1555934 (WAS 209550) **004018**
For chassis with a distance between the main members of **1050mm - 1250mm**

AL-KO part no. 1556005 (WAS 241859) **004004**
For chassis with a distance between the main members of **1265mm - 1515mm**

AL-KO part no. 1556010 (WAS 241860) **004015**
For chassis with a distance between the main members of **1465mm - 1815mm**

AL-KO part no. 1556159 (WAS 1287180) **004006** Pre-assembled
For chassis with a distance between the main members of **1410mm - 1715mm**

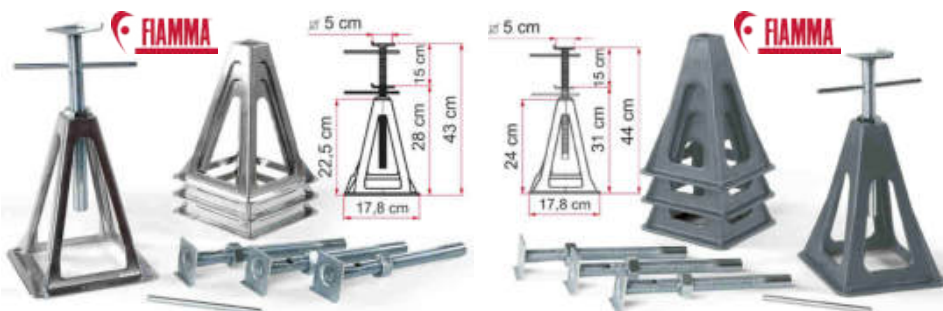

Aluminium axle stands

Supplied in a pack of 4. Max load 1000kg
Adjustable in height from min 28cm to max 43cm. Weight 0.9kg each **007353**

Plastic axle stands

Plastic UV resistant axle stands supplied in a pack of 4. Max load 750kg
Adjustable in height from min 31cm to max 44cm. Weight 0.8kg each **007352**



Stack Jack axle stands

Set of 4 aluminium axle stands. Max capacity 2722kg per jack. Extends 28-43cm. For stabilising only-Not for lifting **007358**



12v air compressor inflator/deflater

Preset pressure mode with automatic cut off. High intensity LED white light. Handy storage case and a tyre deflation valve. Inflates a tyre to 35psi in under 3 minutes **017304**



Digital 12v air compressor

Preset pressure mode with automatic cut off. Red light for SOS and high intensity LED light. Handy storage case and a tyre deflation valve. Inflates a tyre to 35psi in under 3 minutes **017303**

Hitch covers

A



W4 hitch cover

White P.V.C. weather - proofing cover with drawstring for secure fixing. Singly or 10 per outer
007335



W4 'A' Frame cover

Hard-wearing cover which protects the hitch, handbrake mechanism and cable storage ports. Singly or 5 per outer
007336



AL-KO hitch cover black

To cover the towing hitch/stabiliser Suitable for the AKS2004/3004 stabiliser **007350B**

National hitch covers PVC coated nylon cover with drawstring. Singly or 10 per outer



England **007342**



Scotland **007343**



Wales **007344**



Nylon hitch covers

PVC coated nylon cover with drawstring. Singly or 10 per outer
Green **007340** Black **007340BL**

Printed nylon hitch covers

Printed with your company name and logo. Minimum order of 100 pieces. Alternative colours also available **007341**

Keep Calm and Caravan hitch covers

Nylon hitch cover with drawstring.
007345A



Matching products also available

Mains cable bag **016177A**

Peg bag **109563A**



Breakaway cables

Note: Cables should be connected as per instructions to ensure effective operation.

W4 Breakaway cables

Singly or 10 per outer.
Poly-bagged and header carded.



W4 standard breakaway cable
007118



W4 plastic coated cable
007120



W4 cable with split ring
007125



W4 easy fit cable
007127



Al-ko Standard
007130



Al-ko detachable
007135

Shock absorbers

Octagon shock absorbers

Designed to complement AL-KO Euro Axles. Colour coded for easy weight identification – provides the ultimate in road holding and ride comfort. Set of 2. 1 pair required for single axles. 2 pairs required for tandem axles.



Green
Upto 900kg for single axle
Upto 1600kg for tandem axle
007425



Blue
901-1350kg for single axle
1601-2700kg for tandem axle
007426



Red
1351-2000kg for single axle
2701-3500kg for tandem axle
007427



Black
2001-4000kg for single axle
3501-7500kg for tandem axle
007424

Corner steady braces & wheel wrenches

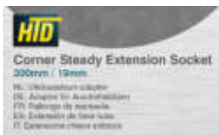

Extension sockets
For use with cordless drills for lowering and raising corner steadies. 19mm socket.
Singly or 20 per outer
30cm **007161**
45cm **007162**
55cm **007162A**



Master wheel wrench
Chrome plated carbon steel body with 17/19mm vanadium socket. Telescopic handle gives adjustable length. 350-530mm. Product supplier changes occasionally
Singly or 10 per outer
007169A



AL-KO corner steady brace
Singly or 10 per outer
670mm **007168A**



Kronings corner steady brace
Ideal for use with kronings semi-automatic movers
006699

Chassis spares

Note: More chassis spares can be found in our spares catalogue



Corner steady nuts
16mm thread \varnothing **007428**
20mm thread \varnothing **007429**



One shot nuts
Supplied 10 per outer
20mm thread \varnothing 32mm Socket **007662**
25mm thread \varnothing 36mm Socket **007689**

WOW Bulk offers of 50 or more are available on One shot nuts

Levelling accessories



WOW Ideal for soft ground and to help support the weight of the vehicle



HTD jack pads

Set of four high quality pads with metal pins. Specially moulded to locate perfectly into HTD foot stackers.

Singly or 12 per outer **007391A**

HTD foot stackers

Set of four foot stackers for levelling the vehicle on very uneven ground. For use with jack pads.

Singly or 12 per outer **007392**



HTD wheel chocks (2)

A vital safety device when parking up or changing a wheel. 90 x 150 x 100mm

Singly or 24 per outer **007312A**



Fiamma Plates pro

Kit of 4 anti-sinking bases with pins, permanently fitted whilst travelling.

007382



Fiamma Plates

Kit of 4 reinforced anti-sinking plates for the feet of the caravan.

007381



Target level

Circular spirit level for 360° levelling indication.

HTD **007297V**

W4 packed **007297**

10 per outer



HTD Level aid

Singly or 10 per outer

007299

W4 grip trak

Ridged on both sides of track for maximum wheel to ground traction

007368



U-Level

The wireless levelling system. The smart & safe way to level your caravan before towing and also to level your caravan or motorhome on site.

Contains two units, a transmitter and receiver as well as a handy hanging/carrying strap. By simply turning on both units and placing the transmitter on a suitable flat surface inside the vehicle, the receiver can then be used outside to adjust and refine the level and weight distribution.

007300



Levelling accessories



WOW For more information on Fiamma products see our comprehensive Fiamma section at the end of the catalogue



Level Up (2)

Dimensions (mm) 570 x 200.
Maximum height 130.
Maximum axle weight 5 tons.
Grey **007326**
Level bag **007333**



Level PRO (2)

Dimensions (mm) 430 x 170.
Maximum height 90.
Maximum axle weight 5 tons.
Singly or 6 per outer.
Grey **007320**
Level bag **007332**



Anti slip plate (2)

To help prevent slipping on paved surfaces. Suitable for all blocks except Level System Jumbo
Grey **007328**



Chock level (2)

Lightweight chock for use with Level up, Pro and Magnum on longer stays. Comes with 2 steel hooks to firmly fasten to chocks when used on levels
Grey **007327**

Each kit comes with 2 Level Ups and a washable Polyester carry bag.
Easy to carry with comfortable shoulder strap.



Level bag S

For level pro (007320), magnum (007322) and wheel saver (007331)
Grey **007332**

Level bag

For level up (007326)
Grey **007333**

Kit Level Up (2)

Dimensions (mm) 570 x 200.
Maximum height 130.
Maximum axle weight 5 tons.
Comes with washable polyester carry bag. Easy to carry with comfortable shoulder strap.
Grey **007316**

Kit Level Up Jumbo (2)

Dimensions (mm) 580 x 240.
Maximum height 140.
Maximum axle weight 8 tons.
Comes with washable polyester carry bag. Easy to carry with comfortable shoulder strap.
Grey **007318**



Level Plate (2)

Anti skid system for installation on Fiamma level up. It increases traction, avoiding skids and slips on smooth surfaces and helps to prevent sinking on soft ground.
Grey **007329**



Fiamma Grip System (2)

Anti skid system with superior traction. The two grips can be combined into one long piece to position under the motor home or caravan wheels. Ideal on sand or mud.
Grey **007367**



Fiamma Wheel savers

Ideal for long stays or storage. Suitable for wheels up to 70cm diameter.
Dimensions (mm) 460 x 210.
Maximum height 60. Can use level bag S 007332
Grey **007331**

Magnum (2)

Dimensions (mm) 500 x 200. Maximum height 90.
Maximum axle weight 8 tons
Singly or 6 per outer
Yellow **007322**
Level bag **007332**

Jumbo (2)

Dimensions (mm) 600 x 260. Maximum height 120.
Maximum axle weight 12 tons
Yellow **007323**



Stabilisers



WOW For hitch locks and security devices please see section B



AL-KO MkII AKS 3004 stabiliser
 Developed for caravans and trailers from 200kg up to a maximum gross weight of 3000kg
 Stabiliser only **007938**



Winterhoff WS3000 stabiliser
 The slender design guarantees excellent angular flexibility for manoeuvring.
 Stabiliser only **007850**

WOW MkII AKS 3004 Triple pack consisting of stabiliser, premium security device, towball and safety ball **007939**

AL-KO stabiliser accessories



Towball kit
008003



Towball cover
008006



AKS security barrel and two keys
 For all models **007723**



3004 4x4 handle
 Replacement handle for 4x4's to avoid fouling of the rear door. For red AKS 3004 **007934**



Safety ball
 Locks into hitch head for extra security. Supplied in a display box of 24 **002120**

Replacement friction pads



Side 1300 Stabilisers
007957



Side 2000/2500 stabilisers
 To 1993 **008004**



Side 2004/3004 stabilisers
 From 1994 **008005**



Front/rear 2004 stabilisers
007935



Front/rear 3004 stabilisers
 From 1994 **007936**



Winterhoff friction pads
 For Winterhoff WS3000 Stabiliser from Aug 2002 onwards **007852**

Stabilisers

AL-KO Trailer Control



Avoidance manoeuvres or side wind can cause caravans to start swaying. AL-KO Trailer Control (ATC) actively works against these forces and gently brakes the caravan automatically. The emergency system reacts when the swaying of the vehicle combination exceeds limit values.

- Sensors react to small lateral accelerations
- The caravan immediately brakes automatically. The driver barely notices this correction
- The caravan is brought back into line and under control automatically. The vehicle combination once again drives safely

WOW ATC is now available as a retrofit for nearly all caravans. **Please call with the year, make, model, maximum weight and whether it is a single axle or twin axle to establish the model required.** Personnel who have not been trained to fit ATC can request specific training in how to fit, service and upgrade ATC by contacting AL-KO either by phone on 01926 818500 or via email mail.uk@alko-tech.com

AL-KO No.	Grove No.	Weight Limits
1289273	007870	Single Axle 750 - 1300Kg
1289274	007872	Single Axle 1301 - 1500Kg
1289275	007874	Single Axle 1501 - 1800Kg
1289276	007875	Twin Axle 1301 - 1600Kg
1289277	007876	Twin Axle 1601 - 2000Kg
1289278	007877	Twin Axle 2001 - 2500Kg
1289279	007878	Single Axle 750 - 1300Kg
1289280	007880	Single Axle 1301 - 1500Kg
1289281	007882	Single Axle 1501 - 1800Kg
1289282	007883	Twin Axle 1301 - 1600Kg
1289283	007884	Twin Axle 1601 - 2000Kg
1289284	007885	Twin Axle 2001 - 2500Kg

1289286	007886	Single Axle 1301 - 1500Kg
1289288	007887	Twin Axle 1301 - 1600Kg
1289289	007888	Twin Axle 1601 - 2000Kg
1289290	007890	Twin Axle 2001 - 2500Kg
1289296	007892	Single Axle 750 - 1300Kg
1289297	007894	Single Axle 1301 - 1500Kg
185001001	007896	Single Axle 750 - 1300Kg
185001002	007897	Single Axle 1301 - 1500Kg
185001003	007898	Single Axle 1501 - 1800Kg
185001004	007899	Single Axle 1601 - 2000Kg
185001009	007915	Twin Axle 1601 - 2000Kg

Leaf type stabilisers - Spares shown for Driver stabiliser



Driver stabiliser

Comes with quick release kit, 4.5" friction discs and standard L bracket to suit AL-KO and similar taperline chassis

007800



Stronghold stabiliser

2 year mechanical warranty, with quick release mechanism and fast fit 'L' bracket that clamps onto the chassis which eliminates drilling. Fitted with 2 x 4" friction discs. Supplied with canvas carry bag.

007775

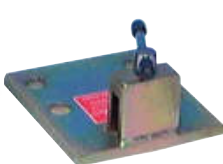

4 Hole car plate
007804



2 Hole car plate
007805



TC car plate
007808



L bracket
007812

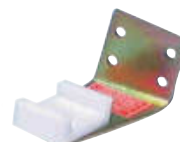

Extended L bracket
007814



Slipper block
007822



Toggle screw
007819



4.5" Friction discs
007825



4" Friction discs
007824

Jockey wheel assemblies

Al-ko standard Plastic

Shaft Ø	48mm
Length closed	470mm
Extension max	220mm
Stationary load max	150kg
Nose load max	90kg
Wheel type	Plastic rim / solid rubber
Wheel size	200x50mm
Weight	4.8Kg
Grove Number	007194



Al-ko standard metal

Shaft Ø	48mm
Length closed	550mm
Extension max	250mm
Stationary load max	150kg
Nose load max	90kg
Wheel type	Metal rim / solid rubber
Wheel size	200x50mm
Weight	5.0Kg
Grove Number	007179



Al-ko H/Duty Pnuematic

Shaft Ø	48mm
Length closed	580mm
Extension max	250mm
Stationary load max	200kg
Nose load max	120kg
Wheel type	Metal rim / Pneumatic
Wheel size	260x85mm
Weight	5.0Kg
Grove Number	007197



Al-ko H/Duty Plastic

Shaft Ø	48mm
Length closed	560mm
Extension max	250mm
Stationary load max	150kg
Nose load max	90kg
Wheel type	Plastic rim / Soft rubber
Wheel size	215x65mm
Weight	5.0Kg
Grove Number	007195



Al-ko Premium

Shaft Ø	48mm
Length closed	645mm
Extension max	250mm
Stationary load max	300kg
Nose load max	180kg
Wheel type	Metal rim / solid rubber
Wheel size	230x80mm
Weight	9.8Kg
Grove Number	007193B

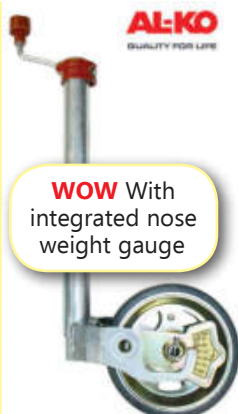

WOW With integrated nose weight gauge

Al-ko Soft Wheel

Shaft Ø	48mm
Length closed	490mm
Extension max	250mm
Stationary load max	150kg
Nose load max	90kg
Wheel type	Soft Wheel
Wheel size	240x90mm
Weight	4.8Kg
Grove Number	007192



Trailer 34mm

Shaft Ø	34mm
Length closed	575mm
Extension max	200mm
Max load	100kg
Wheel type	Metal rim / solid rubber
Wheel size mm	160x60
Clamp	Included
Weight	4.1kg
Grove Number	007170



AL-KO manoeuvring handle
For use with caravan and trailer jockey wheel assemblies with 48mm diameter stems
007250

Jockey wheel accessories



For 34mm jockey assembly
Overall ø 160mm
Spindle hole length 60mm
007171



For std 48mm jockey assembly
Overall ø 195mm
Spindle hole length 60mm
007173



Al-Ko Soft wheel
Overall ø 240mm
Spindle hole length 90mm
007196



Pneumatic wheel & tyre
Overall ø 250mm
Spindle hole length 90mm
007189



Pneumatic wheel
Overall ø 260mm
Spindle hole length 85mm
007198



Jockey wheel clamp
Suitable for 48mm tube
007276



Steel clamp
Pressed steel for 90S/3 assembly
007639



Steel clamp
Pressed steel for 161S & 251S assembly
007619



Cast clamp
Pressed steel for 161S & 251S assembly
007640



Jockey wheel clamp for rotary ailer
For use with caravan and trailer jockey wheel assemblies with 48mm diameter stems. Ideal for both TV aerial poles and rotary airers
095470C



























































Clamp handle
007178



























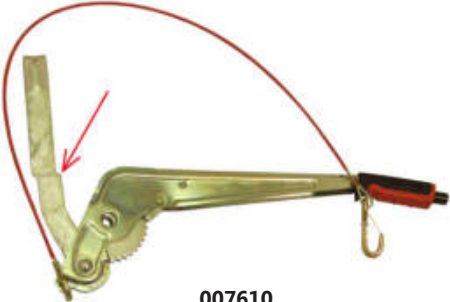

Clamp handle
007642

Al-ko Spare parts

A

STABILISERS / SECURITY						
 007712 Arm left hand 2700	 007713 Arm right hand 2700	 007733 Arm left hand 2004/3004	 007734 Arm right hand 2004/3004			
 007708 Operating lever left 2700 Type A	 007709 Operating lever right 2700 Type A	 007710 Operating lever left 2700 Type B	 007711 Operating lever right 2700 Type B			
 007700 Operating handle 1300	 007704 Hand wheel 1300	 007730 Handle left hand 2004/3004	 007731 Handle right hand 2004/3004			
 007937 Handle complete 3004	 007745 Black handle 3004	 007934 4 x 4 Handle 3004	 007701 Retaining screw 1300			
 007705 Bearing set 1300	 007702 Seal Kit 1300	 007707 Split rings (4) 1300	 007727 Packing piece 35mm			
 007736 Bearing set 2000	 007737 Seal ring 2004/3004	 007717 Bearing bolt (locked)	 007726 Packing piece 40mm			
 007706 Fixing kit for security 1300	 007703 Fixing kit 1300	 007743 Fixing kit 2004/3004	 007728 Packing piece 45mm			
 007724 Fixing kit for security 2700	 007725 Fixing kit for 2700	 007735 Gaiter for AKS stabilisers	 007723 Lock & keys for Security hitch lock	 001850 Lock & key for Compact security		
 007739 Mushroom head bolt M12 x 75	 007740 Cylinder bolt M12 x 75 2004	 007741 Cylinder bolt M12 x 75 3004	 007718 Cylinder bolt M10 x 85	 007835 Bolt 8 x 97 torx- 8.8	 007738 Nut M12-10 A3C	 007718A Nut M10 nyloc
 007719 Indicator button kit - 3004	 007720 Indicator button (outer)	 007721 Indicator button spring	 007722 indicator button inner			
 007932 Friction pad shim kit	 007937A Cover 3004 friction pad	 007937B O-ring for friction pads	 007957 1300 Friction pad kit			
 007935 Friction pads front/rear for 2004/3004	 007936 Friction pads front/rear 3004	 008004 Friction pads side to 1993	 008005 Friction pads side from 1994			
 007910 ATC LED bulb Swift	 007911 ATC LED bulb non swift	 007912 ATC release bar	 007913 ATC LED fixing plate	 007914 ATC control unit		

Al-ko Spare parts

A-FRAME / OVERRUN ASSEMBLIES			
 007619 Clamp steel for 161S & 251S	 007639 Clamp steel 90S/3	 007642 Clamp handle	 007178 Clamp handle
 007644 Rivet nut kit	 007640 Clamp cast for 161S & 251S	 007643 Pressure pad	
 007735 Gaiter for AKS 2004/3004	 007601 Overrun gaiter	 007638 90 S/3 gaiter	 007738 Nut M12-10 A3C
 007609 161S pivot bolt	 007622 161S/251S gas strut pivot bolt	 007741 Cylinder bolt M12 x 75 3004	 007631A Overrun nut
 007600 161S Delta overrun damper		 007605 161S Delta overrun damper (old)	
 007625 251S Delta overrun damper		 007630 251S Delta overrun damper (old)	
 007610 161S Spring cylinder hand brake assembly	 007624 Hand grip	 007637 90 S/3 Spring cylinder hand brake assembly	
	 007604 Burst ring		
 007623 161S & 251S from 08/95 Gas strut hand brake assembly	 007130 Breakaway cable	 007628 251S to 07/95 Gas strut hand brake assembly	
	 007135 Detachable breakaway cable		

Al-ko Spare parts

A

A-FRAME / OVERRUN ASSEMBLIES			
 007627 Welded draw shaft	 007606 Bearing bush set	 007629 Bump rubber	 007608 Grease nipple
 007616 Split pin	 007635 Tension bar	 007633 Fork end	 007634 Spring cylinder
BRAKES			
 Bowden Cable 007645 890mm 007646 1020mm 007647 1130mm 007649 1230mm 007648 1320mm		 007651 Connecting eye	 007677 Reverse lever spring 2051/2361
		 007652 Reverse lever spring left 1637	 007653 Reverse lever spring right 1637
 007654 Auto reverse lever LH 1637	 007655 Auto reverse lever RH 1637	 007678 Auto reverse lever LH 2051/2361	 007679 Auto reverse lever RH 2051/2361
 007667 Bearing bolt	 007616 Split pin	 007669 Compression spring	 007670 Adjusting assembly
 007673 Bowden cable shell	 007658 Spread hinge lock 1367	 007682 Spread hinge lock 2051/2361	 007672 Cover plate
 007657 Pull off spring 1637	 007681 Pull off spring 2051/2361	 007676 Protecting cap 1367/2051	 007693 Protecting cap 2361
 007664 Wheel bolt spheric m12 x 1.5	 007671 Plug for brake plate	 007667A High temperature axle grease	 107008 Cross check red sealant

Al-ko Spare parts

BRAKES			
<p>007662 Flange nut 20mm (32mm socket) 1637/2051</p>	<p>007663 Dust cap</p>	<p>007689 Flange nut 25mm (36mm socket) 2361</p>	<p>007690 Dust cap</p>
<p>007659 100 x 4 / m12 x 1.5 1637 - After 10/94</p>	<p>007684 100 x 4 / m12 x 1.5 2051</p>	<p>007685 112 x 5 / m12 x 5.5 2051 - Less than 750Kg</p>	<p>007684A 101.6 x 4 / m10</p>
<p>007660 Brake Shoe Kit for 1637 after 1994</p>	<p>007683 Brake Shoe Kit for 2051 after 1994</p>	<p>007687 Brake Shoe Kit for 2361 after 1994</p>	
CORNER STEADIES			
<p>007432 Corner steady 205808</p>		<p>007433 Corner steady 205817</p>	
<p>007434 Corner steady 267265</p>		<p>007435 Corner steady 1221694</p>	
<p>007428 Nut 16mm</p>	<p>007429 Nut 20mm</p>	<p>007436 Security Device Premium</p>	<p>007430 Nut 20mm and washer kit of 5</p>
<p>007431 Spindle 20mm</p>			

Weight Control

A



HTD Aluminium nose weight gauge

Comes with plastic foot.
Measures nose weight up to 100kg.
Singly or 20 per outer
007313



HTD Plastic nose weight gauge

Measures nose weight up to 100kg.
Singly or 20 per outer
007314



W4 weigh-it extra

Calibrated in both pounds and kilograms. Measures nose weight up to 250lbs/115kg
007310



Caravan Weight Control

The Caravan Weight Control (CWC) gives you 100% control over the total weight and the partial weights of the individual wheels. Using the handy balance may easily prevent excess and uneven loads which may have a negative impact on vehicle handling.

- Can measure the load per wheel up to 1000Kg yellow or 1500kg orange
- Totals the weight once measured on either a single or twin axle vehicle
- Can be used as a nose weight gauge
- Requires 3 x AAA batteries (not included)
- Simple to use
- Weighs 1 Kg
1500Kg orange **007304**
1000Kg yellow **007305**



Reich TLC

Towbar Load Control. Accurate and reliable digital measurement in 1kg intervals up to 100kg. Simply place on Tow ball then rest the caravan on the TLC for an accurate measurement of weight on the towball. Requires 2 x AA batteries not supplied.
007306
MUST BE REMOVED BEFORE TOWING.

Specialist Jockey wheels



Kronings Camper Belt

Avoid your jockey wheel sinking in wet and soft surfaces by mounting the Kronings Camper Belt. Kronings Camper Belt divides the weight and vertical pressure on two wheels and the rubber belt, which increases, lift when driving. The Camper Belt can be installed only by replacing the existing jockey wheel.
Weight 8kg complete
007205



WOW Demonstration DVD available!

Reich Easy Wheel set

Transform your existing jockey wheel into a double jockey wheel. Increase your manoeuvrability on any surface. Quick and easy assembly / disassembly.
007210



WOW Al-ko Premium jockey wheel with a built-in nose weight gauge shown on page 12

Towing Safety



Collapsible safety cone
Sturdy reflective safety cone
007396



16 LED warning disk
Magnetic warning disk, high visibility, with multiple light settings. In case of emergency place on car roof
007398



21 LED warning triangle
Battery powered (3 x AA not supplied) 21 bright LEDs.
440 x 440 x 440mm.
007393



Warning triangle
E approved.
Singly or 10 per outer
007390



Grayston coil spring assisters
To stiffen and raise suspension by approximately 38mm.
To measure the size - jack the vehicle up to take weight from springs then measure the gap between two parts of the spring

GE13	18mm-25mm	008019
GE14	26mm-38mm	008008
GE15	39mm-51mm	008027
GE15A	52mm-65mm	008036



Rear view lens
Manufactured from optical grade PVC with viewing angles of upward 13° sideways 25° and downward 28°, these lenses help eliminate the blind spot and therefore make reversing safer.
9" x 7" **120137**
10" x 8" **120138**
14" x 11" **120139**



Beam converters
Headlamp beam adaptor for continental driving. By law, at any time - day or night, when driving in Europe you must convert your headlamps to avoid dazzling other road users
015606

Towing mirrors

Note - All mirrors sold by Grove are "E" marked

HANDY mirror range

This range features the unique "Handy" ratchet system which gives minimal vibration and maximum stability. Simple to install and remove: the unique "Handy" ratchet allows a tight fit to the existing mirror every time. Attaching to the vehicle's existing mirror these universal fitting mirrors are suitable for most vehicles and include models suitable for vans and motorhomes as well as cars, and will fit left or right hand mirrors. Glass size 190mm x 120mm. All Singly or 6 per outer.



Handy XL standard mirror
Arm length 310mm
120140



Handy Super Flex mirror
Wide angle arms for most vans and motor homes. Arm length 230mm
120144

WOW The Handy XL achieved "Best Overall towing mirror" when on test in Practical Caravan magazine - September 2013. Conclusion: "(the) ratchet tensioning system gives a satisfyingly secure feel when fitted" and "once securely fastened to the towcar mirror it was rock steady. The mirror image was superb with no distortion visible. The field of view was massive and vibration was insignificant." **89/100**



Standard towing mirror
Glass size 150mm x 110mm.
Arm length 220mm
Singly or 20 per outer **120154**
Spare straps **120153**



Excellent View towing mirror
After initial set up the bracket can be left on, head and extension mirror can be removed.
Glass size 185mm x 120mm.
Arm length 270mm
Singly or 20 per outer **120168**
Spare straps **120169**



XXL towing mirror
Glass size 185mm x 120mm.
Arm length 200mm
Singly or 20 per outer **120158**



Summit RV98T
Adjustable arms, mirror head adjustable through 360° and shatterproof glass.
Singly or 10 per outer
120148



Summit RV3200
Removeable arm, mirror head adjustable through 360°, shatterproof glass and complete with built-in blind spot.
Singly or 10 per outer
120151



Ring RCT1440 Multi fixing

- Adjustable clamp system for multi vehicle fixing
- Dual angle flat/convex lens for improved field of vision
- Fully adjustable mirror to ensure the correct field of vision
- Improved rearward visibility when towing
- Suitable for left and right fixing / top or bottom fixing
- Reg 46 'E' Approved

120147 Singly or 10 per outer



Kronings mirror set
A pair of extruded aluminium and ABS towing mirrors. Minimum vibration. Designed to fit 95% of all vehicles, this set comes with all required tools and fitment combinations. Supplied with: 3 different sized gripping handles, 2 x flat and 2 x convex mirrors, 4 x different sized holding pins, 2 x different sized rubber ends. Weight 468g
120130

Kronings spares

Speed strap	120131
Flat mirror glass (2)	120132
Convex mirror glass (2)	120133

Self adhesive stickers

All stickers are sold 10 per outer



Scotland flag
Medium rectangle
110 x 65mm
013577



SCO
Large oval
140 x 100mm
013576



Wales flag
Medium rectangle
110 x 65mm
013582



Cymru
Large oval
140 x 100mm
013581



Ireland flag
Medium rectangle
110 x 65mm
013588



IRL
Large oval
140 x 100mm
013587



AA GB Magnetic badge
Large oval
180 x 135mm
013598



GB sticker
Large oval
180 x 135mm
013603



GB sticker
Large oval
140 x 100mm
013602



Euro GB
122 x 88mm
013605



NI
Large oval
140 x 100mm
013586



Euro Scotland
122 x 88mm
013575



Euro Cymru
122 x 88mm
013580

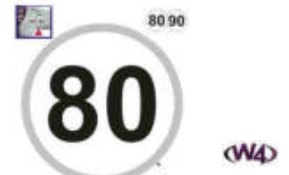

French speed limit stickers
150mm ø. 2 stickers included (80 & 90)
013609F



Tracking fitted
110 x 65mm
Motorhome 013613
Caravan 013614

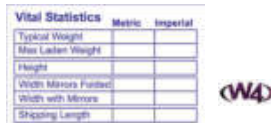

Vital statistics
60 x 48mm
013619



Tyre pressure
60 x 48mm
013615



60mph
100mm ø
013609

Rectangular number plate stickers

40 x 110mm

Adapt your number plate with ease at low cost



GB 013608



SCO 013578



CYMRU 013583



IRL 013589



LPG sticker
100 x 100mm
013610



GB 013579



SCO 013578A



CYMRU 013583A



ENG 013579A



Fresh water
60 x 55mm
013618

Number plates



Reflective backings

100 per outer	013305
Reflective yellow	013313
Reflective white	013303
Bordered yellow	013322
Bordered white	013311
Scottish yellow	013310
Scottish white	013309
Border Scottish yellow	013312
Cymru yellow	013312W
Cymru white	013317
Square yellow	



Acrylic plates

50 per outer	Oblong	013306
25 per outer	Square	013315

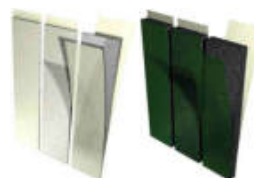

Adhesive pads

20 per outer	
1mm	013523
6mm	013524
Bulk	
1mm (200)	013525
6mm (150)	013526



Individual digits (20)

013408
Followed by number or letter

3D digits (20)

013409
Followed by number or letter

Digit starter pack

100 of each digit
013407

Staticlean fluid

Apply to the acrylic sheet (and to the reflective if required) before use in order to reduce static
50ml **013512A**

Sponge pad bottle

013421

Trailer boards



3' Trailer board

H135 x W915 x D70mm. 4m cable 12N plug
015248



4' Trailer board

H140 x W1230 x D70mm. 4m cable 12N plug
015259

Marker lamps



Jokon EL61
Lamp 015457A



Jokon
Lamp 015465A



Jokon PL96
Lamp 015454A



Britax 881
Lamp 015438



Jokon EL61
Lamp 015459A

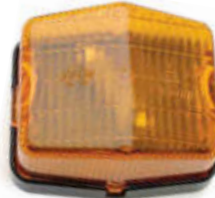

Jokon
Lamp 015467A
Lens 015468



Jokon PL96
Lamp 015456



Britax 883
Lamp 015440



Jokon EL61
Lamp 015452A



Britax 814
Lamp 015384



Britax 813
Lamp 015404



Britax 882
Lamp 015442



Hella oblong
Lamp 015461



Hella oval
Lamp 015444



Britax 536
Lamp 015450



Britax 764
Lamp 015337



Hella oblong
Lamp 015463



Hella oval
Lamp 015446

Number plate lamps



Britax Small 015476



Hella Small 015479



Hella oblong
Lamp 015464



Jokon with clip on lens
Lamp 015472A



Jokon with screw on lens
015473



Jokon oblong red/white
015474A



Jokon
Lamp 015470A

Caraluna caravan lights

A



MK1 left hand, reverse
015001



MK1 right hand, fog light
015002



MK1 left hand, fog light
015018



MK2 right hand, fog light
015003



MK2 left hand, reverse
015000



MK2 right hand clear lens
015020

Other rear lights



MK2 left hand, fog light
015017



Britax 9300 wrap round
Stop/tail, flasher, fog & reverse
382mm x 130mm **015050**



MK2 left hand fog clear lens
015021



Jokon wrap round
Stop/tail, flasher, reverse & fog
385mm x 112mm **015007A**



Britax 9002 lamp
015056

Caraluna motorhome lights



MK1 left hand
015015



MK1 Right hand, fog light
015016



MK2 left hand, reversing light
015013



MK2 Right hand, fog light
015014



Caraluna vertical
Dimensions (HxWxD):
406 x 168 x 80mm
Left hand - Includes reverse
014493



Caraluna modular
Dimensions (HxWxD):
612 x 163 x 92mm
Left hand **014490**



Caraluna modular
Dimensions (HxWxD):
612 x 163 x 92mm
Right hand **014491**

Reflectors



10 per outer
Self adhesive reflectors
105 x 50mm. 79mm hole centres.
Red **015268**
Amber **015277**
White **015286**

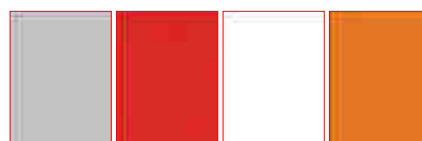

Road light repair stickers
250 x 70mm 10 per outer
Headlight - Silver vinyl **013620**
Brake/Tail - Red vinyl **013621**
Reverse - Clear vinyl **013623**
Indicator - Amber vinyl **013622**

HTD Caravan Covers

A



Superior heavy duty breathable 4 ply material allows condensation to evaporate
 Outer layer - durable non-woven to give UV and water resistance, but with breathability
 2nd layer - Treated non-woven to give UV protection and strength
 3rd layer - PE film, enables the cover to breathe but helps with water resistance
 Inner layer - Extra soft non-woven material to protect the vehicle's paintwork

- Easy to fit (fitting instructions included)
- Ideal for winter storage
- UV stable
- Nylon straps for a secure fit
- Elasticated hem for a tailored fit
- Storage bag included
- 2 YKK zips either side for easy access
- 12 months warranty

WOW Available in 3 widths for a more tailored fit!

Standard		
Part No.	Length	Imperial Size
106754	Up to 450cm	Up to 14'9"
106755	450 to 500cm	14'9" to 16'4"
106756	500 to 550cm	16'4" to 18'0"
106757	550 to 600cm	18'0" to 19'8"
106758	600 to 650cm	19'8" to 21'3"
106759	650 to 700cm	21'3" to 22'11"
106760	700 to 750cm	22'11" to 24'7"

233cm wide

253cm wide

Extra wide		
Part No.	Length	Imperial Size
106761	Up to 650cm	19'8" to 21'3"
106762	650 to 700cm	21'3" to 22'11"
106763	700 to 750cm	22'11" to 24'7"
106764	750 to 800cm	24'7" to 26'2"

213cm wide

Extra narrow		
Part No.	Length	Imperial Size
106750	Up to 450cm	Up to 14'9"
106751	450 to 500cm	14'9" to 16'4"
106752	500 to 550cm	16'4" to 18'0"
106753	550 to 600cm	18'0" to 19'8"



Storage bag included

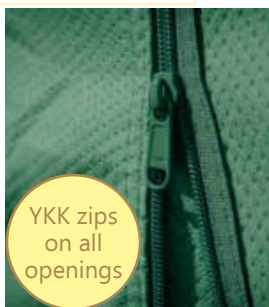

YKK zips on all openings



Buckled straps for a secure fit

HTD Motorhome Covers



Superior heavy duty breathable 4 ply material allows condensation to evaporate
 Outer layer - durable non-woven to give UV and water resistance, but with breathability
 2nd layer - Treated non-woven to give UV protection and strength
 3rd layer - PE film, enables the cover to breathe but helps with water resistance
 Inner layer - Extra soft non-woven material to protect the vehicle's paintwork

- Easy to fit (fitting instructions included)
- Ideal for winter storage
- UV stable
- Nylon straps for a secure fit
- Elasticated hem for a tailored fit
- Storage bag included
- 2 YKK zips either side for easy access
- 12 months warranty

Part No.	Length	Imperial Size
106765	Up to 550cm	Up to 18'0"
106766	550 to 600cm	18'0" to 19'8"
106767	600 to 650cm	19'8" to 21'3"
106768	650 to 700cm	21'3" to 22'11"
106769	700 to 750cm	22'11" to 24'7"
106770	750 to 800cm	24'7" to 26'2"

240cm wide



Storage bag included

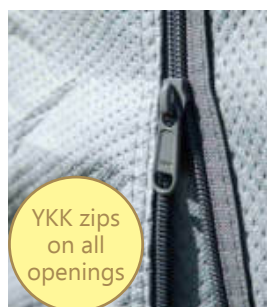

YKK zips on all openings



Buckled straps for a secure fit

Top covers

A



Caravan top cover

- Superior top cover offering protection for your caravan
- Water resistant heavy duty silver polyester material
- Ideal for winter storage
- UV stable material ensuring long product life
- Elasticated straps with nylon coated steel hooks
- Elasticated hem for tailored fit
- Storage bag included
- Additional straps supplied for different fitment options
- 12 months warranty



106830	Caravan top cover up to 14'
106831	Caravan top cover 14-17'
106832	Caravan top cover 17-19'
106833	Caravan top cover 19-21'
106834	Caravan top cover 21-23'
106835	Caravan top cover 23-25'

Thermoval screen protectors



All-season thermal windscreen covers

- Made with PVC film bonded to a thin foam
- Opening panels to allow in the light (Luxe models)
- Won't wrinkle or tear
- Easy to roll up and store
- Easy to fit and remove
- Ultra-quick wipe clean and dry
- Reduces condensation
- 2 year Guarantee



Grove No.	Model	To Fit
106900	Standard	Peugeot / Fiat / Citroen June 1993 onwards
106901	Standard	Peugeot / Fiat / Citroen June 2006 onwards
106902	Standard	Ford Transit June 2006 onwards
106903	Standard	Ford Transit June 2014 onwards
106904	Standard	Mercedes June 2006 onwards
106905	Standard	Renault Master June 2010 onwards
106906	Standard	VW T5 June 2002 onwards
106907	Luxe	Peugeot / Fiat / Citroen June 1993 onwards
106908	Luxe	Peugeot / Fiat / Citroen June 2006 onwards
106909	Luxe	VW T5 June 2002 onwards

Thermoval screens are fixed using sucker pads with tongue for easy removal. The suckers can be screwed on to leave the sucker permanently in place. They fix around wing mirrors using buckles. The range will fit a wide variety of makes and models.

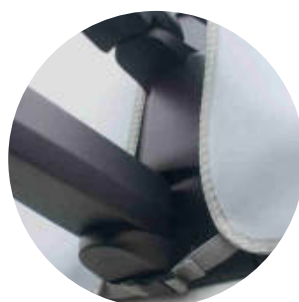

Fiamma covers



Cover Premium M

For motor homes up to 7.1m long
 Dimensions 7.16 x 2.59 x 2.74m
 Weight 10kg
106870A

Cover Premium L

For motor homes up to 8m long
 Dimensions: 8.08 x 2.59 x 2.74m
 Weight 11kg
106872A



Fiamma Cover Top

Sturdy and hard wearing cover made with UV resistant and heavy duty vinyl to protect the motor home from dirt and sun. Easy to tighten using ropes or elastic cords (not included). Reinforced corners and tie down grommets.
 Dimensions: 8.5 x 5.2m.
 Weight 6kg
106875



Fiamma Thermoglas XXL Ducato

For Fiat Ducato after 06/2006
 Weight 11kg
106466



Fiamma Wall Cabin

For fiat Ducato after 06/2006
 Dimensions: 182 x 150cm
 Weight 1.8kg
106470



Rear Door Cover

Fiat Ducato 106893

(Citroën Jumper, Peugeot Boxer and Mercedes Sprinter high roof after 06/06) Comes with: Double rail, awning with sides and front panel, rafter for increased stability and an elastic tension kit

VW T5 106895

Comes with: Set of floor poles, complete enclosure, set of pegs and an elastic tension kit.

Canopy poles 106897

Set of aluminium poles to extend the door



Fiamma Coverglas XL Ducato

For Fiat Ducato after 06/2006
 Weight 3.5kg
106465



Fiamma Draught skirt

- 1** Motorhome: L 550cm H 60cm
- 2** Caravan: L 450cm H 60cm
- 3** VW T5/T6: L 250cm H 42cm
- 4** Fiat Ducato: L 397cm H 55cm
- 5** VW T5/T6 Rear
- 6** Fiat Ducato Rear

- 109505**
- 109504**
- 109506**
- 109507**
- 109506A**
- 109507A**

The Camper Trolley



Camper Trolley's revolutionary design provides an innovative solution to the limitations of movers presently on the market. No wiring or drilling, simply attach the bracket, the Camper Trolley is moved into place and attached to the bracket, the unit can then be moved into place by remote control.

Stylish, compact and powerful, it can be fitted to chassis with low ground clearance, or where a conventional mover cannot be fitted due to restrictions. It can also be used on multiple vehicles or retained when a new vehicle is purchased (saving your investment)

Includes: *The CamperTrolley Mover, remote control, battery charger, mounting fittings and bag for storage*



CT1500
Low tower for single axles up to 1500kg
006590



CT2500
High tower for Twin axles up to 2500kg
006592



Closed frame bracket
006595

Kronings Caravan mover mounting accessories



ERIBA Touring kit
006615



AL-KO Vario III kit
For "Flat Frame" BPW or Al-Ko Vario III chassis
006617



M-Chassis kit
006635



Low chassis kit
006633



Spacer Kit
15mm **006625**
30mm **006627**



Flat clamp set
006637



Upper clamp bracket
006665



Lower clamp bracket
006666



Mounting bolts set
006669



Remote control
Single axle **006662**
Twin axle **006660**



Wiring set
006673



Main switch
006675



Centre bar
Comes with synchronising bar
006698



Stop block set (2)
Stops any Kronings mover from slipping on the chassis
006639



Anti-theft lock bolt set (2)
To help prevent the mover from being removed without authorisation
006642



Kronings winding handle
006699

Caravan moving systems

Buy the caravan mover that gives you more year after year!

Each product is carefully tested before shipment. Kronings caravan moving systems and equipment have a built in 64 bit encryption radio transmitter as standard. This Kronings Code technology protects your remote control against interference from other transmitters and receivers!



WOW Five year warranty on all movers when the mover is serviced after years 1 and 3 by a Kronings service centre!
 Future proof – Software upgrades available through Kronings service centres!



Light weight Caravan mover Manual engagement

Compact, clean design and minimal maintainance - easy to use. Manual engagement with cross actuation allowing both rollers to be engaged from one side.

Controlbox on all models can be individually programmed by Kronings service centres, to meet the exact demands of the customer.

When new software is developed, the controlbox can always be upgraded with newest functions by any Kronings service centre.

Single axle up to 1,800kg

006600

Twin axle with 4 motors

006604

(all wheel drive) up to 3,000kg

Caravan mover Fully Automatic engagement

Compact, clean design and minimal maintainance - easy to use. Automatic engagement by control buttons on the handset.

Controlbox on all models can be individually programmed by Kronings service centres, to meet the exact demands of the customer.

When new software is developed, the controlbox can always be upgraded with newest functions by any Kronings service centre.

Single axle up to 2,000kg

006606

Twin axle with 2 motors

006608

up to 2,300kg

Twin axle with 4 motors

006610

(all wheel drive) up to 3,000kg

	006600	006604	006606	006608	006610
	MANUAL ENGAGEMENT		AUTOMATIC ENGAGEMENT		
	Single axle	Twin axle 4 motors (AWD)	Single axle	Twin axle 2 motors	Twin axle 4 motors (AWD)
Weight	28.7kg	57.5kg	32kg	32kg	64kg
Frequency	433.92MHz	433.92MHz	433.92MHz	433.92MHz	433.92MHz
Voltage	12V	12V	12V	12V	12V
Recommended Battery Size	85-105 (Ah)	105 (Ah)	85-105 (Ah)	85-105 (Ah)	105 (Ah)
Rise	16% (1800kg) 23% (1275kg)	13% (2500kg) 15% (2100kg)	17% (1800kg) 25% (1275kg)	15% (2300kg) 18% (2000kg)	14% (3000kg) 20% (2000kg)
Electric Usage (Firm ground) Standby	25-35Ah < 10mAh	25-35Ah < 10mAh	25-35Ah < 10mAh	25-35Ah < 10mAh	25-35Ah < 10mAh
Speed cm/s (Firm ground)	12-14	12-14	13-16	13-15	14-15

Powrtouch Caravan Movers

Powrtouch caravan movers are designed to fit caravans that have shock absorbers fitted or have a narrow gap (less than 105mm) between the chassis and the tyre. They are fitted with a reduction gearbox to provide more moving power to the caravan wheels than comparative traditional caravan movers. Under ideal conditions it is expected that Powrtouch movers will move a 1,500 Kgs (approx 1.5UK tons) caravan up a 1 in 4 slope.

powrtouch

CARAVAN MOVERS

WOW 5 Years Warranty on
Powrtouch movers!



Powrtouch Freedom Caravan Mover

- Powrtouch Freedom mover for single axle caravans will fit all standard Alko & BPW chassis with or without shock absorbers
 - Powrtouch adaption brackets are available to allow fitment to non standard chassis
 - High strength, high grade steel reduction gearbox giving improved power delivery
 - Ability to engage both rollers from one side via the included cross actuation engagement system
 - Powerful enough to move caravans weighing 1500kgs on a 1 in 4 slope (levelling ramps)
 - Robust and durable construction achieved through the use of high grade steel & materials
 - Hard wearing roller construction in aluminium to save weight
 - Precise & accurate Soft Start Powr Drive control giving smooth mm by mm manoeuvring
 - 360° directional precision control with in-motion directional adjustment
 - Comprehensive directional performance, all with 4 speed settings
 - Multifunction handset and base unit warning indication system
 - Designed & manufactured to the highest industry standards including ISO 9001:2008
 - Industry leading five year no quibble guarantee is fully supported by Powrtouch's factory trained technicians and engineers
- 006813**

HTD Mirror Protectors

Protect-it

Protect your wing mirrors as well as your wallet. Protect, upgrade, customize!

- Helps to prevent damage to wing mirrors. Improves the appearance of the vehicle, covers existing damage with a professional gloss lacquer finish.
- Easy to fit, simply stick on to the mirror housing without the need for any additional tools. Extra strong double-sided permanent adhesive tape for protection against theft
- Impact resistant up to 90kmph against stationary and moving objects
- Set of 2

For Fiat Ducato, Peugeot Boxer and Citroen Relay (Jumper) models manufactured after 2006

Coachbuilt (motorhome) version for long arm mirrors

White **120171W**

Black **120171B**

Chrome **120171C**

Utility (campervans) version for short arm mirrors

White **120170W**

Black **120170B**

Chrome **120170C**



Hitchlocks and security devices



AL-KO
QUALITY FOR LIFE

fits



AKS 3004

Fits all models of 2004/3004 stabilisers
007941

fits



AKS 1300 / AK300

Fits 1300 stabilisers and AK300 coupling heads
007961

fits



AK160

Fits AK160 50mm coupling heads
007975

Security Premium

Safety Premium meets the highest international safety standards such as the criteria for the "Sold secure Gold standard" (UK).

The sturdy steel construction with powder-coated housing and a solid galvanised bolt (free of chromium(VI)) is supplied with two keys.



SOLD SECURE
GOLD STANDARD

fits



AKS 1300

Comes with necessary fittings
007960

fits



AKS 3004

Fits all models of 2004/3004 stabilisers
007940

Safety Plus

The tried-and-tested solution offers protection both on the road and when parked. So the caravan remains secure even when taking a break. With additional drill protection! Especially high-strength steel, additional reinforcements and the lock with drill protection, the Plus version offers great anti-theft protection even in unsafe areas. The red colour also means - this caravan is perfectly secured

AKS security barrel and two keys

007723



fits

AKS 2700 security device

Supplied with safety ball
008007



SOLD SECURE
GOLD STANDARD

fits

Winterhoff Robstop Plus

Supplied with safety ball
007860



AL-KO AK 10 lock

For Al-Ko AK 7, 9 + 10 hitches. Comes with 2 keys. Singly or 10 per outer
002105



AL-KO AKS1300 lock

Integral lock for the AKS1300 stabiliser. Comes with 2 keys
002118



AL-KO AK 13 lock

Integral lock for Al-Ko AK13, AK21 and AKS 2700 stabiliser. Comes with 2 keys
002116



Corner steady lock

For use with AL-KO premium corner steady
007436



Trailerlock Mk2

To fit 50mm ball couplings. Supplied with 2 keys
002090



Grayston hitchlock

To fit 50mm ball couplings. Supplied with 2 keys
002087



AL-KO safety ball

Dispaly box of 24
002120

AL-KO Secure wheel clamps

Lozenge insert only - Is the red insert only

Compact kit - Includes:

Rim Specific Insert, Kneeling Mat, Wheel Brace
Lock Components Box Including:

- Locking Bolt & Locking Bolt Socket
- Barrel Lock & 2 Barrel Lock Keys
- Barrel Lock Weather Cover
- Instruction Manual With Registration Card



WOW

The AL-KO Secure Wheel lock has been tested to Diamond standard from SOLD Secure and **is the only product on the market with this level of security.**

WOW

Many more models held in stock not illustrated. Other models available to order by special request!

- Compact No. 26 **001891**
- Insert No. 26 **001891INS**
- Compact No. 22 **001883**
- Insert No. 22 **001883INS**
- Compact No. 21 **001888**
- Insert No. 21 **001888INS**
- Compact No. 18 **001899**
- Insert No. 18 **001899INS**
- Compact No. 17 **001896**
- Insert No. 17 **001896INS**
- Compact No. 14 **001897**
- Insert No. 14 **001897INS**
- Compact No. 11 **001904**
- Insert No. 11 **001904INS**
- Compact No. 10 **001902**
- Insert No. 10 **001902INS**
- Compact No. 3 **001898**
- Insert No. 3 **001898INS**



No. 2

Hawk 14"

Used by Various
1287647
Compact Kit **001900**
Insert Only **001900INS**



No. 8

Salida 14"

Used only by Lunar
1287650
Compact Kit **001903**
Insert Only **001903INS**



No. 15

Challenger 14"

Used by Swift on Challengers
& Conquerors < 2014
1287992
Compact Kit **001892**
Insert Only **001892INS**



No. 16

Bailey 14"

Used by Swift on various models
1287993
Compact Kit **001909**
Insert Only **001909INS**



No. 19

Hawk 15"

Used by various manufacturers
1287990
Compact Kit **001908**
Insert Only **001908INS**



No. 20

Pageant 6 14"

Used by Bailey on Pageant series 6
models
1287645
Compact Kit **001882**
Insert Only **001882INS**



No. 23

Roven 14"

Used by Swift on a range of
models < 2015
1289106
Compact Kit **001894**
Insert Only **001894INS**



No. 24

Lunar 5514 14"

Used only by Lunar
1289166
Compact Kit **001895**
Insert Only **001895INS**



No. 25

Storm 14"

Used by Swift on a range of
models < 2015
1289487
Compact Kit **001890**
Insert Only **001890INS**



No. 27

Pegasus 14"

Used by Bailey on Pegasus &
Olympus models
1289779
Compact Kit **001889**
Insert Only **001889INS**



No. 28

Unicorn 15"

Used only by Bailey on Unicorn
models
1289824
Compact Kit **001884**
Insert Only **001884INS**



No. 29

Vortex 14"

Used by Coachman
1553574
Compact Kit **001885**
Insert Only **001885INS**



No. 30

Vortex 15"

Used by Coachman
1553575
Compact Kit **001886**
Insert Only **001886INS**



No. 31

Lunar 14"

Used only by Lunar
1555497
Compact Kit **001887**
Insert Only **001887INS**



No. 33

Bailey 14"

Used by Bailey
1556873
Compact Kit **001880**
Insert Only **001880INS**



No. 34

Scorpion 15"

Used by Swift
1556874
Compact Kit **001881**
Insert Only **001881INS**



No. 35

Tardis 14"

Aftermarket potential on All
Hymer, Corona, Xplore, Avante,
Affinity and dealer specials
1557310
Compact Kit **001877**
Insert Only **001877INS**



No. 36

Scorpion 14"

Used by Swift
1557312
Compact Kit **001879**
Insert Only **001879INS**



No. 37

Vision 14"

Used by Coachman
1557613
Compact Kit **001875**
Insert Only **001875INS**

AL-KO Secure wheel clamps



No. 38

Lunar 14"
Used by Lunar
1557619
Compact Kit
Insert Only

001876
001876INS



No. 39

Bailey 14"
Used by Bailey
1558298
Compact Kit
Insert Only

001880A
001880AINS



No. 42

Lunar 14"
Used by Lunar
1558766
Compact Kit
Insert Only

001874
001874INS



No. 43

Swift 15"
Used by Swift
1559389
Compact Kit
Insert Only

001873
001873INS



No. 44

Swift 14"
Used by Swift
1559417
Compact Kit
Insert Only

001872
001872INS



No. 47

Falcon 15"
Used by Coachman
1559565
Compact Kit
Insert Only

001886A
001886AINS



No. 48

Otium 14"
Used by Bailey
Option on Pegasus Grande
1821118
Compact Kit
Insert Only

001871
001871INS



No. 49

Otium 15"
Used by Bailey
Option on Pegasus Grande
1821134
Compact Kit
Insert Only

001870
001870INS



No. 50

Basecamp 16"
Used by Swift
1821165
Compact Kit
Insert Only

001869
001869INS



Protective Covers

Secure No.2	001960
Secure No.5	001963
Secure No.8	001966
Secure No.15	001968
Secure No.23	001972
secure No.26	001973
Secure No.30	001980
Secure No.34	001984

Secure No.35	001984A
Secure No.36	001985
Secure No.37	001986
Secure No.38	001987
Secure No.43	001993
Secure No.44	001994
Secure No.48	001998
Secure No.49	001999
Secure No.50	002000



Receiver Cap Yellow
Pack of 5 **001959**



Replacement Barrel and 2 keys
001850

Stronghold Security

Stronghold products come with a 2 year mechanical warranty. The hitchlocks can be fitted hitched or unhitched. All locks have high security pick free locks, supplied with 3 keys giving millions of key combinations. Handy and colour pictorial fitting instructions.

DO NOT USE WHILST TOWING



Stronghold AL-KO hitchlock

- Sold Secure Gold
- Fits Alko Hitches, AK130, AK160, AKS1300, AKS2004 and AKS3004 (all versions)
- Easy fit in under 10 seconds
- Case hardened steel body and locking bolt

001703



Stronghold Winterhoff hitchlock

- Sold Secure Gold
- Fits Winterhoff WS3000 hitches
- Easy fit in under 10 seconds
- Supplied with steel security ball for the un-hitched position
- Case hardened anti-saw location pins

001705



Maypole AL-KO hitchlock

- Fits Alko Hitches, AK130, AK160, AKS1300, AKS2004 and AKS3004 (all versions)
- Lightweight and robust construction
- Insurance approved

001703A



Maypole strongbox hitchlock

- Fits Alko, Albe, Winterhoff, Harrison, B&B and most other original open handle hitch types
- Robust steel construction
- Anti-prising lip

001701



Apex wheel clamp

- Sold Secure Gold
- Fully adjustable for wheel diameter (set once)
- Strong and robust steel hardened patented design
- Covers wheel nuts, wheel trims and alloy wheels
- Protective rubber on back plate to prevent damage to the wheel
- Easy to fit in under a minute - no tools required

12"-13" Fits tyre widths up to 165mm

001716A

13"-15" Fits tyre widths 175-195mm

001718A

15"-18" Fits tyre widths 205-225mm

001720A



The leg lock

- 2 year mechanical warranty
- Supplied with 3mm allen key and hexagon adjustor key

001707



Alloy wheel clamp

- Sold Secure Gold
- Fits 13" to 15" rim sizes
- Fits 165mm to 205mm tyre sizes
- Easy fit onto security wheel bolt in under a minute
- Strong and robust hardened steel construction

001722



Atlas wheel clamp

- Sold Secure Gold
- Fits steel and alloy wheels up to 265mm width
- Easily fitted in under a minute
- Durable PVC coating prevents damage to the wheels

001714A



Protector wheel clamp

- Sold Secure Gold
- Universal fit not restricted by tyre size or width
- Prevents tow away theft by stopping rotation of the wheel
- Easily fitted in under a minute
- Foam protection to prevent damage to the wheels
- Ideal for alloy wheels

001730A



Maypole security post

- Additional security for private or commercial use
- Highly visible deterrent
- Folds down for convenient vehicle access
- 3 mounting holes for bolts (not included)
- Includes integral lock and protective cover

001729

SECURITY

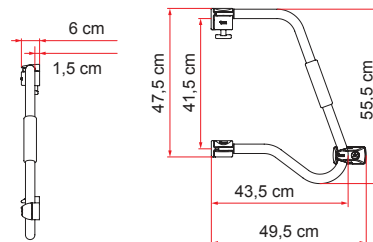
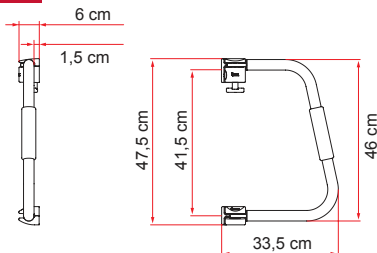
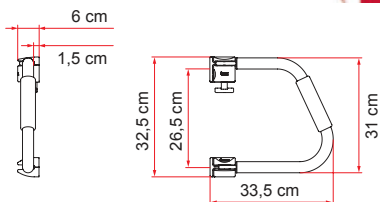

B

Security 31

Security device made from solid painted aluminium with 30mm diameter and 2mm thickness. It also serves as a conventional handle to make entering and exiting the vehicle easier. Adapts to all doors opening both to the right and to the left.

001201

Security 46

Extra long version of Security 31

001203

Security 46 PRO

Special version of Security for motor home doors or for applications where a strong structure is required. Made in light but solid aluminium. Delivered with Kit Security Lock that offers major safety and strength thanks to a third fastening point on the door.

001204

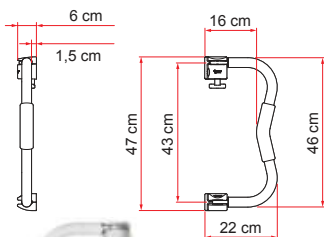

Kit Security Grip

Comfortable polyester anti-slip cover to protect the safety grip of the security handles. Now delivered as standard with security handles it is available as an option for previous versions.

001203A

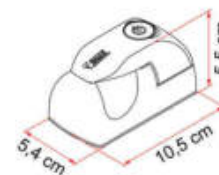

Security S

M-shaped ergonomic handle with less projection than the standard handle

001200A

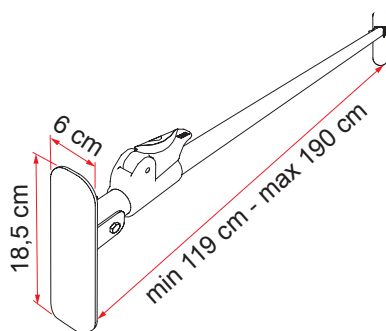

Kit Security Lock

Optional additional safety lock kit for Security 31 and Security 46 to be installed on the door of the motorhome. Delivered as standard with keys and internal brackets. Weight 0.5kg. White

001218

Duo-Safe Pro

Strong security bar allows blocking of the front doors from the inside. Quick and ready to use. Universal model thanks to the telescopic frame and Quick Lock hooks provided, to adapt to most vehicle cabins.

Tested on:

Fiat Ducato, Citroen Jumper, Peugeot Boxer and Renault Master before 06/2006

Mercedes Sprinter, Fiat Ducato, Renault Master and Ford Transit after 06/2006

Also suitable for Iveco Daily cabin.

Weight 1kg

Grey

001204A

SAFE DOOR®



Safe Door®

Safety block for motor home or caravan door. It works as an anti-theft device as it is made from sturdy anodized aluminium without plastic parts. It is easily installed to the vehicle wall with bolts and internal support brackets. Weight 0.6kg.

- White **001206A**
- Grey **001206B**
- Black **001206C**

Safe Door® 3

A set of 3 Safe Doors with the same key number for convenience.

- White **001206D**
- Grey **001206E**
- Black **001206F**

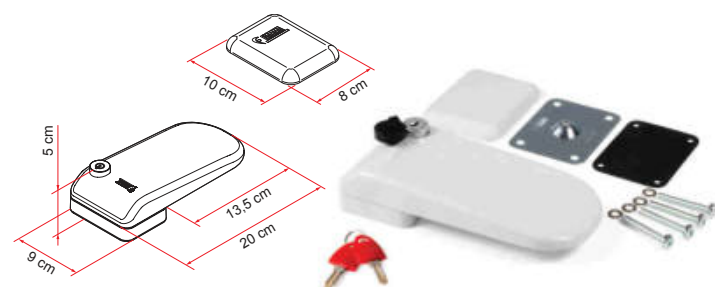

Safe Door® Magnum

A Safe Door® with extended length to 20cm to cover the locks of camper doors. Weight 0.6kg. White. **001211**

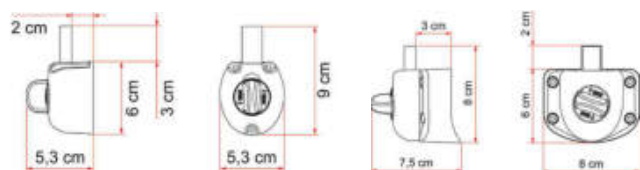

Standard
001213

Ducato
After 09/09
001214

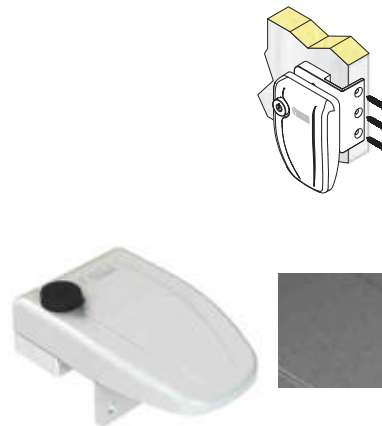

Safe Door® Frame

A Safe Door® that is installed on the side frame of the door or garage compartment with self-tapping screws. Weight 0.5kg.

- White **001208A**
- Grey **001208B**
- Black **001208C**

Safe Door® Frame 3

A set of 3 Safe Door Frames with the same key number for convenience.

- White **001208D**
- Grey **001208E**
- Black **001208F**

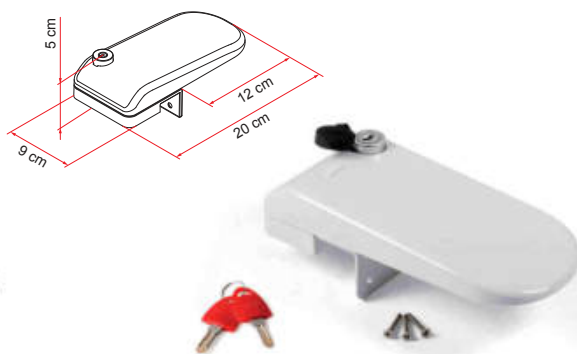

Safe Door® Magnum Frame

Installed on the inside profile of the door this special Safe Door® Frame Magnum is a Safe Door® Frame with extended length to 20cm to cover the locks of camper doors. Weight 0.6kg. White. **001211A**

Safe Door® Guardian

Security block created to be placed on the inside of the door or the garage of the motor home or caravan to secure the doors of the vehicle. Excellent protection against theft as it is made of strong aluminium, without any plastic parts. It is installed instead of the standard plastic security blocks, in the same position and using the same fixing holes.

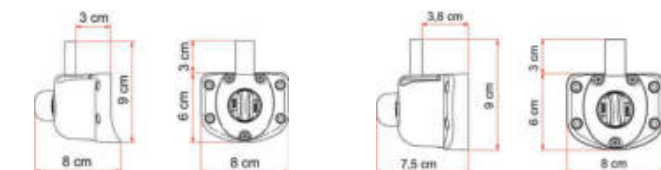

Ducato
After 06/06 before 09/09
001214A

Transit
After 06/06
001214C

Exterior door locks

WOW A left hand lock fits on a door with the hinges on the left as you look from the outside



Caraloc 640

- Left hand complete **001103**
- Right hand complete **001105**
- Left hand interior only **001104**
- Right hand interior only **001106**

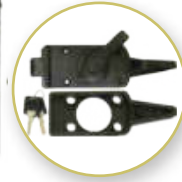

Caraloc 2000

- Left hand complete **001012**
- Right hand complete **001014**
- Left hand interior only **001013**
- Right hand interior only **001015**



Zadi round door lock

- Right hand black **001131**
- Left hand black **001132**



Zadi round door lock

- Right hand cream **001133**
- Left hand cream (black interior) **001134**



Caraloc 680

001001



Caraloc 700

- Left hand **001078**
- Right hand **001089**
- Exterior only **001091**

Locker locks



Compartment lock assembly

Complete assembly and 2 keys
001168



W4 external locker door lock

Replacement door lock assembly complete with WD lock and 2 keys. Used by manufacturers on external lockers
001169



Black oblong 50mm
001161



Black square 45mm
001180



Black square 45mm Including cover
001162

Locks and keys



WD Standard barrel
 Supplied with 2 WD keys
 standard barrel with removal
 tool
001164



WD short threaded barrel
 Supplied with 2 WD keys. A WD
 short barrel lock with a female
 thread to enable attachment to
 gas locker door mechanisms
001167



All keys are supplied
 individually packed in outers
 of 3

MC keys
001147 followed by key
 number
Key merchandiser
 Includes 3 of the available keys
 between
 1 and 40 **001149**
 41 and 80 **001150**



WD Short barrel
 Supplied with 2 WD keys
001166



Caraloc spare barrel
 Supplied with 2 MC keys
001130

ALL NUMBERS BETWEEN 1 AND
 80 ARE AVAILABLE



Caraloc security barrel
 To replace caraloc and WD
 standard barrels with a high
 security lock with over 1000
 combinations. Comes with
 removal tool and 4 keys
002127



Zadi spare barrel
 As used on Hartal doors and
 Vecam lock assemblies. Supplied
 with 2 Zadi keys
001154



All keys are supplied
 individually packed in outers
 of 3

WD keys
001155
 followed by the key number
Key merchandiser
 Includes 3 of the available
 72 keys between 1 and 199
001160

1	2	3	4
5	19	20	28
29	30	32	47
48	52	53	54
58	59	60	62
64	67	69	78
82	83	84	85
97	98	99	100
101	105	106	107
108	109	110	123
124	125	126	130
131	132	133	134
135	148	149	150
151	152	156	157
158	159	160	161
174	175	176	177
178	182	183	184
185	186	187	199



Snake cut lock barrel
 Replacement barrel lock
 cylinder, complete with one
 fold-away key fob and one
 over-moulded key. As used by
 Coachman Caravans
001170



**Waterproof laminated
 padlock**
 Singly or 20 per outer
001177

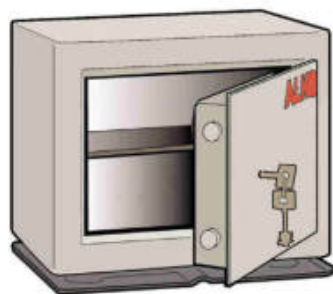

AL-KO Personal effects safe
 Complete with removable internal shelf,
 mounting plate, with all fixings and 2 keys. 14
 Litres. Outer wall thickness: 3mm
 External Dimensions: 300 x 240 x 200mm.
 Weight: 8.5kgs
002165

Alarm systems



Swift Stinger 310
002178S



Coachman Stinger 310
002178C

Sargent Stinger 300 Alarm kit

The Stinger 300 is best suited to aftermarket applications or as a replacement for our older AS210 system. It uses a simple to fit 2 wire power connection and is supplied with a mating cable for use if your caravan doesn't have an appropriate socket.

Key fob operated alarm system with:

- PIR movement sensor
- Tilt Sensor
- Awning light operation (via extra wiring)
- Battery back-up
- Loud 110db siren

002177



IDM PIR sensor
Fits IDM 2, 3 & 4
002173A



IDM charger
Fits IDM 2, 3 & 4
002171



IDM battery
Fits IDM 2, 3 & 4
002172



IDM Key pad
Fits IDM 4
002175

IDM4 Alarm kit

A keypad operated alarm system able to operate for many months from its integral battery.

- Stylish keypad with 10,000 possible codes, sensor and battery test functions and programmable settings
- 3 possible power sources – plug-top charger, leisure battery, solar panel (optional extra)

002174



Haegil H-847 Caravan alarm

A 12 volt remote control caravan / motorhome alarm that provides interior protection with a night mode to protect while you sleep. It features tow vehicle ignition sensing, unauthorised hitch-up detection, two sirens and an awning light output. It has been designed with additional alarm trigger inputs that allow the alarm to be tailored to your specific requirements, providing the ability to use additional pin switches, magnetic contacts or shock sensors to protect external lockers and equipment.

The system is supplied with 2 remote control encrypted transmitters each with its own panic facility. The main module contains an integrated tilt sensor which can be adjusted to any angle, ensuring the alarm will sound if an attempt is made to hitch-up the caravan illegally. A separate movement sensor fitted within the vehicle provides interior protection that can be disabled when you wish to sleep in the caravan with the alarm switched ON. An external awning light can be set to illuminate when switching the alarm ON or OFF for convenience on returning to the caravan. The alarm has 2 sirens, one with its own internal battery for additional security.

002150



Safe Can

Store your valuables where the thief won't find them. All labels and cans are 100% genuine and supplied by the manufacturer under licence. Recognised by Police Forces, Neighbourhood Watch groups and Insurance Companies worldwide as an excellent deterrent to theft, the Safe Can is an ideal place to hide money, jewellery and valuables. Just unscrew one end to reveal a great hiding place. Supplied 10 per outer

Soup **002252** Beans **002253**

Supplied 50 per outer

Assorted soup, beans, spaghetti **002250**

Vechline 230v plugs, sockets and accessories

Mains Extension Leads

230V 16A IP44.
3 x 2.5mm² cable.
Conform to:

- BS EN 60309 (Plug & Coupler)
 - BS EN 50525 (Cable)
 - Low Voltage Directive (LVD2014/35/EU)



Mains extension lead with carry bag

10m lead **016161A**
25m lead **016162A**

Mains extension lead in polybag

10m lead **016161B**
25m lead **016162B**



Hook-ups and Trailing sockets

230V 16A IP44.
Conform to:

- BS EN 60309 (Couplers)
 - BS EN 1363-1:2016 (UK Socket)
 - BS EN 1363-1:2016 (UK Plug)
 - VDE BS EN 50525-2:2011 (Cable)
- Low Voltage Directive (LVD2014/35/EU)



Mains hook-up adapter UK

Polybagged and header carded
Singly or 12 per outer
016118A

Mains hook-up adapter Continental

Polybagged and header carded
Singly or 12 per outer
016125A

Trailing socket

Polybagged and header carded
Singly or 12 per outer
016090A

Mains Plugs & Couplers

230V 16A IP44.
Conform to:

- BS EN 60309
 - Low Voltage Directive (LVD2014/35/EU)



Mains site plug

Singly or 12 per outer
Polybagged and header carded
016007A

Singly or 10 per outer
Loose
016008A



Mains coupler

Singly or 12 per outer
Polybagged and header carded
016018A

Singly or 10 per outer
Loose
016019A

W4 accessories



W4 mains hook-up adaptor UK

Enables a mains lead to be connected to a 13A 3 pin socket
Singly or 10 per outer
016118



W4 mains hook-up adaptor continental

Enables a mains lead to be connected to a continental 13A 2 pin socket
Singly or 10 per outer
016125



W4 13A trailing socket

230v male site plug with 13A trailing socket.
Singly or 10 per outer
016090



W4 universal mains testing kit

All you need to test the site supply at source, both in the UK and Europe. Especially useful for testing for polarity reversal
016100A



W4 mains testing kit

For checking the polarity directly from site electrical post. Components can be used separately
016095A



W4 mains tester

For electrical safety. Considered essential on the continent. Tests Earth, Live and Neutral.
Singly or 5 per outer
016099A



W4 mains splitter 3 way

230v male 3 pole 16A to 3 way female splitter. Conforms to EN60309
Weight 363g
Singly or 10 per outer
016020



W4 universal bulb kit

Contents:
H1, H4 & H7 headlight bulbs.
11 x assorted bulbs
3 x assorted blade fuses
2 x assorted mini blade fuse
010802



W4 inside/outside kit

Contents:
20mm fuses x 5 (1A, 2A, 3A, 5A & 10A),
30mm fuses x 3 (5A, 10A & 15A),
Mains fuses x 2 (5A & 13A),
Blade fuses x 4 (3A, 5A, 10A & 15A)
12V bulbs x 9 (Stop and tail, flasher/fog, no. plate, tail, 10W spot, 15W spot, 10W G4, 5W festoon & 10W festoon).
Singly or 25 per outer
010800



W4 budget kit

Contents:
12V bulbs x 7 (5W festoon, 4W Ba9s, 5W capless bulb, 5W Ba15s, 10W Ba15s, 21W Ba15s & 5/21W Ba15s) 2 x Blade fuses (10A, 15A)
010801



W4 motor home headlight kit

Contents:
12V bulbs x 7 (5W festoon, 4W Ba9s, 5W capless bulb, 5W Ba15s, 10W Ba15s, 21W Ba15s & 5/21W Ba15s)
3 x Blade fuses (10A, 15A & 20A),
2 x Mini blade fuses (10A & 15A)
Plus the following
H1 headlight bulb **010803**
H4 headlight bulb **010804**
H7 headlight bulb **010805**

230v mains inlets and outlets



Oblong flush mains inlet

230v male 3 pole 16A mains inlet in an IP44 housing.
Installation hole:
150x92x65mm (HxWxD)
White **016036**
Grey **016036G**



Cover and pins

Fits 016036, 016038, 016039, 016044 and 016043 (by cutting fins).
160 x 100mm
White **016040**
Grey **016040G**



W4 flush mains inlets

230v male 3 pole 16A mains inlet with lever release in an IP44 housing.
Installation hole: 100x100x80mm (HxWxD).
Singly or 10 per outer
White **016045**
Black **016046**



W4 waterproof flush socket

IP55 230v 13A socket in an IP44 housing. Installation hole:
150x92x65mm (HxWxD)
016043



W4 flush mains outlet

230v female 13A socket in an IP44 housing. Installation hole:
150x92x65mm (HxWxD)
016039



W4 mains angled inlet

Surface mounted 230v male 3 pole 16A inlet complying with BS4343 and IEC 309 CEE17
016029

W4 garage socket

230V female 3 pole 16A mains outlet. IP44
016049



W4 waterproof socket

230v 13A socket IP55
016044



W4 flush dual 230v/12V outlet

230v female 13A socket & 12V lighter type socket in an IP44 housing. Installation hole: 150x92x65mm (HxWxD)
016038



Truma mains outlet

230v 13A socket in an IP44 housing. Prewired for simple installation.
Installation hole:
90x80x65mm (HxWxD)
Overall dimensions:
140x125x108mm (HxWxD)
840701

230v mains accessories



"Keep Calm and Caravan" mains cable bag
Reinforced nylon bag **016174A**



Mains lead bag
Reinforced nylon bag **016174**



Cord wheel
Stores up to 45 meters of cable, cord, rope or flat hose keeping it tangle free and ready for use.
6 per outer **016269**



Matching Hitch cover **007345A**
Peg bag **109563A**



W4 cable keeper & storage bag
Will hold up to 25 metres of cable comes with nylon storage bag
016267



W4 cable keeper
Will hold up to 25 metres of cable
016266



Cable connecting case
Waterproof safety box for housing the connection when using 2 mains cables
016188

WOW Printed bags have the same unit cost as standard bags (for single colour printing) minimum quantity 100. Please speak to your sales contact for more details. For personalised product please allow a minimum of 6 weeks for first time orders and 4 weeks for repeat orders to receive your delivery.

Cables

Priced per metre. Sold by the roll.
Except 13 core cable which is sold by the length.
All PVC sheath with PVC insulated cores

7 core Black - 7 cores of 21 strands x 0.2mm Ø 100m roll
011542

7 core Grey - 6 cores of 21 strands x 0.3mm Ø and 1 core of 35 strands x 0.3mm Ø
30m roll
011553

13 core Black - 5 cores x 2.5mm Ø & 8 cores x 1.5mm Ø manufactured to ISO 11446
3m length **011554**
5m length **011555**

Twin core flat - 2 x 32/0.2, 8 amp, (1.0mm²) black
30m roll
011586

Mains cable 3 x 2.5mm² with orange
100m roll
016175

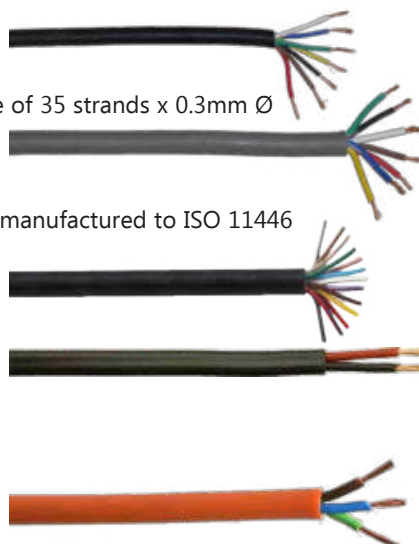

Solar panel kits

Monocrystalline

Rigid solar panel kits

High-performance monocrystalline cells. Supplied with integrated aluminium brackets, relevant charge controller, 6m cable, roof grommet, sealant and primer kit.



Part No.	010365	010366A	010367A
Pmax (W)	75	100	120
Vmp (V)	18	18	18
Imp (A)	4.31	5.56	6.67
Isc (A)	4.74	5.94	7.13
Voc (V)	21.06	21.06	21.06
Tolerance	+/- 5%	+/- 5%	+/- 5%
Dim. (LxWxD mm)	1096 x 540 x 57	1296 x 540 x 57	1326 x 660 x 57
Weight (Kg)	9.2	10.5	12.6

WOW All Vechline solar panels comply with NCC recommendation EN1648

3 year
Construction guarantee

10 year

Cell output guarantee

(Cells will produce a minimum of 90% of the rated output after 10 years)



All Vechline solar panel kits are supplied with the relevant charge controller, 6m cable, roof grommet, sealant & primer

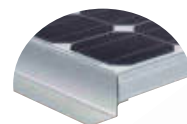

Integrated aluminium profile

Flexible solar panel Kits

Ideal for use on curved roof, profiles, greenhouses, boats and awnings. High-performance monocrystalline cells. Bending radius 10° max. Excellent holding in the marine environment. Ultra lightweight and high efficiency. Break-resistant. Supplied with relevant charge controller, 6m cable, roof grommet, sealant and primer kit.

Part No.	010369AK	010369BK	010369CK
Pmax (W)	100	120	150
Vmp (V)	18.97	18.97	17.8
Imp (A)	5.28	6.33	8.45
Isc (A)	5.69	6.83	9.30
Voc (V)	22.76	22.76	22.76
Tolerance	+/- 5%	+/- 5%	+/- 5%
Dim. (LxWxD mm)	1240 x 570	1430 x 680	1600 x 680
Weight (Kg)	4.0	4.5	4.8



Solar Technology panels

Solar Panel kits for use on motorhomes and caravans. High efficiency crystalline cell for "all weather" charging. Solar Technology panels are all accredited with the internationally recognised IEC 61215 certification that guarantees robust construction and high performance in all weather conditions. 10 year module warranty – 20* year cell output warranty.
 (*Output will be minimum 80% of specification after 20 years)

Solar



40Wp **010351**



60Wp **010352**



90Wp **010353**

Folding solar panel kits includes solar panel with fold away support legs, extension cable with crocodile clips, premium carry bag and fitting instructions

Part no.	Kit Power	Dimensions (mm)	Charge Control Included	Weight	Average Amp/ hours per day
010351	40Wp	500 x 353 x 76	10Ah (010380A)	7kg	Up to 15.54
010352	60Wp	500 x 500 x 76	10Ah (010380A)	8.5kg	Up to 22.3
010353	90Wp	700 x 520 x 76	10Ah (010380A)	11.5kg	Up to 33.41



60Wp **010363A**



80Wp **010364A**



120Wp **010367**



150Wp **010368**

Aero profile panel kits includes solar panel, relevant charge controller, 5m cable bundle, 1 set of Aero profiles, cable feed gland, tube ISR bonding agent, pack of fuses / ring terminals etc. and fitting instructions

Part no.	Kit Power	Dimensions (mm)	Charge Control Included	Weight	Average Amp/ hours per day
010363A	60Wp	685 x 670 x 35	10Ah (010380A)	6kg	Up to 23.82
010364A	80Wp	815 x 670 x 35	10Ah (010380A)	7.8kg	Up to 30
010367	120Wp	1250 x 670 x 35	10Ah (010380A)	12kg	Up to 47.58
010368	150Wp	1490 x 670 x 35	10Ah (010380A)	15.2kg	Up to 58.32



Foldout solar panel
 4W. Encased in hard wearing ABS material and it can be used in all weather conditions – inside and out!
 ● Support stand incorporated in the hard wearing body
 ● In built LED charge indicator
010350A



Premium profiles
 18cm straight pack of 2 **010388**
 Corner pack of 4 **010386**



Waterproof cable gland
 Single comes with an extra gland to add a 2nd cable in future if necessary
 Single **010391**
 Double **010390**

WOW Charge controllers comply with NCC recommendation EN1648



Twin charge controllers
 Can charge up to 2 batteries simultaneously
 10Ah **010380A**
 20Ah **010383A**



Twin charge controller
 LCD Display to provide intelligent information about the solar panel performance
 ● Protects against battery reverse feed, overload, open circuit, lightning surge, deep discharge and currents up to 30A
 30Ah **010384**

Solar panels and accessories

Ring solar autotrickle charger 12V

Designed for cars and motorhomes when in storage to send a maintenance level charge to the battery, helping prevent flat batteries. Simply sits on the dashboard or windscreen and connects to the 12V cigar lighter socket.

Complete with suction cups (for windscreen mounting), LED charge indicator, 12V DC power plug, battery clips and 2.7 metre lead. Can be left connected overnight.

- Solar panel trickle charger to manage battery drain in parked vehicles.
- Can be connected to the cigarette lighter or directly to the battery.
- Will not overcharge or damage batteries.
- Charging voltage 13-14V, open circuit 22V.
- Applicable for all types of 12V batteries



Power 1.5W
520x170x30mm (HxWxD)
010370

Power 2.4W
525x265x35mm (HxWxD)
010373

Power 6W
580x385x60mm (HxWxD)
010377

ROKK wireless charging

The IPX6 waterproof 12/24V Qi certified waterproof wireless charging range enables wireless charging for the outdoor environment, without the need for phone charging cables. Designed from the ground up, this is the **world's first waterproof wireless charge system created specifically for use on board**, with the unique technology is housed in an IPX6, fully encapsulated and sealed unit.

Working directly with 12/24V systems, ROKK Wireless is ideal for life on the move and is perfect for sail and power boats and also RV. Easy install, anywhere you need your phone - indoors or out. No more wires! Exceeding the latest and highest standards of the Qi wireless protocol, ROKK Wireless is independently certified to deliver ultra-safe, wireless charging anywhere on board.



ROKK Hidden 12/24V wireless charger

Sub-surface, hidden from view but always ready to charge. Engineered to be installed under the surface and leave the top surface un-cluttered and looking perfect. Simply etch in your logo to identify the charge location. Ideal for GRP or wood, the unit can be installed under tables, cabinets, consoles or worktops. The installation system is simple to install and works with a variety of panel depths and materials.

010060

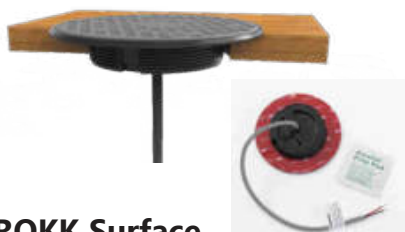

ROKK Surface 12/24V wireless charger

Low-profile, flush-mounted charge pad with an ultra grippy, nonslip surface. Contemporary look with two-tone colour, designed to complement modern interiors and exteriors. Designed to fit to any smooth surface, indoors or out.

010061



ROKK Bezel 12/24V wireless charger

The easiest to install, this option includes the non-slip surface pad but simplifies installation even further. Simply drill a 10mm cable access hole and fit to your chosen location and fast, Qi wireless charging is ready to go.

010062



ROKK receiver patch

Simply plug the Micro USB or Lightning charge patch into your phones charging port, place on the back of the phone and then clip on your phone case over the top.

Lightning (iphone)
Micro USB (android)

010064
010065



ROKK Waterproof high impact cable seal

Watertight installations for your aerial and solar panel cables! Produced in high impact, UV stable, glass filled nylon. IPX6 & 7 rated. Seal compression system, no sealant required with 3M waterproof gasket supplied.

2-6mm Cable seal
6-10mm Cable seal

010066
010067

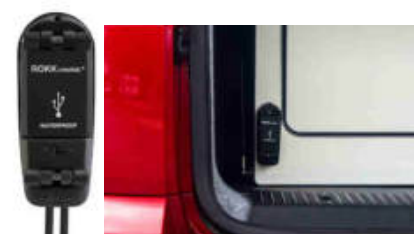

ROKK Waterproof double USB socket

Easy Install. Click and lock lid. IPX6 waterproof with cover closed. Output current 4.2A (total), up to 3x faster than standard USB sockets. Waterproof with 1, 2 and even no cables plugged in. Anti-corrosion coating on circuit board. UV resistant, with 316 stainless hinge and spring. Anti-snap cover aligns cables when closed.

29 x 94mm **010063**

Plugs, sockets, multisockets and testers

Ring 12V MultiSockets & testers

Enables multiple use of 12V appliances with cigar lighter plugs. All come with battery status indicator with the exception of 011701 & 011710. All are blister packed with euro slot



Twin MultiSocket & tester

Singly or 10 per outer
011702



Triple MultiSocket & tester

Singly or 10 per outer
011703



4-way MultiSocket & tester

Singly or 10 per outer
011704



Twin MultiSocket 12V/USB & tester

Allows the recharging of MP3 players and mobile phones. Singly or 10 per outer
011712



Can Multi-Socket & tester

10 amp 12V DC can shaped multi socket with battery analyser, width adjusting fitment collar, guide light rings and coiled cable. Singly or 10 per outer
Twin with twin USB
011714

12/24V plugs and sockets



Lighter type socket

12/24V, surface mounted, heavy-duty socket. 20amp
011695



Lighter type socket & cap

12/24V. Flush mounted, with a dust and splash proof cap. Push fit mounting. 20amp
011698



DIN to Lighter type converter

12/24V. Converts any single pole socket to a lighter-type socket. No fuse. 8amp
011691



DIN socket & cap

Single pole socket surface mounted with a dust & splash-proof cap. 16amp
011690



DIN multisocket

12/24V. Three single pole sockets mounted on a 90 x 36mm panel. 16amp
011693



Universal plug

12/24V. Heavy duty suitable for use in both lighter type sockets and single pole sockets. 8 amp fused
011665



Universal plug

12/24V. Heavy duty suitable for use in both lighter type and single pole sockets. 16 amp fused, built in power indication LED
011694



Bendable universal plug

A heavy duty plug similar to 011665 but can be angled at up to 90°. 8 amp fused
011696



Standard DIN plug

12/24V basic single pole plug without a fuse. Rated 8amp
011689



Standard DIN plug

A high-quality single pole plug without a fuse. Rated 15amp
011697



Coiled extension lead

12/24V. 8amp fused universal plug with coiled cable (0.6 to 3m)
011699



Lighter socket extension 3.6m

12/24V. Heavy-duty extension lead rated to 20amps. Lighter-type plug on one end, lighter-type socket on the other. Length 12 feet, 3.6 metre
011682

Plugs, sockets, multisockets and testers



W4 illuminated cigar socket
For flush fitting in a 28mm Ø hole. 12V
011671



W4 recessed lighter socket
Flush mounted socket for permanent fixing. 12V, 5A.
10 per outer **011669**



W4 quick fit lighter socket
12V 20A. 29mm ø.
42mm depth
011647A



W4 adapt-it
2 pin 12V plug to lighter type socket adaptor. 10amp.
Singly or 5 per outer
011650



W4 Dual purpose Plug
Can be used as both lighter type and single pole plug.
12V, 8 Amp. 10 per outer
011686



W4 fused lighter Plug
12V with 5amp fuse.
10 per outer **010647**



W4 lighter socket
Inline socket. 12V, 5amp.
10 per outer
011649



W4 adapt-it 2
3 pin 12V plug to lighter type socket adaptor. 2amp.
Singly or 5 per outer
011652



W4 DIN socket
Single pole 12V, 19A flush fitting socket. For flush fitting in a 18mm Ø hole.
011631



W4 DIN plug & socket
Single pole 12V, 8A plug & socket. 10 per outer
011630



Hella plug and socket
Single pole 12V plug.
Singly or 10 per outer
011635
Single pole socket & cap
011646



W4 adapt-it 3
Parallel pin 12V plug to lighter type socket adaptor. 10amp. Singly or 5 per outer
011654



W4 compact double USB socket
12/24V with reverse polarity protection. LED power indicator. 36.8mm ø. 40mm depth. Output : 5V DC 2.1A Max. No data transmission possible
010648



W4 2-way adaptor
Converts a lighter type socket to a double socket - internally fused at 15amps.
Singly or 10 per outer
011685



W4 adapt-it 4
2 fully insulated crocodile clips to lighter type socket adaptor with 1 metre cable. 10amp. Singly or 5 per outer
011655



W4 cigar plug/socket lead
Adaptor lead to extend lighter type sockets to a distance of 2 or 5 metres. Fuse (5 amp) built into plug. Singly or 10 per outer
2m **011675** 5m **011680**



W4 adapt-it 5
Single pole plug to lighter type socket adaptor. 8 amp. Hella type. Singly or 5 per outer
011657

Pack-it Ranges Electrical & TV

Stands complete with 10 packs of 24 of the best selling items in each range are available as a stand package. Please speak to your sales contact for details. All pack-it items are sold in outers of 10 unless otherwise stated



30A Terminal strip
6 way
010500



15A Terminal strip
12 way
010504



2A Terminal strip
12 way
010531



Push-on terminal &
cover (4)
Female 6.35mm
010503



Push-On terminal (3)
Insulated female
6.35mm
Red **010566**
Blue **010567**



Push-On terminal (3)
Male 6.35mm
Red **010569**
Blue **010570**



Push-On terminal (3)
Female 2.8mm
Red **010575**



Piggy back terminal
(3)
6.35mm
Blue **010573**



Ring terminal (3)
Blue 6mm ø
010578 *
Yellow 8mm ø
010579



Self stripping cable
connectors (4)
Blue **010506**



Cable clip (10)
Flat 10mm
010501



Cable clip (10)
Round
6mm **010502**
10mm **010565**



Crocodile clips
(pair)
5A **010517**



Crocodile clips
(pair)
50A **010529**
25A **010530**



Cable ties
100 x 2.5 mm (6)
010526 *
190 x 4.8 mm (3)
010527



Releasable cable
ties (3)
300 x 4.8 mm
010593 *



Cable tie base (3)
010528



Cable clip (3)
Self adhesive
010592



PVC insulation tape
19m x 4.5mm
010507



Bolt set (3)
For towing sockets
M5 x 35mm
010515



2 pin plug
040535



2 pin socket
040536



2 pin flush fitting
socket & plug
040537

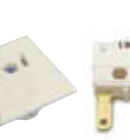

Microswitch for
taps
010583



Brass battery
terminals (Pair)
010645



Surface TV point
040546



Surface coaxial /
satellite point
040588



Surface satellite
point
040576



2-way coaxial
splitter
040586



Coaxial coupler
040544



Coaxial plug
040543



Satellite
'F' plug
040577



W4 Battery tester

Useful gadget for checking power in all sizes of dry cell batteries. Singly or 10 per outer **016093**



DC voltage tester

6-24v DC tester with neon indicator complete with 1 metre lead and crocodile clip. Singly or 10 per outer **016041**



W4 multimeter

Tests AC/DC voltage, DC current and resistance, diode & transformer check. Audible continuity check. Auto polarity indication. With impact resistant holder and plug in leads. Battery supplied. Singly or 10 per outer **016096**



W4 Compact multimeter

Tests AC/DC voltage, DC current, resistance. Audible continuity check. Automatic low battery indicator. Singly or 10 per outer **016094**



Press switch
010514



Satellite lead 2m
F plug to F plug
040585

Aerial lead 2m
Male to male
040547



12v 1.8m power lead with reversible socket and 4 interchangeable plugs 1.3mm, 2.1mm, 2.5mm, and 3.5mm mono jack plug.
040595



Rolson multimeter

Tests AC/DC voltage, DC current, decibel ratios, continuity, diode & transistors. With plug in leads. Battery supplied. Singly or 24 per outer **016097**

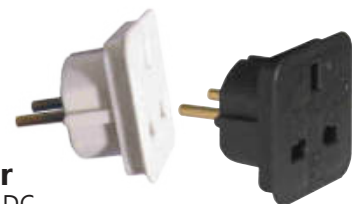

Travel adaptor

UK 3 pin socket to Euro 2 pin plug 7.5A capacity. Singly or 10 per outer White **016130** Black **016131**

Vechline lighting LED bulbs

WOW STABILight technology stops flickering. 12 & 24v operation with a 3 Year Warranty.



Vechline lighting LEDs consume very little energy compared to traditional bulbs. Their performance is exceptional, 40-100 lumen / watt depending on the model. They emit virtually no heat and are highly resistant to vibration. Vechline lighting LEDs have a lifespan of 50,000 hours and use STABILight technology that allows guaranteed lighting without flickering (especially when starting up other electrical appliances). Vechline have selected a light colour that allows for the ideal compromise between visual comfort and ambient brightness

- 12V & 24v (10-30v functioning range)
- Colour temperature 4500°K (cool white)
- Class A++
- 3 Year Warranty

Bulb terminology

Ba = bayonette fitting
E = Edison screw fitting
G/GX/GU = Bi-pin connector
s = Single contact
d = Double contact
MR = Multifaceted reflector



Ba15d bulb
12/24V, 0.6w, 60 lumen,
16 SMDs.
010450



Ba15s bulb
12/24V, 0.6w, 60 lumen,
16 SMDs.
010451



MR11 G4 bulb
12/24V, 2.5w, 220 lumen,
3 SMDs 30°.
010455



MR16 GU5.3 bulb
12/24V, 5w, 220 lumen,
4 SMDs 30°
010456



G4 back pin bulb
12/24V, 2w, 205 lumen,
12 SMDs.
010452



G4 side pin bulb
12/24V, 2w, 200 lumen,
12 SMDs.
010453



G4 bulb
12/24V, 0.7w, 85 lumen,
15 SMDs. 360°
010454



G4/Ba15s dome bulb
12/24V, 1.6w, 145 lumen,
30 SMDs.
010460



31mm Festoon bulb
12/24V, 0.8w, 70 lumen,
4 SMDs.
010457



37mm Festoon bulb
12/24V, 0.5w, 50 lumen,
3 SMDs.
010458



42mm Festoon bulb
12/24V, 0.5w, 50 lumen,
3 SMDs.
010459



T10 bulb
12/24V, 1.2w, 85 lumen,
15 SMDs. 360°
010461

W4 Pack-it bulbs



12V 21W Ba15s
Indicator
010510



12V 21W Ba15s
Amber. Indicator
010564
Offset pins
010595



12V Ba15s
10W **010551**
15W **010552**



12V LED Ba15s P21
010657A



12V LED Ba15s 207
010657C



12V 5W Ba15s
Tail/side
010512



12V Ba15s Halogen
5W **010558** 10W
010559



12V Ba15d
Tail/interior
5W **010550**
21W **010553**



12V 21/5W Ba15d
Stop/tail
010509



12V LED Ba15d P21/5
010657B



12V 10 SMD G4
Back entry
2W
10 SMD **010540**



12V 12 SMD G4
Side Entry
2.4W
12 SMD **010539**



12V LED Wedge 501
010657D



12V 5W capless
Tail/side
010556



12V 1.2W capless
5mm
010556A



12V LED
G4 1.5W
130 Lumen
010541



12V LED
G4 2.5W
170 Lumen
010657F



12V G4 Halogen (2)
5W **010543**
10W **010563**
20W **010591**



230v 25W G9 halogen
010544



12V LED
G9 2.5W
220 Lumen
010657G



12V G4
30° MR11 dichroic
10W **010533**
20W **010534**



12V SMD G4
30° MR11 dichroic
1.8W
9 SMD **010538**



12V SMD GX5.3 36°
MR16 dichroic
1.2W
12 SMD **010656**



12V GX5.3
36° MR16 dichroic
10W **010651**
20W **010652**



230v GU10
40° dichroic
Singly
50W **010589**



12V E14
15W **010554**
25W **010555**



230V 25W E14 Pigmy
bulb
010561



230v 25W E14 Golf
ball bulb
010562



12V 24W
B22d
010560



230v B22d
Globe bulb
25W **010590**
40W **010596**



12V 10W Ba9s
Halogen
Side/No. plate
010650



12V 4W Ba9s
Side/No. plate
010511



12V LED Festoon 239
010657E



12V Festoon
Interior/Awning
5W **010508**
10W **010513**
18W **010557**

Fuses



Blade fuses mixed (10)
2 x 3A, 5A, 10A, 15A & 20A
10 packs per outer
010633



Mini blade fuses mixed (8)
2 x 5A, 10A, 15A & 20A
10 packs per outer
010631



LED Blade fuses (3)
LED glows when fuse blown
10 packs per outer
5A **010670**
10A **010671**
15A **010672**
20A **010673**

Standard blade fuses (3)

10 packs per outer
3A **010634**
5A **010635**
7.5A **010636**
10A **010637**
15A **010638**
20A **010639**
25A **010640**
30A **010641**

Mini blade fuses (3)

10 packs per outer
5A **010605**
10A **010610**
15A **010615**
20A **010620**



10A in-line fuse holder
010516



Blade fuse holder
010642



4 Way blade fuse box
010594



Continental fuse mixed (6)
10 packs per outer
2 x 8A, 16A & 25A
010643



30 x 6.35mm fuses (3)
10 packs per outer
3A **010519**
5A **010520**
10A **010521**
15A **010518**



20 x 5mm fuses (3)
10 packs per outer
1A **010632**
2A **010522**
3A **010523**
5A **010524**
10A **010525**



Mains fuses mixed (6)
25mm
10 packs per outer
2 x 3A, 5A & 13A
010644

Clipsal plugs, sockets and switches



Coax and 2 pin socket
86 x 32mm
038638



2 pin socket and coax
12V polarised socket and coax socket
87 x 87mm
038681



Double switch
10 amp. Two gang switch.
86 x 32mm
038643



Single gang socket
Brown and silver sand
87 x 87mm
038682



Silver sand surround only
038684



Fused switch with neon
230v 13 amp fused switch with neon indicator
038675



Blanking plate
038686



Coax socket
87mm x 87mm
038622



2 pin socket and coax
87 x 87mm
038678



2 pin socket
15 amp polarised socket
87 x 87mm
038617



Single flush mounting box
With push on black trim.
89mm x 89mm x 30mm
038664

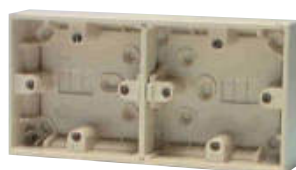

Divided box
For two single sockets.
Overall: 175mm x 85mm
Recess: 165mm x 75mm
038669



W4 mains backing boxes
Suitable for flush fitting of most 13 amp sockets.
Adjusts from 1-10mm.
Singly or 10 per outer
Single **038723** Double **038724**
Twin **038725**

Berker sockets



UK socket

250V 13A BS1363

- White **038800**
- Anthracite **038801**
- Brown **038802**



Single pole socket

6-24V, 16A

- White **038808**
- Anthracite **038809**
- Brown **038810**



Cigar socket

6-24V, 20A (at 2.5mm²)

- White **038806**
- Anthracite **038805**



USB charging point

5V output (not for data)

- White **038824**
- Anthracite **038825**
- Brown **038826**

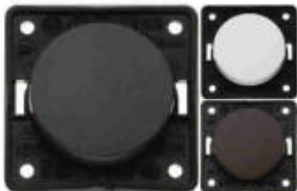

Rocker switch

Can be used as 12V or 230V (16A at 230V) 2 pole

- White **038828**
- Anthracite **038829**
- Brown **038830**
- Chrome **038831**

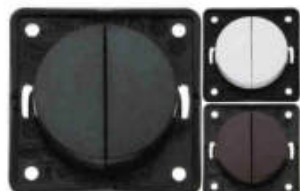

Rocker switch twin

12V/230V, 16A, 2 pole. Common input terminal

- White **038832**
- Anthracite **038833**
- Brown **038834**
- Chrome **038835**



Rocker switch twin

12V, 5A, 2 pole. Isolated input terminals

- Anthracite **038836**



Twin USB charging point

5V output (not for data)

- Anthracite **038827**



TV aerial point

- White **038812**
- Anthracite **038813**
- Brown **038814**



Satellite point

- White **038820**
- Anthracite **038821**
- Brown **038822**



TV/satellite point

- White **038816**
- Anthracite **038817**
- Brown **038818**



Blanking plate

- Anthracite **038882**



12V cigar socket / TV point

- Anthracite **038815**



12V cigar socket / satellite point

- Anthracite **038819**



Step switch

5 contact push button for step. 12-24V

- Anthracite **038840**



Frame & lid

With foam gasket. IP44

- White **038870**
- Anthracite **038871**
- Gloss chrome **038856A**

Granite	Frames
Pure	Frames are available in two design styles: "Pure"-flat & "Flow"-bevelled
White	An approximation of colours is shown opposite.
Flow	
Anthracite	Granite frames
Flow	Single 038851
Matt Chrome	Double 038860
Flow	White frames
Stainless Steel	Single 038852
Pure	Double 038861
Gloss Chrome	Triple 038866W
Flow	Single & lid (IP44) 038870
Gloss black	Anthracite frames
Pure	Single 038853
Brown	Double 038862
Flow	Triple 038866
	Single & lid (IP44) 038871
	Matt chrome frames
	Single 038855
	Double 038864

Frames are available in two design styles: "Pure"-flat & "Flow"-bevelled. An approximation of colours is shown opposite.

Stainless steel frames

- Single **038856PSS**
- Double **038864PSS**
- Triple **038868PSS**

Gloss chrome frames

- Single **038856**
- Double **038865**
- Triple **038867**
- Single & lid (IP44) **038856A**

Gloss black frames

- Single **038857**
- Double **038865GB**
- Triple **038868**

Brown frames

- Single **038854**
- Double **038863**



Back box

45.5mm depth. Flame resistant **038850**



Back box

Surface mounted. Can be used with all frames, single, double and triple **038880**

CBE sockets and switches



WOW CBE switches and sockets are supplied in three parts. Please order the support frame and "nl" frame as well as the switch or socket required.



Support frames grey
 Single 86x78mm **038500**
 Double 139x78mm **038503**
 Triple 192x78mm **038506**



Module "nl" frames
 Single dark grey **038518**
 Single light grey **038509**
 Double dark grey **038521**
 Double light grey **038512**
 Triple dark grey **038524**
 Triple light grey **038515**



12V Switch
 2 way
038527



12V Switch & LED
038530



12V Double switch
 2 way
38533



12/24V Switch & step switch
 3 position 2 way
038563



Pump & light switch
038560



230V uk socket
 Comes with back box
038536



12V lighter type socket
038545



12V watertight lighter type socket
038548



12V Single pole socket
038551



USB charging socket
038539



TV & satellite socket
038542



12V lighter type, TV & satellite socket
038554



12V single pole, TV & satellite socket
038557



12V battery tester
 4 level indication. Does not include surround.
038569



Fuse holder 4 fuse
038590



Waste & fresh water level indicator
 4 level fresh and full indication waste. Includes 2 x 4m cables, frame, spacer and probes. **038566**



Fresh water level indicator
 4 level indication. Includes 4m cable, frame, spacer and probe. **038578**



Waste water level indicator
 4 level indication. Includes 4m cable, frame, spacer and probe. **038581**



Digital clock
 LCD 65x32x11mm
038584



Fuse holder 50A
038587



Back box
 50mm 34mm depth **038593**
 45mm 22mm depth **038596**

Sargent Electrical



EC155 Power Supply Unit

The EC155 is specifically designed for converters. If you have a one off build or are a small to medium manufacturer then this would be the perfect choice for your requirements. It is a compact 155W power supply unit and charger.

Includes:

- RCD & 3 x MCB mains output protection
- 155w Electronic Charger / Converter
- Battery input fuses
- Multiple output fuses
- Built in charging & EMC relays
- Multiple relay switching channels

016910



EC155 kit with EC50 control panel

The kit contains comes with the EC50 control panel that is connected via a 2m control lead. The DIY harness simply plugs into the EC155 unit and provides the available 230V and 12V inputs and outputs for you to terminate to.

Kit Contents:

- EC155 Power Supply Unit
- EC50 Control Panel
- 5 metre length Control Lead
- DIY 230V & 12V Harness

016912



EC155 kit with EC51 control panel

As above with the addition of the fresh and waste water sensor harnesses, both connect directly onto the back of the EC51 control panel to show the levels of the fresh water tank, and indicates when the waste tank is full. Can be used to indicate one or both tanks.

Kit contents:

- EC155 Power Supply Unit
- EC51 Control Panel
- 5 Metre length Control lead
- EC155 DIY 230V & 12V Harnesses
- Waste Water Harness
- Fresh Water Harness
- Waste Tank Sensor
- Fresh Tank Sensor Kit

016914

EC160 Power Supply Unit

The EC160 PSU features a 230v AC 16A input via a pre-wired lead.

Includes:

- RCD & 3 x 10a MCB mains output protection
- 150w Electronic Charger / Converter
- 5 x 10a 12v fused outputs
- Built in split charging relay
- EMC isolation relay
- Digital voltmeter with on/off switch
- Reverse polarity indicator

Black horizontal EC160 **016896**

Black vertical EC160V **016897**

Silver horizontal EC160S **016898**

Silver vertical EC160SVS **016899**



EC328 Power Supply Unit

The EC328 PSU that has now replaced the earlier EC325 model.

New intelligent 300W (~25A) battery charger and power supply which incorporates a 3 stage intelligent charge routine. Built in solar panel regulator for the direct connection of up to a 100 watt solar panel providing the simultaneous charging of both the leisure and vehicle batteries. The charge current is displayed on the matching EC328 control panel. Attractive 'round edge' case in silver with distinctive graphics and logical component layout.

016920



EC328 kit

The EC328 Complete Electrical Kit is specifically designed for customers that are building their own motorhome or caravan conversion, and have the need for a powerful 25 amp charging system with added features. The kit contains:

- EC328 power supply unit
- Digital display EC328 control panel
- 5 metre length data control lead
- DIY 230V and 12V harness
- Fresh and waste water cables including sensors
- External temperature cable with probe

016922

Sargent Electrical



PSU2005

The PSU2005 has been a popular unit for over 5 years. The unit provides protection for the 230V (mains) and 12V equipment, supplies 12V power and charges the internal leisure battery

016902



PX300 3 stage charger

A 300W 3 stage intelligent battery charger and power supply.

This air cooled unit is ideal as a replacement for many makes and models of charger, and is also suitable for new installations.

It comes with a short adaptor cable which matches the 12V connector on many Nordelectronica charger units. This cable can also be used with 6.3mm female spade terminals. A short 230V mains cable is also supplied, for connection to a 5A fused 230V supply.

016900



Digital control panel

Works with the EC328, EC325, EC225 and EC200 PSUs. Menu displays water levels, battery voltage and current*, auto battery protect circuit, clock / alarm with event timer*. Connects to the PSU via a 20-way data cable, available separately. * depends on PSU

016934



EC50 control panel

LED logic control panel for use with the EC155 PSU, via a low current data link.

- 5 LED bar graph for battery voltage
- Battery protect automatic cut-off (both batteries)
- Pump control with pump active indication
- Lighting circuit power control via dedicated switch (lights are connected direct to the PSU)
- Easy selection between leisure and vehicle batteries

016930



EC51 control panel

LED logic control panel for use with the EC155 PSU, via a low current data link.

- 5 LED bar graph for battery voltage and fresh water levels
- Waste tank full indicator
- Battery protect automatic cut-off (both batteries)
- Pump control with pump active indication
- Easy selection between leisure and vehicle batteries

016932

Other mains electrical products



W4 MCB

Mini Circuit Breaker 16A
010597

W4 mains electrical pack

Contains all the necessary components for a safe and efficient mains installation in a caravan. Supplied with comprehensive fitting instructions

Contents:

- Consumer Unit - A compact housing with hinged clear lid (IP44) enclosing doublepole RCD together with a 6 and 10 amp MCB
- 2 x 13 amp sockets with flush fitting backing boxes
- Surface mounting angled mains inlet
- All necessary cables and connectors.

016277



STE48

Mains consumer unit includes the same charger specifications as STE47 3 stage charger

Main unit specification

- 0-16A 230V AC input (site limited)
- 3 x 10A MCB - 40A RCD protected
- Water & space heater outputs
- BS EN 60335-2-29 approved

Singly or 5 per outer

017125

WOW All Stellings products have a 2 year guarantee.



STE48 to Nord NE143RM
017128



STE48 to Nord NE143DU
017127

Bonus Electrical (CEC / Plug-in-systems)



Mains unit 225SPN

Fully insulated enclosure (IP65) containing a 40A RCD and two single pole, neutral switched MCB's (10A and 6A). Used in conjunction with a charging system and distribution panel the 225SPN can supply and protect all aspects of power supply to a caravan or motor home. Dimensions: 150x110x90mm (HxWxD)
017050



3 stage charger 18A

A light weight and efficient leisure battery charger. Thermal, short circuit and overload protection. Fan protection. 3-stage charging - bulk mode, absorption mode and float mode - charges your battery to 100% capacity. Operates from 184v to 264v AC. Temperature operation -25°C to +50°C. Dimensions: 176x162x74mm (LxWxD)
017053



Open charger 18A

This open charger can be used on all CEC units. May need slight adjustment on the fixing points on older models. If you are using this on an ESM2000 make sure the small switch on the side is pointing at "FLOAT" not "3 stage". Dimensions: 167x113x59mm (LxWxD)
017052



CEC PMS 3

Power management system combining mains/12V distribution and protection with an 18A battery charger. Terminal block connections for easy installation. 40A RCD, 3 resettable MCBs (10A, 6A & 6A), polarity indicator, pump switch, battery selector switch and battery condition indicator
Vertical **017040**
Horizontal **017041**



CEC PMS 4

A combined mains 230v AC and 12V DC distribution unit. Earth leakage protection via 40A RCD device. Over current protection via 3 x MCB devices (10A, 6A & 6A). Reverse polarity 240v neon indicator. 12A or 18A charger with overcurrent, short circuit and thermal protection. Six fused outputs via automotive blade fuses. Connecting kit with all necessary plugs and sockets provided. Dimensions: 225x335x115mm
017051



ESM 2000/2

Designed to operate on a mains supply of 185-265 volts AC. The 40A RCD gives protection against earth faults and also acts as the main switch. Includes 3 resettable MCBs, to protect against overcurrent. Allocation of the MCBs is as follows: MCB1 (10A) - Sockets / heater MCB2 (6A) - Water heater / Lights MCB3 (6A) - Fridge / Charger Includes a transformer/charger. Provides 12V circuits with power and charges the 12V battery when connected to the mains supply. 18A maximum output. Dimensions: 225x123x255mm (HxWxD)
017045



CP1 volt meter



CP2 distribution panel

Switch the power from car/cab batteries and van/auxiliary batteries or isolate both.
017062



Custom volt meter



CP3 distribution panel

Switch the power from van/auxiliary batteries. Includes pump isolation switch. Pump running indicator displays water pump activity
017063



KT9SCU distribution panel

Switch the power from car/cab batteries and van/auxiliary batteries or isolate both. Includes pump isolation switch. Pump running indicator displays water pump activity
017057

Zig Electronics



CF8 charger

Fully automatic electronic charging plus 230/12V conversion. 12A max charge depending on battery state. Up to 4.5A continuous current on transformer. Features include 3 x 10A switched and fused outlets for the vehicle accessories, battery condition monitor, automatic self re-setting, current overload and thermal trip. Dimensions: 162x206x110 (HxWxD)

Black **017024**
Brown **017026**



CF9 charger

Fully automatic electronic charging plus 230/12V conversion. 12A max charge depending on battery state. Up to 4.5A continuous current on transformer. Switched selection of source, car or auxiliary battery. Double pole illuminated mains switch. Safety - the C9 incorporates no less than 8 protection devices to eliminate overheating and over current problems. Dimensions: 105x300x140mm (HxWxD)

Brown **017028**



X70 ce charger 12.5A

A lightweight compact battery charger and power supply with a stabilised output for maximum efficiency and control.

L195 x W115 x H70mm
017020



X80 ce charger 16.5A

A lightweight 230V AC low noise forced cool battery charger and power supply with increased power for additional accessories.

L195 x W115 x H90mm
017022

CBE Power Supply and Distribution



CBE Waste & fresh water level indicator

4 level fresh and only full indication of waste. Includes 2 x 4m cables, frame, spacer and probes.

038566

CBE Waste water level indicator

4 level indication. Includes 4m cable, frame, spacer and 300mm probe.

038581



CBE Fresh water level indicator

4 level indication. Includes 4m cable, frame, spacer and 300mm probe.

038578

CBE 12V battery tester

4 level LED indication. Does not include frame.

038569



CBE Power Supply and Distribution



PC100 control panel

Microprocessor controlled digital system with LED control panel. Includes: Vehicle and auxiliary battery indicator (B1 and B2 condition), fresh water tank level indicator and waste water tank alarm. Controls for battery, fridge and lights. Fuse protection fuses and save battery function.

PC100 192 x 78mm

038599



PC150 control panel

Microprocessor controlled digital system with LED control panel. With the same specifications as the PC100

PC150 245 x 165mm

038597



PC200 control panel

LCD control panel only. Microprocessor controlled digital system. Includes: Clock, battery (car and aux) level indication, fresh water level indication (%), internal and external temperature display, and controls for lights, water pump, fridge, vehicle battery charging and exterior lights. Fuse protection and save battery function. Dimensions: 192 x 78mm

017003



DS120 mains distribution unit

The DS120 is a RCD main switch with a double pole 13A MCB to control and protect various mains circuits. 138x180x85mm

017004



DS300 12V distribution unit

For use with PC200 **017006**

For use with PC100/150 **038598**



Chargers

Designed specifically for the caravan, motorhome and marine markets. Thermal protection from overheating and short circuit and reverse polarity protection on 12V. For lead acid and gel batteries. TUV approved. Automatic operation, once voltage is reached it will continue to charge for 90mins (lead acid) or 8hrs (gel). Continuous maintenance 13.5V (lead acid) and 13.8V (gel). After 10 hours of maintenance the charger will switch to standby and charge again only when the battery drops below 13V. Dimensions: 180x140x85mm (LxWxD) 10A CB510 **017000**



6m Cable for control panel
017013



Fresh water Tank Probes
400mm **017007**
300mm **017009**



Waste water Tank Probes
017010



Cables with temperature sensors

Internal and external temperature sensors
017015



Fuse 50A & holder
038587



White junction box
016190



6m Cables for probes
017012

Please order the following products to build a CBE electrical kit

Control panel	038599 PC100	038597 PC120	017003 PC200
230V distribution	017004 DS120		
12V distribution	038598 DS300		
Charger	017000 10A	017001 16A	
Fresh water probes	017007 400mm	017009 300mm	
Waste water probes	017010		
Cables for probes	017012 1 separately required for fresh and 1 for waste		
Cable for control panel	017013 6m		
Temperature sensor	017015 Cables with temperature sensors		
Fuse with holder	038587 50A		

Charging



CTEK chargers charge all types of batteries to the maximum capacity. Lightweight and portable. Enables the leisure battery to provide as much as 25% more power than the 'on board' system. Can significantly prolong a battery's life. Can help prevent a 'dead' battery. Can be permanently connected to ensure perfect battery condition.



MXS 7.0 transformer/charger
 Max charging current 7.0A
 Supply Voltage 13.6V
 Battery size 14ah to 150ah (or 225ah for maintenance only)
 8 charging steps
010027



MXS 5.0 charger
 Max charging current 5.0A
 Battery size 1.2ah to 110ah (or 160ah for maintenance only)
 8 charging steps
010026

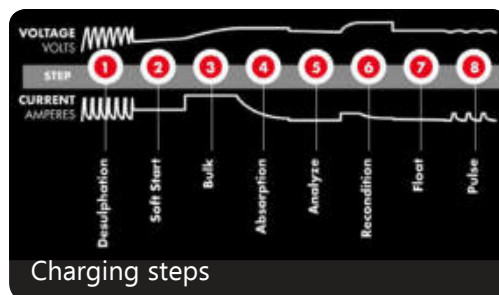

MXS 3.8 charger
 Max charging current 3.8A
 Battery size 1.2ah to 85ah (or 120ah for maintenance only)
 7 charging steps (no "Recondition" function)
010025

Ring Automotive SmartChargers



Multi stage fully automatic chargers, ideal for charging 12V batteries. Supplied with 230v 13A plug with interactive LCD display. Auto charge applies the fastest charge, based on battery size, settings for vehicles with start/stop function and battery repair tools to increase performance and battery life.

Includes the following battery and alternator analysis tools:

- *Battery Voltage* - % display for voltage status of the battery
- *Start power test* - Measures voltage drop during engine start to identify potential problems
- *Alternator test check* - Tests the recharging performance of the alternator
- *Battery cranking performance* - (12A only) Measures the cold cranking performance to determine the engine starting ability



SmartCharge 8A
 Up to 8A
010047A



SmartCharge 12A
 Up to 12A
010049A

For batteries from 25 to 300Ah. Memory saver function allows vehicle and audio settings to be retained if the battery has been removed



Ring Automatic Workshop Charge 20

12V, 20A fully automatic battery charger. Tough metal and rubber construction for professional use. Fast (20A) and slow (3A) charge rate settings. 80A jump start function. High quality professional battery chargers. Dim. (HxWxD) 215x265x230mm
010058



Ring Automatic Standard Charge 8

12V, 8A fully automatic battery charger. Fast (8A) and slow (3.7A) charge rate settings. Easy to read LED indicators clearly show charger status. Reverse polarity indicating LED. Ideal for DIY, enthusiasts and standard battery charging. Dim. (HxWxD) 215x260x100mm For leisure batteries up to 120Ah
010054



Ring Automatic Standard Charge 12

12V, 12A fully automatic battery charger. LED display screen shows battery voltage and charge rate applied. Fast (12A) and slow (3.7A) charge rate settings. Reverse polarity indicating LED. Ideal for DIY, enthusiasts and standard battery charging. Dim. (HxWxD) 215x260x100mm For leisure batteries up to 180Ah
010056



Kronings battery charger

Commercial automotive battery charger/maintainer - Automatic switching power, digital processing. Shows status as follows:

- No AC power
- Stand by
- Charging
- 75% Charged
- Charged and maintaining
- Deeply discharged or defective battery

For lead acid, Gel, AGM and VRLA leisure batteries up to 180Ah
010292

Inverters



PowerSource inverters

PowerSource inverters are suited to leisure and occasional use applications such as charging mobile phones, laptops etc, for periods of up to 4 hours continuously. They connect either by attaching directly to the leisure battery or into the 12V cigar socket. Made from light weight durable ABS. Includes an AC socket and a 2.1A USB charging socket.



E:Can Inverter 150w

12V DC to 230v AC can sized modified sine inverter suitable for cup holders. Suitable for laptop computers, video game consoles, MP3 players etc. USB charging point to allow the recharging of electronic devices. Peak Power Rating: 240W. Operates from 10-15 volts. Low battery shutdown protection, over voltage protection, overload protection and temperature protection
017213



150W
017215



300W
017230



500W
017234

300W compact inverter

300W continuous power rating with 0.5amp USB charging socket.
195 x 95 x 58mm
017230A



PowerSourcePro Inverters

High quality modified sine inverters, ideal for the professional user requiring mains power for heavy duty applications. These are well suited to more demanding applications and can provide power for up to 12 hours continuously. Now with a smaller footprint (40% smaller area than previous versions). Heavy duty extruded casings.



1kW
1kW continuous power rating.
2kW peak power rating.
2.1amp USB charging socket.
340 x 170 x 81.5mm.
2.7kg
017238



2kW
2kW continuous power rating.
4kW peak power rating.
340 x 170 x 162mm.
4.6kg
017241



3kW
With integrated multi-function LCD display.
3kW continuous power rating.
6kW peak power rating.
400 x 170 x 162mm.
5.7kg
017243

PowerSourcePure Inverters

Providing an extremely pure sine output which replicates the normal domestic mains supply, and as such are ideal for powering more sensitive electronic equipment. Certain products are not compatible with modified sine wave inverters such as some power tool re-chargers, coffee machines, laser printers, and sensitive audio/video equipment. The hard wired outputs on these models allow a more integrated solution for service vehicle and similar installations. With integrated multifunction LCD display for up to 12 hours continuous use. Heavy duty extruded casings.



1kW
1kW continuous power rating.
2kW peak power rating.
2.1amp USB charging socket.
320 x 247 x 118.5mm.
4.3kg
017239



2kW
2kW continuous power rating.
4kW peak power rating.
2.1amp USB charging socket.
420 x 247 x 118.5mm.
5.9kg
017242



EFOY COMFORT

The best energy supply for your travel enjoyment - irrespective of the weather and all year round.



Can be used all year round

In summer or very cold winter, whether you are under a shady tree, or on a cloudy day - even at sub-zero temperatures!



Extremely quiet

When EFOY COMFORT is installed as recommended, you will not hear it at all.



Fully automatic and maintenance-free

All you have to do is to make sure that fuel is always supplied. You do not even need to clean or maintain the EFOY COMFORT!



Eco-friendly

The EFOY COMFORT is economical in use and does not produce emissions that harm the environment.

How does it work?

The EFOY COMFORT charges the on-board battery fully automatically. The integrated charge controller permanently monitors the charge level of the 12V battery. The EFOY COMFORT starts automatically and switches off again once the battery is charged.

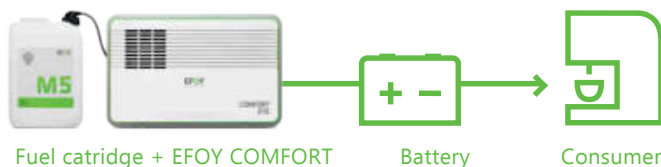

EFOY Fuel Cartridges - No mains supply for weeks at a time

EFOY fuel cartridges are a safety-tested fuel system that was specially developed for EFOY fuel cells. EFOY fuel cartridges can be changed in seconds. With an M10 fuel cartridge, you could be on the road for up to 4 weeks without a mains supply.



MADE BY **SFC** ENERGY

Cartridge*	M5	M10
Volume	5 Litre	10 Litre
Weight	4.3 kg	8.4 kg
Dimensions (L x l x H)	19.0 x 14.5 x 28.3 cm	23.0 x 19.3 x 31.8 cm
Part number	010347	010348

EFOY COMFORT Models



EFOY COMFORT	80	140	210
Maximum Power	40 W	72 W	105 W
Charge capacity /day	80 Ah	140 Ah	210 Ah
Nominal voltage	12 V		
Charge current @12 V	3.3 A	6.0 A	8.8 A
Nominal consumption / kWh	0.9 l		
Dimensions (L x l x H)	44.3 x 20.2 x 28.8 cm		
Weight	7.1 kg	7.8 kg	8.5 kg
Part number	010336	010340	010342

Supplied with full installation kit.

5 Years Warranty

For all three EFOY COMFORT models you have the opportunity to purchase a 5 year extended warranty. You get a two year warranty free with all models.

<https://garantie.efoy.com/en/home.html>



Energy Calculator

With the convenient new online energy calculator you can quickly and easily find the right EFOY COMFORT model to meet your needs.

www.efoy-comfort.com/energy-calculator

Accessories	Part number
Service Fluid	010334
Extension cable for "Sense" line, 8 m	010328
Extension cable for Power line, 8 m	010329
Control Panel for EFOY 600-2200	010332
Insulated exhaust hose	010326
Off heat tube	010327

Other EFOY spares / accessories are available to order please speak with your sales contact for more details.



10R-040718



Leisure Batteries PLATINUM

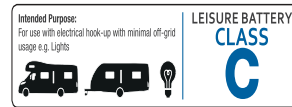

S685L - 75ah
Voltage - 12
Life cycles at DOD 50% - 70
L267 x W172 x H222mm
NCC Class - C
010310S



S6110L - 110ah
Voltage - 12
Life cycles at DOD 50% - 70
L328 x W171 x H237mm
NCC Class - C
010311S



LB6110L - 100ah
Voltage - 12
Life cycles at DOD 50% - 70
L351 x W174 x H188mm
NCC Class - C
010313

ODYSSEY BATTERY

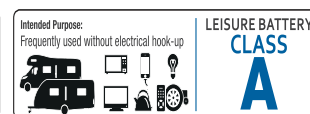

Thin Plate
Technology



PC1350 - 95ah
Voltage - 12
Life cycles at DOD 50% - 1850
L353 x W175 x H190mm
NCC Class - A
010318

- Suitable For Motor Movers
- 3x More Power
- Recharge in 1 hour
- Extreme Electrical Usage
- Longer Life, Better Value
- Up To 1850 Life Cycles

PLATINUM

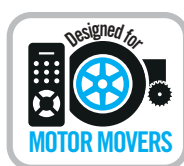
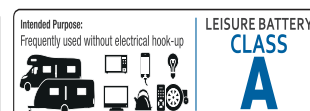

AGMLB6110L - 95ah
Voltage - 12
Life cycles at DOD 50% - 360
L354 x W175 x H190mm
NCC Class - A
010314

- Designed For Motor Movers
- AGM Technology
- 2x Faster Recharge
- Extreme Electrical Usage
- Longer Life, Better Value
- 360 Life Cycles

**Get Money For Your Scrap
Batteries
With Legally Required
Documentation**



- Ensure you bring your battery back to somewhere that will recycle your battery via a legally compliant scrap recycling scheme.
- We have a duty to protect the environment that we work and live in. After all, a healthy planet and a healthy community go hand in hand.

This scheme provides product verification for batteries used in leisure vehicles. With modern leisure vehicles featuring more technology and electrical appliances than ever before, buying an NCC verified leisure battery will give you confidence that the battery purchased is fit for purpose and will perform as advertised.

Light weight battery packs **kronings**

Optima high-performance AGM batteries aren't like any other batteries in the world. Their exclusive spiral cell technology design is among the most advanced commercially available lead-acid technologies out there. It delivers an incredibly strong and clean power source that can't be touched by today's lead-acid batteries. With longer lasting battery life under both starting and deep-cycle applications. Vibration resistant, spill proof and built to last. Low internal resistance also provides more constant power output and faster recharges.



2.7 power pack
For vehicles
up to 1650 kg
010282

4.2 power pack
For vehicles
up to 2000 kg
010284

5.5 power pack
For vehicles
over 2000 kg
010286

Specifications	Optima		
YTS = Yellow Top Standard terminals	41Ah 2.7 YTS	55Ah 4.2 YTS	75Ah 5.5 YTS
Rated voltage	12.0V	12.0V	12.0V
Fully Charged voltage	13.1V	13.1V	13.1V
Cut-off voltage	10.5V	10.5V	10.5V
Battery Charger recommended	13.8 to 15V, 10A max	13.8 to 15V, 10A max	13.8 to 15V, 10A max
Charging time at 50A	65 mins (90%)	75 mins (90%)	112 mins (90%)
Charging time at 10A	6-12 hours (100%)	6-12 hours (100%)	6-12 hours (100%)
Length	237mm	254mm	325mm
Width	129mm	172mm	165mm
Height (at terminals)	227mm	200mm	238mm
Weight	11.6kg	19.9kg	26.5kg
	010282	010284	010286

Battery accessories

Battery boxes

Acid resistant plastic boxes. Comes with battery strap, 2 retainers and a buckle.



Red
Internal Dim (mm):
270x195x190
010320

Yellow
Internal Dim (mm):
410x200x200
010321



Lift-Off battery clamps

Suitable for all standard round battery terminals. Colour coded.
Pair (packed). Singly or 10 per outer
010009
Bulk pack. 150 pairs per outer
200100



Via Mondo battery isolator switch and key
12V 100A. Max rating 300A for 5 seconds. Includes key.
010301



W4 battery strap retainers
2 per pack.
10 packs per outer
010324



Via Mondo isolator switch key
Loose **010303**

Simple and Effective!



Wire5
A pair of zinc plated multi-wire battery connectors. For round battery terminal posts. Connect up to 5 cables. Simply tighten the screws onto wires.
010011

Dry cell batteries



Fuji EnviroMAX batteries

Eco-responsible replacement batteries – with unsurpassed power and longevity! You get the best of both worlds with Fuji EnviroMAX – at no added cost. Independent tests show Fuji EnviroMAX batteries equal, and most often exceed the performance and longevity of equivalent major brands.

- Contains no harmful Mercury or Cadmium
- Will not harm the environment if disposed of through normal waste systems
- Fully recyclable packaging
- Made in some of the world's most eco-respectful battery plants, operating under some of the most strict standards of environmental responsibility

No other batteries are so respectful of our environment as Fuji EnviroMAX.



AA MN1500 (4)
Alkaline
12 per outer
019159



AA MN1500 (2)
Alkaline
12 per outer
019158



AAA MN2400 (4)
Alkaline
12 per outer
019161



C MN1400 (2)
Alkaline
12 per outer
019155



D MN1300 (2)
Alkaline
12 per outer
019154



9V MN1604
Alkaline
12 per outer
019163



AA MN1500 (4)
Zinc
Extra Heavy Duty
12 per outer
019169



9V MN1604
Zinc
Extra Heavy duty
12 per outer
019172

Duracell alkaline batteries



AA MN1500 (4)
20 per outer
019126



AA MN1500 (2)
20 per outer
019135



AAA MN2400 (4)
10 per outer
019140



C MN1400 (2)
10 per outer
019117



D MN1300 (2)
10 per outer
019108



9V MN1604
10 per outer
019144

Zinc Chloride batteries

Good value, high quality dry cell batteries.

Please note that images are for illustration purposes only - the manufacturer may change periodically.



AA MN1500 (4)
24 per outer
019204



C MN1400 (2)
24 per outer
019202



D MN1300 (2)
12 per outer
019200



9V MN1604
24 per outer
019206



MN9100 (2)
Clock battery
10 per outer
019145



E23A
Hob / Ignitor
10 per outer
019147

Lighting



LED awning light
LxDxH: 574 x 36 x 32mm
31 LED 12V
018500



LED sensor light
LxDxH: 574 x 36 x 32mm
31 LED 12V with light and movement sensors
018508



LED awning case
12V LED lights for F45 (not T5 models) and Fiamma ZIP awnings. Delivered with 5 x 50cm lengths (one with 12V wiring attached)
018509
Case Kit 50
Additional 50cm lengths
018510



Rafter LED
Suitable for use with F45s, F45L and Fiamma ZIP awnings. Can be used on F65s and F65L with optional 108263L shown below.
12V, 36 LED lights
018505



Adaptor kit for Rafter LED
To use Rafter LED on F65s and F65L
108263L



Awning arms LED
4 x 30cm LED light kits for any F45, F65 or ZIP awning
018503



Kit awning LED
12V switched LED light with 2 x 10 LED lengths. 5m of cable
018501



Kit cables guide
2 x lengths of flexible profile 1225mm long, 6.5mm ø
018515



Kit cables rail
2 x Self adhesive lengths of 1225x13x3mm.
018514



LED garage light
LxDxH: 574 x 36 x 32mm
31 LED 12V with switch
018511



LED awning gutter light
LxDxH: 690x 80 x 35mm
31 LED 12V. Ideal to stop the drips of rain above the door
018502



LED step light 12V
12V 6 LED. It can be shortened from 50-23cm
106204



Rafter LED Caravanstore
12V switched, 36 LED lights for F35 and Caravanstore awnings.
018506



Kit awning LED strip
Suitable for use with F65L and F80 awnings. Consisting of a 5m high brightness LED sticky strip, can be easily cut to length. Supplied with 10 x 50cm lenses to fit inside the profile of the lead bar.
12V, 300 LED lights
018504



LED warning solar lights (2)
LxDxH: 80 x 25 x 55mm
Kit of 2 rechargeable lights
018520

Interior lighting



lighting on the move
www.lumo.eu.com

12V dc lighting
specifically designed for
use in caravans and
motorhomes



Lumo 1
12V 8W switched fluorescent.
375 x 55 x 22mm
Singly or 10 per outer
Clear/white **018046**



Lumo 3
12V 2 x 8W switched fluorescent.
375 x 85 x 27mm
Clear/white **018057**



LED24 StripLite
12V 2W LED Switched.
385 x 50 x 40mm
Singly or 10 per outer
Satin **018000**

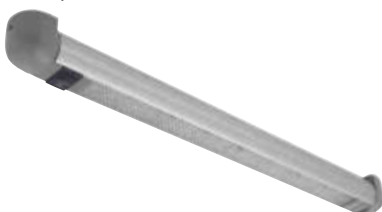

LED24 RotaLite
12V 2W LED rotating head,
switched.
390 x 35 x 32mm
Grey **018001**



LED20 RotaLite Mini
12V 2.4W LED rotating head,
switched. 345 x 25 x 20mm
Satin **017999**



LED Rigid StripLite
Can be cut to size every 3 LEDs.
12V 18 LED 300mm **017978**
12V 30 LED 500mm **017979**



Ellipse
Stylish elliptical 12V switched
ceiling light. 2 x 8W fluorescent
418 x 100 x 32mm
Silver sand **018276**



Coronet
Discreet 12V switched wall or
ceiling light. 220 x 140 x 47mm.
9W PL
Chrome **018274**



LED Coronet
Discreet 12V switched wall or
ceiling light. 220 x 140 x 47mm.
3.5W LED.
Chrome **018019**
Silver sand **018273A**



LED Crown
12V switched wall or ceiling light
3.5W LED. 217mm diameter. 47mm
depth
Satin **018017**



LED21 CeilingLite
12V 1.75W LED unswitched with
'dimming facility', water-resistant.
150mm diameter. 25mm depth
Satin **018003**



LED Corner Light
12V switched wall light. LED
Silver sand **018003C**



LED01 ecospot
12V 1W LED, switched
Brushed Nickel **017984**



LED Spotlight
12V 40mm arm. 1W LED, switched
Chrome **017983A**



LED Spotlight
12V 1W LED, switched
Chrome **017985**



lighting on the move
www.lumo.eu.com



LED01 FlexSpot
12V 1W LED, switched
Brushed Nickel **018022**



LED9 CeilingLite
12V 0.75W LED, switched. Surface
mount or recess
Satin **018009**



LED021L DownLite
12V 2W 21LEDs. Warm White
65mm ø, 50mm hole ø, 25mm
depth
Brushed Nickel **018004**



LED Downlight
12V LED, soft touch, switched.
Satin **018003B**



LED 6 Square Step Light
12V 0.36W 6 LEDs, square step light
Chrome **018022A**



LED 6 Round Step Light
12V 0.36W 6 LEDs, round step light
Chrome **018022B**

Common replacement interior bulbs



LED tubes
Includes instructions on how to replace 8W
fluorescent tubes with an LED tube. Under
no circumstances should the tube be simply
swapped. It must be wired directly to the 12V
DC supply.
T5 LED30 tube **018044**



G4 LED1 Capsule
Singly or 10 per outer
018014



G4 LED12 MR11
Singly or 10 per outer
018013



PL-S tubes
Replacement 4-pin tubes
in cool white
11W **019537**



Fluorescent tubes
10 per outer
Replacement 8W tube **018249**
Replacement 13W tube **018257**



2D bulb
4 pin 12V 16W
W4 **010587**
Singly or 10 per outer

Ring Lights



Flexi tent light
90cm flexi 90 LED tent/awning light. Comes with 12V and 230V
adaptors and 2m cables. Velcro or clip attachment for universal
fitting. Light output: 294 lumens. Singly or 6 per outer
019653



Ring awning lamp
12V surface mounted exterior light
H55 x W246 x D86 mm
Silver **018391S**
White **018391W**

Link light

30cm solid 27 LED tent/awning light. Velcro or clip
attachment for universal fitting. More add on units can be
added for bespoke lighting solutions. Light output: 155
lumens per length.



Starter kit
Comes with 12V
and 230V adaptors
and 2m cables.
019646



Add on unit
(requires starter kit)
has 2m additional
cable
019647

Labcraft lighting



KL LED

DX LED



Labcraft Orizon LED

12V LEDs encapsulated in a weatherproof (IP66) casing. 554 Lumen, 6W. Budget light with 24 high intensity LEDs. 10 year warranty. Made in the UK.
522 x 17 x 10mm
018028



Labcraft Nebula LED

12V switched LEDs encapsulated in a weatherproof (IP66) casing. 554 Lumen, 6W. Incorporates the Orizon LED strip light. 10 year warranty. Made in the UK.
624 x 44 x 14mm
018025



Labcraft Trilite LED

12V switched LED. 320 Lumen, 3W. Single LED striplight that is brighter than a twin tube fluorescent version and takes only half the power. 10 Year warranty. Made in the UK.
381 x 78 x 24mm
KL LED **018221**
DX LED **018029**



Labcraft Appollo LED

12V switched LED. 1108 Lumen, 12W. The internal LED strip can be positioned in 3 different angles by the user to direct the light exactly where it is needed. 10 Year warranty. Made in the UK.
610 x 37 x 16mm
018213

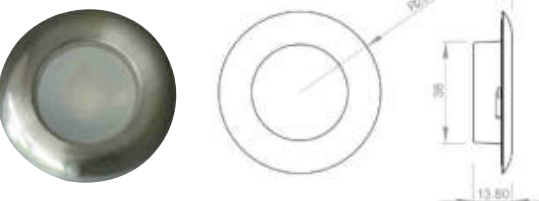

Labcraft Callisto LED downlighter

12V LED downlighter. 160 Lumen, 1.25W. 10 year warranty. Made in the UK.
018039



Labcraft Astro LED awning light

12V LEDs encapsulated in a weatherproof (IP66) casing. 554 Lumen, 6W. Incorporates the Orizon LED strip light. 10 year warranty. Made in the UK.
594 x 43 x 31mm
White **018043**
Grey **018043A**

Britax 891 awning lamp

12V switched light. Can be used as interior or awning lamp. Complete with 10W festoon bulb. Dimensions: 133 x 133mm
891 awning light **018404**
Spare lens **018415**
Spare switch **018388**

Lights and torches



Vechline Power

Vechline rechargeable fan lantern

Charged by a USB cable supplied. Fan, 360° light and torch with an integrated hanging hook. Can be used to recharge other products via the USB. 190 x 88mm Ø. 405g
019767



Vechline Power

Vechline rechargeable bug killer lantern

Charged by a USB cable supplied. With 3 light levels and an integrated hanging hook. 129 x 88mm Ø. 269g
019768



Vechline Power

Vechline bug killer lantern

230V. Attracts and kills flying insect pests. Chemical free and effective for up to 20m². Supplied with 1.5m cable. 235 x 155 x 105mm. 774g
019769



Rolson 24 LED bright light

Super bright 24 LED, now with dimmer switch, complete with hanging ring. Ideal for camping or as a patio table light. Supplied with 4 x D batteries. 2 per display box
019733



Milestone ultra bright 12 LED mini lantern

Super bright 12 LED. Soft touch rubber casing. Dimmer controls to adjust light levels. Indoor and outdoor use. Light weight with folding carry handle. 3 x AA batteries not included. 6 per outer
019733A



Milestone ultra bright waterproof LED lantern

Waterproof to IP54. Pull open to activate. Super bright LEDs, metal carrying handle. Light weight compact design. Operates for 8 hours. 3 x AA batteries not included. 2 per display box
019733B



Folding USB desk lamp

USB / battery operated desk lamp. Supplied with USB lead and 4 x AAA batteries. 100% / 50% / off. 127 x 71.5 x 40mm closed 127 x 71.5 x 320mm open 6 per display box
019499



W4 LED handy lamp

Powered by USB lead (supplied) or 3 x AA batteries (not supplied). Singly or 10 per outer
019498



LED pull light

Hang anywhere, pull on/off. 970mm chord length. Cool white 50 lumens. Battery powered (supplied).
019496



LED sticky light set

Bright white LED that can last up to 100 hours on a single set of batteries. Simply stick to any surface. Push to activate the 3 LEDs. Each light requires 3 x AAA batteries (not supplied) 8 per display box
019740



3 SMD Camping light

70mm ø x 42mm height. Supplied with swivel hook and 5 x modes (100% / 50% / 30% / quick flashing and flashing). 3 x AAA batteries supplied 5 per display box
019737

Lights and torches



LED switch light
Ultra bright 3W (200 lumen) long lasting LEDs. 3 x AAA batteries (not included). 75 x 112 x 25mm. 10 per outer
019497A



LED switch light double
Ultra bright 4 way 2W (200 lumen) long lasting LEDs. 4 x AA batteries (not included). 120 x 112 x 25mm. 10 per outer
019497B



Compact LED switch light
Ultra bright (200 lumen) long lasting 8 LEDs. 3 x AAA batteries (not included). 75 x 95 x 20mm.
019497C



LED switch light with dimmer
Ultra bright 2W (200 lumen) long lasting LEDs with dimmer control. 4 x AA batteries (not included). 110 x 112 x 25mm.
019497D



3 Watt COB light
LED. Manufactured in ABS with rubber housing finish. With hook and magnet. 3 x AAA batteries supplied. 6 per display box
019736



Rolson 72 LED camping light
Super bright 72 LED light with three strong magnets on reverse for mounting on most metal objects, along with swivel hook for hanging. Supplied with 4 x AA batteries.
019730



Multi-purpose 3 LED COB light
With magnetic stand and hanging hook. 3 x AAA batteries (not included). 12 per outer
019736A



LED Wire lights
Decorative wire frame with pretty LED lights

- Brighten up any room with a warm white glow
- High quality LED's for energy efficiency
- Use 3 x AA batteries (not included)

"LOVE" **019800A**
"HOME" **019800B**
"DREAM" **019800C**
"HAPPY" **019800D**



Rolson 28 LED aluminium torch
Manufactured from aluminium, simple push button operation with 28 LED's - 100 Lumens. Supplied with 3AAA batteries. Complete with wrist strap. 12 per outer
019742



3W COB LED aluminium torch (2)
Manufactured from aluminium, simple push button operation with 28 LED's - 100 Lumens. Supplied with 3AAA batteries. Complete with wrist strap. 12 per outer
019741

Vehicle Specific Naviceivers



EDGE Naviceiver: Model for:
Fiat Ducato, Citroën Relay (Jumper),
Peugeot Boxer
Z-E3756 **03885D**



EDGE Naviceiver: Model for:
Mercedes Sprinter II, Vito, Viano, A
and B class
Z-E4626 **03885E**



EDGE Naviceiver: Model for:
Volkswagen, Seat and Skoda
platforms, including VW T5
Z-E2050 **03885F**

Vehicle specific naviceivers by ZENEC. Innovative and advanced motorhome navigation systems specifically developed for the motorhome market and each vehicle's dashboard. They blend in perfectly with the original look of the vehicle, and can be conveniently controlled from the high resolution 7" / 17.8cm touchscreen display. With ZENEC you are able to experience an amazing range of entertainment options in the vehicle. Thanks to its new multituner system, there is a crystal clear radio reception, including for DAB+. The built in CD/DVD drive and a USB port (with 0.8m extension) on the rear of the device will allow you to play the latest video and audio formats. A 4 X 50 Watt amplifier complete with DSP suite (equalizer, time alignment and vehicle presets) ensures optimum sound quality. The powerful bluetooth module from Parrot, now with database support, gives you easy access to telephone functions and playlists. With European map package with 47 countries, including the camping point of interest package with more than 6 million premium points of interest, the ZENEC will guide you safely to any destination. By choosing vehicle specific profile and entering vehicle-specific data, you can plan any route more effectively.



Vehicle Specific
Fits seamlessly into the dashboard of the most common base vehicles for motorhomes, stalk controls for steering wheel interface available separately on most models



Motorhome/Caravan Navigation Software
Specifically designed software ensures the most appropriate route for your journey, with 47 EU country maps included



Multituner with DAB+
Optimal signal and choice with two FM/AM and two DAB+ tuners. A fifth tuner takes care of traffic management



Preconfigured Vehicle Profiles
Set your vehicle dimensions and weight to plan your route more effectively. Various profiles available (towing, roof boxes, bike racks etc)



CampingPoints of Interest Package
6m+ POI package includes more than 20,000 sites and stop over points. A comprehensive database allows you to see facilities with a connective phone no.



Bluetooth from Parrot
Advanced phonebook contact search and favourites. Two smart devices can be connected at one time



USB Media Management
Gracenote function allows you to set your play list by your mood or genre, MLT (more like this) function perfectly designed for entertainment on the move

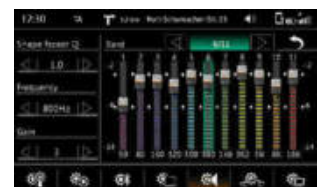

Digital Sound Processing
For perfect sound staging whilst listening to the radio in the driver's seat or in the habitation area of the motorhome

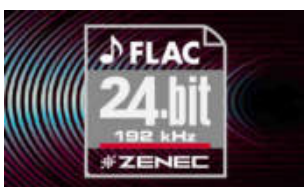

FLAC digital audio
Plays most modern audio and video files without complicated conversion



Screen Rear View Camera Interface (Camera optional)
Adjustable distance markers on screen (rather than on the camera) mean accurate distance observations



Camera Hard Key
Access the camera at any time via a touch of the button

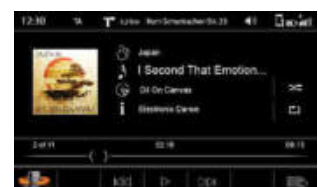

ZENEC for Future Proof
With easy software updates your ZENEC is future proof

Fiat Ducato Installation

Also for Peugeot Boxer and Citroen Relay (Jumper)



To replace OEM DAB+ radio (U-Connect 3):
 Z-E3756 Naviceiver **038885D**
 or F220 Naviceiver **038890C**
 Fiat OEM facia **038884**
 014.808-0 Steering wheel Interface **038894E**
 FD2319 Fakra to DIN **038896**
 FS2352 Fakra to SMB **038896B**

To replace OEM FM radio (U-Connect 3):
 Z-E3756 Naviceiver **038885**
 or F220 Naviceiver **038890C**
 Fiat OEM facia **038884**
 014.808-0 Steering wheel Interface **038894E**
 FD2319 Fakra to DIN **038896**
 AS2611 DAB+ Splitter **038895A**



To replace U-Connect 5 that has DAB+ radio:
 Z-E3756 Naviceiver **038885**
 or F220 Naviceiver **038890C**
 Fiat OEM facia **038884**
 011.801-2 Steering wheel Interface **038894D**
 FD2319 Fakra to DIN **038896**
 FS2352 Fakra to SMB **038896B**

To replace U-Connect 5 that does not have DAB+ radio:
 Z-E3756 Naviceiver **038885**
 or F220 Naviceiver **038890C**
 Fiat OEM facia **038884**
 011.801-2 Steering wheel Interface **038894D**
 FD2319 Fakra to DIN **038896**
 AS2611 DAB+ Splitter **038895A**



For new vehicles without OEM radio DAB+ solution :
 Z-E3756 Naviceiver **038885**
 or F220 Naviceiver **038890C**
 AS2611 DAB+ Splitter **038895A**
 014.805-0 Steering wheel Interface **038894A**

For new vehicles without OEM radio FM solution :
 Any universal naviceiver
 206.000-0 DIN to DIN **038896A**
 002.285-3 Bracket **038893A**

Where a Z-E3756 or F220 Naviceiver is suggested, a more cost effective solution can be found by replacing this with any 2-DIN universal product X-402 **038890E**

Also add:
 002.306P0-3 Bracket **038893B**
 Do not use Fiat OEM facia **038884** where suggested.

C1

VW Installation



For VW installations simply add a DAB+ aerial where vehicles have no DAB+ aerial installed otherwise this aerial is not required:
 Z-E2026 Naviceiver **038885B**
 DA2770 Active DAB+ Window Antenna **038895G**

Mercedes Installation



Mercedes-Benz

For new vehicles with DAB+ Aerial :
 Z-E4626 Naviceiver **038885E**
 Please call with new vehicles details to see what additional products are necessary, if any.

For vehicles with FM aerial :
 Z-E4626 Naviceiver **038885E**
 FD2319 Fakra to DIN **038896**
 AS2611 DAB+ Splitter **038895A**
 or
 DA2770 Active DAB+ Window Antenna **038895G**

Multimedia systems

XZENT



XZENT X-F220

- Fiat Ducato vehicle specific multimedia system:*
 FIAT Ducato III · Type 250/251 · model year 2006 – 2011
 FIAT Ducato III · Type 250/251 · model year 2011 – 2014
 FIAT Ducato III · Type 250/251 (X290) 2014 onwards
 Citroën Jumper II · Type 250/250D/250L 2006 onwards
 Peugeot Boxer II · Type 250/251 2006 onwards
- FM and DAB+ radio
 - 6.2" / 15.7 cm 16:9 touchscreen display
 - DVD/CD player
 - 6.2" / 15.7cm TFT LCD touchscreen
 - Bluetooth connectivity with internal Bluetooth microphone for handsfree calling
 - 2 x rear USB 2.0 port, supporting Apple, Android and other audio and video formats
 - 4 x 40W amplifier

F220 **038890G**



SDHC card with motorhome specific navigation software for F220. EU map package with 47 countries, Camping POI package and 6 million+ premium POI
 X-F220-SDFEU **038890D**

XZENT X-402

- Multimedia system:
- FM and DAB+ radio
 - 6.2" / 15.7 cm 16:9 touchscreen display
 - DVD/CD player
 - 6.2" / 15.7cm TFT LCD touchscreen
 - Bluetooth connectivity with internal Bluetooth microphone for handsfree calling
 - 2 x rear USB 2.0 port, supporting Apple, Android and other audio and video formats
 - 4 x 40W amplifier

X-402 **038890E**



SDHC card with navigation software for X402. EU map package with 47 countries and 6 million+ premium POI
 X-402-SDFEU **038890F**

Audio Accessories



Zenec DAB+ Tuner
 ZE-DAB60
038887



Zenec TV Tuner
 ZE-DVBT40
038887A



ATB20P Active Subwoofer
038888B



AXTON 2 Channel Amp
 A250
038888

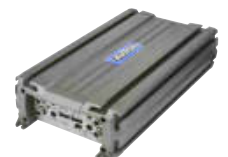

AXTON 4 Channel Amp
 A460
038888A



N-ADUC-IS01
 Plug and play 1 Channel
038889

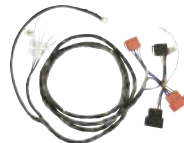

N-ADUC-IS02
 Plug and play 2 Channel
038889A



N-ADUC-IS04
 Plug and play 4 Channel
038889B



Fiat speaker
 ATC26-DUC
038891



Voltage stabiliser 12V
 13285-004.02300
 Plug and play behind the radio
038897

Installation Accessories



1 Din installation bracket
001.285-3
Fiat Ducato without OEM radio fitted > 2006
038893



2 Din installation bracket
Fiat Ducato without OEM radio fitted > 2011.
002.285-3 Matt Black
038893A
002.285P0-3 Gloss Black
038893C



2 Din installation bracket
002.306P0-3
Fiat Ducato with OEM radio fitted > 2011
Gloss Black **038893B**



Fiat Facia
Use when replacing a Factory fitted radio or Naviceiver in new vehicles
038884



1 Din installation bracket
001.10251-2
For all VW T5 models 2010-2014
038893E



2 Din installation bracket
PRVC EU 90001/bp
For all VW T5 models 2010-2014
038893D



Fakra to SMB
FS2352
To connect original DAB+ Fiat antenna to Zenec/Xzent products
038896B



Fakra to DIN
FD2319
To allow simple connection to the original U-connect wiring
038896



FM Fiat connector
206.000-0
To connect FM Fiat antenna to a radio
038896A



Steering wheel remote control interface Fiat
014.805-0
Only for vehicles without OEM radio but with telephone buttons on the steering wheel > 2015
038894A



Steering wheel remote control interface Fiat
014.309-0
For vehicles without OEM radio > 2011
038894



Steering wheel remote control interface Fiat
014.808-0
For vehicles with U-connect 3 OEM radio (no Sat Nav)
038894E



Steering wheel remote control interface Fiat
011.801-2
For vehicles with U-connect 5 OEM radio (with Sat Nav)
038894D



Active Splitter
AS2611
Amplifies the signal from the aerial and provides FM and DAB+ inputs for the radio, with +20dB gain. For use with passive aerials (038895D)
038895A



Passive Antenna
PA1501
For use with active splitter (always use with 038895A)
038895D



Steering wheel remote control interface Mercedes
014.857-0
For Mercedes Sprinter
038894F



Steering wheel remote control interface T5
014.810-0
2010 - 2014
038894B



Steering wheel remote control interface T6
014.811-0
> 2015
038894C



Passive Splitter
PS2912
Splits signal from aerial and provides FM and DAB+ inputs. For use with an active aerial
038895B



Dipole Antenna
DP0407
Simple active aerial for installation on stable base such as fibreglass
038895C



Active DAB+ Disc Mount Antenna
DA2762
Requires 12v & earth
038895F



Active DAB+ Window Antenna
DA2770
No extra earth required
038895G



Active DAB+ Glass Antenna
DA4570
For vehicles with fixed windows. No extra earth required
038895E

C1

Reversing Cameras



Compact rear view camera for motor homes

ZE-RVSC62

- Aluminum die cast housing
- Automatic day and night mode with 4 night vision IR LEDs
- View angles: 115° horizontal / 80° vertical
- IP protection rating: IP68
- Dimensions (WxHxD): 36 x 31 x 40 mm
- Weight: 60 g
- 3 m length of main wire harness with 15 m extension wire included

038886



Rear view camera for campers and caravans

ZE-RVSC70

- Corrosion resistant housing with automatic motorised cover made of stainless steel
- Automatic day and night mode with 18 night vision IR LEDs
- View angle: 115° horizontal
- IP protection rating: IP68
- Dimensions (WxHxD): 93 x 111 x 75 mm
- Weight: 590 g
- 5 m length of main wire harness with 12 m extension wire included

038886A



Rear view camera for motor homes

ZE-RVSC90

- Powdered coated Aluminum die cast housing
- Automatic day and night mode with 10 night vision IR LEDs
- Built-in microphone
- View angles: 150° horizontal / 125° vertical
- IP protection rating: IP68
- Dimensions (WxHxD): 84 x 71/99 x 65 mm
- Weight: 330 g
- 3 m length of main wire harness with 15 m extension wire included

038886B



Compact rear view camera for simple mounting

ZE-RVSC80MT

- Aluminum die cast housing
- Super light sensitivity yeilds a super sharp image even in difficult light conditions of dusk and dawn
- View angle: 140° horizontal
- IP protection rating: IP68
- Dimensions (WxHxD): 50 x 20x 78 mm
- Weight: 74 g
- 3 m length of main wire harness with 6 m extension wire included

038886C



Rear view camera built into the number plate holder

ZE-RVC50LP

- Super light sensitivity yeilds a super sharp image even at night
- View angle: 120° horizontal
- Power supply: DC 12 V
- IP protection rating: IP67

038886D

Rear view camera for Fiat Ducato

ZE-RCE3701

- Plastic injected housing with stainless steel bolts
- Fits between the high level rear brake light and the vehicle, brilliantly discrete
- View angles: 130° horizontal / 85° vertical / 150° depth
- IP protection rating: IP69K
- Dimensions (WxHxD): 270 x 40 (exc light) x 49 mm
- Weight: 74 g
- 30cm length of main wire harness with 11 m extension wire included

038886M



Rear view camera for pick up trucks, motorhomes and vans

ZE-RCE4605

- High quality materials guarantee high resistance to corrosion and long life
- Automatic day and night mode with 9 night vision IR LEDs
- View angle: 120° horizontal
- IP protection rating: IP67
- Dimensions (WxHxD): 23 x 19 x 30 mm
- Weight: 200 g
- 10 m length of main wire harness included

038886E



Vechline Visio Reversing cameras



Evo Easy

Mirror mounted for motorhomes
002228



Evo Van

For Van Conversions
002224



Evo

For motorhomes
002222



Evo Dual

For Motorhomes (Close & broad view)
002226

Screen: 5" or 7" is common on reversing camera systems. All Visio products have a 7" LCD colour screen with 400cd/m² that allows you to see the screen in bright conditions and 300000 pixels resolution for a clear picture. Also include antiglare shield.

Wired or wireless: All Visio products are wired to eliminate interference and signal loss.

Audio/microphone function: All Visio products have a built in microphone on the camera with an audio function on the screen, this allows you to hear, as well as see, behind you.

Mirror function: Allows you to choose whether you see the true picture or as if you were looking in a mirror, all Visio products have this feature.

Camera: All Visio cameras have a wide 120° horizontal viewing angle (with the dual also having 45° on the additional camera). The EVO, EVO Easy and EVO Dual have a waterproof rating of IP69K which is the highest available for use with pressure washers. The EVO van has IP68 which is waterproof. Many others on the market are IP66

Mounting: Solid adhesive mounting plates with screw holes. With the exception of the Visio Easy monitor (which is 5G) each model has a camera and monitor with a vibration resistance of 10G (many others on the market have 5G cameras and/or monitors)



Visio Model	EVO Easy 002228	EVO Van 002224	EVO 002222	EVO Dual 002226
Monitor				
Voltage	12/24V	12/24V	12/24V	12/24V
Power	4W	3.6W	3.6W	5W
Screen	7", 16:9	7", 16:9	7", 16:9	7", 16:9
Video Std	PAL / NTSC	PAL / NTSC	PAL / NTSC	PAL / NTSC
Brightness	400cd/m ²	400cd/m ²	400cd/m ²	400cd/m ²
Resolution	420 TV lines	420 TV lines	420 TV lines	420 TV lines
Anti-glare	YES	YES	YES	YES
Audio func'n	YES	YES	YES	YES
Bracket	Clip on	Adhesive	Adhesive	Adhesive
Mirror func'n	YES	YES	YES	YES
Remote control	YES	YES	YES	YES
Automatic stand by	YES	YES	YES	YES
Working temperature	-20°C to 65°C	-20°C to 65°C	-20°C to 65°C	-20°C to 65°C
Vibration resistance	5G	10G	10G	10G
Dimensions mm	250 x 108 x 23	182 x 124 x 38	182 x 124 x 35	182 x 124 x 35
Weight	800g	800g	800g	1100g
Anti-glare	YES	YES	YES	YES
Audio func'n	YES	YES	YES	YES
Bracket	Clip on	Adhesive	Adhesive	Adhesive
Mirror func'n	YES	YES	YES	YES
Remote control	YES	YES	YES	YES
Automatic stand by	YES	YES	YES	YES
Working temp	-20°C to 65°C	-20°C to 65°C	-20°C to 65°C	-20°C to 65°C
Camera				
Voltage	12V dc	12V dc	12V dc	12V dc
Lens	1/3" CCD	1/4" CCD	1/4" CCD	2 x 1/4" CCD
Viewing Angle	120°	120°	120°	120° + 45°
Night vision with 0 lux	18 Infra Red LEDs, 15m	9 Infra Red LEDs, 15m	18 Infra Red LEDs, 15m	30 Infra Red LEDs, 20m
Waterproof	IP69K	IP68	IP69K	IP69K
Resolution	300000 pixels	300000 pixels	300000 pixels	300000 pixels
Cable, mini-DIN	18m	10m	20m	2 x 15m
Sunshield	(Yes) Alu	NO	(Yes) Alu	(Yes) Alu
Audio func'n	YES	YES	YES	YES
Heating	YES	YES	YES	YES
Anti-mist	YES	YES	YES	YES
Working temp	-20°C to 65°C	-20°C to 65°C	-20°C to 65°C	-20°C to 65°C
Vibration resistance	10G	10G	10G	10G
Dimensions mm	72 x 52 x 42	205 x 134 x 59	80 x 60 x 71	98 x 56 x 82
Weight	350g	350g	350g	420g

C1

Satellite Tv Equipment To Suit Any Vehicle & Budget



Roof Mount Satellite System

Fully automatic system. Press and go, the convenience of having all your TV channels ready to watch in an instant at the touch of a button. The ultimate in home entertainment on the move.

- Average search time 30-60 seconds typical
 - 'Easy adjust' manual skew system
 - Single LNB fitted as standard
 - 5 pre-programmed satellites as standard (ASTRA 1, 2, 3, Hotbird & Thor)
 - Easy to use wired control box
 - Future proof with free software updates via a USB stick
 - Watch all available UK TV channels in the UK and into parts of Europe
 - Low stream line profile, only 17cm
 - With 65 or 85cm dish
 - All weather resistant construction
 - For permanent mounting, can be transferred to another vehicle
 - 3 year guarantee
- With 65cm dish **040014C**
 With 85cm dish **040014D**



See our set up video search 'Maxviewltd'

Crank-up Satellite System

Manual operation system. Raising dish using handle, locate satellite and park system from the comfort of inside your vehicle

- Ergonomic handle optimises positional accuracy
 - Cable entry junction box allows for the system to be fitted in the most convenient position on roof
 - Easy to align using the ceiling mounted handle and elevation zone map
 - Watch all available UK TV channels in the UK and into parts of Europe
 - Low stream line profile, only 17cm
 - With 65 or 85cm dish
 - All weather resistant construction
 - For permanent mounting, can be transferred to another vehicle
 - 3 year guarantee
- With 65cm dish **040014A**
 With 85cm dish **040014B**

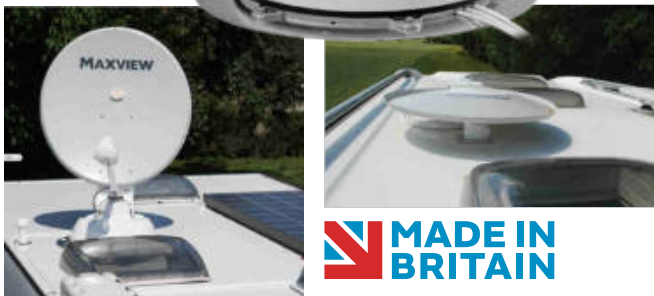

MADE IN BRITAIN

17 cm

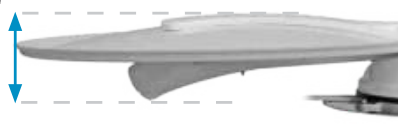

Clear and easy to read elevation angles with simple and effective locking device

Kronings Ultra Light Weight satellite system



Full automatic satellite dish

ONLY 4.7 kg.....

Aluminium dish, 62cm oval, designed to use 30-40% more reflective material than traditional round satellite dishes.

DiSEqC controlled: Fully automatic.

Gain of 80.6 dB signal in digital with BER -0.6, equivalent to a round 80cm dish.

Full HD ready LNB.

Quick intelligent automatic satellite search.

Remembers the last used satellite, leading to fast and easy usage.

Prepared for digital TV.

User friendly display.

Automatic closing when driving.

Can be mounted close to solar panels and airconditioning systems.

- 9 satellites pre-programmed in memory.
 - Türksat 3A 42.0E
 - Astra 1N/2A/2F 28.2E
 - Astra 3A/3B&Thor 2 23.5E
 - Astra 1KR/1L/1M/2C 19.2E
 - Eutelsat Hotbird 13.0E
 - Sirius / Astra 4 4.8E
 - Thor 5&6 & Intelsat 10-02 0.8W
 - Atlantic Bird / Eutelsat 5 5.0W
 - Hispasat 1E 30.0W
- Power supply voltage 11/16 Volt
- Stand-by system absorption 20mA
- Research system absorption 2A typical - 3,5A peak
- Typical search time 30-60 sec
- Max time for complete scanning 300 sec
- External unit weight 4.7 Kg

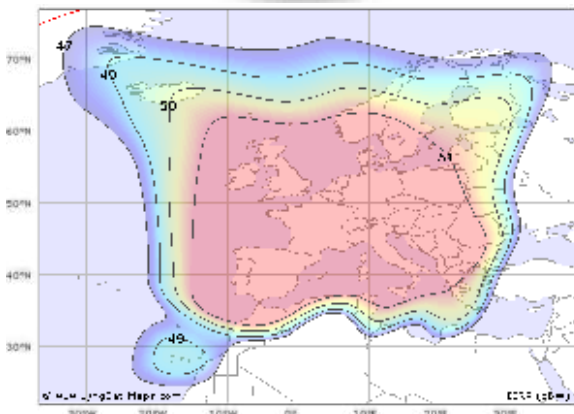

EN 55022, EN 55024, EN 12100-1, EN 12100-2, EN 294, EN 349, EN 60529, 95/56/CEE

If connected via power supply instead of battery:

Voltage: 12V (+/- 15% Max),

Power: 2A (Min),

Power: 24W (Min)

039978



Twin LNB adapter
039978A

Other roof mounted satellite systems



RoadPro domes powered by Wiworld

Complete protection against wind and weather. Roadpro domes offer the widest range of models of any sat-dome manufacturer. Average satellite search times of 30 seconds. One button operation, just switch it on!

- Operating voltage 12V
- Fixes to the roof with sikaflex and / or screws
- Space required for operation: 76cm diameter including mounting feet
 - Search controller dimensions H x W x D mm: 42 x 245 x 146
 - Astra 2 (N & S), Eurobird 1, Astra 1, Hotbird, Sirius, Atlantic bird 3, Hispasat
 - Off-set dish inside a protective plastic cover
 - All weather resistant white dome casing, can be painted
 - Can be used with any satellite receiver including Freesat, Free to air & SKY receivers (not included)
 - 3 year guarantee

Part Number	Dish size (W x H) cm	LNB type	Weight approx. kg (Dish & motor)	Dome height cm	Current Amps approx.	
					During search	In use (search complete)
Static models						
039992	46 x 35	Single	9.5	40	1.5	< 0.1
039990A	46 x 35	Twin	9.7	40	1.5	< 0.1

WOW Use twin LNB version to use pause, record, or other functions of a recording receiver or to use 2 receivers at once.

Portable satellite systems **MAXVIEW** Est 1964

Remora 40 **Suction mount- Portable Satellite System**

For people on the move, the Remora 40 is the ideal portable satellite TV kit, using high strength suction mounts for easy, temporary attachment to a vertical surface on your vehicle

Specifications:

- Use: For outdoors
- Satellite TV: SD & HD channels*, reception dependant on satellite & satellite footprint
- Suction Mount: Dual silicone suction mount suitable for a smooth surface only
- Dish: 40cm Plastic Dish
- LNB: Single Universal LO 10.7 - 12.75 GHz
- Elevation: 10° to 50°
- Skew: -30° to +30°

* Satellite receiver required

Remora 40 - 040002D



WOW "So simple to fit, so easy to use, ideal for people on the move"
N. Greentree - Independent Industry Expert

- **Easy set up**
3 part design requires no tools to assemble or disassemble
- **High strength dual suction mount**
Allows for quick, secure & non-permanent fitting to most flat, vertical surfaces
- **Level Indicator**
Aids a quicker, more accurate setup & elevation reading
- **Elevation Adjustment**
Lets the users easily set the antenna elevation to a high level of accuracy
- **Rotation Lock**
Fixes the system into place once satellite signal has been acquired
- **Security Fixing Point**
Gives peace of mind / security of the satellite system
- **Quick Release Lever**
Two built in quick release levers for easy mount & dismant
- **5m Flexible Cable**
Makes it easier to route to your satellite receiver



3 Main parts for compact storage in high quality bag



40cm Plastic Dish



Satellite compass



Dual suction mount



10.7 - 12.75 GHz LNB

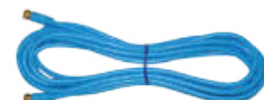

5m High flex F to F cable

Portable satellite systems

MAXVIEW Est 1964

Tripod - Portable Satellite Systems

PRECISION I.D

PRECISION



WOW Precision ID includes a Satellite Identification with a 'Sat Found LED' for user indication. This innovative design now makes it easier than ever to find the right satellite for you.

Sat Found LED: Makes sure you find the right satellite in the simplest way possible. It is designed to let you know you have found the correct satellite easily. When scanning for the satellite you want, the LED will turn on only when the correct satellite is found saving time, effort and guess work.

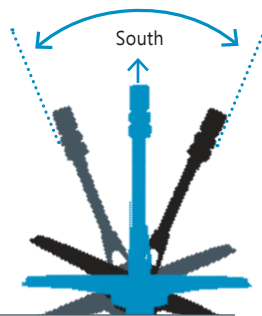

Limited satellite zone. Reduces margin for error, so locking on to the correct signal is quicker and easier.



Pre-assembled parts for very quick and easy set up. Top unit simply drops onto tripod as shown.



Comes complete with holdalls for easy handling

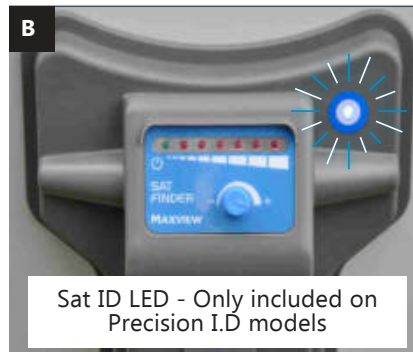
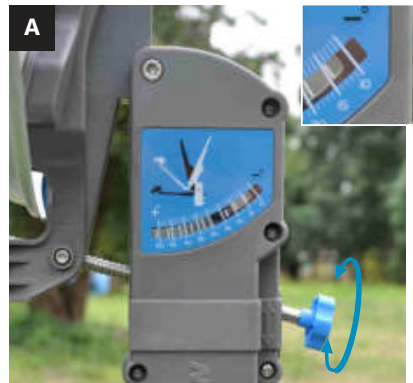

Sat ID LED - Only included on Precision I.D models



- Unique and innovative features include...
- A. Elevation indicator, easy to view elevation read out
 - B. Integrated Sat Finder, helps you align your dish to the satellite
 - C. Level indicator, a level tripod will allow for quicker set up and a more accurate elevation reading
 - D. South leg sticker, point this leg South using included compass for quicker set up
 - E. Magnetic LNB lock, to secure LNB arm for easy storage

MADE IN BRITAIN
PRECISION

- With 55cm dish & single LNB **040001A**
- With 65cm dish & single LNB **040002A**
- With 55cm dish & twin LNB **040001B**
- With 65cm dish & twin LNB **040002B**
- With 75cm dish & twin LNB **040002C**

PRECISION I.D

- With 55cm dish & single LNB **040001AB**
- With 75cm dish & twin LNB **040002CB**

Grove PRODUCTS

Tripod masts **MAXVIEW** Est 1964

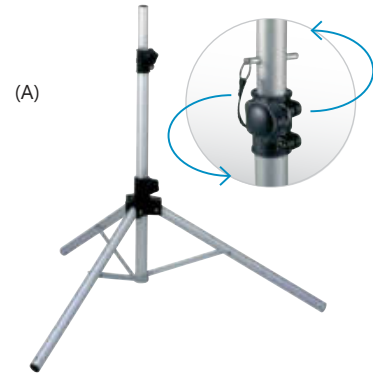

Deluxe Satellite Tripod

- Stainless steel fixings
- Portable mount to position satellite dish in convenient position to achieve clear line of sight to satellite
- Upper mast section rotates freely for ease of use to aid satellite dish alignment (A)
- Long legs and an additional locking device ensure stability
- Folds together for compact storage in supplied holdall
- Lightweight and stable design
- Mast diameter 34mm
- Dimensions: Full height 165cm when legs fully extended

040005

Satellite Tripod

- Stainless steel fixings
- Portable mount to position satellite dish in convenient position to achieve clear line of sight to satellite
- Upper mast section rotates freely for ease of use to aid satellite dish alignment (A)
- Long legs and an additional locking device ensure stability
- Folds together for compact storage
- Lightweight and stable design
- Mast diameter 34mm (Top)
- Dimensions: Full height 93cm when legs fully extended

040003

MAXVIEW Est 1964 VORUBE 2 AUTO



See our set up video search 'Maxviewltd'



Optional kit for roof mounting

040054C



Portable Satellite System

TV/Radio coverage throughout the UK and Europe

- Press and go, the convenience of having all your TV channels ready to watch in an instant at the touch of a button
- Receives transmissions from Astra 1, Astra 2, Astra 3 and Hotbird
- Designed to be permanently mounted to vehicle roof and for portable use
- Ultra lightweight with ergonomically designed carry handle for easy handling
- Can be permanently roof mounted to any touring vehicle using the add on mount pack below. Capable of being transferred to another vehicle if required
- Can be chained to any fixed object looped through the handle. Includes alarm for added peace of mind
- Twin LNB as standard
- 35cm cassetrain dish, equivalent to 50cm offset dish giving increased range
- Clear and easy to use LED Control Box, which is compact in size (W:13 x D:9.5 x H:3cm) allowing unobtrusive mounting in a cupboard space
- All weather resistant and robust casing
- Compatible with any SD/HD Free to air satellite receivers (inc SKY)
- 2 year guarantee

Specifications:

- Weight: 3.5kg
- Frequency: 10.70 - 12.75GHz
- Powering by 12V Control Box
- Dimensions (mm)
- 490 front to back
- 430 side to side
- 350 top to bottom

Includes:

- 12V Control Box
- Velcro Control Box pads
- All required cables & User instructions
- 2 year guarantee

040054B

TV Aerials



Gazelle Touring TV Aerial

- Omnidirectional receives all available digital and HD TV channels through 360 degrees
 - For permanent or temporary mounting
 - Also receives FM and DAB signals
 - Aerodynamic design
 - Includes 12/24V Variable Signal Booster
 - Includes 5m coaxial cable for mounting accessories
 - 2 year guarantee
- 040008**



Omnimax Touring TV Aerial

- Omnidirectional receives all available digital and HD TV channels through 360 degrees
 - For permanent or temporary mounting
 - Also receives FM and DAB signals
 - Includes 12/24V Variable Signal Booster
 - Includes 5m coaxial cable and mounting accessories
 - 2 year guarantee
- 040006**



Mobile TV Aerial - 14 Element

- Receives all available digital, HD & 3D signals
- For all UK coverage
- Quick and easy assembly
- Compact size for travel and storage
- Complete kit, includes accessories shown right above
- Designed for quick, easy and simple installation
- 1 year guarantee

Aerial only with coaxial cable **040043A**
 Aerial Kit including mast & cable **040043B**

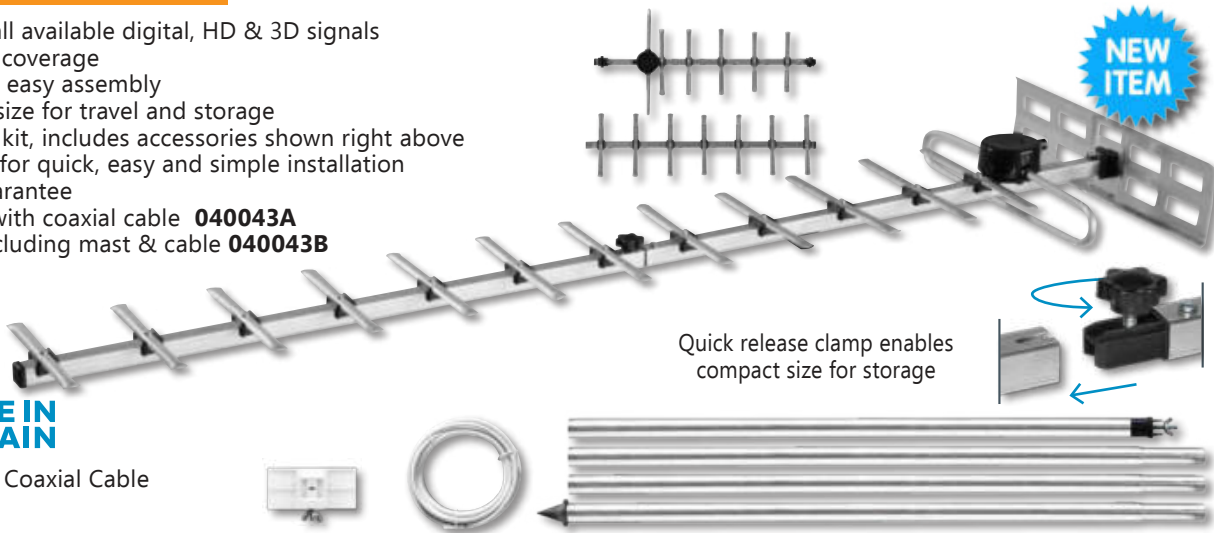

NEW ITEM

Quick release clamp enables compact size for storage



Includes 5m Coaxial Cable

D



Includes Mast, 2 Unimax Clamps and 5m Coaxial Cable



Truvison - Indoor TV Aerial

- Receives all available digital, HD & 3D signals
 - For all UK coverage
 - Ready to use - just flip up and connect to TV
 - Stylish design and folds flat for easy storage
 - 2m coaxial cable allows easy positioning
 - 1 year guarantee
- 040046**



Masts **MAXVIEW** EST 1964



Unimax Mast



- Use to mount a touring TV aerial
- For mounting on the side of a vehicle
- Includes quick release spring action clamps
- Clamps can be fixed to any smooth surface

040089



Vehicle Side Mast



- Use to mount a touring TV aerial
- For mounting on the side of a vehicle
- 4 piece section mast allows up to 2.6m height
- Clamp can be fixed to any smooth surface

040113

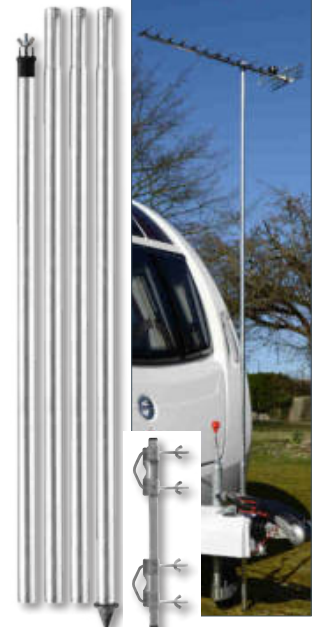

Jockey Wheel Mast



- Use to mount a touring TV aerial
- Mounts onto a caravan jockey wheel
- 4 piece section mast allows up to 2.6m height
- Easy installation, no tools required

040114

Accessories



Magnetic Base

- Designed for use with Maxview Omnimax only
- Temporary fixing to any flat steel surface to provide secure mounting base

040081



Suction Pad Base

- Designed for use with Maxview Omnimax only
- For temporary fixing
- 4 heavy duty suction pads for secure mounting

040080



Unimax Clamps

- Mounts to the side of any touring vehicle
- Can be either screwed into position for permanent mounting or attached using the self adhesive backing for temporary mounting

Packed **040017**
Loose **040086**



Sat Finder

- Designed to help align satellite dish to the satellite with varying audio tone and ascending visual LED display
- Signal sensitivity control for ease of satellite dish adjustment and alignment

040011



Satellite Compass

- Satellite alignment zone to help locate the signal direction for all the main European satellites Astra 1, Astra 2 & Hotbird
- For use as normal navigational compass

040013



Satellite Digital Compass

- Satellite alignment zone to help locate the direction of the signal for all the main European satellites
- All major European satellite positions pre programmed
- Modes: ASTRA 1, 2 & Hotbird, Digital time, thermometer & compass
- Features bubble level
- Back lit LCD display for low light viewing

040018



Sat Finder

- Assists and speeds up aerial alignment for the best terrestrial TV (digital/HD/3D) reception available
- Optimise signal reception before auto tuning TV/receiver
- Features signal sensitive control for high or low signal strength areas
- For use with a directional touring TV aerials
- Simply connects to aerial, adaptors
- Includes battery and velcro mounts

040048



Variable Signal Booster

- Increases the strength of all incoming terrestrial TV (digital/HD/3D) and radio (FM/DAB) signals in weaker reception areas
- 12/24V ideal for use with any touring TV/radio
- Variable gain for high or low signal strength areas
- Gold plated 'F' connectors for improved connectivity
- Low power consumption
- Wall mounting option available
- 2 year guarantee

040062

Sockets & plugs **MAXVIEW** EST 1964

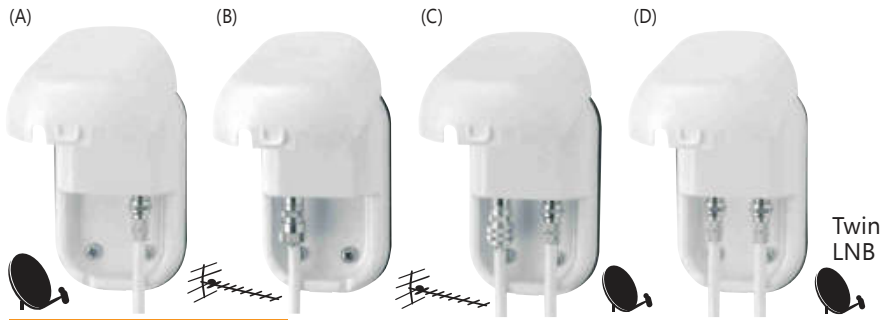

Weatherproof Sockets

- Provides a neat, external weatherproof cable entry point(s) into a vehicle or boat
 - Complete with self adhesive foam seal and screws for easy installation
 - Unobtrusive design
 - 3m Cable length
- Models available:
- 040023** Single Socket & 'F' Connector (A)
 - 040095** Single Socket & Coaxial Connector (B)
 - 040015** Twin Socket & 'F' & Coaxial Connector (C)
 - 040022** Twin Socket & Twin 'F' Connectors (D)

Weatherproof Cable Box

- Waterproof IP66 double membrane seal
 - Designed for roof mounting
 - Self adhesive foam seal
 - Optional four point screw fixing
 - For all cable types 5 - 9mm Ø
 - Can take 2 cables
- 040034**



All products featured are supplied in full colour blister packs - see example



'F' Flyleads

- 1m **040038A**
- 2m **040038**
- 4m **040039**
- 10m **040040**



- With gold contacts

Coaxial Flyleads

- 2m **040026**
- 4m **040083**
- 10m **040029**



Coaxial Flyleads

- 2m **040027**
- 4m **040028**
- 10m **040084**



Flexible 'F' Cables

- 10m Single **040040A**
- 10m Twin **040040B**

- Multi strand core for added cable flexibility
- Less likely to tangle
- Less likely to take a set shape
- Reduces potential trip hazard
- Easy to handle
- Compact



- With right angled connector

Coaxial Flyleads

- 2m **040027A**



HDMI Cables

- 0.8m **040085**
- 1.5m **040037**
- 3m **040037A**



Scart Leads

- 0.8m **040016**
- 1.5m **040025**



2 Way Coaxial 'Y' Splitter **040035**



2 Way Coaxial 'Y' Splitter - Gold **040035A**



Alloy Coaxial Plugs (2) **040019**



Back to Back Coaxial (2) **040031**



Back to Back 'F' (1) **040032**



Coaxial Cable Kit **040033**



Satellite Cable Kit **040036**



'F' Connector (2) **040041**



'F' to Coaxial Adaptors (2) **040042**



Push on 'F' Connectors (2) **040090**



Fast Fit Coaxial Plugs (2) **040030**

New angled accessory range. These adaptors allow a tight angle, perfect for use on slimline (mainly LED) or any flatscreen TV's where space is limited behind TV once wall mounted. Use for easy access to those awkward to get to sockets.



Coaxial Angled Adaptor **040082**



Coaxial Angled Adaptor - Gold **040082A**



'F' Angled Adaptor **040082B**



'F' Angled Adaptor - Gold **040082C**



HDMI Angled Adaptor - Gold **040082D**



HDMI Pivot Adaptor - Gold **040082E**

Accessories



Application example



Universal Satellite Receiver Mounting Brackets

- Mount your receiver securely inside your touring vehicle
 - High performance velcro tested to withstand vehicle motions, vibration & shock
 - Multi mounting position options to suit almost any cupboard space
 - Robust, lightweight design
 - Stand off clearance, designed to allow airflow to prevent receiver overheating
 - Includes all fixings below for secure permanent mounting in a cupboard or shelving space
 - Designed for quick and easy installation
- 040087**



Moonraker DTV-1000 Digi Pro aerial

The DTV-1000 has been specifically designed for digital TV reception. It has an integrated low noise amplifier which can be powered either by the antenna power out option on your set top box, digital TV or even via the 12v DC power cord supplied. The flexible and varied mounting options make the DTV-1000 the simplest way to enjoy digital TV on the road!

040049

Maxview twin LNB upgrade kit

Upgrade your single LNB version for use with SKY+ and other hard drive recording receivers with the Twin LNB upgrade kit. Can also be used with 2 receivers for independent viewing. Includes low noise 0.2dB LNB, adapter and 10m twin coaxial cable. Designed specifically for use with Maxview satellite dishes

040004



Ring FM aerial

Compact design 12v electronic leisure aerial. Telescopic with six sections – overall length 39cm

040129



W4 satellite finder

Easy to read analogue dial as well as an audible signal. Enables effective, quick and reliable satellite alignment for optimum reception. Adjustable gain and sensitivity to suit all situations

040009



- A** Digital Antenna
- B** 12V Power Lead
- C** 230V Mains Lead
- D** Power inserter
- E** 3m Co-axial cable
- F** Screws and wall plugs for fixed mounting
- G** U-bolts and wing-nuts for pole mounting
- H** Mounting bracket for pole and permanent mounting
- I** Sucker mounting bracket for window / wall mounting

Kuma TV



Cosmos aerial

Omni-directional 360° touring aerial, ideal for permanent or temporary mounting

- 12/24v operation
- Also receives FM and DAB signals
- Aerodynamic design
- Built in amplifier
- Includes 4m coaxial cable
- 200mm High x 315mm ø
- Light weight 2830g

Standard **040008C**
Magnetic base **040008D**



**NEW
LOWER
PRICE**

Matrix aerial

Omni-directional 360° touring aerial, ideal for permanent or temporary mounting

- 12/24v operation
- Also receives FM and DAB signals
- Aerodynamic design
- Built in amplifier
- Includes 4m coaxial cable
- 300mm High x 182mm ø

Standard **040007A**
Magnetic base **040007B**

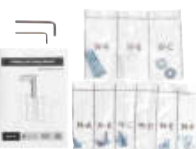

Fittings supplied

Flip down TV bracket

This under cabinet mount fits LCD / LED flat screen TVs and monitors from 15" to 37" is and can also be used as a ceiling mount. The sturdy mount features a space saving design that conveniently tucks your flat panel display under a cabinet when not in use. This high-tech look mount offers perfect viewing angle adjustment.

The arm that is connected to the TV can be extended or shortened to allow the best elevation for the TV. The mount comes with a special lip to secure the TV in folded or closed position. The bracket is sturdy and will hold TVs up to 20kg. Made with high grade quality rugged materials. All mounting hardware included.

Designed for tight spaces, this bracket is ideal for Caravans and Motorhomes or at home in the kitchen.

- Locking and fully rotating
- 110° tilt, 180° swivel left and right
- Fits TVs with VESA mounting hole pattern of 75x75 (3"x3"), 100x100 (4"x4"), 200x100 (8"x4"), 200x200 (8"x8")
- Holds TVs that weigh up to 20kg

040000A



Metal mount disc

Everything you need to fix magnetic-based accessories to non-metallic surfaces.

Simply clean the small area you wish to mount your TV aerial, WiFi aerial or other accessory, apply the supplied adhesive, put the ultra-lightweight disc on top (only weighs 40 grams!), wait 24 hours for the adhesive to cure and that's it. You can now fit any magnetic based product to your composite roof and remove when you have finished.

- Rustproof ultra-light metal disc
- 5ml of waterproof adhesive
- 96mm diameter x 4mm thick
- Weight 40g

040008E

Magpole

A Magnetic Mounting Pole for use with Aerials, Flags or Antennas. Constructed of a high impact plastic shaft with a fully protected magnetic base. 450mm long but can be easily cut to a shorter length if required whilst retaining the full weatherproof functionality.

- Ultra-strong magnetic base with rubber seal cover to protect paintwork
- Completely rustproof
- 450mm Height x 124mm diameter base

040008F



D

TV aerial masts



Mercury mast and clamp

Provides three 3' masts and a jockey wheel clamp. Suitable for use with both the Overlander and Tourer aerials and other aerials with a conventional 'V' bolt fixing
040112



W4 aerial pole kit

Fully telescopic lightweight pole kit extendable to 3.2m. Helps to receive a full range of TV signals with its infinite variety of height adjustments. Can be fitted to the jockey wheel with the special clamps provided
040115



Jockey wheel clamp for rotary ailer

For use with caravan and trailer jockey wheel assemblies with 48mm diameter stems. Ideal for both TV aerial poles and rotary airers
095470C



W4 Jockey wheel satellite pole

A sturdy 30" pole complete with two specially designed brackets for safe attachment to the caravan jockey wheel. Also supplied with a 'U' bolt for fixing the satellite dish. Keeps the dish in a safe and unobtrusive area, no tripod to trip over!
040119



W4 aerial pole clamps

One pair of specially designed clamps. For safe attachment of an aerial pole to the jockey wheel.
040117

W4 Pack-it TV range

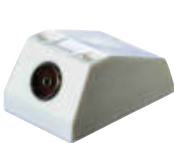

Surface TV point
Coaxial socket
040546



Surface coaxial / satellite point
Coaxial and F socket
040588



Surface satellite point
F socket
040576



Satellite lead
2m F to F plug
040585

Aerial lead
2m male to male
040547



Co-ax cable
5m
040542



Coaxial plug
040543



2-way coaxial splitter
040586



Satellite 'F' plug
040577



2 pin plug
12v 10A
040535



2 pin flush fitting socket & plug
12v 10A
040537



TV Universal Power Lead
040595



Coaxial coupler
040544



2 pin socket
12v 10A
040536

Kuma WiFi

KUMA

WiFi Booster kit

Boost Caravan WiFi, Motorhome WiFi and Canal boat WiFi with ease. The Kuma WiFi package is a complete solution to pick up and boost an external wireless signal and repeat it at full strength. This allows you to create your own secure wireless network in your caravan, motorhome or canal boat and share the boosted connection with all your devices. Everything you need to boost and share a motorhome WiFi connection is included.

The system is compatible with any device which is WiFi enabled, even if it does not have a USB port. You can connect your laptop, iPad, tablet, smartphone or Kindle all at the same time! There are no disks or drivers to install on your devices and no wires between you and the system. If your caravan site charges per device then you will save money instantly if 2 devices connect, (a smartphone and an iPad for example), as the Kuma WiFi Kit will only be seen once by the caravan site router.

The package consists of two main components – The Kuma High-Powered Long Range Directional WiFi Antenna (available on its own part no. 040144) which will pick up any available WiFi network as far away as 1.5km and the Kuma Wireless Repeater which will enable you to rebroadcast this boosted signal. Also included is a 5m USB cable to connect the antenna with the receiver, mounting kit, as well as 12v DC and 230v AC power supplies. Remember our system uses a high power directional antenna – this can take a few seconds longer to set up than an omni-directional antenna but will provide much better results, as you have to transmit to the internet as well as receive when you click your mouse or screen. This is why directional antennas win every time.

To set up – Simply point the directional antenna at the sites wifi signal, connect the repeater to the antenna with the USB cable and then all your devices can connect to the external internet connection wirelessly.

If your campsite service charges you 'per device', as many do, as you will only need one 'connection' for your laptop, phone, iPad etc. No more expensive bills to connect the kids' smartphones.

Includes :

- 5m 2.0 USB lead designed to plug straight from the antenna into the Kuma Router
- Built-in router software security password configuration
- 16dBi gain antenna with a 150M transmission speed to boost signal up to 1.5km (equivalent to a mile)
- Compatible with Windows ME/Vista/7/8/10, Mac OS 10.5-10.8 and all mobile devices
- DHCP for dynamic custom IP configuration
- User-definable application sensing tunnel supports applications requiring multiple connections
- Easy setup and management through web browser interface on any operating system that supports TCP/IP
- Set up guide
- 2 Year Manufactures Warranty
- Router Dimensions: 10cm x 7.2cm x 2.5cm
- Router Weight: Unit Only 81g
- Power Connections: 12/240 Volt

040140



USB Wireless WiFi adapter

This is the WiFi antenna included in the WiFi booster kit. This product includes the antenna, a 5m USB cable, pole mount clip and of course full instructions on how to install, setup and run your mobile WiFi for your

caravan, motorhome, boat or lorry through your laptop.

Compatible with Windows 7, 8 and 10.

Not compatible with Windows XP.

- USB 2.0 interface
- 150M transmission speed
- Compliant with IEEE802.11b/g/n
- 16 dBi gain antenna

040144



4G Mobile Pocket WiFi Kit

Includes free internet access from Three and a Kuma external antenna.

Simply insert the included Three SIM card and browse. When you have used the free 200MB of data, top-up online using your phone, iPad, laptop or tablet at Three's amazing rates.

If you already have a SIM card with data or are going to an area with poor Three coverage, (or arrive on site and there is no Three coverage), insert any network SIM card and share the internet connection with up to 5 devices – smartphones, tablets, iPads or computers.

Why choose a Kuma 4G kit? Get outside strength inside your van with the minimum of fuss. Hide the whole kit in a cupboard and connect wirelessly. Perfect solution with ultimate flexibility. Perfect for use in vehicles such as caravans, motorhomes, trucks and boats where space is limited and 4G internet is a must have.

- Including a powerful 28dBi Antenna with 3-meter cable which can work with speeds up to 150Mbps to help improve your signal. Put the antenna in a window, hang outside, it's truly versatile and comes with sticky pads to allow a permanent mount if required.
- Set up in less than 2 minutes with no technical knowledge required, letting our kit do all the work.
- 4G / 3G and 2G compatible.
- Long-lasting 1500mAh battery and can be charged via a 2.0 USB cable (supplied).
- Connect up to 5 devices at the same time wirelessly. Functions just like your router at home – password protected and has a data counter so you can see how much data you have used
- Weight 280g

040142



Water containers



Jerrycans

25 litre **050055**
 10 litre **050077**
 Singly or 12 per outer



Jerrycans with taps

25 litre **050096**
 10 litre **050078**
 Singly or 12 per outer



Waste container

23ltr capacity container which has a large cap on the side to take two waste pipes.
 6 per outer
050033



15L Compact Carrier

15L collapsible water carrier with tap.
 Singly or 6 per outer
050169B



Cap with integrated tap

For 10L & 25L jerrycans
050109



Spare cap

For 10L & 25L jerrycans
050079

Jerrycan spare parts

Trolleys



HTD Folding trolley truck 80kg

Aluminium foldable trolley with flexible tread. Telescopic arm for simplicity and ease of use. 105cm bungee strap included

- Maximum load: 80kg
 - Dimensions unfolded: (HxWxD) 100 x 38 x 42cm
 - Dimensions folded: (HxWxD) 68 x 38 x 5cm
 - Wheel diameter: 12cm
 - Weight: 3kg
- 2 per outer
050273



HTD Folding trolley truck 50kg

Steel foldable trolley. 140cm bungee strap included

- Maximum load: 50kg
 - Dimensions unfolded: (HxWxD) 98.5 x 34 x 47cm
 - Dimensions folded: (HxWxD) 68 x 38 x 5cm
 - Wheel diameter: 14cm
 - Weight: 2.5kg
- 2 per outer
050272

aquaroll®

Hitchman display stand - **050250**
Please speak to your sales contact for details

WOW Samples of the 2 wall thicknesses are available on request.
PREMIUM 4mm approx.
ECONOMY 2.5mm approx.



WOW aquaroll PREMIUM and wastemaster PREMIUM offer fantastic lifetime value with a **10 year container guarantee!**

aquaroll® PREMIUM 40 Litre

The aquaroll PREMIUM is the UK's best-selling portable water carrier that rolls across the ground making light work of freshwater transportation. The original design was created in 1953 and evolved over the years, resulting in the 40 Litre model which was launched in 1992. The aquaroll PREMIUM is manufactured at FL Hitchmans factory in Shropshire, England. The aquaroll PREMIUM water carriers have the added advantage of an extra side opening to connect directly to a mains water supply via the mains adaptor kit (050187). Even without the mains facility the high capacity of the 40 litre aquaroll is a must for modern caravanning. High quality tyres on deep rims give excellent ground clearance. Easily removeable handle with rust proof ball joints. Filler tube with tap connector and handle are included.

- UK's number 1 rolling water container
 - 10 Year container guarantee
 - Unbeatable lifetime value
 - Container manufactured from 100% food grade virgin material
 - Dimensions: (L x ø): 490 x 390mm
 - Weight – 4.5kg approximately
- Beige PREMIUM 40L **050185**
Silver PREMIUM 40L **050184**

aquaroll® ECONOMY 40 Litre

The aquaroll ECONOMY is also manufactured at FL Hitchman's factory in Shropshire, to the same iconic design as the aquaroll PREMIUM using recycled material on the container and tyres for maximum functionality at excellent value for money.

The aquaroll economy comes with the filler tube and handle just like the aquaroll PREMIUM. It can also connect directly to a mains water supply via the mains adaptor kit (050187).

- 2 Year container guarantee
 - Container manufactured from 100% recycled material
 - Dimensions: (L x ø): 490 x 390mm
- ECONOMY 40L **050185E**



WOW Printed with your company name and logo, the aquaroll and wastemaster bags can be personalised. Please ask your sales contact for details.

aquaroll® storage bag
Made from water resistant PVC coated nylon. With draw string
050190A



aquaroll® mains adaptor storage bag
Made from water resistant heavy duty PVC coated nylon. With all round zip
050189A



aquaroll® level indicator
For use with the aquaroll stand, allows the user to view the current level of water in the container.
050200



aquaroll® stand
40 litre **050259**

aquaroll® mains adaptor

The aquaroll mains adaptor provides you with a safe and reliable way to maintain a constant supply of water to your caravan or motorhome.

There are no expensive alterations as it fits easily to your existing aquaroll, maintaining the water supply to your caravan or motorhome. Using this system gives you piece of mind that mains water pressure will never flow directly into your vehicle.

- Easy to set up
 - No tools required
 - On-demand water supply
 - No risk of flooding your caravan
 - Food grade reinforced hose – no nasty water tastes
 - No need to manually fill your aquaroll
- 050187**

wastemaster™



wastemaster™ PREMIUM

Allows the user to collect and dispose of grey water. Like the aquaroll also manufactured in FL Hitchman's factory in Shropshire. Each wastemaster is hand trimmed to ensure a quality product which is built to last.

- UK's number 1 waste container
- 10 Year container guarantee
- 38 litre capacity / 30 litre low level capacity
- The unique shape gives good balance
- Wheels and axle easily removed
- Wide wheels to spread load on soft ground
- Platform with luggage elastics to carry the toilet waste tank
- Bottom emptying outlet with cap retaining strap
- Dimensions: 355mm x 1000mm x 160/225mm
- Weight – 4.5kg approximately

Beige PREMIUM **050046**
Silver PREMIUM **050047**

wastemaster™ ECONOMY

The wastemaster ECONOMY is also manufactured at FL Hitchmans factory in Shropshire, to the same iconic design as the wastemaster PREMIUM using recycled material on the container for maximum functionality at excellent value for money.

- 2 Year container guarantee
- Container manufactured from 100% recycled material
- 38 litre capacity / 30 litre low level capacity
- The unique shape gives good balance
- Wheels and axle easily removed
- Wide wheels to spread load on soft ground
- Platform with luggage elastics to carry the toilet waste tank
- Bottom emptying outlet with cap retaining strap
- Dimensions: 355mm x 1000mm x 160/225mm

ECONOMY **050046E**

wastemaster™ superclean

Especially formulated product for cleaning wastemaster, waste tanks or other waste water pipe work. Highly concentrated and one 200ml bottle is sufficient to clean a wastemaster twice.
20 per outer
050048



wastemaster™ storage bag

Made from water resistant PVC coated nylon. With all round zip
050047A



aquiroll® filler tube
050236



aquiroll handle
Handle only **050192**
End sockets (2) **050219**



aquiroll® pump connector
40 litre **050231**



spare cap & strap
050206



spare straps (2)
050223



aquiroll® tyre
40 litre **050215**



wastemaster™ spares
Axle and 2 hub caps **050217**
Wheel and hub cap **050218**
Luggage elastics **050226**



cap with tap
050251



mains adaptor ball valve only
050193



mains adaptor extension hose
7.5m **050188**



connector kit
For mains adaptor **050221**



connector kit
For mains adaptor extension hose **050222**



connector seals kit
050220

Fiamma water tanks

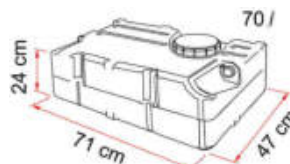

70L water tank

Constructed from non-toxic materials. It can be installed either vertically or horizontally. Complete with all fittings for installation. Water pipe inlet 38mm ø, with air outlet of 13mm ø. Dimensions: (LxDxH) 70x47x24cm. Weight 4.4kg
050050

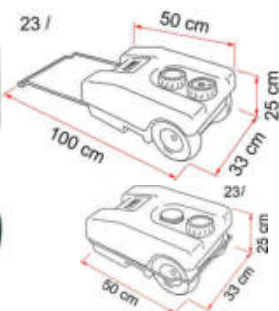

23L Roll tank water

Convenient portable 23 litre water tank with discharge cap at base. Supplied with an extra blanking cap. Weight 2.4kg
050054

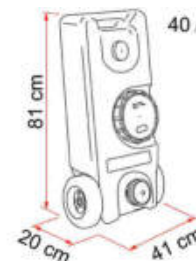

40L Roll tank water

Portable 40 litre drinking water roll tank with easy grip handle and two large wheels that make transportation easy even on gravel. Made of non-toxic material and an easy to clean wide cap. Weight 3.8kg
050054A

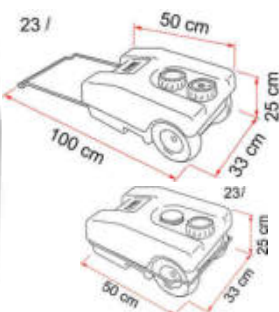

23L Roll tank waste

Practical and portable 23 litre tank for waste water with discharge cap at base. Weight 2.4kg
050051

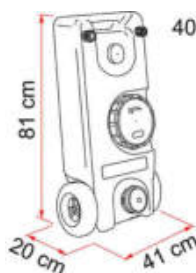

40L Roll tank waste

40 litre waste tank with level indicator and air release valve. Filling and discharging are performed through a Sanitary-Flex (not included). 45° angle adaptor for discharge is included. Weight 3.9kg
050051A



23L spare cap
050056



23L discharge cap
050057



Fiamma Kit sanitary flex
300cm flexible hose, extendable. Delivered as standard with 2 fittings for connection to Roll-Tank 40W, Tank 21W and Quick connection W.
050060A



Fiamma quick connection waste
Adapter to turn the threaded connection into a bayonet connection, to connect the Sanitary Flex to the 23 litre waste tank.
050057A



Insulated aquaroll bag

Designed to reduce the risk of freezing in winter. Reversible with reflective lining to keep water cooler in summer. Clever wrap-round design to remove the need to lift the full container in to the bag.
050194

Water purification



Aqua clean tabs
Water purification tablets.
One tablet per 5 gallons of
Water. 32 tablets per pack.
12 packs per outer **052013**



Aqua tabs mini
Water purification tablets.
One tablet per 1 litre of
Water. 40 tablets per pack.
18 packs per outer **052012**



Aqua mega tabs
Water purification tablets.
For use with water storage
tanks with a capacity of 50
gallons or more.
12 per outer **052015**



Puriclean
Cleanses water systems and
tanks
100g tub **052002**
400g tub **052024**



Aqua Sol
Aqua Sol is a powerful
biocide which destroys
all water borne bacteria
and viruses. In addition it
removes tastes and odours
caused by plastics, chlorine,
GRP and metals, keeping
water fresh for a very long
time. Aqua Sol is approved
by the D.O.E. The 250ml size
will treat 625 litres of water.
Aqua Sol 250ml.
6 per outer **052030**



Waste Guard
Waste Guard provides
rapid control of odour
producing waste products.
It selectively reacts to
oxidise odours from many
sources and does not
emit harmful by products.
300ml.
6 per outer **052039**



Puri Sol
Cleans, sterilises and
deodorises in one action,
leaving no taint or odour.
Clean, disinfect and
deodorise water storage
tanks, pipe work and
fittings. 300ml.
6 per outer **052032**



D Scale
D Scale is a safe, effective way to remove lime scale and rust deposits
and to clean the interior surfaces of water heaters. It is non-corrosive
and can be safely used on Stainless Steel, Copper, Brass, Plastics
and leaves no odour. Periodic use of D Scale in the water heater will
avoid mineral deposits building up, so improving the efficiency and
extending the life of the equipment. D Scale contains citric acid
which is a naturally occurring organic fruit acid especially found in
fruits such as lemons and oranges. Calcium carbonate scale builds
up layers and hard gritty deposits on the interior surfaces of a water
heater. When left without treatment, lime deposits build up and will
clog the interior pipes within the water heater, restricting flow and
reducing operating efficiency.

- Descales and cleans complete hot water systems
- Removes lime scale and rust
- Safe to use on stainless steel, copper, brass and plastics
- Ideal for hot water systems in caravans, motor homes and boats
- Environmentally friendly and biodegradable

1 litre 4 per outer **052048**
500ml 6 per outer **052047**



Winterban
Prevents freezing pipes and other
damage by winterising your motor
home or caravan. Winterban replaces
the water in the water system and is
safe for fresh water plumbing.
It is a propylene glycol solution
(1 part winterban to 1 part water
protects down to -46°C) which has a
dramatically lower burst point than
water. This is the point at which the
liquid expands when frozen, thus
protecting the system from frost
damage. It is recommended that
you drain as much water from your
system as possible. Any excess water
will be absorbed by the solution and
prevents damage to pipes, taps and
water heaters through expansion of
frozen water.
1 gallon **052050** 6 per outer



**Elsan fresh water
tank clean**
Leaves the tank free from
micro-organisms and
black spot. It also removes
calcium and other deposits
that can eventually clog
the system. Tank Clean
contains no chlorine. 1 litre
12 per outer **050035**



Elsan descale
Formulated to remove
calcium deposits caused
by hard water and lime
scale that can be found in
your portable toilet system.
Regular use keeps the waste
tank like new and helps to
prolong its life. 1 litre
12 per outer **050038**

Filler caps



Fiamma water filler cap assembly

Locking water cap which complies with European closure system standards.

Dimensions:

Overall	112mm Ø
Cut out	80mm Ø
Outlet	40mm Ø
Air intake	10mm Ø
Black	050052
White	050053

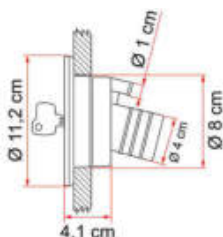

Water filler assembly

Dimensions:

Overall	118mm Ø
Cut out	85mm Ø
Outlet	38mm Ø
Air intake	10mm Ø
Black	050066
White	050068

Water filler cap

78mm Ø
25 (+22)mm depth
Black **050064**
White **050062**

Non toxic water hose

Sold by the roll priced by the metre
e.g order 30 to receive 1 x 30m roll



Blue ½"	30m roll	051339
Clear ⅜"	30m roll	051317
Clear ½"	30m roll	051325
Clear ¾"	30m roll	051348
Red reinforced ½"	30m roll	051356
40mm ID (for water fill assembly)	25m roll	051300

W4 semi-rigid tubes

Sold & priced by the roll
e.g order 1 to receive 1 x 25m roll
See page 101 for John Guest



Tube 12 x 8.5mm	
Blue	25m roll 055200
Red	25m roll 055201

Waste hose

Sold by the roll priced by the metre
e.g order 30 to receive 1 x 30m roll



20mm	Flexible	30m roll	051360
23.5mm	Convolutd	50m roll	051365
28.5mm	Convolutd	25m roll	051368



W4 fill-ups

Singly or 25 per outer	Fill-up 1 (1.25m hose)	050240
Singly or 15 per outer	Fill-up 2 (2m hose)	050241
Singly or 10 per outer	Fill-up 5 (5m hose)	050242
Singly or 5 per outer	Fill-up 10 (10m hose)	050243

Cassette hose

Sold individually



Superflat hose food grade

15m **051314**
20m **051316**



Flat hose 15m

General purpose hose
Not food grade **051310**

Water fittings



Hose sealing sleeves

Enables a better fit between the hose and the connector. 23.5mm hose sealing sleeves also allow 23.5mm hose to be connected to 20.5mm fittings
 10 per outer
 23.5mm **051366**
 28.5mm **051367**



W4 easi 2 drain

For caravans with two 28.5mm waste outlets. Pre-assembled
 Singly or 10 per outer
051138



7 piece 'Y' kit

Versatile kit to allow different combinations of outlets be reduced into 1. For 28.5mm hose
 Singly or 10 per outer
051380



Y connectors

10 per outer
 1/2" **051128**
 3/4" **051137**



Y connector

10 per outer
 28.5mm **051139**



Straight connectors

10 per outer
 3/8" **051140**
 1/2" **051155**
 3/4" **051163**
 28.5mm **051167**



T pieces

10 per outer
 1/2" **051174**
 3/4" **051182**



28.5 - 20mm reducer

Takes 28.5mm down to 20mm.
 10 per outer
051371

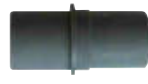

28.5mm - 1 1/4" reducer

Enables 28.5mm hose to fit 1 1/4" sink wastes.
 10 per outer
051369



Elbow

10 per outer
 1/2" **051198**



Reducer

10 per outer
 1/2" - 3/8" **051146**



W4 Tap swirler

Suitable for a variety of tap sizes. 10 per outer
104845



W4 Aqua cap

Dust cap for use with plastic water containers. Singly or 10 per outer
050049



Hose socket with flap

5 per outer
 1/2" **051394**
 3/4" **051405**
 28mm **051408**



Dust caps

10 per outer
 3/8" / 1/2" **051416**
 3/4" **051427**

Hose clips



Hose clip (2) Grove packaged

10 per outer
 OOO/MOO (8-16mm) **070249**
 OO (12-22mm) **051246**
 OX (16-27mm) **051268**



Hose clips (2) W4 packaged

10 per outer
 OOO/MOO (8-16mm) **104832**
 OO (12-22mm) **104833**
 OX (16-27mm) **104834**
 1X (25-45mm) **104836**



Hose clips bulk

Supplied 100 per bag
 OOO/MOO (8-16mm) **070255**
 OO (12-22mm) **051257**

W4 push fit fittings

Individually packed push fittings for semi rigid tube
All packed 5 per outer

E



Equal tee
12mm **055202**
15mm **055302**



Equal straight
12mm **055204**
15mm **055304**



Equal elbow
12mm **055203**
15mm **055303**



Two way adaptor
12mm **055275**



Non return check valve
12mm **055273**



Straight reducer
12-8mm **055205**
12-10mm **055220**
15-12mm **055312**



Elbow reducer
12-10mm **055221**



Shut off valve
12mm **055270**



Stem reducer
Female to male
12-10mm **055210**
15-12mm **055215**



Stem enlarger
Female to male
12-15mm **055216**



Stem elbow
12mm **055222**
15mm **055322**



Shut off valve
Stem elbow 12mm
055272



Stem adaptor male
3/8"bsp-12mm **055263**
1/2"bsp-12mm **055264**



Straight adaptor female
3/8"f-12mm **055238**
1/2"f-12mm **055232**



Straight adaptor male
3/8"bsp-12mm **055213**
1/2"bsp-12mm **055214**



Straight adaptor
12mm-1/2" **055206**



Bulkhead connector
12mm **055212**



Tank fitting assembly
12mm **055266**

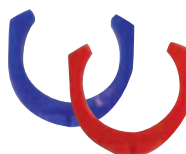

Collet clip 12mm
Blue (5) **055292**
Red (5) **055293**



End plug
12mm **055208**
15mm **055308**



Drain taps
Fresh water food grade. 28mm
Waste water. 28mm



051373
051374



Tube cutters
Light duty **055295**

WOW All W4 water fittings are suitable for contact with foodstuffs and drinking water. ISO 9001 and ISO 14001 certified. FDA and WRAS approved. Complying with the requirements of UK water regulation.

Push fit system stand

Not illustrated. Complete with 5 packs of 24 of the best selling items in this range **055299**

John Guest Speedfit®



LLDPE Tube
12mm OD x 9mm ID
PE-1209-100M-B
Blue 100m roll **055330**
PE-1209-100M-R
Red 100m roll **055331**



Collet covers
PM1912E
12mm Black
055346



The Speedfit System of fittings and pipe is perfectly designed for hot and cold water systems in touring caravans. The pipe is simply pushed into the fitting to form a safe secure connection. Its flexibility ensures it can be cabled easily around the interior and hidden from view. Ideal due to it's resistance to corrosion and freezing, it can be easily demounted and reused

making it very well suited to mobile applications. Manufactured with food grade nitrile 'O' rings, John Guest Speedfit System is especially produced for foodstuff and potable liquids. Ensure the pipe is free of score marks. Cut the pipe square. Push the pipe up until the pipe stops. Collet covers help to prevent accidental disconnection of the tube.



Equal tee
PM0212E
12mm female **055333**



Equal straight
PM0412E
12mm female **055332**



Equal elbow
PM0312E
12mm female **055334**



Male stem reducer
PM061210E
12mm stem to
10mm female
055336



Male stem elbow
PM221212E
12mm stem to
12mm female
055342

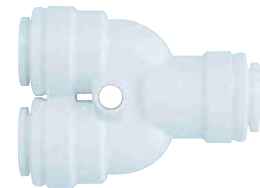

Two way divider
PPM2312W
12mm female
055334A



Male stem to BSP adaptor
PM051514E
12mm stem to 1/2" BSP male
055337
PM051513E
12mm stem to 3/8" BSP male
055338



Female to BSP adaptor
PM011514E
12mm female to 1/2" BSP male
055339
PM011513E
12mm female to 3/8" BSP male
055340



Female to BSP adaptor
CM451214F
12mm female to 1/2" BSP female
055341



Reducing straight
PM201210E
12mm female to 10mm female
055335



Single check valve
12SCV non return valve
12mm
055343



End stop
PM4612E
12mm
055344



Plug
PM0812R
12mm
055345

Drain down system floë

Drain down

The floë system is a simple and cost saving way to drain your water system, protecting it from winter frosts and reducing risk of infection from stagnant water throughout the year. With the simple step by step instructions, you will be guided through the quick and easy process, enabling you to use your leisure vehicle all year round. A matter of minutes draining down your water system will give you peace of mind whatever the season. The drainage kits all come with 1 x Drain down, relevant adaptors and an instructive DVD showing a drain down demonstration.



Drainage kits

Truma Ultraflow **051980**

Whale **051984**

Motorhomes **051988**

Drain down only

Homes, static caravans, and holiday homes **051996**



WOW Practical Caravan Tourer of the year awards 2012. Recommended Best accessory



051996



051980



051984



051988



Floë Induratec 636

Integrated 12v DC water drain-down system.

Floë 636 has its own patented automated compression system, specifically made for draindowns. Everything is now done from inside your vehicle in only 2 minutes. No more climbing in and out in the cold, wind and rain, so you can drain down whenever and as often as you like.

With the convenient flick of a switch you can have peace of mind that, your property is protected without ever having to pay someone to do it for you. Floë will also cleanse your water system to 99.95%, making way for fresh drinking water.

Weight: 850gms

Dimensions: 20x17x6cms

051991



Floë Induratec 868

Integrated 230v AC water drain-down system.

Floë is easily and permanently fitted to the property, so the only thing the owner needs to do is, turn off the mains water supply, switch Floë on and then start opening and draining taps (faucets), showers and toilets. Everything is now operated from the inside the property, comfortably in the warmth. With its own PCB brain and clever compressor, Floë will automatically stop at the correct pressure and restart automatically after each outlet is drained. Better yet, Floë has been carefully designed to be able to be removed again without trace, so should you change your property, you are free to take Floë with you.

Floë 868 is supplied complete with all fittings required and a full installation and instructional DVD. Bonus chapter includes a full winterisation checklist.

Weight: 1160gms

Dimensions: 20x17x6cms

051992

Truma Water systems

Ultraflow

WOW The compact shower outlet is the same size as the compact housing but has no electrical terminals.

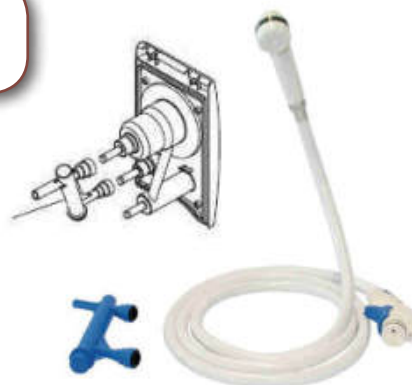

Filter housing assembly

Complete with Ultraflow active carbon filter and blanking plug. The ultraflow housing comes with an exterior accessory point which can be connected (via optional connector) to allow the use of the exterior shower set (optional).

Template size: 108mm x 163mm

White **846011**

Grey **846013**

Replacement lid only white **846961**

Compact housing

The Ultraflow compact housing / winter kit is the standard housing for a pump assembly that does not include a filtration system, accessory point or blanking plug.

Dimensions: 143 x 105mm, bore hole 50mm ø

White **846031**

Grey **846030**

Replacement lid only white **846974**

Outdoor shower set

The pistol grip of the Outdoor Shower is simply plugged in to the Ultraflow filter housing. After fitting the connector it is ready for use.

For pressurised water systems only

846080

Ultraflow bridge connector **846967**

Shower head only **896800**



Conversion kits

To convert Crystal Mk2 to Ultraflow system whilst enabling the use of the original pump assembly. Kits consist of Ultraflow housing, pistol grip pump connector and filter.

Template size: 108mm x 163mm

White **846014**

Compact conversion kit

The Ultraflow compact housing with an Ultraflow pistol grip pump connector to allow the user to utilise their existing pump assembly.

Dimensions: 143 x 105mm, bore hole 50mm ø

White **846034**

Compact shower

Exterior shower housing. For pressurised water systems only

White **846071**

Replacement lid only white **846975**

Shower head only **896800**



WOW A complete range of Truma spares are available in the spares catalogue



Ultraflow pump assembly

This 12v water pump with ergonomically shaped pistol grip is plugged into the Ultraflow filter or compact housing. 9 litres per minute at 3m head at 1.5bar. Tube length 800mm

Pump assembly

846041

Twin cut blue hose

801017

Ultraflow Inlet hose

Compatible with any Ultraflow housing **846340**

Ultraflow Inlet housing

For use only with inlet hose **White 801037**

Ultraflow accessories



Pistol grip pump connector
846977



Ultraflow filter
12 per outer
846020



Filter cap
With O-rings
846964



Blanking plug
With O-rings
846966



Pump connector O-rings (4)
846729



Push fit to flex adaptor
12mm push fit female to
1/2" flex male
846999



Non return valve
For 1/2" flexible hose
846900



Non return valve
For 12mm push fit hose
846880



Ultraflow Waterline

A 15 metre 'food quality' hose pipe which comes complete with fittings and a special pressure reducing adaptor which allows caravanners to connect their water system directly to a mains water supply without modification. Compatible with the Ultraflow filter and Ultraflow compact water systems, simply by being plugged into the Ultraflow housing
846090

Other accessories



Comet exterior water inlet 12v
Complete with plug set for pump cable and sealing cap for water spout.
58mm x 58mm x 55mm **053005**
Spare plug set **053006**



Reich foot switch
Rectangular brown plastic 12v switch suitable for pump control.
45mm x 60mm x 32mm
054366



Comet foot switch
Rectangular beige plastic 12v switch suitable for pump control.
61mm x 63mm x 34mm
053001



Reich non return valve
For 1/2" flexible hose
054368



Reich non return valve
For 12mm push fit hose
054367



Comet foot switch
Round beige plastic 12v switch suitable for pump control.
61mm ø
053001R

Reich pumps



Reich pumps are especially durable and powerful. Their durability is enhanced by special high-tech sealing. A patented vent in many pumps speeds delivery once submerged. All pumps are extremely quiet in use and the housing material is resistant to dirt and this makes them easier to clean when necessary.

WOW 055010 15l slimline pump can be used as a direct replacement for the old Carver/ Truma Thames pump. It has the same dimensions and specifications.



Reich 15L slimline
12v submersible pump. 1 bar. 40mm ø.
Singly or 10 per outer **055010**
Reich pump and hose assembly
A 76cm length of twin tube blue hose attached to 055010
Singly or 10 per outer **055030**



Reich 14L Easy pump
12v submersible pump. 0.5 bar. 43mm ø
055003
Bulk 30 per outer **055003B**



Reich 12L
12v submersible pump. 0.5 bar with automatic vent.
45mm ø
055009



Reich 18L
12v submersible pump. 0.9 bar with automatic vent and strainer. 45mm ø.
Singly or 10 per outer **055014**



Reich 15 litre In-line
12v booster pump. 0.5 bar. 48mm ø.
Singly or 10 per outer **055020**



Reich Powerjet 22L
12v submersible pump. 1.8 bar with automatic vent.
55mmø
Singly or 10 per outer **055018**



Reich twin 19 litre
12v twin submersible pump. 1.4 bar with automatic vent, strainer and non return valve. If one pump fails the TWIN pump will continue to work with reduced power
055017

Flojet pump **FLOJET**

Flojet

- Self priming & Dry running
- Soft, noise absorbing mounts
- Snap in port fittings
- Corrosion resistant materials
- Smooth operation without accumulator tank
- Factory pre tested
- 12 months warranty
- H 121 x L 229 x W 152mm, 1.59kg

Retail Boxed **053007**
Loose packed **OEM053007**



Motor

Permanent magnet, ball bearing, totally enclosed, fully suppressed.

Pump

Three chamber diaphragm design, self priming up to 9 feet suction lift, pump able to run dry without damage.

Pressure switch

Replacement pressure switch **053009**

Specifications			
Volts	Amp Draw @ 10psi (0.7bar)	Flow GPM (LPM)	Pressure switch Max psi (bar)
12V dc	2.2 (5amp fuse)	1.4 (5.3)	30 (2.06)

Onboard pumps and accessories **SHURflo**



Shurflo pumps

- Range of fully automatic triple diaphragm positive displacement freshwater pumps with integral pressure switch
- Die cast alloy lower housing with twin ball bearing drive
- Motors have internal circuit breaker for overload protection
- Run dry without damage
- Low amp draw and extremely quiet in operation
- Barbed hose adaptor and inlet side strainer (053053) supplied with retail pumps



Pump fittings

1/2" elbow and straight connectors. Supplied with individually retail boxed pumps.

053053

	Trail King 7	Trail King 7	Trail King 10	Trail King 10	Trail King 10	2088 Series
Voltage	12V	12V	12V	12V	24V	230V
Flow rate (l/min)	7	7	10.6	7	10.6	11.4
Pressure	20 p.s.i. 1.1 Bar	30 p.s.i. 2.1 Bar	30 p.s.i. 2.1 Bar	45 p.s.i. 3 Bar	30 p.s.i. 2.1 Bar	45 p.s.i. 3 Bar
Max current	4.5A	4.5A	4A	4A	3.5A	0.6A
Weight	1.9kg	1.9kg	1.9kg	1.9kg	1.9kg	2.27kg
Retail individually boxed Shurflo No.	053017 2095-204-412	053018 2095-204-413	053020 2095-403-443	053021 2095-403-443	053023 2095-473-443	053016 2088-594-444
OEM 12 per outer Shurflo No.	053017B 2095-204-112	053018B 2095-204-113	053020B 2095-403-143	053021B 2095-403-444		



Shurflo filter

Screw-on to 1/2" threaded attachment
053034



Shurflo filter

Screw-on filter to 1/2" push-on attachment
053035



Shurflo filter

Screw-on filter with wing nut to 1/2" threaded attachment
053036



Shurflo filter

Screw-on filter with wing nut to 1/2" push-on attachment
053037

Fiamma pumps

WOW For full specifications of the Fiamma pump range please see Section 5



Fiamma aqua 8 pump

7 Litre **053025**
10 Litre **053026**
Pressure switch kit **053028**



Fiamma aqua F pump

8 Litre **053027A**
13 Litre **053027B**



A20 expansion tank

053030

	Aqua 8	Aqua 8	Aqua F	Aqua F
Voltage	12V	12V	12V	12V
Flow rate (l/min)	7	10	8	13
Pressure	21.75 p.s.i. 1.5 Bar	21.75 p.s.i. 1.5 Bar	21.75 p.s.i. 1.5 Bar	21.75 p.s.i. 1.5 Bar
Operating current	1.4A	3.4A	2.0A	2.5A
Weight	1.5kg	1.5kg	1.4kg	2.2kg
Noise	55/60 db	65/70 db	50 db	50 db
Part No.	053025	053026	053027A	053027B

Comet taps



Comet Novo single

Complete with microswitch. Cable length 300mm. Overall tap height 40mm. Maximum pressure 3 bar
 Two tone beige **053970**
 Spare spout beige **053974**
 Microswitch **053979**



Comet Novo mixer tap

Mixer tap complete with microswitches. Cable lengths 300mm. Overall tap height 40mm. Maximum pressure 3 bar
 Two tone beige **053972**
 Spare spout beige **053974**
 Microswitch **053979**



Smev / Comet Florenz

Single lever mixer complete with microswitch. Cable length 600mm. Overall tap height 40mm. Maximum pressure 3 bar. Installation hole 33mm
 Chrome **091240**

Reich taps



Deluxe mixer tap

Mixer tap complete with microswitch. Cable length 300mm. Overall tap height 40mm. Maximum pressure 3 bar
 Matt nickel **054233**
 White **054234**
 Microswitch **054274**
 Spare spout matt nickel **054067**



Mini deluxe single

With a slightly smaller control knob and same spout as standard deluxe. Installation hole 16mm (standard deluxe is 20mm)
 Matt nickel **054215**
 Microswitch **054274**



Deluxe single

Complete with microswitch. Cable length 300mm. Overall tap height 40mm. Maximum pressure 3 bar. Installation hole 20mm
 Matt nickel **054222**
 White **054223**
 Microswitch **054274**
 Spare spout matt nickel **054067**



Style 2005

Single lever mixer complete with micro-switch. Cable length 300mm. Overall tap height 40mm. Maximum pressure 3 bar. Installation hole 20mm
 Chrome **054270**
 Microswitch **054274**
 Spare spout matt nickel **054320**
 Spare spout chrome **054321**



Keramik style

Single lever mixer tap complete with microswitch. Cable length 600mm. The spout raises and lowers vertically. Ceramic cartridge. Overall tap height 40mm. Maximum pressure 6 bar. Installation hole 33mm
 Chrome **054306**
 Microswitch **054274**
 Spare spout matt nickel **054320**
 Spare spout chrome **054321**



Keramik deluxe

Single lever mixer. Same features as Twist but has ceramic sealing and regulating discs instead of a ceramic cartridge.
 Chrome **054307**
 Microswitch **054274**

Reich taps



Twist 90° elbow

Single lever mixer tap complete with microswitch. Cable length 600mm. The spout raises and lowers vertically. Ceramic cartridge. Overall tap height 40mm. Maximum pressure 6 bar. Installation hole 39mm. Chrome left hand 90° elbow **054297**
Microswitch **054303**
Spare spout chrome **054321**



Twist

Single lever mixer tap complete with microswitch. Cable length 600mm. The spout raises and lowers vertically. Ceramic cartridge. Overall tap height 43mm. Maximum pressure 6 bar. Installation hole 50mm. Right hand illustrated
Matt nickel left hand **054301**
Matt nickel right hand **054296**
Chrome left hand **054302**
Chrome right hand **054304**
Microswitch **054303**
Spare spout matt nickel **054320**
Spare spout chrome **054321**



Twist table top

Microswitched single lever mixer tap that can be used with a variety of shower sets. Any standard 1/2" hose will connect to the outlet. Complete with microswitch. Cable length 600mm. Maximum pressure 6 bar. Installation hole 39mm
Table top version **054299**
Microswitch **054303**



Twist under-table top

As above but the shower hose connects under the surface where the water inlet pipes connect
Under table top version **054298**
Microswitch **054303**



Trend S

Single lever mixer tap featuring premium plastic parts for lightness and brass lever and spout for the highest quality finish. Spout rotates 360°. Comes with microswitch. Cable length 600mm. Maximum pressure 6 bar. Spout length 315mm. Installation hole 33mm
Chrome **054266**
Microswitch **054311**



Kama

Single lever mixer tap complete with microswitch. Cable length 600mm. Ceramic cartridge. Installation hole 33mm
Chrome **054275**
Installation hole 27mm
Chrome **054279**
Microswitch **054287**



Kama with Julia shower

Single lever mixer shower tap complete with microswitch with 600mm cable. Can be used as a normal tap or shower tap. Maximum pressure 6 bar
Chrome **054285**
Microswitch **054287**



Charisma

Single lever mixer tap with a 160mm outlet spout that rotates 360°. Complete with microswitch. Cable length 600mm. Ceramic cartridge. Maximum pressure 6 bar. Installation hole 30-35mm
Chrome **054293**
Microswitch **054295**



Ceramic cartridge

1. Caraflo 35mm **054452**
2. Reich 35mm **054312**
3. Reich 25mm **054312A**



Spare spouts

Chrome **054321**
Matt nickel **054320**
Chrome for Kama tap **054322**
'o' ring for spout **054247**

Reich taps



Samba Chrome tap

Single lever tap complete with microswitch.
Fits Smev and Thetford sinks with lids.
 Overall tap height 40mm.
 Maximum pressure 6 bar.
 Installation hole 33mm.
 Available in both single and mixer variants with a choice of connectors as below.

054305B

Flexi 1/2" hose
 Single tap



28.5cm
 length
 hose

WOW
 Bulk
 packs
 available

054305E

Flexi 1/2" hose
 Mixer tap



054305C

Uni-Quick 12mm
 push fit
 Single tap



25cm
 length
 hose

054305F

Uni-Quick 12mm
 push fit
 Mixer tap



054305A

Nozzle
 Single tap



054305D

Nozzle
 Mixer tap



Spare microswitch
 Spare ceramic cartridge

054303
054312A



Trend A

Single lever mixer complete with microswitch. Cable length 600mm.
 Overall tap height 40mm. Maximum pressure 3 bar. Installation hole 27mm
 Chrome **054260**
 Microswitch **054274**



Trend E

Single lever mixer tap with a brass lever and a lightweight plastic body. Ceramic cartridge can be replaced without removing the tap. Complete with microswitch. Cable length 600mm. Maximum pressure 6 bar. Spout length 134mm.
 Installation hole 33mm Chrome **054268**
 Installation hole 27mm Chrome **054268A**
 Spout chrome **054269**
 Microswitch **054311**



Pelikan

Single lever mixer tap complete with microswitch. Cable length 600mm. Spout rotates 360° for versatility. Ceramic cartridge. Maximum pressure 6 bar. Installation hole 33mm
 Chrome **054290**
 Microswitch **054311**



Vector E

Single lever mixer tap complete with microswitch. Cable length 600mm. Ceramic cartridge. Max pressure 6 bar. Installation hole 33mm. Height 199mm
 Chrome/White **054238**



Trend B

Single lever mixer tap supplied with a 360° swivelling metal spout. Spout length 200mm. Folds down into bowl to a height of 40mm. Comes with microswitch. Cable length 600mm. Maximum pressure 3 bar. Installation hole 27mm
 Chrome **054263**
 Microswitch **054274**



Keramik concept S

Single lever mixer tap with a flat spout that avoids dripping of residual water. Spout swivels 360°. Comes with microswitch. Cable length 600mm. Maximum pressure 6 bar. Installation hole 33mm
 Chrome **054313**
 Microswitch **054287**



Vector S

Single lever mixer complete with microswitch. Cable length 600mm. Max pressure 6 bar. Installation hole 33mm. Height 199mm
 Chrome **054241**
 Chrome/Black **054242**

Caraflo taps

caraflo



Milana

Single lever basin mixer tap. Installation hole 30mm

Spout length*	Colour	Part No.
120mm	Chrome	054400
160mm	Chrome	054403
180mm	Chrome	054406
180mm	Nickel	054409
240mm	Chrome	054412

WOW All Caraflo taps are supplied without tails to enable the customer to select which tails they require - see below. They are designed for a pressure-switched system. *Spout length is measured from the front of the tap to the centre of the flow of water along the horizontal.

Modesta

Single lever basin mixer tap. Installation hole 30mm

Spout length*	Colour	Part No.
160mm	Chrome	054415

Caraflo shower taps



Elisa

Single lever pull out mixer tap. Installation hole 40mm
Chrome **054430**



Mila

Single lever shower mixer tap. Installation hole 30mm
Chrome **054427**



Moda

Single lever shower mixer tap. Installation hole 30mm
Chrome **054424**

Tap tails

SP200

SP210

SP220

SP230



Caraflo tap tails

Model	Connection	Length	Part No.
SP200	12mm male nylon	350mm	054440
SP210	12mm cone (1/2") SS	220mm	054443
SP220	12mm female nylon	350mm	054446
SP230	15mm female nylon	390mm	054449



Sun shower rail sets

Riser rail, 1.5m hose, and Sun shower head plastic
054459

Wall bracket, 1.5m hose, and Sun shower head plastic
054462

Double lock 1.5m shower hose
054475



Shower head & hose

Chrome three settings plastic shower head with 1.5m hose
054512



Konus wall bracket
054331



Reich metal shower hose 1.5m

1/2" to 1/2" **054328**
1/2" or 3/8" to 1/2" **054329**

Shower heads and accessories

Ecocamel shower heads

Water and energy saving shower heads. Patented technology increases the water flow from the showerhead. You get the same powerful shower as a full flow shower, but you use up to 45% less water. Using less water means you automatically use less energy to heat it - so you can help save the environment, whilst cutting your bills in the process.

Fantastic for caravans and motorhomes!

- Reduce the need to refill water tanks, or to empty waste tanks.
- With typical 10-14L water heater tank capacity in leisure vehicles, the Ecocamel range makes this equal to a 14-20L tank.
- Less power consumption means fewer gas bottles purchased.



WOW Using Ecocamel you get the same powerful shower as a full flow shower, without using more water.



Jetstorm E
(twin venturi)
054525



Orbit
054528



Carisma
Plastic lever shower head
054325
O ring for Carisma shower head
054327



Sun
Plastic shower head
054468



Kama julia
Plastic shower head
054323



Trigger
Metal lever shower head
054465

Shower and bathroom accessories



W4 towel rail
Compact rail with non slip covering and hanging hooks. Singly or 10 per outer
095594



Chrome towel rail
Includes screws and fittings.
050906



Chrome towel ring
Includes screws and fittings.
050905



W4 3 way towel grip
Complete with screw covers and stainless steel screws. Singly or 10 per outer
099041



W4 concept towel ring
Designed with the confined space of caravan and boat washrooms in mind yet still large enough to hold a bath towel. Complete with screw covers and stainless steel screws. Singly or 10 per outer
095596

Shower and bathroom sinks and accessories

E



W4 toilet roll holder

Plastic holder with special mechanism to prevent roll unravelling whilst towing. Large self adhesive fixing pad. Singly or 10 per outer
060351



Chrome toilet roll holder



W4 2 way robe hook

Complete with screws. Singly or 10 per outer
099040



Double robe hook chrome

Includes screws and fittings.
050907



W4 soap holder

Comes with clip on drip tray. Complete with screws. Singly or 10 per outer
050915



W4 toothbrush holder

Compact 4 way toothbrush holder complete with screws. Singly or 10 per outer
050916



Chrome soap holder

Includes screws and fittings.
050903



Tip up basin

Size HxWxD:
Open: 345 x 500 x 170 mm
Closed: 200 x 500 x 320 mm
050630



Beaker & holder chrome

Includes screws and fittings.
050904



Fiamma dispenser

Elegant - Practical - Useful 200ml refillable liquid dispenser (100 doses) ideal for soap or shampoo. Dimensions: 15 x 8 x 5.5cm
050913



W4 Mini loo brush 2

A compact brush and holder designed for use with caravan/boat toilets. The brush easily clips into the wall mounted holder to keep it secure in transit. Singly or 10 per outer
060346



Shower curtain

White. Superior quality. Waterproof. Size 71" x 71". 6 per outer
050945



Fiamma toilet brush

Toilet brush with container for all types of toilet. Complete with self-adhesive strips
060347



W4 Hold steady

Stops tins, jars, bottles, aerosols from rolling around. Can be used vertically or horizontally
095883



Vanity unit

Manufactured from high impact polystyrene. Features a twin mirror sliding door with travel lock and useful shelf with retainer
Size HxWxD: 550 x 515 x 100mm
050899



Sinks and shower trays



Vanity bowl ivory
Pre-drilled to take any 3/4" sink wastes
Dimensions: 508 x 286mm
050777



Vanity bowl beige
Pre-drilled to take any 3/4" sink wastes
Dimensions: 508 x 286mm
050773



Vanity bowl white
Sink waste not pre-drilled
Dimensions: 520 x 356 x 138mm
050770



Corner bowl 11"
11" corner bowls are pre-drilled to take any 3/4" sink wastes(not supplied)
White 11" **050816**
Ivory 11" **050818**



Corner bowl 14"
14" bowls are pre-drilled to take 1 1/4" sink wastes (not supplied)
White 14" **050860**
Ivory 14" **050861**



Shower tray
Dimensions: 584 x 584 x 127mm
Ivory **050930**
White **050930W**



C220/260 shower trays
Moulded to fit the C220 & C260 range of cassette toilets
Left hand
Dimensions: 1070 x 700mm **050934**
Right hand as shown
Dimensions: 1160 x 700mm **050935**



C200 shower trays
Moulded to fit the C200 range of cassette toilets
Left hand as shown
Dimensions: 1030 x 670mm **050932**
Right hand
Dimensions: 1020 x 700mm **050933**

Stainless sinks



Stainless steel sink and drainer
21 3/4" x 14"
050534



Smev VA936 sink & drainer
With AC 540 siphon and rubber seal.
W590 x D370 x H125mm
091236



Vehicle bowl
12" x 10 1/2" Stainless steel with lip. Bowl 9 1/2" tapering to 7" ø base. Depth 5"
050523



Bezel (seal)
By Thetford 2100mm
091159A

Sinks

E



Basic Line 30

25mm waste outlet, plug, seal and lid included.

Dimensions:

Cut out: Ø390mm.

Overall: Ø405 x D145mm

Inside bowl: Ø328 x D93mm

091158A



Basic Line 33

25mm waste outlet, plug, seal, 35mm tap hole and lid included.

Dimensions:

Cut out: 460 x 460mm.

Overall: H140 x W480 x D480 mm

Inside bowl: H92 x W455 x D276mm

Left hand

091155B

Right hand

091155A as shown



Basic Line 34

25mm waste outlet, plug, seal, 35mm tap hole and lid included.

Dimensions:

Cut out: 387 x 429mm.

Overall: H140 x W400 x D445 mm

Inside bowl: H92 x W338 x D280mm

091158C



Series 23 spun bowl

25mm waste outlet, plug, seal and lid included.

Dimensions:

Cut out: Ø405mm.

Overall: Ø460 x D123mm

Inside bowl: Ø397 x D123mm

091158B



Argent bowl

19mm waste outlet, plug, seal and lid included.

Dimensions:

Cut out: 335 x 430mm.

Overall: H153 x W360 x D470 mm

Inside bowl: H99 x W290 x D368mm

091160B



Argent sink

19mm waste outlet, plug, seal and lid included.

Dimensions:

Cut out: 605 x 415mm.

Overall: H152 x W630 x D470 mm

Inside bowl: H99 x W290 x D368mm

Left hand

091153S as shown

Right hand

091152S

WOW Suitable taps for sinks with lids:
 Florenz, Style and Keramik page 107
 Twist page 108
 Samba and Trend A page 109



Argent Kitchen centre kit

Includes plastic bowl, plastic chopping board, plastic drainer and cutlery rack (inc fixings)

091153K



Bezel (seal)

By Thetford 2100mm

091159A

Sinks



Smev 8005

Includes AC 540 siphon and rubber seal.
 Tap not included, includes pre-drilled
 tap hole (39mm).
 W420 x D370 x H145mm
 Built in dimensions
 W405mm x D355mm
091234

WOW
 Suitable taps for sinks with lids:
 Florenz, Style and Keramik page 107
 Twist page 108
 Samba and Trend A page 109



Sink and shower waste outlets



1 1/4" straight outlet
 5 per outer
 3/4" outlet **051042**
 28mm outlet **051045**



3/4" straight outlet
 5 per outer
 Plastic top **051086**



3/4" straight outlet
 5 per outer
 Stainless steel top **051097**



1 1/4" angled outlet
 5 per outer
 3/4" outlet **051064**
 28mm outlet **051067**



3/4" angled outlet
 5 per outer
 Plastic top **051108**



3/4" angled outlet
 5 per outer
 Stainless steel top **051119**



W4 Sink waste strainer white
 10 per outer
051078



W4 Sink waste strainer chrome
 10 per outer
051078C



Sink waste plug (2)
 10 per outer
 7/8" **051227**



Sink waste plug
 10 per outer
 1 1/4" **051075**



W4 Sink waste plug
 1 1/2" to fit 1 1/4" wastes
 10 per outer
051076



W4 Universal sink waste plug
 10 per outer
051077

Rinsekit

E



WOW RinseKit LUX has 50% more spray time than the original RinseKit

RinseKit

A portable pressurised shower with no pumping and no batteries. It fills with 2 gallons of water from a household tap and delivers a pressurised spray.

Simply stores the water pressure from your home for later use. Water pressure from your tap enters the RinseKit, and compresses the air in the pressure chamber. When you close the valve, that pressure is trapped inside and acts like a spring to force the water through the hose and out of the nozzle. It is possible to fill it with hot water and it will stay warm for up to 6 hours.

A multitude of uses around the car, caravan, motorhome or home.

Comes complete with 1.8m hose, relevant hose connections and shower head.

Dimensions (HxWxD)

35.5 x 43.5 x 30.5cm

054555



RinseKit 12v heater

Plugs into a cigarette lighter with a long cord. Built in timer and auto shut off switch for safety. The stainless steel heating probe screws into the drain plug hole of the RinseKit and does not need to be removed use after use. A hot shower just about anywhere!

- 12v 9A
- 8' long power cord
- 30-60-90 minute timer
- Automatic safety shutoff
- One year warranty
- Stainless steel probe

Includes; heating probe, controller plug, wrench, thread adapter and instructions

054557



RinseKit field refill kit

Allows the user to fill the RinseKit when there is no access to a tap or hose. Simply fill the filling bag with water and pressurise using a bicycle pump (not supplied).

054558



RinseKit hot water tap adaptor

Allows the user to screw the filler hose directly to the tap, which could allow filling with hot or cold water.

Supplied as standard with RinseKit LUX.

054559

RinseKit LUX

The Rinsekit LUX has a soft tote design. It has 50% more spray time than the original RinseKit (up to 8 minutes on the center setting) and is full of features. The hot water tap adapter is included!

The Eon™ pressure chamber has two 1 inch accessory ports to accommodate RinseKit's accessories.

The LUX has two outside pockets, a shoulder strap, a quick access double zipper top and 2 side handles for convenience when loading it into a vehicle. Adding to it's versatility, the LUX tote doubles as a soft cooler. The full zip top allows the pressure chamber to be easily removed allowing the tote to be the perfect cooler.

Dimensions (HxWxD)

32 x 43 x 38cm

054556

Mud Daddy ®

Portable mud and dirt washing brush ideal for grooming muddy dogs - but also suitable for use on bikes, boots, tools and virtually any other muddy item under the sun that needs cleaning quickly and easily. Also a perfect portable shower for camping etc.

The Mud Daddy Washing Brush works without electric or battery power, using a combination water and air pressure to deliver the power you need the all-natural way.

You can fill up your Mud Daddy with hot or cold water, or mix with miniature shampoos.

The gentle low pressure which combined with the brush will remove any dirt or mud.

15-20 hand pumps will give you approximately 3 minutes of washing.

It uses 90% less water than a hose pipe and 80% less water than a jet wash.

- No noise (Perfect for washing animals)
- Super portable & Compact
- Environmentally friendly
- No need for batteries or electric power
- Can be filled with hot water and even mix in a little shampoo
- Perfect for showering, whilst camping, at festivals, etc
- Built-in sprayer brush with locking trigger
- 1 year product replacement guarantee



of

11



Mud Daddy 5L

With 5L tank capacity you can expect 10-12 minutes of washing time.

15-20 hand pump will give you approximately 3 minutes of wash.

With 1.2m hose.

HxWxD: 23 x 16.5 x 34 cm

Green (JoJo) **054550G**

Orange (Ozzi) **054550OR**

Mud Mummy 5L

With 5L tank capacity you can expect 10-12 minutes of washing time.

15-20 hand pump will give you approximately 3 minutes of wash.

With 1.2m hose.

HxWxD: 23 x 16.5 x 34 cm

Pink (Roxy) **054550P**

Mud Daddy 8L

With 8L tank capacity you can expect 16-19 minutes of washing time.

15-20 hand pump will give you approximately 3 minutes of wash.

With 2m hose.

HxWxD: 20 x 20 x 30 cm

Blue (Otis) **054551B**

Yellow (Chico) **054551Y**



Mud Daddy 12L Portable washing brush

With a larger 12L working capacity tank, for longer washing tasks.

Adjustable metal handle with soft grip. Large funnel shaped cap for easy refill and pressure release valve. With 2.2m hose.

HxWxD: 88 x 27 x 30 cm

Purple **054552P**

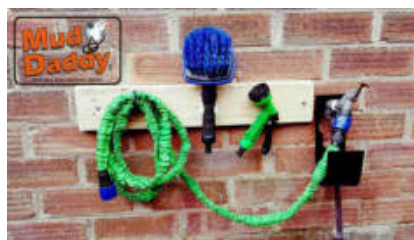

Expandable hose set

Expands up to three times its original length and shrink back at end of the usage. Easy connect/disconnect connector for nozzle and brush change.

Mud Daddy expandable hose set includes:

- 25ft expandable hose with an easy connector on both ends
- Hand wash brush
- 6 pattern nozzle shower head
- Heavy duty metal hanger
- Tap connector

054553HS



Mud Daddy spare brush

Built-in sprayer brush. Easy to connect/disconnect. Durable, good quality brush with on/off locking trigger

054553



Detangling brush

Mud Daddy detangling and deshedding brush. It works great on medium and long hair dogs. Special design removes loose hair, knots and dirt. De-sheds undercoat on wet or dry dogs. Easy grab design.

HxWxD: 12.5 x 7 x 5.5 cm

Blue **054553BB**

Red **054553BR**

Water spare parts

E

ULTRAFLOW			
 846961 UF housing lid white	 846973 UF compact housing lid ivory	 846974 UF compact housing lid white	 846975 UF shower housing lid white
 846041 UF water pump assembly	 846020 UF replacement filter	 846964 UF filter cover & O-ring	 846967 UF bridge connector
 846966 UF blanking plug & O-ring	 846729 UF O-ring 25 x 2 mm (4)	 846090 UF waterline	 801037 Water inlet
 898600 UF pressure switch	 801017 Twin cut blue hose	 846999 UF adaptor Pushfit to flex	
 801039 C2 Pressure release	 801470 Drain plug & o-ring > 1987	 801022 Drain plug o ring (2)	 053009 Flojet pressure Switch
 801036 Water inlet & non-return valve	 801026 Hot water outlet fulham		



Aqua Kem blue original

Thick non-drip toilet fluid, use 150ml per 20 litre holding tank capacity

- Lasts up to 65 days average use
- 13 doses

6 per outer 2 litre **060301**

Concentrated

2.5 times concentrated, use 60ml per 20 litre holding tank capacity

- Less weight, less space, same number of doses

12 per outer 780ml **060301C**



Aqua Kem blue lavender

Thick non-drip toilet fluid, use 150ml per 20 litre holding tank capacity

- Lasts up to 65 days average use
- 13 doses

6 per outer 2 litre **060301L**

Concentrated

2.5 times concentrated, use 60ml per 20 litre holding tank capacity

- Less weight, less space, same number of doses

12 per outer 780ml **060301LC**
24 per outer 120ml **060302A**



Aqua Kem green

Biological toilet fluid, use 150ml per 20 litre holding tank capacity

- Safe to empty in septic tank (Test ISO 11734)

- Lasts up to 40 days average use
- It remains liquid up to -20°C and remains active after defrosting

6 per outer 1.5 litre **060305**

Concentrated

2 times concentrated, use 75ml per 20 litre holding tank capacity

- Less weight, less space, same number of doses

12 per outer 750ml **060305C**



Aqua Rinse plus original

Use 100ml per 15 litre of flush tank capacity. Provides a more effective flush, and keeps the flush water fresh and clean.

- Septic tank safe.
- Leaves a protective film in the bowl that prevents deposit from forming
- The lubrication action makes the blade of the waste-holding tank easier to open and close

6 per outer 1.5 litre **060282**

Concentrated

2 times concentrated, use 50ml per 15 litre of flush tank capacity.

- Less weight, less space, same number of doses

12 per outer 750ml **060282C**
24 per outer 100ml **060283A**

Aqua Rinse Spray

- Specially designed for toilets without an integrated flush water tank
- Leaves a protective film in the bowl that prevents deposit from forming
- The lubrication action makes the blade of the waste-holding tank easier to open and close
- Septic tank safe

500ml **060283** 9 per outer



Aqua Kem blue sachets

One sachet per 20 litre holding tank capacity

- Easy to use: sachets completely dissolve in water
- Highly concentrated
- Suitable for winter camping
- One dose lasts 4 to 5 days with average use

15 per tub, 6 per outer **060307**



Aqua Kem green sachets

Biological water-soluble sachets, one sachet per 20 litre holding tank capacity

- Powerful sachets for the waste holding tank
- All the benefits of Aqua Kem Green in a sachet!
- Safe to empty in septic tank (Test ISO 11734)
- 4 days with average use

15 per tub, 6 per outer **060306**



Thetford Duo Pack

- 1.5 litre Aqua Kem blue
- 1.5 litre Aqua Rinse Plus
- Sold in a retail pack with handy carry handle

3 per outer **060298**

WOW
Thetford point of sale material packs available annually please speak to your sales contact for more details



Concentrate Duo Pack

- 0.78 litre Aqua Kem blue
- 0.75 litre Aqua Rinse Plus
- Sold in a retail pack with handy carry handle

6 per outer **060298A**

THETFORD Maintenance products



Aqua Soft tissue

- Dissolves quickly to prevent clogging
 - Easier to empty waste-holding tank
 - Prevents malfunctions or damage to the waste-holding tank
 - Super-soft
- 12 per outer
4 pack **060312**



Toilet Bowl cleaner

- Removes hard water and soil deposits while safe for plastic and toilet seals
 - Descaling to ensure a smooth bowl, preventing soil build up
 - For an ultra-clean and hygienic toilet bowl
 - Thoroughly cleans leaving a lovely fresh scent behind
- 9 per outer
750ml **050037**



Cassette Tank cleaner

- Thoroughly cleans the inside of the waste-holding tank
 - Easily removes stubborn calcium deposits
 - No scrubbing required
 - Prolongs life span of waste-holding tank
 - Pleasant fresh scent
- 12 per outer
1 litre **060325**



Seal Lubricant

- Protects, lubricates, ensures pliability
 - Developed for safe lubricating of Thetford toilet parts
 - Absolutely safe for plastics, no colouring on plastic parts
 - Ensures smooth operation of valve blades and other items
- 12 per outer
200ml **060355**



Grey Water Fresh

- 10 doses per bottle
- Prevents nasty grey water smells coming from the drains
 - Reduces deposit formation in the grey water tank
 - Outstanding grey water odour control
 - Odour free discharging of the grey water tank
 - Safe for all plastics
- 12 per outer
700ml **050038A**



Bathroom cleaner

- Powerful cleaning agent for daily maintenance
 - Safe for all plastic surfaces, including the outside of the toilet
 - Guarantees perfect hygiene
 - Active foam removes calcium deposits
 - Gives a lovely shine
- 9 per outer
500ml **098320**

Trigano Activ



WOW Manufactured by Thetford, the economical Activ range has the same advantages as the Thetford Aqua products, use a similar dose, but are effective for a slightly shorter period.



ACTIV by **TRIGANO** **THETFORD**



Activ rinse

Use 70ml per 10 litre of flush tank capacity. Provides a more effective flush, and keeps the flush water fresh.

- Leaves a protective film in the bowl that prevents deposit from forming
- The lubrication action makes the blade of the waste-holding tank easier to open and close

6 per outer
2 litre **060245**

Activ blue

Thick non-drip toilet fluid, use 60ml per 10 litre holding tank capacity

- One dose lasts 3-4 days with average use

6 per outer
2 litre **060246**

Activ green

Biological toilet fluid, use 60ml per 10 litre holding tank capacity

- Safe to empty in septic tank
- One dose lasts 3 days with average use
- It remains liquid up to -20°C and remains active after defrosting

6 per outer
2 litre **060247**

B-Fresh



WOW Three year shelf life for great value.



WOW Amazing quality at an unbelievable price!

B-Fresh pink

Multi purpose flush water tank additive for chemical toilets. Keeps your flush water fresh, takes care of a smooth flush, prevents scale and lubricates the seals. Also improves your toilet hygiene with a floral scent.

4 per outer
2L **060251**

B-Fresh blue

Waste tank additive for chemical toilets. Stops unpleasant smells with citrus scent, reduces gas build up and quickly breaks down toilet waste.

4 per outer
2L **060253**

Fenwick's



Fenwick's top & tail

A unique toilet fluid designed for use in both top and bottom tanks which makes it simpler to use and more economical.

Save space by carrying only one bottle.

8 per outer
2.5 litre **060266**



Waste pipe & tank cleaner

Cleans shower and sink drains, toilet cassettes, and eliminates unpleasant odours. Dilute to a 10:1 solution to clean hard surfaces. Fully biodegradable and food safe, kills e-coli, salmonella and other germs. Also removes nicotine, egg, limescale, formaldehyde, and other hard to remove stains

15 per outer
1 litre **097063**

Happy Bowl toilet bowl liners



FIVE REASONS WHY YOU WILL LOVE

1. THEY'RE HYGIENIC
2. THEY'RE BIODEGRADABLE
3. THEY REDUCE WATER USAGE
4. THEY REDUCE ODOUR WITH A FAST FLUSH
5. THEY WORK



WOW Now includes counter display as standard

Biodegradable toilet bowl liners. Use them to line your caravan, motor home, or portable toilet. Simply flush the toilet after use, and the bowl liner and contents are flushed away, leaving your bowl clean and fresh.

12 packs per outer
50 per pack **060311D**

Elsan



Elsan blue

Elsan Blue's powerful anti-bacterial formula kills germs and eliminates odours. British Standard 2893:2005
 2 litre **060362** 8 per outer
 4 litre **060373** 4 per outer

Elsan pink

Elsan Pink keeps the toilet fresh and removes bad odours when the toilet is flushed. It is anti-bacterial so it prevents algae build-up in your flush tank. It also lubricates and cleans the bowl.
 2 litre **060365** 8 per outer

Elsan organic toilet fluid

Elsan Organic biological toilet fluid works in a completely different way to conventional toilet fluids. By dissolving waste and removing odours naturally, with no chemical smell it has a delightful mild fragrance. It can be used in both flush and waste tanks. It can be safely used in septic tanks.
 400ml **060356** 24 per outer
 2L **060359** 4 per outer



Elsan twin pack

1L blue and 1L rinse fluid
 12 per outer
 2 x 1 litre **060375A**



Elsan Blue bags

Quickly dissolves in water, kills the bacteria and eliminates odours whilst imparting a pleasant fragrance. And because each sachet contains an exact dose, no measuring is required. Clean, safe and easy to use, Blue Bags provide the ultimate in performance and reliability.
 12 per outer
 18 per pack **060332**

Elsan double concentrated

Double concentrated to give you the same Elsan performance and reliability on which you've always relied. Now however you only need to use half the quantity giving you a big saving on each dose. British Standard 2893:2005



Double Blue

24 per outer
 400ml **060376**
 12 per outer
 1 litre **060378**



Double BOGOF

2L blue double concentrate and 2L
 rinse double concentrate fluid
 4 per outer
 2 x 2L **060375**



Double Rinse

24 per outer
 400ml **060377**
 12 per outer
 1 litre **060379**

Elsan



Elsan bristol toilet

Close in height to a household toilet, the Bristol is made from high grade easy-to-clean plastic. It features a removable inner container with close-fitting anti-spill lid, a strong, full size seat and lid together with quick release floor fixings, and strong nylon coated carrying handle.
HxWxD 432x362x437mm
Capacity 21 litres
060205



Elsan Tank Clean

Leaves the fresh water tank free from micro-organisms and black spot. It also removes calcium and other deposits that can eventually clog the system. Tank Clean contains no chlorine.
12 per outer
1 litre **050035**



Elsan Tank Fresh

Eliminates grey water odour. Dissolves grease. Helps keep the system fresh, clean and free flowing. Add a little Tank Fresh to your water drains to get rid of stale odours
8 per outer
2 litre **050040**

Fiamma



Super Kem blue

The most powerful detergent for fixed and portable chemical toilets. Disintegrating, deodorising, sanitizing, pleasantly scented fluid. Contains anti-freeze to work at temperatures down to -20°C
6 per outer
2 litres **060389**



Super Rinse

Scented anti-mildew bactericide for chemical toilet fresh water tanks. Effective against algae, cleans and protects.
10 per outer
1 litre **060393**



Fiamma soft toilet tissue

It won't clog up tanks or waste valves. Special 2-ply soft toilet tissue, formulated for chemical toilets. Stronger and softer tissue dissolves quickly in water. 300 sheets per roll.
10 per outer
6 per pack **060388**



Fiamma toilet brush

Toilet brush with container for all types of toilet. Complete with self-adhesive strips
060347



Small Bi-Pot 30

HxWxD 300x345x435mm
Flush tank 10 litres
Waste tank 11 litres
056948



Medium Bi-Pot 34

HxWxD 340x360x435mm
Flush tank 15 litres
Waste tank 13 litres
056949



Large Bi-Pot 39

HxWxD 392x360x435mm
Flush tank 15 litres
Waste tank 20 litres
056950



Bidet Universal

Fits neatly into all Bi-Pot types, also adapts to Thetford Porta Potti, and Cassette 1, 2, 3 and 4 toilets
056953
Bidet 200
Fits neatly into Thetford Cassette C200, C250, C260 and Dometic CT3000 toilets
060100A

Portable toilets

THETFORD Porta Potti range - 3 year warranty. Integrated cover lock for easy transportation, with recess for opening. The smooth lines and subtle curves are not just important to the appearance of the toilets, but also provide optimum comfort and ease of use. An improved blade opener. A new more comfortable handle on the waste holding tank.

Porta Potti®

Hold down kit for PP335
057130



Porta Potti 145

Porta Potti 165

Porta Potti 335

Porta Potti 345

Porta Potti 365

Part no.	Porta Potti Model	Body Colour	Dimensions H x W x D	Pump Type	Level Indicator	Waste tank	Flush Tank	Pack size
056966	145	White	330 x 383 x 427	Bellows	No	12L	15L	All Porta Potti toilets are available singly or 5 per outer
056968	165	White	414 x 383 x 427	Bellows	No	21L	15L	
056970	335	White	315 x 342 x 382	Piston	Waste	10L	10L	
056971	345	White	330 x 383 x 427	Piston	Waste	12L	15L	
056973	365	White	414 x 383 x 427	Piston	Waste	21L	15L	



Porta Potti®

Part no.	Porta Potti Model	Body Colour	Dimensions H x W x D	Pump Type	Level Indicator	Waste tank	Flush Tank
056980	565P	White	458 x 388 x 450	Piston	Waste / flush	21L	15L

056981	565E	White	458 x 388 x 450	Electric	Waste / flush	21L	15L
---------------	------	-------	-----------------	----------	---------------	-----	-----

Porta Potti accessories



056978

Porta Potti bags

Two handles, durable zip, sturdy material, interior gloss finish for easy cleaning. Machine washable (to 40°C).

For 65 toilets

056978

For 35 or 45 toilets

056979



056979



056983

Floor plates

Floor plate to enable you to mount the Porta Potti 565 or 335 to the floor. Helps to prevent accidental movement of the toilet. The toilet simply detaches from the floor plate for emptying. Ideal for boats or home use. Can also be ordered for 165 and 365

Porta Potti 565 plate **056983**

Porta Potti 335 plate **057130**



057130

Cassette toilets **THETFORD**

Toilets with their own flush water tanks

Flush water is drawn from the toilets own fresh water tank. *Cassette toilets no longer come with the service door 3, please choose your door on p121 if required.*

Swivel bowl toilets



C224-CW



C262-CWE



Flush water fill doors are required for swivel bowl toilets with their own flush tank. Available in various colours. Comes with lock and keys.

- White **060084A**
- Cream **060173**
- Light Grey **060084B**
- Dark Grey **060084C**

Part no.	Model	Bowl material	Dimensions H x W x D	Pump Type	Waste Level Indicator	Waste tank capacity	Flush tank capacity	Net Weight
060058B	C224-CW	Plastic	727 x 394 x 580	Manual	Full / empty	18L	9L	8.0kg
060060A	C262-CWE	Plastic	750 x 417 x 603	Electric	3 level	17.5L	8L	8.1kg
060060B	C262-CWE	Ceramic	750 x 417 x 603	Electric	3 level	17.5L	8L	17.2kg



Right Hand cassette

WOW A complete range of OEM Thetford toilets are held in stock and are available at preferential rates to manufacturers only. Please speak to your sales contact for more details.

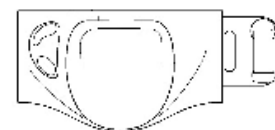

Left Hand cassette



C402-X



C502-X

Part no.	Model	Hand	Dimensions H x W x D	Pump Type	Waste Level Indicator	Flush Level Indicator	Waste tank capacity	Net Weight
060094A	C402-X	Left	512 x 670 x 400	Electric	3 level	3 level	19.3L	8.8kg
060094B	C402-X	Right	512 x 670 x 400	Electric	3 level	3 level	19.3L	8.8kg
060094E	C502-X	Left	502 x 739 x 410	Electric	3 level	3 level	19.7L	9.5kg
060094F	C502-X	Right	502 x 739 x 410	Electric	3 level	3 level	19.7L	9.5kg

Cassette toilets **THETFORD**

For vehicles with on board water tanks

Flush water is drawn from the vehicles fresh water supply. CS - Console supplied with switch mounted. S - No console supplied (holding tank protrudes). CS/S - Removeable console supplied

Cassette toilets no longer come with the service door 3, please choose your door (next page) if required.

Swivel bowl toilets



C200 CS/S

C223-S

C223-CS

C263-S

C263-CSL

C263-CS

Part no.	Model	Bowl material	Dimensions H x W x D	Pump Type	Level Indicator	Waste tank capacity	Net Weight
060095A	C200-CS/S	Plastic	538 x 353 x 580	Electric	Full / Empty	17L	7.2kg
060058	C223-S	Plastic	495 x 365 x 580	Electric	Full / empty	18L	6.8kg
060058A	C223-CS	Plastic	534 x 394 x 580	Electric	Full /empty	18L	7.2kg
060062	C263-S	Plastic	488 x 417 x 603	Electric	3 level	17.5L	7.1kg
060062A	C263-S	Ceramic	488 x 417 x 603	Electric	3 level	17.5L	16.2kg
060063B	C263-CSL	Plastic	540 x 417 x 603	Electric	3 level	17.5L	7.7kg
060063C	C263-CSL	Ceramic	540 x 417 x 603	Electric	3 level	17.5L	16.8kg
060063	C263-CS	Plastic	750 x 417 x 603	Electric	3 level	17.5L	8.0kg
060063A	C263-CS	Ceramic	750 x 417 x 603	Electric	3 level	17.5L	17.1kg

Right Hand cassette



WOW A complete range of OEM Thetford toilets are held in stock and are available at preferential rates to manufacturers only. Please speak to your sales contact for more details.

Left Hand cassette



C403-L



C503-L

Part no.	Model	Hand	Dimensions H x W x D	Pump Type	Level Indicator	Waste tank capacity	Net Weight
060094C	C403-L	Left	512 x 670 x 400	Electric	3 level	19.3L	8.1kg
060094D	C403-L	Right	512 x 670 x 400	Electric	3 level	19.3L	8.1kg
060094G	C503-L	Left	502 x 739 x 410	Electric	3 level	19.7L	9.6kg
060094H	C503-L	Right	502 x 739 x 410	Electric	3 level	19.7L	9.6kg

Permanent toilets **THETFORD**

For direct connection to waste tanks

American-designed floor mounted toilet, drawing flushwater from an independent pressurised water supply. Waste tank located beneath or on the floor.

- Single foot pedal operation
- Deep bowl ensures less splashing
- Easy installation and access of parts



Bravura V low



Bravura V High

Model	Bravura V Low	Bravura V High
Bowl material	Plastic	Plastic
Dimensions (HxWxD)	356 x 421 x 531 mm	454 x 421 x 531 mm
Weight	7.5 kg	8.3 kg
Seat height	333 mm	431 mm
Part number	060096B	060096A



Closet flange

Required to connect the toilet to the waste tank or pipe

060096AF

Service doors **THETFORD**

A comprehensive range of high grade UV resistant quality plastic doors suitable for cassette toilets or as service doors for gas bottles and water tanks. They can all be mounted vertically or horizontally

- Incorporate double seal to help waterproof locks and assist insulation
- Integrated hinges
- Suit wall thickness 24mm to 40mm



Door 3

Standard cassette toilet door. Can be fitted landscape or portrait.

Aperture:
330 x 280mm.

Overall dimensions:
385 x 335mm

White **060105**
Black **060105B**

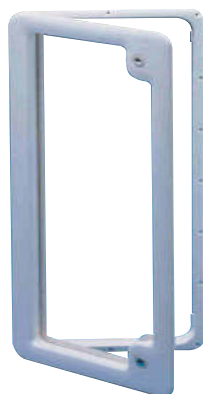

Door 4

Gas and water tank door.

Aperture:
630 x 330mm.

Overall dimensions:
700 x 395mm

Cream **060098**
White **060098W**



Door 5

Water tank and general luggage door.

Aperture:
730 x 280mm.

Overall dimensions:
785 x 340mm

White **060099W**



Door 6

General luggage door for large objects.

Aperture:
980 x 400mm.

Overall dimensions:
1038 x 465mm

Cream **060097**
White **060097W**



Door 7

General luggage door for large objects.

Aperture:
1051 x 282mm.

Overall dimensions:
1108 x 346mm

White **060106**

Cassette accessories



060088S



060089S

Cassette seat raisers

Seat raiser makes it easier to sit down and stand up!

Raises the seat height by approx. 7cm

For C200 **060088S**
For C2, C3, C4 **060089S**

Fresh-up sets

A "new" toilet in 2 steps.

The set includes:

- Waste holding tank with wheels
- Seat & Cover

The Toilet fresh-up set is an easy and economic way to make a used cassette toilet as good as new.

An additional waste holding tank for longer trips? Even then the Toilet fresh-up set is a perfect solution



F



C200 series fresh-up

With yellow accents
060088



C2 / C3 /C4 fresh-up

With yellow accents
Right hand 060089R
Left hand 060089L



C220 series fresh-up

With blue accents
060088A



C250/60 series fresh-up

With orange accents
057196



C400 series fresh-up

With green accents. Includes instructions to fit left or right hand toilets
060241



C500 series fresh-up

With green accents. Includes instructions to fit left or right hand toilets
060094J

Toilet spare parts images

PORTA POTTI SPARES				
				
060197 Water Fill Cap 145/165/335/345/365	060123 Bellows 145/165/335/345/365/Q145/ Q165	060143 Inlet Tube 145/165/335/345/365	060150 Pour Out Spout Complete 145/165/335/345/365	
				
060116 Cap & Spout Seals 145/165/335/345/365/465/C2/ C3/C4/C200	060142 Vent Seal All portables	060153 Vent Button Yellow 145/165/335/345/365/465/C2/ C3/C4/C200/C220/C250/C260		060134 Lip Seal All portables
				
060138 Float Arm 335/345/365/C2/C3/C4	057200 Measuring Cap & Seal Yellow 465/C2/C3/C4/C200/C250/ C260/C400	057201 Measuring Cap & Seal White 465/C2/C3/C4/C200/C250/ C260/C400		
PORTA POTTI QUBE / PORTA POTTI SPARES				
				
058000 Seat & Cover Q145/Q165/Q345/Q365	058001 Seat & Cover Q335	058006 Water Fill Cap All Porta Potti Qubes	058010 Pour Out Spout All Porta Potti Qubes	
				
058014 Dump Cap & Seal All Porta Potti Qubes	060142 Vent Seal All portables	058017 Vent Button All Porta Potti Qubes & Excellence		060134 Lip Seal All portables
				
060123 Bellows 145/165/335/345/365/Q145/ Q165	058020 Level Indicator Dial Q335	058021 Level Indicator Dial Q345/Q365	058024 Piston Pump Q335	058025 Piston Pump Q345/Q365

Toilet spare parts images













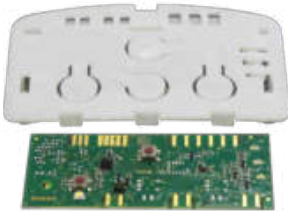

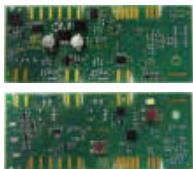



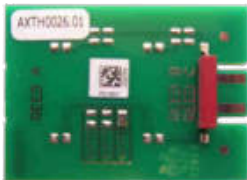
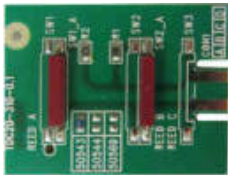
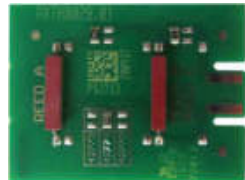



F

PORTA POTTI EXCELLENCE			
 058002 Seat & Cover	 058007 Water Fill Cap	 058008 Water Fill Adapter	 058019 Level Indicator
 058026 Piston Pump	 058027 Electric Pump	 058015 Measuring Cap & Seal	 058011 Pour Out Spout
 060142 Vent Seal All portables	 060134 Lip Seal All portables	 058017 Vent Button All Porta Potti Qubes & Excellence	 058022 Level Indicator Dial
 058030 Float Arm	 056983 Floor Plate		
C2/3/4 BENCH			
 060193 Cassette Retainer Clip	 060136 Drain Cap C2/C4	 060122 Water Fill Funnel C2/C4	 060158 Water Fill Funnel Cap C2/C4/C402C/C402X/C502C/ C502X
 060121 Flush Knob Assembly	 060130 Seat & Lid	 060155 Hinge Post & Pins	 060147 Level Indicator Dial C2/C3/C4
 060118 Cassette Pump C2/C402C/C402X/C200CWE	 060157 Sight Glass Left Hand C2/C4	 060117 Sight Glass Right Hand C2/C4	 060119 Switch C2/C3
 060126 Bellows C4	 060124 Check Valve Body C4	 060176 Pump Assembly C4	 060165 Flush Tube C4
 060132 Fuse 3A < 06/94 C2/C3	 060156 Fuse 3A > 06/94 C2/C3/C200CS/C200S/ C200CW/C200CWE/C402C/ C402X/C403L	 060114 Mechanism C2/C3	 060178 Vacuum Breaker All Cassettes

Toilet spare parts images

C200 / C220 SWIVEL				
 <p>060175 Seat & Cover C200CS/S/CW/CWE</p>	 <p>060178 Vacuum Breaker C3/C200CS/C200S/ C200CW/C200CWE/ C223S/C223CS/C250S/ C250CS/C250CWE/ C263S/C263CS/ C262CWE/C403L/C503L</p>	 <p>060085 Manual Pump C200CW</p>	 <p>060079 Pump retainer C200CW</p>	 <p>060118 Cassette Pump C2/C402C/C402X/ C200CWE</p>
 <p>060081 Reed Switch C200CS/S/CWE</p>	 <p>060087 Reed Switch C200CW</p>	 <p>060087A Flush Switch C200CWE</p>	 <p>060092 Flush Switch C200CS/S</p>	 <p>060172 Electric Valve C3/C200CS/C200S/ C223S/C223CS/C250S/ C250CS/C263S/C403L</p>
 <p>060082 Level Indicator LED C200CS/S</p>	 <p>060086 Bezel C200CWE</p>	 <p>060071 Control Panel C200CS</p>	 <p>060156 Fuse 3A > 06/94 C2/C3/C200CS/C200S/ C200CW/C200CWE/ C402C/C402X/C403L</p>	 <p>060174 Drain Plug C200CWE</p>
 <p>060080 Handle C200CS/S/CW/CWE</p>	 <p>060080A Saddle Bracket C200CS/S/CW/CWE</p>			

Toilet spare parts images

C250 / C260 SWIVEL				
 <p>057164 Overlay C250CS/C250S/C250CWE</p>	 <p>057166 Control Panel SN C250S/C250CS/C250CWE/ C263S/C263CS/C262CWE</p>	 <p>057167 Control Panel SW C250S/C250CS/C250CWE</p>	 <p>057168 Control Panel FF C250S/C250CS/C250CWE/ C263S/C263CS/C262CWE</p>	
 <p>060053 Sticker Control Panel C263S/C263CS/C262CWE</p>	 <p>060050 Control Panel SW C263S/C263CS/C262CWE</p>	 <p>060064F Filter C263S/C263CS/C262CWE</p>	 <p>060045 Electric Ventilator C263S/C263CS/C262CWE</p>	
 <p>057171 Reed Switch Housing C250S/C250CS/C250CWE</p>	 <p>057172 Reed Switch One Switch C250S/C250CS/C250CWE</p>	 <p>057173 Reed Switch Single level C250S/C250CS/C250CWE</p>	 <p>057174 Reed Switch Multi Level C250S/C250CS/C250CWE</p>	
 <p>057188A Ring Blade Mechanism C250S/C250CS/C250CWE/ C263S/C263CS/C262CWE</p>	 <p>057194A Handle C250S/C250CS/C250CWE/ C263S/C263CS/C262CWE</p>	 <p>060044 Seat & Cover C250S/C250CS/C250CWE/ C263S/C263CS/C262CWE</p>	 <p>060047 Seal/ Retainer Nozzle C250S/C250CS/C250CWE</p>	
 <p>060178 Vacuum Breaker C3/C200CS/C200S/ C200CW/C200CWE/ C223S/C223CS/C250S/ C250CS/C250CWE/ C263S/C263CS/ C262CWE/C403L/C503L</p>	 <p>060054 Electric Valve >01/09/13 C263S/C263CS/C503L</p>	 <p>060172 Electric Valve < 01/09/13 C3/C200CS/C200S/ C223S/C223CS/C250S/ C250CS/C263S/C403L</p>	 <p>060052 Reed Switch Single Level C263S/C263CS/ C262CWE</p>	 <p>060051 Reed Switch Multi Level C263S/C263CS/ C262CWE</p>
 <p>057169 Pump C250CWE</p>	 <p>057170 Pump C262CWE</p>	 <p>060048 Wire Harness C250CWE</p>	 <p>060046 Wire Harness C250S</p>	 <p>060049 Wire Harness C262CWE</p>

F

Toilet spare parts images

C400 / C500 BENCH				
 <p>060236 Control Panel C403L</p>	 <p>060183 Control Knob C502C</p>	 <p>060184 Control Knob C502X</p>	 <p>060211 Wall Seal C402C/C402X/C403L</p>	
 <p>060227 Seat & cover C402C/C402X/C403L</p>	 <p>060186 Seat & Cover C502C/C502X/C503L</p>	 <p>060231 Fill Funnel Assembly C402C/C402X/C403L</p>	 <p>060158 Cap Fill Bottle C2/C4/C402C/C402X/C502C/ C502X</p>	
 <p>060117A Drain Tube C402C/C402X</p>	 <p>060240 Float Box / switch C402X</p>	 <p>060232 Switch Housing C402C</p>	 <p>060187 Water Level Sensor C502C/C502X</p>	
 <p>060156 Fuse 3A > 06/94 C2/C3/C200CS/C200S/ C200CW/C200CWE/ C402C/C402X/C403L</p>	 <p>057158 Water Fill Extension C402C/C402X</p>	 <p>060181 Handle Type A C402C/C402X/C403L</p>	 <p>060213 Wire Harness C402C/C402X/C403L</p>	 <p>060179 Shaft C402C/C402X/C403L/C502C/ C502X/C503L</p>
 <p>060118 Cassette Pump C2/C402C/C402X/ C200CWE</p>	 <p>060054 Electric Valve >01/09/13 C263S/C263CS/C503L</p>	 <p>060172 Electric Valve C3/C200CS/C200S/ C223S/C223CS/C250S/ C250CS/C263S/C403L</p>	 <p>060185 Main PCB C503L</p>	 <p>060178 Vacuum Breaker C3/C200CS/C200S/C200CW/ C200CWE/C223S/C223CS/ C250S/C250CS/C250CWE/ C263S/C263CS/C262CWE/ C403L/C503L</p>

Toilet spare parts images

HOLDING TANKS					
 <p>060116 Cap & Spout Seals 145/165/335/345/365/465/C2/ C3/C4/C200</p>		 <p>057200 Measuring Cap & Seal Yellow 465/C2/C3/C4/C200/C250/ C260/C400/C500</p>		 <p>057201 Measuring Cap & Seal White 465/C2/C3/C4/C200/C250/ C260/C400/C500</p>	 <p>060113 Dump Cap Yellow C2/C3/C4/C200</p>
 <p>060115 Pour Out Spout Assembly C2/C3/C4/C200</p>		 <p>057192 Pour Out Spout Assembly C250/C260</p>		 <p>060223 Pour Out Spout Assembly C400/C500</p>	 <p>060140 Vent Button Assembly C2/C3/C4</p>
 <p>060128 Lip Seal < 15/06/00 C2/C3/C4</p>		 <p>060101 Lip Seal > 15/06/00 All holding tanks</p>		 <p>060153 Vent Button Yellow 145/165/335/345/365/465/C2/ C3/C4/C200/C220/C250/C260</p>	 <p>060224 Vent Button C400/C500</p>
 <p>060110 Automatic Vent C2/C3/C4/C200/C220/C500</p>		 <p>060127 Vent Seal C2/C3/C4</p>		 <p>060209 Vent Seal C400</p>	 <p>060171 Outside Vent C200/C220</p>
 <p>060138 Float Arm 335/345/365/C2/C3/C4</p>	 <p>060083 Float Arm C200</p>	 <p>060112 Automatic Vent Seal C2/C3/C4/C200/C220/ C250/C260</p>	 <p>057190 Float Stem Assembly C250/C260</p>	 <p>057191 Float C250/C260</p>	
 <p>060139 Float Vent C2/C3/C4</p>		 <p>060141 Sliding Cover C2/C3/C4/C200</p>		 <p>057189 Sliding Cover C220/C250/C260</p>	 <p>060219 Sliding Cover C400/C500</p>
 <p>057195 Holding Tank Mechanism C250/C260</p>		 <p>060242 Mechanism Complete RH C400/C500</p>		 <p>060243 Mechanism Complete LH C400/C500</p>	 <p>057187 Mechanism Seal C250/C260/C400/C500</p>

Toilet spare parts images

HOLDING TANKS			
 <p>057186 Tank Plate C250/C260</p>	 <p>060078 Blade C2/C3/C4/C200</p>	 <p>057188 Blade C220/C250/C260/C400/C500</p>	 <p>060208 Magnet Assembly C400</p>
 <p>060200 Blade Opener > 15/06/00 C2/C3/C4</p>	 <p>060084 Blade Opener C200/C250/C260</p>	 <p>060218 Blade Opener C400/C500</p>	 <p>060195 Tank Lock Clip C200/C220</p>
 <p>057194 Telescopic Handle C250/C260</p>	 <p>060180 Pull Handle C400/C500</p>	 <p>057193 Wheels (x2) C250/C260</p>	 <p>060226 Wheel & Bearing C400/C500</p>
 <p>060090 Holding Tank Complete LH C400</p>	 <p>060091 Holding Tank Complete RH C400</p>	 <p>060066 Holding Tank Complete LH C500</p>	 <p>060067 Holding Tank Complete RH C500</p>
 <p>057181 Holding Tank Complete C250/C260</p>			

Toilet spare parts images

F

SERVICE DOOR SPARES				
A thick black rubber seal for door 2.	A black rubber seal for door 3.	A black rubber seal for door 4.	A black rubber seal for door 5.	
060137 Seal Door 2 (SD2)	060103 Seal Door 3 (SD3)	060103A Seal Door 4 (SD4)	060103B Seal Door 5 (SD5)	
A white plastic cover for the door 2 lock.	A brass door lock mechanism for door 2.	A pink push button for standard doors.	A door lock mechanism for standard doors.	
060162 Door 2 Lock Cover White	060159 Door 2 Lock (SD2)	060104 Push Button for Standard Doors (SD3/4/5/6/7)	060163 Door Lock for Standard Doors (SD3/4/5/6/7)	
Two metal hinge pins for door 2.	A single metal hinge pin for standard doors.	A blue and white zadi housing for standard doors.	A black and blue zadi housing for standard doors.	
060109 Hinge Pins Door 2	060111 Hinge Pins for Standard Doors (SD3/4/5/6/7)	060163H Zadi Housing White for Standard Doors (SD3/4/5/6/7)	060163HB Zadi Housing Black for Standard Doors (SD3/4/5/6/7)	
A collection of various door lock components including pins, washers, and covers.	A black plastic soft tray for battery boxes.	A white waterfill door.		
060107 Door lock Service Kit	010323 Soft Tray for Battery Boxes	Waterfill Door 060173 Cream White 060084A White 060084B Light Grey 060084C Dark Grey		
A blue door frame for door 3.	A blue door frame for door 4.	A white door frame for door 5.	A blue door frame for door 6.	A white door frame for door 7.
Door 3 060105 White 060105B Black	Door 4 060098 Cream White 060098W White 060103C White (no locks)	Door 5 060099W White	Door 6 060097 Cream White 060097W White	Door 7 060107 White

Calor Gas Products Regulators



CALOR



Butane 21mm Clip-On regulator

Calor Code: 601225

Low pressure butane regulator with effortless Clip-On connection. It has an easy to operate on/off lever with a clear indicator to determine whether its switched on or off

070350C



Butane Screw-On 1.3kg/h regulator

Calor Code: 601226

Low pressure butane regulator ideal for both industrial and domestic use

070323C



Campingaz 29mb regulator

Calor Code: 601227

Low pressure butane Campingaz regulator designed to be used with Campingaz cylinders only

070342C



Patio Gas® 27mm Clip-On regulator

Calor Code: 601228

Low pressure Patio Gas® regulator with effortless Clip-On connection. It has an easy to operate on/off lever with a clear indicator to determine whether it's switched on or off

070345C



Propane Screw-On 1.5kg/h regulator

Calor Code: 601229

Low pressure propane regulator ideal for both industrial and domestic use

070336C



Propane Screw-On 4kg/h regulator

Calor Code: 601230

Low pressure propane screw-on regulator

070351C



Propane HP 0.5-1bar Adjustable regulator

Calor Code: 601231

High pressure propane adjustable regulator (single stage) for use when a more precise flow is required

070352C



Propane HP 0.5-2bar Adjustable regulator

Calor Code: 601232

High pressure propane adjustable regulator (single stage) for use when a more precise flow is required

070353C



Propane HP 0.5-4bar Adjustable regulator

Calor Code: 601233

High pressure propane adjustable regulator (single stage) for use when a more precise flow is required

070354C



Propane HP 1bar Fixed regulator

Calor Code: 601234

High pressure propane fixed pressure regulator (single stage)

070355C



Grove Code	Max Inlet Pressure	Cap. kg/hr	Operating Pressure (mbar)	Inlet	Outlet
070350C	7.5bar	1.3	29	21mm Clip On	8mm Nozzle
070323C	7.5bar	1.3	29	Butane Union 109	
070342C	7.5bar	0.8	29	Campingaz M16x1.5mm	
070345C	16bar	1.5	37	27mm Clip On	
070336C	16bar	1.5	37		3/8" BSP Female Propane POL 105 1/4" BSP Female supplied with 6.3mm Nozzle
070351C	16bar	4	37		
070352C	16bar	8	0.5-1bar 10 Position		
070353C	16bar	6	0.5-2bar		
070354C	16bar	8	0.5-4bar		
070355C	16bar	8	1bar		

Calor Gas Products



Calor Code: 603006

2 stage, 30mBar regulator with 90° 8mm outlet

070395C



Calor Code: 603003

2 stage, 30mBar regulator with 90° 10mm outlet

070396C



Calor Code: 603005

2 stage, 30mBar regulator with 8mm outlet

070399C



Calor Code: 603004

2 stage, 30mBar regulator with 10mm outlet

070400C

Grove Code	Max Inlet Pressure	Capacity kg/hr	Operating Pressure (mbar)	Inlet	Outlet
070395C	16bar	1.5	30	W20 male	90° 8mm
070396C	16bar	1.5	30	W20 male	90° 10mm
070399C	16bar	1.5	30	W20 male	8mm
070400C	16bar	1.5	30	W20 male	10mm

Changeover Valves

IMPORTANT

Recommended only for use on non-fixed installations with 2 cylinders. Not to be used with 4 cylinder upgrade kit



Propane 37mb 2 Cylinder Automatic Changeover Valve with OPSO*

Calor Code: 601238

Automatic changeover valve with OPSO with POL x 1/2" BSP FEM connections. Designed to operate multi cylinder systems, complete with a second stage regulator, 2 hoses, 1 ball valve, 1 Installation kit (gasket, screws)

070421C



Propane 37mb 2 Cylinder Automatic Changeover Valve without OPSO*

Calor Code: 601237

Automatic changeover valve without OPSO with POL 105 x 3/8" BSP FEM connections. Designed to operate two cylinder systems, complete with a second stage regulator, 2 hoses, 1 ball valve, 1 Installation kit (gasket, screws)

070420C



Propane 37mb 4kg/h Manual Changeover Valve*

Calor Code: 601236

Manual changeover valve with POL x 3/8" BSP FEM connections. Designed to operate a 2 cylinder system, complete with a second stage regulator, 2 hoses, 1 ball valve and an installation kit (gaskets and screws)

070419C

Grove Code	Max Inlet Pressure (bar)	Capacity (kg/h)	Pressure (mbar)	Connections
070419C	16	4	37	POL 105 x 3/8" BSP
070420C	16	6	37	POL 105 x 3/8" BSP
070421C	16	4	37	POL x 1/2" BSP



Calor Gas Products Hoses & Pigtails

Accessories



Standard Hose

High quality LPG hosing for use with changeover valves
50cm POL x W20 **070499C**
75cm POL x W20 **070500C**
75cm POL x POL **070501C**



Armoured Hose

High quality LPG hosing for use with changeover valves. Armoured hosing provides extra protection from wear, sharp objects and vermin.
50cm POL x W20 **070503C**
75cm POL x W20 **070504C**
75cm POL x POL **070505C**



8mm Low Pressure Hose & 2 Jubilee Clips

Calor Code: 601258

1m 8mm Low Pressure Hose & 2 Jubilee Clips

070237C



Calor Code: 601259

2m 8mm Low Pressure Hose & 2 Jubilee Clips

070238C



Universal BBQ Hose & Regulator Kit

Calor Code: 601260

A complete kit to get your BBQ up and running. Includes 1m x 8mm hose, 1 Patio Gas® Clip-On regulator and 1 x 5/8" UNF & 1 x 1/4" LH BBQ fittings

070345CK



4 Cylinder Upgrade Kit (Standard)

Calor Code: 601239

4 cylinder OPSO upgrade kit for use when upgrading from a 2 cylinder system to 4 cylinders. Comes complete with 2 hoses and 'T' piece. Only to be used with changeover valves with OPSO (an over pressure protection device)

070510C



4 Cylinder Upgrade Kit (Armoured)

Calor Code: 601240

4 cylinder OPSO upgrade kit for use when upgrading from a 2 cylinder system to 4 cylinders. Comes complete with 2 hoses and 'T' piece. Armoured hosing provides extra protection from wear, sharp objects and vermin.

070511C



Leak Detector Spray 500ml

Calor Code: 601256

Gas leak detector spray specially formulated to detect the smallest of leaks

070549C



Light Weight Spanner

Calor Code: 601255

Spanner designed to aid in the connection of a screw on regulator to a gas cylinder

070221C



Heavy Duty Spanner

Calor Code: 601254

Spanner designed to aid in the connection of a screw on regulator to a gas cylinder

070222C

WOW All Calor Essentials products have a 5 year warranty



WOW Calor point of sale packages available. Please speak to your sales contact for more details



Cylinder sizes, types and offtakes

Propane

Capacity	3.9kg	6kg	6kg Lite	13kg	19kg	47kg
Height	340mm	495mm	495mm	580mm	800mm	1290mm
Diameter	240mm	256mm	256mm	315mm	315mm	375mm
Recommended Offtake	7.5 kW 0.53kg/h	11 kW 0.77 kg/h	11 kW 0.77 kg/h	15 kW 1.05 kg/h	19 kW 1.32 kg/h	34 kW 2.4 kg/h
Colour	Red	Red	Red	Red	Red	Red
Maximum Tare	6.8kg	8.2 kg	4.1kg	15.9kg	18.1kg	38.6kg



Butane

Capacity	4.5kg	7kg	15kg
Height	340mm	495mm	580mm
Diameter	240mm	256mm	318mm
Recommended Offtake	5 kW 0.42 kg/h	7 kW 0.5 kg/h	9.9 kW 0.7 kg/h
Colour	Blue	Blue	Blue
Maximum Tare	6.8kg	8.2 kg	15.9kg



Patio Gas®

Capacity	5kg	13kg
Height	314mm	580mm
Diameter	306mm	315mm
Recommended Offtake	10kW 0.72 kg/h	15 kW 1.05 kg/h
Colour	Green with red handles	Green with a red shroud
Maximum Tare	6.2kg	15.9kg



How to connect and disconnect a cylinder

Connecting a 3.9kg, 6kg, 13kg, 19kg & 47kg Propane cylinder

Propane cylinders have a 'female' valve connection. Check the connection is clean and undamaged before connecting. This is a 'face-to-face' seal and requires the correct size spanner to be sure it is fully tightened. (Left-hand thread).

1. Check that the valve handwheel is OFF by turning clockwise.
2. Remove the protective plug and leave hanging to replace later.
3. Inspect the bullnose connection of the regulator for damage before connecting.

NOTE: A gas tight seal is created by face-to-face connection between the bullnose & cylinder valve.

4. Fit the connecting nut (left hand thread) to the cylinder, using the correct spanner. Note that Propane cylinder connections must be tight.
5. Ensure appliances are turned OFF.
6. When gas is required turn the valve handwheel anti-clockwise (ON).
7. Check for gas soundness using leak detection solution.

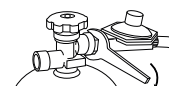
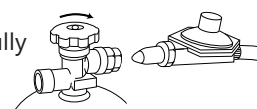

Disconnecting a 3.9kg, 6kg, 13kg, 19kg & 47kg Propane cylinder

Turn the handwheel OFF (clockwise rotation). Wait until the burner/pilot light has gone out.

1. Changeover valves
 - a) If the installation does not have a changeover valve fitted, turn OFF the gas tap, if fitted, to an appliance.
 - b) For installations with a changeover valve, it is only necessary to turn off the cylinder.

N.B. Never remove the regulator (or connecting nut) with the cylinder valve open.
2. Remove the regulator (or connecting nut- left hand thread) with the correct spanner.
3. Replace the protective plug into the valve outlet.

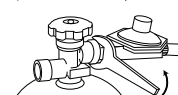
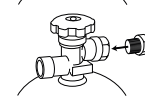
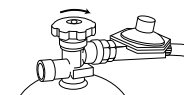

Connecting a 4.5kg Butane cylinder

A 4.5kg cylinder takes a regulator which screws on to the valve outlet. The regulator has a connecting nut that incorporates a black sealing washer. Do not use the rubber washer from the black cap as a sealing washer. Turn the orange cap so that the arrow is pointing to the gap in the shroud.

1. Check that the valve handwheel is off by turning clockwise.
2. Remove protective black cap and retain for future use.
3. Inspect the black sealing washer on the regulator for damage before connecting. Replace the washer if faulty.
4. Fit the connecting nut (left hand thread) to the cylinder using a suitable spanner. Tighten firmly, but do not over tighten as this can damage the washer
5. When gas is required, turn the valve handwheel anticlockwise.

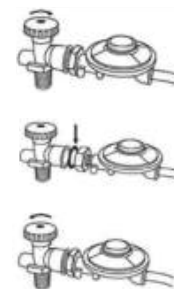

Disconnecting a 4.5kg Butane cylinder

Never disconnect the regulator (or connecting nut) with the valve open.

1. Turn the valve hand wheel off (clockwise rotation).
2. Wait until the burner and pilot lights have gone out. If the flame does not go out, turn the valve hand wheel anticlockwise back to on; leave the appliance alight and call your gas supplier.
3. Disconnect the Regulator (left hand thread) with a suitable spanner.
4. Screw the protective black-cap back on to the cylinder valve.

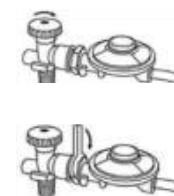

Connecting a 7kg, 12kg & 15kg Butane cylinder

7kg, 12kg and 15kg Butane cylinders have a 21mm valve and must only be used with a 21mm regulator.

1. Turn the orange cap so that the arrow is pointing to the gap in the shroud.
2. Remove the orange safety cap by pulling the lanyard out, then up. Do not use tools and leave the cap hanging.
3. Check the black sealing washer is fitted inside the cylinder valve.
4. Ensure the regulator switch is in the disconnect position (3 o'clock position).
5. Fit the 21mm regulator as per the manufacturer's instructions.
6. When gas is required, turn lever to ON position.

If the regulator ON/OFF switch gets stuck when turning the supply on, it means that the regulator has been connected incorrectly. In this event the regulator must be disconnected and the correct steps to reconnect repeated from the beginning.



Disconnecting a 7kg, 12kg & 15kg Butane cylinder

Never disconnect the regulator with the switch in the ON position.

1. Turn the regulator lever to the OFF position.
2. Wait until the burner and pilot lights have gone out. If the flame does not go out, turn the switch back to on; leave the appliance alight and call your gas supplier.
3. To remove the regulator from the cylinder valve please refer to the manufacturer's instructions.
4. Replace the orange safety cap onto the cylinder valve of the empty or part full cylinder, when not in use.

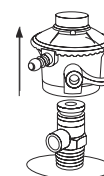

Connecting a 5kg & 13kg Patio Gas® cylinder

Reminder: Patio Gas® cylinders use a 27mm clip on valve and clip on regulators.

Unlike the other propane cylinders you do not need a spanner to connect the regulator.

1. If the cylinder has a yellow tamper evident cap, please remove and discard.
2. Make sure that:
 - a) The regulator is switched to the OFF or disconnect position.
 - b) All taps on the appliance are closed.
 - c) The connecting pipe to the appliance is correctly fitted.
 - d) The valve is clean and free from debris.
3. Put regulator on top of the cylinder valve. Place hand on top of the regulator and push down firmly and vertically until you hear a click.
4. Once the regulator is correctly fitted, switch to on position as directed by manufacturer instructions on the regulator.
ALWAYS: Turn the switch to the OFF position after use.

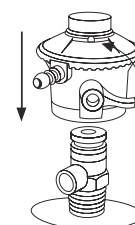

Disconnecting a 5kg & 13kg Patio Gas® cylinder.

1. Make sure the regulator is turned to the OFF position and that the appliance flame is extinguished.
2. Push the ON/OFF switch according to manufacturer instructions and then pull upwards.
REMEMBER: Do not attempt to disconnect the cylinder if the regulator is in the ON/open position.

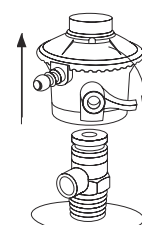

Fixed regulators



WOW
For Calor
branded fixed
regulators
see page 138



Truma regulators

M20 x 1.5Kg/h, 30mbar with pressure protection, integrated 90° elbow and test point

- 8mm outlet **070520**
- 10mm outlet **070525**



Elbow for Truma regulator

070526

MonoControl CS

This safety gas pressure regulation system is ideally suited to ensuring safe heating whilst on the move. It has a built in crash sensor (CS) and integrated test point.

Now can be installed vertically or horizontally.

- Inlet M20
- Regulator capacity 1.5kg/h
- Crash sensor is easy to reset
- Crash sensor activation value: 4.0g +/- 1.0g
- 30 mbar
- 8/10mm **070381**

For gas tank installation
8/10mm **070371**

DuoControl CS Vertical

The DuoControl can be retrofitted, and has a built in crash sensor (CS) and integrated test point. **Not** for use in commercial vehicles.

- Automatic changeover from empty to full gas cylinder.
- Visual display indicating the status of the operating cylinder (empty/full)
- Manual selection of operating cylinder using control knob
- Inlet M20
- Regulator capacity 1.5kg/h
- Crash sensor is easy to reset
- Crash sensor activation value: 3.5g +/- 0.5g
- For vertical installation
- Models available on request for horizontal installation
- 30 mbar 10/8mm **070377**
- 50 mbar 8mm **070378**



Truma gas filter

Helps to prevent blocked regulators by filtering any oily residue in the gas.

- Filter and housing **070555**
- Replacement filter **070556**

DuoControl without crashsensor

The DuoControl has the same specifications as the DuoControl CS but without the built in crash sensor

- 30 mbar 10mm **070376**
- 30 mbar 8mm **070379**



Cavagna 180° regulators

30mbar double stage regulator with 1.5kg/h flow capacity. "UDS" is the standard built in safety device. With integrated test point. W20 inlet

- 8mm outlet **070399**
- 10mm outlet **070400**



Cavagna 90° regulators

30mbar double stage regulator with 1.5kg/h flow capacity. "UDS" is the standard built in safety device. With integrated test point. W20 inlet

- 8mm outlet **070395**
- 10mm outlet **070396**

WOW 5 year warranty
on all Cavagna regulators



Cavagna auto changeover regulators

The Recla automatic changeover gas regulator by Cavagna (30mbar) with 1.5kg/h flow capacity. It combines an automatic changeover with a double stage regulator, integrated "PRV" safety device and test point. Therefore it is the most compact gas regulation system in Europe. W20 inlet

- 8mm outlet **070415**
- 10mm outlet **070416**

Fixed regulator equipment



Propane pigtails
EN16436
500mm **070515**
750mm **070518**
Truma 450mm **070534**



Butane pigtails
EN16436
500mm **070514**
750mm **070517**
Truma 450mm **070533**



HP gas hose with rupture protection
Truma 450mm
GB propane **070557A**
GB butane 4.5kg **850618**

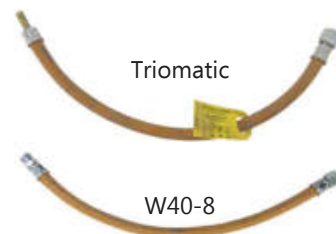

Other gas hoses
Truma 450mm
Triomatic **850615**
W40-8 gas hose **850616**



Campingaz adaptor
Truma **070541**
EN1949 **070548**



21mm butane clip-on adaptor
Truma **070542**
EN1949 **070545**



27mm butane clip-on adaptor
With 90° elbow
Truma **070531**



Pigtail washers W20
10 per outer
Black **070535**
Truma Green **070532**

Standard regulators



Butane regulator
Outlet pressure 28mbar
1.3Kg/h. EN 12864
approved.
Singly or 10 per outer
070323



Regulator washers(5)
10 per outer
070227



Propane regulator
Outlet pressure 37mbar
1.5Kg/h. EN 12864
approved.
Singly or 10 per outer
070336



Propane handwheel regulator
Outlet pressure 37mbar.
1.5Kg/h. EN 12864
approved.
Singly or 10 per outer
070337



Gaz regulator
For use with Campingaz
cylinders. Integral control
valve. Outlet pressure
29mbar 0.8Kg/h. EN 12864
approved.
Singly or 10 per outer
070342



Campingaz regulator
To operate campingaz®
refillable cylinders. Simply
screws onto 901, 904, & 907
cylinders
109919



Patio gas regulator
27mm clip on regulator
for Calor patio gas. Outlet
pressure 37mbar. EN 12864
approved.
Singly or 10 per outer
070345



BP Gas light regulator
Outlet pressure 37mbar.
1.5Kg/h.
070543



Regulator spanner
Light weight **070221**



Regulator spanner
Heavy duty **070222**



Regulator spanner
Truma **070224**

Gas fittings

5 packs per outer unless otherwise stated



**GAS HOSES
NOT
SUPPLIED
ON A REEL**



Carded
10 per outer

Bulk
100 per bag

Low pressure Gas hose BS3212

Composite black gas hose
8mm bore
50m roll
070234

High pressure Gas hose BS3212

Orange gas hose
8mm bore
50m roll
070236

Copper tube

Supplied in 30m rolls
1/4" O.D. **070290**
5/16" O.D. **070295**
3/8" O.D. **070300**

Hose clips

OOO (2) W4 **104832**
OOO (2) carded **070249**
OOO Bulk **070255**
OO (2) carded **051246**
OO Bulk **051257**



Straight couplings

1/4" **070004**
5/16" **070006**
3/8" **070008**
8mm **070010**
10mm **070012**

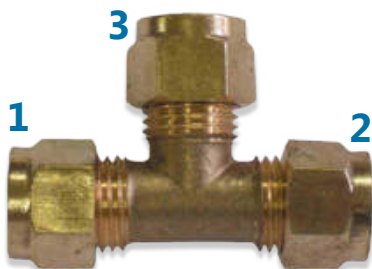

Tee pieces

1 x 2 x 3
1/4 x 1/4 x 1/4" **070068**
5/16 x 5/16 x 5/16" **070074**
3/8 x 3/8 x 3/8" **070079**
5/16 x 5/16 x 1/4" **070081**
8 x 8 x 8mm **070080**
8 x 10 x 8mm **070083**
10 x 10 x 8mm **070085**
15 x 15 x 10mm **070087**
15 x 15 x 8mm **070089**



Elbows

1/4" **070180**
5/16" **070181**
8mm **070175**
10mm **070177**

Elbow reducers

10-8mm **070179**

Reducers

5/16" - 1/4" **070045**
3/8" - 5/16" **070055**
10-8mm **070057**
15mm-3/8" **070059**



Copper nozzles

1/4" **070099**
5/16" **070102**
3/8" **070105**
15mm **070146**



Male nozzle

1/4" **070120**



Female nozzle

1/4" **070137**
3/8" **070140**



Three way nozzle

10 per outer
070174



Stop end
1/4" **070170**



Blank nuts
1/4" **070183**



Copper olives (5)

1/4" **070267**
5/16" **070269**
3/8" **070273**



Line taps

Singly
1/4" **070196**
5/16" **070194**

Gas manifolds



**Straight quick
acting valve**
8mm **823110A**



**2 way
manifold valve**
8mm **824111A**



**3 way
manifold valve**
8mm **824131A**
10mm **824132A**



**4 way
manifold valve**
8mm **824151A**
10mm **824152A**

Gas box equipment



Truma BBQ gas point

Enables external gas appliances to be connected. The only additional equipment you need is a gas pipe with an 8mm diameter

White **070536**
Ivory **070537**



Reich gas supply box with lock and valve

Supply connection for gas, with safety valve and lock. 10mm inlet. Installation dimensions: 157x67mm

070465



Gas outlet box & lid

Fits on outside wall of caravan for easy connection of BBQ. Cut out -60mm Ø 60mm depth.

Finished - 90mm x 85mm
Complete box **070463**
Lid only **070461**
Nozzle only **070462**



W4 gas bottle retaining kit

Gas bottle retaining kit secures up to 7kg gas bottle when travelling.

070321



Gas bottle holder

Keeps gas bottle fixed while in transit. Singly or 10 per outer

070320



W4 compression lock for gas locker

WD barrel compression lock with lever attachments. As used by manufacturers including Explorer, Bailey and Coachman. Supplied with 1 key

070318

Gas servicing equipment



Truma leak test device

For workshop use.
Complete kit
Volumiser canister
Leak test hose

070550
070552
070551



Universal thermocouple

Thermostatic sensor device used in many gas appliances.

900mm length
070215



W4 gas bottle locker lock

Lock supplied together with necessary fittings to enable easy installation into a variety of locker types. Supplied without keys

070319



W4 gas locker key

Replacement steel key for gas lockers (070319). Singly or 10 per outer

070322

Fire safety



ABC powder extinguisher 1kg

Aluminium strong and light weight

- Rating A, B, & C
- Do not use on live electrical fires
- Single piece, deep drawn aluminium alloy body, externally painted with polyester resin, signal red to RAL 3000
- Plastic bracket specially designed for vehicle and marine use

Singly or 6 per outer
070636



Firemax foam extinguisher 1L with gauge

Domestic and commercial vehicle use

- Rating A & B
- Do not use on live electrical fires
- Rechargeable
- 5 year warranty

Singly or 10 per outer
070631



Fire blanket

Manufactured to BS6575. Supplied in wallet which can be hung on the wall. 1 m² blanket.

Singly or 10 per outer
070625



Fire blanket with holder

Manufactured to BS6575. Supplied in rigid plastic container which can be hung on the wall. 1 m² blanket.

Singly or 10 per outer
070627

It is important to choose the right fire extinguisher as specific extinguishers are designed for different types of fire.

The UK recognizes six fire classes:

Class A fires involve organic solids such as paper and wood.

Class B fires involve flammable or combustible liquids, including petrol, grease, and oil.

Class C fires involve flammable gases.

Class D fires involve combustible metals.

Class E fires involving electrical appliances (when the power supply is turned off an electrical fire can fall into any category).

Class F fires involve cooking fat and oil (use blankets)

Gas level indicators



Truma LevelCheck

Gas cylinder level indicator for all (LPG) steel or aluminium gas cylinders with a diameter of 200 to 350mm. The device measures whether there is liquefied gas in the cylinder at the measuring point (by horizontal connection) and indicates this.

- Reliable ultrasonic measurement
- Easy to use with 9v battery supplied
- Integrated LED torch with On/Off switch
- Status LED (green/red/orange) green = Gas, red = no gas, orange = indicates measuring process (also with audible tone)
- Under voltage display

*Not suitable for tank gas cylinders or fillable gas tanks

070560



Gas Genie

Gas level indicator with audible warning alarm and flashing LED's

- No installation required
- Powered by 2 x AA batteries (included)
- Instructions included
- Clips magnetically to steel gas cylinder body
- Weighs only 127g

070565

Other safety products



AA euro travel kit

Includes: Glovebox Atlas Europe, Driving in Europe Guide – Essential Travel Information, hazard warning triangle, headlamp beam converters, magnetic GB plate, reflective emergency jacket, first aid kit

070621

Alarms



FireAngel SB1-T optical smoke alarm

High performance optical sensor reduces nuisance alarms which are generally associated with ionisation technology. **NCC approved.**

- 85db at 1m (Minimum)
 - Wall/Free-standing installation
 - Operating temperature: 0° to 40°C
 - Operating humidity: 30% to 90% RH
 - 113g
 - Certified to BS EN 14604: 2005
 - 9V battery included
 - 3 year warranty
- Singly or 10 per outer
070651



FireAngel carbon monoxide alarm CO-9B

Carbon Monoxide Poisonous Gas Alarm. **NCC approved.**

- 85db Alarm at 1mtr + flashing LED.
 - Wall/Ceiling/Shelf installation
 - Certified to BS EN50291-1:2010+A1:2012 & BS EN50291-2:2010
 - 2 x AA batteries included
 - 7 year guarantee
- Singly or 5 per outer
070665



FireAngel carbon monoxide alarm

The same specifications as the CO-9B with a sealed in power pack, no battery pack required. 7 year life. Includes fast fit bracket for easy installation. 7 year life.

10 per outer
070665A



Kidde carbon monoxide alarm 7COC

With a 10-year sensor that lasts longer than most other CO alarms, this slim, easy-to-use alarm is ideal for use in all living areas and can be installed on a wall or ceiling, or used freestanding.

- Continuous monitoring of CO
 - Approved by BSI to EN50291.2010 Part 1 and 2 (boats and caravans) / CE Approved
 - Multi-function green and red LEDs to indicate power and alarm status
 - End-of-life warning to replace alarm after 10 years of protection
 - Test/Reset button to allow regular testing of alarm function
 - 3 x AA alkaline batteries supplied
- 126mm x 72mm x 35mm / 120g
070668A



SleepSafe CO detector

- Colour change Carbon Monoxide detector
 - Ideal for use in homes, offices, hotels, bedsits, caravans, boats and aircraft
 - Reacts to low level Carbon Monoxide (<50ppm)
 - Easy to use
- 070656**



Kronings TriGas alarm

Digital computerised gas, carbon monoxide and narcotic gas detector. The gas alarm has a unique heating element, which ensures that the air around the sensors is ventilated and renewed which increases safety and reliability.

The TriGas alarm responds to Propane/Butane (LPG) at the floor, carbon monoxide (CO and NO at the ceiling), as well as several other gases with anaesthetic effect, at floor and ceiling. The intelligent electronics tests the calibration every 40 seconds, and adapts to the environment in the caravan to avoid false alarms due to natural changes. The sensor automatically adjusts to the temperature, ensuring proper calibration when temperature is above 25°C, again avoiding false alarms.

070658

Fuel



C206 GLS
Pierceable, can't be disconnected once connected into an appliance. The Gas Lock System, is compliant to the new European standard EN 417:2012 legislation. Contains 190g of butane/propane mix. 36 per outer
109964



CV 300 Plus
High security self-sealing valve. Can be easily disconnected and reconnected even when not empty. Contains 240g of butane/propane mix. 24 per outer
109966



CV 470 Plus
High security self-sealing valve. Can be easily disconnected and reconnected even when not empty. Contains 450g of butane/propane mix. 12 per outer
109967



CP250
Contains 250g of Isobutane. For use with Bistro® type stoves. 12 per outer
109965



CG 1750
Taymar cartridge, for use with blowlamps and blowtorches. 175g. 12 per outer
109969



Coleman 300
Contains 240g of butane/propane mix in threaded self-sealing cartridges with safety valve. Size: Ø 105 x 90 mm. 24 per outer
109970



Coleman 500
Contains 440g of butane/propane mix in threaded self-sealing cartridges with safety valve. Size: Ø 105 x 160 mm. 12 per outer
109971



Propane non-refillable cylinder
Thanks to physical properties of Propane, every last gram of gas in the cylinder is used to operate the appliance. Contains 465 g of propane. Size: Ø 195 x 100 mm. Weight: 935g. 12 per outer
109973



Coleman camp fuel
Coleman fuel is a liquid petroleum fuel (100% light hydrotreated distillate). It has an octane rating of 50 to 55 and a flammability similar to petrol. 1 litre 12 per outer
109974



Refill for gas lighters
250ml. 12 per outer
070480



Campingaz spare parts
Small mantle (3)
Fits Bleuét CV 270L, Bivouac, Camping 206L, Lumostar C, M and plus, and Stellia R
070425
Medium mantle (3)
Fits L470, Rhapsody 470, Soleio R, Sun Force, Symphony, Super Symphony and Frontier CPS
109956



Stove cartridge
Cellophane wrapped economical 4 pack of gas for camping stoves and heaters. Resealable, can be removed when part full for convenient and safe storage. 250g cartridge. 6 per outer
109945

Instaclip (3)
Fits Single, Double and Powerhouse unleaded lanterns
109960

Instaclip tube (3)
Fits Northstar unleaded lanterns
109959

Globe
Medium round globe, fits Lumostar and C206 lanterns
109961

G

Gas lighters and ignitors

Turboflame

All Turboflame lighters have a flip top safety cap that allows easy one handed operation, with adjustable 1300°C clean burn laser jet flames. They operate in any orientation – even upside down (without bending the flame). They work at altitudes up to 3000m (9,800ft). Piezo ignition (10,000 ignitions). Wind resistant. Lanyard fastening hoop.



Turboflame Phoenix PHB

Additional specification:

- Emergency signal mirror embedded inside the safety cap
- Heavy duty metal alloy body with non-slip rubberised coating
- Size: 7.2 x 3.5 cm
- Weight: 74g
- Fuel capacity 4 ml
- 600 short ignitions
- Working flame height 3/4" (2 cm)

070508B



Turboflame Ranger T2R

- Twin laser jet flames
- Visible gas-level indicator
- Heavy duty metal alloy body with rubberised coating
- Size: 7.4 x 3.3 cm
- Weight 80g
- Fuel capacity 2.7 ml
- 650 short ignitions *(approximate with full tank of recommended gas)
- Working flame height 3/4" (2 cm)

070508C



Turboflame V-Flame VFR2

- Twin laser jet V flames
- Visible gas-level indicator
- Heavy duty metal alloy body with rubberised coating
- Size: 7.6 x 3.8 cm
- Weight 90g
- Fuel capacity 4.5 ml
- 800 short ignitions *(approximate with full tank of recommended gas)
- Working flame height 1½" (3 cm)

070508D



Scripto Aim 'n' Flame flex

Disposable lighter. Ultra flexible nozzle. Easier access to BBQ grills, pilot lights, candles, fireplace and more. Built-in hanger to store, out of reach of children. Visible fuel supply. Singly or 16 per outer
070471



Scripto Dual Flame

Disposable lighter. Easily interchangeable switch. Standard flame for indoor use. Wind resistant flame for outdoor use. Visible fuel supply. Singly or 16 per outer
070473



Scripto Ez-Squeeze

Refillable lighter. Innovative ignition system. Eye-catching colours farben. Visible gas level. Adjustable flame. Hanger hook. Singly or 16 per outer
070475



Scripto Folding Utility

Refillable lighter. Unfolds into full size 29cm lighter. Folds into 14.5cm lighter for easy storage. Lights in multiple positions. Visible fuel supply. Singly or 16 per outer
070474



Gas safety lighter

Long reach flame lighter
12 per outer
070498



Piezo lighter

24 per display
070486

First aid kits



Grove caravan & motorhome first aid kits

- 1 x Guidance leaflet
- 10 x Assorted transparent plasters
- 10 x Children's plasters
- 1 x 20ml Eye/wound wash
- 1 x Triangular bandage 90x90x127cm
- 2 x Safety pins
- 2 x Sterile medium dressing 120x120mm
- 1 x Sterile large dressing 180x180mm
- 10 x Alcohol-free moist wipes
- 1 x Medium powder free vinyl gloves
- 1 x Scissors
- 1 x Plastic tweezers

Box **070605**
Pouch **070606**



Grove first aid pouch

Contents include: Alcohol-free wipes, plasters, dressings, bandages, gloves, tape, scissors, emergency blanket, safety pins
070612



Grove camping first aid pouch

- 1 x Guidance on first aid leaflet
- 5 x Skin closure strips 75 x 3mm
- 2 x 20ml Eye/wound wash solution
- 1 x Roll-on insect repellent
- 1 x Medium powder free vinyl gloves
- 1 x Microporous tape 1.25cmx10m
- 5 x Sterile gauze swabs 8ply 5cm²
- 3 x Burnshield hydrogel 3.5ml sachet
- 1 x Foil survival blanket 56 x 84"
- 1 x Sterile eye pad dressing
- 1 x Triangular bandage 90x90x127cm & 2 pins
- 1 x Sterile medium dressing 120x120mm
- 1 x Sterile No. 16 Eye pad dressing
- 1 x Resuscitation face shield foil pack
- 4 x Alcohol-free moist wipes
- 1 x Small scissors green handle 4"
- 20 x Assorted transparent plasters

070607

Truma gas fittings

GAS				
 Gas valve nut 8mm 070561 10mm 070561A	 Olive 8mm 602265 10mm 817200	 Blanking Plug 8mm 801254A 10mm 801254B	 824161 M8 Nut	 824158 Manifold valve nut
 804000 Reducer 8-10mm	 810160 Straight union 8mm	 810170 Elbow union 8mm	 810180 T union 8mm	
 070522 Gas test point inlet 8mm	 070561B 8mm Coupling nozzle	 885500 Gas line int conn Right	 885600 Gas line int conn Left	

Thetford Stainless Steel Sinks



Basic Line 30
25mm waste outlet, plug, seal and lid included.
Dimensions:
Cut out: Ø390mm.
Overall: Ø405 x D145mm
Inside bowl: Ø328 x D93mm
091158A



Basic Line 33
25mm waste outlet, plug, seal, 35mm tap hole and lid included.
Dimensions:
Cut out: 460 x 460mm.
Overall: H140 x W480 x D480 mm
Inside bowl: H92 x W455 x D276mm
Left hand **091155B**
Right hand **091155A** as shown



Basic Line 34
25mm waste outlet, plug, seal, 35mm tap hole and lid included.
Dimensions:
Cut out: 387 x 429mm.
Overall: H140 x W400 x D445 mm
Inside bowl: H92 x W338 x D280mm
091158C



Series 23 spun bowl
25mm waste outlet, plug, seal and lid included.
Dimensions:
Cut out: Ø405mm.
Overall: Ø460 x D123mm
Inside bowl: Ø397 x D123mm
091158B



Argent bowl
19mm waste outlet, plug, seal and lid included.
Dimensions:
Cut out: 335 x 430mm.
Overall: H153 x W360 x D470 mm
Inside bowl: H99 x W290 x D368mm
091160B



Argent sink
19mm waste outlet, plug, seal and lid included.
Dimensions:
Cut out: 605 x 415mm.
Overall: H152 x W630 x D470 mm
Inside bowl: H99 x W290 x D368mm
Left hand **091153S** as shown
Right hand **091152S**

WOW
Suitable taps for sinks with lids:
Florenz, Style and Keramik page 107
Twist page 108
Samba and Trend A page 109



Argent Kitchen centre kit
Includes plastic bowl, plastic chopping board, plastic drainer and cutlery rack (inc fixings)
091153K



Vehicle bowl
12" x 10½" Stainless steel with lip. Bowl 9½" tapering to 7" ø base. Depth 5"
050523



Stainless steel sink and drainer
21¾" x 14"
050534



Bezel (seal)
By Thetford
2100mm
091159A

Thetford Hobs



Topline 902

2.3kW induction hob. Auto heat up, individual zone timers, safety "glass hot" indicator, pan detection, power boost, low temperature and pause functions. Touch control.

Dimensions:

Cut out: W274 x D482mm

Overall: H53 x W305 x D500mm

091129



Topline 981

1.4kW induction and 2.5kW gas hob (1kW and 1.5kW). Auto heat up, pan detection, safety "glass hot" indicator, child safety lock and automatic safety cut-off. 12V ignition on gas.

Dimensions:

Cut out: W480 x D360mm

Overall: H100 x W500 x D380mm

091130



Topline 922

3kW (2 x 1.5kW) gas hob. 12V ignition.

Dimensions:

Cut out: W285 x D485mm

Overall: H95 x W305 x D500mm

091122



Topline 165

4kW (1.5kW and 2.5kW) gas hob. 12V ignition. Surface mounted, coated steel trim and frame with glass lid.

Dimensions:

Cut out: W566 x D349mm

Overall: H106 x W576 x D361mm

Hinged on long side

091125

Hinged on short side

091126



Topline 931

5kW (1kW, 1.5kW and 2.5kW) gas hob. 12V ignition.

Dimensions:

Cut out: W740 x D322mm

Overall: H95 x W770 x D350mm

091123



9 Series

6kW (4 x 1.5kW) gas hob. 230V ignition.

Dimensions:

Cut out: W490 x D455mm

Overall: H125 x W540 x D480mm

091124

Thetford Combination Units



Topline 169

5.5kW (2 x 1.5kW and 2.5kW) gas hob. 12V ignition. Surface mounted, coated steel trim and frame with glass lid.

Dimensions:

Cut out: W514 x D450mm

Overall: H105 x W546 x D482mm

091127



Topline 111

3kW (2 x 1.5kW) gas hob with sink. Includes tap hole (35mm) and 25mm waste outlet. 12V ignition. Surface mounted, coated steel trim and frame with split glass lid.

Dimensions:

Sink Inside: Ø235 x 140mm

Cut out: W888 x D358mm

Overall: H195 x W900 x D370mm

091160A

Thetford Hobs



Basic Line 330
4.5kW (3 x 1.5kW) gas hob. 12V ignition.
Dimensions:
Cut out: W453 x D460mm
Overall: H100 x W480 x D480mm
Left hand **091146A**
Right hand **091147A** as illustrated



Basic Line 345
5.5kW (2 x 1.5kW and 2.5kW) gas hob. 12V ignition.
Dimensions:
Cut out: W527 x D429mm
Overall: H100 x W540 x D445mm
091149A



Argent hob
5.5kW (2 x 1.5kW and 2.5kW) gas hob. 12V ignition.
Dimensions:
Cut out: W545 x D433mm
Overall: H110 x W570 x D470mm
Left hand **091162A**
Right hand **091161A** as illustrated

Thetford Hob & grill



4 burner hob
4 x 1.5kW gas hoptate.
W500 x D400 x H88mm
091150



Hotplate
Free standing and portable unit. 4.8kW gas hob (2 x 1.6kW) with grill (1.6kW). Stainless steel lid/cover.
Dimensions: H160 x W445 x D345mm
091128

Thetford Ovens / Ovens with grill

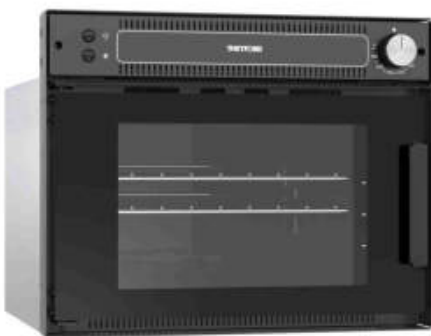

420 Oven only
1kW 23L oven. Includes 2 shelves, light and side opening (reversible) door. 12V ignition.
Dimensions: H x W x D mm
Overall: 335 x 418 x 440
Build in: 336 x 420 x 580
091171



525 Oven & Grill
1.0kW 23L oven with 1.5kW integrated grill. Comes with grill pan and 1 shelf. 12v ignition. Designed with a top hinge, to be installed above a 525mm wide fridge.
Dimensions: H x W x D mm
Overall: 369 x 525 x 480
Build in: 370 x 527 x 516
12V ignition **091169**



Duplex Oven & Grill
1.6kW 36L oven with 1.6kW integrated grill. Comes with grill pan and 2 shelves. Piezo ignition.
Dimensions: H x W x D mm
Overall: 445 x 456 x 490
Build in: 438 x 445 x 490
12V ignition **091172**
Piezo ignition **091172P**

Thetford Cookers



Minigrill
4 Burner Hob & Grill
 4 burner 5.5kW (3 x 1.5kW and 1 x 1kW) hob with 1.6kW 13L grill. Comes with grill pan. 12V ignition.
 Dimensions: H x W x D mm
 Overall: 311 x 513 x 500
 Build in: 312 x 496 x 490
091172C



Triplex
3 Burner Hob, Oven & Grill
 3 burner 6kW (2 x 1.8kW and 1 x 2.4kW) with 1.6kW 36L oven and 1.6kW integrated grill. Comes with grill pan and 2 shelves. Dimensions: H x W x D mm
 Overall: 311 x 513 x 500
 Build in: 312 x 496 x 490
 12V ignition **091176**



Midi Prima MK3
Oven & Grill - 1/2 height
 1.6kW 36L oven with 1.5kW 13L grill. Comes with grill pan and 2 shelves. 12V ignition.
 Dimensions: H x W x D mm
 Overall: 644 x 444 x 450
 Build in: 646 x 445 x 490
091172A



Midi Prima MK3
Oven & Grill - 3/4 height
 1.6kW 36L oven with 1.5kW 13L grill. Comes with grill pan, 2 shelves and an additional lower door for storage. 12V ignition.
 Dimensions: H x W x D
 Overall: 844 x 444 x 450
 Build in: 846 x 445 x 490
091172B



Caprice MK3
4 Burner Gas Hob, Oven & Grill - 3/4 height
 4 burner 5.5kW (3 x 1.5kW and 1 x 1kW) hob with 1.5kW 36L oven and 1.6kW 13L grill. Comes with grill pan, 2 shelves and lower door for extra storage. 12V ignition.
 Dimensions: H x W x D mm
 Overall: 844 x 513 x 500
 Build in: 846 x 496 x 490
091181



Caprice MK3 Dual Fuel
3 Burner gas, 1 hotplate Hob, Oven & Grill - 3/4 height
 3 burner 4kW (2 x 1.5kW and 1 x 1kW) gas, and a 0.8kW electric hotplate hob with 1.5kW 36L oven and 1.6kW 13L grill. Comes with grill pan, 2 shelves and lower door for extra storage. 12V ignition.
 Dimensions: H x W x D mm
 Overall: 844 x 513 x 500
 Build in: 846 x 496 x 490
091189



K1520
4 Burner Gas Hob, Fan Assisted
Oven & Grill
 4 burner 5.8kW (3 x 1.6kW and 1 x 1kW) gas hob with 2kW 37L oven and 1.8kW 19L grill. Comes with grill pan and 2 shelves. 12V ignition.
 Dimensions: H x W x D mm
 Overall: 645 x 515 x 501
 Build in: 646 x 496 x 493
091187C



K1520 Dual Fuel
3 Burner Gas, 1 Hotplate Hob, Fan
Assisted Oven & Grill
 3 burner 4.2kW (2 x 1.6kW and 1 x 1kW) gas, and a 1kW electric hotplate hob with 2kW 37L oven and 1.8kW 19L grill. Comes with grill pan and 2 shelves. 12V ignition.
 Dimensions: H x W x D mm
 Overall: 645 x 515 x 501
 Build in: 646 x 496 x 493
091188A



Aspire MK1 Dual Fuel
3 Burner gas, 1 hotplate Hob, Oven
& Grill
 3 burner 4kW (2 x 1.5kW and 1 x 1kW) gas, and a 0.8kW electric hotplate hob with 1.5kW 37L oven and 1.6kW 16L grill. Comes with grill pan and 2 shelves. 12V ignition.
 Dimensions: H x W x D mm
 Overall: 677 x 517 x 535
 Build in: 670 x 503 x 530
091188B



Enigma
4 Burner Gas Hob, Oven & Grill
 4 burner 5.5kW (3 x 1.5kW and 1 x 1kW) hob with 1.8kW 53L oven and 1.6kW 20L grill. Comes with grill pan, 2 shelves and lower door for extra storage. Enamelled oven and grill. 230V ignition.
 Dimensions: H x W x D mm
 Overall: 760 x 620 x 600
 Build in: 750 x 602 x 600
091187A



Cocina
4 Burner Gas Hob, Oven & Grill
 4 burner 6.5kW (1 x 2.5kW, 2 x 1.5kW and 1 x 1kW) hob with 1.8kW 56L oven and 2.5kW 25L grill. Comes with grill pan, 2 shelves and lower door for extra storage. 230V ignition. Fan assisted.
 Dimensions: H x W x D mm
 Overall: 766 x 618 x 600
 Build in: 766 x 602 x 600
091187B

Oven shelves



Universal oven shelf

- Adjustable shelf
- Suitable for most ovens and fridges
- Width Min 350mm, max 560mm
- Depth 320mm

6 per outer
091190A



Stoves oven shelf
 Width 355mm x depth 308mm
091193

Dometic cooking

WOW For a choice of taps to fit Thetford and Dometic sinks with fold down lids try the Reich Samba tap range shown on page 109.



Smev 9222 2 burner combi

Supplied with hole for optional tap (39mm), siphon and seal.

- Peizo ignition
- Power rating Output 1x1kw, 1x1.8kw
- Gas consumption 204g/h
- Gas supply pressure 30 mbar
- 2 burners
- W900 x D370 x H152mm
- Built in dimensions W793 x D307mm
- Weight 5.8 Kg

Right hand sink **091223**
Left hand sink **091224**



Smev 8322 2 burner combi

Supplied with hole for optional tap (39mm), AC 540 siphon and seal.

- 12v DC (electric ignition)
- Power rating 2.8kw (2 burner) 3.8kw (3 burner)
- Gas consumption 204 g/h (2 burner) 227 g/h (3 burner)
- Gas supply pressure 30 mbar
- Overall W680 x D440 x H142mm - Built in dimensions W666 x D426mm
- Weight 5.6 Kg

091225



Smev 8063 hob & lid

- 12v DC ignition
- Output 4.6kw
- Gas consumption 335 g/h
- Gas supply pressure 30 mbar
- 3 burners
- W560mm x D440mm

091219



Smev VA936 sink & drainer

With AC 540 siphon and rubber seal. W590 x D370 x 125Hmm

091236



Smev 8005 sink & lid

Integrated heat-resistant safety glass, no tap hole, AC 540 siphon, rubber seal. W420 x D370 x H145mm

091234



Smev 30 litre oven & grill

FO311GT

- Voltage 12v DC (electric ignition)
- Oven output 1.2kw
- Gas consumption oven 87g/h
- Grill output 1.6kw
- Gas consumption grill 116g/h
- Gas supply pressure. 30 mbar
- Total output 2.3kw
- Total consumption 203 g/h
- Oven capacity 30L
- Stainless steel
- Thermostatically controlled
- Interior lamp
- Overall: W530 x D415 x H430mm
- Built in: W500 x D460 x H410mm
- Weight 19.5 Kg

091203



Smev 20 litre mini oven & grill

FO211GT

- Same specification as 30 litre
- Oven capacity 20L
- Overall: W530 x D410 x H310mm
- Built in: W504 x D460 x H283mm
- Weight 13.2 Kg

091200



Compact oven 600W

650w 9L compact oven
100°C - 200°C Temperature control
60 minute timer with automatic shut off and alarm bell. Double heat resistant tempered glass door. Includes aluminium baking tray, chrome wire rack and handle for rack/tray

091107

Combination water and space heaters

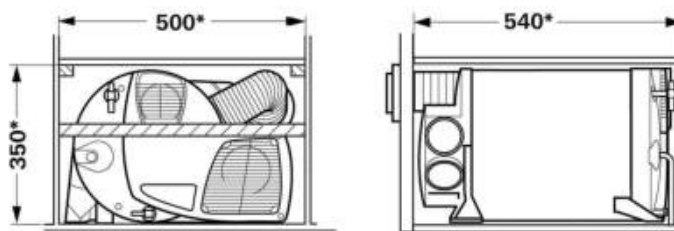

* Minimum installation dimensions.

WOW When buying a Combi, you must choose either a 4kW (2 heat settings) version or a 6kW (3 heat settings) version and whether it has the option for electric heating. You must then purchase separately a flue kit and any necessary warm air distribution ducting (See P161-162)

Truma Combi 4E, Combi 6 (E)

Heat air and water with 98% efficiency.

The Combi family hallmark is its incredible flexibility. Be it heating operation without water, or water heating without heating, you can enjoy double comfort with just one unit with the Truma Combi. All of the energy types are available – always with maximum efficiency and all of the technical advantages for your wellbeing. You are therefore not only looking after the battery, but also your wallet.

- Constant comfortable temperature
- Optimum warm air distribution through 4 warm air outlets
- Short water heating time, but no need to cut your shower short – enjoy!
- Durable stainless steel water tank
- The most lightweight and compact combination heater
- Interior installation
- Comes with FrostControl, the current-free safety drain valve with frost monitoring
- 10 litre capacity
- High heat output of 4000 W (Combi 4) or 6000 W (Combi 6)
- With integrated 1800 W heating elements
- Combined gas/electrical operation possible on 4E and 6E
- Straightforward connection to the existing gas system
- Environmentally friendly and maintenance-free
- Boiler heating time in accordance with EN 15033: approx. 20 min
- Extremely low power consumption: on average approx. 1.2 A, 0.2–5.6 A (12 V), 3.9–7.8 A (230 V - 4E and 6E)
- Low gas consumption: 160–320 g/h (Combi 4), 160–480 g/h (Combi 6), 80 g/h at 1000 W of heat output on average

Heater (excluding exhaust duct) comes complete with room thermostat, control panel with 3 m cable, mounting parts, current-free frost control safety/drain valve and elbow fittings for 10 mm Ø water hoses. *Models with water connections for semi-rigid piping (John Guest System) available on request.*

Combi 4E **833710**
 Combi 6 **833800**
 Combi 6E **833812** with John Guest fittings

**Optional Elbow**

For use with all models. Attaches directly to the outlet to redirect airflow. **834090A**

**Wall cowl Kit**

Includes exhaust duct, air supply duct, clips and cowl Cream **834111K**

**Roof cowl Kit**

Includes exhaust duct, air supply duct, clips and cowl **834122**

WOW Combi 4E OEM kits are available to manufacturers only and are held in stock. Now including diesel only version. Please speak to your sales contact for more details

Storage water heaters



Truma Electroboiler 14 L

Electric 14 litre capacity boiler using innovative insulation which maintains the temperature of the hot water for longer periods of time making it extremely energy efficient.

- With control panel, 2.5m connecting cable and safety drain valve
- Minimal heat loss (approx 1.1°C per hour) due to EPP foam insulation
- Short heating time – from 15°C to 70°C in just 70 minutes
- 230v power supply
- 850w heating element (230v / 3.7A)
- Water pressure of up to 2.8bar
- Weight 3.0kg
- 40.5cm wide, 29.5cm in height
- Max water temp 70°C

871200



Truma Ultrastore

- Stainless steel water tank
- Space saving – 10 litre tank only measuring 26cm in height
- Powerful 1.5kw gas burner
- Heating up time 35 minutes
- Reduces to 20 minutes with the gas and electric version
- Closed combustion system with wall flue
- Easy to operate – temperature selection approximately 30°C - 70°C
- Low battery load – 12v - ignition 0.17A – heating up 0.08A – stand-by 0.04A
- Suitable for all submersible and pressure pumps up to 2.8 bar

Supplied with fittings for John Guest 12mm

Rapid GE Gas and electric (450w) 10 litre complete with control panel

871552

WOW Ultrastore OEM kits are available to manufacturers only and are held in stock. Please ask your sales contact for more details



10L Electric Storage Heater

- The inner tank is made of enameled steel plate – tough, strong, resistant to corrosion and water scale, giving a long life.
- Ultra thick, non-CFC Polyurethane foam insulation
- Super compact design, novel and luxurious appearance, easy to mount
- Thermostatically controlled
- Multiple protection devices against, over temperature, over pressure and electricity-leakage.
- Choice of pipe connections and comes fitted with 3 pin plug for fast and easy installation.
- Dimensions H260 x W520 x D260mm

Voltage: 220V
 Power: 900W
 Frequency: 50-60HZ
 Current: 4.1A
 Max Pressure: 0.8MPa (116psi)
 Min Pressure: 0.05MPa (7psi)
 Temperature: 75°C
 Socket: 250V, 16A

Efficiency: >90%
 Capacity: 10 liters

070754



Malaga 5E

- Capacity 13.5 litre
- Efficient gas burner for faster warm up
- 750W element – use on its own or with the gas burner for speed
- Small flue terminal – neat appearance outside the van
- Safe – combustion products are completely sealed from the caravan interior
- Easy to fit and service
- Electronic control
- Resettable cut out
- Dimensions H250 x W325 x D445mm

070741



Truma Therme TT-2

The proven Truma Therme warms water up using heat from the heating system – a warm air duct runs directly through the device. The Therme also features an electric heating element (300w) so water can be warmed up even if you do not have the heating on.

- Heating time (electrical operation) from approximately 15°C to approximately 60°C - 50minutes
- Power supply 230v 50Hz
- Power consumption 1.3Amp (300w)
- Temperature limit 65°C
- W220 x D370 x H230mm
- Water capacity 5 litres
- Operating pressure (max) 1.2bar
- Weight 2Kg

842012

Therme spare parts

Water container **801500**
 Heating element **814200**
 Drain valve **800400**
 Control panel **819900**



Kronings RVS Water boiler

Replacement water container for the Truma Therme in stainless steel manufactured by Kronings. Reduces the risk of frost damage. 6 litre tank capacity. Easy and simple to replace existing tank 15 to 20 minutes. No plastic taste in water. Fit in original mounting caps and hoses

070766



Cascade/Malaga adaptor plate
070742



Malaga flue terminal
070736



Forcali water heaters



070690



070692



070691
Roof Flue Kit
For 6 litre
For 10 litre



070693

070691
070693



070694

Forcali LPG 6 (FWH-6A-GLP) and 10 (FWH-10A-GLP) litre water heaters operate without a pilot light offering high performance and safety at a size unthinkable until now. To replace an older style model you will need to fit the stand off brackets supplied to bring the flue in line. With the advantages and safety of no permanent flame, the heaters have lower gas consumption and far higher water temperature.

Forcali FS-12S-GLP is a room sealed water heater with electronic ignition. It is a state of the art modern appliance that can operate at extremely low water pressure and flow rates. It uses a mere 35 Watts maximum, and can be installed using an industry standard horizontal flue.

	FORCALI 6	FORCALI 10
Combustion Type	Atmospheric	Atmospheric
Ignition	3v (2 x LR20)	3v (2 x LR20)
Water Flow rate	6 litres / min	10 litres / min
Useful Power	12 kW	20 kW
Flue size	90mm ø	110mm ø
Connections	½"	½"
Energy Efficiency Rating	A	A
Dimensions (mm)	440 x 300 x 160	550 x 330 x 205
Weight	4.3kg	10.2kg
Part Number	070690	070692

	FORCALI 12
Combustion Type	Room sealed
Ignition	220v
Water Flow rate	12 litres / min
Useful Power	24 kW
Flue size	60/100mm ø co axial
Connections	½"
Energy Efficiency Rating	A
Dimensions (mm)	515 x 325 x 167
Weight	12kg
Part Number	070694

Morco water heaters



The new Morco Primo water heaters are direct replacements for the D61B, D61E and G11E. The flue diameter is the same, so if you are replacing a D61 or

G11 you can use the existing flue. They are piezo ignition and are not available with an electronic ignition.

The Primo 6 replaces the D61
The primo 11 replaces the G11E

The MPFK fitting/conversion kit will be required in order to fit the water heater in all circumstances and is NOT INCLUDED with the heater.



070704



070708



Morco Primo Fitting Kit
This kit is required for all Morco Primo water heater installations. It contains a 15mm gas isolation valve.
070704FIX

	MORCO PRIMO 6	MORCO PRIMO 11
Combustion Type	Atmospheric	Atmospheric
Ignition	Piezo	piezo
Water Flow rate	6 litres / min	11 litres / min
Nominal Power	10.1 kW	19 kW
Flue size	90mm ø	110mm ø
Connections	½"	½"
Energy Efficiency Rating	A	B
Dimensions (mm)	550 x 256 x 245	592 x 314 x 245
Weight	8kg	10.6kg
Part Number	070704	070708



Flue cowl
Primo 6 **070728**
Primo 11 **070710**



Flue Pipe
070730

Blown air space heaters



Ducting 60mm per metre **090018**
 Outlet (no reducer) **090019**
 Reducer **090017**

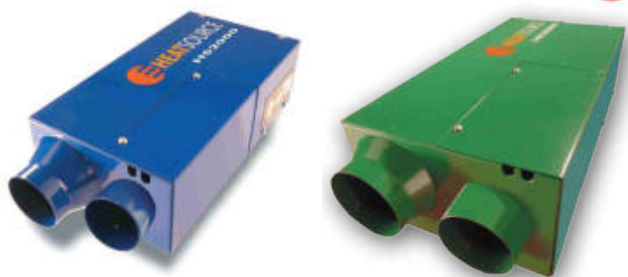

Propex heatsource

Comes with control panel, wiring loom, 3/4 meter exhaust/inlet flue, one meter of ducting, hose clips, fasteners and one air outlet.

- The smallest of this type of heater on the market.
- One of the quietest combustion heaters in production
- Designed for reliable, maintenance-free operation
- Fast warm-up time
- Airflow sensing detects blocked or restricted flue pipes
- Self-diagnostic fault finding

Blown air heaters		
*Gas and current consumption is calculated on a 'continuous running' basis		
Model	Heatsource 2000	Heatsource 2800
Average gas consumption	128g/hr	225g/hr
Heat Input	2kw	3kw
Heat Output	1.8kw	2.8kw
Voltage	12v or 24v	12v or 24v
Current consumption	1.2A	1.9A
Air throughput	50 C.F.M.	85 C.F.M.
Dimensions (mm)	312 x 168 x 95	415 x 210 x 120
Part Number	090016	090028

kronings



HEAT 1500+

Mains electric heating system with 100% thermostatically controlled blower. Ceramic heating elements with 180m³ per hour low volume blower. Temperature range 10°C to 30°C.

- 230v electric heating system
- Fully thermostatically controlled
- Can be combined with the vehicle's original heating system or used as a stand alone system

Dimensions:

Heat 1500+ Heater & control only **090110**
 Heat 1500+ Fan Protector **090112**
 Heat 1500+ Y Adaptor **090114**
 Heat 1500+ Controller **090116**

Fans and air distribution

Trumavent fans

For use with Trumatic S heaters. Circulates hot air throughout the vehicle.

- In all Trumavent fans a flap enables you to individually regulate the air output between the two warm air outlets to suit the room division
- On the TEB-2 / 3 with automatic speed control the air output adjusts to the respective thermal output
- High air flow rate of over 200,000l/h



TEB 3 / TN 3



Multi-vent



Awning warmer

For guiding the warm air from the existing caravan heater directly into the awning.

Contents:

- Warm air outlet with cover
- 1 metre of ducting
- 65mm diameter straight connector
- T-pipe TS and duct shut-off SP2

White **840365**

	TEB 3	TEB 3	TN-3	Multivent
Power Supply	12v	12v	230v	12v
For use with	S3004	S3004	S5004	S2200 / Extractor
Control	Case control	Wall control	Wall control	
Part no.	841241	841242	841251	841140

Radiant heaters



WOW Please order the heater and front casing separately.



Titanium Grey
(aka Titan Grey)



Pearl Grey

Trumatic S3004 gas heater

Designed for use in average sized caravans

- Automatic ignition
- Thermostat and installation box as standard
- Choice of colour on casing
- Uniform heat distribution with the addition of a Trumavent fan
- Exhaust duct via the roof
- Thermal output 3.5kW
- Gas consumption 30 - 280 g/h

S3004 gas heater with auto ignition

831380

Front case Titanium grey

830060TG

Front case Pearl grey

830060PG

Trumatic S5004 gas heater

For large caravans and motor homes

- With automatic ignitor
- Exhaust duct via the roof
- Thermostat and installation box as standard
- Even heat distribution and full utilisation of the high heating capacity with the addition of a Trumavent fan
- Thermal output 6kW, gas consumption 60 - 480 g/h

S5004 heater

831570

Front case Titanium grey

830070TG

Front case Pearl grey

830070PG



Roof flue kit For S3004 and S3002 (3m duct)

830330



Trumatic S2200 gas heater

With 1850 watts of power, this compact heater is the ideal solution for heating a small caravan quickly.

- Gas consumption: 50-170 g/h
 - Auto ignitor or piezo ignitor
- | | |
|------------------------|----------------|
| S2200 Auto Left hand | 831111 |
| S2200 Auto Right hand | 831111R |
| S2200 Piezo Left hand | 831132 |
| S2200 Piezo Right hand | 831132R |
- Rear panel for left hand installation
830190
- Rear panel for right hand installation
830191



Wall flue kit

Long for S2200

830322



55mm Stainless Ducting

Priced by the metre sold in 20m rolls

801536



65mm KR65 Ducting

For use with sapphire air conditioning.

Priced and sold in 15m rolls

840201

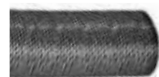

64mm ZR24 Air supply

Priced and sold by the metre

839421



49mm ZR18 Ducting

Priced and sold by the metre

839170



Exhaust duct AA 24, Ø 33 mm

Priced and sold by the metre

839420



Ultraheat electric heater

Additional electric heater with thermostat, control panel and 3 metre connecting cable. Installation is between the heat exchanger and installation box

IMPORTANT!! Installation must be carried out by an expert

- Power supply: 230v/50Hz
 - Power consumption at power rating
- | | |
|--------|------|
| 500w: | 2.2A |
| 1000w: | 4.5A |
| 2000w: | 8.5A |

Suitable for use with Trumatic S3002, S5002, S3002(P) after July 1981, Trumatic S5002 after April 1998 (with semicircular front design) *and with the new Trumatic S3004 / S5004.*

Installation is between the heat exchanger and installation box

830402



65mm Ducting

Priced by the metre sold in 20m rolls

801288



70mm Insulation Ducting

To insulate 801288 when ducting passes through the floor of the vehicle.

Priced by the metre sold in 10m rolls

801291



72mm VR Ducting

Priced and sold by the metre

839550

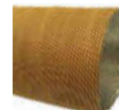

80mm VR Ducting

For use with Varioheat / E2400

Priced and sold by the metre

839580



35mm Perforated Ducting

Priced and sold by the metre

840320

Truma warm air distribution

Suitable for all warm air distributing heaters



Air Outlet
With throttle. Other colours available to order
Grey **801321**
Black **801323**



Lamellar insert
Beige **872102**
Grey **872101**



Back nut
Use with end air and swivel outlets
801325



Swivel Air Outlet SCW2
Comes with adapters for various ducting
Beige **839972**
Black **839971**



Straight
840160



Elbow
876400



T-Piece
801328



T-Piece Outlet
Use with end outlet
840151



Branch T AT
840130



Corner air outlet
Grey Ø 35 mm
803101



Blank cover
801335



Y piece
80mm to 2 x 65/72mm
839610



Elbow combi
834090A



Reducer RZ
72/65 to 49mm
881300



Clamp ZRS
Ø 80 mm
839590



Duct clip
Ø 35 mm
840330

Truma Spare Parts Kits

WOW Some spare parts from Truma are now available only as part of a kit.



Combi Heat Exchanger Kit

For all combis

Contents:

- 34020-61000 Heat exchanger
- 34020-08800 Seal 80 x 2mm
- 34020-52900 Sealing bracket
- 34020-55000 Form seal
- 34020-60000 Screw/nut set
- 34020-60600 Round cord seal set
- 34020-24000 Ducting clips x 3

861101K



Combi Water Container Kit

For all combis

Contents:

- 34020-64500 Replacement tank
- 34020-08800 Seal 80 x 2mm
- 34020-52900 Sealing bracket
- 34020-55000 Form seal
- 34020-60000 Screw/nut set
- 34020-60600 Round cord seal set
- 34020-24000 Ducting clips x 3

833812K



Combi Heating Element Kit

For Combi E

Contents:

- 34020-61100 Heating elements
- 34020-08800 Seal 80 x 2mm
- 34020-52900 Sealing bracket
- 34020-55000 Form seal
- 34020-60000 Screw/nut set
- 34020-60600 Round cord seal set
- 34020-24000 Ducting clips x 3

861100K



Frost Control JG Kit

For all combis with John Guest pipework

Contents:
34020-80300

880300K

Frost control 2.8bar
John Guest



Frost Control TB Kit

For all combis with flexible pipework

Contents:
34020-80200

40060-88500
834101K

Frost control 2.8bar
10mm
Hose clamps

Truma Spare Parts Kits



Combi Solenoid Valve Kit
For combis made before 04/13
Contents:
34020-63000 Solenoid Valve
70000-54600 Set coil holders
10020-25000 Nut m4
34020-24000 Ducting clips x 3
863002K



Combi Solenoid Valve Kit
For combis made from 05/13
Contents:
34020-59000 Solenoid Valve
70000-54600 Set coil holders
10020-25000 Nut m4
34020-24000 Ducting clips x 3
863001K



Combi Combustion Air Motor Kit
For all combis
Contents:
34020-60300 Motor
10010-13800 Screws
34020-24000 Ducting clips x 3
860300K

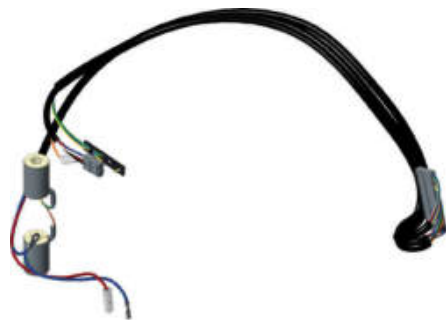

Combi 4/4E Wiring Harness Kit
Contents:
34020-62500 Combi 4 harness
34020-08800 Seal 80 x 2mm
34020-52900 Combi sealing kit
34020-60600 Round cord seal set
34020-08600 Cable bushes
34020-14900 Thermostat plate
833711K

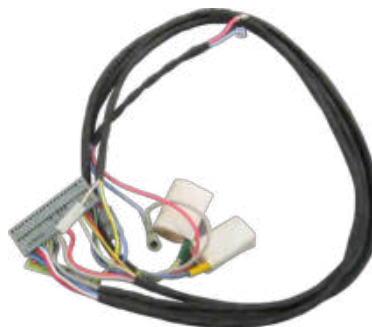

Combi 6/6E Wiring Harness Kit
Contents:
34020-62400 Combi 6 harness
34020-08800 Seal 80 x 2mm
34020-52900 Combi sealing kit
34020-60600 Round cord seal set
34020-08600 Cable bushes
34020-14900 Thermostat plate
833811K



Combi Fuse Kit
For all combis
Contents:
34010-05900 Fuse 10AT, H x 10
805900K



Combi D Glow Plug Kit
For all diesel combis
Contents:
34020-89400 Glow plug 12v
34030-68800 Gasket set
898305K



Combi Cover Kit
For all combis
Contents:
34020-07100 Cover combustion air
34020-07300 Grill
34020-21600 Cover circulation air
10010-13800 Screw
34020-24000 Ducting clip x 3
833814K

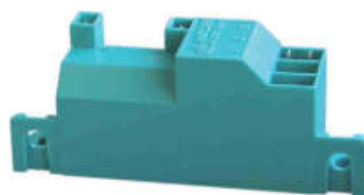

Combi Ignitor Kit
For all combis
Contents:
34020-60200 Combi ignitor
10010-13800 Screws
34020-24000 Ducting clips x 3
833815K



Ignition Electrode Kit
For combi C3402/4002/6002
Contents:
34000-76500 Rectification plug
34000-76300 Ignition plug left
34000-76400 Ignition plug right
10030-27000 O ring
10030-23600 O ring
801334K



Combi Seal Kit
For all Combis
Contents:
34020-09900 Leadthrough bushes
34020-08700 Seal 79 x 3mm
34020-60600 Round cord seal set
10030-24200 O-ring 22 x 3mm
34020-08800 Seal 80 x 2mm
34020-08600 Cable bushes
34020-19700 Profiled gasket
34020-55000 Form seal
34020-52900 Sealing bracket
833816K

Truma Spare Parts Kits

Radiant heater spares



S3002 / S3004 30mbar Burner Kit

Contents:

- 30090-18600 Burner 30mbar
- 30090-16900 Thermocouple
- 30090-22400 Piezo electrode 1m
- 10010-71300 Screws x 2
- 30090-22600 Insulation hose
- 30030-39700 Burner tube 30mbar
- 30030-39900 Pilot burner tube
- 30010-11900 Union screw x 2
- 10030-26500 O-ring 52 x 5mm

803202K

S3002 50mbar Burner Kit

Contents:

- 30040-18700 Burner 50mbar
- 10030-26500 O-ring 52 x 5mm

803201K



S3002 Operating Kit

Contents:

- 30040-13600 Ignitor rod
- 30040-40400 Control knob
- 30040-60700 Knob socket

813600K



S3002 Peizo ignitor Kit

Contents:

- 30040-62900 Peizo ignitor
- 30030-85700 Earth spring

800300K



S3004 Peizo ignitor Kit

Contents:

- 30090-18000 Peizo ignitor
- 30090-14200 Earth spring

818000K



S3002/S5002 Safety Pilot Valve Kit

Contents:

- 30050-58000 Safety pilot valve
- 10030-26500 O-ring 52 x 5mm
- 20000-37600 Manifold valve nut
- 20000-41100 8mm Brass olive

859700K



S3004/S5004 Safety Pilot Valve Kit

Contents:

- 30090-90800 Safety pilot valve
- 10030-26500 O-ring 52 x 5mm
- 20000-37600 Manifold valve nut
- 20000-41100 8mm Brass olive

890800K

Alde Anti-freeze



Premium G13 Antifreeze

Premixed and ready to use ethylene glycol antifreeze, specially formulated for Alde heating systems and containing silicated OAT. VAG G13 Spec. Protects to -37°C, with 5 year corrosion protection

Alde G13

- 1L 12 per outer **899600**
- 25L **899602**

G13 concentrate (alternative brand)

- Dilute with 2 parts water to 1 part concentrate for protection to -20°C
- 1L 12 per outer **899600A**
- 25L **899602A**

Alde servicing equipment



Service Pump with 5m Hose

1900-811

The Alde service pump is an unbeatable aid for filling Alde heating systems. The unit allows the operator to quickly fill and remove air from even the largest heating system in minutes. It is an essential tool for service centres and dealers working with Alde systems, as it also allows for quick and easy replacement of the glycol fluid. Not for use with bottom-filled systems.

899610



12V Circulation pump and plug

2928-420

Circulation pump 12 V for installation in the expansion tank 3000 420 and 3000 495. Plug.

Power consumption 0.2A.

899622



Expansion Tank Wall

Expansion tank including wall-mounting, mounting nuts for circulation pump and drainage hose. Reversible for adaptation to the heating system's pipes.

- Width: 180 mm
- Height: 231 mm incl caps and connecting pipe
- Depth: 75 mm
- Volume: 1.5 litre
- Connection: Ø 22 mm

899625



3010 Compact PCB

Circuit board with ignition transformer

2kW **899640**

3kW **899642**



12V In-line Circulation pump

3010-522

Circulation pump for mounting on Compact 3010 or 3020. Five speed with adjustable dial on motor.

- Power consumption 12 Volt: 0.25 - 1.6 A.
- Ø 22 mm connection.

899620



Clear Braided hose

For fluid change. Priced by the meter, sold in 6 metre lengths.

899604

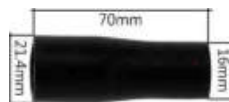

Straight 22-16mm

Hose reduction 16 > 21.4 x 4.25 mm. EPDM. Can be used for replacing glycol fluid with 1900-811 and 1900-839 Alde service pump

899608



Elbow 22-19mm

Rubber elbow 90° with reduction 19 > 21.4 x 4.25 mm. EPDM. Can be used for replacing glycol fluid with 1900-811 and 1900-839 Alde service pump.

With mounted band clips

899606

Mobile heating

WARNING USE GAS CABINET HEATERS IN WELL VENTILATED AREAS ONLY



Mini Radiant heater

- Piezo ignition model
- Infrared, fast heating, energy saving
- Flame failure protection device
- 3 ceramic plates
- Three power setting, power settings from 1.3kW To 4.1kW
- Castors for easy moving
- Space for gas cylinder up to 7kg
- Foldaway base plate
- Gas hose and butane clip-on regulator supplied
- Dimensions H 57 x 38 x 39 cm

Black **090088B** Red **090088R**

Radiant heater black

- 4.2 kW of heat output (1.4kW per plaque)
- Full anti-tilt safety device
- Consumption 100g/h per plaque
- Fully CE approved BS EN449:2002
- Easy rolling swivel castors
- Gas hose and butane clip-on regulator supplied
- Suits up to 15kg gas cylinders
- W403x D367 x H625mm
- Weight 6.8kg

090085



Oscillating halogen heater

- Instant heat
- Voltage 230v – 50Hz
- On/off oscillating facility
- 3 heat levels – 400/800/1200w
- Safety cut off feature
- Thermofuse cut off

Singly or 6 per outer
090066

Quartz heater

- Instant heat
- Safety cut off feature
- 2 heat settings – 400/800w
- Voltage 230v – 50Hz
- Easily cleaned
- Simple controls
- Carry handle

090065

Frost watcher 500w

- 230v heater
- Ideal for caravans to protect against frost over winter
- Thermostatic control
- H 230 x W 250 x D 105mm

Singly or 6 per outer
090069



Mini radiator 500W

- 5 Fins
- 500W
- Easy to assemble
- Portable with a carry handle.
- 1.2m cable length.

090093

Mini radiator 850W

- 7 Fins
- 850W heat output
- Thermostatically controlled

090092

Mini radiator 1kW

- 9 fin
- 1kW heat output
- Thermostatically controlled
- Dimensions: 43 x 41 x 13cm
- Weight: 4.5kg

090094



Cooking spares

THETFORD COOKING						
091002 Caprice knob set Satin (6)	091004A Caprice/Triplex knob set Satin (6)	091016 Triplex/Cara knob set Black (6)	091012A Thermocouple kit Thetford hob (4)	091173 Thermocouple kit Duplex/Triplex	091191 Oven door inner glass	091000K Pan support clips (4)

Heating spares

ULTRAHEAT			
869300 Ultraheat electronics (PCB)	870100 Ultraheat heating element	865100 Temperature control device	865200 Temperature limiter
809300 Control panel cable 3 m	809400 Control panel cable 5 m	834200 Room temperature sensor FFC 2 ONLY	834205 Cable for remote sensor FF 2, 4 m
834206 Adapter cable jack socket	871000 Ultraheat sensor	898400B Control panel black	898500 Ultraheat Control panel original
S2200			
842700 Mica window cpl.	813900 Thermocouple	824160 Magnet inset mini	830191 Rear Panel Right
801263 Roof cowl AK 3, Ø 60 mm	801020 Cowl roof KD	820600 Sealing ring S3	830190 Rear Panel Left





























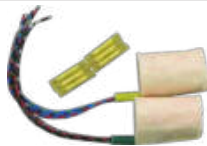
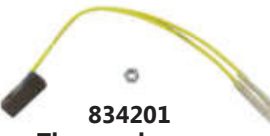

Heating spares

S 3002 / S 5002			
 <p>803202K Burner complete S3002/ S3004 30mbar</p>	 <p>803201K Burner complete S3002/ S3004 50mbar</p>	 <p>859700K S 3002/S 5002 safety pilot valve kit</p>	 <p>813900 S 2200/3002/5002 thermocouple</p>
 <p>865800 S 3002 electrode 45 cm 30mbar 08/04-12/14, 50mbar 08/04-06/06</p>	 <p>865900 S 3002(P) electrode 75 cm 30mbar 05/96-05/99 & 08/04-12/14, 50mbar 08/04-06/06</p>	 <p>808600 S 5002 electrode 55cm</p>	 <p>842700 Mica window</p>
 <p>816100 Shield</p>	 <p>824160 Magnetic inset mini</p>	 <p>824159 MS-nut</p>	 <p>803100 Feed Pipe 05/98-05/99</p>
 <p>804300 Extension Cpl.</p>	 <p>804800 Air intake extension 500mm</p>	 <p>817500 Perforated plate</p>	 <p>828500 Extension spring</p>
 <p>800300 S 3002(P) Piezo ignition 05/96-05/99</p>	 <p>800300K S 3002(P) Piezo ignition kit from 05/99</p>	 <p>860000 S 3002 (P)/5002 retaining spring</p>	 <p>850187 S 5002/S 5004 ignition pipe</p>
 <p>813600K Operating kit S 3002</p>	 <p>853700K Operating kit S 5002</p>	 <p>860900 S 3002/5002 blank cover 52 mm</p>	 <p>860800 S 3002 blank cover 35 mm</p>
 <p>863000 S 3002 Cover black/brown</p>	 <p>852700 S 5002 Cover black/brown</p>	 <p>818700 S 3002 knob socket 05/96-05/99</p>	 <p>858100 Microswitch</p>
 <p>803600 Exhaust duct fitting AE 3</p>	 <p>826500 O-ring 52x5</p>	 <p>853000 Automatic ignitor</p>	























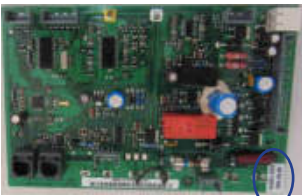



Heating spares

S 3004 / S 5004			
 <p>842700 Mica window cpl.</p>	 <p>826500 O-ring 52 x 5 mm, VMQ, 40 Shore A</p>	 <p>803600 Exhaust duct fitting AE 3</p>	 <p>818000K S 3004 P piezo ignitor kit</p>
 <p>820700 S 3004 control rod</p>	 <p>890800K S 3004/S 5004 safety pilot valve kit</p>	 <p>853000 Automatic ignitor</p>	 <p>850187 S 5002/S 5004 ignition pipe</p>
 <p>858100 Micro switch</p>	 <p>824160 Magnet inset</p>	 <p>824159 Ms-nut</p>	 <p>803202K S 3002(P)/3004(P) burner cpl. 30 mbar</p>
 <p>802000 S 5004 burner set 30 mbar</p>	 <p>891200 S3004/S5004 ignition electrode 53 cm</p>	 <p>804300 Extension complete</p>	 <p>804800 Air intake extension 500mm</p>
 <p>817500 Perforated plate</p>	 <p>828500 Extension spring</p>	 <p>810170 Elbow union 8 mm</p>	
 <p>894900 Cover S3004</p>	 <p>890400 Control knob</p>	 <p>830060PG S3004 Front case pearl grey</p>	 <p>830060TG S3004 Front case titan grey</p>
 <p>830070PG S5004 Front case pearl grey</p>	 <p>830070TG S5004 Front case titan grey</p>		

Heating spares

FANS			
 <p>845000 TEB-2 Control panel cable 0.8 m</p>	 <p>846000 TEB-2 control panel, integrated</p>	 <p>857100 TEB-2 electronics</p>	 <p>893400 TEB-3 electronics</p>
 <p>842000 TEB-2/TEN-2, D.C. motor 12 V</p>	 <p>842400 TEB-2/TEN-2, 12V motor & fan wheel</p>	 <p>893600 TEB-3/TEN-3, D.C. motor 12V</p>	 <p>814300 Multivent D.C. motor 12v</p>
 <p>828800 Carbon brush kit, white/ black</p>	 <p>819000 E 2400 ignitor</p>	 <p>877300 E 2400 remote sensor</p>	 <p>804901 E 2400 electronics 12v 06/12-12/16</p>
TRUMATIC COMBIS			
 <p>898000 PCB C 3402 from 05/2002</p>	 <p>806900 PCB C 6002 EL</p>	 <p>898300A PCB C 6002 07/01-07/09</p>	 <p>807101 PCB C 6002 06/97-06/01</p>
 <p>807100 PCB C 6002 CEH</p>	 <p>833100 Fine wire fuse 4 AT</p>	 <p>898501A C 3402 valve body, 30 mbar</p>	 <p>898501B Solenoid coils</p>
 <p>834201 Therm. observer temperature</p>	 <p>834300 Temperature sensor</p>	 <p>855000 Combustion air fan</p>	 <p>834200 Room temperature sensor FFC 2 ONLY</p>
 <p>898306 O-ring 40 x 2.5 mm, VMQ</p>	 <p>801334K Trumatic C ignition electrode kit</p>	 <p>801040 Water container</p>	 <p>814302 D.C. motor 12V C6002D</p>
 <p>876800 Fine wire fuse 6.3 AT</p>	 <p>898301 C 4002/6002 (EH) valve body, 30 mbar</p>	 <p>802502 Cable red 230v elements</p>	 <p>802503 Cable white 230v elements</p>

Heating spares

TRUMA COMBIS					
					
833814K Combi (E) cover kit	833816K Combi (E) seal kit	833815K Combi (E) ignitor kit	860300K Combustion air motor kit Combi (E)		
					
833813K Combi (E) burner kit	860802 Combi ignition electrode kit	861101K Combi heat exchanger kit	861100K Combi E heating element kit		
					
861300 D.C. Motor	833812K Combi (E) water container kit	805900K Combi microfuse kit T10AH 10 pcs.	863800 Combi / Combi D PCB, 230 V		
					
818200 Combi 4 PCB	818201 Combi 4 E PCB	861900 Combi 6 PCB	826600 Combi 6 E PCB		
					
863001K Combi E 2S0 solenoid kit After 04/13	863002K Combi E 2S solenoid kit 06/07-04/13	833811K Combi 6 E cable harness	833711K Combi 4 E cable harness kit		
					
863200 Water temp. sensor harness	834201 Over temp. sensor	834205 4m Cable for remote sensor	861500K Thermostat plate kit LTF	898305K Combi D glow plug kit	833101 Combi E element replacement tool kit

Heating spares

EXHAUST & AIR SUPPLY				
 <p>834111K Cream Wall cowl kit CW</p>	 <p>834015 Wall cowl WKC, bianco</p>	 <p>834009 Wall cowl WKC, black</p>	 <p>822300 S 2200 Wall cowl disc</p>	
 <p>833600 Cowl outer part WKC, cream</p>	 <p>810600 Cowl outer part WKC, bianco</p>	 <p>812207 Cowl outer part WKC, light grey</p>	 <p>807301 S 2200 air intake grille</p>	
 <p>840660 Air intake nozzle DT Ø 80 mm</p>	 <p>840670 Air intake nozzle DM</p>	 <p>871800 Hose clamp DIN 3017 A-50-70x9-W2</p>	 <p>898306 O-ring 40 x 2.5 mm, VMQ</p>	
 <p>801020 Exhaust cowl screw top AK3</p>	 <p>830702 Exhaust cowl screw top T2</p>	 <p>830703 Exhaust cowl screw top T3</p>	 <p>820600 Sealing ring S3</p>	
 <p>830690 Roof cowl extension SKV 45cm</p>	 <p>820800 Cowl extension AKV 15cm</p>	 <p>812206 Roof cowl extension KVC</p>	 <p>830651 Roof cowl AK 3, Ø 60 mm</p>	
 <p>843200K Ultrastore cowl kit, pure white</p>	 <p>870122 Cowl cover KBS 3, pure white</p>	 <p>812208 Cowl cover KBS 3, bianco</p>	 <p>870121 Cowl cover KBS 2, cream</p>	 <p>870131 Flue extension VBO 2</p>

Heating spares

ULTRASTORE / BOILER / THERME			
 <p>814200 Therme heating element, 230 V</p>	 <p>802500 Heating element 230V 450W</p>	 <p>802501 Heating element 230V 850W</p>	 <p>802505 Heating element 230V 1300W</p>
 <p>802502 Cable red 230v elements</p>	 <p>802503 Cable white 230v elements</p>	 <p>856300 Cable harness</p>	 <p>846022A Sealing ring</p>
 <p>861000 Water container b 10 litre</p>	 <p>801500 Water container with insulation</p>	 <p>828900 Fine wire fuse 1.6 AT</p>	 <p>899500 PCB</p>
 <p>834201 Over temperature sensor</p>	 <p>834300 Temperature sensor</p>	 <p>854200 Boiler burner</p>	 <p>856200 Flame rectifier electrode</p>
 <p>838200 Solenoid valve 30 mbar (05/14-04/16)</p>	 <p>803300 Non return valve TB 10mm</p>	 <p>803400 Non return valve JG 12mm</p>	 <p>800400 Drain valve cpl.</p>
 <p>825001 O-ring 32 x 2.8 mm, VMQ before 12/14</p>			

Heating spares

CONTROLS AND WATER SUPPLY			
 <p>863900 Elbow connection valve JG 10 / TB 10</p>	 <p>864000 Elbow connection valve JG 10 / JG 12</p>	 <p>834151 Elbow connection valve M 20 / TB 10</p>	 <p>834153 Elbow connection valve M 20 / JG 12</p>
 <p>816900 Elbow fitting JG 10 / TB 10</p>	 <p>816200 Elbow fitting JG 10 / JG 12</p>	 <p>870151 Elbow fitting M 20 / TB 10</p>	 <p>870153 Elbow fitting M 20 / JG 12</p>
 <p>870145 Drain valve JG 12 / 2.8 bar</p>	 <p>880300K FrostControl kit JG</p>	 <p>814102 Drain valve TB 10 / 2.8 bar</p>	 <p>834101K FrostControl kit TB</p>
 <p>800400 Drain valve cpl.</p>	 <p>811051 Control panel cable 3 m</p>	 <p>811052 Control extension panel cable 9 m</p>	 <p>833712 Control panel connecting cable</p>
 <p>896200 Control panel cable 3 m</p>	 <p>853500 Control panel cable 5 m</p>	 <p>860600 Cover frame black</p>	 <p>899400 Control knob printed be- fore 06/06</p>
 <p>801600 Therme Control panel 230v to 04/02</p>	 <p>819900 Therme Control panel</p>	 <p>804900 Ultrastore Control Panel 230V</p>	 <p>806700 Ultrastore / Boiler Control Panel</p>
 <p>836400A CP plus control panel</p>	 <p>836001 CP classic single pack includes 860600</p>	 <p>811200 CP Combi electric</p>	

THETFORD N4000 series refrigeration

The next generation of absorption refrigerators

WOW A comprehensive range, Thetford fridges are supplied with a left hand hinge but can be easily changed to right hand (kit included). Framed doors come with a panel supplied. Frameless are solid black. With power cables and 8mm gas inlet tube at the rear base of the refrigerator.



New interior designs

New door bins and vegetable bins for N4080-N4112

New interior for N4145-N4175

Ice grey door bins and slide-out box for N4141 & N4142



New displays

2 versions available, "E+" with blue LED controls and "A" with LCD touchscreen controls. Both versions now have automatic energy source selection.

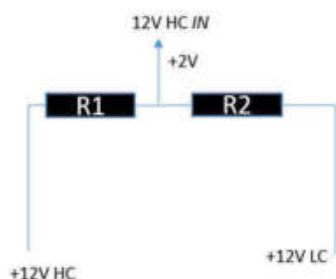

2 way or 3 way installation

A solution for caravans where 12v is not provided by the car or the power is too low and it is not desired to offer a 12v function. The switch is done during installation, by a cable bridge between the low current +12v and the low current earth via two resistors.



Improved 230V performance

230V supply is not always stable on all campsites, the cabinet temperature is currently dependent on the input voltage. Now the cabinet temperature is independent of the input voltage. High performance from 205V to 250V.

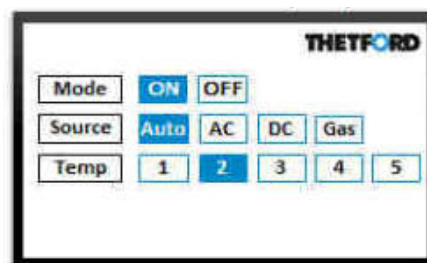

Caravanning Industry- databus (CI-BUS) compatible

With open source programming, it is possible to select, on/off, power source and cabinet temperature from the central display of the vehicle.

Counter height refrigerators

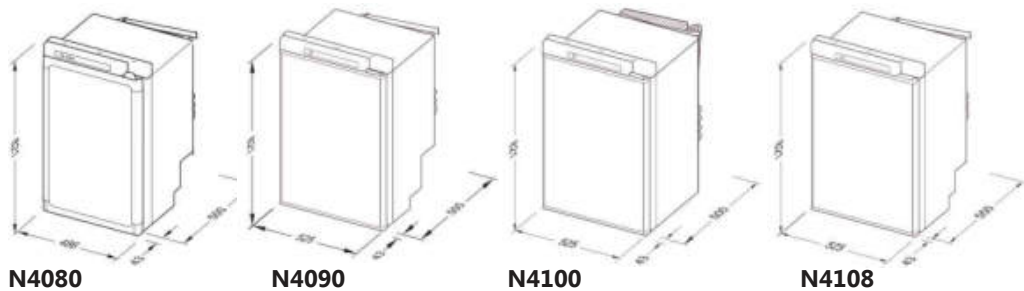

N4080

N4090

N4100

N4108



N4080

Flat Door 486mm Width



N4090 / N4100 / N4108

Flat Door 525mm Width



N4097 / N4104 / N4112
Curved Door 525mm Width

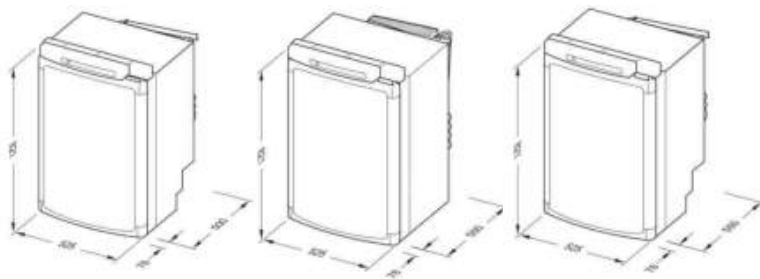

N4097

N4104

N4112

NOTE Series 3 refrigerators are being phased out and replaced by series 4. Series 4 will only be available when series 3 are sold through. Please enquire before ordering, if model version is important. Overall dimensions are the same!

MODEL	N4080E+	N4090E+	N4090A	N4097E+	N4097A
Gross capacity Of which Freezer	81 litre 10 litre	89 litre 11 litre		96 litre 11 litre	
Consumption Gas	2.4 kWh/24h 240 g/24h	2.6 kWh/24h 270 g/24h		2.6 kWh/24h 270 g/24h	
Wheel arch model	Yes	Yes		Yes	
Display	LED	LED	LCD	LED	LCD
Door	Flat	Flat		Curved	
Part Number	089068	089068B	089068A	089068F	089068D
					089068E

MODEL	N4100E+	N4100A	N4104E+	N4104A
Gross capacity Of which Freezer	97 litre 11 litre		105 litre 11 litre	
Consumption Gas	2.8 kWh/24h 330 g/24h		2.8 kWh/24h 330 g/24h	
Wheel arch model	No		No	
Display	LED	LCD	LED	LCD
Door	Flat		Curved	
Part Number	089071	By request	089072C	089072A
				089072B

MODEL	N4108E+	N4108A	N4112E+	N4112A
Gross capacity Of which Freezer	106 litre 14 litre		113 litre 11 litre	
Consumption Gas	2.6 kWh/24h 270 g/24h		2.6 kWh/24h 270 g/24h	
Wheel arch model	Yes		Yes	
Display	LED	LCD	LED	LCD
Door	Flat		Curved	
Part Number	089072E	089072D	089069B	089069A
				089069

K

Tall refrigerators **THETFORD**

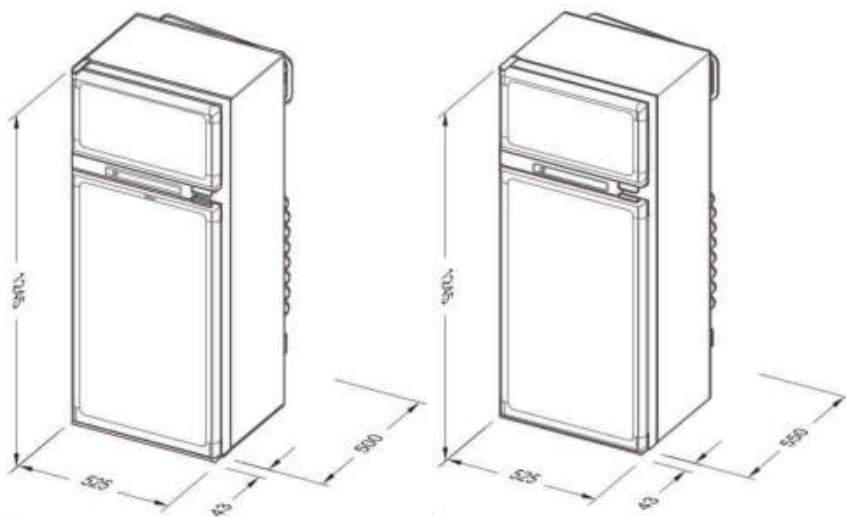

N4145

N4170



N4145 / N4170

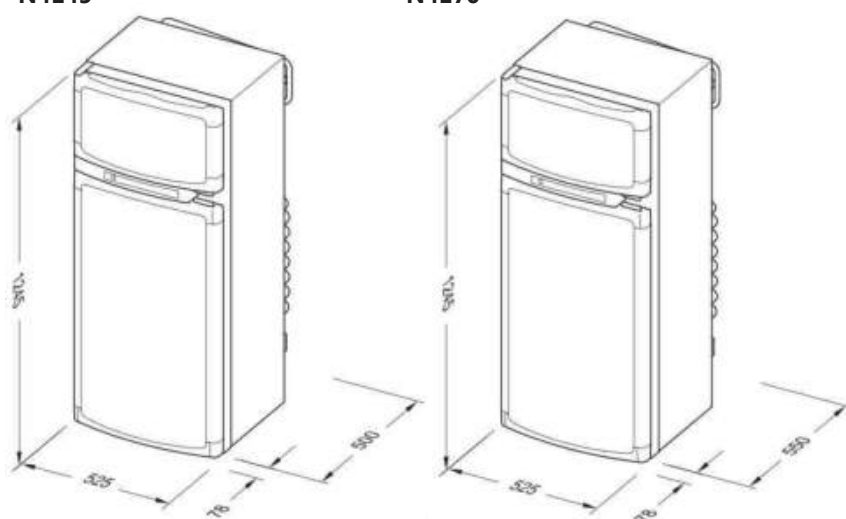

N4150

N4175



N4150 / N4175

MODEL	N4145E+	N4145A	N4150E+	N4150A
Gross capacity Of which Freezer	141 litre 23 litre		149 litre 25 litre	
Consumption Gas	4 kWh/24h 420 g/24h		4 kWh/24h 420 g/24h	
Wheel arch model	No		No	
Display	LED	LCD	LED	LCD
Door	Flat		Curved	Curved Frameless
Part Number	089073A	089073	089073D	089073B 089073C

MODEL	N4170E+	N4170A	N4175E+	N4175A
Gross capacity Of which Freezer	167 litre 29 litre		175 litre 31 litre	
Consumption Gas	4 kWh/24h 420 g/24h		4 kWh/24h 420 g/24h	
Wheel arch model	No		No	
Display	LED	LCD	LED	LCD
Door	Flat		Curved	Curved Frameless
Part Number	089073F	089073E	By request	089073G 089073H

Slimline refrigerators **THETFORD**



N4141E+ With external accessed bottle drawer

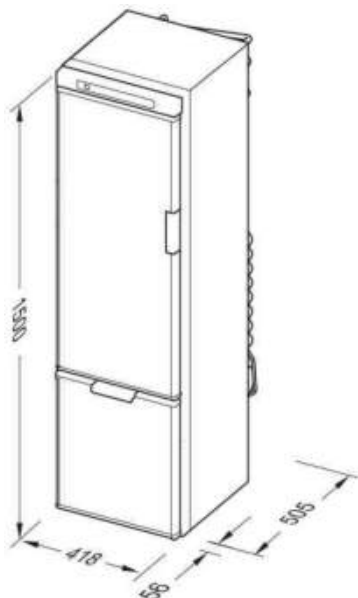

N4142E+ With internal bottle drawer

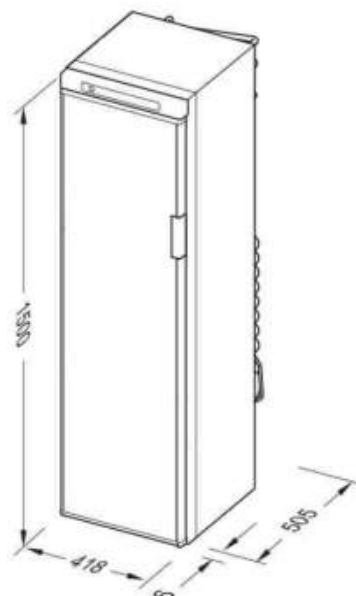

The N4140 series is unique in the range. Big in volume, small in size.

The refrigerators are only 418mm wide, compared to the standard 525mm, yet they still have a large 140 litre capacity including a 15 litre freezer compartment.

They have a user friendly automatic power source selection with an LED control panel. Available as two models, the N3141 (with external drawer) and the N3142 (with internal drawer).

Both models have a unique slide out drawer and of course a perfect cooling performance.

MODEL	N4141E+	N4142E+
Gross capacity Of which Freezer	141 litre 15 litre	142 litre 15 litre
Consumption Gas	3.9 kWh/24h 400 g/24h	
Dim: WxHxD (mm)	418 x 1500 x 561	
Wheel arch model	No	
Display	LED	
Door	Flat Framed	
Part Number	089072F	089072G

Thetford vents



Fridge vent white
186 x 483
089074



Fridge vent cream
186 x 483
089075



Fridge vent black
186 x 483
089076



SR vent screen
089077D



Winter cover pure white
186 x 483 (vent size)
089097



Winter cover cream
186 x 483 (vent size)
089098



Winter cover Fiat Bianco
186 x 483 (vent size)
089100



SR vent lock clip
089077B



SR vent large
281 x 523
White
089077A



SR winter cover large
281 x 523 (vent size)
White
089077C



SR vent
257 x 432
Pure white
White
089077E
089077F



SR winter cover
257 x 432 (vent size)
White
089077

K

Thetford 230v Fridge Elements



Thetford 230V 140W
To 01/07/05
N80/N90/N97/N98/N100/N104/N108/
N109/N110/N112/N115
089231



Thetford 230V 140W
01/07/05 to 14/05/09
N80/N90/N97/N98/N100/N104/N108/
N109/N110/N112/N115
089232



Thetford 230V 140W
To 12/05/09 LCD
N90/N97/N100/N104/N109/N112
089230



Thetford 230V 153W
From 12/05/09 LCD
N90/N97/N100/N104/N112
and
N3080/N3090/N3097/N3100/N3104/
N3108/N3112/N3115
089328



Thetford 230V 200W
N145LED from 17/01/05
089255



Thetford 230V 200W
To 28/05/09 LCD
N145/N150/N175/N180
089229



Thetford 230V 153W
From 14/05/09
N80/N90/N97/N98/N100/N104/N108/
N109/N110/N112/N115
089257



Thetford 230V 220W
From 28/05/09 LCD
N145/N150/N175 (was **200W**)
and
N3145/N3150/N3175/N3180
089242

Thetford 12v Fridge Elements



Thetford 12V 140W
To 14/05/09
N80/N90/N97/N98/N100/N104/N108/
N109/N110/N112/N115
089233



Thetford 12V 190W
From 14/05/09
N80/N90/N97/N98/N100/N104/N108/
N109/N110/N112/N115/N145/N150/
N175
and
N3080/N3090/N3097/N3100/N3104/
N3108/N3112/N3115
089326



Thetford 12V 147W
To 05/12/07 LCD
N145/N150/N175/N180
089234



Thetford 12V 140W
To 12/05/09 LCD
N90/N97/N100/N104/N109/N112
089235



Thetford 12V 140W
From 12/05/09 LCD
(was **153W**)
N90/N97/N100/N104/N112
and
N3080/N3090/N3097/N3100/N3104/
N3108/N3112/N3115
089324



Thetford 12V 200W
From 17/01/05
N145 LED
089256

12 V Compressor refrigerator



The T1090 has a strong but quiet (32dB) 12V compressor, resulting in a powerful performance. Integrated ventilation means outside vents are not required.

The unique shape follows the contours of the vehicle resulting in the best use of space and a comfortable 90 litre volume.

Efficient use of power means more freedom with less need to visit a pitch or campsite.

90 LITRE



WOW
Designed specifically for the campervan, the unique shape allows it to fit at eye level making maximum use of the limited space!

MODEL	T1090
Gross capacity Of which Freezer	90 litre 6.5 litre
Consumption Night mode	0.45 kWh/24h 0.35 kWh/24h
Dim: WxHxD (mm)	418 x 975 x 485
Wheel arch model	No
Display	LED
Door	Flat Framed
Days power on a 95Ah battery Night mode	3.0 4.0
Part number LOW HANDLE	089068C
Part number HIGH HANDLE	089068CH

12 V Compressor slimline refrigerator

The T1152 has the same enclosure dimensions as the N4142 but has more volume and less weight, respectively 152L instead of 142L and 34 kg instead of 37 kg.

The T1152 compressor fridge has a powerful and strong 12V compressor. The fridge is rated as tropical climate class, which means it is suitable for use in ambient temperatures of +16°C to +43°C. Of course, there are different aspects that can influence the performance. One of them is the installation. The small feet at the bottom, and the distance holders at the back, ensure a good installation, and provides the necessary integrated ventilation flow.

MODEL	T1152
Gross capacity Of which Freezer	152 litre 18 litre
Consumption Night mode	0.5 kWh/24h 0.4 kWh/24h
Dim: WxHxD (mm)	418 x 1500 x 561
Wheel arch model	No
Display	LED
Door	Flat Framed
Days power on a 95Ah battery Night mode	2.5 3
Part Number	089067A

152 LITRE



T1152

K

Indel B Compressor fridges

Indel B was founded in 1967 with the aim of producing direct current portable refrigerators. Today Indel B is globally known, it has production facilities in Italy and China and it covers all continents with its sales network.

Its continuous investments in research and development, the ability to anticipate and understand the needs of its customers, the compliance with the highest quality standards, made the most important Heavy Commercial Vehicles manufacturers, such as Scania, Iveco, Renault, Volvo, Kenworth, Peterbilt, Irizar, Irisbus, choose Indel B as their sole supplier for in-cab refrigerators. Indel B is Secop's (Formerly Danfoss) long standing partner, all Cruise fridges use a Secop compressor.

indel B

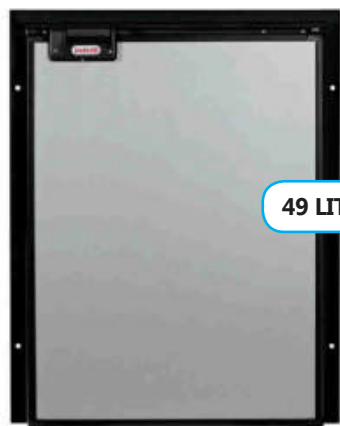

49 LITRE

WOW Installation frame included on Cruise 49. Can be installed with or without this frame.



MODEL	Cruise 49
Gross capacity inc. freezer	49 litre
Consumption	0.278 kWh/24h
Dim: WxHxD (mm)	380 x 530 x 495
Wheel arch model	No
Weight	16.6kg
Part number	087075

The Cruise 49 holds bottles in vertical and horizontal positions. The fan-cooled compressor unit is integrated on the upper part of the refrigerator. Installation frame, adjustable thermostat and inner light are all standard features. The position of the shelves can be adapted to the size of the stored items.

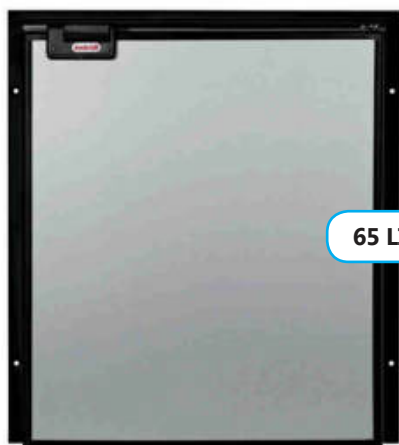

65 LITRE

WOW Installation frame included on Cruise 65. Can be installed with or without this frame.



MODEL	Cruise 65
Gross capacity inc. freezer	65 litre
Consumption	0.288 kWh/24h
Dim: WxHxD (mm)	450 x 530 x 515
Wheel arch model	No
Weight	18.2kg
Part number	087076

The Cruise 65 is a medium-sized refrigerator with a rational design of the inner cabinet so that the capacity can be fully exploited. Half-litre bottles can be stored either on the shelves or in the lower door balcony. The fan-cooled compressor unit is integrated on the upper part of the refrigerator. Installation frame, adjustable thermostat and inner light are all standard features. The position of the shelves can be adapted to the size of the stored items.



85 LITRE

WOW The Cruise 85 is a 635mm tall under counter compressor fridge.



MODEL	Cruise 85
Gross capacity inc. freezer	85 litre
Consumption	0.386 kWh/24h
Dim: WxHxD (mm)	475 x 635 x 545
Wheel arch model	No
Weight	20.8kg
Part number	087077

The Cruise 85 is a full counter height medium-sized refrigerator with a rational design of the inner cabinet so that the capacity can be fully exploited. Half-litre bottles can be stored either on the shelves or in the lower door balcony. The fan-cooled compressor unit is integrated on the upper part of the refrigerator. Adjustable thermostat and inner light are all standard features. The position of the shelves can be adapted to the size of the stored items.

Absorption refrigerators DOMETIC

WOW Many more models available on request please speak to your sales contact for details.



RF60
High performance cooling. Not designed for permanent installation this 12V, 230V and gas model is ideal for use in well ventilated areas where permanent installation is impractical. **MUST BE WELL VENTILATED! CANNOT BE USED IN ENCLOSED AREAS!**
088046



RM5310
Under counter model with user friendly control panel and separate freezer compartment.
087995



RM5330
Wheel arch cut out model with user-friendly control panel and separate freezer compartment.
087996



RMS8401
8-series with wheel arch cut out
Left hand hinge **088007**
Right hand hinge **088009**



RMD 10 Series



TFT control panel
Intuitive control of cooling temperature, energy source and comfort features



Two-point locking system
Fitted on each side of the fridge door for safe and secure usage

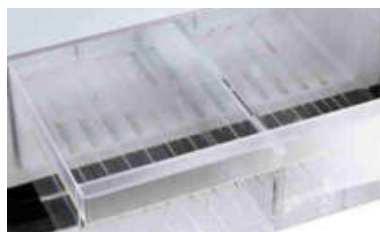

Veg-fresh crisper
With adjustable humidity and a lid that serves as an extra storage shelf



LED light bar
For uniform, energy-saving illumination of the refrigerator compartment

- Double-hinged door – opens left and right without the need to change the hinge
- Best-in-class cooling performance – tested and proven in the Australian outback
- Standard-depth cabinet with two separate doors for fridge and freezer
- Ease of use with intuitive TFT soft-touch controls recessed into the door
- Elegant aluminium door handles extending over the complete fridge height
- Two-point locking mechanism on either side for increased safety
- Flat door with customisable decor panel and variable thickness (1.2-3mm)

RMD 10.5T 088010
RMD 10.5XT 088011



Versatile interior
Innovative concept makes the best and most flexible use of the available space



Caravanning Industry- databus (CI-BUS) compatible
Operate with absolute convenience via the central control panel.

K

Absorption refrigerators DOMETIC

ABSORPTION MODELS	RF60	RM5310	RM5330	RMS8401	RMD10.5T	RMD10.5XT
Grove part number	088046	087995	087996	LH 088007 RH 088009	088010	088011
Ignition system	12v battery	Battery	Battery	MES	AES	AES
Gross capacity (L)	Approx. 60	60	70	80	153	177
Freezer compartment (L)	-	5	5	8*	29	35
Input rating 230V (Watts) 12V (Watts)	110 110	125 120	125 120	125 120	250 170	250 170
Consumption /24h 230V (kW/h) 12V (kW/h) Gas (g)	1.9 1.9 325 / 375	2.5 2.5 270	2.5 2.5 270	2 to 2.2 2 to 2.2 250 to 270	4.4 4.4 580	4.4 4.4 580
Dimensions (W x H x D mm)	486 x 615 x 490	486 x 618 x 474	486 x 821 x 474	486 x 821 x 569	523 x 1245 x 550	523 x 1245 x 605
Stepped model to allow installation over a wheel arch	Not designed for installation	No	Yes	Yes	No	No
Weight	26	20	22	25	40	41.5

* These models have removable freezer compartments to allow increased refrigerator volume. In doing so the gross volume is increased by 5 litres

Compressor refrigerators DOMETIC

RC 10 series

This elegant 10-series compressor refrigerator is ideal for installation in panel vans, boats, or anywhere ventilation presents a challenge. The versatile and spacious interior, including a removable freezer compartment, offers convenient storage options. On top of all that, its cooling power is the best-in-class!

COMPRESSOR MODELS	RC10.4.70	RC10.4.90
Right hand hinge Left hand hinge	087078R 087078L	087079R 087079L
Gross capacity (L)	69	90
Freezer compartment (L)	7.5	7.5
Input voltage	12/24	12/24
Input power Watts 12V 24V	42 58	45 61
Dimensions (W x H x D mm)	420 x 821 x 450	420 x 975 x 485
Refrigerant	R134a	R134a
Weight	22	25



Two-point locking system
Fitted on each side of the fridge door for safe and secure usage



Versatile interior
Innovative concept makes the best and most flexible use of the available space



LED light bar
For uniform, energy-saving illumination of the refrigerator compartment

WOW Dometic compressor fridges have maximum storage flexibility thanks to patented removable freezer compartment

CR range of compressor refrigerators

Premium built-in refrigerator in stainless steel finish for motor homes, caravans, yachts and boats. Interior light. Double lock door with magnetic seal. CRP40 has a detachable cooling unit (saving 182mm depth when installed separately)



CRP40

Ideal where depth of installation is an issue, this compressor refrigerator has a cooling unit that can be installed separately **087090**



CRX50

Compact model compressor refrigerator, ideal for small campervans and conversions **087091**
Optional flush mounting frame **088049**



CRX80

Under counter model compressor refrigerator **087095**

COMPRESSOR MODELS	CRP40	CRX50	CRX80
Grove part number	087090	087091	087095
Gross capacity (L)	39	48	80
Includes freezer compartment of (L)	5.3	5	7.9
Energy supply	12/24V	12/24V	12/24V
Average power consumption (Watts)	40	40	48
Consumption (Ah/h) at +25°C +32°C with interior temperature at +5°C	0.77 1.77	1.4 1.7	1.8 2.1
Weight	18	19	23
Optional flush mounting frame	088049	088049	N/A
Dimensions (W x H x D mm)	380 x 536 x 310 (+182)	380 x 534 x 500	475 x 640 x 528

Dometic 230v Fridge Elements



Dometic 230V, 105W
088090



Dometic 230V, 125W
088124



Dometic 230V, 220W
088123

Dometic 12v Fridge Elements



Dometic 12V, 120W
088077



Dometic 12V, 100W
088089

K

Ventilators and flue kits



LS100 Top vent

Set includes: Upper frame, grill with flue insert, upper winter cover and turn buttons.

LS100 set white **089010T**
 LS100 top vent only white (AS1620) **089010TV**
 LS100 top vent only grey **088113**
 LS100 Frame only **088148**



A1620 insert

White **089017**
 Cream **089018**
 Grey **088111**



LS330 vent only

Outer grill only 438 x 278 mm
 White **088110**



LS200 Bottom vent

Set includes: Lower frame, grill, lower winter cover and turn buttons.

LS200 set white (AS1630) **089010B**
 LS200 Frame only **088128**

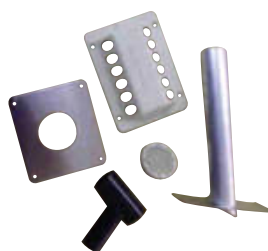

Dometic Flue

Complete kit **089063**
 Round beige flue cover **088167**



LS330 winter cover

401.5 x 223mm
 White **088134**
 Grey **088199**



LS100/200 winter cover set white

Comes with both LS100 and LS200 winter covers

White (WA120/WA130) **089012**
 LS200 winter cover only grey **088130**



Turn buckle

White **089014**
 Cream **089015**

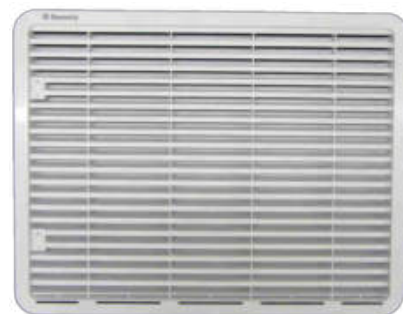

L500 vent only

Outer grill only 479 x 371mm
 For winter covers use 2 x 089010B
 White **088156**

Refrigerator bars



Via Mondo double refrigerator bar

Helps prevent movement of contents whilst travelling. 40.5cm closed. Extending to 71cm.

089065A



Via Mondo double cupboard bar

Useful addition to stop items falling if door opens in transit. 25.5cm closed. Extending to 43cm.

095689A

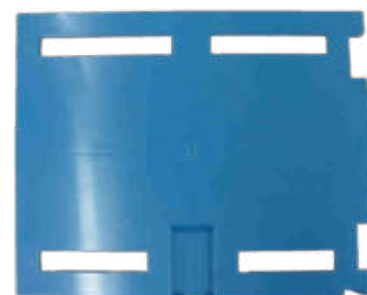

LS230 winter cover

360 x 290mm blue (internal)
088152



MPK vent

Designed for aperture 342mm x 117mm.
 Surface mounted White **089031**

12v / 230v Coolers



Powerbox® Plus

The Powerbox® Plus 12/230V active coolers operate from a 12V car plug-in or a 230V electrical outlet (both cables included), combined with the high performance injected PU foam, the cooler will keep contents at 19°C below the ambient temperature.

It features a control dial with 4 modes, allowing you to choose the performance and efficiency level. The cooler can be turned off by putting the dial to "OFF" mode without the need to unplug the cord. To reduce the noise level of the fan switch to "NIGHT" mode, and for an efficient, yet environmental friendly operation, the "ECO" mode can be used, giving an A++ energy rating. "MAX" mode is available for the ultimate cooling performance.

Inhibiting the ability of micro-organisms to grow, these coolers feature an antimicrobial liner, a powerful protection ensuring resistance to mould and mildew growth inside the coolers and it also blocks unpleasant odours from developing.

- Keeps contents 19°C below the ambient temperature.
- Freeze guard circuit built in - stops freezing to delicate food.
- Battery guard - ensuring your battery will not flatten when in use.
- Very quiet fan (maximum of 39 dB) - won't wake you up at night!
- Antimicrobial lining.



	Powerbox Plus 24L	Powerbox Plus 36L
Gross Capacity (litres)	24	36
Material	Anti-microbial Premium Polyurethane	Anti-microbial Premium Polyurethane
Dimensions outer (H x W x D mm)	423 x 408 x 323	404 x 559 x 348
Dimensions inner (H x W x D mm)	310 x 328 x 243	290 x 467 x 275
Part number	089169C	089169D

Cool box accessories



Coleman Campingaz rectifier 230/12v

Running most 12V coolers from the 230V mains is no problem at all with this 230V AC to 12V DC adapter.

5amp - 65w

089140



M10 185x95x30mm



M30 254x200x30mm

Freez'Pack®

Can be used in any cool box or soft cooler to keep food and drinks cooler for longer. Simply freeze them, then put them inside the cooler with the food or drink. They're available in a range of sizes and the bigger they are the longer they stay cool.

M10 duo pack 12 per outer **089187**
M30 12 per outer **089183**

Fridge Fans



Reich fridge fan with auto heat sensor

Improves fridge performance. Fully automatic. Easy installation. Maintenance free. Uses only 0.25 amps. No television/radio interference. 10,000 hour continuous rated motor

089005



Thetford ventilation kit















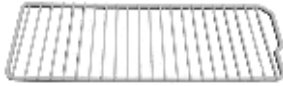
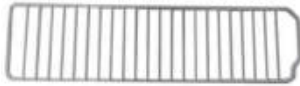













Fits all models. Extra cooling performance for your Thetford fridge

089300

Thetford Fridge spare parts





DOOR & VEGETABLE BINS			
 089078 Bottle Retainer	 089096E SR Bottle Retainer		 089081 Door Bin N80/N145 N3080/N3145/N3175
 089220 Door Bin White N97/N104/N109/N110/N112 N3097/N3104/N3112	 089221 Door Bin Blue N97/N104/N109/N110/N112 N3097/N3104/N3112	 089218 Door Bin Blue N97/N104/N109/N110/N112 N3097/N3104/N3112	 089224 Door Bin White N3141/N3142
 089217 Door Bin Blue N150/N175/N3175	 089227 Door Bin Blue N112	 089228 Door Bin N150/N175	 089216 Flip Top Cover N145
 089236 Flip Top Cover N90/N97/ N100/N104/N109/N110	 089241 Flip Top Cover N108/N112/N115	 089285 Vegetable Bin N90/N97/N108/N112/N115	 089286 Vegetable Bin N100/N104/ N109/N110
 089287 Vegetable Bin N145	 089288 Vegetable Bin N80	 089299 Vegetable Bin N150/N180	 089310 Door Bin 486 Curved N3150/N3175
 089312 Door Bin 486 Flat Shallow N3080	 089314 Door Bin 525 Curved Shallow N3097/N3104/N3112	 089316 Door Bin 525 Flat Shallow N90/N100/N108/N3090/ N3100/N3108	 089318 Door Bin 525 Flat Deep N90/N100/N108/N3090/ N3100/N3108
 089370 Vegetable Bin N3080	 089372 Vegetable Bin N175/N3100/N3104/N3145/ N3150/N3170/N3175	 089374 Vegetable Bin N3108	 089376 Vegetable Bin N3112/N3115

Thetford Fridge spare parts



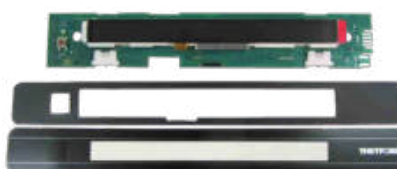



SHELVES & ACCESSORIES			
 <p>089270 Shelf Tray insert N90/N97 403 x 97.9</p>	 <p>089092 Shelf Tray Insert N145 371.3 x 183</p>	 <p>089362 Shelf Tray Insert N100/N104/ N109/N110/N112 403 x 192</p>	 <p>089264A Shelf Tray Insert N150/N175/ N180 371.25 X 212</p>
 <p>089258 Shelf Top N145 428.5 x 143.1</p>	 <p>089259 Shelf N90/N97/N100/N104/ N109/N110 455 x 118.2</p>	 <p>089260 Shelf Top N90/97 455 x 163.9</p>	 <p>089261 Shelf Bottom N100/N104/ N109/N110/N112 455 x 212.3</p>
 <p>089262 Shelf N145/N150 405 x 188.5</p>	 <p>089263 Shelf Top N150 428.5 x 172</p>	 <p>089264 Shelf N150/N175 428.4 x 232.3</p>	 <p>089265 Shelf Bottom N80 415.7 x 118.2</p>
 <p>089266 Shelf Top N80 415.7 x 163.9</p>	 <p>089267 Shelf N108/N112/N115 453.8 x 205</p>	 <p>089268 Shelf N108/N112 453.8 x 180</p>	 <p>089334 Shelf N145 427.5 x 203.3</p>
 <p>089336 Shelf A - N3080 416 x 130</p>	 <p>089340 Shelf C - N3090/N3097/ N3100/N3104 455 x 133</p>	 <p>089342 Shelf D - N3090/N3097 455 x 179</p>	 <p>089344 Shelf E - N3108/N3112/N3115 454 x 205</p>
 <p>089346 Shelf F - N3100/N3104 454 x 220</p>	 <p>089352 Shelf H - N3145/N3150 428.5 x 158</p>	 <p>089354 Shelf I - N3145/N3150 427.5 x 218.3</p>	 <p>089344 Shelf J - N3170/N3175 428.4 x 282.3</p>
 <p>089358 Shelf K - N3170/N3175 428.4 x 232.3</p>	 <p>089360 Shelf L - N3108 455 x 174</p>	 <p>089093 Shelf Clip Small</p>	 <p>089094 Shelf Clip Large</p>
 <p>089348 Shelf food retainer N80/N104/N108/N109/N110/ N112/N145</p>	 <p>089350 Shelf food retainer N98/N112/N115/N150/N175</p>		

K







Thetford Fridge spare parts

PCBS & CONTROLS		
 <p>089330 For Fridges manufactured 03/03/14 to 20/06/15 PCB Kit LCD N3000 series</p>	 <p>089332 For Fridges manufactured 03/03/14 to 20/06/15 PCB Kit LED N3000 series</p>	
 <p>089247 For Automatic ignition fridges with LCD displays Power PCB R2G</p>	 <p>For Electric ignition fridges with LCD displays Power PCB R2G</p>	 <p>089096C For Fridges manufactured after 20/06/15 Power PCB N3000 series</p>
 <p>089214 For fridges with LCD displays Display Module / PCB R2G</p>	 <p>089096A For Fridges manufactured before 3/3/14 Display Module / PCB N3000 series</p>	 <p>089096G For Fridges manufactured after 20/06/15 Display Module / PCB N3000 series</p>
 <p>089096F Control Panel N145 LED</p>	 <p>089211 Control Panel N145 LED</p>	
 <p>089208 Control Panel R2G Curved LCD N97/N104/N112</p>	 <p>089209 Control Panel R2G Flat LCD N90/N100/N108/N150/N175</p>	
 <p>089210 Control Panel R2G LED/standard</p>	 <p>089096D Flat Black Left Hand Hinge Control Panel N3090/N3100/N3108/N3145/N3170</p>	
 <p>089244 Overlay N100 LED</p>	 <p>089245 Overlay N145 LED</p>	
 <p>089096B Universal kit for all except N3080 Sticker N3000 Series</p>	 <p>089243 Overlay R2G LCD for E versions</p>	

Thetford Fridge spare parts

GAS SPARES			
 <p>089253 Selector Switch 5 position</p>	 <p>089254 Selector Switch 6 position</p>	 <p>089212 Electric Ignitor</p>	 <p>089248 Piezo Ignitor</p>
 <p>089089 Control Knob Gas N80/N90/N97/N98/N100/ N104/N108/N109/N112</p>	 <p>089206 Control Knob Selector N80/N90/N97/N98/N100/ N104/N108/N109/N112</p>	 <p>089280 Thermistor</p>	 <p>089282 Thermocouple V2</p>
 <p>089202 Burner Assembly N90/N97/N98/N100/N104/ N108/N109/N110/N112/ N115/N3100/N3104</p>	 <p>089204 Burner Assembly N145/N150/N175/N180/ N3141/N3142/N3145/N3150/ N3170/N3175</p>	 <p>089304 Burner Assembly N3080/N3090/N3097/N3108/ N3112/N3115</p>	 <p>089096 Thermocouple SR V1 N80/N90/N97/N98/N100/ N104/N108/N109/N112</p>
 <p>089226 Gas Valve V2 N80/N90/N97/N100/N104/N108/ N110/N112</p>	 <p>089322 Gas Valve After 25/09/06 N90/N97/N100/N104/N109/N110/N112/N115/ N145/N150/N175/N180</p>		 <p>089320 Gas Valve N3 Series</p>
 <p>089271 Spark Electrode N90/N97/N100/N104/N109/ N110/N112/N115</p>	 <p>089272 Spark Electrode N145/N150/N175/N180</p>	 <p>089274 Piezo Spark Electrode N80/N90/N97/N98/N100/ N104/N108/N109/N112</p>	 <p>089273 Electric Spark Electrode N80/N90/N97/N98/N100/ N104/N108/N109/N112</p>
 <p>089364 Spark Electrode N3080/N3090/N3097/N3108/ N3112/N3115</p>	 <p>089366 Spark Electrode N3100/N3104</p>	 <p>089368 Spark Electrode N3141/N3142/N3145/N3150/ N3170/N3175</p>	 <p>089213 Flame Meter</p>





























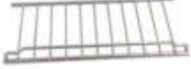

Thetford Fridge spare parts

FRIDGE MISCELLANEOUS			
 <p>089277 Storage Strap V1</p>	 <p>089278 Storage Strap V2</p>	 <p>089091 Latch V1</p>	 <p>089240B Latch V2 Traffic Black</p>
 <p>089300 Ventilator kit</p>	 <p>089238 Freezer Door Hinge</p>	 <p>089239 Freezer Door</p>	
 <p>089079A Interior Lamp Cover</p>	 <p>089079 Interior Lamp</p>		

Dometic Fridge spare parts







DOOR CATCHES			
 <p>088058 Travel Catch 295270007</p>	 <p>088079 Travel Catch 2952148001</p>	 <p>088104 Travel Catch 2412345601</p>	 <p>088120 Travel Catch 241275730</p>
 <p>088172 Travel Catch 295214007</p>	 <p>088175 Travel Catch 2412757805</p>	 <p>088103 Travel catch 2412757607</p>	 <p>088200 Slider only 2412883908</p>
 <p>088165 Door lock 289012711</p>	 <p>088184 Lock catch (lighting) LH 289037102</p>	 <p>088190 Lock catch (lighting) RH 2890371129</p>	 <p>088187 Door mechanism on door 2412126308</p>
 <p>088182 Lock catch receptor tab 2890582709</p>	 <p>088188 Lock catch (lighting) LH 289037105</p>		

Dometic Fridge spare parts

SHELVES & ACCESSORIES			
 <p>088050 Bottle retainer white 300mm 295123700</p>	 <p>088177 Bottle retainer blue 300mm 295123702</p>	 <p>088051 Bottle shelf 384mm 295123810</p>	 <p>088092 Bottle shelf 403.5mm 2412077105</p>
 <p>088094 Bottle shelf 368mm 2412077006</p>	 <p>088162 Bottle shelf blue 411.5mm 241334100</p>	 <p>088096 Door shelf 368mm 241238200</p>	 <p>088052 Door shelf 384mm 2951239009</p>
 <p>088095 Door shelf 200mm 2412076008</p>	 <p>088181 Door shelf 2413343506</p>	 <p>088178 Door shelf blue 373.5mm 2413342102</p>	 <p>088179 Door shelf blue 410.5mm 2413342003</p>
 <p>088053 Door shelf bar 371mm 295187500</p>	 <p>088097 Door shelf bar 357mm 2412104032</p>	 <p>088093 Bottle shelf clip 2412084002</p>	 <p>088180 Door shelf with cover 411.5mm 289023520</p>
 <p>088105 Door shelf 2412077113</p>	 <p>088101 Vegetable bin 365 x 224 x 103mm 2412078004</p>	 <p>088102 Vegetable bin lid 2412079002</p>	 <p>088100 Salad tray blue 241336700</p>
 <p>088139 Grating zinc plated 116 x 449mm 2106253053</p>	 <p>088140 Grating zinc plated 171 x 449mm 2951474259</p>	 <p>088153 Grating zinc plated 130 x 409mm 241322200</p>	 <p>088195 Divider crisper 2413377413</p>
 <p>088065 Grating zinc plated 102 x 236mm 295128225</p>	 <p>088082 Grating zinc plated 66 x 392mm 295152125</p>	 <p>088194 Grating zinc plated 462,5 x 180mm 2413380409</p>	 <p>088064 Grating zinc plated 178 x 418mm 295128125</p>
 <p>088164 Shelf 450 x 310mm 241398130</p>	 <p>088131 Grating zinc plated 392 x 116mm 2951680251</p>	 <p>088149 Grating zinc plated 392 x 172mm 2951422159</p>	 <p>088150 Grating zinc plated 462,5x220mm 241337560</p>

K

Dometic Fridge spare parts

OTHER FRIDGE SPARES			
			
088106 Freezer door 389mm 241211620	088114 Freezer door 430mm 2412195204	088161 Freezer door 430mm 241219531	088061 Inspection glass retainer 2926004009
			
088107 Hinge evaporator flap 2412125003	088127 Bearing evaporator flap 2412865004	088157 Hinge evaporator flap 200224400	088060 Inspection glass 2926724002
			
088143 Knob 2932605013	088108 Thermostat knob grey 2412138006	088086 Gas regulator knob 2951289004	088067 Gas regulator knob 2951289046
			
088189 Push button 289019005	088155 Selector Switch knob 2412137107	088087 Thermostat knob 2951287008	
			
088069 230v Switch green 292627410	088136 230v Switch (orange) 2926275203	088069A 12/24v Switch (red) 2926273505	088173 Gas dial 292349921
			
088137 Control panel housing grey 525mm MES 2412933109	088133 Control panel housing grey 525mm AES 2412941706	088145 Control panel housing blk/gr 523mm RM/S85** 2412941706	088192 Operating panel wiring 2030mm 2890237106
			
088196 Display board complete RM85** MES 2890643006	088197 Display board complete RMD85** AES 2890644004	088132 Operating panel with temperature probe 289063802	088185 Operating panel complete MES 2413977022
			
088170 Electronics kit (PCB) RM/S/L 8**1 MES 241349000	088154 Electronics kit (PCB) RM 7**1L MES 241277111	088158 Electronics kit (PCB) RM 7**5L AES 241277120	
			
088168 Door complete RM/S 85** 519 x 751.5mm 2890264043	088147 Door complete RM/S 84** 486 x 758mm 2413923158	088151 Cover ledge for door RAL 7021 746mm 2413338027	

Dometic Fridge spare parts

GAS & IGNITION SPARES			
 <p>088135 Gas valve complete 2412190205</p>	 <p>088073 Gas regulator valve 30/50mbar 292627611</p>	 <p>088126 Gas Valve GV100 2412798312</p>	 <p>088129 Burner control device 2412789303</p>
 <p>088070 Gas burner complete 2923928408</p>	 <p>088144 Gas burner no nozzle 292343052</p>	 <p>088166 Gas burner no nozzle 241280282</p>	 <p>088163 Wiring for burner control device 241279630</p>
 <p>088119 Nozzle (jet) KZ45 2922033044</p>	 <p>088176 Nozzle (jet) KZ65 2890483007</p>	 <p>088174 Thermocouple 2100mm 292343590</p>	 <p>088074 Thermocouple 1400mm 2923435321</p>
 <p>088071 Thermostat 1400mm 2926528106</p>	 <p>088116 Electrode cable 600mm 2951105713</p>	 <p>088169 Spark electrode 292362620</p>	 <p>088191 Connection block MES / AES 230V 2890189323</p>
 <p>088117 12v ignitor 2951654207</p>	 <p>088159 Ignitor battery 289019010</p>	 <p>088160 Ignitor battery 292302482</p>	 <p>088183 Ignitor extension 56.4mm 2923024588</p>

K

Glass tableware

Corelle high quality glass dinnerware is made in USA from a unique material called vitrelle and is renowned for being thin and lightweight yet strong and durable. Chip and break resistant; microwave, dishwasher and oven safe; patterns won't wash, wear or scratch off.

CORELLE®

12 piece dinner sets.
2 per outer



080269
Mystic Grey



080269A
Sand Sketch



080269B
Ocean Blues



080261
White



080262
CC Flower



080265
Cafe Blue



080263
Memphis



080264
City Block



080266
Geometric



080267
Garden Sketch Bands



080268
Celebration

Melamine tableware

Contemporary designs to complement the latest vehicle interiors

16 piece Dinner Sets: Consisting of 4 x dinner plates, 4 x side plates, 4 x soup/cereal bowls and 4 x mugs.



Ink Design

Dinner set 16 pc Singly or 6 per outer **081070**
Square salad bowl Singly or 6 per outer **081071**
Rectangular platter Singly or 6 per outer **081072**

Navy Pinstripe

Dinner set 16 pc Singly or 6 per outer **081148**
Dinner plate 6 per outer **081145**
Side plate 6 per outer **081143**
Soup/cereal bowl 6 per outer **081144**
Mug 4 per outer **081142**
Salad bowl Singly or 6 per outer **081147**



Monochrome

Dinner set 16 piece
 Singly or 6 per outer
081258

Leaf

Dinner set 16 piece
 Singly or 6 per outer
081122



Cappuccino

Dinner set 16 piece
 Singly or 6 per outer
081177

Petit Fleurs

Dinner set 16 piece
 Singly or 6 per outer
081125

Melamine tableware

16 piece Dinner Sets: Consisting of 4 x dinner plates, 4 x side plates, 4 x soup/cereal bowls and 4 x mugs.



Loops
Dinner set 16 piece
Singly or 6 per outer
081196A



Latte
Dinner set 16 piece
Singly or 6 per outer
081198



Vanilla
Dinner set 16 piece
Singly or 6 per outer
081197

12 piece Dinner Sets: Consisting of 4 x dinner plates, 4 x side plates and 4 x soup/cereal bowls



Granite Grey
Dinner set 12 piece
Singly or 6 per outer 081199
Stacking mugs (4)
Singly or 6 per outer 081201A



Granite Aqua
Dinner set 12 piece
Singly or 6 per outer 081204A
Stacking mugs (4)
Singly or 6 per outer 081206A



Granite Ruby
Dinner set 12 piece
Singly or 6 per outer 081207
Stacking mugs (4)
Singly or 6 per outer 081207B



Azure Premium plus
Dinner set 12 piece
Singly or 6 per outer 081214A
Swirl mug set (4)
Singly or 6 per outer 081214B



Cool White Premium plus
With non slip inlay on base
Dinner set 12 piece
Singly or 6 per outer 081215A
Mug set (4)
Singly or 6 per outer 081215B



Cool Grey Premium plus
With non slip inlay on base
Dinner set 12 piece
Singly or 6 per outer 081216
Mug set (4)
Singly or 6 per outer 081216A

Love Caravanning



Dinner set 12pc & Cool Bag

High quality 12pc dinner set with 16 litre cool bag
Available singly or 3 per outer

081030

Mugs (4)

4pc mug set
Available singly or 12 per outer

081031

Salad Bowl

Available singly or 24 per outer

081035

Platter 35cm

Available singly or 24 per outer

081036

Tall Tumbler (2)

Available singly or 24 per outer

081038

Short Tumbler (2)

Available singly or 24 per outer

081037



Dining accessories



Picnic / Travel Rug

Singly or 12 per outer

081060

16pc Cutlery Set

Singly or 12 per outer

081059

Placemat Set (4)

Singly or 24 per outer

081061

Egg Cup Set (4)

Singly or 24 per outer

080815

Cleaners



40 Shot Dish & treat

Low foaming washing up liquid that also acts as a tank cleaner. Just wash the dishes and let the washing up liquid clean and protect your pipes and tank.

10 per outer **095575**



Melamine soak

Supplied in a tub of 20 tablets.

12 per outer

081409

Camper Smiles

Dinner set 12pc & Cool Bag

High quality 12pc dinner set with 16 litre cool bag
Available singly or 3 per outer
081050

Dinner Plates (4)

4pc 10.5" Dinner plate set
Available singly or 12 per outer
081052

Side Plates (4)

4pc 8.5" Side plate set
Available singly or 12 per outer
081053

Soup / Cereal Bowls (4)

4pc Soup / Cereal Bowl set
Available singly or 12 per outer
081054

Mugs (4)

4pc mug set
Available singly or 12 per outer
081051

Salad Bowl

Available singly or 24 per outer
081055

Platter 35cm

Available singly or 24 per outer
081056

Tall Tumbler (2)

Available singly or 24 per outer
081058

Short Tumbler (2)

Available singly or 24 per outer
081057

Junior picnic set & ruck sack

High quality plate, bowl, tumbler, fork and spoon.
Available singly or 12 per outer
080302



Children's tableware

Dinner sets

Consists of a plate, a bowl, a tumbler, a fork and a spoon. Available singly or 12 per outer



Happy Holiday
080303



Harry & friends
080304



Charlie & friends
080307



Tumbler sets

Consists of 4 different named acrylic tumblers.
Available singly or 12 per outer
080314

Acrylic and polycarbonate drinkware



Wine goblet (2)

Polycarbonate. 2 per display carton.
Available singly or 12 per outer
Small **080119**
Large **080116**



Savoy wine glass (2)

Polycarbonate. 2 per display carton.
Available singly or 12 per outer
Standard **080118A**
Large **080118B**



Wine goblet grey (4)

10oz wine goblet with grey base.
4 per display carton.
Available singly or 12 per outer
080141



Acrylic wine goblets

6 per outer **080102**



Stackable goblet (2)

2 per display carton.
24 per outer
080122



Soda glass

Assorted Colours
12 per outer
080148



Bella goblet grey (4)

14oz goblet with grey base. Supplied
in display carton of 4 pieces.
Available singly or 12 per outer
080146



Bella goblets (4)

14oz goblet suitable for wine, beer or
juice. 4 per display carton.
Available singly or 12 per outer
080089



Acrylic tumblers clear

Available singly or 24 per outer
Tumbler **080090**



Heavy base stacking goblet (2)

Available singly or 24 per outer
Blue **080125**



Heavy base stacking goblet (2)

Available singly or 24 per outer
Clear **080127**



Savoy short tumbler (2)

2 per display carton.
Available singly or 24 per outer
080121

Acrylic and polycarbonate drinkware



Classic short tumbler (2)
Polycarbonate. 2 per display carton.
Available singly or 24 per outer
080120



Daisy short tumbler grey (2)
2 per display carton. Available singly
or 24 per outer
080130



Daisy short tumbler aqua (2)
2 per display carton. Available singly
or 24 per outer
080132



Classic tall tumbler (2)
Polycarbonate. 2 per display carton.
Available singly or 24 per outer
080135



Daisy tall tumbler grey (2)
2 per display carton.
Available singly or 24 per outer
080129



Daisy tall tumbler aqua (2)
2 per display carton.
Available singly or 24 per outer
080131



Stacking tumbler (4)
4 per display carton.
Available singly or 24 per outer
Smoked **080124**
Clear **080123**



Alfresco tumblers
4 per display carton. 8 per outer
Hi-ball **080136**



Slim jim tumblers grey
With grey base. 4 per display carton.
10oz
12 per outer.
080143



Acrylic pilsner glass
Ideal for large gatherings where glass is dangerous. 500ml. Available singly or 12 per outer
080096



Acrylic beer mug
12 per outer
Dimpled **080099**



Acrylic container set
3 Piece acrylic container set with air tight lid. Contains, 1 x 1L, 1 x 1.3L and 1 x 1.9L container.
081075



Hands free glass holder
Holds wine glasses on the grass or beach, made in the UK from 100% recycled polycarbonate. 4 per pack, 24 per outer
Display stand **080162**
080163

Gas Barbeques

Campingaz Party Grill®

The essential camping companion with endless cooking options! This compact, portable stove offers the widest range of cooking options; stove top, grill, griddle, plancha and the lid of the 400 model even doubles as a wok.

All elements of the Party Grill® can fit inside the device. Thanks to its detachable legs and lockable lid it is easy to transport and store. The Party Grill® 200 runs on a Campingaz® CV Plus valve cartridge which can be disconnected and reconnected whilst cooking, should you run out of gas. The Party Grill® 400 model runs on conveniently sized Campingaz® cylinders. The piezo ignition on all models promises simple, match-free lighting wherever you are, so you can get the party started.

Features:

- Grill, griddle and stove cooking options
- Grill and griddle with non-stick coating for better cooking results
- Integrated pan supports for stove top cooking
- Fully adjustable power
- Piezo ignition for convenient lighting
- Non-stick cooking surface
- Water compartment collects grease and fat ensuring easy cleaning
- Folds into compact size for easy transportation

	Party Grill® 200	Party Grill® 400
Gas pressure	30 mBar	30 mBar
Power	2000W	2000W
Gas Consumption	145g/h	145g/h
Boil Time	4min 18sec	6min 5 sec
Ignition	Piezo	Piezo
Runtime	3hrs on CV470+ 2.5hrs on CV300+	19.5hrs on R907 12.5hrs on R904
Fuel source	CV470+, CV300+	R904, R907, butane or propane cylinder
Weight	2.84kg	4.92kg
Dimensions (WxH)	ø32 x 33cm	ø36 x 42cm (on stand)
Grove Number	085950	085955



Party Grill® 400



Party Grill® 200

Portable Stoves



Campingaz Camp Bistro

- Power: 2200 watt
 - Size: 35cm x 28cm
 - Automatic piezo ignition
 - Convenient plastic carry case
 - Operates off CP250 cartridge
- 109941**



Campingaz CP250

Contains 250g Isobutane. For use with Bistro® type stoves
12 per outer
109965



Portable Gas Stove

- Lightweight design and easy to carry
 - Convenient plastic carry case
 - Suitable for picnics, camping, garden etc
 - Requires butane gas cartridge
- 109943**



Stove cartridges (4)

For use with portable gas stoves
6 per outer
109945



Campingaz Chef

Double burner and grill. Toast rack and drip tray with handle.

- Power: 2 x 1500 watt
- Size (open/closed): 60x40x35 / 59.5x32.5x8.5cm
- Piezo ignition
- 327 g/h consumption
- Lid with latch and carry handle

109940

Outdoorchef

European Outdoorchef

The grills manufactured by OUTDOORCHEF are exclusively designed and developed by innovative Swiss engineers. Although their grills are constantly being improved, the core idea behind their unique gas kettle barbecue that allows easy, versatile and healthy grilling has existed for over two decades. OUTDOORCHEF are still passionately committed to making barbecuing a relaxed, fun-filled experience that brings people together and lets them share fun-filled moments.

The unique funnel improves the traditional barbecue:

- It prevents unwanted flare-ups
 - It has perfectly even heat distribution with fewer hot spots
 - Indirect grilling method - a recirculating grill system, ideal for gently cooking meat (especially large pieces)
 - No need to turn the food to be grilled - Leaving you free to spend more time having fun with your guests.
- Thanks to their versatile features, the grills from OUTDOORCHEF can replace an entire kitchen. From meat and crispy pizzas to fresh bread and paella – enjoy culinary creativity without limits.



Minichief Gas BBQ

- Porcelain-enamelled 1-ring burner system with piezo ignition
 - Rotatable porcelain-enamelled EASY FLIP funnel for direct and indirect grilling
 - Integrated lid hinge and thermometer
 - Two removable side shelves
 - Porcelain-enamelled kettle and barbecue grid
 - Nylon-reinforced plastic base frame
 - Large 39.5cm Ø cooking surface
- H x W x D: 43 x 78 x 53cm. 11.4kg
086006



Outdoorchef griddle plate

Cast iron 33cm ø reversible griddle for searing at high temperatures.
086009

Outdoorchef gourmet set

Universal pan 35cm ø, can be used for paella, risotto and vegetable casserole. Pizza / baking plate 35cm ø
086011



COMING SOON!
Minichief Electric
086006E



Outdoorchef Chelsea Gas BBQ

- Porcelain-enamelled 1-ring burner system with piezo ignition
 - Rotatable porcelain-enamelled EASY FLIP funnel for direct and indirect grilling
 - Lid with integrated thermometer and lid holder
- H x W x D: 95 x 67 x 60cm. 11.4kg
086001

Outdoorchef Chelsea Electric BBQ

- 7 heat settings
 - EASY REFLECT heating system with heat reflector
 - Simple, fast assembly to start cooking immediately
 - Lid with integrated lid holder
- H x W x D: 93 x 67 x 60cm. 11.4kg
086005

EasyMat



EasyMat mini portable suction plate. Ideal for first foods and baby led weaning from 6 months and for all babies through to 24 months. Universal fit for high chairs and portable for travel. Complete with 4 suction cups, folding sides, sealed lid and carry case. "Made for mums" gold award winner 2019.

BPA Free 100% LFGB high grade EU standard tested to EN14372:2004

32 cm x 19 cm x 2 cm

Weight: 280 gms

Buttercup

Olive

080299EMBC

080299EMOL



Muggi

Originally conceived by yachtsman David Trotter for use when sailing in rough seas, Muggi tray is a safe way to carry hot and cold drinks. Made from a lightweight but super tough Polypropylene material, it's designed so that it's light and easy to carry, but also strong and secure. Muggi holds your mugs, glasses or cups in four precision moulded slots. Just as useful for a host of outdoor occasions. Perfect to store mugs in transit in your caravan or motorhome.

muggi

WOW Carry, store and much more!
Made in Britain! 88 year "higher than average lifetime" guarantee!



Muggi

Dimensions 200 X 200mm, 70mm high. Each cup holders diameter is 89mm
Made from super tough, lightweight Polypropylene
Non-slip rubber feet (perfect when out sailing)
Dishwasher safe and microwave safe

Grey	080171
Red	080172
Blue	080173
Purple	080174

Microwow

The worlds first microwave and dishwasher safe insulated casserole dish. Microwow has a stainless steel interior that is microwave safe without the lid. It keeps food hot or cold for up to 6 hours.

New thermal bonding technology fuses the casserole dish, completely sealing the unit, making it dishwasher safe. Made from food grade thermal plastics and stainless steel creating a robust casserole dish. Integrated side handles for easy handling and designed with a stylish tri-tone colour finish. Designed for reheating only in microwave, maximum heating time 5 minutes.



Microwow

3 Piece Set includes: 1 x 1 litre capacity dish (D 18cm x W21cm x H 12cm), 1 x 1.5 litre capacity dish (D 22cm x W 27cm x H 14cm) and 1 x 2.5litre capacity dish (D 23.5cm x W29cm x H16cm)

Available singly or 6 per outer

Red **093057R**

Blue **093057B**

Citronella products



Citronella garden light

40 hours burn time
086133 6 per outer



Maxi tealights (12)

10 hours burn time
086145 6 per outer



Tealights (30)

4.5 hours burn time
086143 6 per outer



Garden torches citronella

2 hours burn time. 2 per pack
24 packs per outer
086155

Via Mondo gas kettles

Stainless steel whistling kettles for gas hobs. Individually boxed.

- Stainless steel body and lid
- Heat resistant handle
- Fixed whistle
- Large opening for easy filling and cleaning

Available singly or 6 per outer



1L Kettle Stainless Steel
095055S



1L Kettle Soft Gold
095055SG



All boil it kettles are individually boxed



1.5L Kettle Blue
095056B



1.5L Kettle Black
095056BL



1.5L Kettle Burgundy
095056BU



2L Kettle Copper
095057COP



2L Kettle Lavender
095057L



2L Kettle Stainless Steel
095057S



2L Kettle Soft Gold
095057SG



2L Kettle Turquoise
095057T

Via Mondo kettles and toasters

1.7L Electric low wattage kettles

Cordless, 230v kettle with 900w output ideally suited for site use. With Strix controls designed to meet the most stringent international safety standards and manufactured to consistently exceed 12,000 cycles of normal operation. Individually boxed.

- Overheat & boil dry protection shut off
- 75cm cable length with cord storage
- 360° cordless for left and right handed use
- Water level indicator window
- Push button lid
- Illuminated on/off
- Removeable washable limescale filter
- Non slip feet

Available singly or 6 per outer

Strix
TECHNOLOGY

Safer
by Design



Cream
095066C

Duck egg blue
095066B

Black
095066BL

**Electric low wattage toasters**

2 Slice, 230v, 950w cool wall toaster ideally suited for site use. Individually boxed.

- 75cm cable length with cord storage
- Variable browning control
- Cancel, reheat & defrost functions
- High lift for smaller items
- Removeable washable crumb tray
- Non slip feet

Available singly or 6 per outer

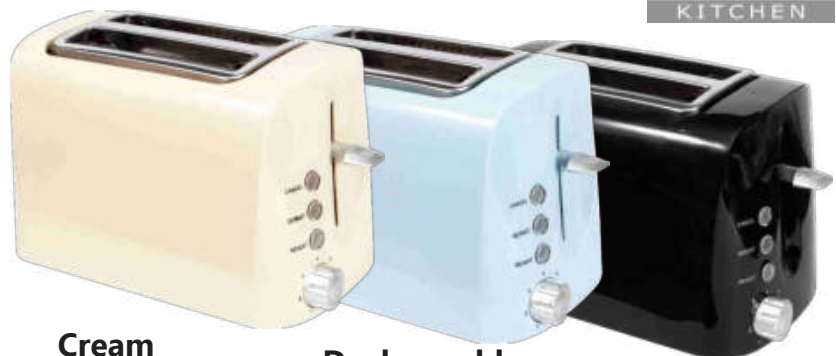

Cream
095069C

Duck egg blue
095069B

Black
095069BL

**0.5L Travel kettle 12/24v**

ON/OFF indicator light, 12v or 24v, automatic switch off, cordless in use. Includes 2 plastic mugs that can be stored inside the kettle. Individually boxed. Singly or 6 per outer
095062

**1L low wattage kettle**

Plastic, cordless, 230v kettle with 900w output ideally suited for site use. Individually boxed. Singly or 6 per outer
095065A

**1.5L low wattage kettle**

Plastic, cordless, 230v kettle with 900w output ideally suited for site use. Individually boxed. Singly or 6 per outer
095065B

**Stainless steel 12v Kettle 0.5L**

100W kettle with fully concealed element. Fitted with cigar lighter plug, ideal for boat, caravan, motorhome or car.
095085

230v Hot water boilers

Thermo Pot by Addis

Hot water at the touch of a button. The ideal product for a family caravan holiday!

- Very low wattage.
 - Initial boil - 680W
 - Reheat - 100W
 - Keep warm - 2W
- No plumbing required
- Instant hot water for vegetables, pasta, porridge, rice, hot water bottle, or just tea and coffee
- 3 dispensing methods. Manual, cup and auto.
- Stays warm at a choice of 5 temp. settings
- Efficient due to Thermal outer layer
- Less risk of spilling hot water, safer for anyone with less firm grip or reduced mobility
- LCD display shows current temperature
- Also perfect for home/office use



Thermo Pot 5 Litre
H x W x D :
40 x 23.3 x 30.2cm
095093

Thermo Pot 3.5 Litre
H x W x D :
34.1 x 23.3 x 30.2cm
095092

Pots, pans and cooking accessories



Grill pan

Complete with trivet and detachable handle.

31 x 18.8cm **094019B**



Cast aluminium griddle

Non stick interior and exterior, folding handle, deep ridged base. 20cm² 5mm gauge.

Singly or 12 per outer

094050



Via Mondo Enamel grill pan

Complete with trivet and detachable handle.

- Ensure handle is firmly in place before lifting grill pan
- Handle can be used on the narrow or broad side for flexibility
- Suitable for use in a dishwasher

28 x 22 x 4cm

094023

Trivet to fit 28 x 22

094023T

35 x 22 x 4cm

094024

Trivet to fit 35 x 22

094024T



32cm roasting tin

Double non-stick coated 0.3 gauge steel. High corrosion resistant. Oven safe to 230 degrees. Dishwasher and freezer safe.

12 per outer

094049



Chef aid non stick grill pan

Foldable handle for excellent space saving and a double layered non-stick coating. It also includes pouring lip to remove any excess juices from the pan when cooking or cleaning

240 x 375 x 30mm

Singly or 12 per outer

094052



Stainless steel pan set

Good quality 3 piece set with one each 16, 18 and 20cm pans with lids in a full colour display box

093017

Milk pan & frying pan

Non stick aluminium 2mm gauge PTFE silver exterior. Singly or 12 per outer

Milk pan 14cm

093032

Frying pan 20cm

093033



Spatter screens

Diameter: 29cm

Non stick coated mesh

Singly or 12 per outer

095009

Mesh

Singly or 10 per outer

095005

Fozzils Fold Flat

WOW THINK FLAT - innovative, space saving products for the indoor and outdoor life. Simple, practical, and fun.

**Twist-fold 3 Teir**

Assembles and collapses with a gentle twist using our patent pending Twistfold™ system. Hidden magnets hold the plates / bowls securely when collapsed for space saving storage. Top rack dishwasher safe, BPA free.

Party bowl

275mm, 235mm, & 175mm ø bowls
Height 85mm closed, 375mm open.

081500**Party Plate**

315mm, 260mm, & 210mm ø plates
Height 45mm closed, 300mm open.

081501**Snapfold dishrack**

Collapsible dish rack assembles quickly and easily with a gentle push on each end. Compact design but easily handles most daily needs with slots for dishes, bowls, and utensils. With built-in drip tray that keeps counters dry. Folds flat for easy storage.

Assembled: LxWxH 34 x 30 x 21cm

Folded: LxWxH 42 x 29 x 4.5cm

095489**Snapfold colander**

A new, fresh, and fun collapsible colander! Easy and quick to use - and super-flat for storage. From drawer to sink in seconds, the colander assembles and collapses with a gentle push or pull on each end.

Assembled: 230 x 240 x 135mm Folded: 295 x 330 x 35cm

Aquamarine / Grey

095235A

Mini colander - Assembled: 160 x 155 x 110mm Folded: 195 x 215 x 35mm

Lavender / Grey

095235M**Snapstakz bowl set**

Durable and reusable, dishwasher safe. Unique, elegant design for home and outdoors. Large capacity (700 ml)

As bowl: 175 x 135mm ø, height 90mm

As plate: 255 x 230mm, height 25mm

Set 1 x Turquoise & 1 x Ivory

081502

Set 1 x Lavender & 1 x Ivory

081503

Microwave ware

WOW Polycarbonate is a superb material for microwave cookware. Tough, non stick, odour resistant and non staining. Completely transparent to cook faster and more evenly. Dishwasher safe.

**Saucepan & lid**

Capacity 0.6L.

Singly or 10 per outer

093039**Rice & veg steamer**

The perfect design for cooking rice and steaming vegetables that retain flavour, vitamins and texture.

Singly or 6 per outer

093048**Egg poacher**

The first microwave egg poacher designed to cook eggs in water to give traditional taste and texture.

Singly or 10 per outer

093045**Mini pots (2)**

Each mini pot has side handles which stay cool in the microwave for easy handling. The lid is vented for safety and gives better results than simply resting a storage lid on top. Cook two foods at the same time using Minipots.

Singly or 12 per outer

093054**Multi-purpose tray**

Designed to raise food so that it cooks more evenly and allows any fat or liquid to drain away. Has an extremely low thermal conductivity. It also stays much cooler than glass and ceramics.

Singly or 10 per outer

093050**Omelette pan**

The hinged design makes folding omelettes easy.

Singly or 10 per outer

093043**Plate cover**

Designed to keep your microwave oven clean when re-heating or cooking.

Singly or 10 per outer

093052

POP Kitchen Gadgets

Space saving collapsible silicon



Folding Colander

23cm Ø, 8.5 (4)cm depth
Singly or 6 per outer

Lime Green **095236**
Blue **095236B**
Grey **095236G**



Folding Medium bowl

21cm Ø, 9.5 (4.5)cm depth
Singly or 6 per outer

Lime Green **095237**
Blue **095237B**
Grey **095237G**



Folding Large bowl

37.5cm Ø, 14 (4)cm depth
Singly or 6 per outer

Lime Green **095245L**
Blue **095245B**
Grey **095245G**



Folding 7L wash basin

43.5 x 27 x 14 (4)cm WxDxH
Singly or 6 per outer

Lime Green **095241L**
Blue **095241B**
Grey **095241G**



Folding Dish drainer with tray

36.5 x 31 x 12.5 (6)cm WxDxH
Singly or 6 per outer

Lime Green **095238L**
Blue **095238B**
Grey **095238G**



Non Slip Chopping Board

37 x 23cm WxD
Singly or 6 per outer

Lime Green **095246L**
Blue **095246B**



Folding 10L bucket

37cm Ø x height 25 (6) cm
Singly or 6 per outer

Lime Green **095239L**
Blue **095239B**
Grey **095239G**



Folding basket

38 x 29 x 16 (5)cm WxDxH
Singly or 6 per outer

Lime Green **095248L**
Blue **095248B**
Grey **095248G**



Pop cup

Folding silicone insulated cup
6 per outer

Assorted colours
095233

Drying racks and drainers

**Mini dish drainer**

Nylon coated wire measuring
30cm x 20cm

6 per outer

White

095520A

Chrome

095510A

**Wire plate rack**

Can be secured for safe transportation
of plates. Measures 27cm wide x 20cm
deep x 12cm high.

6 per outer

White

095521A

Chrome

095511A

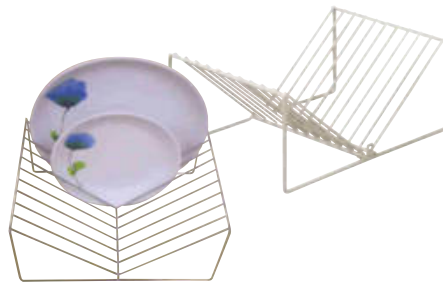
**Wire mug holder**

Can be secured for safe transportation
of mugs or cups. Measuring 9cm
square x 19cm high

6 per outer

White

095527A

Chrome

095517A

**Colours Folding Plate Drainer**

Disassembles to fold neatly into a retail box. Convenient as it does not take up
unnecessary shelf or cupboard space.

Singly or 12 per outer

Black **095497B**

Red **095497R**

Cream **095497C**

**Folding plate rack**

Open dimensions (LxWxH):
37x27x27cm Chrome **095512A**
6 per outer

Cup, plate, cutlery and bottle holders

**Stepped cup and plate rack**

535mm x 90mm.

Beige **095695** Ivory **095701**

Free standing cup and plate rack

525mm x 180mm x 90mm.

Beige **095682** Ivory **095684**

Cutlery trays

Three slot tray 370mm x 190mm x 50mm

Beige **095752** Ivory **095759**

**Glass and bottle holders**

Manufactured from coated sprung steel

Singly or 10 per outer

Three glass **095850**

Six glass **095858**

Single bottle **095862**

Two bottle **095872**

Three bottle **095880**

Cutlery



Cutlery set stripes
16 piece set. Singly or 12 per outer
081059



Cutlery set black
16 piece set. Premium quality.
Singly or 12 per outer
095147



Cutlery set in holder
16 piece set and holder. Hand polished stainless steel.
Singly or 12 per outer
Grey **095145**
Aqua **095146**



3 Piece Non stick Knife set
Assorted colours.
Singly or 6 per outer
With veg knife **095401**
With veg peeler **095402**



Linear cutlery packs
12 per outer
Fork (4) **095154**
Knife (4) **095153**
Spoon (4) **095155**
Teaspoon (6) **095152**



Casa cutlery tray
33 x 30cm
12 per outer
Silver **095760S**
Calico (cream) **095760C**
Duck egg (blue) **095760DE**
Chilli red **095760CR**
Ice white **095760IW**

Kitchen Utensils



Silicone spatula
12 per outer
Black **095212**
Purple **095213**



Silicone turner
12 per outer
Black **095214**
Purple **095215**



Silicone spoon
12 per outer
Purple **095219**



Silicone tongs
12 per outer
Black **095220**
Purple **095221**



Silicone spoon rest
Singly or 24 per outer
Black **095228**
Purple **095229**



Silicone trivet
17cm²
12 per outer
Black **095230**
Purple **095231**



Rubber sink mats
Trim to size. White.
Singly or 6 per outer
26 x 31cm **095535**
32cm ø **095536**

Kitchen Utensils

**Via Mondo double refrigerator bar**

Helps prevent movement of contents whilst travelling.

40.5cm closed. Extending to 71cm.

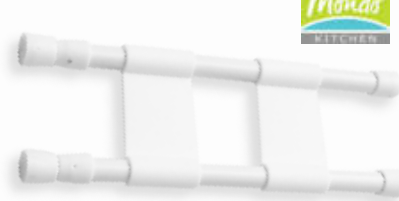
089065A**Via Mondo double cupboard bar**

Useful addition to stop items falling if door opens in transit. 25.5cm closed. Extending to 43cm.

095689A**Tea towel holder**

4 hole

12 per outer **095455****Adjustable kitchen roll holder**

Fits the majority of sizes available.

6 per outer **095461****Kitchen towel holder**12 per outer **095460****Chef aid food cover****095457****BBQ Tongs**Singly or 12 per outer **095350****Kitchen tongs**12 per outer **095452****Butterfly can opener**Singly or 12 per outer **095425****Sidewinder can opener**18 per display **095421****Cushion grip scissors**

3 piece set

12 per outer **095424****Rotary grater**12 per outer **095449****Sink strainer**Stainless steel. 12 per outer **095454****Sink strainer**

10 per outer

Chrome **051078C**White **051078****2 in 1 salt 'n' pepper mill**

Twist one way for salt the other for pepper.

12 per outer

White **095428**Black **095429****2 in 1 oil 'n' vinegar spray**

Twist one way to spray oil the other to spray vinegar.

12 per outer

White **095426W**Black **095426B****Corkscrew**

Chrome plated

Singly or 12 per outer

095396

Kitchen Utensils

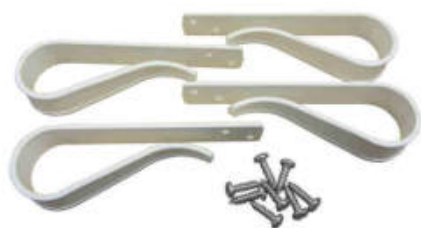
**W4 Curtain/tablecloth clip**

4 per pack.
Singly or 10 per outer
095632

**Tablecloth clip (4)**

Singly or 12 per outer
095640

**Fiamma omni stop**

Ideal to keep plates and items in place as you travel. Securing bar made from anodized aluminium
095697

Gas lighters and ignitors

For full details and specifications of lighters and ignitors please see page 135

**Turboflame Phoenix PHB**

● Size: 7.2 x 3.5 cm
070508B

**Turboflame Ranger T2R**

● Size: 7.4 x 3.3 cm
070508C

**Turboflame V-Flame VFR2**

● Size: 7.6 x 3.8 cm
070508D

**Refill for gas lighters 250ml**

12 per outer
070480

**Piezo lighter**

24 per display
070486

**Scripto Aim 'n' Flame flex**

Disposable lighter.
Singly or 16 per outer
070471

**Scripto Dual Flame**

Disposable lighter.
Singly or 16 per outer
070473

**Scripto Ez-Squeeze**

Refillable lighter.
Singly or 16 per outer
070475

**Scripto Folding Utility**

Refillable lighter.
Singly or 16 per outer
070474

**Gas safety lighter**

Long reach flame lighter
12 per outer
070498

Waste Bins



Garbina waste unit

Easily fixed to any vertical surface with bags held in place by a rubber strap
 095920
 Spare bags (25) 095935



Ekologika bin

Packs away for convenience and can be set to two heights. 4 per outer
 095923



Via Mondo caravan cupboard door bin

Complete with bracket to suspend from door
 095941

M



Fiamma Pack waste

Folding dustbin with 2 hooks that can be dismantled includes 2 fix organizers to hang
 106404



Bag bin

Wall fixing unit from which you suspend carrier bags. 12 per outer
 095995



Cupboard door bin

Complete with bracket to suspend from door
 4 per outer 095939



8L Casa swing bin

10 per outer
 Silver 095986S
 Calico (cream) 095986C
 Duck egg (blue) 095986DE
 Chilli red 095986CR
 Ice white 095986IW



Flextrash

An eco-friendly bin system. Made out of recycled PET bottles! Plastic filaments from the bottles are converted into threads which are then used to manufacture 100% recycled Flextrash.



Step ONE - PICK A BIN

Flextrash is a soft shell bin that comes in various sizes.

3 litre small for your bathroom, the 5 litre medium for your car or motorhome or the 9 litre large for your caravan or motorhome!



Flextrash 3 Litre
095951A



Flextrash 5 Litre
095951



Flextrash 9 Litre
095950



Flextrash trash bags 3L
10 bags per pack
095957A



Flextrash trash bags 5L
10 bags per pack
095957



Flextrash trash bags 9L
20 bags per pack
095956

Step TWO - CHOOSE A SMART CLIP

Patented smart clips let you take Flextrash anywhere you want. Seat clips in your car, the vacuclip for any smooth surface or the campstick on site. The possibilities are endless!



Flextrash wallclip
095952



Flextrash table clip
095953



Flextrash vacu clip
095955



Flextrash seat clip
095960



Flextrash dash clip
095961



Counter top display
Speak to your sales contact for details
095958



Floor display
Speak to your sales contact for details
095959



Flextrash camp stick
095954

Storage

FLEXI STORE -Durable and hardwearing plastic, perfect for all sorts of jobs around the house, caravan, motorhome and garden. Easy to lift with two integrated handles and will easily stack together for compact storage.

**8L Flexi tub round**

6 per outer

Calico (cream) **095998C**
Graphite (grey) **095998G**

**25L Flexi tub round**

6 per outer

Calico (cream) **0959981C**
Graphite (grey) **0959981G**

**40L Flexi tub round**

6 per outer

Calico (cream) **0959982C**
Graphite (grey) **0959982G**

**24.5L Flexi bag**

6 per outer

Coral **095885CO**
Duck egg **095885DE**

**40L Flexi bag**

6 per outer

Coral **095886CO**
Duck egg **095886DE**

**Folding storage box**

32 litre capacity. Measures 475 x 345 x 240mm (43mm when closed). Assorted colours.

Singly or 10 per outer
095892

**W4 elasticated storage pocket**

Can be attached to the inside of cupboard doors. Ideal to store magazines, maps, toiletries etc. Dimensions 30cm x 17cm
095882

**W4 hold steady**

Plastic frame with elasticated cord dividers enables safe storage of many shapes and sizes of items. Can be used horizontally or vertically. Dimensions 30cm x 20cm
095883

Bowls & buckets

**28cm Casa round bowl**

12 per outer

Silver **095537S**
 Calico (cream) **095537C**
 Duck egg (blue) **095537DE**
 Chilli red **095537CR**
 Ice white **095537IW**

**32cm Casa square bowl**

12 per outer

Silver **095538S**
 Calico (cream) **095538C**
 Duck egg (blue) **095538DE**
 Chilli red **095538CR**
 Ice white **095538IW**

**5L Casa bucket**

12 per outer

Silver **095997S**
 Calico (cream) **095997C**
 Duck egg (blue) **095997DE**
 Chilli red **095997CR**
 Ice white **095997IW**

Trolleys

**HTD Folding trolley truck 80kg**

- Maximum load: 80kg
 - Unfolded: (HxWxD) 100 x 38 x 42cm
 - Folded: (HxWxD) 68 x 38 x 5cm
 - Weight: 3kg
- 2 per outer
050273

**HTD Folding trolley truck 50kg**

- Maximum load: 50kg
 - Unfolded: (HxWxD) 98.5 x 34 x 47cm
 - Folded: (HxWxD) 68 x 38 x 5cm
 - Weight: 2.5kg
- 2 per outer
050272

**Folding boot cart**

- Folds flat when not in use
 - Lightweight, durable, rustproof with smooth rolling rubber wheels
 - Extendable aluminium handle
 - Dimensions: 380 x 330 x 360mm
 - Capacity 25Kg
- 6 per outer
095888

Via mondo clothes dryers

**3 Arm folding rotary aier**

12.5m of drying space

- Aluminium frame - Lightweight and strong
- Locking frame - locks in to place giving a secure open and closed position
- Supplied with ground pegs
- Oversized carry bag to make packing away easier

Dimensions: H145cm x L120cm x W120cm

Dimensions closed: 82cm x 27cm x 27cm

Weight: 1.82kg

Max load: 12.5kg

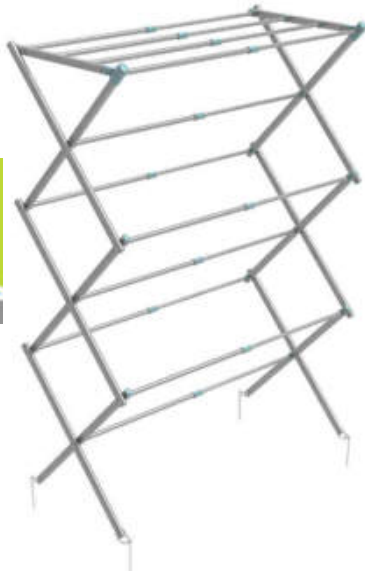
095478A**3 Tier expanding steel aier**

4 to 7.5m of drying space

- Almost double width when expanded
- Durable powder coated steel frame
- Supplied with ground pegs

Dimensions: H104.5 x L37 x W75cm

Dimensions closed: 42.5 x 51 x 9cm

Weight: 2.4kg

Max load: 7.5kg

095479A**4 Arm deluxe folding rotary aier**

20m of drying space

- Aluminium frame - Lightweight and strong with 4 legs for added stability
- Locking frame - locks in to place giving a secure open and closed position
- Supplied with ground pegs
- Oversized carry bag to make packing away easier

Dimensions: H152cm x L170cm x W170cm

Dimensions closed: 11 x 11 x 149cm

Weight: 1.95kg

Max load: 20kg

095478B**Freestanding multi aier**

15m of drying space

- Flat mesh area for delicate items
- Small and compact when folded
- Durable powder coated steel frame
- Four legs for added support and stability
- Supplied with ground pegs and carry bag

Dimensions: H90.8 x L132 x W132cm

Dimensions closed: 11 x 11 x 92cm

Weight: 3.2kg

Max load: 15kg

095478E

Laundry and ironing



Window drying rack

Dimensions: H176cm x L60cm x W31cm
Singly or 40 per outer
095476A



Drying rack

Hooks over the edge of the caravan window providing 6 metres of drying space. Folds flat when not in use. Manufactured from medium gauge steel wire, nylon coated 4.5mm thick. Folded dimensions (WxD): 58 x 48cm Available singly or 10 per outer **095477**



Compact Airing

Hooks over the edge of a door or the caravan window. Folds flat when not in use. Singly or 6 per outer **095476**



Travel steam iron

The fold down handle means you can take this travel steam iron anywhere. 230V. 750W. Singly or 6 per outer **095097**



Winged Ailer

Portable ailer. Folds flat when not in use, with enough space to dry a full load of washing. 6 per outer **095475**



Fiamma Easy Dry

Additional drying rack suitable for use on the folding rail of the Fiamma Carry-Bikes and other brands with a tube diameter of 35mm. You can also travel with the Easy Dry in situ. Complete with plasticized ropes and adjustable handles. Manufactured from anodized aluminium. Weight 1.2kg **095480**

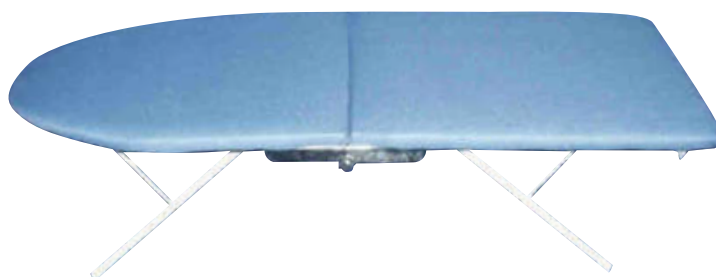

Folding ironing board

Folding legs, quality fabric cover, pressed wood top, chrome-wire iron rest. Folds in half for compact storage in re-usable storage bag. Surface area 81 x 30cm **095095**



Jumbo clothes pegs

32 per pack Assorted colours. 24 per outer **095487**

Moisture absorbers

Slimline moisture trap

Allows significantly more Air Flow than other traps in which the crystals sit very low and restricts air exposure

- Ideal for kitchens, caravans, boats and more
- For closed rooms measuring up to 40 m³
- Excess moisture can cause mildew, wet rot, musty odours and other problems
- Works immediately
- No electricity or batteries required
- Easy fill top lid
- No spill sides
- Refill indicator

110170 12 per outer

Moisture crystal refill

500g **110172** 12 per outer

2 x 500g **110176** 8 per outer

5 x 500g **110178** 4 per outer

Gel safe moisture trap

Helps prevent damp, mould, mildew, bacteria and musty odours, improving overall air quality and comfort. The gel residue cannot be spilled.

- Absorbs 400ml moisture and turns it to gel
- Effective for 6-8 weeks
- Protects against damp
- Improves air quality
- Quick and easy to use
- Non spill and non leak

110185 16 per outer

KILROCK

It's the one that works.



Mini moisture trap

- Last 6-8 weeks

110180 12 per outer

WOW GEL-SAFE traps and refills turn moisture into a gel, stored in a paper bag. Makes disposal safe and easy.



Gel safe refill

Extremely easy to replace

110187 12 per outer

Dry-Bag

An effective and economical product that is both simple and safe to use, eliminating condensation and damp problems. Protects interior fittings, fabrics, clothes, leather, electrical equipment from corrosion, rot, mould, mildew and odours. The Dry-Bag is manufactured using a cloth bag with lanyard and vertical window for hanging and monitoring, the colour will change from light brown to dark brown as it absorbs moisture. Each 1Kg bag can dehumidify an area of approximately 6-10 m³

- Re-usable, simply dry out contents as per instructions
- Can be stored for up to 2 years
- 100% environmentally friendly
- Absorbs up to 75% of its dry weight
- Will not drip even when saturated

Dry-Bag 1 x 1000g **110100** 15 per outer

WOW Reuseable!



Hooks



Small oval hooks

3 per pack
10 per outer
099011



Large oval hooks

2 per pack
10 per outer
099015

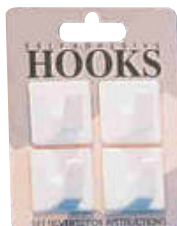

Small square hooks

4 per pack
10 per outer
099019



Large square hooks

2 per pack
10 per outer
099023

Wash Brushes

HTD Telescopic flow-through brushes

Lightweight 22/25 mm diameter aluminium poles with various extensions. With easy-grip handle, super soft bristles, brass/steel connections for extra strength and on/off switch.



HTD Standard Head

- Extends from 116.5 - 200cms
 - 25cms Brush head
 - 1 Angle head
- 12 per outer
097080



HTD Dual Angle Head

- Extends from 116.5 - 200cms
 - 25cms Brush head
 - 2 Angle head
- 12 per outer
097081



HTD Heavy Duty 5 angle Head

- Extends from 116.5 - 200cms
 - 30cms Brush head
 - 5 Angle head
- 12 per outer
097082



HTD Extra Long Dual Angle Head

- Extends from 134 - 304cms
 - 25cms Brush head
 - 2 Angle head
- 12 per outer
097083



Display stand

097088



HTD flow through hand brush

- 53cm handle
- 10 per outer
097047B

Vacuum cleaning



Upright and hand held Vacuum cleaner 2 in 1

- 600 Watt
 - Compact and Lightweight
 - Upright & bagless design
 - Quick release dust tank
 - Includes crevice & brush nozzles.
 - Cyclonic HEPA filtration
 - 5m extra long cord
- Available singly or 6 per outer
096099

Fenwick's products

WOW Manufactured and designed in the UK.



Caravan cleaner

Cleans up to 40 caravans. It will safely remove black streaks, algae, moss, fungus, road and traffic film. Safe to use on acrylic windows, aluminium, rubber, decals, mastics, sealants etc.
 1 litre **098056** 10 per outer
 25 litre **098061**



Motorhome cleaner

Improved formula for use on motor homes. Contains corrosion inhibitors to protect steelwork. Power washers are often used so cleaning activity has been increased
 1 litre **098057** 10 per outer



Bobby dazzler

A unique finishing product for caravans, motor homes, cars, vans and lorries. Provides a protective coating and enhances shine. Simply applied in the rinse water it protects against road traffic film, salt spray, acid rain, rust and air borne pollutants and it contains an algae and mould inhibitor to slow their return.
 1 litre **098058** 10 per outer

Z



Black streak remover

A 10 to 1 solution of caravan cleaner in a handy trigger spray for removing black streaks between washes.
 1 litre **098055** 10 per outer



Overwintering

Superb product to make spring cleaning easy. Simply coat the caravan or motor home with a dilution of over wintering to protect the surface from tree sap, bird droppings and general grime which accumulates over the winter months. Simply rinse with Fenwick's caravan or motorhome cleaner in the spring. Supplied in 1 litre bottles – enough to cover the average caravan twice
 1 litre **098054** 10 per outer



Waste pipe & tank cleaner

Cleans shower and sink drains, toilet cassettes, and eliminates unpleasant odours. Dilute to a 10:1 solution to clean hard surfaces. Fully biodegradable and food safe, kills e-coli, salmonella and other germs. Also removes nicotine, egg, limescale, formaldehyde, and other hard to remove stains
 1 litre **097063** 15 per outer

Fenwick's products

WOW Manufactured and designed in the UK.



Awning & Gazebo reproofer

Restores waterproofing qualities to synthetic materials and canvas. Protects against stains from dirt, grease, oil, food spills, and drinks. Deep penetrating, water based, non flammable formula. *Can be applied in damp conditions.* 1L covers up to 30m². Far safer than solvent based products.

1 litre **108405** 10 per outer



Awning & gazebo cleaner

Quickly and effectively cleans awnings, tents and gazebos. Removes black streaks, green algae and general grime. Spray on, wash off formula.

1 litre **108401** 10 per outer



Fenwick's Protective Coating

Fenwicks have perfected the art of paint sealing. They claim to have developed the best DIY paint sealant there is. Very simple and easy to apply and it lasts a long time.

Fenwicks Protective Coating forms a permanent non-stick flexible barrier to the environment, sealing the surface, making it microscopically smooth and giving a great finish. It may be applied to paint, GRP, aluminium, fibreglass, acrylic windows, glass and plastics in one easy application.

- Reduced cleaning times
- Increased cleaning intervals
- Superior surface protection
- Compatible with Fenwick's Caravan Cleaner and Bobby Dazzler
- Simple and very effective!

Kit contains: Fenwicks Protective Coating 1 litre, foam applicator pad, microfibre polishing cloth.

Protective Coating Kit **098058S**
1 litre spray refill **098058SR**



Fenwicks top & tail

A unique toilet fluid designed for use in both top and bottom tanks which makes it simpler to use and more economical. Save space by carrying only one bottle. 2.5 litre **060266** 8 per outer



Windowize

An effective product to remove scratches from acrylic and plastic windows. When applied by hand it will remove scuff marks caused by trees as well as light scratches caused by dirt and grit.

100ml **098052** 10 per outer



Fenwicks towball cleaner

For dry degreasing of all metal parts

- Improves damping performance
- Reduces stabiliser pad squeal
- Fast, effective, deep cleaning action

200ml **007064**
10 per outer

1drywash waterless products



Starter kit

Kit contains: 1 x 500ml 1drywash with trigger and 2 x microfibre cloths.
Singly or 10 per outer
098075



Caravan & Motorhome kit

Kit contains: 1 x 500ml 1drywash with trigger and 2 x microfibre cloths.
Singly or 10 per outer
098074A



Replacement trigger
098085

1 litre refill kit

Kit contains: 2 x 500ml 1drywash with trigger
Singly or 10 per outer
098077

Mudbuster products



Mudbuster Caravan & Motorhome Cleaner

Exterior & interior cleaner, with 3 in 1 action for an unbeatable shine, every time! Wash & wax with black streak remover built in. Available in 3 sizes for a more comprehensive range
1 litre **098020** 12 per outer
5 litre **098022** 4 per outer
20 litre **098023** 4 per outer

Mudbuster Glass & Acrylic Cleaner

A product that will leave all glass and mirrors clean and streak free. This glass and acrylic window cleaner is so easy to use, simply spray on and wipe off for a supreme shine.
1 litre **098026** 12 per outer
5 litre **098028** 4 per outer

Mudbuster Liquid Wax

A superior shine in two easy steps. Simply spray on and hose off.
1 litre **098024** 12 per outer

De-Solv-It products



Sticky stuff remover

The modern answer for removing paint, oil, grease, adhesive, tar, sticker residue etc.
250ml **098095** 6 per outer



Window & glass cleaner

Quick effective cleaner for general grime on windows, perspex and plastic. Non smearing spray
500ml **098106** 8 per outer



Textured Multi-Task Wipes

- Dual sided tough action textured wipes for cleaning up wet paint, grease, adhesive, oil and more!
 - For use on tools, hands and most surfaces.
 - Dermatologically tested
 - Anti-bacterial tested to BS:EN 1276: 1997 standards
- 80 wipes per pack **098105**
6 packs per outer

Armor All caravan wipes



Caravan One-Step Spot Wipes

- One step cleaning inside and out!
- Removes black streaks, algae, insects and stubborn stains
- Suitable for many surfaces - bodywork, plastic and vinyl

24 wipes per pack **098033**
6 packs per outer



Caravan Rubber Seal Silicone Wipes

- One step cleaning and protection
- Lubricates seals and makes windows easier to open
- Excellent winterising coat to prevent sticking and cracking

24 wipes per pack **098034**
6 packs per outer



Caravan Window Cleaning Wipes

- One step cleaning inside and out!
- Streak free, non-scratch formula
- Suitable for acrylic, plastic and glass windows

24 wipes per pack **098035**
6 packs per outer



Caravan Canvas & Tent Spot Cleaning Wipes

- One step cleaning!
- Removes black streaks, algae, insects, bird lime and stubborn stains
- Suitable for synthetic, canvas and cotton materials

24 wipes per pack **098036**
6 packs per outer

Kilrock cleaning products



Slam Plughole Unblocker Bathroom

Specially formulated for bathroom blockages

- Blasts through hair, grease and soap scum
- Quickly clears bathroom plugholes and pipes
- Stops slow draining water

To prevent the build-up of blockages, give your plughole a SLAM every 2 weeks.

110190B 12 per outer



Slam Plughole Unblocker Kitchen

Specially formulated for kitchen blockages

- Dissolves fat, grease & food
- Quickly clears kitchen plugholes & pipes
- Stops slow draining water
- Stops smelly sinks & kills germs

To prevent the build-up of blockages, give your plughole a SLAM every 2 weeks.

110190K 12 per outer



Descalene Descaler (5)

Multi purpose descaler - effective limescale remover

12 per outer **110189**

Other cleaning products



Silky cream

A cleaner for all painted and synthetic surfaces. Non abrasive. 480ml
098063 12 per outer



Melamine soak

Convenient melamine cleaner supplied in a tub of 20 tablets.
12 per outer **081409**



40 Shot Dish & treat

Low foaming washing up liquid that also acts as a tank cleaner. Just wash the dishes and let the washing up liquid clean and protect your pipes and tank.

10 per outer **095575**

Cleaning equipment



5L Casa bucket

12 per outer
 Silver **095997S**
 Calico (cream) **095997C**
 Duck egg (blue) **095997DE**
 Chilli red **095997CR**
 Ice white **095997IW**



Super jumbo car sponge

Available singly or
 6 per outer **097005**



Microfibre cloths

- Made from microfibre
- Cleans without chemicals
- Lint and streak free results
- Machine washable
- Environmentally friendly
- Magnetic to dust

12 per pack
 20 per outer **097046**

Velcro® brand



Dispensers

20mm x 10 meters
 Stick 'N' Stick Ecru **099412**
 Stick 'N' Stick White **099413**



Heavy duty tape

Extra Strong. Weather resistant adhesive. For Indoor and outdoor use. 50mm x 10 meters **099415**



Coins

Self adhesive discs with many uses.
 16 per pack
099423 12 per outer



Heavy duty strips

Extra Strong. Weather resistant adhesive. For Indoor and outdoor use.
 50mm x 100mm
099420 12 per outer



Velcro® self-grip ties

Perfect for organising bulky heavyweight cables. 30mm x 5 meters
099427 6 per outer



Rigid hang tabs

Repairs euro hook slots when damaged. 500 tabs per roll (53 x 42)
099081

WOW
 New reduced price



Rolson 4 piece cloth set

4 microfibre cloths.
 12 per outer **097025**



W4 handies

One size disposable latex gloves, powdered for easy fitting. 6 pairs per pack
 10 per outer **098150**

Non slip matting



Camco non slip matting

Suitable for many applications. Supplied in 12" wide rolls. Available singly or 10 per outer
 12' beige **096015**
 12' burgundy **096017**



Rolson non slip matting

Black heavy duty
 Supplied in rolls.
 125 x 45cm wide **096020** 30 per outer
 150 x 30cm wide **096019A** 10 per outer

Nicoman Spaghetti mats

Nicoman are the only manufacturer in the UK producing PVC vinyl loop (spaghetti) floor mats to protect and enhance your leisure vehicle and to stand up to the toughest demands at home. The distinctive spaghetti mats are perfect for indoors and outdoors. They keep your vehicle or home clean and hygienic for weeks, due to the innovative design 'collecting' dust and debris preventing it being walked inside.

- Durable yet soft vinyl loops
- Traps mud, dirt, debris and moisture
- Can be cleaned by a hose or power washer



Welcome Spaghetti mat

10 per outer
44 x 75cm **096074**



Home Sweet Home Spaghetti mat

10 per outer
44 x 75cm **096073**



Union Jack Spaghetti mat

10 per outer
40 x 60cm **096069**
44 x 75cm **096069A**



Scottish Spaghetti mat

10 per outer
40 x 60cm **096069C**



Welsh Spaghetti mat

10 per outer
40 x 60cm **096069D**



Brown/beige Spaghetti mat

10 per outer
40 x 60cm **096071BB**
45 x 75cm **096070BB**
60 x 90cm **096072BB**



Charcoal Spaghetti mat

10 per outer
40 x 60cm **096070CH**
45 x 75cm **096071CH**
60 x 90cm **096072CH**



Black Spaghetti mat

10 per outer
40 x 60cm **096070BL**
45 x 75cm **096071BL**

Pink Spaghetti mat

10 per outer
45 x 75cm **096070P**

Grey Spaghetti mat

10 per outer
40 x 60cm **096070GR**

Mats and runners



Miracle Barrier Mat

- Machine washable at 30°C
 - 100% soft polypropylene pile with vinyl backing.
 - Supplied flat with header card and hanger
 - Six assorted colours.
- 40 x 60cm
16 per outer **096026**



Ideal barrier mat

- Hardwearing polypropylene pile.
 - Machine washable at 30°C
 - Vinyl backing
- 40cm x 60cm, assorted colours
16 per outer **096025**

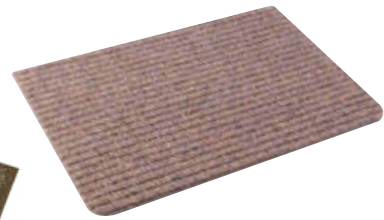

W4 mini mat extra

- Ridged door mat with non-slip backing. 49 x 33cm
- 096044** 10 per outer

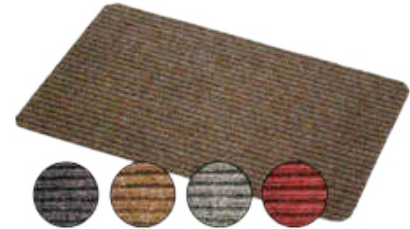

Delta Mat

- Hardwearing polypropylene pile with gel backing
 - Five assorted colours
- 40 x 60cm
25 per outer **096066**



Madras Runner

- Machine washable at 30°C
 - Polypropylene loop pile with latex backing
 - Six assorted colours
- 57 x 180cm
12 per outer **096068**



Madras Mat

- Machine washable at 30°C
 - Polypropylene loop pile with latex backing
 - Six assorted colours
- 40 x 70cm
24 per outer **096067**

Protective matting



Stick'n' Guard

Self adhesive protective carpet film – ideal for use in high traffic areas where carpets need temporarily protecting.

- 60cm width.
- | | | |
|----------------------|-------------------|---------------|
| 10m retail | 6 rolls per outer | 120125 |
| 100m workshop | | 120126 |



Carpet protector

Suitable for use on carpets, supplied in carry home polybag. 68cm width.

- Available singly or 17 per outer
- | | | |
|--------------------|------------------------|---------------|
| 1.5m retail | Singly or 17 per outer | 120121 |
| 30m roll | | 120124 |

MPK Rooflights

Multi-directional rooflight with opaque, flexible double skinned dome and frame available in two colours, beige or white. Telescopic arms allow the rooflight to be opened to any side. The dome skins have spacers between to guarantee free airflow that cannot be reduced by snow weight. Comes complete with removable flynet, and the 420 version comes with flynet and integrated roller blind. Sizes are based on the aperture cut out size.



Opaque rooflight with beige interior

280 x 280 with flynet	102002
360 x 320 with flynet	102008
400 x 400 with flynet	102013
400 x 400 with flynet and blind	102016

Opaque rooflight with white interior

280 x 280 with flynet	101972
360 x 320 with flynet	101978
400 x 400 with flynet	101983
400 x 400 with flynet and blind	101986

Replacement domes with beige handles

280 x 280	102005
360 x 320	102010
400 x 400	102012

Replacement domes with white handles

280 x 280	101975
360 x 320	101980
400 x 400	101982

Replacement flynets



280x280 beige 102019	290x290 beige 102020	360x320 beige 102021	400x400 beige 102023	For MPK 420 400x400 beige 102026 400x400 white 102024
280x280 white 101989	290x290 white 101990	360x320 white 101991	400x400 white 101993	

Replacement roller blind

Beige **102017**



MPK rooflight catches

Catch to lock rooflight in open or closed position 420/430.
4 per pack (2 black and 2 grey)
102018



VisionVent M Pro

Stylish and, simultaneously, highly developed tinted dome rooflight. The aerodynamic conception for an improved flow during driving. The advantages are lower driving noise and reduced air movement, despite permanent ventilation. Easy to operate, the VisionVent M pro rooflight ensures driving enjoyment and the greatest possible level of comfort. A new ventilation principle was developed which ensures improved condensation protection. The interior frame with a pleated blind and flynet, provides reliable protection against sunlight and insects, whilst still achieving 150cm² ventilation when closed.

Possible installation on 24-56mm roof thicknesses.

- Aperture: 400 x 400mm
 - Dome: 560 x 560mm
 - Height: 96mm
 - Inner frame: 565 x 530 x 35mm
- For Caravans free airflow: 150cm² **102028**

VisionStar M pro

VisionStar M pro tinted dome rooflights are available with or without permanent ventilation. The double-walled frame improves insulation. Low profile, smoked, double glazed dome (80mm height above roof) which helps to keep driving noise to a minimum and protects against UV light. The dome opening angle of up to 70° has a very easy single handed operation.

The interior frame with a pleated blind and flynet, provides reliable protection against sunlight and insects, whilst still achieving 120cm² ventilation when closed (permanent vent model only).

Possible installation on 25-60mm roof thicknesses.

- Aperture: 400 x 400mm
- Dome: 490 x 470mm.
- Height: 80mm
- Inner frame: 565 x 530 x 35mm

Permanently vented

For Caravans free airflow: 120cm ²	Boxed	102015
	Bulk	102015B

Non vented

For Motorhomes free airflow: 0cm ²	Boxed	102014
	Bulk	102014B

Heki rooflights



All heki rooflights come complete with inner frame. With weather proof ASA frames and PMMA glazing, they are designed to provide excellent protection from the elements. Permanently vented versions are for caravans and those without permanent ventilation are for motorhomes.

WOW Seitz S4 windows - Dometic Seitz S4 windows are available from stock. Please speak to your sales contact for more details

Fitting kit required for Micro Heki



Micro Heki

Aperture 280 x 280mm
 Exterior required 430 x 390mm
 Glazing Double
 Opening Lever
 Positions 2
 Max angle 50°
 Weight 1.7kg

Permanently vented

For caravans with free airflow:

Pleated flynet only **102073**
 Pleated flynet & blind **102073A**

Non vented

For motorhomes no free airflow:

Pleated flynet only **102072**
 Pleated flynet & blind **102072A**

Fitting kit

Adaptor frame **102071**

Replacement dome for Mini Heki style NON VENTED **102109**



Replacement dome for Mini Heki S **102108**



Mini Heki style

With pleated flynet & blind
 Aperture 400 x 400mm
 Exterior required 550 x 510mm
 Glazing Double
 Opening Lever
 Positions 3
 Max angle 50°
 Weight 3.3kg

Permanently vented

For caravans with free airflow:

25-41mm roofs **102080**
 43-59mm roofs **102081**

Non vented

For motorhomes no free airflow:

25-41mm roofs **102077**
 43-59mm roofs **102078**

Mini Heki S

With pleated flynet & blind
 Aperture 400 x 400mm
 Exterior required 500 x 500mm
 Glazing Single
 Opening Handles
 Positions 5
 Max angle N/A (80mm open)
 Weight 2.9kg

Permanently vented

For caravans with free airflow:

23-41mm roofs **102074**
 43-59mm roofs **102075**

Replacement dome for Midi Heki **102107**



Replacement dome for Heki 2 **102105**



Replacement dome for Heki 3/4 **102106**



Midi Heki

With pleated flynet & blind
 Aperture 700 x 500mm
 Exterior required 880 x 650mm
 Glazing Double
 Opening Lever
 Positions 3
 Max angle 45°
 Weight 8kg

Permanently vented

For caravans with free airflow:

White **102084**
 Grey **102084A**

Non vented

For motorhomes no free airflow:

White **102085**
 Grey **102085A**

Heki 2

With roller flynet & blind
 Aperture 960 x 655mm
 Exterior required 1080 x 790mm
 Glazing Double
 Opening Lever
 Positions 3
 Max angle 55°
 Weight 11kg

Permanently vented

With free airflow:

No 12v lights **102092**

Heki 2 De Luxe

As above with duette (honeycomb) blind and interior lights

Permanently vented

With free airflow
 4 x 12V 5W LED lights **102093**

Heki 3 plus

With pleated flynet & duette (honeycomb) blind
 Aperture 960 x 655mm
 Exterior required 1080 x 790mm
 Glazing Double
 Opening Crank
 Positions Variable
 Max angle 70°
 Weight 15kg

Permanently vented

With free airflow:

No 12v lights **102096**

P

Fiamma Rooflights



Vent 28 F

With aluminium Flynet. Handle wheel opening. Aerodynamic shape. For 28-60mm roof thickness. 80cm² permanent air flow.

Aperture	280 x 280mm
Exterior required	320 x 340mm
Crystal	101097A
White	101097B



Kit Turbo-Vent 28 F

Converts any Vent 28F into a 12v ventilator/aspirator. Leaves 50cm² permanent air flow. Fan: 12v, 25w, 1.9A max, 180mm ø, 9m³ / minute max air flow **101099A**



Vent F Pro

With Flynet and pleated blind. Handle wheel opening. Aerodynamic shape. Double opening arms for reliable, balanced opening and closing. For 28-55mm roof thickness. 100cm² permanent air flow.

Aperture	400 x 400mm
Exterior required	566 x 531mm
Crystal	101100



Fiamma rollo kit 40 x 40

Suitable for fiamma 400 x 400 rooflights, to add a roller blind. **102029**



Vent

With Flynet. Handle wheel opening. Aerodynamic shape. For 30-50mm roof thickness. 80cm² permanent air flow.

Aperture	400 x 400mm
Exterior required	455 x 455mm
Crystal	102030C
White	102030W



Turbo-Vent

Manually operated opening with permanent air flow ventilation and a big fan with a 12V DC variable speed motor with 10 blades. Fan: 12v, 36w, 0.3-3A, 300mm ø, 35m³ / minute max air flow. Includes in/out, on/off switch and "Polar Control" thermostat. 80cm² permanent air flow.

Aperture	400 x 400mm
Exterior required	455 x 455mm
Crystal	101091
White	101092



Turbo-Vent Premium

Just like the Turbo-Vent but where all functions can be set in motion by a simple finger-touch. Fan: 12v, 36w, 0.3-3A, 300mm ø, 35m³ / minute max air flow. 80cm² permanent air flow.

Aperture	400 x 400mm
Exterior required	455 x 455mm
Crystal	101093B
White	101093A

Replacement domes

Vent (400x400) aerodynamic
Crystal **102031C** - White **102031W**
Vent (400x400) non aerodynamic
White **102038**
Vent 28 before 2019 (280x280)
Crystal **102033C** - White **102033W**



Vent 50

Manually operated opening on all 4 sides with practical handles and with permanent ventilation. Comes with blackout roller blind and fly screen. Aperture 500 x 500mm
Exterior required 570 x 570mm
Crystal **101104**
White **101102**



Fiamma turbo kit

Converts any rooflight (36cm to 48cm) into a 12v ventilator/aspirator. Fan: 12v, 4w, 0.2-0.33A, 240mm ø, 7.2m³ / minute max air flow
1 cable for lighter type socket and 1 cable for vehicles electric circuit. Can also work on 8 x D batteries not supplied. **101095**



Fiamma thermo vent 40

Suitable for any 400 x 400 rooflight. Keeps vehicle cooler in summer and warmer in winter. **102032**



Fiamma Universal spoiler

Dimensions 110 x 20 x 12cm **102039**

Fiamma Spoiler 40

49cm width to fit 400x400 rooflights **102039A**

Other rooflights and accessories



Elixir rooflight
Single glazed unit with one way wind up mechanism. Metal surround. To fit aperture size: 360mm x 360mm
White **102033**
Spare dome only
White **102037**



Rooflight domes
Manufactured from vacuum formed acrylic. The domes are not pre-drilled
14.5" x 14.5" **102055**
18" x 18" **102065**

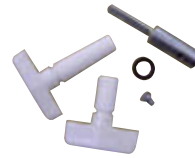

Fiamma handle extension
102034



Universal extension kit
To suit all Fiamma roof lights
102036



Brevette stays
2 per pack
102162



Roof cowl Truma AK3
801020



Mushroom vent
White dimensions: 110mm Ø, Height 50mm, Fits roof depth 22-54mm
103204



Hit and miss vent
White 9.5" x 3.5" **103101**
Brown 9.5" x 3.5" **103112**



Heki 2 handle compensator
102091

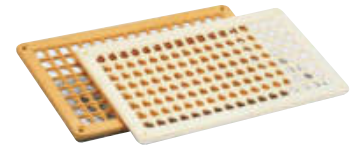

Grille vent
White 6.75" x 3.5" **103145**
Beige 6.75" x 3.5" **103156**



Dometic GY20 vent
A passive ventilator with easy push/pull closing action. Creates permanent ventilation to cut down condensation and musty smells
103202



Hit and miss vent and flyscreen
White 9.5" x 3.5" **103123**
White 9.5" x 6.5" **103134**



Interior louvre vent
White 6.75" x 3.5" **103038**
Brown 6.75" x 3.5" **103047**



Exterior louvre vent and flyscreen
White 9.5" x 3.5" **103083**
White 9.5" x 6.5" **103092**



Exterior louvre vent
White 9.5" x 3.5" **103011**
Brown 9.5" x 3.5" **103020**



MPK vent 5038
117mm diameter (overall)
109mm (vent)
103200



Exterior louvre vent
White 9.5" x 6.5" **103029**

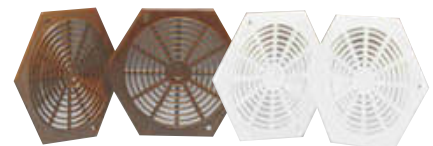

3" hexagonal vent -pair
White **103167** Brown **103178**
10 packs per outer

P

Kronings NORDIC air-conditioners

kronings

Very Powerful - Extremely quiet

Kronings NORDIC air-conditioning systems.

- **A2000** air-conditioner
- **K2400** air-conditioner with heat pump
- **K3400** air-conditioner with heat pump

WOW Great quality at affordable prices!

These powerful models are low weight, with very efficient, and very silent compressors compared to other products on the market. They are developed to cope with the very warm summer temperatures in Australia, and the very cold winters in the Nordic countries.

The compressor is specially made to be able to heat to your temperature setting with an outside temperature of -4°C, and an outside humidity of 40%, which is almost 10°C lower than other similar systems. They are designed to allow refilling of the cooling liquid. With other products on the market this can be difficult and costly, so Kronings air-conditioners have a longer life span compared to others on the market.

Specifications and key features

The reverse cycle heat pump roof top air-conditioner is a lightweight rooftop style unit.

A reverse cycle air-conditioner has unmatched efficiency and provides one of the most economical forms of heating. The K2400 & K3400 units provide both heating and cooling as well as filtered and dehumidified air.

Its lightweight design makes it suitable for a range of applications that the bigger units are unable to achieve.

The unit has many innovative features:

- **Compact Dimensions** makes it very versatile - internal dimensions 40cm x 40cm - the same as standard rooflights
- **Up to 70% more heat** than element type units by using a refrigerative heat pump
- **Ultra low profile** ensures less drag when towing and greater clearance under your carport or garage
- **Automatic de-ice setting** for low ambient heating operation.
- **Infra-red remote control**



A2000 / K2400



K3400

Model	A2000 COOLING ONLY	K2400 COOLING & HEATING	K3400 COOLING & HEATING
Power Supply	220-240V / 50Hz	220-240V / 50Hz	220-240V / 50Hz
Nominal Cooling	2.0kW	2.4kW	3.0kW
Nominal Heating	-	2.4kW	3.4kW
Unit Weight	30kg	31kg	48kg
Rooftop opening	400 x 400mm	400 x 400mm	400 x 400mm
Rooftop unit dimensions	1002 x 567 x 223mm	1002 x 567 x 223mm	1122 x 850 x 223mm
Interior unit dimensions	557 x 536 x 38mm	557 x 536 x 38mm	575 x 515 x 49mm
Power consumption (cool)	750W	920W	1410W
Power consumption (heat)	-	850W	1190W
Current consumption (cool)	3.3Amps	4.0Amps	6.1Amps
Current consumption (heat)	-	3.7Amps	5.2Amps
Part Number	102171	102172	102173

Roof top air conditioning units



WOW Aventa Compact - Powerful cooling. Why pay for heating twice. Save weight, money and power!



1. On/off
2. Mode
3. Fan speed
4. temperature selection
5. Clock
6. Sleep
7. Interior lighting
8. Timer
9. Resend
11. Reset



Aventa Compact

Aventa compact is designed to fit on the roof of any vehicle. In its performance class, it is also the lightest and quietest roof-mounted air conditioning system on the market. Of course, the cooling power is excellent.

Grey **102163B**
 Cream **102163A**

Aventa Compact Plus

With the same advantages as Aventa compact, Truma Aventa compact plus has even more cooling power. The vehicle reaches your desired temperature even faster.

Grey **102163CG**
 Cream **102163C**

Aventa Comfort

Powerful cooling, efficient heating. The Aventa comfort can do more than just powerful cooling. During spring and autumn, you can also use the roof-mounted air conditioning system with integrated heat pump as a heater. And it's extremely energy efficient.

Grey **102166B**
 Cream **102166A**

Model	AVENTA COMPACT COOLING	AVENTA COMPACT PLUS COOLING	AVENTA COMFORT COOLING & HEATING
Power Supply	230V	230V	230V
Nominal Cooling	1.7kW	2.2kW	2.4kW
Nominal Heating	-	-	1.7kW
Unit Weight	27.5kg	29.5kg	33kg
Rooftop opening	400 x 400mm	400 x 400mm	400 x 400mm
Rooftop unit dimensions	785 x 560 x 265mm	785 x 560 x 265mm	1008 x 660 x 248mm
Interior unit dimensions	556 x 496 x 46mm	556 x 496 x 46mm	670 x 523 x 46mm
Power consumption (cool)	645W	990W	965W
Power consumption (heat)	-	-	850W
Current consumption (cool)	2.8Amps	4.3Amps	4.2Amps
Current consumption (heat)	-	-	3.7Amps
Part Number Grey	102163B	102163CG	102166B
Part Number Cream	102163A	102163C	102166A



Optional sealing frame

For installing a Truma Aventa roof-mounted air conditioner. Ensures better sealing of existing holes from the removed rooflight and also assists roof stabilisation.

Reliably seals an area of 460 x 460 mm. **102169**

WOW Easy retrofit through 400 x 400 rooflight, especially with the optional sealing frame **102169**

Roof top air conditioning units

**Freshjet**1700
2200**102183**
102185

Remote control. The digital display shows the selected settings, such as temperature, blower speed, battery status, timer etc.

**FreshLight 2200**
102195

WOW FreshLight - The world's first roof air conditioner with integrated roof window with active ventilation system and single-pleated blackout blind

WOW Both the Freshjet and Freshlight have integrated LED lighting built into the inner frame.

Model	FRESHJET 1700 COOLING & HEATING	FRESHJET 2200 COOLING & HEATING	FRESHLIGHT 2200 COOLING & HEATING
Power Supply	220-240V / 50Hz	220-240V / 50Hz	220-240V / 50Hz
Nominal Cooling	1.7kW	2.2kW	2.2kW
Nominal Heating	0.8kW	1.2kW	2.7kW
Unit Weight	29kg	32kg	42kg
Rooftop opening	400 x 400mm	400 x 400mm	400 x 700mm
Rooftop unit dimensions	787 x 562 x 225mm	787 x 562 x 225mm	1105 x 758 x 210mm
Interior unit dimensions	555 x 470 x 45mm	555 x 470 x 45mm	880 x 550 x 53mm
Power consumption (cool)	620W	950W	950W
Power consumption (heat)	800W	1200W	1200W
Current consumption (cool)	2.7Amps	4.1Amps	4.1Amps
Current consumption (heat)	3.5Amps	5.2Amps	5.2Amps
Part Number	102183	102185	102195

Under bench air conditioning units



Truma Saphir Compact

Storage box system for smaller vehicles. Lightweight, low power consumption: The Saphir compact is ideal for small and medium-sized vehicles up to 5.5 metres long. The storage box system not only cools the air, but cleans and dehumidifies it at the same time.

102169C

Truma Saphir Comfort RC

Cooling and heating with one device Saphir comfort RC is designed to cool vehicles between 5.5 and up to around 6.5 metres long (more than 1 unit can be used). The device can also be used as a heater with heat pump – thanks to the reversible cooling circulation system. With a heat output of 1700 W, the system generates pleasant warmth, especially during spring and autumn.

102169D

Dometic FreshWell 3000

Conveniently housed in the under-bench storage area in motorhomes or caravans, this provides an efficient space-saving air conditioning solution for vehicles up to 8 m in length.

102197A

Model	TRUMA SAPHIR COMPACT COOLING	TRUMA SAPHIR COMFORT COOLING & HEATING	DOMETIC FRESHWELL 3000 COOLING & HEATING
Power Supply	230V	230V	230V
Nominal Cooling	1.8kW	2.4kW	2.7kW
Nominal Heating	-	1.7kW	3kW
Unit Weight	20kg	29.5kg	21kg
Unit dimensions	560 x 400 x 290mm	628 x 400 x 290mm	628 x 400 x 286mm
Power consumption (cool)	645W	965W	965W
Power consumption (heat)	-	850W	850W
Current consumption (cool)	2.8Amps	4.2Amps	4.3Amps
Current consumption (heat)	-	3.7Amps	4.8Amps
Part Number	102169C	102169D	102197A

Air distribution for under bench air conditioning



FreshWell 10m Ducting

Flexible hose for A/C systems, ø 60mm x 10m

102197B



FreshWell circular outlet

Circular air outlet grill kit for A/C systems ø 60mm

102197C



FreshWell Elbow

Underbench 90° elbow for ø 60mm FreshWell ducting

102197D

Consumables

THE WORK SHOP

WOW For workshop consumables please order in units of 1 to receive quantity in brackets.

**Brake cleaner**

500ml aerosols (6) **SAS2**
1 litre (12) **SAS81**

Zinc spray

500ml aerosols (6)
SAS24

Clear fine oil

500ml aerosols (6)
SAS56

Silicone spray

500ml aerosols (6)
SAS8

**White grease PTFE**

500ml aerosol (6)
SAS7

Copper grease

500ml aerosols (6)
SAS17

Clear grease

500ml aerosols (6)
SAS18

Silicone grease

500ml aerosols (6)
SAS19

Multi purpose EP grease

400g cartridges (12) **VC181**
5Kg tub **VC182**

**Easy flow HD cartridge gun**

Heavy duty for cartridges up to 400ml. Welded steel, epoxy-coated frame with zinc coated corrosion resistant sliding components.

TL885

**Rolson caulking gun**

Steel skeleton frame, handle with plunger and release lever. Suitable for most 310-380ml cartridges.

55 x 150 x 390mm.

Available singly or 12 per outer
107087

**Grease gun metal**

Metal bodied with extension pipe and 4 jaw coupler. 1/8" bsp 2.0cc/stroke. Withstands pressure to 10,000psi.

Takes 400g cartridges

TL922

Sprayers

**Chemical sprayer**

Not suitable for solvents including brake cleaner. 600ml **CAN8**

**Pressol chemical sprayer**

Heavy duty polyethylene. 750ml capacity.

Fully adjustable nozzle. Suitable for use with cleaning fluids, lubricants and penetrating agents **CAN3A**

**Solvent sprayer**

Polyamid pump with viton seals. Polyethylene, 1 litre container. Can be used with brake cleaner **CAN12**

Sealants & adhesives



WOW Approved by a host of leisure vehicle manufacturers



Dekaseal 8936

A permanently slightly sticky, non-hardening, sealant. Surplus amounts can be easily dabbed away, saving time and avoiding the risk of damaging side panels. Common uses are for sealing of windows, rooflights and overlaps and joints in vehicle construction. Excellent UV-resistance and ageing properties without any pre-treatment. Use Dekaseal for sealing any fixture that may have to be removed in the future for repair or replacement such as windows, access doors, rooflights and panel overlaps. 310ml cartridge
 Black **107025**
 Light Grey **107027**
 Available singly or 12 per outer



Dekasyll MS2

A multi-purpose adhesive / sealant. Based on MS polymer, it's ideal for fitting equipment such as solar panels, satellite systems, etc to vehicle roofs. It has very high U.V. stability and excellent performance with no need for a primer before application. Use Dekasyll for fitting equipment such as solar panels, satellite domes and TV aerials to vehicle roofs. Extremely high bond strength and elasticity. 290ml cartridge
 Black **107020**
 Grey **107021**
 White **107022**
 Available singly or 12 per outer



Dekasyll MS5

With the same finished properties as MS2 with a shorter curing process for use where a high grab strength is required.
 Black **107024**
 White **107023**
 Available singly or 12 per outer



Dekaphon 9735

An under body and wheel arch protection coating. It does not spray mist when applied, very good resistance to water and abrasion. Can be used on plywood, wood and metal. Use Dekaphon for enhancement and protection. Seals under-carriages and wheel arches, protecting against water ingress. Dekaphon 9750 can also be used as a primer for wood. 500ml aerosol Black **107038**
 Available singly or 12 per outer



Dekapur 2K-90

Flexible polyurethane plastic repair adhesive. Can be used on ABS, PMMA, wood, metals, PVC, Polyester and painted metal. Very fast cure, 5 minutes! Easy and cost effective repair. Use Dekapur for bonding sandwich panels and plastic repairs.
 50ml Black **107042**
 Available singly or 24 per outer

Sealant strips

W4 sealing strip

Formulated for the sealing and re-bedding of caravan and trailer tent fittings. Suitable for use on aluminium mouldings, overlap joints, awning rails, exterior lights, window surrounds, grab handles and most external trims.



2.5mm x 5m Retail packs

- 19mm Grey **107089**
- 19mm White **107092**
- 32mm Grey **107090**
- 32mm White **107093**
- 45mm White **107094**



2.5mm x 5m Workshop packs

- 19mm White **107119**
- 32mm White **107120**
- 45mm White **107121**

Sealants & adhesives



Sikaflex 512 caravan

Multi purpose non-sag elastic one-part sealant. Resistant to UV radiation, ageing and weathering. Bonds well to many substrates. 310ml cartridge
White **107082**
12 per outer



Sikaflex 221

Fast setting one part polysulphide adhesive and sealant. Hardens to a flexible rubber-like consistency. 310ml cartridge
White **107080**
Black **107081**
12 per outer



MK40

Polyurethane sealant and adhesive in one. 310ml cartridge
White **107079**
12 per outer



IDL mastic sealant

Non-drying bedding sealant. 380ml cartridge
Cream **107077** White **107078**
15 per outer



Hodgsons seamseal CV sealant

Non-drying bedding sealant. 380ml cartridge
White **107015**
Available singly or 24 per outer



Hodgsons silfix

Silicone sealant with many uses in and around the leisure vehicle e.g. sealing around toilets, shower trays etc. 310ml cartridge
White **107066** Clear **107067**
Available singly or 25 per outer

Adhesives and glues



Evo-stik impact

Instant contact adhesive. Multi purpose 30g **107145**
6 per outer



Araldite rapid adhesive

2x15ml tubes (2)
VC393



Araldite rapid adhesive

24ml syringe
VC394



SAS activator

Accelerates bonding of super glues. For use on PVCU, metal, glass and plastic. 200ml **SAS325**



Super glue

20g bottle
SAS4950



Bostik super glue

Original strong bond 3g
107150
12 per outer



SAS rapid epoxy

Repair compound for fast bonding of metals, glass, most plastics and other materials 24ml **SAS450**

Specialist Adhesives



Captain Tolley's
Formerly Creeping Crack Cure. Multi-purpose liquid sealant that finds and fixes leaks and seals hairline cracks. Compatible with all caravan building materials. Does not dissolve polystyrene
60ml **107290** 12 per outer



Geocel clear marine sealant
Permanently flexible and waterproof clear silicone rubber sealant. 78g tube
107005
6 per outer



AL-KO red sealant
Used for marking the nut position **107008**



Delamination kit
Floor fix 1.5Kg 2 part low odour epoxy adhesive is supplied with a 2.6ltr bucket for mixing, a pack of 20 (approx.) bungs and a syringe for application
107010

Tapes and packaging



Clear stretchfilm pallet wrap
Clear 400mm x 300 metres **203034**



Black stretchfilm pallet wrap
Black 400mm x 300 metres **203035**



Airsafe bubble wrap
1.5 metres x 100 metres
203036

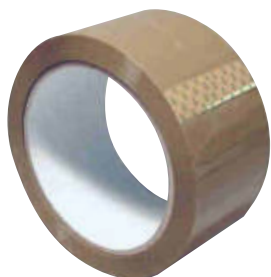

Carton sealing tape
50mm x 66 metres
6 per outer
203031



Fragile sealing tape
50mm x 66 metres
6 per outer
203030



Sealing tape gun
Tape dispenser
203033



Duct tape
Multi-purpose heavy duty tape for indoor or outdoor use.
10 metres silver.
24 per outer
107316



Gaffa tape
Multi-purpose heavy duty tape for indoor or outdoor use. Silver
Available singly or 24 per outer
50 metres **107315**



Double sided adhesive foam tape
Green backing. General purpose tape. Suitable for interior and exterior use.
25mm x 10 metres **VC404**

Double sided tape
Non-foam type.
12mm x 50 metres **VC406**
25mm x 50 metres **VC408**

PTFE tape (10)
12mm x 12 metres
GLU5

Q

Workshop cleaning

**Optimum ProWipers
ResourceRag Textured**

A viable alternative to white wiping rags, the ResourceRag is clean, fresh and made to a monster size giving the user a 'real handful' for any wiping application. ResourceRag is chemical free and strong wet or dry. One case of ResourceRag is equivalent in wiping area to 3 x 10kg sacks of rags. 100 rags (460 x 380mm) per box
098212

Perform Tufwipe smooth

White 1 ply, 400 sheets per roll
21cm x 40cm sheets
1 pack = 2 rolls
098210

Toilet Rolls

White 2 ply luxury quilted.
1 pack = 40 Rolls
098220

Hand gel red beaded
5 litres
VC505

Centre-feed blue wipers

Blue 2 ply, 19cm x 150m
1 pack = 6 rolls
098204

Blue paper wipers

Blue 2 ply, 26cm x 400m
1 pack = 2 rolls
098208

Clips and ties

Hellermann cable ties

Black 100 per pack T30R
150mm x 3.5mm **ECT35**
100mm x 2.5mm **ECT81**

Cable clips

Self adhesive 50 per pack
8mm **EAC2**
14mm **EAC3**

P clips

4.8mm 100 per pack
6.0mm 100 per pack
9.0mm 100 per pack
12.0mm 100 per pack
19.1mm 50 per pack

EAC405
EAC406
EAC409
EAC412
EAC419

Eurolok cable ties

Silver-grey 100 per pack
295 x 4.8mm **ECTG53**
370 x 4.8mm **ECTG57**

Cable tie base

Self adhesive with 2 screw holes.
50 per pack
4.8mm **EAC4**

'O'-clips

Double ear 25 per pack
11-13mm **OC3**
13-15mm **OC4**
15-18mm **OC5**

Assortment boxes



'O' rings metric
404 pieces
AB100



'O' rings metric
325 pieces
AB81



Heat shrink tubing
50mm lengths 172 pieces
AB103



Heat shrink tubing
200mm lengths 30 per pack
AP33



Repair washers
240 pieces
AB22

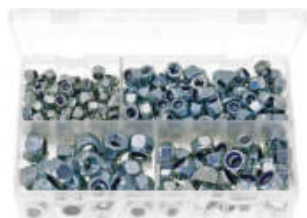

Nylon lock nuts metric
300 pieces
AB15



Split pins
1000 pieces
AB32



Grommet assortment
Black PVC. 140 pieces.
Includes: 30 x 6.4mm, 8.0mm & 9.5mm, 20 x 11.0mm & 12.5mm, 4 x 15.9mm and 3 x 22.2mm & 25.4mm.
6 per outer **105564**

Screws, rivets etc.



Self tapping screws
Counter sunk . Pozi- Zinc
200 per pack
No.6 5/8" 16mm **HTC6/5**
No.6 3/4" 19mm **HTC6/6**
No.6 1" 25mm **HTC6/8**
No.6 1 1/2" 38mm **HTC6/12**
No.8 5/8" 16mm **HTC8/5**
No.8 3/4" 19mm **HTC8/6**
No.8 1" 25mm **HTC8/8**
No.8 1 1/2" 38mm **HTC8/12**



Pan head screws
Pozi - stainless steel
200 per pack
No.6 x 1/2" 13mm **HTA6/4**
No.6 x 3/4" 19mm **HTA6/6**
No.6 x 1" 25mm **HTA6/8**
No.8 x 1/2" 13mm **HTA8/4**
No.8 x 3/4" 19mm **HTA8/6**
No.8 x 1" 25mm **HTA8/8**



Repair washers
Zinc. M6 x 19mm.
Inside \varnothing 1/4" x outside \varnothing 3/4"
200 per pack
HRW14



Steel rivets
Standard flange 100 per pack
4.8 x 12mm **PRS4**
4.8 x 16.5mm **PRS5**

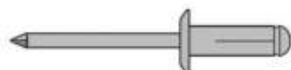

Peel back rivets
100 per pack
4.8 x 12mm **PR47**
4.8 x 19mm **PR48**



Split pins
500 per pack 3/32" x 1 1/2" **HSP4**
250 per pack 5/32" x 1 5/8" **HSP12**

W4 fixings range

'Pack-it' stand complete with 10 of 24 items Part no. **103470**
All supplied 10 packs per outer



W4 Counter sunk screws
Counter sunk - Pozi
Stainless steel
5 per pack 10 packs per outer
No.4 1/2" 13 x 2.9mm **103432**
No.6 1/2" 13 x 3.5mm **103433**
No.6 3/4" 19 x 3.5mm **103434**
No.6 1" 25 x 3.5mm **103436**
No.8 3/4" 19 x 4.2mm **103435**
No.8 1" 25 x 4.2mm **103437**
No.10 3/4" 19 x 4.8mm **103444**
No.10 1" 25 x 4.8mm **103438**



W4 Pan head screws
Pan head - Pozi
Stainless steel
5 per pack 10 packs per outer
No.4 1/2" 13 x 2.9mm **103418**
No.6 1/2" 13 x 3.5mm **103419**
No.6 3/4" 19 x 3.5mm **103420**
No.6 1" 25 x 3.5mm **103422**
No.8 1/2" 13 x 4.2mm **103439**
No.8 3/4" 19 x 4.2mm **103421**
No.8 1" 25 x 4.2mm **103423**
No.10 3/4" 19 x 4.8mm **103441**
No.10 1" 25 x 4.8mm **103424**



Screw Covers (5)
Plastic. To fit screw size
6 to 8, 4.2mm, Beige
103447



Cavity fixer rubber (2)
Standard **103429**
Long **103431**



Polytop Pins (10)
25mm **103428**



Cavity fixer metal (2)
103430

Bulbs



Side & tail bulb
BA15s single contact
10 per pack
Carlex bulbs
5w **EB207**
10w **EB245**
Ring bulbs
10w **ER245**

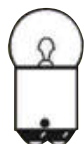

Side & tail bulb
BA15d double contact
10 per pack
Carlex bulbs
10w **EB209**



Capless bulb
W2 x 4.6D
10 per pack
Carlex bulbs
1.2w **EB286**



Stop/flasher bulb
BA15s single contact
10 per pack
Carlex bulbs
21w **EB382**



Stop/tail & daylight running bulb
BAY15d double contact
10 per pack
Ring bulbs
21/5w **ER380**

Cable connectors

Yellow fits 4 to 6mm² \varnothing cable - **Blue** fits 1.5 to 2mm² \varnothing cable - **Red** fits 0.5 to 1.5mm² \varnothing cable



Push-on female
100 per pack
Blue 6.3mm **ET7**
Yellow 9.5mm **ET12**



Insulated female
100 per pack
Red 6.3mm **ET9**
Blue 6.3mm **ET10**



Push-on male
100 per pack
Red 6.3mm **ET36**
Blue 6.3mm **ET37**



Heat shrink butt connectors
Adhesive lined
25 per pack
Blue 5mm **ET92**



Bullets
100 per pack
Blue 5mm **ET16**



Receptacle socket
100 per pack
Blue 5mm **ET19**



Butt connector
100 per pack
Red 3.3mm **ET33**
Blue 4.0mm **ET34**
Yellow 5.5mm **ET35**



Ring terminals
100 per pack
Blue 6.4mm **ET26**
Yellow 8.4mm **ET30**
Yellow 10.5mm **ET32**



Terminal blocks
12 way 10 per pack
15amp **ETB15**
30amp **ETB30**



Copper tube terminals
10 per pack
35mm x 8mm **ET73**
35mm x 10mm **ET74**



PVC insulation tape (10)
Electrical insulation tape. Black. Flame retardant to BS 3924 1980 Category 2.
19mm x 20 metres
EPT1

Relays Electrically operated switch that can be used to isolate the auxiliary battery from the vehicle battery.



12v 20/30A
Normally open contact
ERL7



12v 40A
Normally open contact
ERL11



Fuses



Standard blade fuses
50 per pack
3amp **EFX3**
5amp **EFX5**
7.5amp **EFX7.5**
10amp **EFX10**
15amp **EFX15**
20amp **EFX20**
25amp **EFX25**

Tools

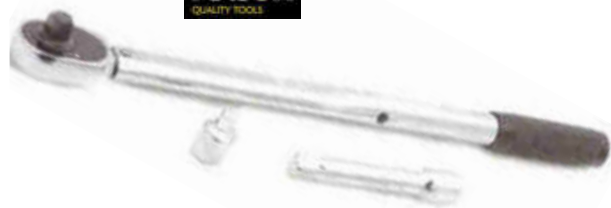

Torque wrench 1/2" drive

- Heat treated steel ratchet head.
 - Fully hardened and tempered.
 - Chrome plated for corrosion resistance.
 - Micrometer type torque range adjustment with flip reverse ratchet mechanism.
 - Range 27-200 Nm, 20-150ft.lb. Length 465mm
- Available singly or 10 per outer **105535**



Mini trifold tool kit (26 pieces)

Contents: 10 x 25mm bit assortment, magnetic tip screwdriver bit handle, mini long nose pliers, mini side cutting pliers, tweezers, 4 x 1/4" Dr sockets, 75mm extension bar, 6 x precision screwdrivers, and hard case. Available singly or 40 per outer **105573**



Jobber twist drill bits

HSS "sprint" DIN 338

10 per pack	
1mm	DRM1
1.5mm	DRM1.5
3mm	DRM3
5mm	DRM5



Emery roll

Blue twill. 50mm width 80 grit.
50 metre roll
WER30



Tape measure with rubber cover

Automatic blade lock, push button retrieval, and belt clip.
12 per outer
5m x 19mm **105539**
7.5m x 25mm **105540**



Stubby screwdriver set (38 pieces)

Consists of stubby ratchet screwdriver. Sizes include Star T10, T15, T20, T25, T27, T30, T40. Square 1, 2, 3. PZ0, PZ1, PZ2 x 2pcs, PZ3. PH0, PH2 x 2pcs, PH3 Hex H2, 3, 4, 5, 6, 1/8", 5/32", 3/16", 7/32", 1/4" Slot 3, 4, 5, 6, 7mm.
6 per display outer
105516



Screwdriver set (4 pieces)

Manufactured from carbon steel, with plastic handles. 1 x 75mm slot 5, 1 x 38mm slot 6, 1 x 75mm crosspoint PH1, and 1 x 38mm crosspoint PH2.
20 per display outer
105510



Cushion handle screwdriver set (2 pieces)

Consists of: 1 x 100mm crosspoint PH2 and 1 x 100mm slotted 6. Manufactured with Chrome Vanadium shaft and soft cushion grip.
10 per display outer
105517



8" combination plier

Drop forged. Fully polished heads. Double dipped cushion handles. Length 200mm.
10 per display outer
105527



Side cutting pliers

Drop forged. Fully polished heads. Double dipped cushion handles. Length: 180mm.
20 per outer
105531



7" eyelet plier set

Designed to punch and secure eyelets into many materials including sheeting, tarpaulins, and cloth. Complete with 100pc x 7mm eyelets. Length 190mm.
10 per display outer
105502

Q

Tools

**Trimming knife**

Metal bodied, heavy duty with snap-off 18mm blade **TL675**

**Trimming knife blades only**

Snap-off 18mm for TL675. 10 blades per pack, 10 packs per outer **TL666**

**Blade dispenser**

With 100 heavy duty blades **TL658**

**Safety utility knife**

Spring activated blade that automatically returns to case after use. 12 per outer **105545**

**10" adjustable wrench**

Drop forged. Heat treated steel. Fully polished jaw faces. Rubber dipped comfort grip handle. 6 per display outer **105533**

**Hex key set (10 pieces)**

Chemically blackened. Sizes 1.5, 2, 2.5, 3, 4, 5, 5.5, 6, 8, and 10.0mm. Available singly or 10 per outer **105550**

Push Locks

**Push lock**

With one side opening. Cupboard catch opens from outside only
White **103500**
Brown **103502**
Matt Nickel **103504**

**Mini push lock**

With one side opening. Cupboard catch opens from outside only
White **103522**
Brown **103524**
Matt Nickel **103526**

**Push lock double**

With dual side opening. Toilet door catch opens from both sides
White **103512**
Brown **103514**

**Button and rose**

Button 23mmØ x H 19mm
Rose 38mmØ x H 7.5mm
Chrome **103528**
Brown **103530**
Brass **103532**
Matt Nickel **103534**

**Mini button and rose**

Button 16mmØ x H 16mm
Rose 24.5mmØ x H 7mm
Matt Nickel **103536**
Brown **103538**

Catches, hinges and fasteners

WOW All packaged with Grove logo
10 packs per outer



Nylon door retainer
104002



Viva door retainer
104004



Plastic door retainer
104011



Stable door catch
Beige 104015



Turn button, spacer & striker
Beige 104030
Ivory 104033



Plastic turnbuckle
104037



Metal turnbuckle
104048



Stable door bolt
104176



Roller catch
Brown 104106
White 104107



Double roller catch (2)
104108



Sliding door gliders
5 per pack 104835T



External catch
Available singly 104790



Metal cupboard hinge
104200



Metal overhead stay
Offset for overlapping doors
104202



Cupboard stay
150mm 104301

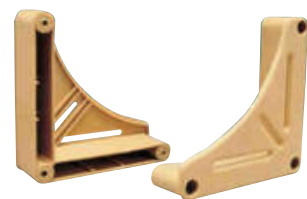

Table storage bracket (2)
104187



Flush hinge (2)
Bronze 2" (50mm)
104220



Plastic flap hinge (2)
104209



Cranked flush hinge (2)
50mm 104222



Kitchen flap support bracket 104323

Q

Door retainers



Door holder Grey
104014

Lever release
Black 104797
Grey 104796
White 104795

Quick release barrel
Black 104798
Grey 104798G

Hinged veneta door retainer
104803H

W4 Catches and water fittings

All supplied 10 packs per outer unless otherwise stated



Nylon door retainer
104801

Plastic door retainer
104802

Veneta door retainer
104803

Viva door retainer
104848

Extended Viva door retainer
104847



Magnetic catch
104823



Magnetic catch heavy duty
104824



Double roller catch (2)
Brown
104817



Rocker catch
White
104818



Panco catch
White
104819



Roller catch
Brown
104821



Mini latch
104822



Plastic turnbuckle
104810



Metal turnbuckle
104811



Glider for sliding door
Brown
104835



Plastic hinge (2)
Brown 1 3/4" (45mm)
104825



Flush hinge (2)
2" Bronze 50mm
104826
1 1/2" Brass 38mm
104844



Cranked hinge (2)
2" Bronze 50mm
104827



Push-in vent (2)
Beige 104815



Hexagonal vent (2)
Beige 104816

W4 Catches and water fittings

All supplied 10 packs per outer unless otherwise stated



Snap retainer lock
Beige 104001
Light grey 104001LB



Cupboard door catch
104302



Push button mini catch
104112



Lever operated mini catch
104109



Mini catch Strike Plate
11mm 104110
15mm 104111



Cupboard door stops (12)
104871



Suction cup and hook (2)
2 per pack 104859



Sink Waste plugs (2)
1 1/2" 051076
Universal self seating 051077



Waste strainer
Chromed 051078C
White 051078



Target leveller
Adhesive 007297



Sink top retainer 104812
Universal tap connector 104845



Pipe clip (5)
1/4" (6mm) 104828
5/8" (16mm) 104829
3/4" (19mm) 104830
1" (25mm) 104831
1 1/4" (31mm) 104809



Hose clip (2)
000(8-16mm) 104832
00 (12-22mm) 104833
0X (16-27mm) 104834
1X (25-45mm) 104836



Elbow connector
1/2" (12mm) 104805



Hose reducer
3/8" x 1/2" (10 x 12mm)
104837



Y connector
1/2" (12mm) 104839
3/4" (19mm) 104842
28.5mm 051139*



Hose connector
1/2" (12mm) 104838
3/4" (19mm) 104841



T connector
1/2" (12mm) 104840
3/4" (19mm) 104843



Combination padlock
104813



Air bed plugs
109480



Hose sealing sleeve
23.5mm 104806
28.5mm 104807



Turnbuckle set
104870



Turnbuckle spacer
104869

Q

W4 Catches and water fittings

All supplied 10 packs per outer unless otherwise stated



Double roller catch
Metal 104857



Pegaline catch
104856



Barrel hinge (2)
104867



Table support catch
104855



Lock cover (2)
104854



Flush hinge
Brass 2" (50mm)
104862



Cranked flush hinge (2)
Brass 2" (50mm)
104863



Flush hinge with finials (2)
Brass 2" (50mm)
104864



Flush hinge with finials (2)
Bronze 2" (50mm)
104865



Nylon hinge (2)
2" (50mm)
104868



Cupboard stay
150mm 104846



Metal cupboard stay
140mm 104853



Locker stay (1)
130mm 104861



Wardrobe rail support end (2)
5/8" (16mm)
104850



Brass bolt
2" (50mm)
104872



Brass necked bolt
2" (50mm)
104873

Awning rail



Aluminium awning rail
4mm opening. 9mm internal diameter, 12mm external.
10 lengths per outer
1.55 metre lengths **105099A**
2.12 metre lengths **105099**
2.7 metre lengths **105099B**



Plastic awning rail
Pre-drilled 2.5 metre lengths
10 lengths per outer
105088



Fiamma rail
1 piece 3 metre length
108313E

Blind and rooflight spares



Remis insert type 2
105212



Remis end cap
Left 105202
Right 105204



Remis end cap covers
105206



Remis clip grey
Closing clip for Remismart
105200



Remis repair kit
105214



Remis mechanism (2)
105208



Remis spring mechanism
105216



Remis mechanism end supports
105218

Window blind spares



Seitz end cap covers
105231



Rail end
Left 105248
Right 105250



End piece
105240



Retaining hook
105252



Long blind lock
105232



Blind lock
105254



Blind slider & catch
105363



Spring 285mm
105242



Long handle
105226



Clip beige
105244



Mechanism (end)
105236



Retaining knob
105224



Window fittings and accessories

How to measure

Stay lengths are found by measuring between points A and B as shown here.

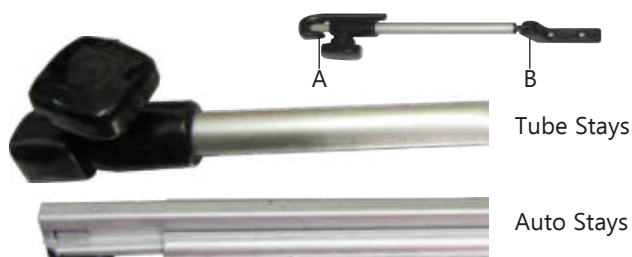

Blister packed

All Polyplastic window stays are sold blister packed in pairs unless otherwise stated.



Fittings for screw on Screw on lever lock end detail



Polyfix lever lock end detail

Screw on perma fix end detail

polyfix perma fix end detail

Screw on fittings

Supplied in pairs and with fittings where indicated

Tube stays with lever lock & fittings

Size	Grove no.
200mm	105300
300mm	105303

Auto stays with lever lock & fittings

Size	Grove no.
230mm	105305
280mm	105308

Auto stays with perma-fix end

Size	Grove no.
210mm	105312
300mm	105315



Lever lock catch screw on
105322

Polyfix fittings

Supplied in pairs unless otherwise stated

Tube stays with lever lock

Size	Grove no.
200mm	105350
300mm	105353

Tube stays with perma-fix end

Right hand stay only

Size	Grove no.
140mm	105360

Auto stays with lever lock

Size	Grove no.
230mm	105355

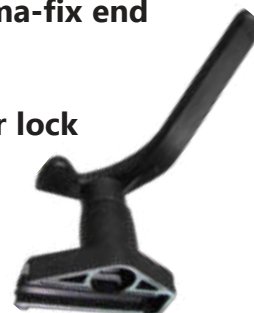

Lever lock catch Polyfix
105372

Othe Window Accessories



Pop-out window stay
105318

Supplied as packed singles with all fittings



Lock plate (2)
Large 105326
Small 105324



End caps Polyplastic (2)
Loose, black
105398

Curtain track and fittings

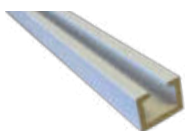

Sprint Track (3m)
5 lengths per outer
105011A



Sprint Gliders (20)
10 packs per outer
105033



Sprint End stops (2)
10 packs per outer
105044



Sprint Curtain hooks (25)
20 packs per outer
105055



Nylonglyde Track (3m)
5 lengths per outer
105067



Nylonglyde Brackets (5)
10 packs per outer
105069



Nylonglyde Gliders (10)
20 packs per outer
105068



Nylonglyde End stops (2)
10 packs per outer
105080



Nylonglyde Curtain hooks (25)
20 packs per outer
105055



Silent gliss Track Top fix (2m)
5 lengths per outer
105071



Silent gliss Track Face fix (2m)
5 lengths per outer
105070



Silent gliss Gliders (25)
10 packs per outer
105072



Silent gliss End stops (2)
10 packs per outer
105074



Silent gliss Curtain hooks (25)
10 packs per outer
105073



Visa Top track (2m)
5 lengths per outer
105005



Visa Bottom track (2m)
5 lengths per outer
105006



Visa Pop-it tape
25m roll **105009**
200m roll **105010**



Visa End stops (2)
20 packs per outer
105007

Panel Trims



Panel trim 15mm
With single lip. Supplied in 10m lengths
Brown **105184**
Grey **105186**



Sealing panel trim 15mm
With sealing rubber. Supplied in 10m lengths
Brown **105188**
Grey **105190**



Door sealing panel trim 15mm
With sealing bubble for doors. Supplied in 10m lengths
Brown **105192**
Grey **105194**



Corner trim 16mm
2.2m lengths
Brown **105196**
Grey **105198**

Table strip



Two part table strip
length 600mm
105167

Window trim



White plastic supplied in 10m rolls. Please note that the trim is measured by the size of the wood that the trim fits over and not the size of the trim.
30mm - 1 1/5" **105130**
35mm - 1 2/5" **105135**
39mm - 1 1/2" **105139**
45mm - 1 3/4" **105145**

Battery box seal



Supplied in 2m lengths.
Complete with mastic.
105170

Steps



Single step

Rigid metal based step, light in weight but sturdy construction.
H260mm x W395mm x Overall depth 415mm.
Capacity 150kg maximum total load.
Available singly or 10 per outer **106198**



Double step

Rigid metal based step, light in weight but sturdy construction.
H350mm x W440mm x Overall depth 760mm.
Capacity 150kg maximum total load.
Available singly or 5 per outer **106211**

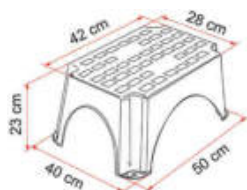

Fiamma step grey

The classic step for caravans and motor homes, made of UV-resistant HD Polythylene for more stability and strength. Non skid surface. Approved to hold 150kg.
106201G

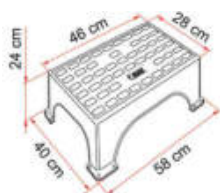

Fiamma magnum step

Oversized and reinforced step. HxWxD 24 x 58 x 40cm. Top surface - 46x28cm. Approved to hold 200kg. Colour platinum.
Available singly or 10 per outer **106201P**

Step accessories



Via Mondo step feet (4)

Helps to spread the weight of caravan steps or furniture to protect the groundsheet and prevent sinking into soft ground. Pegging holes also prevents the step from moving.
30mm x 80mm Ø
106221



Fiamma LED step light 12v

Low consumption lighting system for the entrance of the motor home, to increase safety of the steps and step wells. Made from anodized aluminium, it can be shortened from 50 to 23 cm
106204



AVAILABLE TO ORDER

Fiamma step mat magnum

Made from soft and flexible anti-skid UV resistant rubber.
Dimensions 45 x 27cm
106205



Fiamma clean step

Can be adapted to step sizes: Min 38x40cm to Max 45x40cm.
Green **106213**
Black **106214**

Table leg systems



Fiamma table leg system

The 70cm table leg is made from sturdy anodised aluminium – the leg can be cut to reduce height. It is supplied with two plastic caps. The above floor and recessed bases are also aluminium and supplied with self-threading fixing screws. There is also a reinforced and more stable tripod base for outside use.

- Table leg 70cm aluminium **106001**
- Above floor base aluminium **106024**
- Recessed base aluminium **106036**
- Cap for recessed base **106038**
- Tripod base brown **106039**
- Table leg adaptor tube pro **106002**



Island table leg system

- 26" stainless steel **106004**
- 28" stainless steel **106005**



Island leg clip

106093



Recessed base

106035



Above floor base

106034



Free standing table legs

Folding table leg, powder coated steel 660mm high. Square section. Singly or 5 per outer
Silver sand **106091**
Brown **106092**



Folding table leg

Tubular steel leg 26". Singly or 5 per outer **106099**



Single table leg

27" but can be cut to size required. Singly or 5 per outer **106115**



Folding step stool

Stool is designed to fold flat for easy carrying and storage, with a capacity up to 200lbs, also very sturdy and robust. Singly or 12 per outer **106220**

Exterior ladders

WOW Non-skid steps



Sturdy and lightweight high quality exterior ladders.

- 30mm diameter, 2mm thick tubes in anodized aluminium
- Inside width: 28cm
- Total step width: 35cm

Ladders Deluxe 8 and 5D can be folded up while travelling.

Ladder DJ is supplied with fixing bars for easy and quick installation on the rear door. It can be combined with Carry-Bike DJ.

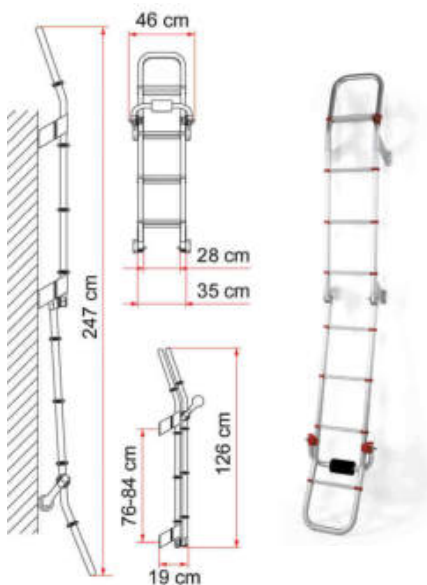

Deluxe 8 ladder

Anodized aluminium ladder with 8 steps.

It can be folded up while travelling.

Weight 5.5kg.

106227

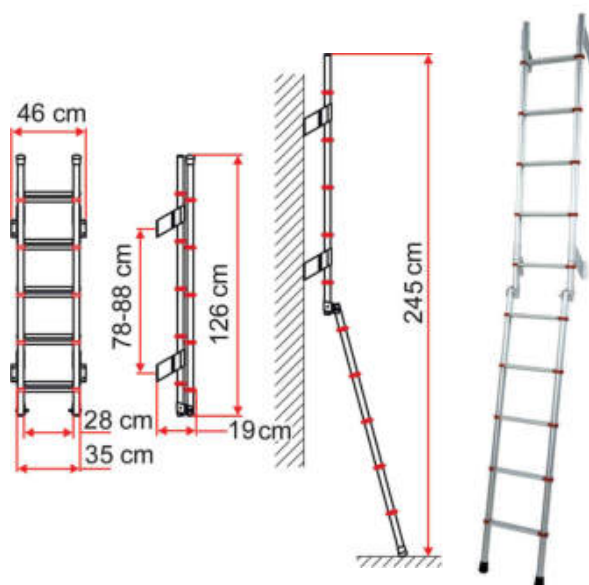

Deluxe 5D ladder

Anodized aluminium ladder with 10 steps.

It can be folded up while travelling.

Weight 4.9kg.

106225

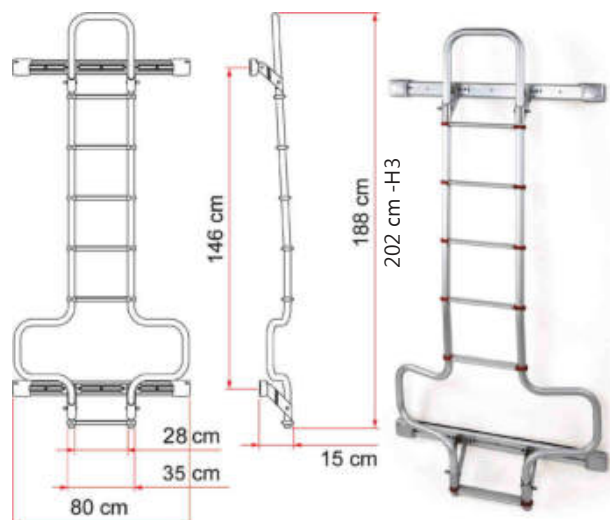

Deluxe DJ ladder

Anodized aluminium ladder with 6 steps.

Weight 6.5kg.

Deluxe DJ **106228**

Deluxe DJ H3 **106228A**

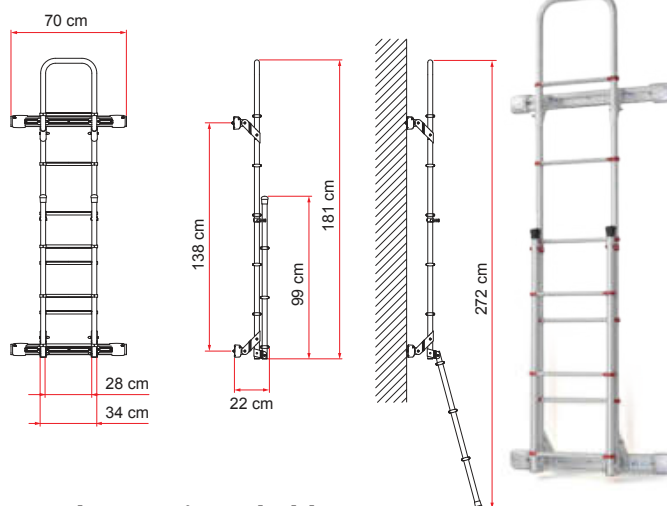

Deluxe sprinter ladder

Anodized aluminium ladder with 8 steps.

It can be folded up while travelling. Weight 7kg.

106336M

Interior ladders

R

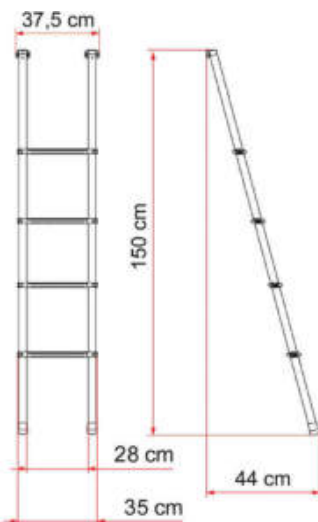

Deluxe 4B ladder

High quality aluminium ladder with 4 steps for mansard roofs and sleeping berths.
Weight 2.4kg.
106223

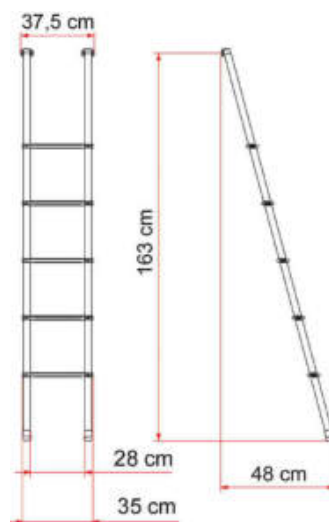

Deluxe 5B ladder

High quality aluminium ladder with 5 steps for mansard roofs and sleeping berths.
Weight 2.6kg.
106224

Safe ladder

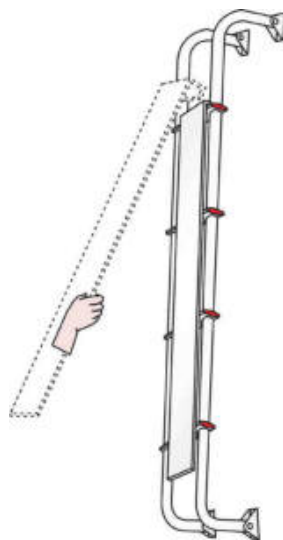

Double Step



Single Step



Sturdy anti-theft safety plate for your motorcarvan ladder. Suitable for single and double steps. Delivered as standard with locks and key.
Dimensions 23 x 78cm. Weight 1.3kg
106229

Note: Ladder not included

Thermal screen protectors



All-season thermal windscreen covers

- Made with PVC film bonded to a thin foam
- Opening panels to allow in the light (Luxe models)
- Won't wrinkle or tear
- Easy to roll up and store
- Easy to fit and remove
- Ultra-quick wipe clean and dry
- Reduces condensation
- 2 year Guarantee

Grove No.	Model	To Fit
106900	Standard	Peugeot / Fiat / Citroen June 1993 onwards
106901	Standard	Peugeot / Fiat / Citroen June 2006 onwards
106902	Standard	Ford Transit June 2006 onwards
106903	Standard	Ford Transit June 2014 onwards
106904	Standard	Mercedes June 2006 onwards
106905	Standard	Renault Master June 2010 onwards
106906	Standard	VW T5 June 2002 onwards
106907	Luxe	Peugeot / Fiat / Citroen June 1993 onwards
106908	Luxe	Peugeot / Fiat / Citroen June 2006 onwards
106909	Luxe	VW T5 June 2002 onwards

Thermal screens are fixed using sucker pads with tongue for easy removal. The suckers can be screwed to leave the sucker permanently in place. They fix around wing mirrors using buckles. The range will fit a wide variety of makes and models.

HTD Caravan Covers



Full caravan covers

Superior heavy duty breathable 4 ply material allows condensation to evaporate
 Outer layer - durable non-woven to give UV and water resistance, but with breathability
 2nd layer - Treated non-woven to give UV protection and strength
 3rd layer - PE film, enables the cover to breathe but helps with water resistance
 Inner layer - Extra soft non-woven material to protect the vehicle's paintwork

- Easy to fit (fitting instructions included)
- Ideal for winter storage
- UV stable
- Nylon straps for a secure fit
- Elasticated hem for a tailored fit
- Storage bag included
- 2 YKK zips either side for easy access
- 12 months warranty

Standard		
Part No.	Length	Imperial Size
106754	Up to 450cm	Up to 14'9"
106755	450 to 500cm	14'9" to 16'4"
106756	500 to 550cm	16'4" to 18'0"
106757	550 to 600cm	18'0" to 19'8"
106758	600 to 650cm	19'8" to 21'3"
106759	650 to 700cm	21'3" to 22'11"
106760	700 to 750cm	22'11" to 24'7"

233cm wide

253cm wide

Extra wide		
Part No.	Length	Imperial Size
106761	Up to 650cm	19'8" to 21'3"
106762	650 to 700cm	21'3" to 22'11"
106763	700 to 750cm	22'11" to 24'7"
106764	750 to 800cm	24'7" to 26'2"

213cm wide

Extra narrow		
Part No.	Length	Imperial Size
106750	Up to 450cm	Up to 14'9"
106751	450 to 500cm	14'9" to 16'4"
106752	500 to 550cm	16'4" to 18'0"
106753	550 to 600cm	18'0" to 19'8"



Storage bag included

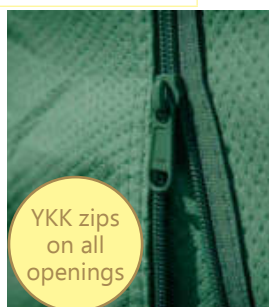

YKK zips on all openings



Buckled straps for a secure fit

HTD Motorhome Covers



Motorhome covers

Superior heavy duty breathable 4 ply material allows condensation to evaporate

- Outer layer - durable non-woven to give UV and water resistance, but with breathability
- 2nd layer - Treated non-woven to give UV protection and strength
- 3rd layer - PE film, enables the cover to breathe but helps with water resistance
- Inner layer - Extra soft non-woven material to protect the vehicle's paintwork

- Easy to fit (fitting instructions included)
- Ideal for winter storage
- UV stable
- Nylon straps for a secure fit
- Elasticated hem for a tailored fit
- Storage bag included
- 2 YKK zips either side for easy access
- 12 months warranty

Motor home covers		
Part No.	Length	Imperial Size
106765	Up to 550cm	Up to 18'0"
106766	550 to 600cm	18'0" to 19'8"
106767	600 to 650cm	19'8" to 21'3"
106768	650 to 700cm	21'3" to 22'11"
106769	700 to 750cm	22'11" to 24'7"
106770	750 to 800cm	24'7" to 26'2"

240cm wide



Storage bag included

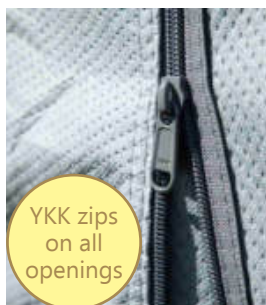

YKK zips on all openings



Buckled straps for a secure fit

HTD Mirror Protectors



Protect-it

Protect your wing mirrors as well as your wallet. Protect, upgrade, customize!

- Helps to prevent damage to wing mirrors. Improves the appearance of the vehicle, covers existing damage with a professional gloss lacquer finish.
- Easy to fit, simply stick on to the mirror housing without the need for any additional tools. Extra strong double-sided permanent adhesive tape for protection against theft
- Impact resistant up to 90kmph against stationary and moving objects
- Set of 2



For Fiat Ducato, Peugeot Boxer and Citroen Relay (Jumper) models manufactured after 2006

Coachbuilt (motorhome) version for long arm mirrors

- White **120171W**
- Black **120171B**
- Chrome **120171C**

Utility (campervan) version for short arm mirrors

- White **120170W**
- Black **120170B**
- Chrome **120170C**

S



Accessories



Motorhome dirt skirt

Keeps the rear of the motor home including windows and cycles clean, protecting against dirt, splashes and slush. Kit contains 2 lengths of dirt skirt 122cm wide x 57cm deep
106400



W4 Hi-vis cargo straps

A pair of highly visible, quick to use velcro straps. Simply thread the strap through the nylon buckle, adjust to size and fasten it back on itself. Length 400mm
109514



W4 Cargo straps

A pair of retaining straps (3m approx) with durable nylon grip-lock buckles - won't mark or scratch
109513

Fiamma covers



Cover Premium M

For motor homes up to 7.1m long
Dimensions 7.16 x 2.59 x 2.74m
Weight 10kg
106870A

Cover Premium L

For motor homes up to 8m long
Dimensions: 8.08 x 2.59 x 2.74m
Weight 11kg
106872A



Fiamma Cover Top

Sturdy and hard wearing cover made with UV resistant and heavy duty vinyl to protect the motor home from dirt and sun. Easy to tighten using ropes or elastic cords (not included). Reinforced corners and tie down grommets.
Dimensions: 8.5 x 5.2m.
Weight 6kg
106875



Fiamma Thermoglas XXL Ducato

For Fiat Ducato after 06/2006
Weight 11kg
106466



Fiamma Wall Cabin

For fiat Ducato after 06/2006
Dimensions: 182 x 150cm
Weight 1.8kg
106470



Rear Door Cover

Fiat Ducato 106893

(Citroën Jumper, Peugeot Boxer and Mercedes Sprinter high roof after 06/06) Comes with: Double rail, awning with sides and front panel, rafter for increased stability and an elastic tension kit

VW T5 106895

Comes with: Set of floor poles, complete enclosure, set of pegs and an elastic tension kit.

Canopy poles 106897

Set of aluminium poles to extend the door



Fiamma Coverglas XL Ducato

For Fiat Ducato after 06/2006
Weight 3.5kg
106465







































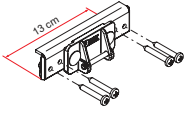
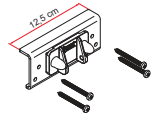

Fiamma Draught skirt

- 1** Motorhome: L 550cm H 60cm
- 2** Caravan: L 450cm H 60cm
- 3** VW T5/T6: L 250cm H 42cm
- 4** Fiat Ducato: L 397cm H 55cm
- 5** VW T5/T6 Rear
- 6** Fiat Ducato Rear

- 109505**
- 109504**
- 109506**
- 109507**
- 109506A**
- 109507A**

Fiamma spare parts

Carry-Bike

 <p>106379 98656-290 Hand wheel</p>	 <p>106376 98656-582 Bike block reduction</p>	 <p>106378 98656-246 Anti scratch</p>	 <p>106385 98656-071 Tap washer red</p>
 <p>106391 98656-671 Nut cover M6</p>	 <p>106391A 98656-562 Nut & knob kit M5</p>	 <p>106365K 98656-765 Red knob M6</p>	 <p>106382 98656-378 Rack holder grey</p>
 <p>106386B 98656-328 Rail quick blue 128cm</p>	 <p>106377 98656-079 Rail end cap red</p>	 <p>106387F 98656-489 Rail quick C red cap</p>	 <p>106387E 98656-271 Rail premium cap</p>
 <p>106388A 98656-419 Original securing strap</p>	 <p>106388 98656-320 Strip kit red</p>	 <p>106389 98656-318 Strip kit black</p>	 <p>106390 98656-386 Quick safe</p>
 <p>106394F 98656-220 Lower fix kit M6 x 65mm</p>	 <p>106381 98656-665 Lower bracket cover (2)</p>	 <p>106380 98656-276 Internal bracket cover (2)</p>	 <p>106393 98656-682 Support bar kit (2)</p>
 <p>106394 98656-588 Top fix kit M6 x 50mm</p>	 <p>106394C 98656-409 Top fix kit M6 x 55mm</p>	 <p>106381A 98656-664 Upper bracket cover (2)</p>	 <p>106392 98656-275 Aluminium brackets (2)</p>
 <p>106394A 98656-474 Fixing bar</p>	 <p>106360 07752-01 Dust guard for fixing bar</p>	 <p>106394AB 98656-487 Left end cover - fixing bar</p>	 <p>106394AA 98656-488 Right end cover - fixing bar</p>
 <p>106394AC 98656-486 Fix bracket for bar DJ</p>	 <p>106394E 98656-558 Fix support garage 2 brackets & bar</p>	 <p>106348A 98656-640 Fixing kit Dethleffs < 2010</p>	 <p>106348B 98656-725 Fixing kit Dethleffs < 2010</p>
 <p>106381B 98656-076 Lower bracket VWT4</p>	 <p>106383 98656-292 Adjustable foot VWT4</p>	 <p>106384 98656-580 Articulated foot VWT5/D</p>	 <p>106397 98656-338 Cable lock 2.5m & 2 keys</p>
 <p>106353A 98656-263 Folding upper tube</p>	 <p>106394D 98656-268 Pro upper kit</p>	 <p>102372 98656-485 Square plate kit (4)</p>	 <p>106394H 98656-760 Lift 77 crank handle</p>

S



Fiamma spare parts

Wall mounted awnings				
 108231B 04380-01 End cover LH F45iL/F1L white	 108231H 04381-01A End cover RH F45iL/F1L white	 108231C 98655-014 End cover LH F45i white	 108231G 04274-01C End cover RH F45i white	
 108231D 98655-147 End cover LH F45Ti/ZIP white	 108231ED 98655-145 End cover RH F45Ti/ZIP white	 108232HE 98655-211 End cover LH F45Ti/ZIP titanium	 98655-209 End cover RH F45Ti/ZIP titanium	
 108231E 98655-539 End cover LH F45s before 2019 white	 98655-540 End cover RH F45s before 2019 white	 108231EA 98655-588 End cover LH F45s titanium	 108231EC 98655-589 End cover RH F45s titanium	
 98673-080 End cover LH F45s from 2019 white	 108231EB 98673-401 End cover RH F45s from 2019 white	 108279F 98655-586 End cover LH F45L / ZIP White	 108296A 98655-587 End cover RH F45L / ZIP White	
 108231A 02740-01- End cover LH F45+ white	 108231F 02741-01- End cover RH F45+ white	 108231AB 98655-178 End cap LH F45+L white	 108231AC 98655-956 End cap LH F45+L white	 108231FA 02520-01- End cover RH F45+L white
 98655-234 Inner end cap LH F45TiL/ZIP	 108232FA 98655-235 Inner end cap RH F45TiL/ZIP	 108232GB 98655-958 Inner end cap LH F45+	 108232GC 98655-965 Inner end cap LH F45i	 108232GA 98655-959 Inner end cap RH F45+ / F45Ti / F45i
 108231IA 98655-153 Winch & slot F45i/F45Ti/F45s/ ZIP white	 108231J 98655-134 Winch slot F45i/F45Ti/F45s/ ZIP/F65s white	 106316AF 98655-137 Winch slot F45i/F45Ti/F45s/ ZIP/F65s black	 108231I 98655-106 Winch & slot F45iL/F45TiL/F45L	 108232HD 98673-036 Lead bar 4m F45s white















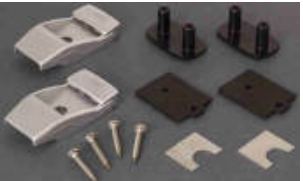









Fiamma spare parts

Wall mounted awnings

 <p>108232H 98655-556 Lead bar end cap LH F45s white</p>	 <p>108232HA 98655-557 Lead bar end cap RH F45s white</p>	 <p>98655-581 Lead bar end cap LH F45L white</p>	 <p>108279I 98655-582 Lead bar end cap RH F45L white</p>
 <p>108231BB 05139-01- Lead bar end cap LH F45i white</p>	 <p>108232G 05139A01- Lead bar end cap RH F45i white</p>	 <p>108231BA 04384-01A Lead bar end cap LH F45iL grey</p>	 <p>04384A01A Lead bar end cap RH F45iL grey</p>
 <p>108232HB 98655-157 Lead bar end cap LH F45i white</p>	 <p>98655-159 Lead bar end cap RH F45i white</p>	 <p>108232FD 98655-257 Lead bar end cap LH F45Ti / ZIP white</p>	 <p>108232FB 98655-259 Lead bar end cap RH F45Ti / ZIP white</p>
 <p>108269 98655-054 Knuckle complete LH F45i / F45Ti / ZIP</p>	 <p>108268 98655-056 Knuckle complete RH F45i / F45Ti / ZIP</p>	 <p>108232A 98655-549 Knuckle fixing kit LH F45s / F70 / ZIP</p>	 <p>108232B 98655-550 Knuckle fixing kit RH F45s / F70 / ZIP</p>
 <p>108270B 98655-052 Knuckle complete LH F45iL / F65</p>	 <p>108270A 98655-053 Knuckle complete RH F45iL / F65</p>	 <p>98655-551 Knuckle LH F45s / F70 / ZIP</p>	 <p>108232P 98655-552 Knuckle RH F45s / F70 / ZIP</p>
 <p>108174 98655-452 Screw leg clamp</p>	 <p>108178 98655-171 Lower leg clamp kit F45s / Caravanstore</p>	 <p>108232E 98655-261 Knuckle fixing kit LH F45Ti / F45L / ZIP</p>	 <p>108232F 98655-263 Knuckle fixing kit RH F45Ti / F45L / ZIP</p>
 <p>108265B 98655-094 Wall brackets for telescopic handle (2)</p>	 <p>108232HC 98655-036 Leg stop plate lead bar F45i/Ti/iL/ZIP</p>	 <p>98655-265 Knuckle LH F45Ti / F45L / ZIP</p>	 <p>98655-267 Knuckle RH F45Ti / F45L / ZIP</p>



Fiamma spare parts

Wall mounted awnings				
 <p>108232J 98655-050 Plastic legs pins (2)</p>	 <p>108265A 98655-176 Wall bracket kit plastic (2)</p>	 <p>108265 98655-728 Wall bracket kit alu (2)</p>	 <p>108279G 98655-583 Roller tube support</p>	
 <p>108231O 98655-757 Leg top (LH or RH) F45i / F45Ti / F65 / ZIP</p>	 <p>108232N 98655-763 Leg top kit (LH & RH) F45L / F45TiL / ZIP</p>	 <p>108178A 98655-217 Leg top (LH or RH) F45s 1.5-2.3m</p>	 <p>108232L 98655-575 Leg top LH F45s / F70 / F65s / F65L / ZIP</p>	 <p>108232K 98655-576 Leg top RH F45s / F70 / F65s / F65L / ZIP</p>
 <p>108231N 05577A01 Arm LH F45i 3-4m / F45Ti 3-4.5m / ZIP 3-3.5m</p>	 <p>108231NA 05577A01A Arm RH F45i 3-4m / F45Ti 3-4.5m / ZIP 3-3.5m</p>	 <p>108232O 06271A01 Arm LH F45s 3-4.5m / F70 4-4.5m / ZIP 3-3.5m</p>	 <p>108232OA 06271A01A Arm RH F45s 3-4.5m / F70 4-4.5m / ZIP 3-3.5m</p>	
 <p>108232M 05106-03- Leg LH F45i 3.5-4m / F45Ti 3.5-4.5m / ZIP 3.5m</p>	 <p>108232MA 05106-03A Leg RH F45i 3.5-4m / F45Ti 3.5-4.5m / ZIP 3.5m</p>	 <p>108232I 06270-08 Leg LH F45s 3.5-4.5m / F70 / ZIP 3.5m</p>	 <p>108232MA 06270-08A Leg RH F45s 3.5-4.5m / F70 / ZIP 3.5m</p>	
 <p>108232PA 05106-02 Leg LH F45i 3m / F45Ti 3m / ZIP 3m</p>	 <p>05106-02A Leg RH F45i 3m / F45Ti 3m / ZIP 3m</p>	 <p>06270-07 Leg LH F45s 3m / ZIP 3m</p>	 <p>108232MB 06270-07A Leg RH F45s 3m / ZIP 3m</p>	
 <p>108232FC 05695-03 Leg LH F45TiL / F45L / ZIP</p>	 <p>05695-03A Leg RH F45TiL / F45L / ZIP</p>	 <p>108231Q 98655-123 Case bracket insert LH F45i / F45Ti / F45iL / ZIP</p>	 <p>08231QA 98655-124 Case bracket insert RH F45i / F45Ti / F45iL / ZIP</p>	



Fiamma spare parts

Roof mounted awnings

 <p>108316AE 98655-307 End cover LH F65s white</p>	 <p>106316AE 98655-309 End cover RH F65s white</p>	 <p>106316AK 98655-425 End cover LH F65 / F65L white</p>	 <p>106316AJ 98655-426 End cover RH F65 / F65L white</p>
 <p>98655-319 Lead bar end cap LH F65s white</p>	 <p>108316A 98655-321 Lead bar end cap RH F65s white</p>	 <p>108316AH 98655-337 Lead bar end cap LH F65s titanium</p>	 <p>108316AF 98655-339 Lead bar end cap RH F65s titanium</p>
 <p>108316AB 98655-408 Lead bar end cap LH F65s black</p>	 <p>108316AC 98655-409 Lead bar end cap RH F65s black</p>	 <p>98655-486 Knuckle LH F65s / F65L</p>	 <p>108270C 98655-487 Knuckle RH F65s / F65L</p>
 <p>108270B 98655-052 Knuckle complete LH F45iL / F65</p>	 <p>108270A 98655-053 Knuckle complete RH F45iL / F65</p>	 <p>108316AG 98655-478 Knuckle fixing kit LH F65s / F65L</p>	 <p>108316AD 98655-479 Knuckle fixing kit RH F65s / F65L</p>
 <p>106316AI 98655-333 Winch & slot F65 / F65L white</p>	 <p>108231J 98655-134 Winch slot F45i/F45Ti/F45s/ZIP/F65s white</p>	 <p>106316AF 98655-137 Winch slot F45i/F45Ti/F45s/ZIP/F65s black</p>	 <p>1082310 98655-757 Leg top (LH or RH) F45i / F45Ti / F65 / ZIP</p>
Privacy room			
 <p>108232C 98655-897 Fast clip fix kit F45s / F45Ti</p>	 <p>108232CA 98655-900 Fast clip fix kit F45i / F45Ti 250-300</p>	 <p>108232D 98655-898 Fast clip fix kit F45L / F45TiL</p>	 <p>108263GA 98655-899 Fast clip fix kit F65 / F65s</p>
 <p>108225 98655-349 Privacy peg kit (10)</p>	 <p>108225A 98655-901 Privacy fast clip fix kit</p>	 <p>108225B 98655-334 Side/sunview c-clips (10)</p>	 <p>108262A 98655-031 ZIP side rafter 2m extension</p>
			 <p>108262B 05161-05- ZIP side rafter 2.5m extension</p>

Fiamma spare parts

Roll out awnings				
 <p>108144 05263-01 Caravanstore knuckle LH 05</p>	 <p>108146 05263-01A Caravanstore knuckle RH 05</p>	 <p>108219A 05535-01 Caravanstore / F35 knuckle LH 07</p>	 <p>108219B 05535-01A Caravanstore / F35 knuckle RH 07</p>	
 <p>108219D 98671-01 Caravanstore / XL knuckle LH 13</p>	 <p>98671A01 Caravanstore / XL knuckle RH 13</p>	 <p>108172 05220D01 Caravanstore leg assembly LH 05</p>	 <p>108168 05220D01A Caravanstore leg assembly RH 05</p>	
 <p>108179 03567C05 Caravanstore side rafter 2.8m 07 / 13</p>	 <p>108218A 04151C05 Caravanstore side rafter end piece only 2.8-4.4m 07 / 13</p>	 <p>108147 03569A05 Caravanstore / ZIP support leg LH 07 / 13</p>	 <p>108148 03569A05A Caravanstore / ZIP support leg LH 07 / 13</p>	
 <p>108181 03567D05 Caravanstore / ZIP side rafter 3.1-4.4m 07 / 13 < SN 9601000</p>	 <p>108181A 03567D06 Caravanstore / ZIP side rafter 3.1-4.4m 13 > SN 9601000</p>	 <p>108178A 98655-217 Leg top (LH or RH) Caravanstore / ZIP / F35</p>	 <p>108219C 98655-690 Caravanstore F35 rafter middle spring button</p>	
 <p>108184 97733-035 Caravanstore rafter rubber end cap 16mm</p>	 <p>108227 03458-01 Caravanstore rubber foot</p>	 <p>108176 98655-171 Caravanstore leg clamp 05 / 07 / 13 / F45s 1.8-2.3m</p>	 <p>108221C 98655-097 Rafter wall installation kit</p>	 <p>108178B 98655-952 Caravanstore / F35 Tie down cable terminal (2)</p>
 <p>108221A 98655-707 Rafter wall support kit</p>	 <p>108221B 98655-027 Wall protection pads (10)</p>	 <p>108313Q 98655-492 F35 rafter fix kit case bracket</p>	 <p>108313X 98655Z006 F35 safety strip</p>	 <p>108222 98655-186 Caravanstore end stops (2)</p>

Fiamma spare parts

S

Security				
 <p>001205C 98656-689 Safe door lock cover</p>	 <p>001215 98656-701 Lower cover security</p>	 <p>001216 98656-700 Upper cover security</p>	 <p>001218 98656-433 Safety lock kit security</p>	
 <p>001219 98656-345 Spare barrel & keys security</p>	 <p>001220 98656-457 Spare barrel & keys safe door</p>	 <p>102260 98654-037 Spare barrel & keys ultra-box</p>		
Water				
 <p>053025A 98657-015 Aqua 8 upgrade kit</p>	 <p>053028 01203B02 Pressure switch kit</p>	 <p>053030A 98657-008 Pump membrane</p>	 <p>050057 98669-018 Discharge cap</p>	 <p>056955A 05313-01 Small cap & seal Bi-pot 30</p>
 <p>056957 98659-010 Cap & seal Bi-pot upper tank</p>	 <p>056958 98659-016 Cap & seal Bi-pot lower tank</p>	 <p>050056 98659-021 Roll tank cap</p>	 <p>056955 98659-013 Seal roll tank/Bi-pot cap</p>	
Rooflights				
 <p>102031C 98683-101 Spare dome crystal Vent</p>	 <p>102031W 98683-100 Spare dome white Vent</p>	 <p>102033C 98683-108 Spare dome crystal Vent 28</p>	 <p>102033W 98683-106 Spare dome white Vent 28</p>	
 <p>102038 98683-121 Spare dome white Vent / Turbo vent pro</p>	 <p>101095B 98683-020 Motor kit</p>	 <p>101095C 98683-129 Vent opening mechanism</p>	 <p>101095D 98683-026 Transparent fan</p>	
 <p>101095A 98683-116 Ivory knobs & extension kit</p>	 <p>102036 98683-112 White knobs & extension kit</p>	 <p>102034 98683-066 Handle extension 70mm</p>	 <p>101096A 98683-046 Vent opening handle wheel</p>	

Trigano Awnings



Montreux

All season awning. Roof lining as standard.

- Roof material Double sided PVC coating, 480 g/m²
- Wall material Double sided heavy duty PVC coating, 450 g/m² and 335 g/m²
- Frame Steel frame with welded and strengthened corners 25mm ø

250cm Depth

Size E (805-840cm)	SM993217
Size F (840-875cm)	SM993218
Size G (875-910cm)	SM993219
Size H (910-945cm)	SM993220
Size I (945-980cm)	SM993822
Size J (980-1015cm)	SM993823
Size K (1015-1050cm)	SM993824
Size L (1050-1090cm)	SM993825
Size M (1090-1130cm)	SM993826

300cm Depth

Size E (805-840cm)	SM993221
Size F (840-875cm)	SM993222
Size G (875-910cm)	SM993223
Size H (910-945cm)	SM993224
Size I (945-980cm)	SM993827
Size J (980-1015cm)	SM993828
Size K (1015-1050cm)	SM993829
Size L (1050-1090cm)	SM993830
Size M (1090-1130cm)	SM993831



Touquet

Full PVC awning.

- Roof material PVC coated, 420 g/m²
- Wall material PVC coated 335 g/m²
- Frame Steel frame 25mm ø, fibreglass optional

250cm Depth

Size B (700-735cm)	SM9811182
Size C (735-770cm)	SM9811183
Size D (770-805cm)	SM9812161
Size E (805-840cm)	SM9812162
Size F (840-875cm)	SM9812163
Size G (875-910cm)	SM9813200
Size H (910-945cm)	SM9813201
Size I (945-980cm)	SM9816284
Size J (980-1015cm)	SM9816285
Size K (1015-1050cm)	SM9816286
Size L (1050-1090cm)	SM9816287
Size M (1090-1130cm)	SM9816288



Sicile

Half PVC and half polyester

- Roof material Single sided coated woven polyester, 240 g/m²
- Wall material Woven polyester 180 g/m², with PVC coating 335 g/m²
- Frame Steel frame 25mm ø, fibreglass optional

270cm Depth

Size B (700-735cm)	SM9811184
Size C (735-770cm)	SM9811185
Size D (770-805cm)	SM9812164
Size E (805-840cm)	SM9812165
Size F (840-875cm)	SM9812166
Size G (875-910cm)	SM9813202
Size H (910-945cm)	SM9813203
Size I (945-980cm)	SM9818141
Size J (980-1015cm)	SM9818142
Size K (1015-1050cm)	SM9818143
Size L (1050-1090cm)	SM9818144
Size M (1090-1130cm)	SM9818145



Etretat

Half PVC and half polyester

- Roof material Single sided coated woven polyester, 240 g/m²
- Wall material Woven polyester 180 g/m², and 335 g/m² coated polyester
- Frame Steel frame 25mm ø, fibreglass optional

240cm Depth

Size A (665-700cm)	SM9811178
Size B (700-735cm)	SM9811179
Size C (735-770cm)	SM9811180
Size D (770-805cm)	SM9812158
Size E (805-840cm)	SM9812159
Size F (840-875cm)	SM9812160
Size G (875-910cm)	SM9813198
Size H (910-945cm)	SM9813199
Size I (945-980cm)	SM9816279
Size J (980-1015cm)	SM9816280
Size K (1015-1050cm)	SM9816281
Size L (1050-1090cm)	SM9816282
Size M (1090-1130cm)	SM9816283

Trigano Awnings



Adriatic

Woven polyester with coated patterned roof

- Roof material Single sided coated woven polyester, 180 g/m²
- Wall material Woven polyester 180 g/m²
- Frame Steel frame 25mm ø, fibreglass optional

250cm Depth

Size H (910-945cm)	SM9813197
Size I (945-980cm)	SM9816274
Size J (980-1015cm)	SM9816275
Size K (1015-1050cm)	SM9816276
Size L (1050-1090cm)	SM9816277
Size M (1090-1130cm)	SM9816278



Miami

Woven polyester roof and PVC walls

- Roof material Single sided coated woven polyester, 240 g/m²
- Wall material PVC coated 335 g/m²
- Frame Steel frame 22mm ø

240cm Depth

Size A (665-700cm)	SM983139
Size B (700-735cm)	SM983140
Size C (735-770cm)	SM983141
Size D (770-805cm)	SM983731
Size E (805-840cm)	SM983732
Size F (840-875cm)	SM983733
Size G (875-910cm)	SM983658
Size H (910-945cm)	SM983659
Size I (945-980cm)	SM983660
Size J (980-1015cm)	SM983661



Solette VIP

Ten Cate® polyester, 240 g/m², with leather reinforcement 450 g/m². 350cm Depth. Size is the length of the roof. Optional side and front panels available.

	Nacre White	VIP	Premium
Size	White	Light grey	Dark grey
490cm	M/7615/100	7615/90	7615/95
540cm	M/7615/101	7615/62	7615/54
585cm	M/7615/102	7615/63	7615/55
630cm	M/7615/103	7615/64	7615/56
660cm	M/7615/104	7615/65	7615/57
680cm	M/7615/105	7615/66	7615/58
725cm	M/7615/106	7615/67	7615/59
765cm	M/7615/107	7615/68	7615/60

Light	Side	Door	Window
490cm	7615/69	7615/91	7615/92
540cm	7615/69	7615/7	7615/18
585cm	7615/69	7615/8	7615/19
630cm	7615/69	7615/22	7615/23
660cm	7615/69	7615/9	7615/20
680cm	7615/69	7615/9	7615/20
725cm	7615/69	7615/82	7615/84
765cm	7615/69	7615/83	7615/85

Dark	Side	Door	Window
490cm	7615/61	7615/97	7615/96
540cm	7615/61	7615/39	7615/33
585cm	7615/61	7615/40	7615/34
630cm	7615/61	7615/41	7615/35
660cm	7615/61	7615/42	7615/36
680cm	7615/61	7615/42	7615/36
725cm	7615/61	7615/80	7615/74
765cm	7615/61	7615/81	7615/75



Solette

Woven polyester, 240 g/m². 240cm Depth

300/380	SMA6800101
380/450	SMA6800102
450/540	SMA6800103
540/610	SMA6800104



Solette Luxe

Woven polyester, 240 g/m². 240cm Depth. 1 side panel included with window, 1 additional is optional.

Size A (665-700cm)	SMA686371
Size B (700-735cm)	SMA686372
Size C (735-770cm)	SMA686373
Size D (770-805cm)	SMA686374
Size E (805-840cm)	SMA686375
Size F (840-875cm)	SMA686376
Size G (875-910cm)	SMA686377
Size H (910-945cm)	SMA686378
Size I (945-980cm)	SMA686379
Size J (980-1015cm)	SMA686380
Optional side window	SM686381

Trigano Awnings



Ocean

- 100% polyester
- Roof material Coated polyester, 280 g/m²
- Wall material Polyester 220 g/m²
- Frame Steel frame 25mm ø

250cm Depth

- | | |
|----------------------|-----------------|
| Size B (700-735cm) | SMA60312 |
| Size C (735-770cm) | SMA60321 |
| Size D (770-805cm) | SMA60322 |
| Size E (805-840cm) | SMA60331 |
| Size F (840-875cm) | SMA60332 |
| Size G (875-910cm) | SMA60333 |
| Size H (910-945cm) | SMA60334 |
| Size I (945-980cm) | SMA60341 |
| Size J (980-1015cm) | SMA60342 |
| Size K (1015-1050cm) | SMA60343 |
| Size L (1050-1090cm) | SMA60344 |
| Size M (1090-1130cm) | SMA60345 |



Atlantique

- 100% polyester
- Roof material Coated polyester, 280 g/m²
- Wall material Polyester 220 g/m²
- Frame Steel frame 25mm ø

270cm Depth

- | | |
|----------------------|------------------|
| Size C (735-770cm) | SMA60143 |
| Size D (770-805cm) | SMA60144 |
| Size E (805-840cm) | SMA60125 |
| Size F (840-875cm) | SMA60126 |
| Size G (875-910cm) | SMA60127 |
| Size H (910-945cm) | SMA60128 |
| Size I (945-980cm) | SMA60136 |
| Size J (980-1015cm) | SMA60137 |
| Size K (1015-1050cm) | SMA60138 |
| Size L (1050-1090cm) | SMA60139 |
| Size M (1090-1130cm) | SMA601310 |



Austral

- Breathable polyacrylic walls and coated polyester roof
- Roof material Coated polyester, 280 g/m²
- Wall material Polyacrylic 280 g/m²
- Frame Steel frame 25mm ø

300cm Depth

- | | |
|----------------------|-----------------|
| Size C (735-770cm) | SMA60421 |
| Size D (770-805cm) | SMA60422 |
| Size E (805-840cm) | SMA60431 |
| Size F (840-875cm) | SMA60432 |
| Size G (875-910cm) | SMA60433 |
| Size H (910-945cm) | SMA60434 |
| Size I (945-980cm) | SMA60441 |
| Size J (980-1015cm) | SMA60442 |
| Size K (1015-1050cm) | SMA60443 |
| Size L (1050-1090cm) | SMA60444 |
| Size M (1090-1130cm) | SMA60445 |



Goa

- 100% polyester with double mud wall
- Roof material Coated polyester, 280 g/m²
- Wall material Polyester 220 g/m²
- Frame Steel frame 25mm ø

270cm Depth

- | | |
|----------------------|------------------|
| Size C (735-770cm) | SMA60145 |
| Size D (770-805cm) | SMA60146 |
| Size E (805-840cm) | SMA60129 |
| Size F (840-875cm) | SMA601210 |
| Size G (875-910cm) | SMA601211 |
| Size H (910-945cm) | SMA601212 |
| Size I (945-980cm) | SMA601311 |
| Size J (980-1015cm) | SMA601312 |
| Size K (1015-1050cm) | SMA601313 |
| Size L (1050-1090cm) | SMA601314 |
| Size M (1090-1130cm) | SMA601315 |



Awning extension

- Woven polyester, 220 g/m². 160cm Depth
- Size E-F (805-875cm) **SA680086**
- Size G-H (875-910cm) **SA680087**
- Size I-J-K (910-1050cm) **SA680088**
- Size L-M (1050-1130cm) **SA680089**



Partiel

- Full PVC porch awning.
- Roof material PVC coated 420 g/m²
- Wall material PVC coated 450 g/m²
- Frame Steel frame 25mm ø

240cm Depth

- | | |
|-------|-----------------|
| 350cm | SM75079 |
| 475cm | SM750710 |
| 600cm | SM75085 |

Trigano Awnings



Samoa 280



Samoa 350



Samoa 390



Samoa 420

Samoa

Inflatable porch awning, available in 4 sizes

- Fabric Polyester Ripstop 300D PU 5000mm
- Frame Air tubes 10cm ø Thermo-polyurethane
2 rear telescopic steel poles
4 steel canopy poles

240cm Depth 235-250cm Height

280cm Width	3 main beams, 2 cross beams	Samoa 280	SM76221
350cm Width	4 main beams, 3 cross beams	Samoa 350	SM76225
390cm Width	4 main beams, 3 cross beams	Samoa 390	SM76222
420cm Width	4 main beams, 3 cross beams	Samoa 420	SM76227



Lima 410

Inflatable porch awning, available in 2 sizes

- Fabric Polycotton Ripstop 300D PU 10000mm
- Frame Air tubes 10cm ø Thermo-polyurethane
2 rear telescopic steel poles

Lima 300

240/290cm Depth 235-250cm Height

300cm Width	3 main beams, 4 cross beams	Lima 300	SM76245
410cm Width	4 main beams, 6 cross beams	Lima 410	SM76246
Annex 225 x 180cm	SM76247	Annex inner	SM76244



Lagoon

Inflatable single arch porch awning.

- Fabric Polyester Ripstop 210D PU 5000mm
- Frame 1 air tube 10cm ø Thermo-polyurethane
2 rear telescopic steel poles

Indiana

Inflatable porch awning for pop up caravans.

- Fabric Polyester Ripstop 300D PU 5000mm
- Frame 2 air tubes 12cm ø Thermo-polyurethane
5 air tubes 10cm ø Thermo-polyurethane

250cm Depth 325cm width

235-250cm Height **SM76231**

250cm Depth 390 Width

180-220cm Height **SM76212**

Trigano Awnings



Bali M & XL

Inflatable drive away awning.

- Fabric Polyester Ripstop 300D PU 5000mm
- Frame 2 air tubes 15cm ø Thermo-polyurethane
3 air tubes 15cm ø Thermo-polyurethane
2 central support poles

230cm + 80cm Depth 300cm width
220-250cm Height **SM76206**
250-280cm Height **SM76207**



Hawaii S & XL

Inflatable drive away awning.

- Fabric Polyester Ripstop 300D PU 5000mm
- Frame 2 air tubes 10cm ø Thermo-polyurethane
3 air tubes 10cm ø Thermo-polyurethane
2 central support poles

230cm + 80cm Depth 300cm width
180-220cm Height **SM76204**
250-280cm Height **SM76205**



Santa Cruz

Inflatable drive away awning.

- Fabric Polyester 190T 68D PU 3000mm
- Frame 2 connected air tubes 15cm ø Thermo-polyurethane

230cm + 80cm Depth 300cm width
180-240cm Height **SM76261**



Sapporo

Pop-up freestanding tail-gate awning

- Fabric Polyester 190T 75D PU 2000mm
- Frame Automatic umbrella frame for ultra fast pitching and packing up

250cm + 150cm Depth 250cm width
180-240cm Height **SMA74111**



Bivouac car

Fibreglass frame drive away awning.

- Fabric Ultralight polyester
- Frame 11mm ø fibreglass

330cm Depth 300cm width
200cm Height **SMA74101**



Awning Mini Silver

For model 270.

- Roof material Coated woven Polyester 240 g/m²
- Wall material Polyester 240 g/m²
- Frame Steel frame 25mm ø

SM71971



Solette Mini Silver

For models 270 and 290.

- Material Polyester 180 g/m²
- Frame Steel frame 19mm ø

SMA680098

Trigano Awnings



Storage annex
 200 x 150cm
 Dual slope PVC coated roof. Inner tent optional. Frame 19mm ø
 Annex **SA76121**
 Inner tent **S73982**



Kitchen annex
 190 x 110cm
 Dual slope PVC coated roof. Inner tent optional. Frame 19mm ø
SA72474



Bedroom annex with inner tent
 190 x 130cm
 Woven coated polyester roof. Cotton inner tent included with sewn in groundsheet. Frame 19mm ø
SA76111



Inflatable Annex outer for Lima
 225 x 180cm
 Poly Oxford 300D. TPU 10mm ø tube
SM76247



Annex inner for Lima
 210 x 160cm
 Polyester 68D. With sewn in groundsheet.
SM76244



Bedroom pack with inner tent
 190 x 140cm
 Woven coated polyester roof. Cotton inner tent with sewn in groundsheet included. Frame 19mm ø
SA75274



Trigano windbreak standard
 Shelters you from the wind and provides privacy.
 Fabric: polyester 190T PU 1000 mm.
 Length: 3 x 145cm
 Height: 130 cm
 Weight: 2.6kg
 Open dimensions: 435 x 130 cm
 Frame: ø 16 mm steel
SMA925G01



Trigano windbreak XL
 Shelters you from the wind and provides privacy.
 Fabric: polyester 190T PU 1000 mm.
 Length: 4 x 145cm
 Height: 130 cm
 Weight: 4kg
 Open dimensions: 580 x 130 cm
 Frame: ø 16 mm steel
SMA925L03

Groundsheets



Breathable Awning Carpet
Allows grass to breathe but keeps out bugs and dirt. Washable and rot-proof. Fully eyeleted and hemmed. Comes with a re-useable zipped bag. 2.5m Width. Available singly or in various outers

- 250cm **107874G**
- 260cm **107875G**
- 280cm **107876G**
- 300cm **107876GA**
- 350cm **107877G**
- 390cm **107878G**
- 400cm **107878GA**
- 450cm **107879G**
- 500cm **107880G**
- 550cm **107881G**
- 600cm **107882G**
- 650cm **107883G**
- 700cm **107884G**
- 750cm **107885G**



Deluxe Awning Carpet Grey

Heavy duty. Allows grass to breathe but keeps out bugs and dirt. Washable and rot-proof. Fully eyeleted and hemmed. Comes with a re-useable zipped bag. 2.5m Width. Available singly or in various outers

- 260cm **107906G**
- 280cm **107907G**
- 350cm **107908G**
- 390cm **107909G**
- 450cm **107910G**
- 500cm **107911G**
- 550cm **107912G**
- 600cm **107913G**
- 650cm **107914G**
- 700cm **107915G**
- 750cm **107916G**



Deluxe Awning Carpet Striped

Heavy duty. Allows grass to breathe but keeps out bugs and dirt. Washable and rot-proof. Fully eyeleted and hemmed. Comes with a re-useable zipped bag. 2.5m Width. Available singly or in various outers

- 260cm **107906S**
- 280cm **107907S**
- 350cm **107908S**
- 390cm **107909S**
- 450cm **107910S**
- 500cm **107911S**
- 550cm **107912S**
- 600cm **107913S**
- 650cm **107914S**
- 700cm **107915S**
- 750cm **107916S**



Dark Grey Interlocking floor tiles

Interlocking floor tiles (60 X 60 X 1.2cm) with 2 edging strips for each tile. Allows grass to grow while giving a comfortable feel underfoot. Ideal for stoney or rocky ground.

- 4 Pack** **107937**
- 8 Pack *** **107937A**
- 6 Pack *** **107937B**

* Includes reuseable storage bag



Wood Effect Interlocking floor tiles

Interlocking floor tiles (60 X 60 X 1.2cm) with 2 edging strips for each tile. Allows grass to grow while giving a comfortable feel underfoot. Ideal for stoney or rocky ground.

- 4 Pack** **107938**

Via Mondo Pegs packed



Titan Peg 20.3cm (20)

20 heavy duty rock pegs 6.5mm ø in a solid carry case. Steel peg with hi-viz top.

Available singly or 12 per outer
109306



Rock Peg 23cm (20)

20 heavy duty rock pegs 6mm ø in a solid carry case. Steel peg with cross-bar.

Available singly or 12 per outer
109305



Lunar Peg 20.3cm (20)

20 heavy duty rock pegs 6.5mm ø in a solid carry case. Steel peg with a glow-in-the-dark top.

Available singly or 12 per outer
109308



Comet Peg 18.3cm (20)

20 heavy duty screw pegs 7.3mm ø in a solid carry case. Steel peg with hi-viz fixed top and 13mm screw head

Available singly or 12 per outer
109312



Screw Peg Adapter

13mm socket to be used with Comet pegs (109312). Poly bagged and header carded.

20 per outer
109313



Meteor Peg 20.3cm (20)

20 heavy duty hard ground pegs 7.3mm ø in a solid carry case. Steel peg with hi-viz fixed top.

Available singly or 12 per outer
109310



Steel Round wire Peg 20cm (10)

10 pack of steel tent pegs 4mm ø. Poly bagged and header carded.

24 per outer
109314

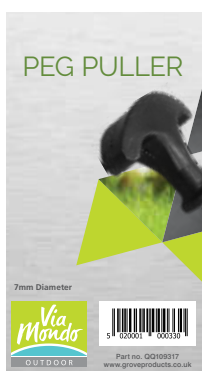

Steel Peg Puller 9mm

Strong peg puller with ergonomic handle. Poly bagged and header carded.

20 per outer
109317

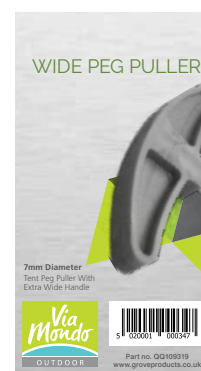

Wide Handle Peg Puller 7mm

Peg puller with extra wide handle. Poly bagged and header carded.

20 per outer
109319

Via Mondo Pegs bulk

Grey Groundsheet Peg 9cm (200)
109300



Red Plastic Peg 19cm (200)
109301



Titan Peg 20.3cm / 6.5mm (150)
109307



Steel Roundwire Peg 20cm / 4mm (200)
109315



Also available poly bagged in 10's
24 per outer **109314**

Meteor Peg 20.3cm / 7.3mm (150)
109311



Rock Peg 23cm / 6mm (200)
109316



Lunar Peg 20.3cm/6.5mm (150)
109309



Plastic Peg 22.5cm (200)
109302



Red Deluxe Plastic Peg 28cm (200)
109304



Yellow Spiral Peg 20cm (200)
109303



Heavy Duty Marquee Peg 35cm / 11.4mm (20)

Individually labelled
109318



Dog Anchor 42cm / 8mm

Individually labelled. 6 per outer
109320



Ladder Band 215mm x 26mm (50)
109325



Also available poly bagged in 10's
24 per outer **109324**



Via Mondo Camping Accessories

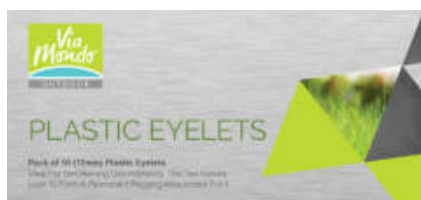

Plastic Eyelets 12mm (10)
 Ideal for tent/awning carpets. The two halves lock to form a permanent pegging/attachment point. Poly bagged and header carded.
 20 per outer
109323



Tarp Snaps (4)
 Push together from either side of the material to form a strong pegging/attachment point on many types of material. Poly bagged and header carded.
 10 per outer
109345



Extra Strong Tarp Snaps (4)
 Locking peg forms a strong pegging/attachment point on many types of material. Poly bagged and header carded.
 10 per outer
109346



Guyline White 4m / 4mm (4)
 4 pack of 4m white guylines, 4mm thick, with tensioners. Poly bagged and header carded.
 12 per outer
109329



Guyline Yellow 4m / 4mm (4)
 4 pack of 4m yellow guylines, 4mm thick, with tensioners. Poly bagged and header carded.
 12 per outer
109330



Guyline Yellow 50m / 3mm
 50m roll of yellow guyline, 3mm thick, on a reel.
 Available singly or 10 per outer
109328



Guyline White 20m / 4mm
 20m of white guyline, 4mm thick, comes on a winder. Handle has built in slot for hanging.
 Available singly or 20 per outer
109327



Guyline Green 20m / 4mm
 20m of bright green guyline, 4mm thick, comes on a winder. Handle has built in slot for hanging.
 Available singly or 20 per outer
109326

Via Mondo Camping Accessories



Tie Down Kit

Universal tie down kit to help prevent damage to awnings in windy conditions. 1 x 12m & 1.5m adjustable polypropylene straps, 2 x 38cm steel pegs and 1 x 15cm tension spring. Available singly or 12 per outer **109343**

Steel handle Mallet 29.5cm

16oz rubber head with steel handle. Supplied carded for easy hanging. 6 per outer **109322**



Awning Canvas Bag

100 x 42cm. 600D heavy duty, blue. **109550A**



Awning Pole Bag

110 x 23.5cm. 600D heavy duty, blue. **109553A**



Awning Tent Peg Bag

32 x 14 x 12cm. 600D heavy duty, blue. **109561A**



Awning Bag

85 x 43 x 43cm. 600D heavy duty, blue. **109550B**



Awning curtains (8 curtains per pack)

Good quality 50% polyester, 50% cotton 118g/m². Each curtain measures 134 x 90cm approx. Fitted with clips and sewn in seam for curtain rods. **123455A**

Tent and awning poles



Steel verandah bars
 Pole clamp on both ends.
 25/22mm ø 170-260cm
 Available singly or 10 per outer
109333



Aluminium verandah bar
 Pole clamp on both ends.
 25/22mm ø 170-250cm
 Available singly or 10 per outer
109334



Rear pad poles
 A set of two poles with foot on one side and flattened end on the other. Holds pads neatly to the wall. Suitable for light weight awnings.
 Available singly or 10 per outer
109331



Steel roof beam
 Pole clamp on one end with pole hook on the other.
 22/19mm ø 170-260cm
 Available singly or 10 per outer
109335



Aluminium roof beam
 Pole clamp on one end with pole hook on the other.
 25/22mm ø 170-260cm
 Available singly or 10 per outer
109337



Steel pole spike with foot
 Pole spike on one end with foot on the other.
 22/19mm ø 140-200cm
 Available singly or 10 per outer
109338



Steel pole spike with foot
 Pole spike on one end with foot on the other.
 22/19mm ø 170-260cm
 Available singly or 10 per outer
109339



Alu pole spike with foot
 Pole spike on one end with foot on the other.
 Aluminium 25/22mm ø 170-260cm
 Available singly or 10 per outer
109340



Steel storm pole with flanged foot
 Pole clamp on one end with flanged foot on the other.
 Steel 22/19mm ø 170-260cm
 Available singly or 10 per outer
109341



Aluminium storm pole with flanged foot
 Pole clamp on one end with flanged foot on the other.
 Aluminium 25/22mm ø 170-260cm
 Available singly or 10 per outer
109342



Canopy pole set
 Complete with 2 x 180cm 19mm steel poles, 2 x guylines and 2 pegs. Suitable for any tent or awning with fitted eyelets.
 Available singly or 10 per outer
109332



Via Mondo / HTD Awning Accessories



Rail Protection Strip

Keeps awning rail clean and free of dirt. Available retail packed with 12m of strip in each pack, or by the roll. Can be easily cut with scissors to offer an exact size for your customer. Loose is priced by the meter but sold by the roll.

Yellow

Retail packed 12m **105107A**
Loose (50m roll) **105108**

White

Retail packed 12m **105107B**



Suction cup fastener

Suction cup fastener with 2 hooks. Extra strong grip with simple lever action to release.

109494



Awning channeling

6mm 50m roll.

Priced by the meter sold by the roll **109571**



Keder

6mm/4mm 50m roll.

Priced by the meter sold by the roll **109572**



Keder

6mm/6mm 50m roll.

Priced by the meter sold by the roll **109573**

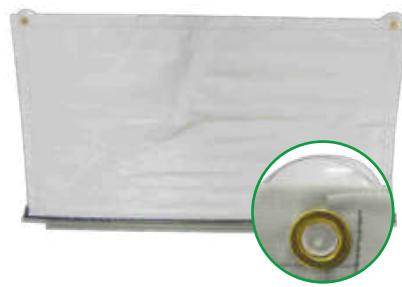

Wheel Arch Covers

Awning draught skirt with 6mm high quality beading and brass eyelets. Comes with figure of 8 to connect to the draught skirt and 2 suckers to hold it onto the vehicle.

Single **109498A**
Double **109497A**

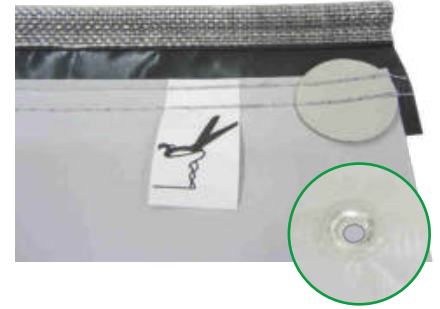

Awning Draught Skirt

Awning draught skirt with 6mm high quality beading and rubber eyelets. Handy cutting guide is stitched on every 50cm to keep measuring and off-cuts to a minimum. Priced by the meter but sold by the roll.

50cm depth (50m roll) **109504A**
75cm depth (50m roll) **109504B**

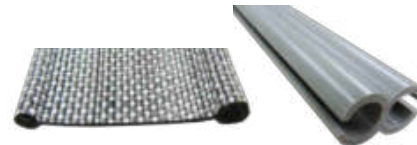

Awning Driveway Kit

3 x 80cm lengths Figure 8 and 240cm of 6/4mm back to back keder.

109508B



Figure 8

3 lengths of 80cm per pack

109495A

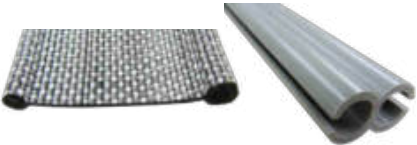

XL Awning Driveway Kit

4 x 80cm lengths Figure 8 and 320cm of 6/4mm back to back keder.

109508A

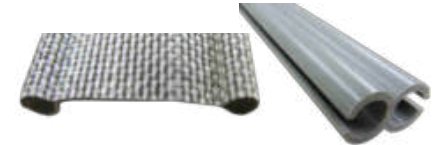

Driveway Kit

3 x 80cm lengths Figure 8 and 240cm of 6/6mm back to back keder.

109508C



Magnetic Connecting strips

3 x 80cm lengths Figure 8 and 240cm of 6mm keder with sleeves filled with magnetic strips. Comes with 4m of spare awning cord.

109508D

Fabric Maintenance



The whole Fenwick's range has been designed with the needs of the caravan, motor home and car owner in mind. Many products have been created from specific requests by satisfied customers.



Awning & Gazebo reproofer

Quickly restores waterproofing qualities to synthetic and canvas awnings, tents and gazebos. Protects against stains from dirt, grease, oil, food spills, and drinks. Deep penetrating, water based, non flammable formula. Can be applied in damp conditions. 1L covers up to 30m². Far safer than solvent based products, due to the biodegradable and environmentally friendly properties.

1 litre **108405** 10 per outer

Awning & gazebo cleaner

Quickly and effectively cleans awnings, tents and gazebos. Removes black streaks, green algae and general grime. Spray on, wash off formula.

1 litre **108401** 10 per outer



Waterproofs and mould proofs weathered canvas of all weights: cotton, nylon, terylene fabrics and unpainted leather. It preserves them and keeps them cleaner. As no film is formed the breathing of canvas fabrics and leather is retained. The tinned Fabsil contains a UV protector.



1 litre Reproofer

With UV protector
10 per outer
108406



2.5 litre Reproofer

With UV protector
6 per outer
108407



5 litre Reproofer

With UV protector
3 per outer
108408



400ml Reproofer

12 per outer
108409



600ml Reproofer

12 per outer
108410



Beeswax proofer

Clothing reproofer 80g
24 per outer **108415**



Fabsil display stands

Single display stand
108379

Portable Stoves

**Campingaz Camp Bistro**

- Power: 2200 watt
 - Size: 35cm x 28cm
 - Automatic piezo ignition
 - Cartridge safety locking system
 - Enamelled pan support
 - Aluminium burner
 - Convenient plastic carry case
 - Operates off CP250 cartridge
- 109941**

**Campingaz Chef**

- Double burner and grill. Toast rack and drip tray with handle.
- Power: 2 x 1500 watt
 - Size (open/closed): 60x40x35 / 59.5x32.5x8.5cm
 - Piezo ignition
 - 327 g/h consumption
 - Lid with latch and carry handle
- 109940**

W4 Pegs **Goundsheet Peg (5)**

3.5" with hole for peg extractor
10 per outer **108577**

**Rippled Peg (5)**

5.5" with hole for peg extractor
10 per outer **108594**

**Red Plastic Peg (5)**

8"
10 per outer **108570**

**Steel Wire (5)**

7"
10 per outer **108593**

**Steel Wire (5)**

9"
10 per outer **108571**

**Steel Rippled Peg (3)**

8"
10 per outer **108596**

**Heavy Duty Peg**

8"
10 per outer **108597**

**Awning Peg (5)**

8" plus layflat head, with hole for peg extractor.
8 per outer **109482**
Bulk (50) **109483**

**W4 Peg extractor**

For easier removal of tent pegs.
10 per outer **109425**

**W4 Reflect-a-line**

Reflective strips to fit on guy lines for safety at night.
10 per outer **109423**

**Red Plastic Peg 12"**

200 per outer **109413**

Awning accessories



Via Mondo awning bracket pads (3)

Packet of three awning bracket pads designed to fit most makes of awnings. Simply attach to the inside beading, slide to the desired position and lock the clamp to prevent it from moving. The awning frame can then be hooked into the pad. 50 x 56mm
Available singly or 10 per outer **109587**



Via Mondo 6mm awning rail end stops (2)

Packet of 2 awning rail stops. 30mm
Available singly or 10 per outer **109588**



Fiamma Caravanstore end stops (2)
Packet of 2 awning rail stops which prevent the awning from moving in transit
108222

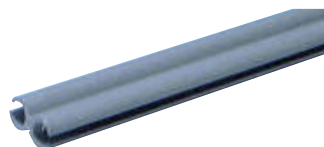

W4 figure 8 channel

Plastic double channel strip to join the wheel cover to the awning skirt. Available singly or 10 per outer
Length 750mm **109495**
Length 1200mm **109496**



W4 awning pads (3)

Simply glue to inner roof beading to hold awning poles and remove the need to screw awning brackets to the caravan.
Available singly or 10 per outer **109040**



W4 awning pole suckers

Replacement rubber suckers. For pole size 3/4" (19mm)
2 per pack, 10 per outer **109489**
Bulk (20) **109488**

For pole sizes 7/8" (22mm) & 1" (25mm)
2 per pack 10 per outer **109487**
Bulk (20) **109487B**



W4 awning rail lubricant

Makes awnings much easier to thread. Clean the awning channel before application. Can also be applied to ease the fitting and removal of toilet seals.
10 per outer **105100**

W4 Awning rail brush

Useful brush for cleaning or lubricating awning rail.
Available singly or 5 per outer **105085**

W4 Awning rail spreader

Simply insert into the awning rail and tap through any troublesome areas. The compact head is especially effective on awkward corners.
10 per outer **105104**

Awning rail care kit

Contains one of each of the above supplied in a handy vinyl pouch
105105

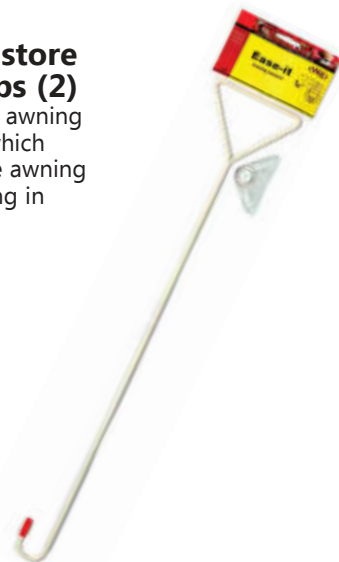

W4 ease-it

A simple tool to make the erection of awnings easier. Attach the reinforced eyelet to your awning then pull through channel with the hooked pole.
Available singly or 10 per outer **109490**



W4 awning anti friction pads (2)

A pair of cushioned nylon pads that slide on to the strapping of most awning tie down kits to help prevent vibration and chafing. A simple answer to a constant problem
109511



W4 quick release awning tie down kit

Durable nylon buckle, easy to fit, quick to release. Dual tensioners with 2 heavy duty elasticated cord and snap hooks for easy adjustment. Supplied with two anchors & 10 metres of high tensile strapping
Available singly or 10 per outer **109510**

Tent and awning spares - All packed 10 per outer



Brass eyelets
 $\frac{3}{8}$ " (9.5mm) (20) **108559**
 $\frac{1}{2}$ " (13mm) (10) **108552**



Eyelet closing tool
 $\frac{3}{8}$ " (9.5mm) (20) **108560**
 $\frac{1}{2}$ " (13mm) (10) **108553**



Awning skirt studs (5)
108561



Awning skirt studs, poppers (5)
108562



Awning popper closing tool
108578



Self adhesive awning stud (2)
 Available singly or 5 per outer
109128



Guy line
 6 metres
108569



Elasticated cord
 5 metres
108590



Guy runners (5)
 Plastic
108595



Guy runners (5)
 Metal bent
108554



Guy runners (5)
 Metal slotted
108555



Airbed plugs (3)
109480



Pole spike
 $\frac{3}{4}$ " (19mm)
108568



Pole ends (2)
 $\frac{3}{4}$ " (19mm) **108583**
 $\frac{7}{8}$ " (22mm) **108584**
 1" (25mm) **108585**



Gutter clamp (2)
 21-23mm **108645**
 25-28mm **108646**



Pole C clips (2)
 $\frac{3}{4}$ " (19mm) **108566**
 $\frac{7}{8}$ " (22mm) **108567**



Pole clamps (2)
 $\frac{3}{4}$ " (19mm) **108556**
 $\frac{7}{8}$ " (22mm) **108557**
 1" (25mm) **108586**
 $1\frac{1}{4}$ " (29mm) **108580**



Pole flanged foot
 19mm **108588**
 22mm **108647**
 25mm **108648**



Inner tent clips (3)
 $\frac{3}{4}$ " (19mm) **108551**
 1" (25mm) **108641**



Rain cowls (2)
108589



Pole ring with 2 pins (2)
108548



Pole spring joiners (3)
108558



Spring buttons (3)
108550



Pole marking kit
108576



Toggled tent band (5)
108579



Tent band large (3)
 90mm **108574**



Tent band extra large (3)
 150mm **108587**



Inner tent bands (5)
108575



Ladder bands (5)
 210 x 25mm
108573



Ball loops 75mm (3)
108549



Bunk bracket with screws
 $1\frac{1}{4}$ " (32mm) **108591**
 Bulk **108591B**



Canopy hooks (3)
108581



Rope hooks (3)
108582



Pole hanging hooks (3)
108565



Wall mounted 'Pack-it' stand

With optional feet for free standing conversion. Tent & awning 48 hook range **108650**
 Includes 10 of each of the 48 best selling "pack-it" items. Please speak to your sales contact for more details.



Awning rail screws (10)
108563



Awning brackets (2)
108572



Small padlock
108564

Awning Accessories



Awning companion

New improved design. Tensions awning poles in seconds with one hand and without the hassle. You will wonder how you ever managed without it! Available singly or 6 per outer **109585**



Inner tent tall annexe

Fits all tall annexes and includes a heavy duty reinforced base. 198x130x160cm **109980**



Hercules

Hook the Hercules to the pole at a distance of approximately 15cm from the screw. Let the steel loop rest on the nut. Now see how easy it is to tension your awning correctly **109580**



W4 mosquito netting

Pre-cut lengths of netting for use on windows or rooflights. Complete with fixing kit

1m square **101070**
 1m x 1.5m **101080**
 1m x 2m **101075**
 Mosquito fixing kit **101085**



W4 Dog Tie-out

10 per outer
 3m **109320A**
 6m **109320B**



Pole adjusting clamps (2)

10 packs per outer
 23mm **109102**



Inner tent clips (6)

For suspending inner tent in awning.
 10 packs per outer **109082**



Awning brackets (3)

Supplied with screws.
 10 packs per outer
109038



Nylon 'C' clips (4)

10 packs per outer
 19mm **109113**
 23mm **109124**



Multi hook hanger

Useful five hook plastic hanger for tent or awning poles.
 Available singly or 10 per outer
109010



Aluminium awning rail

10 lengths per outer
 1.55m **105099A**
 2.12m **105099**
 2.7m **105099B**



Plastic awning rail

Pre-drilled 2.5 metre lengths
 10 lengths per outer
105088



Seal repair adhesive 28g

Suitable for most types of fabric. Gives an extremely durable mend. Dries to a flexible finish. Easy to apply.
 12 per outer
109449

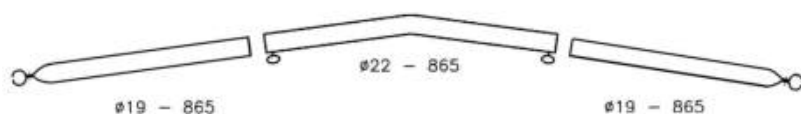

Bent crossbeam

22/19 mm 170-250cm
 with 2 clamps
109218

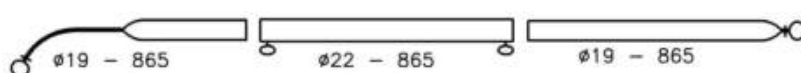

Stretching pole

22/19 mm 166-255cm
 with 2 clamps
109210

Luggage Elastic



W4 adjustable luggage elastic

Meets BS AU 258:1995.
1 metre length with 1 fixed and 1 self locking hook.
10 per outer **109519**



W4 Luggage elastic (2)

Meets BS AU 258:1995
10 per outer
46cm **109515**
60cm **109516**
76cm **109517**
91cm **109518**



Multipurpose rope 30m

Working load limit of 175lbs. Working load limit is a guideline for the maximum allowable weight capacity of a new rope.
6 packs per outer **109436**



Rolson 15ft ratchet tie down

1" strap . 136kg approx. tie down capacity. Trouble free, push button quick release mechanism.
4 per outer **109523**

Camping accessories



Folding toaster

23cm diameter with four "sure grip" wire toast holders. Heavy steel plate. Folds flat.
109643



Salt/pepper shaker

Rugged all plastic construction with easy flip-up caps. The bottom is removable for easy filling.
109647



Stainless steel camping mirror

3¼"x4¼"
12 per outer **1097625**



Camping mirror

Quality mirror in sturdy, colourful plastic frame. Unique metal hook on back enables mirror to stand, clamp on pole or hang. 5"x7"
12 per outer **109762**



Egg holders

Protective plastic case for carrying eggs
2 eggs, 6 per outer **109650**
6 eggs, singly or 12 per outer **109651**
12 eggs, singly or 12 per outer **109652**

EasyPets

rollabowl



rollabowl double

Non-slip feeding station helps protect against mess. A complete double food and water bowl with mat. 100% high Grade FDA approved silicone. BPA, Lead and phthalate free. Bacteria and mould resistant. Ideal to feed your pet at home or on the move!

Each bowl holds 1 large beaker of dry food or 1 pint (600ml) of water, or 2 pints if both bowls are used for water – plenty for even the thirstiest of large breed dogs.

The unique patented design ROLLS UP in seconds to the size of a newspaper! Simply clasps together to make a compact portable pet bowl and mat for wherever you want to go with your pet. Includes a handy water-resistant carry case. Dishwasher safe.

Mat: 45 x 27, with 5cm bowl height

Rolled up: 27 x 5 x 5cm

Singly or 36 per outer

Turquoise **124135**

Grey **124136**

Grove
PRODUCTS

fold-a-bowl



fold-a-bowl single

A unique fold-down design means this portable dog bowl can fit in the palm of your hand! Simply seals with a silicone band to make a compact portable pet bowl for wherever you want to go with your dog (or cat!). Can be used anywhere and even fits in trouser or coat pockets, or tied to a rucksack or belt, with handy Carabina clip!

100% high Grade FDA approved silicone. BPA, Lead and phthalate free. Bacteria and mould resistant. Ideal to feed your pet at home or on the move!

Capacity 300ml.

Dishwasher safe.

Singly or 36 per outer

Olive **124133**

Grey **124134**

TRIGANO Spares



Corner plastic bracket
For fibre frame. Reversible
901175



Centre corner plastic bracket
For fibre frame
901178



Centre plastic corner
For steel frame
901066



Via Mondo awning bracket pads (3)
Available singly or 10 per outer
109587



Trifix fixing bracket
901064



Awning bracket
901039



Ball joint
6mm thread
901068



Pole clip
For fibre frame
25/28mm
901190



Plastic hooked clip
25mm
901092



Power grip
Reversible
For fibre frames
901185



Power grip
For metal frames
901067



Roof lining / inner tent clip
901121



Pole end
20-22mm
901075



Spiked foot
For fibre frame
20/22mm
901195



Grey feet
23-25mm
901084



Rubber rings
40 x 48 x 9mm
901131



Adjustable strap
901138



Spring button
22-25mm
901005



Metal clip
20-22mm
901012



Curtain hook - annexe
901115



Curtain hooks
901117



Curtain rod end
901119

I-Spy books All packed 6 per outer

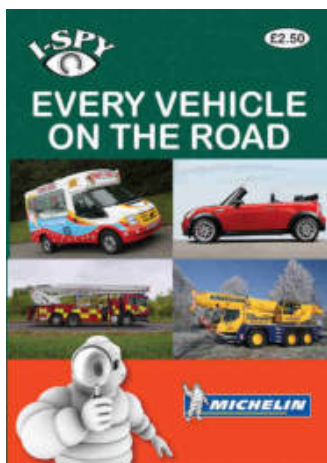

Every Vehicle on the Road
120254

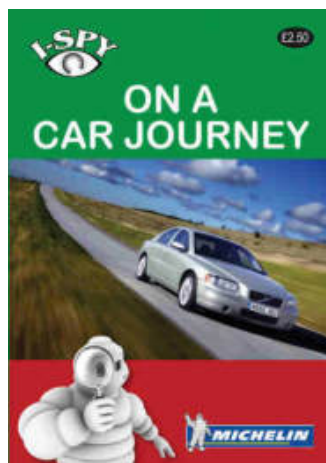

On a Car Journey
120245

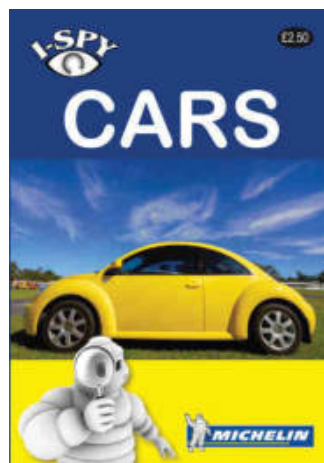

Cars
120242

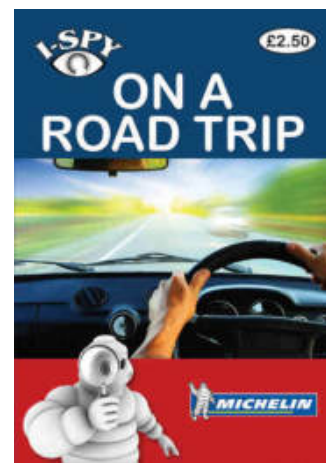

On a Road Trip
120255

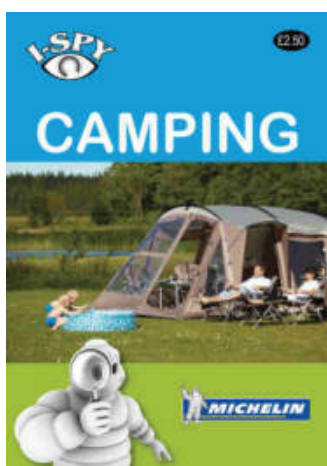

Camping
120247



Birds
120241

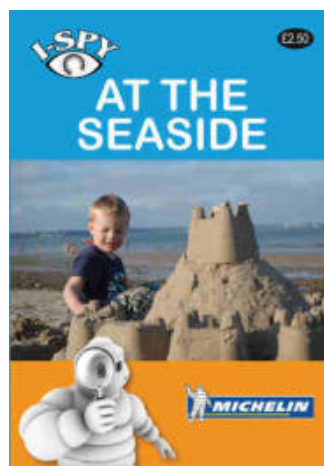

At the Seaside
120246



On a Ferry
120253

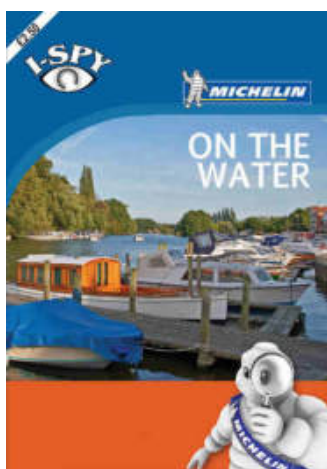

On the water
120239

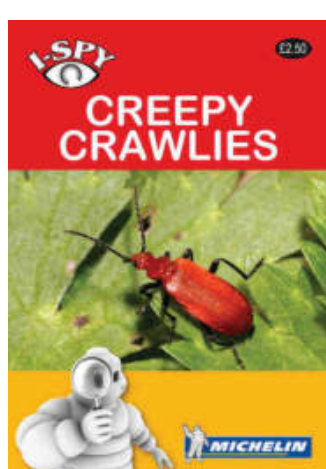

Creepy Crawlies
120243



Dogs
120237

WOW The perfect travelling companion for children

I-spy merchandiser
120265 - free of charge

I-spy 24 pocket spinner
120266 - free of charge

Specialist books and DVDs



Caravan Manual

Content includes guidance on maintaining older caravans as well as detailed information on recent developments

120175

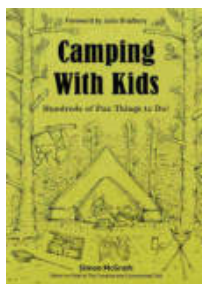

Camping with Kids

Learn to make a moth catcher, cook a world class bacon sarnie and whittle a tent peg. Light a fire from scratch, master a few card tricks and identify constellations.

With 400 cool campsite based ideas on getting back to nature, learn survival skills, weather watching, cooking, bush-craft and just having fun.

120300

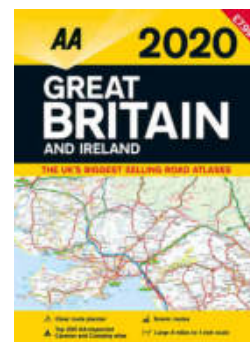

AA Atlas Great Britain

A3. Clear 4 miles to 1 inch scale. Fully updated, route planner and 8,000 places to visit. New speed camera locations.

10 per outer

120200

Toys



Sea cruiser transporter

6 per display outer

124074



Motorhome & trailer

6 per display outer

124070



Holiday fun car & caravan

6 per display outer

124069

Bird boxes

Made from high quality waterproof poly-resin. Approximately 20cm width, 13cm height and 10cm depth



1930's Vintage caravan

124080



1950's Vintage caravan

124082



Vintage campervan

124084



Flamingo Caravan

124085



Surfing Campervan

124086

Via Mondo Chairs

3D Padded mesh chairs

Charcoal mesh fabric with padded filler.



DIRECTORS CHAIR

Includes side table

Seat (W x D): 50 x 54 cm
 Seat-height: 44 cm
 Backrest: 43 cm
 Table size: 54 x 25.5cm
 Folded: 85 x 65 x 15 cm
 Weight: 3.6 kg
 Max capacity: 120 kg
 6 per outer
107698



HIGH BACK STANDARD

Seat (W x D): 48 x 45 cm
 Seat-height: 46 cm
 Backrest: 80 cm
 Positions: 7
 Folded: 109 x 64 x 11.5 cm
 Weight: 5.1 kg
 Max capacity: 120 kg
 4 per outer
107697A



HIGH BACK WITH ADJUSTABLE HEAD REST

Seat (W x D): 48 x 45 cm
 Seat-height: 48 cm
 Backrest: 69 cm
 Positions: 7
 Folded: 93 x 62.5 x 10.5 cm
 Weight: 5.3 kg
 Max capacity: 120 kg
 2 per outer
107697



FOOTREST FOR MESH HIGH BACK CHAIRS

6 per outer
 Fits 107697 and 107697A **107697AB**



TEXTILENE HIGH BACK

Seat (W x D): 48 x 40 cm
 Seat-height: 43 cm
 Backrest: 80 cm
 Positions: 6
 Folded: 109 x 58 x 20 cm
 Weight: 3.25 kg
 Max capacity: 100 kg
 Lime Green 2 per outer
 Purple 2 per outer
 Charcoal 2 per outer
 Grey 4 per outer

107699L
107699P
107699C
107699G

Grey patterned version is 8 position

Contemporary designed high quality aluminium frame chairs with a Textilene fabric (PVC coated polyester fibres that are weather and UV resistant)

Via Mondo Tables



Folding camping table

With integrated carry handle.

- Weight: 3.45kg
- Weight limit: 30kg

80 x 60 x 69cms

Grey **107709**
Charcoal **107709C**



Aluminium slatted folding tables

Comes with carry bag

- Table top: Painted aluminium with new plastic chain system for connecting slats
- Frame: Aluminium 25 mm Ø



Small

- Weight: 3.63kg
 - Weight limit: 30kg
- 80 x 61 x 70cms
107700



Medium

- Weight: 5.05kg
 - Weight limit: 30kg
- 110 x 71 x 70cms
107701



Large

- Weight: 6.42kg
 - Weight limit: 30kg
- 140 x 81 x 70cms
107702

Coleman chairs



Standard Quad chair Khaki

Adjustable arm height for comfort. Includes 1 mesh cup holder in armrest. Patented hub on front cross braces provides an easy to open yet stable structure. Plastic feet prevent the chair from sinking in soft ground and there are holes to allow you to peg down the chair - ideal if you get up from the chair in windy conditions

Fabric: Polyester for abrasion resistance

Frame: Steel, provides a strong and stable structure

Size (WxDxH): Open 74 x 90 x 50 cm
Folded 22 x 94 x 16 cm

Weight: 3.3kg

Max capacity: 113 kg

Material: 600D Oxford polyester

Available singly or 6 per outer

107689



Leisure table/stool

Handy aluminium stool that transforms into a side table with the addition of the included table top.

- Weight: 1.37kg
 - Weight limit table: 30kg
 - Weight limit stool: 80kg
- 40 x 40 x 47cms

Grey **107708**
Charcoal **107708C**

V

Via Mondo Tables

Folding tables

With solid wood table tops

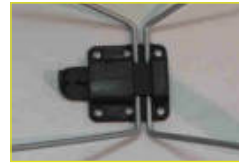
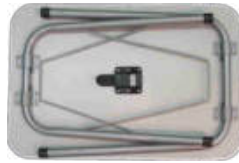

Large folding table

Adjustable legs

- Weight: 7.5kg
- Weight limit: 30kg

120 x 60 x 50/69cms

Grey **107707**
Charcoal **107707C**

Medium folding table

Adjustable legs

- Weight: 6.9kg
- Weight limit: 30kg

80 x 60 x 50/69cms

Grey **107706**
Charcoal **107706C**

Small folding table

- Weight: 4.02kg
- Weight limit: 30kg

60 x 40 x 50cms

Grey **107705**
Charcoal **107705C**

Via Mondo Camping Cupboards

Via Mondo premium quality quick erect camping cupboards and wardrobe. Featuring a 16/19mm aluminium scissor frame which make them quick and easy to use as well as lightweight.

Made from high quality 600D polyester, the units include removable aluminium edged MDF shelves and top.

All models come with zipped front doors which can be tied back for easy access, storage pockets on the outside and a handy storage/carry bag



Medium storage cupboard

3 aluminium edged MDF shelves included for extra strength.

Weight: 5.3kg
HxWxD: 104 x 66 x 52cms
107727



Storage cupboard with wardrobe

5 aluminium edged MDF shelves included for extra strength with full length hanging area.

Weight: 8.5kg
HxWxD: 140 x 90 x 52cms
107729



Tall storage cupboard

4 aluminium edged MDF shelves included for extra strength.

Weight: 7.5kg
HxWxD: 140 x 66 x 52cms
107728



Storage cupboard

2 aluminium edged MDF shelves included for extra strength.

Weight 3.85kg
HxWxD: 64 x 60 x 45cms
107726

Dukdalf Chairs



The Dukdalf camping furniture range is produced in the Netherlands using Italian designed upholstery.

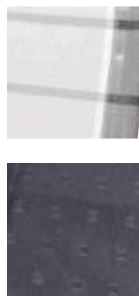

DYNAMIC

Seat: 47 x 44 cm.
 Seat-height: 45 cm.
 Backrest: 77 cm.
 Positions: 10
 Folded: 100 x 62 x 9 cm.
 Weight: 4 kg.
 Maximum capacity 140 kg.
 Material: 70% PVC, 30% Polyester

A stable and compact chair with an ergonomically shaped back and seat. It can be folded to less than 9cm thickness thanks to it's special design. The frame of double reinforced anodised oval aluminium tube makes the chair not only very strong but also very light.

- 4 per outer
- Blue (as illustrated) **107601**
- Grey **107602**
- Grey stripe **107603**



ASPEN

Seat: 49 x 43 cm.
 Seat-height: 44 cm.
 Backrest: 78 cm.
 Positions: 8
 Folded: 108 x 62 x 10 cm.
 Weight: 2.8kg.
 Maximum capacity 100 kg.
 Material: 70% PVC, 30% Polyester

Very light weight, the Aspen chair has a round aluminium tubular frame. It can be folded to 10cm thickness and reclines in 8 positions. It features a high back with built-in head rest.

- 2 per outer
- Blue **107617**
- Grey **107618**
- Grey stripe (as illustrated) **107619**



Legrest fusion

The ergonomic legrest fits all Dukdalf chairs and offers extra comfort. Simply lays across the sampler bar attached to each chair, turning a comfortable chair into a relaxer. **Oval legs.**

- Dimensions folded: 86 x 49 x 8 cm - Maximum capacity: 25 kg.
 Available singly or 4 per outer
- Blue **107613**
 - Grey **107614**



Legrest sampler

The ergonomic legrest fits all Dukdalf chairs and offers extra comfort. Simply lays across the sampler bar attached to each chair, turning a comfortable chair into a relaxer. **Tubular legs.**

- Dimensions folded: 86 x 49 x 8 cm - Maximum capacity: 25 kg.
 Available singly or 4 per outer
- Blue **107621**
 - Grey **107622**
 - Grey stripe **107623**

Leisure Vehicle Bedding

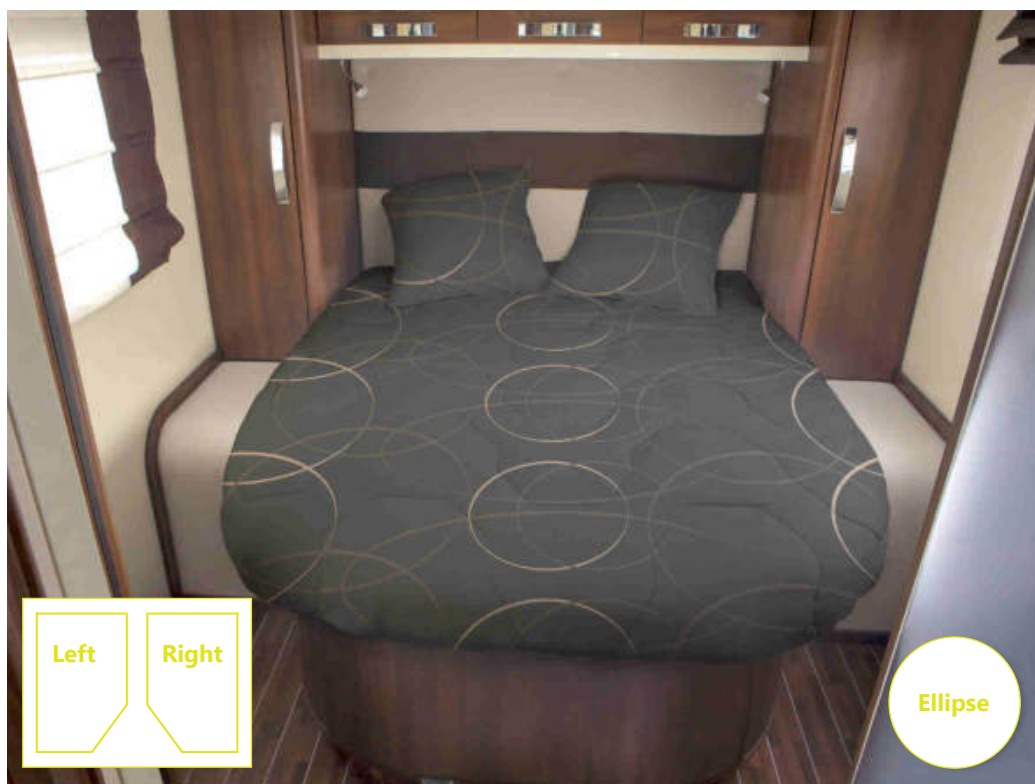

These ready made bedding systems are supplied in a sturdy reuseable plastic bag with carry handle and zip. The elasticated fitted sheet simply fits onto the fixed bed, zips onto the top sheet which then zips onto the fitted duvet, providing a neat and tidy bed during the day, and a comfortable home-like bedding system for sleeping in at night.

Includes: 1 x Elasticated and fitted 100% cotton sheet, 1 x 100% cotton top sheet and 1 x Fitted duvet with 100% cotton cover and 250g/m² 100% fire retardent polyester filling, plus 2 square pillow cases.

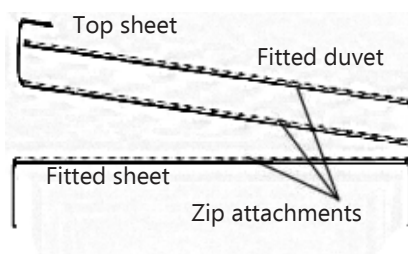

Part No.	Length (cm)	Width (cm)	Cut off corner*
123170	190	80	
123175	190	140	
123180	210	140	
123185	210	160	
123190	190	140	Right
123195	190	140	Left

Ellipse pattern available from stock

Sleeping



BI-OME® mattress protectors

The human body releases each night about ½ a litre of liquid in the form of perspiration. This highlights the importance of using mattress and pillow protectors to improve the protection of your bedding and increase its lifespan.

Anti-mite, Anti-bacterial, Anti-mold - Hypoallergenic BI-OME® permanent, non-harmful odour control technology guarantees an optimal freshness and hygiene for all kinds of textiles.

How it works!

1. Micro-organisms are attracted by the fabric coating.
2. Once in contact with the coating, their cell membrane is punctured.
3. This deactivates the micro-organism, preventing growth and proliferation.

- Prevents odour formation
- Eliminates all types of micro-organisms (bacteria, algae, fungi)
- Permanent & high wash-durability: functionality remains for the product lifetime
- Tested to both EU and US safety standards

All models - height 30cm.

80/90cm x 190/200cm	123161
130/140cm x 190/200cm	123162
140cm x 210cm	123163
160cm x 210cm	123164
Left cut 140cm x 190cm	123165
Right cut 140cm x 190cm	123166
145cm x 195cm	123167
160cm x 200cm	123168

COOLPLUS® mattress toppers

Extend the life of your mattress by protecting it from the normal wear of time while improving comfort. It helps provide good ventilation of the mattress and is a barrier against all types of parasites (mites, bacteria, molds). It can also be used as an extra mattress as a temporary solution.

- Removable and washable cover.
- Finished by all around zip.
- Material: Cover: Coolplus 100% polyester mesh
Foam: Micro perforated PU foam 32kg/m³
- Micro-perforated - ultra breathable - high resilience

● Height 5 cm	
80/90cm x 190/200cm	123200
130/140cm x 190/200cm	123201
140cm x 210cm	123202
160cm x 210cm	123203
Left cut 140cm x 190cm	123204
Right cut 140cm x 190cm	123205
145cm x 195cm	123206
160cm x 200cm	123207

Let's Camp children's sleeping bag and pillow



- 66 x 142cm (40x66cm pillow)
- Brushed polyester outer and lining
- 300g/m² polyester hollow fibre filling
- 2 bags zip together to make a double
- Double zip feature (can be opened from the top or bottom)

Available singly or 6 per outer

Let's camp 123024



V