

# Uniden®

## **G37xx Series** **VIDEO SURVEILLANCE SYSTEM**

---

*For more exciting new products please visit our website:  
Australia: [www.uniden.com.au](http://www.uniden.com.au)*

---

# **OWNER'S MANUAL**

## IMPORTANT SAFETY INSTRUCTIONS

This manual contains important information about this product's operation. If you are installing this product for others, you must leave this manual or a copy with the end user.

When using your equipment, always follow basic safety precautions to reduce the risk of fire, electric shock and injury to persons, including the following:

- **This equipment is NOT waterproof.** DO NOT expose it to rain or moisture (for the weatherproof video camera: DO NOT expose it to excessive water or moisture).
- DO NOT immerse any part of the product in water. Do not use this product near water, e.g., near a bathtub, wash bowl, kitchen sink or laundry tub, in a wet basement or near a swimming pool.
- To avoid any risk of electric shock from lightning, avoid handling any electronic devices (except battery powered ones) during an electrical storm.
- Use only the power cord and/or batteries indicated in this manual. Never dispose of any batteries in a fire: they may explode. Check with local codes for possible special disposal instructions.
- Never tug or pull on any power cord: be sure to leave some slack in the cord when placing your equipment, and always use the plug to unplug cord from the wall outlet.
- Never leave power cords where they can become crushed, cut, or frayed; when running power cords, avoid letting them rub against any sharp edges or lie across any high traffic areas where people might trip over them.
- Do not use the device if the adaptor cords or plugs have been damaged, the unit has been exposed to liquids, or the unit has been dropped or is damaged.

## **Warning to Parents and Other Users**

Failure to follow these warnings and the assembly instructions could result in serious injury or death. This product is not designed or intended for use as a medical monitor, nor should this product be used as a substitution for medical or parental supervision. Always be sure that both the transmitter and receiver are working properly, and are within range of each other.

**STRANGULATION HAZARD.** Keep the adapter cords out of the reach of children.

## **WARNING: KEEP OUT OF THE REACH OF CHILDREN.**

Allow for proper ventilation when units are in use. Do not cover the camera or receiver with any object such as a blanket. Do not place it in a drawer or in any location which would muffle the sound or interfere with the normal flow of air.

---

## ***SAVE THESE INSTRUCTIONS!***

---

### **For best results**

To avoid damage to your equipment, follow these simple precautions:

- Do not drop, puncture or disassemble any part of the equipment. There are no user-serviceable parts inside.
- Do not expose the equipment to high temperatures, and avoid leaving the equipment in direct sunlight for more than a few minutes. Heat can damage the case or electrical parts.
- Do not place heavy items on top of the equipment or expose the equipment to heavy pressure.
- Remove the power adaptor during long periods between usages.
- Clean only with a dry cloth.

***Failure to follow the instructions in this operating manual will void the warranty. Uniden assumes no liability for damages to property or injury to persons caused by improper handling or failure to comply with these safety instructions.***

# CONTENTS

<b>WHAT'S IN THE BOX?</b> .....	<b>5</b>
<b>INSTALLATION</b> .....	<b>6</b>
General Placement Considerations .....	6
Installing the Monitor .....	7
Installing the Camera .....	7
<b>BASIC OPERATION</b> .....	<b>9</b>
Hardware .....	9
G37xx Monitor .....	9
G3700 Camera .....	10
G3700L Camera .....	10
<b>USING G37 SERIES</b> .....	<b>11</b>
MONITOR SCREEN .....	11
G37XX OPERATION .....	12
LCD DISPLAY .....	13
<b>SYSTEM MENUS</b> .....	<b>16</b>
OVERVIEW .....	16
LIGHT SETTINGS (Only works with a paired G3700L) .....	16
ALARM .....	18
BRIGHTNESS .....	18
GENERAL SETTINGS .....	19
CAMERA SETUP SCREEN .....	21
RECORDING SETUP SCREEN .....	23
SYSTEM SETTINGS SCREEN .....	27
MOTION DETECTION SETTINGS SCREEN .....	30
NETWORK SETUP SCREEN .....	32
FIRMWARE UPGRADE SCREEN .....	34
<b>G37XX OPERATION BASICS</b> .....	<b>36</b>
<b>REMOTE VIEWING</b> .....	<b>40</b>
<b>MAINTAINING YOUR SYSTEM</b> .....	<b>48</b>
<b>TROUBLESHOOTING</b> .....	<b>49</b>
INTERFERENCE .....	50
<b>SPECIFICATIONS</b> .....	<b>51</b>
<b>ONE-YEAR LIMITED WARRANTY</b> .....	<b>54</b>

# WHAT'S IN THE BOX?



G3700  
Cameras\*



G3700L  
Cameras\*



Digital Wireless  
Monitor

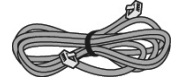

Ethernet Cable



9V 0.6A Camera  
Power Adaptors\*

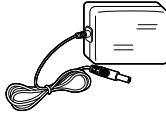

5V 2A Monitor  
Power Adaptor\*



Screws and  
anchors

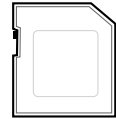

8GB SD Card

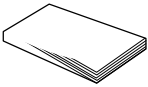

Owner's Manual

\* Refer to the table below.

Model Name	7" Monitor	G3700 Camera	G3700L Camera	Adaptors
G3710	1	1	-	1 x Camera Power Adaptors 1 x Monitor Power Adaptors
G3720	1	2	-	2 x Camera Power Adaptors 1 x Monitor Power Adaptors
G3721L	1	2	1	3 x Camera Power Adaptors 1 x Monitor Power Adaptors
G3722L	1	2	2	4 x Camera Power Adaptors 1 x Monitor Power Adaptors

- Image may vary slightly from the actual product.
- If any item is missing or damaged, contact your place of purchase immediately.  
**Never use damaged products!**
- Need help? Get answers at our website:  
**[www.uniden.com.au](http://www.uniden.com.au)** for Australian model.

All trademarks are registered trademarks of their respective owners.

# INSTALLATION

## General Placement Considerations

- The cameras included with your monitor are weatherproof and have an IP65 weather rating. Water can be sprayed on them and they will still work; however, the cameras cannot be submerged underwater.
- Although the cameras can be exposed directly to the rain, it is recommended that, if they are used outdoors, they be mounted under some type of cover like a patio overhang or eave. As rainwater drops start to dry on the camera glass, it can create spots that will reflect the light from the infrared LEDs used for night vision, thus causing lower quality video.
- Also, as dust, grime, and cobwebs accumulate on the camera glass, they can reflect light from the infrared LED and might lower video quality. Periodically, clean the lens glass with a soft cloth.

## Consider the following when placing the camera:

- Clear line of sight video transmission distance is up to 150 meters.
  - Walls, especially brick and concrete, shorten the transmission distance.
  - Placement next to windows allows better transmission.
- Avoid having a direct light source in view of the camera. This includes street lights, ceiling or floor lamps, spotlights in the driveway, etc.
- The cameras are equipped with built-in infra-red LEDs so you can use night vision for 24-hour surveillance. The LEDs automatically activate at night and the picture viewed turns to black and white. The night viewing range is up to 12 meters. Avoid pointing the camera lens directly at clear glass; the night vision LEDs will cause a blurred image.
- Optimized motion detection range is up to 12 meters. The farther away an object is, the less accurate the motion detection.
- Avoid pointing the camera directly at any bushes, tree branches, or moving objects that might naturally move due to winds. Otherwise, the motion detection feature may record unnecessarily.
- Out of Range displays when the monitor and camera are too far apart. Reposition the equipment.
- A Low Battery icon displays when you need to recharge the battery.

## Installing the Monitor

1. Flip out the stand on the back of the monitor and position the antennas.
  2. Connect the 5V 2A AC adapter to the power input on the rear of the monitor. Connect the other end of the adapter to a standard indoor power outlet.
- ⚠ **The monitor comes with a partial charge. Plug it in and let it charge for a full 8 - 9 hours before using it.**
3. Press and hold the **POWER** button on the top of the monitor for 3 - 4 seconds to power it up.
  4. The monitor displays the *Uniden Guardian* screen for a few seconds and then transitions to the LIVE view if the paired camera has been powered on. Otherwise *Out of Range* message displays.
- ⚠ **The screen remains dark until the cameras are powered up.**

## Installing the Camera

When you are positioning the camera, bring the monitor along; it's much easier to get the camera into the right position when you have the display handy.

- ⚠ **The monitor's battery will last about 1.5 hours on its own when it is fully charged.**
1. Install the antennas (if needed), position the camera where you want it, plug it into power, and check video on the monitor. Move the camera if the view is not what you want.
  2. Hold the base of the camera stand where you want to mount it and mark the location of the screw holes.
  3. Use the included screws and anchors to attach the base to the wall or ceiling.
  4. Tug gently on the stand to make sure it is securely in place.
  5. Connect one end of a **DC 9V 0.6A** for G3700 and **DC 9V 2A** for G3700L AC adaptor to the camera's power pigtail and plug the other end into a standard indoor power outlet.
  6. Cameras provided in the kit are already paired to the monitor. Once they are powered up, the monitor displays images from that camera.

Adjust the camera viewing position, if needed.

If...	Try...
there is no camera picture	Verify that the power supply adaptor for the camera(s) is plugged in.
the picture quality is poor	Clean the camera lens.
a white image appears at night	The camera's infra-red LED shines due to the invisible light that reflects off surfaces such as glass, causing white light. Place the camera on the other side of windows with the lens side flush against the surface to improve the night vision, or place the camera in a well-lit area.

## Night Vision

This camera has built-in IR LEDs, which provides the camera with the ability to view images in no/low light conditions. It is important to use the provided power adaptor (and not the batteries) when using the camera for prolonged periods in low light conditions.



# BASIC OPERATION

## HARDWARE

### G37xx Monitor

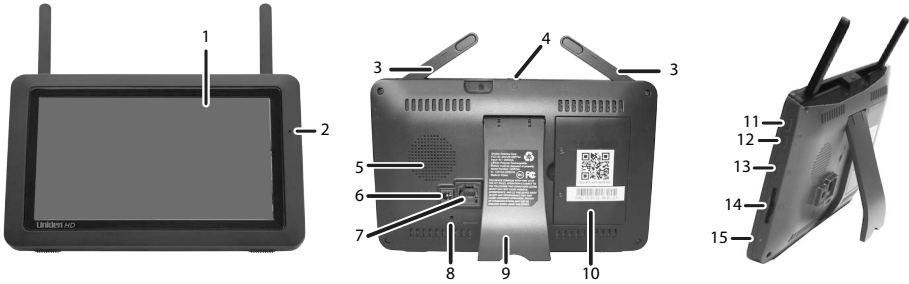

No.	What it is
1	LCD Screen: Displays video from the camera(s) or system operation interface.
2	Microphone
3	Wireless Antenna
4	Power Button/ Scan Button: Press and hold about 5 seconds to turn the receiver on/off. Press and release while the unit is powered on to turn Scan mode on/off.
5	Speaker
6	Power Port: Connect to a local power outlet using the included power adapter.
7	Ethernet Port (RJ-45): Connect the receiver to your router using the included Ethernet cable to enable remote viewing functionality.
8	Reset: Using a paper clip or other thin object, push the reset button to restore the system to its default settings.
9	Receiver Stand
10	Battery Cover
11	Volume Up
12	Volume Down
13	Talk. Press and hold to talk through the camera. Release to listen for a response.
14	SD Card Slot. Insert SD card for recording videos.
15	Blue LED Flashing - Battery power is low

## G3700 Camera

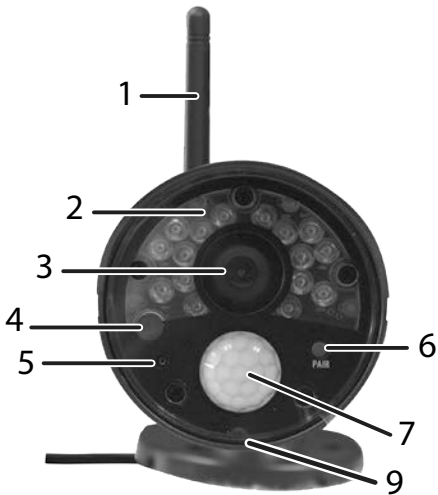

## G3700L Camera

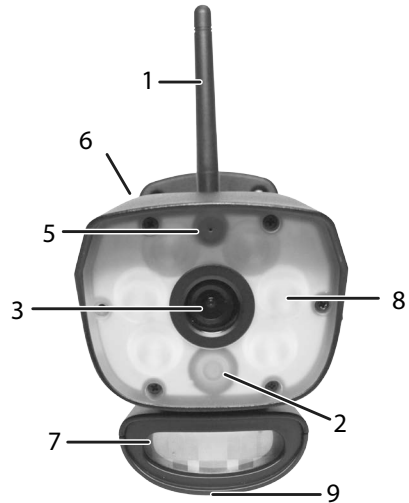

No.	What it is
1	Camera Antenna: Sends and receives signals to/from the monitor.
2	IR LEDs. Infrared LEDs provide viewing in low/ no light conditions.
3	Camera Lens: Catches the video in front of the lens and transmits video from camera to monitor.
4	Light Sensor: Sense brightness for changing between daytime and nighttime vision
5	Microphone: Transmit audio to monitor.
6	Pair Button: The pair button is located on the front (rear for G3700L) of the camera. It is used to pair the camera with monitor.
7	PIR Sensor: Detects motion in front of the lens and emits detection signal to transmitter.
8	6 white LEDs turn on when motion is detected or when a preset time range begins
9	Speaker (at the bottom of the camera): Produces the sound transmitted from the monitor.

# USING THE G37 SERIES

## MONITOR SCREEN

The G37xx monitor's screen has 3 main parts:

- Live View area. The main screen area displays live video from the camera(s).
- Pop Out Menu Tab. Tap this tab to display 4 menus that let you manage the system. See page 16 for details.
- Icon bars. Icons display on the top and bottom of the monitor screen. See page 13 for icon details.

## Viewing Modes

The Live View area displays live video from the cameras. Each camera can display in its own section of the screen or on the full screen. The number of cameras that display depends on how many cameras are turned on (see page 22).

There are 3 viewing modes:

- Multi-Channel mode (Dual or Quad).  
If you have 2 cameras turned on, video displays in Dual mode.  
If you have 3 or 4 cameras turned on, video displays in Quad mode.

DUAL MODE

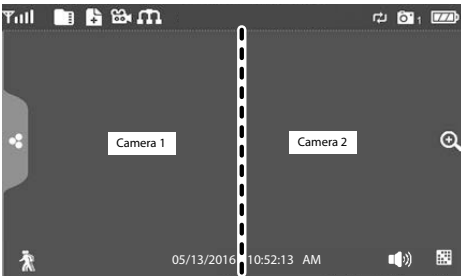

QUAD MODE

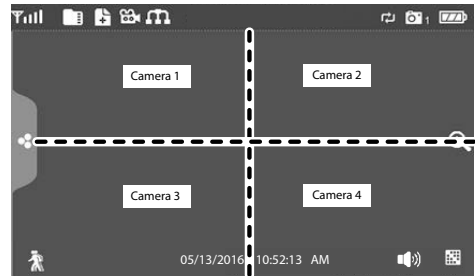

- Single Channel mode displays one camera at a time on full screen. From Dual or Quad channel mode, tap the center of a channel's screen to display that channel in full screen. Press  to change between the channels. Tap the center of the image to return to the previous mode.

## Channel Cycling Modes

There are two ways to cycle between channels - Scan and Auto Sequence.

With Scan mode, the monitor's screen and speakers are off until a camera detects motion. That camera then displays at full screen (sound and video on) until there has been no motion for 15 seconds. After that, the monitor screen turns off again. Quickly press and release **POWER** to turn Scan mode on and off.

In Auto Sequence mode, each channel displays automatically in sequence in full screen. Access this mode from Single channel mode. Tap  to turn on Auto Sequence mode; **SEQ** displays. Tap **SEQ** to turn it off and return to Multi-Channel mode (Dual or Quad).

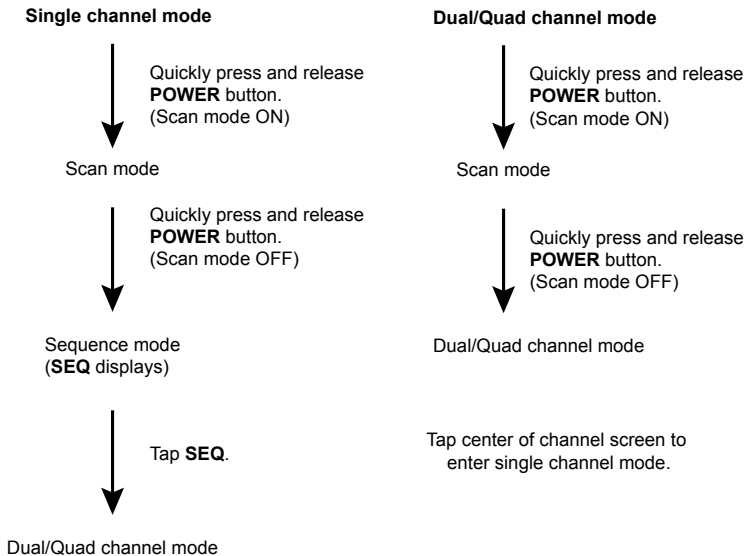

## G37XX OPERATION

Your G37xx monitor operates through a series of screens that let you choose groups of operations. For example, when you tap **SD CARD INDICATOR**  in the pop-up menus, you can view recorded files. Tapping **SETTINGS** in the pop-up menus let you set up how your system will operate (i.e., camera setup, recording schedule, motion detection sensitivity, etc.).

### Live View Screen

The Live View screen is the monitor's main screen that displays video from your camera(s). You can have the system display a single camera or you can set the screen to display all of them. You can also set the screen to cycle between all live video feeds. Tap the  icon to change the Live screen video displays.





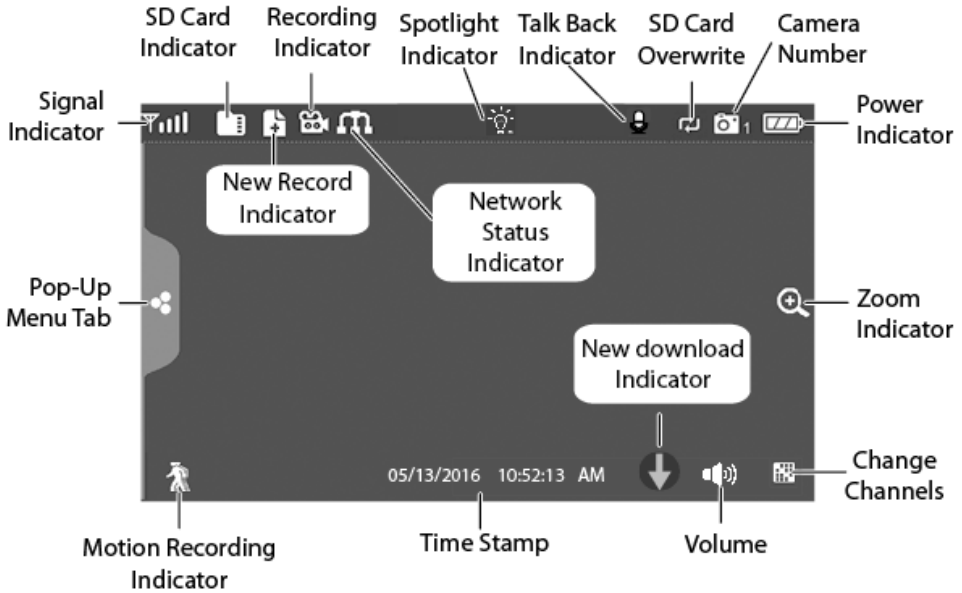

## G37xx Live Screen Icons



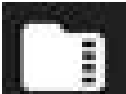







Different icons display on the monitor screen depending on what is going on with your cameras. This image shows an example of what could be on your screen (the video image is removed to make it easier to see the icons). A table follows of possible icons and their definitions.

## LCD DISPLAY

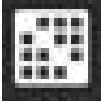

*NOTE: Icons on the screen display in BLUE. Icons that display will vary according to system configuration.*

G37xx Icon	What it does
<b>SIGNAL INDICATOR</b> 	<ul style="list-style-type: none"> <li>Shows how strong the camera's signal is. Signal ranges from 4 bars down to 0 bars (out of range).</li> </ul>
<b>SD CARD INDICATOR</b> 	<p>This graphic displays if an SD card is inserted into the monitor.</p> <p>If blue, recording space is available.</p> <p>If red, the SD card is full.</p> <p>Tap this icon to view recorded files.</p>
<b>NEW RECORD INDICATOR</b> 	<p>New recordings are saved on the SD card.</p>
<b>RECORDING INDICATOR</b> 	<p>When this icon flashes red, it indicates that recording is in progress.</p>
<b>NETWORK STATUS INDICATOR</b> 	<ul style="list-style-type: none"> <li>Green - System is connected to the internet and the monitor is connected with internet mode.</li> <li>Yellow - System is connected to internet and the monitor is connected with intranet mode.</li> <li>Red - Connection has failed or system is not connected to a network.</li> </ul>
<b>SPOTLIGHT INDICATOR</b> <small>(WORKS WITH G3700L ONLY)</small> 	<p>If blue, spotlight is on.</p> <p>If grey, spotlight is off.</p> <p>Tap the icon to manually switch on or off spotlight camera and letter 'm' will appear.</p>
<b>TIME STAMP</b>	<p>Current date/time in month/day/year, hour/minute/second format.</p>
<b>SD CARD OVERWRITE</b> 	<p>Displays if the SD card is allowed to overwrite files when it is full.</p>
<b>CHANNEL INDICATOR</b> 	<p>Displays the current channel number you are currently viewing. If viewing multiple cameras at once, the camera indicator will appear above each video display.</p>

<p><b>BATTERY INDICATOR</b></p> 	<p>Indicates the LCD monitor's battery life:</p> <ul style="list-style-type: none"> <li>• Flashing Red - Low battery</li> <li>• Blue - Full battery</li> <li>• Flashing Blue - Charging</li> </ul>
<p><b>ZOOM INDICATOR</b></p> 	<p>When you tap this icon on the screen, the monitor breaks the screen image into 5 areas. Tap the area you want to see in Zoom. That area displays in 2X size and the magnifying glass icon changes to the arrows icon (  ). Tap the arrows icon to exit Zoom mode.</p>
<p><b>VOLUME INDICATOR</b></p> 	<p>The Volume Indicator displays when you tap + or - to raise or lower the volume while in single channel display. It indicates current audio volume.  displays when the volume is off (mute).</p>
<p><b>TALK BACK INDICATOR</b></p> 	<p>Displays when <b>TALK</b> is pressed. Press and hold <b>TALK</b> on the side of the monitor to talk back through the camera. Release <b>TALK</b> to wait for a reply.</p>
<p><b>NEW DOWNLOAD INDICATOR</b></p> 	<p>Displays if new firmware is available.</p>
<p><b>SEQUENCE INDICATOR</b></p> 	<p>Displays when the monitor is in auto switch mode; it will change channels automatically.</p>
<p><b>CHANGE CHANNEL</b></p> 	<p>Tap this icon to manually change channels. See page 11.</p>
<p><b>MOTION RECORDING INDICATOR</b></p> 	<p>Indicates motion detection status.</p> <ul style="list-style-type: none"> <li>• Blue - Automatic recording OFF. Press BLUE icon to record. Icon turns RED.</li> <li>• Red - Automatic recording ON. Press RED icon to stop recording. Icon turns BLUE.</li> </ul>
<p><b>POP-UP MENU TAB</b></p> 	<p>Tap to access the pop up menu system.</p>

# SYSTEM MENUS

## OVERVIEW

This section describes the G37xx pop-up menu screens in detail. These pop-up menus enable you to:

- Set the spotlight camera settings
- Set alarms tone volume
- Set the brightness of the display
- Set up cameras for recording, motion detection, and other system and network requirements.

Tap  and the pop-up menu display.

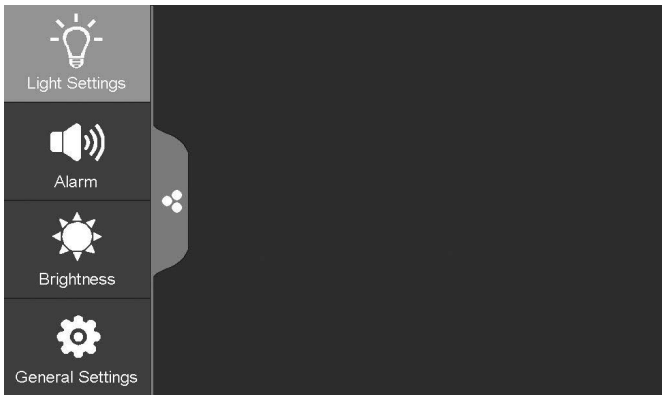

## LIGHT SETTINGS (Only works with a paired G3700L)

When G3700L is paired (see page 21), you can set how long the light will be on once it is activated, set a timer for the light to be on during a specified time period and dim the light intensity

1. Tap . The following screen displays.

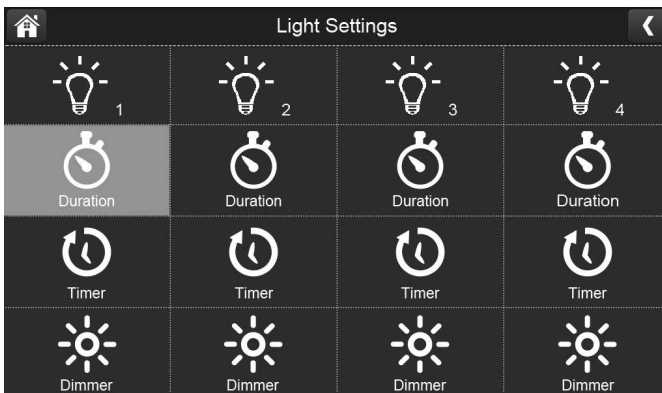



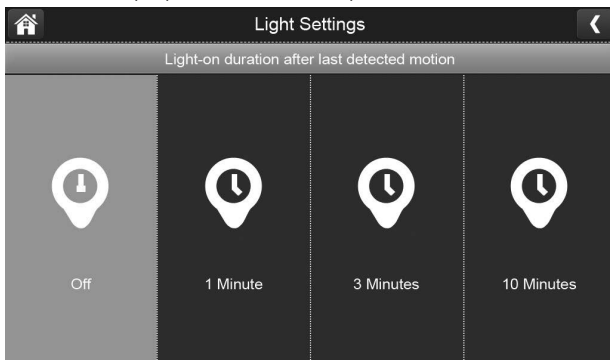

2. Tap  to allows you to set the length of time the light stays on after it is triggered. Options are 1, 3, or 10 minutes, or Off.

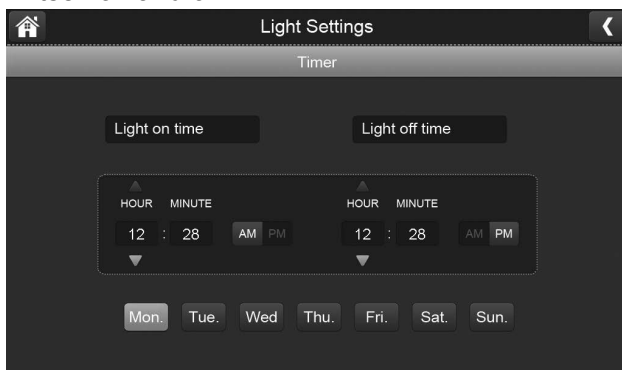

3. Tap  option lets you set a start and end time and also the day for the light camera to turn itself on and off.



4. Tap  option lets you set how strong the LED lights will display. Options are 25%, 50%, 75%, and 100%.

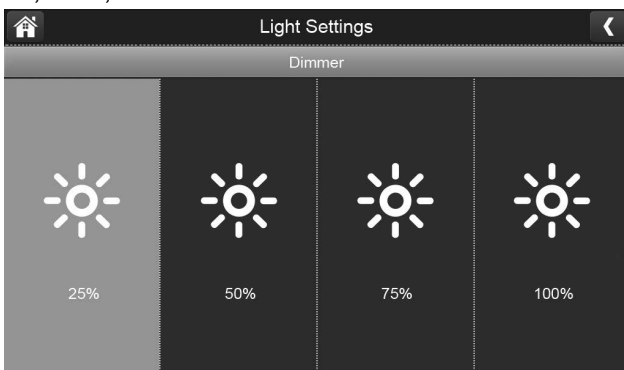

5. Tap  at anytime return to viewing mode.

# ALARM

When motion triggers the camera to begin recording, the monitor sounds an alarm tone. This screen lets you determine how loud that tone will be.

1. Tap . The following screen displays.





2. Tap + or - to increase or decrease the alarm volume. Tap  when you are finished.

# BRIGHTNESS

This feature allows you to set each camera's brightness level from single camera mode.

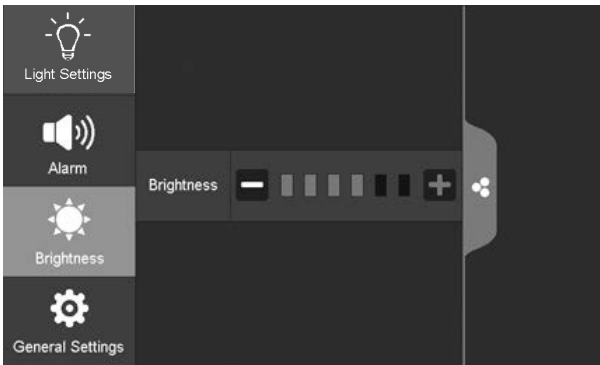
1. Tap . The following screen displays.



2. Tap + or - to increase or decrease the selected camera's brightness. Tap  when you are finished.

# GENERAL SETTINGS

The *General Settings* screen contains 6 subsections, each of which may contain sub-screens. These sub-screens let you set features about your system. You can turn cameras on and off, establish a specific schedule for specific cameras to record, set the date and time, and motion detection sensitivity, among other features. The rest of this section provides details using these screens.

Tap the following icons as they appear on the screens:

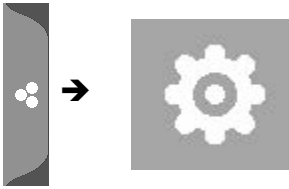

This screen should display:

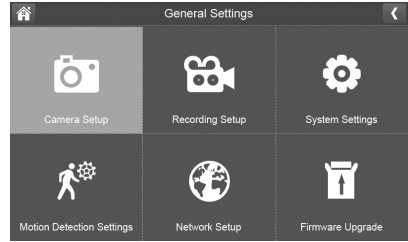

Main Screen	Sub-Screens	What it Does
<i>Camera Setup</i> (see page 21)	<i>Pairing</i> (see page 21)	Use Pairing to assign these cameras to different channels or to pair additional new cameras to the monitor.
	<i>ON/OFF</i> (see page 22)	Makes the cameras visible to the monitor.
	<i>Resolution</i> (see page 22)	Adjusts the video quality of each camera.
<i>Recording Setup</i> (see page 23)	<i>Duration</i> (see page 23)	Set the length of time the camera records once motion sensitivity triggers the camera to record. Choices are 15 seconds, 30 seconds, or 1 minute (Default - 15 seconds)
	<i>Schedule Recording</i> (see page 24)	Set up a schedule for pre-determined recording times and lengths.
	<i>File Overwrite</i> (see page 26)	Overwrites the oldest recorded data on the SD card once the card is full.
	<i>Audio On/Off</i> (see page 26)	Turns microphones on or off for each camera.

<b>Main Screen</b>	<b>Sub-Screens</b>	<b>What it Does</b>
<i>System Settings</i> (see page 27)	<i>Date &amp; Time</i> (see page 27)	<ul style="list-style-type: none"> <li>• Time Setting. Set the current time (including Daylight Savings Time).</li> <li>• Time Zone. Set the time zone for your G37xx system.</li> </ul>
	<i>Time Zone</i> (see page 28)	<ul style="list-style-type: none"> <li>• Set the time zone for your G37xx system.</li> <li>• Enable/Disable Daylight Savings Time</li> </ul>
	<i>Language</i> (see page 28)	Changes language setting for the monitor.
	<i>Default Settings</i> (see page 29)	Restores the G37xx to default settings..
	<i>Format SD Card</i> (see page 29)	Reformats the SD card and deletes all existing data.
	<i>Information</i> (see page 30)	Displays firmware information for the monitor and each camera.
<i>Motion Detection Settings</i> (see page 30)	A single screen lets you set motion detection sensitivity for each camera. It also lets you determine which viewing areas for each camera should be masked from motion detection.	
<i>Network Setup</i> (see page 32)	<i>Advanced Setup</i> (see page 32)	Set up Dynamic or Static IP address
	<i>Reset Password</i> (see page 33)	Reset Guardian Full HD app password to default (000000).
	<i>Information</i> (see page 33)	Displays information about your network and the monitor's unique UID number.
<i>Firmware Upgrade</i> (see page 34)	Lets you select how you want to upgrade your firmware (from SD card or from server).	

## CAMERA SETUP SCREEN

The *Camera Setup* screen lets you:

- Pair cameras
- Turn cameras on and off
- Adjust the resolution

### Pairing

Your cameras in the kit are paired to the monitor at the factory. When you add a new camera to your system, you have to “introduce” the camera and monitor to each other so they can communicate.

🔊 **You can also use this procedure to move a camera from one channel to a different channel.**

### ***Some things to know about pairing cameras:***

- If a camera is already assigned to the selected channel, the pairing operation overwrites that camera link with the new one.
- Only pair one camera at a time! The monitor links to the first camera it detects. If two or more cameras are in pairing mode, you can't control which camera the monitor will detect first.

Tap the following icons as they appear on the screens:

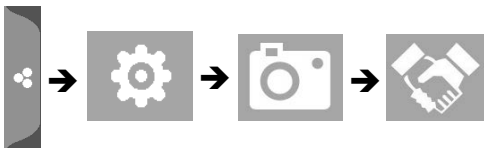

This screen should display:



1. Tap *Pairing* on the *Camera Setup* screen.
  2. Tap the channel number you want to pair the camera to.
  3. A message displays with instructions to press the **PAIR** button on the camera. Press and release the **PAIR** button on the camera (see page 10). A 30 seconds countdown begins.
- 🔊 **You must press the PAIR button on the front/rear of the camera during the 30 seconds countdown; otherwise, the camera will not be paired.**
4. The system displays live video 3 seconds after the camera is successfully paired.

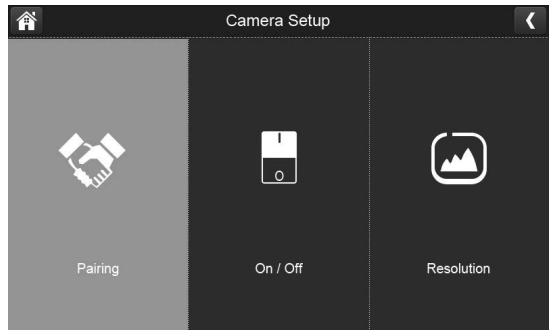

## On/Off

When you add a camera to your system, pair up the camera with the monitor and the system will automatically turn it on.

Tap the following icons as they appear on the screens:

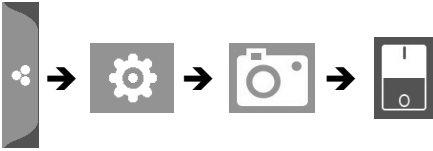

This screen should display:

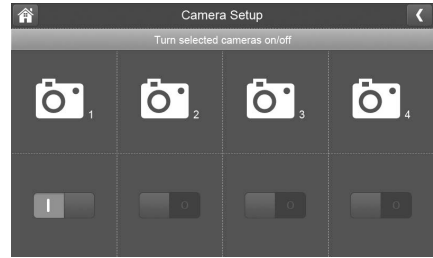

1. Tap the switch bar under the camera you want to turn on or off.
  2. The switch bar indicator turns green when the camera is on. It is greyed out when the camera is off.
- ⚠ **Although the camera is turned off, it is still powered. The monitor will not receive video signals from that camera.**
3. Tap  to return

## Resolution

Tap the following icons as they appear on the screens:

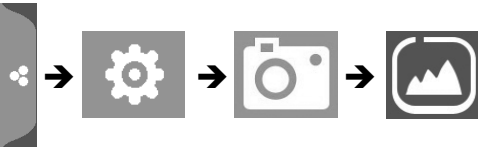

This screen should display:



1. Tap *High* or *Low* to set the resolution for each camera (High - 1080P; Low - 720P).
2. Tap  to return to the previous screen and tap it again to return to the general Settings screen.

## RECORDING SETUP SCREEN

Use the *Recording Setup* screen to:

- Set the length of time the system will automatically record when something triggers motion sensitivity.
- Schedule a set time and duration to automatically record from a specific camera.
- Set up file retention requirements
- Turn camera's sound on or off for recording

Tap the following icons as they appear on the screens:

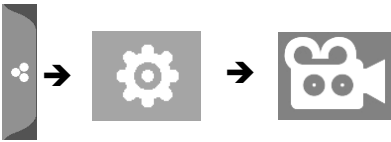



This screen should display:

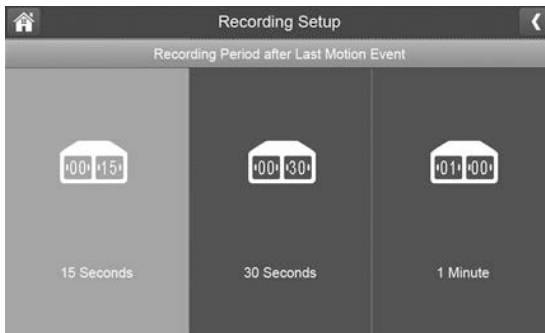

### Duration

You can set how long the camera keeps recording after motion detection triggers it. The options are 15 seconds, 30 seconds, or 1 minute. (Default = 15 seconds)



1. Tap the duration you wish to set.
2. Tap  to return to the previous screen.

## Schedule Recording

This feature lets you set up a block of time for a camera to record on a weekly schedule. You can set up multiple cameras to record at the same time and the recording times can overlap between cameras. (Default=No schedule recording)

- ✎ **Total recording time is limited to the space available on the SD card. If you set the SD card to delete the oldest files when it is full (see page 26), the system continues recording; otherwise, recording stops until space is available.**

### Set up a schedule for recording time and length

1. Tap ; the *Schedule Recording Overview* screen displays.
2. Tap **MODIFY** in the lower left corner. The *Schedule Recording Setup* screen displays.

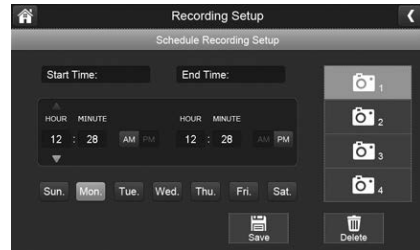
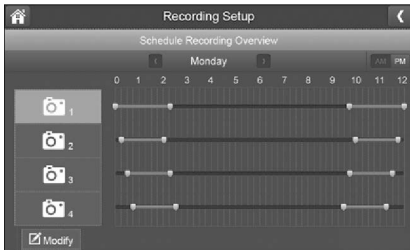



3. Select a camera. If you want more than one camera to record at the same time, select both cameras.
4. Set the recording start and end times.
  - Tap the **AM/PM** block to toggle between them.
  - Tap the hour and minute boxes separately and tap the up and down arrows to set the start and end times in HH:MM format.
  - Tap the days for which this recording schedule applies.
5. Tap **SAVE**. The system returns to the *Schedule Recording Overview* screen with the recording period indicated.
6. Tap **MODIFY** again to set up another recording session to schedule. If you want to modify schedule recording, you will need to delete previous schedule recording (see page 25).
- ✎ **Scheduled recordings are broken up into 5 minute file sizes. For example, if you record a 12 minute event, you will have two 5-minute recordings plus one 2-minute recording.**
7. Tap  to return to the previous screen.

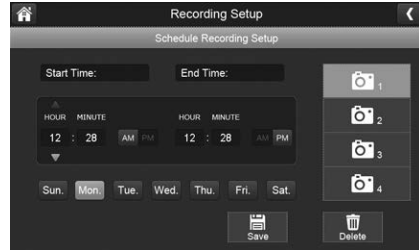
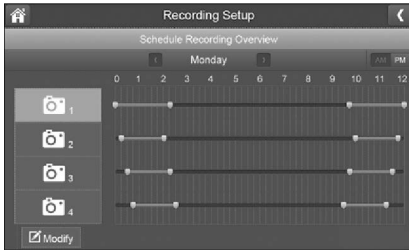

## Delete a schedule for predetermined recording time and length

1. Tap  ; the *Schedule Recording Overview* screen displays.
2. Tap **MODIFY** in the lower left corner. The *Schedule Recording Setup* screen displays.





3. Select a camera. If you want to modify or delete schedule recording for more than one camera to record at the same time, select other cameras.
4. Set the recording start and end times that you want to delete.
  - Tap the **AM/PM** block to toggle between them.
  - Tap the hour and minute boxes separately and tap the up and down arrows to set the start and end times in HH:MM format.
  - Tap the days for which this recording schedule applies.
5. Tap **DELETE**. The system returns to the *Schedule Recording Overview* screen with the recording period indicated.
6. Tap  to return to the previous screen.

## File Overwrite

This feature lets you set the system to automatically overwrite the oldest files once the SD card is full. This will allow you to continue recording. If you do not allow overwrite, recording stops when the SD card is full.

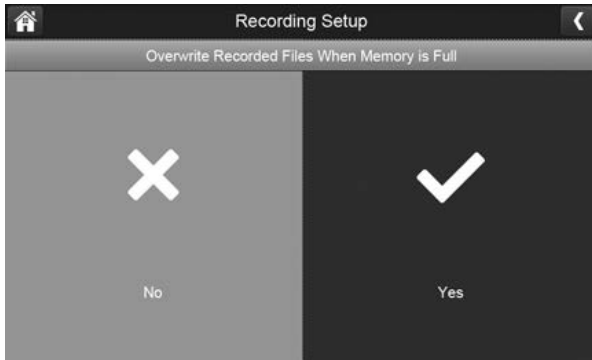
1. Tap  to access the File Overwrite function. The following screen gives you the option of allowing File Overwrite (tap YES) or, if File Overwrite is on, cancelling it (tap NO).



2. Tap  to return to the previous screen and again to return to the general Settings screen.

## Audio On/Off

This feature lets you turn the microphone on or off for any camera.

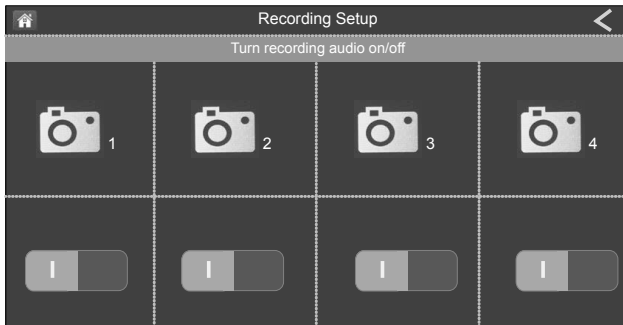

Toggle the ON/OFF button under the desired camera.

# SYSTEM SETTINGS SCREEN

Use these setting options to configure your system:

- Date and Time
- Time Zone
- Language
- Default Settings
- Format Memory Card
- Information

Tap the following icons as they appear on the screens:

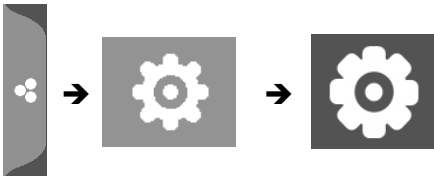

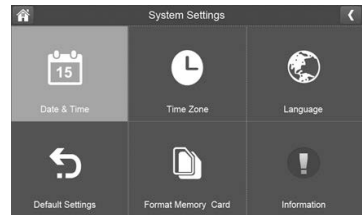

This screen should display:

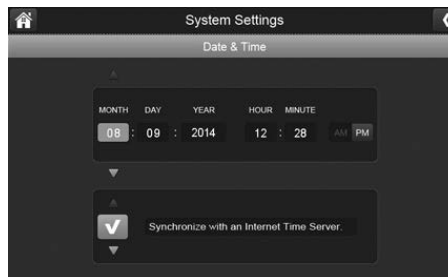

## Date and Time

1. Tap  to access the *Date & Time* screen.





2. Tap the up or down arrow to set the month, day, and year.
  3. Tap the up or down arrow to set the time.
    - Tap the **AM/PM** block to toggle between them.
    - Tap the up or down arrows to set the correct hour and minute.
  4. Tap *Synchronize with an internet time server* if you want the internet clock to set your time automatically.
- ✎ **You must keep your system connected to your wireless network using the Ethernet cable in order to synchronize with the internet time server.**
5. Tap  to return to the previous screen.

## Time Zone

Time Zone allows you to set the time zone your monitor is in. Your system will know that your request refers to the time zone the monitor is in. [Default = (GMT+10:00) Canberra,Guam, Melbourne, Sydney].

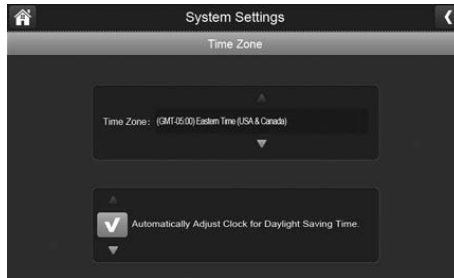
1. Tap . The *Time Zone* screen displays.



2. Scroll up and down to your camera's time zone and then tap it. The most commonly used time zones for this system are:
  - GMT+8:00 - Perth
  - GMT+9.30 - Darwin & Adelaide
  - GMT+10:00 - Brisbane, Sydney, Canberra & Melbourne (Default)
3. Tap the next option to turn Daylight Savings Time on or off.
4. Tap  to return to the previous screen.

## Language

Tap  to set the language used on your system. Options are English, Español, and Français.

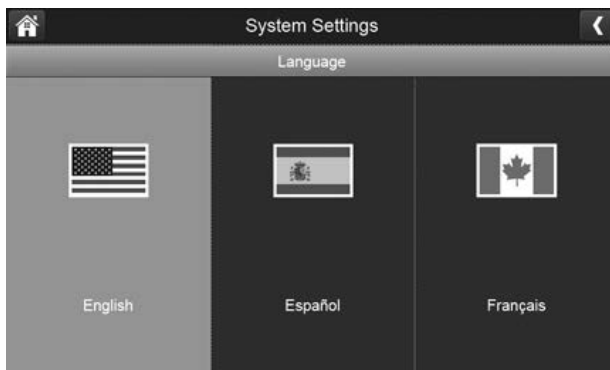

1. Tap the language you want your system to use.
2. Tap . The system returns to the previous screen and automatically changes over to the requested language; no reboot is necessary.

## Default Settings

1. Tap  to return your system to the original default settings.

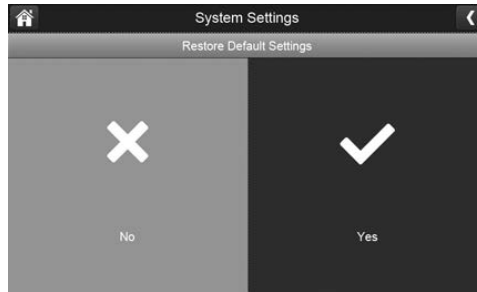

2. Tap **YES** on the *Restore Default Settings* screen.
3. Tap **OK** to confirm the reset.
4. Tap  to return to the previous screen.

## Format SD Card

Formatting the SD card erases all data stored on the card. (Default = **NO**)

1. Tap  to reformat your SD card.

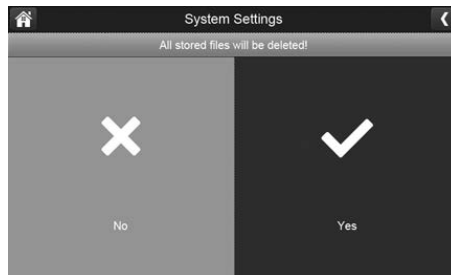



2. Tap **YES** on the *All stored files will be deleted!* screen (Default = **NO**). A confirmation screen displays. Tap **YES** to it.



3. A progress bar displays on the screen. After formatting completed, a *Format OK* message displays and the system returns to the System Setting screen.

## Information

This screen lists the firmware information of the monitor and all cameras paired to it.

1. Tap  to display the screen.
2. Tap  to return to the previous screen.

🔔 **Uniden recommends that you check your monitor firmware version against the most recent version (<http://www.uniden.com.au>) at least twice a year. If you need to upgrade your monitor firmware (see page 34).**



3. Tap  to return to the general Settings screen.

## MOTION DETECTION SETTINGS SCREEN

Video motion detection settings control how strong the motion needs to be to trigger recording. This settings screen also lets you mask off any areas in the image for the camera to ignore. For example, you may have trees in the image area that would set off motion detection if there is a breeze.

Tap the following icons as they appear on the screens:

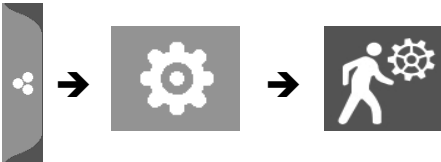

This screen should display:



## Sensitivity

This selection allows you to set the camera's motion detection sensitivity levels to *High*, *Low*, or *Off*.

1. Tap . The following screen displays.

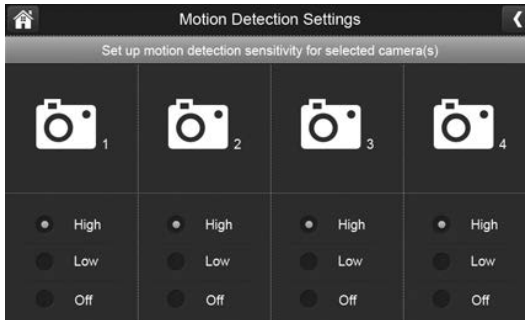

2. Tap *High*, *Low*, or *Off* to set sensitivity.
3. Tap  to return to the previous screen.

⚠ **Note: Even if the sensitivity set to OFF, it will still detects an object with heat with PIR sensor (couldn't be switch off) to trigger recording and push alarm notification (if internet was available).**



## Mask Area

Use this selection to mask off any parts of the viewing area you do NOT want to be included for motion detection.

⚠ **Note: the video image is removed to make it easier to see the masking grid.**

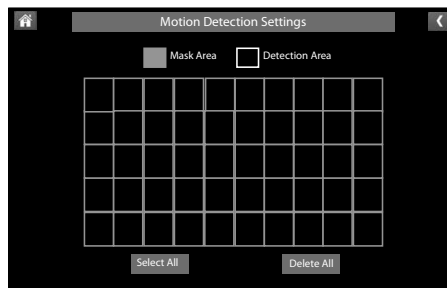
1. Tap . The *Mask Area* screen displays, superimposed over the image from that camera.



2. Tap the squares that cover the areas of the image you do not want affected by motion detection.
3. When you are finished, tap  to return to the *Motion Detection Settings* screen.
4. Tap  to return to the general Settings screen.

## NETWORK SETUP SCREEN

This selection lets you determine your network connection type, reset the App password and review your network details.

Tap  to see the *Network Setup* screen and option.

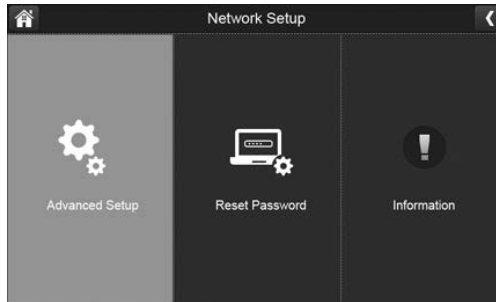

## Advanced Setup

1. Tap  to display the *Advanced Setup* screen.

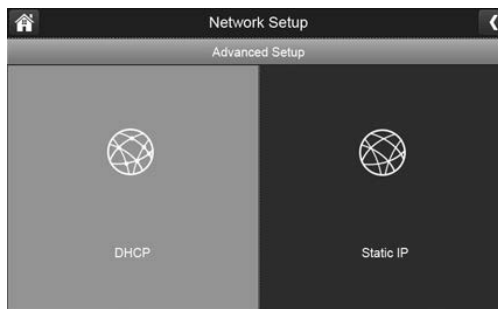

2. Tap on your selection and fill in the fields requested. Tap **SAVE**.

### DHCP



### Static IP

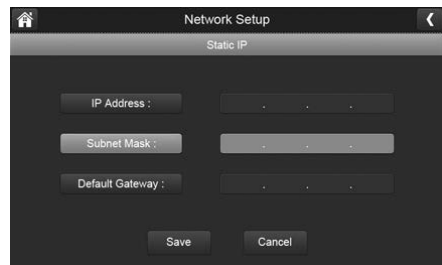

3. Tap on your selection and fill in the fields requested.

 **DHCP is the most common connection. Your router will automatically assign an IP address to your G37xx system. Static IP is for those that have the ability to specify an IP address for their system.**



4. Reboot the monitor when prompted.

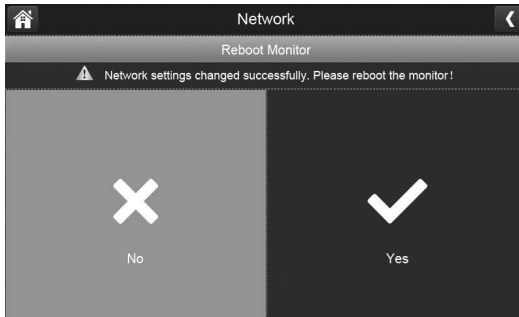

## Reset Password

The Reset Password feature resets the Guardian Full HD app's password to the default (000000).



Tap **YES**; the *Reset Password* screen displays again. Tap  to return to the *Network Setup* screen.





Tap  to return to the general Settings screen.

## Information

This screen displays current IP information when the system is connected to the internet.

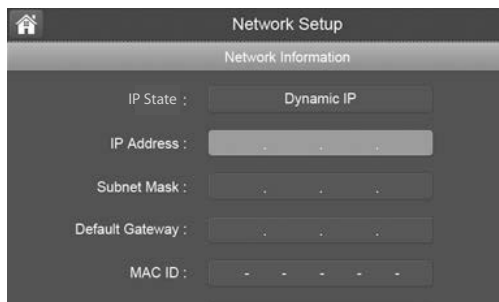
Tap  to display the *Information* screen, then tap  to return to the *Information* screen.



Tap  to return to the general Settings screen.

## FIRMWARE UPGRADE SCREEN

Uniden recommends that you periodically check your monitor firmware version against the most recent version ([www.uniden.com.au](http://www.uniden.com.au)). See page 48 to copy the new firmware to your monitor's SD card.

Tap the following icons as they appear on the screens:

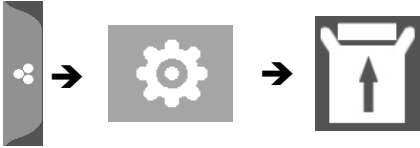

This screen should display:



### Upgrade from SD Card

1. Tap  to upgrade the firmware through the SD card. A confirmation screen displays. Tap **YES**.

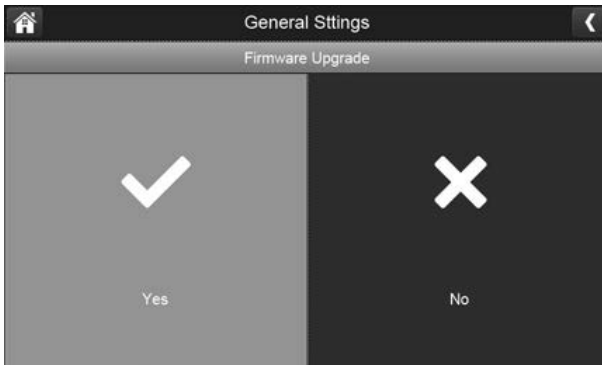

2. A progress screen displays.



3. When the update is complete, the monitor displays *Firmware Upgrade Successful* and automatically reboots.

## ***Upgrade from Server***

1. Use the Ethernet cable (provided) to connect your monitor to your router.
2. Tap  to upgrade the firmware through the Server.
3. A confirmation screen displays. Tap **YES**.
4. The system checks to see if new firmware is available. If new firmware is available, the monitor installs it and automatically reboots.

# G37XX OPERATION BASICS

This section gives you instructions on how to perform the most commonly used actions for the G37xx. There is also a table of other actions you might find useful.

## MANUALLY RECORDING LIVE VIDEO (NOT SCHEDULED)

1. From a single-channel mode Live view screen, tap the blue  for the camera to begin recording. The icon blinks and turns red while recording.
2. Tap it again to stop recording. The icon stops blinking and turns blue.

You can record from all cameras at the same time. However, you must manually activate recording on each camera. Repeat the steps above for each camera.

## PLAYING BACK RECORDED VIDEO

Manage recorded files with this screen. You can see what recorded files you have, play them, and delete them. To access recorded video files, tap the SD card icon (  ) on the Live screen. The following screen displays.



The screenshot shows a calendar titled "Recording File List" for June 2014. The days of the week are Sun, Mon, Tue, Wed, Thu, Fri, and Sat. The dates are arranged in a grid. The date June 6th is highlighted in grey, indicating that recordings were made on that day.

Sun	Mon	Tue	Wed	Thu	Fri	Sat
1	2	3	4	5	6	7
8	9	10	11	12	13	14
15	16	17	18	19	20	21
22	23	24	25	26	27	28
29	30	1	2	3	4	5

1. Days that are highlighted have recorded files. Tap on the highlighted day containing the recording you want to view or on a specific camera to only view that camera's recordings. The *Recording File List* screen displays those recordings.



The screenshot shows a list view of recorded files titled "Recording File List" for 08.09.2014. The list contains four entries, each with a file ID, a timestamp, and icons for camera selection and deletion.

File ID	Timestamp	Camera	Delete
102530P1	10:25:30 PM	Camera 1	Delete
112530A2	11:25:30 AM	Camera 2	Delete
113000P3	11:30:00 PM	Camera 3	Delete
102530P4	12:25:30 PM	Camera 4	Delete

USED/TOTAL: 41M/1875M

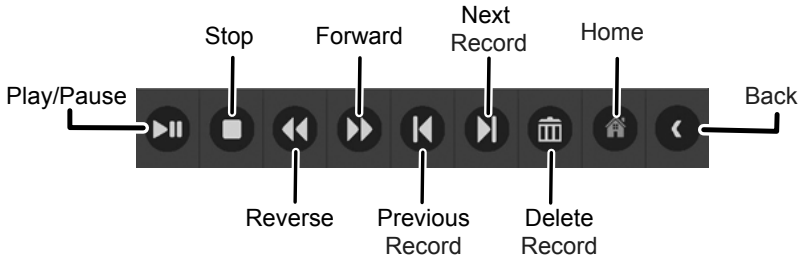

**If you tap on a day that is not highlighted, there will be no action taken at all.**

2. Tap on the recording you want to view. It begins playing. Control icons display across the bottom of the screen.



3. Tap on any area of the screen that does not have control icons to bring up the playback progress bar. Tap any area again to close it. While playback progress is visible, you can fast forward/rewind by dragging the playback bar forwards or backwards.

🔊 **On the playback progress bar, tap the double arrow to skip forward or backwards about 10 seconds. Tap the arrow and bar to skip to the next or previous video.**

4. When playback ends, tap  to return to the *Recording File List*.
5. Tap the  icon to delete the file if desired.

## ADDING NEW CAMERAS





Your monitor supports a total of four active cameras at a time. When you add a camera, you have to pair it to the monitor (that is, you have to “introduce” the camera and monitor to each other so they can communicate).



- If a camera is already assigned to the channel you want to assign the new camera to, the monitor overwrites the existing camera link with the new one.
- Only pair one camera at a time! The monitor links to the first camera it detects. If two or more cameras are in pairing mode, you can’t control which camera the monitor will detect first.

## PAIR CAMERAS

1. From the *Pairing Camera* screen (see “Pairing” on page 21), tap the camera image you want to pair. A processing icon displays for a 30 seconds countdown.
2. During the 30 seconds countdown, quickly press and release the Pairing button on that camera (see “Pairing” on page 21).
3. The system automatically adjusts the *Live View* screen accordingly.

## G37XX BASIC OPERATION

To do this...	From monitor, do this...
Manually start/stop recording video	<ol style="list-style-type: none"> <li>1. Tap the blue  icon on the monitor screen. The icon turns red and flashes, indicating that recording has started.</li> <li>2. Tap the icon again to stop recording. The icon turns blue.</li> </ol>
Set up automatic recording schedule	<ol style="list-style-type: none"> <li>1. From <i>General Settings/Recording Setup</i>, tap  icon. The <i>Schedule Recording Overview</i> screen displays.</li> <li>2. Tap <b>MODIFY</b> to view the <i>Recording Setup</i> screen (see page 25).</li> </ol>
Delete recording schedule	<ol style="list-style-type: none"> <li>1. From <i>General Settings/Recording Setup</i>, tap  icon. The <i>Schedule Recording Overview</i> screen displays.</li> <li>2. Select the day you want to modify and tap <b>MODIFY</b> to view the recording schedule for that day (see page 25).</li> <li>3. Select the camera(s) whose schedule you want to delete. Enter the schedule (or part of a schedule) you want to delete and tap <b>DELETE</b>.</li> </ol>
Watch recorded video	<ol style="list-style-type: none"> <li>1. On the Live screen, tap . The <i>Recording File List</i> displays the recorded files. Tap the day you want to view, and then tap the file.</li> <li>2. The video begins playing (see page 36).</li> </ol>
Delete recorded videos	<ol style="list-style-type: none"> <li>1. From the <i>Recorded File List</i>, tap  icon.</li> <li>2. Tap <b>YES</b> to confirm deletion.</li> </ol>
Take snapshots	Download Uniden's Guardian Full HD app to take and manage snapshots of recorded video.
View snapshots	Download Uniden's Guardian Full HD to take and manage snapshots of recorded video.

Delete snapshots	Download Uniden's Guardian Full HD app to take and manage snapshots of recorded video.
Modify password (smartphone only)	Go to Advanced Settings in Guardian Full HD app (see page 45) to change the app password.
Reset password (Resets the app password)	<ol style="list-style-type: none"> <li>1. From <i>General Settings/Network Setup</i>, tap .</li> <li>2. Tap <b>YES</b> to confirm the change.</li> <li>3. The app returns to the default password (000000).</li> </ol>
Hear audio from camera	<p>From the <i>Live View</i> screen, tap . Sound is now audible through the monitor.</p> <p>Tap the icon again to turn sound off.</p>
Change channels (view a different camera)	<ol style="list-style-type: none"> <li>1. Tap the  icon.</li> <li>2. The next channel displays.</li> </ol>
The camera's signal status icon shows no bars	<ol style="list-style-type: none"> <li>1. Make sure the camera is plugged in.</li> <li>2. Make sure that the camera's antenna is attached and the monitor's antenna is extended.</li> <li>3. Make sure the camera is paired to the correct channel.</li> <li>4. Re-pair the camera and monitor.</li> </ol>
The camera won't pair with the monitor	<ol style="list-style-type: none"> <li>1. Make sure the camera is plugged in.</li> <li>2. Press and release the pairing button quickly. Do not press and hold the pairing button.</li> </ol>

# REMOTE VIEWING

## Overview

You can use the Guardian Full HD app to remotely view the system. Download the app through Apple App Store or Google Play Store.

## Set Up the Guardian Full HD App

1. Connect the G37xx monitor to your router using the Ethernet cable included.  
Turn on the monitor.
2. From your smartphone, go to Apple App Store or Google Play Store to download and install the Guardian Full HD app.  
The Guardian Full HD app supports:  
iPhone®: iOS v.8.0 and above.  
Android™ Phone: Android™ v.4.3 and above.  
**Attention! App may not be responsive if used with an iPad or Android Tablet.**  
**Please download the app in the store for iPhone if using iPad.**
3. Tap the app to launch it. You will get the following screen.

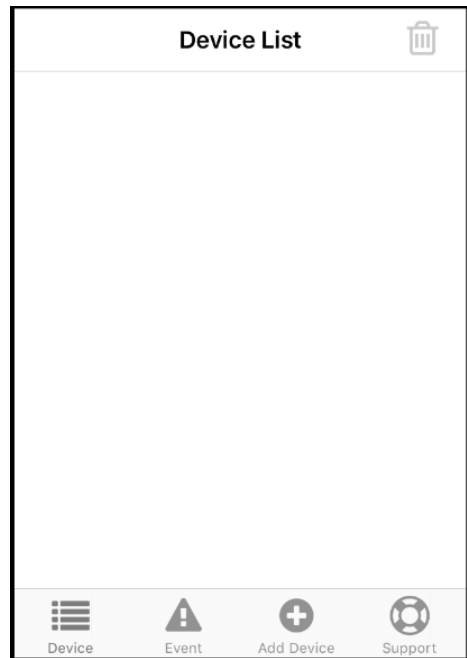



1. Tap on the option, *Add Device*. You have the option to either add the device manually or you can scan the QR code.

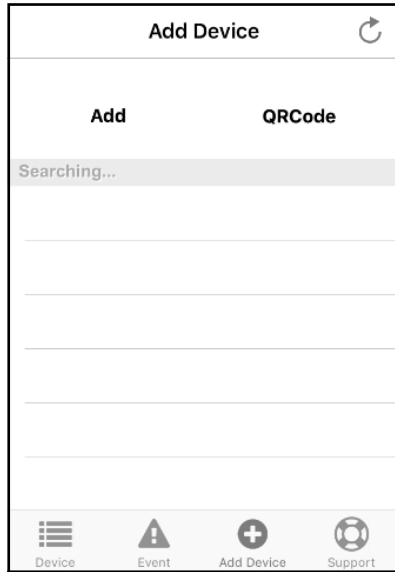

2. If you want to manually add the device tap on the option, *Add*, to get the screen shown below.

The screenshot displays a form for manually adding a device. At the top, there are three buttons: "Cancel", "Add Device", and "Save". The form contains three input fields, each with a label on the left and a placeholder text on the right: "Name" with "Device", "UID" with "Device UID", and "Password" with "Device Password". The bottom portion of the form is a large, empty grey rectangular area.

3. Tap on the *Name* field, and enter a name for your system.
4. Tap on the *UID* field and enter the UID code found on the cradle.
5. Enter the default password '000000', and then tap *Save*.
6. You could opt to scan the *QR Code* too, in that case, tap the option *QR Code Add Device* screen.
7. Position the QR Code (found on rear side of the monitor) within the viewfinder rectangle to scan.

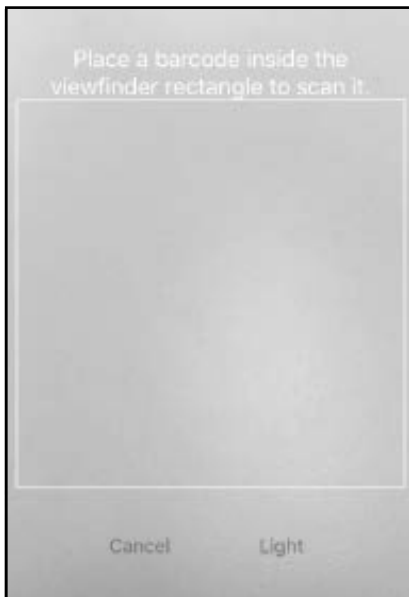







8. The *Add Device* screen displays with the UID code in the field. Enter the default password '000000' and tap *Save or OK*. The *Device List* screen displays. Tap on the image to get Live View.

## Live View

From the *Device List* screen, tap on the snapshot view to display the Live View.



Icon/Option	Function
	Tap on this icon to view the saved snapshots.
	Tap to take a snapshot in Live View.
	Tap to turn on/off audio.
	Tap and Press and hold to talk through the camera. Release to listen for a response.
	Tap to turn on/off the light. (for G3700L camera only)
	Tap to view from a different camera/channel.
Back	Tap to go to the previous screen.

# Advanced Settings

## Password

Uniden strongly recommends changing the default password to a more personalized password.

After your device displays on your *Device List* screen, tap on the ⓘ icon to access the *Edit Device* screen. If you forgotten the password, please reset network setup (see page 34).

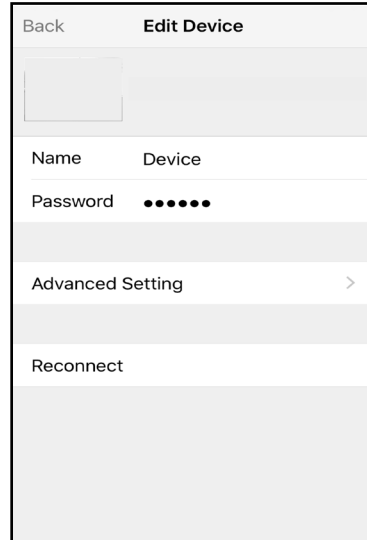
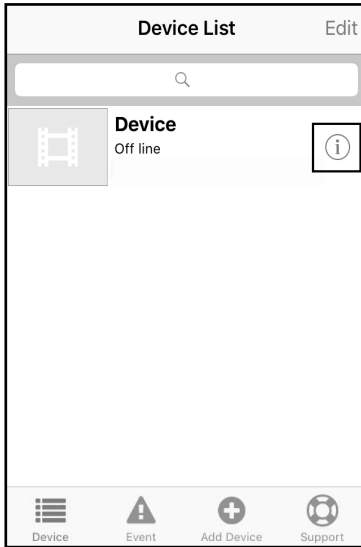

Tap on the *Advanced Setting* option to display the *Advanced Setting* screen below.

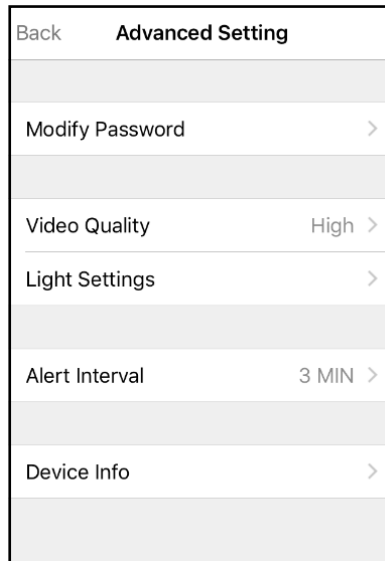

## Modify Password

On the *Advanced Setting* screen, tap the option, *Modify Password* option to key in and confirm the new password.

Cancel	<b>Modify Password</b>	OK
<hr/>		
<b>Old</b>	Old Password	
<hr/>		
<b>New</b>	New Password	
<hr/>		
<b>Confirm</b>	Confirm Password	
<hr/>		

## Video Quality

On the *Advanced Setting* screen, tap the option, *Video Quality*, to select the resolution of the video. The option available are: Max, High, Medium, Low, Min.

Back	<b>Video Quality</b>
<hr/>	
<hr/>	
High	
<hr/>	
Medium	
<hr/>	
Low	
<hr/>	



## About Device

On the *Advanced Setting* screen, tap the option, *Device Info*, to view the model name and network information.

Back	Device Info
Model	G37XX
IP Address	192.168.1.1
Gateway Address	192.168.1.1
Net Mask	255.255.255.0

# MAINTAINING YOUR SYSTEM

## UPGRADING YOUR G37XX MONITOR FIRMWARE

Check your system firmware version on the *Network Information* screen.

Go to [www.uniden.com.au](http://www.uniden.com.au) and search for the G37xx product page. Check the current firmware version against your system firmware level. If you need to update your G37xx firmware, download the most current firmware version to your system's SD card and then upload that firmware to the monitor.

1. Eject the SD card from the monitor.
2. Insert the SD card into your PC. If your PC does not have an SD card slot, you will need to use an SD card to USB adapter (not included.)
3. Copy the latest firmware to the SD card.
4. Remove the SD card and reinsert it into the monitor.
5. Upgrade the firmware (see page 34).

## TAKING CARE OF YOUR HARDWARE

### Monitor

As you use your monitor keep the screen clean by wiping it with a soft cloth to remove fingerprints, dust, etc.

### Cameras

When dust and grime builds up on the camera lens and glass, it affects night vision capability. The infrared light reflects off of the dust and grime, limiting the camera's "vision." Use a soft cloth to regularly clean the cameras or when night vision video is cloudy or unclear.

## MANAGING RECORDED FILES

Over time, your SD card will fill up with recorded files. If there are files you need to keep, transfer them to your computer for storage and view videos at later time. Otherwise, it is recommended to reformat your SD card every 4 to 6 weeks (see page 29).

### Copying Files from the SD Card to your Computer

1. Remove the SD card from the monitor.
2. Insert it into your computer's SD card slot.
3. Navigate to the SD card and locate your files.
4. Copy them to the computer. These files can now be deleted from the SD card or the SD card can be formatted.



## TROUBLESHOOTING

If you have any trouble with your system, try these simple steps. If you are still having a problem with your camera, check the manual that came with your camera. If you still have a question, visit the Uniden website at [www.uniden.com.au](http://www.uniden.com.au) for assistance.

If...	Try..
The motion sensor won't respond to movement.	<ul style="list-style-type: none"> <li>• Increasing the sensitivity of the motion sensor (see page 31).</li> <li>• Checking the masking pattern (see page 31).</li> </ul>
The motion sensor goes off when there's nothing there.	<ul style="list-style-type: none"> <li>• Decreasing the sensitivity of the motion sensor (see page 31).</li> <li>• Checking placement considerations (see page 6).</li> </ul>
I can't play my video clips in another program.	<ul style="list-style-type: none"> <li>• For MAC: Download another video payer such as VLC player.</li> <li>• For PC: Video will play in players such as Windows Media® Player if an H.264 CODEC plug-in is installed.</li> </ul>
I schedule a recording, save the schedule, and the recording does not happen at the scheduled time.	<ul style="list-style-type: none"> <li>• Check the settings on the Schedule Recording Set-up screen (see page 24).</li> <li>• Ensure that the system time is set to the current time.</li> <li>• Make sure that the SD card is inserted into the monitor and there is still memory available on that card.</li> </ul>
The camera's signal status icon shows no bars.	<ul style="list-style-type: none"> <li>• Making sure the camera is plugged in.</li> <li>• Making sure the camera is paired to the correct channel.</li> <li>• Re-pairing the camera and monitor.</li> <li>• Moving the camera closer to the monitor; it might be out of range.</li> <li>• Making sure the camera is turned on in Camera Setup (see page 22).</li> </ul>
The camera's signal status icon shows one or two bars or the video quality is poor.	<ul style="list-style-type: none"> <li>• Moving the monitor closer to the camera.</li> </ul>

<p>The camera won't pair with the monitor.</p>	<ul style="list-style-type: none"> <li>• Making sure the camera is plugged in.</li> <li>• Pressing and releasing the pairing button quickly. Do not press and hold the pairing button.</li> <li>• Check if other cameras in the area are also in Pairing mode. Disconnect power to other cameras.</li> </ul>
<p>When I power up my monitor and cameras for the first time, they seem to be on but there is no picture on the screen.</p>	<ul style="list-style-type: none"> <li>• Verifying that the cameras are turned on (see page 22).</li> <li>• Verifying that the monitor is displaying a channel with a camera assigned to it.</li> </ul>
<p>The monitor picture has frozen.</p>	<p>Using a blunt object like an unbent paper clip to press <b>RESET</b> on the back of the monitor to reset the monitor. The monitor turns off. Press <b>POWER</b> to turn it back on.</p>
<p>I cannot remotely access my recorded files.</p>	<ul style="list-style-type: none"> <li>• Verify that the monitor is connected to the internet.</li> <li>• Verify that the time zone is set correctly for the monitor.</li> </ul> <p>⚠ <b>If you are away from your system, you will need someone to verify these items for you.</b></p>

## INTERFERENCE

If this equipment does cause interference to radio or television equipment reception, which can be determined by turning the equipment off and on, the user is encouraged to try to correct the interference by one or more of the following measures:

- Reorient or relocate the receiving antenna.
- Move the equipment away from the monitor.
- Plug the equipment into an outlet on a circuit different from that to which the monitor is connected.
- Consult the dealer or an experienced radio/television technician for additional suggestions.

⚠ **CAUTION! Any changes or modifications to this equipment not expressly approved by the party responsible for compliance could void your authority to operate the equipment.**

# SPECIFICATIONS

<b>G37xx Monitor Specifications</b>	
Display Size / Type	7" TFT LCD Panel
Resolution	1024 x 600
Viewing Angle	120°
SD Card	Supported up to 64GB (8GB included)
Power Requirement	5V 2A DC
Power Consumption	Max 10W
Battery Type/Capacity	3.7V 2000mAh
Hours of Battery Operation	1.5 hours
Battery charging time	8~9 hours
Operating Temperature Range	0~40° C
Operating Humidity Range	0~85%
Image Resolution /Frame	Cam x 1 : 1080P x 1 up to 10 fps Cam x 2 : 720P x 2 up to 25 fps Cam x 4 : 720P x 4 up to 15 fps

<b>G3700 Camera Specifications</b>	
Image Sensor	1/2.7 inch Color CMOS Image Sensor
Effective Pixel Area	1920 x 1080
Image Processing Format	H.264
Image Resolution / Frame Rate	1080P up to 10fps / 720P up to 24fps
Lens	3.6mm F1.9
Low Light Resolution	1-8 lux
Low Light Solution	16 IR LEDs, 1 low light sensor
Night Vision	Up to 12 meters
IR cut filter	Yes
Viewing Angle	101°
Automatic Gain Control	Auto
Automatic Electric Shutter (AES) Speed	1/30~1/1000 Second
White Balance	Auto
Power Requirement	9V 0.6 DC A
Power Consumption	Max 5.4W
Operating Temperature Range	-10° C to +50° C
Operating Humidity Range	0 ~ 85%
Environment Rating	IP65
Camera Housing Material	Plastic

<b>G3700L Camera Specifications</b>	
Image Sensor	1/2.7 inch Color CMOS Image Sensor
Effective Pixel Area	1920 x 1080
Image Processing Format	H.264
Image Resolution / Frame Rate	1080P up to 10fps / 720P up to 24fps
Lens	3.6mm / F1.8
Night Vision	Up to 12 meters
IR cut filter	Yes
Viewing Angle	92°
Automatic Gain Control	Auto
Automatic Electric Shutter (AES) Speed	1/30~1/1000 Second
White Balance	Auto
Power Requirement	9V 2A DC
Power Consumption	Max 18W
Operating Temperature Range	-10° C to +50° C
Operating Humidity Range	0 ~ 85%
Environment Rating	IP65
Camera Housing Material	Metal

# ONE-YEAR LIMITED WARRANTY

## G37xx Series

**IMPORTANT Satisfactory evidence of the original purchase is required for warranty service.** Please refer to our Uniden website for any details or warranty durations offered in addition to those contained below.

## Warrantor

The warrantor is Uniden Australia Pty Limited ABN 58 001 865 498 (“Uniden Aust”).

## Terms of Warranty

Uniden Aust warrants to the original retail purchaser only that the G37xx Series (“the Product”), will be free from defects in materials and craftsmanship for the duration of the warranty period, subject to the limitations and exclusions set out below.

## Warranty Period

This warranty to the original retail purchaser is only valid in the original country of purchase for a Product first purchased either in Australia or New Zealand and will expire one (1) year from the date of the original retail sale.

If a warranty claim is made, this warranty will not apply if the Product is found by Uniden to be:

- (A) Damaged or not maintained in a reasonable manner or as recommended in the relevant Uniden Owner’s Manual;
- (B) Modified, altered or used as part of any conversion kits, subassemblies or any configurations not sold by Uniden Aust;
- (C) Improperly installed contrary to instructions contained in the relevant Owner’s Manual
- (D) Repaired by someone other than an authorized Uniden Repair Agent in relation to a defect or malfunction covered by this warranty; or
- (E) Used in conjunction with any equipment, parts or a system not manufactured by Uniden.

## Parts Covered

This warranty covers the Product and included accessories.

## User-generated Data

This warranty does not cover any claimed loss of or damage to user-generated data (including but without limitation phone numbers, addresses and images) that may be stored on your Product.

## **Statement of Remedy**

If the Product is found not to conform to this warranty as stated above, the Warrantor, at its discretion, will either repair the defect or replace the Product without any charge for parts or service. This warranty does not include any reimbursement or payment of any consequential damages claimed to arise from a Product's failure to comply with the warranty.

Our goods come with guarantees that cannot be excluded under the Australian Consumer Law. You are entitled to a replacement or refund for a major failure and for compensation for any other reasonably foreseeable loss or damage. You are also entitled to have the goods repaired or replaced if the goods fail to be of acceptable quality and the failure does not amount to a major failure.

This warranty is in addition to and sits alongside your rights under either the COMPETITION AND CONSUMER ACT 2010 (Australia) or the CONSUMER GUARANTEES ACT (New Zealand) as the case may be, none of which can be excluded.

## **Procedure for Obtaining Warranty Service**

Depending on the country in which the Product was first purchased, if you believe that your Product does not conform with this warranty, you should deliver the Product, together with satisfactory evidence of your original purchase (such as a legible copy of the sales docket) to Uniden. Please refer to the Uniden website for address details. You should contact Uniden regarding any compensation that may be payable for your expenses incurred in making a warranty claim. Prior to delivery, we recommend that you make a backup copy of any phone numbers, images or other data stored on your Product, in case it is lost or damaged during warranty service.

### **UNIDEN AUSTRALIA PTY LTD**

Phone number: 1300 366 895

Email address: [custservice@uniden.com.au](mailto:custservice@uniden.com.au)

**Uniden®**

©2016 Uniden Australia Pty Ltd  
Printed in PRC