

Giant Eagle Owl



2002-11-09





100 → 67 High

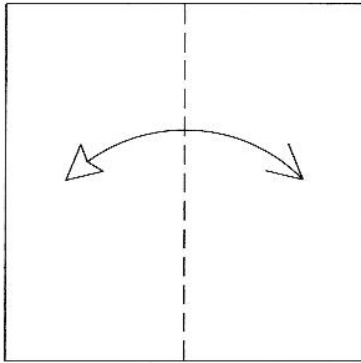

1. Pre-crease.

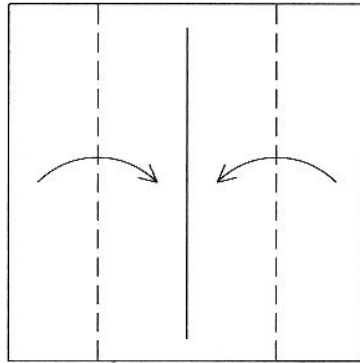

2. Valley Fold to the center.

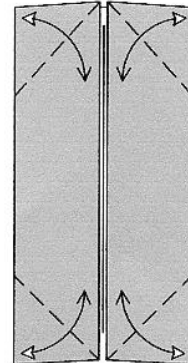

3. Fold and Unfold.

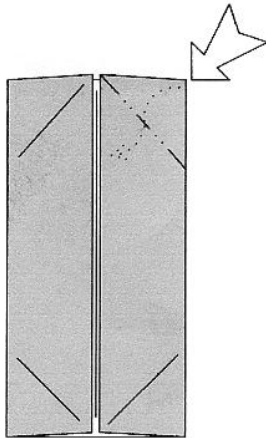

4. Inside Reverse Fold.

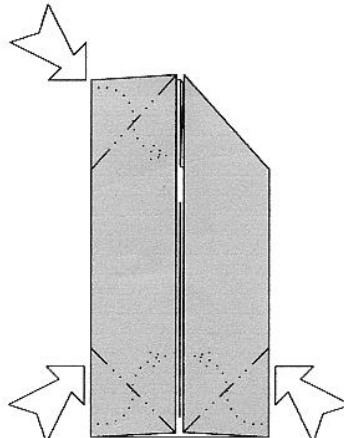

5. Repeat step 4 on the other three corners.

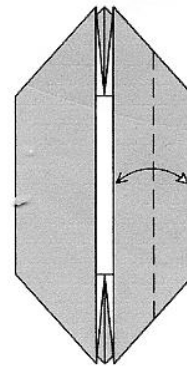

6. Fold and Unfold through all layers.

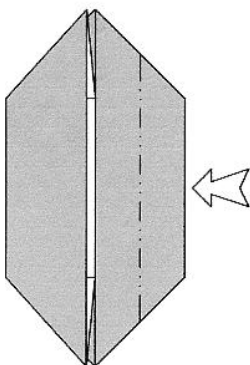

7. Open Sink.

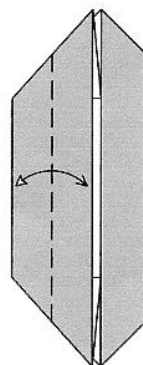

8. Repeat steps 6 to 7 on the left.

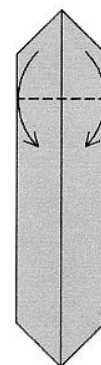

9. Valley Fold down two points.

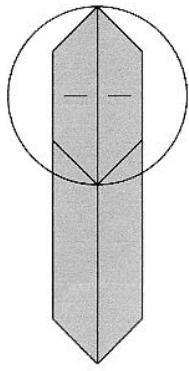

10. Enlarge.

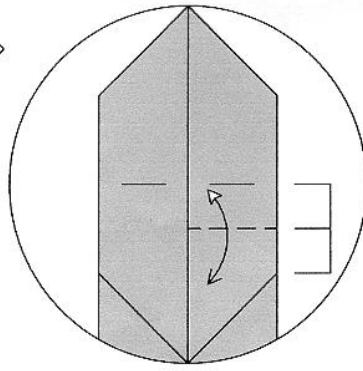

11. Fold and Unfold.

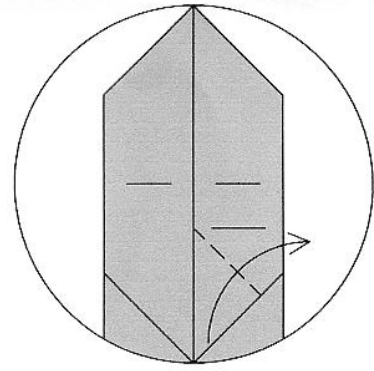

12. Valley Fold to the crease.

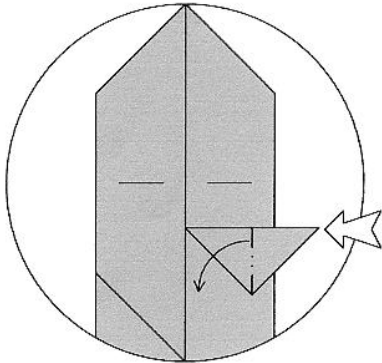

13. Squash Fold.

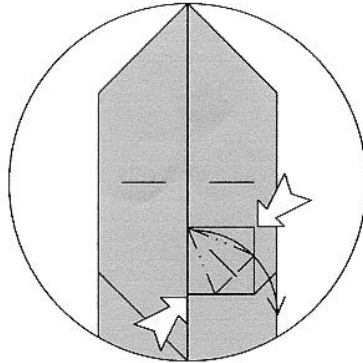

14. Petal Fold.

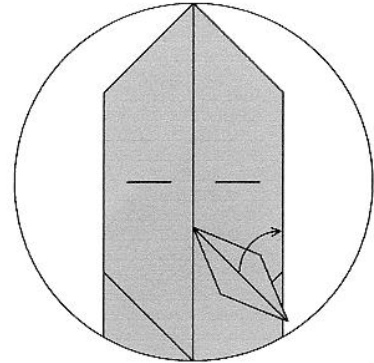

15. Wrap one layer behind to colour change on each side.

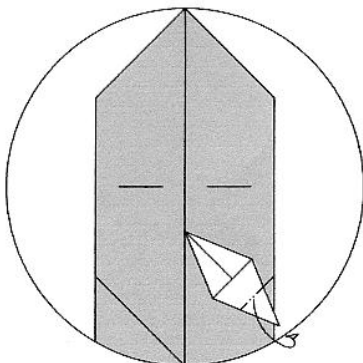

16. Mountain Fold.

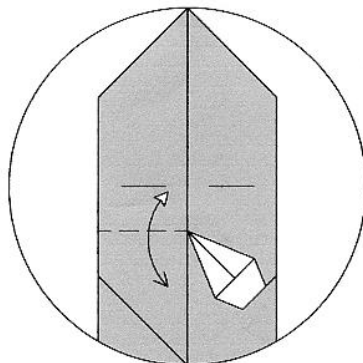

17. Repeat steps 11 to 16 on the left.

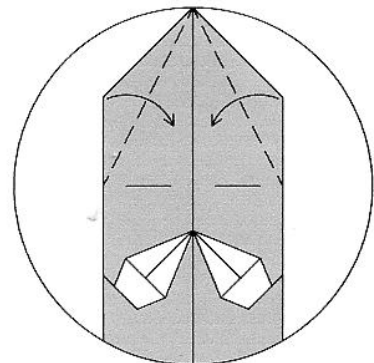

18. Valley Folds.

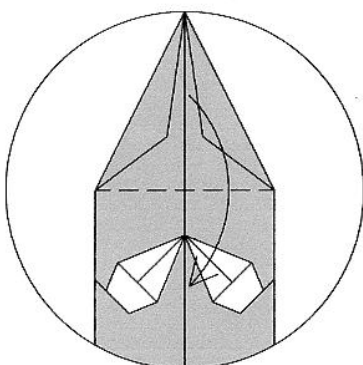

19. Valley Fold down. Enlarge.

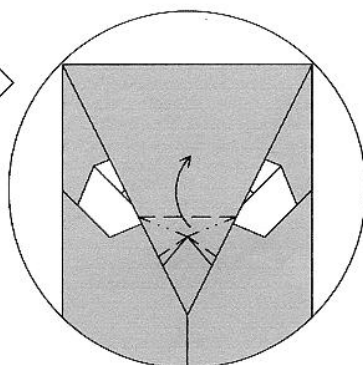

20. Shape the beak with Squash Folds.

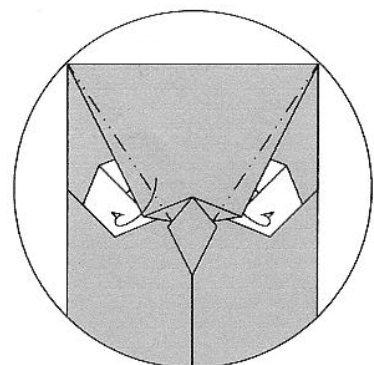

21. Mountain Folds.

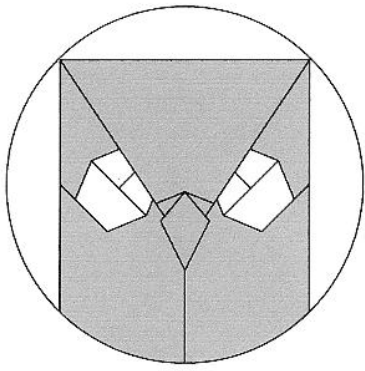

22. Like this.
Scale change.

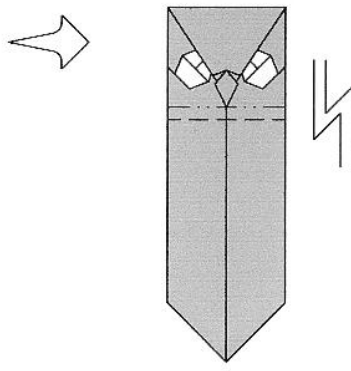

23. Pleat Fold.

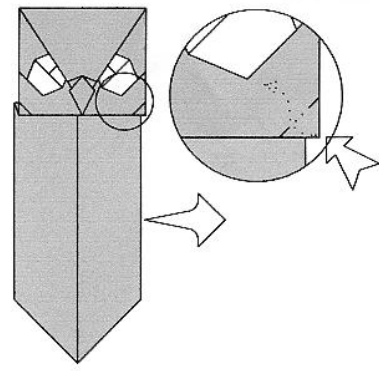

24. Enlarge.
Inside Reverse Fold.

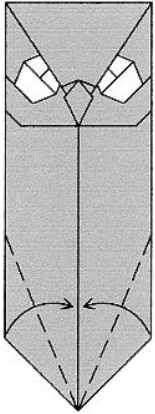

25.

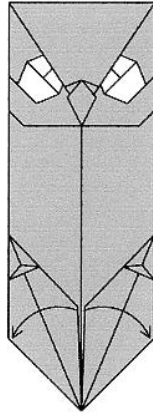

26.

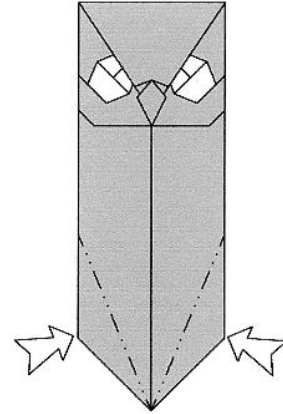

27. Open Sinks.

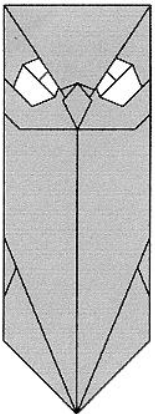

28. Turn around.

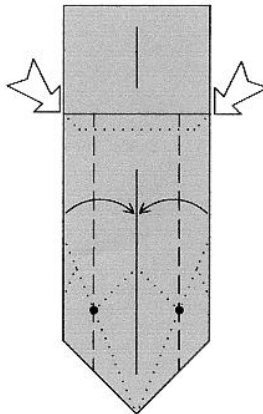

29. Valley Fold one layer only.
Squash Fold the top
corners.

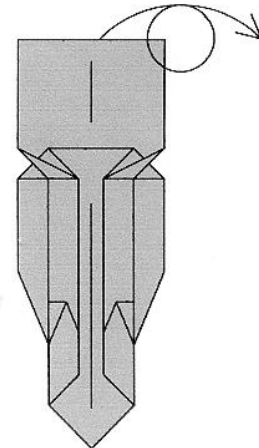

30. Like this.
Turn around.

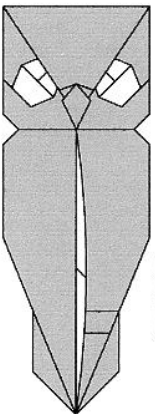

31. Lift one layer and Crimp
fold underneath.

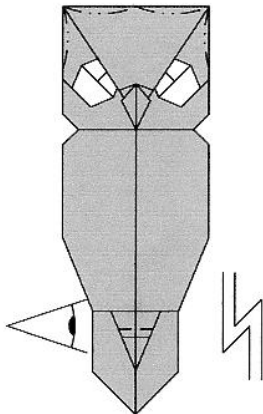

32. Pleat Fold the claws.
Shape the head.

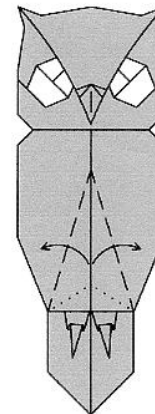

33. Swivel Folds.

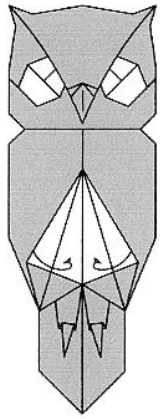

34. Mountain Fold on existing creases.

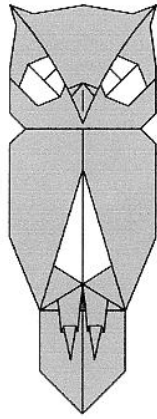

Giant Eagle Owl.
Perch the owl on your drink to
watch over it.

