



## Introduction

Let me Introduce this nice Program - Equalizer in the Style of a British Console EQ. I have designed this familiar EQ in 500 API compatible Format. It works in 500 VPR or 51X Lunchboxes on the +16V and -16V rails. I used mainly the schematic of the Orange 4000 EQ with an extra THAT 1246 In- and THAT 1646 Outputstage. In my Version I added switchable Low Cut and High Cut Filters for full Flexibility in colouring the sound with this EQ Module. This Guide will help with setting up this nice EQ. Have Fun!

**DISCLAIMER:** Proceed at your own risk. I am not liable for any damage, harm or loss of any kind resulting from the assembly and/or use of this PCB set. Safety provisions should always be exercised whenever working with any electronics. The following instructions are guidelines only. I can make no guarantee of the accuracy of contents contained within this document.

## TABLE OF CONTENTS

Introduction	1
Functions	2
Variants of Filters	3
Stuffing Boards	3
Potentiometers, Switches and LEDs	4
Final Assembly	5
Calibration	7
PCB layout for reference	10
Schematics	11
Bill of Materials (BOM)	12

# Functions

This Pot levels the amount of the High Frequency Band in a range of +/-18dB Gain



This Pot levels the amount of the High Mid Frequency Band in a range of +/-18dB Gain

This Pot sets the Q-Factor of the HMF Band from narrow to wide

This Pot levels the amount of the Low Mid Frequency Band in a range of +/-18dB Gain

This Pot sets the Q-Factor of the LMF Band from narrow to wide

This Pot levels the amount of the Low Frequency Band in a range of +/-18dB Gain

This Button switches from BELL-MODE into SHELF-MODE of the HF-Band

This Pot sets the Frequency of the High Frequency Band in a range of 1.4kHz to 16kHz

This Pot sets the Frequency of the High Mid Frequency Band in a range of 0.6kHz to 6kHz

This Button enables the High Cut Frequency Filter at 8kHz

This Button enables the Equalizer. If it is not pressed the Unit is in True Bypass.

This Switch enables the Low Cut Frequency Filter at 80 Hz

This Pot sets the Frequency of the Low Mid Frequency Band in a range of 0.2kHz to 2 kHz

This Pot sets the Frequency of the Low Frequency Band in a range of 30 Hz to 450 Hz

This Buttons switches from BELL-MODE into SHELF-MODE of the LF-Band

SLQ51X



## Variants of Filters

First of all these nice High and Low Cut Filters are set at fixed Frequencies. In my design i set this Frequency for the Low Cut at 80Hz and for the High Cut at 8kHz. For learning about Filter design I really can recommend this webpage:

<http://sim.okawa-denshi.jp/en/Fkeisan.htm>

For all that want to change these Frequencies, you are welcome to do it on your own by changing some resistor values. The Calibration Process of this Filter will shown at the end of the guide.

### LOW CUT Resistor changes

Change these to the same value **RH3,RH4,RH5**

50Hz - 33k

60Hz - 27k

80Hz - 20k (standard value supplied with the kit)

100Hz - 16k

120Hz - 13k

160Hz - 9.1K

### HIGH CUT Resistor changes

Change these to the same value **RL3,RL4,RL5**

5Khz - 330R

6Khz - 270R

8Khz - 200R (standard value supplied with the kit)

10kHz - 160R

12Khz - 130R

16Khz - 91R

## Stuffing Boards

After we decided which High and Low Cut Filters we want use, we will go over to stuffing the boards. First Step is to place all Resistors and Diodes. Check before Soldering if your Diode-Placement is right. Check for right Diode orientatation before soldering!

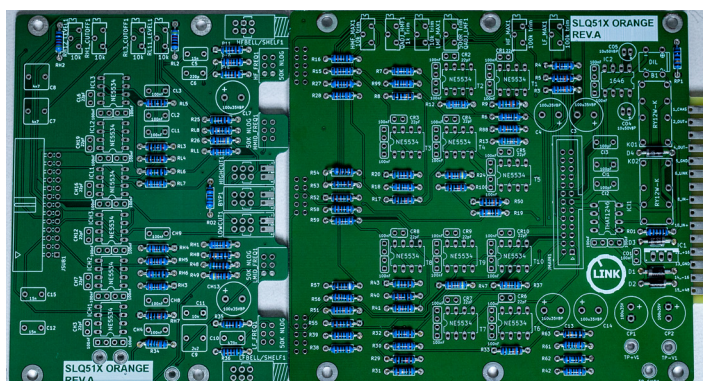

After Placing and Soldering all Resistors, we solder the next bigger parts like IC-Sockets and small Capacitors, like 37x100nF and 16x22pF

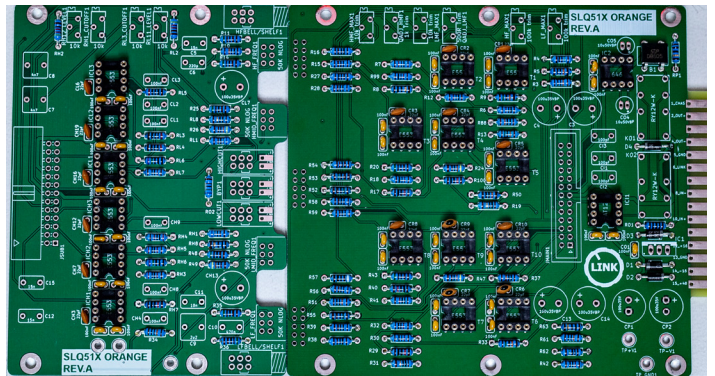

After that Step solder all Wima Capacitors and Board Connectors like on the pictures. On the Small Board, the short pins are soldered as close as possible to the board. Its important that you press them flush in place during soldering. We need them to sit flush and straight for the mechanical assembly later.

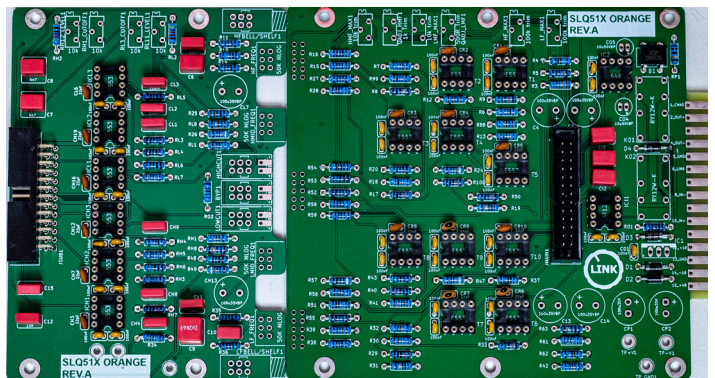

Now we change over to bigger parts like Relais, Voltage Regulator and Electrolyt Capacitors. Pay extra attention to the orientation of CP1 and CP2 as they are polarized. The other Capacitors are NonPolarized/Bipolar so the Orientation doesn't matter. After this step you can clean the boards. After cleaning boards with alcohol/water/your preferred method you can solder the trimpots. But don't clean after the Trimpots are installed. Trimpots, Switches, Potentiometers don't like cleaning and that can lead to problems with electrical contact.

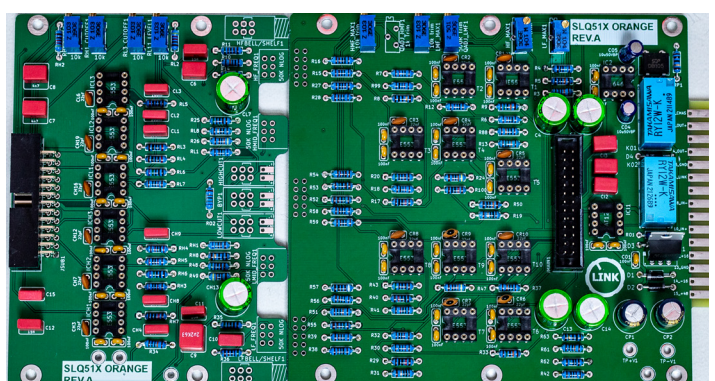



## Potentiometers, Switches and LEDs

Now we are heading again to the subboards. First we take the small one and cut all leads of the pinrows as short as possible. We will be doing this process later also with the potentiometers since we need to make sure that this Equalizer don't touch any neighbour modules of any kind

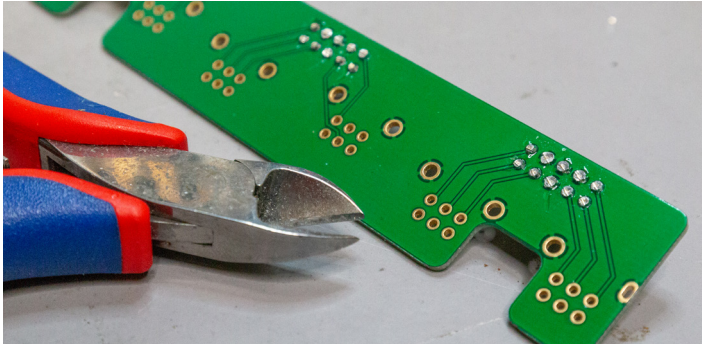

After we shortened all the pins we install all pots on this board at the same time. Get all pots on the PCB and solder just one pin in the middle and press the POT as much as possible on to the PCB. After Soldering one Pin make sure the alignment of the pot is flush and straight. You can check that with printed silkscreen on the PCB. Check also if the GAIN-Pots are center detent and the ,Q' is at the right place.

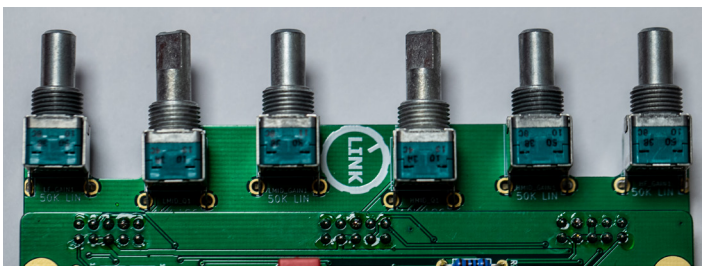

After having one pin of each pot soldered we add the bracket like shown in the picture above. The direction of the bracket is shown in the picture below. After having all pots screwed to the bracket, we can solder all pins, then we need to cut the pins.

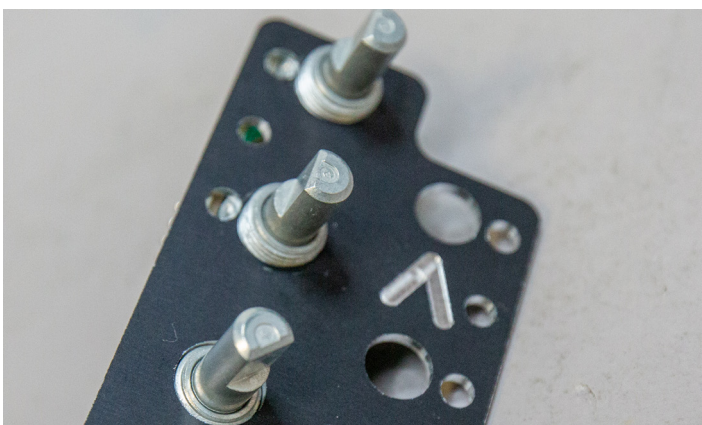

I cut all the pins before soldering, then they look better, but you can also cut them afterwards. Then unscrew the board from the bracket again.

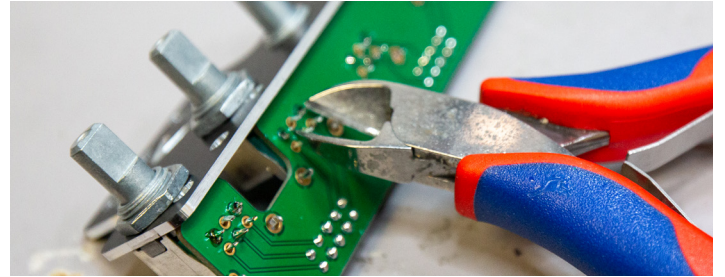

In the next Step we cut all leads on the upper subboard as short as possible.

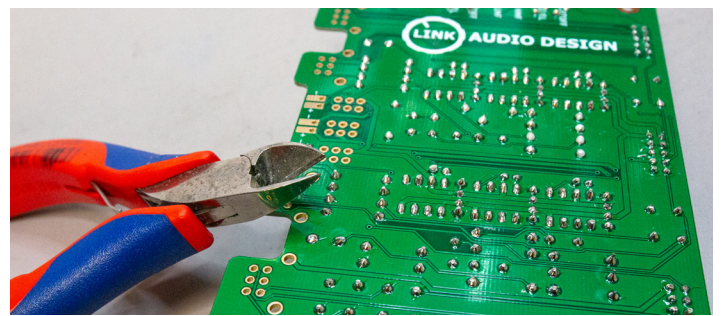

The next step is focusing on the pots and switches of the upper subboard, we can solder all pots and switches. Make sure to press them flush and firm to the board and fix them with one solder point.

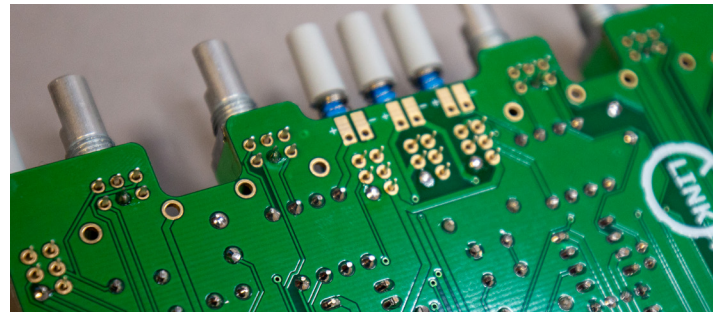

Check the alignment of the switches and pots from the upside again and try to bring them in line like the silkscreen is printed. After that install the blank bracket on the upper subboard and solder the pots in place.





Now it's time to use the Frontpanel for the first time to get the Switches and LEDs in place. Use the spacers and bring the Frontpanel in place with the subboard. You can use the nuts to screw it together, but you also can use clamps to press bracket and frontpanel together. Install the pushbuttons and rearrange the switches on the PCB until they are in the middle of the hole of the Frontpanel. After this process you can solder them completely. After soldering in all of the Pots and Switches make sure that their leads are also trimmed short.

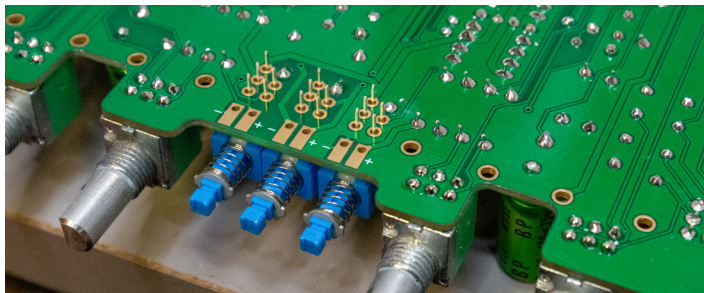

Now we will cut the LEDs legs. Make sure you have the right leg for + and - ( Long leg is + and short leg is -). I usually don't cut them straight and keep two different size legs, so you still know which leg is + and which is -. Make sure the LED is sitting flush with the frontpanel. First solder one leg to make sure the LED is in place, then solder the other leg. After soldering all LEDs to the Mainboard unscrew the Frontpanel and bracket again, we need that for next step.

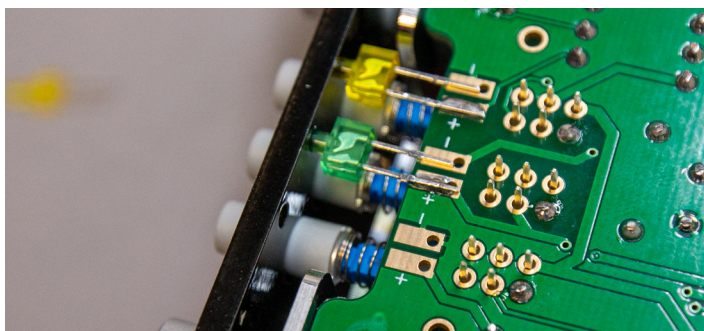

## Final Assembly

For the final assembly we need first to bring the small subboard and the mainboard together. For this we need to build two small adapters for the right height. We use a screw and a nut from the hardware pack. Both adapters used in the corners and are placed there just during the process of soldering on a table.



Now we gonna solder the pins of the headers. First one pin of each row. Every time we solder one pin we press the boards together.

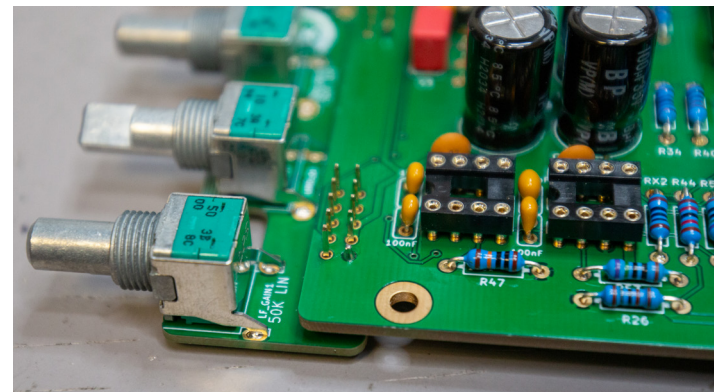

After that we can solder all the other pins and cut the pins also as short as possible. Then you can split our built adapter screws in two parts again.

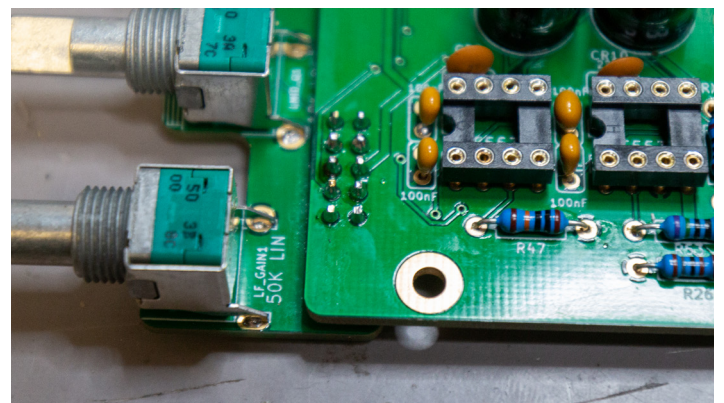

Now we have soldered all parts and want to check without the IC and Opamps installed if the **voltages are right**. For that we don't use the Frontpanel or the bracket. We use the ribbon cables to connect the boards. Use an adapter for your lunchbox/ or power it up on another way to measure all Voltages near the ICs. The Voltage Meter should show something like +/-15,3V, because of the drop of the diodes at the power input. Check also if the LEDs are working and the relays are switching. If everything seems good install the ICs. Check the Orientation of each IC before installing. Check the Datasheets of NE5534, THAT1246 and THAT1646 to find the Input Pins where the Opamps get their Voltage.



First we use the bracket to install the mainboard with the M9 nuts for the Gain Pots.

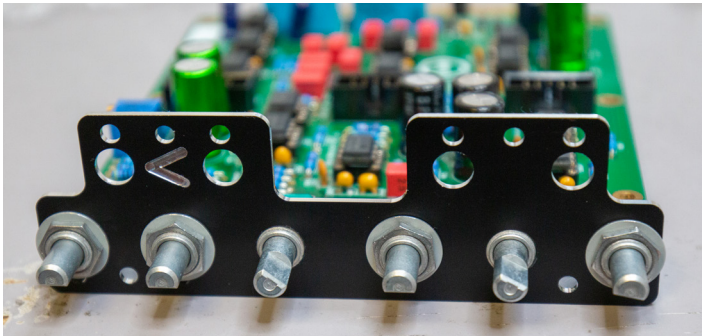

Then check all ICs for the right orientation again. Next put all the ribbon cables on the mainboard.

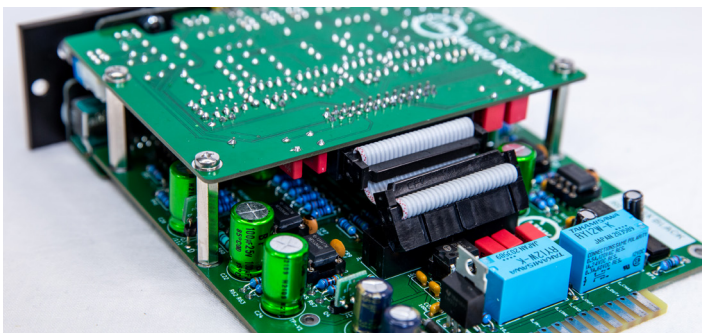

Now we install the upper subboard by holding it angled and connect the ribbon cables at the same time.

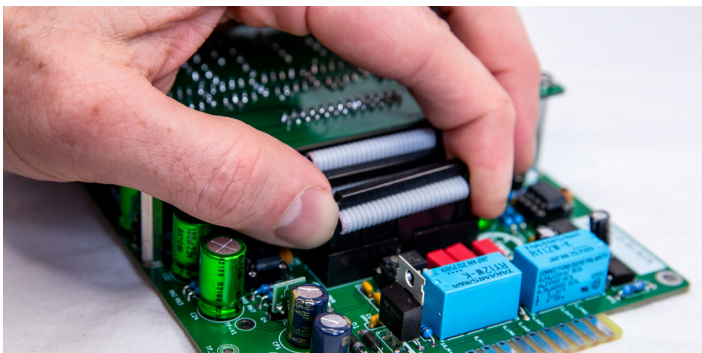

Add the nuts for the M7 Frequency Pots.



Now we add the 25mm Spacers between the two boards and screw them together.

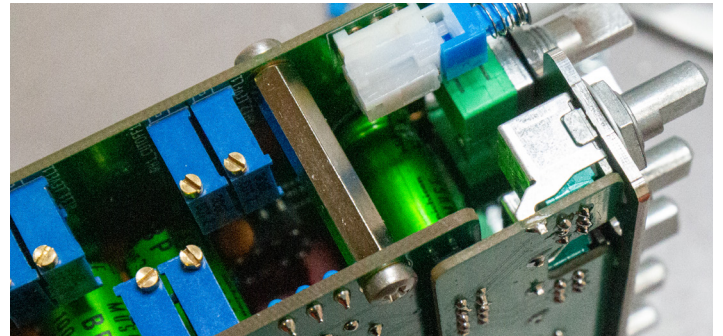

Now it's time to add the Frontpanel to complete the Equalizer. Use the spacers and the M3 Nuts to finish it. The Caps for the Knobs are sorted as following:

- Red - HF**
- Green - HMF**
- Blue - LMF**
- Orange - LF**

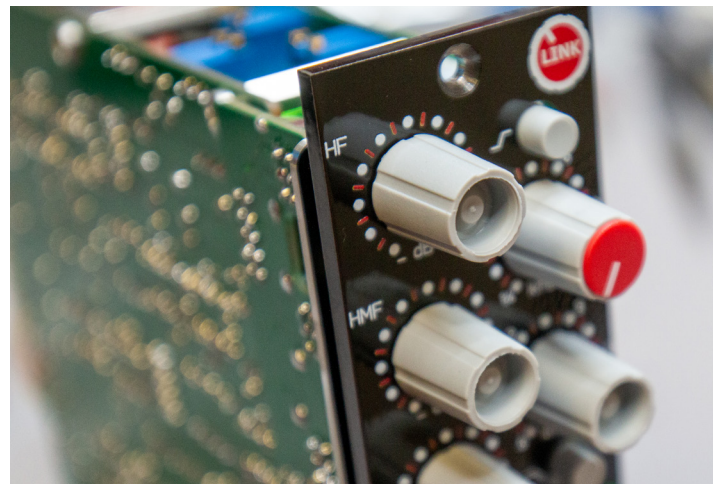

After finishing try to run an Audio Signal thru the Unit and try all switch modes, if everything works fine. If you have a bump when switching the Low or Highcut Filter, don't worry these filters need to be calibrated to have the right level. Try also if all Gains and Frequency Pots are working. You can do that either in the measure software or with Audio Signals. In the next step we will calibrate this wonderful Equalizer.



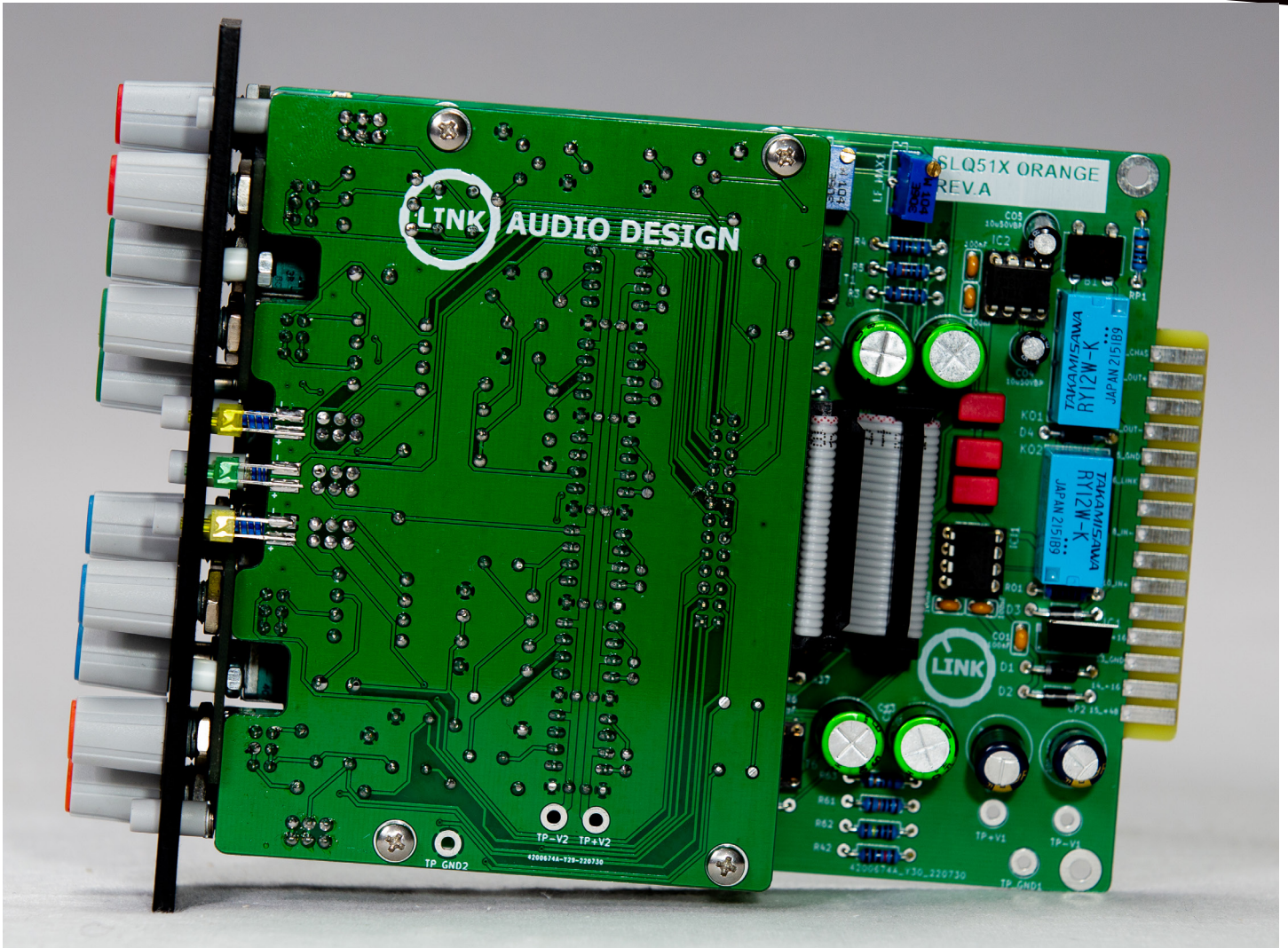

## Calibration

Calibration of this unit is no Rocket Science and it's quite easy. You need to playback different Sinus tones in different levels and frequencies. Make sure you have enough headroom that you don't get clipping when capturing the response of the EQ. I try to have at least 20dB headroom before my interface clips. That Calibration works with every DAW but the easiest way to calibrate this EQ is using the free-ware software REW.

First of all we need a constant reference level, I use the Software REW. I calibrated my Output Measure signal to +6dBu as my maximum output and Input, you should read on your multimeter 1,545Volts. My reference Sine signal is set at -12dBu. The Voltage equivalent on your multimeter should be 0,154Volts. I switch in REW for a better Overview to dBFS scaling.

To calibrate your Measuring System and learning about levels I highly recommend. The Setup of REW by DIYRE (3 parts on Youtube):

<https://www.youtube.com/watch?v=OwwKV-4QTfWU>

To calculate levels i use the Calculator of Sengpiel:

<http://www.sengpielaudio.com/Rechner-db-volt.htm>



## Calibrating the Unit

- First set all controls to their detent positions
- Switch the EQ section in
- Send a constant White Noise signal through the unit and check all bands if they work, check boost and cut of each band and also change frequency and ,Q' Settings.
- You can check that with a scope or by hearing on a control system if the unit changes the sound
- If all of the above mentioned conditions are met we can calibrate the bands
- Set your reference Signal to SINE-SIGNAL

## HMF Calibration

- First set all controls to their detent positions
- Set the Oscillator frequency to 3kHz
- Switch the EQ section in
- Full HMF Boost
- Narrow ,HMF Q'
- Adjust the frequency control until the output level peaks( read the level and find it's maximum with the fequency control)
- At this frequency and ,Q' setting the Boost/Cut control should give +18dB of gain
- Set the **Q-Adjust trimmer** that you read a boost of +18dB
- This should be set with the preset control marked ,**QADJ HMF'**
- Next Step is ,HMF Q' Calibration
- Full HMF Boost
- Wide ,HMF Q'
- At this ,Q' setting the Boost/Cut control should give +12dB of gain
- Set the ,**HMF\_MAX'** trimmer that you read a boost of +12dB
- Check if narrow ,HMF Q' is still at +18dB
- readjust ,**QADJ HMF'** if needed

## LMF Calibration

- First set all controls to their detent positions
- Set the Oscillator frequency to 1kHz
- Switch the EQ section in
- Full LMF Boost
- Narrow ,LMF Q'
- Adjust the frequency control until the output level peaks( read the level and find it's maximum with the fequency control)
- At this frequency and ,Q' setting the Boost/Cut control should give +18dB of gain
- Set the **Q-Adjust trimmer** that you read a boost of +18dB
- This should be set with the preset control marked ,**QADJ LMF'**
- Next Step is ,LMF Q' Calibration
- Full LMF Boost
- Wide ,LMF Q'
- At this ,Q' setting the Boost/Cut control should give +12dB of gain
- Set the ,**LMF\_MAX'** trimmer that you read a boost of +12dB
- Check if narrow ,LMF Q' is still at +18dB
- readjust ,**QADJ LMF'** if needed



## LF Calibration

- First set all controls to their detent positions
- Set the Oscillator frequency to 200Hz
- Switch to Bell Mode(Standard Mode)
- Switch the EQ section in
- Full LF Boost
- Adjust the frequency control until the output level peaks( read the level and find it's maximum with the fequency control)
- At this frequency setting the Boost/Cut control should give +18dB of gain
- Set the **Q-Adjust trimmer** that you read a boost of +18dB
- This should be set with the preset control marked **,LF\_MAX'**

## HF Calibration

- First set all controls to their detent positions
- Set the Oscillator frequency to 8kHz
- Switch to Bell Mode(Standard Mode)
- Switch the EQ section in
- full HF Boost
- Adjust the frequency control until the output level peaks( read the level and find it's maximum with the fequency control)
- At this frequency setting the Boost/Cut control should give +18dB of gain
- Set the **Q-Adjust trimmer** that you read a boost of +18dB
- This should be set with the preset control marked **,HF\_MAX'**

## Low Cut Calibration

- First set all controls to their detent positions
- Set the Oscillator frequency to 1kHz
- Switch Low Cut on and read Level
- Adjust **,LC LEVEL'** to the Same Level you are reading without Low Cut enabled.
- Set the Oscillator frequency to 80Hz.
- Read the Level and then adjust **,LC CUTOFF'** Trimmer. You should have a -3dB drop at 80 Hz.
- Set the Oscillator frequency again to 1kHz and adjust the **,LC LEVEL'** to the same Level you are reading without Low Cut enabled.
- After that set the Oscillator frequency to 80Hz and check if the drop is still at -3dB at 80Hz.
- Repeat this until both conditions are set.

## High Cut Calibration

- First set all controls to their detent positions
- Set the Oscillator frequency to 1kHz
- Switch High Cut on and read Level
- Adjust **,HC LEVEL'** to the Same Level you are reading without Low Cut enabled.
- Set the Oscillator frequency to 80Hz.
- Read the Level and then adjust **,HC CUTOFF'** Trimmer. You should have a -3dB drop at 8kHz.
- Set the Oscillator frequency again to 1kHz and adjust the **,HC LEVEL'** to the same Level you are reading without Low Cut enabled.
- After that set the Oscillator frequency to 8kHz and check if the drop is still at -3dB at 8kHz.
- Repeat this until both conditions are set.



# PCB layout for reference

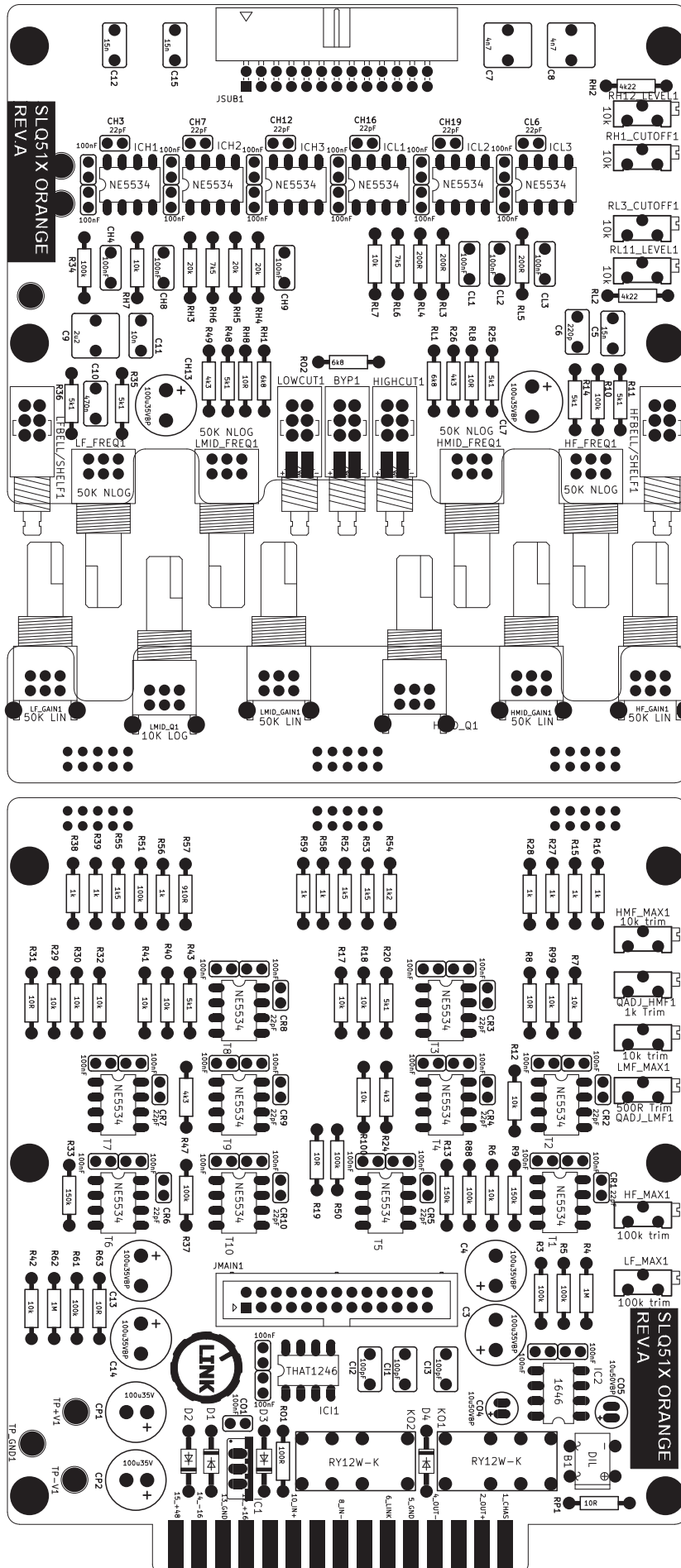





## Bill of Materials (BOM)

ID	PART ON PCB	TYPE	COUNT	VALUE
1	RL1,RO2,RH1	RESISTOR	3	6k8
2	RH8,RL8,RP1,R63,R31,R19,R8	RESISTOR	7	10R
3	RH3,RH4,RH5	RESISTOR	3	20k
4	RL2,RH2	RESISTOR	2	4k22
5	RL7,RH7,R100,R99,R42,R41,R40,R32,R18,R12,R7,R29,R30,R17,R6	RESISTOR	15	10k
6	RH6,RL6	RESISTOR	2	7k5
7	RL3,RL5,RL4	RESISTOR	3	200R
8	R48,R36,R35,R14,R25,R11,R43,R20	RESISTOR	8	5k1
9	R49,R26,R47,R24	RESISTOR	4	4k3
10	R34,R10,R61,R3,R88,R51,R50,R37,R5	RESISTOR	9	100k
11	R59,R38,R56,R39,R58,R27,R16,R28,R15	RESISTOR	9	1k
12	R55,R53,R52	RESISTOR	3	1k5
13	R57	RESISTOR	1	910R
14	R54	RESISTOR	1	1k2
15	RO1	RESISTOR	1	100R
16	R62,R4	RESISTOR	2	1M
17	R33,R9,R13	RESISTOR	3	150k
18	CH16,CH12,CH3,CH7,CL6,CH19,CR3,CR4,CR2,CR1,CR10,CR8,CR6,CR9,CR7,CR5	CERAMIC 2,5mm	16	22pF
19	CH15,CL4,CL5,CH10,CH2,CH5,CH14,CH11,CH6,CH18,CH1,CH17,CN19,CN21,CN4,CN17,CN22,CN15,CN7,CN6,CN8,CN18,CN16,CN13,CN12,CN11,CN14,CN3,CN20,CN5,CO3,CIP1,CN1-0,CN9,CIP2,CO2,CO1	CERAMIC 2,5mm	37	100nF
20	C5,C15,C12	WIMA 5mm	3	15n
21	C11	WIMA 5mm	1	10n
22	C10	WIMA 5mm	1	470n
23	C6	WIMA 5mm	1	220p
24	CI3,CI2,CI1	WIMA 5mm	3	100pF
25	C9	WIMA 5mm	1	2u2
26	C7,C8	WIMA 5mm	2	4n7
27	CH4,CH9,CH8,CL3,CL2,CL1	WIMA 5mm	6	100nF
28	CH13,CL7,C13,C4,C14,C3	ELECTROLYT	6	100u 25V/35V BiPolar
29	CO4,CO5	ELECTROLYT	2	10u35V/50V BiPolar
30	CP1,CP2	ELECTROLYT	2	100u35V



31	LF_MAX1,HF_MAX1	TRIMMER	2	100k Trim
32	QADJ_HMF1	TRIMMER	1	1k Trim
33	LMF_MAX1,HMF_MAX1,RL3_CUTOFF1,RH12_LEVEL1,RL11_LEVEL1,RH1_CUTOFF1	TRIMMER	6	10k Trim
34	QADJ_LMF1	TRIMMER	1	500R Trim
35	D4,D1,D3,D2	DIODE	4	1N4007
36	ON	GREEN LED	1	FLAT LED
37	LPF, HPF	YELLOW LED	2	FLAT LED
38	JMAIN1	CONNECTOR	1	Conn_02x13_Odd_Even
39	JSUB1	CONNECTOR	1	Conn_02x13_Odd_Even
40	Buscable	BUSCABLE	1	Buscable
41	Interconnect	INTERCON	3	Interconnect
42	KO2,KO1	RELAIS	2	RY12W-K
43	IC1	RECTIFIER	1	LM317
44	HF BELL/SHELF1, LFBELL/SHELF1, HIGH CUT1, BYP1, LOWCUT1	SWITCH	5	ALPS
45	LMID_GAIN1, LF_GAIN1, HMID_GAIN1, HF_GAIN1	POT	4	50K LIN
46	HMID_Q1, LMID_Q1	POT	2	10K LOG
47	HF_FREQ1, LMID_FREQ1, LF_FREQ1, HMID_FREQ1	POT	4	50K NLOG
48	IC2	OPAMP	1	THAT1646
49	IC11	OPAMP	1	THAT1246
50	U6,U9,U5,U7,U10,U1,U2,U4,U3,U8, ICH1, ICH2, ICL3, ICH3, ICL2, ICL1	OPAMP	16	NE5534
51	B1	RECTIFIER	1	DIL
52	SOCKET-08	SOCKET	18	GS 8P
53	25mm Spacer	HARDWARE	4	25mm Spacer
54	Screw M3	HARDWARE	8	Screw M3
55	Nut M3	HARDWARE	4	Nut M3
56	Spacer 0.145	HARDWARE	4	Spacer 0.145
57	Washer M7	HARDWARE	4	Washer M7
58	Screw M7	HARDWARE	4	Screw M7
59	Washer M9	HARDWARE	4	Washer M9
60	Screw M9	HARDWARE	4	Screw M9
61	Pushbutton Knob	KNOB	5	Pushbutton Knob
62	Knob 11mm	KNOB	10	Knob 11mm

63	Knobcap Green	KNOB	3	Knobcap Green
64	Knobcap Blue	KNOB	3	Knobcap Blue
65	Knobcap Red	KNOB	2	Knobcap Magenta
66	Knobcap Black	KNOB	2	Knobcap Black
67	Mainboard	MAINBOARD	1	Mainboard
68	Subboard1	SUBBOARD	1	Subboard1
69	Subboard2	POTBOARD	1	Subboard2
70	Backpanel	BACKPANEL	1	Backpanel
71	Frontpanel	FRONTPANEL	1	Frontpanel