

**INSIDE 14-PAGE BTCC PREVIEW**

# **AUTOSPORT**

THE WORLD'S BEST RACING WEEKLY

www.autosport.com

MARCH 28 2013 • £3.50

# VETTEL SPARKS WAR

**Has Horner  
lost control?**

**Five years  
of animosity  
explained**

**25 PAGES OF  
MALAYSIAN GP  
ANALYSIS**

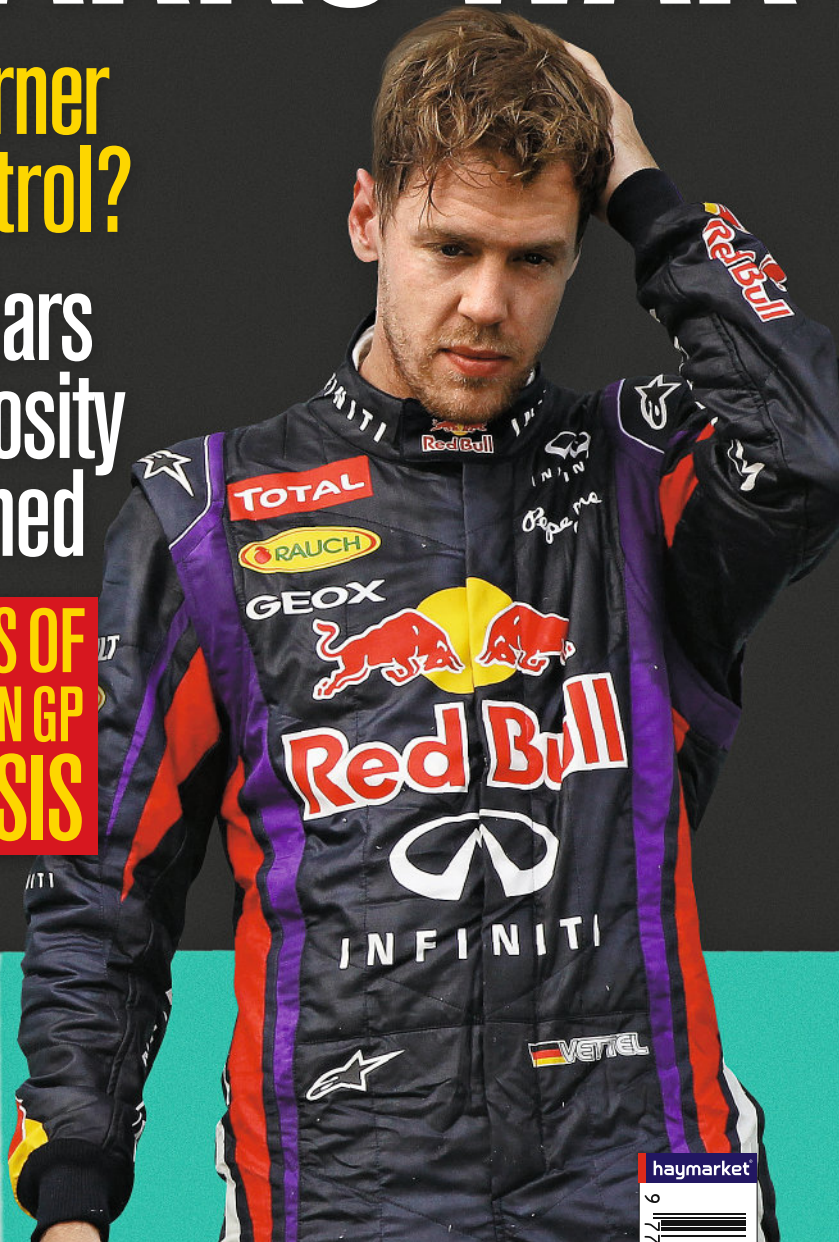

**HINCHCLIFFE SCORES  
FIRST INDYCAR WIN**  
**Franchitti hits the wall**



haymarket



# MOBIL SERVICE CENTRE DRIVING PERFORMANCE



01	GBR	03	GBR	05	BEL	07	NLD	09	GBR
GT	OULTON PARK 30 MARCH - 1 APRIL 2013	GT F3	SILVERSTONE 25 - 26 MAY 2013	F3	SPA-FRANCORCHAMPS 25 - 27 JULY 2013	GT	ZANDVOORT 6 - 8 SEPTEMBER 2013	GT	DONINGTON PARK 5 - 6 OCTOBER 2013
02	GBR	04	GBR	06	GBR	08	GER		
GT	ROCKINGHAM 5 - 6 MAY 2013	GT	SNETTERTON 15 - 16 JUNE 2013	GT F3	BRANDS HATCH 10 - 11 AUGUST 2013	F3	NÜRBURGRING 21 - 22 SEPTEMBER 2013		



Avon Tyres  
**British GT**  
Championship



COOPER TIRES  
**BRITISH FORMULA 3**  
INTERNATIONAL SERIES



# Mobil 1™

## SERVICE CENTRE

 **WP Racing**  
Race Fuels & Lubricants

[www.mobilservicecentre.co.uk](http://www.mobilservicecentre.co.uk)

NEW RENAULT CLIO

# RESTART YOUR HEART



MULTIMEDIA TOUCHSCREEN WITH NAVIGATION  
BASS REFLEX SOUND SYSTEM WITH BLUETOOTH  
ALL NEW EFFICIENT ENERGY ENGINES

FROM £179 PER MONTH\*

**4** FOUR YEARS  
WARRANTY  
ROADSIDE COVER  
INCLUDED SERVICING  
FINANCE PACKAGE

YOU'LL NEVER FORGET THE FIRST TIME YOU SAW THE  
**NEW RENAULT CLIO**

**DRIVE THE CHANGE**



The official consumption figures in mpg (l/100km) for the new Clio core range are: Urban 40.4 (7)-78.5 (3.6); Extra Urban 60.1 (4.7)-94.2 (3.0); Combined 51.4 (5.5)-88.3 (3.2). The official CO<sub>2</sub> emissions for the range are 127-83g/km.

FOUR YEARS WARRANTY ROADSIDE COVER INCLUDED SERVICING FINANCE PACKAGE Terms and exclusions apply. Warranty 100,000 miles. Service 48,000 miles. Visit [renault.co.uk/4plus](http://renault.co.uk/4plus) for details. \*Rental stated is for Renault Lease. If you choose Renault Lease then you will not own the car. When you have paid the final rental at the end of the contract, you can keep using the car and pay an annual rental equivalent to one monthly rental. Typical example: New Clio Dynamique MediaNav 1.2 16V 75, advance rental **£1,500 inc. VAT** followed by **48** monthly rentals of **£179 inc. VAT**, final rental **£4,542 inc. VAT**. A finance facility fee of £149 will be payable with the advance rental. Guarantees and indemnities may be required. You must be at least 18 and a UK resident (excluding the Isle of Man and Channel Islands) to apply. Finance provided by RCI Financial Services Limited, PO Box 149, Watford WD17 1FJ. Available at participating dealers only. Not available in conjunction with any other schemes or finance offers, please check with your local dealer for information. Offers are available to retail and business customers (but exclude fleet customers with own terms), and are valid on new vehicles when ordered by 1 July 2013. Flame metallic paint an additional £535.

# Pole Position

## The 'other' Vettel – who's out of control

**I SUSPECT I'M IN THE MINORITY HERE, BUT I BELIEVE** Sebastian Vettel's apology to Red Bull team-mate Mark Webber was genuine. How so? Because it wasn't *that* Sebastian who had something to apologise for – hence his "I didn't do it on purpose" qualification, which taken at face value makes no sense at all.

That's because the Sebastian who *did* do it deliberately – quite outrageously ignoring a direct team order to pass Mark Webber to win – is the one who takes over when he puts his helmet on.

I've met *this* Sebastian once. I intercepted him between parc ferme and the weighbridge after an F3 Euro Series race that he'd messed up in. The helmet was off, but it was so soon after the race that 'other Sebastian' was still in residence. His personality was totally different, ugly almost. "Seething" is the word I wrote in my notepad – he said so few words I had little else to jot down.

On Sunday, we heard him growl on the radio: "Mark is too slow, get him out of the way." Even Helmut Marko admits that *this* Sebastian is "out of control". So what chance does Christian Horner have?

*Charles Bradley*

**CHARLES BRADLEY EDITOR**  
charles.bradley@haymarket.com  
@Autosport\_Ed



## Bamber's week

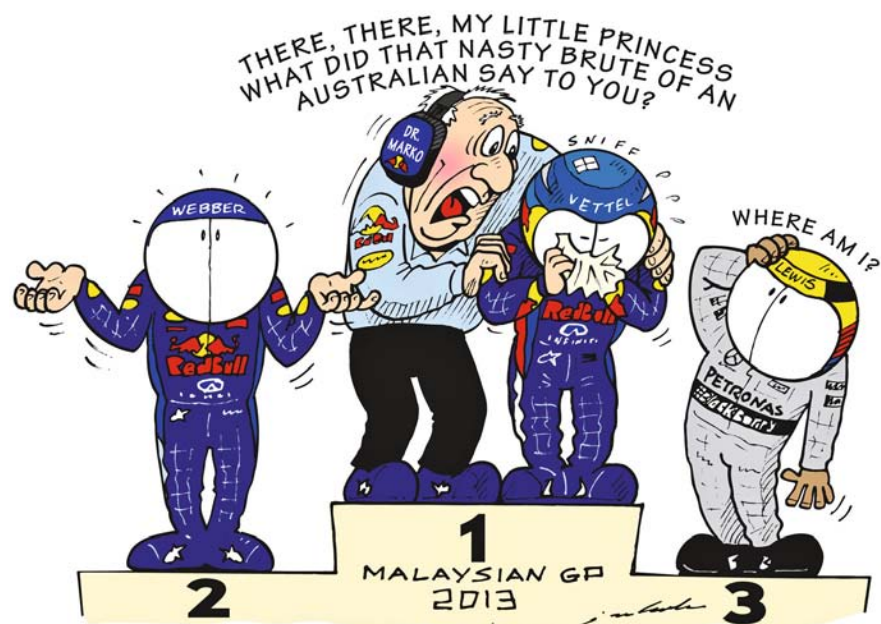

### 8 THIS WEEK IN F1

11 **MARK HUGHES: MPH**

### 12 THIS WEEK IN MOTORSPORT

15 **EDD STRAW: THE INSIDE LINE**

Team orders are nothing new, so get over it!

16 **MALAYSIAN GRAND PRIX**

The full story from the controversial Sepang event; driver by driver; technical appraisal; full results

32 **VETTEL AND WEBBER HAVE 'HISTORY'**

34 **PIRELLI UNDER FIRE FOR 2013 TYRES**

36 **CITROEN EYES KUBICA WRC MOVE**

39 **FIA GTs LIVE TO FIGHT ANOTHER DAY**

41 **15 QUESTIONS: ALAN JONES**

The 1980 world champion on crashing and crying

44 **GP2 SEPANG**

Leimer and Coletti triumph in Malaysian heat

46 **INDYCAR ST PETERSBURG**

Maiden series win for James Hinchcliffe

50 **RACE CENTRE**

AutoGP; NASCAR; Indy Lights, European Rally

56 **WTCC MONZA**

Muller doubles up in privateer RML Chevrolet

58 **EUROPEAN F3 MONZA**

Two for Marciello, one for Wehrlein in Italian opener

60 **BTCC SEASON PREVIEW**

Full guide to Britain's biggest, brashiest race series

87 **CLUB AUTOSPORT**

JRM Nissan GT-Rs commit to British GT; Seb Morris switches to BRDC Formula 4; British GT and FFord season previews

96 **THIS WEEK**

Readers' letters; best pictures; product reviews

98 **WHAT'S ON**

The best track and TV action in the coming week

101 **RACE OF MY LIFE**

Dennis Rushen, Jyllandsring Euro FF2000, 1982

**Find us on**



# THE BIG PICTURE

Malaysian GP, lap two: Fernando Alonso exits after his front wing snaps off and sends him into the gravel trap. No escape; zero points. How costly might this be?

6



7

# This week in F1

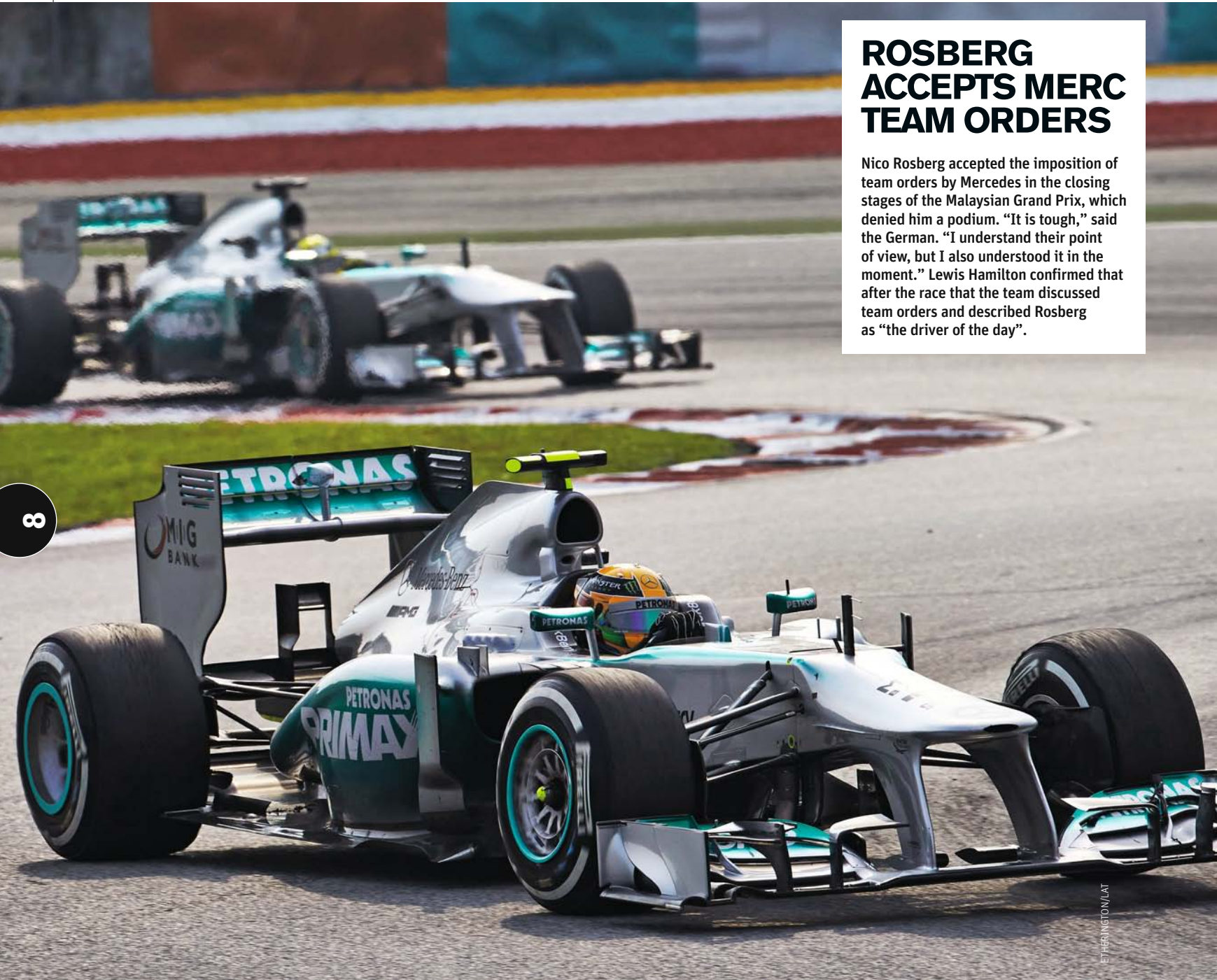

## ROSBERG ACCEPTS MERC TEAM ORDERS

Nico Rosberg accepted the imposition of team orders by Mercedes in the closing stages of the Malaysian Grand Prix, which denied him a podium. "It is tough," said the German. "I understand their point of view, but I also understood it in the moment." Lewis Hamilton confirmed that after the race that the team discussed team orders and described Rosberg as "the driver of the day".

8

## PROST EXPANDS RENAULT ROLE

Alain Prost has taken an advisory role on Renault Sport F1's executive committee. The four-time world champion became a brand ambassador for the manufacturer last year. "I will use my experience and knowledge of the sport to advise on strategic and technical challenges," said Prost, who won nine grands prix for Renault from 1981-83 and won the 1993 world championship with its engines in his Williams.

# 200

**Both Fernando Alonso and Mark Webber marked their 200th grands prix entered in Malaysia last weekend. However, officially they were in their 198th races as both have failed to start on two occasions.**

## FORCE INDIA TO KEEP WHEELNUTS

Force India is to modify its new captive (or retained) wheelnut system. It was forced to retire both cars from the Malaysian GP after high temperatures caused the axle to expand, meaning the bolt insert was stuck to it rather than detaching with the wheelnut.



“Lewis rolled his eyes... but I told him he had nothing to lose as he wanted out of McLaren”

GILHAM/GETTY



**Bernie Ecclestone on Lewis Hamilton's reaction when he floated the idea of the 2008 world champion switching to Mercedes last year**

## WILLIAMS EYES 2012 PARTS

Williams is likely to revert to its 2012-specification exhaust while it troubleshoots its latest Red Bull-style Coanda design. The team was satisfied it was able to make progress with the car in Malaysia, but admits it still faces a downforce deficit.



DUNBAR/LAT

COATES/LAT



## FRY TO STEP DOWN FROM MERC

Nick Fry is to stand down as CEO of the Mercedes team. Fry, who joined the team as managing director at the start of 2002, was part of the management buyout to revive the ex-Honda squad as Brawn, prior to it being sold to Mercedes.

### FRY AT BRACKLEY

**2002** As part of Prodrive's operation of the team, Fry is appointed BAR managing director.

**2005** Leaves Prodrive to become CEO of BAR-Honda

**2008** Honda quits F1 at end of the season.

**2009** Fry is, along with Ross Brawn, one of the five shareholders in a management buyout of the ex-Honda team, which goes on to win the championship as Brawn GP. Mercedes buys the team at the end of the season, although Fry retains a stake.

**2011** Mercedes buys Fry's stake in the team.

**2013** Steps down as CEO, but will remain a consultant.

## TELEMETRY WOE AGAIN

A repeat of the FIA telemetry glitch that struck in Australia meant the Malaysian GP also went ahead without in-cockpit warning lights or race control being able to deactivate the DRS. A change of supplier for this year has been blamed.

## McLaren blames human error

Human error and Jenson Button's quick reactions were to blame for a blunder that cost McLaren fifth place in the Malaysian Grand Prix. Button left the pit with the front-right wheel not attached after a green light was triggered for 120 milliseconds.



FERRARO/LAT

## Sauber fuel-system change

Sauber changed its fuel-system procedures ahead of the Malaysian GP after Nico Hulkenberg's Australian non-start. The tank was damaged in Melbourne when a vacuum was created while fuel was being removed.

## ROSSI SET FOR OUTINGS

Alexander Rossi is set to drive for Caterham on some Fridays this season. It is not yet clear how many outings the American will have, but he could appear in around half. His first outing could be in Bahrain on April 19.

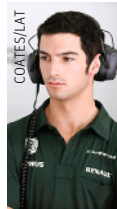

COATES/LAT

## Button in GPDA role

Jenson Button is a new director of the Grand Prix Drivers' Association, replacing Felipe Massa. Sebastian Vettel stays as a director and Pedro de la Rosa remains as chairman.

## TORO ROSSO FINED

Scuderia Toro Rosso was fined €10,000 for releasing Jean-Eric Vergne's car into the path of Charles Pic's Caterham during the Malaysian Grand Prix. Team principal Franz Tost said: "We agree with their decision."

## KOVALAINEN AIMS FOR F1 RETURN

Heikki Kovalainen, who attended the Malaysian Grand Prix as a guest of Caterham team owner Tony Fernandes, is focused on an F1 return. "I love F1," he said. "I really enjoyed my time here and would enjoy being here today. I already had a few discussions with different teams."



COATES/LAT



## FERRARI TAKES BLAME FOR ALONSO'S SHUNT

Ferrari team boss Stefano Domenicali accepted the team was responsible for gambling on leaving Fernando Alonso on track with a broken front wing during the Malaysian Grand Prix. Domenicali described it as "a risk that didn't pay off" after Alonso's front wing collapsed at the start of the second lap, causing the car to plough into the gravel at Turn 1.

COATES/LAT



'Been lapped again' topped the second round of the 2013 Castrol EDGE Grand Prix Predictor, amassing 153 points and a prediction accuracy rate of 58 per cent. Not only did they call Sebastian Vettel leading Mark Webber home, but also correctly predicted Romain Grosjean to finish sixth ahead of Kimi Raikkonen, Nico Hulkenberg and Sergio Perez. To play, visit [gppredictor.com](http://gppredictor.com).

# SIGN UP NOW & CHALLENGE CHANDHOK

Play the game against Karun Chandhok and you could win amazing prizes

## THE GAME

### CAN YOU BEAT AN F1 DRIVER?

Karun Chandhok is playing the Castrol EDGE Grand Prix Predictor in 2013. Can you outscore the former F1 driver?

### FREE & EASY

Online, on Facebook and optimised for your mobile – it's free and easy to play.

### PLAY AGAINST MATES

Create private mini-leagues with mates, as well as competing in the main game.

## 2013 ULTIMATE PRIZE

A LUXURY TRIP TO NEXT SEASON'S  
MONACO GRAND PRIX



## REGISTER NOW

# PRIZES EVERY RACE

Great prizes for the highest-scoring prediction at each race, starting with a Galaxy Tab 2\*.



\*Prizes are subject to availability and may change during season

START PLAYING TODAY:

**GPPREDICTOR.COM**



# Mark Hughes

## MPH



The Pirelli era certainly delivers a thrilling spectacle, but should the spirit of F1 be sacrificed on the altar of entertainment?

**T**he driver stood up in the Grand Prix Drivers Association meeting and asked (and I'm paraphrasing because obviously I wasn't there and have been told the tale by someone who was): "So how did we allow this to happen? When did we become circus performers just putting on a show rather than F1 drivers racing flat-out?"

The target of his ire was Pirelli and though it's fair to say he's been one of those most competitively disadvantaged by the behaviour of the latest rubber, and therefore his impartiality might be questioned, he makes an interesting point.

The subject is a bit of an old chestnut and was in the news this time last year when Michael Schumacher said driving on Pirellis was "like driving on raw eggs". It painted the picture rather well. Michael's complaint was that he didn't feel much like a racing driver when having to drive to a delta time for a significant part of the race, just in order to keep his tyres alive.

The complaint of the 2013 generation of tyres is that their graining or wear is so totally car-dependent, there's nothing the driver can do about it. He does the pace dictated by his car's tyre management and

that you had at the start of the year when everyone is trying to find out where they are, and how to maximise the combination of chassis and tyre performance, it tends to start like this. But then it starts to move away when people get used to it. We don't see the need to make any changes. We've just had the most exciting Melbourne in years. Do you want us to make boring races?"

Well, there are your two choices. Most fans are loving the Pirelli era of races. They make for a great show – and Sunday's grand prix in Malaysia was a case in point: wheel-to-wheel thrills and a good dose of controversy into the bargain, triggered by the tyres. If all the cars were on all-out performance tyres rather than rubber deliberately configured with chemical limitations, the Red Bulls would be winning races by a lap. That's the estimation of Pirelli itself... They see the fast-corner loads of all the cars. Those of the Red Bull simply use up more energy than the tyre has available for any length of time. Instead the drivers, not just of the Red Bulls, drive up to 2s off the pace for big parts of the race.

So if the participants are telling you that what you're watching and being thrilled by isn't what

**“The whims of the casually interested fan shouldn't be allowed to pollute the sport”**

the race plays out accordingly. Because this gives a different competitive order than the measure of one-lap pace that is qualifying, so it plays out to give a race in which there are plenty of place changes. It still looks like racing to the casual spectator. But from inside the car it doesn't feel like it. It feels like you are just sitting there driving below the car's potential and having the race just play out almost independently of your efforts. It feels to him like he's a non-critical component in a championship for suspension kinematics. Which isn't what most fans assume they are watching...

"You can take the quotes from the last two seasons," says Pirelli's Paul Hembery, "and, in the first three races, it's exactly the same. There tends to be a phase at the start of the year and, after six to eight races, it all changes. If we look back at the type of comments

you think it is, that it's just an exercise in tyre conservation and that the real competition is between the suspension engineers, what do you think? Some hate being told and close their eyes, put their fingers in their ears. Others lament it. It comes down to whether you view F1 as a sport or as entertainment. Sometimes it cannot be both.

Personally, I feel F1 should be the ultimate, a test to find and reward the all-out fastest. If it means that occasionally that kills the entertainment of those only casually interested, then the casually interested are free to be entertained in some other way. Their whims shouldn't be allowed to pollute the sport. But it can't always be a sport. It signed a pact when it started taking huge quantities of money from the outside world – and the drivers are deriving their salaries from that pact. ❄

# This week in motorsport

## GREEN GETS RED BULL CAR

Jamie Green's Abt Sportsline Audi RS5 ran for the first time in its definitive Red Bull livery during official DTM testing at Barcelona on Tuesday. The car was driven at the test by Filipe Albuquerque, with Green in Mike Rockenfeller's Phoenix Racing-run machine.



12

### GTs hit target

FIA GT Series boss Stephane Ratel has topped his target of 20 full-season entries ahead of this weekend's opener at the Nogaro circuit in France.

A total of 21 full entries has been confirmed for the successor to the GT1 World Championship, while Ratel is predicting that more teams could sign up in time for round two at Zolder in April.



### DA COSTA ON TOP AT TEST

Formula Renault 3.5 title favourite Antonio Felix da Costa smashed the Barcelona lap record by a second in the final pre-season test. Britain's Will Stevens set the pace on the second day for P1 Motorsport as many teams focused on low-downforce set-ups for the first race weekend at Monza.



### MEGATRON FOR PORSCHE

The Megatron name, famed for badging BMW Formula 1 engines in the 1980s, will return to international motorsport this year in the Porsche Supercup.

The US-based logistics company, which gave its name to the powerplants used by Arrows in 1987-88 (above) and Ligier in '87, is joining forces with racing-accessories giant Momo to form the new Momo-Megatron team. It will be run out of

a base in Luxembourg by former Zakspeed technical director Andreas Leberle.

The team will run 2005 Supercup champion Alex Zampedri and Blancpain Endurance Series regular Jochen Habets. Dylan Derdaele will replace Zampedri for the two races the Italian is unavailable for.

An Audi R8 LMS ultra has also been entered under the Momo-Megatron DF1 banner for the European Le Mans Series.

### AJ could increase programme

AJ Allmendinger's stint in Team Penske's third IndyCar entry could be increased to include Long Beach in April. Allmendinger is currently slated to race at Barber and the Indianapolis

500, but team owner Roger Penske confirmed last weekend at St Petersburg that Long Beach is under consideration. "It's something we'll talk about after this weekend," he said.

### KARTHIKEYAN JOINS AUTO GP

Formula 1 refugee Narain Karthikeyan endured a trying time at Monza last weekend after securing a last-minute deal to contest the Auto GP season opener with Zele Racing.

The 36-year-old Indian was restricted to 12th on the grid after a qualifying puncture, and had to rally to fifth in the first race after being spun at the first corner.

A brake problem then forced him out of Sunday's wet second race, but he remains open-minded about continuing in the series next time out in Morocco.

"We have to see about Marrakech," he said. "I usually go well in street races, so it should be better. I thought we were slow here, but looking at the times we were right up there."

### Barker moves to Supercup

Porsche Carrera Cup GB runner-up Ben Barker will graduate to the Supercup this year with Team Bleekemolen. The Briton, 21, won the 2010 Australian F3 crown and has won races in both the Australian and British Carrera Cups.



## Peugeot considers Pikes Peak return

Peugeot is considering a return to the Pikes Peak hillclimb in a purpose-built 208 that could be driven by Sebastien Loeb.

The French firm admitted it was investigating the possibility of an entry on this summer's Colorado Springs event.

A Peugeot spokesperson told AUTOSPORT: "After the

announcement of the cancellation of the 908 sportscar last year, Peugeot said to Peugeot Sport, "You have to see a lot of different races and events in the world."

"Pikes Peak is one event, but it's too early say we will compete there. We are thinking about it and about a lot of different things. There

is speculation about Sebastien Loeb, but that's all this is. Nothing is signed and we shouldn't forget he is an ambassador for Citroen."

Peugeot has won the hillclimb twice with Ari Vatanen (pictured) and Bobby Unser driving factory-built 405 T16s. The film *Climb Dance* was based on the Finn's 1988 success.

## Alpine reveals its colours

The wraps have come off the sports-prototype that will take the famous Alpine marque back to the Le Mans 24 Hours in June. The Alpine-badged ORECA-Nissan O3 LMP2 will run in the French racing blue in which its early Le Mans and world rally contenders competed in the 1960s and early '70s. Tristan Gommendy will join Pierre Ragues and Nelson Panciatici in the car.



## ERC WANTS UK COMEBACK

European Rally Championship boss Francois Ribeiro wants to see the UK back in the series next year.

The Circuit of Ireland, which should have run as an ERC round this month, was forced out due to a lack of funding. Ribeiro wants the event – or another potential rally based in Sunderland – on a reduced ERC schedule in 2014.

"I am pushing for the UK," said Ribeiro.

"We have two candidates – the Circuit of Ireland organisers really understand they missed an opportunity.

"As well as this, I am in touch with another UK region to do a gravel event [believed to be Sunderland-based]. We understand the ERC has to be in the UK and I would love to do it next year."

The current 13 rallies is expected to be cut to 11 or 12 events for next season.

## SOLBERG SR FOR LYDDEN

World Rally competitor Henning Solberg will fight against brother Petter in this weekend's European Rallycross Championship opener at Lydden.

The older Solberg, who has been granted a wildcard entry, will drive an Eklund Motorsport Saab. Other one-offs include last year's Lydden winner Tanner Foust in an MSE Ford and Jussi-Petteri Leppihalme in a Pauwels Ford Focus.

Michael de Keersmaecker has confirmed that he will join the Albatec Racing squad in a Peugeot 208 supercar in time for the second round in Portugal. The Belgian misses Lydden due to injury.



## Wilson back in the groove

M-Sport boss Malcolm Wilson tested Ken Block's Ford Fiesta ST RX43 last week and said it was the best rally car he had driven. "I was the only person available to test it, but I'm glad I did," he said. Block competes in the car for the first time at Brazil's X Games in April.



## New MG livery

The works MG6s that will be raced by Jason Plato and Sam Tordoff in the British Touring Car Championship showed off their new liveries for the first time at the series' media day at Donington Park last week. Eurotech Honda man Andrew Jordan went fastest in the official pre-season test session held during the afternoon, less than a tenth of a second faster than Plato.

## In brief



### STCC DACIA REVEALED

Dacia has unveiled the Logan that it will field in the Scandinavian Touring Car Championship this year. Regular frontrunner Mattias Andersson will run and drive the car under the Dacia Dealer Team banner.

### ZANELLA TO FR3.5

Formula 2 frontrunner Christopher Zanella will race for ISR in Formula Renault 3.5 this year. The Swiss driver joins Russian Sergey Sirotkin at the team.

### BENBOW BACK TO BTCC

Dave Benbow, who engineered Adrien Tambay at the Abt Audi DTM squad last year, has returned to the British Touring Car Championship to perform a similar role for Eurotech Honda driver Jeff Smith.

### McBRIDE HEADS HOME

Former British Formula 3 series racer Nick McBride will switch to the Australian series in a Dallara-Mercedes F307 run by Astuti Motorsport. Briton James Winslow defends his title in a similar car run by Team BRM, starting this weekend at Mount Panorama.

### HAMLIN INJURED

Denny Hamlin has been diagnosed with a fractured back following his final-lap clash with Joey Logano during the NASCAR Sprint Cup race at Fontana last Sunday. It is unknown how long he will be sidelined for or whether surgery will be required.

## BIG NUMBER

53

The number of GT class wins achieved by Prototype Technology Group, which is shutting down after 25 years. All wins came during its BMW spell in the 1990s and 2000s.



SERIOUS HEAD PROTECTION



# CONGRATULATIONS KIMI!

for his impressive victory in Melbourne. Kimi Raikkonen won the opening race of the 2013 Formula 1 season in Australia for his first race with the new BELL HP7.



facebook

facebook.com/BellRacingEU

## HP7

Kimi Raikkonen, as well as other leading F1 drivers, is wearing the new Bell HP7. This helmet benefits from the latest technological evolutions, and is already the helmet of choice for open cockpit racing.



SNELL SA 2010 homologated FIA - 8860 approved

Available soon at your local BELL dealer!  
[WWW.BELLRACING.INFO](http://WWW.BELLRACING.INFO)

# Edd Straw



## The inside line

Amid the Red Bull fallout, it's vital to remember that working for the good of the team has always been an intrinsic part of motor racing – and other sports

It's human nature to view motor racing as an individualistic endeavour. There's the car, there's the driver in the cockpit; intuitively, it's obvious. But it isn't so straightforward. In Formula 1, the sheer size of even the smallest teams is evidence enough of that. This is what makes the debate about the validity of team orders far more complex than most armchair critics would have you believe.

Team orders have been a fact of life since grand prix racing was in its infancy. If anything, they have become rarer, less-formalised, but that's not to say they are not a legitimate and very necessary tool – especially in circumstances like last weekend's Malaysian Grand Prix, where the frontrunners were very marginal on tyres. Remember, this wasn't the enforcement of a pre-ordained pecking order, with one driver subservient to the whim of the other. This was all about ensuring the team got the result.

You only had to watch Adrian Newey's reaction on the pitwall, as the Sebastian Vettel-versus-Mark Webber battle-that-wasn't-supposed-to-be-unfolded, to realise how seriously teams take this situation. While Red Bull's chief technical officer was very sharp when the main television feed cut to him, suddenly sitting very still and staring intently at

The standard argument is that 'fans' at home won't be able to understand what's happening. For starters, that grossly insults even casual followers. The same argument is never raised when it comes to cycling, where whole teams of riders are deployed for the benefit of a leader. Even those who have never seen a bike race before can easily grasp the concept of a domestique or a lead-out man. Insulting the intelligence of the watching world isn't a valid argument for outlawing such tactics in F1. Creating the circumstances where such inevitable activities must be clandestine is where the sport has let down its fans in the past.

The ban on team orders was a moronic, PR-driven, kneejerk reaction to the hang-wringing and wailing resulting from a particularly crass execution of team orders by Ferrari in the 2002 Austrian Grand Prix. Such an egregious application of team orders is to be discouraged, not least because Michael Schumacher – who was handed victory on the run to the line when team-mate Rubens Barrichello finally obeyed his radio messages – was already well ahead in the championship.

Not only is a ban unnecessary, but it is also unworkable, forcing team orders underground. The

**“The ban on team orders was a moronic, PR-driven, kneejerk reaction to Ferrari in 2002”**

the screen, during the moments before he was far more animated. He was tearing his (metaphorical) hair out and looked just about ready to lean onto the track and grab Vettel's rear wing to slow down the second RB9 as it blasted past. In Newey's mind's eye, he will have been standing aghast as his drivers recreated 2010's Turkey Redbullageddon, squandering the hard work of hundreds of people.

Newey will have been involved in the micro-managing of the race. Engine maps, fuel use, KERS operation, strategy and laptime targets will all have been fed to Vettel and Webber throughout the Malaysian Grand Prix. This is a fact of life of grand prix racing and arguably has to be if it is to remain anywhere near the cutting edge of technology. The parameters for the battle between the two drivers were clearly established and for good reason: race to the final pitstop, but after that hold station. The team's objective for every race is to finish first and second with the driver order secondary, and simply letting them race with zero constraints can be costly.

disappointment triggered by Ferrari ordering Felipe Massa to cede the lead of the 2010 German Grand Prix to Fernando Alonso was nothing compared to the outrage of the watching world when both drivers and team clearly lied about it because of the ludicrous and vague team-orders ban.

Motor racing is a complicated sport, a symbiosis of driver, team and machine. At its root, the idea of no-holds-barred competition between two team-mates is appealing, and that's what we saw in Malaysia between Webber and Vettel... until the final pitstops. As it happened, the battle between the pair was spectacular, but given the stakes it's understandable that teams are wary of allowing such scraps to take place.

As for the drivers' feelings, it all depends which end of the debate you are on. In Malaysia, Webber was aggrieved. In case you're wondering, that's the same Webber who reckoned team orders were unnecessary and that he could attack Vettel in the closing stages of the 2011 British Grand Prix. ❄

# THE RACE REPORT

QUALIFYING • TRACKSIDE VIEW • LAP CHART • DRIVER BY DRIVER • RESULTS

## Vettel steals, Aussie thunders

Modern Formula 1 walks a tightrope between the show, rampant ambition and teamwork.

At Sepang it fell into the abyss below as Vettel beat Webber, as MARK HUGHES reports

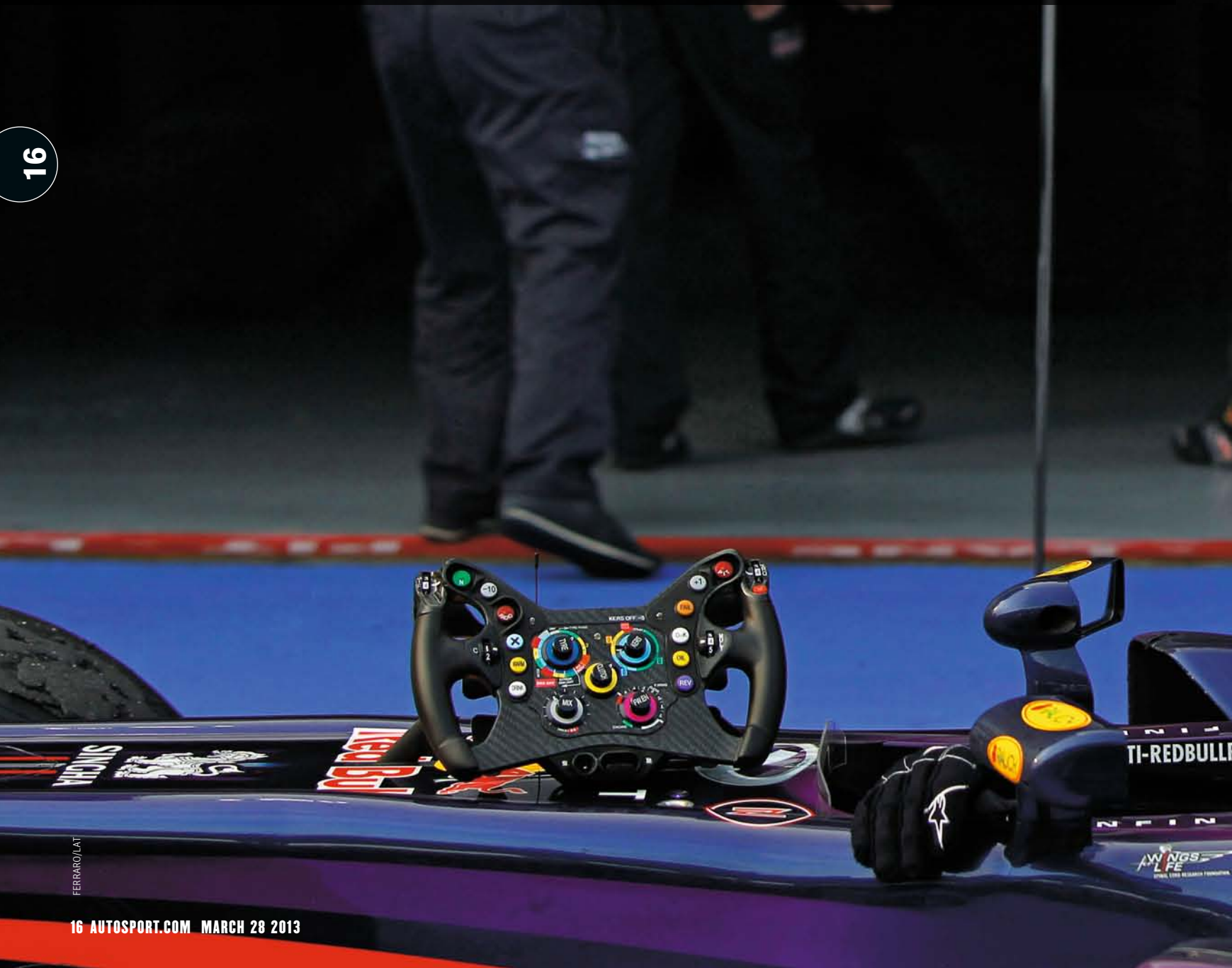

## At a glance

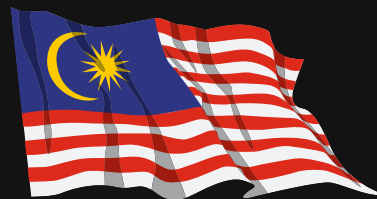

**MALAYSIAN GP**  
Sepang, March 24

**ROUND** 2/19

**LAPS** 56

**WINNER**  
Sebastian Vettel  
1h38m56.681s

**POLE POSITION**  
Sebastian Vettel  
1m49.674s

**FASTEST LAP**  
Sergio Perez  
1m39.199s

**RACE RATING**  
★★★★★ Great battling for the lead between the Red Bulls, but a fair fight?

**DRIVERS' STANDINGS**  
Vettel 40pts  
Raikkonen 31pts  
Webber 26pts



# Qualifying 16.00, 23.3.2013



Massa, Vettel and Alonso scooped top three places in tricky weather conditions

FORMULA ONE MANAGEMENT SUPPORTS THE FIA ACTION FOR ROAD SAFETY CAMPAIGN



It was another Sebastian Vettel pole, but not as we know it. Of the four Q3 qualifiers who took the gamble to come in partway through the session for fresh intermediates – Vettel's Red Bull, the Ferraris and Kimi Raikkonen's Lotus – Seb was the fastest by a full 0.9s from Felipe Massa. Potential pole challenges from the Mercedes pair of Nico Rosberg and Lewis Hamilton evaporated with their choice of staying out for multi-lap runs on one set each of inters.

The gamble hinged upon timing and weather. Coming in for a fresh set left you with just one flying lap to produce the time; no margin for error on a surface that invited error. The first half of the track was almost dry, but from the fast switchback of Turns 5-6 onwards it remained very wet from the sudden downpour in the latter part of Q2. In such circumstances a used inter can frequently be faster than a new one, as there is less heat build-up and deformation of the shoulder through the dry sections. But in this

case they were just too old as the track was at its driest near the end, and new inters were the rubber to be on. There wasn't a right or wrong answer in live time, only in hindsight.

So it was pole number 38 from 81 attempts for Vettel who, under big pressure, delivered flawlessly. He'd been only 15th and ninth quickest in Q1 and Q2 respectively, trying to eke out a single set of options to cover both sessions, thinking ahead to tyre choice on race day. Team-mate Mark Webber, trailing Seb by a few tenths for most of the weekend, fitted a fresh set for Q2 to go second quickest there, and into Q3 decided to stay out for a multi-lap run on a single set of inters. A pitwall error led him to believe he still had two laps left as the final seconds were in fact ticking down. He allowed Hamilton past, not realising that in doing so he would fail to cross the line in time for a final lap on the drying track. It left him back in fifth and his mood, already darkened by the high wear of the Pirellis on the RB9 in the dry, was not good.

Although the Ferraris couldn't approach Vettel's time, their choice of coming in for fresh rubber – exactly as the team had done in similar circumstances at Hockenheim last

year – secured Massa and Fernando Alonso second and third. Massa shaded his team leader by a couple of tenths, making it four from the last four. Alonso doubted that they would have been so far up had the session been dry: "The two Mercedes, Webber's Red Bull and maybe Raikkonen might have been ahead, I think."

Hamilton was last to cross the line and therefore got the driest track, but on his by-now worn inters the best he could do was fourth fastest. He had less graining than team-mate Nico Rosberg, who was sixth, 0.9s behind. In the dry Rosberg looked a likely pole challenger, comfortably fastest in Q2 and best of the hard-tyre runners in Q1. Mercedes had devoted a lot of time to long-run consistency after the disappointment at Melbourne and, as the track grip had increased into Saturday (before the rain), so it seemed to benefit those cars like the Mercs with a little inherent understeer and hurt those with strong front ends (Red Bull, Lotus). But rain at the vital time changed things again.

The Lotus is not at its best in cool track temperatures and, even though Raikkonen got onto fresh inters in Q3, he could do no better than seventh quickest, later penalised three places



Massa outqualified Alonso for the fourth time in a row

for impeding Rosberg. Not that he'd been super-quick on the dry track, only fourth quickest on new option tyres in Q2. The car was nothing like as beautifully balanced as it had been on Friday, Kimi finding oversteer and tyre degradation rather than neutrality and consistency. In the team's other car, Romain Grosjean got out too late in Q2 to avoid the rain and lined up 11th. He had been suffering wild oversteer on Friday, but a thorough going-over of the car overnight had it behaving better into Saturday.

McLaren was in better shape than in Melbourne, helped by the smoother track and a few on-the-hoof fairly brutal aero tweaks, plus also perhaps by the way the track evolution fitted the car's understeer traits quite well. Both Jenson Button and Sergio Perez made it into Q3 where, on multi-lap inters runs, they went eighth and 10th fastest respectively, each promoted a place

**'Pole number 38 from 81 for Vettel who, under pressure, delivered flawlessly'**

after Raikkonen's penalty.

Adrian Sutil was in fine form in the Force India, quick enough in the dry that a set of mediums helped him to fastest Q1 time. His Q2 time, 0.7s off Rosberg, was more representative but that was enough to get him into Q3. The car felt too oversteery in the wet of Q3 and he lined up ninth. But that was better than team-mate Paul di Resta, who was another to get out too late in Q2 to avoid the rain, a couple of spectacular moments and 15th on the grid all he had to show for his efforts.























Nico Hulkenberg's used-tyre Q2 lap in the Sauber put him 12th, while team-mate Esteban Gutierrez, similarly limited by the timing of his runs and the rain, was back in 14th. The pair was separated by Daniel Ricciardo in the only Toro Rosso to make it through to Q2. In the Q1 part of the grid, Jules Bianchi got the Marussia to within a couple of tenths of Valtteri Bottas's Williams.



**P30 RESULTS**

MASON/GETTY

## The Grid

 <b>2</b> MASSA FERRARI 1m50.587s Intermediates	 <b>1</b> VETTEL RED BULL 1m49.674s Intermediates
 <b>4</b> HAMILTON MERCEDES 1m51.699s Intermediates	 <b>3</b> ALONSO FERRARI 1m50.727s Intermediates
 <b>6</b> ROSBERG MERCEDES 1m52.519s Intermediates	 <b>5</b> WEBBER RED BULL 1m52.244s Intermediates
 <b>8</b> SUTIL FORCE INDIA 1m53.439s Intermediates	 <b>7</b> BUTTON McLAREN 1m53.175s Intermediates
 <b>10</b> RAIKKONEN LOTUS 1m52.970s* Intermediates	 <b>9</b> PEREZ McLAREN 1m54.136s Intermediates
 <b>12</b> HULKENBERG SAUBER 1m38.125s Intermediates	 <b>11</b> GROSJEAN LOTUS 1m37.636s Intermediates
 <b>14</b> GUTIERREZ SAUBER 1m39.221s Intermediates	 <b>13</b> RICCIARDO TORO ROSSO 1m38.822s Intermediates
 <b>16</b> MALDONADO WILLIAMS no time Intermediates	 <b>15</b> DI RESTA FORCE INDIA 1m44.509s Intermediates
 <b>18</b> BOTTAS WILLIAMS 1m38.207s Intermediates	 <b>17</b> VERGNE TORO ROSSO 1m38.157s Intermediates
 <b>20</b> PIC CATERHAM 1m39.314s Intermediates	 <b>19</b> BIANCHI MARUSSIA 1m38.434s Intermediates
 <b>22</b> VAN DER GARDE CATERHAM 1m39.932s Intermediates	 <b>21</b> CHILTON MARUSSIA 1m39.672s Intermediates

\* – three-place grid penalty for impeding Rosberg.

## Trackside View Mark Hughes



### GRAND PRIX EDITOR

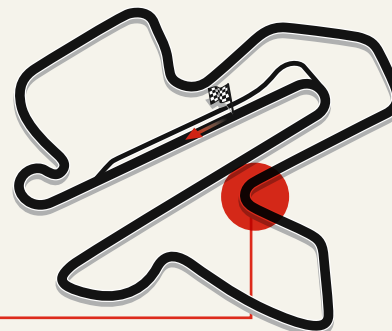

The sky is already changing from blue to grey, bubbling up for the daily downpour, as Max Chilton circulates in the fierce tropical heat. Down at the entry to the tight uphill hairpin of Turn 9 he's already got a shallow oversteer going on. It's helping him turn in the Marussia neatly enough – and the banked camber of the turn helps limit the slide – but it's surely going to kill those delicate rear tyres on a track that devours them. It's a good place to study contrasts in technique as some drivers try harder than others to find ways around keeping as much load as possible from the rears. Getting the car 'rotated' – pivoted around the inside front – so the direction change is made quickly, limiting the amount of time the rears are under lateral load, is a key endeavour around this sort of turn with this sort of tyres. Sebastian Vettel, for instance, is shallow into the turn, early from a long way back and staying on the power late. Only when he's almost upon the apex does he turn the wheel more decisively, the Red Bull then rotating around that inner front as the rear relaxes into that familiar roll-oversteer. It's all dealt with in a blur of steering and throttle, the exhaust gases nailing that wayward rear, and his line through the corner has formed a 'V' rather than the classic 'U' used by Mark Webber. Alonso's Ferrari doesn't behave like the Red Bull, but here Fernando gets that rotation onto the car early in the corner, well before the apex. Then there are the Mercedes drivers; they aren't so different on actual cornering technique but in how they are using the engine and its exhaust-blowing, Hamilton changing down early for full exhaust-enhanced downforce on the automatic throttle blips, Rosberg very late and therefore without the aggressive downchanges, keeping the longitudinal stresses off the rear tyres. Kimi Raikkonen – another using the 'V' technique – has been in for a while (a KERS problem) and upon his return the track has a lot more grip. You can see the moment under braking he feels this, and releases some pedal pressure, allowing the Lotus to almost coast up to the turn. Just a little snapshot of evolution in both track and technique. Meanwhile, with Chilton's long run coming to an end now, all that early oversteer has left him almost totally devoid of rear grip, the car completely unable to put its power down. Further evolution needed.

**'Vettel line forms a 'V' rather than the classic 'U' used by Webber'**

## Race

16.00, 24.3.2013



Something had to give. Just like the 2010 Turkish Grand Prix, circumstance brought the ferocious competitive tension that's a part of Formula 1, but usually hidden, out into the open – and old unsettled scores and festering animosity came spilling out for all the world to see and hear.

None of this was apparent at the start, as Sebastian Vettel led the intermediate tyres-shod field into a damp first turn, the flash storm having passed, the track already beginning to dry fast.

The Ferraris veered towards each other, Lewis Hamilton's Mercedes went to their left, Mark Webber's Red Bull to their right. Fernando Alonso reached the tight downhill Turn 2 in second place, and was surprised at how Vettel seemed to almost stop at the apex. He clipped the back of the Red Bull, sliding him out wide and dislodging the Ferrari's front wing.

Webber, meanwhile, had sliced past the Mercs and Felipe Massa's Ferrari and was now battling out second with Alonso, and would do for the rest of the lap, Fernando's sheer fighting spirit and the greasy surface keeping him in play. Ferrari thought the only way it might rescue his weekend was to keep him out

**'Webber fell in love with an F1 that was all about pushing to the limit'**

on the damaged wing for a couple of laps and then be first onto slicks, when the wing could be replaced. That was the only hope. As the wing then folded under the car at the end of the pit straight, trapping itself beneath the front wheels, so Alonso was just a passenger and he slewed into the Turn 1 gravel, having delayed Webber for all that first lap.

Vettel – with a potential title rival now out of the race and his team-mate already 3.5s behind – disappeared off into the humid Malaysia afternoon. That looked like being that, unless the Red Bulls destroyed their tyres. But that's not how it played out. Webber came back at Vettel and took control of the race, until...

Three of the biggest pains in Webber's world – the one-sided ferocity of Vettel's competitiveness, his protection within Red Bull and the very particular demands of racing on Pirelli tyres – all conspired to rob Mark of a victory he thought he'd already bought.

For one reason or another, days like Webber was enjoying until lap 46 are pretty rare – when he has taken on the



Alonso gets a mite too close to Vettel after start...

world's best, seen off any number of challenges and emerged in front. From the moment he placed himself beautifully through the opening sequence of turns to vault from fifth to second, he was doing everything right. The timing of his move from inter to slicks two laps later than Seb's was perfect, leapfrogging him to the front. His judging of pace against tyre life – particularly precarious on a Red Bull that's capable of more than saturating the latest Pirellis and inflicting an extra stop – was perfect.

Then, just before the third of four stops, with Vettel coming back at him, Mark was going slower than Seb, possibly trying to back him into the aggressively pursuing Mercedes of Lewis Hamilton. "Mark is too slow," said Seb over the radio. "Get him out the way." On the very next lap Webber upped his pace by 0.3s. He wasn't slow; he was conserving. The fact that you cannot race flat-out on the Pirellis was beginning to build conflict out on track.

Later, after Seb had been leapfrogged



ETHERINGTON/LAT



...and pays the price  
a lap later while  
battling with Webber

for second by Hamilton as a result of Webber having backed him up, Mark contained the Mercedes threat, while still looking after those Pirellis. Then, Vettel used DRS to pass Hamilton and was looming back into Webber's world on the eve of the final stops. He was aided by Red Bull having been obliged to bring Seb in the lap before Webber in response to Hamilton – Webber had exited the pits still just ahead, brawled through that first sequence of switchback turns, sidewalls almost touching, and prevailed.

Webber was leading the race after the final stops, the Mercedes threat receding as Hamilton desperately saved fuel, so team orders were imposed. 'Multi 21', both drivers were instructed. It's a code that essentially means to turn everything down, cease racing, hold position, save the tyres. For Webber it was essentially job done, beautiful job; surely just a 13-lap cruise to the flag now.

But it wasn't as satisfying for him as it would once have been. He fell in love with an F1 that was all about pushing to the limit, seeing who could stretch furthest into those limits, the ultimate test of pure relentless, pummelling pace.

"You watch Rafa Nadal and Roger Federer play each other and it's playing with the lines, with precision for a five-set match," he said. "But we are driving at eight tenths, conserving our pace... The racing is completely around nursing and trying to make the tyres survive, and they are not conducive to driving a car on the limit. You don't see us pushing on the limit. Generally no drivers are really on the limit today."

Even before the incident on lap 46, which sent that tyre-nursing gripe into an altogether more controversial orbit, the subject had been a contentious one. The Red Bull RB9 has so much more fast-corner downforce than anything else that it's simply overwhelming a control tyre designed around equalising the field. Its tyre usage had proved disastrous during the long runs of Friday practice.

Team boss Christian Horner and tech chief Adrian Newey are very vexed about that, feel that their rightful advantage for producing a faster car is being neutralised – just one more attempt at reining them in, part of a sequence that includes tougher flexibility tests, a limit on blown diffusers, extractor wheels and torque-limiting engine maps. Horner has been pushing hard for Pirelli to provide something tougher in future races. His rivals – suspecting that it's only the current tyre that's keeping them anywhere near the Red Bull – laughed at the idea when Pirelli canvassed their views.

Webber is every bit as vexed as Horner about Pirelli, frustrated that his reward for aggressively pushing, using his physical strength, gaining time from standing harder on the brakes than anyone else, from the sheer competitive desire to push on, has now been nullified. Those demands have been ►

## Friday



COATES/LAT

**1034 Max Chilton** (above) becomes the first driver to complete a lap, 34 minutes into free practice one.

**1055 Kimi Raikkonen** hits the track for the first time after a lengthy delay to replace a KERS battery.

**1101 Esteban Gutierrez** spins off at Turn 14.

**1118 Chilton's** left-rear tyre breaks up, but he is able to keep control of car.

**1120 Adrian Sutil's** engineer **Brad Joyce:** "Adrian, can you stay off kerbs, stay off kerbs during this run." **Sutil:** "So no KERS." **Joyce:** "No KERBS. KER-B-S. As in the side of the circuit."

**1405 Gutierrez** runs wide in FP2 and clouts a kerb, setting off his fire extinguisher. He's asked: "Can you drive back with that?" He does, and returns to the pits.

**1424 Charles Pic** spins into the gravel, but is able to recover.

**1437** Rain starts to fall, but it doesn't set in immediately.

**1449** The rain intensifies. **Di Resta**, who has a big slide at Turn 8: "The rain's getting really bad now, starting to get heavy." Everyone heads to the pits.



FERRARO/LAT

**1451 Nico Hulkenberg**, on slicks in the damp, spins his Sauber in the pit entry.

**1508 Perez** runs wide into the gravel after losing the rear in the damp. "OK, Checo, I've seen you've been through the gravel, please box this lap, box this lap."

**1540 Mark Webber** rails against tyres being the key performance factor in modern F1. "The whole category is geared around tyres at the moment."

**1625 Romain Grosjean** reveals that he is suffering from a repeat of the mystery car problem that blighted his Australian Grand Prix.

**2053 @JensonButton:** "Good day of data collecting oh and it seems the car works in the wet! ;) not bad considering there is normally a downpour PM everyday!"

◀ replaced by finesse and conservation. But what's even worse, he'd grafted his whole career – 17 years – to get into a quick F1 car and, just one year after he'd finally achieved that, Pirelli changed the game. As if it wasn't bad enough having to compete against a freakishly fast team-mate with in-team protection...

A similar story had been evolving at Mercedes. Nico Rosberg is emerging as a star of Pirelli-era racing, with a perfectly efficient style that minimises stressing the rubber while still maintaining formidable pace. Clear-thinking and massively motivated by the arrival of Lewis Hamilton and his reputation, he has actually been the faster Mercedes driver so far. But he'd lost out to graining intermediates in qualifying and took until the third lap to clear the inters-graining Massa and the McLaren of Jenson Button. By the time he went around the outside of JB at Turn 4, Hamilton was already over 3s clear in third and taking the fight to the Red Bulls.

This too was reminiscent of Turkey 2010: Hamilton chasing the Red Bulls hard but eating into an aggressively light

**'There is a disconnect between giggly, fun Vettel and ferociously competitive Vettel'**

fuel load as he did so, taking a lot out of the tyres too. Just like Button at that race three years ago, Rosberg judged that he'd be better just economically hanging onto the back of that line rather than getting involved too early.

Vettel had initiated the stops, coming in at the end of lap five, too early as it turned out: inters would be faster than slicks for a couple of laps yet. Webber and Hamilton came in together on the seventh lap and got out with Mark now ahead of Seb, and with Hamilton's deficit to Vettel cut (even though Lewis had made a comedy interlude by briefly trying to stop at his old McLaren garage).

Rosberg had to wait until the eighth lap, but no matter: he was already well clear of the fifth-place battle. Early in each new stint Hamilton would attack, putting pressure on the Red Bulls, while Rosberg glided efficiently around saving fuel and tyres and staying in touch, but not getting so close that he would abuse

that delicate rubber. He was lining himself up perfectly. "I could see them just ahead, I had the pace when needed and I felt I was fighting for the win," he would recall later, in a state of great disappointment.

Shadowing the lead trio like a below-the-radar menace, by the time he exited from his fourth and final stop Rosberg could see Hamilton's resources were spent. Lewis was in extreme fuel-saving mode and Rosberg was ready to make his move, to pick up the Mercedes baton in the chase of the Red Bulls. It took only three laps before he was on Lewis's tail. Using DRS, he passed him down the back straight on lap 43. But Hamilton passed him back in similar fashion down the pit straight. On lap 44 the same, Nico ahead up to the final turn, Lewis retaliating down the pit straight. Then the call, the authoritative tones of Ross Brawn: "Nico, hold position behind Lewis."

"I can go much faster, just let me past." "Negative Nico. Lewis is doing the pace we've told him to."

"But what about the Red Bulls? We can push them. Maybe their tyres will go."

"Understood. But maintain position." He was furious, but ultimately obeyed.

In the cockpit of Red Bull number 1 things weren't so clear-cut, Multi 21 or not. Some – in the Webber camp, admittedly – call him 'the smiling assassin' and there is in Vettel a disconnect between the giggly, open, fun guy out of the car and the ferocious, competitive animal inside it. He had not enjoyed it in the Brazil title-decider last year, when Webber's squeeze on him into the first turn triggered the choreography that had him facing the wrong way with a damaged car a few corners later. Nor when Webber was later fighting him for position and had to be told to move aside.

Losing the lead to Webber here, through pitting too early for slicks, was just one of those things, and Vettel had minimised the damage of that brilliantly. By the end of the out-lap he was fighting his way back past the group of cars that had swarmed past him as he'd struggled to bring the slicks up to temperature. But what had happened on lap 26, when he felt Webber was trying to back him into Hamilton – and which did in fact result in Hamilton being able to briefly jump ahead of him at the third stops – surely reminded him of Turkey 2010. The build-up to their collision then had been Webber trying to back him towards Hamilton... So he used DRS to pass the fuel-saving Mercedes into lap 39, and Webber was 4.2s up ahead with 17 laps to go. There was history and animosity in this contest and the team management was going to be powerless to contain it.

Furthermore, Vettel was now on his new option tyres, saved from the day before by making one set last for both Q1 and Q2, whereas Webber had used up two sets. Webber was now on primes, and assuming he had the race won, 'Multi 21' and all that.



**Webber (left) didn't think Vettel was about to attack...**



KALISZ/XPB



**Tension at Red Bull post-race**

COATES/LAT



KALISZ/XBP



...but the German sliced past him to win regardless

Vettel was in no mood for Multi 21. He was far from finished. Pitting the lap before Webber found him a big chunk of time and, as Mark had exited the pitlane going into lap 44, they were wheel-to-wheel, Webber aggressively holding him to the outside in Turn 1, chopping across him into 2 and staying ahead. "We issued the team instructions at this point," said

**"Remember this one," said the angry Rosberg into the radio at the end'**

Horner. "We were in a position to take maximum points for the team, these tyres are very delicate and we didn't want them racing and maybe screwing the tyres. The Mercs weren't all that far behind." (Mercs that, by Pirelli's own estimates, would be probably a lap behind, along with everyone else, if the Red Bulls could use their full performance advantage...)

Vettel wasn't listening, not even as Horner's voice replaced that of the race engineer on the radio as he continued to attack: "Come on Seb; this is silly." Into lap 46 he got onto his KERS and DRS, aimed his car down the inside of Webber's towards the end of the pit straight, Webber squeezing him towards the wall, wheels close to touching at 180mph, Vettel coming through regardless.

Webber hung on around the outside of Turn 1, squeezed himself back ahead into the inside of 2 and compromised his line out of there. Vettel got a better run up through the kink of Turn 3, moving for the outside as they approached the tight uphill right of 4. Webber was pincered in and cautious; Vettel, with the adrenalin coursing, was fast, decisive and ahead around the outside. A clear, defiant breach of team orders.

Webber came back at him around the outside of Turn 1 next lap, but Vettel pushed him across to the edge of the track to prevent him getting the inside line for 2. Even after that he was running his KERS in overtake mode to keep Webber behind, threatening to overload it, with his race engineer imploring him to stop doing so. "Be careful with your left-front tyre," was another warning; in the cockpit was just the steely resolve of a 27-time winner.

So Webber trailed angrily, professionally, behind. Hamilton and the angry Rosberg crossed the line 12s adrift of the Red Bulls. "Remember this one," said Nico into the radio at the end. Button — on one stop fewer — might have applied some late pressure to the fuel-saving Mercs had he not been released from his final stop prematurely, before the right-front-wheel man had finished his task. A micro-switch in the pitstop lights system erroneously ▶

## Saturday



**1315 Kimi Raikkonen** (above) complains about his Lotus's handling in FP3: **"The car feels wrong; I don't know what's wrong with it."** He later adds: **"Still too much on the nose. I can't understand how it can change so much from yesterday."**

**1400** Hamilton returns to the pits with a heavily-damaged front-right tyre after a big lock-up.

**1613 Nico Hulkenberg** claims he's impeded by Perez into Turn 9 in Q1. **"He was in the way on the braking line."**

**1622 Jules Bianchi** gets huge praise for his Q1 efforts: **"Great job, well done, only half a second from getting into Q2."**



**1632** With no rain radar, **Lewis Hamilton** plays weatherman: **"It's raining between Turns 5 and 6."**

**1636 Paul di Resta** spins in rain at Turn 7, and fails to make Q3. Back in the pits he says: **"Too late. Far too late."** His engineer says: **"Don't shake your head at me Paul, we misjudged it."**

**1655** In the middle of Q3, **Sebastian Vettel's** engineer 'Rocky' asks: **"What tyres do you want?"** He replies: **"Another set of intermediates."** Asks: **"Front-wing adjustment?"** Seb replies: **"Minus-4."**

**1657 Raikkonen** is told: **"It's definitely one timed lap, you have to get it on one timed lap."** **Jenson Button** is told the same thing.

**1700 Mark Webber** informed: **"We missed it, we missed the line. Box this lap. We finished P5."** **Webber:** **"Unbelievable."**

**1701** To **Raikkonen:** **"Stay in one gear to maintain hydraulic pressure, do not upshift or downshift."**

**1702 'Rocky':** **"P1, pole position!"** **Vettel:** **"Yes, yes, yes — again!"**

**1847 Raikkonen** hit with three-place grid penalty for impeding **Nico Rosberg.**

**1914 @alo\_oficial** **"Very good result today! Second and third on the grid! It will be an interesting race tomorrow. #Happy"**



Both Force Indias were forced out with wheelrim/nut issues

'Schumacher in this situation would simply plough and bluff; Seb came partially clean'



No repeat of Oz GP for Raikkonen

DUNBAR/LAT

produced a green for 120 milliseconds; Button reacted and was gone – only to then be told to stop. By the time this was sorted, he was nowhere and a tactical retirement beckoned.

Massa, whose day had been defined by the awful graining he suffered on his inters in the early laps, had realised late in the race that Romain Grosjean's Lotus was beginning to pull away from him but that there was still plenty of time to make a fourth stop. He did so on lap 47 and the new-tyre advantage saw him quickly past Nico Hulkenberg's Sauber, Kimi Raikkonen's Lotus and

Grosjean to take fifth position.

The Lotuses had been similarly poor on inters, just as in qualifying. An oversteer balance was never fully cured, and with that imbalance went their previous tyre advantage. Raikkonen spent much of the race behind an aggressively defensive Hulkenberg before finally prevailing.

Paul di Resta would have likely headed this little group, having flown in the Force India early on. Both he and team-mate Adrian Sutil were forced to retire with wheelrim/nut failures at the second stops. Ninth-place Sergio Perez had

## The race lap by lap

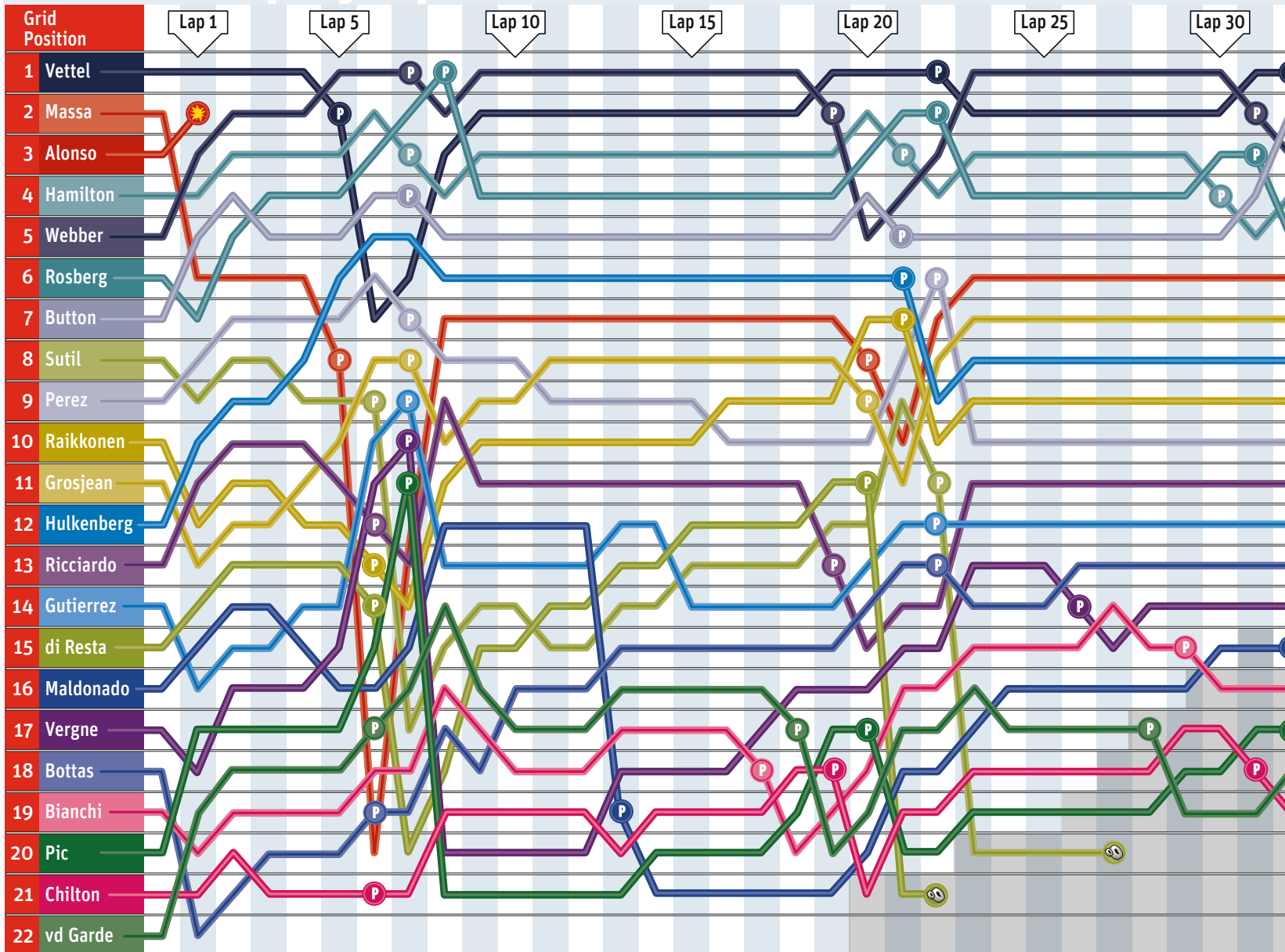



Hamilton (left) won the other intra-team war from Rosberg

such a gap over Jean-Eric Vergne's Toro Rosso that he was able to bring the McLaren in for an unplanned fourth stop with just two laps to go, without losing a place. New-tyre grip on a near-empty fuel tank garnered him fastest lap.

As Vettel removed his helmet, so the ferocious red-eyed monster subsided and the fun, smiling Seb returned – only to be shocked by the reception he received from Webber. As the normal world rushed in and overwhelmed the intense, solitary world of the cockpit, so he had some adjustments to make.

Michael Schumacher in these

situations would try to simply plough and bluff his way through; Seb came at least partially clean: "I'm not entirely happy. I think I did a big mistake today. We should have stayed in the position we were. I didn't do it on purpose, I see Mark is upset and I want to apologise to him. The difference in pace at the end wasn't fair because he was trying to save the car and tyres. I took a lot of risk to pass him. I fucked up."

Just to complete the unhappy podium, Hamilton was similarly contrite: "Nico drove a much smarter, more-controlled race than I did and he should be here, not

me. It's not the best feeling being here in these circumstances... These tyres make it very hard. It's not fun; I didn't enjoy the race. It's not the same as back in the day when you were pushing to the maximum the whole time and had tyres that lasted."

Two years ago, after this very event, we wrote here that this new Pirelli era was a facsimile of racing – it looked like it on the surface but wasn't to be confused with the real thing. Finally the players are breaking ranks to reveal the reality behind the show. As Vettel and Webber have shown, the reality isn't always pretty. But it has the virtue of being real. ❄



**1604** "Jenson, Alonso has a broken front wing, be wary."

**1645** Engineer 'Rocky' to Vettel: "Same strategy as the last stint: 3s gap. Save your tyres."

**1652** Vettel: "Mark is too slow, get him out of the way. He's too slow." He is told by 'Rocky': "Understood, look after your tyres."

**1656** Webber is asked what tyre he wants to run on final stint: "Happier on the prime, mate."

**1710** Kimi rages over Hulk: "Do you see what he's doing? Putting me off and now he hit me."

**1712** Vettel passes fuel-saving Hamilton at Turn 1, who reports: "My tyres are knackered"

**1715** Button latches on to tail of leaders, a lap down: "Oooh guys, this is painful. These guys are really struggling for tyres. What's the rule on overtaking them?"

**1720** Vettel attacks Webber after final stop. 'Rocky': "Careful Sebastian, careful. You need 13 laps on these tyres, don't forget."

**1723** Horner to Vettel: "This is silly Seb, come on."

**1725** Webber's engineer: "OK Mark, he was told, he was told."

**1726** Vettel: "I was really scared, all the time he was moving and I had to leave the line."

**1733** Rosberg: "I can go so much faster than this." Brawn: "Negative, Nico, negative. Lewis's pace is what we're asking him to do. He can go a lot faster as well." Rosberg: "Let's go and try and get the Red Bulls, they might have tyre drop-off."

**1740** Rosberg: "Tell him to speed up, he's going too slow." Brawn: "There's a massive gap behind and nothing to gain in front, we have to look after the cars and bring them home."

**1752** Webber to Vettel in pre-podium green room: "Multi 21, Seb [slams drink bottle down]... Yeah, Multi 21."

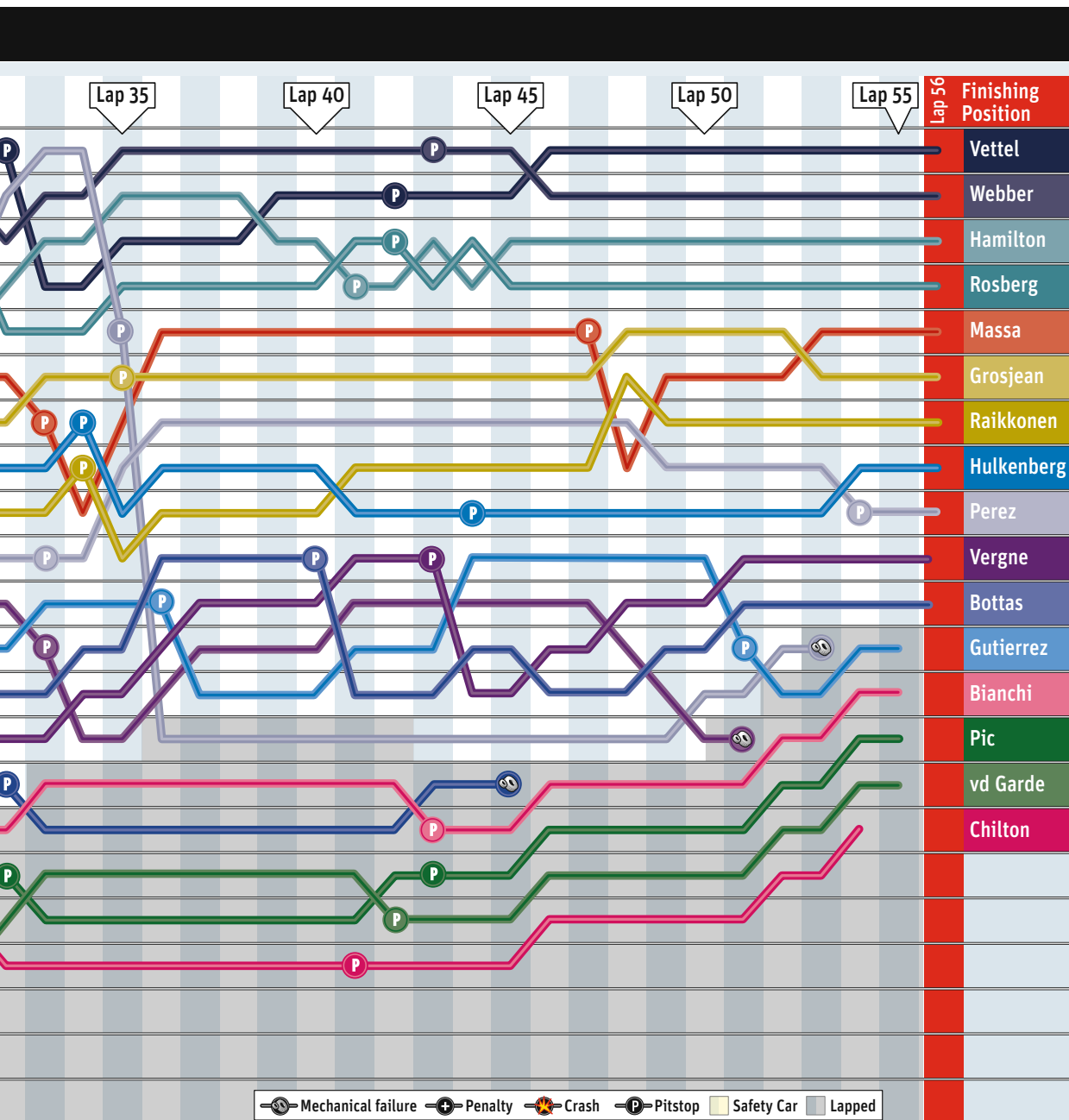

# Team by team

## Red Bull



### Team orders fiasco mars final result

**1**  
4/10  
Event rating

CIANFLORE/GETTY

**SEBASTIAN VETTEL**  
Red Bull-Renault RB9-03  
Start: 1st; Finish: 1st  
Strategy: 4 stops (inter-medium-hard-hard-medium)



His excellent qualifying performance, too-early first stop and pass for the lead must all be taken into account, but his race will be remembered for his defiance of team orders. Maybe a true great always goes for victory, but it could be argued he let down a team of hundreds of people for his own ends. Vettel is one of the all-time greats, but this wasn't his finest hour, hence the very low score.

**2**  
8/10  
Event rating

THOMPSON/GETTY

**MARK WEBBER**  
Red Bull-Renault RB9-02  
Start: 5th; Finish: 2nd  
Strategy: 4 stops (inter-hard-medium-hard-hard)



Webber blamed his disappointing qualifying on a team timing error, but getting caught up with Hamilton at the final corner was what really cost him. A good first lap in the race put him into contention, and by running two laps longer than Vettel on intermediates, he made the perfect tyre call, just keeping Vettel at bay after the final stops. He would have been a worthy winner, but for Vettel's manoeuvring.

## Ferrari

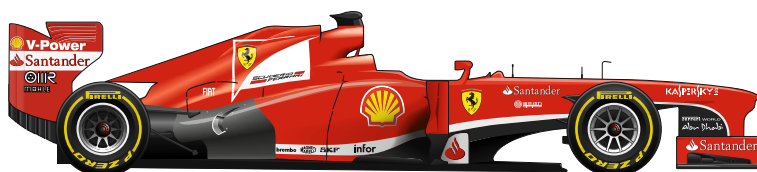

### Massa continues fine qualifying form

**3**  
4/10  
Event rating

XPB/LAT

**FERNANDO ALONSO**  
Ferrari F138-299  
Start: 3rd; Finish: DNF  
Strategy: Retired lap 2 (inter-retired)



Alonso was outqualified by Massa for the fourth consecutive race, but some of the deficit was down to being on track at the wrong time. After a good start, Alonso was caught out by Vettel's legitimate slow apex speed at Turn 2 and clobbered the back of the Red Bull. It was his mistake, but less in his control was the decision to stay out with a wing that was visibly badly deranged in the hope of making it to the slicks window.

**4**  
8/10  
Event rating

XPB/LAT

**FELIPE MASSA**  
Ferrari F138-300  
Start: 2nd; Finish: 5th  
Strategy: 4 stops (inter-medium-hard-medium-medium)



For the first time since Bahrain in 2010, his opening race as Alonso's team-mate, Massa qualified on the front row due to an excellent lap in tricky conditions. A disappointing getaway and chronic graining on his intermediates cost him almost 17 seconds to the race lead by the time the field had settled after the first stops. That he was 25 seconds down at the end after a decent recovery shows third was on the cards.

26

## McLaren

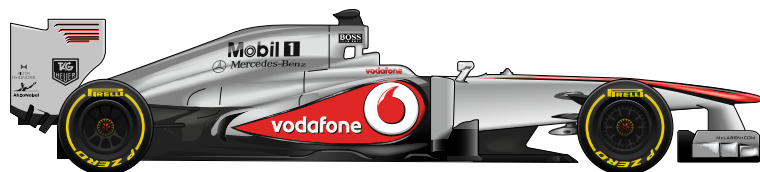

### Progress fails to soothe Button's pain

**5**  
9/10  
Event rating

XPB/LAT

**JENSON BUTTON**  
McLaren-Mercedes MP4-28-05  
Start: 7th; Finish: 17th  
Strategy: Retired (inter-medium-medium-hard)



You had to feel for Button. Buoyed by progress made with the car, he qualified and raced well, only to head home pointless. Had he gone on to finish fifth and within sight of the Mercedes, which is probably how the race would have panned out, it would have been an excellent weekend's work. As it is, the quality of Button's drive in difficult circumstances shouldn't be overlooked.

**6**  
7/10  
Event rating

XPB/LAT

**SERGIO PEREZ**  
McLaren-Mercedes MP4-28-06  
Start: 9th; Finish: 9th  
Strategy: 4 stops (inter-medium-medium-hard-hard)



Qualifying was disappointing, with a one-second deficit to Button, but the race went a little better. Perez had a crack at running a three-stop strategy that could have put him in the mix, although he ended up some way from pulling it off. Even so, he bagged his first points for McLaren, and his first since signing for the team last year. Squandered some time with needless scrapping.

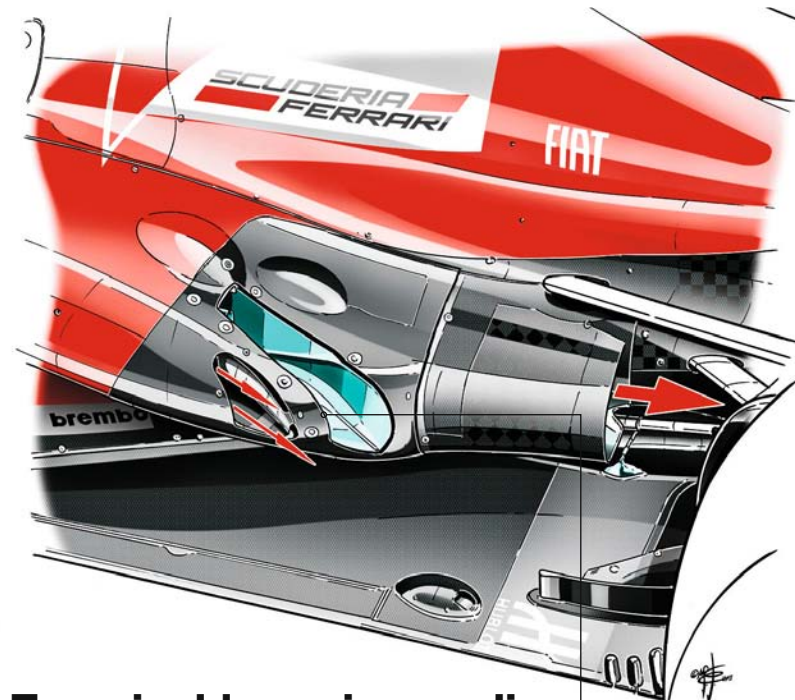

### Ferrari adds engine cooling

➔ Ferrari took precautions to protect its engines from the tropical heat of Sepang with an extra radiator exit area in the enclosed box section behind the exhaust outlet.  
**GARY ANDERSON** Ferrari has put extra radiator exhaust in a low-pressure

area, where the airflow is only just about staying attached. You will get a good return in efficient cooling by opening up a hole there, but at the possible risk of getting a bad return aerodynamically. The car needs to be cooled, so you just have to go with the best solution you can find.

# Lotus



## Australia seems a distant memory

**7**  
6/10  
Event rating

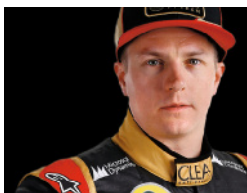

**KIMI RAIKKONEN**  
Lotus-Renault E21-03  
Start: 10th; Finish: 7th  
Strategy: 3 stops (inter-medium-medium-hard)



While Raikkonen was able to make one stop fewer than the leaders, that's where the similarities with his Australian victory ended. The die was cast by the car's struggles in intermediate conditions, with the Finn unable to do better than seventh in qualifying, even before a three-place penalty for impeding Rosberg. He lost a heap of time in the damp early in the race, which meant he spent far too much time in traffic.

**8**  
7/10  
Event rating



**ROMAIN GROSJEAN**  
Lotus-Renault E21-01  
Start: 11th; Finish: 6th  
Strategy: 3 stops (inter-medium-medium-hard)



The Franco-Swiss was downbeat after Friday, when the same mystery car problem that had ruined his Australian GP struck again. However, he was back in business on Saturday, only for a combination of bad timing and his failure to get more out of the car on used mediums to leave him outside of Q3. His race performance was stronger when not on intermediates, and he did a very good job to beat Raikkonen to sixth.

## A response to engine mapping regs

→ Kimi Raikkonen ran a new sidepod/exhaust/rear bodywork combination (original shown in main picture) on the Lotus, with enhanced coke-bottle section at the expense of the exhaust-blowing area. This is believed to be a response to the regulation clarification in engine mapping made recently. With Renault Sport's original interpretation, there would have been more exhaust-blowing effect, and hence more bodywork devoted to it. The clarification will have changed the compromise between exhaust effect and airflow through the Coke-bottle profile.

### GARY ANDERSON

The ramp area coming down from pipe, the length of duct going to diffuser and the length of the coke bottle are the three areas of change. The new version has a shorter sidepod, a much steeper ramp where the exhaust outlets are and the intake duct to the diffuser is shorter. This has allowed more of a Coke bottle for the airflow, giving more gap between the rear tyre and the body. There's a compromise to be made between getting the exhaust gases going where you want them and getting the airflow through the Coke bottle

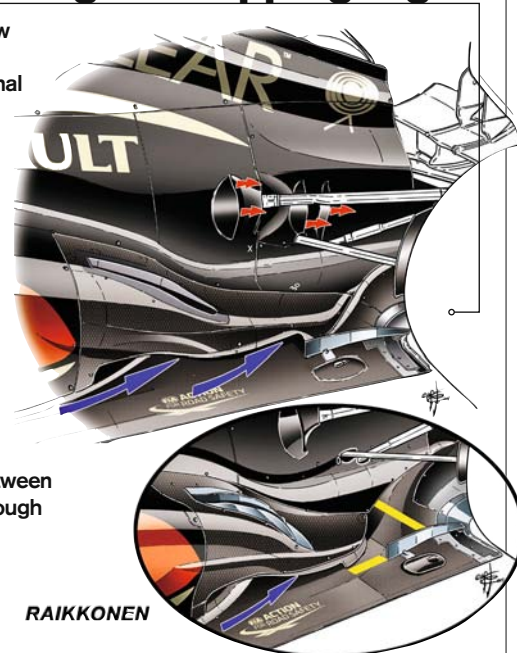

section. One of the hazards of the ramp is that it can keep the air attached over the top of the sidepod, creating lift. Maybe the shorter pod/steep ramp combination helps negate that. The reduced inlet area for the duct to the diffuser suggests that with the old design the bigger inlet was reducing the velocity too much. There is a compromise to be struck there between volume of air and its velocity.

## Lotus reduces downforce

→ Lotus responded to the reduced downforce levels required for Sepang with a revised front wing endplate (main picture, with the previous component inset).

**GARY ANDERSON** Lotus' previous version of the front wing endplate was a sort of two-piece affair, trying to turn the airflow a bit earlier. It's not just that this is a new wing replacing the earlier one – this is a different downforce level. At Sepang, you're not running maximum downforce, and you don't want to just take the old wing out of its sweet spot of wing angle. You

want the trailing edge of the main flap as consistently angled as possible. When you change that dramatically, you end up with a different airflow over the whole car. So this will reduce front downforce without affecting how the whole airflow works over the car. You don't want to lose front downforce by backing off the wing angle when that then loses you downforce further back as well.

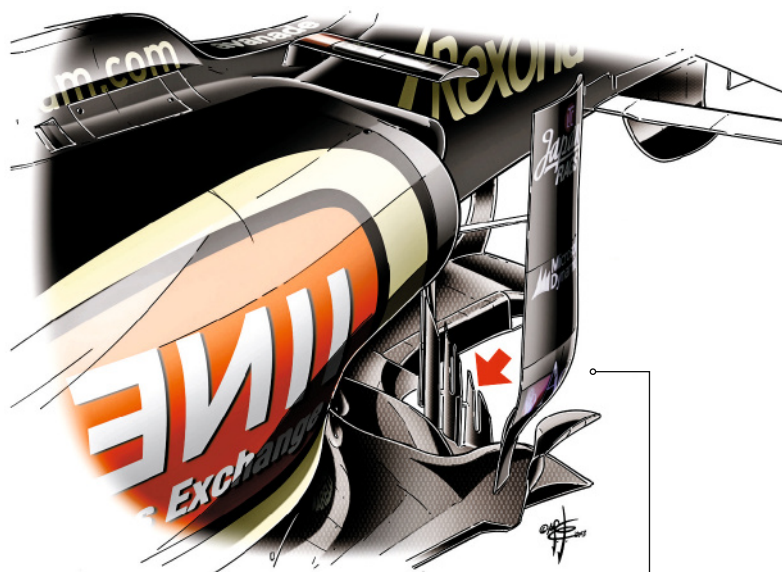
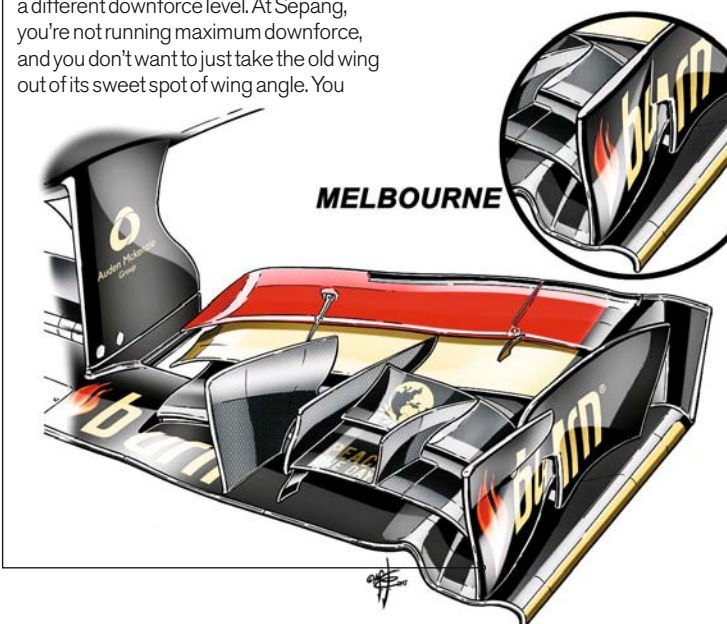

## Managing sidepod airflow

→ Lotus has a very intricate stepped arrangement of vanes around the front of the sidepod and a small lift-generating wing section ahead of the top of the sidepod.

**GARY ANDERSON** The wing ahead of the sidepod is trying to get the airflow to go over the top of the sidepod where it tends to create lift. All the other turning vanes are

managing airflow through the undercut and Coke bottle area. Lotus has a very elaborate vortex-generating bargeboard. We've seen bargeboards with little steps in before, but this takes that concept further in trying to generate the vortex around that corner, scavenging the underneath of the chassis a lot more and dragging the flow over the front wing harder.

# Mercedes

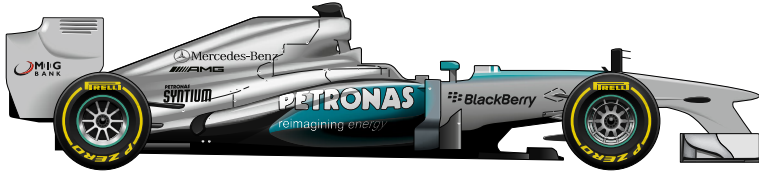

## Little to choose between Merc pair

**9**  
8/10  
Event rating



XPB/LAT

**NICO ROSBERG**

Mercedes F1 W04/03  
Start: 6th; Finish: 4th  
Strategy: 4 stops (inter-medium-medium-hard-medium)



The pattern of qualifying from Australia, with Rosberg faster than Hamilton in Q1 and Q2, before ending up two places behind him in the top-10 shoot-out was repeated. The one-second gap in a damp Q3 showed only that Hamilton did a better job of stringing a lap together before the intermediates were too far gone. Rosberg's underlying race performance was very similar to his team-mate's, but he was frustrated at not being allowed to pass in the final stint.

**10**  
8/10  
Event rating



XPB/LAT

**LEWIS HAMILTON**

Mercedes F1 W04/04  
Start: 4th; Finish: 3rd  
Strategy: 4 stops (inter-medium-medium-hard-medium)



The encouraging start to Hamilton's Mercedes career continues, with him taking only the team's seventh podium since the works effort was revived at the start of 2010. While he did have to rely on team orders to finish ahead of Rosberg, that was partly down to his aggression earlier in the race when it looked possible to mix it with the Red Bulls. He was also quietly effective in qualifying, emerging as the best placed of those who didn't stop for fresh inters.

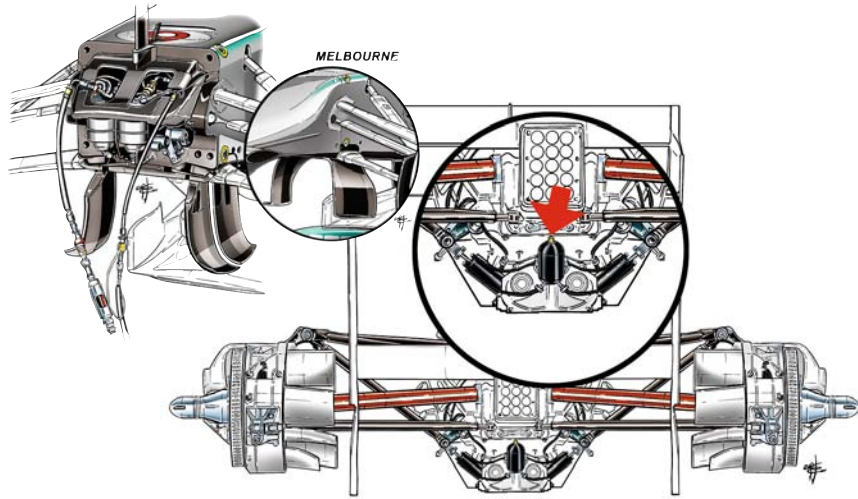

## Mercedes tries FRIC

**➔ Above is Mercedes' FRIC (front and rear inter-connected) system that hydraulically links the front and rear suspension. It's believed Lotus has been running something similar for two seasons, and now other teams have it. Mercedes also made changes to the vanes and pillars beneath the nose.**

**GARY ANDERSON** If you're connecting the front and rear suspension, you have an actuator at the front and the rear linked by hydraulic lines. It's a displacement of fluid from one end to the other to either support the front or keep the rear in attitude. In many road cars, you have hydraulic attitude compensation to keep the car level under different loads. It's the sort of thing you find in Mercedes estate cars. This is quite similar, but working to maximise the aerodynamics

through the attitude of the car. When you brake these cars at more than 5g, you are transferring around 250kg onto the front from the rear, and the system helps compensate for that, bringing the rear of the car down. It allows you to use peakier downforce maps because you can narrow the working window better without the usual downsides. You could run more rake, as the front will be prevented from scraping the ground when you brake. Underneath the chassis, the tea tray and tall side fences form turning vanes. The front wing pillars are trying to get as much air as possible to come into the centre section, and then you have to accelerate it back out again at as high a velocity as possible. The fences try to do that – then offer it up to the front of the sidepods in as good a condition as possible.

# Sauber

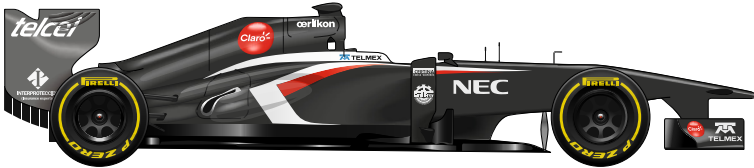

## Hulkenberg outshines his team-mate

**11**  
9/10  
Event rating



XPB/LAT

**NICO HULKENBERG**

Sauber-Ferrari C32-01  
Start: 12th; Finish: 8th  
Strategy: 4 stops (inter-medium-medium-hard-hard)



When evaluating any driver's weekend, a good indication of how well they have done is whether there is evidence to suggest they could have qualified or finished higher. In Hulkenberg's case, there was nothing he could have done about the weather misjudgement that left him 12th after setting a time on used rubber. In the race, he excelled in the low-grip conditions and finished only five seconds shy of Raikkonen.

**12**  
6/10  
Event rating



XPB/LAT

**ESTEBAN GUTIERREZ**

Sauber-Ferrari C32-03  
Start: 14th; Finish: 12th  
Strategy: 4 stops (inters-hard-medium-medium-hard)



The Mexican looked very average compared to his team-mate, but considering how well Hulkenberg is performing, it would be unfair to use that to damn the rookie. But he should have set a better Q2 time, even though he was on used slicks and was caught out by the rain. He had a relatively quiet race, but his strategy was based on being able to make only three stops, something he fell five laps short of.

# Force India

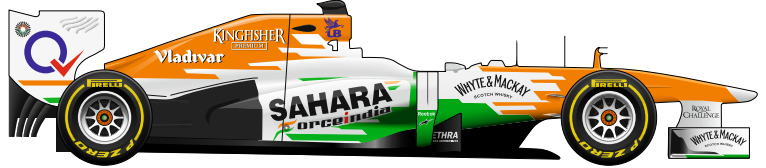

## Wheelnut issue forces double DNF

**14**  
6/10  
Event rating



XPB/LAT

**PAUL DI RESTA**

Force India-Mercedes VJM06/04  
Start: 15th; Finish: DNF  
Strategy: Retired (inter-medium-hard-retired)



This was one of those weekends when everything went wrong. The team was well and truly caught out by conditions in Q2, which led to the Scot having a couple of offs trying to put in a lap on slicks while the rain was falling. The race started promisingly, but he lost time queuing behind Sutil at the first stop. He set some quick times while trying to recover, before eventually having to retire thanks to the team's wheelnut problem.

**15**  
7/10  
Event rating



XPB/LAT

**ADRIAN SUTIL**

Force India-Mercedes VJM06/03  
Start: 8th; Finish: DNF  
Strategy: Retired (inter-medium-hard-retired)



The German's comeback continues to go very much to plan, with a first visit of the season to Q3. He was a bit disappointed not to be higher up the grid, but had a solid start to the race in conditions in which he usually excels, suggesting there's still more to come from him as he reacclimates to F1. Like his team-mate, his race was ruined by Force India's captive wheelnut disaster, but on track he was competitive.

# Williams

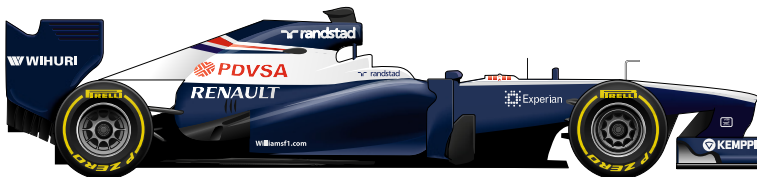

## Maldonado rues car's shortcomings

**16**  
5/10  
Event rating



CIANFLONE/GETTY

**PASTOR MALDONADO**  
Williams-Renault FW35-02  
Start: 16th; Finish: DNF  
Strategy: Retired (inter-medium-medium-medium)



Maldonado continues to be frustrated by the Williams' shortcomings, although his determination to drive around these is surely causing more problems than it solves. An off on an installation lap was embarrassing but excusable. Less forgivable was running off the track and damaging his front wing when he had dragged the car into a promising position. His eventual retirement was down to a KERS problem rather than driver error, though.

**17**  
7/10  
Event rating



XPB/LAT

**VALTTERI BOTTAS**  
Williams-Renault FW35-01  
Start: 18th; Finish: 11th  
Strategy: 4 stops (inter-medium-medium-medium)



Considering that Bottas was last on lap one after running wide while scrapping with a Caterham, coupled with the fact that he was driving a car still some way off where it's expected to be, to finish just a second and a half off the points was impressive. Given how close he was to Vergne at the finish, a point may have been possible. However, the Toro Rosso is a much stronger car, so that's probably an unfair ask.

# Toro Rosso

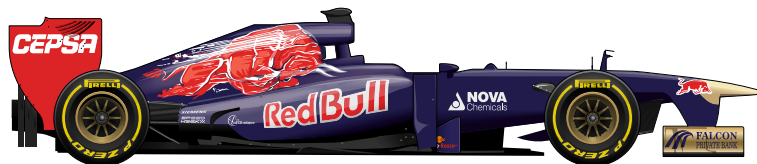

## Mixed weekend for Toro Rosso men

**18**  
8/10  
Event rating



XPB/LAT

**JEAN-ERIC VERGNE**  
Toro Rosso-Ferrari STR8-03  
Start: 17th; Finish: 10th  
Strategy: 3 stops (inter-hard-hard-medium)



On paper, his qualifying performance was disappointing, although his exit in Q1 was partly down to hitting traffic at an inopportune moment. He made up for it in the race, however. He lost 25 seconds after his STR crew released him into the path of Charles Pic's Caterham at the first stop, but did an excellent job to fight back and score a point, passing Bottas late on to take 10th. After throwing away a top 10 in Australia, this was an accomplished drive.

**19**  
6/10  
Event rating



XPB/LAT

**DANIEL RICCIARDO**  
Toro Rosso-Ferrari STR8-01  
Start: 13th; Finish: 18th  
Strategy: 3 stops (inter-medium-medium-hard)



Thirteenth in qualifying was a decent return for the Australian, although there was a feeling of frustration that the opportunity was there to do even better given the conditions. Ricciardo's opening stint looked to have laid the foundations for a push for points, but his pace in the dry wasn't as strong, perhaps because of floor damage inflicted when he spun into the gravel on an installation lap. He eventually retired with an exhaust problem.

# Caterham



## Drivers outperform their machinery

**20**  
8/10  
Event rating



XPB/LAT

**CHARLES PIC**  
Caterham-Renault CT03-06  
Start: 20th; Finish: 14th  
Strategy: 4 stops (inter-medium-hard-medium-medium)



Qualifying was so-so, although Pic complained of understeer in Q1, which perhaps exaggerated the gap to Bianchi's Marussia. When Toro Rosso released Vergne's car into his path at the first stop, with predictable consequences, it cost Pic 20-odd seconds, yet his pace was good enough to get back ahead of team-mate van der Garde and Chilton. At the end, he was only a little over half a minute behind Bianchi.

**21**  
7/10  
Event rating



XPB/LAT

**GIEDO VAN DER GARDE**  
Caterham-Renault CT03-05  
Start: 22nd; Finish: 15th  
Strategy: 4 stops (inter-hard-hard-hard-medium)



The pace gap between van der Garde and Pic was not as big as the six-tenths in qualifying suggests, with the Dutchman's real deficit around the three-tenths mark. Considering this was only his second GP weekend, that's respectable. His team-mate's pit disaster gifted him the initiative in the intra-Caterham team battle, but he was unable to capitalise. More important was his defeat of Chilton in a close-fought contest.

# Marussia

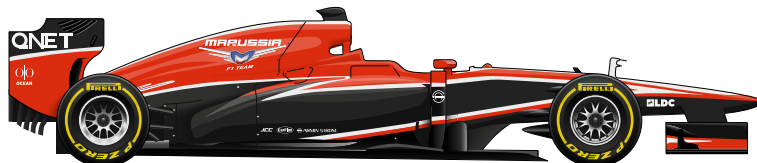

## Bianchi excels as Chilton struggles

**22**  
9/10  
Event rating



XPB/LAT

**JULES BIANCHI**  
Marussia-Cosworth MR-02-02  
Start: 19th; Finish: 13th  
Strategy: 4 stops (inter-medium-hard-hard-medium)



The Frenchman's performance in Australia was impressive, but the evidence of Malaysia proves there's still more to come. The Caterhams were a greater threat, but Bianchi always had them covered. His pace was outstanding, but the key to his weekend was delivering when it mattered, specifically with an excellent qualifying lap and by turning in consistently strong race laps. His tyre management also impressed.

**23**  
5/10  
Event rating



XPB/LAT

**MAX CHILTON**  
Marussia-Cosworth MR-02-03  
Start: 21st; Finish: 16th  
Strategy: 4 stops (inter-medium-hard-medium-hard)



Even when you take into account the car problems that compromised Chilton's practice, it was a disappointing weekend. The qualifying gap to his team-mate was distorted by him running wide at Turn 6 after overcommitting into T5, meaning the four-tenths between the two cars on their first run was more representative. A poor start compromised his race, but his pace just wasn't good enough often enough.



PRACTICE 1: Friday

POS	DRIVER	TIME
1	WEBBER	1m36.935s
2	RAIKKONEN	1m37.003s
3	VETTEL	1m37.104s
4	ALONSO	1m37.319s
5	ROSBERG	1m37.588s
6	SUTIL	1m37.769s
7	MASSA	1m37.771s
8	DI RESTA	1m37.773s
9	HAMILTON	1m37.840s
10	GROSJEAN	1m37.915s
11	BUTTON	1m38.173s
12	MALDONADO	1m38.673s
13	PEREZ	1m38.830s
14	HULKENBERG	1m39.054s
15	GUTIERREZ	1m39.204s
16	BOTTAS	1m39.208s
17	VERGNE	1m39.284s
18	RICCIARDO	1m39.567s
19	VAN DER GARDE	1m40.728s
20	BIANCHI	1m40.996s
21	PIC	1m41.163s
22	CHILTON	1m41.513s

PRACTICE 2: Friday

POS	DRIVER	TIME
1	RAIKKONEN	1m36.569s
2	VETTEL	1m36.588s
3	MASSA	1m36.661s
4	ALONSO	1m36.985s
5	WEBBER	1m37.026s
6	GROSJEAN	1m37.206s
7	ROSBERG	1m37.448s
8	DI RESTA	1m37.571s
9	HAMILTON	1m37.574s
10	SUTIL	1m37.788s
11	PEREZ	1m37.838s
12	BUTTON	1m37.865s
13	HULKENBERG	1m38.068s
14	GUTIERREZ	1m38.645s
15	VERGNE	1m38.738s
16	MALDONADO	1m38.801s
17	RICCIARDO	1m38.904s
18	BIANCHI	1m39.508s
19	BOTTAS	1m39.660s
20	PIC	1m40.757s
21	VAN DER GARDE	1m40.768s
22	CHILTON	1m41.438s

PRACTICE 3: Saturday

POS	DRIVER	TIME
1	VETTEL	1m36.435s
2	HAMILTON	1m36.568s
3	SUTIL	1m36.588s
4	WEBBER	1m36.613s
5	RAIKKONEN	1m36.806s
6	DI RESTA	1m36.807s
7	BUTTON	1m36.822s
8	MASSA	1m36.946s
9	ROSBERG	1m36.949s
10	ALONSO	1m37.302s
11	MALDONADO	1m37.359s
12	PEREZ	1m37.538s
13	HULKENBERG	1m37.685s
14	GROSJEAN	1m37.690s
15	BOTTAS	1m37.936s
16	GUTIERREZ	1m38.294s
17	VERGNE	1m38.376s
18	RICCIARDO	1m38.425s
19	PIC	1m38.995s
20	BIANCHI	1m39.717s
21	VAN DER GARDE	1m40.209s
22	CHILTON	1m40.495s

Weather: dry

Weather: dry, with rain showers

Weather: dry

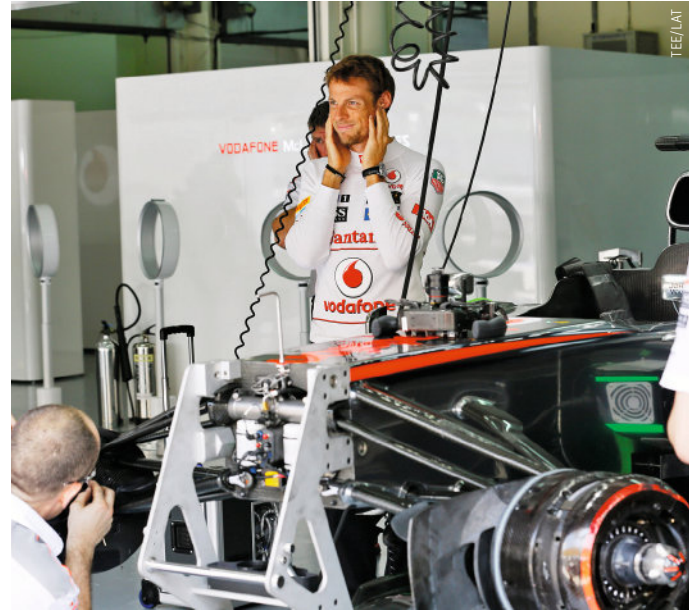

QUALIFYING TIMES

POS	DRIVER	QUALIFYING 1	QUALIFYING 2	QUALIFYING 3
1	VETTEL	1m37.899s (15)	1m37.245 (9)	1m49.674s
2	MASSA	1m37.712s (12)	1m36.874s (6)	1m50.587s
3	ALONSO	1m37.314s (4)	1m36.877s (7)	1m50.727s
4	HAMILTON	1m37.513s (8)	1m36.517s (3)	1m51.699s
5	WEBBER	1m37.619s (9)	1m36.449s (2)	1m52.244s
6	ROSBERG	1m37.239s (3)	1m36.190s (1)	1m52.519s
7	RAIKKONEN	1m36.959s (2)	1m36.640s (4)	1m52.970s
8	BUTTON	1m37.487s (6)	1m37.117s (8)	1m53.175s
9	SUTIL	1m36.809s (1)	1m36.834s (5)	1m53.439s
10	PEREZ	1m37.702s (10)	1m37.342s (10)	1m54.136s
11	GROSJEAN	1m37.363s (5)	1m37.636s	-
12	HULKENBERG	1m37.931s (16)	1m38.125s	-
13	RICCIARDO	1m37.722s (13)	1m38.822s	-
14	GUTIERREZ	1m37.707s (11)	1m39.221s	-
15	DI RESTA	1m37.493s (7)	1m44.509s	-
16	MALDONADO	1m37.867s (14)	no time	-
17	VERGNE	1m38.157s	-	-
18	BOTTAS	1m38.207s	-	-
19	BIANCHI	1m38.434s	-	-
20	PIC	1m39.314s	-	-
21	CHILTON	1m39.672s	-	-
22	VAN DER GARDE	1m39.932s	-	-

QUALIFYING STATISTICS

	HEAD TO HEAD		
VETTEL	2	0	WEBBER
ALONSO	0	2	MASSA
BUTTON	2	0	PEREZ
RAIKKONEN	2	0	GROSJEAN
ROSBERG	0	2	HAMILTON
HULKENBERG	2	0	GUTIERREZ
DI RESTA	1	1	SUTIL
MALDONADO	1	1	BOTTAS
VERGNE	1	1	RICCIARDO
PIC	1	1	VAN DER GARDE
BIANCHI	2	0	CHILTON

BAD BOYS & ENGINE USAGE

	PENALTIES	FINES	ENGINES
VETTEL	0	€0	1
WEBBER	0	€0	1
ALONSO	0	€0	1
MASSA	0	€1400	1
BUTTON	0	€0	1
PEREZ	0	€0	1
RAIKKONEN	1	€0	1
GROSJEAN	0	€0	1
ROSBERG	0	€0	1
HAMILTON	0	€0	1
HULKENBERG	0	€1000	1
GUTIERREZ	0	€800	1
DI RESTA	0	€0	1
SUTIL	0	€1000	1
MALDONADO	0	€0	2
BOTTAS	0	€2800	1
VERGNE	0	€10,000	1
RICCIARDO	0	€0	1
PIC	0	€0	1
VAN DER GARDE	0	€0	1
BIANCHI	0	€2800	1
CHILTON	0	€0	1



## THE RACE: 56 laps, 192.888 miles

POS	DRIVER	TEAM	LAPS	TOTAL TIME	FASTEST LAP	PIT STOP	TIME IN PITS	GRID
1	SEBASTIAN VETTEL	RED BULL-RENAULT	56	1h38m56.681s	1m40.446s	4	84.713s	1
2	MARK WEBBER	RED BULL-RENAULT	56	+4.298s	1m40.685s	4	83.396s	5
3	LEWIS HAMILTON	MERCEDES	56	+12.181s	1m41.001s	4	89.218s	4
4	NICO ROSBERG	MERCEDES	56	+12.640s	1m40.755s	4	86.423s	6
5	FELIPE MASSA	FERRARI	56	+25.648s	1m39.805s	4	86.569s	2
6	ROMAIN GROSJEAN	LOTUS-RENAULT	56	+35.564s	1m41.226s	3	66.302s	11
7	KIMI RAIKKONEN	LOTUS-RENAULT	56	+48.479s	1m41.769s	3	70.485s	10
8	NICO HULKENBERG	SAUBER-FERRARI	56	+53.044s	1m40.727s	4	90.522s	12
9	SERGIO PEREZ	MCLAREN-MERCEDES	56	+1m12.357s	1m39.199s	4	85.181s	9
10	JEAN-ERIC VERGNE	TORO ROSSO-FERRARI	56	+1m27.124s	1m40.492s	3	92.556s	17
11	VALTTERI BOTTAS	WILLIAMS-RENAULT	56	+1m28.610s	1m41.373s	3	75.942s	18
12	ESTEBAN GUTIERREZ	SAUBER-FERRARI	55	-1 lap	1m40.929s	4	91.908s	14
13	JULES BIANCHI	MARUSSIA-COSWORTH	55	-1 lap	1m42.423s	4	94.653s	19
14	CHARLES PIC	CATERHAM-RENAULT	55	-1 lap	1m42.942s	4	116.660s	20
15	GIEDO VAN DER GARDE	CATERHAM-RENAULT	55	-1 lap	1m43.157s	4	93.820s	22
16	MAX CHILTON	MARUSSIA-COSWORTH	54	-2 laps	1m43.150s	4	97.419s	21
17	JENSON BUTTON	MCLAREN-MERCEDES	53	-3 laps (vibration)	1m40.556s	3	148.309s	7
18	DANIEL RICCIARDO	TORO ROSSO-FERRARI	51	-5 laps (exhaust)	1m42.581s	3	66.812s	13
R	PASTOR MALDONADO	WILLIAMS-RENAULT	45	KERS	1m43.465s	3	80.001s	16
R	ADRIAN SUTIL	FORCE INDIA-MERCEDES	27	wheelnuts	1m42.791s	2	127.234s	8
R	PAUL DI RESTA	FORCE INDIA-MERCEDES	22	wheelnuts	1m43.094s	2	166.837s	15
R	FERNANDO ALONSO	FERRARI	1	accident	-	-	-	3

## TYRE CHOICE

STINT 1	STINT 2	STINT 3	STINT 4	STINT 5
Inter	Medium	Hard	Hard	Medium
Inter	Hard	Medium	Hard	Hard
Inter	Medium	Medium	Hard	Medium
Inter	Medium	Medium	Hard	Medium
Inter	Medium	Hard	Medium	Medium
Inter	Medium	Medium	Hard	
Inter	Medium	Medium	Hard	
Inter	Medium	Medium	Hard	Hard
Inter	Medium	Medium	Hard	Hard
Inter	Hard	Hard	Medium	
Inter	Medium	Medium	Medium	
Inter	Hard	Medium	Medium	Hard
Inter	Medium	Hard	Hard	Medium
Inter	Hard	Hard	Hard	Medium
Inter	Medium	Hard	Hard	Medium
Inter	Medium	Hard	Hard	Medium
Inter	Medium	Medium	Hard	
Inter	Medium	Hard	dnf	
Inter	Medium	Hard	dnf	
Inter	dnf			

Weather: damp then dry. Winner's average speed: 116.967mph. Fastest lap: PEREZ 1m39.199s (125.000mph) on lap 56.

Lap Leaders: 1-4 Vettel; 5-7 Webber; 8 Rosberg; 9-18 Webber; 19-22 Vettel; 23-30 Webber; 31-32 Vettel; 33-34 Button; 35-45 Webber; 46-56 Vettel.

Option tyre in bold; new set in red; used set in black

## DRIVERS' STANDINGS

POS	DRIVER	PTS	AUS	MAL	PRC	BRN	E	MC	CDN	GB	D	H	B	I	SGP	ROK	J	IND	UAE	USA	BR	
1	VETTEL	40	3 <sup>rd</sup>	1 <sup>st</sup>																		
2	RAIKKONEN	31	1 <sup>st</sup>	7 <sup>th</sup>																		
3	WEBBER	26	6 <sup>th</sup>	2 <sup>nd</sup>																		
4	HAMILTON	25	5 <sup>th</sup>	3 <sup>rd</sup>																		
5	MASSA	22	4 <sup>th</sup>	5 <sup>th</sup>																		
6	ALONSO	18	2 <sup>nd</sup>	ret																		
7	ROSBERG	12	ret	4 <sup>th</sup>																		
8	GROSJEAN	9	10 <sup>th</sup>	6 <sup>th</sup>																		
9	SUTIL	6	7 <sup>th</sup>	ret																		
10	DI RESTA	4	8 <sup>th</sup>	ret																		
11	HULKENBERG	4	ns	8 <sup>th</sup>																		
12	PEREZ	2	11 <sup>th</sup>	9 <sup>th</sup>																		
13	BUTTON	2	9 <sup>th</sup>	17 <sup>th</sup>																		
14	VERGNE	1	12 <sup>th</sup>	10 <sup>th</sup>																		
15	BOTTAS	0	14 <sup>th</sup>	11 <sup>th</sup>																		
16	GUTIERREZ	0	13 <sup>th</sup>	12 <sup>th</sup>																		
17	BIANCHI	0	15 <sup>th</sup>	13 <sup>th</sup>																		
18	PIC	0	16 <sup>th</sup>	14 <sup>th</sup>																		
19	VAN DER GARDE	0	18 <sup>th</sup>	15 <sup>th</sup>																		
20	CHILTON	0	17 <sup>th</sup>	16 <sup>th</sup>																		
21	RICCIARDO	0	ret	18 <sup>th</sup>																		
22	MALDONADO	0	ret	ret																		

ROBERTSON/GETTY



## SECTOR 1 TIMES

POS	DRIVER	TIME
1	GUTIERREZ	25.540s
2	PEREZ	25.665s
3	MASSA	25.673s
4	WEBBER	25.751s
5	VETTEL	25.761s
6	VERGNE	25.767s
7	RAIKKONEN	25.783s
8	HULKENBERG	25.810s
9	HAMILTON	25.852s
10	ROSBERG	25.906s

## SECTOR 2 TIMES

POS	DRIVER	TIME
1	VETTEL	33.309s
2	PEREZ	33.408s
3	MASSA	33.752s
4	HAMILTON	33.789s
5	BUTTON	33.807s
6	ROSBERG	34.020s
7	VERGNE	34.031s
8	GUTIERREZ	34.031s
9	WEBBER	34.074s
10	HULKENBERG	34.254s

## SECTOR 3 TIMES

POS	DRIVER	TIME
1	VETTEL	40.063s
2	PEREZ	40.126s
3	GUTIERREZ	40.239s
4	MASSA	40.286s
5	WEBBER	40.358s
6	VERGNE	40.565s
7	HULKENBERG	40.588s
8	HAMILTON	40.616s
9	GROSJEAN	40.704s
10	ROSBERG	40.710s

## MAX SPEEDS (MPH)

POS	DRIVER	SPEED
1	GUTIERREZ	191.5
2	MASSA	190.6
3	SUTIL	190.5
4	RAIKKONEN	190.4
5	GROSJEAN	190.1
6	BOTTAS	189.8
7	MALDONADO	189.2
8	CHILTON	189.2
9	DI RESTA	189.0
10	HAMILTON	188.7

## MAXIMUM SPEEDS BY EACH CONSTRUCTOR

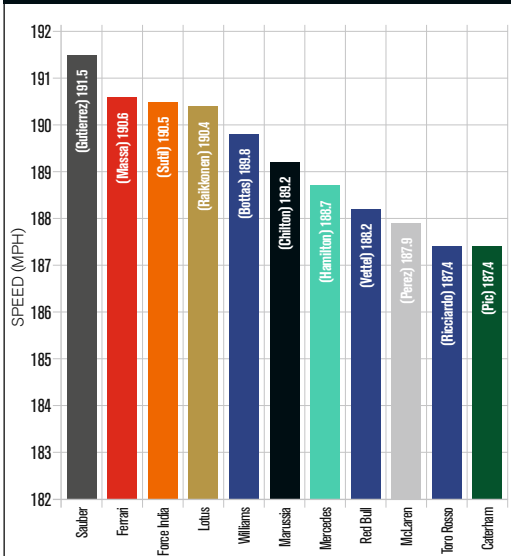

## CONSTRUCTORS' STANDINGS

POS	DRIVER	PTS	AUS	MAL	PRC	BRN	E	MC	CDN	GB	D	H	B	I	SGP	ROK	J	IND	UAE	USA	BR	
1	RED BULL	66	23	43																		
2	LOTUS	40	26	14																		
3	FERRARI	40	30	10																		
4	MERCEDES	37	10	27																		
5	FORCE INDIA	10	10	0																		
6	SAUBER	4	0	4																		
7	MCLAREN	4	2	2																		
8	TORO ROSSO	1	0	1																		
9	WILLIAMS	0	0	0																		
10	MARUSSIA	0	0	0																		
11	CATERHAM	0	0	0																		



ETHERINGTON/LAT

FOR IN-DEPTH F1 RESULTS FORIX

# Why Vettel & Webber have previous

Last weekend's Malaysian GP is simply the latest episode in their war. By **EDD STRAW**



ETHERINGTON/LAT

32

lap 46 of the 2007 Japanese Grand Prix. Lewis Hamilton leads under the safety car in sodden conditions. Behind him is Mark Webber. The Australian knows that this is his moment to take a first grand prix victory. Then, after backing off a little to avoid overtaking the leading McLaren – which has eased off after almost tripping over the safety car – Webber is taken out by a 20-year-old Formula 1 newcomer in a Toro Rosso by the name of Sebastian Vettel.

After the incident, a furious Webber denounced Vettel as a “kid with not enough experience to do a good job” among other choice words that led to his ITV interview being swiftly curtailed.

From that moment, the relationship

between the Red Bull stablemates has been most generously described as uneasy. On-track, the rivalry flared up again in 2010 when Vettel hit Webber while attempting to take the lead of the Turkish Grand Prix, costing both a chance of victory. It was again brought to the fore in last Sunday's Malaysian Grand Prix, when Vettel disregarded team orders to hold station after the final pitstops and passed Webber for victory.

Many of the controversies between the pair in recent years have been stoked, or even created, by Webber himself, but this was a clear case of Vettel transgressing. While the triple world champion's decision gives him an extra seven points that could prove decisive in a title fight, it reopens old wounds that could

derail the team's bid for a fourth consecutive double crown.

This is very different to the 2010 Silverstone controversy, when Webber complained about Vettel being given “his” new-specification front wing and gained widespread sympathy, even though the decision had been made not to run it after practice. On that occasion Webber was creating the kind of conflict he thrives upon. In Malaysia it was created for him and – even Vettel accepts this – he was in the right.

Not that Webber has always respected team orders. In Brazil last year, during the crucial title showdown, Webber twice fought Vettel too hard for Red Bull's liking, infuriating the team and leading to his being given a dressing down post-race. The suspicion is that Webber wanted Fernando Alonso to win the drivers' championship rather than his own team-mate.

“There has never been a great deal of trust between the two of them since Istanbul in 2010,” said Red Bull team principal Christian Horner after last weekend's race. “But there is a real respect between the two of them. If you think of Brazil last year, Mark was told to hold position and



MOV/XPB

started racing him. These things happen. They are race drivers and they will push to the limit and that is part of what their DNA is. That's why we sign them to do their jobs.”

Whether or not Vettel felt justified in overtaking Webber given what happened in Brazil is impossible to be certain of. But teams cannot afford to have drivers riding roughshod over their orders. While many fans are morally against the concept, it's important to note that Webber was racing to a set team plan and had turned down the engine, having



CRIPPA/LAT



Fuji 2007: Vettel crashes into Webber behind the safety car

## VETTEL: A RUTHLESS SMILING ASSASSIN

*AUTOSPORT's resident mind coach DON MACPHERSON says triple world champion showed mental weakness in his attack on Mark Webber*

In the Middle Ages, if you were said to be full of 'ruth' you were charitable, kind and compassionate. So, 'ruthless' people clearly were not very pleasant and unlikely to buy the latest copy of *The Big Issue* from a homeless person.

Sebastian Vettel certainly didn't have much ruth when told to follow team orders in the Malaysian GP, did he? The baby-faced *Little Britain* fan really is a smiling assassin. Vettel may

feel the number-one driver status is his by right, but has he made an error of judgement? Not for the first time he has shown a surprising inability to control his emotions.

But what if your default personality is to be full of ruth and possess a feminine side? Well, you can still be world champion, but you have to learn a special mental skill and act 'as if' you are a mean son of a bitch

— but only when you go racing.

When you come into the pits you just switch off 'as if' mode, smile sweetly at the cameras, charm the media with one-liners, and apologise to your team-mate after you've attacked him when he wasn't looking.

Like an actor in a film, your role is to be a right bastard — but only for as long as the cameras are rolling! [www.donmacpherson.co.uk](http://www.donmacpherson.co.uk)

made it through the final round of pitstops ahead. In that respect, it was not a fair fight. Given his history, it's no surprise that he made his feelings very clear after the race.

Initially, suspicion that the team had misled him about Vettel being told to hold station meant Webber refused to go onto the podium. He was quickly talked around, using Martin Brundle's podium interviews as an opportunity to tell the world what he thought. But while Webber suggested that Vettel would have "protection" from Red Bull, the

German's actions have caused real concerns within the team.

Horner and chief technical officer Adrian Newey were unimpressed with their orders being disregarded, while even Red Bull motorsport advisor Helmut Marko, viewed as Vettel's protector, was angry.

With fuel and tyre management so important, Red Bull could lose races from its drivers refusing to adhere to instructions.

The relationship between Vettel and Webber is unlikely to become as corrosive as that between Ayrton

Senna and Alain Prost at McLaren, as the past three years have proved that Webber is not Vettel's equal over a season. But there is now a danger that their frostily cooperative relationship will turn into something more destructive for Red Bull.

It could jeopardise any chance of Vettel and Webber, who have taken Red Bull to three constructors' championships, matching the record for one driver line-up of five, set by Michael Schumacher and Rubens Barrichello for Ferrari from 2000-04.

## THE WORST TEAM-MATES

Red Bull duo Sebastian Vettel and Mark Webber are not the first team-mates to fall out. But at least they've never attacked each other with a hammer...

### FAGIOLI V CARACCIOLA

Luigi Fagioli often disregarded team orders at Mercedes. His relationship with Rudolf Caracciola was especially bad. He left for Auto Union, and then reportedly attacked Caracciola with a hammer at the Tripoli GP.



### REUTEMANN V JONES

Alan Jones started the 1981 season as reigning champion. Reutemann, who would miss out on the title by one point, refused to cede the lead of the Brazilian GP to Jones, which soured their relationship dramatically.



### PIRONI V VILLENEUVE

Gilles Villeneuve famously vowed never again to speak to Didier Pironi after he blamed the Frenchman for defying team orders to win the 1982 San Marino GP. He was killed two weeks later during Belgian GP qualifying.



### PIQUET V MANSELL

Williams signed Nelson Piquet for 1986, but Nigel Mansell was stronger opposition than expected. Piquet's claim that he'd been assured number-one status was the root of tension; neither won the '86 title.



### SENNA V PROST

The most famous team-mate bust-up of them all was stoked by Ayrton Senna ignoring an agreement not to pass after the first corner in the 1989 San Marino GP. They barely spoke after, and Prost left.



### HAMILTON V ALONSO

Lewis Hamilton's searing pace undermined his status as support act to Fernando Alonso at McLaren in 2007. Hamilton was frustrated by team orders in Monaco; in Hungary Alonso sabotaged Hamilton's final qualifying run in the pitbox.



LAT ARCHIVE

LAT ARCHIVE

LAT ARCHIVE

LAT ARCHIVE

LAT ARCHIVE

ETHERINGTON/LAT

Trying to manage the life of the '13 tyres is "pretty tricky", says Jenson Button



34

# Has Pirelli gone too far?

Amid all the fuss over the Red Bulls in the aftermath of the Malaysian Grand Prix, there were also complaints at the high level of wear with the new 2013 tyres. **EDD STRAW** investigates

**A**lmost unnoticed among the team orders controversies that dominated the headlines after the finish of the Malaysian Grand Prix was a comment that Mark Webber made in the post-race press conference. It came in response to a question about Sebastian Vettel's defiance of team orders, its incongruity revealing that this was less answering a question than lobbying in the court of public opinion.

In the days building up to the race, the 2013 Pirelli rubber proved to be the main talking point. Webber had already complained about tyres dominating the sport after Friday practice ("Tyres, tyres, tyres, tyres, tyres," he said) and after the race he was at it again.

"You still have to drive the grands prix these days at eight tenths," he said. "It's not like the old days when

grand prix drivers are driving flat-out and leaning on the tyres like hell because the tyres are wearing out. It's not the most satisfying thing for us as grand prix drivers these days."

It's not a new complaint. Since the Pirelli era started in 2011 the debate about whether its tyres wear and degrade too much has flared up

periodically. This is a particularly popular topic early in the season when teams are still getting on top of the rubber. But this year, the criticisms are a little different, with several drivers suggesting that it's very difficult for them to influence tyre life. Jenson Button is among those who have found that the

tyre has a finite lifespan that doesn't vary according to the way you use it.

"A lot of people found that when you look after the tyres, sometimes that's not a good thing," said Button before the race in Malaysia. "It's not like last year in terms of getting the tyre into the working range, but looking after the tyres is pretty tricky."

Unsurprisingly given its tyre troubles, Red Bull has been lobbying Pirelli for change, specifically a return to the 2012 rubber. This was always a very unlikely course of action, not least because it was unable to drum up any support among other teams. Red Bull's position is that regardless of car balance, it is using up the tyres at an accelerated rate as a penalty for having the best car.

But the race last weekend weakened the case that the tyres degrade too rapidly. Even though

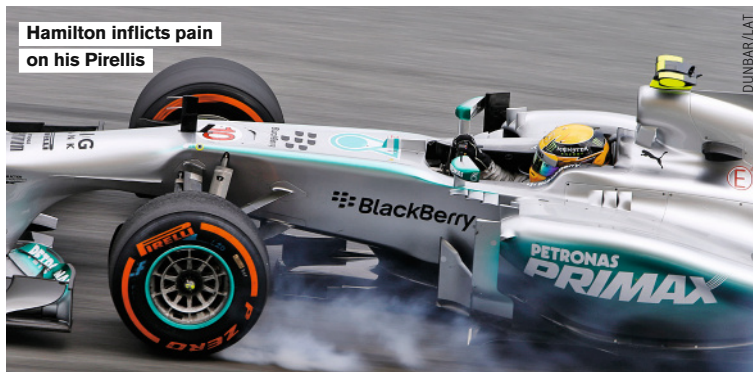

Hamilton inflicts pain on his Pirellis

DUNBAR/LAT



TEE/LAT

the majority of drivers made four stops, this was distorted by the field running on intermediate rubber in the early laps.

"We felt that some comments were a bit misguided," said Pirelli motorsport director Paul Hembery after the race. "The results proved that Red Bull has a very competent, quick car and it worked extremely well with the tyres. It's a situation that they [Red Bull] might have to review.

"The race would definitely have been a three-stopper. If you look at the spread of laps that they did, they could have done three."

But this is only half of the debate. The evidence of the first two races suggests that Pirelli's objective, which is a reflection of what it has been asked to do for the good of the spectacle of producing two/three-stop races, has been achieved. But key to this philosophy is producing rubber that the drivers can have a tangible effect on. If there is no edge to be gained from effective tyre management or a limit on the influence that a driver's pace has on his result, then there is potentially a problem.

"Sometimes you try to go 'under' the tyre to give yourself a little more later on," said Vettel of the rubber. "Sometimes it works and sometimes it doesn't. It's not always in the driver's control. Sometimes there

## PITSTOP COMPARISON

Pirelli motorsport boss Paul Hembery argues that the situation at the start of this season in terms of tyre degradation and wear is similar to previous years. A look at the number of pitstops made in Australia and Malaysia during the Pirelli era proves that to be the case. Although there is an increase from 41 to 53 stops between this year and last year in Australia, part of that difference is caused by the fact that three cars did not make it to their first pitstop in 2012 compared to just one this year.

The graphs also include the number of pitstops in 2010, the final year of Bridgestone's involvement, when one-stop races were the norm.

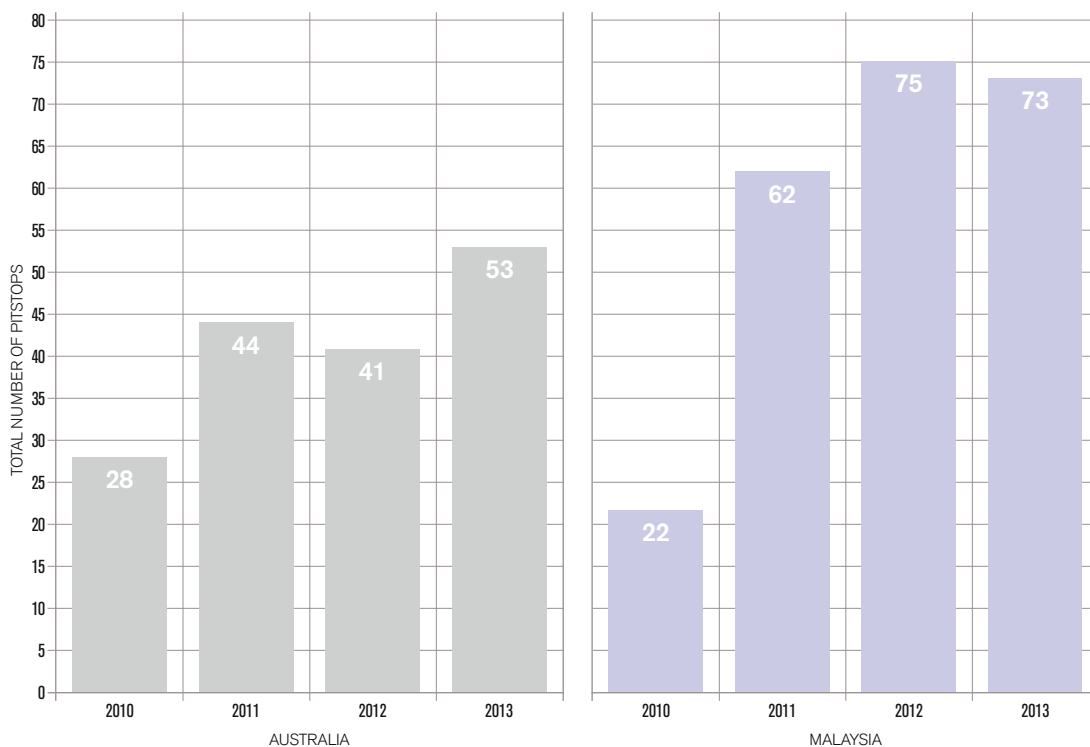

Red Bull has called for a return to last year's Pirelli rubber

HONE/LAT

is not so much you can do from the inside of the car to control tyre degradation. You can try to make fewer mistakes but sometimes there's more and sometimes there's less you can do."

But while most teams accept that there is a degree of truth to the claim that tyre wear can't be influenced as much as it was last year, few go to the extreme of suggesting there is nothing a driver can do.

When asked whether he had seen the trend some had complained of, with drivers unable to influence tyre life, Williams technical director Mike Coughlan said: "Yes, a little but certainly not to the same extent.

"We do a fast-slow-fast run and

then we go again and the tyre is finished completely. It is very difficult to manage it."

The first two races suggest there are cars — notably the Lotus and the Force India — that are very easy on tyres and can gain an advantage from it. It is likely that the drivers will gain greater influence over tyre management as the season progresses. Either way, it's unlikely that there will be any major change in the tyres for this year.

But with Pirelli yet to sign a contract for 2014, this is the logical time for F1 to consider whether it wants to continue with the high-degradation approach that it has had since 2011, or change tack.

**EDD STRAW**  
F1  
EDITOR

edd.straw  
@haymarket.com



### THE DEBATE OVER FORMULA 1'S

tyre philosophy is a tense one that must balance the desire to create a good 'show' with staying true to the spirit of grand prix racing.

The ideal, in a money-no-object world, would be a flat-out tyre war. Unfortunately, economic factors make this nigh-on impossible to achieve. So in a control tyre formula, there is a need to lay down the objectives.

Taking safety as a given, the priority must be that the rubber is not so great a limiting factor that it eliminates driver differentiation. Tyre management has always been part of this sport. Speed has to be of the essence, but ensuring the rubber is a variable that creates an ebb and flow in the race should allow the driver's role in the overall competitive equation to be stronger than it would if degradation and wear are irrelevant.

But achieving this magical tyre is not a simple task, especially with the brilliance of the 11 engineering teams that will do everything they can to create the kind of predictable, durable tyre they love.



FIA would allow car tweaks for WRC

# Rallying's top

Citroen already thinking about moving the ex-grand prix winner to the WRC

**B**y the middle of Friday morning, the European Rally Championship was not enough. Three stages in and three stages won at this level, Robert Kubica was ready for the next step. He was ready for the World Rally Championship.

Citroen team principal Yves Matton smiled. He'd seen the times on last week's Canaries Rally and he'd seen this question coming.

"It's the idea to do one year [in ERC and WRC 2]," said Matton. "Then the idea is to bring him to the top level. We will see rally after rally and then we will make a conclusion at the end of the year."

Did the top level mean a seat in the Citroen factory team? Not right now. But there's no doubt the French team has one eye on the future. To the extent that it has already checked that the FIA's dispensation for the changes in specification to the DS3 RRC Kubica used in Gran Canaria are applicable to a DS3 WRC. They are.

The world championship scene, then, is set.

**"I am not thinking about the WRC. What I'm doing this year is important"**

All that was needed now was to put it to the 28-year-old himself.

How he laughed.

"I am not thinking about the world championship," he said. "I am thinking about now, what I am doing today and what I am doing this year. This is what's important."

Whatever Kubica said, his performance on the opening day of competition on the Spanish island was nothing short of extraordinary. He won every one of Friday's eight stages. Granted, his soft tyre was the

nearest thing to a perfect solution on the first damp loop. But he was still fastest when everybody had a better tyre in the second loop and still fastest when it was bone dry in the last loop.

And in the middle of this astonishing day, he still found time to revolutionise the way Citroen thought about rallying on asphalt. And let's not forget, Citroen doesn't have a bad record when it comes to rallying on that surface.

"I used some of my F1 experience to make some changes," said Kubica. "I will not tell you the set-up change. The team hasn't done those kind of changes before. It is something we used to work a lot in F1 and in rallying, apparently, it is not common to work like this – but I think it's a good direction."

Beyond his outright speed, two things hit home about Kubica in Las Palmas last weekend: his work rate, and his ability to come at things from a different angle.

Before the event, everybody predicted the 2008 Canadian Grand Prix winner would struggle with pacenotes. For a racing driver, somebody telling you what to do and when to do it is entirely alien. Kubica looked like a natural. Largely because he'd done his homework.

His friend and competitor Jan Kopecky explained: "He came to one rally and said: 'I have the notes already.' I didn't understand how he had done that, when he hadn't done the rally before, but he said he made the notes from watching the onboard. This would not be easy to do, but Robert is a very special guy."

And he certainly had Kopecky on the run last week. Right up until he was caught out by a downhill right-hander on Saturday morning, Kubica gave the rest of the ERC a driving masterclass.



Kubica was dominant until he crashed out last weekend

"He's the best driver in the world," said Kopecky, "across the sport."

And his work rate is phenomenal. Most drivers don't bother watching the onboard video from their recce before the start, but Kubica's alarm went off at five o'clock on Saturday morning so he could do just that.

"It is necessary," said Kubica. "It has to be done. It is helping me and I knew before choosing rallying that I would have 100 times more work than on the circuit. But I'm not scared of working and actually I think I enjoy it

and that's the most important thing."

Kubica's ability to find grip in ever-changing conditions was well documented from his time in an F1 car. What surprised last week was the speed with which he was able to dial that ability into a rally car.

Kopecky's seen this all before. "Ask him how long he's been playing in rally cars," he smiled, knowing the answer would stretch seven or eight years. His story of how he met Kubica appears to be typical Robert as well.

Comprehensive motorsport insurance products to keep you on track;

- ✔ Worldwide On Track
- ✔ Personal Accident
- ✔ Storage and transit
- ✔ Track day
- ✔ Liability
- ✔ Commercial

Please complete an online quote request form at – [www.ryanmi.com](http://www.ryanmi.com)

Email – [info@ryanmi.com](mailto:info@ryanmi.com) Tel – +44 (0)1799 524202

Ryan Motorsport Insurance Limited is an appointed representative (G57405) of Independent Broking Solutions Limited who are authorised and regulated by the Financial Services Authority, registration number 312026



# level awaits Kubica

after the Pole's explosive start to his first season of international rallying last week. By **DAVID EVANS**



"In 2006, I was at the German Grand Prix," said Kopeczky. "Somehow I'd got a pit pass and I was walking down the pitlane when somebody came up to me and said: 'Hey, I'm Robert. I have followed you for a long time, I like your driving style! I was very shocked!'"

That Kubica loves rallying was highlighted with his final act in Las Palmas. Arriving back in the hotel, having waited by his stricken rally car for a couple of hours, the upbeat aura that had surrounded him the previous day had gone. He politely answered questions about the shunt, but was keen to escape. That was until ERC boss Jean-Pierre Nicolas handed over the Colin McRae Flat Out Trophy.

Kubica softened, smiled, but was ready with an immediate quip.

"This means a lot," he said. "Colin's in all of our hearts."

His day didn't seem quite so bad.

## COMPARISONS WITH KIMI RAIKKONEN

Robert Kubica is not the first F1 driver to step into a Citroën rally car – Kimi Raikkonen completed two World Rally Championship seasons with the French firm. And Benoit Nogier has worked with both.

The Citroën Racing Technologies chief said both drivers showed the high levels of data analysis you would expect from top-level circuit drivers.

"The feedback from both of them is very similar and very nice," said Nogier. "But to compare them is a little difficult because they come to the sport in a different context. Robert is further forward when he starts with us than Kimi was. Robert is much more familiar with the sport, he owns several rally cars, talks a lot about the sport and has many friends in the sport. Kimi did not really have this when he started."

Nogier says Kubica's familiarity with



the sport will potentially help him progress quicker than Raikkonen.

"He [Kubica] is a bit more aware about rallying and is more able to say 'OK, the car is like that and I need it to be a bit more like that'. This helps to make the decisions regarding the set-up. Kimi had a lot of feeling and he could explain what it was, but it was a bit more difficult for

him to say what he needed."

Nogier added that both drivers have shown similar motivation.

"Robert is very motivated and Kimi was also at the start," added Nogier. "Perhaps Kimi lost a little bit of motivation month after month, when he realised it was a long way to go to the top."



# TRACK DAY INSURANCE

Give Simon and the friendly team a call:

## 0844 338 68 71

[mcemotorsport.com](http://mcemotorsport.com)



OPENING HOURS:  
Monday - Friday 9.00am-5.30pm



*Trident*  
Racing Supplies



MS NAS AN

Unit 31 Silverstone Circuit Northants NN12 8TL UK  
Tel: +44 (0)1327 857822 Fax: +44 (0)1327 858096  
[sales@tridentracing.co.uk](mailto:sales@tridentracing.co.uk) [www.tridentracing.co.uk](http://www.tridentracing.co.uk)

speedsport promotions

## HELMET PAINT PROTECTION KITS £49.99



OUR PROTECTION KITS ARE MADE FROM THE HIGHEST QUALITY PROTECTION TAPE ON THE MARKET, TESA 54994, WE SUPPLY THIS TAPE TO A NUMBER OF FORMULA 1 TEAMS.

5 PIECE PAINT PROTECTION KIT - FRONT TOP, FRONT BOTTOM, BOTH SIDES AND REAR KIT IS COMPLETELY TRANSPARENT. 100% RESISTANT TO YELLOWING. PROTECTS FROM IMPACT CHIPS AND FROM RUBBING. PROTECTS FROM ABRASION.

OUR KITS COME WITH FULL INSTRUCTIONS ON HOW TO FIT THE KIT TO YOUR HELMET.

ALTERNATIVELY WE ARE BASED AT SILVERSTONE CIRCUIT AND WILL FIT THE KIT FOR YOU (RECOMMENDED).

EXAMPLE SHOWN IS FOR AN ARAI GP6 RC, PROTECTION KITS ARE AVAILAIBLE FOR ARAI, BELL AND STILO HELMETS.

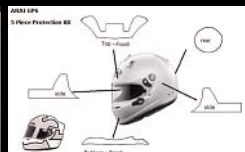

EMAIL US AT [INFO@SPEEDSPORT.CO.UK](mailto:info@speedsport.co.uk) OR CALL US ON 01327 858167



angleseycircuit  
tracmon

# Testing

Sunday, April 7

Sessions for open and closed wheel cars  
Full day £165 if booked by April 3,  
£190 thereafter

Book on-line:  
[www.angleseycircuit.com](http://www.angleseycircuit.com)  
or telephone:  
**01407 811400**  
Monday - Friday 9am-5pm



Photo Kevin Hughes

WRC champion Loeb  
will be star attraction  
in the new GT Series

# How series boss brought GTs back from the dead – again

Stephane Ratel's new FIA GT Series replaces the old FIA GT1 World

Championship this season, and it's looking good, says **GARY WATKINS**

**S**tephane Ratel, the master magician, has plucked the rabbit out of the hat one more time. He did it ahead of the three years of the FIA GT1 World Championship and has now done it again with its successor, the FIA GT Series. The entry for the 2013 season, which kicks off this weekend at Nogaro, has defied the doubters both in terms of its quantity and its quality.

A total of 21 full-season entries will line up for the series opener over the Easter weekend. That could grow to 22 by the time the trucks roll into the French Circuit Paul Armagnac, and more full-time participants could join in at round two at Zolder in April. There are also five cars competing on a race-by-race basis at Nogaro.

## PRO CUP ENTRIES

TEAMS	DRIVERS
HTP Gravity Charouz Mercedes-Benz SLS AMG	Maximilian Buhk (D)/Alon Day (IL)
Phoenix Racing Audi R8 LMS ultra	Anthony Kumpen (B)/Enzo Ide (B)
Sebastien Loeb Racing McLaren MP4-12C	Sebastien Loeb (F)/Alvaro Parente (P)
	Andreas Zuber (A)/Mike Parisy (F)
WRT Audi R8 LMS ultra	Stephane Ortelli (MC)/Laurens Vanthoor (B)
	Frank Stippler (D)/Edward Sandstrom (S)
Doerr Motorsport McLaren MP4-12C	Niclas Kentenich (D)/Daniel Keilwitz (D)
BMW Team Brazil BMW Z4	Caca Bueno (BR)/Allam Khodair (BR)
	Ricardo Zonta (BR)/Sergio Jimenez (BR)
Vita4One Racing Team BMW Z4	Frank Kechele (D)/Greg Franchi (B)
Seyffarth Motorsport BMW Z4	Karun Chandhok (IND)/Jan Keyffarth (D)

Ratel has the top teams, such as Vita4One, WRT and Phoenix, as well as newcomers in the form of Sebastien Loeb Racing, BMW Team Brazil and a pair of factory-funded Nissans.

In addition, the organiser has a quality of driver that exceeds that of the final season of the world championship in 2012. Loeb, a nine-times World Rally champion, is the biggest name on the grid, although five-times Brazilian Stock Car champion Caca Bueno could probably run him close in his homeland. Then there are the former grand prix drivers Ricardo Zonta and Karun Chandhok, GT stars Stephane Ortelli, Rene Rast and Allan Simonsen, and up-and-comers such as Alvaro Parente and Frank Kechele.

No one would have predicted such strength in depth as the GT1 World Championship staggered towards the end of its final season. A lot of people have wondered why Ratel has bothered. In the Blancpain Endurance Series, he has a championship that is bursting at the seams.

Ratel admits that it would have made his life easier, but he draws a distinction between FIA GTs and the Blancpain. "The Blancpain is at its heart a pro-am series, but there is room for a professional GT championship," he says. "I believe passionately in the format of one-hour sprint races."

There is a contradiction here. Ratel has got his grid by adopting the Blancpain class structure and enshrining the place of the amateur. In addition to the all-professional Pro Cup class, there is a Pro-Am division that does what it says on the tin, along with the Gentlemen Trophy for all-amateur line-ups.

Ratel argues that pragmatism was required in what he is billing as a "rebuilding year". He makes no secret of his desire to return towards the stellar line-ups that made for such amazing racing in the first two seasons of GT1 World.

TV will be key, and the irony is that Ratel has a better package now than in



Ratel returns with a bang

the days of GT1 World. The money that paid for FIA world championship status has been ploughed into TV, with an onus on Germany. Ratel believes his deal with RTL, the country's largest free-to-air broadcaster, has resulted in the late influx of German teams, such as Doerr and Seyffarth.

The FIA GTs might have retrenched back towards its homeland (five of the six rounds are in Europe), but it still has the international flavour of its predecessor. Ratel has drivers from Russia, India and Israel, and even a non-European outfit, in Antonio Hermann's BMW Team Brazil, that he craved in GT1 days.

"I spent three years trying to go around the world," he says. "And now the world is coming to me."

# 2013 EVENTS

WWW.SILVERSTONE.CO.UK

DATE	MONTH	EVENT
03	MARCH	ADIDAS HALF MARATHON
12-14	APRIL	FIA WORLD ENDURANCE CHAMPIONSHIP
25-26	MAY	F3/GT CHAMPIONSHIPS
01-02	JUNE	BLANCPAIN ENDURANCE SERIES
15-16	JUNE	MG LIVE!
28-30	JUNE	2013 FORMULA 1 BRITISH GRAND PRIX
12-14	JULY	INTERNATIONAL GT OPEN
26-28	JULY	SILVERSTONE CLASSIC
02-04	AUGUST	FIM SUPERBIKE WORLD CHAMPIONSHIP
11	AUGUST	FORD FAIR
29-01	AUG/SEPT	2013 HERTZ BRITISH GRAND PRIX (MotoGP™)
08	SEPTEMBER	TRAX
14-15	SEPTEMBER	THE SILVERSTONE 24 HOUR CYCLING GRAND PRIX
21-22	SEPTEMBER	BRITCAR SILVERSTONE 1000KM
28-29	SEPTEMBER	DUNLOP MSA BRITISH TOURING CAR CHAMPIONSHIP
04-06	OCTOBER	MCE INSURANCE BRITISH SUPERBIKE CHAMPIONSHIP
02-03	NOVEMBER	WALTER HAYES TROPHY



TICKETS ON  
SALE NOW

SEE WEBSITE OR CALL 0844 3750 740  
FOR ALL 2013 EVENTS



DATES ARE SUBJECT TO CHANGE



SILVERSTONE

# Fifteen questions for Alan Jones

**Q** What's been your biggest disappointment?

**A** Not winning back-to-back F1 world titles...

**Who has been your fiercest rival?**

Nelson Piquet gave me the hardest time for the championship in Formula 1.

**Who was your childhood hero?**

Jimmy Clark, as I admired the way he could get his bum into anything and make it competitive.

**When were you happiest?**

In my mother's womb.

**Which living person do you most admire and why?**

The leader of North Korea, because of his political correctness, his stature and good looks...

**What has been your most embarrassing moment?**

Probably losing it *in the warm up* going into the chicane at Thruxton and ending up in the ditch in a Formula 3 race.

**What is your most treasured possession?**

My family and my world championship trophy.

**Who would play you in the film of your life?**

Jackie Gleason.

**What is your favourite smell?**

BBQ.

**What is your guiltiest pleasure?**

Chocolates.

**To whom would you like to say sorry and why?**

I've upset a lot of people and would need a lot of time to apologise!

**What does success feel like?**

It feels good! What else would you say to a journo who asks you how you feel after winning a grand prix: 'I feel terrible mate, I just won a grand prix?'

**What has been your biggest disappointment?**

Not winning back-to-back world championships through no fault of my own.

**If you could edit your past, what would you change?**

Nothing.

**How do you relax?**

I drink alcohol.

**When was the last time you cried?**

I cry a lot. I'm reasonably emotional at times, especially when I see a film where children are being hard done by.



Jones leads his 'fiercest rival' Piquet at Monaco in 1980



# RACE CENTRE

REPORTS • NEWS • ANALYSIS • OPINION

42



LEVITT/AT

**46 IndyCar St Petersburg** The streets of the Florida city were crowded with IndyCars last weekend – and James Hinchcliffe took a highly-popular maiden series win



**44 GP2 SEPANG**  
Fabio Leimer and Stefano Coletti share opening spoils



**56 WTCC MONZA**  
Dismal weather can't rain on Yvan Muller's Chevrolet double



**58 EURO F3 MONZA**  
Ferrari protege Marciello and DTM-bound Wehrlein win



**55 ERC CANARIES**  
Kubica stars until crash hands victory to Kopecky

# GP2 Sepang

March 22-24  
Round 1/11



## RESULTS

RACE 1: 31 LAPS, 106.775 MILES; RACE 2: 22 LAPS, 75.776 MILES

Pos	Driver	Team	Time	Gap
1	FABIO LEIMER (CH)	Racing Engineering	57m49.385s	
2	JAMES CALADO (GB)	ART Grand Prix	+2.045s	
3	STEFANO COLETTI (MC)	Rapax Team	+11.271s	
4	FELIPE NASR (BR)	Carlin	+12.810s	
5	JULIAN LEAL (CO)	Racing Engineering	+28.837s	
6	JOLYON PALMER (GB)	Carlin	+34.209s	
7	SAM BIRD (GB)	Russian Time	+41.183s	
8	STEPHANE RICHELMI (MC)	DAMS	+58.941s	
9	SIMON TRUMMER (CH)	Rapax Team	+1m02.853s	
10	MITCH EVANS (NZ)	Arden International	+1m13.730s	
11	RENE BINDER (A)	Venezuela GP Lazarus	+1m16.137s	
12	JOHNNY CECOTTO (VV)	Arden International	+1m18.357s	
13	CONOR DALY (USA)	Hilmer Motorsport	+1m20.096s	
14	TOM DILLMANN (F)	Russian Time	+1m21.812s	
15	PAL VARHAUG (N)	Hilmer Motorsport	+1m23.754s	
16	KEVIN GIOVESI (I)	Venezuela GP Lazarus	+1m35.775s	
17	KEVIN CECCON (I)	Trident Racing	+1m37.928s	
18	JAKE ROSENZWEIG (USA)	Addax Team	+1m43.252s	
19	SERGIO CANAMASAS (E)	Caterham Racing	+2m00.257s	
20	RIO HARYANTO (RI)	Addax Team	-1 lap	
21	MA QING HUA (PRC)	Caterham Racing	-1 lap	
R	NATHANAEEL BERTHON (F)	Trident Racing	19 laps	
R	DANIEL ABT (D)	ART Grand Prix	9 laps	
R	DANIEL DE JONG (NL)	MP Motorsport	3 laps	
R	ADRIAN QUAIFE-HOBBS (GB)	MP Motorsport	3 laps	
R	MARCUS ERICSSON (S)	DAMS	0 laps	

Race 1 Winner's average speed: 110.797mph. Fastest lap: Bird, 1m48.777s, 113.991mph.  
 Race 2 Winner's average speed: 111.370mph. Fastest lap: Berthon, 1m48.780s, 113.988mph.  
 \*three-place grid penalty for impeding another driver  
 \*\*excluded from qualifying for unacceptable reaction to being impeded  
 All drivers in Dallara-Mecachrome GP2/11

## CHAMPIONSHIP

1	COLETTI	36	6	EVANS	11
2	LEIMER	25	7	LEAL	10
3	NASR	24	8	PALMER	8
4	CALADO	18	9	BIRD	8
5	RICHELMI	12	10	CECOTTO	6

## TEAMS

1	RAPAX	42	4	ART GRAND PRIX	18
2	RACING ENGINEERING	35	5	ARDEN INTERNATIONAL	17
3	CARLIN	32	6	DAMS	12

## POINTS SYSTEM EXPLAINED

Race 1: 25-18-15-12-10-8-6-4-2-1 to top 10 finishers. Race 2: 15-12-10-8-6-4-2-1 to top eight. Pole for race one: 4. Fastest lap of top 10 finishers in each race

FOR IN-DEPTH RESULTS



# Leimer plays the long game

Swiss racer's canny strategy reaps rewards in the feature race but Coletti strikes back in the sprint. By CHARLES BRADLEY

## CONVENTIONAL GP2 SERIES WISDOM LABELS

Fabio Leimer as perennially unfortunate. But it seems the more practice he gets, the luckier he becomes. His victory in the season-opening feature race at Sepang owed nothing to fortune, however, and everything to astute strategy and sheer pace when he needed it.

In the tropical heat and humidity of a Malaysian early afternoon, the key to success was always going to be a blend of tyre management and track position. Leimer's maiden main-series feature-race victory was rooted in his fantastic start: not only a flying getaway that catapulted the Racing Engineering driver past Carlin's Felipe Nasr and ART's James Calado, but the nous to not challenge poleman Stefano Coletti's (Rapax) into Turn 1. That would come later.

With his track position boosted, Leimer wisely engaged 'stalk mode'. Coletti has a reputation for being tough on his tyres, and Leimer's close proximity made him push harder on his soft-compound tyres than even he wanted. He fell short of his target pitstop lap (nine) by three tours, while Leimer was able to stretch his soft boots until the end of lap 10. This big-picture thinking would pay off in the long term.

Leimer's pace was awesome once released from



behind Coletti, but Racing Engineering refused the temptation to bring him in earlier than planned to jump him at this point. As Coletti was then able to lap more consistently quickly on fresh hards, Leimer rejoined 2.4s in arrears. But the damage was inflicted on Coletti's long game; Leimer would have four laps of tyre life over the leader. Stalk mode was engaged once again.

Behind them, the opening tour had been frantic for most and painful for some. Nasr and Calado fought so hard over third in the opening corners that Mitch Evans jumped them both at Turn 4. Calado struggled with low tyre temperatures initially, and took until lap three to repass Evans, but was 6s behind. Unless there was a Coletti/Leimer collision or a safety car period, his victory hopes were already gone.

Out already was expected frontrunner Marcus Ericsson, who flew over the back of Jolyon Palmer at Turn 9, later apologising to his reigning champion team, DAMS. Also on the first lap, Julian Leal clattered Rio Haryanto on the exit of Turn 2, sending the Indonesian into the pits for a new tyre.

Out front, Leimer soon caught Coletti. With six laps remaining, Coletti locked up at Turn 14 – time for Leimer to disengage stalk mode and turn it up to 'pounce'. His car wasn't the quickest in a straightline, however, so he had to wait until Coletti was truly traction-limited, and this happened at the exit of Turn 4 with five laps remaining.

"When he passed me my tyres were completely gone – I had massive drop-off," admitted Coletti. Leimer added: "By going longer I knew I'd have better tyres. He was actually quicker than I thought he'd be, so it was a case of waiting and waiting. Then I saw him in trouble with his rears, so it was time to push."

While the leaders had held each other up, Calado was pushing for all his worth in the closing stages. He got the gap down to 1.3s before Leimer passed Coletti, and then it was his turn to attack the



Leimer took first blood for Racing Engineering

DUNBAR/LAT

tyre-troubled Monegasque. After a fumbled attempt at the final corner resulted in an overshoot that allowed Coletti to repass, Calado nailed his man with a clinical lunge down the inside, having thrown an old-school feint to the outside.

"Fabio had the pace today, all through the race," reckoned Calado. "To be honest, I don't think I could've won that race. I had a small balance issue, but second means lots of points in the bag."

Nasr and Leal finished a distant fourth and fifth.

As the majority had started on softs, it was natural that the few who gambled on hards for the first stint would lead when they pitted comparatively early. But it was a surprise that top hard-runner was Palmer, who started 22nd after a sticking throttle in practice. Despite front-wing damage, Palmer led for nine laps, and rejoined on softs in sixth place. He managed his rubber well to maintain that position to the finish, a result he described as "epic".

The top hard-starter by rights should have been Sam Bird, but his hopes were dashed by being one of seven drivers pinged for improving their final sector times after MIP Motorsport drivers Adrian Quaife-Hobbs and Daniel de Jong indulged in fratricide. After a drivethrough penalty, Bird tumbled back to seventh, his highlight a pass on Stephane Richelmi and Evans in one move at Turn 1.

Sunday's sprint race was a far more straightforward affair. Richelmi led into the first corner, but Coletti – who made a stormer from P6 – grabbed the lead at Turn 2.

On the run to Turn 4, Calado misjudged his braking point and hit the right-rear of Leimer, which jammed his wing under his front wheels and sent him grasswards. Out of control, he was fortunate to only clip Leal and Bird, rather than striking them amidships, but with enough force to put all three of them out.

Out front, Coletti charged into a 2.5s lead over the first five laps. Nasr was up to second, having

## IN THE PADDOCK

### Bird's return a wild affair

IT WAS THE WORLD VERSUS SAM BIRD AT Sepang. The GP2 comeback kid, with new team Russian Time, couldn't buy a break all weekend.

First he was given a three-place grid penalty in qualifying for impeding Johnny Cecotto – who drove him clean off the track in retaliation!

Bird then got a drivethrough in the feature race for not backing off enough under yellows, but drove a storming race to finish seventh with fastest lap.

"I was upset with all the penalties, they scuppered my weekend," said Bird. "I have to live with that. I saw the yellow flag, I just followed the pace of the cars in front, I didn't gain or drop back.

"What annoys me most is why did I get a penalty [in qualifying]? Being demoted to eighth [from fifth] was a bitter blow.

"I worked hard to get out of [Cecotto's] way. I got to the inside as quickly as I could. My part in that incident was particularly marginal. He could've continued his lap, maybe he'd have lost a tenth. He had plenty of room. I don't need to comment on what happened next – he couldn't control his own actions."

On Sunday, Bird was taken out on the first lap by James Calado (who apologised) but having used all his hard-compound tyres on Saturday, chances are he'd have been doomed anyway on the softs.



Bird (leading) and Palmer both starred

DUNBAR/LAT

passed Richelmi at Turn 1 on lap two, with Evans now giving chase to the poleman.

As expected, Coletti's pace dropped in the latter stages, but his fresh set of hards (as most of the grid had saved for this race) held up to their early punishment. Nasr closed the gap to under half a second starting the final lap, but never got close enough to try a passing move.

"We worked really hard last night to make the car better today," said Coletti, who now leads the championship. "I did a really good start, and my car was still fast in the last two laps – so it was a big step forward."

Nasr added: "My plan was to look after my tyres, but even then I ran out of them at the end."

Richelmi, struggling with a shoulder injury, threw his podium chance away by outraking himself with five laps to go. A lap later, Leimer gave up a handful of points for sixth when he took a gravelly excursion. Johnny Cecotto finished fifth, a decent result given his outrageous behaviour in qualifying (see panel).

The star of the race was Palmer. He stalled on the dummy grid, and started from the pitlane, but as on Saturday he charged forwards, gaining 32 places over the two races: "If I had started third I surely could have won," he rued after finishing ninth.

Cecotto turned keyboard warrior



STALEY/LAT

### BIRD & CECOTTO TWITTER RUMBLE

Twitter was a well-used weapon in the GP2 paddock at the weekend for the fallout from the Sam Bird/Johnny Cecotto clash in qualifying. @sambirdracing tweeted: "That boy!!!! Jesus!! #greasystick" was countered by @JCecotto: "He braked in front of me on purpose in my fast lap making me lose my only lap on these tyres and almost made me crash. After that what I did for sure wasn't the best thing".

### CANAMASAS & BERTHON CLASH

A post-qualifying weighbridge spat between Caterham's Sergio Canamasas and Trident's Nathanael Berthon, which involved Canamasas prodding him repeatedly in the head, also caused amusement in the paddock. Canamasas said: "Sometimes people do silly things, and you have to tell them!"

### NEW TEAMS HIT THE MARK...

New-to-GP2 teams Russian Time and Hilmer Motorsport scored points on their series debut at Sepang. Russian Time's Sam Bird finished seventh in the feature race and bagged the additional points for fastest lap, with Hilmer's late-signing Conor Daly taking a couple of points with seventh in the sprint race.

### NEW BOYS TAKE EACH OTHER OUT

The other new team to GP2 in 2013, MP Motorsport, suffered a disastrous first race when Adrian Quaife-Hobbs punted team-mate Daniel de Jong into a spin on the third lap. To make matters worse, de Jong rolled back into Quaife-Hobbs's path – a second collision damaging the rear wheels of both cars so they went no further. De Jong finished 14th in Sunday's sprint race.

### MEDICAL CENTRE IN DEMAND

There was a huge sicklist of drivers in the GP2 paddock. Worst affected was Caterham's Chinese driver Ma Qing Hua, who was forced to withdraw ahead of Sunday's sprint race after being diagnosed with gastroenteritis. Mitch Evans scored a podium in the sprint, despite suffering food poisoning. Stephane Richelmi was nursing a shoulder injury, while Jake Rosenzweig was carrying injuries sustained when he fell off a moped last week avoiding some monkeys!

### CALADO TUNES IN TO OWN LAP

After a thrilling qualifying session on Friday, in which the top three were covered by 0.008s, James Calado revealed how he knew he'd failed to beat poleman Stefano Coletti by 0.004s. "As I crossed the line, I looked at the big TV," he said. "Even before my engineer told me on the radio, I saw my time was orange [it would have been green if he'd have grabbed pole] and then I could see Stefano jumping up and down as he sat on the pitwall!"



Calado watched himself on telly

STALEY/LAT

## INDYCAR St Petersburg



March 22-24  
Round 1/16

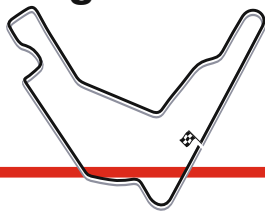

### RESULTS

110 LAPS, 198.00 MILES

<b>1</b>	<b>JAMES HINCHCLIFFE (CDN)</b>	<b>2h22m12.5502s</b>
	Andretti Autosport Dallara-Chevrolet	Qualifying 4th-1m01.8229s
<b>2</b>	<b>HELIO CASTRONEVES (BR)</b>	<b>+1.0982s</b>
	Team Penske Dallara-Chevrolet	Qualifying 5th-1m01.8991s
<b>3</b>	<b>MARCO ANDRETTI (USA)</b>	<b>+16.3664s</b>
	Andretti Autosport Dallara-Chevrolet	Qualifying 7th-1m01.6883s
<b>4</b>	<b>TONY KANAAN (BR)</b>	<b>+19.6083s</b>
	KV Racing Technology Dallara-Chevrolet	Qualifying 11th-1m01.9139s
<b>5</b>	<b>SCOTT DIXON (NZ)</b>	<b>+20.7627s</b>
	Chip Ganassi Racing Dallara-Honda	Qualifying 20th-1m02.1715s
<b>6</b>	<b>SIMONA DE SILVESTRO (CH)</b>	<b>+20.7890s</b>
	KV Racing Technology Dallara-Chevrolet	Qualifying 3rd-1m01.7670s
<b>7</b>	<b>EJ VISO (YV)</b>	<b>+20.8229s</b>
	Andretti Autosport/HVM Dallara-Chevrolet	Qualifying 22nd-1m02.1986s
<b>8</b>	<b>TAKUMA SATO (J)</b>	<b>+21.1878s</b>
	AJ Foyt Racing Dallara-Honda	Qualifying 2nd-1m01.5776s
<b>9</b>	<b>JUSTIN WILSON (GB)</b>	<b>+21.6832s</b>
	Dale Coyne Racing Dallara-Honda	Qualifying 13th-1m02.1777s
<b>10</b>	<b>ALEX TAGLIANI (CDN)</b>	<b>+22.5569s</b>
	Bryan Herta Autosport Dallara-Honda	Qualifying 17th-1m02.3328s
<b>11</b>	<b>SEBASTIEN BURDAIS (F)</b>	<b>+22.7354s</b>
	Dragon Racing Dallara-Chevrolet	Qualifying 21st-1m02.6537s
<b>12</b>	<b>CHARLIE KIMBALL (USA)</b>	<b>+24.5429s</b>
	Chip Ganassi Racing Dallara-Honda	Qualifying 14th-1m02.1198s
<b>13</b>	<b>GRAHAM RAHAL (USA)</b>	<b>+37.5324s</b>
	Rahal Letterman Lanigan Racing Dallara-Honda	Qualifying 15th-1m02.2709s
<b>14</b>	<b>ED CARPENTER (USA)</b>	<b>+45.2054s</b>
	Ed Carpenter Racing Dallara-Chevrolet	Qualifying 23rd-1m02.6634s
<b>15</b>	<b>JAMES JAKES (GB)</b>	<b>+45.7793s</b>
	Rahal Letterman Lanigan Racing Dallara-Honda	Qualifying 18th-1m02.1658s
<b>16</b>	<b>WILL POWER (AUS)</b>	<b>-3 laps</b>
	Team Penske Dallara-Chevrolet	Qualifying 1st-1m01.2070s
<b>17</b>	<b>ORIOLE SERVA (E)</b>	<b>-6 laps</b>
	Panther Dreyer & Reinbold Racing Dallara-Chevrolet	Qualifying 12th-1m02.1483s
<b>18</b>	<b>RYAN HUNTER-REAY (USA)</b>	79 laps-throttle
	Andretti Autosport Dallara-Chevrolet	Qualifying 8th-1m01.7339s
<b>19</b>	<b>JR HILDEBRAND (USA)</b>	78 laps-accident
	Panther Racing Dallara-Chevrolet	Qualifying 24th-1m02.3179s
<b>20</b>	<b>SEBASTIAN SAAVEDRA (CO)</b>	72 laps-accident
	Dragon Racing Dallara-Chevrolet	Qualifying 9th-1m01.7944s
<b>21</b>	<b>TRISTAN VAUTIER (F)</b>	69 laps-exhaust
	Schmidt Peterson Motorsports Dallara-Honda	Qualifying 6th-1m02.0645s
<b>22</b>	<b>ANA BEATRIZ (BR)</b>	55 laps-exhaust
	Dale Coyne Racing Dallara-Honda	Qualifying 25th-1m03.2551s
<b>23</b>	<b>JOSEF NEWGARDEN (USA)</b>	50 laps-clutch
	Sarah Fisher Hartman Racing Dallara-Honda	Qualifying 16th-1m02.1592s
<b>24</b>	<b>SIMON PAGENAUD (F)</b>	26 laps-exhaust
	Schmidt Hamilton Motorsports Dallara-Honda	Qualifying 19th-1m02.4736s
<b>25</b>	<b>DARIO FRANCHITTI (GB)</b>	18 laps-accident
	Chip Ganassi Racing Dallara-Honda	Qualifying 10th-1m01.8150s

Winner's average speed: 83.539mph. Fastest lap: Power, 1m02.7279s, 103.303mph.  
All drivers in Dallara DW12

### DRIVERS' CHAMPIONSHIP

<b>1</b>	<b>HINCHCLIFFE</b>	<b>51</b>	<b>6</b>	<b>DE SILVESTRO</b>	<b>28</b>
<b>2</b>	<b>CASTRONEVES</b>	<b>43</b>	<b>7</b>	<b>VISO</b>	<b>26</b>
<b>3</b>	<b>ANDRETTI</b>	<b>35</b>	<b>8</b>	<b>SATO</b>	<b>24</b>
<b>4</b>	<b>KANAAN</b>	<b>32</b>	<b>9</b>	<b>WILSON</b>	<b>22</b>
<b>5</b>	<b>DIXON</b>	<b>30</b>	<b>10</b>	<b>TAGLIANI</b>	<b>20</b>



### POINTS SYSTEM EXPLAINED:

50-40-35-32-30-28-26-24-22-20-19-18-17-16-15-14-13-12-11-10-9-8-7-6 for the top 24, with 5 for all other starters. 2 points for leading the most laps, 1 point for leading at least one lap, one point for pole position.

FOR IN-DEPTH  
RESULTS

FORIX

## 'Hinch' hits the heights

The Canadian comes up with the perfect response to those who thought he might be losing his way in IndyCar with a gritty first victory in St Petersburg. Mark Glendenning reports



THERE ARE FEW THINGS AN ATHLETE FEARS MORE than not fulfilling their potential. James Hinchcliffe has long been touted as one of IndyCar's rising stars, and it's a reputation he reinforced with some strong performances early last year, only to fade as the season went on. However, the Canadian found the perfect way to reverse the slide by holding Helio Castroneves at bay to claim his first career win in last Sunday's championship curtain-raiser on the streets of St Petersburg in Florida.

The Andretti Autosport driver had been a frontrunner throughout the day, but his victory did not come easily. Castroneves was never more than half a second behind him in the closing laps. Coupled with this, the one place that Hinchcliffe was struggling slightly was at the final corner — a place that also happened to be the best overtaking spot on the track due to the long straight that follows it. Nevertheless, he managed to hold on and claim a popular win.

Starting from fourth place on the grid, Hinchcliffe owed much of his early progress to restarts, which he seized upon to pass Will Power for second (twice) and Castroneves for the lead. The real key to his afternoon, however, was the decision to throw on hard tyres for the final stint when many of those around him, Castroneves included, had opted for softer rubber. The Brazilian was potentially quicker early in the stint, but once Hinchcliffe had weathered that, he was able to benefit from tyres that were more consistent over the final few laps. While it might have seemed like a strategic masterstroke, Hinchcliffe admitted that he didn't really have a choice.

"We were really rough on the red [softer] tyres," he said. "As the first stint went on, the car

developed a vibration — a sign of excessive wear. There was nothing wrong with the red tyre. It was just the way our car was handling it.

"When we did the second stint, the black tyres were more consistent, even though they weren't quite as quick. Obviously other guys used reds, and held on with them. I don't think that our car could have done that. The decision to throw the blacks on at the end is, I believe, absolutely what gave us the win here today."

For last year's victor Castroneves, a second-place finish was a bitter pill to swallow on a day on which he was convinced that he had a race-winning car. To some extent, though, he was an architect in his own downfall. He'd taken the lead from Penske team-mate Power at a restart early in the second stint, but lost it to Hinchcliffe in exactly the same way when he went wide into the first corner on a restart with 27 laps to run.

"I don't think I warmed up the tyres enough," he admitted. "I was braking in pretty much the same place as on a fast lap. Unfortunately, it locked the rears. Thank God nobody was in front of me because probably it would have been a big accident."

"At the end of the race, I was just going for it. Unfortunately, the tyre was just giving up. Second is better than nothing, but I feel upset, because when you have a good car, it's hard to give up opportunities like that."

Behind the top two, things quickly got funky, as if the series was trying to compensate for its six-month off-season by cramming eight races-worth of weirdness into one afternoon. Andretti Autosport claimed a one-three, but the 'three' in the equation was Marco Andretti, a guy whose name, in recent times, has only been mentioned in



'Hinch' was a popular winner

the same sentence as 'street circuits' when accompanied by a word such as 'struggle'.

"This feels like a win for me," said the 26-year-old American. He was sufficiently chastened by the experience of finishing 16th in the year his team-mate won the title to devote the winter to addressing his weaknesses. But it's a safe bet he didn't expect to reap dividends quite so quickly.

It was a popular result, tainted only slightly by the fact that it came at the expense of what would have been an even bigger feel-good story. Andretti had hauled himself up to the front by being conservative midway through his final stint, saving his tyres at a time when many of those ahead of him were pushing hard. When their rubber started

to go off, he was in good enough shape to start pushing. Before long he was fourth, and in a scene that would have been completely unthinkable last year, the only obstacle between himself and the podium was Simona de Silvestro.

The new KV signing had been quick right from the beginning of the weekend, clearly relishing the opportunity to race on level terms after being mired in a Lotus tar pit during 2012. She'd been in the top six throughout the race, and capitalised on a mistake by Power – more on that soon – to get into a podium position. However, towards the end of the race she was visibly struggling with fading rear tyres. For a while, it looked like her downfall might come at the hands of team-mate Tony



Andretti (25) beat Kanaan for third

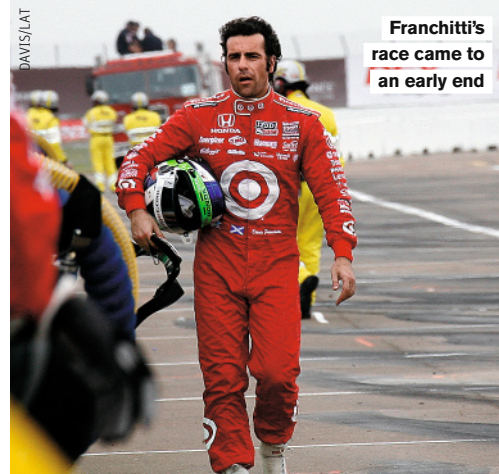

Franchitti's race came to an early end

Kanaan, but the Brazilian was picked off by Andretti before he had chance to pass de Silvestro.

Using all of her remaining push-to-pass facility, de Silvestro held Andretti at bay until two laps from home, when she ran slightly wide and gave him an easy route into third. In fairness, even had she not made the mistake, he'd almost certainly have got by her anyway.

"It felt awesome to be running up the front with Will, Hinch and everybody," she said. "It was hard at the end. We had a used set of reds for that last stint, and it was really a struggle to try to keep people behind us. I lost a few positions, but it was a good day for us."

De Silvestro ended up sixth, with Andretti's pass being followed by similar moves from Kanaan and Scott Dixon, whose fifth place probably doesn't sound such a big deal until you consider that he started 20th and had a wastegate fail during the race, leaving him with half the usual boost.

For another of Honda's frontliners, the weekend went in the other direction. The Japanese manufacturer was a distant second to Chevrolet early in the weekend, but Takuma Sato, whose St Petersburg weekend marked the beginning of his tenure with AJ Foyt Racing, offered the most resistance to 'The Bowtie'. He qualified on the front row alongside pole-sitter Power, but started going backwards almost immediately after suffering a damaged front wing. He fell as far down as 15th before recovering back to eighth behind EJ Viso, who was also making his debut with a new team following his move from KV to Andretti.

And Power? Had the race gone green all the way, he'd probably have won by about two minutes. He led away at the start, and was leaving Sato behind at a rate of 0.4s per lap before the first caution on lap eight. He was passed by Castroneves at the restart, but the real crisis began later when JR Hildebrand became distracted while using the controls on his steering wheel during a caution period and launched himself off the back of Power's car. The Australian escaped with a right-rear puncture and a broken mirror, both of which were repaired in the pits – only for him to make a rare mistake and put himself into the tyres later on.

Power's pain would have been eased somewhat by the knowledge that reigning champion Ryan Hunter-Reay was already out after having suffered a stuck throttle. And Power wasn't even the best-credentialed driver to wall it: Dario Franchitti triggered the first caution of the race when he made a rookie mistake on cold tyres and understeered into the barriers.

So, as things stand, Power has crashed on a street course, Hunter-Reay was a DNF, de Silvestro nearly got on the podium, and Franchitti is last in the series standings. And that's after just one race. Heaven knows what will happen at Barber in two weeks. ▶

# GRAND PRIX BREAKAWAYS

BE PART OF THE ACTION



SPANISH | MONACO | BRITISH | GERMAN | HUNGARIAN | BELGIUM | ITALY

## Executive coach travel to ALL the European Grand Prix

- Purpose made Grand Prix breaks.
- Circuit transfers from the hotels.
  - Various U.K. collection points.
  - Executive travel.
- Tour details are on our website.

[www.grandprixbreakaways.co.uk](http://www.grandprixbreakaways.co.uk)

[info@grandprixbreakaways.co.uk](mailto:info@grandprixbreakaways.co.uk)

+44 (0) 114 2875201 +44 (0) 779 4302218



## MONACO GP ROAD TRIP 2013

18TH-26TH MAY 2013

Join Delta Racing Limited at this year's Monaco Grand Prix with the choice of two fabulous packages:

### MONACO GP ULTIMATE ROAD TRIP PACKAGE

TRIP INCLUDES:

- 4 NIGHTS ACCOMMODATION ON HALF-BOARD BASIS EN ROUTE TO MONACO
- TRACK DAY EN-ROUTE AT THE CIRCUIT DE MORNAY
- 5 NIGHTS ACCOMMODATION ON ROOM ONLY BASIS IN VILLEFRANCHE-SUR-MER
- PRIVATE TRANSPORT TO THE MONACO GP CIRCUIT
- ROAD BOOKS/ROUTE MAPS
- Delta Racing ASSISTANCE FOR THE 9 NINE DAY TRIP

PRICES FROM £1,095 PER PERSON BASED ON 2 PEOPLE SHARING (SINGLE ROOM SUPPLEMENTS WILL APPLY)

ATTRACTIVE TRACKSIDE VIEWING PACKAGES AVAILABLE ON REQUEST

### MONACO GP SPECTATOR PACKAGE\*

TRIP INCLUDES:

- ACCESS TO THE GP CIRCUIT FOR 4 DAYS WITH TRACKSIDE VIEWING ON THE TERRACE OF LE CÔTÉ JARDIN, HÔTEL DE PARIS
- PRIVATE TRANSPORT TO THE MONACO GP CIRCUIT
- 5 NIGHTS ACCOMMODATION ON ROOM ONLY BASIS IN VILLEFRANCHE-SUR-MER
- TRANSFERS FROM NICE AIRPORT

PRICES FROM £1,300 PER PERSON BASED ON 2 PEOPLE SHARING (SINGLE ROOM SUPPLEMENTS WILL APPLY)

\* ALTERNATIVE TAILOR-MADE PACKAGES ARE AVAILABLE ON REQUEST (INCLUDING PRIVATE BALCONY OPTIONS)

FULL DETAILS AND ITINERARY FOR THE ROAD TRIP ARE ON OUR WEBSITE

[www.delta-racing.co.uk](http://www.delta-racing.co.uk)

OR CALL STEWART ON 07797 789075 FOR FURTHER DETAILS

[Delta-Racing.co.uk](http://Delta-Racing.co.uk)



# THE BIGGEST **VODAFONE** DMAX CHAMPIONSHIPS YET!



Prices are £180 per Endurance Round and £165 per Heats Round  
**£280 to enter both**

Cumulative Loyalty Discount of 2.5% for each round entered.

A full season of Heats Racing for £1476 or Enduro Racing for £1610 inc VAT

Feb 17th	Daytona MK
Mar 17th	Daytona SP
Apr 21st	PF International
May 19th	Rye House
Jun 16th	Lydd
Jul 21st	Bayford Meadows
Aug 18th	Whilton Mill
Sep 15th	Red Lodge
Oct 20th	Daytona MK
Nov 17th	Daytona SP

Tel: 0845 644 5504

[www.daytonamax.co.uk](http://www.daytonamax.co.uk)



vodafone

## IN THE PADDOCK

## Mark Glendenning



From a vantage point here in the USA, you could make a case that IndyCar squandered some of the opportunities presented by crowning an American champion last year. Based on early evidence, the series' profile isn't any larger than it was 12 months ago – and Ryan Hunter-Reay is still able to walk into his local department store without being mobbed, unlike Tony Stewart or Jimmie Johnson would be in their neighbourhoods.

After St Petersburg, though, the series has another chance. If neutrals in the paddock were asked to nominate the two drivers they'd most like to see win at St Pete, the majority would have plumped for James Hinchcliff and



De Silvestro has star potential

Simona de Silvestro. Not only are both great drivers and thoroughly nice people, they are also IndyCar's best shots at tapping into the mainstream consciousness.

Hinchcliff has personality to burn, and is already being heavily pushed by sponsor GoDaddy. De Silvestro, meanwhile, is no Danica Patrick, but that's not necessarily a bad thing. No, she might not be interested in posing in a swimsuit for *Sports Illustrated*, but she's a more versatile driver. Both have the potential to be bona fide stars. Let's hope that the opportunity is recognised.

## IndyCar may not replace CEO



Miles has plans for management change

**MARK MILES, CEO OF INDIANAPOLIS MOTOR Speedway and IndyCar parent company Hulman & Co,** has suggested that former IndyCar CEO Randy Bernard might have no direct replacement if he believes that a more efficient management structure can be created that covers both the series and the Speedway.

Bernard split with the series late last year, with IMS CEO Jeff Belskus having initially been named as his interim replacement. However, Miles, whose past experience includes heading the ATP Tennis World Tour, is not convinced this is the best solution for the future.

"Folks have thought that we were looking for the person to replace Randy, but I don't know that that's where we'll end up," he said.

"You've got a structure at the Indianapolis Motor Speedway that has sales and marketing and licensing and communications," he continued. "Then you've got the exact same functions staffed differently at IndyCar. The two organisations are across the street from each other. Could we be a higher-performing, more effective organisation with more money to invest in human resources if we put them together?"

According to Miles, a new structure could be mapped out in time for the Indianapolis 500 in May.

## REMEMBER WHEN?

James Hinchcliff is the first Canadian to win an IndyCar race since Scott Goodyear (4) triumphed at the Texas Motor Speedway in 2000 in a Panther Racing Dallara-Oldsmobile.

During the same period there were several Canadian wins in the rival Champ Car series. Paul Tracy took the last of those in 2007 at Cleveland.



OCTOBER 15, 2000



Wheldon memorial

## WHELDON MEMORIAL UNVEILED

A memorial dedicated to the life of Dan Wheldon was unveiled next to the St Petersburg circuit last Thursday. Nameplates of the St Petersburg race winners will be added to the memorial, which comprises a pillar bearing Wheldon's likeness and career achievements. Wheldon lived in St Petersburg for the final six years of his life.

## HILDEBRAND ADMITS TO BLAME

JR Hildebrand took responsibility for the accident that launched him over the side of Will Power's car during a caution period. "I was dialling steering-wheel knobs back and getting ready for the restart," he said. "The guys in front slowed and I ran into the back of Will. It was totally my fault."

## TEAM ERROR CAUSES VISO CRASH

Andretti Autosport admitted that EJ Viso's crash during last Saturday's practice session was due to a team error rather than a parts failure, as originally reported. AUTOSPORT sources suggest that Viso's steering column was not correctly installed.

## RAHAL HAS TROUBLED START

Graham Rahal paid tribute to his new employer Rahal Letterman Lanigan Racing, despite a difficult outing in St Petersburg. Rahal finished 13th in the race after suffering an electrical glitch that kept prompting his car to shut off, and a fuel-pressure problem that prevented him from running full power. "There are things we need to improve, but the guys did a good job," he said.

## GEORGE IS BACK ON BOARD

Tony George has returned to the board of directors of Hulman & Co. The former IMS and IndyCar boss resigned his position as a director last year when his connection to a group linked to an attempted buyout of IndyCar raised questions over a conflict of interest. The company says that the collapse of the buyout bid means that the conflict has now been resolved.

## SERVIA BREAKS LEAD DROUGHT

The St Petersburg race marked the first time that Oriol Servià has led an IndyCar race since the 2011 Indianapolis 500. The Spaniard went off-sequence to head the order midway through the race, although his afternoon was ruined by a clutch problem in the pitlane that left him unable to select a gear.

Servià led for first time since 2011



**Busch won at Fontana**



## NASCAR NATIONWIDE

Kyle Busch claimed Joe Gibbs Racing's ninth-straight Fontana Nationwide win after reducing the lead of Penske's Sam Hornish Jr to nothing at the fourth caution. Regan Smith (JR Chevy) fought back from a lap down to finish third and now trails Hornish by 28 points in the championship.

## EUROPEAN TOURING CAR

Czech Petr Fulin leads the championship after taking a wet class win, a second place and bonus points for pole at Monza. The Krenek BMW driver was beaten in the opener by the Honda Civic of Peter Rikli. Jordi Oriola and Nikolay Karamyshev won in their SEAT Leons as the ex-Eurocopa cars dominated the Super 2000 machines in the rain. Clio Cup UK graduate Nicolas Hamilton twice finished sixth in the one-make class for the SEATs.

## CARRERA CUP ASIA

Former Porsche factory junior driver Martin Ragginger held off a determined effort from champion Alexandre Imperatori to win the Malaysian Grand Prix support event at Sepang by just 0.3s, with Earl Bamber third. Ex-GP2 racers Fairuz Fauzy and Ho-Pin Tung drove guest cars.

## PRO MAZDA

A broken gear lever in qualifying limited Matthew Brabham to eighth on the St Petersburg grid, but the Andretti Autosport driver still won twice to increase his series lead. Juncos Racing's Diego Ferreira and Brabham's Andretti team-mate Shelby Blackstock had a second and a third each.

## US F2000

Scott Hargrove won twice in St Petersburg for Cape Motorsports/Wayne Taylor Racing to increase his series lead as Wyatt Gooden took a pair of second places. Brits James Fletcher and Michael Epps took best results of eighth and 15th respectively.

## MIDDLE-EAST RALLY

Nasser Al-Attiyah dominated the Kuwait Rally to take his 47th Middle-East Rally Championship win by 1m13.9s in his Autotek Ford Fiesta RRC. Regular series rival Khalid Al-Qassimi (Citroen DS3 RRC) and recent WRC2 event winner Abdulaziz Al-Kuwari (Ford) completed the podium.



**Al-Attiyah on top again**



**Campana was delighted to win at Monza**

**AUTO GP SERIES MONZA (I), MARCH 23-24, RD 1/8**

# Bells ring out for Campana

**THE LIFELINE OF AN OFFER TO RACE** for globe-trotting restaurateur Giuseppe Cipriani salvaged former Italian Formula 3 champion Sergio Campana's wavering hopes of competing in this year's Auto GP series. The call arrived just two days before Monza's season opener...

Budget-strapped Campana greatly improved the prospect of extending his one-round deal by rewarding Cipriani with a debut victory for his new team, Ibiza Racing.

Euronova's exciting Formula 3 recruit Kimiya Sato took an impressive second place in race one, but the Japanese driver's reaction to the result was difficult to gauge through a sometimes formal demeanour.

"There's no problem," said team boss Vincenzo Sospiri. "But Kimiya really feels he has the ability to win, despite it being his first time here."

Sato realised his target in race two on Sunday. Unfazed by foul weather, the Japanese driver's enhanced commitment when running in thick spray produced a 20-second margin of victory and an early championship lead. Like Campana, Formula 2 champion Luciano Bacheta had also secured a late deal, and without the benefit of even a shakedown he produced a fine drive to finish second.

Former HRT grand prix driver Narain Karthikeyan partnered the Brit at Zele Racing. Zero mileage before practice and a tyre delamination in qualifying contributed to a modest 12th spot on the grid.

Pole, by a healthy margin, went to

Italian F3 champion Riccardo Agostini, but the Manor MP driver's qualifying form failed to translate into similarly dominant race pace. An entertaining three-car fight rapidly formed as he fought to hold off Campana and Sato.

The trio arrived at the first chicane on lap two in tight formation. Defending on the inside, Agostini cut the chicane and allowed Campana a clear path into the lead.

Campana's only drama came when lapping Meindert van Buuren at mid-distance. The Dutchman was not blue-flagged and attempted to stave off the leader. An unfortunate spin when wheel-to-wheel with Campana at the first chicane provided a scare, but no lasting damage.

Karthikeyan received a setback of being tagged into a spin on the opening lap, but a comeback charge netted a worthy fifth. Brake issues ruled the Indian out of action prematurely on Sunday.

Third-placed qualifier Vittorio Ghirelli, whose car went into safety mode at the lights, remarkably fought back to recapture third on the road. But a 2s penalty for cutting a chicane demoted the Super Nova man a spot.

Sunday's near-washout provided Ghirelli's opportunity to seal a podium position for keeps. Illustrating the difficulty of the conditions, the Italian narrowly avoided a collision with Bacheta on the cooldown lap after he failed to see the chequered flag.

● Peter Mills

## RESULTS

**Race 1 Sergio Campana**, 14 laps in 23m40.402s; 2 Kimiya Sato, +7.575s; 3 Robert Visoiu; 4 Vittorio Ghirelli; 5 Narain Karthikeyan; 6 Antonio Spavone. **Race 2 1 Sato**, 14 laps in 32m25.073s; 2 Luciano Bacheta, +20.020s; 3 Ghirelli; 4 Campana; 5 Riccardo Agostini; 6 Visoiu. **Points 1** Sato, 39; 2 Campana, 36; 3 Ghirelli, 24; 4 Visoiu, 21; 5 Bacheta, 19; 6 Agostini, 15.



**Sato won in awful conditions**

# KX BTCC RACE GUIDE

## 30-31 March Brands Hatch



“ There are quite a few scholarship programmes but most of them are geared up for people aiming to get to F1. Until the KX Akademy there wasn't really anything for people who wanted to race touring cars or GTs. The BTCC package is where it's at and we realised we could kill two birds with one stone: take a great opportunity to help people and to get awareness for KX.

We have a desire to help people. I've really enjoyed being involved in schemes like the

McLaren AUTOSPORT BRDC Award to help people along and I've been fortunate to be able to pull things together so I can give something back.

First and foremost the KX Akademy drivers have to be winners. It's not just about the budget, which is substantial, it's all the other marketing, sponsorship and media elements we'll teach them to help them build professional motorsport careers.”

**Jason Plato**



 @KXENERGY

 @KXAKADEMY

 KX ENERGY

[www.kxakademy.com](http://www.kxakademy.com)



## SAM TORDOFF

### BTCC with MG KX Momentum Racing

**TORDOFF MAY ONLY** be 23, but he has been around the British Touring Car package since 2009. He has been a race winner in the Renault Clio Cup and Porsche Carrera Cup, and even started a one-off BTCC round at Brands Hatch in 2010, but now is his opportunity to prove

himself across a full British Touring Car campaign.

"The aim is to be in the top 10," says Tordoff, who will be double BTCC champion Jason Plato's new team-mate. "It's important that we score points early on and I think we will."

"Testing has been a bit tricky – we've not had great weather – but it's proved quite useful. It's also been about settling in at the team. "Porsches made me a better driver and I'm quite comfortable with front-wheel-drive from my time competing in Clios." ■



## STEFAN HODGETTS

### Renault Clio Cup with Scuderia Vittoria

**THE KX AKADEMY** helped Hodgetts with a late deal for a part-season in the Renault Clio Cup last year and he took four wins. Perennially underfunded, Hodgetts now has a full programme in place thanks to KX and there's no doubt he is a championship favourite.

"The main aim for the year is definitely to win the title," says the 30-year-old. "We have been really fast in testing, but it doesn't mean anything – we still have to go to Brands and get points on the board." Hodgetts will dovetail his Clio Cup campaign with a drive in the British

GT Championship's GT4 division for Toyota and is aiming for both crowns. "It's amazing I'm sitting here with two proper drives," he adds. "Because of KX we got the Clio deal sorted pretty early, so my preparation has been the best I've ever had." ■



## ANT WHORTON-EALES

### Renault Clio Cup with Scuderia Vittoria

**ONE OF THE** promising youngsters in the 2012 Renault Clio Cup, Whorton-Eales has moved from Westbourne Motorsport to Scuderia Vittoria for this season. He managed eighth in the standings and took two podiums last year, but has yet to take a

breakthrough first Clio victory. This year, Whorton-Eales has a good benchmark in experienced team-mate Stefan Hodgetts and is looking to put together a title assault.

"Testing has been pretty good so far and it's looking pretty

promising," says the 18-year-old. "We've got to aim for the championship, but you've got to have a bit of luck in Clios! "I did a few races with some of the Scuderia Vittoria guys back in 2011, so I already know them pretty well." ■



## JAKE HILL

### Renault Clio Cup with Scuderia Vittoria

**DESPITE A LACK** of budget, Hill has been a star of rear-wheel-drive Ginetta racing in recent years. He was a race winner in the GT Supercup last season, but switches to front-wheel-drive Clios for 2013. "We weren't aiming to do Clios initially, but then Jason Plato rang

after the application process and said 'what do you think?' I was happy to consider it and now KX has given me the chance to do the Renault Clio Cup I think it'll be a great year," says the 19-year-old. "I've not had the opportunity to do much testing, but it doesn't worry

me. It's completely different to what I was racing in before – front-wheel-drive – but I know I'll be fine. "My ultimate aim would be to finish in the top three in the championship, but we'll have to see how it goes." ■

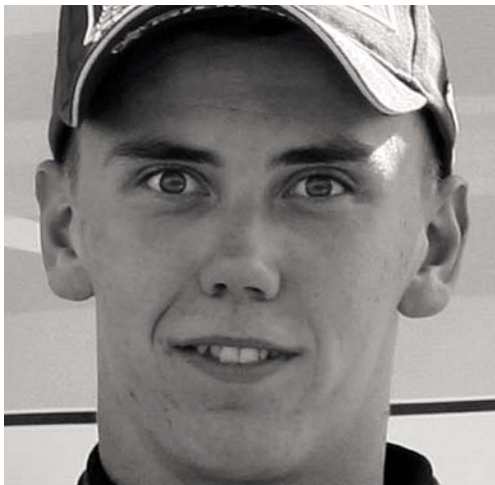

# DANIEL LLOYD

## Porsche Carrera Cup with Team Parker Racing

AFTER A SUCCESSFUL season in the German Volkswagen Scirocco R Cup, former Renault Clio Cup racer Lloyd returned to the British Touring Car Championship package last year. He became a race winner in the Porsche Carrera Cup and this season will be aiming to become

champion as the only KX Akademy representative in the field. "We've been quick in testing and we're always up there," says the 21-year-old. "I learnt a lot last year and I think I'll be stronger for it. We're definitely aiming for the title."

Lloyd is also looking forward to benefitting from the mentoring and support that that KX Akademy gives its scholars during the course of the season. "So far it's been great," he adds. "As a package they're doing a really great job." ■



# TOM INGRAM

## Ginetta GT Supercup with JHR

LIKE HODGETTS, INGRAM was one of the first KX members in 2012 and put together a great season, finishing third in the Ginetta GT Supercup. He returns in 2013 with the same JHR squad and says he will be expecting to fight for the championship.

"We came away from last year with things we wanted to achieve and we're going to come back fighting," says the 19-year-old. "We're in a much better position than I have been before. To have the continued support of KX is a great thing. "It's going to be close. We've gone

to lots of circuits and tried lots of things on the car and know what works." Ingram will also be working with new KX Akademy member Rob Boston. "We can talk things through and, as team-mates, work together," he adds. ■



# ROB BOSTON

## Ginetta GT Supercup with JHR

A STAR IN Mazda and Lotus club racing, Boston gets his chance to shine on a bigger stage in the Ginetta GT Supercup. He has had very little running in the G55 so far, but hopes it won't take him too long to get on the pace. "It'll be a really steep learning

curve," says the 30-year-old, who will partner fellow KX Akademy driver Tom Ingram at the JHR team. "I'm used to having a car moving around all the time and these cars on slicks don't really do that, but I'm still going out to win.

"I hope I can get up to Tom's pace quite quickly. I think the hardest thing will be getting the best from new tyres in qualifying; I'm quite happy about my racecraft. "I wouldn't have had this chance without the support of KX, my family and close friends." ■

## KX Energy launches Jason Plato Special Edition can

To celebrate the first round of the British Touring Car Championship at Brands Hatch this weekend, Tesco has launched a Jason Plato Special Edition of its KX Energy drink. The 500ml can will be emblazoned with Plato's name and signature, as well as a chequered flag. The Jason Plato Special Edition 500ml can will be available at all Tesco stores and Tesco Petrol filling stations.



# 30-31 March Brands Hatch



“It’s going to be an exciting time at Brands Hatch, with the KX Akademy and the BTCC. The KX Akademy is only six months old and we have a chance to win in

all the categories we’re in at Brands. It’s one of the best circuits to go along and see everything. If you’ve never been to a BTCC round, come along to Brands. This is my guide to the 1.2-mile Indy Circuit.”

## ❶ PADDOCK HILL BEND

5th gear, 90mph

“It’s the iconic corner on the circuit, hugely challenging. We’re approaching at 140mph and it’s almost a 100mph corner. It’s old-style – it’s a long corner, which means you can tee people up there, it’s a racing corner.”

## ❷ DRUIDS

2nd gear, 45mph

“It’s uphill braking and just before the end of the braking zone you come over a crest, making it tricky. You always feel you can go faster, but if you try it’s easy to go off. Druids isn’t an overtaking place unless you’ve set it up at Paddock.”

## ❸ GRAHAM HILL BEND

3rd gear, 70mph

“You’ve got to use the kerbs to be quick there and it’s a crucial corner for laptime.”

## ❹ SURTEES

5th gear, 100mph

“It’s a very fast, demanding left-right, which requires commitment. It’s not flat in an NGTC car, not even on new tyres.”

## ❺ CLEARWAYS

3rd gear, 55mph

“You’re never straight and it’s difficult for braking. It’s one of my favourite corners and good for overtaking corner – both in and out. It’s crucial for laptime.”

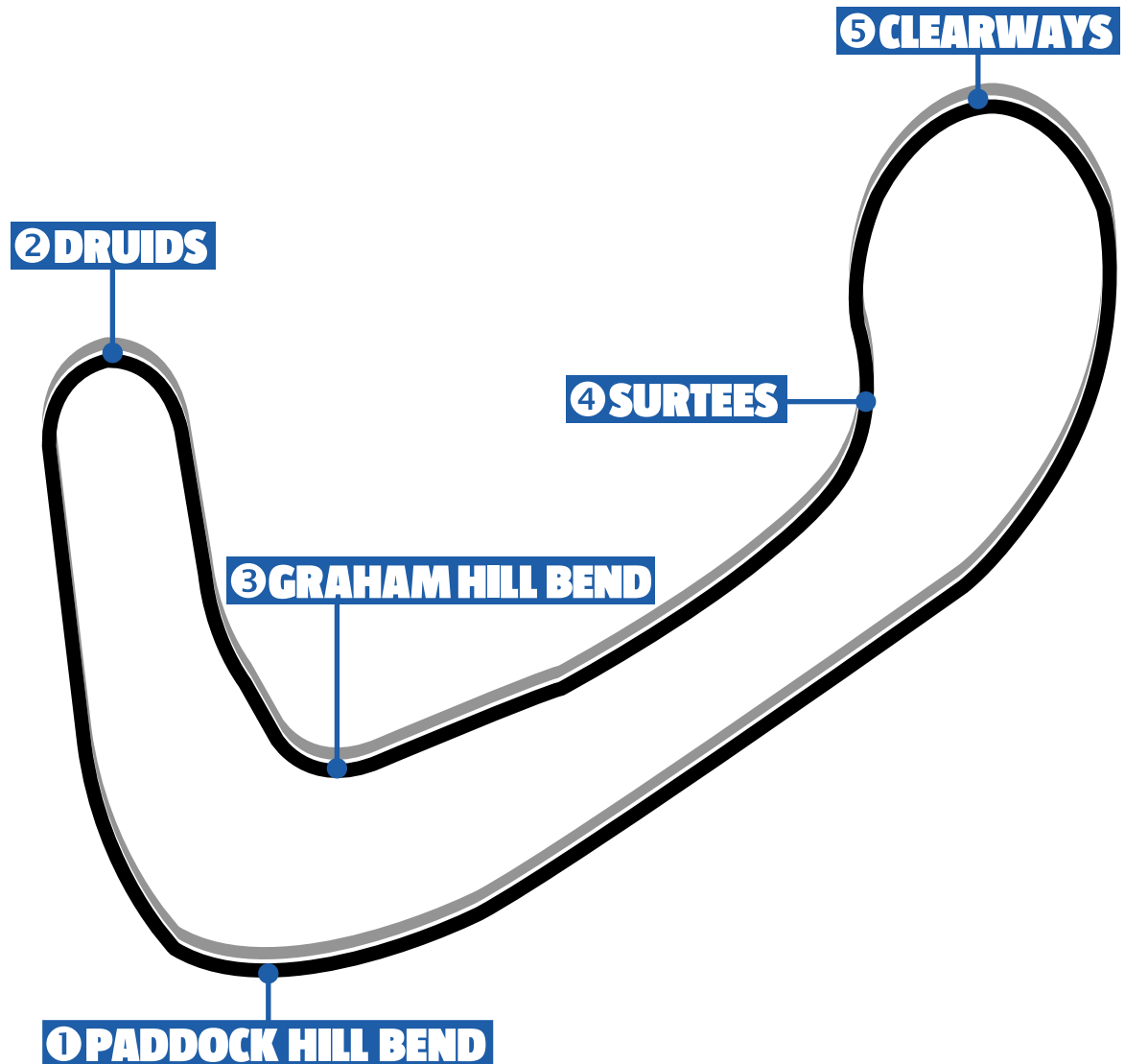

## ROUND 1: SATURDAY MARCH 30

Kentagon, Brands Hatch from 1830 hosted by Alan Hyde

Live interviews, questions and debate at every round of the 2013 British Touring Car Championship. FREE entry to race fans (limited capacity).

Join us to hear the stories behind the headlines - what really happens behind the scenes from the people who make the decisions. And you can ask the questions.

**IF YOU’RE COMING TO BRANDS HATCH ON SATURDAY MARCH 30, JOIN US FOR KX QUESTION TIME - YOU ASK THE QUESTIONS AND YOU COULD GO HOME WITH A GREAT PRIZE.**

**ON TELEVISION >>>**

**LIVE:** Sunday, 1045-1800, ITV4, ITV4 HD and itv.com

**HIGHLIGHTS:** Tuesday, 1630-1800, ITV4 and ITV4 HD  
**HIGHLIGHTS:** Thursday, 0300-0430, ITV and ITV HD

NASCAR SPRINT CUP FONTANA (USA), MARCH 24, RD 5/36

# Busch dodges drama to take victory

**KYLE BUSCH INHERITED VICTORY AT** Fontana after the fight for the lead of the California oval's Sprint Cup round erupted with a violent last-lap crash between Joey Logano and Denny Hamlin.

Logano and Busch had dominated for most of the distance but, after pitting for fresh tyres before a restart with 10 laps to go, Hamlin surged forward and infiltrated their dice. He demoted the sister Joe Gibbs Racing Toyota of Busch to third and spent many of the final laps alongside Logano.

With just one corner to go, contact between the pair sent Logano into the outside wall and Hamlin spearing head-on into the inside barrier with a savage impact. He went to hospital complaining of lower-back pain.

Logano's battered car scraped past the flag to be credited with third place. He then found himself under

attack from an enraged Tony Stewart in the pits, with crews having to intervene as the three-time champion physically confronted Logano over a blocking move at the last restart.

While Logano and Hamlin became embroiled with each other, Busch had swept around the outside to take the lead even before they tangled. He duly claimed Gibbs's second Cup win of the year, and a clean sweep of Fontana for himself after winning in the Nationwide Series the previous day.

Dale Earnhardt Jr took the points lead by recovering from a bad pitstop to second place. Erstwhile leader Brad Keselowski's overheating car could only finish 23rd, but the champ had earlier made it into the top five after starting at the back due to a practice engine failure. Greg Biffle faced the same penalty and collected sixth, behind Carl Edwards and Kurt Busch.

● Connell Sanders Jr



## RESULTS

**1 Kyle Busch (Toyota Camry)**, 200 laps in 2h57m19s; 2 Dale Earnhardt Jr (Chevrolet SS), +1.261s; 3 Joey Logano (Ford Fusion); 4 Carl Edwards (Ford); 5 Kurt Busch (Chevy); 6 Greg Biffle (Ford); 7 Matt Kenseth (Toyota); 8 Paul

Menard (Chevy); 9 Kasey Kahne (Chevy); 10 Ryan Newman (Chevy). **Points** 1 Earnhardt, 199; 2 Brad Keselowski, 187; 3 Jimmie Johnson, 183; 4 Edwards, 164; 5 Biffle, 164; 6 Kyle Busch, 163; 7 Kahne, 159; 8 Menard, 154; 9 Logano, 146; 10 Denny Hamlin, 145.

EUROPEAN RALLY C'SHIP CANARIES RALLY (E), MARCH 22-23, RD 3/13



# Kubica crash gifts Kopecky success

**JAN KOPECKY COLLECTED HIS THIRD** Canaries Rally win last weekend, the Skoda driver retaking the lead of the European Rally Championship. But that's only half the story.

The first half of the event was all about Robert Kubica. Making his debut in a Citroen DS3 RRC, the Pole destroyed his rivals with a brilliant run through an opening day plagued by rain and ever-changing grip levels. He was fastest on every stage to open a lead of over a minute to Kopecky.

A dream debut went awry on the second stage on Saturday, when Kubica crashed at a downhill right hander, breaking his left-rear wheel.

By his own admission, Kopecky and his S2000 Fabia had struggled to keep pace with Kubica's turbocharged Citroen. Kopecky was sure he could do more on Saturday, and he did win the opening stage to stem the flow of scratch times heading Kubica's way, but throttled back as soon as he heard of the leader's exit.

Kopecky had a massive moment in SS7, when he locked the Skoda up for 40 metres and only just made the ensuing corner. After that, he was all about the points.

Craig Breen's own superb Canaries debut was shaded by Kubica's, but the Irishman's pacy drive netted him a fine second place in his Peugeot 207. Local hero Luis Monzon clinched third in a Prodrive Mini. Andreas Aigner was the top Production runner in his Subaru.

● David Evans

## RESULTS

**1 Jan Kopecky/Pavel Dresler (Skoda Fabia S2000)**, 2h24m30.9s; 2 Craig Breen/Paul Nagle (Peugeot 207 S2000), +1m52.4s; 3 Luis Monzon/Jose Deniz (Mini RRC); 4 Andreas Aigner/Jurgen Heigl (Subaru Impreza STi R4); 5 Germain Bonnefais/Olivier Fournier (Renault Megane RS); 6 Gorka Antxustegi/Alberto Iglesias (Suzuki Swift S1600). **Points** 1 Kopecky, 76; 2 Breen, 58; 3 Jari Ketomaa, 39; 4 Francois Delecour, 32; 5 Bryan Bouffier, 31; 6 Monzon, 24.

INDY LIGHTS ST PETERSBURG (USA), MARCH 24, RD 1/12

# Hawksworth wins; Colombians collide

**JACK HAWKSWORTH MADE THE MOST** of his rivals' mistakes to win on his Indy Lights debut on the streets of St Petersburg.

The Briton, who won last year's Star Mazda (now Pro Mazda) title, started second but dropped back at the first corner. He'd worked his way back up to third, and was chasing lead duo Gabby Chaves and Carlos Munoz when the Colombian pair collided on lap 10.

Hawksworth's Schmidt Peterson team-mate Chaves was eliminated from the race immediately, but Andretti Autosport-run Munoz was able to continue, albeit with a drive-through penalty for causing avoidable damage. He was picking his way through the pack when a gearbox problem put him out.

With Chaves and Munoz out of the way, Hawksworth opened a buffer over Peter Dempsey by as much as

0.4s per lap, eventually crossing the finish line 4.9s ahead of the Irishman.

"Everybody knew this race was going to be won at the end rather than at the beginning or the middle because the tyres were going away," Hawksworth said. "I was really concentrating on being able to maintain the gap and not ruin my tyres for the end of the race so I could pull away if there was another restart."

American Sage Karam completed the podium, with Juan Pablo Garcia, Zach Veach and Jorge Goncalvez the only other finishers.

● Mark Glendenning

## RESULTS

**1 Jack Hawksworth**, 45 laps in 54m06.120s; 2 Peter Dempsey, +4.907s; 3 Sage Karam; 4 Juan Pablo Garcia; 5 Zach Veach; 6 Jorge Goncalvez. **Points** 1 Hawksworth, 52; 2 Dempsey, 40; 3 Karam, 35; 4 Garcia, 32; 5 Veach, 30; 6 Goncalvez, 28.



# WTCC



## Monza (I)

March 23-24  
Round 1/12

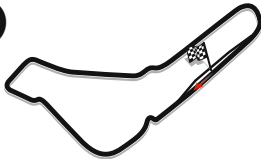

### RESULTS

RACE 1: 12 LAPS, 43.20 MILES; RACE 2: 10 LAPS, 36.00 MILES

<b>1</b>	<b>YVAN MULLER (F)</b> RML Chevrolet Cruze 1.6T	<b>30m02.783s</b>
	Qualifying 1st-1m56.486s	Race 2 1st 23m27.254s
<b>2</b>	<b>TOM CHILTON (GB)</b> RML Chevrolet Cruze 1.6T	<b>+0.923s</b>
	Qualifying 2nd-1m57.345s	Race 2 5th +5.612s
<b>3</b>	<b>ALEX MACDOWALL (GB)</b> Bamboo-Engineering Chevrolet Cruze 1.6T	<b>+5.101s</b>
	Qualifying 3rd-1m57.685s	Race 2 20th R 9 laps-puncture
<b>4</b>	<b>GABRIELE TARQUINI (I)</b> JAS Engineering Honda Civic	<b>+8.053s</b>
	Qualifying 5th-1m57.946s	Race 2 3rd +4.994s
<b>5</b>	<b>TIAGO MONTEIRO (P)</b> JAS Engineering Honda Civic	<b>+15.261s</b>
	Qualifying 15th-1m59.155s	Race 2 8th +20.573s
<b>6</b>	<b>ROB HUFF (GB)</b> Munnich Motorsport SEAT Leon WTCC	<b>+17.349s</b>
	Qualifying 24th-no time	Race 2 10th +25.442s
<b>7</b>	<b>JAMES NASH (GB)</b> Bamboo-Engineering Chevrolet Cruze 1.6T	<b>+19.964s</b>
	Qualifying 6th-1m58.005s	Race 2 7th +14.445s
<b>8</b>	<b>NORBERT MICHELISZ (H)</b> Zengo Motorsport Honda Civic	<b>+20.338s</b>
	Qualifying 21st-2m00.799s	Race 2 22nd -1 lap
<b>9</b>	<b>TOM CORONEL (NL)</b> ROAL Motorsport BMW 320 TC	<b>+28.837s</b>
	Qualifying 17th-1m59.386s	Race 2 11th +37.126s
<b>10</b>	<b>FREDY BARTH (CH)</b> Wiechers-Sport BMW 320 TC	<b>+37.740s</b>
	Qualifying 20th-2m00.090s	Race 2 14th +45.921s
<b>11</b>	<b>JEAN-PHILIPPE DAYRAUT (F)</b> ANOME BMW 320 TC	<b>+39.226s</b>
	Qualifying 23rd-2m00.957s	Race 2 18th +1m06.537s
<b>12</b>	<b>FERNANDO MONJE (E)</b> Campos Racing SEAT Leon WTCC	<b>+41.656s</b>
	Qualifying 11th-1m58.814s	Race 2 15th +50.678s
<b>13</b>	<b>DARRYL O'YOUNG (PRC)</b> ROAL Motorsport BMW 320 TC	<b>+48.116s</b>
	Qualifying 10th-1m58.781s	Race 2 12th +41.394s
<b>14</b>	<b>MARC BASSENG (D)</b> Munnich Motorsport SEAT Leon WTCC	<b>+50.920s</b>
	Qualifying 8th-1m58.518s	Race 2 4th +5.081s
<b>15</b>	<b>CHARLES NG (PRC)</b> Team Engstler BMW 320 TC	<b>+54.412s</b>
	Qualifying 22nd-2m00.901s	Race 2 17th +59.157s
<b>16</b>	<b>RENE MUNNICH (D)</b> Munnich Motorsport SEAT Leon WTCC	<b>+58.733s</b>
	Qualifying 19th-1m59.978s	Race 2 21st -1 lap
<b>17</b>	<b>MEHDI BENNANI (MA)</b> Proteam Racing BMW 320 TC	<b>+2m05.913s</b>
	Qualifying 18th-1m59.885s	Race 2 19th +1m26.721s
<b>18</b>	<b>TOM BOARDMAN (GB)</b> Special Tuning Racing SEAT Leon WTCC	<b>10 laps-contact</b>
	Qualifying 14th-1m59.116s	Race 2 16th +53.591s
<b>19</b>	<b>FRANZ ENGSTLER (D)</b> Team Engstler BMW 320 TC	<b>9 laps-mechanical</b>
	Qualifying 13th-1m59.046s	Race 2 13th +43.904s
<b>20</b>	<b>MICHEL NYKJAER (DK)</b> Nika Racing Chevrolet Cruze 1.6T	<b>-3 laps</b>
	Qualifying 7th-1m58.172s	Race 2 2nd +2.482s
<b>R</b>	<b>PEPE ORIOLA (E)</b> Tuenti Racing Team SEAT Leon WTCC	<b>8 laps-puncture</b>
	Qualifying 4th-1m57.833s	Race 2 6th +6.755s
<b>R</b>	<b>STEFANO D'ASTE (I)</b> PB Racing BMW 320 TC	<b>3 laps-accident</b>
	Qualifying 12th-2m00.475s	Race 2 9th +23.722s
<b>NS</b>	<b>JAMES THOMPSON (GB)</b> Russian Bears Lada Granta	<b>accident damage</b>
	Qualifying 9th-1m58.689s	
<b>NS</b>	<b>ALEKSEI DUDUKALO (RUS)</b> Russian Bears Lada Granta	<b>accident damage</b>
	Qualifying 16th-1m59.303s	

Race 1 Winner's average speed: 85.87mph. Fastest lap: Chilton, 2m18.673s, 93.44mph.  
Race 2 Winners' average speed: 91.59mph. Fastest lap: Oriola, 2m17.987s, 93.91mph.

### CHAMPIONSHIP

<b>1</b>	<b>MULLER</b>	<b>55</b>	<b>6</b>	<b>MONTEIRO</b>	<b>14</b>
<b>2</b>	<b>CHILTON</b>	<b>32</b>	<b>7</b>	<b>BASSENG</b>	<b>12</b>
<b>3</b>	<b>TARQUINI</b>	<b>28</b>	<b>8</b>	<b>NASH</b>	<b>12</b>
<b>4</b>	<b>MUNNICH</b>	<b>18</b>	<b>9</b>	<b>ORIOLA</b>	<b>10</b>
<b>5</b>	<b>MACDOWALL</b>	<b>18</b>	<b>10</b>	<b>HUFF</b>	<b>9</b>

### YOKOHAMA TROPHY

<b>1</b>	<b>NASH</b>	<b>16</b>	<b>4</b>	<b>BARTH</b>	<b>9</b>
<b>2</b>	<b>MACDOWALL</b>	<b>12</b>	<b>5</b>	<b>O'YOUNG</b>	<b>8</b>
<b>3</b>	<b>NYKJAER</b>	<b>11</b>	<b>6</b>	<b>D'ASTE</b>	<b>6</b>

### POINTS SYSTEM EXPLAINED

25-18-15-12-10-8-6-4-2-1 to top 10 finishers. 5-4-3-2-1 to top 5 qualifiers.

MacDowall had podium finish



FOR IN-DEPTH RESULTS



Muller led all-Chevy 1-2-3 in race one

# Muller's Monza mop-up

AFTER A WINTER OF CHANGE, MONZA played out to a familiar beat. He may no longer be a works driver but nothing, not Sunday's downpour, frozen wipers or reversed grids, could stop Yvan Muller from dominating the 2013 World Touring Car Championship opener. More than a second clear of everyone bar RML team-mate Tom Chilton in dry qualifying, Sunday's rain offered a small glimmer of hope that Muller's Chevrolet Cruze could be headed. He stamped that out effectively within a lap of each contest, racing to what was a worryingly easy double victory and an early – and sizeable – championship lead.

All eyes before the weekend had been on how Honda's and Lada's new works efforts would match up against the Cruzes now that Chevrolet's factory backing had been withdrawn. Honda's challenge effectively ebbed away as the pace increased, at least in the dry. Second in the opening practice session became seventh in the first part of qualifying, and while the evergreen Gabriele Tarquini did manage to arrest that in Q2 by going fifth, a deficit of 1.4 seconds was evidence that Honda wasn't in the game.

Nor was Lada, but for very different reasons. James Thompson was a regular top-10 fixture in practice, but on lap two of Q1 his and the team's weekend was undone by a moment of madness from team-mate Aleksei Dudukalo. The Russian massively misjudged his braking point for the first chicane and, with no hope of making the corner, ploughed straight into Thompson just as he turned in.

Remarkably Thompson limped home and even got out in Q2 to set the ninth-fastest time, but the prospect of a front-row start in race two was salt in the wound; post-session inspections revealed the full extent of damage to both cars and led to the decision to withdraw them.

With defending champion Rob Huff also faring badly – early contact with Freddy Barth meant he failed to complete a lap in qualifying and had to start from the back of both races – it fell to Chilton and Bamboo-Engineering's Alex MacDowall to keep Muller honest in the opening

contest. Both men played their roles excellently, particularly Chilton, who was quick enough to have several looks down the inside of his triple world champion team-mate. Caution prevailed though, with the two Brits earning maiden WTCC podiums as a consequence.

"I thought I could overtake Yvan, but ultimately it wasn't worth the risk," Chilton said. "I felt the car was faster than in the warm-up because of tweaks I'd made, but it was interesting that Yvan followed my set-up and didn't like the change."

Behind the leaders things were far more frantic. After a post-qualifying penalty, Tarquini came from ninth to fourth, reassuring Honda's fears of the unknown in what was its first proper wet running. Team-mate Tiago Monteiro followed him home, while Huff charged from 22nd to sixth despite a brake issue that was a hangover from his qualifying damage.

"I was just out-accelerating everyone really, relying on my feel to get out of the corner better, but every time I braked it was like an earthquake underneath," he reflected.

Muller had far more to do in race two after starting 10th, but there was an inevitability to his charge as soon as he made up six places on the opening lap. By lap four he was leading, having picked off Michel Nykjaer, Marc Basseng and Tarquini in quick succession. By lap five, with a margin of more than 2s, the perfect weekend was all but wrapped up.

"I wasn't looking for the victory, just the top five," Muller said afterwards, "But I didn't make any mistakes and others did. For the rest of the season though I am afraid, because we will not test or develop and other teams will. Staying at this level could be tough."

Behind him a fantastic three-way fight for second played out across the final five laps. Nykjaer eventually broke clear, while Tarquini salvaged a podium for Honda, defeating Basseng by just 0.087s after a barnstorming last lap.

In reality though they were fighting for the scraps from Muller's table. On this evidence, that might be the best they can hope for. ❁

## IN THE PADDOCK

## Sam Tremayne



"Both races were really tough," Yvan Muller said. "In the first I lost my wipers after the second lap, which made tricky conditions even harder, while in the second it was almost impossible to see even the lights of the cars in front. At one stage I braked maybe 100 metres before the right point. In such conditions it was always difficult."

Not that his on-track performance showed such hesitancy. Muller was supreme from the start, rapidly extinguishing the hopes of Honda and the rest of the pitlane. This was his weekend.

For the good of the championship, the hope is that he will face tougher challenges. Honda always knew Monza would be its worst track, while Rob Huff's Munnich squad admitted it is still way short of mastering its SEAT Leons. But as they struggled, Muller basked.

"Last year we won both races at Monza, but this weekend was different," he reflected. "It wasn't just the weather; we've spent so much energy since Chevrolet pulled out to put this programme up, and even three weeks ago we were still far away. Being here now, I'm definitely pleased."



Muller fears pack closing in on him

## BIG NUMBER

23

Yvan Muller's WTCC points lead over his RML Chevrolet team-mate Tom Chilton. The Frenchman had only three times previously taken a double win in the series – at Donington Park and Valencia in 2011, and at Monza in 2012. All of those double successes came in factory Chevrolets run by the RML squad.

## Honda loses speed to RML

**HONDA ADMITTED AT MONZA THAT IT HAS** lost speed relative to the RML Chevrolet Cruzes during the winter, despite carrying out an intense development programme.

The Japanese manufacturer arrived at Monza with hopes of challenging for victory after making comprehensive revisions to the prototype Civic WTCC in which Tiago Monteiro took a podium at Macau last year.

After an encouraging first practice session, however, Monteiro, factory team-mate Gabriele Tarquini and privateer Norbert Michelisz in the Zengo-run Civic all

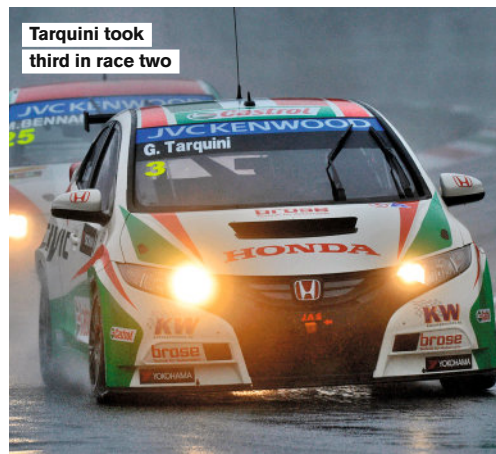

Tarquini took third in race two

struggled in qualifying. Tarquini was the only man to make it into Q2 and finished fifth, but was still more than 1.4 seconds slower than poleman Yvan Muller.

Alessandro Mariani, whose JAS outfit runs the two works Hondas, told AUTOSPORT that performance levels were below what had been expected.

"Monza is the most difficult track for us, which we knew already, but I still expected to be closer," he said.

"The technical performance was satisfactory, but we are not happy. We have a problem with the maximum speed, which we are analysing in detail. We are struggling, and we have to analyse what we can change.

"At Macau we were very competitive and could fight against the Chevrolets when they were trying to win the championship and weren't playing. We have lost speed compared with Macau, and we have to understand why.

"Don't forget this is the fourth race with the car, and the 2013 car is totally new because we raced a prototype last year. We have changed a lot of parts since then and maybe we need to review each one better."

Mariani added that there were still positives to take from the weekend, not least because the Civic proved predictable in the way it reacted to set-up changes.

"The car is very reactive, so when you make changes it reacts in the correct way, which is a great characteristic," he said. "The chassis is very stiff but still pretty gentle on the tyres, so there are positives."

Tarquini salvaged a race-two podium and now sits third in the championship, 27 points behind Muller.

## Lada's weekend ruined during Q1

**LADA DRIVER JAMES THOMPSON SAYS HE** has no hard feelings towards Aleksei Dudukalo, despite having to withdraw from both Monza races as a result of the damage suffered in an intra-team qualifying crash.

Dudukalo misjudged his braking for Monza's first chicane and ploughed into the side of Thompson's Granta Sport after just two laps of Q1. Thompson was able to continue and took ninth in Q2, giving him a share of the front row for the second race. At midnight, however, he was told Lada could not repair his car in time.

"Dudukalo didn't do it on purpose. I'm OK, he's OK. The cars were badly damaged, but he did not want to do that – that's the only way to sum it up, and that's the best way to leave it," Thompson told AUTOSPORT.

"It's a great shame as the car showed good potential and I wanted to see what we could do from the front row. On top of that we have two new cars and the first races were good chances for us to develop them further."



Lada's weekend was ruined

## ARGENTINA ON CARDS FOR JULY

AUTOSPORT understands that Argentina could replace Brazil on the 2013 calendar should the proposed Curitiba race on July 27-28 fall through. While the venue is yet to be decided, the new race – should it be incorporated – would take place on August 3-4. Confirmation is expected in the coming weeks.



## CHILTON HAPPY

Tom Chilton said that a maiden WTCC podium was everything he could have hoped for following his late switch to RML. "Perhaps I could have overtaken Yvan [Muller] in race one, but it was too risky," he said. "Even if I'd got taken out in race two I'd still have been bloody happy. It's amazing."

## DUDUKALO'S FUTURE IN DOUBT

Lada's principal backer Lukoil is considering dropping Aleksei Dudukalo as a result of his qualifying error, AUTOSPORT understands. Evgeny Malinovskiy, head of Lukoil Racing, confirmed Dudukalo was a doubt for Marrakech and the rest of the season. "I think he will go back to Russia," Malinovskiy said.

## ORIOLA'S PROMISE UNFULFILLED

Pepe Oriola was restricted to just 10 points despite starring at Monza in his SEAT. The Spaniard qualified as the best non-Chevrolet driver in fourth, a position in race one until a late puncture denied him points three laps from the end. After a long battle with James Nash he finished sixth in race two.

## HUFF REWRITES HIS OWN RECORDS

Rob Huff's storming drive from 22nd on the grid to sixth at the flag in the opening race equals his best recovery drive in the WTCC. On only one other occasion has he made up 16 places – when he charged from 24th to eighth in a works Chevrolet Lacetti at Brno in 2006.

# EURO F3



## Monza (I)

March 23-24  
Round 1/10

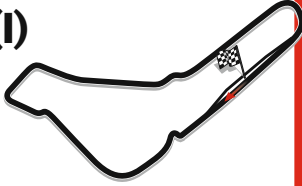

### RESULTS

RACE 1: 19 LAPS, 68.39 MILES; R2: 14 LAPS, 50.39 M; R3: 8 LAPS, 28.80 M

<b>1</b>	<b>RAFFAELE MARCIELLO (I)</b> Prema Powerteam DMB F312 <b>27.878s</b>
	Q3-1m45.280s; Race 2 2nd +2.569s (Q2); Race 3 1st 20m05.546s (Q1-1m44.781s)
<b>2</b>	<b>LUCAS AUER (A)</b> Prema Powerteam DMB F312 <b>+2.079s</b>
	Q2-1m45.274s; Race 2 R 3 laps-accident (Q3); Race 3 4th +18.823s (Q4-1m45.026s)
<b>3</b>	<b>PASCAL WEHRLEIN (D)</b> Mucke Motorsport DMB F312 <b>+5.200s</b>
	Q1-1m45.245s; Race 2 1st 37m18.470s (Q1); Race 3 2nd +2.182s (Q2-1m44.946s)
<b>4</b>	<b>WILL BULLER (GB)</b> T-Sport DN F312 <b>+13.956s</b>
	Q12-1m45.918s; Race 2 R 11 laps-accident (Q9); Race 3 7th +29.684s (Q10-1m45.452s)
<b>5</b>	<b>HARRY TINCKNELL (GB)</b> Carlin DVV F312 <b>+15.855s</b>
	Q5-1m45.638s; Race 2 5th +6.964s (Q6); Race 3 6th +23.935s (Q8-1m45.321s)
<b>6</b>	<b>FELIX SERRALLES (USA)</b> Fortec Motorsport DMB F312 <b>+23.933s</b>
	Q13-1m45.919s; Race 2 7th +8.804s (Q10); Race 3 16th +51.624s (Q13-1m45.662s)
<b>7</b>	<b>JORDAN KING (GB)</b> Carlin DVV F312 <b>+24.316s</b>
	Q8-1m45.723s; Race 2 R 11 laps-accident (Q8); Race 3 9th +37.723s (Q6-1m45.259s)
<b>8</b>	<b>ALEX LYNN (GB)</b> Prema Powerteam DMB F312 <b>+27.867s</b>
	Q7-1m45.692s; Race 2 6th +7.888s (Q5); Race 3 3rd +8.455s (Q3-1m44.987s)
<b>9</b>	<b>DENNIS VAN DE LAAR (NL)</b> Van Amersfoort Racing DVV F312 <b>+34.768s</b>
	Q10-1m45.870s; Race 2 10th +11.095s (Q13); Race 3 R 6 laps-acc damage (Q16-1m45.774s)
<b>10</b>	<b>EDDIE CHEEVER (I)</b> Prema Powerteam DMB F312 <b>+35.304s</b>
	Q6-1m45.670s; Race 2 13th +15.346s (Q12); Race 3 8th +32.987s (Q7-1m45.296s)
<b>11</b>	<b>PIPO DERANI (BR)</b> Fortec Motorsport DMB F312 <b>+36.399s</b>
	Q17-1m46.177s; Race 2 19th +20.140s (Q14); Race 3 5th +21.508s (Q5-1m45.240s)
<b>12</b>	<b>SVEN MULLER (D)</b> Ma-con Motorsport DVV F312 <b>+45.153s</b>
	Q14-1m46.086s; Race 2 9th +10.584s (Q16); Race 3 15th +50.322s (Q11-1m45.530s)
<b>13</b>	<b>TOM BLOMQUIST (GB)</b> EuroInternational DMB F312 <b>+55.303s</b>
	Q4-1m45.514s; Race 2 3rd +3.018s (Q4); Race 3 10th +38.326s (Q9-1m45.355s)
<b>14</b>	<b>SEAN GELAE (RI)</b> Double R Racing DMB F313 <b>+56.183s</b>
	Q27-1m47.437s; Race 2 16th +17.106s (Q26); Race 3 18th +1m03.648s (Q25-1m47.218s)
<b>15</b>	<b>SPIKE GODDARD (AUS)</b> T-Sport DN F312 <b>+56.694s</b>
	Q26-1m47.276s; Race 2 24th -1 lap (Q29); Race 3 20th +1m19.308s (Q24-1m46.964s)
<b>16</b>	<b>NICHOLAS LATIFI (CDN)</b> Carlin DVV F312 <b>+57.796s</b>
	Q19-1m46.301s; Race 2 15th +16.496s (Q18); Race 3 R 6 laps-accident (Q17-1m45.822s)
<b>17</b>	<b>DMITRY SURANOVICH (BY)</b> Fortec Motorsport DMB F312 <b>+59.794s</b>
	Q29-1m48.596s; Race 2 22nd +22.014s (Q29); Race 3 19th +1m08.533s (Q23-1m47.596s)
<b>18</b>	<b>SANDRO ZELLER (CH)</b> Jo Zeller Racing DMB F312 <b>+1m00.737s</b>
	Q23-1m46.936s; Race 2 21st +21.510s (Q29); Race 3 NC -3 laps (Q29-1m47.782s)
<b>19</b>	<b>TATIANA CALDERON (CO)</b> Double R Racing DMB F312 <b>+1m04.155s</b>
	Q28-1m47.675s; Race 2 23rd +24.581s (Q27); Race 3 22nd +1m29.124s (Q28-1m47.763s)
<b>20</b>	<b>ANDRE RUDERSDORF (D)</b> Ma-con Motorsport DVV F312 <b>+1m31.679s</b>
	Q24-1m47.085s; Race 2 14th +15.752s (Q23); Race 3 24th 7 laps-accident (Q23-1m46.725s)
<b>21</b>	<b>MICHELA CERRUTI (I)</b> Romeo Ferrari DMB F313 <b>+1m33.147s</b>
	Q30-1m48.836s; Race 2 R 8 laps-spun off (Q30); Race 3 21st +1m21.158s (Q30-1m48.981s)
<b>22</b>	<b>ANTONIO GIOVINAZZI (I)</b> Double R Racing DMB F312 <b>18 laps-stalled</b>
	Q22-1m46.486s; Race 2 12th +13.273s (Q22); Race 3 13th +42.927s (Q21-1m46.332s)
<b>23</b>	<b>JOSH HILL (GB)</b> Fortec Motorsport DMB F312 <b>-1 lap</b>
	Q9-1m45.806s; Race 2 8th +9.279s (Q15); Race 3 12th +42.195s (Q14-1m45.717s)
<b>24</b>	<b>GARY THOMPSON (IRL)</b> Romeo Ferrari DMB F313 <b>-1 lap</b>
	Q25-1m47.131s; Race 2 20th +20.600s (Q24); Race 3 17th +55.293s (Q26-1m47.223s)
<b>R</b>	<b>MITCHELL GILBERT (AUS)</b> Mucke Motorsport DMB F312 <b>16 laps-puncture</b>
	Q16-1m46.119s; Race 2 11 laps-spun (Q19); Race 3 23rd 7 laps-accident (Q19-1m46.143s)
<b>R</b>	<b>JANN MARDENBOROUGH (GB)</b> Carlin DVV F312 <b>16 laps-accident</b>
	Q18-1m46.189s; Race 2 11th +12.842s (Q17); Race 3 14th +47.397s (Q22-1m46.355s)
<b>R</b>	<b>LUCAS WOLF (D)</b> URO Rennsport DMB F312 <b>16 laps-accident</b>
	Q20-1m46.398s; Race 2 18th +18.791s (Q21); Race 3 R 6 laps-accident (Q15-1m45.748s)
<b>R</b>	<b>FELIX ROSENQVIST (S)</b> Mucke Motorsport DMB F312 <b>10 laps-accident</b>
	Q11-1m45.900s; Race 2 4th +5.160s (Q7); Race 3 11th +40.935s (Q12-1m45.547s)
<b>R</b>	<b>ROY NISSANY (IL)</b> Mucke Motorsport DMB F312 <b>0 laps-accident</b>
	Q21-1m46.424s; Race 2 17th +17.747s (Q20); Race 3 R 4 laps-acc damage (Q18-1m45.919s)
<b>R</b>	<b>MANS GRENHAGEN (S)</b> Van Amersfoort Racing DVV F312 <b>0 laps-accident</b>
	Q15-1m46.090s; Race 2 R 11 laps-accident (Q11); Race 3 NS (Q20-1m46.204s)

Race 1: Winner's average: 122.27mph. Fastest lap: Wehrlein, 1m44.743s, 123.71mph.  
Race 2: Winner's average: 80.73mph. Fastest lap: Wehrlein, 2m09.630s, 99.96mph.  
Race 3: Winner's average: 85.42mph. Fastest lap: Marciello, 2m10.903s, 98.99mph.  
Key: D=Dallara; MB=Mercedes-Benz; VW=Volkswagen; N=Nissan

### CHAMPIONSHIP

<b>1</b>	<b>MARCIELLO</b>	<b>55.5</b>	<b>6</b>	<b>BLOMQUIST</b>	<b>15.5</b>
<b>2</b>	<b>WEHRLEIN</b>	<b>49</b>	<b>7</b>	<b>BULLER</b>	<b>15</b>
<b>3</b>	<b>AUER</b>	<b>24</b>	<b>8</b>	<b>SERRALLES</b>	<b>14</b>
<b>4</b>	<b>TINCKNELL</b>	<b>24</b>	<b>9</b>	<b>ROSENQVIST</b>	<b>12</b>
<b>5</b>	<b>LYNN</b>	<b>19.5</b>	<b>10</b>	<b>KING</b>	<b>7</b>

#### POINTS SYSTEM EXPLAINED

In each race: 25-18-15-12-10-8-6-4-2-1 to top 10 finishers. NB Race 3 was half-points.



Marciello leads Wehrlein through the Monza rain

# Marciello storms to Monza double success

WHILE FERRARI HERO FERNANDO ALONSO was enduring a miserable Malaysian Grand Prix, the team's young Italian protege was getting his Formula 3 European Championship campaign off to a flying start thanks to two wins within the storied walls of the Autodromo di Monza.

Well, make that one and a half wins actually, for Raffaele Marciello's second success of the weekend came in streaming wet conditions that ultimately caused the truncation of the final race before the 75-per-cent-distance cut-off point required for full points to be awarded.

It was a great weekend's work for the Swiss-born Italian, who is as mild-mannered out of the car as he is spectacular and brave in it. Particularly so as Pascal Wehrlein, the only other race winner (and the only man to take points from Marciello), is not even racing in F3 beyond the Monza weekend. So, while Marciello's points lead is 6.5 over Wehrlein in black-and-white, effectively it's a gargantuan 31.5 over Harry Tincknell and Lucas Auer.

Marciello's performance topped a brilliant weekend for the Dallara-Mercedes-equipped Prema Powerteam in this, the first race outing of its 30th-anniversary season. All four of Prema's drivers – Marciello, Auer, Alex Lynn and Eddie Cheever – went top-eight in both qualifying sessions, and its star driver, mindful of "a lot of zeroes" in his maiden Euro F3 season last year, was driving very much with the title in mind.

His trickiest task could have been race one, which he started from third on the grid behind Wehrlein and Auer, but a lightning start from Marciello took him straight into the lead. Wehrlein clung onto second, but aerodynamic changes applied by the Mucke Motorsport team to its quartet of Dallara-Mercedes for the race did not work and he was struggling to hold off Auer.

Wehrlein, aware that too persistent a defence of second could allow the chasing Tincknell and Will Buller to close and leave him further vulnerable, elected to concede to Auer so they

could draw away in tandem. It worked to a point as he then set fastest lap in the Austrian's slipstream, but when he outraked himself into the Rettifilo chicane with three laps remaining he was condemned to third place.

Marciello's title focus was even more evident after the wet second race, in which he lost the lead to Wehrlein after being baulked by Spike Goddard, who was recovering from a spin, through the Lesmos. "Spike blocked me a bit, but it's OK," he shrugged. "I didn't fight Pascal, and I think he would have overtaken me in any case."

The third race, even wetter, was simply a case of survival, with very little overtaking. As long as Marciello kept it on the track, the win was always going to be his.

In that race, Marciello and Wehrlein pulled away from third-placed Lynn at an extraordinary two seconds per lap. For the Brit, at this point it was important not to make any mistakes after an up-and-down weekend, which included two visits to the gravel in first qualifying and a trip down the Rettifilo escape road on the first racing lap. His climb from 14th at the end of lap one to eighth, via some solid dispensing of a wildly-slipstreaming midfield group, was arguably his best performance of the event.

Tincknell had a very solid weekend to lead the Carlin Dallara-Volkswagen squad with a trio of top-six finishes. He didn't have the pace to hold off Will Buller for fourth in the opening race as the T-Sport Dallara-Nissan stormed through from 12th on the grid. Tincknell would also concede fourth in race two, this time to Mucke man Felix Rosenqvist, who otherwise had a disappointing time after heading free practice. F3 rookie Jordan King, his team-mate at Carlin, was close at hand for most of what was a weekend of promise.

Now the task for all these UK guys with their UK teams is to try to do something about Marciello. If he beats them next time out on their home ground at Silverstone, he'll be looking very good for the crown.

## IN THE PADDOCK

# Marcus Simmons Wehrlein's victorious swansong



Lucas Auer doesn't deserve to have his opening European F3 weekend of 2013 remembered for an embarrassing crash out of third place in race two, when he aquaplaned into the barriers behind the safety car.

The nephew of Gerhard Berger, whose last European F3 win came at this track in June 1984, was on form at Monza. He only did a couple of events at this level of F3 at the end of 2012, so to beat Pascal Wehrlein to second in race one was pretty impressive.

Auer was the unlucky one behind the safety car. As Harry Tincknell explained, when the tyre pressures go down, so does the ride height, and it's actually harder to keep control on the water than when you're cutting through it at racing speed.

The safety car pretty much plagued activity on Sunday, which was a massive shame as everyone had been pumped up by Saturday's great race and the mega 30-car field. A spate of mid-race accidents in the finale meant it came out yet again and, with weather conditions ever worsening, it was decided to red-flag it with nine minutes left rather than go racing again. Or was the biggest worry that they could not keep control behind the safety car?

Either way, F3 continues to be the best proving ground for Formula 1, this time by calling off track activity in the wet...



Auer finished second in race one

## MILESTONE

Red Bull junior Tom Blomqvist gave the EuroInternational team a podium on its debut weekend in the F3 European Championship.



### BY THE TIME YOU READ THIS, PASCAL

Wehrlein will be starting his new life as a DTM driver with a test at Barcelona in his RSC Mücke Motorsport Mercedes C-Coupe.

The German was understandably keen for his Formula 3 swansong to include a victory, and started the weekend in style with a double pole position for races one and two, but the win did not come until Sunday morning with a very strong performance in the wet.

Wehrlein fell off the road at the first Lesmo on the opening racing lap, skimming the gravel trap and conceding the lead to Raffaele Marciello. But his pressure on the Italian paid off when he was able to retake the lead with a clean move at the Ascari chicane.

"It's great because this is my last weekend in F3, so big thanks to the team," said Wehrlein, who has been with Mücke since his car-racing career began as a 15-year-old in Formel Masters.

But who is going to replace the German in the vacant Mücke Dallara-Mercedes? Prema refugee Michael Lewis was evident in the paddock at Monza, and the American



Wehrlein signed off with a victory

confirmed that, after landing from a recent transatlantic flight, his phone immediately beeped with a call from the Berlin-based team.

Nothing is done yet, because Lewis needs to confirm a budget, while Mücke chief engineer Peter Fluckiger would not be drawn at all on the subject. But don't be surprised to see Lewis behind the wheel of the orange machine next time out at Silverstone.

## Grenhagen has violent triple-roll

### MANS GRENHAGEN, JORDAN KING AND WILL

Buller all emerged unscathed from a frightening accident in the second race at Monza, in which Grenhagen performed a triple barrel-roll aboard his Van Amersfoort Racing Dallara-Volkswagen.

A mistake by Buller, where he strayed onto the grass at Parabolica, had brought the Northern Irishman into the clutches of King, who in turn was being chased by Grenhagen as they all battled for seventh.

Into the Rettifilo chicane, Grenhagen took off over King's rear wheels, then bounced off the track into Buller, an impact that launched him into the roll.

Remarkably, European F3 Open graduate Grenhagen was optimistic that the VAR mechanics could rebuild the car for the third race, but he was praying for miracles. Nevertheless, the carbonfibre tub is intact and it will be fine for the next round at Silverstone.

"I saw King make a mistake at the Parabolica [something the Brit disputed]," said the Swede. "I was quite close, but down to the braking point I could not see the signs because of the spray all over my visor, and I couldn't judge when to brake.

"When I braked, I locked my wheels and after one second saw King's car – I had no time to move. I shunted into his car and didn't even notice I was hitting Buller, because I had my eyes closed, hoping for the best!

"The funny thing is I feel good. I'm not hurt anywhere. I'm very lucky – it could have been a lot worse."

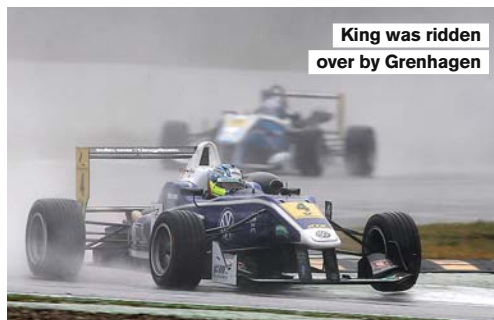

King was ridden over by Grenhagen

### BULLER LOSES TEST-PACE FORM

Will Buller was the star of pre-season testing, but the best he could manage in qualifying was a disappointing ninth in his T-Sport Dallara-Nissan. With track temperature up to 33C on Friday, the balance had gone, and T-Sport's lack of experience on the Hankook tyres left him struggling to recapture form. The team improved handling for racing, where he did a lot of passing.

### BLOMQVIST'S FOAM PROBLEM...

EuroInternational had a scare in scrutineering when Tom Blomqvist's fire extinguisher was found to be empty after both qualifying sessions. A dash to the Dallara factory for two replacements on Friday night by team boss Antonio Ferrari remedied the problem, and Blomqvist finished third in race two.

### ...AND CLASH WITH ROSENQVIST

One person unhappy with Blomqvist was Felix Rosenqvist, whom he spun out of sixth place in the opening race, an offence for which Blomqvist earned a drive-through penalty. It was an uphill battle all weekend for Rosenqvist, one of the title favourites. The Mücke Motorsport team reckoned it was down to his not getting a tow in qualifying, and a fourth place in race two was his only points-scoring finish of the weekend.

### FERRARIS HOPE FOR THOMPSON

The Romeo Ferraris team hopes to continue with Irishman Gary Thompson beyond the Monza weekend. Thompson performed respectably, bearing in mind he had had just one day in a current-spec Dallara under his belt pre-weekend. Team boss Dario Calzavara said: "Eight weeks ago there was nothing, not even a truck, and we only did our first shakedown on March 4!"

### MARDENBOROUGH CLOSE TO POINT

Nissan GT Academy protege Jann Mardenborough narrowly missed out on points on his F3 debut with Carlin, taking 11th in race two. The Welshman raced well in the hectic midfield scrum in race one and was unlucky to be involved in a shunt: "In GTs you can show your nose and a lot of the time the position is yours. In this you have to work for it – it's a lot more aggressive!"

### HILL'S BAPTISM OF WATER

Josh Hill had never raced at Monza, or driven a current-spec F3 car in the rain, so to finish eighth in race two in his Fortec Dallara was a sound effort. A qualifying spot of ninth, after intelligently using the tow, was also impressive. But he was not too popular with team-mate Pipo Derani, whom he punted down the field on the first lap of race one. "They were three-wide, the track was blocked. I had to go somewhere," said a contrite Hill.

# IT DOESN'T GET ANY

With 32 drivers, including four former champions, 11 different makes and wall-to-wall TV coverage, the



# CLOSER THAN THIS

2013 British Touring Car championship promises to serve up another vintage, door-banging season's racing



61

# THE BRITISH TIN-TOP

All the signs are that this season will be a close and exciting one in the BTCC. **KEVIN TURNER** outlines



62

**T**he 2013 field is arguably the best British Touring Car entry since the days of Super Touring. A returning champion, more NGTC machines, and a few rules tweaks mean there are genuinely around a dozen drivers who could win races on merit. We could even get a capacity 32-car grid during the season.

The benchmark, however, remains the same. The Honda Civic took 14 wins last season, not to mention every championship prize going. Reigning champion Gordon Shedden and works Honda team-mate Matt Neal have finished one-two in the drivers' standings for the past two years so it would be brave to suggest they're not favourites heading into Brands Hatch this weekend.

Shedden is certainly confident, despite the increased competition. "I've got as good a chance as anyone else," he says. "The Civic was really good last year and we've worked hard over the winter to try to improve it."

Shedden and Neal undoubtedly make a strong team and the momentum is certainly with them at the moment, providing they don't get hit too hard by the series' boost-equalisation system.

All the teams have been affected by poor weather during testing, so the form has been

difficult to gauge, but chief among the threats to the Team Dynamics Hondas is likely to be double champion Jason Plato. His new Triple Eight-run works MG6 was the top qualifier last year, but poor pace in the wet helped limit him to third in the final table.

Trying to find a solution to that has been the one thing that team boss Ian Harrison believes has been good about the poor British weather. "We've been thrashing round in the wet when everyone else has been drinking coffee!" he says.

Plato himself believes the squad has a better handle on the car, but knows it is still not perfect. "We're a bit better prepared than last year," he says. "I think we're in good shape and it'll be a really competitive year."

"We were *the* pace in the dry last year. Our Achilles' heels were unreliability and pace in the wet. Our difficulty is improving it in the wet without compromising it in the dry, which ultimately we'll have to do a little bit. I still think we'll be playing catch-up in the wet."

Plato underlined his dry-weather pace in Snetterton testing, and was second fastest on the media day at Donington Park. He's also got a new team-mate in the form of Porsche Carrera Cup race winner Sam Tordoff and the feeling is that he will be a more competitive proposition for MG than Andy Neate, who has left to set up his own Chevrolet Cruze operation. ▶

# BATTLE STARTS HERE

a few of the key things to watch out for, including new drivers, new cars and tweaks to the regulations





# 'It would be brave to suggest that the Team Dynamic Honda Civics were not favourites'

## STRONG AND INDEPENDENT

The biggest improvements to the field are probably among the top Independent teams. After several years working with one S2000 technical disadvantage or another (no turbo, then smaller brakes and tyres than the opposition), WSR finally now has an NGTC project in the shape of the BMW 125i M Sport.

The new machine has bigger tyres, bigger brakes, and a wider track than the outgoing 3 Series. Dick Bennetts' squad has also added 2009 champion Colin Turkington to the line-up, alongside Rob Collard and Nick Foster, so all the ingredients are there to challenge at the front.

Given how new the car is – it has only started testing in recent weeks – it's unlikely to be right at the front straight away. Turkington was only 10th fastest at the media day, but rival teams believe the BMW will become a threat.

Motorbase team manager Oly Collins, who will run two NGTC Ford Focuses for Mat Jackson and Aron Smith, certainly thinks so. "There are very definitely 12 cars I can see that will be strong and the interesting ones will be the BMW and [Rob Austin Racing] Audi," he says. "Rear-wheel drive has always been an advantage and cars have been ballasted, but because these are new rules they are running the same weight. I think at some

point they will have an advantage."

Nevertheless, Motorbase itself can't be discounted. It now has greater understanding of its NGTC Focus, which was introduced mid-way through last season and became a winner. It also has a strong driver line-up in Jackson, who has fought for the title before and was second in 2008, and Smith, who impressed last year in an S2000 Focus and took his first win at the Brands finale.

"Last year, every race was a test," adds Collins about the team's NGTC project. "This winter we've been able to take stock and get everything as it should be.

"Aron proved last year he's no slouch and has a good head on his shoulders. I'm relishing having



Jackson should be a threat in sorted NGTC Motorbase Ford Focus

EBREV/LAT

two drivers that can push each other.

"I think it'll be the best year ever for competitiveness in the BTCC."

Eurotech and its Honda Civics beat both WSR and Motorbase to the Independents' titles last year and, like them, the squad's target is now taking on the works outfits for the overall crown.

Reigning Independents champion Andrew Jordan certainly has the speed to be a title contender. He was the second highest qualifier on average in 2012 and he topped the media-day test, setting a time quicker than last year's pole.

For team boss Mike Jordan, 2013 is more about a change of attitude than any major tweaks with the machinery.

"We have to set our sights and challenge [for the overall crown]," says Jordan Sr, who has brought in ex-Audi DTM engineer Dave Benbow to oversee Jeff Smith's car, leaving him in a broader team-boss role.

"To go up against Dynamics and Triple Eight is a big challenge for a small team like us, but that's what we've got to do.

"Andrew had never won in a big circuit-racing championship before last year. Now he's got that monkey off his back I think he'll relax a little bit. I think that will make a huge difference to him. He's fast enough to do it."



Reigning champion  
Gordon Shedden will  
be in the spotlight

## OTHER CHALLENGERS

The Toyota effort should be better this year, too. Paul O'Neill demonstrated the pace of Speedworks Motorsport's Avensis at Knockhill last year and new recruit Dave Newsham has the speed and experience to be a regular frontrunner. It will also be interesting to see how late signing Ollie Jackson, who had a troubled 2012 with AmD, compares with double reversed-grid race winner Newsham.

Frank Wrathall's Toyota-engined (as opposed to TOCA-motivated) version won at the end of 2012, while Adam Morgan – now running under his family's Cicely Racing banner – needs to avoid the incidents that prevented the rewards his speed deserved last season.

Like Wrathall, Rob Austin and Daniel Welch were among the first to go down the NGTC route. Bad luck, budget issues and the odd scrape have so far prevented Austin's Audi A4s fulfilling their potential, but that could be different this year. Backing from Wix Filters has helped steady the ship and should leave Austin and team-mate Will Bratt to start making the most of the rear-wheel-drive machines.

Welch has a new team-mate in experienced tin-top racer David Nye, who will drive an S2000 Ford Focus. Welch sticks to his NGTC Proton and

should be a regular points contender if he can overcome the car's technical niggles.

The biggest question mark perhaps surrounds Tony Gilham's Team Hard operation. The ambitious team plans to run both Vauxhall Insignias and self-built Volkswagen Passat CCs. None has yet hit the track, but an interesting driver squad of race winner Tom Onslow-Cole, Renault Clio Cup champion Jack Goff, former single-seater racer James Cole and youngster Howard Fuller means points could be possible if everything comes together.

## REGULATION TWEAKS

There are few rule changes for 2013, the main one concerning the introduction of an option tyre. Dunlop has produced a soft tyre, based on one of its American Le Mans Series sportscar compounds, and drivers have to use it in one race per weekend (except Thruxton). They must also nominate the race in which they wish to use it before qualifying.

"It is to bring a degree of strategy and a new twist to it," says BTCC boss Alan Gow.

Some feel the softer rubber will be an advantage on some circuits, like Brands Hatch and Donington Park, but slower over a race run on more abrasive tracks such as Croft and Rockingham. Others feel the degradation will make it slower than the standard tyre more often than not.

Dunlop's Michael Butler says: "It's going to be quicker at some tracks. It'll be a season of learning, we've not had much testing. If we have to tweak it we will.

"It'll be about tyre management and it'll mix things up. But nobody's got any real data yet."

If there is an advantage, most top teams would likely use it in race one, to get the best result and help the grid slot for race two. If it is slower, race three seems a more likely option.

Whatever the case, Motorbase's Oly Collins still thinks the best drivers will shine through. "There are so many theories," he says, "but the top five drivers are going to know how to manage them," he says.

Apart from grid penalties being dished out for persistent on-track driving offences, the other change involves the boost-equalisation regulations. On top of tweaked baseline boost levels, the adjustments will take data from a three-race rolling average, instead of two-race as in 2012. The changes will kick in from Thruxton (based on just the Brands Hatch and Donington data) and the total extra boost allowed has been reduced from 0.125 bar to 0.08 bar, meaning that, at most, a car should only be able to run about 20bhp more than its base level at any given meeting.

The possibility of applying the adjustments to individual drivers or teams has been dropped, so changes will again be made to all the same models.

The hope is that the swings will be less extreme than last year, while still preventing any single car from dominating.

"I think it'll be better," says Eurotech's Mike Jordan. "This year there won't be such big swings. The scope has been narrowed down a lot so there won't be the chance for a bad car to do so well."

With teams increasingly getting on top of the NGTC regs, an enhanced driver line-up, and – hopefully – fewer arguments about boost, this season could be the best for years. And it would be a surprise if it didn't go down to the wire. ❄



Veteran Kaye  
will fight for JST  
title in AmD's VW

## JACK SEARS TROPHY

A new addition to the BTCC this year is the Jack Sears Trophy, named in honour of the series' inaugural champion and created to give the ageing Super 2000 cars a new lease of life.

With S2000s deliberately being left behind in performance terms compared with the newer NGTC machines, the trophy will not be contested by the overall frontrunners, and will doubtless draw much-needed attention to some spirited performances in the midfield.

Five cars look likely to contest the trophy in its inaugural campaign, and chief among the protagonists is two-time BTCC independents' champion James Kaye, who has AmD Tuning's Volkswagen Golf at his disposal and is likely to face stern competition from Lea Wood, campaigning last year's Vauxhall Vectra.

The pacesetter at last Thursday's Donington test was, surprisingly, Liam Griffin, whose Motorbase Ford Focus is a proven outright racewinner. Former one-make racer David Nye makes his BTCC debut in a Focus run by Welch Motorsport, while Production Touring Car Trophy graduate and fellow debutant Joe Girling runs an ex-RML Chevrolet Cruze run jointly by Tech-Speed and Clio Cup squad Finesse Motorsport.

## DAVID ADDISON: ITV'S NEW BTCC COMMENTATOR

Is this the biggest commentary job of your life?

**DA:** Absolutely. I've done live TV before for FIA GTs, Superleague Formula and others, but this is one of the biggest and best championships in the world. It's a real privilege to have such a great bunch of people at ITV Sport both on the presentation side and behind the scenes, and to have the chance to broadcast to such a knowledgeable audience as the BTCC fans.

What was your first BTCC experience?

**DA:** Oulton Park in March 1978. It was two fairly small grids because it was in the days of the class system and the field was spilt according to engine size. Gordon Spice won the race for the big cars in his Capri and Richard Lloyd was very much the man to beat in the VW Golf GTI in the race for the smaller-capacity cars.

Who is your tip for the title?

**DA:** Jason Plato is always my starting point because he's like Fernando Alonso or Garth Tander – he can take a car that should be fourth or fifth and win races in it. He's like a magician in the way he can conjure a result. For anyone to beat him, like Gordon Shedden did last year, they have to be damn good.

David Addison was talking to Jamie O'Leary

# How 'Airfix' approach transformed BTCC kit

The clever NGTC regulations have allowed works teams and privateers to compete in the BTCC on an even keel, as **MARCUS SIMMONS** explains



Honda, MG and Toyota have proved NGTC car's worth

**T**he never-ending balancing act of accessible motor racing is critical to the success of most modern-day championships, and the British Touring Car Championship is no exception. With manufacturer-supported top teams such as Dynamics and Triple Eight staffed by leading engineers, you're never going to get these guys to unlearn their knowledge and stop stealing an advantage. But you can make it possible for plucky privateer operations to at least have a chance of glory on a smaller budget. That's where the NGTC regulations come in.

GPR Motorsport won the five-year contract to build the BTCC's standard chassis in 2010. In typical motorsport fashion, the Buckingham-based company had just 16 weeks after winning the NGTC tender to build a new-spec Toyota Avensis that would be demoed by James Thompson at that year's Brands Hatch season finale. Now, on the eve of the 2013 season, GPRM is knocking on 20 chassis built. And counting.

GPRM is fronted by engineering chief Roger King and operations and spares boss Gary Blackham. King cut his teeth on design of the much-loved Group 2 Ford Escorts for Broadspeed, where he became firm friends with the team's young driver Andy Rouse. Through

the 1980s and up to the mid-'90s, King worked as engineer with Rouse, on machinery such as the Ford Sierra RS500s, Toyota Carinas and Ford Mondeos. Here, he first came into contact with Alan Gow, freshly arrived in the UK and fronting the sales department for Rouse, before moving on to run TOCA and the BTCC. "In those days he used to smile!" jokes King.

Meanwhile, Blackham's background was in Group C Spice and Aston Martin projects, before he joined up with King at Audi Sport UK, where they helped win the BTCC for the German manufacturer first time out in 1996.

After stints for King at Triple Eight and for Blackham at Bentley's initial Le Mans test programme, they formed GPRM. Projects have included design on the 2002 BTCC Honda Civic, chassis work on Rouse's SCV8 Jaguar and the JCB Dieselmax land-speed record car, as well as sub-contract work for Toro Rosso in Formula 1. It is now also planning to build customer versions of its new Toyota GT86 GT4 racer.

"As a company, we wanted to model our package on Broadspeed," says King, "as a one-stop engineering solution, looking after manufacture, design and build. We have a big, modern CNC shop, design and fabrication facilities, nine or 10 welding plants and a car workshop. We do 90 to 95 per cent of our machining in-house. Because we were in the right position, with our vision of manufacture



Blackham (l) and King spearhead GPRM

and design, that put us in a good position to take on the NGTC project."

"When we pitched for it, it was in the expectation of a shared project with TOCA," adds Blackham. "We put some investment into the original prototype. The idea was to make a cost-effective, controlled-component car. To a degree that's been lost in revisions over the past 18 months. Some people say that's a natural development, but costs have moved things on.

"When we started off, building the first Avensis cars and the Audi A4s, we were working to a budget that was £60,000 less than it is now, but since then teams have spent a lot of money building up cars. Unfortunately it does mean that we've been tarred with a brush that's unjustified by people who didn't understand the concept."

King points out: "Alan Gow's original brief is still there. You can take a frame from a Toyota and fit it in a Honda. The problem is it costs quite a lot of money, but from then on the



EBREV/LAT

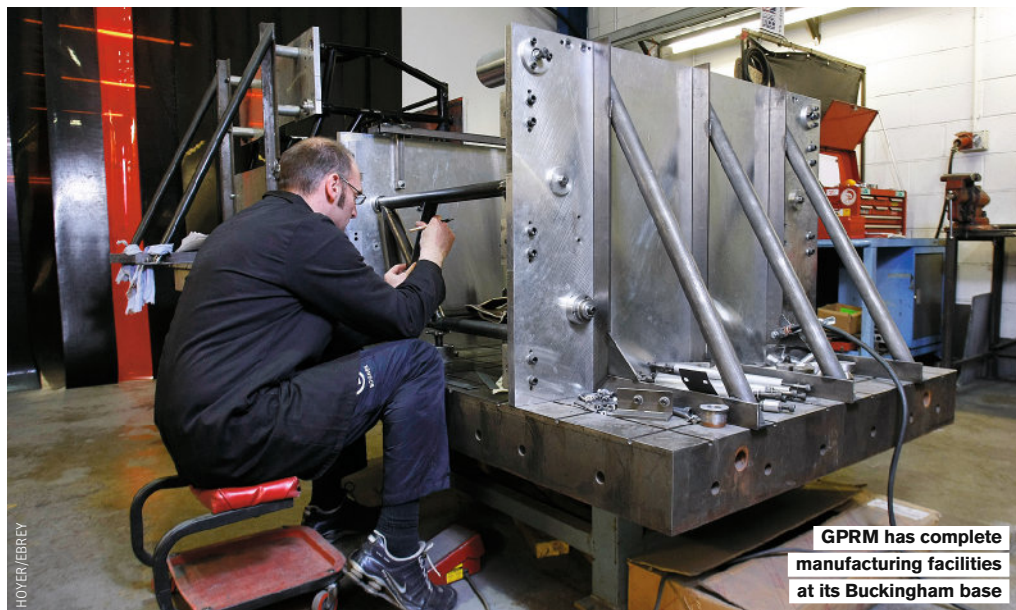

HOVER/EBREY

GPRM has complete manufacturing facilities at its Buckingham base



King started his career working on Broadspeed Escorts

LAT ARCHIVE

# “Alan Gow realised that manufacturers would not be around to put millions in”

running costs, with spares and so on, diminish rapidly. We carry all spares to the circuit and the cars are pretty robust.”

“Alan understood that there were so many variants,” adds Blackham. “Peter Riches [BTCC technical director] did a lot of homework on wheelbases and all of that, and Roger had to come up with a base design that fitted everything. The new Honda Civic didn’t quite fit the envelope, and that had to have slightly revised design work – we had to revisit certain areas and design and modify it.” [It should be pointed out that Dynamics design and race engineer Eddie Hinckley was involved in working on the original design of the NGTC with King].

Effectively, teams buy a kit from GPRM, comprising wishbones, subframes, axles and uprights, before building up their cars. As such, ‘Airfix-model’ BTCC racing has allowed new privateer teams through the doors. “Dynojet, Speedworks and Tony Gilham would never have

been able to afford to build cars in days gone by,” says Blackham. “I think Dynojet would admit it was more expensive than they thought at first, but two years down the line it’s cheaper. Also, Toyota were massively supportive – they’d never have been in a position to go racing otherwise – and the Proton wouldn’t have happened in any other circumstance.”

“There’s a website the teams have access to with the build manuals and technical drawings,” says King. “It’s the same with AP [brakes], Cosworth [electronics] and Xtrac [gearbox]. That’s available to all the teams.”

The demands of front- and rear-wheel drive mean that the front subframes are different on the two concepts, but the mounting points are the same across the board. Interestingly, the arrival of WSR’s new BMW 125i, with an engine position different from the norm for rear-wheel-drive cars, means that Rob Austin Racing can change the siting of the powerplant in its Audi

A4, under the TOCA philosophy that no team should be disadvantaged by the arrival of a new model of car.

The development of that new BMW also represents the latest milestone in the changing of the BTCC landscape. Since Dynamics’ success with its NGTC Civic in 2012, and Triple Eight’s new MG6, it’s been clear that the new concept is the way to go. “To begin with, it was a fairly hard sell for Alan and TOCA,” says King. “Each team had their own engineering capabilities – Triple Eight had seven designers!”

“But Alan saw that the manufacturers would not be around to put the millions in,” adds Blackham. “It was a brave move to come up with the concept. He sold it to new privateers, but the big change came when Triple Eight and Dynamics changed people’s perceptions of what was going on. Meanwhile, Motorbase were working quietly on their new Ford Focus and when that was quick straight away the writing was on the wall.” ❖

**The 2009 season was a breakthrough one for you in the BTCC. How disappointing was it not to be able to defend your crown the following year?**

It was heartbreaking at the time. That year was the highlight of my career – my ambition as a youngster was to race in touring cars and try to win, and we achieved that. But you never know what's around the corner and I didn't expect to be out of racing the next year. Ultimately, 2009 was the last time the BMW was truly competitive and we had a real chance of winning. The timing is now good to come back, especially in a brand-new project like this, with a car with so much potential.

**Did you always hope to return and was WSR always the team you aimed to come back with?**

Every year I tried to be on the grid with whoever. I spoke to a lot of teams, but WSR was probably always going to be my top pick because of the history we've had together. It just took a little bit longer than expected to make it happen.

**How did the 2013 deal come about?**

I came quite close in 2012. It didn't happen at the last minute so I thought to myself, 'I'm only going to give this one more crack. It's got to be next year or never'. There are only so many times you can knock on the door. I knew the intention was for [WSR boss] Dick Bennetts to do an NGTC car. There was an available seat once Tom Onslow-Cole moved on, but my situation is like everyone else's – you have to bring your own sponsorship. This time we were able to do that and hopefully we can have a strong year, which makes it easier to continue.

**How easy has it been to settle back into WSR?**

I was able to slot straight back in. I've driven for WSR so much there are so many familiar faces. There are a few new ones, but it's like coming home. There's no settling in period at all – it's like being back with your mates again. It's a really nice, relaxed atmosphere.

**What did you miss most about the BTCC?**

I missed the excitement and buzz of the race weekends. I raced in World Touring Cars and in Sweden, but none of those race weekends come close to what the feeling is like on a busy day at Brands Hatch or something, with the crowds you get and the buzz you feel.

# TURKINGTON RETURNS WITH A POINT TO PROVE

The 2009 champion returns with WSR this season and he has a brand-new NGTC BMW too. **KEVIN TURNER** caught up with him

**Quite a lot has changed in the series since you last raced in it – turbos are back, the NGTC rules have arrived, and Gordon Shedden has finally won the championship. How healthy do you think the series is now?**

For sure it's healthy when you look at the grid we're going to have this year and the level of competition – it's coming from all angles now. I think the NGTC rules have probably levelled the playing field. There are a lot more guys who can challenge for wins because everybody has got the common parts.

**What are your targets for 2013? Do you think being away will present any disadvantages?**

At the moment it's got to be one step at a time. We'll realise the potential of the car in the coming weeks. At Brands it's to just try to do a good job with the car. I think we might struggle to match the ultimate pace at the first couple of events, so we have to be realistic. There's a huge learning curve ahead, but there is a strong team of engineers at WSR, and experienced drivers, so hopefully we can be in the mix. To be honest, being away has done me good on the mental side. I think it's good to



Turkington raced WSR Chevy Cruze in Shanghai WTCC round in 2012



WSR BMW 125i gives '09 champ chance of title #2

have a break from something so that you can come back feeling refreshed and hungry.

### What do you think the strengths and weaknesses of the new BMW will be?

If you ask the other teams if they think will this be a good package, I think they'd all agree it will be and are slightly concerned about its potential. With the two-litre turbos it's about putting the power down – and a rear-wheel-drive car offers traction advantages. Hopefully we can be strong out of the slow corners. It looks like it takes a few laps to get the tyres to come in and that was a problem with the 3-series. That could be the new car's Achilles heel, but these will be things we'll look at straight away.

### Do you consider Rob Collard and Nick Foster team-mates or rivals?

It's hard to know. I think everybody starts the year doing their own thing. It always helps when you have other strong drivers in the team – it raises the bar and people start to push. I think we have the right mix of drivers. 🏆

#### TURKINGTON BTCC STATS

Wins	19
Poles	9
Fastest laps	21
Titles	1 (2009)



#### TURKINGTON CV

Born Portadown, N Ireland Age 31

2012	Two races in WTCC with WSR
2011	5th in Swedish Touring Cars; six races in WTCC with Wiechers-Sport
2010	10 races in WTCC with WSR (1 win)
2009	1st in BTCC with WSR (6 wins)
2008	3rd in BTCC with WSR (4 wins)
2007	5th in BTCC with WSR (3 wins); four races in WTCC with WSR
2006	3rd in BTCC with WSR (2 wins)
2005	6th in BTCC with Vauxhall (2 wins)
2004	6th in BTCC with WSR (1 win)
2003	8th in BTCC with WSR (1 win)
2002	14th in BTCC with Team Atomic Kitten



# BTCC RACER v ROAD CAR

They may look similar, but there is quite a difference between a BTCC racer and its road-going equivalent. Our technical expert **Craig Scarborough** explains the changes



70

**O**ver the years British Touring Cars have evolved from modified standard cars through to the current breed of NGTCs. Historically, a model's success was largely down to the design of the car on which it was based, or the lengths to which a well-funded

manufacturer would go to improve it.

This meritocracy was all well and good, but it did limit which manufacturers could enter the series with a reasonable budget and a reasonable chance of success. Cars in the older era were very much modified production cars, while the current crop are very much pure-bred racers, albeit built to a budget.

Fundamentally, the current generation of touring car exploits a kit of bespoke parts and engine upgrades. The three key areas that separate an NGTC racer from its road-car cousin are the engine, gearbox and suspension.

## ENGINES

For more than 20 years the championship has imposed a limit of cars powered by two-litre engines. With touring car rules being set around the manufacturer's biggest sales category – the four- or five-door saloon – the engine also matches this sector's preferred powerplant. The four-cylinder, two-litre petrol engine is the ubiquitous choice for the company-car sector.

Getting more power from a production-based engine costs money, involves the replacement of key parts with specialist race items and hours of development on dynos. These costs are not sustainable, but fans want to see powerful cars that can set fast lap times.

So the two-litre regulations remain, but now the cars run turbochargers. This boosts power outputs to a level at which the racing becomes exciting, but is not as expensive a development route as traditional methods. These lower-stressed engines can therefore run many standard parts and do not need the extensive modifications used, for example, to make less-suitable cylinder heads work better.

For manufacturers without a suitable engine

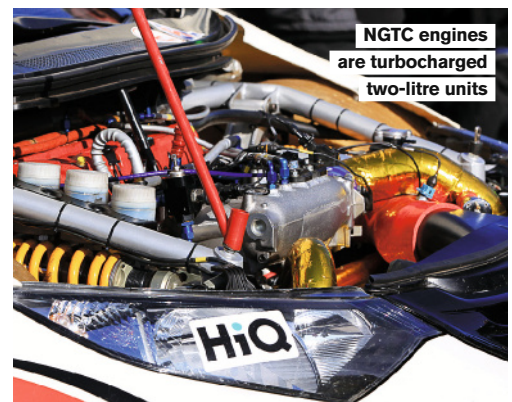

NGTC engines are turbocharged two-litre units

in their range, the TOCA engine is available. This is another example of the way the current rules aim to encourage new manufacturers to participate with a chance of winning.

## GEARBOXES

If engines have to be closely based on the road-car equivalent, the gearbox is a bespoke racing design. Due to the stresses involved, it's

Spot the difference:  
Ford Focus BTCC  
racer and road car



71

EBREY/LAT

not likely that a road car gearbox could be reasonably modified, and with such a wealth of specialist gearbox suppliers in the market, a purpose made set-up makes economic sense. Although the current gearbox was introduced in 2011, the use of homologated gearboxes has existed in the sport since 2001, with Xtrac the preferred supplier.

With six gears that are selected sequentially, the driver simply has to push or pull the oversize gear-lever to select gears. Flappy paddles are banned, but the gear shift mechanism will momentarily cut ignition to quicken upshifts.

One benefit for the chassis with this type of gearbox is the size of the gearcase: it's far smaller than a road-car equivalent, allowing the heavy engine to be positioned lower and further back. This repositioning helps with the handling, reducing bodyroll and understeer. The old Super Touring practice of having gearboxes and diffs ahead of the engine is no longer possible.

## SUSPENSION

Having balanced the cost and competitiveness of the powertrain, the current NGTC rules go

further by also trying to equalise the various chassis. Manufacturers are increasingly taking different routes with road-car suspension, from cheap and simple McPherson struts and beam axles, to complex double-wishbone or multi-link solutions.

Each of these options provides different geometry and, with a single tyre supplier in the series, making the most of the available grip is all down to the suspension. This rewards manufacturers at the higher end of the road-car market and penalises those opting to run the cheaper solutions.

It's not realistic for manufacturers to build a homologation special with a totally different suspension set-up. So, with a view to retaining the bodysell of the original car, the NGTC package replaces the original suspension with standard front and rear subframes.

These subframes are designed and made by GPRM. They sport double wishbones and pushrod-activated springs and dampers. This suspension layout apes cutting-edge practice in single-seater and GT racing. There are minimal changes needed to the bodysell

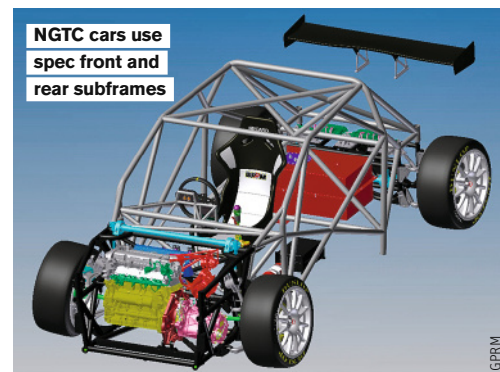

GPRM

to incorporate the subframes, since they bolt directly to the NGTC-specification chassis.

While levelling the playing field with standardised suspension layout, the subframes allow for the adoption of different mounting points and shims. This allows the teams' engineers to play with the suspension and, allied to the adjustability of the dampers, means a bit of hard work in this area can still reap the rewards out on track. 🏆



Trust the professionals.



## PEOPLE WHO KNOW USE VALVOLINE™

For more than a hundred years, mechanics have used Valvoline's top quality products to protect the world's fastest cars. These professionals understand that engines have to work in order to get the job done right. Valvoline is proud to announce another team of professionals embracing our top quality products. The 2012 BTCC Winning Honda Yuasa Team has partnered with us to secure yet another winning season. To see these professionals in action, join us for Round 1 of the 2013 Dunlop MSA British Touring Car Championship race event on Sunday March 31 at Brands Hatch circuit in Kent. For other events and more information about BTCC, please visit [www.btcc.net](http://www.btcc.net)

For more information on Valvoline products and to experience our passion for racing, go to [www.valvolineuk.com](http://www.valvolineuk.com)



Valvoline is a trademark of Ashland or its subsidiaries, registered in various countries. © 2013, Ashland

**Donington**  
The heart of British motorsport



# BRITISH TOURING CARS

## SATURDAY 20<sup>TH</sup> & SUNDAY 21<sup>ST</sup> APRIL

FAST AND FURIOUS COMES TO DONINGTON PARK

**BUY YOUR TICKETS NOW!**

**ADVANCE ADULT TICKETS\***

- SATURDAY £10
- SUNDAY £25
- WEEKEND £30

**CHILDREN 13 & UNDER GO FREE!**

\*Advance ticket prices end on Wednesday 17th April at 5pm



Telephone 0844 873 7343 · [www.donington-park.co.uk](http://www.donington-park.co.uk)



Official Donington Park Racing



@DoningtonParkUK

**ADRENALINE FILLED RACING THAT YOU DON'T WANT TO MISS!!**

# TEN AGES TO WATCH

## 1 Jason Plato

(MG – MG6)

**Wins 74 Poles 39 Championships 2**

He already has more wins than anyone else in BTCC history, and with a year of work now behind the Triple Eight-run MG, he's a surefire championship contender once more.



## 7 Rob Collard

(WSR – BMW 125i)

**Wins 7 Poles 0 Championships 0**

Probably the most improved driver of the past two years, Collard now blends great speed with his usual grit and determination. Has the potential to show Turkington up if given the chance.



## 2 Gordon Shedden

(Honda Racing – Honda Civic)

**Wins 29 Poles 9 Championships 1**

Stepped up a gear yet again last year and was rewarded with the title. With the Honda looking no weaker than 12 months ago, he will figure in the championship fight again.



## 8 Rob Austin

(Rob Austin Racing – Audi A4)

**Wins 0 Poles 0 Championships 0**

Brings British F3 race-winning pedigree and has shown great pace whenever his self-run Audi has allowed it. He needs better reliability and to avoid the scrapes of others to move up the points.



## 3 Matt Neal

(Honda Racing – Honda Civic)

**Wins 48 Poles 15 Championships 3**

The BTCC's most experienced driver is approaching his 500th start, but is as fast as ever. He'll be especially keen to avenge his defeat by Team Dynamics-run team-mate Shedden last year.



## 9 Frank Wrathall

(Dyenojet – Toyota Avenis)

**Wins 1 Poles 1 Championships 0**

Built on a solid first year in the BTCC by taking a maiden win at the 2012 finale. Has lots of potential, but taking another step forward will be hard for his small, family-run team.

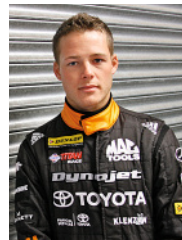

## 4 Colin Turkington

(WSR – BMW 125i)

**Wins 19 Poles 9 Championships 1**

Back after a three-year absence, Turkington is the great unknown, largely because his NGTC BMW is brand new. WSR has been there before though, so it should be ultra-quick and win races.



## 10 Dave Newsham

(Speedworks Motorsport – Toyota Avenis)

**Wins 2 Poles 0 Championships 0**

Speedworks showed its true colours when Paul O'Neill jumped in the Avenis last year, and race winner Newsham should help it continue to climb up the grid.



## 5 Andrew Jordan

(Eurotech Racing – Honda Civic)

**Wins 4 Poles 2 Championships 0**

The reigning Independents' champ has his eyes on a bigger prize this season. He has shown he has the pace, now he just needs to add that regular points-scoring knack. Could be a dark-horse for the title.



## 6 Mat Jackson

(Motorbase Performance – Ford Focus)

**Wins 19 Poles 2 Championships 0**

An early switch from S2000 to NGTC Focus last August derailed his 2012 title hopes, but he's already won a race in it, proving the validity of his choice. Always races better than he qualifies.



## CALENDAR

DATE	LOCATION
March 31	Brands Hatch Indy
April 21	Donington Park
May 5	Thruxton
June 9	Oulton Park
June 23	Croft
August 4	Snetterton
August 25	Knockhill
September 15	Rockingham
September 29	Silverstone
October 13	Brands Hatch GP



Shedden took title last year for Honda

## PAST FIVE CHAMPIONS

YEAR	DRIVER
2012	Gordon Shedden (Honda)
2011	Matt Neal (Honda)
2010	Jason Plato (Chevrolet)
2009	Colin Turkington (BMW)
2008	Fabrizio Giovanardi (Vauxhall)



A total of 21 cars made it to the season launch

**NEW RULES** The big change is the introduction of a soft Dunlop tyre, which drivers have to use in one race per weekend. The boost-equalisation system has also been tweaked. It will be done on a three-race rolling average, instead of two, and adjustments will be smaller.

**SENATE  
GRAND PRIX**  
.....  
EXCLUSIVE HOSPITALITY

# Monaco Grand Prix 2013

**The finest selection of accommodation, race-viewing and exclusive hospitality packages.**

Senate Grand Prix specialises in providing the F1™ teams, drivers, sponsors, as well as a vast array of corporate and private clients with the finest hotel accommodation and race viewing hospitality for the worlds most glamorous race.



## ACCOMMODATION

We have the largest range of accommodation options in Monaco and the surrounding area:

- Over 800 rooms to choose from
- Trackside hotels available
- Multiple Nice hotel options
- Transport to Monaco available



## RACE VIEWING

Watch the race from the best locations around the circuit with VIP hospitality:

- 10+ locations to choose from
- Exclusive Hotel de Paris suites
- Shared or private facilities
- Fully catered VIP hospitality



## EXCLUSIVE EVENTS

Senate Grand Prix has the contacts and know how to open all doors to you in Monaco:

- Meeting drivers and teams
- Exclusive party access
- Dinner at the best restaurants
- Senate Concierge service

**Please call us now or visit our website for more details of the packages we offer for the 2013 Monaco Grand Prix**

**Tel: +44 (0) 1342 830495**  
**f1racing@senategrandprix.com**  
**www.senategrandprix.com/f1racing**



# Numbers crunched

## TOP-10 WINNING DRIVERS

While the current three-race format has had a hand in Jason Plato's lofty total, there's no denying the incredible strike rate of the two-time champion since his 1997 BTCC debut. He has won in Renault, Vauxhall, SEAT, Chevrolet and MG machinery.

### DRIVERS

1	Jason Plato	74
2	Andy Rouse	60
3	Matt Neal	48
4=	Alain Menu	36
4=	Yvan Muller	36
4=	James Thompson	36
7	Frank Gardner	35
8	Gordon Shedden	29
9	Gordon Spice	28
10	Fabrizio Giovanardi	24



## TOP-10 WINNING MARQUES

Ford is way out front in this league, having won for the first time as long ago as 1963. Vauxhall is 102 wins behind, but only started winning in 1991. Honda could grab second place in the table with another title-winning campaign this year.

### MAKES

1	Ford	235
2	Vauxhall	133
3	Honda	114
4	Chevrolet	79
5	BMW	71
6	SEAT	44
7	Jaguar	43
8	Rover	39
9	Renault	38
10	Nissan	25

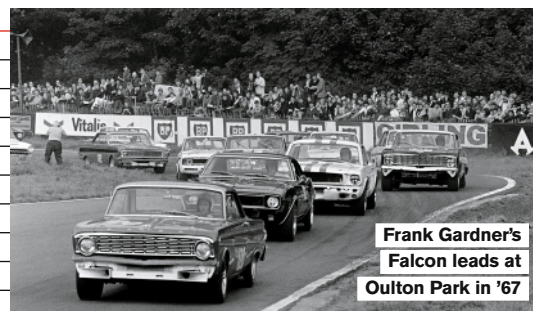

## DID YOU KNOW?



Matt Neal has contested more than half the BTCC races run since its inception in 1958 as the British Saloon Car Championship. At the Donington Park round in April, the three-time title-winner is set to make his 500th start in the series. Jason Plato, the BTCC's record race winner, is likely to chalk up his 400th start during 2013.

## LONGEST TRACK SNETTERTON (2.969 Miles)

Snetterton

## SHORTEST TRACK BRANDS HATCH INDY (1.198 Miles)

Brands Hatch Indy

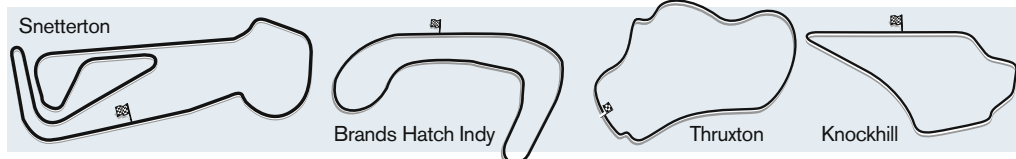

## FASTEST TRACK THRUXTON (110.22MPH)

Thruxton (110.22mph)



## SLOWEST TRACK KNOCKHILL (80.11MPH)

Knockhill (80.11mph)



\*Based on 2012 dry pole times

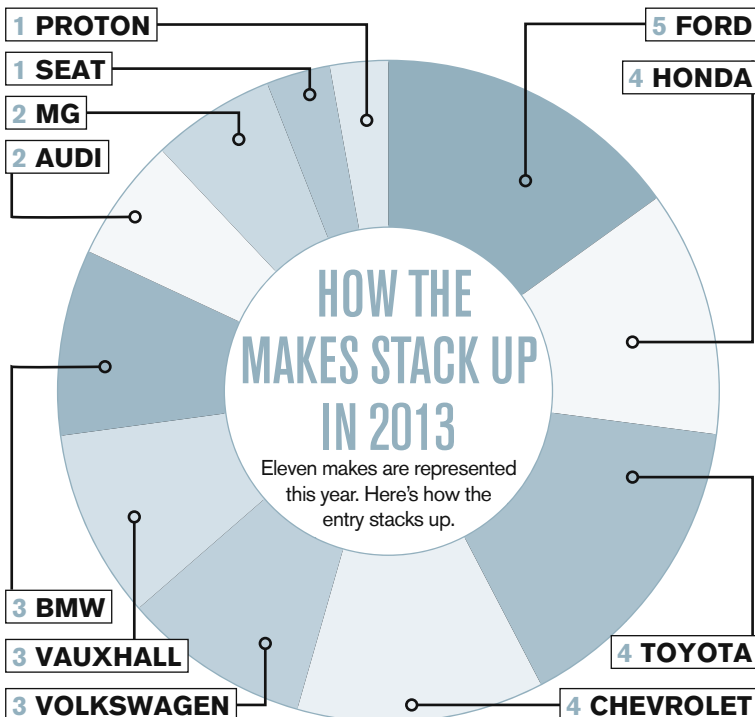

## DID YOU KNOW?

Jack Sears Trophy contender James Kaye already has three BTCC titles to his name. He repeated his 1992 TOCA Privateers' Cup success two years later (pictured), each time driving a Park Lane Toyota Carina E, and then added a title in the short-lived production class in 2002, this time in a Barwell Honda Accord.



## itv4 HOW TO WATCH THE BTCC

If you can't make it to any of the rounds this year, don't worry as ITV is back with its unrivalled coverage of the series. Every round will have seven hours shown live on ITV4, ITV4 HD and via the ITV Sport website. Hour-long highlights packages will be screened on ITV and ITV HD, ITV4 and ITV4 HD and the website.



# Web Directory

## CAR BROKERAGE

**RACING CARS FOR SALE**  
ALAN CORNOCK FCS  
BUYING - SELLING - BROKERAGE  
[www.racingcarsforsale.co.uk](http://www.racingcarsforsale.co.uk)  
TEL: 01480 891212

## DRIVER DEVELOPMENT

eugene **O'BR**ien.co.uk  
**DRIVER DEVELOPMENT**  
Tel: 0775 383 5629

## EXHAUSTS

Stainless Steel Exhaust Specialists  
**SIMPSON**  
Race Exhausts  
Tel: 01753 532222  
[www.simpsonraceexhausts.com](http://www.simpsonraceexhausts.com)

## GEARBOXES

**eLITE**  
Rally & Race Gearboxes,  
GearKits, LSD's and Driveshafts  
Tel: 01782 280136 Fax: 01782 269913  
Email: sales@eliteracingtransmissions.com  
[www.eliteracingtransmissions.com](http://www.eliteracingtransmissions.com)

## GEARBOXES

**Gearboxman.com**  
COMPETITION TRANSMISSION SERVICES  
Gearboxes and Axles for Road, Race, Rally, and more  
Telephone: 01582 840008, Fax: 01582 840007

## HELMET GRAPHICS

**Mike Fairholme Designs**  
Sole approved painter of Arai helmets.  
Silver Birches, Corby Birkholme, Nr Grantham, Lincs NG33 4LE.  
Tel: 01476 550630. Fax: 01476 550029.  
email: fairholmedesigns@btconnect.com  
[www.fairholmedesigns.co.uk](http://www.fairholmedesigns.co.uk)

## MEMORABILIA

**JMJ AUTOMOBILIA** America's #1 supplier  
of CART and Formula  
One Racing memorabilia. Large selection of signed  
original collectables. See our ad under marketplace  
Memorabilia. Call or fax or a mail listing at (609) 575 1143  
or visit our website @ [www.JMJAuto.com](http://www.JMJAuto.com)

## MERCHANDISE

F1 Merchandise bought and sold.  
**Meadowhall, Sheffield**  
Tel: 0114 256 9835  
[www.theformula1shopandmore.co.uk](http://www.theformula1shopandmore.co.uk)

## MODELS

**Diecast**  
[www.racemodels.com](http://www.racemodels.com)  
Specialists in 1:2 Scale Replica F1 Helmets

## RACE PARTS

**ARE DRY SUMP SYSTEMS**  
ARMSTRONG RACE ENGINEERING INC.  
[www.DRYSUMP.COM](http://www.DRYSUMP.COM) (916) 652-5282

## RACE RADIO

**Pit to Car** Radio solutions  
0044(0)1508 528837  
**Autotel Digital Race Radio**  
[www.raceradio.co.uk](http://www.raceradio.co.uk)

## RACE PRODUCTS

**demon tweeks**  
MOTORSPORT Direct  
[www.demon-tweeks.co.uk](http://www.demon-tweeks.co.uk)

## RACE PRODUCTS

**MARDI GRAS MOTORSPORT**  
[www.mardigras.co.uk](http://www.mardigras.co.uk)

**msar** LONDON  
MOTORSPORT  
SHOWROOM  
[www.msar.co.uk](http://www.msar.co.uk)

**PIPER**  
[www.pipercams.co.uk](http://www.pipercams.co.uk)

[www.porscheshop.co.uk](http://www.porscheshop.co.uk)  
**PORSCHESHOP**  
+44 (0) 121 585 6088

## RACEWEAR

**CROYDON RACE & RALLY CENTRE**  
[www.croydonraceandrally.co.uk](http://www.croydonraceandrally.co.uk)  
220-222 Portland Road  
South Norwood  
London SE25 4QB  
For Racewear & Motorsport equipment  
Tel: 020 8656 7031

**GPR** **SPARCO** **hans gear** **uvex** **OMP**  
**SCHMIDT** **Arai** **BELL**  
RACEWEAR | KARTWEAR | SIMULATION  
[www.GPRDIRECT.COM](http://www.GPRDIRECT.COM)

**JJC** raceandrally  
PASSIONATE ABOUT MOTORSPORT  
[www.jjcraceandrally.com](http://www.jjcraceandrally.com)

[WWW.ROYALPURPLE.CO.UK](http://WWW.ROYALPURPLE.CO.UK)  
**ROYAL PURPLE**  
SYNTHETIC RACE OILS  
01209 216 666

## SPONSORSHIP

**The Million Pound Touring Car™**  
2013 British Touring Car Championships Contender  
Put your name/advertise your company on our front  
running Touring car in 2013  
[www.themillionpoundtouringcar.com](http://www.themillionpoundtouringcar.com)

**BRIAN JAMES TRAILERS**  
**CLUBMAN**  
Tel. 01327 308833  
Web. [www.brianjames.co.uk](http://www.brianjames.co.uk)

**PRG TRAILERS**  
[www.prgtrailers.co.uk](http://www.prgtrailers.co.uk)  
Phone no: +44 (0) 1270 812402

**Image** Manufacturers of bespoke  
split rim alloy wheels  
[www.imagewheels.co.uk](http://www.imagewheels.co.uk)  
**IMAGE WHEELS INTERNATIONAL LTD**

## TRAILERS & TRANSPORTERS

## WHEELS

**AUTOSPORT**

TO ADVERTISE IN THE WEB DIRECTORY PLEASE CALL  
020 8267 5992 OR EMAIL: [autosport.ads@haymarket.com](mailto:autosport.ads@haymarket.com)

# Trailers & Transporters

**BRIAN JAMES TRAILERS**

»» Connected to you



[www.brianjames.co.uk](http://www.brianjames.co.uk)

## The degree of excellence

At **Brian James Trailers**, we are exceeding expectations. Combining British engineering with powerful design, quality manufacturing and reliable service – we understand your needs.

The model shown is a Race Transporter 4  
374-0010 available from £ 7,099 (excl. VAT).

**RACE TRANSPORTER**

T +44 (0)1327 308 833

For more information and details of your local BJT dealer please call or visit our website.

# Trailers & Transporters

## WOODFORD TRAILERS

Call Us Now! tel. 01327 263 384

www.woodfordtrailers.com sales@woodfordtrailers.com



**RL 5000**  
£7,300 + vat



**RL 6000**  
£9,500 + vat



### HOSPITALITY UNIT ... FOR SALE ...

- Articulated Unit, currently white, with low mileage Renault Premium truck 16mtr total length.
- Commercial kitchen, central office, rear horseshoe lounge. Main 5 mtr awning and secondary 4 mtr.
- In built generator. Tables, chairs, flooring included.

Price **£40,000** ono.

Or / Would possibly consider full season hire, with or without Hospitality service

For further details;  
Email: [studispires@hotmail.com](mailto:studispires@hotmail.com)  
or call: **44 7768 256524**



### WINNEBAGO MOTOR CARAVAN

**£45,000.00**

- PRIVATE HGV REGISTRATION ; 0U08 FOC
- MODEL 33 VISTA
- BOUGHT NEW, 20 05 2008
- COLOUR, WHITE
- 12000 miles



Contact: **VIC NORMAN**  
[vic@aerosuperbatics.com](mailto:vic@aerosuperbatics.com)

**ONLY USED FOR AIRSHOWS FOR TWO SEASONS, VERY GOOD CONDITION.**

Trailers & Transporters

## East Midlands TRAILERS

www.eastmidlandstrailers.com

Email: [info@eastmidlandstrailers.com](mailto:info@eastmidlandstrailers.com)

Call: 01664-823877

- Has Your Trailer Broken Down?
- Need A Trailer In A Hurry?
- Want Short / Long-Term Hire?



We have new /used trailers for sales and hire and are a Westfalia tow bar fitting centre.

Why not visit our new trailer centre at Unit 21 Old Dalby Business Centre Old Dalby Leicestershire LE14 3NJ

**MAN - 2 Axle / Rigid / 2003**  
first registered 14.03.2003  
Twin sleeper cab  
Professionally converted in 2011.  
Mileage: 254,415 miles  
Tax until: 01.04.13  
MOT: September 13



- Slide out to main body for extended office area
- Slide out decking area from under and steps to main body / stainless balustrades
- Built in full body lockers
- Built in 100gallon water tank connected to built-in jet wash
- Integrated Honda 6.5kva inverted Honda generator
- Shower / WC
- Kitchen area with cupboards / storage / Microwave / sink / Hot & Cold water
- Air conditioning / central heating
- Desk space for 5 staff

- Storage / draws / shelves for office use
- Integrated / professionally fitted satellite for wireless internet / satellite TV
- 2 x 42 inch plasma Samsung TV's built in
- Surround sound in main office area
- Steps to roof viewing area capable of holding 20 people / balustrades around roof
- Rear office with table and seating for up to 6 people
- Storage space under seating
- TV with RGV connection and power from table
- **Price: Please Call**

**MONACO Monarch American Motorhome**  
2008 / First registered 10.03.2008  
Professionally converted in 2012  
Mileage: 9,489

- Originally a 4 berth American RV fully transformed in to a mobile promotional / bar / hospitality vehicle
- The vehicle still sleeps 4 - with large rear double bedroom with slide out.
- Rear bedroom with double island bed and integrated WC / Shower room
- Leading to main living area that has been totally transformed (costing over £20,000)
- **Price: Please Call**



Mobile no: M: +44 (0) 7850 790689  
Email address: [steve@e22sports.com](mailto:steve@e22sports.com)

# Trailers & Transporters



**All trailers now come with European COC certificate**

PRG Trailers | Cheshire | UK | Tel: +44 (0) 1270 812402  
Web: www.prgtrailers.co.uk | Email: info@prgtrailers.co.uk

optional colour finishes shown

SPECIALISTS IN CAR SHIPPING  
AND TRANSPORTATION  
Worldwide export and import services



- Customs clearance • UK & European collection & delivery
- SAFE • SECURE • COMPETITIVE

t: 01394 695566 f: 01394 673031  
www.rjjfreight.co.uk  
kevin.lewis@rjjfreight.co.uk chinita@rjjfreight.co.uk Jeff.parslow@rjjfreight.co.uk

## Paul Grimshaw Vehicle Movements Ltd

We specialise in moving.....

- Highperformance cars
  - Hi-value cars
  - Classics
  - Prototypes
  - Freight
  - Motorsport
  - Trackdays (From 1 car to 20!)
  - Race Truck Hire
- Throughout UK and Europe!



Email: info@pgvm.co.uk or Join us on Facebook  [www.facebook.com/PaulGrimshawVehicleMovements](http://www.facebook.com/PaulGrimshawVehicleMovements)

# Race & Rally Cars

The Nordschleifen centre of excellence is looking for you!



**GREENHELL**

 Find us on Facebook  
[roadrunnerracing](https://www.facebook.com/roadrunnerracing)



**roadrunner racing**

Call: +49(0)175 5282851  
Email: team@roadrunnerracing.de  
[www.roadrunnerracing.de](http://www.roadrunnerracing.de)



We offer:

- "Arrive and Drive" packages in VLN, RCN and 24h-race at the Nurburgring Nordschleife – for both beginners and experienced drivers
- Full-Racing and trackday services for your race & trackday car (Porsche, BMW Ferrari, Maserati, Lamborghini,...)
- State of the art infrastructure near to the Ring
  - Modern workshop
  - All-wheel dyno
- An english-speaking team with over 20 years experience at the Nuerburgring, with class wins in both VLN and the 24h-race
- Engineering & Tuning
- Car-storage
- Airport-service



... success as a result of passion and determination.

# Race & Rally Cars

Drives Available

**Rollcentre**  
Racing

**Drives Available**  
01480 498640  
sales@rollcentre.com



Ferrari 458 Challenge  
BRITISH GT Cup Class  
2012 race winning car  
Aero kit  
Suspension upgrades  
Competitive Budget  
One driver required



Mosler Super GT  
Britcar, GT Cup,  
Supercar Challenge,  
24 Hour Races.  
Superfast car, easy to  
drive and win.



Toyota GT86  
Britcar, 24 Hour races,  
ABS, Traction Control,  
Stability Control.  
Superb Endurance car.  
Drive or Sell.



Praga R1  
Single seater handling  
Carbon tub, 350bhp/ton  
Supercar Challenge  
Arrive and Drive

**RACING CLUB PARTNERS**

searching for

**2 PILOTS  
ELITE**

**2 PILOTS  
OPEN**

**NATHALIE MAILLET**

+352 691 26 67 07

nmaillet@racingclubpartners.com



**EURO NASCAR**

**2013**



Race Cars For Sale

**mygale**  
RACING CAR CONSTRUCTOR

**FOR SALE 3  
2010 MYGALE FOMULA 3**



- 1 F3 rolling chassis (VW Kit) € 50000
- 2011 aerokit
- 2012 Italian F3 Champion
- Excellent condition
- 2x complete F3 with Fiat engine: € 70000 each

For more information +33 (0)3 86 21 86 21 or email commercial@mygale.fr

Race Cars For Sale

**Team ES Racing.com are proud to offer a combination of 1 or 2 race winning cars along with an extensive spares package.**



These cars which won 2 races in the 2012 BTCC along with 6 other podiums are in excellent condition & have been maintained to the very highest standards throughout their whole life. Team ES Racing.com purchased these cars from 888 Race Engineering late in 2011.

Team ES Racing are selling these as they look to move on to the full NGTC cars in 2013.

The S2000 Cup will be running on the same grid in the BTCC from 2013, with an estimated three year life span.

Spares included with each car include gear ratios, uprights, roll bars, numerous springs, dampers, panels, bearings, steering racks, pumps, pads, discs, drop links, wheels, tyres etc. The list goes on & literally has to be viewed to be appreciated. Viewing welcome & recommended!!

**Prices are:**

**£54,995 + Vat per car including some spares**

**£105,000 + Vat for BOTH cars & all spares**

**\*\*\*\* IF BOTH CARS ARE SOLD TO THE SAME BUYER WE WILL RELEASE OUR FULL DATA FROM 2012, INCLUDING ALL SETUP SHEETS, AND DRIVER DATA FROM EVERY SESSION & RACE IN 2012!!!!\*\*\*\***

**Please e-mail info@teamesracing.com or call 07581 258837 & ask for Chris for further details & to arrange viewing.**

# New for 2013

## Ferrari 458 Challenge Upgrade

### The E2M Phase II kit comprises of:

- 1 New Anhedral Rear Wing
- 2 Billet Alloy Rear Wing Support
- 3 Carbon Ultra - Lite Doors - uses factory window and locks
- 4 Carbon Aero Vented Carbon Rear Bumper
- 5 Carbon Rear Diffusor
- 6 Carbon Aero Vented Front Wings
- 7 Carbon Aero Vented Louvered Bonnet
- 8 Carbon Aero Vented Front Bumper
- 9 Carbon Dive Planes
- 10 Carbon 100mm Front Splitter with Integral Carbon Floor and Strengthened Carrier
- 11 Power Upgrade to 625 BHP
- 12 4 Way Adjustable Suspension

Evolution 2 Motorsport now offers an all new for 2013 ultra lite performance aerokit, to both reduce weight and improve aerodynamic performance. With over 25 years of race winning experience, the aerokit has been designed and manufactured to factory standards. All parts use existing mounting points, with excellent fit, quality and finish.

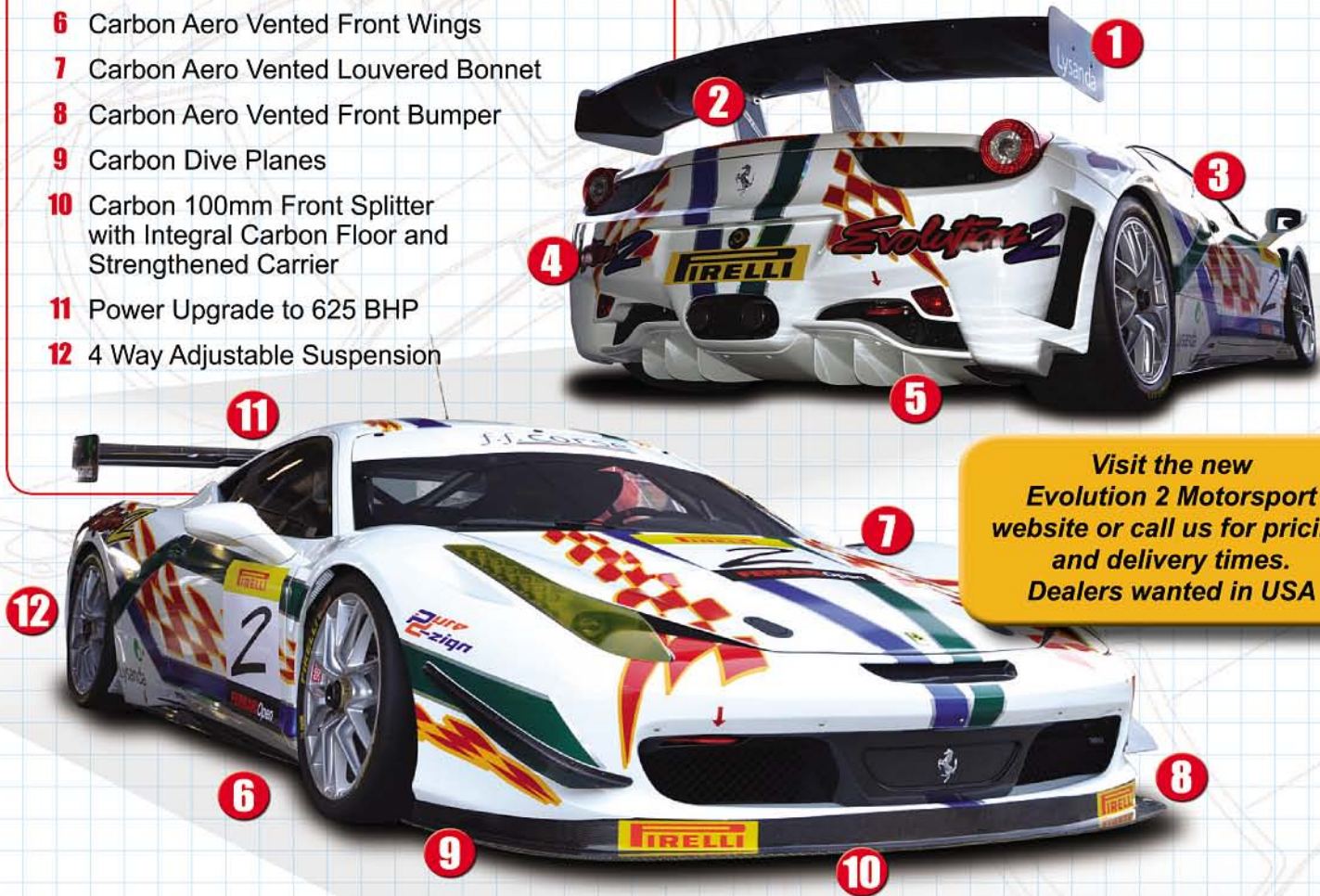

**Evolution 2**  
MOTORSPORT

Email [info@evolution2motorsport.com](mailto:info@evolution2motorsport.com)  
Telephone +44 (0) 1753 885 453  
[www.evolution2motorsport.com](http://www.evolution2motorsport.com)

# Marketplace

## AUTOMOBILIA

**F1 COLLECTORS .COM**



**#1 FOR F1 MEMORABILIA**  
We buy and sell F1 items  
AYRTON SENNA specialists  
Call CHRIS GRINT 01763 274448  
email: sales@f1collectors.com

**JMJ Automobilia**  
SUPPLIERS OF RACE  
MEMORIBILIA SINCE 1992

Florida, USA (609) 575-1143  
email: [JMJAUTO.COM](mailto:JMJAUTO.COM)  
[WWW.JMJAUTO.COM](http://WWW.JMJAUTO.COM)

## APP NOW AVAILABLE

**Race  
Car  
Market**

Advertise on  
**RCM**

The only iPhone  
app dedicated  
to buying and  
selling Race Cars



## CAR TYRES

FOR ALL YOUR  
**AVON**  
TYRES  
**MOTORSPORT**  
RACING TYRES  
Inc. ACB 10 Formula Ford  
Contact

**BMTR LTD**  
Tel: 0121 331 1122  
Fax: 0121 331 1144  
email: [sales@bmtr.co.uk](mailto:sales@bmtr.co.uk)  
see our new web site at [www.bmtr.co.uk](http://www.bmtr.co.uk)

## FLOORING

**Kiwi Tiles**  
Interlocking Plastic Floor Tiles, as used by leading  
race teams throughout Europe.

- Easy installation & removal
- Many colours
- Lightweight
- Strong and durable
- Compact & easy to store
- Top quality
- Value for money

Stock Colours:  
Red, Blue, Green,  
Yellow, Silver, Orange,  
Grey, Black, White,  
Dayglo Red

**Ralt Engineering**  
Tel: 01865 883354 Fax: 01865 883789  
Email: [enquiries@kiwitiles.com](mailto:enquiries@kiwitiles.com)  
[www.kiwitiles.com](http://www.kiwitiles.com)

## FRANCHISES

**Mac Tools**  
GREAT TO WORK WITH

Business for sale:  
Mac Tools is part of StanleyBlack & Decker, an \$11+ billion global organisation and owner of the world famous Stanley Black & Decker and DeWalt brands. If you have the desire and passion to work for yourself, available cash of £15,000 and the ability to build relationships, our franchise businesses give you the power to drive your future with our training and support.



Call us on: 08450 6000 60  
Email: [franchise@mactools.co.uk](mailto:franchise@mactools.co.uk)  
[www.mactools.co.uk](http://www.mactools.co.uk)

## GEARBOXES

**RACING**  
TRANSMISSIONS

SPECIALISING IN  
GEARBOX REBUILD,  
REPAIR AND SERVICING  
FOR GT, LMP, F3  
AND MORE...

**Hewland Specialist**  
Call 07976 877 612  
[jono@racing-transmissions.co.uk](mailto:jono@racing-transmissions.co.uk)  
[www.racing-transmissions.co.uk](http://www.racing-transmissions.co.uk)

**AUTOSPORT**

MISSED AN ISSUE?  
THEN CALL OUR  
BACK ISSUE HOTLINE  
**0844 848 8817**

## INSURANCE



**TEST &  
RACE DAY  
INSURANCE**

Give Simon and the friendly team a call:

**0844 338 68 67**

[mcemotorsport.com](http://mcemotorsport.com)

OPENING HOURS:  
Monday - Friday 9.00am-5.30pm



## FOR SALE



Foot of the South Downs, close to Goodwood Motor Circuit and Chichester. Why not move your operation and your man or your mistress or your wife into my old converted Coach House with current garaging for 6-7 cars, or easily changed to house 10 cars plus. Plenty of parking.

Private, secure and very accessible. Oh yes, plus the charming Stone and Flint converted Coach house with 5/6 bedrooms, 4 baths, Jacuzzi, Inglenook, Office and easy access Main Road position.

If this property was ON the Downs, it would be £1 million - IT'S NOT, so priced accordingly, £600,000. Unique opportunity - could easily be a B & B.



Tel: Owners in Residence, Peter or Carole +44(0)1243 544445.  
P.S. No Chains Thanks. Been there, done that.

# Marketplace

## RACE PRODUCTS

• EXPERT ADVICE • MASSIVE STOCKS • RAPID DELIVERY



**www.demon-tweaks.co.uk** **QZ252A**

**DON'T DELAY, CALL TODAY**  
**0844 375 2196**

**demon tweaks**  
**MOTORSPORT Direct**  
LOW CALL RATE CALLS MAY BE RECORDED FOR TRAINING PURPOSES

**London Motorsport Showroom**  
**www.msar.co.uk**



**msar** UK agent for **SCHRÖTH RACING**

ORDER HOTLINE: 020 8655 7877

# CARTEK

## MOTORSPORT ELECTRONICS



**Innovative products:**

- Solid State Battery Isolators
- Power Distribution Modules
- Wireless Steering Wheel Controls
- Coolant Sensors
- FiA Rain Lights
- Shift Lights



**www.CARTEKMOTORSPORT.com**  
**CARTEK AUTOMOTIVE ELECTRONICS Ltd**  
 44 (0)2380 637600  
 info@cartekmotorsport.com

## RACEWEAR

# Grand Prix Racewear

WWW.GPRDIRECT.COM

## 2013 CATALOGUE

**AVAILABLE NOW**

REQUEST YOUR COPY  
 GO ONLINE OR CALL US ON:

**08435 070 858**

**RACEWEAR | KARTWEAR | SIMULATION**



**DRIVEN BY PASSION**

**Grand Prix Racewear**  
 2013 Catalogue

Scan code to view it online now

# Marketplace

## SUSPENSION

[WWW.REIGERSUSPENSION.COM](http://WWW.REIGERSUSPENSION.COM)

The best suspension for:

- Rally
- Rallycross
- Autocross
- MotoCross
- Quads
- Sidecar Cross
- Rallye Raid
- Trial

Reiger Suspension BV  
 Molenenk 5a  
 NL-7255 AX Hengelo Gld.  
 Tel.: +31 (0)575-462077 Fax: +31 (0)575-463316  
 info@reigersuspension.com

**REIGER**  
 Racing  
 Suspension

## TYRES

# NÜRBURGRING OR MOTORWAY.

FALKEN HIGH PERFORMANCE TYRES

**30** YEARS  
OF PERFORMANCE  
**FALKEN**



**FALKEN**  
High Performance Tyres

**AZENIS** FK453

falken-europe.com

From race track to road.

## T-SHIRTS & MERCHANDISE

# OFFICIAL AUTOSPORT MERCHANDISE

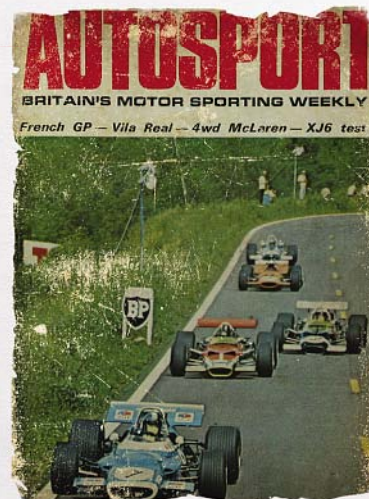

Just visit [www.autosport.com](http://www.autosport.com) and click the t-shirt link.

Publication date every Thursday

Call 020 8267 5820

RACHEL.BROCK@HAYMARKET.COM

**BOOKING DEADLINE:**

MIDDAY MONDAY PRIOR TO PUBLICATION

**COPY DEADLINE:**

MONDAY 5PM PRIOR TO PUBLICATION

ALL ADVERTS PLACED FEATURE IN THE APPOINTMENTS SECTION OF AUTOSPORT.COM FOR ONE WEEK

FOR ALL AVAILABLE VACANCIES PLEASE GO TO THE JOBS SECTION OF AUTOSPORT.COM

## Event Truck Driver



Anglo American Oil Company Ltd is looking for a service minded and enthusiastic "truck driver" to deliver race fuels to race meetings. This position consists of 10% driving and 90% working at race events at weekends. ADR is a plus but for the right candidate training will be provided. It is a very hands on job so it is important that you are fit and able. The position is available immediately.



Please email your CV with a covering letter to:  
Anders Hildebrand, anders@aaoil.co.uk



### 750 Motor Club - Marketing & Communications Executive

One of the UK's leading providers of truly accessible motorsport, the club is based at Donington Park and manages a portfolio of 14 championships as well as organising car tours, sporting trials and the largest annual Austin Seven rally in the world.

The Marketing & Communications role is new and combines the responsibility for developing and implementing Marketing & Communications strategy across the club's complete activity set alongside the development and implementation of new services and events for our heritage and non-racing members.

Can you demonstrate a good track record in all aspects of marketing as well as a natural enthusiasm for motorsport and our automotive heritage? If so, check out the club web site to find out what else you need and how you can apply.

<http://www.750mc.co.uk>

Applications close on April 15th.



MERCEDES-AMG  
PETRONAS FORMULA ONE TEAM

Mercedes-Benz has been setting the standard in racing for over 100 years. The MERCEDES AMG PETRONAS Formula One™ Team continues the proud history of the legendary Silver Arrows with the clear ambition of winning the FIA Formula One™ world championships. Based in Brackley, UK, we are recruiting highly motivated, talented new members of our team.

Vacancies have arisen to join the Mercedes AMG PETRONAS Formula One Team. Please find further information about our roles and our team in the 'join our team' area of our website [www.mercedes-amg-f1.com](http://www.mercedes-amg-f1.com)

### MECHANICAL DESIGN ENGINEER

REF: SW403/1710

This role is reporting to the Head of Mechanical Design. The successful candidate will be responsible for the design and development of a variety of suspension and driver control related assemblies and will oversee projects through from conceptual design to assembly, testing and development.

**Key Accountabilities and Responsibilities:**

- Design and development of mechanical car components and assemblies
- Design and development of structural composite car components including manufacturing support & guidance
- Reliability management throughout component lifecycle
- R&D test support
- Basic structural analysis by means of hand calculation and Catia FEA
- Close liaison with other departments and external suppliers

**Relevant Experience and Qualifications:**

The ideal candidate will be a highly motivated and innovative design engineer with excellent design flair and a strong ability to deliver design solutions to the highest standard. The candidate will have a mechanical, automotive or aeronautical engineering degree (2:1 minimum grade) or similar qualification with some experience in F1, another top level motorsport or equivalent high level engineering industry. Knowledge of Catia V5 would be an advantage.

### AERODYNAMICS MACHINISTS (WEEKEND SHIFT)

REF: SW510/1102

These roles are reporting to the Aero Machine Shop Team Leader. The successful candidates will form part of a close-knit and highly-driven team responsible for satisfying wind tunnel and special project production requirements.

**Key Accountabilities and Responsibilities:**

- Responsible for programming, setting and operating CNC and manual machinery as required meeting the daily production schedule
- Responsible for rapid production of one-off accurate components
- Responsible for maintaining high house-keeping standards and daily maintenance routines whilst always maximising the throughput of components
- Departmental processes and procedures must be complied with at all times

**Relevant Experience and Qualifications:**

- Proven capability in the production of high-quality machined components within a time-pressured environment - motorsport, aerospace or similar high-precision engineering experience
- Good working knowledge of modern CAD/CAM systems
- Confident in running multiple CNC milling machines and a competent manual machinist
- Experienced in working as part of a team, able to contribute to process improvement
- Time-served, recognised apprenticeship or equivalent qualification
- CAD/CAM experience, preferably CATIA or UG

Flexibility in hours and approach is required, along with the ability to use own initiative with a 'can do', 'team playing' attitude. Good verbal and written communication skills are very important. The ability to work under minimal supervision to strict deadlines and in a professional manner is essential.

In return for your work and commitment, we offer a competitive package including bonus, life assurance, private medical cover, Mercedes company car lease scheme, 25 days holiday, on-site gym, subsidised restaurant facilities together with the chance to work in a truly unique environment.

If you wish to apply for this position please forward your CV and letter of application with current remuneration details/salary expectations, quoting the job title/reference and where you saw the advertisement to [recruitment@mercedes-amg-f1.com](mailto:recruitment@mercedes-amg-f1.com)

Closing date: 11th April 2013

NO AGENCIES PLEASE



facebook.com/FormulaFordGB



twitter.com/formulafordGB



youtube.com/forduktv



## Formula Ford 2013

### BE PART OF THE NEW EXCITING SEASON

- First 15 grid places already taken
- 30 race series as part of the BTCC package
- Live TV coverage for the full season on ITV4
- Fastest junior single seat car in the UK - Powered by Ford EcoBoost
- New winged car with Ford kinetic Design
- FIA safety approved chassis
- Join us! If you want to race, contact RacingLine on:

08456 805077 or britishformulaford.co.uk



Go Further

# CLUB AUTOSPORT

NATIONAL RACING • HISTORICS • RALLYCROSS • HILLCLIMB • TRACK TESTS

Nissan will be on the British GT grid after all



EBREY/TT

## Factory Nissans join British GT

Car builder JRM will run two GT-R NISMOs at Oulton Park opener

**NISSAN DEVELOPMENT PARTNER** JRM Racing has made two late entries for this weekend's British GT opener at Oulton Park in what could turn into a full-season campaign.

Sussex-based JRM, which is developing the Japanese manufacturer's GT-R NISMO GT3 contender, has entered cars for Jody Fannin, last year's GT4 class champion in the British series, and race returnee Mark Cole. The duo, who will both drive solo at Oulton, are seeking deals to remain in the series.

JRM team boss James Rumsey, whose team's main 2013 programme is in the Blancpain Endurance Series, said: "This is a good opportunity for us to demonstrate the performance, reliability and affordability of the Nissan GT-R. We want to prove the car in what is a very competitive environment."

Rumsey revealed that the original approach involved Fannin and Cole driving together. Because both are silver-graded drivers, this would have meant a 65kg weight penalty, which JRM calculated would render the GT-R uncompetitive.

Instead, Fannin and Cole will have to

climb out and back into their respective Nissans during the mandatory pitstops, and receive 20-second time penalties.

Rumsey continued: "We wanted to put them into a competitive situation so that they can get their sponsors across the line and attract bronze drivers to help with the funding."

Former Porsche Cup GB champion Cole, who will be racing for the first time since 2007, said: "I need a solid result at Oulton to show that I have the old speed and the car has potential."

### GT GRID FILLS UP

British GT is set for a capacity 34-car grid for this weekend's opening round at Oulton Park.

New arrival Fortec has paired international GT racer James Walker with historic ace Jason Minshaw, whose brother Jon returns in a Trackspeed Porsche.

Fortec has yet to confirm drivers for its second Mercedes AMG SLS, but Trackspeed has added a third Porsche 997 GT3-R for David Ashburn. The 2010 GT3 champion has come out of retirement to race at Oulton and will be partnered by Porsche factory driver Nick Tandy.

British GT veterans the Jones twins will drive a McLaren MP4-12C run by Team Pyro. The 2009 champions will continue to race their Mercedes AMG SLS in the Blancpain Endurance Series.

Historic racer Roger Wills will meanwhile deputise for the injured Richard Meins. Meins was set to share United Autosports' second MP4-12C with ex-F1 racer Mark Blundell, but sustained broken ribs and a knee injury in a recent testing crash at Oulton.

Meins said: "Not having raced at Oulton Park since 2000 I was looking forward to the test. On our second day I started to put in some decent lap times, but then I put a rear wheel on the grass at the kink before the first chicane. I suffered a side impact with the tyre wall that resulted in broken ribs and a fractured knee, not to mention the damage to the car.

"It wasn't the start to the season I hoped for, and to say I am very disappointed is an understatement, but I'm looking forward to getting back behind the wheel at Silverstone."

► P92 BRITISH GT PREVIEW

**BEN ANDERSON**  
NATIONAL  
EDITOR

ben.anderson  
@haymarket.com



### ELONGATED WINTER WEATHER

has blighted spring and fresh snowfall also did for last week's race meetings at Donington and Oulton Park.

Given the severity of winter storms in the north of the British Isles this was the only sensible decision (see page 91). Sadly, Masters/MSVR does not expect to find a replacement for its Oulton event, while the 750MC faces a battle to find alternative track time for the seven classes that were due to kick off their 2013 seasons at Donington.

Hopefully the weather will pick up as we head towards Easter, because there are quality meetings in the offing.

British GT is a real success story of the past year and is set for the most competitive season in its 20-year history after attracting a quality field of more than 30 cars to the opening round at Oulton Park (see page 92).

Those in the south are really spoiled for choice. Brands Hatch is the place to be for BTCC fans of course, where British Formula Ford with wings will make its debut on the TOCA package (page 94). The Blue Oval is working hard to make its EcoBoost class work after a tough first season last year. Now we will begin to see whether its brave decisions were the right ones.

For historic aficionados, Thruxton is the only choice. The HSCC has more than 270 entries for its Easter Revival meeting (a circuit record). It seems the popularity of this growing branch of the sport knows no bounds.

Speaking of popularity, Lydden's annual European Rallycross opener always attracts massive crowds and this weekend should be no different with IMG promoting and former WRC champ Petter Solberg taking part.

Wherever you decide to head, you're surely in for a treat.



Morris was set for Euro Renault move but will now race with Hillspeed in F4



# Morris makes BRDC F4 switch

FORMULA RENAULT BARC WINTER Series champion Seb Morris will contest BRDC Formula 4 this season.

Morris, who finished third in the main BARC series in 2012, planned to stay with Fortec Motorsport for Formula Renault NEC this year, but education commitments mean the 17-year-old has decided to take on the UK-based F4 series. He will

return to Hillspeed, with which he won the 2011 Ginetta Junior title.

Morris's manager Andy Meyrick said: "With Seb's A-level and MSA Academy commitments, together with a delay in overseas sponsorship, it became apparent our preparations for a NEC title challenge were compromised.

"We will now mount an F4 challenge instead, which we consider to be a very

meaningful and competitive category."

Morris believes he can be a frontrunner in F4 and still plans to test with Fortec ahead of a move to the continent in 2014. "I really am looking forward to competing in F4 this year and delivering as many wins as I can," he said. "I want to thank [Fortec owner] Richard Dutton and his team for all they have done for me."

Former world karting champion Matthew Graham, 16, has also confirmed he will contest F4 this season, after signing for Sean Walkinshaw Racing.

Pietro Fittipaldi, grandson of double F1 world champion Emerson, is also set to join the F4 grid, with MGR. He will dovetail this with a Formula Renault BARC campaign at Jamun Racing.

## British Formula Ford

### Falcon expands to three cars for British Formula Ford assault

#### CLUB FORMULA FORD RACER

Neil Winn and ex-InterSteps driver Lassi Halminen will both race in British Formula Ford this season with Falcon Motorsport.

Winn, 20, steps up after winning last year's Champion of Oulton FF1600 title. Halminen was a podium finisher for Falcon in the final season of InterSteps last year.

The pair joins karting graduate Harrison Scott, bolstering Falcon's line-up to three cars for the inaugural season of winged EcoBoost Formula Ford on the TOCA package. They will shake down their Mygale chassis at Oulton Park on Wednesday ahead of the first round at Brands Hatch this weekend.

Team boss Nick Streatfield said: "Lassi showed impressive pace last year - things just didn't go his way. He's a typical Finn and will adapt quickly to Formula Ford."



Scott will have two team-mates in Falcon squad

Winn added: "The deal has come together very late but I'm really happy to be on board. Being realistic we are going to Brands on the back foot and will treat it as a test. We'll see what we can achieve, but I'm not expecting to be fully competitive."

**P94 FORMULA FORD PREVIEW**



Powell will race Dallara F307

## F3 Cup

### Powell leaves GP3 for F3 Cup

FORMER GP3 RACER ALICE POWELL will contest the F3 Cup this season with Mark Bailey Racing.

Powell, who will make her debut at Oulton Park this weekend, tested her Dallara F307 during the MSVR media event at Brands Hatch last Wednesday.

"British F3 is pretty much dead and F3 Cup is a good championship for a good budget," she said. "It's a great chance for

me to keep racing. I still want to get to F1 and the best step for me was F3 Cup."

Powell won the Formula Renault BARC title in 2010 and finished 19th in GP3 last season with Status GP, scoring a solitary point in the final round at Monza.

"I need to keep racing because a year out can damage you," she added. "I'd have liked to keep moving up the ladder but this is not a step backwards, it's a great step."

Comprehensive motorsport insurance products to keep you on track;

- Worldwide On Track
- Personal Accident
- Storage and transit
- Track day
- Liability
- Commercial

Please complete an online quote request form at [www.ryanmi.com](http://www.ryanmi.com)  
Email - [info@ryanmi.com](mailto:info@ryanmi.com) Tel - +44 (0)1799 524202

Ryan Motorsport Insurance Limited is an appointed representative (557405) of Independent Broking Solutions Limited who are authorised and regulated by the Financial Services Authority, registration number 312026

**RYAN**  
MOTORSPORT INSURANCE

Endurance racing

## Ex-MR2 racer wins Peugeot drive for Nurburgring 24 Hours

**FORMER TOYOTA MR2 RACER**

Bradley Philpot has won the chance to be a factory driver for Peugeot at this year's Nurburgring 24 Hours.

The French marque sought eight drivers from eight different nations to contest the enduro in a pair of factory 208 GTIs (see AUTOSPORT, January 24). Philpot was one of five Brits selected to contest the final shootout at the La Ferte Gaucher test circuit earlier this month.

Philpot, Ginetta Challenge racer David Pittard, ex-Formula Palmer Audi champion Nigel Moore, VW Golf racer Jamie Martin and V8 MG racer Spencer McCarthy all made it through to the final of the '208 GTI Experience' following single-lap shootouts in road cars at Bedford Autodrome.

MotorSport Vision instructors Philpot and Pittard went head to head on the afternoon of the final at La Ferte Gaucher, near Paris, before Philpot was chosen as the British winner. He is due to take in three rounds of the VLN long-distance championship by way of preparation for the



Philpot last raced in MR2s in 2007

Nurburgring 24 Hours, but has so far been thwarted by snow.

Philpot, 27, said: "I haven't raced a car since 2007 but I was quite happy about the first shootout being at Bedford. It's unexpected but an incredible opportunity.

"It's really nice to get to do something on merit. They were timing everything to thousandths of a second, not just judging on stopwatches and opinions. It literally came down to who was fastest."

Ginetta GT Supercup

## Breeze to defend Ginetta title after failing to fund graduation

**REIGNING GINETTA GT SUPERCUP** champion Carl Breeze will return to the series to defend his title this season.

Breeze made a slow start to 2012, but won the championship after switching from Tollbar Racing back to TCR.

Breeze, who raced in the BTCC from

2002-04, admitted that moving up from the G55s was out of the equation due to a budget shortfall.

"Money basically is the reason," said the 33-year-old. "I'd love to step up but I don't have the funding."

Breeze has claimed 27 G50 Cup/Supercup wins since his debut in 2009. He finished as runner-up in the series in '10 and '11 before finally claiming the title at last year's final round.

He said he was excited by the chance to return as series champion. "I've got a great opportunity to stay in the series, have the number 1 on my car and try to defend my title."



Breeze will return to defend G55 crown

Euro NASCAR

## Formula Ford champion Gough makes Euro NASCAR move

**FORMULA FORD RACER STUART**

Gough will move into European NASCAR racing this season.

The 2010 FF1600 Champion of Oulton has completed a late deal to drive in the Euro Racecar NASCAR Touring Series for Italian team T-Engineering. He will make his debut in the V8 stock car series at Nogaro this weekend.

"NASCAR is one of the most recognisable brands in the world and to be part of the first NASCAR series in Europe is very special," said Gough.

"The opportunity to develop a career within the NASCAR ladder made the championship an easy choice. The American Speedfest at Brands Hatch in June will be a very special event to be



Gough is excited by NASCAR

involved in as a British driver.

"The plan for the first round is to learn quickly, get some solid points and build from there. We are jumping in the deep end with no testing, but at the end of the day, while it will feel alien to begin with, it's still a racing car."

# Humble Pye

## The voice of club racing



Porsche 911s 50th birthday will be celebrated at Goodwood FoS

## Goodwood's Festival of Speed is a still-growing phenomenon

**T**he phenomenal growth of the Goodwood Festival of Speed over the past 20 years was highlighted by last Wednesday's press day, at which the number of media invitees rivalled the total attendance at either day of 1993's inaugural event. The roster of cars, bikes and stars was also superior.

Inspired by grandfather Freddie's hillclimb at his family seat in 1935, the current Lord March's vision could not have extended past a 'suck-it-and-see' event, prior to which it was impossible to gauge public interest. A small programme print run is testament, thus the chequered editions are cherished.

It's been said before that Charles March's photographically trained eye demands the fanatical attention to detail that defines Goodwood's motorsport events (the Revival meeting celebrates its 15th birthday in September). In a special year both will enhance the brand aesthetically.

Reselecting show-stoppers from two decades of favourites – from antediluvian speedsters, through Bob Riggles's wheel-standing Plymouth Barracuda, to Formula 1 cars from eight teams – is a great Festival starting point. Last week Goodwood House's carriage circle was jammed with delicious clues to July's mechanical feast.

Ninety years of the Le Mans 24 Hours was bookended by the fourth-placed Bentley 4½-litre of 1929 and the 2003-winning Speed 8. And where else could you see

Regie Renault's '78 Alpine A442B winner, a droolsome Ford GT40 pack (set for the Revival's Madgwick Cup race), a Ferrari 512S nose-to-tail with a Gulf Porsche 917K, and the victorious McLaren F1 GTR of '95 on a week day?

Forming a shapely stripe across the lawn, meanwhile, six Porsche 911s chronicled the evolution of the Stuttgart icon, which turns 50 this year and remains deeply aspirational. Perhaps if I had tried harder at school – and landed that boring high-earning career – I'd have owned one by now. No harm in dreaming...

As a microcosm of its twin events, the atmosphere at Goodwood reeked quality. Even the food was stunning, with artisans offering tucker from a fleet of charismatic corrugated Citroen H vans. I'm no veggie, but Wholefood Heaven's Buddha's Bowl was sublime.

When Goodwood's hallowed racetrack closed in 1966, after 19 seasons, the BARC found a new home at Thruxton, another airfield perimeter circuit of strikingly similar contours. This Saturday and Sunday the Andover venue celebrates its 45th anniversary with a venue-record entry for the first HSCC Easter Revival meeting. Be there!

## Marcus Pye



**"Goodwood's carriage circle was jammed with delicious clues to July's coming feast"**

~~£3.50~~ **£2.69 AN ISSUE**

# FREE

# ADIDAS BAG

WHEN YOU SUBSCRIBE TO



GREAT REASONS TO SUBSCRIBE:

- **FREE ADIDAS RACE BAG** worth £39.99
- **SPREAD THE COST** - just £34.99 every 13 issues with easy direct debit instalments
- **FREE P&P** - every issue delivered direct to your door
- **SAVE 23%** on the cover price



Subscribe online at:

[www.themagazineshop.com/ASPO/M0313P](http://www.themagazineshop.com/ASPO/M0313P)

Or call our hotline and quote offer code M0313P:

Offer closes April 4, 2013.

Please have your bank details ready

# 08448 488 817



Yes, please start my subscription to AUTOSPORT, paying just £34.99 every 13 issues by direct debit, saving 23% on the cover price. **Please send me my FREE Adidas bag.**

**YOUR DETAILS** – must be completed (BLOCK CAPITALS PLEASE)

Title: \_\_\_\_\_ Name: \_\_\_\_\_  
 Surname: \_\_\_\_\_  
 Address: \_\_\_\_\_  
 \_\_\_\_\_  
 Postcode: \_\_\_\_\_  
 Telephone: \_\_\_\_\_  
 Mobile: \_\_\_\_\_  
 Email: \_\_\_\_\_

**DIRECT DEBIT PAYMENT (UK ONLY)**

To the manager, bank name: \_\_\_\_\_  
 Address: \_\_\_\_\_  
 \_\_\_\_\_

Postcode: \_\_\_\_\_  
 Name of account holder(s): \_\_\_\_\_

Bank sort code   -   -

Bank/building society account number

Please pay Haymarket Media Group direct debits from the account detailed on this instruction subject to the standards assured by the direct debit guarantee. I understand that this instruction may remain with Haymarket Media Group and, if so, details will be passed electronically to my bank/building society.

Signature(s): \_\_\_\_\_  
 Date: \_\_\_\_\_

**Please return this form to:**  
**AUTOSPORT**  
**FREEPOST RSBY-ZLLA-SZZS**  
**PO Box 326**  
**Sittingbourne ME9 8FA**

Terms and conditions: This offer is open to UK residents only. Overseas rates are available on +44 (0) 1795592 974 and residents of USA and Canada should call 1-866-918-1446 or visit [www.imsnews.com](http://www.imsnews.com) for rates. Please allow 35 days for delivery of your gift and first issue. The gift will be sent under separate cover from the magazine. Should we run out of gifts, you may be offered an alternative gift – there is no cash alternative. Direct debit rates are valid for one year after which they are subject to change – should prices change we will inform you in writing. We ask that you enter into a direct debit agreement with the intention that your subscription will continue for a minimum period of 12 months, even if the frequency of payment is for a shorter period; however, you will still have the right to cancel your direct debit in accordance with direct debit guarantee. Should you wish to cancel your subscription, it will be cancelled on expiry of the current term which will not be refundable, other than in exceptional circumstances. If a gift is included as part of the subscription offer we reserve the right to request the return of the gift. Details of the direct debit guarantee are available on request. Savings are based on the standard UK cover price of £3.50. Offer ends April 4, 2013. Haymarket Media Group Ltd uses a best-practice layered privacy policy to provide you with details about how we would like to use your personal information. To read the full privacy policy please visit our website [www.haymarket.com/privacy](http://www.haymarket.com/privacy) or call us on 08448 482 800. Please ask if you have any questions as submitting your personal information indicates your consent, for the time being, that we and our partners may contact you about products and services that will be of interest to you via post, phone, e-mail and SMS. You can opt out at ANY time by emailing [datacontroller@haymarket.com](mailto:datacontroller@haymarket.com) or by calling 08448 482 800.



Donington Park was still covered in snow on Monday morning

WALKER

750MC/Masters

## Heavy snow forces race meeting cancellations

**HEAVY SNOW OVER MUCH OF THE** British Isles decimated last weekend's club racing programme.

The 750 Motor Club and Masters Historic Racing/MSVR made decisions on Friday to call off their respective Saturday meetings at Donington and Oulton Park, rather than risk turning away competitors and officials after difficult journeys.

Kirkistown's sprint was also canned.

750MC competition secretary Giles

Groombridge sent photographs of Donington's GP circuit and paddock to his clerks of the course before announcing the postponement at noon. "It was thoroughly miserable," he said. "The track was covered with snow. There was a slight thaw in the afternoon but the forecast for heavy snow overnight was entirely right.

"My headache now is rescheduling the races when most venues are booked solid. Our switch to Silverstone's International

circuit in August may make a day on the National track possible for variety. I just hope Mallyory Park [where the remaining 750MC series open] is OK next Monday."

Snow fell over Thursday night at Oulton Park, but staff salted the circuit to offer Friday testing. The decision to can Saturday's race event came at 1700.

Masters' Rachel Bailey said: "This has never happened to us before and we're unlikely to be able to reschedule this year."



Jordan tested GT40 at Donington Park

WALKER

Historics

## Jordan joins Walker in GT40

**FORMER BRITISH TOURING CAR** race winner Mike Jordan will drive a Ford GT40 in historic events this season.

Jordan will share Philip Walker's machine, the reincarnation of chassis P-1041, which had been lost for many years. Gelscoe Motorsport has built up the car with old parts and a new chassis.

Jordan and former GT racer Walker plan to race the car at the Brands Hatch GP Masters Festival at the end of May, before taking in other events, including the Silverstone Classic and Spa 6 Hours.

"It's a fantastic opportunity to drive a

car like that and this one is outstanding," said Jordan, who tested the GT40 at Donington Park earlier this month.

"I'm driving it all year, which is lovely. I do enjoy my historic racing – to do these sorts of events is fantastic. We're very hopeful of a Goodwood [Revival] entry for the GT40-only race too."

Jordan also confirmed that he will continue to share Nigel Ainge's Honda Integra in 2013. The duo will focus on the Britcar Production Championship and could also take it selected CSCC Tin Top races.

Historics

## Mallock to race Marsh Aston

**THE MARSH PLANT HIRE TEAM**

will return to competition this season with experienced GT racer Michael Mallock.

Marsh Plant scored many UK club successes in the 1980s and '90s, chiefly with Aston Martin machinery.

Geoffrey Marsh's squad will run Mallock in a lightweight DB4 to celebrate Aston's 100th birthday, and the 50th anniversary of opening its own head office.

Mallock will contest the Intermarque race at Silverstone on April 6 and could share with father Ray at the Aston Centenary meeting at Brands Hatch in July.

Mallock Jr said: "It's great to get back in a car with more power than grip. I'm keen to do more historic racing this year."

He will also contest this weekend's Historic FF1600 race at Thruxton.



Mallock will race Aston DB4

HAWKINS



Fletcher will step up from Minis

Porsche GT3 Challenge

## Emmerdale actor to Porsche Cup

**EMMERDALE ACTOR KELVIN**

Fletcher will race for Redline Racing in the Porsche GT3 Cup Challenge this season.

Fletcher, a 16-year veteran of the ITV soap, raced in Mighty Minis last year and won the Silverstone Classic celebrity race.

"The plan is to do all six rounds in the

GT3 Cup," he said. "I want to give a good account of myself but it's going to be a steep learning curve. It's a step up by quite a few levels, particularly with 420bhp.

"Hopefully I'll be a quick learner. I've got the ambitions of a 10-year-old kid obsessed with motorsport."



### The Geddies go Dutch

Ex-British GT champions Jim and Glynn Geddie will race a United Autosports-run McLaren (above) in the Dutch Supercar Challenge this season. The father-and-son duo won British GT3 in 2011 aboard a Ferrari 458. Glynn hopes to use the campaign as a springboard to a professional drive in GT3. "This series will keep me sharp," he said.

### Cevallos goes quickest

Telmex-backed Mexican Jorge Cevallos set the fastest time during official pre-season Formula Renault BARC testing at Silverstone last week. The MGR driver lapped the National circuit inside 2012 champ Scott Malvern's lap record and 0.3s clear of team-mate Chris Middlehurst. Diego Menchaca, who will race in F4 with MGR, was third with Jamun Racing. The series has 19 drivers signed up so far.

### More VW for Cartwright

Classic Ferrari racer Jim Cartwright will return to the VW Racing Cup for a full season this year in a self-run Golf. Cartwright won on his front-wheel-drive debut in the series at Brands Hatch in May last year. He will be part of a 27-car grid at Oulton Park this weekend.

### Holliday dies in hospital

Race mechanic Brian Holliday died in hospital on March 17, two months after heart surgery. He was 60. He formed HWR Motorsport with Jeff Wilson in 1976 and worked on the ex-Mick Hill VW Beetle-Chevrolet Super Saloon, and Wilson's Chevron B30-based BMW M1 and Jade-based Elise Special.

### Shaw's Fiesta comeback

Former Sport Maxx Cup champion Simon Shaw is returning to racing after three years out of the sport. The 30-year-old will race in BRSCC Ford Fiesta STs (below) with technical support from Ginetta squad HHC Motorsport and British GT driver Richard Abra. Shaw spent his sabbatical driver coaching.



15

# They've never had it so good

**British GT is 20 years old this season and 2013 is shaping up to be its best year yet.**

By **BEN ANDERSON**



**Triple Eight will run latest Bimmer Z4**

EBREY



**WRC squad M-Sport wants to learn the GT ropes with R8**

EBREY



**World champs AF Corse will run 458 for Scott/Dhillon**

EBREY

**B**ritish GT has never known times like these. Last season was undoubtedly the best in the championship's 20-year history. It featured a title battle that went down to the wire, embroiled seven different crews, and delivered a dramatic climax live on Motors TV.

Top that! Difficult as it seems, British GT may be able to do even better in 2013. GT3 is still sweeping the globe and Britain has reaped the benefit. Last season's grid had strength and depth, but this year's will have even more.

AF Corse (the best Ferrari team in the world), Triple Eight (one of the best touring car teams on the planet), Fortec (one of the world's best junior single-seater squads), and M-Sport (champions on the world rally stage) are all joining the British GT party.

World Endurance GT champions AF Corse will run the latest Ferrari 458 Italia for Aaron Scott/John

Dhillon from a new base in Britain, while the Triple Eight squad that masterminds Jason Plato's MG BTCC effort has joined up with Optimum Motorsport to run two BMW Z4s for Joe Osborne/Lee Mowle and Dan Brown/Steve Tandy. Fortec has LMS GT ace James Walker and historic star Jason Minshaw in one of its two Mercedes AMG SLSs, while M-Sport will run an Audi R8 LMS ultra for Warren Hughes/Rembert Berg. The Cumbrians are learning race craft for their Bentley GT3 project.

Many of the teams that made last year's title battle so thrilling will return with renewed impetus. Barwell Motorsport (two BMWs, one Aston), Trackspeed (three Porsches), MTECH (two Ferraris), United Autosports (two McLarens and one Audi), plus the Beechdean Aston Martin Vantage should all be in the mix too. The depth of this year's field makes it incredibly difficult to pick a winner.

Former Porsche Carrera Cup ace Michael Caine stealthily won last year's GT3 title for BTCC squad Motorbase without winning a race. He may just, *just*, be the favourite to make it two in a row. His 2012 co-driver Daniele Perfetti (the standout amateur of last year) is gone, but replaced by reigning Carrera Cup Pro-Am1 champ Ahmad Al Harthy, who was generally quicker than Swiss lollipop magnate Perfetti when the two were Carrera Cup rivals in 2011. Caine/Al Harthy looks the best-balanced driver line-up on paper, but much will depend on Al Harthy's adjustment to endurance racing, and how much Motorbase is hobbled by having to strap an extra 75kg into its Porsche. Caine is not the fastest pro, but he's a canny racer, and quick enough to hold his own against a strong field. Staying out of trouble will be key, and as long-time British GT entrant Andrew Howard says: "Whoever wins British GT this

year will thoroughly deserve it"

The driving talent for this year's series matches the quality of the teams. Racers with international pedigree, such as Allan Simonsen, Warren Hughes, Rob Barff, Nick Tandy, Matt Griffin, Alvaro Parente, Rob Bell, James Walker, Mark Blundell, Matteo Bobbi, Richard Westbrook, and Adrian Zaugg will all feature this year.

That's before you consider established national aces like Joe Osborne, Aaron Scott, Matt Bell, Phil Keen, Oliver Bryant and Dan Brown – all of whom have won British GT races in the past. The Pro driver qualifying sessions should really be worth watching this year. Places in the top 10 will not come easily.

One presence missing from this year's melting pot will be Nissan's PlayStation GT Academy. Welsh rookie Jann Mardenborough starred last season, almost taking the title with Alex Buncombe in an RJN-run



**AF CORSE** team owner

LAT

**"Looking down the entry list, British GT is going to be the best national championship in Europe. It is very strong."**

**Amato Ferrari**



**FORTEC** team manager and chief engineer

LAT

**"The grid is strong. Every year there is more competition than before. It's a good opportunity for Fortec to grow its horizons."**

**Trevor Foster**

The teams that  
made last year's  
battle so thrilling  
will return in 2013



Fortec will run  
two Mercedes  
in British GT3



## ENTRY LIST

NO	TEAM	DRIVER 1	DRIVER 2	CAR	CLASS
1	Motorbase	Ahmad Al Harthy	Michael Caine	Porsche 997 GT3-R	GT3
3	Rosso Verde	Hector Lester	Allan Simonsen	Ferrari 458 Italia	GT3
6	PGF - Kinfaun AMR	Phil Dryburgh	John Gaw	Aston Martin V12 Vantage	GT3
7	Beechdean AMR	Andrew Howard	Jonny Adam	Aston Martin V12 Vantage	GT3
8	888Optimum	Lee Mowle	Joe Osborne	BMW Z4	GT3
10	M-Sport Racing	Rembert Berg	Warren Hughes	Audi R8 LMS ultra	GT3
11	PE Group Blendini Moto	Dom Evans	Tom Roche	Audi R8 LMS	GT3
13	AF Corse	John Dhillon	Aaron Scott	Ferrari 458 Italia	GT3
14	Fortec	TBA	TBA	Mercedes AMG SLS	GT3
15	Fortec	Jason Minshaw	James Walker	Mercedes AMG SLS	GT3
16	LNT	Richard Sykes	Lawrence Tomlinson	G55 Ginetta GT3	GT3
18	FF Corse	Gary Eastwood	Rob Barff	Ferrari 458 Italia	GT3
21	Mtech	Duncan Cameron	Matt Griffin	Ferrari 458 Italia	GT3
22	Preci Spark	David Jones	Godfrey Jones	McLaren MP4-12C	GT3
23	United Autosports	Zak Brown	Rob Bell	McLaren MP4-12C	GT3
24	United Autosports	Richard Meins	Mark Blundell	McLaren MP4-12C	GT3
25	United Autosports	Mark Patterson	Matt Bell	Audi R8 LMS ultra	GT3
27	Vita4one Team Italy	Jay Palmer	Matteo Bobbi	Ferrari 458 Italia	GT3
31	Trackspeed	David Ashburn	Nick Tandy	Porsche 997 GT3-R	GT3
32	Trackspeed	Gregor Fisker	Richard Westbrook	Porsche 997 GT3-R	GT3
33	Trackspeed	Jon Minshaw	Phil Keen	Porsche 997 GT3-R	GT3
40	IDL-CWS	Colin White	Tom Sharp	Ginetta G55	GT3
41	Mtech	Derek Johnston	TBA	Ferrari 458 Italia	GT3
43	Century Motorsport	Zoe Wenham	Declan Jones	Ginetta G50	GT4
44	Optimum Motorsport	Ryan Ratcliffe	Rick Parfitt Jnr	Ginetta G50	GT4
50	Redgate Lifetime	Matt Smith	Dan Eagling	Ginetta G50	GT4
51	Nigeria Racing Eagle	Christian Ebong	Adrian Zaugg	Audi R8 LMS	GT3
53	Complete Racing	Steven Chaplin	Tom Wilson	Aston Martin Vantage	GT4
69	APD Sport	James May	Alex Osborne	Ginetta G50	GT4
78	Barwell Motorsport	Ron Johnson	Piers Johnson	BMW Z4	GT3
79	Ecurie Ecosse	Marco Attard	Oliver Bryant	BMW Z4	GT3
80	Barwell Motorsport	Mark Poole	Richard Abra	Aston Martin V12 Vantage	GT3
86	GPRM	TBA	Stefan Hodgetts	Toyota GT86	GT4
230	JRM	Jody Fannin	TBA	Nissan GT-R NISMO	GT3
320	JRM	Mark Cole	TBA	Nissan GT-R NISMO	GT3
888	888Optimum	Steve Tandy	Dan Brown	BMW Z4	GT3

GT-R. But series boss Benjamin Franassovici decided this type of driver pairing undermined the series' Pro/Am ethos, so GT Academy has moved to FIA GT and the Blancpain Endurance Series. Car builder JRM will instead enter two GT-Rs. Mark Cole and reigning British GT4 champ Jody Fannin will each drive solo at the first round with special penalties applied, but JRM hopes they will find team-mates to complete the season.

With GT3 doing so well, the next stage is to improve the baby GT4 class, which needs a boost after a lean period. The loss of Lotus and Mazda hurts variety in this Ginetta-dominated category, but Toyota will bring its GT86 later this year with Clio ace Stefan Hodgetts at the wheel. There is also hope the new pan-European GT4 Trophy will boost numbers at selected events.

Regardless, British GT is set to have a capacity 34-car grid for this weekend's Oulton opener.

## BRITISH GT CALENDAR

RND	CIRCUIT	DATE	FORMAT
1	Oulton Park	Mar 30 & Apr 1	2x 60 min races
2	Rockingham	May 5-6	1x 120 min race
3	Silverstone	May 25-26	1x 180 min race
4	Snetterton	June 15-16	2x 60 min races
5	Brands Hatch	August 10-11	1x 120 min race
6	Zandvoort	September 6-9	2x 60 min races
7	Donington Park	October 5-6	1x 120 min race

"This is the most successful period British GT has ever had since it started in the mid-90s," says Stephane Ratel, whose SRO organisation promotes the series. "This is down to Benjamin and Lauren [Granville]. We shouldn't forget that we had only 11 or 12 cars on the grid a few years ago and the economy hasn't changed much in that time. Benjamin understood, maybe better than I did, that this championship is about Pro/Am driver line-ups. I think we're going to have a fabulous competition this year – even better than last year." ❄



LAT  
TRIPLE EIGHT team owner

"It's a new challenge for us and it's a long-term opportunity. You can race the cars not just in the UK but globally."

Ian Harrison



LAT  
M-SPORT team owner

"We're very excited about British GT and I can't wait for Oulton Park. It's going to be a new challenge for M-Sport."

Malcolm Wilson

# Formula Ford spreads its wings



The British championship will support the BTCC with winged cars this season. **BEN ANDERSON** is your guide

**F**ormula Ford with wings. Utter heresy, or long overdue, depending on who you talk to. But Formula Renault UK is dead (for now) and Ford is determined to grab its opportunity with both hands.

By any stretch of the imagination, 2012 was not a good season for British Formula Ford. It introduced new cars with new EcoBoost engines but grids were poor. Only retaining

a class for the outgoing Duratec machines averted catastrophe.

Something had to give. So Formula Ford EcoBoost has had a facelift. Wings have been added front and rear, and power has increased from 175 to 200bhp to compensate for the extra drag.

“When we first started planning EcoBoost, some of the first images were sketched with wings,” explains Ford motorsport chief Mike Norton.

“We talked about it throughout 2010 and ’11 and almost introduced the new car last year with wings, but we were still at the point where most teams didn’t want them.

“Ford has been renowned as the first rung on the professional ladder and we were quite happy being different and quite happy that drivers came to Formula Ford because of the learning experience it gave and the heritage it has.

“But the impact of that heritage diminishes over time, because the people who remember it are of a certain age. Damon Hill [whose son Josh did Formula Ford in 2009-10], Perry McCarthy [who managed 2010 champ Scott Pye] and Sergio Rinland [who looked after 2012 race winner Eric Lichtenstein], all came to Ford because that’s where they learned their craft.

“The reason we’ve changed comes down to drivers like Sebastian Vettel and Lewis Hamilton. Dads and managers in their 30s and 40s don’t necessarily remember Formula Ford, and kids now think they need to get to F1 before they’re out of nappies – ‘You want me to do a year in a car

that doesn’t have wings? I’m wasting my time’. They want a small F1 car. Show young drivers the same car with wings and without, and they always choose the one that looks like an F1 car.”

Ford is keen to retain the close racing that has made the category famous. So the new wings are designed to give negligible downforce at low speeds, and help cars retain downforce when they are following each other closely. Creating a good show will certainly go down well with Formula Ford’s new audience.

The category will return full-time to Alan Gow’s coveted TOCA package this year, for the first time since the early noughties, having defected from SRO’s British F3/GT bill. Thirty races, across 10 events, all broadcast on free-to-view television, is one of the key selling points of the new-look category, which has attracted fresh entries from Radical Sportscars, Falcon Motorsport and SWB Motorsport, alongside established teams JTR, Jamun and Enigma.

Ford has also increased its support

**New Sinter design will take on Mygale in multi-make series**



EBREY



for the series, which has ramped up following the manufacturer's withdrawal from the World Rally Championship. This is especially welcome given Formula Ford will face stiff competition from the established (and cheap) Formula Renault BARC series, and Jonathan Palmer's new BRDC F4 initiative. Norton is not too worried, though.

"Ford has been here for so long as others have come and gone," he says. "Formula Ford is regarded globally as a good junior starting formula. Palmer doesn't have that reputation. We're in direct competition, but we don't look at it like that. We'll do our own thing and concentrate on that. Palmer works very hard and I'm sure he'll make F4 a success. But we'll be successful too, and we've got Ford behind us."

Ford put up £150,000 for the series to invest in its 2013 plans. This was used to offer free entries and testing to the first 15 drivers to sign up. Early signs are positive. The EcoBoost grid has already doubled compared with this time last year, though it still lags slightly behind FR BARC (19) and



BRDC F4 (15) at present.

"I can't stress enough just how committed Ford has been," adds Norton. "Having recently announced a £1.8 billion loss in Europe, to commit to this for three years is fantastic. If we had very low grids it would be difficult to justify the programme, but we've committed to TOCA for three years and it's down to us to make it work. We didn't have a good year last year, so we decided to be bold. Let's hope it works." ❄

**ENTRY LIST**

NO	DRIVER	TEAM	CAR
1	Dan Cammish	JTR	Mygale M13-SJ
2	tba	JTR	Mygale M13-SJ
6	Harrison Scott	Falcon	Mygale M13-SJ
7	Neil Winn	Falcon	Mygale M13-SJ
9	Lassi Halminen	Falcon	Mygale M13-SJ
10	Matt Rao	tba	tba
17	George Blundell	Enigma	Mygale M12-SJ
21	Fred Martin-Dye	SWB/Fluid	Sinter LA12
23	Scott Malvern	Jamun	Mygale M12-SJ
24	Luke Williams	Jamun	Mygale M12-SJ
25	Nico Maranzana	Jamun	Mygale M12-SJ
26	Juan Rosso	Jamun	Mygale M12-SJ
34	Camren Kaminsky	JTR	Mygale M13-SJ
74	James Abbott	Radical	Sinter LA12

**FORMULA FORD CALENDAR**

RND	CIRCUIT	DATE
1	Brands Hatch Indy	March 30-31
2	Donington Park	April 20-21
3	Thruxton	May 4-5
4	Oulton Park	June 8-9
5	Croft	June 22-23
6	Snetterton	August 3-4
7	Knockhill	August 24-25
8	Rockingham	September 14-15
9	Silverstone	September 28-29
10	Brands Hatch GP	October 12-13

**5 TO WATCH**

**1 Scott Malvern**

A shock late addition to the grid. Malvern returns to the championship he won in the last year of the Duratec era in 2011. As reigning Formula Renault BARC champion, Malvern has to be the favourite to return the crown to Jamun Racing.



**2 Dan Cammish**

Another category graduate returns, as JTR's title hopeful. Cammish won races in a KMR Spectrum in 2010 and was a podium finisher in the final season of Formula Renault UK in 2011. Has sat on the sidelines since breaking his back in the 2012 FR Eurocup opener.



**3 James Abbott**

The son of Radical Sportscars boss Phil arrives in Formula Ford with a season of F3 Cup under his belt, plus the many Radical races he's done in recent years. Abbott and Formula Ford returnee Fred Martin-Dye (SWB) will fly the flag for Lindsay Allen's new Sinter against the numerically dominant Mygales.

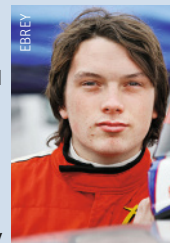

**4 Luke Williams**

Williams has been in British Formula Ford for what feels like forever. Last year was easily his best (a win and five podiums for Jamun), but coincided with a very weak season for the category. Malvern will be a good benchmark for gauging Williams' progress.

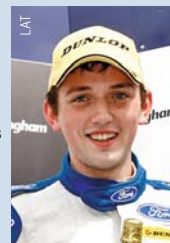

**5 Harrison Scott**

Car racing rookie Scott arrives in Formula Ford with an impressive record in karting, including top-three results in European and World KF3 in 2010-11. Should come on strong as the year progresses with Nick Streatfield's three-car Falcon team, which returns to Formula Ford after two decades away.

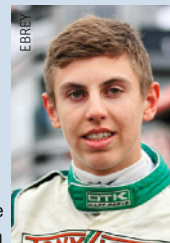

Teddington Studios, Broom Road, Teddington, Middlesex TW11 9BE, UK.  
Tel: +44 (0) 20 8267 5804 Fax: +44 (0) 20 8267 5922  
E-mail: mail@autosport.com Website: www.autosport.com

**EDITOR-IN-CHIEF**

Andrew van de Burgt  
andrew.vandeburgt@haymarket.com ext.5974

**EDITOR**

Charles Bradley  
charles.bradley@haymarket.com ext.5889

**GROUP F1 EDITOR**

Jonathan Noble ext.5810  
jonathan.noble@haymarket.com

**F1 EDITOR**

Edd Straw ext.5887  
edd.straw@haymarket.com

**FEATURES EDITOR**

Kevin Turner ext.5432  
kevin.turner@haymarket.com

**NEWS EDITOR**

Glenn Freeman ext.5309  
glenn.freeman@haymarket.com

**REPORTS EDITOR**

Jamie O'Leary ext.5811  
jamie.oleary@haymarket.com

**MANAGING EDITOR**

Peter Hodges ext.5903  
peter.hodges@haymarket.com

**RALLIES EDITOR**

David Evans  
david.evans@haymarket.com

**DEPUTY NEWS EDITOR**

Sam Tremayne ext.5952  
sam.tremayne@haymarket.com

**ART EDITOR**

Aubrey Smith ext.5914  
aubrey.smith@haymarket.com

**PRESENTER/SUB-EDITOR**

Henry Hope-Frost ext.5835  
henry.hope-frost@haymarket.com

**CHIEF SUB-EDITOR**

Marcus Simmons ext.5807  
marcus.simmons@haymarket.com

**NATIONAL EDITOR**

Ben Anderson ext.5425  
ben.anderson@haymarket.com

**SENIOR DESIGNER**

Michael Cavalli  
peter.mills@haymarket.com

**PICTURE EDITOR**

Peter Mills ext.5918  
peter.mills@haymarket.com

**AUTOSPORT.COM**

**TECHNICAL TEAM LEADER**  
Geoff Creighton  
geoff.creighton@haymarket.com

**AUTOSPORT.COM USER**

**INTERFACE DEVELOPER**  
Pete Holmes  
peter.holmes@haymarket.com

**SECRETARY**

Joanne Grove  
joanne.grove@haymarket.com

**PHOTOGRAPHS**

LAT Photographic

**SPECIAL CONTRIBUTORS**

Mark Hughes Adam Cooper  
Gary Watkins Gary Anderson  
Marcus Pye Giorgio Piola  
Mark Glendenning Alan Eldridge

Jim Bamber  
Pablo Elizalde  
Matt Beer

**CORRESPONDENTS**

**ARGENTINA**  
Tony Watson  
**AUSTRALIA**  
Phil Bramagan  
**AUSTRIA**  
Gerhard Kuntschik  
**BELGIUM**  
Gordon McKay  
**BRAZIL**  
Lito Cavalcanti  
**FINLAND**  
Esa Ilmnen  
**GERMANY**  
Rene de Boer  
**GREECE**  
Dimitris Papadopoulos

**ITALY**  
Roberto Chinchero  
**JAPAN**  
Iiro Takahashi, Len Clarke  
**NEW ZEALAND**  
Bernard Carpinter  
**RUSSIA**  
Gregory Galychev  
**SOUTH AFRICA**  
Richard Asher  
**SPAIN**  
Ralph Nansen Duran  
**SWEDEN**  
Tege Tornvall  
**USA**  
Jonathan Ingram, Bruce

Martin, David Phillips,  
Diego Mejia, Robin Miller,  
Jeremy Shaw  
**UK & IRE**  
David Addison,  
Jonathan Crawford,  
Kerry Dunlop, Lesanne  
Fahy, Paul Healy, Paul  
Jurd, Paul Lawrence,  
Stephen Lickorish, Marc  
Orme, Graham Read, Hal  
Ridge, Peter Scherer, Ian  
Somman, Oliver Timson,  
Ian Titchmarsh, Matt  
Upton, Eddie Walder,  
Richard Young

**ADVERTISING**

Tel: +44 (0) 20 8267 5820  
Fax: +44 (0) 20 8267 5850  
E-mail: autosport.ads@haymarket.com

**AD PRODUCTION**

Tel: +44 (0) 20 8267  
5740 Fax: +44 (0) 20  
8267 5320

**COMMERCIAL**

**MANAGER**  
Rachel Brock,  
ext: 5820  
rachel.brock@haymarket.com

**CLASSIFIED**

**ADVERTISING**  
Matt Simpkin,  
ext: 5560  
matt.simpkin@haymarket.com

**DISPLAY ADVERTISING**

Gary-Lee Hoebeek,  
ext: 5576  
garylee.hoebeek@haymarket.com

**LUKE RICKETTS**

ext: 5992  
luke.ricketts@haymarket.com

**ALEX NEWBERRY**

ext: 5244  
alex.newberry@haymarket.com

**EMILY CLARK**

ext: 5865  
emily.clark@haymarket.com

**ONLINE ADVERTISING**

Leanne Foley,  
ext: 5846  
leanne.foley@haymarket.com

**BILLY JONES**

ext: 5367  
billy.jones@haymarket.com

**SUBSCRIPTIONS**

UK 0844 8488817  
**OVERSEAS** +44 (0)1795 592 974  
**EMAIL**  
autosport@servicehelpline.co.uk  
**US & CANADA** 1-866-918-1446  
**US & CANADA EMAIL**  
haymarket@msnews.com  
AUTOSPORT, ISSN number 0269946X,  
is published weekly by Haymarket Media  
Group, Teddington Studios, Broom Road,  
Teddington, TW11 9BE, United  
Kingdom. The US annual subscription  
price is \$235. Airfreight and mailing in

the USA by agent named Air Business  
Ltd, c/o Worldnet Shipping Inc., 156-15,  
146th Avenue, 2nd Floor, Jamaica, NY  
11434, USA. Periodicals postage paid at  
Jamaica NY 11431. Subscription records  
are maintained at Haymarket Media  
Group, Teddington Studios, Broom Road,  
Teddington TW11 9BE. Air Business Ltd  
is acting as our mailing agent.  
**BACK ISSUES**  
Tel: 0844 8488817  
**DIRECT MARKETING EXECUTIVE**  
Karen McCarthy, ext: 5658  
karen.mccarthy@haymarket.com

**MANAGEMENT**

**GROUP PUBLISHER**  
Alastair Lewis

**PUBLISHING MANAGER**  
Samantha Jempson

**SPECIAL EVENTS MANAGER**  
Laura Coppin

**DIGITAL SPECIAL PROJECT**  
**MANAGER**  
Simon Strang, ext: 5093  
simon.strang@haymarket.com

**DIGITAL PRODUCT MANAGER**  
Simon Grayson, ext: 5346  
simon.grayson@haymarket.com

**© 2013, HAYMARKET MEDIA GROUP LTD**

Publishing, trade and further subscription  
details on www.autosport.com While due  
care is taken to ensure the contents of  
AUTOSPORT are accurate, the publishers  
and printers cannot accept liability for  
errors and omissions. Advertisements are  
accepted for publication in AUTOSPORT  
only upon Haymarket Media Group Ltd's  
Standard Terms of Acceptance of  
Advertising, copies of which are available  
from the Advertising Sales Department  
of AUTOSPORT.

**CIRCULATION TRADE ENQUIRIES**

Frontline Ltd, Park House, 117 Park Road  
Peterborough, Cambs, PE21 2TS. Tel: +44  
(0)1733 555161. Printed in England  
by Wyndeham Heron Ltd. Cover and  
centre sections printed by CSI Impact,  
Basingstoke. Colour origination: FMG,  
90-92 Pentonville Road, London N1 9HS.  
ISSN 0269-946X. AUTOSPORT,  
incorporating Autoclassic, is published  
weekly by Haymarket Consumer Media,  
Teddington Studios, Broom Road,  
Teddington,  
TW11 9BE, UK.

**EDITORIAL DIRECTOR**

Mark Payton

**CREATIVE DIRECTOR**  
Paul Harpin

**STRATEGY AND**  
**PLANNING DIRECTOR**  
Bob McDowell

**PUBLISHING**

**DIRECTOR**  
Patrick Fuller

**MANAGING**  
**DIRECTOR**  
David Prasher

**CHIEF EXECUTIVE**  
**OFFICER**  
Kevin Costello

Haymarket is certified by  
BSI to environmental  
standard ISO14001



# THIS WEEK

LETTERS • BEST PICS • LATEST GEAR • ON TRACK & SCREEN • ONLINE

## What you think of the motorsport news of the past week



**What are you going to do now, Seb – swap trophies after the champs?**

## Don't say sorry for winning

What a ridiculous situation, where a racing driver apologises for winning. I am talking of Sebastian Vettel in Malaysia, of course.

By all means apologise to the team and your team-mate for disobeying team orders, but for the millions of

others around the world, congratulations to Sebastian for showing that he wants to race and win at all costs.

We so often used to complain about processions, but here was a driver who entertained us all.

**David Hayhoe, Seaford, East Sussex**

**I suspect most were not surprised when Sebastian Vettel behaved like an over-indulged child who couldn't have his own way on Sunday.**

He should learn from the behaviour of Nico Rosberg, frustrated with a faster car under him in the closing stages of the race, but prepared to play the team game.

**David Denham-Smith**  
Woodhall Spa, Lincolnshire

do and the other had the maturity to acknowledge he was being paid by his team and with that came a certain responsibility. Respect Nico!  
**Carol Mason**  
By email

**If Vettel had followed team orders, he'd have deprived the public of one of the most exciting incidents of the weekend. Seeing the Red Bulls racing wheel to wheel is the type of action that helps quench the thirst of F1 fans. They pay to see motor racing, not team principals getting precious over constructors' points.**  
**Clive Eaton**  
By email

**Vettel rescued the Malaysian GP from the blight of team orders, and should be praised for giving**

the fans watching an actual race. Some fans complain that DRS and degrading tyres are reducing F1's sporting prowess, but really there is nothing less sporting than having the order of cars on the track determined in a team meeting before the race has even started.

**Chris Davies**  
Kirkby in Ashfield, Nottinghamshire

**While I do not applaud Vettel for his actions, neither do I condemn him. Just a few laps before the Red Bull incident, I was shouting at my TV for Rosberg to ignore the team orders placed on him. How I would have loved his racing instinct to defeat his calm head! Sebastian, it seemed, was unable to bury that instinct.**  
**David Herron**  
Washington, Tyne and Wear

# In pictures

Our lensmen pounding the beat, from Malaysia to the Canary Islands

**SPLASH BEFORE THE TEAM STORM**  
Poleman Sebastian Vettel leads as Mark Webber prepares to pass both Ferraris on the first lap in Malaysia. The Red Bull twins would get a lot closer later in the race



COATES/LAT



**KOPECKY'S CANARY**  
Once Robert Kubica had crashed out in his Citroen DS3, Jan Kopecky's Skoda Fabia won the ERC Canary Islands Rally by nearly two minutes

**PREMATURE CELEBRATION FOR ALONSO?**  
The Ferrari team celebrates Fernando Alonso's 200th GP outing in Malaysia, although he's only actually started 198 F1 races so far...



GILHAM/GETTY

**KYLE'S CAPERS**  
Kyle Busch smokes some serious rubber after taking a last-gasp win in the NASCAR Sprint Cup race at Fontana last weekend in his Joe Gibbs Toyota



LAT

## In the shops

Desirable new releases

### SCALEXTRIC CATERHAM 7

£55 – [pendleslotracing.co.uk](http://pendleslotracing.co.uk)

Purchase the all-new Scalextric Caterham 7 in Slot Car Festival livery, limited to just 350 pieces worldwide, and you'll get one free adult entry ticket to the Slot Car Festival itself at the Heritage Motor Centre in Warwickshire on May 12. The car is fitted with Magnatraction and comes with a detailed driver figure.



### PORSCHE 917 STORY BOOK

£95 – [autosport.com/shop](http://autosport.com/shop)

'Porsche 917-021: The Fabulous Story' is just that. It recounts the amazing life of the 21st 917 to be built by the Porsche factory. Interviews with team players and ex-drivers are complemented by amazing original documentation and imagery unearthed during the research of a car that raced around the world, became a road car and then underwent a full restoration.



### AUTOSPORT T-SHIRT RANGE

£17.99 – [shotdeadinthehead.com](http://shotdeadinthehead.com)

AUTOSPORT now has its own dedicated area on this site featuring T-shirts, hoodies, mugs and iPhone cases. The latest, and very topical, design features the once-secret 'hold station' code issued to Red Bull drivers Sebastian Vettel and Mark Webber. Fat lot of good it proved in Malaysia last weekend, but those in the know will appreciate the latent humour.



# What's on

Your guide to the best events taking place in the UK and around the world – plus TV and online

## On track in the UK

### BRANDS HATCH

#### TOCA

March 30-31

Admission **£13 Sat, £31 Sun**  
(discounts available online)

Tel: 01474 872331

The British Touring Car Championship is back! Can Gordon Shedden defend his title, or will Jason Plato's MG be good enough for long enough to snatch it away? You can never discount Matt Neal's Honda, while Mat Jackson will be gunning to realise the potential of Motorbase's NGTC Ford Focus. Then there's former champ Colin Turkington, returning to the fold in WSR's new NGTC BMW 125i. Support comes from British Formula Ford (now with added wings), Porsche Carrera Cup GB, Clio Cup UK, Ginetta GT Supercup and Ginetta Junior.

### KX QUESTION TIME

Don't miss Jason Plato's KX Question Time in the Brands Hatch Kentagon at 6.30pm on Saturday night. Ask a great question – you'll win a prize!

### OULTON PARK

#### British GT

March 30 & April 1

Admission **£13 Sat, £22 Mon**  
(discounts available online)

Tel: 01829 760301

British GT is all set for the best season in its history. More than 30 supercars will contest two one-hour races. Support comes from VW Cup, Ginetta Challenge, F3 Cup, Northern Sports and Saloon Cars, and the Club MSV Trackday and Team Trophies. There is no track action on Sunday.



New British GT season kicks off at Oulton Park

### THRUXTON

#### HSCC

March 30-31

Admission **£12 on the gate**  
each day, **£17 weekend**

Tel: 01264 882222

The HSCC's Easter Revival has attracted a record entry of more than 270 cars to Thruxton. There are 14 races across two days for 70s Road Sports, Historic Formula Junior, the Jochen Rindt Trophy (for European Formula 2 cars), Martini Trophy (for '60s and '70s sports-racers), Guards Trophy, Historic Road Sports, Historic FF 1600, Historic FF2000 and Classic Racing

Cars, plus the first races for the new Touring Car Trophy series for cars from the Super Touring era and earlier.

### CASTLE COMBE

#### CCRC/BRSCC

April 1

Admission **£15**

Tel: 01249 782417

The inaugural 'Howard's Day' race meeting in memory of the Wiltshire circuit's late saviour. There are races for the resident Formula Ford, Saloon and Sports & GT series, plus Mighty Minis, Super Mighty Minis, Production Golf GTIs and Mazda MX5s.

### LYDDEN

#### ERC

March 31-April 1

Admission **£18 Sun,**  
**£20 Mon,**

**£35 weekend**

Tel: 01304 830557

European Rallycross enters the first stage of a new era in Kent this weekend. Renowned sports promoter IMG is bringing the sport to a new global audience and laying the foundations for a full-blown world championship. Crowds will no doubt flock to Lydden to see how ex-World Rally champion Petter Solberg gets on against the ERC regulars.

### MALLORY PARK

#### 750MC

April 1

Admission **£11**

Tel: 01455 842931

Two races each for 750 Formula, 750 Trophy, Classic Stock Hatch, Locost and Stock Hatch.

The BTCC starts its fun and games



## On track around the world

### FIA GT SERIES

Rd 1/6

Nogaro, France

March 30-April 1

fiagtseries.com

### SUPER TC2000

Rd 1/12

Buenos Aires street

circuit, Argentina

March 31

super-tc2000.com.ar

### AUSTRALIAN F3

Rd 1/7

Mount Panorama, New

South Wales, Australia

March 30-31

formula3.com.au



FIA GTs get going at Nogaro with a new look

## On television

### THURSDAY MARCH 28

1035-1210 **Motors TV**  
 FIA European F3: Monza Highlights  
 2000-2100, 2315-0015 **Sky Sports F1**  
 The F1 Show  
 2100-2315 **Sky Sports F1**  
 Classic Races: Fernando Alonso's maiden win, Hungary 2003

### FRIDAY MARCH 29

0000-0030 **Eurosport**  
 Inside the WTCC  
 1000-1100 **ESPN**  
 IndyCar: St Petersburg Highlights  
 1100-1200 **ESPN**  
 IndyCar Lights: St Petersburg Highlights  
 1200-1300 **ESPN**  
 NASCAR Now  
 2100-2315 **Sky Sports F1**  
 Classic Races: Lewis Hamilton's maiden win, Canada 2007

### SATURDAY MARCH 30

0400-0425 **Channel 5**  
 Motorsport Mundial  
 1300-1445 **Motors TV LIVE**  
 FIA GT: Nogaro Qualifying Race  
 2100-2235 **Motors TV**  
 FIA GT: Nogaro Highlights  
 2100-2315 **Sky Sports F1**  
 Classic Races: Mark Webber's maiden win, Germany 2009  
 2235-0010 **Motors TV**  
 FIA European F3: Monza Highlights

### SUNDAY MARCH 31

1045-1800 **ITV4 LIVE**  
 BTCC: Brands Hatch  
 1600-1750 **Motors TV LIVE**  
 FIA GT: Nogaro Championship Race  
 1000-1100, 1700-1800 **Sky Sports 3**  
 Racemax  
 2000-2100 **BBC2**  
 Donald Campbell: Speed King  
 2100-2315 **Sky Sports F1**  
 Classic Races: Sebastian Vettel's maiden win, Italy 2008  
 2100-2305 **Motors TV**  
 FIA GT: Nogaro Highlights

### MONDAY APRIL 1

2030-2100 **BBC4**  
 Motor Racing at the BBC

### TUESDAY APRIL 2

1210-1415 **Motors TV**  
 FIA GT: Nogaro Highlights  
 1630-1800 **ITV4**  
 BTCC: Brands Hatch Highlights  
 1930-2000 **ESPN**  
 NASCAR Now  
 2200-0030 **Sky Sports F1**  
 GP2: Malaysia Replay

### WEDNESDAY APRIL 3

1200-1230 **ESPN**  
 Planet Speed  
 1340-1515 **Motors TV**  
 FIA European F3: Monza Highlights  
 1545-1750, 2205-0010 **Motors TV**  
 FIA GT: Nogaro Highlights

## Online

### HOT ON THE WEB THIS WEEK

YOUTUBE: ROBERT KUBICA CRASHES OUT OF CANARIES RALLY LEAD



**SEARCH FOR:** ROBERT KUBICA CRASH ERC CANARIAS 2013 SS10 Citroen DS3 (0:45)  
 Former F1 star Robert Kubica is dominating the European Rally Championship qualifier in the Canaries aboard his Citroen DS3 RRC when a misjudged sequence on a cliff-top asphalt stage spells the end of his challenge and a serious near-miss with oblivion.

## AUTOSPORT+

Exclusive content coming up in our premium website this week

### Vettel: The monster Red Bull created

AUTOSPORT's Jonathan Noble looks at how Sebastian Vettel came to ignore Red Bull team orders and wonders if irreparable damage has been done. Could Christian Horner have been firmer, like Ross Brawn at Mercedes, in the Malaysian GP?

### GET AUTOSPORT ON THE MOVE

- IN THE IPAD ISSUE THIS WEEK...
- WATCH HIGHLIGHTS OF THE INDYCAR OPENER AT ST PETE AND FULL EURO F3 COVERAGE FROM MONZA
- ON SALE ALL OVER THE WORLD FOR ONLY £2.99



Download it now from [autosport.com](http://autosport.com)

AUTOSPORT

# Revved up over what's on the box



"57 CHANNELS AND NOTHIN' ON", The Boss once sang back in the 1990s when that seemed like a lot of options. These days there's almost that many dedicated sports channels and on most weekends, contrary to what Bruce Springsteen might have thought, the opposite is usually the case, as Mrs Revved Up will unhappily attest.

But due to a host of World Cup qualifying matches last week, there was almost no domestic football come the weekend. This meant fans of IndyCar racing were able to watch the season opener from St Petersburg live on its new home, ESPN.

After years on Sky, where Keith Huewen

and a series of guests (with varying levels of expertise) filled in gaps during the numerous American ad breaks, the disappointingly small number of viewers it garnered meant it was forced to find a new home on the airwaves.

Aside from a lot of very short ad breaks and nothing in the way of pre- or post-race analysis, there was little to frustrate an avid IndyCar viewer last Sunday, but don't expect this to last.

Only that perfect storm of Friday internationals interrupting the Bundesliga, Serie A and La Liga action created that hole in the schedule for IndyCar to fill. And opportunities like that don't come around often. The next round at Alabama on April 7

won't be shown live, forcing you into the murky world of scouring the web for a live feed of dubious legality.

And who knows what will happen when the BT takeover of ESPN comes into full effect in July? Just taking a US feed with no studio programme around it doesn't appear to sit with the multi-million-pound investment BT is making as it tries to carve into Sky's dominance of the live sporting world.

With a host of topline Brits in good cars, IndyCar ought to be big news over here. Hopefully there's someone in TV land who appreciates that.

**Revved Up**

# TAKING **SERIOUS FUN** TO ANOTHER LEVEL



Be part of the new and exciting single make race series in the UK, featuring the sensational **Ariel Atom**. 8 Race weekends at 6 of the best race tracks in the UK featuring 16 races.

- Affordable package options
- Full hospitality with Absolute Taste (part of the McLaren group)
- MotorsTV coverage of all rounds
- Full factory support at all races
- Honda reliability
- Very attractive sign up offers

# SIGN UP **TODAY!**

Call **01926 258028** or e-mail: [info@atomcup.co.uk](mailto:info@atomcup.co.uk)  
to secure your place on the grid

For further details visit: [www.atomcup.co.uk](http://www.atomcup.co.uk)

# Dennis Rushen

■ Ayrton Senna ■ Euro FF2000 ■ Jyllandsring ■ August 22, 1982 ■ Van Diemen RF82 ■ Title victory



Senna celebrates title victory in the Jyllandsring pitlane

**WORKING WITH SOMEONE** like Ayrton Senna meant there were obviously plenty of highlights – lots of races stood out from my time running him in Formula Ford.

But the best one, and it was one that I know meant the most to Ayrton in his junior career, was when he wrapped up the European Formula Ford 2000 championship in Denmark in 1982.

The race at Jyllandsring was the penultimate round that year and, if I remember correctly, Ayrton had to win it to make sure of winning the championship, because he'd screwed up a few times earlier in the year. He wasn't quite as perfect as everyone thought, you know!

To give you an idea of the frame of mind he was in for that big-pressure weekend, brought on by the early-season problems: he'd had engine failure in the opening round at Zolder, won at Donington from pole then inexplicably thrown it off while leading during the second visit to Zolder. I told him that weekend

– it was the same one Gilles Villeneuve was killed – that if he won he could borrow my car to go and see some girl he'd met and I'd catch a lift home some other way. Well, after the shunt he had to come home with me and he had a face like thunder – he didn't speak to me the whole way back!

Next time out at Hockenheim he'd

cooked his clutch off the line and fallen back. He then got caught up in a big smash avoiding leader Cor Euser's wreck so, points-wise, he had some work to do.

He then got his head together and won at Zandvoort, Hockenheim and Osterreichring, all from pole, to put himself back in contention.

The Jyllandsring race was actually

fairly straightforward. He won again from pole and clinched the title. But it was what it meant to him and how he reacted afterwards that was the most significant and satisfying thing for me.

Winning the 2-litre title must have been a big deal because that night he had a couple of vodka-tonics – it was the first time I'd ever seen him drunk. And later on he pinched a scooter in the town and was doing wheelies up and down the streets!

I asked him years later which championship meant the most – [FFord] 1600 or 2-litre, F3 or his three F1 titles – and he said this one in 2-litre. It was his first overseas crown against drivers all aiming for the top. F1 wasn't that big a deal to him – he was always going to do it.

We had some great times at Rushen Green in the early 80s, with lots of great young drivers, and not forgetting my partner Robin Green, who was the brains behind it all! ✽  
*Dennis Rushen was talking to Henry Hope-Frost*

## Profile

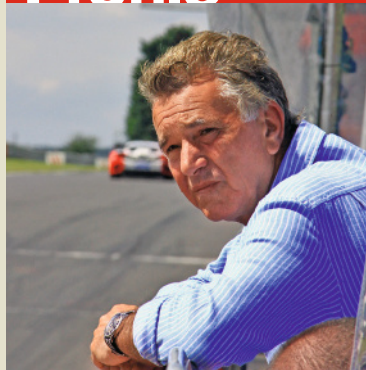

### DENNIS RUSHEN SERVED HIS

motorsport apprenticeship at Lotus under Colin Chapman, and worked at Brabham, March and Williams before joining Ralph Firman at Van Diemen. With the support of racing accountant Robin Green, he soon founded super-successful junior single-seater team Rushen Green Racing. That disbanded in the mid-'80s, Rushen then running a team in the US. He continues to guide the careers of several young drivers.

**NEXT WEEK** WHAT'S WRONG AT McLAREN?  
And how it plans to fix it **DON'T MISS IT!**

**DRIVEN BY SUCCESS.**

**Jack HARVEY**  
**BRITISH F3 SERIES**  
**WINNER 2012**

[www.formula3.co](http://www.formula3.co)



COOPER TIRES IS PROUD TO BE THE OFFICIAL TYRE SUPPLIER AND TITLE SPONSOR OF THE 2013 BRITISH FORMULA 3 INTERNATIONAL SERIES. This prestigious and fiercely competitive series is widely acknowledged as the toughest domestic single-seater championship in the world and is a genuine stepping stone for great drivers on their way to F1. Motorsport at this level therefore requires the very best components in every area, including tyres. When you need tyres that perform on your car or 4x4 Cooper tyres are the fitting choice.

Discover a world of opportunity,  
visit [www.coopertire.co.uk](http://www.coopertire.co.uk)





The power. The glory.



**British GT**  
Championship

Race Calendar 2013

Oulton Park	01/04/2013
Rockingham	05/05/2013
Silverstone	25/05/2013
Snetterton	15/06/2013
Brands Hatch	10/08/2013
Zandvoort	06/09/2013
Donington Park	05/10/2013

[www.avon-tyres.co.uk](http://www.avon-tyres.co.uk)

An epic journey requires an invigorating connection between you and the road. A connection formed by the performance, control and tenacity of Avon tyres. Wherever and whenever they're called upon, our tyres deliver an experience unlike any other. Meaning they're the difference between the everyday and the epic.





BY APPOINTMENT TO  
HER MAJESTY THE QUEEN  
SUPPLIER OF CAR CARE PRODUCTS  
AUTOGLYM, LETCHWORTH, ENGLAND



BY APPOINTMENT TO  
H.R.H. THE PRINCE OF WALES  
SUPPLIER OF CAR CARE PRODUCTS  
AUTOGLYM, LETCHWORTH, ENGLAND



Sunday 10:15am. YOU, THAT PERFECT FINISH AND THE OPEN ROAD.  
INDULGE IN THE GLORY.



Attacking the twists and bends with the sun shimmering on pristine bodywork and supple leather – it makes that bit of effort worthwhile. Don't worry, you're not alone, we share your passion for detail. For us it's an obsession that started over 40 years ago and continues to drive us today. That's why our products work beautifully, are quick and easy to use and more durable than ever. It also means you and your car get to look good for longer. *That's the Autoglym way. Always has been.*



Made in Great Britain

[www.autoglym.com](http://www.autoglym.com)

PASSION for PERFECTION

