

INSTRUÇÃO DE MONTAGEM

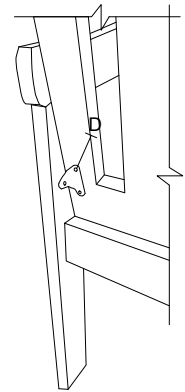

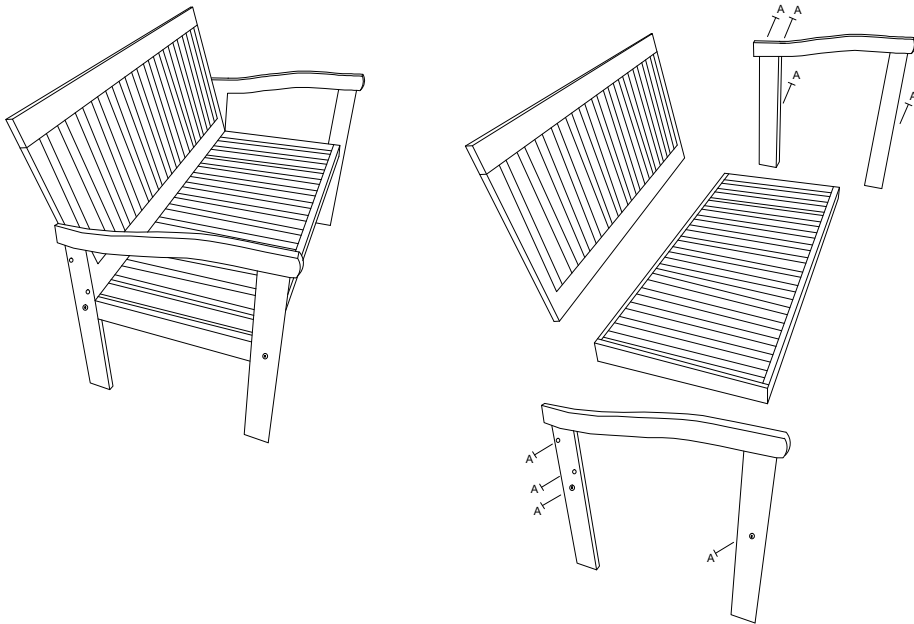

* Montagem da poltrona grande e pequena são iguais.

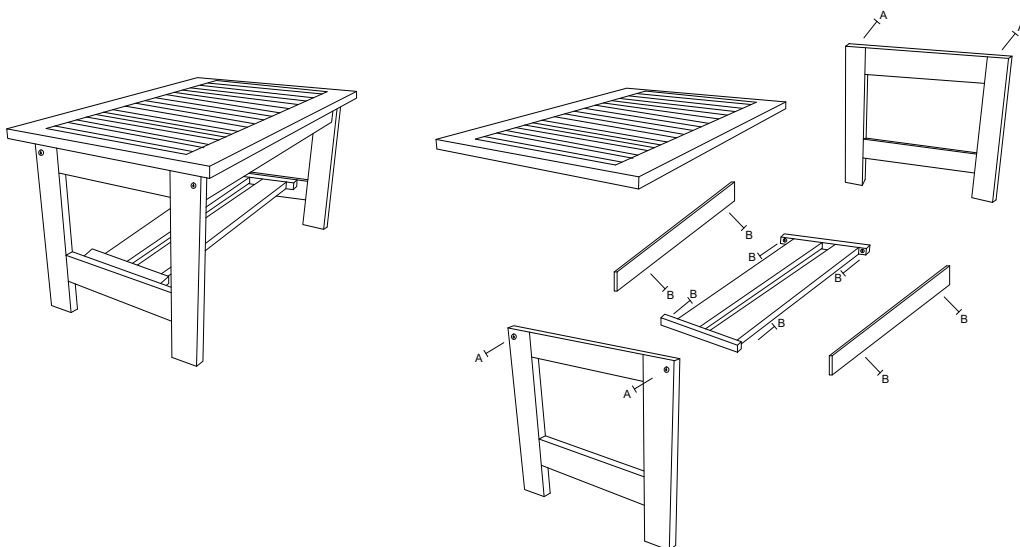

Fixação na face traseira da poltrona

MESA DE CENTRO



A	 Soberbo $\frac{1}{4} \times 50\text{mm}$	28
B	 4,0 x 50mm	8
C	 Chave	1
D	 3,0 x 16mm	6

Importante:

- * Monte todos os itens com atenção.
- * Aperte bem os parafusos.
- * Verifique periodicamente para que partes não estejam soltas, nestes casos precisam ser reapertadas.