

# AUTOSPORT

20 YEARS ON: IMOLA '94

www.autosport.com • MAY 1 2014 • £3.60

## F1'S DEADLY WEEKEND BY THOSE WHO WERE THERE

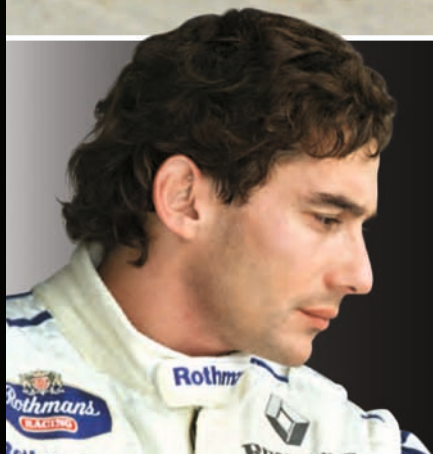

### PROST ON SENNA

"We talked about the bad safety"

### VILLENEUVE ON RATZENBERGER

"At least he was living his dream"



# McLaren Honda MP4/4

AYRTON SENNA'S 1988 TITLE-WINNING CAR



BUILD YOUR OWN AYRTON SENNA McLAREN MP4/4

**Available Now**  
Superb official 1:8 scale model  
whilst stocks last



**KYOSHO**  
THE FIRST ROAD CONTROL MODEL

**NEW!**

DIE-CAST METAL • BUILD IT YOURSELF • OFFICIAL REPLICA MODEL

1:8 Scale

Fascinating magazine

Officially Licensed with  
McLaren

High-Quality Kyosho  
Parts

£40 per month  
complete in 20 months



INSIDE YOUR FIRST BATCH



NOT AVAILABLE IN STORES

**GO TO:**

**SENNASMCLAREN.CO.UK OR CALL 0845 1489 251**



**POLE POSITION**

# Ratzenberger & Senna: gone but not forgotten

**IN THE 20 YEARS SINCE IMOLA 1994, MUCH HARD** work has been done to improve safety standards in motorsport and, thankfully, the deaths of Roland Ratzenberger and Ayrton Senna were the last drivers we've had to mourn in Formula 1.

There are far-more-qualified people than me to comment on that awful weekend two decades ago, which is why we've spoken to 23 drivers and others who were central to the events for this issue. Back then I was a cub reporter just out of my teens, covering a Bank Holiday clubbie at Oulton Park, but even there – hundreds of miles from Imola, a world away from F1 – the pervading air was one of huge loss and great sadness.

I'd only witnessed Senna race once (his junior career in Britain was just before my time) and what a race it was – the 1993 European GP at Donington Park that encapsulated his genius. I'd seen Ratzenberger in action far more often: in Formula Ford, F3, F3000 and the BTCC. He might have lacked Senna's natural talent, but I've not seen anyone try harder behind the wheel.

They say that God loves a trier, but he certainly turned his back on our sport at Imola 20 years ago.



*Bradley*

**CHARLES BRADLEY EDITOR**  
charles.bradley@haymarket.com  
@Autosport\_Ed

**FROM THE ARCHIVE**

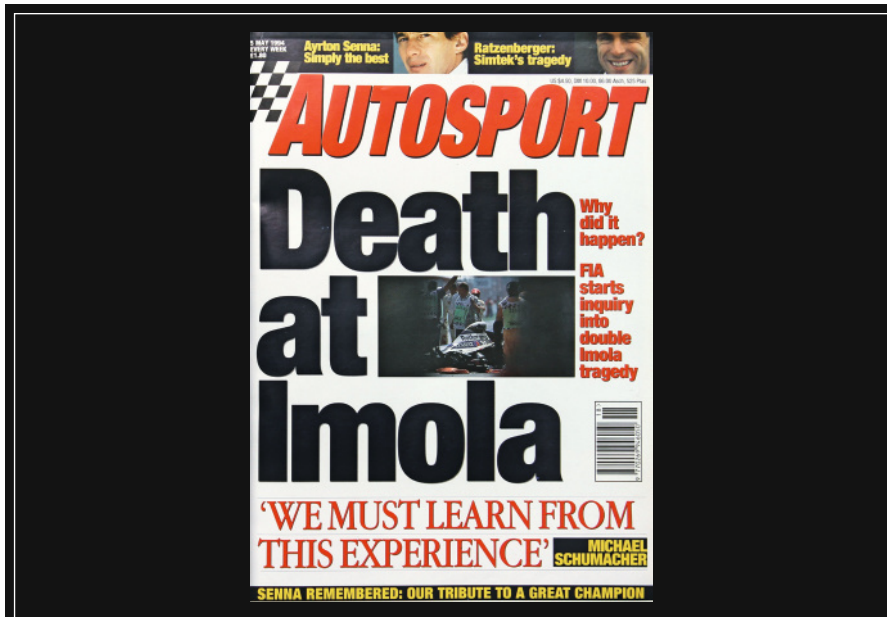

**FIND US ON**



Cover images: Loubat/Gamma-Rapho/Getty Images; LAT

**PIT & PADDOCK**

- 6 **THIS WEEK IN F1**
- 9 **JONATHAN NOBLE: F1 NEWSHOUND**
- 10 **THIS WEEK IN MOTORSPORT**
- 13 **DIETER RENCKEN: F1 POLITICS**

**IMOLA 1994 RETROSPECTIVE**

- 14 **IMOLA GRID: IN THEIR OWN WORDS**  
How the men who competed at the 1994 San Marino Grand Prix remember F1's most turbulent weekend
- 28 **SENNA'S LEGACY IN BRAZIL**  
How the great man is remembered in his homeland
- 30 **ALAIN PROST**  
Frenchman looks back on war and peace with Senna
- 32 **GERHARD BERGER**  
Austrian talks of life – and keeping up – with his friend
- 34 **ROLAND RATZENBERGER**  
Remembering a man who lived for his racing
- 38 **DAVID BRABHAM**  
Why he bravely raced on after team-mate's death

**DEBRIEF**

- 40 **LESSONS LEARNED 20 YEARS ON**  
How '94 tragedies sparked wide-reaching safety push
- 42 **McLAREN REGROUPS FOR EUROPE**  
Woking team's new plan to get back to the front
- 44 **SMEDLEY ON HIS NEW ROLE**  
Why Massa's 'wingman' went from Ferrari to Williams

**RACE CENTRE**

- 46 **INDYCAR BARBER MOTORSPORTS PARK**  
Hunter-Reay redeems himself in shortened race
- 50 **FORMULA RENAULT 3.5 ARAGON**  
Rowland does the business for maiden win
- 52 **NASCAR; GT MASTERS; INDY LIGHTS; FACCELERATION 1; V8 SUPERCARS**

**SUBSCRIBE FOR A FREE GIFT**

- 54 **FREE MERCEDES F1 PEN**  
Subscribe for a great free gift and digital package

**DTM PREVIEW**

- 56 **MERCEDES: TIME TO BOUNCE BACK**  
How Three-Pointed Star is planning return to glory
- 58 **'ROCKY' BACK IN THE RING**  
Interview with reigning champion Mike Rockenfeller

**INSIDE LINE: GARY PAFFETT**

**CLUB AUTOSPORT**

- 73 **TEAM QUITS CLIOS IN NEW-CAR RUMPUS**  
Stalwart squad JHR fed up with TOCA support series
- 74 **ROUSE AND ROVER FOR GOODWOOD**

- 78 **NATIONAL REPORTS**  
Brands Hatch 750MC; Silverstone MSVR; Donington Park MSVR; Prescott hillclimb; Kirkistown 500MRCI

**THE BACK STRAIGHT**

- 86 **THIS WEEK**  
Readers' letters; best pictures; product reviews
- 88 **WHAT'S ON**  
The best track and TV action in the coming week
- 90 **RALLY OF MY LIFE: TERRY KABY**



# THE BIG PICTURE

Twenty years ago today (Thursday) the most infamous grand prix in history gets under way at Imola with Ayrton Senna starting on pole position for Williams...



# This week in F1



6

## PUSH TO MAKE F1 MORE EXCITING

Teams are pushing to make Formula 1 cars more spectacular with the return of sparks, glowing brake discs and vapour trails all under consideration. Leading F1 outfits are concerned recent design trends have robbed the sport of the drama provided by previous generations of cars, and the sport's Strategy Group is considering proposals to bring back some of that excitement.

### THE IDEAS

- Make glowing brake discs more obvious.
- Use active suspension to make cars spark.
- Aerodynamic tweaks to create vapour trails.
- Standing starts after safety car periods.
- Reduced race lengths.
- More advanced pitstop technology.

"It's a dream for the aerodynamicists. My concern would be that we'd go back to cars that look like Scalextric cars - glued to the track."

Ex-driver Martin Brundle is concerned F1 could become dull if active suspension returns for 2017



STALEY/LAT

### McLaren sticks with blockers

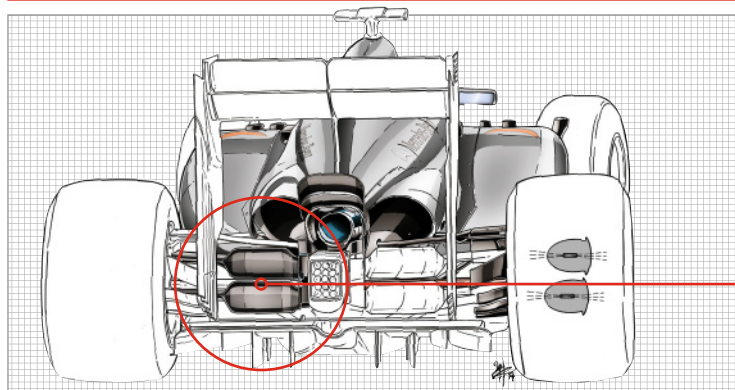

McLaren is fully committed to its radical suspension blockers, despite testing without them in Bahrain last month. The MP4-29 has lacked downforce so far this season, so the team elected to re-check the blockers during the post-Bahrain GP test.

"In terms of downforce and drag numbers it has now been validated, so we are happy to carry on with this," said McLaren racing director Eric Boullier. "The car has been developed around this device so we have to keep developing the car as it is now."

### HOW McLAREN STACKS UP

AUTOSPORT's pace comparison, taking an average based on the fastest lap by each car across a race weekend expressed as a percentage, shows McLaren's MP4-29 has been the sixth fastest car so far this season.

Mercedes	100.000
Ferrari	100.716
Red Bull	100.936
Williams	101.200
Force India	101.339
McLaren	101.348
Toro Rosso	101.783
Sauber	102.647
Lotus	103.126
Marussia	104.446
Caterham	105.119

GRAPH BASED ON GARY ANDERSON INDEX

### Set-up issues hurting Vettel

Sebastian Vettel's struggles against Red Bull team-mate Daniel Ricciardo are the result of being uncomfortable with the 2014 car, according to team boss Christian Horner. "He is tremendously sensitive to certain aspects of the set-up and he's not getting the feedback he wants," Horner said. "The compound effect is that he's damaging the tyre more, which is very unusual for Seb. As soon as he's worked his issues out he will be back with a bang."



HONE/LAT

For all the breaking news, visit **AUTOSPORT.COM**

If this was a normal company, and a customer hasn't paid you, you have an issue and you deal with it. But because this is F1, it gets blown a bit out of proportion



Lotus owner Gerard Lopez says the team's financial struggles last winter were exaggerated

**BIG NUMBER**

**470**

The number of staff working for the Lotus F1 team, according to owner Gerard Lopez. This represents a reduction of 95 compared to 2013.



**No F1 race for Long Beach**

The renewal of IndyCar's deal to race at Long Beach until the end of 2018 has scuppered plans for F1 to return to the Californian street circuit next year. The local council voted 8-0 to extend the IndyCar deal for three years, with two additional one-year options, but left the future open to F1 by instructing city officials to investigate a possible switch to an alternative championship after 2018.

I don't know if current F1 cars could absorb the conditions of the track surface here. They'd have to resurface like they do in Monte Carlo every year



**Ex-BAR and Super Aguri F1 racer Takuma Sato thinks a Long Beach Grand Prix is unlikely...**

There's no way that an F1 race could happen around here anymore. In the 1980s you could do that, but now it doesn't make any sense.



**... As does his IndyCar rival Justin Wilson, who raced in F1 in 2003**



**Ecclestone back in court**

Bernie Ecclestone reiterated his innocence of bribery charges last Thursday as the Formula 1 supremo's high-profile court case in Germany got underway. Ecclestone is accused of paying a \$44 million (£26 million) bribe to former banker Gerhard Gribkowsky to help secure the sale of BayernLB's 47 per cent stake in the sport to private equity firm CVC Capital Partners in 2006. The prosecutors allege Ecclestone helped secure his place as the head of the sport by selling to CVC. Gribkowsky has been jailed for his part in the affair, but Ecclestone has consistently pleaded innocence, claiming he was being blackmailed. If Ecclestone is found guilty, he faces up to 10 years in jail. The case was due to resume tomorrow (Friday).

**Rossi's Canada Caterham run**

Caterham's reserve driver Alexander Rossi will get his first taste of the CT05 during practice for June's Canadian GP. Rossi is focusing on GP2 this season, but will also run in US GP free practice for Caterham.



**Hill's Halow ride**

Former world champion Damon Hill will undertake the halow250 cycle ride, a 250-mile round trip from Putney in London to Caen in France, to raise money for the Halow Project of which he is patron.

• Visit <http://uk.virginmoneygiving.com/DamonHill> to make a donation.



**De Silvestro tests Sauber**

Sauber affiliate Simona de Silvestro completed her first Formula 1 test last weekend. The former IndyCar racer racked up 180 laps in a two-year-old C31 over two days at Ferrari's test track at Fiorano



**Raikkonen: I'm still motivated**

Kimi Raikkonen has hit back at suggestions his motivation is suffering as a result of his difficult start to the season. "I don't know why you always come up with motivation - if I didn't have motivation I wouldn't be here," Raikkonen told reporters when it was suggested his motivation might be waning. "It's f\*\*k all to do with this."

# SENNA *EXPERIENCE*

A DRIVER AS SPECTACULAR  
AS AYRTON SENNA DESERVES A  
TRACK AS BIG AS THE WORLD.

[www.sennaexperience.com.br](http://www.sennaexperience.com.br)

SENNA EXPERIENCE is a special place where you can share your memories, pictures, videos and homages to your idol. You will also be able to check out special official content and discover other tributes from fans from all over the world. Login now and join us and help us build this great tribute.



 Enjoy our fan page.  
[/oficialayrtonsenna](https://www.facebook.com/oficialayrtonsenna)

Also Visit:  
[www.ayrtonsenna.com.br](http://www.ayrtonsenna.com.br)





# Jonathan Noble

## F1's newshound

Sparks, vapour trails and glowing brake discs would be good, but what F1 really needs is wholesale restructuring of revenue share

Everyone loves watching a bit of retro Formula 1 fever. And there has been no shortage of good excuses to do just that this week thanks to the latest chatter about a potential return for active suspension, glowing brake discs, vapour trails and sparking cars.

Watching once again that magical moment when Nigel Mansell overtook Ayrton Senna at Barcelona in 1991 – centimetres apart, titanium sparks scattered high, and vapour trails curling off their rear wings – it's hard not to think that bringing some of the visual excitement back to F1 would be a good thing.

Indeed, the sport's chiefs should be applauded for finally thinking about areas in which F1 has gone wrong in recent years. But, equally, it would be a huge mistake to think that rewinding the clock and simply resurrecting some populist elements from the past is going to suddenly make F1 brilliant again and revive its flagging audiences. For the real reason why interest has been on the wane has nothing to do with what the cars look like.

Instead, it's everything to do with the competitive situation in F1 – where things are so skewed in favour of its bigger teams that it's stifling competition. The move by powerhouses Ferrari, Red Bull, Mercedes and McLaren in recent years to secure a big share of F1's commercial rights income is fully understandable from their perspective – and they have every right to be rewarded for everything they have delivered over the years.



Red Bull at the front, Ferrari playing catch up and McLaren on the back foot.

We all loved F1 in the 1990s, not because the cars sparked or the suspension was active, but because there was some good racing, and different winners. There was the chance of some giant-killing performances too, and new teams could come in and make an impact.

As F1 heads to the Spanish Grand Prix next week – scene of that famous Mansell/Senna duel – it should be alarmed that it risks hitting an unenviable landmark.

**“F1 would be better served by ripping up the commercial structure and starting again”**

When you're talking about what's right for the sport itself – rather than individual teams – F1 would be better served by ripping up the current commercial payment structure and starting again. For we have been left with a scenario where the bigger teams have by far the biggest budgets to further stamp their dominance on the sport to earn even more money – leaving the smaller outfits with no chance of catching up.

Look at last year's earnings. Thanks to a mixture of historical and performance-based payments, F1's top earners Ferrari and Red Bull took home more money each than Force India, Williams and Sauber combined. That's a commercial structure that does not open itself up to close competition. In fact, it's a one-way ticket to boring domination.

And it perhaps explains why, after the biggest technical regulation shake-up in recent F1 history, the story of the season is not one of a hugely mixed up grid full of surprises. Instead, it's all a bit 2013 again. Mercedes and

For if Lewis Hamilton, Nico Rosberg or Sebastian Vettel triumph (and you would be brave to bet against them) then it will mark a full 12 month spell where only three men have won grands prix.

It's something that F1 has not witnessed since Ayrton Senna, Alain Prost and Gerhard Berger locked out the top step of the podium from the 1987 Japanese GP to the 1988 Australian GP. So if you want to rekindle the magic of the 1990s, don't stop the talk at sparks and vapour trails, look at the competition.

A more equal distribution of the funds would make for closer racing and a better spectacle for everyone. Yes, winning should carry with it its rewards, and a meritocracy should remain, but it should not be weighted as heavily in favour of F1's big guns as it is right now.

For if the field is not close enough that the victory spoils aren't spread around, then it doesn't matter what the cars look or sound like. Good racing is where the conversation should start and end. ❧

# This week in motorsport

## BIG PUSH FOR BUSCH

NASCAR star Kurt Busch's challenge for the Indianapolis 500 with Andretti Autosport was unveiled on Monday. Busch will become only the fourth man to attempt The Double – IndyCar's showcase and the 600-mile Charlotte Sprint Cup round – on the same day.

 P46 INDYCAR REPORT



LEVITT/LAT

10

## WRC shoot-out moves closer



World Rally Championship rounds are in line for a major shake-up next season, with the final day of events looking increasingly likely to be run as a single-stage shoot-out.

The WRC promoter and manufacturers are pushing for a change to the current format in an effort to cut costs and make more of a media spectacle.

One option – first talked about last year – is for drivers to battle (against the clock, not on the road) in pairs for their overall position, culminating in a live TV scrap for victory between the crews running first and second in the classification.



## Porsche takes weight hit for Spa

Porsche has been hit with a performance penalty after its one-two in GTE Pro in the opening round of the World Endurance Championship at the Silverstone 6 Hours.

The minimum weight of the Porsche 911 RSR has been raised by 25kg ahead of this weekend's second round at Spa under WEC Balance of Performance rules. The two factory

Manthey 997-shape Porsches will now run at 1235kg.

Aston Martin has been given a performance break for the Belgian event after its contender was off the pace at Silverstone following an increase in rideheight of five millimetres. Its Vantage GTEs will run at 1195kg, 15kg lighter than at Silverstone.



BLOXHAM/LAT

## Heidfeld: 'Ring 24 with Nissan

Ex-Formula 1 racer Nick Heidfeld has joined Nissan for next month's Nurburgring 24 Hours.

Heidfeld, a judge and mentor with the German Nissan GT Academy, will share a GT-R NISMO GT3 with Florian Strauss – winner of the German Nissan scheme last year – as well as marque favourites Alex Buncombe and Lucas Ordenez.

Meanwhile, veteran Michael Krumm joins Japanese trio Kazuki Hoshino, Katsumasa Chiyo and Tetsuya Tanaka in the sister car.

For all the breaking news, visit **AUTOSPORT.COM**

## NASCAR fight action unlikely

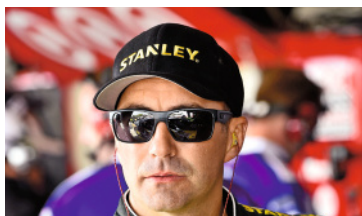

KINRADE/LAT

NASCAR is unlikely to issue any penalties to Marcos Ambrose and Casey Mears for their post-race fight at Richmond last Saturday.

Mears had finished 19th, one place behind Ambrose (above), and appeared to push the Australian, who then punched Mears in the face.

NASCAR senior vice-president of competition Robin Pemberton said: "We don't think it was anything too severe. We'll get all the footage we can, look at it and see what happens from there."

## Formula E – testing done

The Formula E SPARK-Renault concluded its development testing at Montebelco in Spain last week.

The all-electric racer completed race-simulation runs with Jonathan Cochet, Antoine Leclerc and Ho-Pin Tung. SPARK will now focus on completing the first batch of cars.

## Audi S1 for Ekstrom RX

Audi DTM star Mattias Ekstrom's new World Rallycross team has plumped for the Audi S1 model.

The EKS squad will run Ekstrom – when his DTM commitments allow – and reigning Junior World Rally champion Pontus Tidemand.

Ekstrom said: "I grew up in the rallycross paddock because of my father, and I'm very excited to be driving a Supercar and to witness the sport growing into a world championship."



EBREY/LAT

## Lancaster gets Le Mans deal

GP2 race winner Jon Lancaster is to make his Le Mans 24 Hours debut with the Race Performance LMP2 team.

The Briton will share the team's ORECA-Judd/BMW with team owner Michel Frey and Franck Mailleux, who are

contesting the European Le Mans Series together and took second place in the Silverstone opener (pictured).

Lancaster, 25, said: "This will be good for my CV and could open doors in LMP1, which is only going to continue to grow."



EBREY/LAT

## Tiny grid for British F3 opener

This weekend's British Formula 3 opener at Rockingham looks set to feature just seven cars on the grid.

Teams are hopeful that more drivers could be attracted for the second round at Silverstone in late May. Those running current-spec FIA engines are now eligible for points, but a clashing European round at Hockenheim rules

out any takers for Rockingham.

As AUTOSPORT closed for press, the grid looked set to comprise: Britons Sam MacLeod, Matt Rao (both Fortec) and Alice Powell (Carlin); Chinese racers Martin Cao (Fortec), Andy Chang (Double R) and Peter Li (Carlin); and American Camren Kaminsky (Double R).

### DRIVERS AT FIRST BRITISH F3 ROUND (IN CARS ELIGIBLE FOR MAIN TITLE)

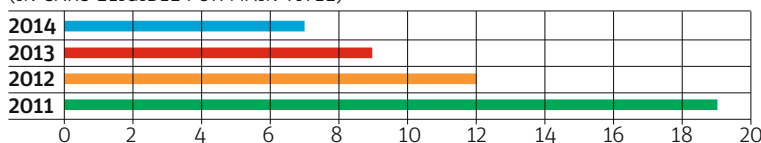

## Astons pull out of 24 Hours

Three Aston Martins are among five withdrawals from the Le Mans 24 Hours.

The two Le Mans-only Aston Martin Racing entries – one in GTE Pro and one in Am – and Hong Kong-based Craft Racing Vantage GTE were joined by the pair of Millennium Racing ORECA-Nissan O3 LMP2s. They have all been replaced by the remaining cars from the reserve entry list.

Two Porsche 911 GT3-RSRs run by the Imsa and ProSpeed squads have joined their respective lead cars on the entry list. Because they were the only GTE cars left on the standby list, three LMP2 reserves have moved up: Larbre Competition with its Morgan-Judd; the Greaves Motorsport-entered Caterham entry for a Zytek-Nissan; and Pegasus Racing's Nissan-engined Morgan.

## In brief

### COE LEAVES RALLY GB

MSA chief executive of International Motorsport Ltd boss Andrew Coe will leave his post, which entails being the head of Rally GB, this week as part of a shake-up. Coe had been in the position since 2001.

### WRC ROW PROGRESS

World Rally Championship manufacturers and the promoter reported a positive outcome from last week's crunch talks following significant dispute between both parties. Scenes similar to Rally of Portugal, where Sebastien Ogier was instructed not to give interviews to official WRC television reporters, are said to be unlikely to be seen again.

### CARPENTIER FOR RX

Former Indycar ace Patrick Carpentier will contest the Trois-Rivieres round of the World Rallycross series in a Marklund Motorsport VW Polo.

### RAM MISSES SPA

British-based Ferrari team Ram Racing has withdrawn its pair of 458 Italias from this weekend's Spa 6 Hours due to an "unforeseen budget shortfall". The pull-out has been made in a bid to ensure it has sufficient resources for next month's Le Mans 24 Hours.



EBREY/LAT

## Electric lap on for Le Mans

Nissan believes its radical ZEOD RC is on course to achieve its objectives at the Le Mans 24 Hours – including the first all-electric lap of the 8.47-mile Circuit de la Sarthe.

Nissan global motorsport boss Darren Cox told AUTOSPORT that he was confident that the ZEOD would be able to complete a lap during the race using only energy retrieved by its hybrid systems and be able to attain 300km/h (186.4mph) down the Mulsanne Straight on electric power.

But Cox stressed that it was unrealistic to expect the ZEOD to complete the race without problems.

# THE MEMORABILIA EXPERIENCE

One of the World's Largest Providers of Rare and Unique Formula 1 and Vintage Race Memorabilia



Trade, Buy, Sell or Consign your memorabilia & rare collectables with The Memorabilia Experience!  
We specialize in locating and designing your collectable space!

Senna, Schumacher, Vettel, Clarke, Villeneuve, Webber, Barrichello, Alonso, Massa, Stewart and so many more greats available.

**Call Us Today!**

1-705-481-1109 / 1-855-481-1109

email: [info@thememorabiliaexperience.com](mailto:info@thememorabiliaexperience.com)

[www.thememorabiliaexperience.com](http://www.thememorabiliaexperience.com)



- Commercial Insurance
- Public liability
- Public liability for track days
- Storage and transit
- Team travel
- Motor trade
- Products liability,
- Personal accident

## Providing insurance packages for motorsport teams, individuals and organisers

We are still based in our Warwick office providing the same old TLC

Contact us on **01926 439 439**  
or email: [motorsport@towergate.co.uk](mailto:motorsport@towergate.co.uk)



Towergate Insurance is a trading name of Towergate Underwriting Group Limited. Registered in England No. 4043759. Registered address: Towergate House, Eclipse Park, Sittingbourne Road, Maidstone, Kent ME14 3EN. Authorised and regulated by the Financial Conduct Authority.



# Dieter Rencken

## F1's political animal

It's unclear whether the meeting today (May 1) between the sport's rulemakers and teams will sort out the cost control disagreement

**O**stensibly called by FIA President Jean Todt to discuss regulatory cost control, the meeting scheduled today (May 1) at Formula One Management's Biggin Hill headquarters will severely test the executive powers of F1's Strategy Group, and, by extension, the body's future.

Formed as part of the sport's post-2012 governance procedure, the Group consists of the FIA (six votes), FOM (ditto) and four so-called 'Championship Constructors Bonus' teams – Red Bull, Ferrari, McLaren and Mercedes – plus Williams (through heritage) and Lotus, as reward for it being highest-placed non-CCB team in 2012-'13.

However, this said 'test' presupposes the Strategy Group will survive in its present form after four 'disenfranchised' teams, namely Caterham, Force India, Marussia and Sauber addressed a strongly worded letter to Todt after he told AUTOSPORT that previously agreed plans for cost capping had been abandoned after an abrupt Strategy Group U-turn.

"Most of the teams were in favour of the cost cap, but I understand all the teams that are part of the Strategy Group are against it now," he said. "Clearly, if the commercial rights holder and six teams, which means 12 of 18 are against [on a simple majority basis], I cannot impose it. It's mathematics. So in this case, no more cost cap."

In compensation the Group proposed a raft of

The intention was for these agreements to be enshrined in a full Concorde Agreement – the tripartite covenant that governs F1's sporting, commercial and administrative issues – acceptable to all player groups. To date no Agreement has been signed, although the FIA and FOM agreed an outline framework known as the Concorde Implementation Agreement (CIA). However, some Strategy Group members and non-SG team principals are adamant the Strategy Group was not clearly defined in the commercial agreements – one team boss stated the only reference was "a vague clause outlining a group to formulate future strategy, not one with sweeping powers to overturn what was agreed".

Todt's response – a copy of which was seen by this writer – seemingly substantiates this, the Frenchman writing that the Strategy Group was provided for in the (CIA), which was agreed between the governing body and FOM in July 2013 and subsequently ratified by the FIA World Motorsport Council.

By implication the teams have not (yet) agreed to the CIA, and thus, by extension, not formally approved a Concorde Agreement or indeed the Strategy Group. Given that the 2010-12 Concorde makes provision for its Schedule 9 (governance procedure) to be carried over where no formal replacement exists, a case could be made that the Strategy Group has (as yet) no executive powers or authority.

In his letter Todt states the non-SG teams do have

**“By implication the teams have not (yet) approved any Concorde Agreement or Strategy Group”**

“cost saving” measures – on the face of them mostly tailored to suit their own ends, and by their nature unlikely to save the immediate £30m per annum a cost cap would impose.

In their letter the quartet – saliently Red Bull sister team Toro Rosso abstained, thus it sits in neither faction – questioned the legality of the Strategy Group under EU monopolies/abuse laws, with the letter referencing fair play and ethics as prescribed by the International Olympic Committee, to which the FIA recently subscribed.

On the face of it the CCB teams (and FOM, whose CEO Bernie Ecclestone currently has weightier issues on his mind as he fights serious bribery charges in a Munich court) appear unmoved, with Red Bull's Christian Horner arguing that all teams accepted the revised governance process as part of their individual commercial negotiations with Ecclestone in early 2012 to cater for the 2013-20 period.

input into the process via the Formula 1 Commission, on which sit all teams, FIA, FOM, circuit owners, sponsors and technical partners. The counter argument is that the Commission does not frame regulations, but merely passes items agreed at SG level to the WMSC for ratification, and therefore the four (of 25 seats) effectively hold no sway.

The last thing the FIA and the sport's commercial owners CVC Capital Partners, who acquired the majority rights as part of a contentious process being dissected in Munich, need is an EU investigation (or IOC intervention), but so desperate are some of the disenfranchised outfits to save their teams from collapse they could well turn to Brussels – before or after.

Indeed, rumours are rife that one of the four is down to its last £5m (10 per cent of the most parsimonious budget) with no relief in sight, and fears abound that even Thursday's meeting, regardless of outcome, could be too late. ❧



1 SENNA



3 BERGER



5 LEHTO



7 FRENZEN



9 KATAYAMA



11 MORBIDELLI



13 BRUNDLE



15 ALBORETO



17 BERNARD



19 PANIS



21 DE CESARIS



23 BERETTA



25 GACHOT



2 SCHUMACHER



4 HILL



6 LARINI



8 HAKKINEN



10 WENDLINGER



12 BLUNDELL



14 MARTINI



16 FITTIPALDI



18 COMAS



20 HERBERT



22 LAMY



24 BRABHAM



DNS BELMONDO



DNS BARRICHELLO



# THE IMOLA GRID LOOKS BACK ON A BLACK WEEKEND

Formula 1 was rocked to its core at the San Marino Grand Prix in 1994.

Many drivers admit now that they considered stopping in the aftermath.

In their own words, this is how the drivers coped with those devastating events of 20 years ago, as told to

ANTHONY ROWLINSON, PETER MILLS,  
GARY WATKINS, ANTHONY PEACOCK  
HEIKKI KULTA AND EDD STRAW

## 2

## MICHAEL SCHUMACHER

#5 BENETTON-FORD B194 Race: 1st

**“I struggled with the fact that people could lose their lives in Formula 1”** MICHAEL SCHUMACHER

SUTTON-IMAGES



I was always a great admirer of Ayrton. I had seen him at a karting race, back in Zolder, and this guy I didn't know at that time immediately caught my attention: the lines he was driving, the way he was doing it, I just loved the way he was karting there. From that day on I knew his name, and obviously when he entered F1 I still looked at him. And when I got to F1 it was the same, I just loved the way he was driving. So in a way Ayrton was my idol, even if I wasn't happy

at first with his approach towards young drivers when I entered F1. But this was part of the game, so it was no big deal.

The 1994 season started surprisingly well for us, and we found ourselves in the position to eventually fight for the championship, which was great. I looked forward to fighting against Ayrton and Imola was the next step in this fight.

I saw his accident but I wasn't informed what had happened. So at first, I wasn't aware of the

consequences. But when I heard about it, I remember it was a deep shock.

You know, it might sound strange, but that weekend, with Roland Ratzenberger and Ayrton Senna dying, was the first time for me that I experienced that somebody found death through the sport I loved so much. For me, dying on a race track was something related to the past, to the times I didn't know a lot about, but clearly not to 'our' times.

The Sunday night after the race I was totally shattered. I was seriously thinking about quitting F1, as I struggled with the fact that people could lose their lives there. I really wasn't sure if I wanted to go on, and I was speaking a lot with [my wife] Corinna about it. I remember at the next test I was mainly trying to find out for myself if I still liked it.

*Schumacher was speaking to AUTOSPORT prior to his skiing accident in December 2013*

## 3

## GERHARD BERGER

#28 FERRARI 412T1 Race: DNF

Most of you are going to ask whether it was right to continue to drive. Honestly, I saw Roland's accident. I saw it in repeat and I know what happened. I know how heavy it was, how bad it was for the driver.

I knew before I went out that the situation was critical. But without even knowing, I could feel it myself. It was the first time that I have found myself shaking after an accident. I was sitting in the car, I watched it on the monitor, and when they started to get him out of the car, I could see that it was going to be very bad.

Of course, in our job you are sometimes a bit prepared to see situations like this. But as it was another Austrian driver, as it was a personal contact to a person, it was even worse. I know that it should not make a difference between a driver that you know and a driver that you do not know. But it affects you in a different way.

I went out from the car. I felt sick. I went to the motorhome and I was shaking, all my body. Then the difficult situation was coming, to say if I was going to drive or not.

I told myself that it was not whether I was going to drive now. The question was whether I would drive tomorrow [in the race] and in the future, or if I was not going to drive at all. It was not related to this [Saturday] afternoon, it is related to whether you are prepared to have this

risk or not. It wasn't going to make any difference to Roland if I drove or not. But I had to decide if I was prepared to still take risks like this.

Honestly, when Barrichello went off, it gave me a picture of how close sometimes we are between life and death. I felt really on the limit.

But I said to myself, 'Do you want to race tomorrow or are you not going to race?' And I said I was going to race.

From this moment on, I told myself to concentrate on the job, because it was not going to make any difference to anybody. It was a difficult situation and it was very hard.

But Ayrton — I think he was incredibly unlucky to have the head impact where he had it. There had definitely been worse accidents at that corner. It's true that he was worried about safety that weekend, particularly after Roland's accident. He talked to me quite a lot about it and then again after the drivers' briefing on Sunday. I went to the hospital to see Ayrton immediately after the race and that was a very heavy impact for me. He was dead, but on a life support machine and that's when I saw him for the last time. I went to both funerals — Roland's in Salzburg and Ayrton's in Sao Paolo and, OK, that's when you say goodbye in an official way.

But what you see at a racetrack when two of your friends die is what affects you the most.





4

**DAMON HILL**

#0 WILLIAMS-RENAULT FW16 Race: 6th (with fastest lap)

Imola 1994 was basically the most enormous experience and test of everything in my life, as a racing driver and as a person – certainly of my professional career. It was surreal. At the time it just didn't seem real and after seeing *Senna*, the film, I realise there were some bits that I had forgotten and some bits that were very uncomfortable. There were things, too, that I really didn't want to go into again and maybe had shut away.

So many things happened... little things... and then it became a weekend where everything happened and led to one big catastrophe. Everyone was stunned and after that weekend didn't know how to proceed.

We didn't realise immediately that Ayrton was dead. Nobody really knew. It had only just happened. Real information about Ayrton's condition wasn't available to anyone apart from Sid [Watkins]. It wasn't until the end of the race that we knew Ayrton had been killed. I'd heard that it wasn't good and the team tried to protect me to some extent. These things are so enormous it takes time for the enormity of it to sink in.

As for the race... does anyone really remember what happened? Just being a grand prix driver on the grid is a bit surreal anyway, you're so focused on what you've got to do. And when something goes as wrong as this, part of you is concerned about what happened. But then you realise there's not a role for you to play in it. So I felt that we had to go out there and get on with it. That was all I could do at the time.

It was the first European event of the season so there was an added buzz ahead of the weekend that wasn't there in the previous races.

I was still getting used to the added dimension that Senna brought to the event. The interest and intrigue that surrounded him was even more keenly felt when you got to Imola. So it just kind of built and built, and created a lot of excitement.

After his bad start to the season, there was pressure mounting on Ayrton to perform. And I remember AUTOSPORT the week before running a cover that added pressure on Ayrton.

Really we were at the start of a new era. We didn't really know who Michael Schumacher was. He was very much the new kid on the block and we were all re-adjusting to this new dimension. When you look back at it and think about it, it's apparent that there was a sense of a shift into a new era that started at Imola. At the start of the season the mood was that Ayrton had got himself into the best car, in the best team, and another world championship – though it wouldn't be easy – would be a lot easier than it was actually proving to be.

Then on the weekend itself, to be brutal about it, when Roland was killed, it felt already that things had got as bad as they could get. It didn't seem possible that it could get any worse. We all believed that we'd got beyond the time when drivers being killed was a regular occurrence. And particularly for people who had come into the sport after that time, or started following it, the fact that drivers were dying at a race was deeply shocking. It all seemed to be contributing to the power of what happened. It hit everyone very, very hard and made lots of people question why should they be doing something that had these consequences. And added to that it was beamed into people's homes.

The shockwaves had an enormous effect on the sport. From my point of view, my life completely changed at that point. My career was completely thrust into a different trajectory. Imola '94 was a huge, seismic shift in the sport. And the good thing that came out of it, if anything can be seen in that light, is that car and circuit safety has improved immeasurably. The tragedy is that it took that weekend to make that happen.



5

**JJ LEHTO**

#6 BENETTON-FORD B194 Race: DNF

Imola was my race debut for Benetton as I was still recovering from a huge testing accident at Silverstone in January, in which I broke my neck.

It was only 92 days since the accident, but we rushed a bit to get me back in the car and I was still in a lot of pain.

Before travelling to Imola I had dinner in Monaco with Roland, who was my close friend. The next day we drove together to Italy. I saw his fatal accident during qualifying on Saturday.

I started fifth, I think, but the race was the shortest of my F1 career, as Pedro Lamy's Lotus hit my car from behind, while I was stuck on the grid. The front tyre of Lamy's car was hurled over the barrier towards spectators. Four spectators and one policeman were hurt.

Then, later that day, Ayrton, my long-time idol, had his fatal accident at Tamburello corner. I had been training with him in the gym just the night before. Things like this cannot happen even in the most dreadful nightmares.



6

## NICOLA LARINI

#27 Ferrari 412T1 Race: 2nd

When we were on the podium, no-one knew about what had happened to Ayrton. The race had been stopped, but there was no other information about him other than he was in hospital. But I was worried about my crew because Michele Alboreto had lost a wheel in the pitlane and hit three of my mechanics. On the podium, we were thinking about what happened on Saturday with Roland Ratzenberger, so we couldn't use the champagne. But to imagine that Ayrton was lost? No...

**“When Ayrton was killed it seemed all the bad things were coming together all at once”** HEINZ-HARALD FRENTZEN

7

## HEINZ-HARALD FRENTZEN

#30 SAUBER-MERCEDES C13 Race: 7th

I have tried many times to think back to this weekend and it always stands apart. It had an almost 'mystical' quality, if I can say such a thing.

Now when we think of it we paint it as such a totally depressing, disastrous weekend, but beforehand I can't remember any particularly bad feeling.

So it was quite a shock when Rubens went off in practice, but for me the real shocks started on the Saturday, when my friend Roland was killed, and there was a feeling that things were going to get worse every day and maybe without stopping.

I was close to Roland as we had spent 18 months together racing in Japan before F1 and you know he was really a good person, a great guy. It felt to me like everyone we lost at Imola was a special individual in some way. We'd had a few conversations that weekend and we took some pictures together in scrutineering. We were having some fun, you know?

Ayrton spoke to me that weekend, too – I remember feeling quite proud that he took the time to have a conversation. He'd done the same in Brazil and Aida at the start of the year. It was my first season in F1 and he wanted to know more about me, how I was getting to know the business, how I was 'settling in'. He'd started having a chat even earlier, actually, back in pre-season testing at Estoril. He seemed to have a real personal interest in all the young drivers.

When he was killed it seemed all the bad things were coming all together and there were so many all at once. We'd had many accidents before – big ones with heavy damage, but

drivers not suffering too serious injuries – then suddenly the worst ones altogether.

When we got to Monaco two weeks later, my team-mate Karl Wendlinger had his crash in practice and really, then, there was such a tremendously bad vibe. It was disastrous: it felt like this was never going to stop.

Everyone was so shocked and disappointed and it meant that all anyone could talk about was safety. But it did create a very big development in safety in all aspects. In some ways it went over the top, with what we did at circuits at the time, but we wanted to cover every possibility. It was a very fundamental time and it gave a lot of energy to everyone to make changes and improvements in Formula 1.

The accidents were a message for us, I think, that something had to be done and it meant, for example, that we got the GPDA going again, which got the drivers involved in safety issues once more.

The thing I remember feeling during that period was that I didn't really know what to think or do. I was totally confused. It made me think back to one of the first times I ever went karting and one of the kids there was in a really serious accident and it was like a warning sign – like, 'My God, I only came here to have fun and something like this can happen!'

Imola and Monaco reminded us that there was always danger in motor racing and that something like this can happen and that basically you have to be really focused on what you're doing.



Frentzen's Sauber was competitive on a shocking weekend for F1



© of ASE under license from Instituto Ayrton Senna



Montegrappa  
ITALIA



[www.montegrappa.com](http://www.montegrappa.com)  
Montegrappa Limited Tel: 01245 225775

Available at : Harrods, Selfridges, The Pen Shop, Penfriend & Frost of London



Hakkinen questions the decision to continue racing...

LAT

8

MIKA HAKKINEN

#7 McLAREN-PEUGEOT MP4/9 Race: 3rd

My first memory, of course, is what a horrible weekend it was. Just a black weekend. There is no other way to describe it; nothing positive from it, or to say about it. When I do think back to it though, I do have many positive, human memories of Roland and Ayrton and these guys will always stay in my thoughts.

All I wish is that we could turn back time and that it had never happened, but obviously that is not possible.

Really I think the race weekend should have been stopped when Rubens had his accident on Friday. It was obvious there was something about the track, or the combination of those cars on the track. They should have said, 'OK, something's wrong here'. And after Roland was killed, well obviously, then, that should have been it. We shouldn't have gone racing. It's easy to say these things now and sure it would have been a tough decision to take at the time, but...



...and there was little joy on the podium

19

10

KARL WENDLINGER

#29 SAUBER-MERCEDES C13 Race: 4th



Wendlinger was shocked when he heard the news

LAT

The whole weekend is clear in my mind. Rubens had his big crash and wasn't badly hurt, so everyone said that in a modern F1 car nothing could happen to you. Then the next day we had the death of Roland Ratzenberger. It was a big shock, but it didn't really sink in.

On raceday I remember passing the accident and thinking that must be a Williams. They stopped us before the grid and Tim Wright, who was my race engineer, told me that Senna had had an accident but he should be OK. Then after the race there was the shock news.

I couldn't really see what happened. You were passing that place at such speed that all I knew was that the car was quite badly damaged.

After the race I came back to the Sauber pit and there was a bad atmosphere. I said, 'Hey what's going on?' Mr Sauber told me the news with tears in his eyes: 'Senna is dead.' I don't have the right words in English to explain my feelings. The whole weekend was so strange. I couldn't believe it. Nothing had happened for so many years and then two guys dead. I just got my stuff and left.

# 11

## GIANNI MORBIDELLI

#10 FOOTWORK-FORD FA15 Race: DNF

It was such a tough and dramatic weekend that it is impossible to cancel from your mind. It was one of the worst and most difficult situations that I had in my career, starting with Barrichello's accident on Friday, then Ratzenberger on Saturday and then Senna.

The day after, many of us started to wonder if there was any sense in carrying on because we felt so bad. But of course you have to carry on in life. It's the same with the [skiing] accident we had recently with Michael Schumacher. You know that in every single moment in life something can happen so you have to live. I always think about destiny. Everyone has a destiny already written, it doesn't matter if you make a life in a sport as dangerous as ours or if you are skiing on vacation or at home watching TV. Everything can happen.

After that weekend, F1 changed a lot because

the FIA started to see things differently. They introduced very strict rules concerning the safety of the car. What they did was incredible. They made a big step forward in safety.

With Ayrton, I remember one thing: when I first arrived in F1 at Phoenix in 1990, he was walking through the paddock and I was there in my overalls. He came to me just to say welcome and I appreciated that. It was such a good emotion for me to have.

After the crash and the red flag, I went to the motorhome and there was Jackie Oliver, the owner of the team. I asked him, 'Jackie, how is Senna?' He said, 'Don't worry, drive your race, don't think about that.' But I understood that there was something strange because it was not the normal Jackie Oliver I knew.

We did the race with a bad feeling. It was a very sad weekend. This is life, the bad part.



Morbidelli says several F1 drivers considered stopping

**“You know that in every moment something can happen”** GIANNI MORBIDELLI

# 12

## MARK BLUNDELL

#4 TYRRELL-YAMAHA 022 Race: 9th

Obviously it was a weekend with very bad memories and bad vibes, starting with Rubens, then Roland, then the startline accident, then Ayrton. It seems strange to say it now, but the atmosphere was very subdued all weekend, not like an Italian race at all. I remember sitting in the drivers' briefing on Sunday with this very strong feeling that even after what had happened already, it wasn't finished, there was more to come. There was a sense of realisation that 'yes, this can happen' and that we were risking our lives even if we chose not to think of it like that. We'd put it to the back of our minds, but events brought it to the front.

After Rubens' accident on Friday, there were conversations around the garage, but it wasn't something we chose to dwell on. We didn't want to keep talking about it. I remember saying to the guys, 'we don't know exactly what's happened. We just have to wait'. Any racing driver at the top level will say the same if you can get them to admit it: we have to be able to put things in boxes and compartmentalise. We have a job to do and we have to go out and do it and that becomes your focus, even in the most difficult circumstances.

The worst thing for me, actually, were the conversations with my family. My eldest was old enough to understand what had happened, but I didn't want to talk to him about it. I remember calling to talk to my mum and dad and that wasn't an easy conversation. Talking to them was quite an emotional release – certainly more of one than you can afford to have in the garage, or with your team. You don't open up like that unless you have to.

Blundell had tough conversations with his family after the deaths

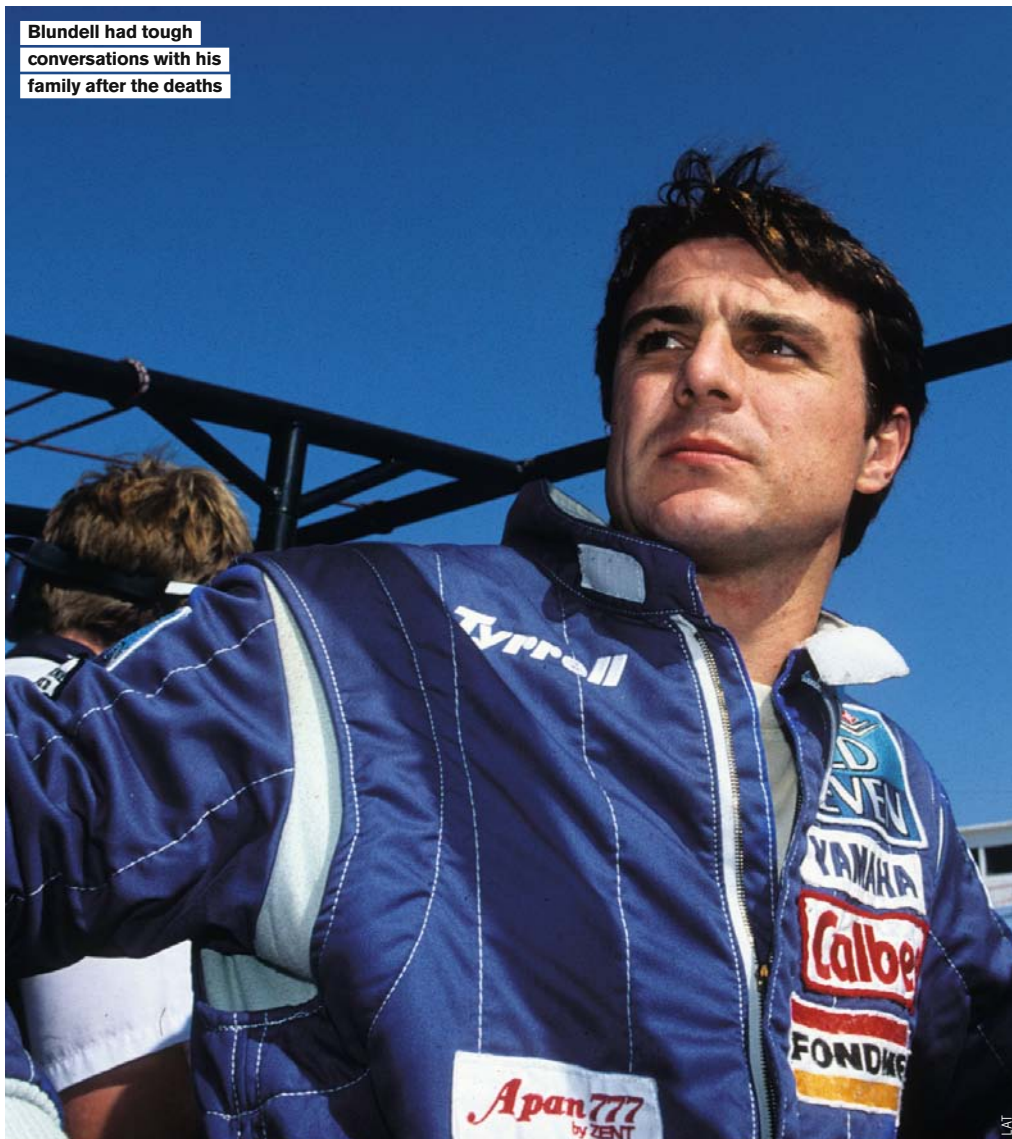



Brundle had known Senna since F3 in 1983 and joined McLaren after the Brazilian left

# 13

## MARTIN BRUNDLE

#8 McLAREN-PEUGEOT MP4/9 Race: 8th

My feeling that weekend was that it reminded me very much of the sportscar days in 1985 when we were losing lots of drivers and there was very much a feeling of, 'what's going to happen next?' and 'what's really going on?' and 'why are they all coming at once?'

At Imola there was Rubens' accident, then Ratzenberger, then Senna and two weeks later there was Wendlinger's massive shunt at Monaco.

We hadn't had a driver death since Elio [de Angelis] in 1986, but there had been a lot of big shunts, so that feeling of invincibility had started to creep in. That made Imola a pretty shocking weekend. I was with Senna in a lift in a little hotel we were staying in the night before his accident. He was pretty upset with the Ratzenberger news.

We had the drivers' briefing the next day and it was pretty emotional. I can't pretend to remember the detail super-clearly, but I can remember the room and I can picture myself sitting there. Seeing the *Senna* movie reminded me of some things I'd forgotten and even one or two things that I hadn't noticed at the time with my 'driver blinkers' on.

Things like the shunt at the start, then the hassle in the pitlane, leaving four mechanics needing medical treatment. And one thing that surprised me, watching the film, was how good

Ayrton's car seemed to be. There was one lap of in-car footage before the accident that I hadn't seen before. That surprised me.

I distinctly remember getting back to the grid after Ayrton's accident. It was a big shunt: I remember ducking around bits and pieces that came back onto the racetrack. Initially I was under the impression that it was Damon. Then we heard it was Senna. Then all the TV screens in the garages were getting switched off. Then we were told he was OK and we'd all seen him move his head, but we all know now that was almost his last movement.

When we restarted I was thinking it had been a big shunt, but survivable. We'd seen bigger accidents at Tamburello – like Berger's [in 1989]. So off we went racing. We didn't know that Ayrton was effectively killed instantly. I was very disappointed that we carried on racing where there was literally a pool of Ayrton's blood sitting by the side of the track.

After the race there was this atmosphere in the paddock... The thing you noticed most was the deafening silence. People were just mooching about, going about their business. There was a lot of denial going on.

One of the first people to know what had happened was Keke Rosberg. He told me and soon after Ron Dennis asked me what I'd

heard. I told him what Keke had told me and Ron said absolutely nothing. He was very close to Ayrton.

Later, I left the track for the airport with Giorgio Ascanelli, who was my race engineer at McLaren and had been Senna's. We got half way to Bologna airport with Giorgio saying absolutely nothing. And then suddenly he said: 'And what do you know about the accident?' And I said: 'I'm told he's dead. I'm told he didn't make it.'

That seemed to set the tone after that. We went a bit safety crazy for a while and got the GPDA reformed. Each of us was allocated circuits to go and look at with regard to the safety aspects. To an extent there was a knee-jerk reaction and we saw tyre chicanes in places like Barcelona. The thing was, we all knew, either consciously or sub-consciously, that there were corners where you could well die if you got it absolutely wrong, or where if something went wrong there was a good chance you could die.

There was a feeling that, as racing drivers, we needed to take control of the safety element. There was definitely a sense of making a statement. Then it began to normalise a bit, but it was a time that forever changed F1. It was also a time when people seemed to become more aware of F1, bizarrely.

# Tribute to a legend

# Ayrton Senna

1/18 RESIN MODEL  
COLLECTION



McLaren MP4/6 #1  
1991 Japanese Grand Prix  
A. Senna 2nd Place  
(TSM141819R)

LIMITED  
500



McLaren MP4/5 #1  
1989 Monaco Grand Prix  
A. Senna Winner  
(TSM124331)

McLaren MP4/6 #1  
1991 Brazilian Grand Prix  
A. Senna Winner  
(TSM124333)

1/43 RESIN MODEL  
COLLECTION

McLaren MP4/4 #12  
1988 Japanese Grand Prix  
A. Senna Winner  
(TSM134323)

McLaren MP4/6 #1  
1988 Monaco Grand Prix  
A. Senna Winner  
(TSM134324)

14

## PIERLUIGI MARTINI

#23 MINARDI-FORD M193B Race: DNF

It was a terrible, sombre weekend from start to finish. Most drivers have experienced the death or serious injury of a colleague before, but it doesn't make it any easier to cope with. In Ayrton's case the worst part was the fact that we had even had a short exchange before the start of the race, when he said to me: 'Look, us older guys need to get together soon and do something about the Federation because yesterday when I went to see the place where Roland had his accident, I was actually fined...'

As for Ayrton's accident, at the time, as a driver, you were just concentrating on what you were doing in the race. I think I was somewhere around the top 10, maybe ninth, and what I remember most clearly was just a wheel bouncing on the track and me doing my very best to avoid that. The way the sun was shining in my eyes meant that I couldn't actually see which car was involved but after the race was red-flagged Giancarlo Minardi told me: 'It's Ayrton, but he's moving!'

So then the race restarted, and it ended for me about 20 laps from the finish when I went off. I was being taken back to the pits by ambulance and it was only there that I heard the ambulance crew joking with each other saying: 'well, it doesn't look like this Brazilian is going to be on the grid again!'

I remember feeling absolutely furious with their insensitivity and lack of respect: I shouted at them and demanded that they took me to the medical centre so I could find out for myself what was happening. When I got there, the circuit doctor told me the simple truth: that Ayrton's brain injuries were incompatible with survival.

The first driver I saw after I heard the news was my team-mate Michele Alboreto. He was sitting at the back of our garage with his head in his hands, looking more downcast than I had ever seen him. He had retired from the race shortly after me when his wheel had come off in the pitlane and injured some mechanics. 'In this job, you also have to take into account the worst that can happen,' he said, which is horribly ironic when you consider what happened to him years later.

Ayrton's accident really altered my approach to the sport and was ultimately what led to my retirement from F1 the following year: a greater awareness of the risks and what I had to lose. Once you start thinking that way, it's time to move on.



Senna's accident led to Martini's retirement



Fittipaldi felt bad before race but was going well before retiring

16

## CHRISTIAN FITTIPALDI

#9 FOOTWORK-FORD FA15 Race: 13th

It was a hard weekend. Rubens had a pretty big one on Friday and then Roland's accident was devastating on Saturday. I remember going to bed on Saturday night and thinking 'a guy just got killed, it's not like he just broke his arm or leg'. Then the crash on Sunday just completed the black Imola weekend.

They threw a red flag for Roland's crash during qualifying so we came back into the pits and saw the images on the TV. As soon as he hit the wall and the car came to a stop you could see his head going to one side and we knew then that it was pretty bad. As a driver, you have seen so many accidents in your life and you know when it's OK and when it's not. As soon as the safety crew arrived, they started covering up the car and instead of the TV image getting better, it just got worse. Maybe half an hour later, the news came back to the pits that he had passed.

It was difficult to race the next day, but life goes on in the same way as when there is an airplane crash. Does that mean you are never going to fly again?

On Sunday morning, if I woke up and felt really bad, I shouldn't be in the car. Being a driver, you are exposed to certain risks that other professions don't offer: more risks than a guy who works in a bank. If I'm not prepared to take those risks I shouldn't be doing what I do.

When Ayrton's crash happened, I remember vaguely that I passed by and it had just come to a halt and that was it. I was running 12th or 14th, something like that, so I went by a few seconds later and, to be honest, even when I stopped on the grid, it never crossed my mind

that Ayrton had suffered a fatal accident. I thought maybe he's broken a leg or an arm and he'd be back in the car later but not for one second did I think it was that serious.

I did my race, but unfortunately I was fifth when I retired a few laps from the end. Frenzen stopped at the side of the track and I got a ride back to the pits with him. When I got back, it was a really sombre mood, everything was grey. It was a weird feeling and it started sinking in that this was a lot more serious than we had anticipated.

I remember I went to the motorhome to get changed and after that I bumped into Lehto and he was the one who gave me the news. That was, at the most, 40 minutes after the race.

He said, 'did you hear about it?' and I said, 'hear about what?', which again re-emphasised that it had never crossed my mind this could happen. Like everyone, I had this image of Ayrton as untouchable and everyone thought about him as driving for another 10 years and then retiring and being this great legend that had won so much. It never crossed my mind he could die in F1. Lehto said, 'I think he's died!'

At that point, I basically froze. You become suddenly static, especially inside. I think I looked at him and said, 'dead what?' – I didn't realise. Then the news started spreading that it was fatal.

It was hard but the whole weekend was a disaster. We had lost another colleague as well, 24 hours before that and because I was a Brazilian the emphasis was on Ayrton and us. But we must not forget that Roland passed on Saturday. Of all the racing weekends I have been involved with, it was the worst in my racing career.

**19**

**OLIVIER PANIS**

#26 **LIGIER-RENAULT JS39B** Race: 11th

It was the worst memory I have had in motor racing to be honest. Everybody was such big fans of Ayrton, and Roland also. This weekend was a nightmare really and it still is, even though it was a long time ago. It's a weekend that in some ways I would like to forget, but it happened and we cannot change that. I wanted to leave the circuit as quickly as possible to try to forget about it, but as a young Formula 1 driver, as I was then, at the beginning of my career [the '94 San Marino GP was his third], there was no question of stopping. But still I felt very sad about everything that happened.

Afterwards the drivers did make a lot more effort with safety and the GPDA. It's always sad that it takes something like this to make people respond and to have a big change in safety.

**18**

**ERIK COMAS**

#20 **LARROUSSE-FORD LH94** Race: DNF

I sat next to Ayrton in the drivers' briefing on race morning and for the first time everyone was talking about safety. He said, 'we cannot carry on like this'.

Ayrton basically saved my life at Spa in 1992. The weekend before the GP was the Spa 24 Hours and they had removed the inside kerb at Blanchimont and forgotten to put it back for F1. After only three laps of free practice JJ Lehto put dirt and gravel all over the track. I was just seconds behind and went straight off. I had an accident just like Ayrton's. The right front wheel hit my helmet and knocked me out. All the cars passed my car, including my team-mate [Thierry Boutsen], but Ayrton heard that my

engine was still running, stopped and turned the master switch off. After that we had a close relationship and we were both shocked by the events of the first two days at Imola.

During the safety car situation at Imola, Eric Bernard bumped me and I had a huge vibration, so I decided to stop to get the car checked over. The team was concentrating on fixing the car and didn't realise Senna had crashed. When my car was fixed, I went to the end of the pitlane. There was a big confusion about whether I could rejoin but eventually the marshal let me go.

When I got to Tamburello I couldn't pass because there were ambulances and a helicopter there. I had to stop my car and get out. I could see my friend lying there but couldn't help. It was a terrible feeling. I didn't wait for the restart. I left the track and flew home to London.

At first I didn't want to race in F1 anymore but Gerard Larrousse and others persuaded me to do a test and then Monaco, and finally I decided to continue through the season.

It was a very traumatic experience for me; it was impossible for me to talk about it for more than 10 years.



**20**

**JOHNNY HERBERT**

#12 **LOTUS-MUGEN-HONDA 107C** Race: 10th

I was at Lotus that year and we were having a bit of a difficult time as we weren't really up to the speed that we wanted to be. From my point of view, with the Lotus situation, and having a frustrating time there, it was an added shock to the system as we were all feeling a bit low anyway. Very suddenly we'd lost a good friend.

Roland was someone I knew very well, as I'd known him since the Formula Ford days and he was one of the last people who used to do the whole lot himself: live in a Transit with his girlfriend, trailer his car, do the preparation, fuel it, change the tyres, be the mechanics... the whole monty. And of course he won the FF Festival in 1986, so it was very sad that he got his F1 chance only for it to be taken away so quickly.

He was a lovely, down-to-earth guy. The accident happened when he lost his wing and it tucked under the car at 200mph, then he was head-on into the barriers.

After all this, we were a bit sensitive in the warm-up. When we eventually started the race, we had the first accident with Pedro hitting JJ and the wheel going into the crowd. Then after the restart we weren't aware what had happened to Ayrton... We saw his crash in the race, but none of us knew what had happened to him. It didn't actually look too bad. His car had just stopped moving when I passed it and I could see a crack in the chassis but basically it looked alright, so I didn't think so much of it.

When we found out it made us all very aware



of how fragile life is. We knew he used to drive with God on his side and he was very calculated about how he did that: on the edge, with the belief that God was his protection. I knew Ayrton quite well and the way that it all happened was surreal. It actually ended up being a whole month of incidents.

There was Karl's accident at Monaco two weeks later and then, in the same month, Pedro's accident in testing at Silverstone. That gets a bit forgotten about but I was Pedro's team-mate and we were the only two cars on track that day – in fact I was only 100 yards behind him. It happened just as he went out of sight into the old Abbey. After Imola we'd had the big diffusers cut back to the rear-axle line, so there was a lot more stress going through the rear wing mounting. Unfortunately Pedro's failed in a split second and as I went round Abbey all I could see in front of me was a smoking engine in the middle of the track. No bits, nothing, just engine.

I stopped and got out to see what had happened.

I went up the banking at the side of the track and only when I got there could I see that he'd barrel-rolled into the pedestrian tunnel. I could see a little flame coming from the mouth of the tunnel and from about 20 metres away, the remains of a monocoque. I realised he was stuck in the tunnel, so I rushed in there.

The monocoque had broken in half hitting the handrail going into the tunnel and Pedro was in there, slumped forward with his legs sticking out, crossed, almost like he was sitting in a deck chair. There was a little fire burning behind him where the refuelling cap was, and the paint on his helmet had started smoking. I remember thinking that I didn't know if he was alive, then that if I didn't help him, his brains were going to get burned.

Eventually a marshal found us and got the extinguisher going, but that just filled the tunnel with powder. Pedro was conscious by now and we got him out and his eyes were massive, out on stalks – he was in a total state of shock, not surprisingly. It all added to the surreal feeling of that time.

In F1 we'd sort of got used to feeling invincible but sadly it took an accident like Ayrton's to make the safety changes that have made such a massive difference today. I was one of only two drivers who went to both Roland's and Ayrton's funerals. It felt like the right thing to do as I didn't want Roland to be forgotten. Even after all the sadness it's good to remember that I raced both of them. They're nice memories.



# 21

## ANDREA DE CESARIS

#15 JORDAN-HART 194 Race: DNF

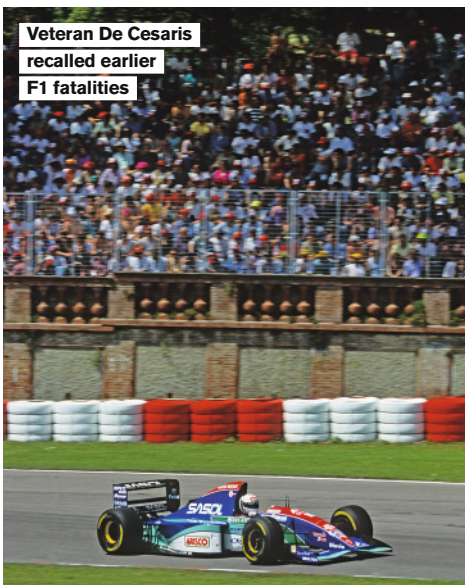

I clearly remember something was going wrong since the beginning of the weekend. Sometimes there is a connection between bad things and the pressure starts to build around that. So the weekend was an escalation of bad accidents.

When I started in F1, things were totally different. The thought of a fatal accident was in the mind of any driver. I first drove in F1 because of the death of Patrick Depailler in the Alfa Romeo, but since then a great job has been done on safety.

That weekend, it was not the loss of a great driver that made the difference. Actually, I am more sad for the death of a driver that did not have so much success [Ratzenberger] because it was more of a loss. At least Senna will always be remembered and did not die in vain.

The accident of Ayrton was very unlucky. At that stage, the cars were quite safe and he had the steering failure and hit the wall at 250km/h without any damage to the chassis.

# 22

## PEDRO LAMY

#11 Lotus-Mugen-Honda 107C Race: DNF

I was on one side, there was a car in front of me and I didn't realise that a car had stalled. I had just time to avoid crashing straight into the back of JJ and managed to hit him with my right-hand side.

People didn't realise at the time how big Ayrton's accident was initially. I was standing next to some Portuguese and Brazilian TV people and they didn't know how bad it was. Even when people were telling me that Ayrton was in trouble, I couldn't believe it. I think it was the same for everyone there: Ayrton could not die.

It was a difficult weekend. Rubens' accident, Roland Ratzenberger's death, my accident and then Senna's. It was a wake-up call for F1.

# 23

## OLIVIER BERETTA

#19 LARROUSSE-FORD LH94 Race: DNF

It was a strange and sad weekend. I saw the big crash at Tamburello. I didn't know which car it was, but I knew it was a big one. We all knew the speeds there and that there were no tyres, no protection before the wall. I knew it was a big one, but I never imagined that it was Senna.

There was a red light and we all stopped. There was a lot of confusion. Erik [Comas] had stopped in the pits and gone back onto the track because there was no red light at the end of the pits. I could see on the faces of the mechanics that something had happened. I tried to find out and they said they thought something bad had happened to Ayrton.

Just before the race restarted, I heard on the radio that Erik would not take the restart. The team said they couldn't find him. I knew something bad had happened. I did my race and when the engine failed I went to the marshals. They said it is a very sad day today. They told

me what had happened; there was nothing more to say. It was an extremely sad moment that's difficult to explain.

Ayrton was such a nice guy. I remember at my first GP in Brazil, he saw me in the drivers' briefing and said, 'Ah, a new face here?' I said, 'Yeah, it's my first GP'. He told me that if I needed anything, I just had to pop by and see him.

I had a small problem with the engine, which delayed me, and that saved me from a big accident. In those days you had a foot clutch, and it wasn't perfect. I had a little delay and that was just enough to save me. Lamy hit Lehto and I was just behind. I can't remember everything; all I know is that because I didn't do a perfect start, I was saved a big one.

I also had a big crash just after Barrichello. It was almost exactly the same accident, but I went in backwards. During free practice Hakkinen broke an engine and there was oil



Beretta spins in front of Senna during previous round at Aida

at the chicane [Variante Bassa]. I am sure that Barrichello went out because of the oil. There was a red flag, but they didn't see the oil. I was the first car to restart and I arrived at the chicane and went off. I have a picture of my car a metre up in the air, but going backwards.

26

# 25

## BERTRAND GACHOT

#34 PACIFIC-ILMOR PR01 Race: DNF

The first shock was Barrichello. He only got away with it because he was so small. A bigger driver would have suffered more. Then what happened to Roland was terrible, I knew him very well but we had a big crash at Zandvoort in 1987 and only made friends again at the Pacific GP.

There was so much debris, I thought Senna and Schumacher had gone off together. When I parked on the grid, I spoke to an official, who said Senna only had a broken leg. My engine broke in the race and I got to the airport as fast as I could. I met Max Welti there and he told me what happened. I remember the sad sight of Ayrton's plane on the runway as I took off. What happened to him showed it could happen to anyone because it was a corner that was easily flat, effectively a straight, even in the wet.



Gachot's Pacific retired from race

It didn't start off as a good weekend, and it just got worse and worse. I had to deal with Roland's accident, not just as an individual but also because I had my pregnant wife there. Not just that, with the team being so young and so stretched financially, there was a lot of shit going on. You don't quite know how to deal with the situation like that because you've never experienced it before.

Normally you wouldn't race in that situation: you would pack up and go home. I was asked on the Saturday night if I wanted to go on. Because I hadn't been in that situation, I didn't really know how to answer it. I said that I would do the warm-up and see how I felt. For whatever reason, we were halfway up the times, which wasn't normal. I came into the pits and I could just sense this massive black cloud that had been over the team starting to lift. I did the race for the team, not for myself. I felt that it was the best way for the team to move forward.

The front wing did have a problem and they beefed it up, and Nick [Wirth] swore on his life that it was a lot stronger and perfectly safe. I took his word and did the race.

We took off after the safety car and I was at the back. By the time I got to Senna's accident, the dust was beginning to settle. I thought it was a Tyrrell, not a Williams. We ended up stopping and word went around who it was. At the time I didn't know how bad the accident was; there was no information coming to us.

I only got word that Ayrton had died when

# 24

## DAVID BRABHAM

#31 SIMTEK-FORD S941 Race: DNF



Brabham raced on for the good of the team

I got home and looked at teletext. I must admit that I didn't feel like hanging around [after going out of the race early]. I got a flight that night. It was a massive shock having gone through all the stuff with Roland. I sat there with my head spinning.

# DNQ

## PAUL BELMONDO

#33 PACIFIC-ILMOR PRO1 Race: DNS

Barrichello's accident on the Friday was a big one, but we knew pretty quickly that he was OK and the weekend went on from there pretty normally. It was the kind of accident that we were all used to.

I think it was the same even after Ratzemberger was killed on the Saturday. It was difficult for a driver like me with a small team – and we were in the pit next door to Simtek – and a very painful situation. But for many, many drivers it didn't change that much.

People were talking about Roland, of course, but everyone was just getting on with their weekend. I would say that Ayrton was the only one of the top drivers who was very tense about it.

Senna's death was different, because he was one of the biggest names in our sport and such a charismatic guy. I had experienced deaths in motorsport in the Paris-Dakar Rally, but I think that everyone felt that nothing could happen to you in F1, that you could hurt yourself, but not die.

Imola was a big shock. All of a sudden two people – one a big name and the other a really nice guy – were not there any more.

# DNQ

## RUBENS BARRICHELLO

#14 JORDAN-HART 194 Race: DNS

I remember everything about that weekend. I had a good start to practice and we were really well set in the morning. I remember being eight-tenths up on my previous lap, when of course as I was coming up to the end of the lap I crashed going into the Variante Bassa. All I remember about the accident itself was that a very young and very silly Rubens Barrichello tried to go too fast into the corner. Pretty much as soon as I did I said: 'Oops...' It was such a big shunt I don't remember the impact. I just remember the 'Oops'.

I can't remember Senna visiting me in the hospital. I don't remember the hospital at all, in fact. But I do remember coming back to the circuit the next day with my broken nose and it was still very hard to breathe. Thinking

about it now, it was a really big shunt – it was measured at 95g. But because I was basically OK, I went back to England to stay with a friend and watch the race before going back to Brazil. That's where I saw the accident. The atmosphere was already very sad after what happened to Roland. Then with Senna's accident, when he crashed, he moved his head and to us it was a sign that he was still alive, although of course it was the very opposite. It was all so very sad, in every aspect.

Ayrton was the first person whose funeral I attended – it hadn't happened to me then with family, even. There was something wrong about that whole weekend, you know. You may or may not believe in spiritual things, but that weekend the spiritual feeling was all wrong. ❧



Barrichello's accident was just the start of terrible event

# What Senna meant to Brazil



**AUTOSPORT's veteran Brazilian correspondent and long-time F1 TV commentator LITO CAVALCANTI knew Ayrton Senna since his early racing days, and reflects on the great Brazilian's legacy**

**T**wenty years have passed since that tragic Sunday morning in Brazil when every television set in the country was switched on in anticipation of their hero's 42nd grand prix victory. There he was, at the front of the pack. It was only a matter of another 50-or-so laps and he would take the whole nation to heaven with another glorious demonstration that he was unbeatable. He was not just

Ayrton Senna, he was *Ayrton Senna do Brasil*.

But this time it was not to be. On lap six, he crashed heavily. There was hope at first when he moved his head, but later he was declared dead. The news bulletins kept on coming one after the other as the horror of what had happened sunk in. There was no more doubt, no more hope, and the whole nation cried in pain at the loss of its greatest idol. Brazil had expected another jubilant moment but instead witnessed the death of its dearest son.

The painful days of mourning that followed showed how beloved he had been. Millions followed his coffin across Sao Paulo to the Morumbi cemetery and every day somebody still makes a pilgrimage to his modest grave with a flower and a prayer to the greatest Brazilian of all. He lived and died like a hero and cannot be forgotten.

There is no doubt that Ayrton Senna still lives on in Brazil and every May 1 is his day. None better represented the working people than him. He



Senna's grave is still well looked after

exemplified a life's hard work in search for perfection. His words live on: "If you are not going to be the best, there is no sense in life".

Today (Thursday) marks the 20th anniversary of his death, but the inevitable tributes to his life on Brazilian television have been going on for days. Newspapers and magazines have produced special editions about his life and his career. National network TV Cultura dedicated a prime-time slot to showing one of his earliest F1 interviews.

At that time, he was still driving for Lotus and had only a few victories to his name, but his

charisma was already making him into a star. SporTv 2, one of the three sports-dedicated cable channels of the mighty TV Globo, showed Senna's 10 most memorable races, not all of them victories.

They start with the unforgettable 1984 Monaco Grand Prix, when the world learned about this kid from Brazil who could make a humble Toleman into a threat to Alain Prost in the wet. Then comes his first win, at a flooded Estoril circuit, which was the ideal stage for the then-unsung rainmaster. And so on until 10pm, when the show hits its peak with a showing of the *Senna* movie.

No matter what age, everyone in the country knows who Senna was and what he represents. There has never been, and there will never be, anybody else like him. We experience his legend again and again on the screen. We relive his fight against the decisions of FIA president Jean-Marie Balestre. We all enjoy his strike back at the first corner in the 1990 Japanese GP. And we will all proudly say that while we would rather fight clean, if someone chooses to fight dirty, we can also do this. Because we never surrender.

Every child learns about him from their father. He will show them the green-and-yellow flag flying on the podiums of the world, that they can be proud to share nationality with that man. And, just like in those days, people will forget for a moment inflation, violence, unemployment and the growing social dissatisfactions in Brazil.

Fears of the bad times to come, riots on the streets protesting against corruption and public



LAT/REX

expenditures like the football World Cup are not new, but nowadays they are no longer softened on those glorious Sunday mornings when the national hero flew the flag for Brazil. There is no longer a superhero to show us that bad things can be changed, to remind us that it's only a matter of fighting for what you believe.

Senna's feats on and off the track taught valuable lessons to the Brazilian people. His sister Viviane, mother of Bruno Senna, dedicated her life to the Ayrton Senna Institute, which benefits about two million children per year. They receive free education and health care.

It was one of the most intense concerns of Ayrton in his last days. And it was also one of the most intriguing aspects of his personality. While he would expose himself and his opponents to life-threatening risks while fighting for position, there was nothing capable of stopping him when it came to help someone in need.

Since the moment he died, Brazilian drivers have been unable to find peace. Young rising star Rubens Barrichello was chosen by Ayrton as his successor, but it proved too heavy a load for his shoulders. Second places in the world championship, and more than 10 victories each was not enough for Brazilian people to accept him and Felipe Massa as their representatives on the same stage where Senna shone so intensely.

It could never be any different. No human being can replace a god like *Ayrton Senna do Brasil*. Unlike Senna, Rubens and Felipe are only human. ❧

## A PERSONAL REMEMBRANCE

Ayrton Senna da Silva first caught my eye as a teenaged kart driver. The way he committed to every race, every corner, was much too intense. It was clear he was there to beat everyone, no matter what it took. He was different.

After beating all the established stars, he felt ready to cross the wall that separates the Interlagos kart circuit from the GP track. At that time, he visited us at the office of Brazilian magazine *Auto Esporte*. He had two paths ahead of him: start his single-seater career in the Brazilian 1300cc Formula Vee or head straight to British Formula Ford.

I remember telling him to take the airport route,



LAT



because he was capable of much more than the national racing scene could offer. He smiled proudly and pursued his destiny. When we met again, at the end of that year, he had become Ayrton da Silva, the British Formula Ford 1600 champion, but remained an unknown at home.

From then on, he became the most shining Brazilian star and grew strong enough to influence the life of my country in many ways. Those were politically difficult times, the economic situation was tough and the only joys were those Sunday mornings when he would show a Brazilian could rule the world.

He was strong, he was fast, he was tough and could overcome every and any obstacle. He was our champion, our hero, our model.

*Ayrton Senna do Brasil never dies.*

PROST ON SENNA...

# THE BITTER FEUD THAT HEALED

Alain Prost tells **CHARLES BRADLEY** why his relationship with his great rival changed for the better once he'd retired from F1

30

# “I’M

not going to celebrate like some people that it’s 20 years on,” says Alain Prost of the anniversary of Ayrton Senna’s death at Imola on May 1 1994. “I can answer these questions about him, no problem – he was an exceptional guy – but I just don’t see it the same way as the other guys do.”

To understand why, you have to appreciate the background of their shared history: Prost and Senna fought out what was arguably Formula 1’s greatest rivalry. After becoming team-mates at McLaren in 1988, the first spark flew when Senna aggressively shoved Prost towards the pitwall at Estoril, later prompting the Frenchman to state: “Sometimes I admit I was frightened by him; he was prepared to do anything.”



Apart from several media spats that occurred before Senna was crowned world champion in 1988, the true ignition point for their bitter conflict was Imola ’89. Senna passed Prost on the approach to Tosa at the restart after Gerhard Berger’s fiery crash, breaking what Prost saw as an agreement not to pass each other there. But Senna was adamant he had the move completed before the corner, so in his mind that didn’t count. Whether it was gamesmanship on Senna’s part or twisting logic in his own favour, Prost was furious and their enmity would run and run.

Their successive title-deciding collisions at Suzuka in 1989 and ’90 tarnished F1’s reputation and moved the goalposts in terms of the lengths drivers would go to win. Both felt hard done by: Senna that the FIA had manipulated the ’89 result in Prost’s favour – “a result of the politics we had,” he’d claim – while Prost questioned Senna’s ethics and sanity.

But the antipathy that rumbled for half a dozen years was ended by Prost’s retirement following his 1993 title success with Williams. From that point on, these sworn enemies became friends. Which is almost unbelievable, given what had gone before when Senna had often refused to refer to Prost by name, never mind shake his hand or speak to him directly.

“I don’t keep the bad moments or any bad souvenirs in my mind about him,” Prost says today. “I keep the last six months [of his life] in mind. That’s when I knew Ayrton much more than ever before. He was a completely different person, I understood who he was and why he was acting sometimes.”

When you considered the ferocity of their duel, encapsulated by Senna launching his McLaren flat-out into Prost’s Ferrari at the first corner at Suzuka in 1990, this is quite a reversal in their relationship to comprehend.

“I look back on how he was [when they were rivals] as a compliment,” he adds. “I came to





Australia '93: after his final GP win, Senna pulled Prost onto top step of podium



Before their war: Prost welcomed Senna into McLaren



Suzuka '89: collision that sparked bitterness



Suzuka '90: Senna's revenge was ruthless

“Near the end, when we were close, we’d talk about safety”

understand that Ayrton’s main motivation, almost his sole motivation, was to focus on me and on beating me.

“That is why when we were on the podium together in Australia in ’93, when I stopped, just a few seconds later he was already a different person [recall that following what would be his last-ever victory, Senna insisted that Prost stand with him on the top step of the podium after Alain received his runner-up trophy, physically pulling him up to stand arm-in-arm together]. That is the souvenir of our relationship that I carry with me today.”

Prost recalls his post-retirement dealings with Senna fondly, and acknowledges the irony that their conversations of the time were often about the need to increase car and circuit safety with what transpired.

“Near the end, when we were close, it was very strange because we would talk about the bad safety and this kind of thing,” says Prost. “He would ask me many times to take the lead of the GPDA, and I said no. We had some very private discussions together around this time.

It was very strange.

“I keep this souvenir [of him] from then right until his last day, because I met him two or three times, and just before [the race at Imola] – and of course he was already this different person to me. That is why I prefer to think about that alone.”

Of the terrible events of Imola that dark weekend in 1994, a race Prost attended to commentate on for French TV, he spoke to Senna on numerous occasions – twice on the morning of the race: once when Senna sought him out in the TV compound; and a second time when Prost went to see him in the Williams garage. Recall too that Senna had sent the radio message (“a special hello to my dear friend Alain – we all miss you Alain”) from his car to the commentary box over the radio during a lap in practice.

Prost confirms: “Ayrton called me on Saturday, so I met him on Saturday, and I met him on Sunday twice – the main constant [of their conversations] was safety and the fact that he was not happy with the situation, thinking that the Benetton was not legal. He was very focused on that, but it was very weird... Very weird.”

## BERGER ON SENNA...

# “WE WERE SPORTING AND FAIR; WE HAD FRIENDSHIP”

32

Gerhard Berger was one of Ayrton Senna's best friends in racing. He tells **MARCUS SIMMONS** about a special relationship

Sitting in his Monaco office, Gerhard Berger reflects upon 1987, a year when it seemed that the sky was the limit. The Austrian was feted as a hero after breaking Ferrari's two-year win drought, and another flourishing talent was producing astonishing performances in his third year with Lotus: Ayrton Senna.

“In a way we were the two young stars,” says Berger, “him with Lotus and me with Ferrari. So our paths crossed day by day, either wheel to wheel, or in negotiating contracts – even waving to the fans.”

When he joined McLaren for 1990, alongside the incumbent Senna, Berger would become the closest friend among the F1 drivers that the great Brazilian would ever have. But their first proper conversation had come courtesy of a faulty stopwatch on the other side of the world...

When Berger moved into Formula 3 in 1983, he bought a Ralt RT3 from West Surrey Racing chief Dick Bennetts, who had run Enrique Mansilla to the runner-up spot in British F3 in that chassis the previous season. Senna had taken over the car for his F3 debut, the non-championship November Thruxton race, which he won convincingly.

With Bennetts as a conduit, the two met briefly at Silverstone in June '83, where the British championship and the European – for which Berger had entrusted the running of his car to Helmut Marko – competed together. But it wasn't until the Macau Grand Prix in November when they really entered each other's orbits.

“I realised how quick he was in Macau,” says Berger. “I finished third, and in every corner he was five metres further ahead, and then suddenly he was gone – we could see that he handled the track in a better way than we did.”

The records show that Senna set the fastest lap in each of the two heats, but initially there was confusion regarding the second race. “I was given the trophy for the quickest lap,” says Berger, “and when we went to the party afterwards he came to me and said, ‘It's not true – I have the quickest lap. I know from my own records that he had the quickest, but the officials had made a mistake. He couldn't even celebrate at the party because the biggest problem was he hadn't taken the quickest lap to go with his win and pole position. This for him was a killer!’

“I was joking with him, and that's where we started to talk a little bit. The chemistry was right and from this moment we got along quite well.”

They met again in Monaco in 1984 – both men



ALL PICS: LAT



would finish second, Senna in the truncated grand prix, Berger in the F3 support race: “I was just walking in the evening, and he had his bicycle and was checking out kerbs or something. He said, ‘Gerhard, what are you doing? Why are you not with us yet in Formula 1?’ I said, ‘Don't worry, I'm coming.’ When I got to F1 a few months later, we had careers that ran very parallel.”

Six years later, Berger laid down a marker with pole position for his first race alongside Senna at McLaren, the US GP at Phoenix. “When I signed up for McLaren I knew he was going to be a strong team-mate,” says Berger, “but also



Senna and Berger enjoyed a harmonious relationship at McLaren



Senna and Berger side by side into Tosa at start of San Marino GP

## BERGER v SENNA AT IMOLA, 1990

Ask Gerhard Berger about his favourite practical joke on Ayrton Senna, and it's clear that it's a subject he's been quizzed upon several times too often.

Instead, he prefers to talk of an epic scrap for pole at Imola in 1990, their first season as McLaren team-mates.

"He got out of his car and walked over to mine and said, 'It's getting dangerous now, we play ping-pong the whole time with the quickest lap. OK, a fresh set of tyres!' My lap was quickest, then him again, then me again... He said, 'Let's do the next run and then stop.'

In the end, Senna took pole by over half a second in an all-McLaren front row.

"It was tough to be with someone fighting the whole time, so on the limit," adds Berger. "But we did the opposite in holiday time – we went on boats, did a lot of things together. In this time, we just tried to laugh, enjoy it and have fun."

And the practical jokes? Just search online; there are plenty to choose from...

**"We heard he was out of the car, and in our language 'out of the car' means he's OK, not 'dead out of the car'"**



[Michele] Alboreto was tough, [Nigel] Mansell was tough, [Teo] Fabi was tough in some ways. So I said, 'He's another one, and I've never had any problems with anyone.'

"In the race at Phoenix I had a crash because my foot was stuck between the pedals – the layout of the car was very small, for Alain Prost [who had effectively swapped drives with Berger, moving to Ferrari]. Anyway, I went back to my parties, and he went back to Brazil training, and he thought carefully about it, and from this point I started to see his real ability. I have to say he was just better, but I became close friends with

him because I didn't try to win advantages from him. Instead, I tried to respect him. I said, 'If I want to do better, I have to work on myself.' That was my philosophy, and it meant we were sporting and fair, and we had the friendship.

"McLaren treated me very nicely, always. It was extremely difficult to have Ayrton next to me, because he was the hero there, but they never let me down, always gave me good material and allowed me everything they could so I could compete in the right way."

By 1994, Berger was into the second year of his return to Ferrari, while Senna was now leading

the Williams team. At Imola, the red machine was chasing leader Senna and second-placed Michael Schumacher's Benetton: "I saw him going off, crashing into the wall, and I looked and thought it was not too bad. When the race was stopped, we heard he was out of the car, and in our language 'out of the car' means he's OK, it doesn't mean 'dead out of the car'."

"I was leading the restart but had a damper problem and stopped, and that's when I realised he had a problem. I was sitting in the pit, and asked a couple of people and they told me he was in very bad shape, that he was on the way to Bologna. So I took a helicopter and flew with Jo Leberer [Senna's physio] to Bologna, and we were then able to see him in the operation room. But his head was covered and that's when we felt that it was the last time we would see him."

These were dark days for F1, but even Berger – by now one of the elder statesmen – carried on competing. "It's always hard," he says, "but as a racing driver you switch something, and say, 'This is something that can happen.' You know about it, but you keep doing it because you accept it."

"But Ayrton was such a special personality, such a special talent, in such a special position, that we never could have expected him in a situation like this. That was very difficult." ❧

IMOLA 1994  
20 YEARS ON

Tragic tale of F1's dream



LAT

Enjoying the success  
of 1986 Brands Hatch  
Festival victory



**Roland Ratzenberger's death at Imola has often been overshadowed by that of Ayrton Senna, but the Austrian's story was no less tragic. ADAM COOPER remembers a true fan of F1**

**O**ctober 26 1986 is remembered as the day that Nigel Mansell's spectacular tyre failure in Adelaide handed the world championship to Alain Prost. It was also the day that Roland Ratzenberger won the Formula Ford Festival at Brands Hatch, firmly marking himself out as a man of the future.

That evening the beaming Austrian celebrated in the Kentagon, the bar at the top of Paddock Bend.

Among the first to congratulate him was Johnny Herbert, winner of the 1985 event. Inevitably the two men chatted about their hopes for the future. Roland had recently signed to drive for BMW in the new World Touring Car Championship, while Johnny was heading towards British F3 with Eddie Jordan. Both men had loftier ambitions.

"We talked about where the journey was leading us," Herbert recalls. "He'd had the difficult times, and then won the Festival. I had won the Festival the year before, but then had a difficult '86 season in the FF2000 Quest. We just discussed how things can go so well and then turn against you - but if you had the right mentality, it was something you would always get over. F1 was the thing we talked about. We knew what the stepping stones were, we knew we were on the road."

Remarkably, Herbert would be an F1 driver within just two and a half years, but for Ratzenberger, that road would be a long one. When he won the Festival he was 26, although he'd lost two years on his CV in an attempt to appear younger. With no parental support he'd already spent an age trying to get his career off the ground, working as a mechanic for less talented drivers and instructing in racing schools. The BMW deal for 1987 was the first time he'd earned any proper money.

Always good at winning people over with his big smile and genuine charm, he found enough sponsorship to compete in British F3 and F3000, and when he ran out of options, he moved into sportscar racing to keep his career afloat. The big break came in '90, when he landed a drive with the SARD Toyota team in Japan. He emerged as a major force, which led to chances in local F3000.

He earned good money in Japan, but F1 remained his goal. When at the end of 1993 opportunities

opened up for his friends and F3000 rivals Eddie Irvine and Heinz-Harald Frentzen, Roland was happy for them, but inevitably a little envious.

"He loved F1," says Irvine. "He was addicted to it, and it was amazing how much he wanted it. He had a great career in Japan, but he kept pushing for F1, especially with me and Frentzen jumping across. It must have been tough, but it also encouraged him."

Ratzenberger's own chance would come with the new Simtek team, following an introduction by Gerhard Berger's manager Burghard Hummel, a wheeler dealer who helped Roland informally. Over the winter of 1993-'94 Ratzenberger put a deal together with Simtek boss Nick Wirth, having landed support from a wealthy Monaco-based German who had taken a shine to him.

"He'd got the backing of Barbara Behlau," says Wirth. "She had befriended Roland and decided that she should support him. So she put a lot of the money up, which helped him to get the drive and us to get the team together. It was really with her backing, Roland's tenacity and Burghard's help that the whole thing came together."

A deal was agreed for Ratzenberger to drive alongside David Brabham. At 33 he was finally an F1 driver - but initially his contract covered only the first six races, and others with money were circling.

"When I heard about it I was really happy for him, because I knew how hungry he had been," says Herbert. "I knew how frustrated he was as a typical driver, knowing that a couple of us had got our way into it. He finally had the backing that he needed to give himself that chance."

"When I saw him I remember giving him a bit of a hug and saying, 'You've made it'. He said: 'It's been a little bit tougher for me than you!' He was probably the very last one who had been his own mechanic, working on his Formula Ford car, who got to F1."

There was little time for testing, and Roland's own chassis was only finished on the eve of the Brazilian GP. "We started off with a big pile of bits in the garage, trying to build his car and nicking nuts and bolts from McLaren and Williams," says Brabham's engineer Rod Nelson. "We didn't have enough bits to build the car, but we got him out."

With two cars failing to qualify at each race - and Simtek fighting with fellow newcomers Pacific for the last spots in the field - the pressure was on. Beset by mechanical gremlins, and still learning ▶

Ratzenberger's F1 chance  
finally came with Simtek

**MINI FESTIVAL BRANDS HATCH**  
**SUN 11 MAY 2014**

**FREE ADMISSION TO ALL MINI OWNERS!**  
**PLUS DISCOUNTED ENTRY FOR PASSENGERS TOO!**  
 see website for more details

**0843 453 9000**  
**MINI-FESTIVAL.CO.UK**

**Online Tickets from £14 Kids 12 and under Go Free**

\*Advance tickets available until midday Wednesday 7 May. Postage fee applies

Brands Hatch

- All Mini Race Line-Up
- Huge Mini Club stands
- Mini parades and demonstrations
- Funzone plus more family entertainment
- Trade Village & Live Music

When it comes to On Track insurance,  
 there's only **one** place to turn

Trust **Ellis Clowes** to provide your 2014 motorsport cover

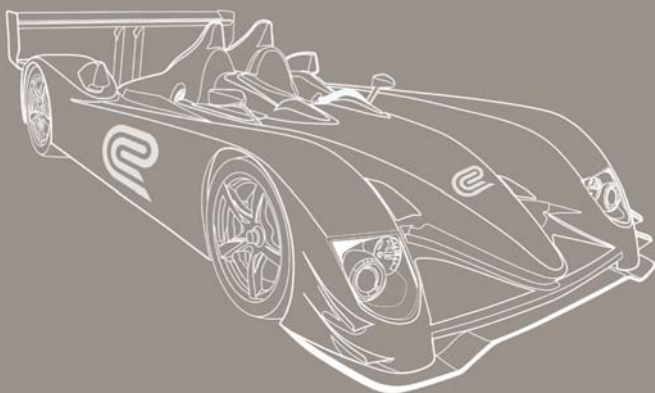

At Ellis Clowes, we pride ourselves on both our speed of response and our intimate knowledge of motorsport, which means not just efficient, but *effective* service.

So trust us with your team's cover, particularly where you have bespoke requirements. Through our network of insurers, we can provide the **perfect** level of cover, whatever your needs.

- 30 years' experience
- Dedicated On Track team
- Lloyd's Broker
- 2013 MIA Award Winner

For your On Track quote, call us today:

01295 221190

Or email: [motorsport@ellisclowes.com](mailto:motorsport@ellisclowes.com)



2013 WINNER

**ellis clowes**

[www.ellisclowes.com](http://www.ellisclowes.com)

Regulated by the Financial Conduct Authority.



Tragic wreckage is taken away after crash



Behlau (left) helped bring deal together

► his way around the S941, Roland was devastated when he missed the cut. "It was you race or you don't race, you succeed or fail," says Wirth. "Pressure like they don't have now. If you don't make it from Q3 into Q2, big deal. In '94 it was you do not race and you go home. We were a new team with new cars, and it was a bloody steep learning curve."

However, Ratzenberger impressed the small team with his knowledge and approach.

"The whole car was just thrown together very quickly," says his race engineer Humphrey Corbett. "It's not surprising that there were one or two problems. You knew he wasn't bullshitting you, he wanted to succeed as much as we did. I remember thinking, 'bloody hell, this guy knows what's going on in the car'. He would also say, 'I need to find more time in myself, which is very refreshing in a driver.'"

Second time out in Aida, Ratzenberger missed Friday qualifying after a crash in the morning. Nevertheless he made it into the field on Saturday. The following day he managed to bring the car safely home in 11th and last.

"To get both cars racing was an unbelievable thing," says Wirth. "The odds were stacked against us. I was so happy for Roland as well, because I knew how disappointed he was from Brazil, and how much it all meant to him. It was, 'We're on the way now!'"

However Ratzenberger was frustrated with his own performance, especially in the slow corners. At the third race at Imola he struggled with the brakes, and he was convinced something was amiss. Roland was vindicated when Brabham backed his assessment after sampling his car on Friday.

"Certainly after he got new brakes he made good progress," says Brabham. "And I thought, 'Great, there's some good competition within the team.'"

Meanwhile the big story that day was a huge

**"I went past the wreckage and my heart sank because it looked pretty bad immediately"** DAMON HILL

crash for Jordan's Rubens Barrichello.

"I spoke to Roland on Friday," says Herbert. "We just discussed what we'd seen, and how violent it was. 'That was scary'. He mentioned that we should stick together a little bit more about the safety stuff."

Come Saturday, and with his car now working more effectively, Ratzenberger was in an optimistic mood. Following Barrichello's accident the entry was down to 25, which meant that he had to beat just one Pacific – in effect that of the tardy Paul Belmondo – to make the grid.

"He was always very upbeat, and always very positive," says Corbett. "I think he felt that almost for the first time he could put in a good performance, and he was probably chirpier than he normally was."

Early in the session the Austrian was indeed faster than Belmondo. Simtek's data would later indicate that on a subsequent lap he had a minor excursion, and had then given the steering wheel a shake to ensure that all was OK, and to clean the tyres. He then went for another quick lap.

"He didn't lose a lot of time, but it was enough

for him to check the car," says Brabham. "Looking at the data he'd zig-zagged and braked, and in his mind he'd be saying, 'Do I come in and check it?' I can understand why he didn't. He couldn't have felt if there was an issue with the front wing, and off he went. And that lap is when he didn't come round."

As he headed into the Villeneuve corner the front wing came adrift, probably after two of the four bolts that attached it to the nose had worked loose. He ran off the road and hit the concrete wall at high speed.

"I went past the wreckage of Roland's car and my heart sank because it looked pretty bad immediately," says Damon Hill. "Guys were standing around the car and waving us past, but there was no attempt to get him out of the car, and he looked limp."

Herbert recalls: "I saw the red flags. I saw it was a Simtek, but I didn't know which one. As I got to him I slowed up and looked. I remember him being slumped, and thinking 'shit!..'"

It wasn't long before the stunned F1 paddock learned that Roland had died. "It was really quite emotional for me," says Johnny. "I remember having a little cry back at the hotel after I heard the news."

Corbett adds: "I engineered Paul Warwick as well. And I still have those two deaths on my mind the whole time. In the back of my diary I make a note of the day that Roland died, and the day that Paul died."

Herbert was one of the few F1 drivers to attend Roland's funeral, joining Gerhard Berger in an overnight dash from the Ayrton Senna memorial in Sao Paulo to Salzburg.

"What happened on the Sunday almost completely and utterly wiped away the Saturday," says Johnny. "That's why I went to both funerals, to pay my final respects. It was so unfair that he was taken away and he wasn't given that chance of competing in F1 properly." ❧

## VILLENEUVE ON RATZENBERGER

In 1992 Jacques Villeneuve signed for the TOM'S Toyota F3 team, and thus become part of the close-knit group of foreigners racing in Japan.

As a keen student of motor racing history, Ratzenberger was keen to meet the son of Gilles, one of his heroes. However, he was disappointed when the newcomer appeared to have so little to say about his father's career.

"I could see there was some form of respect," Jacques recalls. "But I was too young to understand why or what. At that time I was just minding my own business on that subject."

Despite a gulf in age and experience, the two



Ratzenberger was a race winner in Japanese F3000

became friends: "I always had a very good relationship with him. I was the young kid there, and he took me under his wing a little bit, which was nice. I arrived in Japan and it was like a university, and I didn't know what I was doing. He'd been there for a while.

"When I started doing some Group C he was very helpful, because those cars were monsters to drive. He was very manly – in those days it was very physical, as well as dangerous."

They had less contact after Jacques switched his focus to North America in 1993, but they remained in touch. "It was great to see him in F1," adds Villeneuve. "His aim was to race at least once in F1. He'd already had his career, he wasn't going to have a long F1 career, he was past that and he knew it. But at least he could do a season of F1. Why not? It just didn't turn out well. But at least he was living his dream."

Fate decreed that Ratzenberger would crash at Villeneuve corner, where a puncture had sent a helpless Gilles off the road in 1980.

"I remember that a lot more than what happened to Ayrton the following day, because Roland was a friend," says Jacques. "Afterwards when I started racing at Imola in F1 every year there was always the question about Ayrton's anniversary or something like that. And all I could think about was this is where Roland had his accident."

IMOLA 1994  
20 YEARS ON

**BRABHAM**

**“I FELT  
LUCKY  
I GOT  
OUT OF  
THERE  
ALIVE”**

David Brabham was Roland Ratzenberger's team-mate at Simtek when the Austrian was killed in qualifying.

Brabham opted to race on, almost with dire consequences, as he tells **ADAM COOPER**



Over the past two decades much has been written about the 1994 San Marino GP, but one story has rarely been told, and it concerns the bravest man at Imola that weekend. During qualifying on Saturday afternoon, David Brabham drove past the wreckage of the car of Simtek team-mate Roland Ratzenberger. The following day the Australian made the bold decision to take part in the race in an attempt to boost his grieving team, only to suffer a car failure that could have had its own devastating consequences.

Damon Hill also lost a team-mate that weekend, and would face a similar challenge as he tried to lift the spirits of Williams in the coming weeks. He deserves credit for taking the restart after Ayrton Senna's accident, but it's worth remembering that the true consequences for the Brazilian were not yet clear, and nor did the team suspect that there had been a failure that might be replicated on Hill's car. Damon himself acknowledges the extraordinary fortitude that Brabham showed that day.

"David's experience has been largely overlooked because of the Ayrton follow-on," says Hill. "He went out in the car on Sunday morning in the

race.' We gave David the option of doing the warm-up and seeing how he felt."

"To be fair to the team I don't think any of us knew what to do," Brabham recalls. "There were so many emotions flying around that you couldn't control. That night the team said, 'It's entirely up to you if you feel like driving or not.' Obviously my biggest concern was the safety of the car."

It was apparent that the front wing had come off Ratzenberger's car. Although the precise cause was not clear, it was suspected that bolts holding the wing to the bottom of the nose had worked loose, possibly as a result of the endplate banging a kerb and being forced upwards.

That evening the crew worked to modify the wing-mounting arrangement on Brabham's car. Originally four bolts went up into the solid carbon in the bottom of the nose. They were replaced by bigger and longer ones. Holes were drilled through the carbon, and substantial nuts and washers were then attached in the nose's hollow inside, along with an aluminium plate, to make it improbable for the new bolts to come adrift. More plate was fixed under the wing itself.

"I felt that we had to just be whiter than white," says Brabham's race engineer Rod Nelson. "I went to Charlie Whiting and said, 'We intend to do this,



Brabham's car broke just before high-speed corners

# "I only raced because I needed to pick the team up, to help them get through the situation"

warm-up after his team-mate had been killed, and tried to bring people back to the job in hand. He played an enormous part in trying to refocus them onto something more positive. It's too easy to forget what happened down at Simtek, and what the experience of all those guys was. It was completely overshadowed."

History suggested that after a fatality in a grand prix qualifying session the team involved would withdraw from the race. It had happened with BMW at the Nurburgring in 1969 (Gerhard Mitter), Lotus at Monza in 1970 (Jochen Rindt), Tyrrell at Watkins Glen in 1973 (Francois Cevert) and Ferrari at Zolder in 1982 (Gilles Villeneuve). In Simtek's case the question of whether Brabham should race or not was left open on the Saturday evening.

"I felt Roland was the ultimate racer," team boss Nick Wirth said a few months after Imola. "We felt that we could withdraw out of respect to Roland, or we could race out of respect to Roland. We decided that he would be saying, 'Don't mess about, go and

that and the other, we want to race tomorrow,' and showed him what we were doing. It wasn't in reaction to any failure that we were aware of. It was just 'we're going to do the maximum to make this car as safe as we possibly can.'"

Brabham adds: "Nick Wirth assured me that they had reinforced the front wing to make sure that there was no problem whatsoever. And I said the only thing I could do is do the warm-up and see how I feel, and if I didn't feel right then I wouldn't race. We were relatively fast in the warm-up. I don't know if they put me on empty tanks or whatever, but our pace was better than it had been up to that point.

"I came into the pits and I noticed that the dark clouds had turned light grey, and it felt like the team had lifted slightly. I just felt I've got to race, I've got to race for them, to help get them through the situation. I felt that was an avenue of doing it."

After the Senna red flag and restart, Brabham was running 16th when TV pictures showed him

parked at the last-corner chicane. Little was said at the time, but he had suffered a catastrophic steering failure. Had it occurred as he headed into the next lap, at Tamburello or Villeneuve, the consequences could have been dire.

"He went to go right at the flick where Rubens [Barrichello] had his accident on the Friday and the car went straight off," says Nelson. "He thought that he'd lost the front wing, because he turned in and nothing happened. What actually happened was that the UJ joint on the steering broke. There was no connection between the steering column and the rack. He came straight back to the garage, and he was pretty wound up about it all."

Brabham recalls: "For some reason it was between the corner before the chicane and the chicane. It actually broke on the straight. By the time something like that happens your brain is just completely fried, you just don't know what's going on. It puts you in such a different place... Not that I blamed the team at all. We were a new team, and things happen.

"But like I said before, I only did it because I needed to pick the team up. We did the warm-up and everyone felt only slightly better, but at least it was in the right direction. And that's why I raced. But I came away from the weekend feeling lucky that I got out of there alive..."

A few weeks ago Brabham returned to Imola, in company with Hill, to film a Sky Sports F1 feature.

"It was a heavy day," he says. "All those emotions start coming back, and you start reliving those moments. You move on, life happens so fast, and it was a long time ago. But going back there changes the way you feel, no doubt about it, particularly standing on the spot where Roland stopped." ❧



Simtek worked hard to make car as safe as possible



Brabham was running 16th when his steering failed

Senna's Williams is recovered after crash



# What Imola '94 deaths taught F1

After the tragedies of Imola 1994, the sport had to act. **EDD STRAW** looks at the safety improvements that have been made over the past two decades, and their legacies

**T**he deaths of Ayrton Senna and Roland Ratzenberger at Imola 20 years ago this week shook Formula 1 to its core.

But their legacy is of vastly improved safety, not just in grand prix racing but all of motorsport.

Senna's death, live on TV in front of around 200 million people, ensured there was the will for drastic changes. After the initial, kneejerk reactions, some of which were rejected by teams, the FIA was a key player in research-driven change that has had a tangible effect.

As Andy Mellor, technical director

of the FIA Institute for Motor Sport Safety, said when giving the Motorsport Safety Fund Watkins Lecture at AUTOSPORT International last year, 1994 was "the watershed year" for motorsport safety. One crucial area of improvement was in the protection of the driver's head. Raised cockpit sides were mandated in 1996, as well as the introduction of an energy-absorbing headrest.

"That year, the first accident where the headrest made a difference and possibly saved a life was that of Jos Verstappen when he crashed at Spa,"



L-r: Berger, Schumacher and Lauda talk safety as GPDA reformed after Imola '94

ALL PICS: LAT

## WHAT CAUSED AYRTON SENNA'S FATAL CRASH?

Ayrton Senna's death was caused by a suspension part attached to the right-front wheel striking him in the head and penetrating the visor of his helmet, leading to what was described during the ensuing trial as "a massive blow above the right eyebrow". But there is no definitive answer to the question of what caused his Williams to fly off the road at Tamburello, across the nine-metre run-off area and into the wall.

During the trial, prosecutor Maurizio Passarini contended that Williams had "modified, acting with negligence and imprudence, the steering column of the vehicle". A 12.3cm section of 18-inch steel had been inserted into the existing 905cm, 22-inch steel column pre-season. The column did break, but Williams believed this was likely a result of the impact.

A power-steering failure is also possible. Data from the Renault black box (the Williams black box contained no recoverable data) confirmed that the power steering had not failed outright, but an unexplained rise and then fall in



Many theories as to why Senna lost control

the hydraulic pressure moments before Senna went off was noted.

Senna had also run over a small shard of debris, believed to be from JJ Lehto's Benetton, which had stalled on the grid and been collected by Pedro Lamy's Lotus shortly before the accident. It is possible that this became lodged in the car and destabilised the aerodynamics.

It is also possible that low tyre pressures, caused by the slow pace behind the safety car before the race was restarted on the lap before Senna's crash, lowered the rideheight. The car did bottom out,

leading to visible sparks two tenths of a second before the rear end stepped out and one tenth of a second before Senna corrected before going off.

Adrian Newey, then the chief designer at Williams, is uncertain as to the cause but has suggested that a puncture from debris, which lowered the rideheight and led to the car bottoming out, is the most likely cause. Goodyear confirmed that a tyre failure was not responsible, and if this is the case it would have been a slow puncture, leading to only a partial loss of pressure.



'Kneejerk' chicanes appeared in 1994, here at the Spanish GP

said Mellor. "The headrest was destroyed, so instead of the energy going into the helmet and the head, we have now managed to put all of that energy into the headrest."

Other significant advances were made with the introduction of accident data recorders [in 1997], improved safety barriers, and changes to crash-test regulations and nose design, along with improved side-impact protection. The introduction of the HANS device in 2003 and the new 8860-2004 standard 'advanced F1 helmet' for the '04 season were also crucial.

"Probably the first accident where HANS made a difference and potentially saved a driver's life was in 2004 when Felipe Massa crashed in Canada," said Mellor. "The HANS carried a huge load during that impact and, if that load had been carried by Felipe's neck, then it probably would have been a very grave outcome."

It would be wrong to state that



HANS Device was a crucial development

none of these changes would have happened without the death of Senna. Pressure for action was increasing in 1994 with a raft of accidents anyway. But without the high-profile impetus provided by the tragedy, progress would have been slower. As Max Mosley, FIA president from 1993-2009 and a prime mover in the safety changes,

told Reuters last week, it is not just those competing in motorsport who have reason to be thankful for the legacy of Imola '94. The benefits of the research conducted in its wake have spread far and wide.

"That [weekend] was the catalyst for change on the roads that has literally, without question, saved tens of thousands of lives," he said. ❧

## LEGAL FALLOUT OF A TRAGEDY

### May 1 1994

Senna crashes at Tamburello at 2.17pm on the sixth lap of the San Marino Grand Prix. He is airlifted to Maggiore Hospital and pronounced dead at 6.40pm, just a day after Roland Ratzenberger's fatal accident in qualifying.

### March 20 1997

Trial commences at Imola, with six defendants charged: the Williams team's Frank Williams, Patrick Head and Adrian Newey, FIA circuit director Roland Bruynseraede, circuit boss Giorgio Poggi, and Federico Bendinelli, the boss of the company that owned Imola.

### November 26 1997

Trial comes to a close, with prosecutor Maurizio Passarini having asked for acquittal for all defendants except Head and Newey.

### December 12 1997

Verdict released, with all six defendants cleared of manslaughter charges.

### June 15 1998

Full 381-page report of trial released, stating that a steering-column failure was to blame for the crash. The courts later overthrow the verdict that the steering column was 'proved' to have failed before the impact.

### October 4 1998

Chief prosecutor Passarini appeals the verdict on the basis that Head and Newey should be held responsible for the steering-column failure blamed in the original verdict.

### November 22 1999

Appeal rejected on the basis that no new evidence is presented.

### January 27 2003

Italian court annuls the 'not-guilty' verdicts on Newey and Head, later citing procedural errors in the appeal of November 1999.

### May 27 2005

Italian court rules that Newey is innocent, and that a case against Head has timed out under statute of limitations.

### April 13 2007

Italian Supreme Court rejects Head's appeal to be fully acquitted, citing lack of new evidence.

# McLaren pins hopes on new approach



After a promising start in Australia, McLaren's season has gone backwards.

**JONATHAN NOBLE** found out what the famous squad is planning to do about it

42

**M**cLaren has begun a restructuring of the organisation that it is convinced will help lift it out of its current difficulties. Although the Woking-based outfit started the 2014 campaign strongly, with a double podium finish in the Australian Grand Prix, its form has stalled since then.

Matters reached a head at the Chinese GP when neither Jenson Button nor Kevin Magnussen were able to score points, despite making it to the chequered flag. That performance came off the back of a double non-finish in Bahrain.

McLaren's struggles have been blamed on a lack of downforce on the MP4-29 – which is a legacy of weaknesses in the team structure that were so exposed last year.

To turn things around, racing director Eric Boullier has now agreed with Group CEO Ron Dennis and F1 CEO Jonathan Neale an action plan to move the team forward. "For me we have the best facilities by far in

F1, we are one of the two strongest brands in F1 and there is this winning culture in McLaren," Boullier told AUTOSPORT.

"We just need to maybe polish it. And once we put everything back together in terms of leadership, the McLaren organisation is going to pick this up and is going to work."

## WHAT HAS GONE WRONG?

McLaren endured one of its worst campaigns in 2013, with it failing to finish on the podium for the first time since 1980.

That disastrous form prompted Dennis to stage a boardroom coup and return to F1 duties – moving Martin Whitmarsh aside and installing a new management structure featuring Boullier and Neale. Since their appointment, Boullier has been tasked with a detailed analysis of McLaren's strengths and weaknesses.

Having concluded that work, he is convinced the team is not lacking in staff or skill. However, it had failed



Dennis and Boullier discuss the changes

to manage what it had properly.

"If there are weakness, it maybe needs a bit of regrouping people and improving the internal communications between the different entities," he said. "It happens in every organisation that gets bigger and bigger and bigger."

"I will use the words of Ron actually: getting bigger is fine, getting fatter is wrong."

## WHAT IS GOING TO CHANGE?

Boullier sees no need for a revolution inside the team – either by replacing senior staff or bringing in a big hitter from outside, like Ross Brawn.

He does accept that its aerodynamic department needs a boost though. The team has to wait until next year for the arrival of aero chief Peter Prodromou, and it is



2014

Magnussen was second in Oz...

DUNBAR/LAT



2014

...but team has since hit problems

HONE/LAT

## McLAREN 2013 V 2014

### HOW THE FIRST FOUR RACES COMPARE

	2013	2014
Points	23	43
Constructors' championship position	6th	5th
Best grid position	7th Malaysian GP	4th Australian GP
Average grid position	10.375	9.125
Best result	5th Chinese GP	2nd Australian GP

Squad failed to score podium last year

2013



HONE/LAT

### BEST CAR PERFORMANCES

GP	2013	2014
<b>AUSTRALIA</b>		
Qualifying	10th	4th
Race	9th	2nd
<b>MALAYSIA</b>		
Qualifying	7th	8th
Race	9th	6th
<b>BAHRAIN</b>		
Qualifying	10th	6th
Race	6th	DNF
<b>CHINA</b>		
Qualifying	8th	12th
Race	5th	11th



McLaren will tweak its working processes

TEE/LAT

“This year we should see some drastic change”

Eric Boullier, McLaren racing director



Neale, Morris and Boullier are key figures

TEE/LAT

going to court with Red Bull over a contract it had with Dan Fallows.

As an addition, McLaren's recruitment of aerodynamicists is ongoing – with it concluding deals with Tony Salter from Sauber and Guillaume Cattelani from Lotus. Both will join the team when their current contracts end.

Beyond lifting the aero department, Boullier thinks that

having better chains of command between the different departments at McLaren, as well as specific department goals for improving car performance, will help. Furthermore, he wants clearer responsibilities for technical director Tim Goss and engineering director Matt Morris so they can focus on areas that play to their strengths.

“McLaren is composed of brilliant individuals, they have been winning many races and have been fighting for championships,” added Boullier. “I think we just need to make sure the same people are working together in one way with strong leadership and strong guidance. It will help them to recover their past success.

“You need to do it smartly. There are great individuals, and these people have been working together in the past and have been winning races with very, very fast cars.

“It is about restoring some leadership today – both in technical and management terms. Once we

have this leadership in place with clear strategy, then we have to make sure the communication flow within the company is maybe a little simpler to make it faster and better in the end. That will be key for me – the key point to drive this company back to success.”

Clear divisions of responsibility between the three chiefs is also essential – something Boullier thinks has been achieved with himself, Dennis and Neale all accepting what their roles are: “Ron is here to bring the strategy to the team. He is in charge as well of the finance, in terms of the sponsorship part of the team. All the daily management is just divided between Jonathan and myself.

“Plus Jonathan and myself are very, very complementary. I don't want to be doing what he is doing and he doesn't want to be doing what I am doing, so it is clear.

“As long as the roles are clear and there is no overlap for me, it is perfect.”

### PATIENCE IS NOW NEEDED

Although the new structure will be implemented quickly, Boullier is under no illusions that it will still take some time for the changes to impact on track performance.

Progress has been made in recent weeks in the windtunnel, with sources suggesting that dramatic downforce improvements have been unlocked that should be delivered to the car over the next few races.

But with a new partnership with Honda around the corner, and work still ongoing in capturing a title sponsor, Boullier is eager to make sure that long-term ambitions are not compromised by focusing everything on the current situation.

“It depends if you want to be very aggressive in the short term, or aggressive in the medium term, which I would favour,” he said.

“We think we will see the benefit of this during the course of this season – but definitely next year. Already this year we should see some drastic change though.”

Smedley is enjoying life at Williams

HONE/LAT



# “My ambition is to do the job I’m doing now and do it well”

**Former Ferrari man Rob Smedley recently joined Williams as part of a technical overhaul. He spoke to BEN ANDERSON about why he left Maranello**

**R**ob Smedley is clearly a man who doesn't mince his words. As the quote above suggests, he's a no-nonsense North East Englishman with a single-minded drive to help return the faded star of Williams to its former glory.

Felipe Massa's off-season move to Grove, after a decade in Ferrari colours, was perhaps no surprise given his ailing form (just three podiums across the last three campaigns) and several seasons spent playing second fiddle to Fernando Alonso.

Perhaps it's also unsurprising to see his race engineer for much of that period – a man known for keeping an occasionally emotional Massa on the straight and narrow during his more difficult moments at Ferrari – follow him out of Maranello and join Williams as its new head of vehicle performance.

But in fact the pair of moves were entirely unconnected.

“As far as Felipe and I were concerned, the moves were done completely independently, and perhaps not in the chronological order they appeared,” Smedley explained. “But that doesn't matter. Felipe being here I'm very happy about, because I know he's a very good driver and a good benchmark.”

“We know we've got two good ones in the car – Valtteri has already shown for all his age and inexperience he's very, very good – and that's very important for us as engineers because it takes away that question mark. The car is laid bare.”

The real driving force behind Smedley's move to Williams was not the chance to link up with an old colleague, or even the fact he appears to have been ‘promoted’ (“I'd been race engineering for so long it would have been remiss of Ferrari not to have me doing more”), but more to do with a certain former Renault boss

Williams is in better shape this year than it was in 2013



DUJANBAR/LAT

## MASSA'S REVIVAL

A change of scenery can often reinvigorate a driver, and Rob Smedley feels Felipe Massa is driving with more freedom since swapping Ferrari for Williams.

Smedley believes his old charge is far more relaxed in his new environment, and capable of emerging as a team leader.

"Felipe's been given the freedom of headspace here to do what he's paid to do, and he's delivering," said Smedley. "I see Felipe now very relaxed, incredibly experienced, and there's a maturity about him.

"He understands that the job he has to do here is not just about driving the car, it's about driving the people as well. He's had some very good teachers in that area – I would cite Michael Schumacher as one – and now his time has come."



ETHERINGTON/LAT



Massa has more freedom at Williams and is driving well

STALEY/LAT



DUNBAR/LAT

"The first impression is very good because he has a lot of experience and already some ideas on what we can do better"

Bottas on Smedley

who took over the technical reins at Grove last season.

"It's no secret that Pat Symonds was a big factor in getting me here," Smedley confirmed. "If you look around at the active technical directors in Formula 1, how many people of Pat Symonds' calibre do you have? I can tell you, not many.

"He's a great engineer, an excellent manager, a great motivator, he's won numerous world championships, and is very influential in the paddock.

"He's somebody I can learn from, and I need that at this stage in my career – in all aspects of senior level engineering, and senior level management."

The enthusiasm of CEO Mike O'Driscoll and team principal Claire Williams when they approached Smedley in the middle of 2013 also played a big part in persuading their new man to give up working for one of Formula 1's biggest teams to join one that hasn't challenged for a world championship in a decade.

"Doing a 10-year stint at Ferrari

and leaving on my own terms; you can probably count the number of foreigners who've done that on one hand – you could probably count them on two fingers in fact!" said Smedley. "Stefano Domenicali was like a big brother to me. He helped me through difficult career moments and very difficult personal moments as well.

"That was evident as I started talking to Mike and Claire. They care about the people. And as Enzo Ferrari said, it's the people who make the cars, not the other way around."

Smedley started his new job at April's Bahrain Grand Prix, having been on gardening leave at his old team. His role is to provide a stronger link between the factory and the race team in terms of developing the car – something Williams has struggled with in recent seasons.

"It's about having someone with the personality to bring everybody together – understanding everybody's strengths and weaknesses and fitting function

around those people," Smedley explained. "A mistake that's often made is defining the functions and trying to fit people inside those boxes. That's completely the wrong approach."

Nor will Smedley storm in like a bull in a china shop, demanding everyone at Williams replicates Ferrari methods.

He reckons his new team already has the talent to succeed, it's just a case of extracting a bit more out of that group and finding a little more money to spend on development. If Williams can get this right, Smedley is convinced it can return to the top echelon of F1 outfits.

"As long as everybody is getting the right direction from the senior engineers, we'll get there. It's not a question of 'if' it's a question of 'when,'" Smedley stated. "Williams is in a state of transition. It's a team that's clearly in a certain position at the moment, but it wants to change and it wants to win.



DUNBAR/LAT

"If you go back to the Honda project of 2008; that has now changed into Mercedes and they've become the absolute force to be reckoned with. Can that happen at Williams? Well, if I didn't think it could I wouldn't be here."

But what of Smedley's ultimate ambitions? He's progressed from race engineer to head of vehicle performance, so surely he has his sights set on a top technical role in the future?

"This may sound weird to you but I haven't got an ultimate ambition," he declared. "I don't sit there and say, 'I want to be chief technical officer, I want to be technical director', those things are not of a great deal of interest to me.

"My ambition is to do the job I'm doing now and do it f\*---\*g well!

"The ambition of being a technical director, or a chief technical officer, or a team principal, or a deputy team principal I don't really give a shit about to be honest." ❧

"He's a great engineer and he's very intelligent. He brings so many qualities, so many ideas. There are so many reasons it will be positive"

Massa on Smedley

## INDYCAR

### Barber (USA)

April 27

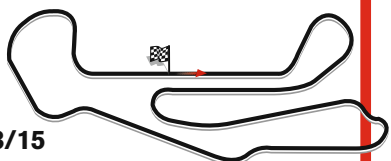

Round 3/15

#### RESULTS

69 LAPS, 158.7 MILES

<b>1</b>	<b>RYAN HUNTER-REAY (USA)</b>	<b>1h40m43.3337s</b>
	Andretti Autosport Dallara-Honda; Grid: 3rd-1m08.4264s	
<b>2</b>	<b>MARCO ANDRETTI (USA)</b>	<b>+1.0364s</b>
	Andretti Autosport Dallara-Honda; Grid: 9th-1m08.6634s	
<b>3</b>	<b>SCOTT DIXON (NZ)</b>	<b>+1.4286s</b>
	Chip Ganassi Racing Dallara-Chevrolet; Grid: 5th-1m08.5151s	
<b>4</b>	<b>SIMON PAGENAUD (F)</b>	<b>+2.4350s</b>
	Schmidt Peterson Hamilton Motorsports Dallara-Honda; Grid: 10th-1m08.8682s	
<b>5</b>	<b>WILL POWER (AUS)</b>	<b>+3.1559s</b>
	Team Penske Dallara-Chevrolet; Grid: 1st-1m08.3120s	
<b>6</b>	<b>JUSTIN WILSON (GB)</b>	<b>+3.7009s</b>
	Dale Coyne Racing Dallara-Honda; Grid: 16th-1m09.2018s	
<b>7</b>	<b>JAMES HINCHCLIFFE (CDN)</b>	<b>+4.6538s</b>
	Andretti Autosport Dallara-Honda; Grid: 2nd-1m08.3409s	
<b>8</b>	<b>JOSEF NEWGARDEN (USA)</b>	<b>+5.3417s</b>
	Sarah Fisher Hartman Racing Dallara-Honda; Grid: 4th-1m08.4702s	
<b>9</b>	<b>TONY KANAAN (BR)</b>	<b>+6.2513s</b>
	Chip Ganassi Racing Dallara-Chevrolet; Grid: 23rd-1m09.5829s	
<b>10</b>	<b>CHARLIE KIMBALL (USA)</b>	<b>+6.8371s</b>
	Chip Ganassi Racing Dallara-Chevrolet; Grid: 17th-1m09.1941s	
<b>11</b>	<b>RYAN BRISCOE (AUS)</b>	<b>+7.6182s</b>
	Chip Ganassi Racing Dallara-Chevrolet; Grid: 20th-1m09.2722s	
<b>12</b>	<b>JACK HAWKSWORTH (GB)</b>	<b>+8.5257s</b>
	Bryan Herta Autosport Dallara-Honda; Grid: 22nd-1m09.4201s	
<b>13</b>	<b>TAKUMA SATO (J)</b>	<b>+9.6750s</b>
	AJ Foyt Racing Dallara-Honda; Grid: 14th-1m09.1451s	
<b>14</b>	<b>MIKE CONWAY (GB)</b>	<b>+10.1933s</b>
	Ed Carpenter Racing Dallara-Chevrolet; Grid: 21st-1m09.8580s	
<b>15</b>	<b>SEBASTIEN BOURDAIS (F)</b>	<b>+11.3198s</b>
	KVSH Racing Dallara-Chevrolet; Grid: 12th-1m10.0283s	
<b>16</b>	<b>CARLOS HUERTAS (CO)</b>	<b>+12.8894s</b>
	Dale Coyne Racing Dallara-Honda; Grid: 15th-1m09.0267s	
<b>17</b>	<b>GRAHAM RAHAL (USA)</b>	<b>+13.7182s</b>
	Rahal Letterman Lanigan Racing Dallara-Honda; Grid: 18th-1m09.2228s	
<b>18</b>	<b>SEBASTIAN SAAVEDRA (CO)</b>	<b>+14.0955s</b>
	KVAFS Racing Dallara-Chevrolet; Grid: 13th-1m08.9674s	
<b>19</b>	<b>HELIO CASTRONEVES (BR)</b>	<b>+16.1476s</b>
	Team Penske Dallara-Chevrolet; Grid: 6th-1m08.6258s	
<b>20</b>	<b>ORIOLE SERVA (E)</b>	<b>-1 lap</b>
	Rahal Letterman Lanigan Racing Dallara-Honda; Grid: 19th-1m09.2935s	
<b>21</b>	<b>JUAN PABLO MONTOYA (CO)</b>	<b>-1 lap</b>
	Team Penske Dallara-Chevrolet; Grid: 8th-1m08.6453s	
<b>22</b>	<b>MIKHAIL ALESHIN (RUS)</b>	<b>63 laps-accident</b>
	Schmidt Peterson Motorsports Dallara-Honda; Grid: 11th-1m09.1708s	
<b>23</b>	<b>CARLOS MUNOZ (CO)</b>	<b>29 laps-accident</b>
	Andretti-HVM Dallara-Honda; Grid: 7th-1m08.6388s	

Winner's average speed: 94.537mph. Fastest lap: Dixon, 1m09.2995s, 119.481mph.  
All drivers in Dallara DW12

#### CHAMPIONSHIP

<b>1</b>	<b>POWER</b>	<b>125</b>	<b>6</b>	<b>ANDRETTI</b>	<b>73</b>
<b>2</b>	<b>HUNTER-REAY</b>	<b>107</b>	<b>7</b>	<b>WILSON</b>	<b>67</b>
<b>3</b>	<b>PAGENAUD</b>	<b>92</b>	<b>8</b>	<b>CASTRONEVES</b>	<b>66</b>
<b>4</b>	<b>DIXON</b>	<b>87</b>	<b>9</b>	<b>KANAAN</b>	<b>62</b>
<b>5</b>	<b>CONWAY</b>	<b>82</b>	<b>10</b>	<b>NEWGARDEN</b>	<b>58</b>

#### POINTS SYSTEM EXPLAINED:

50-40-35-32-30-28-26-24-22-20-19-18-17-16-15-14-13-12-11-10-9-8-7-6 for the top 24, with 5 for all other starters. 2 points for leading the most laps, 1 point for leading at least one lap, 1 point for pole position.

#### Rookie Aleshin (right) and Bourdais battled early on



FOR IN-DEPTH RESULTS  
forix.autosport.com



Hunter-Reay runs wheel to wheel with Hinchcliffe as Power leads



THE ROAD TO REDEMPTION CAN BE LONG AND GRIM; a slow, public march of repentance that carries no promises other than that of sleepless nights. Alternatively, you can knock it on the head in just two weeks.

A fortnight ago Ryan Hunter-Reay was IndyCar's former champion-turned-*persona non grata*. A momentary lapse of patience at Long Beach triggered an accident that eliminated six drivers — including his team-mate — and started a conversation about exactly where the limits of on-track accountability lay. Hunter-Reay himself went through a process almost perfectly described by the Kubler-Ross model: denial, anger, bargaining, depression and, finally, acceptance.

The 'redemption' part was merely the icing on the cake, and it came in the form of a masterful drive in pretty awful conditions around the leafy hills outside Birmingham, Alabama. Sunday's race at Barber was the latest in a never-ending series of reminders that the weather in America's south-east is not something to be trifled with, but perhaps the sole constant of the afternoon was Hunter-Reay's dominance. That the race finished under yellows masked the extent of his command: had Mikhail Aleshin not wiped out a tyre barrier, Hunter-Reay's margin of victory would have been something in the order of seven seconds.

"As you can imagine, the week after Long Beach was a pretty long one," he admitted. "I just wanted to get back into a race car as soon as I could."

But if redemption came quickly, he still had to work for it. Heavy thunderstorms in the lead-up to — and for some time after — the scheduled start time prompted a delay that eventually led to the

Marco Andretti drove a stormer to finish second



green flag being waved well over two hours late. TV commitments then forced the race to be switched from a 90-lap affair to a timed race, and a mere 100 minutes rather than the standard two hours at that.

And then there was the track itself: soaking wet at the start; varying degrees of dry at the end.

"I had the car in the wet, I had the car in the dry," Hunter-Reay said. "[The team] gave me exactly what I needed. [But] we were tiptoeing around. It's a fine line between getting it all right or all wrong. You have to go onto the risk side to get the reward out of it. It's easy to throw it all away."

A vivid illustration of the last point was offered by Will Power, who had started from pole and enjoyed an immense lead during the opening laps. His advantage had blown out to more than five seconds when the combination of the conditions and the tricky downhill braking zone approaching Turn 5 caught him out, and he slithered his car through the grass and gravel.

"I kept moving my braking point further and



# Hunter-Reay atones by stalking on water

Andretti's Long Beach bad boy came good in Alabama, despite dreadful weather conditions early on. By **MARK GLENDENNING**



further into the corners and I got caught going too far," he said. "It's tough to not push past the limit with wet patches everywhere. We didn't have the pace in the dry anyway, but I didn't help the cause by going off the course."

Although he came excruciatingly close to the wall, the only real damage was on the stopwatch. Power rejoined in second, but had conceded an instant 4s lead to Hunter-Reay and, as the conditions evolved beyond what his car was set up for, his threat faded and he eventually finished fifth behind the excellent Simon Pagenaud.

Power had loomed as one of the early weekend favourites for the win, and his mishap created an opportunity for others to step up. Plenty distinguished themselves, but few more so than Marco Andretti, who'd settled into second place just after half-distance and never let it go, despite the occasional threat from Scott Dixon.

That meant a one-two for Andretti Autosport. All four of the team's cars had been strong at

Barber, but James Hinchcliffe's early-race promise was dulled when he lost a few places in the pits, and Carlos Munoz's hopes ended with the classic rookie mistake of too much throttle on a damp track, an error that flicked his car against the wall and broke the suspension.

Andretti, on the other hand, had his mishaps earlier in the weekend. "My speed didn't show in qualifying," he said. "I was on a great lap and I screwed it up. That's the reason I had to come through from ninth. [But] I don't think I'd have caught Ryan. He gapped me too much."

Meanwhile, Scott Dixon's extraordinary streak of four second-place finishes from four starts at Barber finally came to an end when he crossed the line in third. The reigning champion felt that his finishing position was a fair representation of his car's capabilities on the day, although he admitted to some frustration over how the conditions were handled from a scheduling perspective.

"The race should be full distance," he complained.



"To shorten these races for TV... I understand the difficult predicament that everybody is in, but these are championship races. They all pay the same amount of points, so to take 30 minutes off them... Then you finish on a caution, which is a bummer for the fans. In the future, hopefully we can find a way around that."

The big curveball of the race came in the unexpected form of KV/AFS's Sebastian Saavedra, who ignored the crowd when they all pitted for slicks under caution and stayed out for a long first stint on wets instead. He wasn't having an easy time making it work: the gradually drying track forced him to take increasingly unconventional lines in search of any patch of dampness to keep his tyres cool. Had the yellows fallen differently his gamble might have turned into a masterstroke.

As it transpired, it would prove decisive in the race, but perhaps not in the way he intended. When Hunter-Reay finally overtook him, Saavedra acted as a buffer to the rest of the field and helped Hunter-Reay to build a huge lead before the Colombian finally pitted and released everyone else a lap or so later.

It could also have been a big race for another Colombian before fate intervened. Juan Pablo Montoya was one of the biggest movers early in the race, making rapid progress from eighth up to fourth. That was stunted by a spin into the gravel that dropped him off the lead lap.

"Dixon lifted more than I expected, and I had to lift a lot more and it started tail-slapping," he said. "After that, something broke in the car. I don't know what happened."

Even more impressive was Tony Kanaan, who started from 23rd, made up nine positions in the opening laps, and continued to gain ground throughout the afternoon on his way to an eventual finishing position of ninth. After occasionally having his credentials on road and street courses called into question, the Indy 500 winner was buoyed by his performance, particularly in light of the conditions.

"It was a good day for us," he said. "I mean, we passed half the field on a track that people say you can't pass on."

Similarly excellent performances were on display from Britons Justin Wilson (16th to sixth) and Jack Hawksworth (22nd to 12th).

"[During the first stint] I couldn't see a thing," Wilson admitted. "You were getting on the brakes on the straight and just hoping the guys behind were in the same boat. Fortunately, they were."

If Barber 2014 will be remembered as a basket case, it has at least set things up beautifully for the run into May and Indianapolis. Power, despite his mishap, holds a slender points lead; Hunter-Reay has moved up to second. One Chevy, one Honda.

And on the immediate horizon, a road course that nobody has raced an IndyCar on, and a fabled superspeedway. Think it's been interesting so far? The real fun is just getting started. ▶

## Good design sometimes needs a little help...

...that's why global race teams use Sandwell as a prime supplier of performance engineering solutions.

- Controlled Shot Peening
- Superfinishing
- Low Friction Coatings
- Kephos Coatings

Sandwell works with design and development engineers throughout the world of manufacturing to improve component performance.

- Improve component fatigue life
- Increase component strength
- Improve reliability
- Reduce component weight
- Reduce surface friction
- Apply corrosion resistant coatings

Visit our new website at [www.sandwell-uk.com](http://www.sandwell-uk.com)

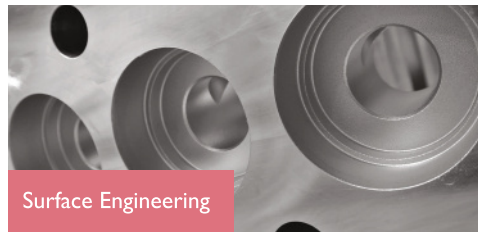

Sandwell UK Ltd. 2 Foundry Place, Towcester, Northamptonshire NN12 6FP

T: +44 (0) 1327 350205 E: [sales@sandwell-uk.com](mailto:sales@sandwell-uk.com) [www.sandwell-uk.com](http://www.sandwell-uk.com)

## IN THE PADDOCK

MARK GLENDENNING  
INDYCAR CONTRIBUTOR

@m\_glendenning



THE CHEQUERED FLAG AT BARBER marked the end of a long, frustrating and, truth be told, not entirely fulfilling Sunday. When you've spend the preceding 48 hours building up to an event, a 165-minute rain delay and a shortened race full of cautions can only feel anti-climactic.

In those sorts of situations, it helps to find some kind of spark; a reminder that even though the media centre is flooding and the wife has been down for three hours, things could be worse. It was Will Power's wife Liz who came to the rescue.

"There's a tornado coming through here tomorrow," she said. "At least, that's what the

woman in the gas station told me."

Further investigation revealed that Mrs Power's source was spot-on, with multiple weather warnings in effect for the Birmingham area for the days immediately following the race. And it helped illustrate why IndyCar found itself between rocks and hard places in terms of Sunday's downpour.

With tornadoes looming, delaying the race until Monday – as the series did in Sao Paulo in 2011 – was clearly not an option. And calls for the race to be red-flagged after Mikhail Aleshin's accident to eventually allow for a green-flag finish failed to take into account that the host broadcaster was minutes away from flicking over to the NHL play-offs. Under those circumstances, a green finish would have meant an untelevised finish.

So were the circumstances of Sunday's race ideal? Far from it. But they were preferable to the likely alternatives.



Early chequers avoided threat of TV blackout

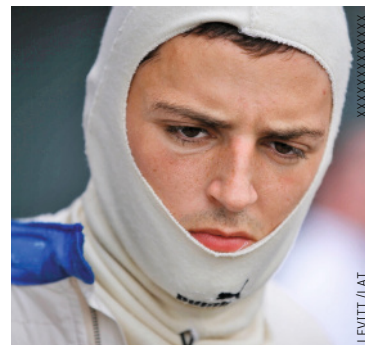

LEVITT/LAT

## THIRD COYNE CAR PLAN

Dale Coyne Racing is aiming to field a third car for this month's Indianapolis 500. No driver has been confirmed for the seat, although Stefan Wilson (above) is among the frontrunners. DCR engine supplier Honda confirmed to AUTOSPORT that it was not planning to support any additional cars, effectively ruling out a second entry from Bryan Herta Autosport.

## PENALTIES SERVED

IndyCar's new engine-penalty system was put into play for the first time in the lead-up to last weekend's race at Barber, with Chevrolet being docked 50 manufacturer points and Honda losing 30 for breaches of rules relating to permissible engine changes and/or minimum mileage. Prior to 2014, such breaches resulted in 10-place grid penalties for drivers.

## HCN MAKES PIT ERROR

Helio Castroneves's race was derailed when he was issued a drive-through penalty for inadvertently stopping in Justin Wilson's pitbox, a mistake he blamed on the similarity between the uniforms of the crews. The Penske driver was also warned for jumping a restart, a punishment later decried as too lenient by Ganassi's Scott Dixon.

## BOURDAIS PUNISHED

Sebastien Bourdais's mistake-peppered start to the season continued at Barber when he was issued a drive-through penalty for spinning Mikhail Aleshin early in the race.

## KIMBALL RACES T-CAR

Charlie Kimball was forced to race his spare Chip Ganassi Racing car after crashing his main chassis heavily during the Sunday morning warm-up session. Kimball rewarded the team's frantic rebuild efforts with a top-10 finish.

## RAHAL RUES BALANCE

Graham Rahal spent most of the Barber race struggling with his car's balance, but claims that the first few laps on slicks will remain burned in his mind. "Those were honestly the most difficult laps I have ever driven. I hope I don't see them again," he said.

LEPAGE/LAT



## Marco scores a 'huge' result

MICHAEL ANDRETTI BELIEVES that son Marco's strong performance in the wet at Barber could prove to be the confidence boost that he needs to compete for wins more regularly.

The younger Andretti rebounded from an awful 2012 to enjoy a solid season last year, although he was the only one of the team's three frontline drivers not to secure a win.

"We had a little bit of a talk before the race," said Andretti Sr. "He drove really well. He was aggressive when he needed to be, then paced himself really well when he got in front of Will [Power]. I think it was huge for him."

## Cosworth targets IndyCar return

COSWORTH IS CONTINUING TO work on plans to enter IndyCar, and says that it is hoping to meet with a shortlist of potential manufacturer partners at the Indy 500.

The company confirmed its intentions to investigate an IndyCar programme in February and met with series officials a short time later. Cosworth marketing director Tom Buckler told AUTOSPORT that he

remains confident that the firm could compete successfully.

"We've done it before, and there's not really a doubt in the mind of Bruce Wood, our technical director, that we could design a race-winning engine," he said. "And the business case, we believe, makes sense. We've done analysis, and the exposure the brand would get, and there's a very positive ROI [return on investment] in that."



Famous name could return to Indy engine ranks

DUNBAR/LAT

## Montoya applauds new self-policing approach

Montoya thinks the drivers are "smart enough"



LEPAGE/LAT

INDYCAR'S NEW-FOR-2014 POLICY of allowing drivers to self-police was met with a mixed reaction in the paddock following the incident-laden Long Beach race two weeks ago, but the idea has the full support of Juan Pablo Montoya.

"I think it's awesome," the Penske driver told AUTOSPORT. "We're not the smartest bunch of people, but we're smart enough to realise what we're supposed to do and what we're not supposed to do. People were starting to rely too much on, 'oh, he hit me, penalise him', and it was destroying the racing. People were afraid of passing

because they didn't want to get a penalty."

Several drivers, including Will Power and Ryan Hunter-Reay – both of whom were at fault for accidents at Long Beach – said that there is scope for a clearer delineation of what is acceptable on the track, but Josef Newgarden doubts that self-policing can ever work with single-seaters.

"It doesn't work with these cars, and it never has," said the Sarah Fisher Hartman Racing driver. "They're dangerous pieces of equipment, and you've got to respect each other. We want to promote hard racing, but there's got to be a line."

## FR3.5

### Aragon (E)

April 25-27

Round 2/9



#### RESULTS

RACE 1: 25 LAPS, 83.015 MILES

1	CARLOS SAINZ JR (E)	43m14.984s
2	NIKOLAY MARTSENKO (RUS) Comtec Racing; Grid: 3rd-1m40.474s	+14.335s
3	OLIVER ROWLAND (GB) Fortec Motorsports; Grid: 2nd-1m40.436s	+24.291s
4	MARLON STOCKINGER (RP) Lotus (Gravity-Dharouz); Grid: 7th-1m40.692s	+24.488s
5	ZOEL AMBERG (CH) AVF; Grid: 5th-1m40.611s	+33.825s
6	ROBERTO MERHI (E) Zeta Corse; Grid: 4th-1m40.581s	+34.652s
7	MATTHIEU VAXIVIERE (F) Lotus (Gravity-Dharouz); Grid: 13th-1m41.193s	+34.942s
8	SERGEY SIROTKIN (RUS) Fortec Motorsports; Grid: 9th-1m40.709s	+37.387s
9	PIERRE GASLY (F) Arden Motorsport; Grid: 6th-1m40.624s	+38.662s
10	PIETRO FANTIN (BR) International Draco Racing; Grid: 8th-1m40.702s	+42.885s

Winner's average speed: 115.140mph. Fastest lap: Sainz, 1m43.174s, 115.885mph.

RACE 2: 24 LAPS, 79.694 MILES

1	ROWLAND	41m44.385s
2	GASLY	+13.770s
3	WILL STEVENS (GB) Strakka Racing; Grid: 4th-1m40.375s	+14.764s
4	SAINZ	+14.916s
5	AMBERG	+15.228s
6	MERHI	+16.296s
7	MARCO SORENSEN (DK) Tech 1 Racing; Grid: 9th-1m40.601s	+17.337s
8	VAXIVIERE	+19.236s
9	JAZEMAN JAAFAR (MAL) ISR; Grid: 6th-1m40.461s	+24.481s
10	NORMAN NATO (F) DAMS; Grid: 17th-1m40.977s	+28.141s

Winner's average speed: 114.580mph. Fastest lap: Rowland, 1m42.124s, 117.066mph.

#### DRIVERS' CHAMPIONSHIP

1	SAINZ	62	6	MERHI	36
2	ROWLAND	49	7	STOCKINGER	30
3	GASLY	45	8	SIROTKIN	25
4	STEVENS	40	9	AMBERG	24
5	MARTSENKO	36	10	GHIOTTO	12

#### TEAMS' CHAMPIONSHIP

1	FORTEC	74	4	STRAKKA	41
2	DAMS	63	5	LOTUS	40
3	ARDEN	57	6	COMTEC/ZETA	36

#### POINTS SYSTEM EXPLAINED

In each race: 25-18-15-12-10-8-6-4-2-1 to top 10 finishers.



FOR IN-DEPTH RESULTS  
forix.autosport.com



Rowland celebrates his maiden FR3.5 win

## Rowland sets his sights on Sainz as title race ignites

FOLLOWING ANOTHER DOMINANT PERFORMANCE from Carlos Sainz Jr at Aragon on Saturday, fellow podium finisher Oliver Rowland made a confident declaration. He reckoned the Spaniard – who had beaten him to pole position that morning by just 0.018 seconds – was there for the taking.

“He can have his dominance now,” said the Briton. “It’s a long season and I’m confident. As long as we are finishing third or fourth on our bad days, his lead is not unassailable.”

Rowland was adamant that without a mistake on his qualifying lap he would have been on pole, and he delivered on that promise a day later. Sainz, who had warned that he and DAMS were not as far ahead as the race-one results (see left) suggested, could only manage fifth. From there he was part of a frenetic battle for best of the rest, as Rowland charged off into the distance for his maiden win.

“The car was unbelievable,” said the winner. “This championship can turn around very quickly, and I think we can get stronger and stronger now.”

Sainz, who lost third place to fellow Red Bull junior Pierre Gasly in the closing stages as they both fought to pass Will Stevens, accepted that Sunday was a sign of the 2014 championship fight coming alive.

“Today we have seen who is in the picture,” he said. “Those guys have shown that they are going to be in the fight. As soon as you don’t get everything perfect in this championship you can be P5, and then it is impossible to demonstrate your pace. Oliver has proven today that getting pole position is a big part of the job.”

As well as being a couple of rows back to what he was becoming used to, Sainz had to “improvise” at the start as his car’s launch system failed, dropping him even further into the pack. Considering that, and his car nearly stalling in the pits, a fightback to third would have been more than acceptable. But a misjudgement under braking for the hairpin three laps from home, when he was caught out by the defensive Stevens braking early, handed Gasly the opportunity he needed to steal second place on the final lap.

For Stevens, the disappointment of being bumped down to third in sight of the flag was tempered by the fact that he and Strakka had

recovered from a disastrous start to the weekend. The team has struggled to get the most out of new tyres in qualifying this year, but on Sunday that changed, and a new engine (installed earlier in the weekend) also made a difference.

“We don’t have much to find,” said Stevens, with the caveat: “we need to find it soon though.”

Gasly was another to enjoy a much more productive Sunday, after a scrappy Saturday where he was outsmarted and outmuscled at times in the pack left him ninth and giving up the championship lead he and Stevens had shared with Sainz coming into the weekend.

The struggles of some of the more fancied runners on Saturday allowed some other names to shine. Nikolay Martsenko took a well-deserved second place behind Sainz, declaring his Comtec car “the best I’ve ever driven”, while Zoel Amberg had put up a serious fight against Rowland for third. The race-two winner admitted to feeling “80 per cent less fatigued” after his victory compared with Saturday’s battle.

Not all Sainz’s potential challengers made up for a bad first race. Will Buller was caught up in midfield incidents in both races as he tried to recover from grid positions that didn’t reflect his true pace, while Sauber F1 reserve Sergey Sirotkin is already concerned about his deficit in the title race after a weekend blighted by set-up issues and reliability gremlins (including his car’s anti-stall kicking in twice during race two).

For now, it’s up to Sunday’s top three – Rowland, Gasly, Stevens – to prevent this season becoming a Sainz walkover.



Sainz dominated Saturday's race

ALL PICS: RENAULT-SPORT

## IN THE PADDOCK

**GLENN FREEMAN**  
ONLINE EDITOR

@glenn\_autosport



TWO YEARS AGO OLIVER ROWLAND was sitting on the Fortec pitwall watching Robin Frijns take a dominant maiden Formula Renault 3.5 victory in the second race of the weekend at Aragon. Rowland, back then a Fortec driver in the Formula Renault Eurocup, told the team that he could win in that car too. It was a declaration that several members of his crew were quick to remind him of when he returned to the garage after his podium celebrations on Sunday afternoon.

Behind all of Rowland's confidence last weekend, he knew the pressure he was facing. He was starting from pole without a decent getaway to his name so far in these cars, and was about to take part in his first race to feature a mandatory pitstop. He also felt that he needed to prove himself to Fortec after an indifferent opening weekend at Monza.

To keep all of that pressure under control was a fine showing of mental strength, something that Rowland openly admits is a result of the efforts of the Racing Steps Foundation and Derek Warwick. They've given him a very hard time over the past couple of years in particular, but last Sunday everyone got to see why they do it.



**Frijns en route to 2012 victory**

## 8 BIG NUMBER

Oliver Rowland's race-two pole position broke a streak of eight consecutive poles for DAMS. Draco's Andre Negrao was the last non-DAMS driver to take pole, at the Hungaroring on September 14, 2013.



DUTCHPHOTOAGENCY/LAT

### FORMULA RENAULT EURO CUP RD 1/7

## McLaren's de Vries leads the way in Eurocup

### McLAREN JUNIOR NYCK DE VRIES

came away from the Formula Renault Eurocup opener with the championship lead, having shared the first-weekend spoils with Andrea Pizzitola.

The Dutchman survived an early onslaught in the opening race, acting as the guinea pig for the field as spots of rain fell around the circuit. That allowed a pack to develop on his tail, as Egor Orudzhev, Aurelien Panis, Bruno Bonifacio and Alexander Albon all too advantage of the leader's caution.

"The leader has to give the pace in those conditions, and you don't know how much the grip is being affected by the rain," said de Vries. "I was holding the pack up but it would have been the same if it had been someone else in the lead."

Once the rain disappeared so did de Vries, marching off into the distance as Orudzhev switched his focus to keeping Bonifacio at bay. The Russian seemed to have the measure of the Brazilian, but he confessed to making too many errors that kept his pursuer on his tail to the end.

Race-two winner Pizzitola was not a factor in race one, having been sent to the back of the grid after his car finished qualifying without the required amount of fuel. It was put down to higher-than-expected fuel consumption rather than



**De Vries led away in tricky conditions**

an error by his Manor MP team, and he responded with a maiden Eurocup victory from pole position the following day.

Behind Kevin Jorg in second, Bonifacio came out on top in a race-long fight with de Vries to take another third place and second in the standings. Bonifacio had handed de Vries the place early on with an error at the final hairpin, but when the points leader made a mistake of his own a fierce side-by-side battle ensued through the middle sector, before being settled in Bonifacio's favour on the backstraight. De Vries had one more lunge at the final hairpin later on, but a massive lock-up sent him off the track and consigned him to P4.

"The key to this championship is to be consistent," said Bonifacio. "This weekend

has been a good confirmation that our pace in testing was genuine, so we just need to keep up the good job."

Orudzhev's hopes of building on his race-one podium were shot when he was tagged by Albon as they fought over fifth in race two, giving the former a puncture and the latter some front wing damage.

### RESULTS

**Race 1 1 Nyck de Vries**, 14 laps in 27m29.083s; 2 Egor Orudzhev, +2.872s; 3 Bruno Bonifacio; 4 Alexander Albon; 5 Aurelien Panis; 6 Gustav Malja. **Race 2 1 Andrea Pizzitola**, 14 laps in 27m18.228s; 2 Kevin Jorg, +2.948s; 3 Bonifacio; 4 de Vries; 5 Levin Amweg; 6 Simon Gachet. **Points 1 De Vries 37**; 2 Bonifacio 30; 3 Pizzitola 25; 4 Jorg 18; 5 Orudzhev 18; 6 Albon 14.



**Fighting Sainz cost Stevens**

## DRS use plays a decisive role

### THE FORMULA RENAULT 3.5

drag-reduction system was at the centre of a thrilling battle for second place during race two at Aragon.

The DRS, which differs from the Formula 1 system because it stalls the rear wing, has rarely had a big impact on races since being introduced in 2012. However, the high winds on Sunday combined with most of the cars running high-downforce spec allowed drivers to get strategic with how they used their 350 seconds of DRS through the race.

Will Stevens was using up his quota to keep Carlos Sainz – who was running

with less wing – at bay on the straights. Behind them Pierre Gasly was sitting in their tow and saving his allowance for use in the closing stages.

By the time Sainz locked up and handed third place to Gasly, Stevens had no more DRS to use, leaving him powerless to defend down the long backstraight on the final lap.

Stevens had pinned his tactics on the fact that the Spaniard couldn't keep up with him through the twisty middle sector leading onto the backstraight. Had Sainz not made an error to hand third to Gasly, the Briton would have been safe.



### SAINZ GETS FINED

Carlos Sainz Jr was fined €500 for his post-race victory celebrations on Saturday. The Spaniard pulled into the asphalt run-off in front of the grandstand at the end of the start/finish straight to perform burnouts for his local fans, but it was deemed dangerous by officials.

### ONE MORE FOR WEBB

Oliver Webb's deal with Pons Racing will conclude after the following round of the series in Monaco. The Briton will then switch his focus back to his European Le Mans Series sportscar programme with the Signatech Alpine squad.

### DUPONT MOVES ON

Renault Sport technologies sporting manager Benoit Dupont attended his final World Series by Renault event last weekend before joining the FIA Formula E championship. "Over the past 10 years Renault Sport has confirmed its place as a leader in the single-seater world and I'm proud I played a role in it," he said.



Logano (right) grabs lead from Kenseth (left), Gordon (behind) and Keselowski

NASCAR SPRINT CUP RICHMOND (USA), APRIL 26 RD 9/36

## Logano at the last gasp in thriller

JOEY LOGANO STOLE VICTORY IN A bruising short-track classic at Richmond on Saturday night, leaping from fourth to first with three laps to go as those ahead became too focused on barging each other and left the door wide open for the Penske Ford.

Matt Kenseth had appeared to be taking control of the race as he stormed towards the front in the final quarter and took first place from Jeff Gordon — who would lead the most laps but tended to fare better on long runs and suffer on restart sprints — with 48 of 400 laps to go.

But Kenseth struggled for pace

after the final restart eight laps from the end and found himself under pressure from all sides as Gordon and a flying Brad Keselowski swarmed all over his Joe Gibbs Racing Toyota.

The lead trio bounced off each other more than once and, as panels bashed and tempers rose, Logano crept up on the inside and slipped through to grab the lead and his second win in three races.

With Keselowski and Kenseth embroiled in retaliatory contact that would continue on the way back to the pits after the chequered flag, it was Gordon who emerged in second.

Kyle Busch grabbed fresh tyres under the final caution and tore through the field to third, reaping the benefits of fresh rubber on a night when everyone struggled to keep their Goodyears in shape. Many drivers suffered punctures, with champion Jimmie Johnson ending up 32nd as a consequence of tyre troubles, and Clint Bowyer and Reed Sorenson having dramatic fires in their cars due to damage from flailing rubber.

Bowyer had earlier tagged polesitting rookie Kyle Larson — who started first by virtue of practice pace when rain hit on Friday — into a spin

on the way into the race's very first corner. Larson recovered to 16th.

● Connell Sanders Jr

### RESULTS

**1 Joey Logano (Ford Fusion)**, 400 laps in 3h12m47s; 2 Jeff Gordon (Chevrolet SS), +0.946s; 3 Kyle Busch (Toyota Camry); 4 Brad Keselowski (Ford); 5 Matt Kenseth (Toyota); 6 AJ Allmendinger (Chevy); 7 Dale Earnhardt Jr (Chevy); 8 Ryan Newman (Chevy); 9 Carl Edwards (Ford); 10 Martin Truex Jr (Chevy). **Points 1 Gordon, 341;** 2 Kenseth, 336; 3 Edwards, 313; 4 Kyle Busch, 310; 5 Earnhardt, 309; 6 Logano, 292; 7 Keselowski, 287; 8 Jimmie Johnson, 282; 9 Newman, 272; 10 Brian Vickers, 256.

ADAC GT MASTERS OSCHERSLEBEN (D), APRIL 26-27 RD 1/8

## Rast Audi moves into lead

RENE RAST AND 17-YEAR-OLD SOUTH African Kelvin van der Linde leapt to the top of the points with a win and a second with their Prosperia C Abt Racing Audi.

The pair was a close second in the first race behind the HTP Motorsport Mercedes of Maxi Buhk and Maxi Gotz. From third on the grid, Buhk took the lead on the dash to the first corner, and — after a late safety car caused by Heinz-Harald Frentzen spinning the sister HTP Merc — Gotz held off a late challenge from Rast.

The first-race winners went out in a massive startline crash in race two, in which Nicki Thiim barrel-rolled his Audi — the Dane stayed overnight in hospital with minor injuries.

Behind the winning Audi, Jaap van Lagen passed Dominik Baumann for second in the early stages, and the Schutz Motorsport Porsche — co-driven by Christian Engelhart — took its second podium of the event.

Oliver Gavin had a disaster, crashing his Corvette in race one when the throttle stuck before co-driver Daniel Keilwitz was eliminated in the second-race start pile-up.

● Rene de Boer

### RESULTS

**Race 1 1 Maximilian Buhk/Maximilian Gotz (Mercedes SLS AMG GT3)**, 37 laps in 1h01m00.112s; 2 Rene Rast/Kelvin van der Linde (Audi R8 LMS ultra), +0.307s; 3 Christian Engelhart/Jaap van Lagen (Porsche 911 GT3-R); 4 Daniel Dobitsch/Florian Stoll (Audi); 5 Maro Engel/Jan Seyffarth (Mercedes); 6 Dominik Baumann/Claudia Hürtgen (BMW Z4 GT3).

**Race 2 1 Rast/van der Linde**, 32 laps in 1h14m39.781s; 2 Engelhart/van Lagen, +2.491s; 3 Baumann/Hürtgen; 4 Robert Renauer/Norbert Siedler (Porsche); 5 Herbert Handlos/Alfred Renauer (Porsche); 6 Diego Alessi/Patrick Assenheimer (Chevrolet Corvette Z06.R).

**Points 1 Rast/van der Linde, 43;** 2 van Lagen/Engelhart, 33; 3 Gotz/Buhk, 25; 4 Baumann/Hürtgen, 23; 5 Siedler/Renauer, 18; 6 Dobitsch/Stoll, 12.



Winning Audi takes the flag



Chaves rescued his weekend with win

INDY LIGHTS BARBER (USA), APRIL 26-27 RD 3/10

## Veach takes cut at Barber

ZACH VEACH EXTENDED HIS POINTS lead over main rival Gabby Chaves at last weekend's double-header, despite Chaves winning race two.

Veach left Alabama with a nine-point advantage, and owed the gain to a friendly-fire incident that took Belardi team-mates Chaves and Alex Baron out of contention at the start of race one.

Frenchman Baron mounted a spirited recovery, passing Chaves late in the race to eventually finish fifth, and providing most of the race's entertainment in the process. Veach, meanwhile, won comfortably from Luiz Razia and Jack Harvey.

Chaves's chance to salvage something from the weekend came

when he started from pole on Sunday, and he made the most of his opportunity to lead Baron across the line in a rain-shortened race.

In the other IndyCar ladder series, Spencer Pigot won both Pro Mazda races, with RC Enerson doing a US F2000 double.

● Mark Glendenning

### RESULTS

**Race 1 1 Zach Veach**, 30 laps in 39m40.1544s; 2 Luiz Razia, +3.8444s; 3 Jack Harvey; 4 Matthew Brabham; 5 Alex Baron; 6 Gabby Chaves. **Race 2 1 Chaves**, 38 laps in 51m37.3715s; 2 Baron, +1.5904s; 3 Veach; 4 Razia; 5 Harvey; 6 Juan Pablo Garcia. **Points 1 Veach, 181;** 2 Chaves, 172; 3 Razia, 132; 4 Harvey, 132; 5 Baron, 118; 6 Brabham, 105.

**FORMULA ACCELERATION 1**  
**ALGARVE (P), APRIL 26-27 RD 1/8**

## Bortolotti makes dream start for Italy

**EX-FORMULA 2 CHAMPION MIRKO**

Bortolotti swept to a double win as the new Formula Acceleration 1 series got going at the Algarve circuit.

From a field of 11 Lola-Zytek cars previously used in the A1GP series, reigning Megane Eurocup champion Bortolotti controlled proceedings from pole position in both races, handing the Ghinzani-run Team Italy operation a perfect birth in the nation-based category.

"This has been absolutely awesome for me," said Bortolotti. "It's been quite a while since I drove a single-seater and you lose a little bit of rhythm, but the team knew these cars from before and we did a good job to prepare ourselves during the test days."

Bortolotti's main opposition came from former GP2 and Formula Renault 3.5 racer Nigel Melker (Team Netherlands) and F3 star Felix Rosenqvist (Team Sweden), with the trio enjoying a clear edge over the rest of the field throughout the weekend.

Saturday's race, run over 30 minutes with one mandatory pitstop, was effectively settled at the start, as Bortolotti grabbed the lead and Melker slotted into second. Rosenqvist was delayed in a lengthy



**Bortolotti excelled on single-seater return**

pitstop, promoting Team Germany's Sebastian Balthasar (who, like Rosenqvist, was run by Performance Racing) into third place.

There was an exciting three-way scrap for victory on Sunday, with Bortolotti holding a slender lead over Rosenqvist and Melker after the second and final pitstop phase. But Rosenqvist dropped back with a loss of power, while Melker never managed to quite bridge the gap to Bortolotti.

Other drivers of note included

Marussia F1 tester Rodolfo Gonzalez and Auto GP regular Sergio Campana.

● Mattias Persson

### RESULTS

**Race 1** 1 Mirko Bortolotti, 19 laps in 30m46.906s; 2 Nigel Melker, +5.057s; 3 Sebastian Balthasar; 4 Felix Rosenqvist; 5 Richard Gonda; 6 Armando Parente. **Race 2** 1 Bortolotti, 28 laps in 45m46.750s; 2 Melker, +3.602s; 3 Rosenqvist; 4 Balthasar; 5 Parente; 6 Oliver Campos Hull. **Points** 1 Bortolotti, 49; 2 Melker, 33; 3 Rosenqvist, 25; 4 Balthasar, 24; 5 Parente, 16; 6 Campos Hull, 12.

**V8 SUPERCARS PUKEKOHE (NZ), APRIL 25-27 RD 4/14**

## Winterbottom springs to the front in NZ

**MARK WINTERBOTTOM ADMITTED THAT** drove badly at Pukekohe last Friday, but he turned it around to seize the V8 Supercar points lead.

The Ford Performance Racing man bounced back to take first, second and first in the three subsequent races and in doing so took out the Jason Richards Trophy, named in honour of the New Zealand-born driver who passed away from cancer in 2010. To make FPR's wins even sweeter, Chaz Mostert bounced back from a Friday clash to take two podium finishes in his best weekend since joining the

team at the start of the season.

Jason Bright and Shane van Gisbergen gave Holden the other two wins, and Scott McLaughlin took two poles and two podiums in his Volvo, but the big question of the weekend was the lack of speed from the Triple Eight Holdens. Jamie Whincup led the first 12 laps of the opening race until he struck powersteering problems, and from that point he and Craig Lowndes clearly struggled for speed. Team boss Roland Dane has promised "all leave is cancelled" as investigations are launched into the team's woes.

McLaughlin apart, the new makes struggled on the fast Auckland track, Will Davison and Michael Caruso giving Mercedes and Nissan respectively a fifth place each. The other big loser was David Wall, who came out worse in a race-one clash with Mostert. Wall's Dick Johnson Racing Ford took no further part in the races and may be a write-off.

● Phil Branagan

### RESULTS

**Race 1** 1 Jason Bright (Holden Commodore), 33 laps in 40m48.31s; 2 Shane van Gisbergen (Holden), +1.67s; 3 Craig Lowndes (Holden); 4 James Courtney (Holden); 5 Will Davison (Mercedes E63 AMG); 6 Nick Percat (Holden). **Race 2** 1 Mark Winterbottom (Ford Falcon), 35 laps in 39m39.70s; 2 Courtney, +1.95s; 3 Chaz Mostert (Ford); 4 Jamie Whincup (Holden); 5 van Gisbergen; 6 Scott McLaughlin (Volvo S60). **Race 3** 1 van Gisbergen, 35 laps in 39m34.13s; 2 Winterbottom, +0.28s; 3 McLaughlin; 4 Whincup; 5 Garth Tander (Holden); 6 David Reynolds (Ford). **Race 4** 1 Winterbottom, 69 laps in 1h16m14.07s; 2 McLaughlin, +6.98s; 3 Mostert; 4 van Gisbergen; 5 Michael Caruso (Nissan Altima); 6 Bright. **Points** 1 Winterbottom, 94; 2 Lowndes, 83; 3 Fabian Coulthard, 82; 4 Courtney, 78; 5 van Gisbergen, 77; 6 Whincup, 77.



**Winterbottom on exuberant form**

CIANE/ONE/GETTY

## In brief

### VLN

Alex Buncombe claimed the maiden VLN pole for Nissan on the Nurburgring Nordschleife, but it was Marc VDS BMW men Dirk Adorf and Nick Catsburg who won a close-fought race by three seconds from Dorr Motorsport McLaren trio Kevin Estre, Arno Klases and Rudi Adams.

### V8 STOCK CARS

Atila Abreu opted for staying out until the last lap of the mandatory pitstop window and benefited from a perfect stop from the AMG crew to win the first race of the weekend at Brasilia from Rafa Matos and Luciano Burti. Tenth in the initial race, Thiago Camilo started the second from pole and led from lights to flag, pressed by Julio Campos and Caca Bueno.

### NZ V8 SUPERTOURERS

Greg Murphy took his second successive New Zealand V8 SuperTourers title after winning three of the four races in the final round at Pukekohe. Holden team-mate Richard Moore won the final race after a tough contest. Simon Evans – older brother of GP2 racer Mitch – was second in the championship, and Moore third.

### FIA WORLD CUP RALLY

Nasser Al-Attiyah took a start-to-finish victory in the five-day Sealine Cross-Country Rally across the Qatar desert. The Mini All4 Racing driver won four of the five selective sections on a 1739.55km route in sweltering conditions. Russian Vladimir Vasilyev (Mini) finished second.

### NASCAR NATIONWIDE

Chase Elliott couldn't find an answer to Kevin Harvick at Richmond in his bid to win a third successive race, but extended his points lead with second place.

### FRENCH GT

Nicolas Armindo's Porsche couldn't repel an Audi attack late in the first race at Le Mans, and it was the Sebastien Loeb Racing R8 of Mike Parisy (and started by Henry Hassid) that won from Sainteloc's Gregory Guilvert/David Hallyday. A stunning wet opening stint from Soheil Ayari in race two set up Jean-Claude Police to take the Duqueine Ferrari to victory, with Bruce Lorgere-Roux/Gilles Vannelet completing a Ferrari one-two.

### GERMAN FORMULA 3

With two wins for German Markus Pommer and one for Malaysian Nabil Jeffri (in the reversed-grid race), local team Motopark had a clean sweep at Oschersleben. Briton Sam MacLeod took third in two of the races.



# SUBSCRIBE TO AUTOSPORT AND GET... A FREE MERCEDES AMG PETRONAS TEAM PEN



54

**AUTOSPORT**  
20 YEARS ON: IMOLA '94  
www.autosport.com MAY 1 2014 £3.00

**F1'S DEADLY WEEKEND**  
BY THOSE WHO WERE THERE



**PROST ON SENNA**  
"We talked about the bad safety"

**VILLENEUVE IN RATZENBERGER**  
"At least he was living his dream"

## SUBSCRIBE NOW!

Visit [www.themagazineshop.com/aspo/m0514p](http://www.themagazineshop.com/aspo/m0514p)

Or call  
and quote  
M0514P

# 08448 488 817

Please have your bank details ready. Offer ends June 5 2014

- ✓ Save 25% on the cover price
- ✓ Pay just £34.99 every 13 issues by Direct Debit

[themagazineshop.com](http://themagazineshop.com)

# +PLUS+

# FREE DIGITAL EDITION SUBSCRIPTION & UNLIMITED ACCESS TO **AUTOSPORT.COM**



## FREE GIFTS

- ✓ Free MERCEDES AMG PETRONAS TEAM PEN  
Never miss on a chance to get Nico's or Lewis's autograph!  
Also comes in a gift box
- ✓ Free subscription to the AUTOSPORT Digital Edition and unlimited access to **AUTOSPORT.com**

## THE BENEFITS OF SUBSCRIBING!

- ✓ Never miss an issue
- ✓ Free delivery direct to your door
- ✓ Unlimited access to news and views from the paddock
- ✓ Access to subscriber-only analysis and comment

## **AUTOSPORT** SUBSCRIPTION ORDER FORM

Please start my subscription to AUTOSPORT, paying just £34.99 every 13 issues by Direct Debit, saving 25% on the cover price.

**Please send me my FREE Mercedes AMG Petronas Team Pen**

**YOUR DETAILS** – must be completed  
(BLOCK CAPITALS PLEASE)

Title: \_\_\_\_\_ Name: \_\_\_\_\_

Surname: \_\_\_\_\_

Address: \_\_\_\_\_  
\_\_\_\_\_

Postcode: \_\_\_\_\_

Telephone: \_\_\_\_\_

Mobile: \_\_\_\_\_

Email: \_\_\_\_\_

### DIRECT DEBIT PAYMENT (UK ONLY)

To the manager, bank name: \_\_\_\_\_



Address: \_\_\_\_\_  
\_\_\_\_\_

Postcode: \_\_\_\_\_

Name of account holder(s): \_\_\_\_\_

Bank sort code   -   -

Bank/building society account number

Please pay **Haymarket Media Group** Direct Debits from the account detailed on this instruction subject to the standards assured by the Direct Debit Guarantee. I understand that this instruction may remain with Haymarket Media Group and, if so, details will be passed electronically to my bank/building society.

Signature(s): \_\_\_\_\_

Date: \_\_\_\_\_

This offer is open to UK residents only. If you require any assistance following the purchase of your subscription, then you can speak to a member of our customer service team on 0333 777 3309, calls are charged at local rate. Overseas rates are available on +44 (0) 179592 972. Please allow 35 days for delivery of your gift and first issue. The gift will be sent under separate cover from the magazine. Should we run out of gifts, you may be offered an alternative gift – there is no cash alternative. To activate your Autosport online account visit <https://secure.autosport.com/subs/activate.php> and enter your activation code (your personal magazine subscriber number which will be included in your welcome email/letter) along with your email address to access your extra Autosport content. Direct Debit rates are valid for one year after which they are subject to change – should prices change we will inform you in writing. We ask that you enter into a Direct Debit agreement with the intention that your subscription will continue for a minimum period of 12 months, even if the frequency of payment is for a shorter period, however, you will still have the right to cancel your Direct Debit in accordance with Direct Debit Guarantee. Should you wish to cancel your subscription it will be cancelled on expiry of the current term which will not be refundable, other than in exceptional circumstances. If a gift is included as part of the subscription offer we reserve the right to request the return of the gift. Details of the Direct Debit Guarantee are available on request. Savings are based on the standard UK cover price of £3.60. Offer ends June 5 2014. Haymarket Media Group Ltd uses a best-practice layered Privacy Policy to provide you with details about how we would like to use your personal information. To read the full privacy policy please visit our website [www.haymarket.com/privacy](http://www.haymarket.com/privacy) or call us on 08448 482 800. Please ask if you have any questions as submitting your personal information indicates your consent, for the time being, that we and our partners may contact you about products and services that will be of interest to you via post, phone, e-mail and SMS. You can opt-out at ANY time by emailing the [datacontroller@haymarket.com](mailto:datacontroller@haymarket.com) or by calling 08448 482 800.

**Please return this form to:**  
**AUTOSPORT**  
**FREEPOST RBSU-TALE-BXJT**  
**PO Box 326**  
**Sittingbourne ME9 8FA**

Mercedes has tried  
to solve its problems  
on the soft rubber



XPB/LAT

56

# Can Mercedes bounce back?

The Three-Pointed Star had a difficult 2013 in the DTM, but things are looking better ahead of this weekend's season opener at Hockenheim. **ANDREW VAN LEEUWEN** finds out why

**B**eing in the dark is no fun in motor racing. There are few things as frustrating for drivers and engineers as being off the pace and having absolutely no idea why. Being slow is bad enough, but not knowing where to even start fixing the problem makes it a whole lot worse.

In that respect, Mercedes is in a decent position heading into the new DTM season. Sure, 2013 was hardly a classic year for the Three-Pointed Star in Germany's premier touring car class: Mercedes took just two wins and finished third, otherwise known as last, in the manufacturers' standings – by some margin.

But the good news is that Mercedes isn't in the dark. With the new season approaching, an opportunity for it to make amends for a disappointing 2013, the Stuttgart crew is confident that a lot of last year's form was down to a lack of speed on the option tyre, particularly over a long stint. That's been a focus during pre-season testing, and it's got the drivers making some positive noises.

"Last year we struggled with the option," admits HWA driver Gary Paffett. "We were actually very strong on the prime tyre, and we won races because of our performance on the hard tyre last year, but our strategy was limited."

That lack of soft-tyre speed certainly hurt Mercedes last season. With Audi able to piece

together longer, faster stints on the option, it was always going to be hard to keep up.

But things are different in 2014. Not only has Mercedes had a decent chance to identify and improve its issue with the option tyre, double stints on the softer rubber will be a thing of the past thanks to the new sporting regulations that limit its use to just 50 per cent of the race.

"Obviously this year, it's better for us," Paffett says. "Firstly, we've improved our performance on the option; the long runs we did in Hungary [testing] were very strong and very consistent."

"And Audi last year were running races on the option. Ultimately, the tyre didn't work as it

should have done. The option tyre was supposed to be a soft tyre that was quick and then wore out quickly. But Audi were using it for the whole race last year, pretty much. They can't do that this year, because they can only use it for half the race. So I think that will even things up a little bit."

Another regulation change that could work in Mercedes' favour is the reduction of compulsory pitstops from two to one. According to Paffett's HWA team-mate Robert Wickens, confidence in prime tyre pace could be very useful – particularly if a driver is willing to start the race on the harder rubber.

"Basically, if there are battles going on in front

**"We have worked hard to keep our strengths and improve our weaknesses. I think we are looking strong"**

ROBERT WICKENS



Wickens is confident  
improvements have  
been made for 2014

XPB/LAT



Paffett didn't do enough of this last season

# FORMER CHAMPION RETURNS AFTER HIS F1 JOURNEY



Di Resta has high hopes



F1 refugee Vitaly Petrov has joined Mercedes

XPB/LAT

of you and you can cling on to the back of the pack on the harder tyre, it's not a bad strategy for the start," Wickens says. "Then, with less fuel you can really take advantage of the option to the end."

"At the end of the day, the same philosophy stands, where you want as many clear laps as possible on your option tyre. That's still going to be a factor."

Of course, the regulation changes alone won't be enough to help Mercedes get back on top, but they will help in the fight to get on terms with BMW and Audi. Combine that with the reinforcement of the C-class coupe's strength, pace on the harder compound

Hankooks, and 2014 has the potential to be a much better year for Mercedes.

"We took our strong areas and have worked to keep them strong, and we took our weak areas, or what we perceived to be our weak areas, and we've worked on them," adds Wickens. "I think Mercedes is looking pretty strong."

Paffett adds: "We want to be competitive, and we want to be winning races. Obviously we don't want to be the second or third best car all the time, so we're working very hard to try to get ourselves on top. I feel we have a very strong team, the team of drivers we have is very, very good. I think we can have a strong season."



Mercedes has improved its driver line-up

Paul di Resta is back in the DTM. And he's not planning on taking time getting back up to speed.

The Scot returns to the HWA Mercedes fold for the 2014 season after a three-year stint racing in Formula 1 with Force India, and with him comes a decent boost to the experience of Mercedes' relatively young line-up.

After all, di Resta is a proven quantity in the DTM. He was the last man to win a title in a Mercedes, and despite the obvious differences between an F1 car and touring car, he's planning on being in the mix to add a second title in 2014.

In other words, there's no room for 'settling in' time. Di Resta has set a clear deadline as to when he wants to be back to 100 per cent in the DTM...

"By qualifying at Hockenheim," he says. "I left the series as a champion, so I'd like to think I can come back and be in a similar position as I left. I had four very competitive years in the DTM, and although it's a new generation of car, I think the ultimate style should be the same."

"It's taking some time. It's showing to be difficult to come back. But that's why we have testing, to prepare for Hockenheim. When we get to the first race, where everything is the same, we'll find out. Slowly, but surely, I'm learning a lot about the car, and I would like to think that I'll get to a competitive level."

Given that no other Mercedes driver has been able to win a title since he did in 2010, di Resta is under no illusions when it comes to knowing that improvements are needed for 2014.

"Last year Mercedes certainly needed to move on in terms of development and speed. We've had a very strong winter behind us, and until we get to Hockenheim we won't know, but I think everybody has the same goal in mind, and we as a manufacturer need to be back at the front, winning races, and putting in the effort."

"If we need to do more work, I think we're all within our capabilities of achieving it"

DI RESTA IN THE DTM

42	STARTS	6	WINS
219	POINTS		

21 PODIUMS

SERIES FINISHES	
2007	5TH
2008	2ND
2009	3RD
2010	1ST



# ROCKY II

## THE CHAMPION'S DEFENCE

**Audi's Mike Rockenfeller took the DTM title last year, but the game has changed in 2014.**

**ANDREW VAN LEEUWEN asks what it means for his chances of repeating that success**

**W**inning back-to-back titles is a little tricky in the DTM. In the last 14 years of the 'new' era, it's only been done twice, by Bernd Schneider in 2000-01, and Timo Scheider in 2008-09. With the margins so small, the cars so even and the overall level of driver professionalism so high, making lightning strike twice is a tough job.

That's the challenge facing Mike Rockenfeller this season. The reigning champion has a title to defend, and he knows it won't be easy.

The Phoenix Audi squad has been dealt a bit of a blow in terms of the new sporting regulations for 2014. Consistency on the option tyre, strategic nous and efficiently arriving at a race-friendly set-up were all keys to success last year, but the game has changed.

For example, being able to nail a set-up played a big part in Rockenfeller's title tilt last season, but it was more about finding a set-up that would work for Sunday, not for Saturday. He and the Phoenix team worked to the theory that having a car capable of a long stint on the softer tyres was much more

important than a good starting position, and it proved to be the case.

Yes, Rockenfeller's two wins last season did come from pole, but it was turning double-digit grid spots into solid points hauls – as he did at Spielberg, Norisring and the Nurburgring – that played a huge part in winning the title.

But that theory may well not work in 2014. Just one mandatory stop, and a 50 per cent race distance limit on the softer Hankooks, will take an element of strategy out of the game. And turning bad starting spots into top-five finishes will be a lot tougher. Qualifying will be significantly more important.

The upside to it all is that the new regulations will only penalise Rockenfeller and Phoenix if they

Rockenfeller's focus on a race set-up paid dividends last year



XPB/LAT

go into the new season trying to pull the same tricks as in 2013. And there seems to be little danger of that, with 'Rocky' already working on a new plan to defend his title.

"Qualifying will be a bit more important than last year because of the race format," Rockenfeller confirms. "So, last year, you could play a lot with the strategy. You could really use the advantage of the option tyre to its best. Now, you can only use it for 50 per cent of the race, and therefore there will be less chances of overtaking.

"This will make how you go into the weekend different. Last year, from P15, you could still finish on the podium."

Of course, that doesn't make that ability to quickly hone in on a suitable set-up during practice any less important. It will just be that the set-up they will be chasing will be different.

"The qualifying session itself will be the same. You always try your best," says Rockenfeller. "But let's say the focus on the set-up will be interesting, because of the parc ferme. You can't change your car [on Saturday night], so whatever you have for qualifying, you have for the race.

"Before, you could choose to focus on setting the car up for a long run on the option tyre, and sacrifice a bit of performance in qualifying. Now I think we'll be working the other way around."

So there seems to be a plan in place: nail that qualifying set-up, start near the front, and let a good stint on the softer tyres, one of Audi's great strengths, do the rest.

But there's one other factor to consider – the driver. Is Rockenfeller feeling the pressure of being the reigning champion heading into this season?

"To be honest, it takes some pressure off," he says, matter-of-factly. "Last year, I finally won the championship. I fulfilled the goal I've always had. This took some weight off my shoulders, for sure.

"Now, I can go into the season like any other season, except that I'm not running after something. It's the same goal – if the car's quick enough I want to win the championship, if it's not quick enough I want to be the best Audi. That's been my goal ever since I got the chance in a new car; with the old car it was different.

"Anyway, this is the goal. And having the #1 on the car doesn't really help me, it's just the fact that I won. Yeah, it's cool to have it on the car because it means I achieved something, but it doesn't make a huge difference."

It's not going to be an easy year for Rockenfeller, Phoenix and Audi. The BMWs were quick last year, something that is unlikely to have changed over the winter despite the marque's switch to the new M4, and Mercedes will be out for revenge after a disappointing 2013.

Despite having even the statistics against him, Rockenfeller is very clear about his expectations for his title defence: "As the defending champion, it would be quite odd to not have the goal of winning the championship." ❧

# SIX DRIVERS ROCKY HAS TO BEAT...

## Mattias Ekström

Abt Audi  
**CAREER WINS 17**  
**2013 CHAMPIONSHIP POSITION 7th**  
 A somewhat predictable choice, but hard to go past given that Ekström was Audi's second-best driver in the points last season. Will need to qualify a little better this season, though.



## Bruno Spengler

Schnitzer BMW  
**CAREER WINS 14**  
**2013 CHAMPIONSHIP POSITION 3rd**  
 Always supremely quick in qualifying, and that could be a decisive factor with the new sporting regulations. Every chance the 2012 champion will be a title contender again for BMW.

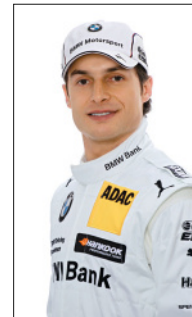

## Augusto Farfus

RBM BMW  
**CAREER WINS 4**  
**2013 CHAMPIONSHIP POSITION 2nd**  
 The Brazilian won three races last season, more than anyone else, so he has to be on this list. If he can score more consistently than he did in 2013, Farfus could well be in the hunt.

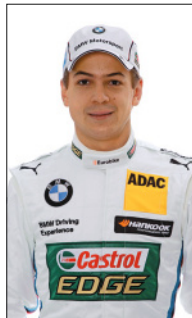

## Timo Scheider

Phoenix Audi  
**CAREER WINS 6**  
**2013 CHAMPIONSHIP POSITION 10th**  
 Scheider has been moved over to Phoenix, so he will be Rockenfeller's direct team-mate this season. The guy knows how to win the title – he's done it twice – so the intra-team battle could be a beauty.

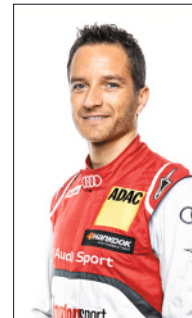

## Gary Paffett

HWA Mercedes  
**CAREER WINS 19**  
**2013 CHAMPIONSHIP POSITION 6th**  
 Paffett starts every season as a genuine title contender. He's experienced, he's quick, and if the Mercedes is up to it, he'll be right up there as he bids to replicate his 2005 success.



## Robert Wickens

HWA Mercedes  
**CAREER WINS 1**  
**2013 CHAMPIONSHIP POSITION 5th**  
 It was a tough call between Wickens and Paul di Resta on this list, but the Canadian makes it based purely on his breakthrough 2013 season. He's hungry to score more wins.



## NEW TECH REGULATIONS

- The option tyre must be used, but cannot be used for more than 50 per cent of the race distance. A six-lap grace period will be allowed if the safety car happens to be out when the race reaches exactly half-distance.
- Drivers will now only have to complete one mandatory pitstop (reduced from two). The stop can't be made in the first third of the race, or behind the safety car.
- Qualifying will now be contested over three parts (reduced from four). The bottom five will be eliminated in Q1. Q2 will determine grid positions nine through 18, while Q3 will give the last eight drivers a shot at pole.
- DRS can now be used right up until the end of the race, rather than being disabled for the last three laps.
- The winning driver, as well as any other drivers in the top 10 from the same manufacturer, will carry 5kg of performance ballast in the next race. Any drivers from the winning manufacturer outside the top 10 will carry just 2.5kg of extra weight.
- Conversely, drivers from the third best-placed manufacturer in a race will be able to remove 2.5kg of ballast for the next event if they finish inside the top 10, or 5kg of ballast if they finish outside the top 10.



DRS can now be used to the end

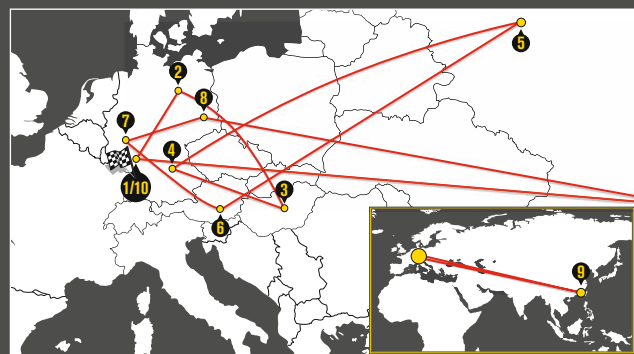

## DTM SEASON 2014

RD	DATE	LOCATION
1	May 4	Hockenheim (D)
2	May 18	Oschersleben (D)
3	June 1	Hungaroring (H)
4	June 29	Norising (D)
5	July 13	Moscow Raceway (RUS)
6	August 3	Spielberg (A)
7	August 17	Nurburgring (D)
8	September 14	Lausitzring (D)
9	September 28	Guangzhou (PRC)
10	October 19	Hockenheim (D)

# AUTOSPORT WORLD RX OF GREAT BRITAIN



**AUTOSPORT**

LYDDEN HILL, CANTERBURY, KENT

**24 MAY - 25 MAY 2014**  
SPRING BANK HOLIDAY WEEKEND



**RX FIA WORLD RALLYCROSS CHAMPIONSHIP**

**RALLYCROSSRX.COM**



**TICKET HOTLINE: 0844 858 8518**  
(CALLS COST 6P PER MINUTE PLUS NETWORK EXTRAS)  
**BOOK ONLINE: LYDDENHILL.CO.UK**

**SAVE UP TO 20% BY BOOKING YOUR TICKETS IN ADVANCE:**  
SATURDAY £20 SUNDAY £25 WEEKEND £40 (BOOKING FEE APPLIES)  
GRANDSTAND SEATS PLUS VIP HOSPITALITY PACKAGES AVAILABLE

**KIDS GO FREE**



# Gary Paffett

## The Inside Line



On the eve of his 11th DTM season, the 2005 champion revels in the close competition in the tin-top series

Over the last few weeks a lot of people have asked me who the championship favourite is in the DTM this year, and the incredible thing about this series is that there isn't one! There are so many drivers on the grid who can win races and championships, and that makes this time of year very exciting.

Since the regulations regarding the cars were changed for the 2012 season and BMW came back in, the competition has been closer than it's ever been. And the level of driver is very, very high. I really believe the depth of talent is better than anywhere else in the world. I don't even think Formula 1 can say it has as many good drivers. Obviously F1 has some of the top drivers in the world at the front, but I think across the whole field the DTM is stronger than any other series. That makes it so difficult today. You don't have the comfort of being a few tenths off the pace and still being able to finish in the top six – you're in the back half of the field now.

A lot of drivers are seeing the DTM as a great place to be racing and earning money, and I think the mix of experienced winners and young guys coming in is making it a great series. When I won the championship in 2005 I don't think the depth in the field was as strong, even if the level at the front was very high.

It's frustrating that I've only won one championship so far, but on the other hand I've got to be proud of



veteran but still proving I can beat everyone else is something I'm happy to be doing.

We have a good group of guys at Mercedes, and of course this year we have Paul di Resta back after three seasons in F1. Things are a bit different from when Paul was with us before. He's a great asset to the team, and he's won the DTM championship. You can tell he has learned a lot from his time in F1, but because I've stayed in the DTM while he was with Force India, he's

**“Across the whole field, the DTM is stronger than any other series. That makes it so difficult to win”**

what I've achieved. I've won more races than any other driver on the grid at the moment, and I've fought for championships in five of my 10 seasons. It's been a long time, but it's not been down to poor performances on my side. I've worked very hard and I feel I'm a better driver than when I won the title.

I feel like a veteran in the DTM now, but that's a good feeling. I remember when I used to go testing for Mercedes when I was younger, it was always a bit stressful. There would be high expectations – from me – to do a good job and it was a little bit uncomfortable at times. Now I'm more experienced and I know it's just part of the job. You know what you've got to do to get the most out of the car, to develop things in the right direction, and I've been around the people at Mercedes for a long time which makes things easier.

I like helping the younger guys, I feel I'm quite good at giving advice; and while they're not beating me they can have as much help as they like! Being the

asking a few more questions than he would have in the past. There are a lot of things he has to relearn.

He's definitely on the pace, but whether he can get that ultimate last bit of speed out of the car to take pole and win races right now, I don't know. That's only natural, and I think Paul would probably admit that he's got a little bit more to find before he's fully up to speed again.

Paul coming back is a sign that the DTM is a series that's growing. People aren't as aware of it as they should be, unfortunately, but I think the future is looking very good. There's the tie-up with Super GT in Japan, and hopefully something in America would be incredible, but obviously that's still a few years off.

Right now we're days away from the start of the 2014 season after a long winter, and I'm excited about going racing again. This is the thing I love doing, and I don't think the anticipation is any less than when I was one of the new kids on the block 10 years ago. ☺

# SENNA FEATURE



# Chater's

Motoring Booksellers

126 Murrell Green Business Park  
Hook, Hampshire, RG27 9GR

Tel 01256 765443 | Fax 01256 767992

Email [Books@chaters.co.uk](mailto:Books@chaters.co.uk)

Showroom open daily Monday to Friday  
9am ~ 5.30pm

Probably the Worlds LARGEST Selection of Motoring Books & DVD's

[www.chaters.co.uk](http://www.chaters.co.uk)



Welcome to  
**F1 COLLECTORS .COM**



#1 FOR F1 MEMORABILIA & AUTOGRAPHS  
We buy and sell F1 items  
**AYRTON SENNA** specialists  
Call CHRIS GRINT  
**01763 274448**  
email:- [sales@f1collectors.com](mailto:sales@f1collectors.com)



Coming up next month, look out  
for our new Fanzone feature.

Call Katy Snowball on  
**020 8267 5367** to advertise here.

SENNA FEATURE



# Motorsport Artwork





21.03.1961  
01.05.1994

[www.motorsportartwork.com](http://www.motorsportartwork.com)

# SENNA FEATURE

THE **MOTORSPORT** SHOP



## ORIGINAL AYRTON SENNA NACIONAL CAP Worldwide Senna Specialists

Letter of Authenticity provided as a former licensee.  
Tag insert reveals Ayrton Senna Foundation label.  
The Motorsport Shop Australia was the first of this model to Authenticate the Cap with ASFL.  
First sold 1994 Australian Grand Prix.  
Visit our eBay store **ThemotorsportShop**

13 Connells Point Road, South Hurstville, NSW 2221  
PH +612 9546 2654 • email: [patrick@gpshop.net](mailto:patrick@gpshop.net)  
Website: [www.gpshop.net](http://www.gpshop.net) • Website: [www.motogp.net.au](http://www.motogp.net.au)

**FINALLAP**

Revealed:  
The history of  
Formula One

Senna Rindt Prost  
Villeneuve Mansell  
Pittipaldi Hill Hawthorn  
Piquet Clark  
Hamilton Ascari  
Taruffi Button

FI Collectables • Team Memorabilia • Clothing  
Buy • Sell • Evaluations  
One of Europe's largest collections  
+44 (0)1245 287588 • +44(0) 7771 920345 • [sales@finallap.net](mailto:sales@finallap.net)  
[www.finallap.net](http://www.finallap.net) **FINALLAP**  
For Everything Formula 1

### Genuine Senna Memorabilia

# PRODUCT SHOWCASE

**Autotel Digital Race Radio**

Drivers Helmet kits & Custom Earpieces for all types of system

Team Radio Solutions Sales & Rental

[www.raceradio.co.uk](http://www.raceradio.co.uk)

Tel:+44(0)1508 528837- [sales@autotel.co.uk](mailto:sales@autotel.co.uk)

**ATLL**  
AERO TEC LABORATORIES LTD

**CLOSED LOOP REFUELLING BOWSER**  
SAFE, FAST, CLEAN REFUELLING

**ZERO VAPOUR**  
WITH INTEGRATED SAFETY FEATURES

FOR MORE INFO, PLEASE CONTACT:  
**ATLL LTD.COM**  
[sales@ATLLTD.com](mailto:sales@ATLLTD.com) +44(0)1908 351700

**CARTEK** **NEW**  
MOTORSPORT ELECTRONICS  
**Wireless Steering Wheel Pushbutton Controls**

CARTEK now offer a quick and easy solution to installing 8 pushbutton controls to detachable racing steering wheels.

This wireless system is fully configurable incorporating momentary, latching and flashing functions for uses such as: radio, pit limiter, dash, lights, wipers, etc...

£499 +vat

[www.CARTEKMOTORSPORT.com](http://www.CARTEKMOTORSPORT.com)  
Battery Isolators, FIA Rain Lights, PDMs, Shift Lights...  
Available from: Demon Tweaks, Competition Supplies, Powervamp, Rallynuts, Pandamonium, Interex ....

# WEB DIRECTORY

## CAR BROKERAGE

**RACING CARS FOR SALE**  
ALAN CORNOCK FCS  
BUYING - SELLING - BROKERAGE  
[www.racingcarsforsale.co.uk](http://www.racingcarsforsale.co.uk)  
TEL: 01480 891212

## ENGINES

**JULIAN GODFREY**  
**ENGINEERING**  
visit our new online shop [www.racetuners.com](http://www.racetuners.com)

## EXHAUSTS

Inconel & Stainless Steel Specialists  
**SIMPSON**  
Race Exhausts  
Tel: 01753 532222  
[www.simpsonraceexhausts.com](http://www.simpsonraceexhausts.com)

## GEARBOXES

**Gearboxman.com**  
COMPETITION TRANSMISSION SERVICES  
Gearboxes & Axles for Road, Race, Rally and more  
Telephone: 01582 840008 Fax: 01582 840007

## HELMET GRAPHICS

**Mike Fairholme Designs**  
Sole approved painter of Arai helmets.  
Silver Birches, Corby Birkholme, Nr Grantham, Lincs NG33 4LE.  
Tel: 01476 550630, Fax: 01476 550029.  
email: fairholmedesigns@btconnect.com  
[www.fairholmedesigns.co.uk](http://www.fairholmedesigns.co.uk)

## MEMORABILIA

**FINAL LAP**  
For Everything Formula One  
[www.finallap.net](http://www.finallap.net) **WE BUY AND SELL**  
+44 (0) 1245 287588 / 07771 920345

## MERCHANDISE

**GRANDPRIXGRAPHICS**  
SPECIALISTS IN MOTORSPORT GRAPHICS  
RACE CARS, SUPPORT VEHICLES,  
F1 TYPE BOTTLES, SIGNS.  
07902061423 or 01992 666913  
[www.grandprixgraphics.co.uk](http://www.grandprixgraphics.co.uk)

## MODELS

**www.Diecast**  
**race models.com**  
Specialists in 1:2 Scale Replica F1 Helmets

## RACE PARTS

**ARE DRY SUMP SYSTEMS**  
ARMSTRONG RACE ENGINEERING INC.  
[WWW.DRYSUMP.COM](http://WWW.DRYSUMP.COM) (916) 652-5282

## RACE PARTS

**MARDI GRAS MOTORSPORT**  
[www.mardigras.co.uk](http://www.mardigras.co.uk)

## RACE PRODUCTS

**PORSCHESHOP**  
10% off with website  
voucher code AUTOTEN  
Or Call: 0121 585 6088

**msar** LONDON  
MOTORSPORT SHOWROOM  
[WWW.MSAR.CO.UK](http://WWW.MSAR.CO.UK)

## RACE PRODUCTS

**PIPER**  
[www.pipercams.co.uk](http://www.pipercams.co.uk)

**JJC) race and rally**  
PASSIONATE ABOUT MOTORSPORT  
[www.jjcraceandrally.com](http://www.jjcraceandrally.com)

## RACE RADIO

**Pit to Car Autotel**  
Radio solutions **Digital Race Radio**  
0044(0)1508 528837  
[www.raceradio.co.uk](http://www.raceradio.co.uk)

## RACEWEAR

**demon tweeks**  
MOTORSPORT Direct  
[www.demon-tweeks.co.uk](http://www.demon-tweeks.co.uk)

**Grand Prix Racewear** THE RACEWEAR EMPORIUM  
[WWW.GPRDIRECT.COM](http://WWW.GPRDIRECT.COM)  
08435 070 858  
sparco, uvex, OMP, Arai, BELL, SCHROTH, HANS-SEPT

AUTHORISED DISTRIBUTOR  
**OMP** **YBRACING**  
MOTORSPORT & PERFORMANCE  
[WWW.YBRACING.COM](http://WWW.YBRACING.COM)

## RACEWEAR

**CROYDON RACE & RALLY CENTRE**  
[www.croydonraceandrally.co.uk](http://www.croydonraceandrally.co.uk)  
220-222 Portland Road  
South Norwood  
London SE25 4QB  
FORECOURT PARKING  
For Racewear & Motorsport equipment  
Tel: 020 8656 7031

## RACING OIL

OLD HALL PERFORMANCE LTD T: 02476 717 100  
**RED LINE** SYNTHETIC OIL  
sales@redlineoil-europe.com [www.redlineoil-europe.com](http://www.redlineoil-europe.com)

## THROTTLE & DRY SUMP SYSTEMS

**at power**  
[www.atpower.co.uk](http://www.atpower.co.uk)  
+44 (0)1953 857800

## TRAILERS & TRANSPORTERS

**BRIAN JAMES TRAILERS**  
» Connected to you  
[www.brianjames.co.uk](http://www.brianjames.co.uk)

**PRG TRAILERS**  
[www.prgtrailers.co.uk](http://www.prgtrailers.co.uk)  
Phone no: +44 (0) 1270 812402

## WHEELS

**Image** Manufacturers of bespoke split rim alloy wheels  
[www.imagewheels.co.uk](http://www.imagewheels.co.uk)  
IMAGE WHEELS INTERNATIONAL LTD.

**BRIAN JAMES TRAILERS**

»» Connected to you



[www.brianjames.co.uk](http://www.brianjames.co.uk)

## Next generation

Acknowledged class leaders, the latest Race Transporter models feature advanced aluminium and lightweight composite construction.

Continuing a long history with many illustrious race teams over the years, Brian James Trailers are proudly transporting the Generation Bentley GT3 Racing Team taking part in the 2014 British GT Championship.

Main photograph, Race Transporter 6 with 12v electric winch and radio control system, double assistor ramps, central storage tray with aluminium lids and 'style B1' Alloy wheels.

Race Transporter range from £ 7,099 (excl. VAT).



**T +44 (0)1327 308 833**

For more information and details of your local BJT dealer please call or visit our website.

**RACE TRANSPORTER**

# TRAILERS & TRANSPORTERS



## HOSPITALITY UNIT ... FOR SALE ...

- Articulated Unit, currently white, with low mileage Renault Premium truck 16mtr total length.
- Commercial kitchen, central office, rear horseshoe lounge. Main 5 mtr awning and secondary 4 mtr.
- In built generator. Tables, chairs, flooring included.

Price **£35,000** ono.

For further details;

Email: [studispire@hotmail.com](mailto:studispire@hotmail.com)  
or call: **44 7768 256524**

**PRG TRAILERS**

*Finest Built British Trailers.*



PRG Trailers | Cheshire | UK | Tel: +44 (0) 1270812402  
Web: [www.prgtrailers.co.uk](http://www.prgtrailers.co.uk) | Email: [info@prgtrailers.co.uk](mailto:info@prgtrailers.co.uk)



# Rentamericanmotorhomes.com

[info@rentamericanmotorhomes.com](mailto:info@rentamericanmotorhomes.com)

07827 929613 / 07780220577

## MOTORSPORT HIRE

At [Rentamericanmotorhomes.com](http://Rentamericanmotorhomes.com) we pride ourselves on being the UK's premier supplier for **American RV's** to the **Motorsport Industry**. We are now taking bookings for **Le Mans**, **British GP** & many more major events. **Discounts** on season hires.



# WOODFORD TRAILERS

[www.WOODFORDTRAILERS.com](http://www.WOODFORDTRAILERS.com)  
HIGH QUALITY TRAILERS FOR CLUB, PRIVATE AND PRO MOTORSPORTS



Email: [sales@woodfordtrailers.com](mailto:sales@woodfordtrailers.com)

CALL US NOW **01327 263 384**



**HOPKINS**  
MOTORSPORT

☎ 0117 950 9294

**ORDERS NOW**

BEING TAKEN FOR **2015** DELIVERY  
POP UP ROOF & HYDRAULIC SLIDE OUT  
VEHICLES TO ANY SPECIFICATION

**Europe's Largest Motorhome-Office-Hospitality Vehicle**



**ULTIMATE IN LUXURY**

**BUILT TO IMPRESS**

Everybody in motorsport has different requirements, be it mobile garages, living, offices or hospitality or a combination; Hopkins Motorsport will build your vision - however radical!

A revolutionary design with 1,100 sqft of living space incorporating 4 slide out pods, a hydraulic pop up roof to achieve three levels with 2.1metre of headroom in each level and still be able to travel legally throughout Europe. Once at a venue this vehicle can be easily set up by one person in under an hour!

This extraordinary vehicle will accommodate eight people in homelike comfort and luxury.

[www.hopkinsmotorsport.com](http://www.hopkinsmotorsport.com)

**THE RACE TRANSPORTER SPECIALISTS**

NEW & USED SALES :: RENTAL :: REFURBISHMENT

# RACE & RALLY CARS

## SUPERSPEED ANGLIA GROUP 2 RACE CAR



**£32,500** (half the build cost).

For full spec and photos

Max Rostron **07568 058286** or  
email [zena.rostron@btinternet.com](mailto:zena.rostron@btinternet.com)

Built four years ago to the highest possible standard replicating period specification.

Complete with FIA HTP Papers it is eligible for any historic race series worldwide including Goodwood Revival, Masters, U2TC and HSCC. Successfully raced in the masters series in the UK.

Absolutely immaculate condition and ready to go and race anywhere tomorrow.

Spares package including spare wheels with slicks for hill climb competition. Very affordable way to go historic racing with a non depreciating asset.



## 2002 3.21 Porsche Boxster S

Fully race ready / recently built, ready to enter porsche championship

- Full engine rebuild / race ready at cost of over £9,000, no expense spared
- New clutch, brake pads / disks etc.
- 2 brand new sets of wheels and tyres.
- McLaren engine oil.
- 'Li feline' fire extinguisher system and autoelec system.
- 'Recaro' racing seat with 'Schroth' 3 point safety harness.
- 'Custom Cages' roll cage.
- Carbon fiber internal door panels, floor and dashboard
- 'Vidbox' camera /recording system (optional).

can be used for Trackdays, BRSCC Porsche championship, Britcar, GT cup, Modern Classics, 750 motor club

Less than 30mins test from new build, beat the lap record at Donnington.

**£25,000** ono Contact Kevin - tel - **07973 675 734** email - [kevin@ruffordhall.com](mailto:kevin@ruffordhall.com)

## 1973 GRD F 3



1600 Lotus Twin Cam with mech. petrol injection, sliding throttle. Excellent condition, 2 set of wheels, additional smaller wing. Eligible for Monaco Historic Grand Prix. FIA Historic Technical Passport with the car.

**Contact: JFTAB@T-online.de**

# MARKETPLACE

### CAR TYRES

FOR ALL YOUR  
**AVON TYRES**  
**MOTORSPORT**  
RACING TYRES  
Inc. ACB 10 Formula Ford  
Contact

### BMTR LTD

Tel: 0121 331 1122  
Fax: 0121 331 1144  
email: [sales@bmtr.co.uk](mailto:sales@bmtr.co.uk)  
see our new website at [www.bmtr.co.uk](http://www.bmtr.co.uk)

### MEMORABILIA

F1 COLLECTORS .COM



**#1 FOR F1 MEMORABILIA & AUTOGRAPHS**

We buy and sell F1 items  
**AYRTON SENNA specialists**

Call CHRIS GRINT

**01763 274448**

email:- [sales@f1collectors.com](mailto:sales@f1collectors.com)

### HOSPITALITY



**SILVERSTONE HOSPITALITY**  
suites available

Speedsport have two Woodcote/Paddock hospitality suites available for most 2014 meetings.

We can provide full catering package at the major meetings, including British Grand Prix, BTCC and Moto GP, or an 'economy' package including tickets, use of suite, tea and coffee all day at all other meetings including British GTs, Silverstone Classic, HSCC etc. with prices from only £25 pp.

Please call or email for further details.  
01327 858167 | [info@speedsport.co.uk](mailto:info@speedsport.co.uk)  
[www.speedsport.co.uk](http://www.speedsport.co.uk)

### RACE PRODUCTS

**demon tweeks** **NEW 2014**  
**MOTORSPORT Direct** **CATALOGUE**

508 pages of the best motorsport parts, accessories and innovative new products.

TEL **0906 250 1516** [www.demon-tweeks.co.uk](http://www.demon-tweeks.co.uk)  
Calls to 0906 numbers cost 50p per minute at all times. (Calls should last no longer than 11/2 minutes).

OR TEXT CODE MSAS TO 84010 WITH YOUR NAME, ADDRESS, POSTCODE If you do not wish us to contact you by mail or text with any information, promotion or special offers we may have in the future, insert X at the end of your message. Brochure requests via SMS are charged at £1.50 per message sent. Calls to 0906 numbers cost 50p per minute at all times. (Calls should last no longer than 11/2 minutes).



## AUTOSPORT

IF YOU'D LIKE TO  
ADVERTISE YOUR  
PRODUCTS AND  
SERVICES IN THE  
MARKETPLACE CALL:

**0208 267 5865**

# MARKETPLACE

## GEARBOXES

**Hewland Series 5, Formula 3 Gears.  
1 1/8 Layshaft**

18/34 - 19/24 - 24/26 - 24/28 - 18/32 - 22/28 -  
21/31 - 16/24 - 16/35 - 16/24 - 21/28

£60 each +VAT (All Good)

12/31 Mk 9, First Gear (5 Speed)

£60 +VAT

**Woodcote Racing, Silverstone**  
**Phone: 01327 858074**  
**Fax: 01327 858235**

## MEMORABILIA

**FERRARI V12 ENGINE**  
COFFEE TABLE



£3500

Free delivery worldwide

[enginecoffees.com](http://enginecoffees.com)

## RACE PRODUCTS

### Elite Carbon Fibre

Carbon fibre race car component manufacturer

EliteCarbonFibre Ltd.  
Units 20-22 Norwich Road Ind. Est.  
Watton, Thetford, Norfolk IP25 6DR

Contact – Dave Greenwood 07809390316  
Email – [davecarbonelite@googlemail.com](mailto:davecarbonelite@googlemail.com)  
Website – [elitecarbonfibre.co.uk](http://elitecarbonfibre.co.uk)



**Carbon Composite Wings, Bodywork & Repairs**

## FLOORING



**Robust interlocking  
floor tiles**  
**No messy adhesives**  
**DIY or Installation  
service available**  
**Call 01676 523386**  
**for your no obligation  
quotation**

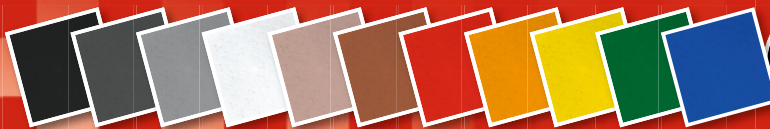

CHOICE  
OF 11  
ATTRACTIVE  
COLOURS

**DYNOTILE**

Turn your garage into a showroom.

Typical 20ft x 17ft garage supplied and installed with skirting for less than £1500.00.  
Installation service not available in all areas of the UK - contact Dynotile for details.

**WWW.DYNOTILE.CO.UK**

# MARKETPLACE

## EQUIPMENT



### MARDI GRAS MOTORSPORT

Saloon Car Preparation

Unit 45, Silverstone Circuit  
Towcester  
Northampton NN12 8GZ

tel: 01327 858006 fax: 01327 858800  
email: info@mardigras.co.uk  
web: www.performanceclutch.co.uk

#### Distributors and agents for:



**FIRE SERVICES**  
Extinguisher Refills on Site



## RACE PRODUCTS



Walkers Garage Ltd.  
Northallerton DL7 9HT  
0044(0)1609 777221  
www.walkersgarage.co.uk  
www.teknofibra-racing.co.uk  
www.walkers-radiators.co.uk  
www.tecno2.co.uk  
www.energa-batteries.co.uk

Heat resistant material  
to 1000 °C

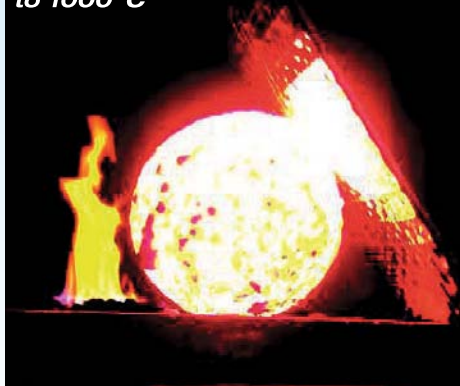

**Bespoke radiator manufacture**



**Up to 5 years life expectancy**

360 cranking amps – 1.28 kg.  
600 Cranking amps – 2.25 kg.

- Importers & Manufacturers
- Teknofibra heat resistant materials
- Lightweight Lithium Batteries
- Walkers Competition Radiators
- Tecno2 Performance Products
- Competition wheel studs & nuts



## RACE PRODUCTS

### MOCAL OIL COOLERS

- Winning races since 1967
  - Wide Range of oil coolers and components
  - **British** design and manufacture
- For the best in Oil Cooling systems...  
**make it MOCAL!!**



#### WORLDWIDE ENQUIRIES

visit: [www.mocal.co.uk](http://www.mocal.co.uk)

phone: +44 0208 568 1172

#### USA ENQUIRIES

visit: [www.batinc.net](http://www.batinc.net)

### CARTEK MOTORSPORT ELECTRONICS



#### Innovative products:

- Solid State Battery Isolators
- Power Distribution Modules
- Wireless Steering Wheel Controls
- Coolant Sensors
- FIA Rain Lights
- Shift Lights



[www.CARTEKMOTORSPORT.com](http://www.CARTEKMOTORSPORT.com)  
**CARTEK AUTOMOTIVE ELECTRONICS Ltd**  
44 (0)2380 637600  
[info@cartekmotorsport.com](mailto:info@cartekmotorsport.com)

# MOTORSPORT JOBS



## WE ARE CURRENTLY LOOKING TO RECRUIT THE FOLLOWING POSITIONS WITHIN RED BULL TECHNOLOGY:

HR02081301D – ELECTRICAL SYSTEMS ENGINEER

HR10021401D – ELECTRONICS ENGINEER

HR04111301B – CFD TOOLS ENGINEER

HR25041401 – AERODYNAMICS DESIGN ENGINEER

HR31031401 – STRUCTURES ANALYST

HR17041401 – ANALYST/PROGRAMMER

### To Apply:

For further information on the above roles and details of how to apply for positions at Red Bull Technology and Red Bull Racing, please visit the recruitment page on our website [www.infiniti-redbullracing.com](http://www.infiniti-redbullracing.com).

PLEASE NOTE: No Agencies please.



FEDERATION INTERNATIONALE DE L'AUTOMOBILE

The FIA Technical Department in Geneva is seeking to fill the position of:

### ELECTRONICS ENGINEER

The successful candidate will be in charge of implementing and following up on the monitoring tools used on one or more FIA championships, assisting the officials of the Event, checking compliance with the technical regulations governing the championships, making observations and reports on the running of the Event and the development of the necessary monitoring tools for the different FIA championships.

He or she will also help to achieve the common objectives of the technical department (definition of tools, general procedures, etc.), contribute to cross-disciplinary technical reflection and participate in homologation inspections.

- At least 5 years' experience as an electronics engineer in the field of motor sport is required.
- Native level of English; good knowledge of French.
- Rigorous, autonomous and reactive, the successful candidate is at ease with putting forward proposals, has excellent analytical skills, is diplomatic, and knows how to work as part of a team.
- He/she has to be familiar with monitoring controls in automobile applications and have command of programming languages (C, Simulink, etc.).
- He/she has to be proficient in the use of the data analysis tools commonly used in the motor racing world (Wintax, Atlas, or PI toolbox, etc.).
- This position requires frequent travel.

Please apply by email: [recruitment@fia.com](mailto:recruitment@fia.com)



## CREATING YOUR LEGACY THANKS TO OURS

McLaren Automotive Careers

### WE WANT YOU ON OUR TEAM:

**AERODYNAMICISTS**  
**VEHICLE DYNAMICISTS**  
**CAE PROJECT LEAD**

(ALL GRADES FROM GRADUATE TO SENIOR)

McLaren Automotive has built an unrivalled reputation for technology thanks to the outstanding team behind the name. We strive to continue that success into a new era and we'd love you to share the journey with us. There are now exceptional opportunities available to join our dynamic team.

As a growing company, we are developing new processes, technologies and products. Help us to shape our future with challenging new ideas and boundless enthusiasm.

Join us and be part of the legacy of McLaren Automotive. Evolve your career as together we evolve McLaren.

Send your CV to [rob.legg@mclaren.com](mailto:rob.legg@mclaren.com)



[WWW.McLAREN-JOBS.COM](http://WWW.McLAREN-JOBS.COM)



**DOMINATE THE TRACK. RULE THE STREET.**



IMPERIAL RANGE



METRIC RANGE



TENDER | HELPER



OFF ROAD



COIL SLEEVE



BUMP STOPS

**ERS | Eibach Race Spring System**

- Over 1,300 single components - main and tender springs - metric and imperial, various auxiliary race suspension accessories, ready and in stock on 5 continents
- Comprehensive Program of single components
- Single Main Springs with highest rate-linearity and lowest rate tolerance
- Progressive Characteristics via set-up of different springs serially - double or even triple spring combinations
- Extreme Low Weights achieved through Super Hi-Ten materials and manufacturing technology
- Smallest Solid heights, maximized spring travels and higher maximum loads
- Spring Surface Stabilization through specialized shot peening
- Every ERS Spring preset to block
- Block and Sag Resistant
- Smallest Tolerances and precise plane parallelism of spring ends
- High Dynamic Durability - under Motorsports conditions
- High quality corrosion protection by phosphating and epoxy coating
- Springs Printed with part-number (speaking code = rate and dimensions)
- Individual protective single box packaging



eibach.com

# CLUB AUTOSPORT

NATIONAL RACING • HISTORICS • RALLYCROSS • HILLCLIMB • TRACK TESTS



Pattison (5) will switch to Pyro after tough start

**SCOTT MITCHELL**  
ASSISTANT EDITOR

scott.mitchell@haymarket.com  
@ScottMitchell89



## THIS WEEKEND'S RENAULT CLIO

Cup UK grid looks likely to consist of 11 cars. That's a far cry from recent seasons, but onlookers need not fear for the category's future just yet. If history is anything to go by its low ebb comes early and its peak much later.

Categories like the Clio Cup are naturally dependent on the whim of their respective manufacturer when it comes to what car is used, and as we highlighted in our season preview Renault had no desire to continue with the older-model Clio in Britain. Especially when you consider that the turbocharged machine has picked up a year's racing experience in Europe.

In the past, the introduction of a new car into the UK series means an instant drop in numbers before the grid slowly rebuilds over the course of the next two seasons. By the third year the tin-top category boasts grids of 20-plus cars and all is rosy again.

Yes, the new car is expensive, and I don't doubt JHR boss Steven Hunter for a minute when he complains of finding faults with it – teething problems are almost unavoidable with something new. What's more concerning is the perceived lack of support from Renault's technical arm in France – though those managing the series in this country are adamant that the on-site services at Brands Hatch and Donington provided everything the teams needed.

JHR has not severed its ties with Renault for all eternity. When Hunter is satisfied that his issues with the series are solved, his team may well return. And his decision to withdraw the team is very much a warning, rather than a death knell. It would be ludicrous to suggest that two rounds into the series' new era it was on the ropes.

## JHR quits Clios over new car

Leading team slams state of UK series as rival bosses defend Renault

### FRONTRUNNING RENAULT CLIO

Cup UK outfit JHR Developments has quit the series, with team boss Steven Hunter labelling the current state of the championship a "farce".

JHR, which won the teams' championship in 2008 and 2009, had originally planned to run two of the new-for-2014 turbocharged models this season but scaled back to just one, for Lee Pattison, before the start of the campaign.

After a difficult beginning to its season, during which the team has suffered a variety of mechanical faults, Hunter has withdrawn from the series with Pattison switching to the champion Pyro outfit for Thruxton this weekend.

Although Pattison will be on the grid at the Hampshire circuit, Craig Milner and Mark Howard will skip this weekend's races, but both will return for Oulton Park.

That means the grid will drop to 11 and Hunter cited its poor numbers, along with an alleged lack of technical support from Renault, among the reasons for quitting the championship.

"I'm very disappointed," he said. "For the level they see themselves at they need to be at a better standard. The car is not fit for purpose and the technical support we needed wasn't there. There's also been a massive lack of interest in the series. [Attracting drivers was] probably the hardest task I've experienced in motorsport."

"It's genuinely as poor as I've ever known it. It's got nothing to offer. [Withdrawing] almost feels like someone has lifted the weight off our shoulders. It has been a nightmare from start to finish."

Renault UK's Jeremy Townsend defended the start of the category's new era, claiming that Renault Sport and Cosworth representatives have

been present at each round while a representative from Renault France was also at the Brands Hatch opener.

"I think the racing we've had has been fantastic," he added. "We'd like some more cars but it's new and it has to prove itself. I think the response has been positive."

Rival team bosses have also rallied behind the new car. Paul Rivett, whose WDE team is new to Clio racing, said: "We've had the help that we've needed – it's as good as it's always been. So it's so far, so good in that respect. I'm really confident with where we are with the car. It's a great car, it's another step forward."

Simon Hunt, who runs the two-car 20Ten Racing outfit, added: "When we have had means to talk to Renault, we've managed to talk to people. They've performed fantastically and we've not had a problem with them."

## Team reaction

### Steven Hunter, JHR Developments

"We've had nothing but problems with the car since it arrived. It's not fit for the race track and we're being stretched to such a degree just to try to solve these faults. It's sensible not to have any involvement."



### Richard Colburn, Westbourne Motorsport

"We had a few teething problems with the car, but they sorted them out and they did a good job. I think it's harder than the old car to drive, but once the teams get on top of it, it'll be a really good car."



### Simon Hunt, 20Ten Racing

"It's slightly more expensive to run, but no, I can't fault them at all. We have had no problems at all. It's a fantastic car, just like the old one. I was worried when I heard all the rumours last year, but they've been faultless."



### Mark Hunt, Team Pyro

"I think the car's very good. It is very good in Europe and we've had no problem at all. Renault seems to be working hard at it. Initially it was quite expensive and had issues but they have solved quite a lot of problems."





Rouse won '84 BTCC title in Rover SD1

Goodwood

# Goodwood plans Rouse Rover reunion

BRITISH TOURING CAR legend Andy Rouse could be reunited with his title-winning Rover SD1 at the Goodwood Festival of Speed this year.

Four-time champion Rouse, a winner of 60 BTCC races, has been asked to drive the car he used to win the 1984 title at the June 26-29 event.

It would be the first time he has driven the car, in which he won seven races en route to the '84 crown, since claiming his third championship 30 years ago.

"I haven't committed yet but it's been restored and it looks just like it did," said Rouse. "They asked me to drive it up the hill, but it depends. We'll do something.

If I don't drive it [Aston Martin Racing driver] Stuart Hall might."

Meanwhile 1966 BTCC champion John Fitzpatrick, who won his title in a Ford Anglia, is being lined up to drive an ex-John Paul Jr Porsche 935. The Mauro Borella-owned car was an IMSA race winner in the hands of Paul and will be part of the event in order to raise money for

his Huntington's Disease fund.

AUTOSPORT also understands 1990 BTCC champion Robb Gravett could contest the Goodwood Revival in an Austin A35. Gravett took part in the Members' Meeting in March and was supposed to test the A35 at Brands Hatch last week but it suffered early mechanical failure.

BRDC F4

## Star F3 Cup rookie Sowery could make BRDC F4 move in 2014

**DOMINANT F3 CUP ROOKIE TOBY** Sowery could contest a BRDC Formula 4 round later this season.

Sowery, 17, made the move to the budget Formula 3 series for his first season of car racing in a Lanan Racing-prepared, Volkswagen-powered Dallara F305.

He has won the first four races in dominant fashion but with F3 Cup numbers low is considering a cameo appearance in BRDC F4 after budget restrictions ruled out a full-time drive.

"This year is 100 per cent about winning the F3 Cup," he said. "I hope we can do it early and do something else to get my name out there."

Lanan has three cars in the series



Sowery's F3 team Lanan is in BRDC F4

this season including early points leader George Russell's and is open to helping Sowery if possible.

Teams are not allowed to run four cars but Lanan would be able to offer assistance if the entry was independent, which it is willing to consider if it did not compromise its trio of full-time drivers.

Renault Eurocup

## Files starts Eurocup title defence with Aragon podium

**JOSH FILES BEGAN HIS** Eurocup Clio title defence with a podium at Aragon last weekend as Clio Cup UK points leader Alex Morgan made his debut in the European series.

Files claimed his fifth consecutive pole position but dropped to second at the start of race one, a position he held until the finish. The second encounter was a sterner test as he fell from fifth on the grid to a ninth-place finish.

He lies fourth in the points, 28 behind



Parry was seventh in FR Eurocup opener

double race winner Oscar Nogues.

Former British rival Morgan claimed a 12th and a 10th on his maiden weekend in the flagship category.

Matt Parry was top Brit in the Formula Renault Eurocup races, finishing seventh in race one, but he was later spun off by Denis Korneev on the first lap of the second race. Matthew Graham was 10th and 18th and Gregor Ramsay 17th and 21st, with Jack Aitken 19th and then last in the final race.

## Quick and competitive Track Day Insurance

The first online "quote and buy" system solely for the track day user, supplied by established track day and motorsport insurance provider - Ryan Motorsport Insurance

**INSUREMYTRACKDAY.COM**

- Damage to your car on a track day, regardless of fault.
- Any circuit in Europe, including Spa and Nürburgring Nordschleife.
- Inclusive cover for barrier damage at the Nordschleife.
- Vehicle recovery available for circuits in Great Britain.
- Organisers and Clubs - promotional rates and discounts
- Storage and transit for vehicles and trailers

Log on to [www.InsureMyTrackday.com](http://www.InsureMyTrackday.com) to obtain your online quote today

Ryan Motorsport Insurance Limited is an appointed representative (557405) of Independent Broking Solutions Limited who are authorised and regulated by the Financial Conduct Authority. Its Financial Services Register number is 312026

British Formula Ford

## Injured Barlow to skip Thruxton but Jamun will return to FFord grid

**JACK BARLOW WILL MISS THE** Thruxton round of the British Formula Ford Championship this weekend as he recovers from the back injury sustained in a testing crash earlier this month.

The BRDC Formula 4 race winner was forced to skip the races at Donington two weeks ago after breaking a vertebrae when he rolled his Jamun-run Mygale at the official TOCA test at Thruxton.

Initial reports suggested he would make an immediate return to the grid but

that failed to materialise and he has since been forced to delay his return further.

"They didn't say it wasn't bad at first, but they gave us a bit of hope," he said. "I spoke to [spine specialist] Dr Paul Trafford and he said there's no way I can race at Thruxton.

"My initial feeling was I might as well not do the rest of the year. But it's better to stay in the limelight. At the end of the day I'm extremely lucky. Another knock on my back and I could never race again."

His Jamun team will return to the grid, however, after finalising a deal to run karter Samuel Oram-Jones, who tested with them pre-season.

Ex-Formula Vee racer Ashley Sutton will return to the grid after missing the Donington round, while Bobby Thompson will continue with Meridian after making his debut two weeks ago.



Jamun missed Donington

EBREY/LAT

Historics

## Deletraz set for Monaco debut

**FORMER GRAND PRIX DRIVER** Jean-Denis Deletraz will make his Monaco debut at the wheel of a Formula 1 car at this month's Grand Prix Historique.

The 50-year-old, who started three grands prix in 1994-'95 for Larrousse and Pacific, will drive an ex-Alan Jones Surtees-Cosworth TS19 in the race for 1973-'78 F1 machinery at the May 9-11 event. The car is part of an F1 fleet owned

by Frederic Fatien, who backs Deletraz's son Louis in Formula Renault NEC.

Deletraz, who hasn't competed regularly since 2011, said: "I never managed to drive at Monaco during my career, so it will be nice to finally race there. These cars are so much fun, you can really play with them."

Fatien, whose GP Extreme team runs his cars, will race an ex-James Hunt Hesketh-Cosworth 308 in the same event.



Deletraz will drive Surtees at Monaco

LAT

Formula Masters China

## Macau runner-up Wells to make Formula Masters China return

**HONG KONG-BASED BRITON DAN** Wells will make a full-time return to the Formula Masters China series this year.

The 22-year-old has been attempting to join the Japanese Formula 3 grid for two years but financial difficulties mean he returns to the category in which he finished runner-up in 2012 when it was known as Formula Pilota China.

Wells spent most of 2013 on the sidelines but returned at the FPC end-of-season showcase on the streets of Macau last year, finishing second.

"I am so pleased," said Wells, who will be racing for the KC Motorgroup outfit in



Wells is heading back to FMC

the 18-race championship, which begins on May 10-11 at Zhuhai.

"Our target is to fight for the title this year and I am sure KCMG will give me the tools necessary to do so."

## HUMBLE PYE

### The voice of club racing



Civics thrilled Pye at Brands

HAWKINS

## Civic Cup pocket rockets: the latest 750MC success

**L**ike every motorsport fanatic I love watching a really good race, no matter which class provides it. Attending around 30 meetings per season I'm familiar with most grassroots and historic grids, but when something that hadn't previously blipped my radar generates an exceptional spectacle I would certainly like to see more.

The Tegiwa Civic Cup has been around for a while, but is new to the 750 Motor Club's portfolio this season. If Sunday's spectacular double-header on Brands Hatch's Indy circuit is an accurate barometer the promotion would appear to offer a lot of bang for your buck with no shortage of Type Rs available and have enormous potential in a hugely popular niche market.

Minis aside, single-model tin-top racing has never been my thing, but the beauty of the Civic Cup is that it caters for all the Japanese pocket rockets built between 1990-2013. Unlike today's 'yoof' I'm not evangelical in my recognition of the generations, but with control-spec 1600cc B16 or two-litre K20 VTEC engines they appear to be extremely well matched.

The immaculate EP3s of Robert Baker (winner of the opening rounds at Donington in March) and former hovercraft racing champion Luke Sedzikowski (co-founder of Stoke-on-Trent-based Tegiwa Imports, a big player in the massive performance parts after-market for Japanese cars) were split by three tenths of a second in qualifying. A similar span covered the next six!

With a colourful and varied 19-car grid the Civic Cup had a real buzz about it – like a mini version of the British Touring Car Championship – as it lined up. Once the lights went

out the crescendo of high-revving engines translated into great racing throughout the Toyo-tyred field, with many place changes in both dry and wet conditions.

Baker and defending champion Rich Hockley (EK4) scored a win apiece, but in race two their best laps and those of pursuers Nathan Burrell and Sedzikowski were blanketed by 0.04s, with fifth and

"The Civic Cup has enormous potential in a niche market. I see it growing rapidly"

sixth placed Mark Anderson and Andrew Gaugler lapping within half a second of the ultimate pace.

With skilful management I can see the Civic Cup growing rapidly, if not at the startling rate of the BMW Compact Cup where the rolling stock is more affordable. But getting the thousands of young Honda drivers who are passionate about these cars behind it and building a big brand following by making events a destination for them would be the real triumph.

### Marcus Pye

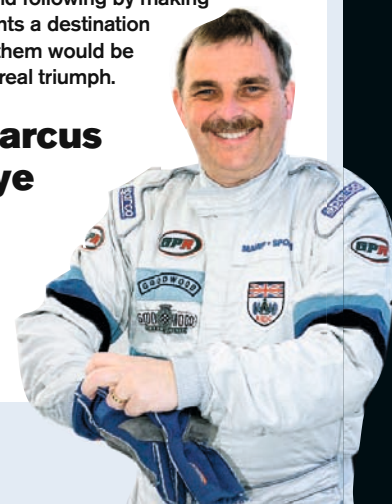

[AUTOSPORT.COM](http://AUTOSPORT.COM)

FANTASY LEAGUE GP  
IS LIVE FOR 2014!

\$100M TO BUILD YOUR  
ULTIMATE TEAM OF 6 DRIVERS!



WHO'S IN YOUR TEAM?

[autosport.fantasyleaguegp.com](http://autosport.fantasyleaguegp.com)

 **fantasy**  
league **GP**



Three-time BTCC champion Neal was quickest in class at Gurston Down meeting

Hillclimb

# BTCC star Neal in hillclimb debut

## THREE-TIME BRITISH TOURING

Car champion Matt Neal made his hillclimb debut at a celebratory Gurston Down meeting last Sunday.

The works Honda driver drove a normally aspirated 260bhp Honda Jazz in a special Chairman's invitation class at the event, the venue's 300th meeting.

Neal overturned Honda Team Synchro boss Alyn James's early advantage to

take the class win by 0.3 seconds.

"The main thing that took me by surprise was how narrow it is," said Neal. "I was very tentative on my first run, especially as it was raining – I was very conscious of not wanting to beach the car on a bank, or worse. It was awesome fun though; I absolutely loved the Jazz."

The 47-year-old, who is fifth in the BTCC points with three podiums in the

new Team Dynamics-run Civic Tourer, said the run was only for fun but he had been more nervous than he expected.

"The BTCC can get very intense sometimes, so it was good to come to a more relaxed event like this," he added. "It was very different. There wasn't much time to get to grips with it all. I had to try to take everything on board pretty quickly and I scared myself a couple of times."

## In brief

### Charity race for Heroes

British Touring Car race winner Paul O'Neill, current drivers Rob Austin and Dan Welch and ex-British GT champion Calum Lockie will be part of a charity race organised by military charity Mission Motorsport. The eight-hour race will be held at Anglesey on November 8-9. Mission ran ex-soldier David Birrell (pictured) at the Welsh track last weekend in a Mazda MX5.

### Points tweak for F4

The BRDC Formula 4 points system has been tweaked for this season to give greater reward for the non-reversed-grid races. Last year the winner of any of the weekend's three races would receive 30 points but that has been changed for 2014, with 35 points available for a win in races one and two and 25 for race two.

### Lister anniversary trophy

The Lister Motor Company has launched the Brian Lister Trophy as part of its 60th anniversary celebrations. It will be awarded to the best performing Lister in the Stirling Moss Trophy series for pre-'61 Sports cars and Sports Racers. All Lister cars competing in five rounds held at prestigious European historic events will be eligible for the trophy.

### Britcar champ returns

Former British Endurance champion Richard Adams will return to the Britcar fold at Donington Park on May 10-11. He will be joined by David Green, whose 18-year-old son Max will also take part. Run by Bullrun, the squad will enter both 90-minute races and the trio of Sports and Touring races in its SEAT Cupra.

### New pair's rally triumph

Matt Edwards and Kim Baker (below) teamed up for the first time to win last Saturday's Tour of Hamsterley. Edwards took control from the start of the 45-mile event and, when the similar Ford Escort Mk2 of Matthew Robinson/Sam Collis hit alternator problems on the penultimate stage, comfortably beat Nick Elliott/Dave Price back to second.



O'Donovan is back in Supercar

Rallycross

# British RX ace's Supercar return

FORMER BRITISH RALLYCROSS champion Ollie O'Donovan will return to the Supercar division at Knockhill.

The 2007 title winner, who has spent several years competing in the RX150 category, will drive a Ford Focus at the May 11 event. O'Donovan will also contest the AUTOSPORT World RX of Great Britain, the second round of the World Rallycross Championship, at Lydden Hill on May 24-25.



F3 Cup grids are well down on last year

F3 Cup

# Lowest-ever entry for F3 Cup

## F3 CUP BOSS SIMON DAVEY

believes the series will bounce back from its lowest-ever entry.

Only eight drivers took part in the second race at Silverstone on Sunday, the series' poorest grid since becoming a championship in 2011.

Davey believes it will be boosted to 13 or 14 cars for the next round, while some Formula Renault teams have

enquired about possible entries. BRDC Formula 4 frontrunner Struan Moore could also join the grid at Spa.

Davey reckons a compromise with British F3, which is set for a grid of seven for Rockingham this weekend, would benefit both series.

"It doesn't make sense to do it like this," he said. "People must be looking at it [a merger]."



Hoad was third in RF90

FF1600

# Hoad restores Duckhams FFord

## FORMULA FORD 1600 RACER

Jonathan Hoad restored Michael Vergers's championship-winning Van Diemen RF90 to its factory Duckhams colours for last weekend's Jim Walsh Trophy race at Silverstone.

The former works machine, raced by

Vergers to the 1990 British Formula Ford title, was put on pole by Hoad by almost one second. He went on to claim the final spot on the podium.

Hoad will not be present for the Champion of Brands event next month but plans further Super Series outings.

# Young guns top 750 Formula thriller



HAWKINS

**AN AWESOME LEAD BATTLE BETWEEN** Billy Albone and Bill Cowley, driving 750 Formula cars built 42 years apart, underlined the quality of Britain's longest-established club racing championship and the ethos of the 750 Motor Club in its 75th anniversary year.

Rain master Cowley planted his wonderful machine – originated by his late grandfather in 1969 – on pole, but Racekits Falcon designer Martin Kemp was on his heels, with Williams Formula 1 vehicle dynamics boffin Robin Gearing (Darvi P88) 0.79s shy in third. Albone sat on row four, meanwhile, his Batten's Fiat engine blunted by a misfire.

As the leaders entered Paddock Bend four abreast, with Gearing boring down the inside, Albone sliced through to lead into Druids. Try as Cowley did to retaliate, the Essex lad ran out a clear winner. Following a fine scrap with Gearing – who spun at the hairpin – 10-time champion Mick Harris secured third behind Cowley, with Bob Simpson and Gearing next in.

Yorkshireman Cowley led the first half of the second stanza under intense pressure from his old Velocity Motorsport karting team-mate, but Albone dived past at Druids. Cowley outbraked him into Paddock next

time round, forcing Billy to repeat his manoeuvre. Thereafter he inched away from the sleek Cowley MkIV (the Fiat engine of which drives its parallel gearbox via a toothed belt) with Gearing a close-up third.

Two outstanding Civic Cup races saw 19 raucous Hondas slug it out. Muscled back to sixth by the exit of Paddock in the opener, poleman Rob Baker hurtled back to demote 2012-'13 champion Rich Hockley, adding to his Donington double.

Hockley was first into his stride second time out and, with Baker breathing down his neck as rain complicated matters, held his nerve to end his rival's winning streak. Luke Sedzikowski finished a splendid third in race one but later, on a devilishly

slick track, was bumped to fourth by Nathan Burrell.

Both Sport Specials bouts were crackers, Eclipse duo Paul Boyd and Clive Hudson (from row five) claiming one-tuos, in opposite orders, the combined winning margin 0.71s. Top qualifier Eddie Ives (Elite Pulse) bagged thirds, with a diverse pack covering the spectrum of aesthetic merit in his mirrors.

Sunday's BMW Compact Cup pack was divided into three, each group racing twice. LED Denser's Alex Dew just kept Mike Tovey's fast-closing Safety Devices car behind in the initial dash, with Alan Kirkaldy third on his first Brands outing since Formula Ford in 2002.

Champion Stephen Roberts was

invincible subsequently, stemming Kirkaldy's challenge until the Scot spun, then heading Stuart Voyce and Simon Roche who had inverted his RTR car in the Paddock gravel bed during qualifying.

Dew led until lap two of the soggy finale, then stalked Roberts relentlessly. David Drinkwater atoned for a poor qualifying with third, ahead of Tovey and James Nutbrown, up from 17th. Eric Zaleski's race was mercurial. Swatted by a sideways Voyce at Graham Hill Bend while disputing fifth, the Pole recovered to ninth, spun to 12th then fought through to eighth!

Formula Vee champion Paul Smith's AHS Dominator hat-trick attempt started with a Saturday win, although 2013 Brands Festival victor Peter Belsey (Spyder) caught him before losing third gear and a duff spark plug hobbled 2010-'11 titlist Martin Farmer (GAC). Paul Taylor (GAC) and Smith's team-mate Steve Ough completed the podium, the latter's third a career-best.

Smith was controlling Sunday's race when "fuel starvation" hit suddenly two laps from home. He could only crawl home eighth as Farmer, whose engine was pinking, landed a surprise win – an early wedding present – over a delighted



HAWKINS



Cowley's '69 racer leads Albone's modern Batten



Race-one winner Boyd leads the Sport Specials pack



Baker and Hockley shared Civic success

RESULTS

**750 FORMULA (BOTH 16 LAPS)** 1 Billy Albone (Batten 3) 14m39.79s (79.09mph); 2 Bill Cowley (Cowley MkIV) +7.71s; 3 Mick Harris (Darvi 877); 4 Bob Simpson (SS/F); 5 Robin Gearing (Darvi P88); 6 Martin Kemp (Racekits Falcon). **CW** Andrew Lake (Darvi 91D). **FL** Albone 53.22s (81.71mph). **RACE 2** 1 Albone 14m35.07s (79.51mph); 2 Cowley +0.67s; 3 Gearing; 4 Simpson; 5 Harris; 6 Kemp. **CW** Lake. **FL** Albone 53.19s (81.76mph).

**CIVIC CUP (15 LAPS)** 1 Robert Baker 14m16.26s (76.18mph); 2 Rich Hockley +1.12s; 3 Luke Sedzikowski; 4 Mark Anderson; 5 Nathan Burrell; 6 Tim Evans. **FL** Baker 56.00s (77.66mph). **RACE 2 (14 LAPS)** 1 Hockley 14m23.79s (70.48mph); 2 Baker +0.45s; 3 Burrell; 4 Sedzikowski; 5 Anderson; 6 Andrew Gaugler. **FL** Hockley 57.24s (75.97mph).

**SPORT SPECIALS (BOTH 16 LAPS)** 1 Rob Boyd (Eclipse SM1) 14m26.30s (80.32mph); 2 Clive Hudson (Eclipse SM1) +0.40s; 3 Eddie Ives (Elite Pulse); 4 Paul Collingwood (Sylva J15); 5 Stewart Fenton (Tiger RS6); 6 Stephen Ward (Westfield Aerorace). **CW** Ives; Adrian Cooper (Procomp LA Gold). **FL** Mark Cousins (Westfield SeW) 52.46s (82.90mph). **RACE 2** 1 Hudson 14m23.19s (80.61mph); 2 Boyd +0.31s; 3 Ives; 4 Collingwood; 5 Fenton; 6 Anton Landon (Cyana Mk2). **CW** Ives; Marcus Roskill (Sylva Phoenix). **FL** Hudson 52.35s (83.07mph).

**BMW COMPACT CUP B & C (11 LAPS)** 1 Alex Dew 10m55.82s (72.94mph); 2 Mike Tovey +0.24s; 3 Alan Kirkaldy; 4 Neil Roche; 5 David Drinkwater; 6 Mike Gray. **FL** Drinkwater 58.26s (74.64mph). **C & A (11 LAPS)** 1 Stephen Roberts 11m03.72s (72.07mph); 2 Stuart Voyce +1.16s; 3 Simon Roche; 4 Neil Roche; 5 Gray; 6 Ireneusz 'Eric' Zaleski. **FL** Voyce 58.64s (74.16mph). **A&B (12 LAPS)** 1 Roberts 14m07.74s (61.56mph); 2 Dew +0.18s; 3 Drinkwater; 4 Tovey; 5 James Nutbrown; 6 Voyce. **FL** Drinkwater 1m09.34s (62.72mph).

**FORMULA VEE (BOTH 16 LAPS)** 1 Paul Smith (AHS Dominator) 14m25.75s (80.37mph); 2 Paul Taylor (GAC) +16.11s; 3 Steve Ough (AHS Dominator); 4 Ben Miloudi (Storm); 5 Ian Jordan (Sheane Jordan); 6 Graham Gant (WEV). **CW** Jack Wilkinson (Sheane Mk3). **FL** Smith 52.97s (82.10mph). **RACE 2** 1 Martin Farmer (GAC) 14m34.19s (79.59mph); 2 Jordan +3.00s; 3 Daniel Pitchford (GAC); 4 Taylor; 5 Ough; 6 Gant. **CW** Jack Wilkinson. **FL** Smith 52.48s (82.87mph).

**LOCOST GROUPS B & C (ALL 14 LAPS)** 1 Tom Collier 14m02.20s (72.29mph); 2 Tom Robinson +11.68s; 3

Martin Wellard; 4 Richard Bradley; 5 Matthew Booth; 6 Ian Allee. **FL** Collier 58.41s (74.45mph). **C & A** 1 Danny Andrew 13m54.85s (72.93mph); 2 Mathew Brooks +4.76s; 3 Lee McNamara; 4 Wellard; 5 Richard Jenkins; 6 Allee. **FL** Andrew 58.24s (74.67mph). **A & B** 1 Andrew 14m05.27s (72.03mph); 2 Collier +1.73s; 3 Robinson; 4 Lee Bankhurst; 5 Bradley; 6 Brooks. **FL** Collier 58.70s (74.09mph).

**STOCK HATCH & SMART FOUR-TWO (BOTH 15 LAPS)** 1 Lee Deegan (Citroen Saxo VTR) 14m38.21s (74.28mph); 2 Tom Bell (Saxo) +0.40s; 3 Shayne Deegan (Saxo); 4 Philip Wright (Saxo); 5 Steven Powlesland (Saxo); 6 Terry Roughton (Saxo). **CW** Jake Jackson (Smart 4:2). **FL** Lee Deegan 57.51s (75.62mph). **RACE 2** 1 Lee Deegan 14m36.45s (74.43mph); 2 Bell +0.81s; 3 Shayne Deegan; 4 Carl Swift (Saxo); 5 Paul Jarvis (Saxo); 6 Powlesland. **CW** Jackson. **FL** Bell 57.24s (75.97mph).

**CLASSIC STOCK HATCH (BOTH 14 LAPS)** 1 Lee Scott (Ford Fiesta XR2i) 13m58.42s (72.62mph); 2 Andy Philpotts (XR2i) +3.10s; 3 Andrew Thorpe (Citroen AX GTi); 4 Matt Rozier (Peugeot 205 GTi); 5 Andrew Lightstead (Ford Fiesta XR2); 6 Matthew Stubbington (205 GTi). **FL** Scott 58.64s (74.16mph). **RACE 2** 1 Scott 13m58.42s (73.01mph); 2 Thorpe +0.17s; 3 Philpotts; 4 Lightstead; 5 Martin Fowdrey (XR2); 6 Martin Cayzer (XR2i). **FL** Thorpe & Scott 58.40s (74.47mph).

**TOYOTA MR2 (15 LAPS)** 1 Matthew Palmer 14m37.48s (74.34mph); 2 Stuart Nicholls +6.19s; 3 Jim Davies; 4 Robert Wells; 5 Mick Nicholls; 6 Michael Wells. **CW** Stuart Nicholls. **FL** 57.35s (75.83mph). **RACE 2 (13 LAPS)** 1 Palmer 14m45.97s (63.81mph); 2 Davies +7.12s; 3 Ben Rowe; 4 Stuart Nicholls; 5 Tim Heron; 6 John Wilson. **CW** Davies. **FL** Palmer 1m06.52s (65.38mph).

**5 CLUB MAZDA MX-5 (14 LAPS)** 1 Brian Chandler 13m54.63s; 2 Will Blackwell-Chambers +0.02s; 3 Gary Hufford; 4 James Rogers; 5 Chris Lovett; 6 Andrew Coombs. **FL** Chandler 58.05s (74.88mph). **RACE 2 (12 LAPS)** 1 Chandler 11m49.44s; 2 Blackwell-Chambers +8.32s; 3 Hufford; 4 Rogers; 5 Lovett; 6 Stephen Crags. **FL** Chandler 57.85s (75.17mph).

**500CC F3 (13 LAPS)** 1 Darrell Woods (Cooper-Norton Mk12) 14m01.71s; 2 Simon Frost (Cooper-Norton Mk13) +3.40s; 3 Ian Phillips (Cooper-Norton Mk10); 4 Xavier Kingsland (Staride-Norton Mk3); 5 Richard de la Roche (Smith Buckler-JAP); 6 Neil Hodges (Cooper-JAP Mk8). **CW** Kingsland; Shirley Monro (Cooper-JAP Mk4). **FL** Woods 1m03.49s (68.50mph).



Compact king Roberts won twice

Ian Jordan (Sheane Jordan) and Daniel Pitchford (GAC).

Two Sunday wins, the latter over Saturday victor Tom Collier whose engine started cutting-out, asserted Danny Andrew as the Locost points leader, a lap record underlining new-found pace. Second for Mathew Brooks on his race debut (backed up by a fighting sixth in the finale) indicated considerable promise, but Tom Robinson's spectacular rise from 18th to third in race three suggests a title rival for Andrew.

Outqualified by brother Shayne, Lee Deegan had better fortune in traffic and thus won both Stock Hatch races. Having dumped his Citroen in the gravel during qualifying, champion Tom Bell made tremendous starts from 12th to split his Regency Autos teammates. Jake Jackson dominated the Smarts set, in which Paul Bates and James Palmer's scrap spanned Sunday's race.

Classic Stock Hatch champ Lee Scott was another to start his campaign perfectly, although the Ford XR2i stalwart was fortunate that Citroen AX GTi-mounted Andrew Thorpe – who had snatched the lead audaciously into Paddock at the start – “tried to go outside a backmarker and went into the back of a [Peugeot] 205” at Clearways on the final lap. “I

got lucky,” admitted Scott, who finished 0.17s clear of Thorpe.

Dry or wet there is currently no catching Matthew Palmer in Toyota MR2s, the champion making it four out of four this term with consummate ease. Roadster men Stuart Nicholls and Jim Davies wound up closest, but Ben Rowe's third position – from eighth on the grid – rewarded a particularly combative effort in the treacherous second encounter.

The 5Club Racing Mazda field boasted 27 entries, but polesitter Brian Chandler beat resurgent Will Blackwell-Chambers by 0.02s in the opening stanza. They started race two from row five, and while Chandler led astoundingly by Druids, WB-C took 10 laps to recapture second with a sensational lunge past both James Rogers and Gary Hufford into Paddock.

Revelling in wet practice, Richard de la Roche claimed Stuart Lewis-Evans memorial 500cc F3 race pole in his JAP-engined Smith Buckler. On a dry afternoon, however, Norton power trumped the combo, Darrell Woods, Simon Frost and Simon Phillips (Coopers) and Xavier Kingsland (Erskine Staride) sweeping past.

● Marcus Pye

Russell took his first wins in car racing



SILVERSTONE, APRIL 26-27 MSVR

# Lanan's latest charger makes his mark

**BIG THINGS ARE EXPECTED OF GEORGE RUSSELL** this season, and the 16-year-old rookie showed why with two victories at Silverstone's BRDC Formula 4 curtain raiser.

The Lanan Racing youngster had been singled out as the man to beat before the weekend, but it was the HHC duo of Raoul Hyman and Sennan Fielding that occupied the front row for race one. Hyman raced into a commanding early lead from pole and after two laps his advantage stood at more than three seconds as Fielding edged clear of Russell, who'd started fourth, and Diego Menchaca.

Fielding eradicated Hyman's advantage with a trio of blistering laps before immediately attacking into Brooklands, but Hyman defended fiercely and they narrowly avoided contact. As they squabbled Menchaca — who had passed Russell on the second lap — nipped ahead of Fielding. Nicolas Beer briefly demoted him further but, as Hyman kept Menchaca at arm's length, Fielding regained third with Russell restricted to a watching brief in fifth.

Sunday morning arrived with rain



Hyman won the opener

clouds lurking, and Arjun Maini led away from the reversed-grid pole as Gustavo Lima jumped ahead of front-row starter Will Palmer. By the end of the opening lap Lima was in front after rain hit the back of the circuit almost immediately after the start, with several frontrunners escaping a trip across the grass at Becketts, and Maini tumbled down the order.

Russell was one driver to get away with a first-lap excursion and took full advantage of his good fortune by picking off a trio of cars on the opening lap and then passing Lima

for the lead into Stowe. Beer joined Lima in the fight for second, while Struan Moore picked off Palmer, Menchaca and Hyman and was soon on the back of that battle.

Beer and Lima swapped places at The Loop on the penultimate lap and the Dane fought off the Brazilian's attempted retaliation to make second place his at Brooklands, with Moore — who had retired from the opening race with a driveshaft failure but had risen phoenix-like from the back row — outdrugging Lima out of Luffield and moving by through Woodcote for third. Russell, though, had built a 4.5s lead and claimed his first single-seater win in fine style as Beer staved off a final-lap push from Moore to finish second, and Hyman rose to fourth late on as Fielding dropped back to 10th.

Fielding, whose fastest lap from the first race earned him pole for the weekend's denouement, held off the fast-starting Beer into Copse as the finale began but lost out to the SWR man later around the opening lap. Russell moved up to second having started sixth — “that was the turning

point for winning or losing the race” — and the race-two winner was at the head of the pack by the third lap.

As Russell moved clear and contact with Fielding forced Beer into retirement, Lanan team-mate Maini set about hassling Menchaca for second, slipping past just after mid-distance and easing clear to complete a one-two for the team. Menchaca completed a strong weekend a lonely third, but a battle raged behind for fourth.

Chris Middlehurst had endured a difficult BRDC F4 debut after a race-ending collision in the opening encounter, but the Formula Renault BARC champion claimed a fighting seventh in race two and charged up the order from 15th in the finale.

He picked off drivers almost every lap to move into fourth. Although Moore, again starting from the back of the grid, harried him for all he was worth, Middlehurst just held on. The recovering Fielding kept Moore on his toes in a close sixth, but was excluded post-race as a consequence of the earlier contact with Beer.

● Scott Mitchell



Charging Moore starred on Sunday



Menchaca impressed with podium brace

## RESULTS

**RACE 1 (10 LAPS) 1 Raoul Hyman 21m15.579s (103.30mph);** 2 Diego Menchaca +0.505s; 3 Sennan Fielding; 4 Nicolas Beer; 5 George Russell; 6 Gustavo Lima. **Fastest lap** Fielding 2m05.960s (104.61mph).

**RACE 2 (9 LAPS) 1 Russell 20m57.416s (94.32mph);** 2 Beer +3.890s; 3 Struan Moore; 4 Hyman; 5 Lima; 6 Will Palmer. **FL** Palmer 2m10.858s (100.70mph).

**RACE 3 (10 LAPS) 1 Russell 21m26.172s (102.45mph);** 2 Arjun Maini +3.025s; 3 Menchaca; 4 Chris Middlehurst; 5 Moore; 6 Palmer. **FL** Russell 2m06.985s (103.77mph).

**POINTS 1 Russell, 79; 2 Menchaca, 66; 3 Hyman, 64; 4 Maini, 52; 5 Palmer, 47; 6 Lima, 45.**

LOTUS CUP UK SILVERSTONE,  
APRIL 26 MSVR

# Randaccio penalty gives Hall victory

ADRIAN HALL WON A CHAOTIC Lotus Cup UK and Elise Trophy race that was punctuated by two safety car periods that meant more than half the encounter was spent under caution – but only after the on-the-road leader was penalised.

Fabio Randaccio's Lotus Europa made the early running after jumping poleman Adrian Hall, but the Exige S1 driver fought back and led as the pit window opened. That coincided with the first safety car period, caused by a crash between Clive Willis and Tomasz Kasprzyk and, as the leaders pitted, Randaccio jumped ahead of Hall, who fell to fourth.

The safety car period lasted almost 20 minutes and the yellows were out almost immediately after they were withdrawn when the Miller-Britten Exige and Seth Walpole Elise collided on the start-finish straight as racing resumed, both cars hitting the pitwall.

Just a handful of racing laps



remained when that caution period ended, and Hall disposed of third-placed Adam Balon and then Jonathan Walker on the final lap to claim second, with Balon following him through to take third on the road.

Randaccio was then hit with a 10-second penalty for overtaking a backmarker under the yellow flags, promoting Hall, Balon and Walker as he dropped to fourth. Marcus Jewell was sixth at the flag but given a

two-lap penalty for a pitstop infringement, dropping him to 44th.  
● Scott Mitchell

**RESULTS (20 LAPS) 1 Adrian Hall (Exige S1) 1h02m01.587s (70.81mph);** 2 Adam Balon (Exige V6); 3 Jonathan Walker (Exige V6); 4 Fabio Randaccio (Europa); 5 Adam Knight (Exige V6); 6 Freddie Hetherington (Exige S1). **Class winners** Balon; Simon Deacon (2 Eleven); Fulvio Mussi (Elise S1). **FL** Hall 2m21.849s (92.90mph).

Rookie Sowery is unbeaten in F3 Cup



F3 CUP SILVERSTONE, APRIL 26-27 MSVR

# Unstoppable Sowery doubles up again

FOUR RACES; FOUR VICTORIES FOR F3 Cup rookie sensation Toby Sowery.

The Lanan Racing youngster blasted his Dallara-Volkswagen into a comfortable lead in the opening two laps of the first Silverstone race as the fast-starting Tristan Cliffe moved into second.

Cliffe tried to live with Sowery but was dropping back on each lap until a spin on lap seven at Village as rain started to fall. That dropped him to the back as Louis Hamilton-Smith assumed second, 15-odd seconds behind the leader. As Hamilton-Smith attempted to fend off Henry Chart, Sowery – who was adamant

post-race he was “taking it steady” – continued undeterred by the challenging conditions to win by 24 seconds. Chart nicked second from Hamilton-Smith on the final lap while Mark Harrison just held off front-row starter Lee Morgan, who had an awful first lap, to take fourth.

Sowery was left staring at the rear of an F3 car for the first time as Cliffe got the better of him off the line at the start of race two, although he dived back past into Becketts moments later to restore the status quo. Cliffe made no mistake this time to claim second, albeit 16s back, while Chart had a lonely race in third after

Hamilton-Smith failed to take the start due to an engine problem.

● Scott Mitchell

**RESULTS (BOTH 10 LAPS) 1 Toby Sowery (Dallara F305-Volkswagen) 21m00.743s (104.52mph);** 2 Henry Chart (Dallara F399-Opel Spiess) +24.844s; 3 Louis Hamilton-Smith (Dallara F307-Volkswagen); 4 Mark Harrison (Dallara F306-Mugen Honda); 5 Lee Morgan (F307-Mugen Honda); 6 Stuart Wiltshire (F307-Mugen Honda). **Fastest lap** Sowery 2m00.199s (109.63mph). **RACE 2 1 Sowery 20m10.878s (108.82mph);** 2 Tristan Cliffe (Dallara F307-Mugen Honda) +16.766s; 3 Chart; 4 Harrison; 5 Morgan; 6 Wiltshire. **FL** Sowery 2m00.133s (109.69mph).



## In brief

### Jim Walsh Trophy

Oliver White (above) took a dominant win in the Formula Ford 1600 Super Series' Jim Walsh Trophy race after starting from the final row of the 16-car grid. Erstwhile leader Michael Moyers claimed second after fending off a late charge from Jonathan Hoad's Duckhams-livered Van Diemen. Luke Williams rotated at The Loop mid-race but recovered to claim fourth.

### Mk2 Golf GTi

The Volkswagen Mk2 Golf GTi races yielded two comfortable wins for Jamie Martin. Tom Witts led initially in race one but retired on lap two, leaving Martin to ease to the win ahead of James Bark. Martin dropped to third as race two began but was swiftly back ahead and led home Jason Tingle, third in race one, with Bark completing the podium.

### Sports 2000

Patrick Sherrington ensured the packed Sports 2000 race was devoid of any meaningful action. Once the poleman converted his grid position into a first-corner advantage he was able to flex the muscles of his MCR to romp well clear to a 35-second victory. Nick Bates gave chase having jumped Tom Stoten early on, with Stoten holding off Peter Needham in the late stages.

### VAG Trophy

Dan Rose passed Paul Taylor on the opening lap of the first race before easing to a comfortable win in his SEAT Leon, with David Fairbrother third. Taylor's Mk4 Golf rocketed into the lead from second on the grid in race two and finished almost 12 seconds clear. Fairbrother and Richard Morgan completed the podium.

### Atom Cup

Andrew Smith won the first encounter comfortably after surviving a lap-four tangle that dropped Nick Whitehead down the order. Martin James and Paul Donkin completed the podium. Whitehead (below) responded with a narrow race-two victory over Smith, who was classified third after a five-second penalty for exceeding track limits promoted Danny Keirle to second.



Belshaw/Keen won,  
Plato (77) retired then  
lucked out



**RADICAL SR3 CHALLENGE DONINGTON PARK, APRIL 26-27 MSVR**

# Wins shared after Plato woes

IT WAS SO NEARLY A DOUBLE WIN FOR Peter Belshaw and Phil Keen at the Radical SR3 Challenge opener but after the safety car wiped out their race-one lead and Belshaw spun under pressure, it all came good at the second time of asking.

Keen made a flying start from pole but couldn't shake off the attentions of Lewis Plato as they both edged clear of Jeremy Ferguson, who began to consolidate third.

Plato was still threatening after 13 laps when Keen was held up by a backmarker, and he surged ahead as

they arrived at the chicane. The lead had grown to two seconds when Plato began to slow. "A fuse had gone and I began to lose charge and couldn't get gears so had to pull off," he explained.

Plato's woes coincided with the pitstop window opening, with Ferguson up to second and first to stop. Keen stayed out for another six laps before handing to Belshaw, who had a six-second cushion until the safety car came out.

The pressure was on but time was running out when Belshaw went off at Redgate, rejoining in seventh and

leaving Ferguson clear for the win. Bradley Ellis took over from Andy Cummings in sixth and charged through the order to grab third from Hui Sun-Kim as the safety car came out, which then became second, with Jesper Westerholm third.

Plato led race two by a comfortable margin, but elected to change tyres and settings as the track dried. Marcello Marateotto led from the stops but couldn't hold off the Keen and Belshaw partnership, pulling out a 4.7-second winning margin in the last five laps. Nick Jones and Scott

Malvern completed the podium after Brian/Tom Harvey had a late penalty. ● Peter Scherer

**RESULTS (33 LAPS) 1 Jeremy Ferguson 40m50.512s (95.94mph);** 2 Andy Cummings/Bradley Ellis +1.540s; 3 Jesper Westerholm; 4 Brian Harvey/Tom Harvey; 5 Phil Abbott/Jason Kenny; 6 Phil Keen/Peter Belshaw. **Fastest lap** Keen 1m06.730s (106.76mph).

**RACE 2 (31 LAPS) 1 Belshaw/Keen 41m00.756s (89.75mph);** 2 Marcello Marateotto +4.769s; 3 Nick Jones/Scott Malvern; 4 Shahin Nouri; 5 Westerholm; 6 Lewis Plato. **FL** Ellis 1m06.808s (106.64mph).



Caudle led home  
Davey twice

**MINI CHALLENGE DONINGTON PARK, APRIL 26-27 MSVR**

# Mini man Caudle in control

THERE WAS A THREE-CAR BREAK IN race one with Chris Knox heading Luke Caudle and Lawrence Davey. Simon Quinn took third at Coppice on lap three, before Caudle had the lead at McLeans.

As he gradually made his lead decisive, Davey was left clear in second after Quinn went off at Redgate, taking Knox with him and giving debutant Neil Newstead third.

Caudle had the edge over Davey for the whole of race two, with Newstead third by a comfortable margin over Quinn and Knox.

Knox established himself at the head of a red-flag-shortened race from the second lap and although

Caudle demoted Hamish Brandon from second on lap four, his hopes of a hat-trick eluded him. ● Peter Scherer

**RESULTS (15 LAPS) 1 Luke Caudle 20m05.209s (88.67mph);** 2 Lawrence Davey +1.85s; 3 Neil Newstead; 4 Hamish Brandon; 5 Mark Steward; 6 Simon Quinn. **Class winner** Shane Stoney. **FL** Caudle 1m19.464s (89.65mph). **RACE 2 (14 LAPS) 1 Caudle 21m15.284s (78.21mph);** 2 Davey +1.135s; 3 Newstead; 4 Quinn; 4 Chris Knox; 5 Brandon; 6 Steward. **CW** S.Stoney. **FL** Davey 1m18.661s (90.57mph). **RACE 3 (9 LAPS) 1 Knox 13m20.358s (80.11mph);** 2 Caudle +4.635s; 3 Brandon; 4 Davey; 5 Newstead; 6 Steward. **CW** S.Stoney. **FL** Knox 1m27.301s (81.61mph).

**RADICAL CLUBMANS CUP DONINGTON PARK, APRIL 26-27 MSVR**

# Kruger and Burgess on top

BOTH RACES FEATURED BATTLES FOR the lead between Oskar Kruger and Steve Burgess and it was no surprise that the wins were shared, too.

In race one Kruger led through the Craner Curves on the opening lap and despite staying close, Burgess had to settle for second. John Macleod was third initially, but lost out to Craig Butterworth at the chicane and Dan Vaughan a lap later.

Vaughan battled Butterworth for third before his rival was punted off by a backmarker, which brought Macleod back to finish fourth.

Kruger was set for a second win until he was badly baulked exiting the chicane on lap 11, leaving the

way clear for Burgess to take command. Vaughan spun out of third at the chicane on lap 14, handing the place to Butterworth with Marcello Marateotto fourth. ● Peter Scherer

**RESULTS (18 LAPS) 1 Oskar Kruger (PR6) 20m22.172s (104.93mph);** 2 Steve Burgess (SR3) +0.556s; 3 Dan Vaughan (SR3); 4 John Macleod (SR3); 5 Ben Dimmack (PR6); 6 Marcello Marateotto. **CW** Burgess; Chris Car (SR1). **FL** Kruger 1m06.972s (106.38mph).

**RACE 2 (17 LAPS) 1 Burgess 20m39.493s (97.71mph);** 2 Kruger +0.859s; 3 Craig Butterworth (SR3); 4 Marateotto; 5 Macleod; 6 Dimmack. **CW** Kruger; Car. **FL** Kruger 1m07.010s (106.32mph).



Burgess triumphed  
in race two

GT CUP DONINGTON PARK, APRIL 26-27 MSVR

# Balfe Ferrari dominates GT Cup opener



Balfe streaked to a trio of victories

**SHAUN BALFE'S FERRARI 458 GT3** proved unbeatable on its way to a winning treble in mixed conditions.

Apart from during the pitstops he was never headed in the first race, with Jim Geddie's McLaren a solid second despite a late stop-go penalty. Richard Chamberlain's Porsche 935 was third but later excluded, promoting Iain Dockerill to third.

Geddie led from the start of race two but Balfe took charge from the second lap. He briefly lost out though to a charging Dan Stringfellow at Redgate, who then planted his Lamborghini Gallardo in the Old Hairpin gravel and brought out the safety car. Geddie came back to

challenge for the lead before a second safety car period, but from there Balfe was away again for win number two, with Will Plant's Porsche completing the podium after taking David Walley with a lap to go.

For the first six laps of race three Geddie just had the edge but was unable to shake off the determined Balfe. He finally went by just before the safety car was in action again, but no sooner had the green flag been shown, the red followed with Chris Dockerill's Ferrari off at the chicane. It was Balfe's win, with Geddie retaining second, well clear of Chamberlain.

● Peter Scherer

**RESULTS (37 LAPS) 1 Shaun Balfe (Ferrari 458 GT3) 45m48.118s (95.92mph);** 2 Jim Geddie (McLaren MP4-12C GT3) +26.556s; 3 Iain Dockerill (Porsche 997 RSR); 4 John Seale/Jamie Stanley (458 GT3); 5 William Plant/Oliver Bryant (Porsche 997 GT3); 6 Arwyn Williams/Aaron Scott (458 GT3). **CW** Plant/Bryant; Seale/Stanley; Ian Payne/David Bearman (Ginetta G50). **FL** Balfe 1m06.975s (106.37mph). **RACE 2 (15 LAPS) 1 Balfe 26m17.664s (67.73mph);** 2 Geddie +4.187s; 3 Plant; 4 David Walley (997 GT3); 5 Chris Dockerill (Ferrari 430); 6 Tim Hood (TVR Sagaris). **CW** Plant; Seale; Colin Broster (Porsche 996). **FL** Balfe 1m15.793s (94.00mph). **RACE 3 (12 LAPS) 1 Balfe 18m48.345s (75.77mph);** 2 Geddie +1.040s; 3 Richard Chamberlain (Porsche 935); 4 Hood; 5 I Dockerill; 6 Walley. **CW** Walley; Seale; Marcus Clutton (996). **FL** Balfe 1m07.845s (105.01mph).



## In brief

### Racing Saloons

The BMWs of Matt Seldon and Karl Cattliff shared the Racing Saloons victory spoils. In race one there were several changes with Stephen Pearson, before Seldon held sway from lap three. With Seldon an early retirement, Pearson duelled with Cattliff in race two, but from the chicane on lap 10 Cattliff was in charge, with Mike Dugdale second after Pearson went off at the Old Hairpin.

### Production BMW

Once Stuart Waite had vacated his early lead in race one, Rob Gray was left in the clear, with Harry Goodman taking Mark Palmer for second on lap seven. Goodman led the second race for the first three laps, but once Gary Feakins had the lead Goodman gradually tailed off. He was well clear of third-placed James Foard when it was red-flagged.

### Monoposto Duratec, 1800, 1600 & Classic

Daniel Hands' Van Diemen ousted Lee Cunningham's Van Diemen on the third lap to take victory in the restarted race one, with Francis Phillips' Reynard 923 a distant third over Mike Hatton's Vauxhall Lotus on the last lap. Hands led the second race for five laps, before giving best to Kevin Otway's Van Diemen before it was red flagged.

### Monoposto 2000 & Moto Mono

Starting from the sixth row of the grid no one was more surprised than Chris Woodhouse (below) to lead into the chicane on the opening lap. Jonathon Hughes's Dallara was established in second from lap three, with Ben Cater's Dallara completing the top three. Adrian Wright's Gem was the victor in a red-flag-shortened race two, from Robbie Watt's Lola and Cater.



BRITISH HILLCLIMB CHAMPIONSHIP  
PRESCOTT, APRIL 26-27, ROUNDS 1-2

# Summers reigns at Prescott

LAST SEASON'S HIGH-SCORING sensation Alex Summers continued where he left off, winning both run-offs at Prescott and defeating 2013's title rivals with relative ease.

Reigning champion Scott Moran made a promising start to his title defence as the second-highest scorer with his father Roger next in line.

Trevor Willis also made a great start with second in round one, excelling on a damp track, but later got it badly wrong at the Esses and ended up at the bend-with-no-name with a wheel and rear wing off the car.

Wallace Menzies suffered when his car would not fire up for the first run-off. He appeared later but could only finish ninth. A similar fate befell Will Hall a few runs earlier when his remote starter coupling came apart.

He made a better recovery than Menzies, however, with a third-place finish in the second run-off.

Alastair Crawford equalled his best



Summers took a Prescott double

**ROUND 1 1 Alex Summers (1.3s DJ-Suzuki Firehawk) 43.78s;** 2 Trevor Willis (3.2 OMS-RPE 28) 44.68s; 3 Scott Moran (3.5 Gould-NME GR61X) 45.62s; 4 Roger Moran (3.5 Gould-NME GR61X) 45.74s; 5 Alastair Crawford (2.8 Gould-NME GR55) 46.36s; 6 Richard Spedding (1.6 Force-Suzuki PC) 46.62s; 7 David Uren (1.3t Force-Suzuki PC) 46.78s; 8 John Bradburn (3.5 Gould-Cosworth GR55) 46.90s; 9 Andy Dunbar (1.0 Force-Suzuki PT) 47.35s; 10 Rob Capper (1.0 Force-Suzuki PT) 48.00s. DNS Wallace Menzies (3.2 DJ-Cosworth Firestorm) DNS Will Hall (3.5 Force-Nissan WH).

**ROUND 2 1 Summers 37.94s (BTD);** 2 S Moran 38.21s; 3 Hall 38.40s; 4 R Moran 38.90s; 5 Bradburn 39.25s; 6 Crawford 39.67s; 7 Tom New (4.0 Gould-Judd GR55) 39.87s; 8 Spedding 39.90s; 9 Menzies 40.63s; 10

Oliver Tomlin (4.0 Pilbeam-Judd MP97) 40.78s; 11 Rob Stevens (1.4s Force-Suzuki SR4) 40.84s; DNF Willis. **Class winners** Ian Richards (2.0 Renault Clio) 57.59s; Paul Harris (2.0t Mitsubishi Evo 6) 49.92s; Simon Jenks (1.6 Caterham-Suzuki) 47.85s; Carl Jones (1.3 Austin Mini) 51.21s; Darren Balster (2.0 Ford Escort) 52.10s; Eynon Price (2.2s Vauxhall VX220) 46.38s; Martin Watts (1.0 Sylva Riot) 50.13s; Mike Bainbridge (1.8 Ginetta-Ford G20) 57.47s; Stevens 41.32s; Gary Hill (0.6 OMS-Yamaha) 44.79s; Chris Aspinall (1.0 Empire-Suzuki Wraith) 41.98s; Darren Gumbley (1.6 Formula Ford) 49.32s; Spedding 41.18s; Summers 38.97s; S Moran 38.56s.

**POINTS 1 Summers, 20;** 2 S Moran, 17; 3 R Moran, 14; 4 Crawford, 11; 5 Willis/Bradburn, 9; 7= Hall/Spedding, 8; 9= New/Uren, 4.

performance and, with the sweet sounding NME V8 running properly, could well achieve his maiden top-10 finish this year.

John Bradburn arrived almost

breathless from holiday but was as consistent as ever and currently sits fifth in the points table, equal with 2012 champion Willis.

● Eddie Walder



DEMPSTER

## In brief

### Formula Libre Ireland

Eamon Matheson (above) took a dominant win at Kirkistown and looked set for success in the second, despite coming under pressure from Mark Crawford, Stanley Watson and Tim Buckley. However, a determined lunge by Watson at the hairpin in the closing stages took him into the lead while Matheson found himself facing the wrong way. He recovered to place fifth.

### Ginetta Juniors

Two superb races at Kirkistown ended with Jack Finlay and Wilson Thompson separated by little more than a cigarette paper. Finlay took the honours in the first encounter while Thompson came up trumps in the second. John Mulholland took third in the first race while James Roe was the final podium finisher in the second.

### Caterham Sigmamax

Jeremy Webb eased himself clear of Neil Shinner to win the first Caterham Sigmamax Graduate race at Anglesey, after Mick Whitehead spun back to ninth on lap two. Richard Pursglove was a distant third. After some late-race dicing with Martin Amison, Shinner just held on to win race two, with Webb recovering to third after an earlier excursion.

### Max5

Jonathan Cryer continued his Max5 domination with victory in race one at Anglesey, leaving poleman Ian Loversidge to keep Jonathan Halliwell at bay for second. Loversidge won the non-championship race then inflicted a first proper defeat on Cryer, who briefly nosed ahead again four laps later but couldn't hold on. Halliwell completed the podium again.

### Junior Saloons

James Dorlin converted his pole position into a comfortable Junior Saloons win at Anglesey, with Ben Mills a clear second and Ben Colburn just taking third from Alex Day. Tom Stockton led race two from pole until he outbraked himself into the final turn on lap six, handing the advantage to Mills (below).



BOURNE



Murray converted pole to two race wins

DEMPSTER

FF1600 KIRKISTOWN, APRIL 26 500MRCI

## Unrivalled Murray cleans up at Kirkistown

**TWO SUPERB STARTS FROM POLE** followed by a brace of unchallenged wins allowed Niall Murray to move into a commanding position in the Northern Ireland Formula Ford 1600 Championship last weekend.

His tenure at the top is such that he didn't really need the two extra points he received for producing a couple of fastest laps. Behind him though, there was plenty of action with Noel Dunne and Adrian Pollock locked in combat throughout the weekend. Pollock reached the chequered flag before Dunne in the opening race, before the tables were turned in the second encounter.

Fourth and Pre-'90 honours in both races went to defending Northern Ireland Sevens champion Alan Davidson, who had his first outing in the Mondiale used by Jonny McMullan last year.

Behind him an entertaining struggle in the first race enlivened things with Chris Paul, Andrew Noble, Ryan Campbell and Mike Todd all involved – Todd setting a new Pre-'87 record along the way. Paul and Noble eventually took the final top-six places.

The pair resumed their battle in the second race and it looked likely to last until the end, but a tangle at

Colonial brought out the red flags as Paul emerged from his upturned car. ● Richard Young

**RESULTS (16 LAPS) 1 Niall Murray (Van Diemen LA10) 16m35.573s (88.847mph);** 2 Adrian Pollock (Van Diemen DP08) + 6.791s; 3 Noel Dunne (Van Diemen RF01); 4 Alan Davidson (Mondiale M89S); 5 Chris Paul (Van Diemen RF97); 6 Andrew Noble (Van Diemen LJO12K). **Class winners** Davidson; Mike Todd (Mondiale M84S); Colin Coates (Crossle 32F). **Fastest lap** Murray 1m01.263s (88.842mph). **RACE 2 (11 LAPS) 1 Murray 11m12.548s (88.331mph);** 2 Dunne + 3.745s; 3 Pollock; 4 Davidson; 5 Paul; 6 Noble. **CW** Davidson, Todd & Coates. **FL** Murray 1m01.621s (88.331mph).

SALOON & GT KIRKISTOWN, APRIL 26 500MRCI

## Finn flies to double Saloon and GT glory

**CONNAIRE FINN TOOK TWO WINS** IN the combined Saloon and GT encounters last weekend, but the Ginetta driver didn't have things all his own way, with Jim Hutchinson's Sonny Howard Escort providing plenty of opposition.

In the opening race the Escort shadowed the Ginetta until close to

the end when a bonnet pin gave way, depriving him of visibility and second place, which went to Mike Johnston's supercharged BMW Compact.

Race two was closer, however, and the Escort led until the final lap when Finn found a way past to take the honours by 0.8 seconds. Johnston was in the thick of the action, until

the BMW lost two cylinders a couple of laps from home eventually limping in behind David Beatty's Ginetta.

Stephen Traub was best of the front-wheel-drive brigade, finishing fifth in the second race, but he had to give best to Richard Ryan in the first. Andrew Armstrong and team-mate Aiden Vance provided much of the entertainment, circulating side-by-side, but in both races it was Armstrong ahead when the flag fell. ● Richard Young



Finn was the class of the field

**RESULTS (13 LAPS) 1 Connaire Finn (Ginetta G50) 13m37.685s (88.602mph);** 2 Mike Johnston (BMW M3) +0.372s; 3 David Beatty (Ginetta G50); 4 Richard Ryan (BMW M3); 5 Stephen Traub (Honda Integra); 6 Donal O'Neill (SEAT Cupra). **Class winners** Johnston. **FL** Johnston 1m01.248s (88.869mph) **RACE 2 (12 LAPS) 1 Finn 14m01.972s (88.275mph);** 2 Jim Hutchinson (Ford Escort) +0.862s; 3 Beatty; 4 Johnston; 5 Traub; 6 Ryan. **CW** Johnston. **FL** Beatty 1m01.638s (88.306mph).

# NATIONAL RESULTS ROUND-UP

## SILVERSTONE APRIL 26-27, MSVR



**JIM WALSH TROPHY (7 LAPS)** 1 Oliver White (Van Diemen RFO1) 16m44.513s (91.83mph); 2 Michael Moyers (Ray GRO7) +4.267s; 3 Jonathan Hoad (Van Diemen RF90); 4 Luke Williams (Ray GR13); 5 Ben Anderson (Ray GR507); 6 Ashley Dibden (Mygale SJ-01). **FL** White 2m21.822s (92.91mph).  
**MK2 GOLF GTI (BOTH 6 LAPS)** 1 Jamie Martin 16m28.779s (79.96mph); 2 James Bark +1.120s; 3 Jason Tingle; 4 Josh Johnson; 5 Chris Skipp; 6 Adam Hance. **Class winner** Andrew Aldridge. **Fastest lap** Bark 2m39.576s (82.58mph).  
**Race 2 (15 LAPS)** 1 Martin 15m58.322s (82.50mph); 2 Tingle +2.160s; 3 Bark; 4 Johnson; 5 Skipp; 6 Dan Gibbs.  
**CW** Adrian Ward. **FL** Tingle 2m38.445s (83.16mph).  
**SPORTS 2000 (14 LAPS)** 1 Patrick Sherrington (MCR) 30m52.877s (99.56mph); 2 Nick Bates (Lola B07/90); 3 Tom Stoten (Gunn TS11); 4 Peter Needham (MCR); 5 Paul Streat (MCR); 6 Scott Guthrie (Van Diemen).  
**CW** Guthrie; Roger Donnan (MCR); Michael Gibbins (Lola T590); Damien Griffin (Lola T598); Phillip Ledger (Crosle 9S); Rollo Tomasi (Swift DB2). **FL** Sherrington 2m11.152s (100.47mph).  
**VAG TROPHY (BOTH 6 LAPS)** 1 Dan Rose (SEAT Leon Cup) 15m02.396s (87.61mph); 2 Paul Taylor (VW Mk4 Golf R32) +6.356s; 3 David Fairbrother (VW Scirocco); 4 Ken Lark (VW Corrado VR6); 5 Harry Vaulkhard (Mk2 Golf GTI); 6 Martin Culley (VW Beetle RSI 3.2). **Class winners** Darren Bedford (Mk4 Golf GTI); James Bark (Mk2 Golf GTI); Peter Kennerly (Mk4 Golf GTI).  
**FL** Stewart Lines (Scirocco) 2m27.503s (89.33mph).  
**Race 2 (15 LAPS)** 1 Taylor 15m13.491s (86.55mph); 2 Fairbrother +11.803s; 3 Richard Morgan (Mk5 Golf GTI); 4 Lark; 5 Rose; 6 Culley. **CW** James Dowding (Mk4 Golf GTI); Tony Taylor (Mk3 VR6); Adam Hance (Mk2 Golf).  
**FL** Rose 2m29.093s (88.38mph).  
**ATOM CUP (BOTH 9 LAPS)** 1 Andrew Smith 21m50.891s (90.47mph); 2 Martin James +15.710s; 3 Paul Donkin; 4 Ben Hingeley; 5 Nick Whitehead; 6 Richard Marler. **FL** Smith 2m23.702 (91.70mph). **Race 2 (15 LAPS)** 1 Whitehead 21m50.399s (90.50mph); 2 Danny Keirle +3.810s; 3 Smith; 4 James; 5 Donkin; 6 Hingeley. **FL** Smith 2m23.953 (91.54mph).  
**MSVT TEAM TROPHY (23 LAPS)** 1 Stephen Darbey/Alistair Stenhouse (BMW 3-series) 1h00m57.886s (82.85mph); 2 Darren Goes (SEAT Supercopa) +0.875s; 3 Matthew Weymouth (BMW M3); 4 Mark Flower (BMW M3); 5 Chris Fryer/Chris Oakman (Mini Cooper S JCW); 6 Matt Cherrington/Martin Gambling (BMW Z3). **CW** Fryer/Oakman; Cherrington/Gamble; Edward Christie (BMW E30 M3). **FL** Richard Preece/James Reed 2m30.666s (87.46mph).

## DONINGTON PARK APRIL 26-27, MSVR



**ROAD SALOONS (15 LAPS)** 1 Matt Seldon (BMW E36 M3) 20m31.973s (86.74mph); 2 Stephen Pearson (BMW E36 M3) +2.611s; 3 Karl Cattliff (BMW E36 M3); 4 Mike Dugdale (BMW E36 M3); 5 Richard Evans (BMW E36 M3); 6 Dave Griffin (BMW E36 M3). **Class winners** Eddie McKean (BMW E36 M3); Ross Elliott (BMW 328i Coupe); Tony Maryon (BMW E30 320); Richard Ibrahim (BMW E30 325i). **FL** Pearson 1m20.756s (88.22mph).  
**Race 2 (15 LAPS)** 1 Cattliff 20m30.920s (86.82mph); 2 Dugdale +11.954s; 3 Nigel Innes (BMW E36 M3);

4 Evans; 5 Darren Stamp (BMW E36 M3); 6 Pearson. **CW** McKean; Rodney Frost (Jaguar XJS); Ibrahim; Maryon; Colin Stubbs (Rover 216 GTi). **FL** Cattliff 1m20.301s (88.72mph).  
**MONO DTEC/1800/1600/CLASSIC (9 LAPS)** 1 Daniel Hands (Van Diemen O1) 10m48.945s (98.80mph); 2 Lee Cunningham (Van Diemen) +0.761s; 3 Francis Phillips (Reynard 923); 4 Mike Hatton (Vauxhall Lotus); 5 Alistair Bell (Reynard 883); 6 Shane Kelly (Van Diemen FR). **CW** Paul Britten (Van Diemen RFOO); Luke Rosewell (Ray 96); Douglas McLay (Mygale SJ10). **FL** Hands 1m10.768s (100.67mph).  
**RACE 2 (7 LAPS)** 1 Kevin Otway (Van Diemen 99) 10m28.466s (79.35mph); 2 Hands +6.253s; 3 Cunningham; 4 Bell; 5 Louis Watts (Van Diemen FX02); 6 Richard Snuggs (Dallara F387). **CW** Britten; Matthew Walters (Formula Vauxhall Junior). **FL** Otway 1m25.734s (83.10mph).  
**TOYO TIRES PRODUCTION BMW (13 LAPS)** 1 Rob Gray 20m22.451s (75.76mph); 2 Harry Goodman +5.804s; 3 Mark Palmer; 4 Matthew Swaffer; 5 Gary Feakins; 6 James Foad. **FL** Gray 1m27.698s (81.24mph).  
**RACE 2 (8 LAPS)** 1 Feakins 14m22m797s (66.06mph); 2 Goodman +0.500s; 3 Foad; 4 Waite; 5 Swaffer; 6 Jack Gabriel. **FL** Waite 1m37.042s (73.41mph).  
**MONO 2000/MOTO (14 LAPS)** 1 Chris Woodhouse (Speads RM04) 16m03.313s (103.54mph); 2 Jonathon Hughes (Dallara F301) +4.431s; 3 Ben Cater (Dallara F301); 4 Adrian Wright (GEM AW3); 5 Jason Timms (Speads RM07); 6 Peter Venn (Dallara F301). **CW** Hughes. **FL** Woodhouse 1m07.441s (105.64mph). **Race 2 (6 LAPS)** 1 Wright 10m41.764s (66.60mph); 2 Robbie Watts (Lola F106/03) +0.683s; 3 Cater; 4 Cian Carey (Formula Renault); 5 Tony Bishop (Dallara F304); 6 Jason Timms. **CW** Watts. **FL** Carey 1m20.800s (88.17mph).

## KIRKISTOWN APRIL 26, 500MRCI



**FORMULA LIBRE (12 LAPS)** 1 Eamon Matheson (E5) 11m16.961s (96.481mph); 2 Mark Crawford (Jedi Suzuki) +7.846s; 3 Tim Buckley (Dallara 304); 4 Stanley Watson (Lola Chevrolet); 5 John Daly (Lola Holden); no other finishers. **FL** Matheson 54.389s (100.076mph). **Race 2 (14 LAPS)** 1 Watson 13m27.696s (94.342mph); 2 Crawford +5.806s; 3 Buckley; 4 Noel Robinson (Tatuus Formula Renault); 5 Matheson; 6 Daly. **FL** Watson 56.387s (96.701mph).  
**GINETTA JUNIOR (BOTH 10 LAPS)** 1 Jack Finlay 12m20.242s (73.528mph); 2 Wilson Thompson +0.001s; 3 John Mulholland; 4 Jordan Dempsey; 5 Boris Nikolov; 6 Charlie Linnane. **FL** Thompson 1m12.503s (75.073mph).  
**Race 2 (11 LAPS)** 1 Thompson 12m18.482s (73.703mph); 2 Finlay +0.153s; 3 James Roe; 4 Mulholland; 5 Nikolov; no other finishers. **FL** Finlay 1m12.214s (75.373mph).  
**ROADSPORTS (7 LAPS)** 1 Paul Conn (Crosle 475) 7m35.375s (83.667s); 2 Clive Heak (Locost Suzuki) +0.534s; 3 John Benson (Crosle 375); 4 John McCandless (Crosle 475); no other finishers. **FL** Conn 1m02.376s (87.261mph).

## ANGLESEY APRIL 26-27, BARC

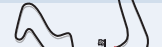

**JUNIOR SALOON (9 LAPS)** 1 James Dorlin 17m15.986s (65.67mph); 2 Ben Mills +3.376s; 3 Ben Colburn; 4 Alex Day; 5 Benn Tilley; 6 Tom Stockton. **FL** Dorlin 1m53.907s (66.36mph).  
**Race 2 (9 LAPS)** 1 Mills 17m17.044s (65.60mph); 2 Stockton +1.612s; 3 Colburn; 4 Charlie Morgan; 5 Dorlin; 6 Charlie Kennedy. **FL** Stockton 1m53.021s (66.89mph).  
**CATERHAM SIGMAX (13 LAPS)** 1 Jeremy Webb

## Stringfellow brought Lambo back to GT Cup



22m52.456s (71.60mph); 2 Neil Shinner +6.481s; 3 Richard Pursglove; 4 Dylan Stanley; 5 Martin Amison; 6 Ray Gilliland. **FL** Pursglove 1m40.954s (74.88mph).  
**Race 2 (19 LAPS)** 1 Shinner 31m46.329s (75.34mph); 2 Amison +0.762s; 3 Webb; 4 Keith Ashworth; 5 Pursglove; 6 Nick Pancisi. **FL** Amison 1m38.930s (76.41mph).  
**MAXS (11 LAPS)** 1 Jonathan Cryer 20m54.508s (66.28mph); 2 Ian Loversidge +5.471s; 3 Jonathan Halliwell; 4 Simon Fleet; 5 Paul Roddison; 6 Thomas Collins. **CW** Amy Barker; Jon Earp. **FL** Cryer 1m48.091s (69.94mph).  
**Race 2 (NON-CHAMPIONSHIP) (12 LAPS)** 1 Loversidge 21m38.613s (69.85mph); 2 Halliwell +9.862s; 3 Fleet; 4 Cryer; 5 Collins; 6 Roddison. **CW** Ged Kelly; Tom Fenton. **FL** Loversidge 1m46.925s (70.70mph).  
**Race 3 (12 LAPS)** 1 Loversidge 21m35.651s (70.01mph); 2 Cryer +2.541s; 3 Halliwell; 4 Roddison; 5 Collins; 6 Fleet. **CW** Kelly; Fenton. **FL** Cryer 1m46.938s (70.69mph).  
**CATERHAM SUPER & MEGA (11 LAPS)** 1 Brett Ray 20m44.485s (66.82mph); 2 Michael Rowland +0.791s; 3 Oliver Gibson; 4 David Hewitt; 5 Adrian Russell; 6 Tom Overton. **CW** Martin Kay. **FL** Rowland 1m50.958s (68.13mph). **Race 2 (19 LAPS)** 1 Matt Thompson 32m13.544s (74.28mph); 2 Ian Anderson +3.725s; 3 Ray; 4 Russell; 5 Hewitt; 6 Rowland. **CW** Toby Briant. **FL** Anderson 1m40.630s (75.12mph).  
**SPORTS SALOONS (14 LAPS)** 1 Garry Watson (Westfield SeiW) 23m12.617s (76.00mph); 2 Joe Spencer (Stuart Taylor Locosaki) +4.214s; 3 Paul Rose (Saker); 4 Cam Forbes (Westfield SeiW); 5 Daniel Prendergast (Pell Genesis Evo); 6 Steve Harris (Saker). **CW** Spencer; Rose; Paul Dobson (Mazda RX7); Steven Hibbert (Lotus Sport Elise); Mike Nash (Peugeot 106 Rallye). **FL** Watson 1m37.356s (77.65mph).  
**Race 2 (15 LAPS)** 1 Rose 23m02.685s (82.01mph); 2 Watson +8.475s; 3 Dobson; 4 Harris; 5 Forbes; 6 David Fuller (Stuart Taylor Locosaki). **CW** Watson; Dobson; Fuller; Hibbert; Nash. **FL** Watson 1m30.338s (83.68mph).  
**CATERHAM SIGMA (13 LAPS)** 1 Tristan Judge 23m25.237s (69.23mph); 2 Nigel Board +1.120s; 3 Nick Haryett; 4 Scott Lawrence; 5 Bill Scott; 6 Jason Gale. **FL** Gale 1m43.224s (73.23mph). **Race 2 (19 LAPS)** 1 Max Robinson 32m31.716s (73.59mph); 2 Judge +0.230s; 3 Zoltan Csaba; 4 Lawrence; 5 Board; 6 Haryett. **FL** Robinson 1m40.894s (74.93mph).  
**CATERHAM CLASSIC (12 LAPS)** 1 Graham Smith 22m06.447s (68.39mph); 2 Stuart Thompson +0.141s; 3 Trevor Harber; 4 Graeme Smith; 5 Mark Carter; 6 David Pearson. **FL** Harber 1m48.963s (69.38mph).  
**Race 2 (18 LAPS)** 1 Graham Smith 32m56.943s (68.83mph); 2 Graeme Smith +0.706s; 3 Thompson; 4 Harber; 5 Colin Jardine; 6 Pearson. **FL** Harber 1m48.809s (69.47mph).

## CROFT APRIL 26-27, BARC



**CLASSIC FF1600 (12 LAPS)** 1 Mike Gardner (Crosle 30F) 20m03.076s (76.30mph); 2 Stuart Kestenbaum (Van Diemen RF79) +3.0681s; 3 Andrew Smith (Van Diemen FA73); 4 Nigel Lingwood (Van Diemen RF80); 5 Steve Pearce (Van Diemen RF78); 6 Benjamin Hopton (Van Diemen RF80). **CW** Smith. **FL** Gardner 1m34.690s (80.56mph).  
**Race 2 (13 LAPS)** 1 Gardner 20m01.589s (82.76mph); 2 Kestenbaum +25.086s; 3 Smith; 4 Pearce; 5 Lingwood; 6 Ted Pearson (Crosle 32F). **CW** Smith **FL** Gardner 1m31.214s (83.86mph).  
**CLASSIC FF2000 (14 LAPS)** 1 Ian Pearson (Van Diemen RF83) 20m34.845s (86.73mph); 2 Paul Wighton (Van Diemen RF82) +3.095s; 3 Chris Lord (Van Diemen RF82); 4 Paul Chippindale (Van Diemen RF82); 5 Clive Wood (Van Diemen RF82); 6 Antonio Armelin (Reynard SF79).

**CW** Armelin **FL** Pearson 1m27.014s (87.91mph).  
**Race 2 (13 LAPS)** 1 Wighton 21m28.723s (77.17mph); 2 Pearson +12.144s; 3 Lord; 4 Paul Burt (Van Diemen RF82); 5 Chippindale; 6 Philip Hart (Van Diemen RF82). **CW** Ken Thorogood (Van Diemen RF 78). **FL** Wighton 1m37.532s (78.43mph).  
**BLUE OVAL SALOON (BOTH 10 LAPS)** 1 Olly Allen (Fiesta) 16m11.054s (78.78mph); 2 Robert Drummond (Escort Cosworth) +8.551s; 3 Mike Webb (Focus ST170); 4 Alex Von Erheim (XR2); 5 Gary Wait (Escort Cosworth); 6 Alan Willet (Fiesta); **CW** Hutton (Sierra Cosworth); Robinson; Alan Willet (Fiesta); Drummond. **FL** Drummond 1m35.174s (80.38 mph).  
**Race 2 (15 LAPS)** 1 Davies 16m11.051s (78.78mph); 2 Webb +13.259s; 3 Robinson; 4 Allen; 5 Von Erheim; 6 Laki Christoforou (Escort RS1600). **CW** Webb; Robinson; Brian Long (Fiesta); Wait. **FL** Davies 1m34.790s (80.70mph).  
**THUNDER SALOON (11 LAPS)** 1 Andy Robinson (Ford Falcon V8) 16m29.353s (85.05mph); 2 Vaughan Fletcher (Subaru Impreza) +8.124s; 3 Dave Cockell (Ford Escort Cosworth); 4 Kevin Wendt (BMW M3 E46); 5 AJ Owen (Ford Sierra Cosworth); 6 Richard Neary (Ford Sierra). **CW** Fletcher; Owen. **FL** Robinson 1m28.485s (86.45mph).  
**Race 2 (9 LAPS)** 1 Wendt 15m23.764s (74.53mph); 2 Owen +3.113s; 3 Fletcher; 4 Cockell; 5 James Card (BMW M3 E46); 6 Ian Froggatt (Subaru Impreza). **CW** Owen; Fletcher. **FL** Wendt 1m40.118s (76.41mph).  
**PRE-'83 TOURING CARS (9 LAPS)** 1 Stephen Primmet (Ford Escort) 15m14.334s (75.29mph); 2 Mark Osborne (Triumph Dolomite Sprint) +26.738s; 3 John Wright (Ford Escort RS); 4 Alan Greenhalgh (Vauxhall Firenza); 5 Len Allgood (Ford Escort); 6 Nic Strong (Ford Capri). **CW** Strong; Neil Bray (Ford Fiesta); Stephen Yates (Ford Escort Mk3 RS1600). **FL** Primmet 1m40.223s (76.33mph).  
**Race 2 (8 LAPS)** 1 Primmet 15m05.062s (67.62mph); 2 Strong +10.116s; 3 Osborne; 4 Bray; 5 Yates; no other finishers. **CW** Strong; Bray; Yates. **FL** Primmet 1m48.607s (70.43mph).  
**PRE-'93 TOURING CARS (BOTH 9 LAPS)** 1 Jim McLoughlin (Ford Sierra Cosworth) 16m44.768s (68.52mph); 2 Paul Bellamy (BMW M3) +8.933s; 3 Dave Hickton (BMW M3); 4 Jerry Hampshire (Renault 5 GT); 5 Rodger Card (BMW M3 E30); 6 Michael Sheraton (BMW M3 E30). **CW** Hampshire; Card; Simon Sheridan (Ford Fiesta XR2); Stephen Kirton (Vauxhall Astra). **FL** Bellamy 1m49.326s (69.97mph).  
**Race 2 (11 LAPS)** 1 McLoughlin 16m30.485s (69.51mph); 2 Bellamy +5.544s; 3 Hickton; 4 Malcolm Wise (Ford Sapphire Cosworth); 5 Sheraton; 6 Graham Myers (Ford Sierra Cosworth). **CW** Sheraton; Kirton; Neil Bray (Ford Fiesta); Nathan Osman (BMW 320is). **FL** McLoughlin 1m47.933s (70.83mph).  
**PRE-2005 PRODUCTION TOURING CARS (10 LAPS)** 1 Steve Rowles (Proton Satria) 18m14.647s (69.88mph); 2 James Fisher (BMW Mini Cooper) +1 lap; 3 Phillip Waller (Peugeot 206 180 GTi); 4 Mohammed Elshimy (Peugeot 206); no other starters. **CW** Fisher; Waller. **FL** Fisher 1m46.592s (71.76mph). **Race 2 (9 LAPS)** 1 Fisher 16m42.632s (68.67mph); 2 Rowles +1m48.171s; 3 Waller; 4 Elshimy; no other starters. **CW** Fisher; Rowles; Waller. **FL** Fisher 1m48.612s (70.43mph).  
**HONDA VTEC CHALLENGE (10 LAPS)** 1 Robert Burkinshaw (Integra Type R) 16m15.705s (78.40mph); 2 Mark Chese (Civic Type R) +25.664s; 3 Phil Wright (Accord Type R); 4 Andy Smith (Accord); 5 Simon Jessop (Integra Type R); 6 Dawn Boyd (Civic Type R). **CW** Wright; Chese. **FL** Burkinshaw 1m36.226s (79.50 mph).  
**Race 2 (9 LAPS)** 1 Burkinshaw 15m16.754s (75.10mph); 2 Wright +43.754s; 3 Jessop; 4 Chese; 5 Smith; 6 Boyd. **CW** Wright; Chese. **FL** Burkinshaw 1m39.417s (76.94mph).

## Packed Vee grids at Brands led to this



HAWKINS

Teddington Studios, Broom Road, Teddington, Middlesex TW11 9BE, UK.  
Tel: +44 (0) 20 8267 5804 Fax: +44 (0) 20 8267 5922  
E-mail: mail@autosport.com Website: www.autosport.com

**EDITOR**  
Charles Bradley ext.5889  
charles.bradley@haymarket.com

**DEPUTY EDITOR**  
Marcus Simmons ext.5807  
marcus.simmons@haymarket.com

**GROUP F1 EDITOR**  
Jonathan Noble ext.5810  
jonathan.noble@haymarket.com

**GRAND PRIX EDITOR**  
Edd Straw ext.5887  
edd.straw@haymarket.com

**F1 ASSISTANT EDITOR**  
Ben Anderson ext.5425  
ben.anderson@haymarket.com

**FEATURES EDITOR**  
Kevin Turner ext.5432  
kevin.turner@haymarket.com

**EDITOR AUTOSPORT.COM**  
Glenn Freeman ext.5309  
glenn.freeman@haymarket.com

**MANAGING EDITOR**  
Peter Hodges ext.5903  
peter.hodges@haymarket.com

**RALLIES EDITOR**  
David Evans  
david.evans@haymarket.com

**ART EDITOR**  
Lydney Row ext.5914  
lydney.row@haymarket.com

**SENIOR DESIGNER**  
Michael Cavalli ext.5381  
michael.cavalli@haymarket.com

**PHOTOGRAPHS**  
LAT Photographic

**PRESENTER/SUB-EDITOR**  
Henry Hope-Frost ext.5835  
henry.hope-frost@haymarket.com

**ASSISTANT EDITOR**  
Scott Mitchell ext.5370  
scott.mitchell@haymarket.com

**GROUP PICTURE EDITOR**  
Peter Mills ext.5918  
peter.mills@haymarket.com

**AUTOSPORT.COM TECHNICAL TEAM LEADER**  
Geoff Creighton  
geoff.creighton@haymarket.com

**AUTOSPORT.COM DEVELOPER**  
Tomasz Trznadel  
tomasz.trznadel@haymarket.com

**OFFICE MANAGER**  
Joanne Grove ext.5804  
joanne.grove@haymarket.com

**SPECIAL CONTRIBUTORS**

Gary Watkins	Dieter Rencken	Alan Eldridge
Marcus Pye	Gary Anderson	Pablo Elizalde
Mark Glendenning	Giorgio Piola	Matt Beer

**CORRESPONDENTS**

<b>ARGENTINA</b> Tony Watson	<b>ITALY</b> Roberto Chinchero	Martin, David Phillips, Diego Mejia, Robin Miller, Jeremy Shaw
<b>AUSTRALIA</b> Phil Branagan	<b>JAPAN</b> Jiro Takahashi, Len Clarke	<b>UK &amp; EIRE</b> Jonathan Crawford, Dan Cross, Kerry Dunlop, Leanne Fahy, Paul Healy, Paul Judd, Linda Keen, Mark Libbeter, Stephen Lickorish, Marc Orme, Graham Read, Hal Ridge, Peter Scherer, Ian Sowman, James Stacey, Oliver Timson, Ian Titchmarsh;
<b>AUSTRIA</b> Gerhard Kuntzschik	<b>NEW ZEALAND</b> Bernard Carpinter	<b>USA</b> Matt Upton, Eddie Walker, Richard Young
<b>BELGIUM</b> Gordon McKay	<b>RUSSIA</b> Gregory Golyshov	
<b>BRAZIL</b> Lito Cavalcanti	<b>SOUTH AFRICA</b> Richard Asher	
<b>FINLAND</b> Esa Illoinen	<b>SPAIN</b> Raimon Duran	
<b>GERMANY</b> Rene de Boer	<b>SWEDEN</b> Tege Iornvall	
<b>GREECE</b> Dimitris Papadopoulos	<b>USA</b> Jonathan Ingram, Bruce	

**ADVERTISING**  
Tel: +44 (0) 20 8267 5820  
Fax: +44 (0) 20 8267 5850  
E-mail: autosport.ads@haymarket.com

**DISPLAY SALES MANAGER**  
Martin Lee, ext: 5289  
martin.lee@haymarket.com

**DISPLAY ADVERTISING**  
Gary Lee Hoebeck, ext: 5276  
gary.lee.hoebeck@haymarket.com

**LUKE RICKETTS**, ext: 5961  
luke.ricketts@haymarket.com

**DON RUPAL**, ext: 5244  
don.rupal@haymarket.com

**CLASSIFIED SALES MANAGER**  
Jonathan Whitehead, ext: 5908  
jonathan.whitehead@haymarket.com

**CLASSIFIED ADVERTISING**  
Peter Musumeci, ext: 5992  
peter.musumeci@haymarket.com

**KATY SNOWBALL**, ext: 5367  
katy.snowball@haymarket.com

**ONLINE ADVERTISING**  
Alex Newberry, ext: 5244  
alex.newberry@haymarket.com

**LEAH MINNMS**, ext: 5846  
leahminnms@haymarket.com

**MATT SIMPKIN**, ext: 5820  
matt.simpkin@haymarket.com

**SUBSCRIPTIONS**  
UK 0844 8488817  
OVERSEAS +44 (0)1795 592 974  
EMAIL autosport@servicehelpline.co.uk

AUTOSPORT, ISSN number 0269946X, is published weekly by Haymarket Media Group, Teddington Studios, Broom Road, Teddington TW11 9BE, United Kingdom. The US annual subscription price is \$235. Airfreight and mailing in the USA by agent named Air Business Ltd, c/o Worldnet Shipping Inc., 156-15, 14th Avenue, 2nd Floor, Jamaica, NY 11434, USA. Periodicals postage paid at Jamaica NY 11431. Subscription records are maintained at Haymarket Media Group, Teddington Studios, Broom Road, Teddington TW11 9BE. Air Business Ltd is acting as our mailing agent.

**MANAGEMENT GROUP DIRECTOR**  
Tim Bulley

**GROUP COMMERCIAL DIRECTOR**  
Ben Guyan

**GROUP EDITOR**  
Anthony Rowlinson

**GROUP EDITOR**  
Anthony Rowlinson

**GROUP LTD**  
Publishing, trade and further subscription details on www.autosport.com While due care is taken to ensure the contents of AUTOSPORT are accurate, the publishers and printers cannot accept liability for errors and omissions. Advertisements are accepted for publication in AUTOSPORT only upon Haymarket Media Group's standard Terms of Acceptance of Advertising, copies of which are available from the Advertising Sales Department of AUTOSPORT.

**EDITORIAL DIRECTOR**  
Mark Payton

**CREATIVE DIRECTOR**  
Paul Harpin

**STRATEGY AND PLANNING DIRECTOR**  
Bob McDowell

**PUBLISHING DIRECTOR**  
Patrick Fuller

**MANAGING DIRECTOR**  
David Prasher

**CHIEF EXECUTIVE**  
Kevin Costello

Haymarket is certified by BSI to environmental standard ISO14001

# THIS WEEK

LETTERS • BEST PICS • LATEST GEAR • ON TRACK & SCREEN • ONLINE

## What you think of the motorsport news of the past week



COATES/LAT

Did Bernie indulge in divide and rule over F1's cash pot?

## F1 finances finally need sorting

An interesting piece last week about cost-cutting in F1 (*Debrief*, p32). Perhaps there wasn't enough space, but it did not address the issue of Bernie Ecclestone's responsibility for the arcane way that the money is divided up between the teams. My perception is that Bernie has split up the money on a sort of divide and rule principle. It's completely unacceptable that teams such as Ferrari and Red Bull got so much when the new squads were left with

so little. No team is bigger than the sport. It has also struck me as unfair the way the tracks are treated when they have so many costs to cover. We can only hope these inequalities are sorted out sooner rather than later.

**Alan Clark Redditch**

Take a look at our archive of Dieter Rencken's columns at autosport.com, Alan. You'll find he explores this subject in exhaustive detail – ed

**It's hard to believe that two** decades have passed since the events of Imola and the tragic deaths of Ayrton Senna and Roland Ratzenberger, and while all enter motorsport knowing the danger, it still comes as a great shock when such events occur.

The safety crusade that originated from the 1970s but was heightened and brought home by that fateful weekend has done a sterling job in the intervening years to prevent such an incident from occurring again, and long may that continue.

**Michael Brierley**  
Stalybridge, Cheshire

**At last, Formula 1 is going to** make some changes to make the sport more appealing. Noise: the new quieter cars are going to be augmented with speakers

playing *Ride of The Valkyries* whenever DRS is active, and *Seven Nation Army* when cars change places.

Sparks: F1 cars will be fitted with friction spark generators, just like the children's push'n'go cars of a bygone age. To ensure consistency, and not rely on the driver taking the car to its limit in specific circumstances and areas of tracks, the friction generators will be set so the cars will spark whenever they exceed 100km/h.

Trails: to help fans follow the technicality of the racing, whenever the ERS is deployed the cars will emit silly string from their rear wings.

Race format: it's clear a race lasting up to two hours is far too long. It would be ideal if races could be completed in half that time. Further, in the interests of cost-cutting all teams should field cars from the same manufacturer. This would have the

added benefit of allowing fans to instantly know which driver was the best. In addition it is felt the name Formula 1 seems a bit like 'formula beginner' and so it should be rebranded as Grand Prix 2.

The naysayers believe that the spectacle should be organic and not contrived: that a car should spark and vapour should condense not on a whim, but only because the car is operating in extremis. To that I say if you want purity follow NASCAR not future F1.

**Paul Irwin**  
Bexleyheath

**In answer to the question posed** by Dr Paul Sheldon (*Letters*, April 24), I would suggest after three consecutive championships and a blatant disregard for team orders.  
**Dr Steven Jeffery**  
Brackley, Northants

# In pictures

Images around the globe, from the USA to Italy, via Spain and New Zealand



**REED ALL ABOUT IT**  
Reed Sorenson had to be dragged from his burning NASCAR Chevy at Richmond on Sunday night, one of the victims of several tyre failures that led to serious conflagration

EHRRARDT/GETTY



**RALLYCROSS STARS HIT TRACK IN ITALY**  
Petter Solberg and Anton Marklund led the way as the FIA World Rallycross Championship geared up at Franciacorta in Italy last week

MCKLEIN/LAT

**THE SON ALSO RISES**  
Carlos Sainz Jr flies high as he celebrates his convincing first win on home soil at Motorland Aragon's Formula Renault 3.5 opener on Saturday



**KERB YOUR ENTHUSIASM**  
V8 Supercar king Jamie Whincup suffered a poor weekend at Pukekohe, with Triple Eight boss Roland Dane declaring that "all leave is cancelled"



CLANFLORE/GETTY

## In the shops

Desirable new releases

### 'SENNA: ALL HIS RACES' BOOK

£40 – [evropublishing.com](http://evropublishing.com)  
Former AUTOSPORT staffer Tony Dodgins has compiled race-by-race memories of Ayrton Senna's full career – from karting to that fateful F1 weekend 20 years ago today (Thursday). The book's real draw, though, is the surplus of telling recollections from those closest to Senna.



### 'SENNA' DVD DOCUMENTARY

£10.99 – [dukevideo.com](http://dukevideo.com)  
Just in case there are any F1 fans who haven't seen the BAFTA-winning documentary on the life of Ayrton Senna – and if so, where've you been?! – here's another plug for it. And it's on offer with our friends at Duke at the moment, so get on line and order the 1h46m epic now.



### SENNA McLaren MP4/6 1:18

£229.99 – [autosport.com/shop](http://autosport.com/shop)  
TrueScale Miniatures' incredible 1:18-scale resin replica of the McLaren MP4/6 used by Ayrton Senna to clinch his third and final title in '91 comes with removable rear bodywork to show the highly detailed Honda V12 engine. It will be limited to just 500 pieces worldwide.



# WHAT'S ON

## ON TRACK IN THE UK

### THRUXTON

**May 3-4**  
**BARC**

UK tin-top action doesn't get any faster than the British Touring Car Championship round at Thruxton. The MGs of Jason Plato and Sam Tordoff flew at Donington Park last time out, while Gordon Shedden claimed the first win for Honda's new Civic Tourer. But it's champion Andrew Jordan who jointly leads the points with Plato. Support comes from the usual cast of Formula Ford, Carrera Cup, Clio Cup, Ginetta GT4 Supercup and Ginetta Juniors.

### ROCKINGHAM

**May 4-5**  
**BRSCC**

A trip to Rockingham on Bank Holiday Monday will reward you with a fraught two-hour dose of British GT entertainment as the bumper grid assembles once again – this time for a single race. The meeting also includes the British Formula 3 season opener, while the usual tin-top and baby GT support comes from the Volkswagen Racing Cup, Ginetta GT5 Challenge, Aston Martin GT4 Challenge and new-for-2014 Ginetta Racing Drivers' Club.

### DONINGTON PARK

**HSCC**  
**May 3-5**

Donington Park welcomes the Historic Sports Car Club back for the second time in 2014 with a host of classic-car action packed into three days. The Donington Historic Festival is fast establishing itself as one of the finest historic meetings on the domestic calendar, with FIA Masters, Pre-'66 Touring Cars and Pre-'63 GT races among the highlights.

### SILVERSTONE

**May 3**  
**750MC**

One day is all you need to sample some of the finest club categories in Britain, courtesy of the 750MC. Its new, dedicated Renault Clio 182 category kicks off with a strong field of budget tin-tops, with support from the 750 Trophy Series and Roadsports among others.

### BRANDS HATCH

**MGCC**  
**May 3-4**

Porsche Club, Ferrari Open and Mazda MX5 SuperCup are just three of the series on display, along with MG Metro Cup, Midget Challenge and Peter Best races from the organising MGCC contingent.



BTCC panel bashers descend on Thruxton

### KNOCKHILL

**May 4**  
**SMRC**

Knockhill's loyal legion of single-seater, tin-top and GT racers reconvene at the home of Scottish motorsport on Saturday. Formula Ford 1600, Fiestas, Mini Cooper Cup, Classic Sports and Saloons, Legends and Sports and Saloons provide the hillside entertainment.

### CASTLE COMBE

**May 5**  
**CCRC**

Another Bank Holiday Monday means another one-day meeting at Castle Combe.

The locals – FF1600, GT, Saloon and Sports-Racing Car Series runners – are joined by the Track Attack Race Club's litany of low-cost categories.

### PIRELLI RALLY

**British Rally Championship**  
**May 3-4**

A belated kick-off for the domestic rally series, with the Carlisle-based Pirelli Rally.



**QUESTION TIME**  
presented by  
**AUTOSPORT MOTORSPORT NEWS**

Come to the next KXQT in the marquee next to the Goodwood Bar at Thruxton's BTCC round this Saturday, from 1830. Question the panel – which will include former champs Jason Plato and Fabrizio Giovanardi, TV presenter Louise Goodman, and rookie Jack Clarke – and you could win a prize.

**FREE ENTRY**

## ON TRACK AROUND THE WORLD



### WORLD ENDURANCE CHAMPIONSHIP

**Rd 2/8**  
**Spa-Francorchamps, Belgium**  
**May 3**  
[fiawec.com](http://fiawec.com)

### UNITED SPORTSCARS

**Rd 4/13**  
**Laguna Seca, California, USA**  
**May 4**  
[imsa.com](http://imsa.com)

### DTM

**Rd 1/10**  
**Hockenheim, Germany**  
**May 4**  
[dtm.com](http://dtm.com)

### EUROPEAN FORMULA 3 CHAMPIONSHIP

**Rd 2/11**  
**Hockenheim, Germany**  
**May 3-4**  
[fiaf3europe.com](http://fiaf3europe.com)

### NASCAR SPRINT CUP

**Rd 10/36**  
**Talladega, Alabama, USA**  
**May 4**  
[nascar.com](http://nascar.com)

### WORLD TOURING CAR CHAMPIONSHIP

**Rd 3/12**  
**Hungaroring, Hungary**  
**May 4**  
[fiawtcc.com](http://fiawtcc.com)

### AUTO GP

**Rd 3/8**  
**Hungaroring, Hungary**  
**May 3-4**  
[autogp.net](http://autogp.net)

### WORLD RALLYCROSS

**Rd 1/12**  
**Montalegre, Portugal**  
**May 3-4**  
[rallycrossrx.com](http://rallycrossrx.com)

### INTERNATIONAL GT OPEN

**Rd 1/8**  
**Nurburgring, Germany**  
**May 3-4**  
[gtopen.net](http://gtopen.net)

### EUROFORMULA OPEN

**Rd 1/8**  
**Nurburgring, Germany**  
**May 3-4**  
[euroformulaopen.net](http://euroformulaopen.net)

### SUPER GT

**Rd 2/9**  
**Fuji, Japan**  
**May 4**  
[supergt.net](http://supergt.net)

### FORMULA ACCELERATION 1

**Rd 2/8**  
**Navarra, Spain**  
**May 3-4**  
[acceleration14.com](http://acceleration14.com)



Super GTs star at Fuji

Your guide to the best events taking place in the UK and around the world – plus TV and online

**ON TELEVISION**

**THURSDAY MAY 1\***

0600-0700; 0915-1015 **Sky Sports F1**  
 Ayrton Senna: Journalists' special  
 0700-0800 **Sky Sports F1**  
 Ayrton Senna: The Last Team-mate  
 0800-0815 **Sky Sports F1**  
 Ayrton Senna: Echoes of the Past  
 0845-0915 **Sky Sports F1**  
 Alain Prost on Ayrton Senna  
 1300-1345 **Sky Sports F1**  
 Classic races: European GP 1993  
 1700-1800 **Sky Sports F1**  
 Classic races: Spanish GP 1986  
 1830-1900 **Sky Sports F1**  
 Remembering Roland Ratzenberger  
 1900-2000 **Sky Sports F1**  
 Ron Dennis on Ayrton Senna  
 2000-2100; 2230-2330 **Sky Sports F1**  
 F1 Legends: Ayrton Senna  
 2100-2230 **Sky Sports F1**  
 Classic races: Brazilian GP 1991  
 2230-0040 **ITV**  
 'Senna' BAFTA-winning documentary

**FRIDAY MAY 2**

2135-2205 **Motors TV**  
 Paddy Hopkirk Gala Special  
 2000-2100 **Sky Sports F1**  
 The F1 Show: Senna tribute  
 2130-2300 **Sky Sports F1**  
 Classic races: Japanese GP 1989  
 2235-2340 **Motors TV**  
 Ayrton Senna: Racing is in my blood

**SATURDAY MAY 3**

0720-0810 **Motors TV**  
 British GT: Oulton Park highlights  
 1300-2000 **Motors TV LIVE**  
 World Endurance Championship: Spa

1730-2100 **BT Sport 2**  
 Int'l GT Open: Nurburgring race 1  
 1930-2000 **Eurosport**  
 Dakar Rally 2014: Race2Recovery  
 2000-2305 **Motors TV LIVE**  
 NASCAR Nationwide: Talladega

**SUNDAY MAY 4**

1100-1830 **ITV4 LIVE**  
 BTCC: Thruxton (plus supports)  
 1200-1350 **ESPN LIVE**  
 Int'l GT Open: Nurburgring race 2  
 1215-1315; 1315-1415 **Eurosport LIVE**  
 WTCC: Hungaroring, races 1 & 2  
 1730-2230 **Premier Sports LIVE**  
 NASCAR Sprint Cup: Talladega  
 1800-2030 **Motors TV LIVE**  
 United SportsCars: Laguna Seca  
 1815-2000 **BT Sport 2**  
 DTM: Hockenheim highlights  
 2115-2230 **Motors TV**  
 European F3: Hockenheim, races 2 & 3

**MONDAY MAY 5**

200-2100 **Sky Sports F1**  
 Architects of F1: Gordon Murray  
 2235-0145 **Motors TV**  
 World Endurance C'ship: Spa highlights

**TUESDAY MAY 6**

2235-0040 **Motors TV**  
 United Sports C'ship: Laguna highlights

**WEDNESDAY MAY 7**

2000-2100 **Sky Sports F1**  
 Legends of F1: Sir Frank Williams  
 \*Many of the Ayrton Senna special programmes on May 1 are repeated throughout the week. Check listings

**ONLINE**

**HOT ON THE WEB THIS WEEK**

YouTube 'AYRTON SENNA - THE RIGHT TO WIN' DOCUMENTARY



**SEARCH FOR:** Ayrton Senna-The Right To Win (With Subtitles) (52:03)  
 Superb documentary on the life and times of Ayrton Senna, with archive footage from his entire career, peppered throughout with personal anecdotes and recollections from friends, family, rivals, team-mates and team bosses.

**AUTOSPORT+**

Exclusive content coming up in our premium website this week

We continue our look back at the events in San Marino in 1994, and Edd Straw warns that F1 cannot afford to reach the same level of complacency it had prior to that terrible weekend. Plus, we pick out the main themes to watch out for in the DTM this season, ahead of the Hockenheim opener.

**GET AUTOSPORT ON THE MOVE**

IN THE IPAD ISSUE THIS WEEK

- HIGHLIGHTS FROM INDYCAR, FR3.5 AND NASCAR, PLUS DTM PREVIEW
- ON SALE ALL OVER THE WORLD FOR ONLY £2.99

DOWNLOAD IT NOW FROM AUTOSPORT.COM



**Revved up over what's on the box**

Although so many years have passed, the memory of the 1994 San Marino Grand Prix still feels raw somehow. Like many disasters that have unfolded live on television, it's something that almost feels like a shared experience even though you weren't actually there.

Of course, it's the people who were actually there, who lived through that grotesque weekend of carnage first-hand, who are those we should listen to when they tell their story. Sky Sports F1's *The Last Team-mate*, featuring Damon Hill and David Brabham, respective team-mates of Ayrton Senna and Roland Ratzenberger, upon their return to Imola 20 years on was utterly compelling.

Thoughtful and highly intelligent racing drivers are a rare breed, but both Hill and Brabham are eloquent individuals. Despite the obvious rush of emotions at returning to the place where they lost



their colleagues, they retained a dignified analytical view of the weekend's effect on Formula 1 as a whole.

Both spoke frankly, and Hill summed it up thus: "The whole weekend was horrific and upsetting. I thought, 'If it's going to be like that every weekend, you can count me out.'" Brabham added: "There are things you want to forget, but things you can't forget."

As you'd expect from an emotion-laden documentary, there was plenty of footage of Hill and Brabham pacing around, staring into the middle distance to the echoes of choral music, filmed in soft-focus, but this subject merited that.

The sight of Brabham returning to Tosa, where Ratzenberger's car came to

rest after its fatal impact with the wall hundreds of yards further up the track, was touching even before he said: "I could see it was him... was he OK? What I saw, I knew he wasn't, I realised he'd gone."

Although in the preamble described as an "untold story" (really?) – the only fresh information that I hadn't heard before was Hill revealing that Senna spoke to his wife Georgie before the race – Ayrton told her that she shouldn't worry about Damon, following the death of Ratzenberger in qualifying, and reassured her he felt the Williams car was safe. So much for the stories of premonitions of his death, then.

A difficult subject, respectfully handled and not overly dramatised for its own sake. **Revved Up**

# Terry Kaby

“Our chase car, laden with spares and tools, ploughed into the back of us!”

■ Monte Carlo Rally ■ January 21-27, 1984 ■ Nissan 240RS ■ Intra-team shunt leads to hectic event



Kaby slithered to a finish in his shortened Nissan

MCKLEIN/DE

**MY FIRST MONTE WAS ONE TO** remember! I had been invited by Nissan to drive a 240RS on the 1984 event. I would be using Timo Salonen's recce car that would be refettled after the finish of the recce. Kevin Gormley would be co-driving and the team would be co-ordinated by Bob Freeborough, who'd co-driven for me in the mid-70s.

Well, my second foreign WRC event started badly during the recce, in fact. Just 10 minutes in and we were hanging over a bridge parapet with a 10-metre drop into the water! And later we broke a trackrod and had to drive the infamous Turini stage with one-wheel steering.

They were the least of my problems, as it turned out. Nissan had elected to start from Paris, with the concentration run ending with all crews converging on Aix-Les-Bains. Within a couple of hours of leaving Paris we were waiting at a junction onto a major road and there was a massive bang – we were pushed broadside into the middle of the road.

Our own chase car, a Nissan Patrol heavily laden with spares and tools and fitted with studded tyres, had ploughed into the back of us.

It was a right mess, with the wheels all rubbing the bodywork. The mechanics worked on it for a long time, bashing bodywork and shortening the left-rear links and extending the damaged right-side links to get the wheels to turn. It

was still running about six inches out of line but it was driveable – just.

It was a pig to drive, in fact, once we got into the first few, snow-lined stages. In one of them we came over a crest and it just swapped ends and went like a top down the road, somehow still facing the right way. Then the alternator belt broke and we had no lights, so we followed the next car to the end of the stage.

We went off again in the La Souche stage – needing spectators to rescue us from our perch over a sheer drop.

The weather deteriorated as the rally went on and we had less than no traction at all, sometimes needing a push from spectators and marshals just to get up hills!

When we went off in Sisteron the road was too narrow to turn round so we had to drive half a kilometre in the wrong direction to find a place to turn – not the most exciting thing to do! I was glad when we got to Monte Carlo for the rest halt, I can tell you.

At the restart with 10 stages left, I stayed out of trouble until the final ascent of the Col St Raphael. We went off on black ice, clouted a wall and broke a trackrod. We had to make a temporary repair to get us to the end, so lost loads of time. We'd been behind Timo, who finished 10th, but dropped to 17th by the end.

It was a hard rally but I wouldn't have missed it for the world. ❧  
*Terry Kaby was talking to Henry Hope-Frost*

## PROFILE



### FORMER AUTOCROSSER

Terry Kaby turned to rallying and won the 1980 Castrol/AUTOSPORT National title for Vauxhall. He was a regular on the RAC Rally, taking a best of seventh in 1985 for Nissan. After “not really retiring” he worked as an instructor and WRC gravel-note driver for Petter Solberg until '08. He now instructs at the Tuthill ice-driving school in Sweden and test-drives for manufacturers.

**NEXT WEEK** RICCIARDO'S FLYING START  
Plus: Why the Spanish GP decides F1's form guide

Global Specialists in Bespoke Vehicle Distribution

For Sale **FINANCE AVAILABLE**



**2008 30' Trail Lite B Class**  
Triple slide, TV, Sleeps 5 in 3 beds, 20,381 miles.  
**£59,000**



**2013 25' Mercedes Winnebago Via 25Q**  
Double slide, 2 TVs+DVD, sleeps 4 in 2 beds,  
Luxurious with good space. Delivery miles. **£120,000**



**2009 36' Damon Daybreak 3070**  
Double slide, 20,000 miles, sleeps 4 in 3 beds,  
2 TVs+DVD. **£59,000**



**2004 37' Monaco Windsor 36PBD**  
Double slide. Sleeps 4 in 2 beds, 2 TVs+DVD+Sat, 68,766  
miles. Great condition. **£69,000 REDUCED TO £65,000**



**2002 32' Newmar Dutch Star**  
Double slide, TV, 24,609 miles. Sleeps 4 in 2 beds.  
Great value. **£39,000 REDUCED TO £35,000**



**2012 37' Four Winds Hurricane**  
Triple slide. Sleeps 7 in 5 beds, 2 TVs+Satellite,  
11,008 miles. Cream leather. **£74,000 + VAT**



**2009 25' Four Winds Dutchmen Dorada**  
Double slide, 2 TVs, sleeps 4 in 2 beds. Perfect for  
touring, 10,727 miles. **£65,000 + VAT**



**2007 34' Damon Daybreak 3272**  
Double slide, sleeps 6 in 4 beds, 2 TVs+DVD+Sat, 22,000  
miles. Ideal for family. **£59,000 REDUCED TO £49,000**



For the finest range of American motorhomes for sale or hire:

visit [www.stingrayRV.com](http://www.stingrayRV.com), call **0870 241 5614**

or email [chris@stingrayRV.com](mailto:chris@stingrayRV.com)

Main Dealers for:



Mercedes-Jet



# UNLEASH THE POTENTIAL



**ALIVE TUNING**  
TUNING TRADITION

From Range Rover to Defender, Alive take your vehicle to new levels of performance & refinement, giving grin inducing acceleration, a sharper chassis, and smoothness you never thought possible. We are Alive - Are you?

[www.alivetuning.com](http://www.alivetuning.com)

+44 (0)1472 812900

@AliveTuning

[facebook.com/AliveTuning](https://facebook.com/AliveTuning)