

TRX

PROFESSIONAL GEAR

WWW.TOUREX.BE



FOLDER PROMO 2023/1

DEWALT



**ANNOVI
REVERBERI**
The Power of Experience

KITPRO
professional tools

GENERMORE
reliable power



PUMA

femi

**KITPRO
BASSO**

ZECO
Core drill - Kernbohrer - Fraise

LARIUS
Paint spraying equipment

DREHMANN

Sous réserve de modifications techniques, de prix et d'images. Les prix, en euros et sans recupel ni bebat, sont valables jusqu'au 30/09/2023. Les images ne sont pas contractuelles. Les spécifications des articles peuvent être modifiées sans préavis. Jusqu'à épuisement des stocks. Sous réserve d'erreurs d'impression. DeWalt® est la marque commerciale de Stanley Black & Decker inc, utilisée sous licence. Tous droits réservés.

FR



4



7



13



18



19



22



25



26



28



29



34



35



44



46



48



49



50



60



63



67



71



72



74



75



76



78



80



83



89



92



GÉNÉRATEURS INVERTER À ESSENCE

LC2000I

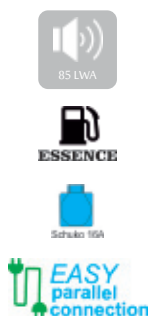

Puissance absorbée:	1,9kVA
Puissance rendue max. AC:	1750W
Puissance en continu AC:	1600W
Type de moteur:	LC145GEN
Niveau sonore:	60dBA 7m
Contenu réservoir:	4L
Poids:	22kg
Lo x La x H:	513x298x425mm
Autonomie en moyenne:	5h
Système de démarrage	Par lanceur

PRIX TARIF
€1115,34
hors TVA

PRIX DE VENTE
€796,67
hors TVA

PRIX DE VENTE
€963,97
TVA incl.

LC3000I



Puissance absorbée:	2,8kVA
Puissance rendue max. AC:	2500W
Puissance en continu AC:	2300W
Type de moteur:	LC164F-4
Niveau sonore:	61dBA 7m
Contenu réservoir:	4,5L
Poids:	27kg
Lo x La x H:	499x298x445mm
Autonomie en moyenne:	4h
Système de démarrage	Par lanceur

PRIX TARIF
€1316,31
hors TVA

PRIX DE VENTE
€940,22
hors TVA

PRIX DE VENTE
€1137,67
TVA incl.

LC3500I0



Puissance absorbée:	3,5kVA
Puissance rendue max. AC:	3300W
Puissance en continu AC:	3000W
Type de moteur:	LCC170F-3
Niveau sonore:	65dBA 7m
Contenu réservoir:	10L
Poids:	33kg
Lo x La x H:	472x400x417mm
Autonomie en moyenne:	9h
Système de démarrage	Par lanceur

PRIX TARIF
€1505,19
hors TVA

PRIX DE VENTE
€1075,14
hors TVA

PRIX DE VENTE
€1300,92
TVA incl.

LC3500ISE



Puissance absorbée:	3,5kVA
Puissance rendue max. AC:	3300W
Puissance en continu AC:	3000W
Type de moteur:	LCC170FD-3
Niveau sonore:	60dBA 7m
Contenu réservoir:	10L
Poids:	45kg
Lo x La x H:	579x440x510mm
Autonomie en moyenne:	9h
Système de démarrage	Par lanceur + dém. à clé

PRIX TARIF
€1756,82
hors TVA

PRIX DE VENTE
€1254,87
hors TVA

PRIX DE VENTE
€1518,39
TVA incl.

LC4800i10



97 LWA



ESSENCE



**SEULEMENT
32KG**

Puissance absorbée:	4,8kVA
Puissance rendue max. AC:	4500W
Puissance en continu AC:	3500W
Type de moteur:	H225G-2
Niveau sonore:	72dBA 7m
Contenu réservoir:	7L
Poids:	32kg
Lo x La x H:	417x455x427mm
Autonomie en moyenne:	6h
Système de démarrage	Par lanceur

PRIX TARIF
€1743,00
hors TVA

PRIX DE VENTE
€1245,00
hors TVA

PRIX DE VENTE
€1506,45
TVA incl.



LÉGENDE PRISES

LC3500PARALLELCONN



2P+PE 10/16A 230V



2P+PE CEE 16/32A 230V
3P+PE CEE 16/32A 230V



3P+N+PE CEE 16/32A 400V



Le connecteur parallèle vous permet de connecter 2 inverters en parallèle.

PRIX TARIF
€136,77
hors TVA

PRIX DE VENTE
€97,69
hors TVA

PRIX DE VENTE
€118,20
TVA incl.

GENERMORE
RENSON
LARIUS
FEMT
DREHMANN
DREIX
BDS
ZECO
TRX
KITPRO
DUMA
AR
DEWALT

GÉNÉRATEURS INVERTER À ESSENCE

LC9000ISE



Puissance absorbée:	9,0kVA
Puissance rendue max. AC:	7500W
Puissance en continu AC:	6500W
Type de moteur:	LC190DF-2 4T OHV
Niveau sonore:	67dBA 7m
Contenu réservoir:	28L
Poids:	120kg
Lo x La x H:	920x765x773mm
Autonomie en moyenne:	6,5h
Système de démarrage	Par lanceur + dém. à clé



PRIX TARIF €4034,21 <small>hors TVA</small>	PRIX DE VENTE €2881,58 <small>hors TVA</small>	PRIX DE VENTE €3486,71 <small>TVA incl.</small>
----------------------------------------------------------	-------------------------------------------------------------	--------------------------------------------------------------

LC9000IO



Puissance absorbée:	9,0kVA
Puissance rendue max. AC:	7000W
Puissance en continu AC:	6000W
Type de moteur:	H420G 4T OHV
Niveau sonore:	72dBA 7m
Contenu réservoir:	25L
Poids:	57,0kg
Lo x La x H:	628x550x552 mm
Autonomie en moyenne:	6,0h
Système de démarrage	Par lanceur + dém. à clé



PRIX TARIF €2287,19 <small>hors TVA</small>	PRIX DE VENTE €1633,71 <small>hors TVA</small>	PRIX DE VENTE €1976,79 <small>TVA incl.</small>
----------------------------------------------------------	-------------------------------------------------------------	--------------------------------------------------------------

GENERMORE
REINSON
LARIUS
FEMI
DREHMANN
DRELUX
BDS
ZECO
TRX
KITPRO
PIUMA
AR
DEWALT

GÉNÉRATEURS À ESSENCE SÉRIE G

G2500-A



Puissance absorbée:	2,5kVA
Puissance rendue max. AC:	2200W
Puissance en continu AC:	2000W
Type de moteur:	LC200F 6,5cv 4T OHV
Niveau sonore:	70dB A 7m
Contenu réservoir:	18L
Poids:	40kg
Lo x La x H:	590x430x467mm
Autonomie en moyenne:	15h
Système de démarrage	Par lanceur

PRIX TARIF
€642,50
hors TVA

PRIX DE VENTE
€458,93
hors TVA

PRIX DE VENTE
€555,31
TVA incl.

G3000-A



Puissance absorbée:	3,0kVA
Puissance rendue max. AC:	2500W
Puissance en continu AC:	2300W
Type de moteur:	LC200F 6,5cv 4T OHV
Niveau sonore:	71dB A 7m
Contenu réservoir:	18L
Poids:	44kg
Lo x La x H:	590x430x467mm
Autonomie en moyenne:	13,5h
Système de démarrage	Par lanceur

PRIX TARIF
€706,91
hors TVA

PRIX DE VENTE
€504,94
hors TVA

PRIX DE VENTE
€610,97
TVA incl.

G3500-A



Puissance absorbée:	3,5kVA
Puissance rendue max. AC:	3100W
Puissance en continu AC:	2800W
Type de moteur:	LC210F 7cv 4T OHV
Niveau sonore:	71dB A 7m
Contenu réservoir:	18L
Poids:	47kg
Lo x La x H:	590x430x467mm
Autonomie en moyenne:	12h
Système de démarrage	Par lanceur

PRIX TARIF
€803,53
hors TVA

PRIX DE VENTE
€573,95
hors TVA

PRIX DE VENTE
€694,48
TVA incl.

G5000D-A



Puissance absorbée:	5,0kVA
Puissance rendue max. AC:	4500W
Puissance en continu AC:	4000W
Type de moteur:	LC340FDV 11cv 4T OHV
Niveau sonore:	71dB A 7m
Contenu réservoir:	25L
Poids:	79kg
Lo x La x H:	730x660x650mm
Autonomie en moyenne:	10h
Système de démarrage	Par lanceur + dém. à clé

PRIX TARIF
€1447,64
hors TVA

PRIX DE VENTE
€1034,03
hors TVA

PRIX DE VENTE
€1251,18
TVA incl.

GENERMORE
RENSON
LARIUS
FEMI
DREHMANN
DREIX
BUS
ZECO
TRX
KITPRO
PUMA
AR
DEWALT

G6500D-A



97 LWA



Puissance absorbée:	6,5kVA
Puissance rendue max. AC:	5500W
Puissance en continu AC:	5000W
Type de moteur:	LC390FDV 13cv 4T OHV
Niveau sonore:	72dBA 7m
Contenu réservoir:	25L
Poids:	81kg
Lo x La x H:	730x660x650mm
Autonomie en moyenne:	9h
Système de démarrage	Par lanceur + dém. à clé

PRIX TARIF
€1575,81
hors TVA

PRIX DE VENTE
€1125,58
hors TVA

PRIX DE VENTE
€1361,95
TVA incl.



- Fusible automatique 23A
- Compteur horaire INCLUS
- Réduction du bruit (silencieux extra large + structure fermée 3/4)

G8000D-A



97 LWA



Puissance absorbée:	8,0kVA
Puissance rendue max. AC:	6500W
Puissance en continu AC:	6000W
Type de moteur:	LC420FDV 14,5cv 4T OHV
Niveau sonore:	72dBA 7m
Contenu réservoir:	25L
Poids:	84kg
Lo x La x H:	730x660x630mm
Autonomie en moyenne:	8h
Système de démarrage	Par lanceur + dém. à clé

PRIX TARIF
€1706,57
hors TVA

PRIX DE VENTE
€1218,98
hors TVA

PRIX DE VENTE
€1474,96
TVA incl.



- Fusible automatique 26A
- Compteur horaire INCLUS
- Réduction du bruit (silencieux extra large + structure fermée 3/4)

G10000D-A*



Puissance absorbée:	10,0kVA
Puissance rendue max. AC:	8000W
Puissance en continu AC:	7000W
Type de moteur:	LC460FDV 16cv 4T OHV
Niveau sonore:	74dBA 7m
Contenu réservoir:	25L
Poids:	90kg
Lo x La x H:	730x660x630mm
Autonomie en moyenne:	7,5h
Système de démarrage	Par lanceur + dém. à clé

PRIX TARIF
€2587,56
hors TVA

PRIX DE VENTE
€1848,25
hors TVA

PRIX DE VENTE
€2236,39
TVA incl.



- Fusible automatique 30A
- Capteur de pression d'huile
- Compteur horaire INCLUS
- Amortissement du bruit (silencieux extra large + structure fermée 3/4)
- Moteur industriel avec lubrification à pression d'huile

G13000D-A*

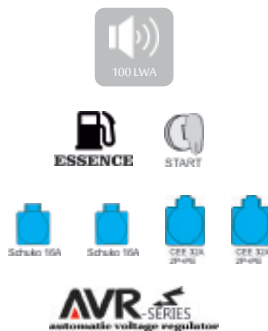

Puissance absorbée:	13,0kVA
Puissance rendue max. AC:	10500W
Puissance en continu AC:	9500W
Type de moteur:	LC196FDV 17,6cv 4T OHV
Niveau sonore:	75dBA 7m
Contenu réservoir:	48L
Poids:	160kg
Lo x La x H:	800x620x650mm
Autonomie en moyenne:	18h
Système de démarrage	Par lanceur + dém. à clé

PRIX TARIF
€4081,00
hors TVA

PRIX DE VENTE
€2915,00
hors TVA

PRIX DE VENTE
€3527,15
TVA incl.



- Fusible automatique 40A
- Capteur de pression d'huile
- Compteur horaire INCLUS
- Amortissement du bruit (silencieux extra large + structure fermée 3/4)
- Moteur industriel avec lubrification à pression d'huile
- Avec crochet de levage

GENERMORE
RENSON
LARIUS
FEMI
DREHMANN
DREIX
BUS
ZECO
TRX
KITPRO
PUMA
AR
DEWALT

CHOISIR UN GÉNÉRATEUR

Lorsque vous choisissez un groupe électrogène, vous devez tenir compte de plusieurs aspects techniques.

Tout d'abord, vous devez déterminer les besoins en énergie des appareils ou des systèmes que vous souhaitez alimenter. Cela peut être calculé en utilisant la puissance (exprimée en watts) des appareils et la puissance totale requise.

Il est important de savoir que deux types de puissance entrent en ligne de compte dans le choix d'un générateur : la puissance de démarrage et la puissance continue. La puissance de démarrage, également appelée puissance de crête, est la puissance supplémentaire nécessaire pour démarrer un appareil. Elle est supérieure à la puissance continue nécessaire pour faire fonctionner l'appareil. Lorsque vous choisissez un générateur, vous devez déterminer la puissance de démarrage et la puissance continue de chaque appareil ou système que vous souhaitez raccorder pour calculer la capacité totale requise. Assurez-vous que le générateur que vous choisissez a une puissance de démarrage suffisante pour répondre aux exigences de tous les appareils.

PUISSANCE DE DÉMARRAGE \approx PUISSANCE CONTINUE

PUISSANCE DE DÉMARRAGE \gg PUISSANCE CONTINUE

PUISSANCE DE DÉMARRAGE $\gg\gg$ PUISSANCE CONTINUE

Le type de carburant utilisé par le générateur est également important. Les générateurs diesel, par exemple, ont un rendement énergétique un peu meilleur que les générateurs à essence mais ils sont plus chers à l'achat et plus compliqués à entretenir. En revanche, les générateurs à essence sont plus portables et plus faciles à entretenir. Il est également important de prendre en compte la capacité de stockage du carburant et l'efficacité de la consommation de carburant du générateur, dépendant du modèle.

D'autres facteurs importants sont la production de bruit et le poids du générateur. Les niveaux sonores sont mesurés en décibels (dB) et peuvent varier en fonction du modèle et de la taille du générateur. Dans certains cas, des boîtiers ou des accessoires insonorisés sont nécessaires pour répondre aux exigences en matière de bruit. Le poids du générateur peut également être un facteur important, surtout si vous devez le déplacer fréquemment. Plus le générateur est puissant, plus il sera lourd.

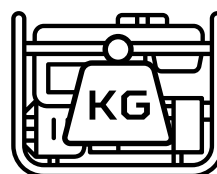

Avec nous, vous pouvez choisir un générateur qui répond à vos besoins exacts, que ce soit pour fournir de l'énergie à votre maison, votre entreprise, un événement ou un chantier. Nos générateurs sont fiables, efficaces et construits pour fonctionner longtemps. Notre personnel expert est prêt à vous aider à choisir le bon générateur et à répondre à toutes vos questions.

Voici un aperçu rapide de ce que vous pouvez obtenir.

(Toutes les options ne figurent pas dans le dépliant, si vous souhaitez quelque chose de spécifique que vous ne trouvez pas dans ce dépliant, veuillez nous contacter).

Option AVR

Tous les générateurs avec "-AVR" dans la référence ont l'option AVR (régulation automatique de la tension).

Option de démarrage électrique

Tous les générateurs avec "E" dans la référence ont une batterie et peuvent être démarrés avec une clé.

Option grand réservoir de carburant

Tous les générateurs avec "L" dans la référence ont un réservoir de carburant plus grand que celui qui est standard sur le moteur.

Option triphasé 400V

Tous les générateurs avec "T400" dans la référence ont un alternateur modifié qui a au moins une prise avec (ou sans) neutre qui donne 3x400V en étoile.

Option triphasé 230V

Tous les générateurs avec "T230" dans la référence ont un alternateur modifié qui a au moins une fiche sans neutre qui donne 3x230V en triangle.

Option kit de roues

Un kit de roues est disponible séparément pour tous les modèles GS, GP, GH et GL. Pour certains groupes, le kit de roues est monté ou inclus en standard.

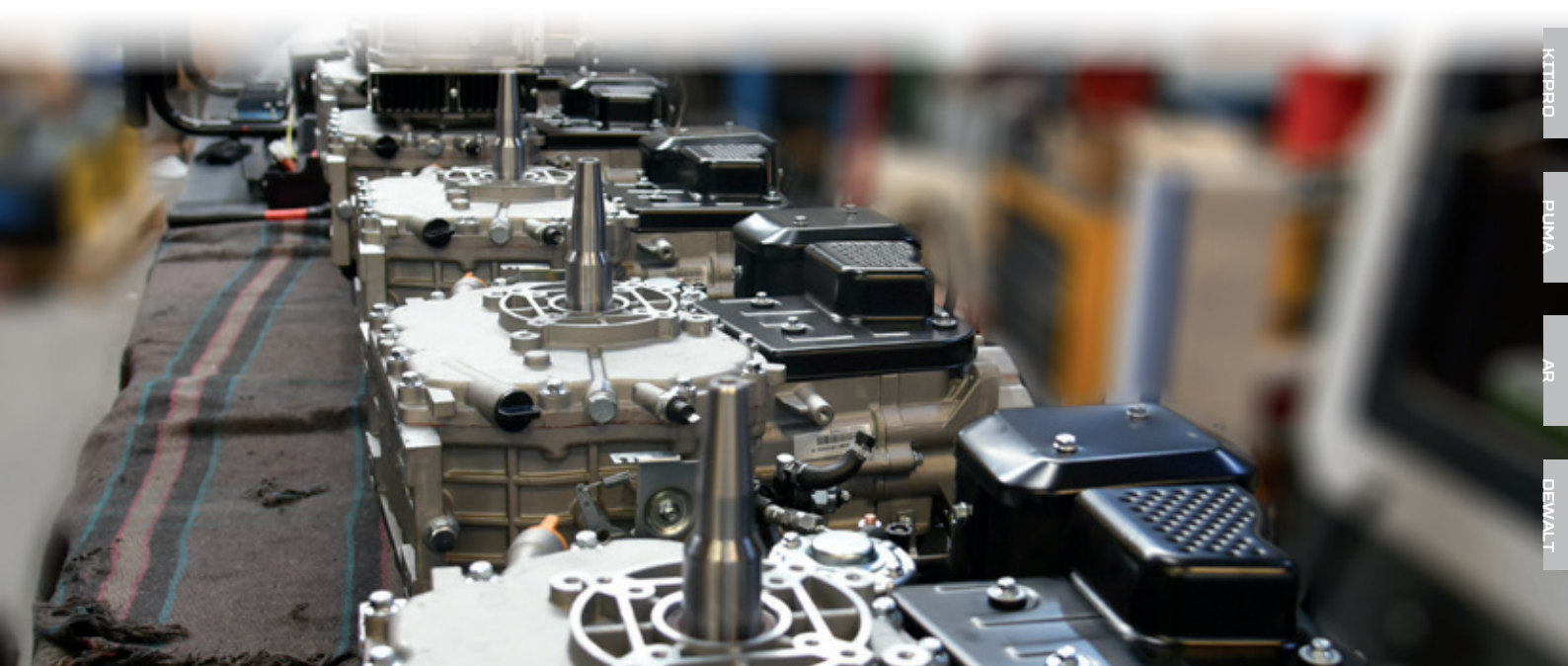

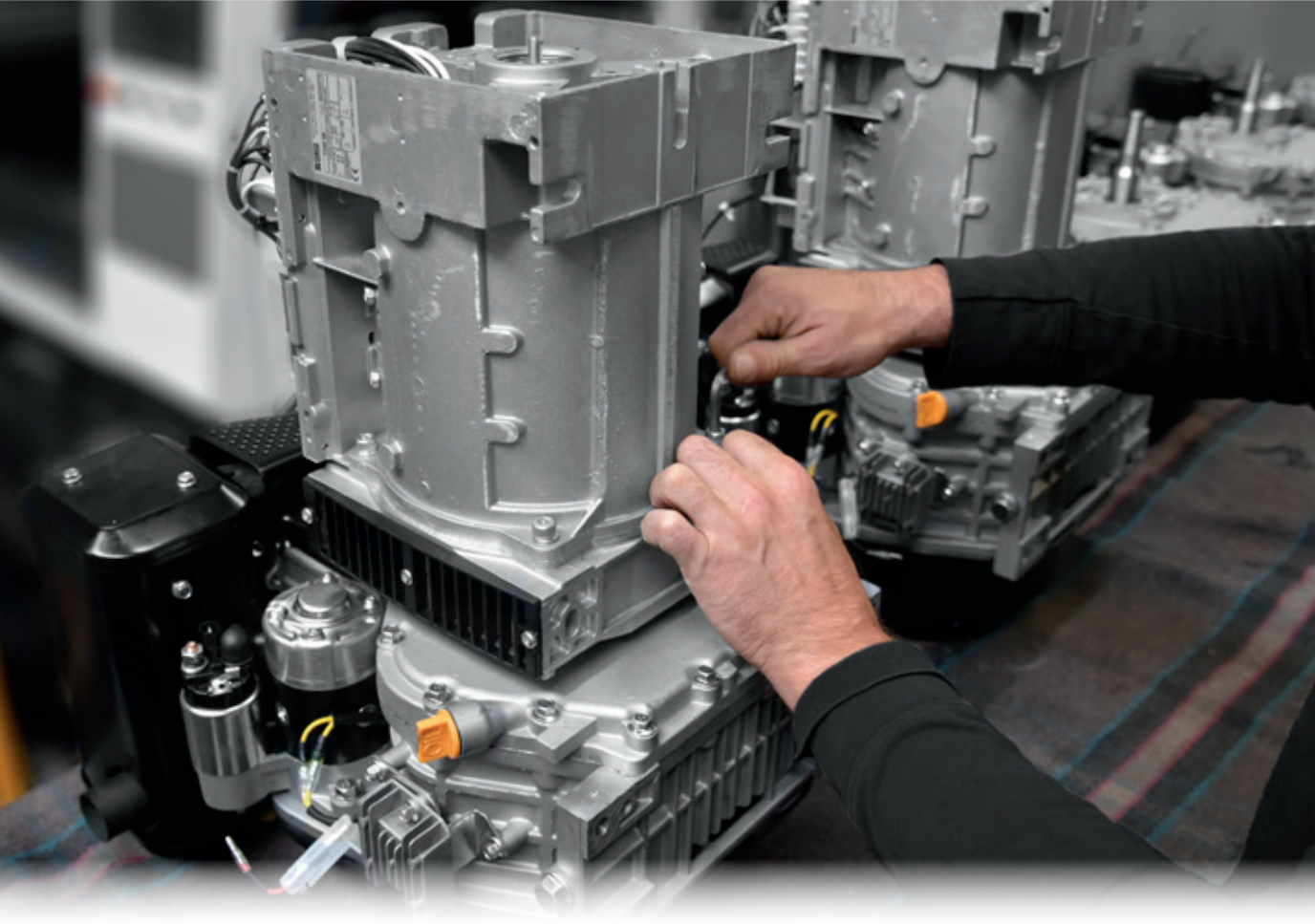

GS3500-AVR

GS4400-AVR



94 LWA



ESSENCE



Puissance absorbée:	3,65kVA
Puissance rendue max. AC:	3050W
Puissance en continu AC:	2750W
Type de moteur:	LC170FV
Niveau sonore:	69dB(A) 7m
Contenu réservoir:	3L
Poids:	40kg
Lo x La x H:	630x495x470mm
Autonomie en moyenne:	2,5h
Système de démarrage	Par lanceur
Kit de roues:	Voir page 15

PRIX TARIF
€946,40
hors TVA

PRIX DE VENTE
€676,00
hors TVA

PRIX DE VENTE
€817,96
TVA incl.



95 LWA



ESSENCE



Puissance absorbée:	4,4kVA
Puissance rendue max. AC:	4000W
Puissance en continu AC:	3600W
Type de moteur:	LC270FV
Niveau sonore:	70dB(A) 7m
Contenu réservoir:	5,5L
Poids:	69kg
Lo x La x H:	630x495x470mm
Autonomie en moyenne:	3h
Système de démarrage	Par lanceur
Kit de roues:	Voir page 15

PRIX TARIF
€1381,80
hors TVA

PRIX DE VENTE
€987,00
hors TVA

PRIX DE VENTE
€1194,27
TVA incl.

GP5000-AVR



Puissance absorbée:	5,0kVA
Puissance rendue max. AC:	4500W
Puissance en continu AC:	4000W
Type de moteur:	LC340FV 11cv 4T OHV
Niveau sonore:	71dBA 7m
Contenu réservoir:	6,2L
Poids:	72kg
Lo x La x H:	795x555x570mm
Autonomie en moyenne:	2,5h
Système de démarrage	Par lanceur
Kit de roues:	Voir page 15

PRIX TARIF
€1538,60
hors TVA

PRIX DE VENTE
€1099,00
hors TVA

PRIX DE VENTE
€1329,79
TVA incl.

GP6500-AVR



Puissance absorbée:	6,5kVA
Puissance rendue max. AC:	5500W
Puissance en continu AC:	5000W
Type de moteur:	LC420FV 14,5cv 4T OHV
Niveau sonore:	72dBA 7m
Contenu réservoir:	6,2L
Poids:	75kg
Lo x La x H:	795x555x570mm
Autonomie en moyenne:	2,5h
Système de démarrage	Par lanceur
Kit de roues:	Voir page 15

PRIX TARIF
€1701,00
hors TVA

PRIX DE VENTE
€1215,00
hors TVA

PRIX DE VENTE
€1470,15
TVA incl.

GP8000-AVR



Puissance absorbée:	8,0kVA
Puissance rendue max. AC:	6500W
Puissance en continu AC:	6000W
Type de moteur:	LC420FV 14,5cv 4T OHV
Niveau sonore:	72dBA 7m
Contenu réservoir:	6,2L
Poids:	78kg
Lo x La x H:	795x555x570mm
Autonomie en moyenne:	2h
Système de démarrage	Par lanceur
Kit de roues:	Voir page 15

PRIX TARIF
€1779,53
hors TVA

PRIX DE VENTE
€1271,09
hors TVA

PRIX DE VENTE
€1538,02
TVA incl.

GP8000E-AVR



Puissance absorbée:	8,0kVA
Puissance rendue max. AC:	6500W
Puissance en continu AC:	6000W
Type de moteur:	LC420FV 14,5cv 4T OHV
Niveau sonore:	72dBA 7m
Contenu réservoir:	6,2L
Poids:	80kg
Lo x La x H:	795x555x570mm
Autonomie en moyenne:	2h
Système de démarrage	Par lanceur + dém. à clé
Kit de roues:	Voir page 15

PRIX TARIF
€1971,76
hors TVA

PRIX DE VENTE
€1408,40
hors TVA

PRIX DE VENTE
€1704,16
TVA incl.

8KVA TRIPHASES



GP8000(E)T400 (3 x 400V)
GP8000(E)T230 (3 x 230V)



GP8000LT400 (3 x 400V)
GP8000LT230 (3 x 230V)



GP8000ELT400 (3 x 400V)
GP8000ELT230 (3 x 230V)



TRIPHASE - 3 X 400V



SCHUKO
16A
(TYPE F (EU))

OU



SCHUKO
16A
(TYPE E (FR))

+



CEE 16A
3P+N+PE



OPTION "AVR":
(REGULATEUR
ELECTRONIQUE DE LA
TENSION DE SORTIE)

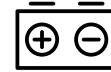

OPTION "E":
BATTERIE
(DEMARRAGE ELECTRIQUE)



OPTION "L":
GRAND RÉSERVOIR

Référence	kVA max.	Puissance max. (W)		Puissance cont. (W) Monophasé	Puissance cont. (W) Triphasé	AVR	Système de démarrage	Type de moteur	Niveau sonore (dB(A))	Capacité du réservoir (L)	Poids (kg)	Autonomie en moyenne (h)	Dimensions sans kit de roues LxOxAxH (mm)	PRIX TARIF hors TVA	PRIX DE VENTE hors TVA	PRIX DE VENTE TVA incluse
		Monophasé	Triphasé													
GP8000T400	8,0	3500	6500	3000	6000	Non	Ma.	LC420FV	72	6,2	80	2h	795	€2309,56	€1649,69	€1996,12
GP8000T400-AVR	8,0	3500	6500	3000	6000	Oui	Ma.	LC420FV	72	6,2	80	2h	x	€2577,94	€1841,39	€2228,08
GP8000ET400	8,0	3500	6500	3000	6000	Non	Ma. + El.	LC420FDV	72	6,2	83	2h	555	€2504,88	€1789,20	€2164,93
GP8000ET400-AVR	8,0	3500	6500	3000	6000	Oui	Ma. + El.	LC420FDV	72	6,2	83	2h	570	€2780,72	€1986,23	€2403,33
GP8000LT400	8,0	3500	6500	3000	6000	Non	Ma.	LC420FV	72	25	88	9h	795	€2721,08	€1943,63	€2351,79
GP8000LT400-AVR	8,0	3500	6500	3000	6000	Oui	Ma.	LC420FV	72	25	88	9h	x	€2989,46	€2135,33	€2583,74
GP8000ELT400	8,0	3500	6500	3000	6000	Non	Ma. + El.	LC420FDV	72	25	91	9h	555	€2923,85	€2088,47	€2527,04
GP8000ELT400-AVR	8,0	3500	6500	3000	6000	Oui	Ma. + El.	LC420FDV	72	25	91	9h	570	€3192,23	€2280,17	€2759,00

TRIPHASE - 3 X 230V



SCHUKO
16A
(TYPE F (EU))

OU



SCHUKO
16A
(TYPE E (FR))

+



CEE 16A
CEE 32A
3P+PE



OPTION "AVR":
(REGULATEUR
ELECTRONIQUE DE LA
TENSION DE SORTIE)

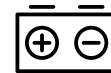

OPTION "E":
BATTERIE
(DEMARRAGE ELECTRIQUE)



OPTION "L":
GRAND RÉSERVOIR

GP8000T230	8,0	3500	6500	3000	6000	Non	Ma.	LC420FV	72	6,2	80	2h	795	€2504,88	€1789,20	€2164,93
GP8000T230-AVR	8,0	3500	6500	3000	6000	Oui	Ma.	LC420FV	72	6,2	80	2h	x	€2773,26	€1980,90	€2396,89
GP8000ET230	8,0	3500	6500	3000	6000	Non	Ma. + El.	LC420FDV	72	6,2	83	2h	555	€2698,71	€1927,65	€2332,46
GP8000ET230-AVR	8,0	3500	6500	3000	6000	Oui	Ma. + El.	LC420FDV	72	6,2	83	2h	570	€2974,55	€2124,68	€2570,86
GP8000LT230	8,0	3500	6500	3000	6000	Non	Ma.	LC420FV	72	25	88	9h	795	€2914,91	€2082,08	€2519,31
GP8000LT230-AVR	8,0	3500	6500	3000	6000	Oui	Ma.	LC420FV	72	25	88	9h	x	€3183,29	€2273,78	€2751,27
GP8000ELT230	8,0	3500	6500	3000	6000	Non	Ma. + El.	LC420FDV	72	25	91	9h	555	€3138,56	€2241,83	€2712,61
GP8000ELT230-AVR	8,0	3500	6500	3000	6000	Oui	Ma. + El.	LC420FDV	72	25	91	9h	570	€3392,03	€2422,88	€2931,68

8KVA OU 10KVA TRIPHASES



97 LWA



ESSENCE



GH8000LT400 (3 x 400V)



100 LWA



ESSENCE



GH8000ELT400 (3 x 400V)
GH10000ELT400 (3 x 400V)*

TRIPHASE - 3 X 400V



SCHUKO
16A
(TYPE F (EU))

OU



SCHUKO
16A
(TYPE E (FR))

+



CEE 16A
3P+N+PE



OPTION "AVR":
(RÉGULATEUR
ÉLECTRONIQUE DE LA
TENSION DE SORTIE)

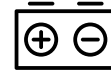

OPTION "E":
BATTERIE
(DEMARRAGE ELECTRIQUE)



OPTION "L":
GRAND RÉSERVOIR

Référence	kVA max.	Puissance max. (W) Monophasé	Puissance max. (W) Triphasé	Puissance cont. (W) Monophasé	Puissance cont. (W) Triphasé	AVR	Système de démarrage	Type de moteur	Niveau sonore (dB(A))	Capacité du réservoir (L)	Poids (kg)	Autonomie en moyenne (h)	Dimensions sans kit de roues LOxLxH (mm)	PRIX TARIF hors TVA	PRIX DE VENTE hors TVA	PRIX DE VENTE TVA incluse
GH8000LT400-AVR	8,0	3500	6500	3000	6000	Oui	Ma.	LC420FV	72	25	93	9h	795	€3255,05	€2325,03	€2813,29
GH8000ELT400-AVR	8,0	3500	6500	3000	6000	Oui	Ma. + El.	LC420FDV	72	25	96	9h	x	€3486,76	€2490,55	€3013,56
GH10000ELT400*	10,0	4000	8000	3600	7200	Non	Ma. + El.	LC460FDV	75	25	102	7,5h	x	€3589,79	€2564,14	€3102,61
GH10000ELT400-AVR*	10,0	4000	8000	3600	7200	Oui	Ma. + El.	LC460FDV	75	25	102	7,5h	570	€3967,46	€2833,90	€3429,02

GH-ROU



Jeu de roues pour tous les modèles GS, GP et GL.

Comprend:

2 x roues, 2 x repose-pieds et 2 x poignées

PRIX TARIF
€159,95
hors TVA

PRIX DE VENTE
€114,25
hors TVA

PRIX DE VENTE
€138,25
TVA incl.

Les générateurs marqués d'un * ne sont pas destinés à être utilisés en air libre dans l'UE



GENERMORE
RENSON
LARIUS
FEMI
DREHMANN
DREIX
BDS
ZECO
TRX
KATPRO
PUMA
AR
DEWALT

GL12000*



GL12000EL (-AVR) GL12000ELT400 (-AVR)

Monophasé Triphasé



Prises

Puissance absorbée:	12,0kVA	
Puissance max. rendue AC :	9500W	10500W (3x400V)
Puissance continue AC:	8500W	9500W (3x400V)
Puissance max. rendue AC :	3500W (1x230V)	
Puissance continue AC:	3150W (1x230V)	
Type de moteur:	LC2V78FV	
Niveau sonore:	75dBA 7m	
Capacité du réservoir:	20L	
Poids:	108kg	
Dimensions:	1270x860x780mm	
Autonomie en moyenne:	6,5h	
Système de démarrage:	Démarrage à clé	

		PRIX TARIF hors TVA	PRIX DE VENTE hors TVA	PRIX DE VENTE TVA incl.
GL12000EL*	Monophasé - 1x230V	€4729,06	€3377,90	€4087,26
GL12000EL-AVR*	Monophasé - 1x230V Avec AVR	€5197,63	€3712,59	€4492,23
GL12000ELT400*	Triphasé - 3x400V	€4925,22	€3518,01	€4256,80
GL12000ELT400-AVR*	Triphasé - 3x400V Avec AVR	€5393,81	€3852,72	€4661,79

GL15000*



GL15000EL -AVR GL15000ELT400 -AVR

Monophasé Triphasé



Prises

Puissance absorbée:	15,0kVA	
Puissance max. rendue AC :	12000W	12800W (3x400V)
Puissance continue AC:	10800W	11500W (3x400V)
Puissance max. rendue AC :	6400W (1x230V)	
Puissance continue AC:	5400W (1x230V)	
Type de moteur:	LC2V80FV	
Niveau sonore:	75dBA 7m	
Capacité du réservoir:	20L	
Poids à vide:	138kg	
Dimensions:	1270x860x780mm	
Autonomie en moyenne:	5,5h	
Système de démarrage	Démarrage à clé	

		PRIX TARIF hors TVA	PRIX DE VENTE hors TVA	PRIX DE VENTE TVA incl.
GL15000EL-AVR*	Triphasé - 3x400V Avec AVR	€5726,30	€4090,22	€4949,16
GL15000ELT400-AVR*	Triphasé - 3x400V Avec AVR	€5584,24	€3988,74	€4826,38

Les générateurs marqués d'un * ne sont pas destinés à être utilisés en air libre dans l'UE

GENERMORE
RENSON
LARTUS
FEMT
DREHMANN
DRELUX
BDS
ZECO
TRX
KITPRO
PUJMA
AR
DEWALT

GL16000*





GL16000EL GL16000ELT400

Monophasé	Triphasé
 	 

Prises

Puissance absorbée:	16,0kVA	
Puissance max. rendue AC :	12800W	13000W (3x400V)
Puissance continue AC:	11500W	11800W (3x400V)
Puissance max. rendue AC :	6500W (1x230V)	
Puissance continue AC:	5800W (1x230V)	
Type de moteur:	LC2V80FV	
Niveau sonore:	75dBA 7m	
Capacité du réservoir:	20L	
Poids à vide:	138kg	
Dimensions:	1270x860x780mm	
Autonomie en moyenne:	5,5h	
Système de démarrage	Elektrische start	

		PRIX TARIF hors TVA	PRIX DE VENTE hors TVA	PRIX DE VENTE TVA incl.
GL16000EL*	Monophasé - 1x230V 	€5659,84	€4042,74	€4891,72
GL16000ELT400*	Triphasé - 3x400V 	€5389,74	€3849,82	€4658,28

GL22000*





GL22000ELT400 (-AVR)

Avec ou sans AVR

Prises



Puissance absorbée:	22,0kVA	
Puissance max. rendue AC:	17600W	(3x400V)
Puissance continue AC:	15000W	(3x400V)
Puissance max. rendue AC:	10000W	(1x230V)
Puissance continue AC:	8000W	(1x230V)
Type de moteur:	LC2V90FV	
Niveau sonore:	81dBA 7m	
Capacité du réservoir:	20L	
Poids à vide:	180kg	
Dimensions:	1270x860x780mm	
Autonomie en moyenne:	4,5h	
Système de démarrage	Démarrage à clé	

		PRIX TARIF hors TVA	PRIX DE VENTE hors TVA	PRIX DE VENTE TVA incl.
GL22000ELT400*	Triphasé - 3x400V 	€6991,75	€4994,10	€6042,87
GL22000ELT400-AVR*	Triphasé - 3x400V Avec AVR 	€7250,94	€5179,24	€6266,89

Les générateurs marqués d'un * ne sont pas destinés à être utilisés en air libre dans l'UE



TH5002



POWERED by HONDA

Puissance absorbée:	5,0kVA
Puissance rendue max. AC:	4500W
Puissance en continu AC:	4000W
Type de moteur:	Honda GX270 9cv OHV
Niveau sonore:	72dBA 7m
Contenu réservoir:	5,3L
Poids:	60kg
Lo x La x H:	730x490x525mm
Autonomie en moyenne:	2,5h
Système de démarrage	Par lanceur

PRIX TARIF
€1922,21
hors TVA

PRIX DE VENTE
€1373,01
hors TVA

PRIX DE VENTE
€1661,34
TVA incl.

TH7502



POWERED by HONDA

Puissance absorbée:	7,5kVA
Puissance rendue max. AC:	6500W
Puissance en continu AC:	6000W
Type de moteur:	Honda GX390 13cv OHV
Niveau sonore:	72dBA 7m
Contenu réservoir:	6,5L
Poids:	76kg
Lo x La x H:	770x570x590mm
Autonomie en moyenne:	2,5h
Système de démarrage TH7502:	Par lanceur
Système de démarrage TH7502E:	Par lanceur + dém. à clé

TH7502
TH7502E

PRIX TARIF
€2783,50
hors TVA

PRIX DE VENTE
€1988,21
€2470,00
hors TVA

PRIX DE VENTE
€2405,74
€2988,70
TVA incl.

LH7000S-AVR



PRÉCABLÉ ATS



AVR SERIES
automatique de régulation de tension

POWERED by HONDA

Puissance absorbée:	7,0kVA
Puissance rendue max. AC:	5600W
Puissance en continu AC:	5000W
Type de moteur:	Honda GX390 4T
Niveau sonore:	63dBA 7m
Contenu réservoir:	15L
Poids:	140kg
Lo x La x H:	1100x540x650mm
Autonomie en moyenne:	5h
Système de démarrage	Par lanceur + dém. à clé

PRIX TARIF
€7522,20
hors TVA

PRIX DE VENTE
€5373,00
hors TVA

PRIX DE VENTE
€6501,33
TVA incl.

LH7000ST400-AVR



PRÉCABLÉ ATS



AVR SERIES
automatique de régulation de tension

POWERED by HONDA

Puissance absorbée:	7,5kVA
Puissance rendue max. AC:	6500W (3x400V)
Puissance en continu AC:	6000W (3x400V)
Puissance rendue max. AC:	2200W (1x230V)
Puissance en continu AC:	2000W (1x230V)
Type de moteur:	Honda GX390 4T
Niveau sonore:	63dBA 7m
Contenu réservoir:	15L
Poids:	140kg
Lo x La x H:	1100x540x650mm
Autonomie en moyenne:	5h
Système de démarrage	Par lanceur + dém. à clé

PRIX TARIF
€7764,40
hors TVA

PRIX DE VENTE
€5546,00
hors TVA

PRIX DE VENTE
€6710,66
TVA incl.

GENERMORE
RENSON
LARTUS
FERMI
DREHMANN
DRELUX
BDS
ZECO
TRX
KITPRO
PUJMA
AR
DEWALT

GÉNÉRATEURS DIESEL SÉRIES GS ET GP

GS4005DE-AVR*



Puissance absorbée:	4,0kVA
Puissance rendue max. AC:	3300W
Puissance en continu AC:	3000W
Type de moteur:	LC350FDI 4T OHV
Niveau sonore:	75dBA 7m
Contenu réservoir:	3,5L
Poids:	67kg
Lo x La x H:	630x495x470mm
Autonomie en moyenne:	2,6h
Système de démarrage	Par lanceur + dém. à clé
Kit de roues:	Voir page 15

PRIX TARIF
€2643,54
hors TVA

PRIX DE VENTE
€1888,24
hors TVA

PRIX DE VENTE
€2284,77
TVA incl.

GP4205DEI-AVR*



Puissance absorbée:	4,0kVA
Puissance rendue max. AC:	3300W
Puissance en continu AC:	3000W
Type de moteur:	LC350FDI 4T OHV
Niveau sonore:	75dBA 7m
Contenu réservoir:	11L
Poids:	78kg
Lo x La x H:	795x555x570mm
Autonomie en moyenne:	6h
Système de démarrage	Par lanceur + dém. à clé

PRIX TARIF
€3661,00
hors TVA

PRIX DE VENTE
€2165,00
hors TVA

PRIX DE VENTE
€2619,65
TVA incl.

GPYAN6000DEI*



Puissance absorbée:	6,0kVA
Puissance rendue max. AC:	5000W
Puissance en continu AC:	4500W
Type de moteur:	Yanmar 10cv 4T OHV
Niveau sonore:	76dBA 7m
Contenu réservoir:	11L
Poids:	124kg
Lo x La x H:	795x555x570mm
Autonomie en moyenne:	6h
Système de démarrage	Par lanceur + dém. à clé

PRIX TARIF
€4126,11
hors TVA

PRIX DE VENTE
€2947,22
hors TVA

PRIX DE VENTE
€3566,14
TVA incl.

GP6205DE-AVR*



Puissance absorbée:	6,0kVA
Puissance rendue max. AC:	5000W
Puissance en continu AC:	4500W
Type de moteur:	LC460FDV 10cv 4T OHV
Niveau sonore:	76dBA 7m
Contenu réservoir:	4,5L
Poids:	98kg
Lo x La x H:	795x555x570mm
Autonomie en moyenne:	2,5h
Système de démarrage	Par lanceur + dém. à clé
Kit de roues:	Voir page 15

PRIX TARIF
€2895,2
hors TVA

PRIX DE VENTE
€2068,00
hors TVA

PRIX DE VENTE
€2502,28
TVA incl.

GP6205DEI-400-AVR*



Puissance absorbée:	6,0kVA
Puissance rendue max. AC:	5000W
Puissance en continu AC:	4500W
Type de moteur:	LC460FDV 10cv 4T OHV
Niveau sonore:	76dBA 7m
Contenu réservoir:	11L
Poids:	122kg
Lo x La x H:	795x555x570mm
Autonomie en moyenne:	6h
Système de démarrage	Par lanceur + dém. à clé

PRIX TARIF
€3066,00
hors TVA

PRIX DE VENTE
€2190,00
hors TVA

PRIX DE VENTE
€2649,90
TVA incl.

GP6205DEI400-AVR*



Puissance absorbée:	6,0kVA
Puissance rendue max. AC:	5000W (3x400V)
Puissance en continu AC:	4500W (3x400V)
Puissance rendue max. AC:	1650W (1x230V)
Puissance en continu AC:	1500W (1x230V)
Type de moteur:	LC460FDV 10cv 4T OHV
Niveau sonore:	76dBA 7m
Contenu réservoir:	4,5L
Poids:	120kg
Lo x La x H:	795x555x570mm
Autonomie en moyenne:	2,5h
Système de démarrage	Par lanceur + dém. à clé

Kit de roues: Voir page 15

PRIX TARIF
€3480,40
hors TVA

PRIX DE VENTE
€2486,00
hors TVA

PRIX DE VENTE
€3008,06
TVA incl.

GP6205DEI400-AVR*



Puissance absorbée:	6,0kVA
Puissance rendue max. AC:	5000W (3x400V)
Puissance en continu AC:	4500W (3x400V)
Puissance rendue max. AC:	1650W (1x230V)
Puissance en continu AC:	1500W (1x230V)
Type de moteur:	LC460FDV 10cv 4T OHV
Niveau sonore:	76dBA 7m
Contenu réservoir:	11L
Poids:	126kg
Lo x La x H:	795x555x570mm
Autonomie en moyenne:	6h
Système de démarrage	Par lanceur + dém. à clé

PRIX TARIF
€3726,80
hors TVA

PRIX DE VENTE
€2662,00
hors TVA

PRIX DE VENTE
€3221,02
TVA incl.

EN12000DE*



Puissance absorbée:	12,0kVA
Puissance rendue max. AC:	10000W
Puissance en continu AC:	9500W
Type de moteur:	CF950F 20cv 4T OHV
Niveau sonore:	85dBA 7m
Contenu réservoir:	20L
Poids:	185kg
Lo x La x H:	1000x550x670mm
Autonomie en moyenne:	6,5h
Système de démarrage	Démarrage à clé

PRIX TARIF
€9516,13
hors TVA

PRIX DE VENTE
€6797,23
hors TVA

PRIX DE VENTE
€8224,65
TVA incl.

GENERMORE
RENSON
LARIUS
FERMI
DREHMANN
DRELUX
BDS
ZECO
TRX
KITPRO
PUJMA
AR
DEWALT

AUTOMATIC TRANSFER SWITCH (ATS)

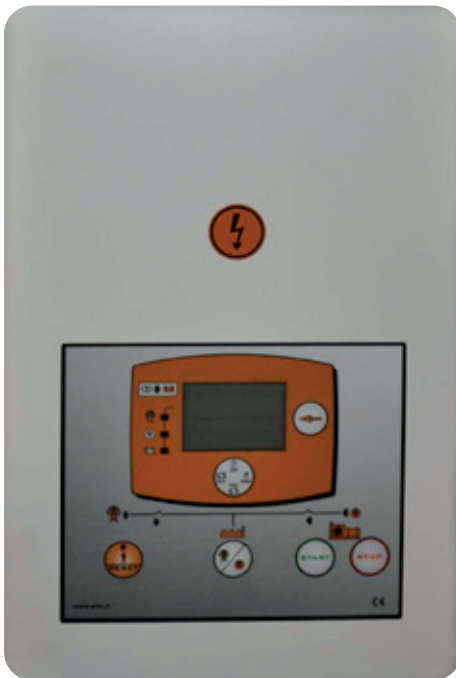

Un commutateur de transfert automatique (ATS) est un dispositif souvent utilisé en conjonction avec un générateur. Il est conçu pour basculer automatiquement entre le réseau ordinaire et le générateur en cas de panne de courant.

Avec un ATS, les utilisateurs n'ont pas besoin de passer manuellement du secteur au générateur en cas de panne de courant. L'appareil détecte automatiquement la panne et met en marche l'alimentation du générateur. Une fois que la panne est résolue et que l'alimentation secteur est à nouveau disponible, l'ATS revient automatiquement à l'alimentation secteur.

L'ATS est une solution pratique et fiable qui permet de s'assurer que l'alimentation électrique n'est jamais interrompue, même pendant les pannes de courant. Il offre commodité et tranquillité d'esprit aux utilisateurs et est donc populaire auprès des particuliers et des entreprises qui ont besoin d'une alimentation électrique continue.

Les générateurs précâblés peuvent être connectés à ce système à l'aide d'une simple fiche.

CFATS6-14KW
CFATS7000(-400)

PRIX TARIF
€1674,20
hors TVA

PRIX DE VENTE
€1195,86
hors TVA

PRIX DE VENTE
€1446,99
TVA incl.

CF12ATS
CF17ATS
CF22ATS
CF30ATS

PRIX TARIF
€1703,65
hors TVA

PRIX DE VENTE
€1216,89
hors TVA

PRIX DE VENTE
€1472,44
TVA incl.

- Unité de commutation courant/générateur télécommandé
- Commande de courant/générateur monophasé
- Charge automatique de la batterie (1A)
- Surveillance automatique des défauts
- Gestion du préchauffage
- Commande du démarreur
- Commandes à distance avec contacts (début - fin - test)
- Programmation des paramètres facilitée par des commutateurs DIP-SWITCH
- Entrée disponible pour l'anomalie
- Horloge pour programmer le démarrage ou l'arrêt du groupe électrogène
- Autodiagnostic hebdomadaire programmable
- Rapport historique des anomalies (incluant les données des 100 dernières anomalies)
- Clé pour le démarrage manuel en cas d'urgence
- Contrôle du voltmètre triphasé
- Interrupteur de surcharge
- Bouton d'urgence
- Connecteur FAST ON pré-câblé

LH7500DSE-AVR



**SILENT PRO SÉRIES
PRÉ CABLAGE ATS**

Puissance absorbée:	6,4kVA
Puissance rendue max. AC:	5100W
Puissance en continu AC:	4600W
Type de moteur:	15LD440 11cv
Niveau sonore:	70dBA 7m
Contenu réservoir:	20L
Poids:	160kg
Lo x La x H:	750x560x620 mm
Autonomie en moyenne:	10h
Système de démarrage	Démarrage à clé

PRIX TARIF
€7413,25
hors TVA

PRIX DE VENTE
€5295,18
hors TVA

PRIX DE VENTE
€6407,17
TVA incl.

LH7500DSELT400-AVR



**SILENT PRO SÉRIES
PRÉ CABLAGE ATS**

Puissance absorbée:	6,4kVA
Puissance rendue max. AC:	5100W (3x400V)
Puissance en continu AC:	4600W (3x400V)
Puissance rendue max. AC:	2550W (1x230V)
Puissance en continu AC:	2300W (1x230V)
Type de moteur:	15LD440 11cv
Niveau sonore:	70dBA 7m
Contenu réservoir:	20L
Poids:	170kg
Lo x La x H:	750x560x620 mm
Autonomie en moyenne:	10h
Système de démarrage	Démarrage à clé

PRIX TARIF
€8279,52
hors TVA

PRIX DE VENTE
€5913,95
hors TVA

PRIX DE VENTE
€7155,87
TVA incl.

GM13000DSEL



**SILENT SÉRIES
PRÉ CABLAGE ATS
LIQUID COOLED
3 CYLINDRES
1500RPM**

Puissance absorbée:	13,2kVA
Puissance rendue max. AC:	10500W
Puissance en continu AC:	9400W
Type de moteur:	Mitsubishi S3L2-Z562SD Stage V
Niveau sonore:	69 dBA 7m
Contenu réservoir:	30L
Poids:	420kg
Lo x La x H:	1450x660x1090mm
Autonomie en moyenne:	6,5h
Système de démarrage	Démarrage à clé

PRIX TARIF
€16245,60
hors TVA

PRIX DE VENTE
€11604,00
hors TVA

PRIX DE VENTE
€14040,84
TVA incl.

GM13000DSELT400



**SILENT SÉRIES
PRÉ CABLAGE ATS
LIQUID COOLED
3 CYLINDRES
1500RPM**

Puissance absorbée:	13,2kVA
Puissance rendue max. AC:	10500W (3x400V)
Puissance en continu AC:	9400W (3x400V)
Puissance rendue max. AC:	3700W (1x230V)
Puissance en continu AC:	2800W (1x230V)
Type de moteur:	Mitsubishi S3L2-Z562SD Stage V
Niveau sonore:	69 dBA 7m
Contenu réservoir:	30L
Poids:	430kg
Lo x La x H:	1450x660x1090mm
Autonomie en moyenne:	6,5h
Système de démarrage	Démarrage à clé

PRIX TARIF
€16189,60
hors TVA

PRIX DE VENTE
€11564,00
hors TVA

PRIX DE VENTE
€13992,44
TVA incl.

DISPONIBLE AU PLUS TÔT À PARTIR DE JUILLET '23

DISPONIBLE AU PLUS TÔT À PARTIR DE JUILLET '23

GENERMORE
RENSON
LARTUS
FERMI
DREHMANN
DRELUX
BDS
ZECO
TRX
KITPRO
PUJMA
AR
DEWALT

GM17000DSELT400

ALIM. DE CHANTIER



Puissance absorbée:	17,0kVA
Puissance rendue max. AC:	13600W (3x400V)
Puissance en continu AC:	12500W (3x400V)
Puissance rendue max. AC:	4500W (1x230V)
Puissance en continu AC:	3000W (1x230V)
Type de moteur:	Mitsubishi S4L2-Z562SD Stage V
Niveau sonore:	69dBA 7m
Contenu réservoir:	30L
Poids:	495kg
Lo x La x H:	1480x680x1140mm
Autonomie en moyenne:	6h
Système de démarrage	Démarrage à clé

PRIX TARIF €18179,00 hors TVA
 PRIX DE VENTE €12985,00 hors TVA
 PRIX DE VENTE €15711,85 TVA incl.



SILENT SÉRIE
PRÉ CABLAGE ATS
LIQUID COOLED
4 CYLINDRES
1500RPM

DISPONIBLE AU PLUS TÔT A PARTIR DE JUILLET '23

GM20000DSELT400

ALIM. DE CHANTIER

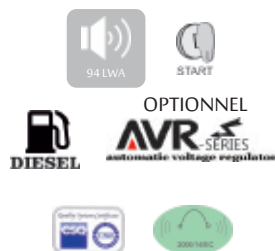

Puissance absorbée:	20,0kVA
Puissance rendue max. AC:	16000W (3x400V)
Puissance en continu AC:	14500W (3x400V)
Puissance rendue max. AC:	5400W (1x230V)
Puissance en continu AC:	4200W (1x230V)
Type de moteur:	Yanmar 4TNV88-BIA2 Stage V
Niveau sonore:	69 dBA 7m
Contenu réservoir:	30L
Poids:	540kg
Lo x La x H:	1450x660x1090mm
Autonomie en moyenne:	5h
Système de démarrage	Démarrage à clé

PRIX TARIF €20939,80 hors TVA
 PRIX DE VENTE €14957,00 hors TVA
 PRIX DE VENTE €18097,97 TVA incl.



SILENT SÉRIE
PRÉ CABLAGE ATS
LIQUID COOLED
4 CYLINDRES
1500RPM

DISPONIBLE AU PLUS TÔT A PARTIR DE JUILLET '23

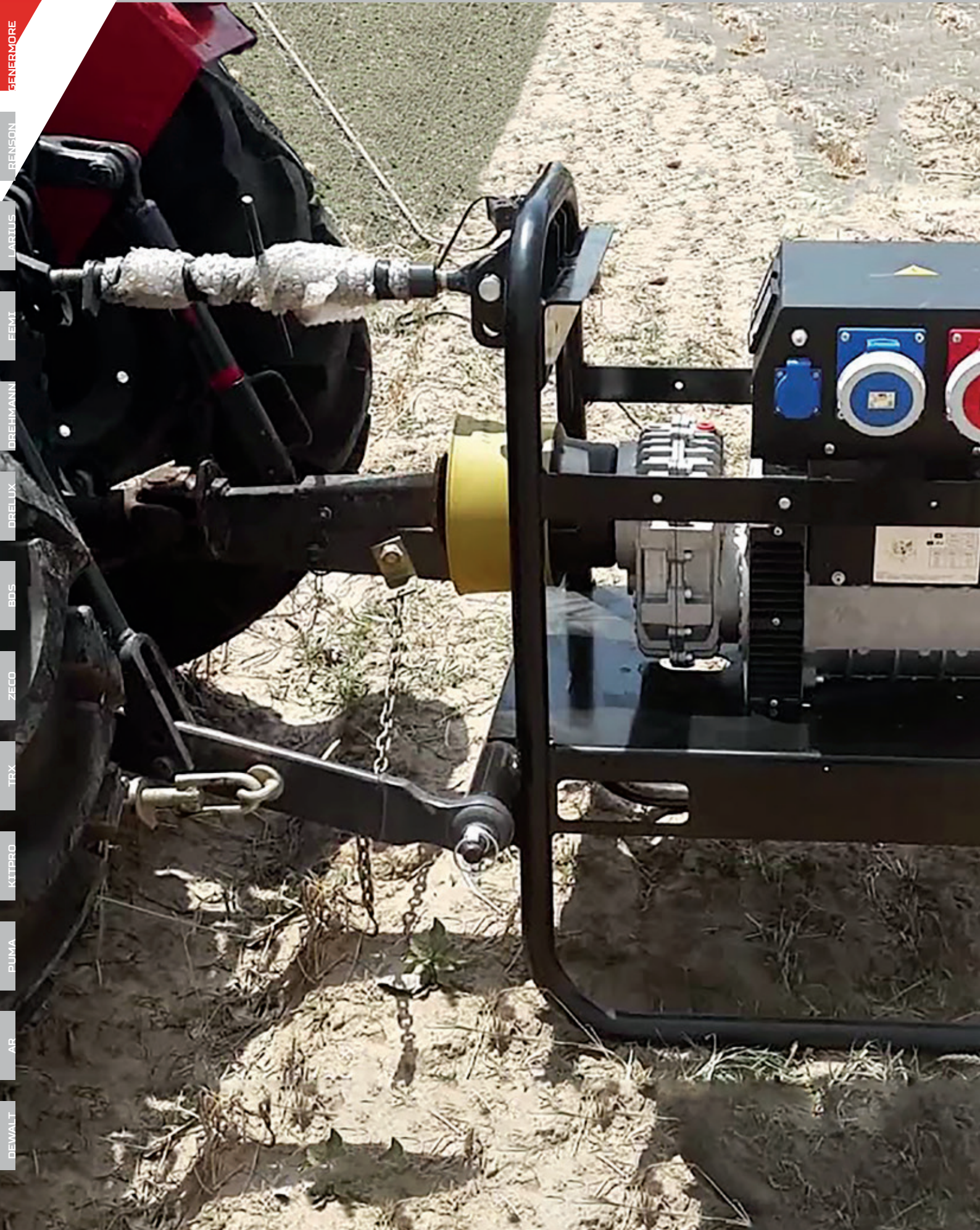



AVR SERIES
automatic voltage regulator

Référence:	GENPTO15-400	GENPTO20-400	GENPTO22-400	GENPTO30-400	GENPTO42-400
Puissance absorbée:	15,0kVA	20,0kVA	22,0kVA	30,0kVA	42,0kVA
Puissance donnée net:	3 x 400V + 1 x 230V	3 x 400V + 1 x 230V	3 x 400V + 1 x 230V	3 x 400V + 1 x 230V	3 x 400V + 1 x 230V
Puissance recommandée:	40cv	50cv	50cv	70cv	100cv
RPM PTO:	435rpm	435rpm	430rpm	430rpm	395rpm
Poids:	125kg	148kg	134kg	216kg	385kg
Lo x La x H:	756x843x953mm	958x843x1003mm	958x843x1003mm	958x843x1003mm	1110x727x1322mm
Type alternateur:	AVR - 2P 3000rpm	AVR - 4P 1500rpm	AVR - 2P 3000rpm	AVR - 4P 1500rpm	AVR - 4P 1500rpm

PRIX TARIF hors TVA	€4398,24
PRIX DE VENTE hors TVA	€3141,60
PRIX DE VENTE TVA incl.	€3801,34

PRIX TARIF hors TVA	€6104,00
PRIX DE VENTE hors TVA	€4360,00
PRIX DE VENTE TVA incl.	€5275,60

PRIX TARIF hors TVA	€5488,00
PRIX DE VENTE hors TVA	€3920,00
PRIX DE VENTE TVA incl.	€4743,20

PRIX TARIF hors TVA	€7236,32
PRIX DE VENTE hors TVA	€5168,80
PRIX DE VENTE TVA incl.	€6254,24

PRIX TARIF hors TVA	€8990,12
PRIX DE VENTE hors TVA	€6421,51
PRIX DE VENTE TVA incl.	€7770,03

GP6205DEWI180AC*

GP6205DEWI180DC*



5m

INCLUS

Puissance absorbée:	6,0kVA
Puissance rendue max. AC:	5000W
Puissance en continu AC:	4500W
Facteur de marche 35%:	180A AC
Facteur de marche 60%:	125A AC
Niveau sonore:	75dBA 7m
Contenu réservoir:	11L
Poids:	112kg
Lo x La x H:	795x555x570mm
Autonomie en moyenne:	6h
Système de démarrage	Par lanceur + dém. à clé

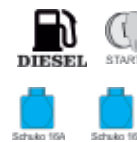

5m

INCLUS

Puissance absorbée:	6,0kVA
Puissance rendue max. AC:	5000W
Puissance en continu AC:	4500W
Facteur de marche 35%:	180A DC
Facteur de marche 60%:	125A DC
Niveau sonore:	75dBA 7m
Contenu réservoir:	11L
Poids:	114kg
Lo x La x H:	795x555x570mm
Autonomie en moyenne:	6h
Système de démarrage	Par lanceur + dém. à clé

PRIX TARIF
€4164,78
hors TVA

PRIX DE VENTE
€2974,84
hors TVA

PRIX DE VENTE
€3599,56
TVA incl.

PRIX TARIF
€4486,64
hors TVA

PRIX DE VENTE
€3204,74
hors TVA

PRIX DE VENTE
€3877,74
TVA incl.

Les générateurs marqués d'un* ne sont pas destinés à être utilisés en air libre dans l'UE

GENERMORE
RENSON
LARIUS
FEMI
DREHMANN
DRELUX
BDS
ZECO
TRX
KITPRO
PUMA
AR
DEWALT



GP8000W200AC

GP8000W200DC

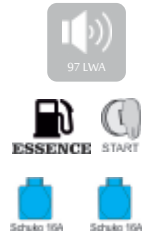

Puissance absorbée:	8,0kVA
Puissance rendue max. AC:	7000W
Puissance en continu AC:	6500W
Facteur de marche 35%:	200A AC
Facteur de marche 60%:	180A AC
Type de moteur:	LC420 14,5cv OHV
Niveau sonore:	72dBA 7m
Contenu réservoir:	6,2L
Poids:	98kg
Lo x La x H:	795x555x570mm
Autonomie en moyenne:	2h
Système de démarrage	Par lanceur



INCLUS

PRIX TARIF
€2734,23
hors TVA

PRIX DE VENTE
€1953,02
hors TVA

PRIX DE VENTE
€2363,15
TVA incl.

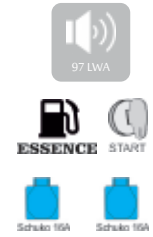

Puissance absorbée:	8,0kVA
Puissance rendue max. AC:	7000W
Puissance en continu AC:	6500W
Facteur de marche 35%:	200A DC
Facteur de marche 60%:	180A DC
Type de moteur:	LC420 14,5cv OHV
Niveau sonore:	72dBA 7m
Contenu réservoir:	6,2L
Poids:	100kg
Lo x La x H:	795x555x570mm
Autonomie en moyenne:	2h
Système de démarrage	Par lanceur



INCLUS

PRIX TARIF
€3093,62
hors TVA

PRIX DE VENTE
€2209,73
hors TVA

PRIX DE VENTE
€2673,77
TVA incl.

GP11000E1W300DC*

GP13000E1W400W300DC*

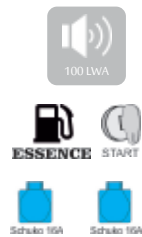

Puissance absorbée:	11,0kVA
Puissance rendue max. AC:	6000W
Puissance en continu AC:	5500W
Facteur de marche 35%:	300A DC
Facteur de marche 60%:	250A DC
Type de moteur:	LC2V80FDV
Niveau sonore:	75dBA 7m
Contenu réservoir:	20L
Poids:	138kg
Lo x La x H:	1270x860x780mm
Autonomie en moyenne:	5h
Système de démarrage	Démarrage à clé



INCLUS

PRIX TARIF
€7478,94
hors TVA

PRIX DE VENTE
€5342,10
hors TVA

PRIX DE VENTE
€6463,94
TVA incl.



Puissance absorbée:	13,0kVA
Puissance rendue max. AC:	8000W (3x400V)
Puissance en continu AC:	7500W (3x400V)
Puissance rendue max. AC:	4000W (1x230V)
Puissance en continu AC:	3800W (1x230V)
Facteur de marche 35%:	300A DC
Facteur de marche 60%:	250A DC
Type de moteur:	LC2V80FDV
Niveau sonore:	75dBA 7m
Contenu réservoir:	20L
Poids:	146kg
Lo x La x H:	1270x860x780mm
Autonomie en moyenne:	4,5h
Système de démarrage	Démarrage à clé



INCLUS

PRIX TARIF
€9458,96
hors TVA

PRIX DE VENTE
€6756,40
hors TVA

PRIX DE VENTE
€8175,24
TVA incl.

TRX790

TUN/WB

CARBONWELD4



Vitesse de fermeture:	1/20000s (0,00005s)
Température ambiante:	-5°C - 55°C
Lo x La x H filtre:	98x55mm
Vitesse d'ouverture:	0,3s - 0,9s (short/middle/long)
Matériaux casque:	Nylon (impact resistant)
Poids:	470g
Protection permanente:	4 Din
Protection UV/IR:	16 Din Permanent
Obscurité:	DIN 9 ~DIN 13
Power ON/OFF:	Automatique
Nombre de capteurs:	4

PRIX TARIF €195,38 hors TVA	PRIX DE VENTE €139,56 hors TVA	PRIX DE VENTE €168,86 TVA incl.
-----------------------------------	--------------------------------------	---------------------------------------

Vitesse de fermeture:	1/20000s (0,00005s)
Température ambiante:	-5°C - 55°C
Lo x La x H filtre:	98x43mm
Vitesse d'ouverture:	0,3s - 0,9s (short/middle/long)
Matériaux casque:	Nylon (impact resistant)
Poids:	450g
Protection permanente:	4 Din
Protection UV/IR:	16 Din Permanent
Obscurité:	DIN 9 ~DIN 13
Power ON/OFF:	Automatique
Nombre de capteurs:	4

PRIX TARIF €143,29 hors TVA	PRIX DE VENTE €102,35 hors TVA	PRIX DE VENTE €123,84 TVA incl.
-----------------------------------	--------------------------------------	---------------------------------------

SMART

LENS COVERS



Vitesse de fermeture:	1/30000s (0,000033s)
Température ambiante:	-5°C - 55°C
Lo x La x H filtre:	95x36mm
Vitesse d'ouverture:	0,25s - 0,8s (short/middle/long)
Matériaux casque:	Nylon (impact resistant)
Poids:	450g
Protection permanente:	4 Din
Protection UV/IR:	16 Din Permanent
Obscurité:	DIN 9 ~DIN 13
Power ON/OFF:	Automatique
Nombre de capteurs:	2

PRIX TARIF €91,17 hors TVA	PRIX DE VENTE €65,12 hors TVA	PRIX DE VENTE €78,80 TVA incl.
----------------------------------	-------------------------------------	--------------------------------------

FRONT LENS COVER:	INVSLASCARWB01
Lo x La x H:	123x98mm
Convient pour:	TRX790TUN TRX790WB CARBONWELD4
FRONT LENS COVER:	INVSLASCAR01
Lo x La x H:	114x90mm
Convient pour:	SMART

PRIX TARIF €2,61 hors TVA
PRIX DE VENTE €1,86 hors TVA
PRIX DE VENTE €2,26 TVA incl.

INSIDE LENS COVER:	INVSLASCARWB03
Lo x La x H:	106x58mm
Convient pour:	TRX790TUN TRX790WB
INSIDE LENS COVER:	INVSLASCAR03
Lo x La x H:	105x46mm
Convient pour:	SMART
INSIDE LENS COVER:	INVSLASCAR05
Lo x La x H:	108x45mm
Convient pour:	CARBONWELD4

PRIX TARIF €1,95 hors TVA
PRIX DE VENTE €1,40 hors TVA
PRIX DE VENTE €1,69 TVA incl.

GENÈRE MOIRE
RENSON
LARIUS
FEMI
DREHMANN
DRELUX
BDS
ZECO
TRX
KITPRO
PUJMA
AR
DEWALT

ACT LC12H21W



LCHOSE15
30m



LCSTORZ15
INCLUS

Profondeur d'aspiration max.:	4m
Hauteur max. de décharge :	21m
Type de moteur:	LC97F 2cv
Débit:	12m³/h 200L/min
Lo x La x H:	335x305x345mm
Poids:	13kg
Lo x La x H sortie/entrée:	1,5" x 1,5"
Utilisation pour:	Eau usée
Accessoires INCLUS:	Voir page 32

PRIX TARIF
€555,58
hors TVA

PRIX DE VENTE
€396,84
hors TVA

PRIX DE VENTE
€480,18
TVA incl.

ACT LC36H30W



LCHOSE20
30m



LCSTORZ20
INCLUS

Profondeur d'aspiration max.:	8m
Hauteur max. de décharge :	30m
Type de moteur:	LC163F 5,5cv
Débit:	36m³/h 600L/min
Lo x La x H:	435x385x385mm
Poids:	26kg
Lo x La x H sortie/entrée:	2" x 2"
Utilisation pour:	Eau usée
Accessoires INCLUS:	Voir page 32

PRIX TARIF
€729,25
hors TVA

PRIX DE VENTE
€520,89
hors TVA

PRIX DE VENTE
€630,28
TVA incl.

ACT LC60H30W



LCHOSE30
30m



LCSTORZ30
INCLUS

Profondeur d'aspiration max.:	8m
Hauteur max. de décharge :	30m
Type de moteur:	LC200F 6,5cv
Débit:	60m³/h 1000L/min
Lo x La x H:	515x420x450mm
Poids:	28kg
Lo x La x H sortie/entrée:	3" x 3"
Utilisation pour:	Eau usée
Accessoires INCLUS:	Voir page 32

PRIX TARIF
€849,26
hors TVA

PRIX DE VENTE
€606,61
hors TVA

PRIX DE VENTE
€734,00
TVA incl.

ACT LC96H30W



LCHOSE40
30m



LCSTORZ40
INCLUS

Profondeur d'aspiration max.:	8m
Hauteur max. de décharge :	30m
Type de moteur:	LC240F 8cv
Débit:	96m³/h 1600L/min
Lo x La x H:	635x515x555mm
Poids:	49kg
Lo x La x H sortie/entrée:	4" x 4"
Utilisation pour:	Eau usée
Accessoires INCLUS:	Voir page 32

PRIX TARIF
€1734,99
hors TVA

PRIX DE VENTE
€1239,28
hors TVA

PRIX DE VENTE
€1499,52
TVA incl.

ACTLC60H30D

ACTLC60H30DE



DIESEL - EAU USÉE



LCHOSE30
30m



LCSTORZ30
INCLUS

Profondeur d'aspiration max.:	6m
Hauteur max. de décharge :	30m
Type de moteur:	LC350D 7cv
Débit:	60m³/h 1000L/min
Lo x La x H:	515x420x450mm
Poids:	48kg
Lo x La x H sortie/entrée:	3" x 3"
Utilisation pour:	Eau usée
Accessoires INCLUS:	Voir page 32

PRIX TARIF
€1889,54
hors TVA

PRIX DE VENTE
€1349,67
hors TVA

PRIX DE VENTE
€1633,11
TVA incl.



DIESEL - EAU USÉE



LCHOSE30
30m



LCSTORZ30
INCLUS

Profondeur d'aspiration max.:	6m
Hauteur max. de décharge :	30m
Type de moteur:	LC350DE 7cv
Débit:	60m³/h 1000L/min
Lo x La x H:	575x490x450mm
Poids:	67kg
Lo x La x H sortie/entrée:	3" x 3"
Utilisation pour:	Eau usée
Accessoires INCLUS:	Voir page 32

PRIX TARIF
€2256,00
hors TVA

PRIX DE VENTE
€1611,438
hors TVA

PRIX DE VENTE
€1949,83
TVA incl.

ACTLC78H30TR



EAU CHARGÉE



LCHOSE30
30m



LCSTORZ30
INCLUS

Profondeur d'aspiration max.:	8m
Hauteur max. de décharge :	30m
Type de moteur:	LC200F 6,5cv
Débit:	78m³/h 1300L/min
Lo x La x H:	590x480x440mm
Poids:	39kg
Lo x La x H sortie/entrée:	3" x 3"
Utilisation pour:	Eau chargée
Accessoires INCLUS:	Voir page 32

PRIX TARIF
€1648,15
hors TVA

PRIX DE VENTE
€1177,25
hors TVA

PRIX DE VENTE
€1424,47
TVA incl.



GENERMORE
RENSON
LARIUS
FEMT
DREHMANN
DRELUX
BDS
ZECO
TRX
KITPRO
PUJMA
AR
DEWALT

POMPES À HAUTE PRESSION POUR EAU CLAIRE

ACTI C11H36W



Profondeur d'aspiration max.:	6m
Hauteur max. de décharge :	36m
Type de moteur:	LC97F 2cv
Débit:	11m³/h 183L/min
Lo x La x H:	380x300x370mm
Poids:	13kg
Lo x La x H sortie/entrée:	1" x 1"
Utilisation pour:	Eau claire
Accessoires INCLUS:	Voir page 32



LCCHOSE15
30m



LCSTORZ15



LCSTORZ10/
15REDUCTION

INCLUS

PRIX TARIF
€656,32
hors TVA

PRIX DE VENTE
€468,80
hors TVA

PRIX DE VENTE
€567,25
TVA incl.

ACTI C13H80W



Profondeur d'aspiration max.:	6m
Hauteur max. de décharge :	80m
Type de moteur:	LC200F 6,5cv
Débit:	13m³/h 217L/min
Lo x La x H:	435x380x390mm
Poids:	25,5kg
Lo x La x H sortie/entrée:	1,5" x 1,5"
Utilisation pour:	Eau claire
Accessoires INCLUS:	Voir page 32



LCCHOSE15
30m



LCSTORZ15

INCLUS

PRIX TARIF
€988,19
hors TVA

PRIX DE VENTE
€705,85
hors TVA

PRIX DE VENTE
€854,08
TVA incl.

ACTI C30H60W



Profondeur d'aspiration max.:	6m
Hauteur max. de décharge :	60m
Type de moteur:	LC200F 6,5cv
Débit:	30m³/h 500L/min
Lo x La x H:	520x415x460mm
Poids:	25,5kg
Lo x La x H sortie/entrée:	2" x 2"
Utilisation pour:	Eau claire
Accessoires INCLUS:	Voir page 32



LCCHOSE20
30m



LCSTORZ20

INCLUS

PRIX TARIF
€1159,67
hors TVA

PRIX DE VENTE
€828,34
hors TVA

PRIX DE VENTE
€1002,29
TVA incl.

ACTI C35H25CHEM



AVEC BOITIER EN PLASTIQUE POUR PISCINE

Profondeur d'aspiration max.:	6m
Hauteur max. de décharge :	23m
Type de moteur:	LC200F 6,5cv
Débit:	35m³/h 583L/min
Lo x La x H:	550x430x470mm
Poids:	28kg
Lo x La x H sortie/entrée:	2" x 2"
Utilisation pour:	Eau claire
Accessoires INCLUS:	Voir page 32



LCCHOSE20
30m



LCSTORZ20

INCLUS

PRIX TARIF
€1040,30
hors TVA

PRIX DE VENTE
€743,07
hors TVA

PRIX DE VENTE
€899,12
TVA incl.

REDUCTEURS + RACCORDS



RÉFÉRENCE	DÉSCRIPTION	hors TVA	TVA incl.
LC60MC30	Réducteur en acier moulu de 3" à 2" BSP	€50,86	€61,55
LC96MC40	Réducteur en acier moulu de 4" à 3" BSP	€49,62	€60,04
LC30MC20/15	Réducteur en alu de 2" à 1,5"	€20,20	€24,45
LC60MC30/20	Réducteur en alu de 3" à 2"	€32,25	€39,02
LCSTORZ10/15REDUCTION	Raccord hex SS304 F 21" x M 1½" BSPT avec filetage	€10,36	€12,54
LCSTORZ20/25REDUCTION	Raccord hex SS304 F 2" x M 2½" BSPT avec filetage	€31,90	€38,60

ACCESSOIRES INCLUS PAR POMPE



LC12H21W
1 x LC12CP15
2 x LC12RC15 - Plastic
3 x Bagues de serrage



LC36H30W
1 x LC36CP20
2 x LC36RC20 - Acier
3 x Bagues de serrage



LC60H30W
1 x LC60CP30
2 x LC60RC30 - Acier
3 x Bagues de serrage



LC96H30W
1 x LC96CP40
2 x LC96RC40 - Acier
3 x Bagues de serrage



LC60H30D
1 x LC60CP30
2 x LC60RC30 - Acier
3 x Bagues de serrage



LC60H30DE
1 x LC60CP30
2 x LC60RC30 - Acier
3 x Bagues de serrage



LC78H30TR
1 x LC78CP30
2 x LC60RC30 - Acier + plastic
3 x Bagues de serrage



LC11H36W
1 x LC11CP10
2 x LC11RC10 - Plastic
2 x Bagues de serrage



LC13H80W
1 x LC12CP15
2 x LC12RC15 - Plastic
2 x LC36RC20 - Plastic
5 x Bagues de serrage



LC30H60W
1 x LC36CP20
2 x LC36RC20 - Plastic
3 x Spanringen



LC35H25CHEM
1 x LC36CP20
2 x LC36RC20 - Plastic
1 x Coude

Ces accessoires ne sont PAS disponibles sous forme d'ensemble!

TUYAUS RETRACTABLES STORZ DES DEUX COTES



CODE	DÉSCRIPTION	P, MAX	hors TVA	TVA incl.
LCHOSE 15	Tuyau 1½" x 30m	4 BAR	€55,86	€67,59
LCHOSE 20	Tuyau 2" x 30m	4 BAR	€67,05	€81,13
LCHOSE 25	Tuyau 2½" x 30m	4 BAR	€94,59	€114,46
LCHOSE 30	Tuyau 3" x 30m	4 BAR	€110,72	€133,97
LCHOSE 40	Tuyau 4" x 30m	4 BAR	€166,85	€201,89

TUYAUS RETRACTABLES



RÉFÉRENCE	DÉSCRIPTION	hors TVA	TVA incl.
LCHOSEASP10	Tuyau 1,0" par mètre courant	€3,47	€4,20
LCHOSEASP15	Tuyau 1,5" par mètre courant	€5,70	€6,89
LCHOSEASP20	Tuyau 2,0" par mètre courant	€10,05	€12,16
LCHOSEASP30	Tuyau 3,0" par mètre courant	€15,18	€18,36

RACCORDE FIXE STORZ - FEMELLE OU MÂLE



RÉFÉRENCE F. (FILETAGE INT.)	RÉFÉRENCE M. (FILETAGE EXT.)	DÉSCRIPTION	Ø UTILE	DISTANCE CAME	hors TVA	TVA incl.
LCSTORZ10	LCSTORZEXT10	Filetage Gx1" Femelle ou Mâle	13mm		€9,15	€11,07
LCSTORZ15	LCSTORZEXT15	Filetage Gx1.5" Femelle ou Mâle	25mm	52mm	€8,99	€10,88
LCSTORZ20	LCSTORZEXT20	Filetage Gx2" Femelle ou Mâle	42mm	66mm	€12,71	€15,37
LCSTORZ25	LCSTORZEXT25	Filetage Gx2.5" Femelle ou Mâle	50mm	81mm	€16,90	€20,45
LCSTORZ30	LCSTORZEXT30	Filetage Gx3" Femelle ou Mâle	60mm	89mm	€21,16	€25,61
LCSTORZ40	LCSTORZEXT40	Filetage Gx4" Femelle ou Mâle	96mm	134mm	€41,58	€50,31

RACCORDS STORZ AVEC TÊTE - FEMELLE



RÉFÉRENCE	DÉSCRIPTION	Ø UTILE	DISTANCE CAME	hors TVA	TVA incl.
LCSTORZTULE15	Filetage 1,5"	25mm	52mm	€8,99	€10,88
LCSTORZTULE20	Filetage 2"	42mm	66mm	€10,04	€12,15
LCSTORZTULE25	Filetage 2½"	50mm	81mm	€13,82	€16,73
LCSTORZTULE30	Filetage 3"	60mm	89mm	€21,27	€25,73
LCSTORZTULE40	Filetage 4"	96mm	134mm	€47,85	€57,90

RACCORDS AVEC TÊTE



RÉFÉRENCE	DÉSCRIPTION	hors TVA	TVA incl.
LC12RC15	Filetage Gx1,5" F	€13,15	€15,91
LC36RC20	Filetage Gx2" F	€15,75	€19,06
LC60RC30	Filetage Gx3" F	€32,06	€38,79
LC96RC40	Filetage Gx4" F	€57,81	€69,95

PANIER D'ASPIRATION



RÉFÉRENCE	DÉSCRIPTION	hors TVA	TVA incl.
LC12CP15	Panier d'aspiration 1,5"	€21,09	€25,52
LC36CP20	Panier d'aspiration 2,0"	€31,51	€38,13
LC60CP30	Panier d'aspiration 3,0"	€44,66	€54,03
LC96CP40	Panier d'aspiration 4,0"	€49,62	€60,04
LC78CP30	Panier d'aspiration en métal 3,0"	€72,36	€87,55

GENERMORE
RENSON
LARIUS
FEMI
DREHMANN
DREX
BDS
ZECO
TRX
KITPRO
PUMA
AR
DEWALT

LC200DRIVE



Type de raccord:	DYNAPAC
Niveau sonore:	72 dBA 7m
Type de moteur:	LC200FI
Contenu réservoir::	3,0L
Lo x La x H:	515x420x450mm
Poids:	25kg
Autonomie en moyenne:	4h

PRIX TARIF
€514,07
hors TVA

PRIX DE VENTE
€367,19
hors TVA

PRIX DE VENTE
€444,30
TVA incl.

- Raccord rapide DYNAPAC
- Ce moteur peut être utilisé en combinaison avec l'aiguille vibrante et/ou la pompe submersible.

AIGUILLE VIBRANTE



		hors TVA	TVA incl.
Type:	H38CVN		
Longueur:	6m	€207,16	€250,67
Diamètre:	38mm		
Type:	H45CVN		
Longueur:	6m	€231,85	€280,54
Diamètre:	45mm		

POMPE IMMERGÉE



		hors TVA	TVA incl.
Type:	H15000SMP-2"		
Longueur:	6m	€278,68	€337,20
Connexion:	2"		
Débit:	55m ³		
Type:	H15000SMP-3"		
Longueur:	6m	€278,68	€337,20
Connexion:	3"		
Débit:	65m ³		



GENERMORE

RENSON

LARTUS

FEMT

DREHMANN

DRELUX

BDS

ZECO

TIRX

KITPRO

PUMA

AR

DEWALT

AXE HORIZONTAL



LC350FDI



LC460FDI



CF510FDI-C23



CF640FDI-C30

Référence:	LC350FDI	LC460FDI	CF510FDI-C23	CF640FDI-C30
Puissance maximale:	6,6cv	10,0cv	12,0cv	14,3cv
Couple maximale:	15,5Nm	24,0Nm	32,9Nm	38,7Nm
Cylindrée:	349cc	462cc	510cc	638cc
Contenu réservoir:	3,5L	4,5L	5,3L	7,2L
Système de démarrage:				
Alésage x course:	78x73mm	86x76mm	85x90mm	95x90mm
Ø Axe de transmission:	1"	1"	C23	C30
Poids:	44kg	53kg	60kg	100kg
Lo x La x H:	400x440x460mm	399x475x500mm	424x456x585mm	444x424x655mm

PRIX TARIF
€1504,00
hors TVA

PRIX DE VENTE
€1074,29
hors TVA

PRIX DE VENTE
€1299,89
TVA incl.

PRIX TARIF
€1810,52
hors TVA

PRIX DE VENTE
€1293,23
hors TVA

PRIX DE VENTE
€1564,81
TVA incl.

PRIX TARIF
€2247,71
hors TVA

PRIX DE VENTE
€1605,51
hors TVA

PRIX DE VENTE
€1942,67
TVA incl.

PRIX TARIF
€2514,90
hors TVA

PRIX DE VENTE
€1796,36
hors TVA

PRIX DE VENTE
€2173,59
TVA incl.

AXE HORIZONTAL



LC148FM



**LC152FM
LC152FI**



LC154FI



**LC135HM
LC160FM**

Référence:	LC148FM	LC152FI	LC152FM	LC154FI	LC135HM	LC160FM
Puissance maximale:	2,3cv	1,9cv	1,9cv	2,7cv	3,5cv	4,9cv
Couple maximale:	5,0Nm	4,0Nm	4,0Nm	4,5Nm	7,3Nm	10,3Nm
Cylindrée:	80cc	79cc	79cc	87cc	133cc	163cc
Contenu réservoir:	1,6L	1,6L	1,6L	1,6L	2,5L	3,6L
Système de démarrage:	Manuel	Manuel	Manuel	Manuel	Manuel	Manuel
Type d'allumage:	CDI	CDI	CDI	CDI	CDI	CDI
Alésage x course:	48,6x43mm	52x37mm	52x37mm	54x38mm	62x44mm	68x45mm
Ø Axe de transmission:	16mm	5/8" (15,87mm)	15mm	5/8" (15,87mm)	18mm	20mm
Poids:	9,5kg	10,5kg	10,5kg	10,5kg	13kg	15kg
Lo x La x H:	243x343x298mm	310x260x305mm	310x260x305	310x260x305mm	305x341x318mm	305x362x335mm

PRIX TARIF hors TVA	€292,12
PRIX DE VENTE hors TVA	€208,65
PRIX DE VENTE TVA incl.	€252,47

PRIX TARIF hors TVA	€337,25
PRIX DE VENTE hors TVA	€240,89
PRIX DE VENTE TVA incl.	€291,48

PRIX TARIF hors TVA	€337,25
PRIX DE VENTE hors TVA	€240,89
PRIX DE VENTE TVA incl.	€291,48

PRIX TARIF hors TVA	€312,10
PRIX DE VENTE hors TVA	€222,93
PRIX DE VENTE TVA incl.	€269,74

PRIX TARIF hors TVA	€413,34
PRIX DE VENTE hors TVA	€295,24
PRIX DE VENTE TVA incl.	€357,24

PRIX TARIF hors TVA	€423,03
PRIX DE VENTE hors TVA	€302,16
PRIX DE VENTE TVA incl.	€365,62

GENERMORE
RENSON
LARIUS
FEMT
DREHMANN
DRELUX
BDS
ZECO
TRX
KITPRO
PUJMA
AR
DEWALT

AXE HORIZONTAL



**LC200FM
LC200FI
LC200FDI
LC200FDM**



**LC212FM
LC212FI
LC212FDI**

Référence:	LC200FM	LC200FI	LC200FDI	LC200FDM	LC212FM	LC212FI	LC212FDI
Puissance max.:	6,5cv	6,5cv	6,5cv	6,5cv	7,0cv	7,0cv	7,0cv
Max. koppel:	12,4Nm	12,4Nm	12,4Nm	12,4Nm	12,5Nm	12,5Nm	12,5Nm
Cylindrée:	196cc	196cc	196cc	196cc	212cc	212cc	212cc
Contenu réservoir:	3,6L	3,6L	3,6L	3,6L	3,6L	3,6L	3,6L
Système de dém.	Manuel	Manuel			Manuel	Manuel	
Type d'allumage:	CDI	CDI	CDI	CDI	CDI	CDI	CDI
Alésage x course:	68x54mm	68x54mm	68x54mm	68x54mm	70x55	70x55	70x55
Axe de trans.	20mm	3/4" (19,05mm)	3/4" (19,05mm)	20mm	20mm	3/4" (19,05mm)	3/4" (19,05mm)
Poids:	16kg	16kg	19kg	19kg	19kg	19kg	22kg
Lo x La x H:	312x376x335mm	312x376x335mm	312x376x335mm	312x376x335mm	317x376x345mm	317x376x345mm	317x376x345mm

PRIX TARIF
€423,04
hors TVA

PRIX DE VENTE
€302,17
hors TVA

PRIX DE VENTE
€365,63
TVA incl.

PRIX TARIF
€423,03
hors TVA

PRIX DE VENTE
€302,16
hors TVA

PRIX DE VENTE
€365,62
TVA incl.

PRIX TARIF
€563,55
hors TVA

PRIX DE VENTE
€402,54
hors TVA

PRIX DE VENTE
€487,07
TVA incl.

PRIX TARIF
€563,60
hors TVA

PRIX DE VENTE
€402,57
hors TVA

PRIX DE VENTE
€487,11
TVA incl.

PRIX TARIF
€423,03
hors TVA

PRIX DE VENTE
€302,16
hors TVA

PRIX DE VENTE
€365,62
TVA incl.

PRIX TARIF
€423,03
hors TVA

PRIX DE VENTE
€302,16
hors TVA

PRIX DE VENTE
€365,62
TVA incl.

PRIX TARIF
€563,55
hors TVA

PRIX DE VENTE
€402,54
hors TVA

PRIX DE VENTE
€487,07
TVA incl.

AXE HORIZONTAL



LC270FDM
LC270FDI



LC390FDM
LC390FDI



LC420FDM
LC420FDI

Référence:	LC270FDM	LC270FDI	LC390FDM	LC390FDI	LC420FDM	LC420FDI
Puissance maximale:	8,2cv	8,2cv	11,1cv	11,1cv	12,3cv	12,3cv
Couple maximale:	17,7Nm	17,7Nm	25,1Nm	25,1Nm	26,8Nm	26,8Nm
Cylindrée:	270cc	270cc	389cc	389cc	420cc	420cc
Contenu réservoir:	6,0L	6,0L	6,5L	6,5L	6,5L	6,5L
Système de démarrage:						
Type d'allumage:	CDI	CDI	CDI	CDI	CDI	CDI
Alésage x course:	77x58mm	77x58mm	88x64mm	88x64mm	90x66mm	90x66mm
Ø Axe de transmission:	25mm	1"	25mm	1"	25mm	1"
Poids:	28kg	28kg	35kg	35kg	35kg	35kg
Lo x La x H:	380x430x410mm	380x430x410mm	405x450x451mm	405x450x451mm	405x452x451mm	405x452x451mm

PRIX TARIF hors TVA	€640,95
PRIX DE VENTE hors TVA	€457,82
PRIX DE VENTE TVA incl.	€553,96

PRIX TARIF hors TVA	€640,95
PRIX DE VENTE hors TVA	€457,82
PRIX DE VENTE TVA incl.	€553,96

PRIX TARIF hors TVA	€743,79
PRIX DE VENTE hors TVA	€531,28
PRIX DE VENTE TVA incl.	€642,84

PRIX TARIF hors TVA	€743,79
PRIX DE VENTE hors TVA	€531,28
PRIX DE VENTE TVA incl.	€642,84

PRIX TARIF hors TVA	€842,40
PRIX DE VENTE hors TVA	€601,71
PRIX DE VENTE TVA incl.	€728,07

PRIX TARIF hors TVA	€842,40
PRIX DE VENTE hors TVA	€601,71
PRIX DE VENTE TVA incl.	€728,07

GENERMORE
RENSON
LARIUS
FEMT
DREHMANN
DRELUX
BDS
ZECO
TRX
KITPRO
PUJMA
AR
DEWALT

AXE HORIZONTAL



LC2V78FD



LC2V80FD



LC2V90FD-C

Référence:	LC2V78FD	LC2V80FD	LC2V90FD-C
Puissance maximale:	19,4cv	24,1cv	32,2cv
Couple maximale:	43Nm	51Nm	73Nm
Cylindrée:	678cc	764cc	999cc
Contenu réservoir:	/	/	/
Système de démarrage:			
Type d'allumage:	CDI	CDI	CDI
Alésage x course:	78x71mm - 2 cylindres	80x76mm - 2 cylindres	90x78mm - 2 cylindres
Ø Axe de transmission:	1"	1"	36,5mm
Poids:	48kg	50kg	61kg
Lo x La x H:	510x400x640mm	507x552x690mm	555x567x723mm

PRIX TARIF
€1999,40
hors TVA

PRIX DE VENTE
€1428,14
hors TVA

PRIX DE VENTE
€1728,05
TVA incl.

PRIX TARIF
€2257,73
hors TVA

PRIX DE VENTE
€1612,67
hors TVA

PRIX DE VENTE
€1951,33
TVA incl.

PRIX TARIF
€3905,00
hors TVA

PRIX DE VENTE
€2789,29
hors TVA

PRIX DE VENTE
€3375,04
TVA incl.

AXE HORIZONTAL



**LC200FB-REDU
LC200FDB-REDU
LC240FDB-REDU**



**LC200FDC-REDU
LC390FDC-REDU**

Référence:	LC200FDC-REDU	LC200FB-REDU	LC200FDB-REDU	LC240FDB-REDU	LC390FDC-REDU
Puissance maximale:	6,5cv	6,5cv	6,5cv	8,2cv	11,1cv
Couple maximale:	12,4Nm	12,4Nm	12,4Nm	15,3Nm	25,1Nm
Cylindrée:	196cc	196cc	196cc	242cc	389cc
Contenu réservoir:	3,6L	3,6L	3,6L	6,0L	6,5L
Système de démarrage:		Manuel			
Type d'allumage:	CDI	CDI	CDI	CDI	CDI
Alésage x course:	68x54mm	68x54mm	68x54mm	73x58mm	88x64mm
Ø Axe de transmission:	3/4" (19,05mm)	3/4" (19,05mm)	3/4" (19,05mm)	22,23mm	25mm
Poids:	19kg	16kg	19kg	28kg	35kg
Lo x La x H:	312x376x335mm	312x376x335mm	312x376x335mm	405x430x410mm	405x452x443mm

PRIX TARIF
€680,39
hors TVA
PRIX DE VENTE
€485,99
hors TVA
PRIX DE VENTE
€588,05
TVA incl.

PRIX TARIF
€636,73
hors TVA
PRIX DE VENTE
€454,81
hors TVA
PRIX DE VENTE
€550,32
TVA incl.

PRIX TARIF
€750,84
hors TVA
PRIX DE VENTE
€536,31
hors TVA
PRIX DE VENTE
€648,94
TVA incl.

PRIX TARIF
€1106,29
hors TVA
PRIX DE VENTE
€790,21
hors TVA
PRIX DE VENTE
€956,15
TVA incl.

PRIX TARIF
€1523,97
hors TVA
PRIX DE VENTE
€1088,55
hors TVA
PRIX DE VENTE
€1317,14
TVA incl.

GENERMORE

RENSON

LARTUS

FEMT

DREHMANN

DRELUX

BDS

ZECO

TRX

KITPRO

PUJMA

AR

DEWALT

AXE VERTICAL



LC1P70F



LC1P88F-1



LC1P92F-1



LC1P96F-1

Référence:	LC1P65FA	LC1P70F	LC1P70FC	LC1P70FAD	LC1P88F-1	LC1P92F-1	LC1P96F-1
Puissance max. :	3,5cv	4,5cv	4,9cv	4,9cv	11,7cv	12,5cv	15,7cv
Couple max.:	8,2Nm/2500rpm	9,0Nm/2500rpm	10,5Nm/2500rpm	10,5Nm/2500rpm	22,0Nm/2600rpm	27,0Nm/2600rpm	36,0Nm/2600rpm
Cylindrée:	153cc	173cc	196cc	196cc	413cc	452cc	608cc
Contenu réservoir:	1,0L	1,0L	1,0L	1,0L	/	/	/
Système de dém.	Manuel	Manuel	Manuel				
Type d'allumage:	CDI	CDI	CDI	CDI	CDI	CDI	CDI
Alésage x course:	65x46mm	70x45mm	70x51mm	70x51mm	88x68mm	92x68mm	96x84mm
Axe de trans.	7/8" (22,2mm)	7/8" (22,2mm)	7/8" (22,2mm)	7/8" (22,2mm)	1"	1"	1"
Poids:	9,0kg	12,5kg	12,8kg	12,8kg	31kg	31kg	35kg
Lo x La x H:	385x340x250mm	379x358x278mm	385x340x250mm	385x340x250mm	432x388x300mm	432x388x300mm	465x434x331mm

PRIX TARIF
€342,74
hors TVA

PRIX DE VENTE
€244,81
hors TVA

PRIX DE VENTE
€296,22
TVA incl.

PRIX TARIF
€381,04
hors TVA

PRIX DE VENTE
€272,17
hors TVA

PRIX DE VENTE
€329,33
TVA incl.

PRIX TARIF
€404,82
hors TVA

PRIX DE VENTE
€289,16
hors TVA

PRIX DE VENTE
€349,88
TVA incl.

PRIX TARIF
€472,93
hors TVA

PRIX DE VENTE
€337,81
hors TVA

PRIX DE VENTE
€408,75
TVA incl.

PRIX TARIF
€955,45
hors TVA

PRIX DE VENTE
€682,46
hors TVA

PRIX DE VENTE
€825,78
TVA incl.

PRIX TARIF
€1086,31
hors TVA

PRIX DE VENTE
€775,94
hors TVA

PRIX DE VENTE
€938,88
TVA incl.

PRIX TARIF
€1292,12
hors TVA

PRIX DE VENTE
€922,94
hors TVA

PRIX DE VENTE
€1116,76
TVA incl.

GENERMORE
RENSON
LARIUS
FEMT
DREHMANN
DREX
BUS
ZECO
TRX
KITPRO
PUMA
AR
DEWALT

AXE VERTICAL



LC2P77FD



LC2P82FD

Référence:	LC2P77F-1	LC2P82F-1
Puissance maximale:	21,8cv	24,5cv
Couple maximale:	47,5Nm	55,0Nm
Cylindrée:	708cc	802cc
Contenu réservoir:	/	/
Système de démarrage:		
Type d'allumage:	CDI	CDI
Alésage x course:	77x76mm	82x76mm
Ø Axe de transmission:	1"	1"
Poids:	42kg	42kg
Lo x La x H:	466x480x356mm	466x480x356mm

PRIX TARIF	€1721,36
hors TVA	
PRIX DE VENTE	€1229,54
hors TVA	
PRIX DE VENTE	€1487,75
TVA incl.	

PRIX TARIF	€1889,84
hors TVA	
PRIX DE VENTE	€1349,89
hors TVA	
PRIX DE VENTE	€1633,36
TVA incl.	

GENERMORE

RENSON

LARTUS

FEMT

DREHMANN

DRELUX

BDS

ZECO

TRX

KITPRO

PUJMA

AR

DEWALT

AXE HORIZONTAL ET INCLINÉ



**LC200FV
LC270FV
LC270FDV
LC340FV
LC420FV
LC420FDV**

**LC2V78FV
LC2V80FV**

SORTIE POUR ALTERNATEUR

Référence:	LC200FV	LC270FV	LC270FDV	LC340FV	LC420FV	LC420FDV	LC2V78FDV	LC2V80FDV
Puissance maximale:	6,5cv	8,2cv	8,2cv	9,7cv	12,3cv	12,3cv	19,7cv	24,1cv
Couple maximale:	12,4Nm	17,7Nm	17,7Nm	22,1Nm	26,8Nm	26,8Nm	43,0Nm	51Nm
Cylindrée:	196cc	270cc	270cc	338cc	420cc	420cc	678cc	764cc
Contenu réservoir:	3,6L	6,0L	6,0L	6,5L	6,5L	6,5L	/	/
Système de démarrage:	Manuel	Manuel		Manuel	Manuel			
Type d'allumage:	CDI	CDI	CDI	CDI	CDI	CDI	CDI	CDI
Alésage x course:	68x54mm	77x58mm	77x58mm	82x64mm	90x66mm	90x66mm	78x71mm	80x76mm
Ø Axe de transmission:	3/16" V-type	3/16" V-type	3/16" V-type	3/16" V-type	3/16" V-type	3/16" V-type	3/16" V-type	3/16" V-type
Poids:	16kg	25kg	28kg	31kg	32kg	35kg	47kg	50kg
Lo x La x H:	312x376 x335mm	380x430 x410mm	380x430 x410mm	405x450 x443mm	405x450 x443mm	405x450 x443mm	510x400 x450mm	507x552 x690mm

PRIX TARIF hors TVA €402,91	PRIX TARIF hors TVA €622,28	PRIX TARIF hors TVA €622,28	PRIX TARIF hors TVA €674,71	PRIX TARIF hors TVA €847,87	PRIX TARIF hors TVA €986,10	PRIX TARIF hors TVA €1999,40	PRIX TARIF hors TVA €2257,73
PRIX DE VENTE hors TVA €287,79	PRIX DE VENTE hors TVA €444,49	PRIX DE VENTE hors TVA €444,49	PRIX DE VENTE hors TVA €481,93	PRIX DE VENTE hors TVA €605,62	PRIX DE VENTE hors TVA €704,36	PRIX DE VENTE hors TVA €1428,14	PRIX DE VENTE hors TVA €1612,67
PRIX DE VENTE TVA incl. €348,23	PRIX DE VENTE TVA incl. €537,83	PRIX DE VENTE TVA incl. €537,83	PRIX DE VENTE TVA incl. €583,14	PRIX DE VENTE TVA incl. €732,80	PRIX DE VENTE TVA incl. €852,27	PRIX DE VENTE TVA incl. €1728,05	PRIX DE VENTE TVA incl. €1951,33

MOTEURS MONOPHASE 1 X 230V

Cl. F - IP54 - 50HZ



TYPE:	kw/cv:	RPM	A	B	H	D	hors TVA	TVA incl.
TRM1002010	0,75/1,0	3000	125	100	80	19	€122,23	€147,90
TRM1002015	1,1/1,5	3000	125	100	80	19	€143,40	€173,52
TRM1002020	1,5/2,0	3000	140	100	90	19	€159,41	€192,89
TRM1002025	1,85/2,5	3000	140	100	90	24	€195,26	€236,26
TRM1002030	2,2/3,0	3000	140	125	90	24	€237,88	€287,83
TRM1002030H2	2,2/3,0	3000	140	125	90	24	€275,13	€332,91
TRM100407	0,55/0,75	1500	125	100	80	19	€126,29	€152,81
TRM1004010	0,75/1,0	1500	125	100	80	19	€136,70	€165,41
TRM1004015	1,1/1,5	1500	140	140	90	24	€160,64	€194,38
TRM1004020	1,5/2,0	1500	140	125	90	24	€184,71	€223,50
TRM1004025	1,85/2,5	1500	140	125	90	24	€211,26	€255,63

VERSION B34 ÉGALEMENT DISPONIBLE POUR CERTAINS MODÈLES !

DEMANDEZ UNE OFFRE DE PRIX !

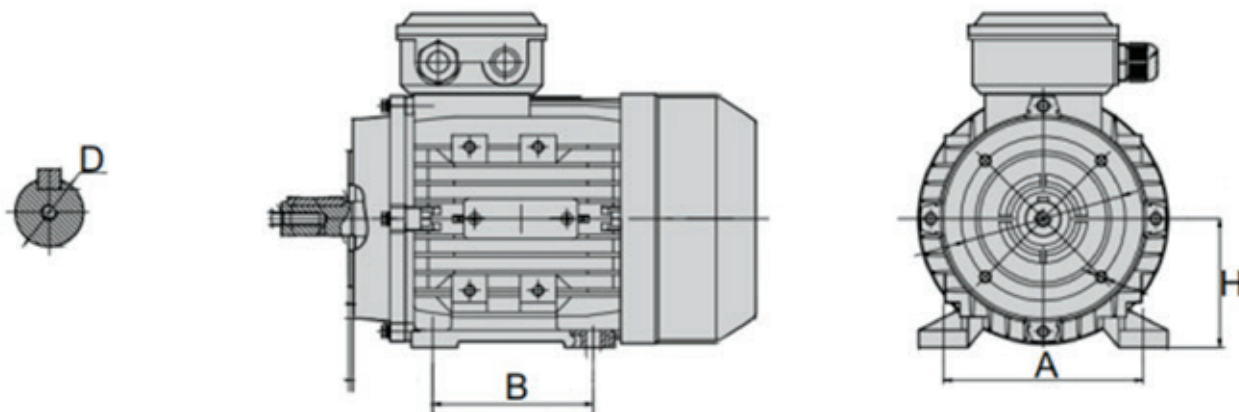

MOTEURS TRIPHASE

Cl. F - IP54 - 50HZ



TYPE:	kW/cv:	RPM	A	B	H	D	hors TVA	TVA incl.
TRT3002010	0,75/1,0	3000	125	100	80	19mm	€123,55	€149,50
TRT3002015	1,1/1,5	3000	125	100	80	19mm	€136,09	€164,66
TRT3002020	1,5/2,0	3000	140	100	90	24mm	€161,39	€195,28
TRT3002025	1,85/2,5	3000	140	100	90	24mm	€175,66	€212,55
TRT3002030	2,2/3,0	3000	140	125	90	24mm	€214,61	€259,68
TRT3002040	3,0/4,0	3000	160	140	100	28mm	€245,62	€297,20
TRT3002055	4,0/5,5	3000	190	140	112	28mm	€324,27	€392,37
TRT3002075	5,5/7,5	3000	216	140	132	28/38mm	€476,98	€577,15
TRT30020100	7,5/10,0	3000	216	140	132	28/38mm	€549,18	€664,51
TRT3004007	0,55/0,75	1500	125	100	80	19mm	€124,67	€150,85
TRT3004010	0,75/1,0	1500	125	100	80	19mm	€147,88	€178,93
TRT3004015	1,1/1,5	1500	140	100	90	24mm	€193,65	€234,32
TRT3004020	1,5/2,0	1500	140	125	90	24mm	€210,39	€254,57
TRT3004025	1,85/2,5	1500	140	125	100	24mm	€242,15	€293,00
TRT3004030	2,2/3,0	1500	160	140	100	28mm	€275,77	€333,68
TRT3004040	3,0/4,0	1500	160	140	100	28mm	€298,59	€361,30
TRT3004055	4,0/5,5	1500	190	140	112	28mm	€367,32	€444,46
TRT3004075	5,5/7,5	1500	216	140	132	28/38mm	€482,19	€583,45
TRT30040100	7,5/10,0	1500	216	140	132	28/38mm	€618,39	€748,25
TRT6002040	3,0/4,0	3000	160	140	100	28mm	€259,57	€314,08
TRT6002055	4,0/5,5	3000	190	140	112	28mm	€356,69	€431,59
TRT6002075	5,5/7,5	3000	216	140	132	28/38mm	€524,67	€634,85
TRT6602055	4,0/5,5	3000	190	140	112	28mm	€367,27	€444,39
TRT6602075	5,5/7,5	3000	216	140	132	28/38mm	€434,13	€525,29
TRT66020100	7,5/10,0	3000	216	140	132	28/38mm	€548,69	€663,91
TRT6604055	4,0/5,5	1500	190	140	112	28mm	€367,85	€445,10
TRT6604075	5,5/7,5	1500	216	140	132	28/38mm	€482,19	€583,45
TRT66040100	7,5/10,0	1500	216	140	132	28/38mm	€618,35	€748,20

GENERMORE
RENSON
LARIUS
FEMT
DREHMANN
DREIX
BUS
ZECO
TRX
KITPRO
PUMA
AR
DEWALT

MOTEURS ESSENCE + MOTEUR DIESEL



SEMELLE ET KIT DE ROUES INCLUS
pour chaque plaque vibrante



TPC60L



TPC75L



TPC80LX



TPC95L



TPC105LX



TPC120LD
(DIESEL)

Référence:	TPC60L	TPC75L	TPC80LX	TPC95L	TPC105LX	TPC120LD
Puissance maximale:	2,5cv	6,5cv	6,5cv	6,5cv	6,5cv	7,0cv
Type de moteur:	1 cylindre 4 temps	1 cylindre 4 temps	1 cylindre 4 temps	1 cylindre 4 temps	1 cylindre 4 temps	1 cylindre 4 temps
Contenu réservoir:	1,6L	3,0L	3,0L	3,0L	3,0L	3,0L
Lo x La semelle:	430x310mm	500x350mm	500x350mm	500x450mm	530x500mm	570x440mm
Force de dommage:	820kg/8,2kN	1070kg/10,7kN	1050kg/10,5kN	1500kg/15,0kN	1300kg/13,0kN	1590kg/15,9kN
Niveau sonore:	108 dBA 7m	108 dBA 7m	108 dBA 7m	108 dBA 7m	108 dBA 7m	108 dBA 7m
Fréquence des vibrations:	5900P/min	5600P/min	5900P/min	5200P/min	5500P/min	5500P/min
Poids:	58kg	66kg	76kg	95kg	100kg	105kg

PRIX TARIF hors TVA	€666,30
PRIX DE VENTE hors TVA	€475,93
PRIX DE VENTE TVA incl.	€575,87

PRIX TARIF hors TVA	€818,41
PRIX DE VENTE hors TVA	€584,58
PRIX DE VENTE TVA incl.	€707,34

PRIX TARIF hors TVA	€1023,02
PRIX DE VENTE hors TVA	€730,73
PRIX DE VENTE TVA incl.	€884,18

PRIX TARIF hors TVA	€992,47
PRIX DE VENTE hors TVA	€708,91
PRIX DE VENTE TVA incl.	€857,78

PRIX TARIF hors TVA	€1266,59
PRIX DE VENTE hors TVA	€904,71
PRIX DE VENTE TVA incl.	€1094,70

PRIX TARIF hors TVA	€1604,93
PRIX DE VENTE hors TVA	€1146,38
PRIX DE VENTE TVA incl.	€1387,12

MOTEUR ESSENCE



SEMELLE ET KIT DE ROUES INCLUS



TPC170E-EXT-REV
AVEC EXTENSIONS LATÉRALES

Référence:	TPC170E-EXT-REV
Puissance maximale:	9,0cv
Type de moteur:	1 cylindre 4 temps
Cylindrée:	270cc
Contenu réservoir:	6,0L
Vitesse de travail:	25m/min
Force de dommage:	3000kg/30kN
Niveau sonore:	108 dBA 7m
Fréquence des vibrations:	4850P/min
Poids:	170kg
Efficacité:	570m ² /h
Lo x La x H semelle vibrante:	700x360mm
Lo x La x H extensions (2x):	700x60mm
Avec réservoir d'eau:	Non

PRIX TABLEAU
€2586,32
hors TVA

PRIX DE VENTE
€1847,37
hors TVA

PRIX DE VENTE
€2235,32
TVA incl.



TPR77L



Puissance maximale:	4,5cv
Type de moteur:	1 cylindre 4 temps OHV
Lo x La x H zoolplaat:	345x285mm
Force de dommage:	1300kg/13,0kN
Niveau sonore:	108 dBA 7m
Fréquence des vibrations:	5600P/min
Poids:	70kg

PRIX TARIF
€2695,86
hors TVA

PRIX DE VENTE
€1925,62
hors TVA

PRIX DE VENTE
€2330,00
TVA incl.

TPR88L



Puissance maximale:	5,5cv
Type de moteur:	1 cylindre 4 temps OHV
Lo x La x H zoolplaat:	345x285mm
Force de dommage:	1350kg/13,5kN
Niveau sonore:	108 dBA 7m
Fréquence des vibrations:	5200P/min
Poids:	76kg

PRIX TARIF
€2407,09
hors TVA

PRIX DE VENTE
€1719,35
hors TVA

PRIX DE VENTE
€2080,41
TVA incl.

TPR90L



POWERED by
HONDA



Puissance maximale:	3,6cv
Type de moteur:	Honda GXR120
Lo x La x H zoolplaat:	345x285mm
Force de dommage:	1250kg/12,5kN
Niveau sonore:	108 dBA 7m
Fréquence des vibrations:	5400P/min
Poids:	72kg

PRIX TARIF
€3985,77
hors TVA

PRIX DE VENTE
€2846,98
hors TVA

PRIX DE VENTE
€3444,84
TVA incl.



LC1600



Puissance maximale:	4400W (5,9cv)
Type de moteur:	LC170F
Largeur de la coupe:	80cm
Profondeur de la coupe:	>15cm
Vitesse de travail:	>350m ² /u
Vitesses:	Marche avant et arrière
Transmission:	Par chaîne
Poids:	60kg
Lo x La x H:	1400x820x1000mm

PRIX TARIF
€875,31
hors TVA

PRIX DE VENTE
€625,22
hors TVA

PRIX DE VENTE
€756,51
TVA incl.

LC1750



Kit de roues
INCLUS

Puissance maximale:	4400W (5,9cv)
Type de moteur:	LC170F
Largeur de la coupe:	85cm
Profondeur de la coupe:	>15cm
Vitesse de travail:	>400m ² /u
Vitesses:	-1 / 0 / 1 / 2
Transmission:	Par chaîne en bain d'huile
Poids:	62,5kg
Lo x La x H:	1500x850x1000mm

PRIX TARIF
€1099,60
hors TVA

PRIX DE VENTE
€785,43
hors TVA

PRIX DE VENTE
€950,37
TVA incl.

LC1900



Kit de roues
INCLUS

Puissance maximale:	4100W (5,5cv)
Type de moteur:	LC200F
Largeur de la coupe:	90cm
Profondeur de la coupe:	>15cm
Vitesse de travail:	>500m ² /u
Vitesses:	-1 / 0 / 1 / 2
Transmission:	Boîte de vitesses en bain d'huile
Poids:	82kg
Lo x La x H:	1500x1050x1000mm

PRIX TARIF
€1388,51
hors TVA

PRIX DE VENTE
€991,79
hors TVA

PRIX DE VENTE
€1200,07
TVA incl.

RÉSERVOIR MOBILE



RS136285 €793,93 hors TVA €960,65 TVA incl.
 Réservoir mobile de 200L
 Avec pompe **RS137982**
 12V-40L/min + tuyau 4m
 + pistolet automatique

RÉSERVOIR MOBILE



RS812142 €1326,11 hors TVA €1604,59 TVA incl.
 Réservoir mobile de 400L
 Avec pompe **RS138974**
 12V-40L/min + tuyau 4m
 + pistolet alu

RÉSERV. MOBILE DUO



RS971835 €2591,43 hors TVA €3135,63 TVA incl.
 1) Réservoir de 400L diesel avec pompe **RS137982** 12V-40L/min + tuyau 4m + pistolet auto + câble de 4m avec pince de batterie
 2) Réservoir de graisse 50L avec pompe 12V-15L/min + tuyau 4m + pistolet manuel

RÉSERVOIR FIXE



RS159059 €2120,03 hors TVA €2565,24 TVA incl.
 1000l avec pompe **RS138328** - 230V-50L/min + compteur numérique **RS971160**
RS141283 €2363,17 hors TVA €2859,44 TVA incl.
 1500l avec pompe **RS138328** - 230V-50L/min + compteur numérique **RS971850**
 - PEHD à double paroi
 - Traitement anti-UV
 - Renforts latéraux en métal

Également disponible sur demande avec des réservoirs de : 2500L, 5000L et 9000L

STATION DISTRIBUTION



RS853229 **Prix sur demande**
 Distributeur à usage privé pour le diesel.
 Tuyau de 4 m INCLUS. 70L/min
RS853216
 Piédestal pour station de distribution
RS853221
 Usb en clés

POMPE FUJEL KIT 12-24V



RS137982 €187,31 hors TVA €226,65 TVA incl.
 12V-40l/min
 Auto-amorçante

RS137998 €246,87 hors TVA €298,71 TVA incl.
 12V-60l/min
 Auto-amorçante

RS138076 €246,87 hors TVA €298,71 TVA incl.
 24V-60l/min
 Auto-amorçante

POMPE FUJEL KIT 12-24V



RS137984 €254,30 hors TVA €307,70 TVA incl.
 12V-40l/min + tuyau 4m
 + pistolet alu
 Auto-amorçante

RS854642 €317,57 hors TVA €384,26 TVA incl.
 12V-60l/min + tuyau 4m
 + pistolet alu
 Auto-amorçante

RS854643 €325,02 hors TVA €393,27 TVA incl.
 24V-60l/min + tuyau 4m
 + pistolet alu
 Auto-amorçante

GENEREMORE
RENSON
LARIUS
FERMI
DREHMANN
DRELUX
BDS
ZECO
TRX
KITPRO
PUJMA
AR
DEWALT

POMPE FUEL 230V

POMPE FUEL KIT 230V



RS138319
230V-50l/min
Auto-amorçante

€204,68 hors TVA / €247,67 TVA incl.

RS138325
230V-80l/min
Auto-amorçante

€258,03 hors TVA / €312,21 TVA incl.



RS138200
230V-50l/min + tuyau 4m
+ pistolet alu
Auto-amorçante

€319,67 hors TVA / €386,80 TVA incl.

RS138209
230V-80l/min + tuyau 4m
+ plastic pistolet
Auto-amorçante

€366,19 hors TVA / €443,09 TVA incl.

STATION DE POMPAGE

STATION DE POMPAGE



RS138201
230V-50l/min - sans filtre
+ tuyau 6m
+ pistolet alu
+ compteur numérique
Auto-amorçante

€467,58 hors TVA / €565,77 TVA incl.



RS138328
230V-50l/min - avec filtre
avec pompe RS138319
+ tuyau 6m
+ pistolet automatique
+ compteur numérique
Auto-amorçante

€619,02 hors TVA / €749,01 TVA incl.

STATION DE POMPAGE

POMPE DIESEL



RS23160
230V-56l/min + tuyau 4m
Ø19, 1"
Auto-amorçante

€742,44 hors TVA / €898,36 TVA incl.



RS159272
230V-40l/min
Auto-amorçante

€174,92 hors TVA / €211,65 TVA incl.

RS103492
230V-40l/min
+ tuyau 4m
+ pistolet alu
Auto-amorçante

€264,57 hors TVA / €320,13 TVA incl.

POMPE DIESEL

POMPE ADBLUE



RS138137
230V-40l/min + tuyau 4m
+ pistolet en plastique
+ kit avec raccords, colliers et
crépines plastiques
Pas auto-amorçante

€194,76 hors TVA / €235,66 TVA incl.



RS159114
12V-35L/min
Auto-amorçante

€338,66 hors TVA / €409,78 TVA incl.

RS973000
24V-35L/min
Auto-amorçante

€338,66 hors TVA / €409,78 TVA incl.

RS159101
230V-35L/min
Auto-amorçante

€338,66 hors TVA / €409,78 TVA incl.

POMPE ADBLUE KIT

POMPE ADBLUE + PLAQUE



RS973100 €530,93 hors TVA / €642,43 TVA incl.
12V-35L/min + kit aspiration 1,5m + tuyau de vidange 6m + raccords

RS973104 €530,93 hors TVA / €642,43 TVA incl.
24V-35L/min + kit aspiration 1,5m + tuyau de vidange 6m + raccords

RS973106 €530,93 hors TVA / €642,43 TVA incl.
230V-35L/min + kit aspiration 1,5m + tuyau de vidange 6m + raccords



RS159499 €663,68 hors TVA / €803,05 TVA incl.
Avec plaque de montage réglable pour les fûts 50-200L + tuyau d'aspiration 1,5m + tuyau de vidange 6m + pistolet

STATION ADBLUE 230V

POMPE A LEVIER



RS159102 €650,48 hors TVA / €787,08 TVA incl.
230V-35L + kit aspiration 1,5m + tuyau de vidange 6m + pistolet



RS138496 €89,69 hors TVA / €108,53 TVA incl.
Huile haute densité, détergents, savons, antigel, rinçage de glace, produits chimiques agricoles, AdBlue..... Avec tube télescopique (980 mm) pour fûts de 50 à 200 litres Débit : 500 ml par pompe

POMPE AUTOMATIQUE

POMPE MANUEL



RS973706 €209,65 hors TVA / €253,67 TVA incl.
Pompe avec double alimentation électrique possible : 12V et 230V. Pour fût de 200L/1000L IBC. Tube télescopique : de 850mm à 1245mm, débit max : 13L/min + pistolet manuel AdBlue



RS138487 €41,80 hors TVA / €50,58 TVA incl.
Diesel, Ad Blue, huile et produits chimiques. 300ml/pompe. Toutes les pièces sont en acier galvanisé

POMPE MANUEL

TRXPOMP300B



RS138494 €67,49 hors TVA / €81,66 TVA incl.
Pour le diesel, Ad Blue, l'huile et produits chimiques. Avec tube télescopique. En fonction du sens de rotation, la pompe va soit pomper, soit aspirer le liquide.



TRXPOMP300B €29,72 hors TVA / €35,97 TVA incl.
Jusqu'à 3500l avec 1 paire de batteries, 10L/min. Parfait pour pomper de l'huile, du diesel ou du mazout, de l'essence, du pétrole, de l'eau et de nombreux autres liquides.
*Piles LR20 non Incluses

GENERMOIRE
RENSON
LARTUS
FERMI
DREHMANN
DRELUX
BDS
ZECO
TRX
KITPRO
PUJMA
AR
DEWALT

ENROULEUR DIESEL



RS104930 **€721,35** **€872,83**
hors TVA TVA incl.

Tuyau 10m, Ø20, 60 l/min max.
Convient pour : diesel

RS857203 **€737,92** **€892,88**
hors TVA TVA incl.

Tuyau 8m, Ø25, 120 l/min max.
Convient pour : diesel

- Revêtement résistant à la corrosion pour l'extérieur
- Système d'arrêt automatique: permet de bloquer le tuyau à la taille souhaitée.



RS518993 **€97,77** **€118,30**
hors TVA TVA incl.

Fixation pivotante

PULVERISATEUR



RS934001 **€4,29** **€5,19**
hors TVA TVA incl.

1L
Pulvérisateur à gachette

PULVERISATEUR



RS934002 **€22,14** **€26,79**
hors TVA TVA incl.

2L
Pulvérisateur à pression

PULVERISATEUR



RS934010 **€70,08** **€84,79**
hors TVA TVA incl.

10L
Pulvérisateur à pression

JERRICANS EN PLAST.

CERTIFIED



RS935110 **€17,98** **€21,75**
hors TVA TVA incl.

10L, pour le carburant et l'huile,
avec bec verseur

RS935120 **€25,79** **€31,21**
hors TVA TVA incl.

20L, pour le carburant et l'huile,
avec bec verseur

JERRICANS EN METAL

CERTIFIED



RS935010 **€31,26** **€37,82**
hors TVA TVA incl.

10L

RS935020 **€41,42** **€50,12**
hors TVA TVA incl.

20L

JERRICANS ALIMENT.

CERTIFIED



RS970724 **€6,52** **€7,89**
hors TVA TVA incl.

5L

RS970725 **€11,73** **€14,19**
hors TVA TVA incl.

10L

CART. DE FILTRATION*

JERRICANS ALIMENT.

CERTIFIED



RS972600 **€27,91** **€33,78**
hors TVA TVA incl.

50L/min max., capacité de 175ml

RS972601 **€27,04** **€32,72**
hors TVA TVA incl.

65L/min max., capacité de 307ml

RS972603 **€49,31** **€59,66**
hors TVA TVA incl.

96L/min max., capacité de 165ml

RS970726 **€20,05** **€24,27**
hors TVA TVA incl.

20L

RS970727 **€28,39** **€34,36**
hors TVA TVA incl.

30L

*Prix par pièce



ENTONNOIR



RS159556
Plastique
Ø195mm

€4,30 hors TVA **€5,21** TVA incl.

KIT DE 4 ENTONNOIRS



RS159555
Plastique
Ø50
Ø75
Ø100
Ø120

€2,95 hors TVA **€3,57** TVA incl.

ENTONNOIR



RS159557
Plastique
Ø160mm
Avec filtre et tuyau flexible

€7,04 hors TVA **€8,52** TVA incl.

ENTONNOIR



RS139533
Plastique
Ø160mm
Avec filtre et tuyau flexible en métal

€14,32 hors TVA **€17,33** TVA incl.

ENTONNOIR



RS139532
Métal
Ø170
Avec filtre

€14,32 hors TVA **€17,33** TVA incl.

ENTONNOIR



RS970518
Plastique
4L
Avec filtre
En particulier pour les véhicules

€11,01 hors TVA **€13,32** TVA incl.

BAC DE VIDANGE



RS159562
6,5L

€5,43 hors TVA **€6,57** TVA incl.

BROC PLASTIQUE



RS159565
2L
Gradué (unité de mesure: ml)

€7,43 hors TVA **€8,99** TVA incl.

RS159567
5L
Gradué (unité de mesure: ml)

€12,77 hors TVA **€15,45** TVA incl.

BROC PLASTIQUE



RS159569
2L (unité de mesure: l) avec tuyau flexible, bouchon et couvercle vissé

€8,07 hors TVA **€9,77** TVA incl.

RS159571
5L (unité de mesure: l) avec tuyau flexible, bouchon et couvercle vissé

€14,32 hors TVA **€17,33** TVA incl.



GENERMORE
RENSON
LARIUS
FEMI
DREHMANN
DRELUX
BDS
ZECO
TRX
KITPRO
PUJMA
AR
DEWALT

POMPE A GRAISSE SUR BATTERIE



RS970244

€374,37 hors TVA / €452,99 TVA incl.

- 18V Li-Ion avec 2 batteries dans le coffre
- + chargeur
- + tuyau haute pression 1m
- + pince à 4 mors



POMPE A GRAISSE



RS970186

€25,01 hors TVA / €30,26 TVA incl.

- 0,80 cm³/pompe, 350- 600bar, tube flexible de 300mm, tube rigide de 150mm, pince à 4 mors



RS165001

€70,60 hors TVA / €85,42 TVA incl.

- 0,90 cm³/pompe, cartouche de 400g, 400-800 bar, tuyau flexible de 300mm, vanne de remplissage et purgeur d'air automatique, pince à 4 mors

PISTOLET A GRAISSE



RS970159

€40,37 hors TVA / €48,85 TVA incl.

- 0,90 cm³/pompe, 450bar, tube flexible de 300mm et tube rigide de 150mm, vanne de remplissage et purgeur d'air automatique, pince à 4 mors



RS165002

€93,04 hors TVA / €112,58 TVA incl.

- 0,80cm³/pompe, cartouche de 400g, 800bar, tube flexible 300mm, pompe aluminium 500cm³, vanne de remplissage, purgeur d'air automatique, pince à 4 mors

KIT DE GRAISSAGE 50:1



RS975812

€492,81 hors TVA / €596,30 TVA incl.

- Fixe, pour fûtes de 200kg

RS975813

€648,66 hors TVA / €784,88 TVA incl.

- Mobile (avec chariot), pour fûtes de 200kg
- Canne d'asp. 740mm Ø32mm
- Débit max. 0.6kg/min
- + Tuyau à graisse 4m avec raccord 1/4"
- + Poignée + pince à 4 mors
- + Couvercle + plateau de suivi



RS975125

€645,60 hors TVA / €781,18 TVA incl.

- Tuyau d'enroulement automatique Flexible 10m 1/4"
- Convient pour les graisses de lubrification

POIGNÉE DE GRAISSE



RS970232

€87,27 hors TVA / €105,59 TVA incl.

- Avec tuyau rigide et pince à 4 mors

RS137484

€100,04 hors TVA / €121,04 TVA incl.

- Avec tuyau flexible et pince à 4 mors



RS970229

€29,96 hors TVA / €36,25 TVA incl.

- Droit MF 1/4"

RS970230

€51,84 hors TVA / €62,73 TVA incl.

- Sous la forme "Z" MF 1/4"

RACCORDS P.D.G.

GENERATOR RENSON LARIUS FEML DREHMANN DREIX BPS ZECO TRX KITPRO PUMA AR DEWALT

SET DISTRIBUTION



RS975833

€637,94 hors TVA / €771,90 TVA incl.

Fixe, pour fûts d'huile de 200L

SET DISTRIBUTION ECO



RS970703

€554,66 hors TVA / €671,14 TVA incl.

Fixe, pour fûts d'huile de 200L

RS975835

€731,01 hors TVA / €884,52 TVA incl.

Mobile (avec chariot), pour fûts d'huile de 200L
+ Quick coupling avec valve
+ Tube d'immersion
+ Tuyau 4m + Gicleur d'huile

SERINGUE D'HUILE



RS138495

€18,23 hors TVA / €22,06 TVA incl.

500cc
+ Tuyau flexible de 300mm



RS970177

€24,50 hors TVA / €29,64 TVA incl.

1000cc
+ Tuyau flexible de 300mm
+ Tuyau rigide 300mm

BIDON D'HUILE METAL



RS159575

€10,30 hors TVA / €12,46 TVA incl.

300ml

RS159577

€11,73 hors TVA / €14,19 TVA incl.

500ml

BIDON D'HUILE ALU



RS165006

€44,03 hors TVA / €53,27 TVA incl.

300ml

Tourne dans toutes les directions

RS165007

€51,84 hors TVA / €62,73 TVA incl.

500ml

Tourne dans toutes les directions

POMPE SEMI-ROTATIVE



RS137957

€181,05 hors TVA / €219,07 TVA incl.

1200 L/h, 3/4", deux extrémités filetés

RS137958

€207,10 hors TVA / €250,59 TVA incl.

1500 L/h, 1", deux extrémités filetés

KIT P. SEMI-ROTATIVE



RS138440

€299,58 hors TVA / €362,50 TVA incl.

1200 l/h, 3/4" + tube d'immersion + tuyau 2m + bec verseur

RS138441

€429,83 hors TVA / €520,10 TVA incl.

1500 l/h, 1" + tube d'immersion + tuyau 2m + bec verseur

GENERMOIRE
RENSON
LARIUS
FEMI
DREHMANN
DRELUX
BDS
ZECO
TRX
KITPRO
PUJMA
AR
DEWALT

TRXPOMP200

ENR. AUTOM. HUILE



TRXPOMP200

€22,27 hors TVA / €26,95 TVA incl.

Un système d'accouplement unique permet d'accoupler les deux tubes d'extension.

- Tube d'extension -200mm x Ø6mm
- Tube d'extension -200mm x Ø8mm
- Couplage



RS975128

€706,50 hors TVA / €854,86 TVA incl.

Tuyau d'enroulement automatique Flexible 10m 1/4" Convient pour : l'huile

PISTOLET A HUILE

PISTOLET A HUILE



RS970746

€195,38 hors TVA / €236,42 TVA incl.

Avec compteur numérique et tuyau rigide 150mm



RS970747

€72,94 hors TVA / €88,26 TVA incl.

Tuyau rigide et compte-gouttes

RS970748

€103,16 hors TVA / €124,82 TVA incl.

Tuyau flexible et compte-gouttes

BAC DE RETENTION

BAC DE RETENTION



RS159275

€404,40 hors TVA / €489,33 TVA incl.

Pour 2 fûts de 200l/150kg



RS159276

€740,59 hors TVA / €896,11 TVA incl.

Pour 4 fûts de 200l/150kg

CHARIOT FEUT

CHARIOT POUR FûTS



RS970397

€169,34 hors TVA / €204,90 TVA incl.

50/60kg









RS970713

€264,15 hors TVA / €319,62 TVA incl.

200L

	Référence:	Nom:	Caractéristiques:	hors TVA	TVA incl.
	RS700061	Pistolet manuel	Aluminium 100l/min	€34,76	€42,06
	RS700063	Pistolet automatique	60l/min	€89,75	€108,59
	RS971420		80l/min	€130,13	€157,46
	RS141571	Raccord pivotant	M 3/4" - F 1"	€17,68	€21,39
	RS141576		M/F 1"	€18,54	€22,44
	RS973532	Buse AdBlue	Manuel, plastique 40l/min	€35,98	€43,53
	RS973531		Automatique 50l/min	€334,94	€405,28
	RS973538		Automatique + compteur numérique 40l/min	€333,70	€403,77
	RS973529	Couplage AdBlue	Pour les réservoirs IBC ou les fûts	€64,38	€77,90
	RS971850	Compteur	Mécanique, 4 chiffres	€127,65	€154,46
	RS971410		Numérique, 4 digits avec turbine	€258,03	€312,21
	RS139742	Tuyau d'alimentation	Ø25mm (1") x 3m avec vanne de filtrage	€49,29	€59,64
	RS971501		Ø25mm (1") x 7m avec vanne de filtrage	€98,62	€119,33
	RS971503		Ø35mm (1.25") x 7m avec vanne de filtrage	€111,49	€134,91
	RS139787	Tuyau de vidange	Ø20mm x 4m avec press connection MM1 "	€41,82	€50,61
	RS971520		Ø20mm x 6m avec press connection MM1 "	€51,57	€62,40
	RS157916		Ø25mm x10m avec press connection MM1 "	€105,92	€128,17

	Référence:	Nom:	Caractéristiques :	hors TVA	€TVA incl.
	RS159104	Tube d'aspiration	AdBlue M56x4	€84,67	€102,45
	RS970196	Tuyau haute pression	300mm, polyamide, 950bar max.	€9,62	€11,64
	RS970198		300mm, caoutchouc, max. 1600bar	€21,40	€25,89
	RS135826	Système de lubrification	Régulateur, nettoyeur et lubrificateur d'air comprimé	€77,89	€94,25
	RS935002	Tuyau	Bec verseur pour jerrican métallique	€10,94	€13,23
	RS935001	Joint d'étanchéité	Joint d'étanchéité pour jerrican métallique	€3,13	€3,79
	RS970731	Robinet	Robinet pour alimentation jerrican 5L	€14,32	€17,33
	RS970732		Robinet pour alimentation jerrican 10L	€9,90	€11,98
	RS970733	Robinet	Robinet pour alimentation jerrican 20L et 30L	€10,16	€12,29



LDALI

PRIX TARIF
€3451,31
hors TVA

PRIX DE VENTE
€2465,22
hors TVA

PRIX DE VENTE
€2982,92
TVA incl.



Puissance moteur:	1,1kW
Débit maximal:	4L/m
Pression maximal:	250bar
Voltage:	230V
Poids:	38,0kg
Ouverture de la buse:	Tot 0,025"
Convient pour:	Intérieur, extérieur, bâtiments industriels

INCLUS



Pistolet Airless

Super fast clean
base + nozzle



Tuyau 10m

GIOTTO

PRIX TARIF
€4166,45
hors TVA

PRIX DE VENTE
€2976,04
hors TVA

PRIX DE VENTE
€3601,00
TVA incl.



Puissance moteur:	2,2kW
Débit maximal:	8L/m
Pression maximal:	250bar
Voltage:	230V
Poids:	50,0kg
Ouverture de la buse:	Tot 0,031"
Convient pour:	Intérieur, extérieur, plafonds bâtiments industriels

INCLUS



Pistolet Airless

Super fast clean
base + nozzle



Tuyau 10m

JOLLY PLUS+

PRIX TARIF
€3930,99
hors TVA

PRIX DE VENTE
€2807,85
hors TVA

PRIX DE VENTE
€3397,50
TVA incl.



Puissance moteur:	0,65kW
Débit maximal:	1,9L/m
Pression maximal:	220bar
Voltage:	230V
Poids:	16,0kg
Ouverture de la buse:	Tot 0,021"
Convient pour:	Intérieur, extérieur, plafonds bâtiments industriels

INCLUS



Pistolet Airless

Super fast clean
base + nozzle



Tuyau 10m

GENERMORE
RENSON
LARIUS
FEMT
DREHMANN
DRELUX
BDS
ZECO
TRX
KITPRO
PLUMA
AR
DEWALT



LZEUS

PRIX TARIF
€11468,32
hors TVA

PRIX DE VENTE
€8191,66
hors TVA

PRIX DE VENTE
€9911,91
TVA incl.



Puissance moteur:	2,0kW
Débit maximal:	4L/m
Pression maximal:	220bar
Voltage:	230V
Poids:	58,0kg
Ouverture de la buse:	1 pistolet tot 0,029" 2 pistolen tot 0,017"
Convient pour:	Intérieur, extérieur, plafonds bâtiments industriels

INCLUS

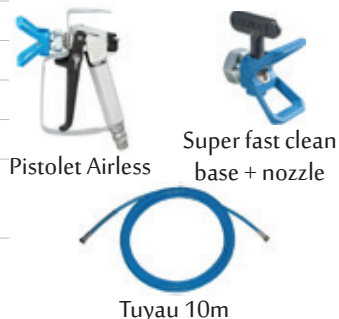

LDRAGON

PRIX TARIF
€14351,35
hors TVA

PRIX DE VENTE
€10250,97
hors TVA

PRIX DE VENTE
€12403,67
TVA incl.



Puissance moteur:	2,4kW
Débit maximal:	5L/m
Pression maximal:	230bar
Voltage:	230V
Poids:	66,0kg
Ouverture de la buse:	1 pistolet tot 0,033" 2 pistolen tot 0,019"
Convient pour:	Intérieur, extérieur, plafonds bâtiments industriels

INCLUS



LINEREXCALIBUR 20L

PRIX TARIF
€11201,48
hors TVA

PRIX DE VENTE
€8001,06
hors TVA

PRIX DE VENTE
€9681,28
TVA incl.



Puissance moteur:	3,7kW
Débit maximal:	2L/m
Pression maximal:	210bar
Voltage:	230V
Poids:	80,0kg
Ouverture de la buse:	Tot 0,023"
Dimensions:	1400x600x1050mm
Convient pour:	rues et autoroutes

INCLUS

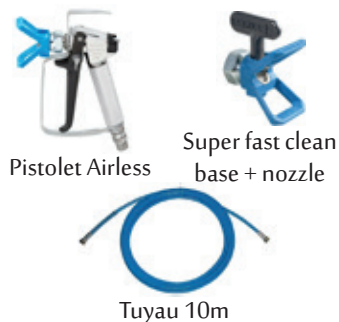

	Référence:	Nom:	Caractéristiques :	Produits:	Filtre:	hors TVA	TVA incl.	
	LW000011H25		Ø 0,23mm/0,11" 25°	Vernis, peintures	Rouge 200 M	€80,40	€97,28	
	LW000011H40		Ø 0,23mm/0,11" 40°	Nitrate, les peintures synthétiques et polyuréthanes	Jaune 100 M	€80,40	€97,28	
	LW000013H20		Ø 0,28mm/0,13" 20°					
	LW000013H25		Ø 0,28mm/0,13" 25°					
	LW000013H40		Ø 0,28mm/0,13" 40°					
	LW000015H20		Ø 0,38mm/0,15" 20°	Peinture anti-rouille	Ø 0,38mm/0,15" 40°	Blanc 60 M	€80,40	€97,28
	LW000015H40		Ø 0,38mm/0,15" 40°					
	LW000017H20		Ø 0,43mm/0,17" 20°	Peinture à l'eau au zinc inorganique	Ø 0,43mm/0,17" 60°	Vert 30 M	90,53	109,54
	LW000017H40		Ø 0,43mm/0,17" 40°					
	LW000017H60		Ø 0,43mm/0,17" 60°					
	LW000018H40		Ø 0,46mm/0,18" 40°					
	LW000019H20		Ø 0,48mm/0,19" 40°					
	LW000019H40		Ø 0,48mm/0,19" 40°					
	LW000021H40		Ø 0,53mm/0,21" 40°					
	LW000023H40		Ø 0,58mm/0,23" 40°					
	LW000025H40		Ø 0,63mm/0,25" 40°					
	LW000026H40		Ø 0,66mm/0,26" 40°					
	LW000027H40		Ø 0,68mm/0,27" 40°	Peinture thixotropique, peinture-colle pour stucco	Ø 0,73mm/0,29" 40°			
	LW000029H40		Ø 0,73mm/0,29" 40°					
	LW000037H40		Ø 0,93mm/0,37" 40°					
LW000041H40	Ø 1,03mm/0,41" 40°							
LW000045H40	Ø 1,13mm/0,45" 40°		Ø 1,13mm/0,45" 40°					
LW000051H40	Ø 1,23mm/0,51" 40°		Ø 1,23mm/0,51" 40°					
	LW000018270	Base Super Fast Clean	/	/	/	€68,78	€83,22	
	LW000018280	Joint Super Fast Clean	Acier inoxydable	/	/	€14,64	€17,72	
	LW35018	Tuyau d'extension	10m, max. 350Bar	/	/	€135,51	€163,97	
	LW85024	Tuyau d'extension	10m, PU	/	/	€231,03	€279,55	
	LW55007	Réservoir de peinture	Capacité : 6L	/	/	€93,93	€113,70	
	LW55007-1	Couvercle	Pour réservoir de peinture 6L	/	/	€14,52	€17,56	
	LW11201	Pistolet professionnel airless avec embout de peinture	Raccord tournant M16x1,5, max. 250bar	/	/	€302,99	€366,62	

FEM782XL



PRIX TARIF
€762,42
hors TVA

PRIX DE VENTE
€544,59
hors TVA

PRIX DE VENTE
€658,95
TVA incl.

Puissance:	950W
Capacité 90°:	<ul style="list-style-type: none"> ● 105mm ■ 105x93mm ■ 102x102mm
Capacité 45°:	<ul style="list-style-type: none"> ● 72mm ■ 105x93mm ■ 68x68mm
Vitesse scie:	60~80m/min
Vitesses:	2
Dimensions scie:	1335x13x0,65mm
Voltage:	1x230V (Mono, 50Hz)
Poids:	17kg
Refroidissement:	Non



Capacité de coupe max. 100x85mm



Moteur puissant 950W avec protection de surcharge.

FEM784XL



PRIX TARIF
€1161,86
hors TVA

PRIX DE VENTE
€829,90
hors TVA

PRIX DE VENTE
€1004,18
TVA incl.

Puissance:	1200W
Capacité 90°:	<ul style="list-style-type: none"> ● 120mm ■ 120x115mm ■ 119x119mm
Capacité 45°:	<ul style="list-style-type: none"> ● 85mm ■ 85x70mm ■ 80x80mm
Vitesse scie:	30~80m/min
Vitesses:	Variable
Dimensions scie:	1440x13x0,65mm
Voltage:	1x230V (Mono, 50Hz)
Poids:	17kg
Refroidissement:	Non



Capacité de coupe max. 120x115mm



Moteur puissant 1200W avec contrôle de la vitesse et protection de surcharge.

FEM785XL



PRIX TARIF
€1734,99
hors TVA

PRIX DE VENTE
€1239,28
hors TVA

PRIX DE VENTE
€1499,52
TVA incl.

Puissance:	1600W
Capacité 90°:	<ul style="list-style-type: none"> ● 152mm ■ 205x150mm ■ 150x150mm
Capacité 45°:	<ul style="list-style-type: none"> ● 106mm ■ 105x95mm ■ 102x102mm
Vitesse scie:	60~80m/min
Vitesses:	2
Dimensions scie:	1735x13x0,9mm
Voltage:	1x230V (Mono, 50Hz)
Poids:	38kg
Refroidissement:	Non



Idéal pour le découpage de profilés larges.

FEM787DAXL



SPÉCIALEMENT POUR LE CHANTIER ALLROAD

Puissance:	1850W
Capacité 90°:	<ul style="list-style-type: none"> ● 175mm ■ 213x150mm ■ 150x150mm
Capacité 45°:	<ul style="list-style-type: none"> ● 140mm ■ 145x80mm ■ 140x140mm
Vitesse scie:	60~80m/min
Vitesses:	2
Dimensions scie:	2140x19x0,9mm
Voltage:	1x230V (Mono, 50Hz)
Poids:	59kg
Refroidissement:	Non

PRIX TARIF €3230,30 <small>hors TVA</small>	PRIX DE VENTE €2307,35 <small>hors TVA</small>	PRIX DE VENTE €2791,90 <small>TVA ind.</small>
---------------------------------------------------	------------------------------------------------------	------------------------------------------------------

PATENTED



- Comprend un jeu de roues avec doubles poignées pour un transport pratique
- Descente hydraulique automatique (réglable fin)
- Possibilité de sciage avec réfrigérant
- Hauteur de la lame 19mm



L'appareil peut également être stocké verticalement.

FEMNG120XL



Puissance:	1300W
Capacité 90°:	<ul style="list-style-type: none"> ● 120mm ■ 120x102mm ■ 112x112mm
Capacité 60°:	<ul style="list-style-type: none"> ● 50mm ■ 50x43mm ■ 48x48mm
Capacité 45°:	<ul style="list-style-type: none"> ● 80mm ■ 78x78mm
Vitesse scie:	35~80m/min
Vitesses:	2
Dimensions scie:	1440x13x0,65mm
Voltage:	1x230V (Mono, 50Hz)
Poids:	18kg
Refroidissement:	Non

PRIX TARIF €1387,64 <small>hors TVA</small>	PRIX DE VENTE €991,17 <small>hors TVA</small>	PRIX DE VENTE €1199,32 <small>TVA ind.</small>
---------------------------------------------------	-----------------------------------------------------	------------------------------------------------------

PATENTED



Facile à transporter



Capacité de coupe max. 120x102mm

FEMNG160



PATENTED

PRIX TARIF
€2255,99
hors TVA

PRIX DE VENTE
€1611,34
hors TVA

PRIX DE VENTE
€1949,80
TVA incl.

Puissance:	2000W
Capacité 90°:	<ul style="list-style-type: none"> ● 150mm ■ 160x140mm ■ 150x150mm
Capacité 45°:	<ul style="list-style-type: none"> ● 100mm ■ 105x120mm ■ 100x100mm
Vitesse scie:	35~80m/min
Vitesses:	2
Dimensions scie:	1735x13x0,9mm
Voltage:	1x230V (Mono, 50Hz)
Poids:	35kg
Refroidissement:	Non



Capacité de coupe max. 120x102mm



Le système de tension innovant garantit toujours la bonne tension du ruban

FEMABSNG120



PRIX TARIF
€1561,32
hors TVA

PRIX DE VENTE
€1115,23
hors TVA

PRIX DE VENTE
€1349,42
TVA incl.

Puissance:	1300W
Capacité 90°:	<ul style="list-style-type: none"> ● 120mm ■ 120x102mm ■ 112x112mm
Capacité 60°:	<ul style="list-style-type: none"> ● 50mm ■ 50x43mm ■ 48x48mm
Capacité 45°:	<ul style="list-style-type: none"> ● 80mm ■ 78x78mm
Vitesse scie:	35~80m/min
Vitesses:	2
Dimensions scie:	1440x13x0,65mm
Voltage:	1x230V (Mono, 50Hz)
Poids:	19kg
Refroidissement:	Non

SCIAGE ENTièrement AUTOMATIQUE SANS OPÉRATEUR

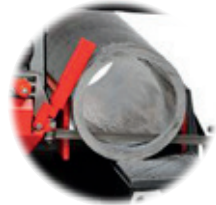

FEMABSNG160



PRIX TARIF
€2429,67
hors TVA

PRIX DE VENTE
€1735,48
hors TVA

PRIX DE VENTE
€2099,93
TVA incl.

Puissance:	2000W
Capacité 90°:	<ul style="list-style-type: none"> ● 150mm ■ 160x140mm ■ 150x150mm
Capacité 45°:	<ul style="list-style-type: none"> ● 100mm ■ 105x120mm ■ 100x100mm
Vitesse scie:	35~80m/min
Vitesses:	2
Dimensions scie:	1735x13x0,9mm
Voltage:	1x230V (Mono, 50Hz)
Poids:	36kg
Refroidissement:	Non

ACTFEMMN276DAXL



Puissance:	1000 - 1300W
Capacité 90°:	<ul style="list-style-type: none"> • 255mm ■ 265x200mm ■ 200x200mm
Capacité 60°:	<ul style="list-style-type: none"> • 110mm ■ 115x100mm ■ 100x100mm
Capacité 45°:	<ul style="list-style-type: none"> • 175mm ■ 200x160mm ■ 170x170mm
Vitesse scie:	35~70m/min
Vitesses:	2
Dimensions scie:	2565x27x0,9mm
Voltage:	3x400V (Tri, 50Hz)
Poids:	311kg
Refroidissement:	Oui



Avec armoire de rangement

PRIX TARIF €6661,31 <small>hors TVA</small>	PRIX DE VENTE €4758,08 <small>hors TVA</small>	PRIX DE VENTE €5757,28 <small>TVA incl.</small>
---------------------------------------------------	------------------------------------------------------	-------------------------------------------------------



Système de contrôle hydraulique pour la découpe automatique

OPTIONS

Référence: FEM721424
1 x butée verticale sur roulements

PRIX TARIF €66,62 <small>hors TVA</small>	PRIX DE VENTE €47,58 <small>hors TVA</small>	PRIX DE VENTE €57,58 <small>TVA incl.</small>
-------------------------------------------------	----------------------------------------------------	-----------------------------------------------------

Référence: FEM7130576
1 x butée de profondeur avec règle de mesure

PRIX TARIF €208,71 <small>hors TVA</small>	PRIX DE VENTE €149,08 <small>hors TVA</small>	PRIX DE VENTE €180,36 <small>TVA incl.</small>
--------------------------------------------------	-----------------------------------------------------	------------------------------------------------------

Référence: FEM7133704
1 x bandes rouleaux 1m in/out
Module supplémentaire à placer à gauche ou à droite

PRIX TARIF €460,90 <small>hors TVA</small>	PRIX DE VENTE €329,21 <small>hors TVA</small>	PRIX DE VENTE €398,35 <small>TVA incl.</small>
--------------------------------------------------	-----------------------------------------------------	------------------------------------------------------

INCLUS

Référence:
FEM7133703
Extensions G + D

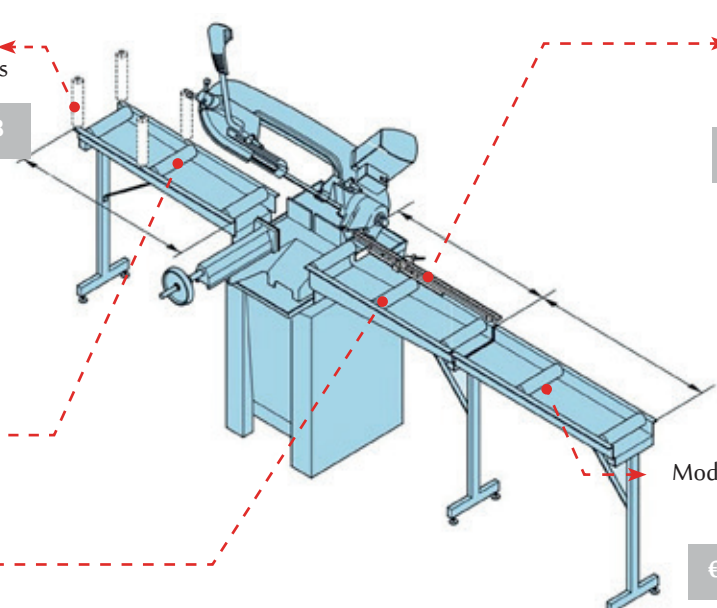

GENEREMORE
RENSON
LARIUS
FEMI
DREHMANN
DRELUX
BDS
ZECO
TRX
KITPRO
PUJMA
AR
DEWALT

DR125MONO

DR135MONO

DR135HYDRO



NEW



Moteur:	¾cv
Capacité 90°:	<ul style="list-style-type: none"> • 127mm ■ 125x130mm
Capacité 60°:	<ul style="list-style-type: none"> • 45mm ■ 45x45mm
Capacité 45°:	<ul style="list-style-type: none"> • 90mm ■ 90x90mm
Vitesse scie:	60m/min
Vitesses:	1
Dimensions scie:	1440x13x0,65mm
Voltage:	230V (mono, 50Hz)
Poids:	40,7kg
Refroidissement:	Non
Châssis INCLUS:	Oui

Moteur:	½cv
Capacité 90°:	<ul style="list-style-type: none"> • 150mm ■ 165x150mm
Capacité 60°:	<ul style="list-style-type: none"> • 70mm ■ 70x70mm
Capacité 45°:	<ul style="list-style-type: none"> • 115mm ■ 130x115mm
Vitesse scie:	65m/min
Vitesses:	1
Dimensions scie:	1735x12,7x0,9mm
Voltage:	230V (mono, 50Hz)
Poids:	82,0kg
Refroidissement:	Non
Châssis INCLUS:	Oui

Moteur:	½cv
Capacité 90°:	<ul style="list-style-type: none"> • 150mm ■ 150x150mm
Capacité 60°:	<ul style="list-style-type: none"> • 60mm ■ 60x60mm
Capacité 45°:	<ul style="list-style-type: none"> • 100mm ■ 130x100mm
Vitesse scie:	65m/min
Vitesses:	1
Dimensions scie:	1735x12,7x0,9mm
Voltage:	230V (mono, 50Hz)
Poids:	100,0kg
Refroidissement:	Oui
Châssis INCLUS:	Oui

PRIX TARIF
€1225,00
hors TVA

PRIX DE VENTE
€875,00
hors TVA

PRIX DE VENTE
€1058,75
TVA incl.

PRIX TARIF
€1367,66
hors TVA

PRIX DE VENTE
€976,90
hors TVA

PRIX DE VENTE
€1182,05
TVA incl.

PRIX TARIF
€1959,01
hors TVA

PRIX DE VENTE
€1399,29
hors TVA

PRIX DE VENTE
€1693,14
TVA incl.

DR210MONO

DR210T230

DR210T400



Moteur:	1cv
Capacité 90°:	<ul style="list-style-type: none"> • 170mm ■ 190x150mm
Capacité 45°:	<ul style="list-style-type: none"> • 125mm ■ 120x95mm
Vitesse scie:	80m/min
Vitesses:	1
Dimensions scie:	2080x20x0,9mm
Voltage:	230V (mono, 50Hz)
Poids:	162,0kg
Refroidissement:	Non
Châssis INCLUS:	Oui

Moteur:	1cv
Capacité 90°:	<ul style="list-style-type: none"> • 170mm ■ 190x150mm
Capacité 45°:	<ul style="list-style-type: none"> • 125mm ■ 120x95mm
Vitesse scie:	40 - 80m/min
Vitesses:	2
Dimensions scie:	2080x20x0,9mm
Voltage:	3 x 230V (Tri, 50Hz)
Poids:	162,0kg
Refroidissement:	Oui
Châssis INCLUS:	Oui

Moteur:	1cv
Capacité 90°:	<ul style="list-style-type: none"> • 170mm ■ 190x150mm
Capacité 45°:	<ul style="list-style-type: none"> • 125mm ■ 120x95mm
Vitesse scie:	40 - 80m/min
Vitesses:	2
Dimensions scie:	2080x20x0,9mm
Voltage:	3 x 400V (Tri, 50Hz)
Poids:	162,0kg
Refroidissement:	Oui
Châssis INCLUS:	Oui

PRIX TARIF
€2722,30
hors TVA

PRIX DE VENTE
€1944,50
hors TVA

PRIX DE VENTE
€2352,84
TVA incl.

PRIX TARIF
€2722,30
hors TVA

PRIX DE VENTE
€1944,50
hors TVA

PRIX DE VENTE
€2352,84
TVA incl.

PRIX TARIF
€2722,30
hors TVA

PRIX DE VENTE
€1944,50
hors TVA

PRIX DE VENTE
€2352,84
TVA incl.

GENERMOIRE
RENSON
LARIUS
FEMT
DREHMANN
DRELUX
BDS
ZECO
TRX
KITPRO
PUJMA
AR
DEWALT

DR275MONO

DR275T230

DR275T400



Moteur:	1 ½cv
Capacité 90°:	<ul style="list-style-type: none"> ● 225mm ■ 245x150mm ■ 190x190mm
Capacité 60°:	<ul style="list-style-type: none"> ● 90mm ■ 120x90mm ■ 90x90mm
Capacité 45°:	<ul style="list-style-type: none"> ● 145mm ■ 190x150mm ■ 150x150mm
Vitesse scie:	90m/min
Vitesses:	1
Dimensions scie:	2480x27x0,9mm
Voltage:	230V (mono, 50Hz)
Poids:	200,0kg
Refroidissement:	Oui
Châssis INCLUS:	Oui

Moteur:	1 ½cv
Capacité 90°:	<ul style="list-style-type: none"> ● 225mm ■ 245x150mm ■ 190x190mm
Capacité 60°:	<ul style="list-style-type: none"> ● 90mm ■ 120x90mm ■ 90x90mm
Capacité 45°:	<ul style="list-style-type: none"> ● 145mm ■ 190x150mm ■ 150x150mm
Vitesse scie:	45-90m/min
Vitesses:	2
Dimensions scie:	2480x27x0,9mm
Voltage:	3 x 230V (Tri, 50Hz)
Poids:	200,0kg
Refroidissement:	Oui
Châssis INCLUS:	Oui

Moteur:	1 ½cv
Capacité 90°:	<ul style="list-style-type: none"> ● 225mm ■ 245x150mm ■ 190x190mm
Capacité 60°:	<ul style="list-style-type: none"> ● 90mm ■ 120x90mm ■ 90x90mm
Capacité 45°:	<ul style="list-style-type: none"> ● 145mm ■ 190x150mm ■ 150x150mm
Vitesse scie:	45-90m/min
Vitesses:	2
Dimensions scie:	2480x27x0,9mm
Voltage:	3 x 400V (Tri, 50Hz)
Poids:	200,0kg
Refroidissement:	Oui
Châssis INCLUS:	Oui

PRIX TARIF
€3464,28
hors TVA

PRIX DE VENTE
€2474,48
hors TVA

PRIX DE VENTE
€2994,13
TVA incl.

PRIX TARIF
€3464,28
hors TVA

PRIX DE VENTE
€2474,48
hors TVA

PRIX DE VENTE
€2994,13
TVA incl.

PRIX TARIF
€3464,28
hors TVA

PRIX DE VENTE
€2474,48
hors TVA

PRIX DE VENTE
€2994,13
TVA incl.

EXTENSIONS



DRROLWAY1000-IN

Longueur: 1000mm

Largeur: 280mm

Peut être assemblé.

PRIX TARIF €539,62 <small>hors TVA</small>	PRIX DE VENTE €385,44 <small>hors TVA</small>	PRIX DE VENTE €466,39 <small>TVA incl.</small>
--------------------------------------------------	-----------------------------------------------------	------------------------------------------------------



DRROLWAY1000-OUT

Longueur: 1000mm

Largeur: 280mm

Y compris l'évaluation.

PRIX TARIF €738,63 <small>hors TVA</small>	PRIX DE VENTE €527,59 <small>hors TVA</small>	PRIX DE VENTE €638,38 <small>TVA incl.</small>
--------------------------------------------------	-----------------------------------------------------	------------------------------------------------------

SCIES À RUBAN BI-MÉTAL

Référence:	Dimensions:	Machine:	hors TVA	TVA incl.
DR090BIMZ14	1335x13x0,65mm Z10/14	DR90	€42,78	€51,76
DR090BIMZ12	1335x13x0,65mm Z8/12	DR90	€42,78	€51,76
DR115BIMZ6/10	1640x0,64x12,7mm Z6/10	DR115	€39,07	€47,28
DR115BIMZ8/12	1640x0,64x12,7mm Z8/12	DR115	€39,07	€47,28
DR115BIMZ10/14	1640x0,64x12,7mm Z10/14	DR115	€39,07	€47,28
DR125BIMZ10	1730x0,64x12,7mm Z6/10	DR125	€41,67	€50,42
DR125-Z14	1730x0,64x12,7mm 14tp	DR125	€41,67	€50,42
DR125BIMZ12	1730x0,64x12,7mm Z8/12	DR125	€41,67	€50,42
DR125BIMZ14	1730x0,64x12,7mm Z10/14	DR125	€41,67	€50,42
DR1735X13X09H10/14	1735x13x0,9mm Z10/14	DR135	€41,67	€50,42
DR135HZ14	1735x13x0,9mm DR135M	DR135	€41,67	€50,42
DR135HZ8H12	1735x13x0,9mm Z8/12	DR135	€41,67	€50,42
DR210BIZ5H8	2080x20x0,9mm Z5/8	DR210	€45,85	€55,48
DR210BIZ8H12	2080x20x0,9mm Z8/12	DR210	€45,85	€55,48
DR210BIM6H10	2080x20x0,9mm Z6/10	DR210	€45,85	€55,48
DR275BIM6H10	2480x27x0,9mm Z6/10	DR275	€62,84	€76,03
DR275BIMZ5H8	2480x27x0,9mm Z5/8	DR275	€62,84	€76,03
DR2480X20X09H5/8	2480x20x0,9mm Z5/8	DR275	€62,84	€76,03
DR2750X27X09H5/8	2750x27x0,9mm Z5/8	DR275	€62,84	€76,03
DR2925X27X5/8 M42	2925x27x0,9mm Z5/8	DR300	€81,63	€98,78
FEM.M42.1335.13.8.12	1335x13mm Z8/12		€27,32	€33,05
FEM.M42.1440.13.8.12	1440x13mm Z8/12		€29,09	€35,19
FEM.M42.1735.13.8.12	1735x13mm Z8/12		€41,58	€50,31
FEM.M42.2140.19.8.12	2140x19mm Z8/12		€48,85	€59,11
FEM.M42.2565.27.5.8	2565x27mm Z5/8		€54,87	€66,39
FEM.M42.2565.27.6.10	2565x27mm Z6/10		€54,87	€66,39
FEM.NG.M42.1440.13.8.12	1440x13mm Z8/12		€29,09	€35,19
FEM.NG.M42.1735.13.8.12	1735x13mm Z8/12		€41,58	€50,31

T-513



Moteur:	2200W
Capacité 90°:	<ul style="list-style-type: none"> ● 130mm ■ 120x120mm ■ 185x95mm
Capacité 45°:	<ul style="list-style-type: none"> ● 105mm ■ 90x90mm ■ 110x80mm
Vitesse:	1300rpm
Dimensions:	610x282x630mm
Poids:	23,0kg

INCLUS:

Ø355mm - Lame de scie à 70 dents pour acier massif

PRIX TARIF	PRIX DE VENTE	PRIX DE VENTE
€1085,90	€775,64	€938,52
hors TVA	hors TVA	TVA incl.

T60250



Moteur:	1800W
Vitesse:	2300mm
Max. zaagdiepte:	83mm
Asgat zaagblad:	25,4mm (1")
Poids:	9,7kg

- Boîte de vitesses à vis sans fin durable
- Système de collecte des poussières
- Changement facile de la lame de scie
- Lumière LED pour une bonne visibilité
- Indicateur de ligne de découpe laser

INCLUS:

Ø230mm - Lame de scie à 48 dents pour tôles ondulées

PRIX TARIF	PRIX DE VENTE	PRIX DE VENTE
€617,78	€441,27	€533,94
hors TVA	hors TVA	TVA incl.

LAMES DE SCIE A METAUX EN CARBURE



Référence:	Taille de la lame de scie:	Acier doux	Inox	Non ferreux	Paroi épaisse	Paroi mince	hors TVA	TVA incl.
TIWA180Z36	Ø180x25,4x2,0-36T	<input checked="" type="checkbox"/>	<input checked="" type="checkbox"/>	<input checked="" type="checkbox"/>	<input checked="" type="checkbox"/>	<input checked="" type="checkbox"/>	€77,06	€93,25
TIWA192Z40	Ø192x20,0x2,0-40T	<input checked="" type="checkbox"/>	<input checked="" type="checkbox"/>	<input checked="" type="checkbox"/>	<input checked="" type="checkbox"/>	<input checked="" type="checkbox"/>	€80,85	€97,83
TIWA210Z42	Ø210x30,0x2,0-42T	<input checked="" type="checkbox"/>	<input checked="" type="checkbox"/>	<input checked="" type="checkbox"/>	<input checked="" type="checkbox"/>	<input checked="" type="checkbox"/>	€94,15	€113,92
TIWA230Z48A	Ø230x25,4x2,0-48T	<input checked="" type="checkbox"/>	<input checked="" type="checkbox"/>	<input checked="" type="checkbox"/>	<input checked="" type="checkbox"/>	<input type="checkbox"/>	€113,89	€137,81
TIWA230Z48B	Ø230x30,0x2,0-48T	<input checked="" type="checkbox"/>	<input checked="" type="checkbox"/>	<input checked="" type="checkbox"/>	<input checked="" type="checkbox"/>	<input type="checkbox"/>	€113,89	€137,81
TIWA230Z68	Ø230x30,0x2,0-60T	<input checked="" type="checkbox"/>	<input checked="" type="checkbox"/>	<input checked="" type="checkbox"/>	<input checked="" type="checkbox"/>	<input checked="" type="checkbox"/>	€144,46	€174,79
TIWA303Z60	Ø300/305x25,4x2,2-60T	<input checked="" type="checkbox"/>	<input checked="" type="checkbox"/>	<input checked="" type="checkbox"/>	<input checked="" type="checkbox"/>	<input type="checkbox"/>	€172,69	€208,95
TIWA303Z80	Ø300/305x25,4x2,2-80T	<input checked="" type="checkbox"/>	<input checked="" type="checkbox"/>	<input checked="" type="checkbox"/>	<input type="checkbox"/>	<input checked="" type="checkbox"/>	€195,58	€236,65
TIWA353Z70	Ø350/355x25,4x2,4-70T	<input checked="" type="checkbox"/>	<input checked="" type="checkbox"/>	<input checked="" type="checkbox"/>	<input checked="" type="checkbox"/>	<input type="checkbox"/>	€223,51	€270,45
TIWA353Z90	Ø350/355x25,4x2,4-90T	<input checked="" type="checkbox"/>	<input checked="" type="checkbox"/>	<input checked="" type="checkbox"/>	<input type="checkbox"/>	<input checked="" type="checkbox"/>	€276,90	€335,05



GENERATEUR
BRENSON
LARIUS
FEMT
DREHMANN
DRELUX
BDS
ZECO
TRX
KITPRO
PUJMA
AR
DEWALT

CSD175IND



Puissance moteur	800W
Vitesse:	2850rpm
Dimensions meule:	Ø175x25mm
Diamètre du trou d'axe:	Ø32mm
Poids:	20,5kg

PRIX TARIF	PRIX DE VENTE	PRIX DE VENTE
€212,57	€151,84	€183,72
hors TVA	hors TVA	TVA incl.

CSD200IND



Puissance moteur	1150W
Vitesse:	2850rpm
Dimensions meule:	Ø200x25mm
Diamètre du trou d'axe:	Ø32mm
Poids:	28,5kg

PRIX TARIF	PRIX DE VENTE	PRIX DE VENTE
€325,04	€232,17	€280,93
hors TVA	hors TVA	TVA incl.

CSD150IW



Puissance moteur	700W
Vitesse:	2850rpm
Dimensions meule/brosse:	Ø150x25mm
Diamètre du trou d'axe:	Ø32mm
Poids:	16,0kg

PRIX TARIF	PRIX DE VENTE	PRIX DE VENTE
€273,87	€195,62	€236,70
hors TVA	hors TVA	TVA incl.

CSD200IW



Puissance moteur	1150W
Vitesse:	2850rpm
Dimensions meule/brosse:	Ø200x32mm
Diamètre du trou d'axe:	Ø32mm
Poids:	24,0kg

PRIX TARIF	PRIX DE VENTE	PRIX DE VENTE
€352,03	€251,45	€304,25
hors TVA	hors TVA	TVA incl.

CSDP150I



Puissance moteur	700W
Vitesse:	2850rpm
Dimensions meule:	Ø150x25mm
Dimensions bande abrasive:	50x1000mm
Diamètre du trou d'axe:	Ø32mm
Poids:	20,0kg

PRIX TARIF	PRIX DE VENTE	PRIX DE VENTE
€295,99	€211,42	€255,82
hors TVA	hors TVA	TVA incl.

FEM34N



Puissance moteur	250W
Vitesse:	2850rpm
Dimensions meule 1:	Ø150x40x20mm
Dimensions meule 2:	Ø150x20x12,7mm
Diamètre du trou d'axe:	Ø32mm
Poids:	14,0kg

PRIX TARIF	PRIX DE VENTE	PRIX DE VENTE
€173,67	€124,05	€150,10
hors TVA	hors TVA	TVA incl.

BROSSE



Meuleuse:	CSA150POLISH
	CSD150IW
Taille:	Ø150mm
Référence:	
CSDM150BRUSH	hors TVA €28,65 TVA incl. €34,66
Meuleuse:	CSD200IW
Taille:	Ø200mm
CSDM200BRUSH	€38,29 €46,33

BANDE ABRASIVE



Meuleuse:	CSDP150I
Taille:	1000x50mm
Référence:	
CSD150/1000K40	hors TVA €5,26 TVA incl. €6,37
CSD150/1000K80	€5,26 €6,37
CSD150/1000K120	€5,26 €6,37

CSA125JB



Puissance moteur	250W
Vitesse:	2850rpm
Dimensions meule:	Ø125x16mm
Diamètre du trou d'axe:	Ø12,7mm
Poids:	6,5kg

PRIX TARIF hors TVA	PRIX DE VENTE hors TVA	PRIX DE VENTE TVA incl.
€120,73	€86,23	€104,34

CSA150



Puissance moteur	300W
Vitesse:	2850rpm
Dimensions meule 1:	Ø150x40mm
Dimensions meule 2:	Ø150x16mm
Diamètre du trou d'axe:	Ø12,7mm
Poids:	9,0kg

PRIX TARIF hors TVA	PRIX DE VENTE hors TVA	PRIX DE VENTE TVA incl.
€149,44	€106,74	€129,16

CSA200



Puissance moteur	500W
Vitesse:	2850rpm
Dimensions meule:	Ø200x20mm
Diamètre du trou d'axe:	Ø16,5mm
Poids:	13,5kg

PRIX TARIF hors TVA	PRIX DE VENTE hors TVA	PRIX DE VENTE TVA incl.
€161,42	€115,30	€139,51

CSA150/200



Puissance moteur	350W
Vitesse:	2850rpm
Dimensions meule 1:	Ø150x20mm
Dimensions meule 2:	Ø200x40mm
Diamater asgat 1/asgat 2:	Ø20/Ø12,7mm
Poids:	10,5kg

PRIX TARIF hors TVA	PRIX DE VENTE hors TVA	PRIX DE VENTE TVA incl.
€150,87	€107,77	€130,40

CSA150POLISH



Puissance moteur	450W
Vitesse:	2850rpm
Dimensions meule:	Ø150x20mm
Dimensions disque de poignet:	Ø150x20mm
Diamètre du trou d'axe:	Ø12,7mm
Poids:	10,2kg

PRIX TARIF hors TVA	PRIX DE VENTE hors TVA	PRIX DE VENTE TVA incl.
€140,82	€100,59	€121,71

CSA150COMBI



Puissance moteur	300W
Vitesse:	2850rpm
Dimensions meule:	Ø150x20mm
Dimensions brosse:	Ø150x20mm
Diamètre du trou d'axe:	Ø12,7mm
Poids:	10,5kg

PRIX TARIF hors TVA	PRIX DE VENTE hors TVA	PRIX DE VENTE TVA incl.
€149,44	€106,74	€129,16

MEULES

DISQUES POLISSOIRS

CSD150 Ø150x25xØ32:

CSDM150H36	€16,41	€19,86
CSDM150H60	€16,41	€19,86
CSDM150H100	€16,84	€20,37

CSD175 Ø175x25xØ32:

CSDM175H40	€21,89	€26,48
CSDM175H60	€22,46	€27,18
CSDM175H100	€23,58	€28,53

CSD200 Ø200x32xØ32:

CSDM200H40	€32,19	€38,96
CSDM200H60	€30,67	€37,11
CSDM200H100	€32,19	€38,96



Meuleuse: CSA150POLISH
Taille: Ø150mm

Référence:	hors TVA	TVA	TVA incl.
CSDM150POLI	€18,87	€22,83	
CSA150H50POLI2	€26,24	€31,75	

↳ Pour montage par flasques

GENERMOIRE
RENSON
LARIUS
FEMI
DREHMANN
DRELUX
BDS
ZECO
TRX
KITPRO
PUJMA
AR
DEWALT

DLX1010



Puissance max.:	1010W
Vitesse:	150-300rpm 300-650rpm
Tige de mélange:	Ø119mm
Poids:	8,0kg

PRIX TARIF €172,85 hors TVA	PRIX DE VENTE €123,47 hors TVA	PRIX DE VENTE €149,39 TVA incl.
-----------------------------------	--------------------------------------	---------------------------------------

DLX1400



Puissance max.:	1400W
Vitesse:	150-300rpm 300-650rpm
Tige de mélange:	Ø136mm
Poids:	8,0kg

PRIX TARIF €225,31 hors TVA	PRIX DE VENTE €160,93 hors TVA	PRIX DE VENTE €194,73 TVA incl.
-----------------------------------	--------------------------------------	---------------------------------------

DLX1800



Puissance max.:	1800W
Vitesse:	150-300rpm 300-650rpm
Tige de mélange:	Ø166mm
Poids:	8,0kg

PRIX TARIF €305,19 hors TVA	PRIX DE VENTE €217,99 hors TVA	PRIX DE VENTE €263,77 TVA incl.
-----------------------------------	--------------------------------------	---------------------------------------

TIGES MALAXEURS



Référence:	Caractéristiques:	hors TVA	TVA incl.
DLX1010DIA119	Ø119mm-M14	€21,49	€26,00
DLX1400DIA136	Ø136mm-M14	€22,98	€27,81
DLX1800DIA166	Ø166mm-M17	€31,57	€38,20

DR250MONO



Moteur:	1,3cv (0,95kW)
Diamètre de scie:	Ø250mm
Capacité 90°:	<ul style="list-style-type: none"> ● 75mm ■ 65x65mm ■ 90x50mm
Capacité 45°:	<ul style="list-style-type: none"> ● 65mm ■ 58x58mm ■ 70x50mm
Vitesse:	42rpm
Voltage:	230V (mono, 50Hz)
Poids:	85,0kg

PRIX TARIF hors TVA	PRIX DE VENTE hors TVA	PRIX DE VENTE TVA incl.
€2149,19	€1535,13	€1857,51

DR250T400



Moteur:	1,3cv (0,95kW)
Diamètre de scie:	Ø250mm
Capacité 90°:	<ul style="list-style-type: none"> ● 75mm ■ 65x65mm ■ 90x50mm
Capacité 45°:	<ul style="list-style-type: none"> ● 65mm ■ 58x58mm ■ 70x50mm
Vitesse:	42rpm
Voltage:	3 x 400V (Tri, 50Hz)
Poids:	85,0kg

PRIX TARIF hors TVA	PRIX DE VENTE hors TVA	PRIX DE VENTE TVA incl.
€2149,19	€1535,13	€1857,51

LAMES DE SCIE HSSDM05 POUR METAL

Référence:	Caractéristiques:
DR250Z128	Ø250 x 2.0-Z128 x Ø32mm
DR250Z160	Ø250 x 2.0-Z160 x Ø32mm
DR250Z200	Ø250 x 2.0-Z200 x Ø32mm
DR250Z220	Ø250 x 2.0-Z220 x Ø32mm
DR275Z180	Ø275 x 2.0-Z180 x Ø32mm
DR275Z220	Ø275 x 2.0-Z220 x Ø32mm
DR300Z220	Ø300 x 2.0-Z220 x Ø32mm
DR315Z200	Ø315 x 2.0-Z200 x Ø32mm
DR315Z220	Ø315 x 2.0-Z220 x Ø32mm

hors TVA	TVA incl.
€63,53	€76,87
€64,98	€78,62
€73,40	€88,81
€86,25	€104,37
€85,72	€103,72
€86,25	€104,37
€133,20	€161,17
€133,20	€161,17
€133,20	€161,17



ACTTRXD800PLUS

Forets:

Capacité max. Ø:	100mm	200mm
Longueur:	400mm	400mm
Matériau à forer:	Beton	Brique

Puissance moteur	1500W
Voltage:	230V (mono, 50Hz)
Dimensions:	49,5x29x38mm
Poids:	18kg

Vitesse 1:	950rpm
Vitesse 2:	180rpm
Vitesse 3:	3450rpm
Raccord:	Intérieur 1/2" G Extérieur 5/4 UNC



+



EMBRAYAGE À FRICTION

+



Ø32x400mm
Ø63x400mm
Ø102x400mm

PRIX TARIF
€1213,97
hors TVA

PRIX DE VENTE
€867,12
hors TVA

PRIX DE VENTE
€1049,22
TVA incl.

HI-DENSITY



Wet

- Pour béton fortement armé
- Pour tous les types de pierres naturelles dures
- Coupe rapide, haute efficacité
- Coupe nette et lisse

FINI=FINI

Type:	Ø Forets:	Longueur:	Raccord:	hors TVA	TVA incl.
TRXJD027400SDW	Ø27	400mm	1/2" G	€51,06	€61,78
TRXJD032400SDW	Ø32	400mm	1/2" G	€54,95	€66,49
TRXJD040400SDW	Ø40	400mm	1/2" G	€63,70	€77,07
TRXJD046400SDW	Ø46	400mm	1/2" G	€67,60	€81,79
TRXJD053400SDW	Ø53	400mm	1/2" G	€70,51	€85,32
TRXJD063400SDW	Ø63	400mm	5/4" UNC	€78,29	€94,73
TRXJD083400SDW	Ø83	400mm	5/4" UNC	€109,90	€132,98
TRXJD102400SDW	Ø102	400mm	5/4" UNC	€117,67	€142,38
TRXJD114400SDW	Ø114	400mm	5/4" UNC	€157,08	€190,06
TRXJD132400SDW	Ø132	400mm	5/4" UNC	€186,74	€225,95
TRXJD154400SDW	Ø154	400mm	5/4" UNC	€207,63	€251,24
TRXJD166400SDW	Ø166	400mm	5/4" UNC	€250,91	€303,61
TRXJD180400SDW	Ø180	400mm	5/4" UNC	€274,75	€332,45
TRXJD202400SDW	Ø202	400mm	5/4" UNC	€317,55	€384,24
TRXJD220400SDW	Ø220	400mm	5/4" UNC	€446,90	€540,74
TRXJD254400SDW	Ø254	400mm	5/4" UNC	€588,40	€711,97

LASER WELD



Wet 

- Pour le béton armé standard
- Coupe rapide, haute efficacité
- Coupe nette et lisse

Type:	Ø Forets:	Longueur:	Raccord:	hors TVA	TVA incl.
TRXJD027400LWW	Ø27	400mm	1/2" G	€41,72	€50,48
TRXJD032400LWW	Ø32	400mm	1/2" G	€43,06	€52,10
TRXJD040400LWW	Ø40	400mm	1/2" G	€48,04	€58,13
TRXJD046400LWW	Ø46	400mm	1/2" G	€49,30	€59,65
TRXJD053400LWW	Ø53	400mm	1/2" G	€55,54	€67,20
TRXJD063400LWW	Ø63	400mm	5/4" UNC	€66,15	€80,04
TRXJD071400LWW	Ø71	400mm	5/4" UNC	€74,25	€89,84
TRXJD083400LWW	Ø83	400mm	5/4" UNC	€81,12	€98,16
TRXJD102400LWW	Ø102	400mm	5/4" UNC	€106,69	€129,10
TRXJD114400LWW	Ø114	400mm	5/4" UNC	€117,94	€142,71
TRXJD0121400LWW	Ø121	400mm	5/4" UNC	€122,30	€147,99
TRXJD0127400LWW	Ø127	400mm	5/4" UNC	€131,66	€159,30
TRXJD132400LWW	Ø132	400mm	5/4" UNC	€142,89	€172,90
TRXJD152400LWW	Ø152	400mm	5/4" UNC	€161,61	€195,55
TRXJD166400LWW	Ø166	400mm	5/4" UNC	€176,59	€213,67
TRXJD180400LWW	Ø180	400mm	5/4" UNC	€197,17	€238,58
TRXJD202400LWW	Ø202	400mm	5/4" UNC	€280,17	€339,01
TRXJD220400LWW	Ø220	400mm	5/4" UNC	€358,16	€433,37
TRXJD254400LWW	Ø254	400mm	5/4" UNC	€394,98	€477,92

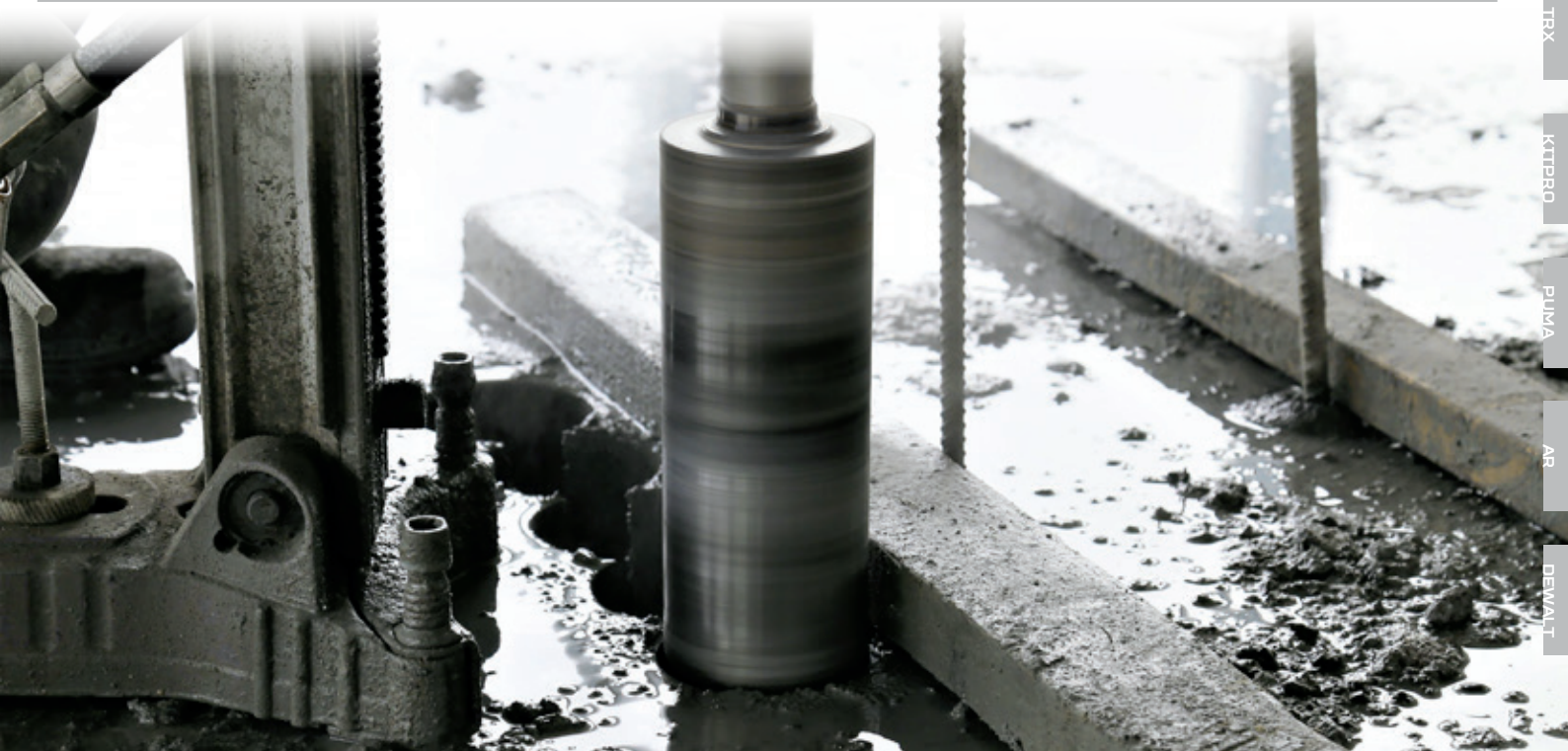

ZECOCUT35



Fraises:
Ø: 35mm



Forets:
13mm

Référence:	ZECOCUT35
Puissance:	1100W
Lo x La aimant:	165x80mm
Course:	210mm
Voltage:	230V AC 50-60Hz
Poids:	10,5kg
Vitesse 1:	450rpm

Mandrin: 19mm (3/4") Weldon

PRIX TARIF
€866,63
hors TVA

PRIX DE VENTE
€619,02
hors TVA

PRIX DE VENTE
€749,01
TVA incl.

ZECOCUT50/2



Fraises:
Ø: 50mm



Forets:
18mm

Référence:	ZECOCUT50/2
Puissance:	1500W
Lo x La aimant:	210x100mm
Course:	170mm
Voltage:	230V AC 50-60Hz
Poids:	19,0kg
Vitesse 1:	250rpm
Vitesse 2:	450rpm

Mandrin: 19mm (3/4") Weldon
CM-3

PRIX TARIF
€1474,48
hors TVA

PRIX DE VENTE
€1053,20
hors TVA

PRIX DE VENTE
€1274,37
TVA incl.

ZECOCUT120/4



Fraises:
Ø: 120mm

Forets:
45mm

Référence:	ZECOCUT120/4
Puissance:	2500W
Lo x La aimant:	280x115mm
Course:	220mm
Voltage:	230V AC 50-60Hz
Poids:	48,0kg
Vitesse 1:	80rpm
Vitesse 2:	125rpm
Vitesse 3:	175rpm
Vitesse 4:	300rpm
Mandrin:	CM-4

PRIX TARIF
€2676,34
hors TVA

PRIX DE VENTE
€1911,68
hors TVA

PRIX DE VENTE
€2313,13
TVA incl.



GENÈREMOIRE
RENSON
LARTUS
FEMT
DREHMANN
DRELUX
BDS
ZECO
TRX
KITPRO
PUJMA
AR
DEWALT



ZHSS

Fraise HSS courte
Profondeur de forage de 30mm
19mm Weldon 3/4"

Goupille d'éjection: ZPIL077

Référence:	Ø (mm)	hors TVA	TVA incl.
ZPIL077	12-60	€5,21	€6,30
ZHSS012	12	€15,93	€19,28
ZHSS013	13	€16,72	€20,23
ZHSS014	14	€15,13	€18,31
ZHSS015	15	€17,79	€21,52
ZHSS016	16	€18,05	€21,84
ZHSS017	17	€18,58	€22,49
ZHSS017.5	17.5	€20,97	€25,37
ZHSS018	18	€17,79	€21,52
ZHSS019	19	€19,65	€23,78
ZHSS020	20	€20,70	€25,05
ZHSS021	21	€22,03	€26,66
ZHSS022	22	€21,77	€26,34
ZHSS023	23	€23,89	€28,90
ZHSS024	24	€25,44	€30,79
ZHSS025	25	€25,47	€30,82
ZHSS026	26	€24,96	€30,21
ZHSS027	27	€27,08	€32,77
ZHSS028	28	€28,14	€34,05
ZHSS029	29	€28,94	€35,01
ZHSS030	30	€29,73	€35,98
ZHSS031	31	€30,53	€36,95
ZHSS032	32	€31,32	€37,90
ZHSS033	33	€42,22	€51,08
ZHSS034	34	€39,02	€47,22
ZHSS035	35	€43,00	€52,04
ZHSS036	36	€45,67	€55,26
ZHSS037	37	€42,74	€51,71
ZHSS038	38	€46,99	€56,86
ZHSS039	39	€52,30	€63,29
ZHSS040	40	€49,91	€60,39
ZHSS041	41	€55,75	€67,46
ZHSS042	42	€58,66	€70,98
ZHSS043	43	€65,84	€79,66
ZHSS044	44	€69,02	€83,52
ZHSS045	45	€66,10	€79,99
ZHSS046	46	€62,39	€75,49
ZHSS047	47	€72,74	€88,01
ZHSS048	48	€75,66	€91,55
ZHSS049	49	€76,19	€92,19
ZHSS050	50	€76,19	€92,19
ZHSS051	51	€81,23	€98,29
ZHSS052	52	€92,12	€111,47
ZHSS053	53	€89,73	€108,57
ZHSS054	54	€105,66	€127,85
ZHSS055	55	€101,41	€122,71
ZHSS056	56	€105,66	€127,85
ZHSS057	57	€98,75	€119,48
ZHSS058	58	€101,72	€123,08
ZHSS059	59	€103,83	€125,63
ZHSS060	60	€115,48	€139,73



ZHSL

Fraise HSS longue
Profondeur de forage de 55mm
19mm Weldon 3/4"

Goupille d'éjection: ZPIL102

Référence:	Ø (mm)	hors TVA	TVA incl.
ZPIL102	12-65	€8,75	€10,59
ZHSL012	12	€21,50	€26,02
ZHSL013	13	€22,03	€26,66
ZHSL014	14	€20,17	€24,41
ZHSL015	15	€23,36	€28,26
ZHSL016	16	€25,22	€30,52
ZHSL017	17	€26,02	€31,48
ZHSL018	18	€24,96	€30,21
ZHSL019	19	€29,46	€35,64
ZHSL020	20	€30,79	€37,25
ZHSL021	21	€31,60	€38,23
ZHSL022	22	€31,60	€38,23
ZHSL023	23	€31,32	€37,90
ZHSL024	24	€35,58	€43,05
ZHSL025	25	€36,37	€44,01
ZHSL026	26	€36,64	€44,33
ZHSL027	27	€40,08	€48,49
ZHSL028	28	€41,15	€49,79
ZHSL029	29	€42,47	€51,39
ZHSL030	30	€43,80	€53,00
ZHSL031	31	€45,39	€54,92
ZHSL032	32	€46,46	€56,21
ZHSL033	33	€47,52	€57,50
ZHSL034	34	€48,57	€58,78
ZHSL035	35	€50,44	€61,03
ZHSL036	36	€54,17	€65,54
ZHSL037	37	€62,92	€76,13
ZHSL038	38	€56,82	€68,75
ZHSL039	39	€58,14	€70,35
ZHSL040	40	€59,19	€71,62
ZHSL041	41	€70,09	€84,81
ZHSL042	42	€60,52	€73,23
ZHSL043	43	€73,01	€88,34
ZHSL044	44	€69,56	€84,16
ZHSL045	45	€71,67	€86,73
ZHSL046	46	€81,23	€98,29
ZHSL047	47	€84,41	€102,14
ZHSL048	48	€79,64	€96,37
ZHSL049	49	€88,59	€107,19
ZHSL050	50	€83,88	€101,49
ZHSL051	51	€94,50	€114,34
ZHSL052	52	€99,56	€120,46
ZHSL053	53	€107,26	€129,78
ZHSL054	54	€111,49	€134,91
ZHSL055	55	€115,22	€139,42
ZHSL056	56	€118,93	€143,90
ZHSL057	57	€122,38	€148,08
ZHSL058	58	€126,10	€152,58
ZHSL059	59	€130,61	€158,04
ZHSL060	60	€133,81	€161,91

ZHML

Fraise en carbure longue
Profondeur de forage de 55 mm
19mm Weldon ¾"

Goupille d'éjection:
ZPIL106 / ZPIL108

Référence:	Ø (mm)	hors TVA	TVA incl.
ZPIL106	12~17	€8,75	€10,59
ZPIL108	18~65	€11,73	€14,19

ZHML012	12	€36,61	€44,30
ZHML013	13	€36,61	€44,30
ZHML014	14	€34,51	€41,75
ZHML015	15	€34,51	€41,75
ZHML016	16	€34,51	€41,75
ZHML017	17	€34,51	€41,75
ZHML017.5	17.5	€36,72	€44,43
ZHML018	18	€34,56	€41,82
ZHML019	19	€34,56	€41,82
ZHML020	20	€34,56	€41,82
ZHML021	21	€35,30	€42,72
ZHML022	22	€35,36	€42,78
ZHML023	23	€35,58	€43,05
ZHML024	24	€35,58	€43,05
ZHML025	25	€35,58	€43,05
ZHML026	26	€36,64	€44,33
ZHML027	27	€36,68	€44,38
ZHML028	28	€38,01	€45,99
ZHML029	29	€38,01	€45,99
ZHML030	30	€38,29	€46,33
ZHML031	31	€46,77	€56,60
ZHML032	32	€46,77	€56,60
ZHML033	33	€47,05	€56,93
ZHML034	34	€47,32	€57,25
ZHML035	35	€47,58	€57,58
ZHML036	36	€52,56	€63,59
ZHML037	37	€53,09	€64,24
ZHML038	38	€53,09	€64,24
ZHML039	39	€53,62	€64,88
ZHML040	40	€53,62	€64,88
ZHML041	41	€61,32	€74,20
ZHML042	42	€61,59	€74,52
ZHML043	43	€61,86	€74,84
ZHML044	44	€61,86	€74,84
ZHML045	45	€61,86	€74,84
ZHML046	46	€61,86	€74,84
ZHML047	47	€65,04	€78,70
ZHML048	48	€65,04	€78,70
ZHML049	49	€65,04	€78,70
ZHML050	50	€66,90	€80,95
ZHML051	51	€75,92	€91,87
ZHML052	52	€75,92	€91,87
ZHML053	53	€75,92	€91,87
ZHML054	54	€80,46	€97,36
ZHML055	55	€80,46	€97,36
ZHML056	56	€88,40	€106,96
ZHML057	57	€88,40	€106,96
ZHML058	58	€92,38	€111,78
ZHML059	59	€92,38	€111,78

ZHML060	60	€92,38	€111,78
ZHML061	61	€109,57	€132,58
ZHML062	62	€109,57	€132,58
ZHML063	63	€109,57	€132,58
ZHML064	64	€109,57	€132,58
ZHML065	65	€116,12	€140,50

ZHML

Fraise en carbure longue
Profondeur de forage de 55 mm
32mm Weldon 1 ¼"

Goupille d'éjection: ZPIL115

Référence:	Ø (mm)	hors TVA	TVA incl.
ZPIL115	66~130	€12,31	€14,90

ZHML066	66	€117,60	€142,29
ZHML067	67	€119,33	€144,39
ZHML068	68	€120,95	€146,35
ZHML069	69	€122,69	€148,45
ZHML070	70	€126,78	€153,40
ZHML071	71	€128,89	€155,95
ZHML072	72	€130,62	€158,05
ZHML073	73	€132,61	€160,46
ZHML074	74	€134,22	€162,41
ZHML075	75	€135,84	€164,37
ZHML080	80	€145,14	€175,62
ZHML085	85	€154,45	€186,88
ZHML090	90	€171,19	€207,14
ZHML095	95	€183,09	€221,54
ZHML100	100	€200,97	€243,17
ZHML105	105	€218,95	€264,93
ZHML110	110	€235,08	€284,44
ZHML115	115	€251,82	€304,70
ZHML120	120	€263,74	€319,12
ZHML125	125	€277,13	€335,33
ZHML130	130	€295,24	€357,24

ZHPL

Foret en spirale
Profondeur de forage de 25 mm
19mm Weldon ¾"

Référence:	Ø (mm)	hors TVA	TVA incl.
ZHPL06	6	€17,28	€20,91
ZHPL068	6,8	€17,28	€20,91
ZHPL07	7	€17,28	€20,91
ZHPL08	8	€17,28	€20,91
ZHPL085	8,5	€18,17	€21,98
ZHPL09	9	€18,20	€22,02
ZHPL10	10	€18,20	€22,02
ZHPL11	11	€18,66	€22,58



ZHM-R

Railcutter en carbure
Profondeur de forage de 30mm
19mm Weldon 3/4"

Goupille d'éjection: ZPIL108

Référence:	Ø (mm)	hors TVA	TVA incl.
ZPIL108	18~60	€11,73	€14,19
ZHM-R026	26	€49,62	€60,04



ZHMEL

Fraise en carbure extra longue
Profondeur de forage de 107mm
19mm Weldon 3/4"

Goupille d'éjection: ZPIL157

Référence:	Ø (mm)	hors TVA	TVA incl.
ZPIL157	18~60	€17,07	€20,66

ZHMEL018	18	€86,13	€104,21
ZHMEL019	19	€69,68	€84,32
ZHMEL020	20	€69,68	€84,32
ZHMEL021	21	€69,68	€84,32
ZHMEL022	22	€69,68	€84,32
ZHMEL023	23	€69,68	€84,32
ZHMEL024	24	€69,68	€84,32
ZHMEL025	25	€69,68	€84,32
ZHMEL026	26	€77,50	€93,78
ZHMEL027	27	€77,50	€93,78
ZHMEL028	28	€77,50	€93,78
ZHMEL029	29	€77,50	€93,78
ZHMEL030	30	€77,50	€93,78
ZHMEL031	31	€89,48	€108,27
ZHMEL032	32	€89,48	€108,27
ZHMEL033	33	€89,48	€108,27
ZHMEL034	34	€89,48	€108,27
ZHMEL035	35	€89,48	€108,27
ZHMEL036	36	€102,85	€124,44
ZHMEL037	37	€102,85	€124,44
ZHMEL038	38	€102,85	€124,44
ZHMEL039	39	€102,85	€124,44
ZHMEL040	40	€102,85	€124,44
ZHMEL042	42	€116,17	€140,57
ZHMEL045	45	€116,17	€140,57
ZHMEL050	50	€138,34	€167,40
ZHMEL055	55	€155,84	€188,57
ZHMEL060	60	€170,12	€205,85

ZHMEL065	65	€192,95	€233,46
ZHMEL070	70	€221,63	€268,17
ZHMEL075	75	€240,21	€290,66
ZHMEL080	80	€262,93	€318,14
ZHMEL083	83	€297,45	€359,92
ZHMEL085	85	€298,76	€361,50
ZHMEL087	87	€329,77	€399,02
ZHMEL090	90	€329,77	€399,02
ZHMEL095	95	€366,78	€443,80
ZHMEL100	100	€398,16	€481,77



ZHSSBOX

HSS Fraise court
Profondeur de forage de 30mm
19mm Weldon 3/4"

Longueurs:

12mm, 14mm, 16mm, 18mm, 20mm, 22mm

Goupille d'éjection: ZPIL077



ZHSLBOX

HSS Fraise longue
Profondeur de forage de 55mm
19mm Weldon 3/4"

Longueurs:

12mm, 14mm, 16mm, 18mm, 20mm, 22mm

Goupille d'éjection: ZPIL102



ZHMLBOX

Fraise en carbure longue
Profondeur de forage de 55mm
19mm Weldon 3/4"

Longueurs:

12mm, 14mm, 16mm, 18mm, 20mm, 22mm

Goupille d'éjection: ZPIL106 ZPIL108

Référence:	Ø (mm)	hors TVA	TVA incl.
ZHSSBOX	12-22	€115,-	€138,84
ZHSLBOX	12-22	€148,04	€179,12
ZHMLBOX	12-22	€218,51	€264,39

GENERMORE
RENSON
LARTUS
FERMI
DREHMANN
DRELUX
BDS
ZECO
TRX
KITPRO
PUJMA
AR
DEWALT

MABASIC200

MABASIC400

MABASIC450



KIT DE FRAISAGE INCLUS AVEC TOUTES LES MACHINES:

ZHSSBOX1 (Ø12, Ø14, Ø16, Ø18, Ø20, Ø22)

D'une valeur de €115,- hors TVA



Fraises:

Forets:

Ø: 32mm

13mm

L: 30mm

50mm



Fraises:

Forets:

Ø: 35mm

13mm

L: 30mm

50mm



Fraises:

Forets:

Ø: 40mm

18mm

L: 30mm

50mm

Puissance moteur 900W

Voltage: 230V, 50Hz

Dimensions aimant: 84x168x41,5mm

Coupe: 160mm

Poids: 12,0kg

Vitesse: 430rpm

Mandrin: 19mm Weldon 3/4"

Puissance moteur 1050W

Voltage: 230V, 50Hz

Dimensions aimant: 84x168x41,5mm

Coupe: 160mm

Poids: 12,0kg

Vitesse 1: 430rpm

Vitesse 2: 760rpm

Mandrin: 19mm Weldon 3/4"

Puissance moteur 1150W

Voltage: 230V, 50Hz

Dimensions aimant: 84x168x41,5mm

Coupe: 160mm

Poids: 13,0kg

Vitesse 1: 250rpm

Vitesse 2: 430rpm

Mandrin: 19mm Weldon 3/4"
CM-2

Référence action:
ACTBDSMABASIC200

PRIX TARIF	€1107,70
hors TVA	
PRIX DE VENTE	€791,21
hors TVA	
PRIX DE VENTE	€957,37
TVA incl.	

Référence action:
ACTBDSMABASIC400

PRIX TARIF	€1410,76
hors TVA	
PRIX DE VENTE	€1007,69
hors TVA	
PRIX DE VENTE	€1219,30
TVA incl.	

Référence action:
ACTBDSMABASIC450

PRIX TARIF	€1603,31
hors TVA	
PRIX DE VENTE	€1145,22
hors TVA	
PRIX DE VENTE	€1385,72
TVA incl.	

MABASIC850



Fraises:

Ø: 75mm

L: 30mm, 55mm,
75mm, 110mm



Forets:

31, 75mm



KIT DE FRAISAGE INCLUS:

ZHSSBOX1 (Ø12, Ø14, Ø16, Ø18, Ø20, Ø22)

D'une valeur de €115,- hors TVA

Puissance moteur	1700W
Voltage:	230V, 50Hz
Dimensions aimant:	110x220x54mm
Coupe:	235mm
Poids:	24,0kg
Vitesse 1:	110rpm
Vitesse 2:	175rpm
Vitesse 3:	245rpm
Vitesse 4:	385rpm
Mandrin:	19mm Weldon ¾" CM-3

PRIX TARIF
€2537,20
hors TVA

PRIX DE VENTE
€1812,28
hors TVA

PRIX DE VENTE
€2192,86
TVA incl.



Référence action:
ACTBDSMABASIC850

MAB925RAIL



Fraises:

Ø: 30mm

L: 30mm
55mm



Puissance moteur	1600W
Voltage:	230V, 50Hz
Coupe:	160mm
Poids:	17,0kg
Vitesse 1:	70-280rpm
Vitesse 2:	80-580rpm
Mandrin:	19mm Weldon ¾" CM-3

Référence: BDSMAB925RAIL

PRIX TARIF
€4129,17
hors TVA

PRIX DE VENTE
€2949,41
hors TVA

PRIX DE VENTE
€3568,79
TVA incl.

MAB155



Fraises:

Ø: 35mm

L: 30mm



Puissance moteur	1050W
Voltage:	230V, 50Hz
Dimensions aimant:	80x160x36,5mm
Coupe:	39mm
Poids:	11,0kg
Vitesse:	400rpm
Mandrin:	19mm Weldon ¾"

Référence: ACTBDSMAB155

PRIX TARIF
€1843,97
hors TVA

PRIX DE VENTE
€1317,12
hors TVA

PRIX DE VENTE
€1593,72
TVA incl.

GENERMOIRE
RENSON
LARIUS
FERMI
DREHMANNI
DRELUX
BDS
ZECO
TRX
KITPRO
PUJMA
AR
DEWALT

MAB100K

AUTOMAB350

AUTOMAB450



KIT DE FRAISAGE INCLUS AVEC TOUTES LES MACHINES:

ZHSSBOX1 (Ø12, Ø14, Ø16, Ø18, Ø20, Ø22)

D'une valeur de €115,- hors TVA



MANDRIN SERRAGE RAPIDE



Fraises:

Ø: 30mm

L: 30mm

55mm

Puissance moteur 1100W

Voltage: 230V, 50Hz

Dimensions aimant: 80x160x41,5mm

Coupe: 70mm

Poids: 9,9kg

Vitesse: 450rpm

Mandrin: 19mm Weldon 3/4"

Référence action:
ACTBDSMAB100K

PRIX TARIF	€1442,29
hors TVA	
PRIX DE VENTE	€1030,21
hors TVA	
PRIX DE VENTE	€1246,55
TVA incl.	



BROCHE AUTOMATIQUE



Fraises:

Ø: 40mm

L: 30mm

Puissance moteur 1050W

Voltage: 230V, 50Hz

Dimensions aimant: 84x168x41,5mm

Coupe: 150mm

Poids: 15,0kg

Vitesse: 460rpm

Mandrin: 19mm Weldon 3/4"
CM-2

Référence action:
ACTBDSMAB350

PRIX TARIF	€2123,07
hors TVA	
PRIX DE VENTE	€1516,48
hors TVA	
PRIX DE VENTE	€1834,94
TVA incl.	



BROCHE AUTOMATIQUE



Fraises:

Ø: 45mm

L: 30mm

Puissance moteur 1150W

Voltage: 230V, 50Hz

Dimensions aimant: 80x160x41,5mm

Coupe: 70mm

Poids: 16,0kg

Vitesse 1: 250rpm

Vitesse 2: 450rpm

Mandrin: 19mm Weldon 3/4"
CM-2

Référence action:
ACTBDSMAB450

PRIX TARIF	€2430,95
hors TVA	
PRIX DE VENTE	€1736,39
hors TVA	
PRIX DE VENTE	€2101,03
TVA incl.	

MAB465

MAB485

MAB525



KIT DE FRAISAGE INCLUS AVEC TOUTES LES MACHINES:

ZHSSBOX1 (Ø12, Ø14, Ø16, Ø18, Ø20, Ø22)

D'une valeur de €115,- hors TVA



Fraises: Forets: Taraudage:

Ø: 40mm
L: 55mm

16mm

M16

Puissance moteur	1150W
Voltage:	230V, 50Hz
Dimensions aimant:	84x168x41,5mm
Coupe:	160mm
Poids:	13,0kg
Vitesse 1:	50-250rpm
Vitesse 2:	100-450rpm
Mandrin:	19mm Weldon 3/4"

Référence action:
ACTBDSMAB465

PRIX TARIF
€1955,42
hors TVA

PRIX DE VENTE
€1396,73
hors TVA

PRIX DE VENTE
€1690,04
TVA incl.



Fraises: Forets: Taraudage:

Ø: 40mm
L: 30mm
50mm

18mm

M16

Puissance moteur	1150W
Voltage:	230V, 50Hz
Dimensions aimant:	84x168x41,5mm
Coupe:	160mm
Poids:	13,0kg
Vitesse 1:	50-250rpm
Vitesse 2:	100-450rpm
Mandrin:	19mm Weldon 3/4" Keyless CM-2

Référence action:
ACTBDSMAB485

PRIX TARIF
€2381,85
hors TVA

PRIX DE VENTE
€1701,32
hors TVA

PRIX DE VENTE
€2058,60
TVA incl.



Fraises: Forets: Taraudage:

Ø: 50mm
L: 30mm
50mm

20mm

M20

Puissance moteur	1600W
Voltage:	230V, 50Hz
Dimensions aimant:	90x180x48mm
Coupe:	160mm
Poids:	16,0kg
Vitesse 1:	70-280rpm
Vitesse 2:	180-580rpm
Mandrin:	19mm Weldon 3/4" Keyless CM-3

Référence action:
ACTBDSMAB525

PRIX TARIF
€2724,24
hors TVA

PRIX DE VENTE
€1945,89
hors TVA

PRIX DE VENTE
€2354,52
TVA incl.

MAB825

MAB825KTS

MAB845



KIT DE FRAISAGE INCLUS AVEC TOUTES LES MACHINES:

ZHSSBOX1 (Ø12, Ø14, Ø16, Ø18, Ø20, Ø22)

D'une valeur de €115,- hors TVA



Fraises: Forets: Taraudage:

Ø: 100mm 31mm M30
L: 30, 50mm
75mm (Ø110mm)

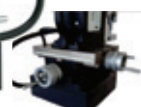

Fraises: Forets: Taraudage:

Ø: 100mm 31mm M30
L: 30, 50mm
75mm (Ø110mm)



Fraises: Forets: Taraudage:

Ø: 100mm 31mm M30
L: 30, 50mm
75mm (Ø110mm)

Puissance moteur	1800W
Voltage:	230V, 50Hz
Dimensions aimant:	110x220x54mm
Coupe:	255mm
Poids:	25,0kg
Vitesse 1:	40-110rpm
Vitesse 2:	65-175rpm
Vitesse 3:	140-350rpm
Vitesse 4:	220-600rpm
Mandrin:	19mm Weldon 3/4" Keyless CM-3

Référence action:
ACTBDSMAB825

PRIX TARIF	€3528,55
hors TVA	
PRIX DE VENTE	€2520,39
hors TVA	
PRIX DE VENTE	€3049,67
TVA incl.	

Puissance moteur	1800W
Voltage:	230V, 50Hz
Dimensions aimant:	220x220x54mm
Coupe:	255mm
Poids:	45,0kg
Vitesse 1:	40-110rpm
Vitesse 2:	65-175rpm
Vitesse 3:	140-350rpm
Vitesse 4:	220-600rpm
Mandrin:	19mm Weldon 3/4" Keyless CM-3

Référence action:
ACTBDSMAB825KTS

PRIX TARIF	€6818,76
hors TVA	
PRIX DE VENTE	€4870,54
hors TVA	
PRIX DE VENTE	€5893,36
TVA incl.	

Puissance moteur	1800W
Voltage:	230V, 50Hz
Dimensions aimant:	110x220x54mm
Coupe:	255mm
Poids:	25,0kg
Vitesse 1:	40-110rpm
Vitesse 2:	65-175rpm
Vitesse 3:	140-350rpm
Vitesse 4:	220-600rpm
Mandrin:	19mm Weldon 3/4" Keyless CM-3

Référence action:
ACTBDSMAB845

PRIX TARIF	€3835,45
hors TVA	
PRIX DE VENTE	€2739,61
hors TVA	
PRIX DE VENTE	€3314,93
TVA incl.	

MAB1300

MAB485SB

MAB525SB



KIT DE FRAISAGE INCLUS AVEC TOUTES LES MACHINES:

ZHSSBOX1 (Ø12, Ø14, Ø16, Ø18, Ø20, Ø22)

D'une valeur de €115,- hors TVA



Fraises: Forets: Taraudage:

Ø: 130mm 45mm M42
L: 30, 50mm
75mm (Ø110mm)

Puissance moteur	2300W
Voltage:	230V, 50Hz
Dimensions aimant:	120x360x65mm
Coupe:	85/310mm
Poids:	51,0kg
Vitesse 1:	30-80rpm
Vitesse 2:	50-120rpm
Vitesse 3:	130-350rpm
Vitesse 4:	210-550rpm
Mandrin:	32mm Weldon Keyless CM-4

Référence action:
ACTBDSMAB1300

PRIX TARIF
€6742,84
hors TVA

PRIX DE VENTE
€4816,31
hors TVA

PRIX DE VENTE
€5827,74
TVA incl.



Fraises: Forets: Taraudage:

Ø: 40mm 18mm M16
L: 30mm
55mm

Puissance moteur	1150W
Voltage:	230V, 50Hz
Dimensions aimant:	84x168x41,5mm
Coupe:	160mm
Poids:	13,0kg
Vitesse 1:	50-250rpm
Vitesse 2:	100-450rpm
Mandrin:	19mm Weldon 3/4" Keyless CM-2

Référence action:
ACTBDSMAB4825SB

PRIX TARIF
€2615,33
hors TVA

PRIX DE VENTE
€1868,09
hors TVA

PRIX DE VENTE
€2260,39
TVA incl.



Fraises: Forets: Taraudage:

Ø: 50mm 20mm M20
L: 30mm
50mm

Puissance moteur	1600W
Voltage:	230V, 50Hz
Dimensions aimant:	90x180x48mm
Coupe:	160mm
Poids:	16,0kg
Vitesse 1:	70-280rpm
Vitesse 2:	180-580rpm
Mandrin:	19mm Weldon 3/4" Keyless CM-3

Référence action:
ACTBDSMAB525SB

PRIX TARIF
€2969,59
hors TVA

PRIX DE VENTE
€2121,13
hors TVA

PRIX DE VENTE
€2566,57
TVA incl.

GENERADRE
RENSON
LARIUS
FEMT
DREHMANN
DRELUX
BDS
ZECO
TRX
KITPRO
PUJMA
AR
DEWALT

EKF300



Puissance moteur	1500W
Voltage:	220V-240V, 50Hz
Dimensions:	310x295x138mm
Poids:	4,6kg
Angle du chanfrein:	30°
Largeur du chanfrein	0-5mm
Type de fraise:	ZFR300.3
Vitesse:	6000 rpm

Référence: BDSEKF300

PRIX TARIF €1186,21 <small>hors TVA</small>	PRIX DE VENTE €847,29 <small>hors TVA</small>	PRIX DE VENTE €1025,22 <small>TVA incl.</small>
---------------------------------------------------	-----------------------------------------------------	-------------------------------------------------------

EKF450



Puissance moteur	1500W
Voltage:	220V-240V, 50Hz
Dimensions:	310x295x138mm
Poids:	4,6kg
Angle du chanfrein:	45°
Largeur du chanfrein	0-6mm
Type de fraise:	ZFR450.3
Vitesse:	6000 rpm

Référence: BDSEKF450

PRIX TARIF €1186,21 <small>hors TVA</small>	PRIX DE VENTE €847,29 <small>hors TVA</small>	PRIX DE VENTE €1025,22 <small>TVA incl.</small>
---------------------------------------------------	-----------------------------------------------------	-------------------------------------------------------

EKF452



Puissance moteur	1500W
Voltage:	220V-240V, 50Hz
Dimensions:	310x295x138mm
Poids:	4,6kg
Angle du chanfrein:	Rayon de 2,5mm
Largeur du chanfrein	Rayon de 2,5mm
Type de fraise:	ZFR452.3
Vitesse:	6000 rpm

Référence: BDSEKF452

PRIX TARIF €1361,34 <small>hors TVA</small>	PRIX DE VENTE €972,38 <small>hors TVA</small>	PRIX DE VENTE €1176,58 <small>TVA incl.</small>
---------------------------------------------------	-----------------------------------------------------	-------------------------------------------------------

EKF645



Puissance moteur	2300W
Voltage:	220V-240V, 50Hz
Dimensions:	400x350x300mm
Poids:	10,2kg
Angle du chanfrein:	45°
Largeur du chanfrein	0-15mm
Type de fraise:	ZFR645
Vitesse:	1600-3000rpm

Référence: BDSEKF645

PRIX TARIF €3026,38 <small>hors TVA</small>	PRIX DE VENTE €2161,70 <small>hors TVA</small>	PRIX DE VENTE €2615,66 <small>TVA incl.</small>
---------------------------------------------------	------------------------------------------------------	-------------------------------------------------------

SKF25



Puissance moteur	1100W
Voltage:	220V-240V, 50Hz
Dimensions:	365x455x270mm
Poids:	22,0kg
Angle du chanfrein:	10-60°
Largeur du chanfrein	15mm
Type de fraise:	ZFR300.3
Vitesse:	2850 rpm

Référence: BDSEKF25

PRIX TARIF €3307,04 <small>hors TVA</small>	PRIX DE VENTE €2362,17 <small>hors TVA</small>	PRIX DE VENTE €2858,23 <small>TVA incl.</small>
---------------------------------------------------	------------------------------------------------------	-------------------------------------------------------



PIPEMAB200

PIPEMAB525



**KIT DE FRAISAGE
INCLUS AVEC
TOUTES LES
MACHINES:
ZHSSBOX1**

Fraises de:

Ø12

Ø14

Ø16

Ø18

Ø20

Ø22

**D'une valeur de €115,-
hors TVA**



Fraises:

Ø: 35mm

L: 40mm

Puissance moteur 1050W

Voltage: 230V, 50Hz

Dimensions aimant: 191x266x88mm

Coupe: 160mm

Poids: 16,0kg

Vitesse 1: 450rpm

Mandrin: 19mm Weldon 3/4"

Référence action:
ACTBDSPIPEMAB200

PRIX TARIF
€2838,08
hors TVA

PRIX DE VENTE
€2027,20
hors TVA

PRIX DE VENTE
€2452,91
TVA incl.



Fraises:

Ø: 50mm

L: 40mm

Puissance moteur 1600W

Voltage: 230V, 50Hz

Dimensions aimant: 191x266x88mm

Coupe: 160mm

Poids: 19,5kg

Vitesse 1: 70-280rpm

Vitesse 2: 180-580rpm

Mandrin: 19mm Weldon 3/4"

CM-3

Référence action:
ACTBDSPIPEMAB525

PRIX TARIF
€3831,80
hors TVA

PRIX DE VENTE
€2737,00
hors TVA

PRIX DE VENTE
€3311,77
TVA incl.



MAGNET
INDICATOR

Taraudage:

M20

Forets:

20mm

GENERMOIRE
REINSON
LARIJUS
FEMJ
DREHMANNI
DRELUX
BDS
ZECO
TRX
KITPRO
PUJMA
AR
DEWALT



La nouvelle BDS PIPEMAB fonctionne avec un aimant permanent qui est indépendant de l'électricité !

La forte adhérence de l'aimant fonctionne même pour des matériaux aussi fins que 3 mm.



La perceuse magnétique est dotée d'une petite poignée pratique pour chacun des deux aimants, ce qui permet de les verrouiller et de les relâcher facilement.

Grâce à ses aimants pivotants pratiques, vous pouvez utiliser la PIPEMAB sur des surfaces rondes ou plates.



La PIPEMAB 200 peut être fixé sur des tubes à partir de 85 mm de diamètre et la PIPEMAB 525 sur des tubes de plus de 85 mm de diamètre.

La PIPEMAB est facile à utiliser grâce à son faible poids de moins de 20 kg.



MANDRIN A CLE



Référence:	Type:	Klemgrootte:	hors TVA	TVA incl.
BDSZBK113	DIN238-B16	1-13mm	€71,63	€86,67
BDSZBK116	DIN238-B16	2,5-16mm	€110,43	€133,62
BDSZBI113	½" x 20NF	1-13mm	€94,64	€114,52
BDSZBI116	½" x 20NF	2,5-16mm	€118,93	€143,91

MANDRIN AUTO



Référence:	Type:	Klemgrootte:	hors TVA	TVA incl.
BDSZSB113	DIN238-B16	1-13mm	€94,64	€114,52
BDSZSB116	DIN238-B16	2,5-16mm	€122,27	€147,94
BDSZSI113	½" x 20NF	1-13mm	€98,59	€119,30
BDSZSI116	½" x 20NF	2,5-16mm	€126,20	€152,71

GOUPILLON D'INJECTION / REDUCTEUR



Référence:	Type:	hors TVA	TVA incl.
BDSZAS002	DIN 228 CM-2	€9,87	€11,94
BDSZAS003	DIN 228 CM-3	€11,83	€14,31



Référence:	Extérieur:	Intérieur:	hors TVA	TVA incl.
BDSZRH210	CM-2	CM-1	€21,13	€25,57
BDSZRH320	CM-3	CM-2	€33,52	€40,56

ADAPTATEUR / EXTENSION



Référence:	Type:	hors TVA	TVA incl.
BDSZKD216	DIN238-CM-2/B16	€17,74	€21,47
BDSZKD316	DIN238-CM-3/B16	€27,61	€33,41



Référence:	Extérieur:	Intérieur:	hors TVA	TVA incl.
BDSZVH220	CM-2	CM-2	€50,20	€60,74
BDSZVH320	CM-3	CM-2	€57,19	€69,20
BDSZVH330	CM-3	CM-3	€67,05	€81,12

COLLECTEUR DE PUCES / MOBILCLAMP



Référence:	hors TVA	TVA incl.
BDSPOW100	€58,00	€70,19



Référence:	hors TVA	TVA incl.
BDSZMC300 + ZMC180	€726,28	€878,79

ADAPTATEURS ET EXTENSIONS



ZAP100



ZAP200

ZAP300



ZAF003

ZAF002



ZAF004

ZAF005

Référence:	Description:	Type:	INCLUS:	hors TVA	TVA incl.
ZAP100	Adaptateur	Arbre Weldon ¾" → ½" x 20 NF	/	€27,61	€33,41
ZAP200	Adaptateur	32mm 1 ¼" Weldon → 19mm Weldon ¾"	/	€69,01	€83,51
ZAP300	Extension	80mm, 19mm Weldon ¾"	ZAK080	€155,78	€188,50
ZAF002	Adaptateur	→ Fraise avec filetage intérieur M18 x 6 P1,5	ZAK125	€85,12	€102,99
ZAF003	Adaptateur	→ Fraise avec Arbre Quick-in	ZAK115	€85,45	€103,39
ZAF004	Adaptateur	→ avec Quick-in OneTouch pour 19mm W. ¾"	ZAK107/ZAK125	€85,12	€102,99
ZAF005	Adaptateur	→ avec Nitto OneTouch pour 19mm W. ¾"	ZAK107/ZAK125	€98,84	€119,59

PORTE-FRAISE



Référence: Support:

Sans lubrification interne pour fraises en 19mm Weldon 3/4"

Référence	Support	hors TVA	TVA incl.
BDSZIA219M	CM-2	€83,26	€100,74
BDSZIA319M	CM-3	€92,03	€111,35
BDSZIA419M	CM-4	€122,69	€148,46

Sans lubrification interne pour fraises en 32mm Weldon 1 1/4"

Référence	Support	hors TVA	TVA incl.
BDSZIA332M	CM-3	€102,97	€124,59
BDSZIA432M	CM-4	€152,91	€185,02

PORTE-FRAISE



Référence: Support:

Avec lubrification interne pour fraises en 19mm Weldon 3/4"

Référence	Support	hors TVA	TVA incl.
BDSZIA219KN	CM-2	€151,17	€182,92
BDSZIA319KN	CM-3	€164,33	€198,84
BDSZIA419KN	CM-4	€195,00	€235,95

Avec lubrification interne pour fraises en 32mm Weldon 1 1/4". Avec tuyau et raccord rapide:

Référence	Support	hors TVA	TVA incl.
BDSZIA332KN	CM-3	€184,05	€222,70
BDSZIA432KN	CM-4	€216,91	€262,46

PORTE-FRAISE

LIQUIDES



Référence: Support:

Avec lubrification interne pour fraises en 19mm Weldon 3/4". Avec tuyau et raccord rapide:

Référence	Support	hors TVA	TVA incl.
BDSZSS200	CM-2	€195,00	€235,95
BDSZSS300	CM-3	€216,91	€262,46



Référence:	Description:	Contenu:	hors TVA	TVA incl.
BDSZHB001	6000 Lubrifiant de refroidissement	1L	€28,29	€34,23
BDSZHS005	5000 Huile de coupe	5L	€80,85	€97,83
BDSZHS006	5000 Huile de coupe	1L	€18,19	€22,01
BDSZHS400	5200 Spray lubrifiant	1 x 400ml	€18,18	€22,00
BDSZHS406	5200 Spray lubrifiant	6 x 400ml	€100,57	€121,69
BDSZHS412	5200 Spray lubrifiant	12 x 400ml	€187,32	€226,66
BDSZHS550	5500 Pâte de coupe	1kg	€31,33	€37,91

ACTDT135

NEW



Mandrin automatique



DT65-VICE

INCLUS



Puissance moteur	1/3cv
Nombre de vitesses:	5
Vitesses:	500~2500rpm
Hauteur machine:	580mm
Voltage:	1 x 230V, 50Hz
Poids:	16,0kg
Taille plateau:	165x165mm
Capacité de forage:	13mm
Mandrin:	B16

PRIX TARIF
€260,99
hors TVA

PRIX DE VENTE
€186,42
hors TVA

PRIX DE VENTE
€225,57
TVA incl.

ACTDT165

NEW



Mandrin automatique



DT75-VICE

INCLUS



Puissance moteur	1/2cv
Nombre de vitesses:	12
Vitesses:	180~2740rpm
Hauteur machine:	900mm
Voltage:	1 x 230V, 50Hz
Poids:	30,0kg
Taille plateau:	195x195mm
Capacité de forage:	16mm
Mandrin:	CM-2

PRIX TARIF
€433,31
hors TVA

PRIX DE VENTE
€309,51
hors TVA

PRIX DE VENTE
€374,51
TVA incl.

ACTDT185

NEW



Mandrin automatique



DT100-VICE

INCLUS



Puissance moteur	3/4cv
Nombre de vitesses:	16
Vitesses:	220~2840rpm
Hauteur machine:	998mm
Voltage:	1 x 230V, 50Hz
Poids:	55,0kg
Taille plateau:	305x305mm
Capacité de forage:	16mm
Mandrin:	CM-2

PRIX TARIF
€647,54
hors TVA

PRIX DE VENTE
€462,53
hors TVA

PRIX DE VENTE
€559,66
TVA incl.

ACTDT185S

NEW



Mandrin automatique



DT100-VICE

INCLUS



Puissance moteur	3/4cv
Nombre de vitesses:	16
Vitesses:	220~2840rpm
Hauteur machine:	1580mm
Voltage:	1 x 230V, 50Hz
Poids:	66,0kg
Taille plateau:	305x305mm
Capacité de forage:	16mm
Mandrin:	CM-2

PRIX TARIF
€768,28
hors TVA

PRIX DE VENTE
€548,77
hors TVA

PRIX DE VENTE
€664,01
TVA incl.

GENERMOIRE
RENSON
LARTUS
FEMT
DREHMANN
DRELUX
BDS
ZECO
TRX
KITPRO
PUJMA
AR
DEWALT

ACTDT25SF

NEW



Mandrin automatique



DT125-VISE

INCLUS



Puissance moteur	1 ½cv
Nombre de vitesses:	16
Vitesses:	160~3000rpm
Hauteur machine:	1635mm
Voltage:	1 x 230V, 50Hz
Poids:	81,0kg
Taille plateau:	356x356mm
Capacité de forage:	25mm
Mandrin:	CM-3

PRIX TARIF hors TVA	PRIX DE VENTE hors TVA	PRIX DE VENTE TVA incl.
€1248,45	€891,75	€1079,02

ACTDT32F

NEW



Mandrin automatique



DT150-VISE

INCLUS



Puissance moteur	1 ½cv
Nombre de vitesses:	12
Vitesses:	150~2450rpm
Hauteur machine:	1730mm
Voltage:	3 x 400V, 50Hz
Poids:	110,0kg
Taille plateau:	475x425mm
Capacité de forage:	32mm
Mandrin:	CM-4

PRIX TARIF hors TVA	PRIX DE VENTE hors TVA	PRIX DE VENTE TVA incl.
€1649,30	€1178,07	€1425,46

ACTDT32FM

NEW



Mandrin automatique



DT150-VISE

INCLUS



Puissance moteur	1 ½cv
Nombre de vitesses:	12
Vitesses:	150~2450rpm
Hauteur machine:	1730mm
Voltage:	1 x 230V, 50Hz
Poids:	110,0kg
Taille plateau:	475x425mm
Capacité de forage:	32mm
Mandrin:	CM-4

PRIX TARIF hors TVA	PRIX DE VENTE hors TVA	PRIX DE VENTE TVA incl.
€1649,30	€1178,07	€1425,46

ETAUX



Référence:	Taille:
DT065-VISE	± 2,5" / 65,0mm
DT075-VISE	± 3,0" / 75,0mm
DT100-VISE	± 4,0" / 100,0mm
DT125-VISE	± 5,0" / 125,0mm
DT150-VISE	± 6,0" / 150,0mm

hors TVA	TVA incl.
€32,91	€39,82
€34,70	€41,98
€29,79	€36,04
€39,87	€48,25
€54,77	€66,28

T200H400



Puissance moteur	750W
Voltage:	230V, 50Hz
Poids:	15,0kg
Capacité de levage : (simple/double)	200kg/400kg
Hauteur de levage: (simple/double)	12m/6m
Vitesse de levage: (simple/double)	8/4 m/min
Diamètre du câble:	Ø 4mm
Longueur câble de contrôle:	1,80m
Efficacité:	S3-25%-10min

PRIX TARIF	PRIX DE VENTE	PRIX DE VENTE
€213,44	€152,45	€184,47
hors TVA	hors TVA	TVA incl.

T300H600



Puissance moteur	1050W
Voltage:	230V, 50Hz
Poids:	20,0kg
Capacité de levage : (simple/double)	300kg/600kg
Hauteur de levage: (simple/double)	12m/6m
Vitesse de levage: (simple/double)	8/4 m/min
Diamètre du câble:	Ø 5mm
Longueur câble de contrôle:	1,80m
Efficacité:	S3-25%-10min

PRIX TARIF	PRIX DE VENTE	PRIX DE VENTE
€283,19	€202,28	€244,75
hors TVA	hors TVA	TVA incl.

T400H800



Puissance moteur	1350W
Voltage:	230V, 50Hz
Poids:	22,0kg
Capacité de levage : (simple/double)	400kg/800kg
Hauteur de levage: (simple/double)	12m/6m
Vitesse de levage: (simple/double)	8/4 m/min
Diamètre du câble:	Ø 5mm
Longueur câble de contrôle:	1,80m
Efficacité:	S3-25%-10min

PRIX TARIF	PRIX DE VENTE	PRIX DE VENTE
€372,48	€266,06	€321,93
hors TVA	hors TVA	TVA incl.

T500H100



Puissance moteur	1600W
Voltage:	230V, 50Hz
Poids:	33,0kg
Capacité de levage : (simple/double)	500kg/1000kg
Hauteur de levage: (simple/double)	18m/9m
Vitesse de levage: (simple/double)	8/4 m/min
Diamètre du câble:	Ø 9mm
Longueur câble de contrôle:	1,80m
Efficacité:	S3-25%-10min

PRIX TARIF	PRIX DE VENTE	PRIX DE VENTE
€599,86	€428,47	€518,45
hors TVA	hors TVA	TVA incl.

T1100



Bras de support - palan non INCLUS

Poids:	9,0kg
Portée extensible:	1,1m
Capacité de charge:	600kg

PRIX TARIF	PRIX DE VENTE	PRIX DE VENTE
€160,21	€114,43	€138,47
hors TVA	hors TVA	TVA incl.

T1ROLLEY



Puissance:	200W
Voltage:	230V, 50Hz
Poids:	5,0kg
Dimensions:	350x30x220mm
Capacité:	999kg
Vitesse:	16m/min
Longueur câble de contrôle:	5m
Diamètre des roues:	85mm

PRIX TARIF	PRIX DE VENTE	PRIX DE VENTE
€323,03	€230,73	€279,19
hors TVA	hors TVA	TVA incl.

GENEREMORE
RENSON
LARIUS
FEMT
DREHMANN
DRELUX
BDS
ZECO
TRX
KITPRO
PUJMA
AR
DEWALT

THW100



Poids: 4,5kg

Capacité: 1150kg

Longueur du câble: 7,6m

Diamètre du câble: Ø 4,0mm

Ratio: 1:10

PRIX TARIF
€67,74
hors TVA

PRIX DE VENTE
€48,38
hors TVA

PRIX DE VENTE
€58,54
TVA incl.

THW170



Poids: 5,0kg

Capacité: 1150kg

Longueur de sangle: 6,0m

Largeur de la corde: 25,0mm

Ratio: 1:10

PRIX TARIF
€72,94
hors TVA

PRIX DE VENTE
€52,10
hors TVA

PRIX DE VENTE
€63,04
TVA incl.



TEW1500D1



Voltage:	12V
Poids:	10,0kg
Dimensions:	286x110x115mm
Capacité:	675kg
Capacité min. de batterie:	60Ah
Longueur du câble:	7,6m
Diamètre câble:	Ø 4,0mm
Ratio:	1:153

PRIX TARIF €191,58 <small>hors TVA</small>	PRIX DE VENTE €136,84 <small>hors TVA</small>	PRIX DE VENTE €165,58 <small>TVA incl.</small>
--------------------------------------------------	-----------------------------------------------------	------------------------------------------------------

TEW2000DW1



Voltage:	12V
Poids:	11,0kg
Dimensions:	285x105x105mm
Capacité:	900kg
Capacité min. de batterie:	60Ah
Longueur du câble:	7,6m
Diamètre câble:	Ø 4,0mm
Ratio:	1:153

PRIX TARIF €227,17 <small>hors TVA</small>	PRIX DE VENTE €162,26 <small>hors TVA</small>	PRIX DE VENTE €196,34 <small>TVA incl.</small>
--------------------------------------------------	-----------------------------------------------------	------------------------------------------------------

TEW3500



Voltage:	12V
Poids:	14,0kg
Dimensions:	333x115x116mm
Capacité:	1587kg
Capacité min. de batterie:	80Ah
Longueur du câble:	14,0m
Diamètre câble:	Ø 5,6mm
Ratio:	1:145

PRIX TARIF €294,22 <small>hors TVA</small>	PRIX DE VENTE €210,16 <small>hors TVA</small>	PRIX DE VENTE €254,29 <small>TVA incl.</small>
--------------------------------------------------	-----------------------------------------------------	------------------------------------------------------

TEW4000

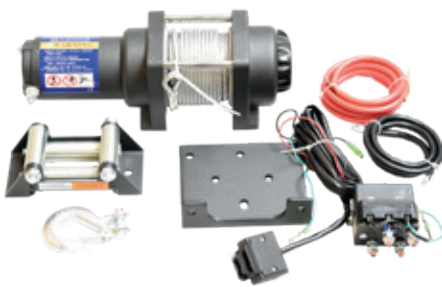

Voltage:	12V
Poids:	16,0kg
Dimensions:	340x110x110mm
Capacité:	1816kg
Capacité min. de batterie:	100Ah
Longueur du câble:	15,2m
Diamètre câble:	Ø 4,8mm
Ratio:	1:166

PRIX TARIF €341,89 <small>hors TVA</small>	PRIX DE VENTE €244,20 <small>hors TVA</small>	PRIX DE VENTE €295,49 <small>TVA incl.</small>
--------------------------------------------------	-----------------------------------------------------	------------------------------------------------------

TEW8500 24V



Voltage:	24V
Poids:	36,0kg
Dimensions:	579x186x236mm
Capacité:	3850kg
Capacité min. de batterie:	120Ah
Longueur du câble:	26,0m
Diamètre câble:	Ø 8,2mm
Ratio:	1:402

PRIX TARIF €976,78 <small>hors TVA</small>	PRIX DE VENTE €697,70 <small>hors TVA</small>	PRIX DE VENTE €844,22 <small>TVA incl.</small>
--------------------------------------------------	-----------------------------------------------------	------------------------------------------------------

TEW9500



Voltage:	12V
Poids:	38,0kg
Dimensions:	579x186x236mm
Capacité:	4275kg
Capacité min. de batterie:	160Ah
Longueur du câble:	26,0m
Diamètre câble:	Ø 8,2mm
Ratio:	1:402

PRIX TARIF €1035,99 <small>hors TVA</small>	PRIX DE VENTE €739,99 <small>hors TVA</small>	PRIX DE VENTE €895,39 <small>TVA incl.</small>
---------------------------------------------------	-----------------------------------------------------	------------------------------------------------------



TRXRIVNUTP1200

INCLUS

RIVNUT1200 en coffre

+

7 mandrins M3 - M12



Force de traction:	>19,1kN
Course:	7mm
Pression standard:	0,55MPa
Pression à l'usage :	0,5-0,7MPa
Consommation d'air :	4,6l
Vitesse du moteur :	2000tr/min
Niveau de vibration :	2,5m/s ²
Niveau sonore:	<75dB(A)
Poids:	2,20kg
Matériel de rivet:	Matériaux compatibles
Caractéristiques des rivets :	M3-M12 (1/8" - 1/2")

PRIX TARIF
€962,65
hors TVA

PRIX DE VENTE
€687,61
hors TVA

PRIX DE VENTE
€832,00
TVA incl.

Ø	M3	M4	M5	M6	M8	M10	M12
AL	●	●	●	●	●	●	●
ST	●	●	●	●	●	●	●
INOX	●	●	●	●	●	●	●



INCLUS
7 mandrins
interchangeables

Référence:	Matériel:	Nombre:	Type:	hors TVA	TVA incl.
TRXRIVNUT1M05STC ↳ Tête fraisée	Acier galvanisé	200	M5	€13,08	€15,82
TRXRIVNUT1M06STC ↳ Tête fraisée	Acier galvanisé	200	M6	€13,63	€16,49
TRXRIVNUT1M08STC ↳ Tête fraisée	Acier galvanisé	200	M8	€21,82	€26,40
TRXRIVNUT1M10STC ↳ Tête fraisée	Acier galvanisé	100	M10	€18,41	€22,28
TRXRIVNUT1M12STC ↳ Tête fraisée	Acier galvanisé	100	M12	€36,11	€43,70
TRXRIVNUTM05ALF	Aluminium	200	M5	€19,19	€23,22
TRXRIVNUTM06ALF	Aluminium	200	M6	€21,36	€25,85
TRXRIVNUTM08ALF	Aluminium	200	M8	€33,80	€40,90
TRXRIVNUTM10ALF	Aluminium	200	M10	€28,35	€34,30

TRXRIVPOP48



Force de traction:	>9kN
Course:	17mm
Pression standard:	0,55MPa
Pression à l'usage :	0,5-0,7MPa
Vacuum:	Oui
Lo x La x H:	276x312x119mm
Niveau sonore:	<75dB(A)
Poids:	1,45kg
Matériel de rivet:	Matériaux compatibles
Caractéristiques des rivets :	(2,4mm - 3,2mm - 4,0mm - 4,8mm) (3/32" - 1/8" - 5/32" - 3/16")

PRIX TARIF
€599,50
hors TVA

PRIX DE VENTE
€428,22
hors TVA

PRIX DE VENTE
€518,14
TVA incl.

TRXRIVPOP64



Force de traction:	>14,68kN
Course:	28mm
Pression standard:	0,55MPa
Pression à l'usage :	0,5-0,7MPa
Vacuum:	Oui
Lo x La x H:	276x312x134mm
Niveau sonore:	<75dB(A)
Poids:	1,64kg
Matériel de rivet:	Matériaux compatibles
Caractéristiques des rivets :	(3,2mm - 4,0mm - 4,8mm - 6,4mm) (1/8" - 5/32" - 3/16" - 1/4")

PRIX TARIF
€833,29
hors TVA

PRIX DE VENTE
€595,21
hors TVA

PRIX DE VENTE
€720,20
TVA incl.

MONOBOLT

		hors TVA	TVA incl.
Référence:	Tête:		
TRXRIVMONOBOLT-ACC48	Ø4,8mm	€53,68	€64,95
↳ Tête Monobolt			
TRXRIVMONOBOLT-ACC64	Ø6,4mm	€53,68	€64,95
↳ Tête Monobolt			

ACT3TRXSABL20L



Réservoir de sable:	20L
Lo x La x H:	273x745mm
Pression de travail:	7 bar
Connexion:	Accouplement à griffes 3/4"
Diamètre tuyau:	Ø28mm

PRIX TARIF
€3030,58
hors TVA

PRIX DE VENTE
€2164,70
hors TVA

PRIX DE VENTE
€2619,28
TVA incl.

INCLUS



- 1 embout de votre choix + Tuyau + Masque de + Sable + Séparateur + Kit de roues
 Ø2,4mm ⇒ 400l/min Ø28mm protection 100kg d'eau
 Ø3,0mm ⇒ 550l/min longueur 10m + Crochet de
 Ø4,8mm ⇒ 950l/min levage

TRXSB60L



Réservoir de sable:	60L
Lo x La x H:	350x1150mm
Pression de travail:	7 bar
Connexion:	Accouplement à griffes 1-1/4"
Diamètre tuyau:	Ø48mm

PRIX TARIF
€5400,49
hors TVA

PRIX DE VENTE
€3857,49
hors TVA

PRIX DE VENTE
€4667,57
TVA incl.

INCLUS



- Tuyau + Kit de roues
avec commande Crochet de levage
Ø48mm Séparateur d'eau
longueur 20m Silencer

- 1 embout de votre choix
 Ø4,8mm ⇒ 950l/min
 Ø6,4mm ⇒ 3000l/min
 Ø8,0mm ⇒ 5400l/min
 Ø9,0mm ⇒ 6600l/min

TRXSB100L



Réservoir de sable:	100L
Lo x La x H:	400x1300mm
Pression de travail:	7 bar
Connexion:	Accouplement à griffes 1-1/4"
Diamètre tuyau:	Ø48mm

PRIX TARIF
€5880,95
hors TVA

PRIX DE VENTE
€4200,68
hors TVA

PRIX DE VENTE
€5082,82
TVA incl.

INCLUS



- Tuyau + Kit de roues
avec commande Crochet de levage
Ø48mm Séparateur d'eau
longueur 20m Silencer

- 1 embout de votre choix
 Ø4,8mm ⇒ 950l/min
 Ø6,4mm ⇒ 3000l/min
 Ø8,0mm ⇒ 5400l/min
 Ø9,0mm ⇒ 6600l/min

GENEREMORE
RENSON
LARIUS
FEMT
DREHMANN
DRELUX
BDS
ZECO
TRX
KITPRO
PUJMA
AR
DEWALT

ACCESSOIRES

	Référence:	Nom:	Caractéristiques	hors TVA	TVA incl.
	TRXSBNOZZL48	Buse en Tungsten	Ø4,8mm, longueur: 135mm (5-5/16")	€122,62	€148,38
	TRXSBNOZZL64		Ø6,4mm, longueur: 135mm (5-5/16")	€128,82	€155,88
	TRXSBNOZZL80		Ø8,0mm, longueur: 145mm (5-3/4")	€162,22	€196,29
	TRXSBNOZZL95		Ø9,5mm, longueur: 145mm (5-3/4")	€202,78	€245,36
	TRXBSNOZZ435-1	Buse en Tungsten mini	Ø2,4mm x 3/4G	€106,33	€128,66
	TRXBSNOZZ435-2		Ø3,4mm x 3/4G		
	TRXBSNOZZ435-3		Ø4,8mm x 3/4G		
	TRXBSNOZZ435-4		Ø6,4mm x 3/4G		
	TRXSBTWINHOSE	Tuyau double d'air comprimé sans commande	20m, Ø int. 8mm, 5/16" x Ø ext. 15mm(0.59")	€133,98	€162,11
	TRXSBHOSES	Tuyau à jet multicouche en caoutchouc	20m, Ø int. (1-1/2") 13mm x Ø ext. (1/3") » Ø28mm, 8Bar - 12Bar	€14,27	€17,27
	TRXSBHOSEL		20m, Ø int. (1-1/4") 32mm x Ø ext. (7/8") » Ø48mm, 8Bar - 12bar	€27,30	€33,03
	TRXSBHELM	Masque de protection	Avec filtre remplaçable	€294,32	€356,13
	TRXSBEATSUN	Casque de sablage	Avec visière droite et tuyau d'air	€434,18	€525,36
	TRXSBSPLENDIT	Casque de sablage	Avec visière panoramique et tuyau d'air	€434,18	€525,36
	TRXSBAIRFLOW-CONTR	Régulateur de débit d'air	Avec ceinture	€95,85	€115,98
	TRXSBCARBFILTR	Filtre à air	8.5bar, accouplement 1	€570,64	€690,47
	TRXSBESEPARAT	Séparateur d'eau	/	€471,39	€570,38
	TRXBSHANDLE	Commande à distance	Sachette	€109,16	€132,09



TPT60

Type de moteur:	LC160
	5,5cv 4T OHV
Niveau sonore:	69db(A)
Contenu réservoir:	3l
Autonomie en moyenne:	2,5h
Diamètre sys. à taloche:	Ø600mm
Vitesse:	60-140tr/min
Poids:	50kg



PRIX TARIF	PRIX DE VENTE	PRIX DE VENTE
€1244,09	€888,64	€1075,25
hors TVA	hors TVA	TVA incl.



Ø60CM



Disque de ponçage

Pales réglables

INCLUS

TPT75

Type de moteur:	LC160
	5,5cv 4T OHV
Niveau sonore:	69db(A)
Contenu réservoir:	3l
Autonomie en moyenne:	2,5h
Diamètre sys. à taloche:	Ø750mm
Vitesse:	60-140tr/min
Poids:	66kg



PRIX TARIF	PRIX DE VENTE	PRIX DE VENTE
€1310,89	€936,35	€1132,98
hors TVA	hors TVA	TVA incl.



Ø75CM



Disque de ponçage

Pales réglables

INCLUS

TPT90

Type de moteur:	LC160
	6,5cv 4T OHV
Niveau sonore:	69db(A)
Contenu réservoir:	3l
Autonomie en moyenne:	2,5h
Diamètre sys. à taloche:	Ø900mm
Vitesse:	60-140tr/min
Poids:	78kg



PRIX TARIF	PRIX DE VENTE	PRIX DE VENTE
€1444,48	€1031,77	€1248,44
hors TVA	hors TVA	TVA incl.



Ø90CM



Disque de ponçage

Pales réglables

INCLUS

GENERMOIRE
RENSON
LARIUS
FEMI
DREHMANN
DRELUX
BDS
ZECO
TRX
KITPRO
PUJMA
AR
DEWALT

TRXTP1200E1D



Temps de charge
3h



Temps de travail
6h



Batterie Lithium



PU roues simple



Poignée multifonctionnelle avec fonction de rampement

Puissance maximale:	750W
Capacité de levage:	1200kg
Profondeur min/max :	80/190mm
Rayon de braquage:	1452mm
Vitesse maximale:	4,8km/u
Batterie:	Li-Ion 48V/20Ah
Longueur fourche:	1150mm
Poids:	125kg
Lo x La x H:	1650x550x1270

PRIX TARIF
€3108,72
hors TVA

PRIX DE VENTE
€2220,51
hors TVA

PRIX DE VENTE
€2686,82
TVA incl.

TRXTP1500E1DX



Temps de charge
3h



Temps de travail
6h



Batterie Lithium



PU roues simple



Poignée multifonctionnelle avec fonction de rampement

Puissance maximale:	850W
Capacité de levage:	1500kg
Profondeur min/max :	80/190mm
Rayon de braquage:	1452mm
Vitesse maximale:	4,8km/u
Batterie:	Li-Ion 48V/20Ah
Longueur fourche	1150mm
Poids:	128kg
Lo x La x H:	1650x550x1270

PRIX TARIF
€3456,06
hors TVA

PRIX DE VENTE
€2468,62
hors TVA

PRIX DE VENTE
€2987,03
TVA incl.



TRX06-F045

0.5CV

Sans huile

3000rpm

PRIX TARIF
€316,33
hors TVA

PRIX DE VENTE
€225,95
hors TVA

PRIX DE VENTE
€273,40
TVA incl.



Air aspiré:	45L/min
Pression de travail:	8 bar
Niveau sonore:	71 dB(A) @ 7m
Connexion:	Orion
Contenu réservoir:	4L
Poids:	12kg

TRX06-85-OF

0.75CV

Sans huile

1500rpm

PRIX TARIF
€269,19
hors TVA

PRIX DE VENTE
€192,28
hors TVA

PRIX DE VENTE
€232,65
TVA incl.



WHISPERCOMPRESSOR 62dB(A)

Air aspiré:	85L/min
Pression de travail:	8 bar
Niveau sonore:	62 dB(A) @ 7m
Connexion:	Orion
Contenu réservoir:	6L
Poids:	15,8kg

TRX08-110-OF

1.0CV

Sans huile

1500rpm

PRIX TARIF
€321,30
hors TVA

PRIX DE VENTE
€229,50
hors TVA

PRIX DE VENTE
€277,69
TVA incl.



WHISPERCOMPRESSOR 62dB(A)

Air aspiré:	110L/min
Pression de travail:	8 bar
Niveau sonore:	62 dB(A) @ 7m
Connexion:	Orion
Contenu réservoir:	8L
Poids:	19,4kg

TRX08-165-OF

1.3CV

Sans huile

1500rpm

PRIX TARIF
€415,99
hors TVA

PRIX DE VENTE
€297,14
hors TVA

PRIX DE VENTE
€359,53
TVA incl.



WHISPERCOMPRESSOR 62dB(A)

Air aspiré:	165L/min
Pression de travail:	8 bar
Niveau sonore:	62 dB(A) @ 7m
Connexion:	Orion
Contenu réservoir:	8L
Poids:	22kg

TRX20-240-OF

2.5CV

Sans huile

1500rpm

PRIX TARIF
€893,11
hors TVA

PRIX DE VENTE
€637,94
hors TVA

PRIX DE VENTE
€771,90
TVA incl.



Air aspiré:	240l/min
Pression de travail:	9 bar
Niveau sonore:	72 dB(A) @ 7m
Connexion:	Orion
Contenu réservoir:	20L
Poids:	44,3kg

TRX24-320-OF

3.0CV

Sans huile

1500rpm

PRIX TARIF
€1191,31
hors TVA

PRIX DE VENTE
€850,94
hors TVA

PRIX DE VENTE
€1029,63
TVA incl.



Air aspiré:	320L/min
Pression de travail:	9 bar
Niveau sonore:	78 dB(A) @ 7m
Connexion:	Orion
Contenu réservoir:	20L
Poids:	54kg

TRXOF195

2.0CV

Sans huile
3000rpm

PRIX TARIF
€706,53
hors TVA

PRIX DE VENTE
€504,66
hors TVA

PRIX DE VENTE
€610,64
TVA incl.



Air aspiré:	195L/min
Pression de travail:	10 bar
Niveau sonore:	83 dB(A) @ 7m
Connexion:	Orion
Contenu réservoir:	8L
Poids:	36kg

TRXOF270

3.0CV

Sans huile
3000rpm

PRIX TARIF
€917,01
hors TVA

PRIX DE VENTE
€655,01
hors TVA

PRIX DE VENTE
€792,56
TVA incl.



Air aspiré:	270L/min
Pression de travail:	10 bar
Niveau sonore:	88 dB(A) @ 7m
Connexion:	Orion
Contenu réservoir:	15L
Poids:	44,5kg

TRXLB25/440

3.0CV

Avec huile
1500rpm

PRIX TARIF
€1103,13
hors TVA

PRIX DE VENTE
€787,95
hors TVA

PRIX DE VENTE
€953,42
TVA incl.



Air aspiré:	440L/min
Pression de travail:	10 bar
Niveau sonore:	82 dB(A) @ 7m
Connexion:	Orion
Contenu réservoir:	25L
Poids:	66kg

TRXLBHOSE30

PRIX TARIF
€243,14
hors TVA

PRIX DE VENTE
€173,67
hors TVA

PRIX DE VENTE
€210,14
TVA incl.



Longueur:	30m
Diamètre extérieur	14,5mm
Diamètre intérieur:	9,5mm
Lo x La x H:	330x360x360mm



KITPRO

professional tools

GENÈREMOIRE
RENSON
LARIUS
FEMI
DREHMANN
DRELUX
BDS
ZECO
TRX
KITPRO
PUJMA
AR
DEWALT

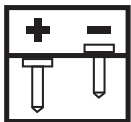

Réglage facile de la profondeur



PLAT

Clous en bande plate



Lumière intégrée



CÔNIQUE

Clous en bande cônica



Gachette multifonctionnelle: tir isolé et tir multiple

BB18/55-A1

Verouillage rapide du nez

Reglage de frappe

Tir isolé/rapide

Crochet de ceinture

Protection à l'appui



BB18/55-A1 avec 2 batteries
Chargeur et lunettes de sécurité
Livré en coffre ABS

Minibrads 18Ga



Référence:	k108000
Accu:	Li-ion 18V - 2,3Ah
Longueur clous:	15-55mm
Capacité:	100
Lo x La x H:	272x92x305mm
Poids (avec accu):	3,25kg

PRIX TARIF
€782,78
hors TVA

PRIX DE VENTE
€559,13
hors TVA

PRIX DE VENTE
€676,54
TVA incl.



AB20/64-A1



AB20/64-A1 avec 2 batteries
Chargeur et lunettes de sécurité
Livré en coffre ABS

Verouillage rapide du nez

Reglage de frappe

Tir isolé/rapide

Crochet de ceinture

Protection à l'appui

Brads 16Ga 20°

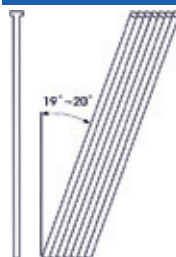

Référence:	k108005
Accu:	Li-ion 18V - 2,3Ah
Longueur clous:	20-64mm
Capacité:	100
Lo x La x H:	291x93x335,5mm
Poids (avec accu):	3,52kg



PRIX TARIF
€821,20
hors TVA

PRIX DE VENTE
€586,57
hors TVA

PRIX DE VENTE
€709,75
TVA incl.

COMBOSET K102021OL45



Convient pour:
isolation, carton,
revêtements de
sol, garnissage



INCLUS
S10/25J-A1
Tuyau d'air comprimé 5m
avec raccords
TRXOF45



PRIX TARIF
€499,31
hors TVA
PRIX DE VENTE
€356,65
hors TVA
PRIX DE VENTE
€431,54
TVA incl.

45 l/min 8bar 4l

COMBOSET K101200OL45

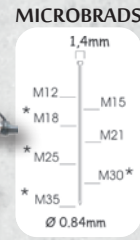

Convient pour:
moules fines,
liens pré-collés et
invisibles



INCLUS
B21/35P-A1
Tuyau d'air comprimé 5m
avec raccords
TRXOF45



PRIX TARIF
€532,11
hors TVA
PRIX DE VENTE
€380,08
hors TVA
PRIX DE VENTE
€459,89
TVA incl.

45 l/min 8bar 4l

COMBOSET K101021OL85

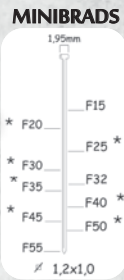

Convient pour:
meubles, moules,
portes et fenêtres,
parquet,
pré-collages



INCLUS
B18/50-A1
Tuyau d'air comprimé 5m
avec raccords
TRX06-85-OF



PRIX TARIF
€514,34
hors TVA
PRIX DE VENTE
€367,38
hors TVA
PRIX DE VENTE
€444,53
TVA incl.

Whispercompressor
62dB(A)
1400 tr/min

85 l/min 8 bar 6l

COMBOSET K106000OL85

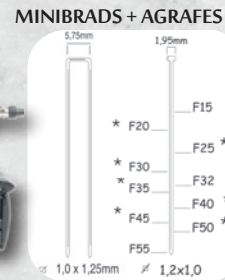

Convient pour:
meubles,
pré collages,
parquet,
moules, portes
et fenêtres



INCLUS
BS50-A1
Tuyau d'air comprimé 5m
avec raccords
TRX06-85-OF



PRIX TARIF
€656,47
hors TVA
PRIX DE VENTE
€468,91
hors TVA
PRIX DE VENTE
€567,38
TVA incl.

Whispercompressor
62dB(A)
1400 tr/min

85 l/min 8 bar 6l

GENERMOIRE
RENSON
LARIUS
FERMI
DREHMANN
DRELUX
BDS
ZECO
TRX
KITPRO
PUJMA
AR
DEWALT

COMBOSET K1020610L85



AGRAFES



Convient pour:
meubles, parquet
moulures, portes et
fenêtres,
pré-collages

INCLUS
S80/16-B1
Tuyau d'air comprimé 5m
avec raccords
TRX06-85-OF

PRIX TARIF
€488,51
hors TVA

PRIX DE VENTE
€348,94
hors TVA

PRIX DE VENTE
€422,21
TVA incl.

Whispercompressor
62dB(A)
1400 tr/min

85 l/min 8 bar 6l

COMBOSET K1010420L110



CLOUS BRIQUE



Convient pour:
plinthes, parquet
moulures, portes
et fenêtres,
faux plafond

INCLUS
B16/50-D1
Tuyau d'air comprimé 5m
avec raccords
TRX08-110-OF

PRIX TARIF
€778,18
hors TVA

PRIX DE VENTE
€555,84
hors TVA

PRIX DE VENTE
€672,57
TVA incl.

Whispercompressor
62dB(A)
1400 tr/min

110 l/min 8 bar 8l

COMBOSET K1010510L110



CLOUS



Convient pour:
meubles, parquet,
portes et fenêtres,
cadres, panneaux

INCLUS
B16/64-A1
Tuyau d'air comprimé 5m
avec raccords
TRX08-110-OF

PRIX TARIF
€699,70
hors TVA

PRIX DE VENTE
€499,78
hors TVA

PRIX DE VENTE
€604,74
TVA incl.

Whispercompressor
62dB(A)
1400 tr/min

110 l/min 8 bar 8l

COMBOSET K10106010L165



CLOUS BRIQUE



Convient pour:
moulures fines,
terrasses, faux
plafonds,
parquet,
plinthes

INCLUS
B22/64T
Tuyau d'air comprimé 5m
avec raccords
TRX08-165-OF

PRIX TARIF
€967,66
hors TVA

PRIX DE VENTE
€691,19
hors TVA

PRIX DE VENTE
€836,33
TVA incl.

Whispercompressor
62dB(A)
1400 tr/min

165 l/min 8 bar 8l

GENERATOR RENSON LARIUS FEML DREHMANN DREIX BUS ZECO TRX KITPRO PUMA AR DEWALT

COMBOSET K10204010L195

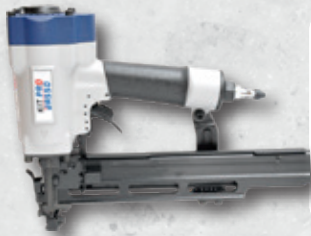

Convient pour:
palettes, gyproc,
lattes, sols



INCLUS
S8/51-A1
Tuyau d'air comprimé 5m
avec raccords
TRXOF195



PRIX TARIF
€1150,57
hors TVA

PRIX DE VENTE
€821,84
hors TVA

PRIX DE VENTE
€994,43
TVA incl.

195l/min 10 bar 8l

COMBOSET K1011023110L270

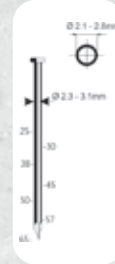

Convient pour:
chevrons, caisses
toitures, gainage,
clôture, emballages



INCLUS
C28/65-F1
Tuyau d'air comprimé 5m
avec raccords
TRXOF270



PRIX TARIF
€1668,25
hors TVA

PRIX DE VENTE
€1191,61
hors TVA

PRIX DE VENTE
€1441,84
TVA incl.

270l/min 10 bar 15L

COMBOSET K102044LB280



Convient pour:
meubles, sols,
sous-planchers,
moulures,
gyproc, panneaux



INCLUS
S8/75-NQ
Tuyau d'air comprimé 30m
TRXLB20-240-OF

PRIX TARIF
€1701,65
hors TVA

PRIX DE VENTE
€1215,46
hors TVA

PRIX DE VENTE
€1470,71
TVA incl.

240 l/min 9 bar 20L

COMBOSET K101082LB440

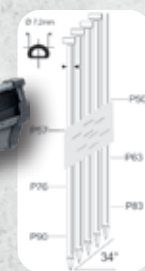

Convient pour:
menuiserie,
coffrages,
toitures,
construction
en bois



INCLUS
A34/90-A2
Tuyau d'air comprimé 30m
TRXLB25/440

PRIX TARIF
€1864,35
hors TVA

PRIX DE VENTE
€1418,24
hors TVA

PRIX DE VENTE
€1716,07
TVA incl.

440 l/min 10 bar 25L

K103010EUROBOX

B18/50P-A3 + tuyau d'air comprimé 5m
Cloueur pneumatique minibrads
+
30000 Clous
(F15 + F25 + F30 +
F35 + F40 + F50)
+ coffre



PRIX TARIF
€315,61
hors TVA

PRIX DE VENTE
€225,44
hors TVA

PRIX DE VENTE
€272,78
TVA incl.

K104010EUROBOX

S10-25P-A2 + tuyau d'air comprimé 5m
Agrafeuse
+
20000 Agrafes
(412K + 425K +
430K + 440K)
+ coffre



PRIX TARIF
€282,22
hors TVA

PRIX DE VENTE
€201,58
hors TVA

PRIX DE VENTE
€243,92
TVA incl.

K102052EUROBOX

S53/16 + **KL16R**
Cloueur pneumatique Cloueur à main
+
12000 Agrafes
(6/8/10/12/14/16 mm)
+
tuyau d'air comprimé 5m
+ coffre



PRIX TARIF
€315,61
hors TVA

PRIX DE VENTE
€225,44
hors TVA

PRIX DE VENTE
€272,78
TVA incl.

K102055EUROBOX

S11/16-A1 + **KLS-5015**
Cloueur pneumatique Cloueur à main
+
12000 Agrafes
(6/8/10/12/14/16 mm)
+
tuyau d'air comprimé 5m
+ coffre



PRIX TARIF
€296,35
hors TVA

PRIX DE VENTE
€225,44
hors TVA

PRIX DE VENTE
€272,78
TVA incl.

B16/64-J2000



Référence:	K107015
Cartouche de gaz:	35ml
Longueur clous:	20-64mm
Capacité:	100
Lo x La x H:	315x86x274mm
Poids:	2,18kg
Convient pour: menuiserie, parclozes	

Brads 16GA

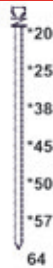

PRIX TARIF
€692,96
hors TVA

PRIX DE VENTE
€494,97
hors TVA

PRIX DE VENTE
€598,91
TVA incl.



B18/50-J2000



Référence:	K107013
Cartouche de gaz:	35ml
Longueur clous:	10-50mm
Capacité:	100
Lo x La x H:	315x86x274mm
Poids:	2,18kg
Convient pour: menuiserie, parclozes	

Minibrads 18GA



PRIX TARIF
€692,96
hors TVA

PRIX DE VENTE
€494,97
hors TVA

PRIX DE VENTE
€598,91
TVA incl.



A20/64-J2000



Référence:	K107020
Cartouche de gaz:	35ml
Longueur clous:	32-64mm
Capacité:	100
Lo x La x H:	332x86x275mm
Poids:	2,27kg
Convient pour: menuiserie, parclozes	

Brads 16GA 20°

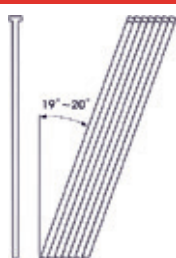

PRIX TARIF
€693,02
hors TVA

PRIX DE VENTE
€495,01
hors TVA

PRIX DE VENTE
€598,96
TVA incl.



A34/64-J2000



Référence:	K107025
Cartouche de gaz:	35ml
Longueur clous:	32-64mm
Capacité:	100
Lo x La x H:	332x126x310mm
Poids:	2,38kg
Convient pour: menuiserie, parclozes	

DA brads 34°

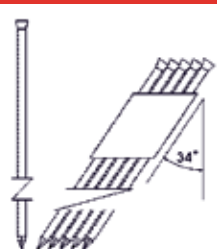

PRIX TARIF
€692,96
hors TVA

PRIX DE VENTE
€494,97
hors TVA

PRIX DE VENTE
€598,91
TVA incl.



GENERMORE
RENSON
LARIUS
FEMT
DREHMANN
DRELUX
BDS
ZECO
TRX
KITPRO
PUJMA
AR
DEWALT

S8/75-J2000



Agrafes série 700
Agrafes série S15

Référence:	K107050
Cartouche de gaz:	80ml
Longueur agrafes:	25-75mm
Capacité:	110
Lo x La x H:	373x108x351mm
Poids:	3,8kg

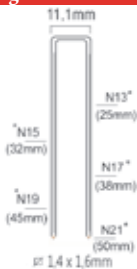

Convient pour: clôtures, emballages, palettes

PRIX TARIF
€1238,19
hors TVA

PRIX DE VENTE
€884,42
hors TVA

PRIX DE VENTE
€1070,15
TVA incl.



B22/64-J2000



Clous T

Référence:	K107045
Cartouche de gaz:	80ml
Longueur clous:	18-64mm
Capacité:	80
Lo x La x H:	370x108x364mm
Poids:	3,87kg



Convient pour: terrasses, plinthes, toitures

PRIX TARIF
€946,40
hors TVA

PRIX DE VENTE
€676,00
hors TVA

PRIX DE VENTE
€817,96
TVA incl.



EG31/40-A1



Agrafes clôtures

Référence:	K107065
Cartouche de gaz:	80ml
Longueur clous:	33-40mm
Capacité:	78
Lo x La x H:	373x108x356mm
Poids:	3,8kg

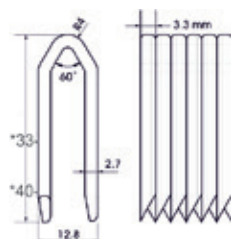

Convient pour: clôtures

PRIX TARIF
€1158,22
hors TVA

PRIX DE VENTE
€827,30
hors TVA

PRIX DE VENTE
€1001,04
TVA incl.



A34/65-A1



CLOUEUR BAT

Metal connector

Référence:	K107070
Cartouche de gaz:	80ml
Longueur clous:	34-64mm
Capacité:	30
Lo x La x H:	355x108x393mm
Poids:	3,8kg

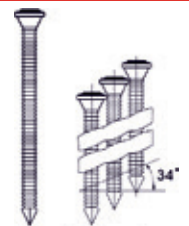

Convient pour: plaques de fer avec trous de clous, bandes de fer avec trous de clous

PRIX TARIF
€1040,30
hors TVA

PRIX DE VENTE
€743,07
hors TVA

PRIX DE VENTE
€899,12
TVA incl.



AG34/90-A1



Coffre avec AG34/90-A1
2 batteries Li-ion et
chargeur batteries INCLUS

Référence:	K107036
Cartouche de gaz:	80ml
Longueur clous:	50-90mm
Capacité:	60
Lo x La x H:	367x108x372mm
Poids:	3,36kg
Convient pour: toitures, palettes	

Clous 34°

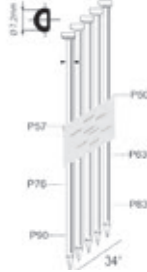

PRIX TARIF
€1000,28
hors TVA

PRIX DE VENTE
€714,49
hors TVA

PRIX DE VENTE
€864,53
TVA incl.



A22/90-J2000



Référence:	K107030
Cartouche de gaz:	80ml
Longueur clous:	50-90mm
Capacité:	32
Lo x La x H:	367x108x372mm
Poids:	3,36kg
Convient pour: construction en bois, toitures	

Clous à tête ronde 22°

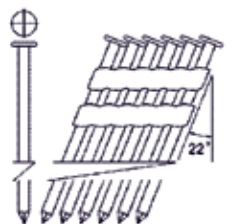

PRIX TARIF
€866,61
hors TVA

PRIX DE VENTE
€619,01
hors TVA

PRIX DE VENTE
€749,00
TVA incl.



GENÈREMOIRE
RENSON
LARTUS
FEMT
DREHMANN
DRELUX
BDS
ZECO
TRX
KITPRO
PUMA
AR
DEWALT

A34/90-N1



Référence action:	ACT2K107035
Référence cloueur:	K107035
Cartouche de gaz:	80ml
Longueur clous:	50-90mm
Capacité:	60
Lo x La x H:	367x108x372mm
Poids:	3,36kg
Convient pour: toitures, palettes	

Clous 34°

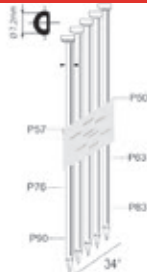

PRIX TARIF
€1446,15
hors TVA

PRIX DE VENTE
€1032,96
hors TVA

PRIX DE VENTE
€1249,89
TVA incl.



A34/90-J2000
+
19800 clous
(6 x 3300 clous 63mm 34°)

A34/90-A2



Référence action:	ACT2K101082
Référence cloueur:	K101082
Longueur clous:	50-90mm
Capacité:	90
Lo x La x H:	450x125x340mm
Poids:	3,50kg
Convient pour: menuiserie, coffrages, construction en bois	

Clous 34°

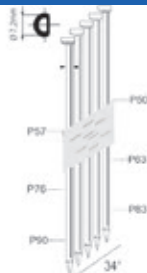

PRIX TARIF
€1294,19
hors TVA

PRIX DE VENTE
€924,42
hors TVA

PRIX DE VENTE
€1118,55
TVA incl.

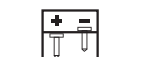

A34/90-A1
+
33000 clous 34°
(6 x 63mm, 3 x 76mm, 3 x 83mm)

TG30/38-A1 CLOUEUR BÉTON



Capacité:	42
Lo x La x H:	432x130x385 mm
Longueur clous:	15~40 mm
Tête de clou (Ø):	5,9~6,5 mm
Long. cartouche de gaz:	165 mm
Poids, sans cart. de gaz:	3,7 kg



Coffre avec TG30/38-A1,
2 batteries, chargeur et
lunettes de sécurité



5000 clous

longueur au choix (mm): 15, 17, 20, 22, 25, 30, 35, 40



5 cartouches de gaz



PRIX TARIF
€1387,64
hors TVA

PRIX DE VENTE
€991,17
hors TVA

PRIX DE VENTE
€1199,32
TVA incl.

ACTK107041

GENERMORE
RENSON
LARIUS
FEMI
DREHMANN
DRELUX
BDS
ZECO
TRX
KITPRO
PUMA
AR
DEWALT

T30/38-A1 CLOUEUR BÉTON



Capacité:	42
Lo x La x H:	459x139x373 mm
Longueur clous:	15~40 mm
Tête de clou (Ø):	5,9~6,5 mm
Poids:	3,6 kg



T30/38-A1



5000 clous

longueur au choix (mm): 15, 17, 20, 22, 25, 30, 35, 40



ACTK1010100

PRIX TARIF
€1122,29
hors TVA

PRIX DE VENTE
€801,64
hors TVA

PRIX DE VENTE
€969,98
TVA incl.

NEXT GEN



LED pour une utilisation pratique dans les coins sombres
Nez à fermeture rapide



Cadran pratique pour le réglage de profondeur



Gachette multifonctionnelle avec 2 fonctions
-tir isolé
-tir rapide



Crochet pivotant pour plus de confort



GENERMORE
RENSON
LARIUS
FEMI
DREHMANN
DRELUX
BDS
ZECO
TRX
KITPRO
PIUMA
AR
DEWALT

B18/55-F4

Convient pour la fabrication de meubles, moulures, portes et fenêtres, ...

Tire des clous de 15 à 55 mm

Très léger avec crochet pivotant

Contrôle de la profondeur et éclairage sont intégrés



**B18/55-F4 + tuyau d'air comprimé 5m
+ 10000 clous (F25 et F40)
EN L-BOXX PRATIQUE**

Référence:	k101023SORTIMO
Pression de travail	5-8bar
Longueur clous:	15-55mm
Capacité:	100
Lo x La x H:	246x64x252mm
Poids:	1,34kg

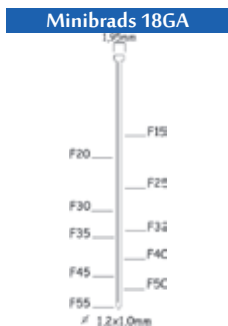

PRIX TARIF
€392,49
hors TVA

PRIX DE VENTE
€280,35
hors TVA

PRIX DE VENTE
€339,22
TVA incl.



S90/40L-F4

Convient pour l'isolation, le rembourrage, meubles et revêtements de sol, ...

Tire des agrafes de 12 à 40 mm

Très léger avec un crochet pratique

Contrôle de la profondeur et éclairage sont intégrés



**S90/40L-F4 + tuyau d'air comprimé 5m
+ 10000 agrafes (425K et 435K)
EN L-BOXX PRATIQUE**

Référence:	k102032SORTIMO
Pression de travail	5-8bar
Longueur agrafes:	12-40mm
Capacité:	100
Lo x La x H:	233x64x238mm
Poids:	1,29kg

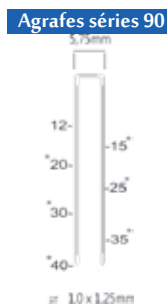

PRIX TARIF
€396,67
hors TVA

PRIX DE VENTE
€283,33
hors TVA

PRIX DE VENTE
€342,83
TVA incl.

GENERATOR
RENSON
LARIUS
FEMI
DREHMANN
DREIX
BUS
ZECO
TRX
KITPRO
DUMA
AR
DEWALT

GENERMOIRE
RENSON
LARTUS
FEMT
DREHMANN
DRELUX
BDS
ZECO
TRX
KITPRO
PUJMA
AR
DEWALT



B23/35-A1



Référence:	K101092
Pression de travail:	4,5-7bar
Longueur clous:	12-35mm
Capacité:	154
Lo x La x H:	226x42x160
Poids:	0,90kg

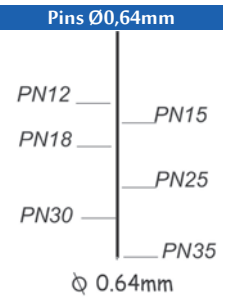

Convient pour: moulures fines, parquet, pré-collages

PRIX TARIF €416,48 <small>hors TVA</small>	PRIX DE VENTE €297,49 <small>hors TVA</small>	PRIX DE VENTE €359,96 <small>TVA incl.</small>
--------------------------------------------------	-----------------------------------------------------	------------------------------------------------------

B21/35P-A1



Référence:	K101200
Pression de travail:	4,5-7bar
Longueur clous:	15-35mm
Capacité:	100
Lo x La x H:	250x55x200mm
Poids:	0,90kg

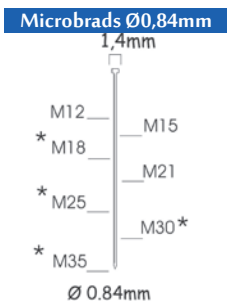

Convient pour: moulures fines, pré-collages

PRIX TARIF €292,09 <small>hors TVA</small>	PRIX DE VENTE €208,63 <small>hors TVA</small>	PRIX DE VENTE €252,45 <small>TVA incl.</small>
--------------------------------------------------	-----------------------------------------------------	------------------------------------------------------

B21/45-A1



Référence:	K101201
Pression de travail:	5-8bar
Longueur clous:	15-45mm
Capacité:	150
Lo x La x H:	261x44x210mm
Poids:	1,10kg

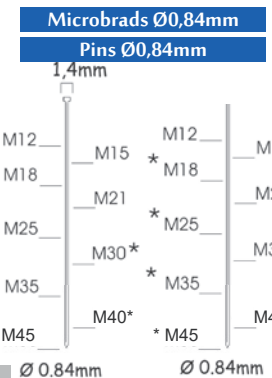

Convient pour: moulures fines, parquet

PRIX TARIF €395,67 <small>hors TVA</small>	PRIX DE VENTE €282,62 <small>hors TVA</small>	PRIX DE VENTE €341,97 <small>TVA incl.</small>
--------------------------------------------------	-----------------------------------------------------	------------------------------------------------------

B18/32P-A2



B18/32-2



POLYMERE

Référence:	K103000
Pression de travail:	4,5-7bar
Longueur clous:	10-32mm
Capacité:	100
Lo x La x H:	253x49x197mm
Poids:	0,60kg

Convient pour: fabrication des meubles, moulures, portes et fenêtres, pré-collages

Minibrads 18GA



Minibrads 18GA



Référence:	K101011
Pression de travail:	4,5-7bar
Longueur clous:	10-32mm
Capacité:	110
Lo x La x H:	255x56x182mm
Poids:	1,20kg

Convient pour: fabrication des meubles, moulures, portes et fenêtres, pré-collages

PRIX TARIF
€142,61
hors TVA

PRIX DE VENTE
€101,87
hors TVA

PRIX DE VENTE
€123,26
TVA incl.

PRIX TARIF
€203,79
hors TVA

PRIX DE VENTE
€145,56
hors TVA

PRIX DE VENTE
€176,13
TVA incl.

B18/50P-A3



SC25/15-A1



POLYMERE

ACTION VOIR PAGE 113

Référence:	K103011
Pression de travail:	5-7bar
Longueur clous:	10-50mm
Capacité:	100
Lo x La x H:	253x59x249mm
Poids:	0,94kg

Convient pour: fabrication des meubles, moulures, portes et fenêtres, pré-collages

Minibrads 18GA



Agrafes ondulées

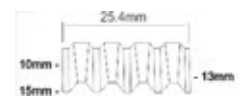

Référence:	K102095
Pression de travail:	5-8bar
Longueur clous:	10-15mm
Capacité:	
Lo x La x H:	376x93x270mm
Poids:	3,00kg

Convient pour: cuir de toit, roofing, bardeaux, isolation

PRIX TARIF
€558,56
hors TVA

PRIX DE VENTE
€398,97
hors TVA

PRIX DE VENTE
€482,75
TVA incl.



B18/50-A1

B18/50-A1

-BOXX



Référence: K101021
 Pression de travail: 4,5-7bar
 Longueur clous: 15-50mm
 Capacité: 154
 Lo x La x H: 226x42x160mm
 Poids: 1,10kg
 Convient pour: moulures fines, parquet, pré-collages

Minibrads 18GA



PRIX TARIF
 €225,60
 hors TVA

PRIX DE VENTE
 €161,15
 hors TVA

PRIX DE VENTE
 €194,99
 TVA incl.

INCLUS



B18/50-A1
 10 000 minibrads
 (5000 x F25 en 5000 x F40)
 Tuyau d'air comprimé 5m
 avec raccords
 Intérieur en mousse NBR

Référence: K101021SORTIMO

PRIX TARIF
 €333,00
 hors TVA

PRIX DE VENTE
 €237,86
 hors TVA

PRIX DE VENTE
 €287,81
 TVA incl.

B16/50L-A1

B16/50L-A1

-BOXX



Référence: K101031
 Pression de travail: 5-8bar
 Longueur clous: 20-50mm
 Capacité: 100
 Lo x La x H: 300x60x256mm
 Poids: 1,20kg
 Convient pour: moulures fines, parquet, fabrication des meubles, panneaux

Brads 16GA

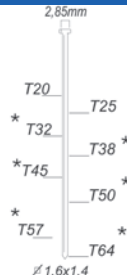

PRIX TARIF
 €269,05
 hors TVA

PRIX DE VENTE
 €192,18
 hors TVA

PRIX DE VENTE
 €232,54
 TVA incl.

INCLUS



B16/50L-A1
 5000 brads
 (5000 x 50mm)
 Tuyau d'air comprimé 5m
 avec raccords
 Intérieur en mousse NBR

Référence: K101031SORTIMO

PRIX TARIF
 €376,73
 hors TVA

PRIX DE VENTE
 €269,09
 hors TVA

PRIX DE VENTE
 €325,60
 TVA incl.

GENERMORE
 RENSON
 LARIUS
 FEMT
 DREHMANN
 DRELUX
 BDS
 ZECO
 TRX
 KITPRO
 PUJMA
 AR
 DEWALT

B16/64-A1

B16/64-A1

-BOXX



Référence:	K101051
Pression de travail:	5-8bar
Longueur clous:	20-64mm
Capacité:	100
Lo x La x H:	299x74x281mm
Poids:	1,70kg

Convient pour: moulures fines, parquet, fabrication des meubles, fenêtres et portes

Brads 16GA

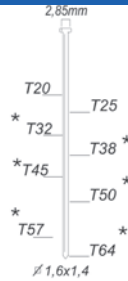

PRIX TARIF
€350,30
hors TVA

PRIX DE VENTE
€250,21
hors TVA

PRIX DE VENTE
€302,76
TVA incl.

SORTIMO



B16/64-A1
5000 brads
(5000 x 50mm)
Tuyau d'air comprimé 5m
avec raccords
Intérieur en mousse NBR

Référence: K101051SORTIMO

PRIX TARIF
€475,73
hors TVA

PRIX DE VENTE
€339,81
hors TVA

PRIX DE VENTE
€411,17
TVA incl.

B16/50-D1

B16/50-D1

-BOXX



Référence:	K101042
Pression de travail:	5-8bar
Longueur clous:	20-50mm
Capacité:	100
Lo x La x H:	295x75x278mm
Poids:	1,90kg

Convient pour: plinthes, cadres, portes et fenêtres, parquet, faux plafonds

Brads 16GA

Clous FST

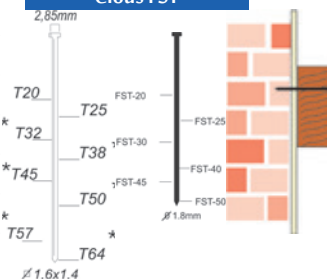

PRIX TARIF
€435,86
hors TVA

PRIX DE VENTE
€311,33
hors TVA

PRIX DE VENTE
€376,71
TVA incl.

SORTIMO



B16/50-D1
5000 brads + 1500 clous
(5000 x 50mm + 1500 x FST32mm)
Tuyau d'air comprimé 5m
avec raccords
Intérieur en mousse NBR

Référence: K101042SORTIMO

PRIX TARIF
€509,21
hors TVA

PRIX DE VENTE
€363,72
hors TVA

PRIX DE VENTE
€440,10
TVA incl.

B22/64T

B22/64T

-BOXX



Référence:	K1010601
Pression de travail:	5-8bar
Longueur clous:	20-64mm
Capacité:	80
Lo x La x H:	283x98x305mm
Poids:	2,70kg

Convient pour: moulures fines, parquet, faux plafonds, terrasses, plinthes

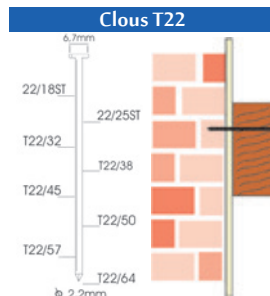

PRIX TARIF	PRIX DE VENTE	PRIX DE VENTE
€471,26	€336,61	€407,30
hors TVA	hors TVA	TVA incl.

INCLUS



B22/64T

2000 brads (1000 x T22 32mm + 1000 x T22 50mm)

Tuyau d'air comprimé 5m avec raccords

Intérieur en mousse NBR

Référence: K1010601SORTIMO

PRIX TARIF	PRIX DE VENTE	PRIX DE VENTE
€605,67	€432,62	€523,48
hors TVA	hors TVA	TVA incl.

BS50-A1

BS50-A1

-BOXX



Référence:	K106000
Pression de travail:	5-8bar
Longueur clous/agrafes:	12-50 + 12-40mm
Capacité:	100
Lo x La x H:	248x54x247mm
Poids:	1,40kg

Convient pour: moulures, fabrication des meubles, portes et fenêtres, pré collages

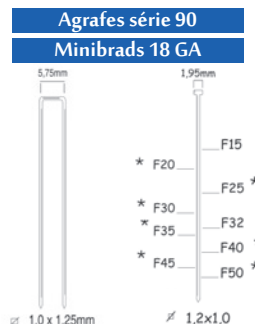

PRIX TARIF	PRIX DE VENTE	PRIX DE VENTE
€315,45	€225,32	€272,64
hors TVA	hors TVA	TVA incl.

INCLUS



BS50-A1

5000 minibrads + 5000 agrafes (5000 x 30mm en 5000 x 25mm)

Tuyau d'air comprimé 5m avec raccords

Intérieur en mousse NBR

Référence: K106000SORTIMO

PRIX TARIF	PRIX DE VENTE	PRIX DE VENTE
€390,37	€278,84	€337,39
hors TVA	hors TVA	TVA incl.

GENERMOIRE
RENSON
LARIUS
FERMI
DREHMANN
DRELUX
BDS
ZECO
TRX
KITPRO
PUJMA
AR
DEWALT

A34/64-A1



Référence:	K101071
Pression de travail:	5-8bar
Longueur clous:	25-64mm
Capacité:	100
Lo x La x H:	348x85x313mm
Poids:	1,90kg

Convient pour: moulures, fabrication des meubles, portes et fenêtres

PRIX TARIF €424,46 <small>hors TVA</small>	PRIX DE VENTE €303,18 <small>hors TVA</small>	PRIX DE VENTE €366,85 <small>TVA incl.</small>
--------------------------------------------------	-----------------------------------------------------	------------------------------------------------------

Clous DA

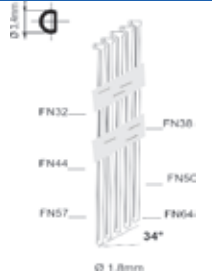

A34/64-A1

L-BOXX

SORTIMO



A34/64-A1
5000 clous
(5000 x 25mm)
Tuyau d'air comprimé 5m
avec raccords
Intérieur en mousse NBR

Référence: K101071SORTIMO

PRIX TARIF €518,41 <small>hors TVA</small>	PRIX DE VENTE €370,29 <small>hors TVA</small>	PRIX DE VENTE €448,05 <small>TVA incl.</small>
--------------------------------------------------	-----------------------------------------------------	------------------------------------------------------

PN34/50-A1



Référence:	K101097
Pression de travail:	5-8bar
Longueur clous:	38 en 50mm
Capacité:	20
Lo x La x H:	277x112x254mm
Poids:	1,88kg

Convient pour: profils métalliques

PRIX TARIF €434,92 <small>hors TVA</small>	PRIX DE VENTE €310,66 <small>hors TVA</small>	PRIX DE VENTE €375,90 <small>TVA incl.</small>
--------------------------------------------------	-----------------------------------------------------	------------------------------------------------------

Metalconnector 34°

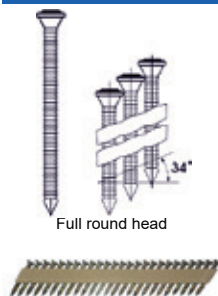

PN34/64-A1



Référence:	K101096
Pression de travail:	5-8bar
Longueur clous:	38 en 64mm
Capacité:	20
Lo x La x H:	277x112x254mm
Poids:	1,88kg

Convient pour: profils métalliques

PRIX TARIF €455,29 <small>hors TVA</small>	PRIX DE VENTE €325,21 <small>hors TVA</small>	PRIX DE VENTE €393,50 <small>TVA incl.</small>
--------------------------------------------------	-----------------------------------------------------	------------------------------------------------------

Metalconnector 34°

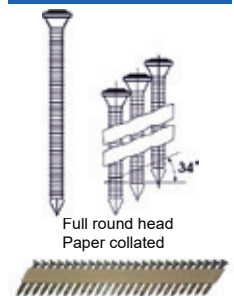

A34/65MC



Référence:	K101073
Pression de travail:	5-8bar
Longueur clous:	38-64mm
Capacité:	30
Lo x La x H:	448x136x335mm
Poids:	2,60kg
Convient pour:	profils métalliques

Metalconnector 34°

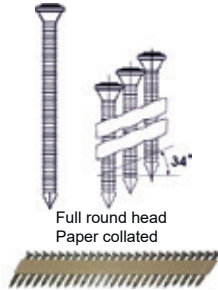

PRIX TARIF	PRIX DE VENTE	PRIX DE VENTE
€713,43	€509,59	€616,61
hors TVA	hors TVA	TVA incl.

A28/90-E1



Référence:	K101079
Pression de travail:	5-8bar
Longueur clous:	50-90mm
Capacité:	81
Lo x La x H:	445x125x339mm
Poids:	3,60kg
Convient pour:	menuiserie, coffrages, construction en bois

Clous 28°

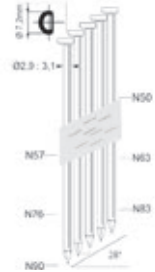

PRIX TARIF	PRIX DE VENTE	PRIX DE VENTE
€637,85	€455,61	€551,28
hors TVA	hors TVA	TVA incl.



A34/90-A2



Référence:	K101082
Pression de travail:	5-8bar
Longueur clous:	50-90mm
Capacité:	90
Lo x La x H:	507x154x373mm
Poids:	3,80kg
Convient pour:	menuiserie, coffrages, construction en bois

Clous 34°

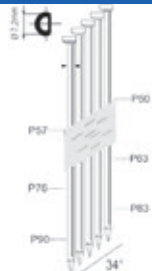

PRIX TARIF	PRIX DE VENTE	PRIX DE VENTE
€666,30	€475,93	€575,87
hors TVA	hors TVA	TVA incl.



A34/100-A2



Référence:	K101083
Pression de travail:	5-8bar
Longueur clous:	50-100mm
Capacité:	90
Lo x La x H:	507x154x373mm
Poids:	3,80kg
Convient pour:	menuiserie, coffrages, construction en bois

Clous 34°

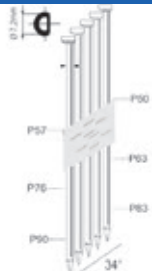

PRIX TARIF	PRIX DE VENTE	PRIX DE VENTE
€775,48	€553,92	€670,24
hors TVA	hors TVA	TVA incl.



A22/90-A1



Référence:	K101084
Pression de travail:	5-8bar
Longueur clous:	50-90mm
Capacité:	64
Lo x La x H:	540x125x335mm
Poids:	3,60kg

Clous 22°

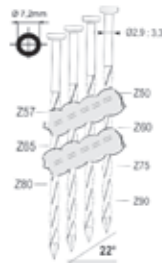

Convient pour: menuiserie, coffrages,
construction en bois

PRIX TARIF
€721,18
hors TVA

PRIX DE VENTE
€515,13
hors TVA

PRIX DE VENTE
€623,31
TVA incl.

A22/100-A2



Référence:	K101085
Pression de travail:	5-8bar
Longueur clous:	50-100mm
Capacité:	60
Lo x La x H:	529x139x369mm
Poids:	3,70kg

Clous 22°

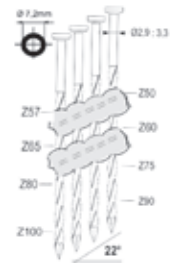

Convient pour: menuiserie, coffrages,
construction en bois

PRIX TARIF
€808,70
hors TVA

PRIX DE VENTE
€577,65
hors TVA

PRIX DE VENTE
€698,95
TVA incl.



A22/130-A1



Référence:	K101086
Pression de travail:	5-8bar
Longueur clous:	50-130mm
Capacité:	54
Lo x La x H:	523x175x478mm
Poids:	6,10kg

Clous 22°

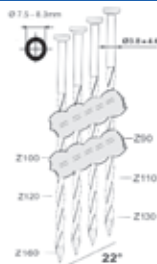

Convient pour: menuiserie, coffrages,
construction en bois

PRIX TARIF
€1070,30
hors TVA

PRIX DE VENTE
€764,50
hors TVA

PRIX DE VENTE
€925,04
TVA incl.

A22/160-A1



Référence:	K101087
Pression de travail:	5-8bar
Longueur clous:	50-160mm
Capacité:	56
Lo x La x H:	568x145x538mm
Poids:	6,90kg

Clous 22°

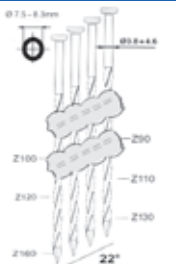

Convient pour: menuiserie, coffrages,
construction en bois

PRIX TARIF
€1239,16
hors TVA

PRIX DE VENTE
€885,11
hors TVA

PRIX DE VENTE
€1070,98
TVA incl.



C21/32F



Clous en bande
plastique mini 0°

Référence:	K1011023122
Pression de travail:	5-8bar
Longueur clous:	20-30mm
Capacité:	150-189
Lo x La x H:	256x98x211mm
Poids:	1,13kg
Convient pour: menuiserie	

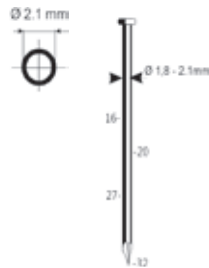

PRIX TARIF
€542,29
hors TVA

PRIX DE VENTE
€387,35
hors TVA

PRIX DE VENTE
€468,69
TVA incl.



C21/38-A1



Clous en rouleaux 15°
Bande plastique 15°

Référence:	K1011105
Pression de travail:	5-8bar
Longueur clous:	25-38mm
Capacité:	200-400
Lo x La x H:	256x98x212mm
Poids:	1,13kg
Convient pour: palettes, coffres, lattes, construction en bois	

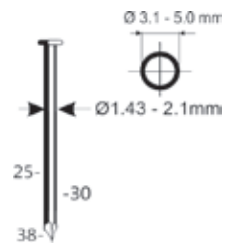

PRIX TARIF
€506,43
hors TVA

PRIX DE VENTE
€361,74
hors TVA

PRIX DE VENTE
€437,70
TVA incl.



C21/50-B1



Clous en rouleaux 15°
Bande plastique 15°

Référence:	K1011100
Pression de travail:	5-8bar
Longueur clous:	25-50mm
Capacité:	200-400
Lo x La x H:	258x108x284mm
Poids:	1,50kg
Convient pour: palettes, coffres, lattes, construction en bois	

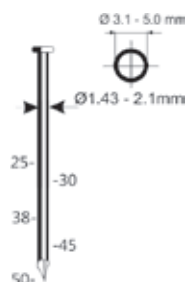

PRIX TARIF
€697,18
hors TVA

PRIX DE VENTE
€497,98
hors TVA

PRIX DE VENTE
€602,56
TVA incl.



C23/57-A1



Clous en rouleaux 15°

Référence:	K1011001
Pression de travail:	5-8bar
Longueur clous:	32-57mm
Capacité:	300-350
Lo x La x H:	302x132x285mm
Poids:	2,70kg
Convient pour: toitures, clôtures, sheathing, sous-planchers, emballages	



PRIX TARIF
€695,49
hors TVA

PRIX DE VENTE
€496,78
hors TVA

PRIX DE VENTE
€601,10
TVA incl.



C25/50-A1



Clous en rouleaux 15°
Bande plastique 15°

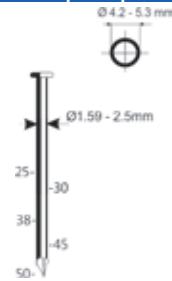

Référence:	K1011012
Pression de travail:	5-8bar
Longueur clous:	25-50mm
Capacité:	200-400
Lo x La x H:	305x128x290mm
Poids:	2,00kg
Convient pour: chevrons, toitures, caisses sous-planchers, gainage, emballages	

PRIX TARIF
€722,29
hors TVA

PRIX DE VENTE
€515,92
hors TVA

PRIX DE VENTE
€624,26
TVA incl.



C28/65-A1



Clous en rouleaux 15°
Bande plastique 15°

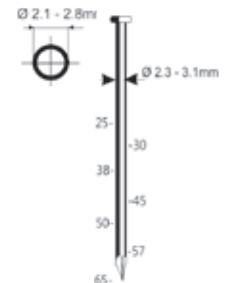

Référence:	K10110231
Pression de travail:	5-8bar
Longueur clous:	32-65mm
Capacité:	300
Lo x La x H:	268x128x306mm
Poids:	2,00kg
Convient pour: chevrons, toitures, clôtures, bardeaux, caisses, emballages	

PRIX TARIF
€749,67
hors TVA

PRIX DE VENTE
€535,48
hors TVA

PRIX DE VENTE
€647,93
TVA incl.



C28/65-F1



Clous en bande plastique 0°

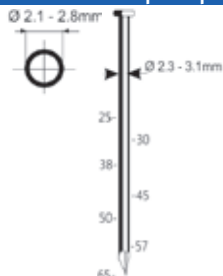

Référence:	K101102311
Pression de travail:	5-8bar
Longueur clous:	35-65mm
Capacité:	300
Lo x La x H:	300x146x320mm
Poids:	2,30kg
Convient pour: menuiserie	

PRIX TARIF
€785,03
hors TVA

PRIX DE VENTE
€560,73
hors TVA

PRIX DE VENTE
€678,49
TVA incl.



C29/65-C1



Clous en rouleaux 15°
Bande plastique 15°

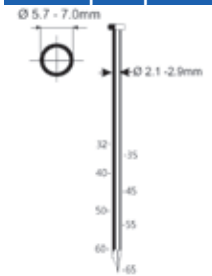

Référence:	K1011222
Pression de travail:	5-8bar
Longueur clous:	32-65mm
Capacité:	300
Lo x La x H:	277x112x254mm
Poids:	2,30kg
Convient pour: caisses, emballages	

PRIX TARIF
€749,67
hors TVA

PRIX DE VENTE
€535,48
hors TVA

PRIX DE VENTE
€647,93
TVA incl.



C29/70-A1



Référence:	K1011023
Pression de travail:	5-8bar
Longueur clous:	32-70mm
Capacité:	250-300
Lo x La x H:	339x129x317mm
Poids:	3,60kg

Clous en rouleaux 15°

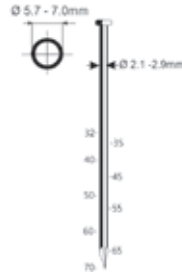

Convient pour: revêtement de façade, palettes, revêtements de sol, sous-planchers

PRIX TARIF
€781,52
hors TVA

PRIX DE VENTE
€558,23
hors TVA

PRIX DE VENTE
€675,46
TVA incl.



C31/45-A1 ROOFING



Référence:	K101104
Pression de travail:	5-8bar
Longueur clous:	19-45mm
Capacité:	120
Lo x La x H:	295x115x275mm
Poids:	2,20kg

Clous roofing 15°

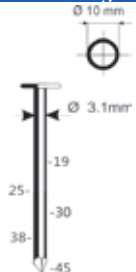

Convient pour: roofing, shingles

PRIX TARIF
€707,45
hors TVA

PRIX DE VENTE
€505,32
hors TVA

PRIX DE VENTE
€611,44
TVA incl.



C31/65-B1



Référence:	K1011022
Pression de travail:	5-8bar
Longueur clous:	32-65mm
Capacité:	200-300
Lo x La x H:	268x128x306mm
Poids:	2,00kg

Clous en rouleaux 15°

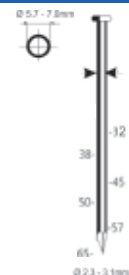

Convient pour: revêtement de façade, palettes, revêtements de sol, sous-planchers

PRIX TARIF
€793,30
hors TVA

PRIX DE VENTE
€566,64
hors TVA

PRIX DE VENTE
€685,64
TVA incl.



C33/83-A1



Référence:	K1011024
Pression de travail:	5-8bar
Longueur clous:	63-83mm
Capacité:	200-300
Lo x La x H:	339x132x365mm
Poids:	3,80kg

Clous en rouleaux 15°

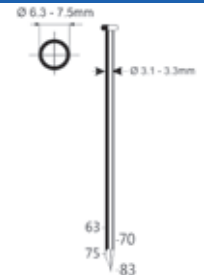

Convient pour: revêtement de façade, palettes, revêtements de sol, sous-planchers

PRIX TARIF
€811,28
hors TVA

PRIX DE VENTE
€579,49
hors TVA

PRIX DE VENTE
€701,18
TVA incl.



GENÈREMOORE
RENSON
LARTUS
FEMT
DREHMANN
DRELUX
BDS
ZECO
TIRX
KITPRO
PUJMA
AR
DEWALT

C33/90-A3



Référence: K1011024
Pression de travail: 5-8bar
Longueur clous: 63-90mm
Capacité: 200-300
Lo x La x H: 339x132x365mm
Poids: 3,80kg
Convient pour: revêtement de façade, palettes, revêtements de sol, sous-planchers

Clous en rouleaux 15°

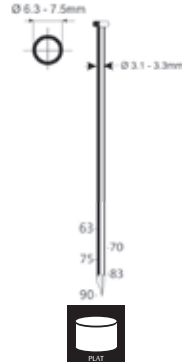

PRIX TARIF
€811,28
hors TVA

PRIX DE VENTE
€579,49
hors TVA

PRIX DE VENTE
€701,18
TVA incl.



C38/90-A1



Référence: K10110350
Pression de travail: 5-8bar
Longueur clous: 63-90mm
Capacité: 150-300
Lo x La x H: 310x132x352mm
Poids: 3,00kg
Convient pour: revêtement de façade, palettes, revêtements de sol, sous-planchers

Clous en rouleaux 15°

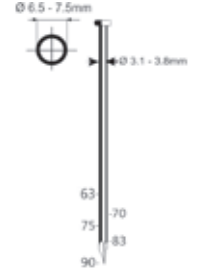

PRIX TARIF
€850,08
hors TVA

PRIX DE VENTE
€607,20
hors TVA

PRIX DE VENTE
€734,71
TVA incl.



C38/100-A1 (EPAL)



Référence standard: K101106
Référence EPAL: K101107
Pression de travail: 5-8bar
Longueur clous: 75-100mm
Capacité: 225-300
Lo x La x H: 338x153x418mm
Poids: 5,25kg
Convient pour: revêtement de façade, palettes, revêtements de sol, sous-planchers

Clous en rouleaux 15°

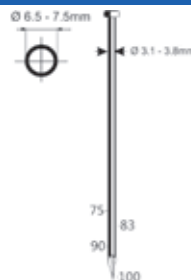

K101106
K101107

PRIX TARIF
€908,41
€981,20
hors TVA

PRIX DE VENTE
€648,86
€700,86
hors TVA

PRIX DE VENTE
€785,12
€848,03
TVA incl.



C38/130-A1



Référence: K101108
Pression de travail: 5-8bar
Longueur clous: 65-130mm
Capacité: 120-225
Lo x La x H: 338x153x478mm
Poids: 5,79kg
Convient pour: menuiserie, coffrages, construction en bois

Clous en rouleaux 15°

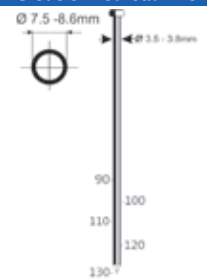

PRIX TARIF
€1282,53
hors TVA

PRIX DE VENTE
€916,09
hors TVA

PRIX DE VENTE
€1108,47
TVA incl.



S10/25J-A1



Référence:	K102021
Pression de travail:	5-8bar
Longueur agrafes:	4-25mm
Capacité:	100
Lo x La x H:	245x55x195mm
Poids:	1,20kg

Convient pour: isolation, carton, garnissage, revêtement de sol

PRIX TARIF
€182,56
hors TVA

PRIX DE VENTE
€130,40
hors TVA

PRIX DE VENTE
€157,78
TVA incl.

Agrafes série 10J

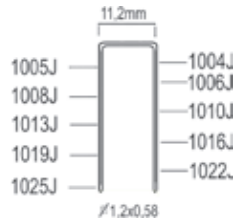

S10/25P-A2



VOIR ACTION PAGE 113

POLYMERE

Référence:	K104010
Pression de travail:	4,5-7bar
Longueur agrafes:	4-25mm
Capacité:	100
Lo x La x H:	244x49x194mm
Poids:	0,60kg

Convient pour: isolation, carton, garnissage, revêtement de sol

PRIX TARIF
€126,66
hors TVA

PRIX DE VENTE
€90,47
hors TVA

PRIX DE VENTE
€109,47
TVA incl.

Agrafes série 10J

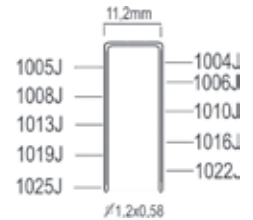

S10/16J-C1

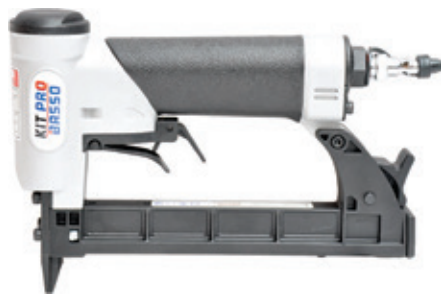

Référence:	K102001
Pression de travail:	4,5-7bar
Longueur agrafes:	4-13mm
Capacité:	134
Lo x La x H:	237x42x152mm
Poids:	0,90kg

Convient pour: meubles, isolation

PRIX TARIF
€189,91
hors TVA

PRIX DE VENTE
€135,65
hors TVA

PRIX DE VENTE
€164,14
TVA incl.

Agrafes série 10J

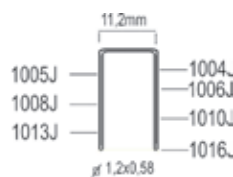

S90/25P-A2



POLYMERE

Référence:	K104000
Pression de travail:	4,5-7bar
Longueur agrafes:	12-25mm
Capacité:	100
Lo x La x H:	244x49x194mm
Poids:	0,6kg

Convient pour: sellerie, isolation, revêtements de sol

PRIX TARIF
€125,41
hors TVA

PRIX DE VENTE
€89,58
hors TVA

PRIX DE VENTE
€108,39
TVA incl.

Agrafes série 90

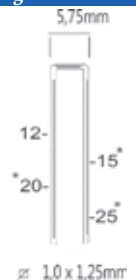

S90/40-A1 S90/40I -A1 S92/25-A1



Référence:	K102035	K102031
Pression de travail:	5-8bar	
Longueur agrafes:	12-40mm	
Capacité:	138	
Lo x La x H:	266x60x253mm	266x42x160mm
Poids:	1,30kg	0,80kg
Convient pour: sellerie, isolation, revêtements de sol		

PRIX TARIF
€464,55
hors TVA

PRIX DE VENTE
€331,82
hors TVA

PRIX DE VENTE
€401,50
TVA incl.

PRIX TARIF
€367,89
hors TVA

PRIX DE VENTE
€262,78
hors TVA

PRIX DE VENTE
€317,96
TVA incl.

Agrafes série 90

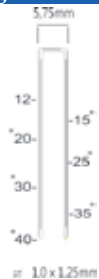

Agrafes série 92



Référence:	K102038
Pression de travail:	5-8bar
Longueur agrafes:	12-30mm
Capacité:	100
Lo x La x H:	266x60x225mm
Poids:	1,20kg

Convient pour: sellerie, isolation, revêtements de sol

PRIX TARIF
€231,85
hors TVA

PRIX DE VENTE
€165,61
hors TVA

PRIX DE VENTE
€200,39
TVA incl.

S92/40-A1 S80/16-B1 S80/16AUTO



AUSSI DISPONIBLE EN VERSION AUTOMATIQUE (S80/16AUTO-C1)

Référence:	K102036
Pression de travail:	5-8bar
Longueur agrafes:	12-40mm
Capacité:	160
Lo x La x H:	310x76x274mm
Poids:	1,70kg

Convient pour: sellerie, isolation, revêtements de sol

PRIX TARIF
€467,94
hors TVA

PRIX DE VENTE
€334,24
hors TVA

PRIX DE VENTE
€404,43
TVA incl.

Agrafes série 92



Agrafes série S80

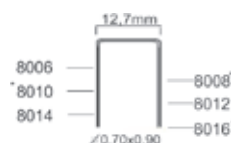

Référence standard:	K102061
Référence auto:	K1020622
Pression de travail:	4,5-7bar
Longueur agrafes:	6-16mm
Capacité:	102
Lo x La x H:	238x42x152mm
Poids:	0,90kg

Convient pour: pré collages, isolation, sellerie

K102061
K1020622

PRIX TARIF
€189,91
€375,14
hors TVA

PRIX DE VENTE
€135,65
€267,95
hors TVA

PRIX DE VENTE
€164,14
€324,22
TVA incl.

GENERATOR RENSON LARIUS FEML DREHMANN DREIX BUS ZECO TRX KITPRO DUMA AR DEWALT

S80/16LN-C2



LONG NEZ

Référence:	K102050
Pression de travail:	4,5-7bar
Longueur agrafes:	4-16mm
Capacité:	102
Lo x La x H:	238x42x152mm
Poids:	0,90kg

Convient pour: pré collages, isolation, sellerie

PRIX TARIF
€279,58
hors TVA

PRIX DE VENTE
€199,70
hors TVA

PRIX DE VENTE
€241,63
TVA incl.

Agrafes série 80

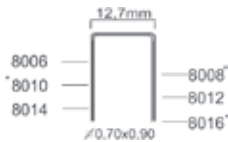

S80/16LM-A2



CHARGEUR LONG

Référence:	K1020623
Pression de travail:	4,5-7bar
Longueur agrafes:	6-16mm
Capacité:	245
Lo x La x H:	377x44x160mm
Poids:	1,35kg

Convient pour: pré collages, isolation, sellerie

PRIX TARIF
€388,87
hors TVA

PRIX DE VENTE
€277,76
hors TVA

PRIX DE VENTE
€336,09
TVA incl.

Agrafes série 80

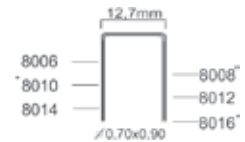

S53/16-C1



VOIR ACTION PAGE 113

Référence:	K102052
Pression de travail:	5-8bar
Longueur agrafes:	4-16mm
Capacité:	214
Lo x La x H:	237x42x152mm
Poids:	0,90kg

Convient pour: pré-collages, moulures fines, meubles

PRIX TARIF
€189,91
hors TVA

PRIX DE VENTE
€135,65
hors TVA

PRIX DE VENTE
€164,14
TVA incl.

Agrafes série S53

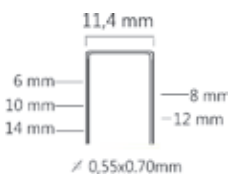

S11/16-A1



VOIR ACTION PAGE 113

Référence:	K102055
Pression de travail:	5-8bar
Longueur agrafes:	6-16mm
Capacité:	115
Lo x La x H:	228x44x153mm
Poids:	0,95kg

Convient pour: pré-collages, moulures fines, meubles

PRIX TARIF
€189,91
hors TVA

PRIX DE VENTE
€135,65
hors TVA

PRIX DE VENTE
€164,14
TVA incl.

Agrafes série T50

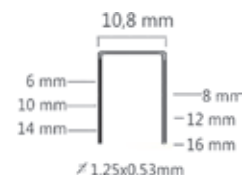

GENÈREMOIRE
RENSON
LARIUS
FEMT
DREHMANN
DRELUX
BDS
ZECO
TRX
KITPRO
PUJMA
AR
DEWALT

S10/40-A1



Référence:	K102033
Pression de travail:	5-8bar
Longueur agrafes:	12-38mm
Capacité:	138
Lo x La x H:	266x60x253mm
Poids:	1,30kg

Convient pour: pré-collages,
mouleurs fines, meubles

PRIX TARIF
€365,13
hors TVA

PRIX DE VENTE
€260,81
hors TVA

PRIX DE VENTE
€315,58
TVA incl.

Agrafes série S10



FS155/50-A1



Référence:	K102090
Pression de travail:	6-8bar
Longueur agrafes:	25-50mm
Capacité:	102
Lo x La x H:	453x80x545mm
Poids:	5,00kg

Convient pour: feutre, matériel isolation

PRIX TARIF
€861,93
hors TVA

PRIX DE VENTE
€615,67
hors TVA

PRIX DE VENTE
€744,96
TVA incl.

Agrafes série FS



S16/1051-A1



Référence:	K102039
Pression de travail:	5-8bar
Longueur agrafes:	25-50mm
Capacité:	130
Lo x La x H:	370x93x282mm
Poids:	2,61kg

Geschikt voor: pré-collages,
mouleurs fines, meubles

PRIX TARIF
€497,98
hors TVA

PRIX DE VENTE
€355,70
hors TVA

PRIX DE VENTE
€430,40
TVA incl.

Agrafes série S16

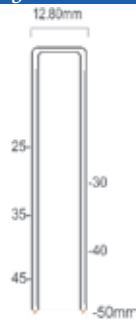

S15/865-A1



Référence:	K102043
Pression de travail:	5-8bar
Longueur agrafes:	25-63mm
Capacité:	130
Lo x La x H:	365x98x338mm
Poids:	2,60kg

Convient pour: gyproc, sols, coffres,
palettes

PRIX TARIF
€563,67
hors TVA

PRIX DE VENTE
€402,62
hors TVA

PRIX DE VENTE
€487,17
TVA incl.

Agrafes série S15 (Q)

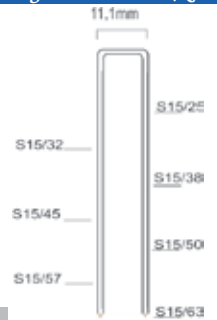

S29/130



Agrafes série S29

Référence:	K1020100
Pression de travail:	6-8bar
Longueur agrafes:	65-130mm
Capacité:	120
Lo x La x H:	400x132x396mm
Poids:	5,85kg

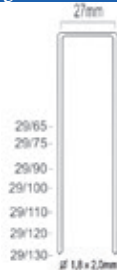

PRIX TARIF €1277,52 <small>hors TVA</small>	PRIX DE VENTE €912,51 <small>hors TVA</small>	PRIX DE VENTE €1104,14 <small>TVA incl.</small>
---------------------------------------------------	-----------------------------------------------------	-------------------------------------------------------

S29/150



Agrafes série S29

Référence:	K1020105
Pression de travail:	6-8bar
Longueur agrafes:	65-150mm
Capacité:	120
Lo x La x H:	400x138x470
Poids:	6,25kg



PRIX TARIF €1435,13 <small>hors TVA</small>	PRIX DE VENTE €1025,09 <small>hors TVA</small>	PRIX DE VENTE €1240,36 <small>TVA incl.</small>
---------------------------------------------------	------------------------------------------------------	-------------------------------------------------------

B5/4/6/67-A



Clous série T22

Agrafes série N

Agrafes série 700

Référence:	K106015
Pression de travail:	5-8bar
Long. agrafes/clous:	25-64mm
Capacité:	225-300
Lo x La x H:	338x153x418mm
Poids:	5,25kg

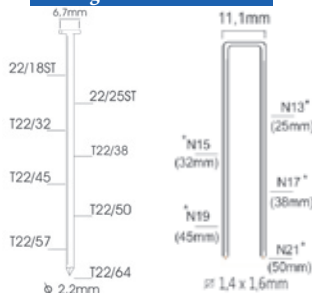

PRIX TARIF €570,52 <small>hors TVA</small>	PRIX DE VENTE €407,51 <small>hors TVA</small>	PRIX DE VENTE €493,09 <small>TVA incl.</small>
--------------------------------------------------	-----------------------------------------------------	------------------------------------------------------



B8/51-B



Agrafes série N

Référence:	K1020401
Pression de travail:	5-8bar
Longueur agrafes:	25-50mm
Capacité:	140
Lo x La x H:	360x78x272mm
Poids:	1,94kg

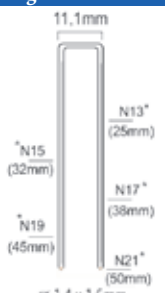

PRIX TARIF €435,86 <small>hors TVA</small>	PRIX DE VENTE €311,33 <small>hors TVA</small>	PRIX DE VENTE €376,71 <small>TVA incl.</small>
--------------------------------------------------	-----------------------------------------------------	------------------------------------------------------



GENÈREMOIRE
RENSON
LARIUS
FEMI
DREHMANN
DRELUX
BDS
ZECO
TRX
KITPRO
PUJMA
AR
DEWALT

S8/75NQ-A1



Agrafes série 815 (N)

Agrafes série S15 (Q)

Référence:	K102044
Pression de travail:	5-8bar
Longueur agrafes:	25-75mm
Capacité:	140
Lo x La x H:	370x98x349mm
Poids:	2,75kg

Convient pour: meubles, moulures fines, sols, sous-planchers

PRIX TARIF
€664,69
hors TVA

PRIX DE VENTE
€474,78
hors TVA

PRIX DE VENTE
€574,48
TVA incl.

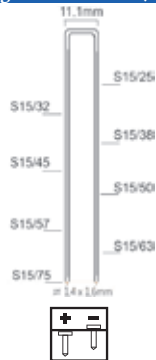

S8/75Z-A1



Agrafes série 700

Référence:	K102042
Pression de travail:	5-8bar
Longueur agrafes:	25-75mm
Capacité:	140
Lo x La x H:	370x98x349mm
Poids:	2,75kg

Convient pour: meubles, moulures fines, sols, sous-planchers

PRIX TARIF
€664,69
hors TVA

PRIX DE VENTE
€474,78
hors TVA

PRIX DE VENTE
€574,48
TVA incl.

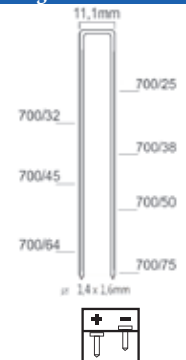

N16/951-A1



Agrafes série N5

Référence:	K102041
Pression de travail:	5-8bar
Longueur agrafes:	32-50mm
Capacité:	130
Lo x La x H:	369x93x286mm
Poids:	2,50kg

Convient pour: isolation, panneaux

PRIX TARIF
€499,31
hors TVA

PRIX DE VENTE
€356,65
hors TVA

PRIX DE VENTE
€431,54
TVA incl.



S25/38-B1



Agrafes larges

Référence:	K102045
Pression de travail:	5-8bar
Longueur agrafes:	15-38mm
Capacité:	140
Lo x La x H:	362x278x236mm
Poids:	2,60kg

Convient pour: emballages, panneaux, sellerie, caisses

PRIX TARIF
€580,58
hors TVA

PRIX DE VENTE
€414,70
hors TVA

PRIX DE VENTE
€501,79
TVA incl.

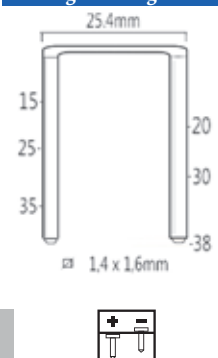

KL-717A



Agrafes série 53

Agrafes série 10J

Agrafes série 18GA

Puissance:	800W
Longueur agrafes:	6-16mm
Capacité:	160
Lo x La x H:	190x45x170mm
Poids:	0,80kg
Matériau:	Plastique

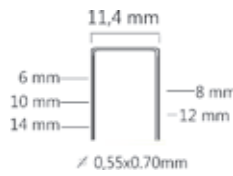

PRIX TARIF
€54,48
hors TVA

PRIX DE VENTE
€38,92
hors TVA

PRIX DE VENTE
€47,09
TVA incl.

KL-16R



Agrafes série 53

Agrafes série 18GA

Puissance:	/
Longueur agrafes:	6-16mm
Capacité:	160
Lo x La x H:	180x30x157mm
Poids:	0,36kg
Matériau:	Plastique

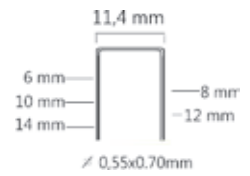

PRIX TARIF
€14,34
hors TVA

PRIX DE VENTE
€10,25
hors TVA

PRIX DE VENTE
€12,40
TVA incl.

KL-S5016



Agrafes série T50

Agrafes série 18GA

Puissance:	800W
Longueur agrafes:	6-14mm
Capacité:	160
Lo x La x H:	190x45x170mm
Poids:	0,80kg
Matériau:	Plastique

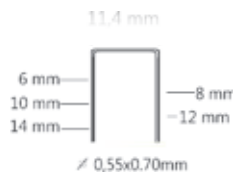

PRIX TARIF
€21,14
hors TVA

PRIX DE VENTE
€15,10
hors TVA

PRIX DE VENTE
€18,27
TVA incl.

KP-100

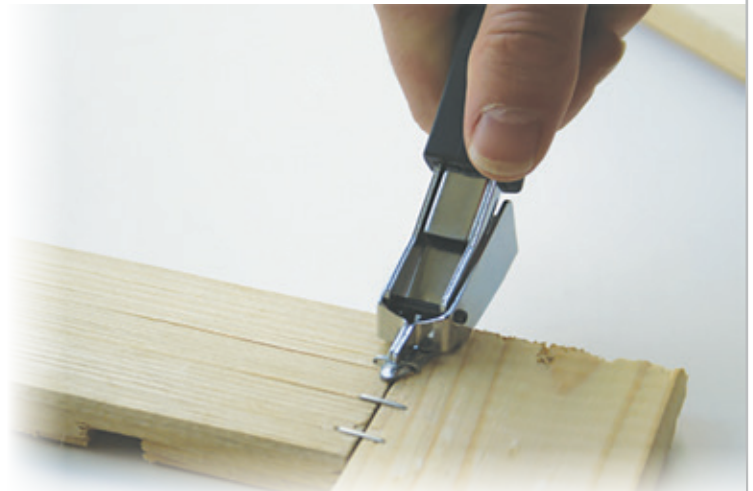

Extracteur d'agrafes

PRIX TARIF
€5,89
hors TVA

PRIX DE VENTE
€4,21
hors TVA

PRIX DE VENTE
€5,09
TVA incl.

GENÈREMOIRE
RENSON
LARIUS
FEMT
DREHMANN
DRELUX
BDS
ZECO
TRX
KITPRO
PUJMA
AR
DEWALT

KL-1011D



Puissance:	72W
Temps échauffement:	10min
Débit:	7g/min
Diamètre cartouche:	Ø 11,2mm
Lo x La x H:	185x35x150mm
Poids:	0,27kg
Matériau:	Plastique

PRIX TARIF €10,18 <small>hors TVA</small>	PRIX DE VENTE €7,27 <small>hors TVA</small>	PRIX DE VENTE €8,80 <small>TVA incl.</small>
-------------------------------------------------	---------------------------------------------------	----------------------------------------------------

KL-1037A



INCLUS

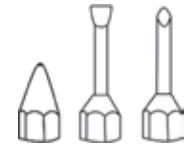

Set de 3 embouts

Puissance:	500W
Temps échauffement:	5min
Débit:	15g/min
Diamètre cartouche:	Ø 11,2mm
Lo x La x H:	210x40x175mm
Poids:	0,32kg
Matériau:	Plastique

PRIX TARIF €21,35 <small>hors TVA</small>	PRIX DE VENTE €15,25 <small>hors TVA</small>	PRIX DE VENTE €18,45 <small>TVA incl.</small>
-------------------------------------------------	----------------------------------------------------	-----------------------------------------------------

KL-1043

BÂTONS DE COLLE



INCLUS

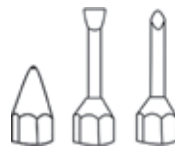

Set de 3 embouts

Puissance:	500W
Temps échauffement:	5min
Débit:	20g/min
Diamètre cartouche:	Ø 11,2mm
Lo x La x H:	230x32x200mm
Poids:	0,38kg
Matériau:	Plastique

PRIX TARIF €25,85 <small>hors TVA</small>	PRIX DE VENTE €18,47 <small>hors TVA</small>	PRIX DE VENTE €22,35 <small>TVA incl.</small>
-------------------------------------------------	----------------------------------------------------	-----------------------------------------------------



Référence: Description:

hors TVA	TVA incl.
----------	-----------

Cartouche de colle courte transparente

KL-GS11 Ø 11.2mm, longueur: 100mm, 10 pièces par paquet

€3,34	€4,05
-------	-------

Cartouche de colle longue transparente

KL-GS12 Ø 11.2mm, longueur: 200mm, 6 pièces par paquet

€3,02	€3,66
-------	-------

KIK107-A1



Couple:	108Nm
Vitesse:	12 000rpm
Longueur:	134mm
Poids:	0,51kg
Type de mandrin:	3/8"
Consommation:	59l/min

PRIX TARIF
€111,38
hors TVA

PRIX DE VENTE
€79,56
hors TVA

PRIX DE VENTE
€96,26
TVA incl.

KIP114-A1



Couple:	258Nm
Vitesse:	10 000rpm
Longueur:	158mm
Poids:	1,23kg
Type de mandrin:	3/8"
Consommation:	71l/min

PRIX TARIF
€126,59
hors TVA

PRIX DE VENTE
€90,42
hors TVA

PRIX DE VENTE
€109,41
TVA incl.

KIK227-A1



Couple:	542Nm
Vitesse:	7500rpm
Longueur:	185mm
Poids:	2,0kg
Type de mandrin:	1/2"
Consommation:	128l/min

PRIX TARIF
€123,10
hors TVA

PRIX DE VENTE
€87,93
hors TVA

PRIX DE VENTE
€106,39
TVA incl.

INCLUS



Jeu de douilles
9, 10, 11, 13, 14, 17,
22, 22, 24, 27mm

KIP240-A1



PINCLUTCH

Couple:	814Nm
Vitesse:	7000rpm
Longueur:	201mm
Poids:	2,28kg
Type de mandrin:	1/2"
Consommation:	128l/min

PRIX TARIF
€235,76
hors TVA

PRIX DE VENTE
€168,40
hors TVA

PRIX DE VENTE
€203,76
TVA incl.

INCLUS



Jeu de douilles
9, 10, 11, 13, 14, 17,
22, 22, 24, 27mm

KIT242-A1



Couple:	814Nm
Vitesse:	7500rpm
Longueur:	197mm
Poids:	2,07kg
Type de mandrin:	1/2"
Consommation:	128l/min

PRIX TARIF
€267,19
hors TVA

PRIX DE VENTE
€190,85
hors TVA

PRIX DE VENTE
€230,93
TVA incl.

INCLUS



Jeu de douilles
9, 10, 11, 13, 14, 17,
22, 22, 24, 27mm

KIT250-A1



Couple:	881Nm
Vitesse:	7500rpm
Longueur:	208mm
Poids:	2,67kg
Type de mandrin:	1/2"
Consommation:	133l/min

PRIX TARIF
€301,79
hors TVA

PRIX DE VENTE
€215,57
hors TVA

PRIX DE VENTE
€260,84
TVA incl.

GENERMOIRE
RENSON
LARTUS
FEMT
DREHMANN
DRELUX
BDS
ZECO
TRX
KITPRO
PUJMA
AR
DEWALT

KIT260-J2



COMPOSITE

Couple:	1058Nm
Vitesse:	7500rpm
Longueur:	191mm
Poids:	1,94kg
Type de mandrin:	1/2"
Consommation:	133l/min

PRIX TARIF
€301,79
hors TVA

PRIX DE VENTE
€215,57
hors TVA

PRIX DE VENTE
€260,84
TVA incl.

KIT3110-A1



Couple:	1763Nm
Vitesse:	5500rpm
Longueur:	227mm
Poids:	5,15kg
Type de mandrin:	3/4"
Consommation:	198l/min

PRIX TARIF
€666,30
hors TVA

PRIX DE VENTE
€475,93
hors TVA

PRIX DE VENTE
€575,87
TVA incl.

KIT4110-A1



Couple:	1763Nm
Vitesse:	5500rpm
Longueur:	227mm
Poids:	5,18kg
Type de mandrin:	1"
Consommation:	198l/min

PRIX TARIF
€688,44
hors TVA

PRIX DE VENTE
€491,74
hors TVA

PRIX DE VENTE
€595,01
TVA incl.

KIT3125-A1



COMPOSITE

Couple:	1763Nm
Vitesse:	5750rpm
Longueur:	219mm
Poids:	3,15kg
Type de mandrin:	3/4"
Consommation:	195L/min

PRIX TARIF
€688,44
hors TVA

PRIX DE VENTE
€491,74
hors TVA

PRIX DE VENTE
€595,01
TVA incl.

KIT4125-A1



COMPOSITE

Couple:	1763Nm
Vitesse:	5750rpm
Longueur:	219mm
Poids:	3,37kg
Type de mandrin:	1"
Consommation:	195L/min

PRIX TARIF
€688,44
hors TVA

PRIX DE VENTE
€491,74
hors TVA

PRIX DE VENTE
€595,01
TVA incl.

KRP207-C1



Couple:	95Nm
Vitesse:	160rpm
Longueur:	227mm
Poids:	1,27kg
Type de mandrin:	1/2"
Consommation:	90l/min

PRIX TARIF
€172,73
hors TVA

PRIX DE VENTE
€123,38
hors TVA

PRIX DE VENTE
€149,29
TVA incl.

INCLUS



Jeu de douilles
9, 10, 11, 13, 14, 17,
22, 22, 24, 27mm

GENERATORE
RENSON
LARTUS
FEMI
BREHMANN
DREIX
BUS
ZECO
TRX
KITPRO
PUMA
AR
DEWALT

KIT4120-A1-6



Couple:	2169Nm
Vitesse:	4500rpm
Longueur:	468mm
Poids:	6,3kg
Type de mandrin:	1"
Consommation:	224l/min

PRIX TARIF
€873,37
hors TVA

PRIX DE VENTE
€623,83
hors TVA

PRIX DE VENTE
€754,84
TVA incl.

KIT4165-A1-6



Couple:	2303Nm
Vitesse:	4500rpm
Longueur:	487mm
Poids:	9,9kg
Type de mandrin:	1"
Consommation:	266l/min

PRIX TARIF
€926,10
hors TVA

PRIX DE VENTE
€661,50
hors TVA

PRIX DE VENTE
€800,42
TVA incl.

KIT4250-A1



Couple:	3390Nm
Vitesse:	4300rpm
Longueur:	433mm
Poids:	12,66kg
Type de mandrin:	1"
Consommation:	269l/min

PRIX TARIF
€1107,81
hors TVA

PRIX DE VENTE
€791,30
hors TVA

PRIX DE VENTE
€957,47
TVA incl.

KIT5250-A1-6



Couple:	3390Nm
Vitesse:	4000rpm
Longueur:	433mm
Poids:	14,3kg
Type de mandrin:	1 1/2"
Consommation:	269l/min

PRIX TARIF
€1352,77
hors TVA

PRIX DE VENTE
€966,26
hors TVA

PRIX DE VENTE
€1169,18
TVA incl.

JEU DE DOUILLES

Référence:	Raccord:	Longueur:	Tailles (mm):	hors TVA	TVA incl.
PIS3001	3/8"	LONGUE	8, 10, 11, 13, 14, 15, 16, 17	€29,52	€35,72
PIS3005	3/8"	COURT	8, 10, 11, 13, 14, 15, 16, 17, 19	€19,82	€23,98
PIS4001	1/2"	LONGUE	11, 12, 13, 14, 16, 17, 19, 21, 22	€44,94	€54,38
PIS4005	1/2"	COURT	11, 12, 13, 14, 16, 17, 19, 21, 22	€33,72	€40,80
PIS6001	3/4"	LONGUE	26, 27, 29, 30, 32, 35, 36, 38	€131,28	€158,85
PIS8001	1"	COURT	24, 27, 30, 34, 35, 38	€186,11	€225,19

KHA67-A1



INCLUS



Vitesse:	2900rpm
Longueur:	217,6mm
Poids:	1,73kg
Longueur coupe:	67mm
Consommation:	76,4l/min
Raccord HEX:	10,18
Compresseur:	>3cv

Jeu de burins
2 x KHA20x180
2 x KHA40x180
KHAP180

PRIX TARIF
€219,61
hors TVA

PRIX DE VENTE
€156,86
hors TVA

PRIX DE VENTE
€189,81
TVA incl.

KHA90-A1



INCLUS



Vitesse:	2000rpm
Longueur:	266,4mm
Poids:	1,94kg
Longueur coupe:	89mm
Consommation:	77,6l/min
Raccord HEX:	10,18
Compresseur:	>3cv

Jeu de burins
2 x KHA20x220
2 x KHA40x220
KHAP220

PRIX TARIF
€249,25
hors TVA

PRIX DE VENTE
€178,04
hors TVA

PRIX DE VENTE
€215,42
TVA incl.

ACCESSOIRES



KHA20...



KHA40...



KHAP...



PAT2002



PAT2001/2



KNS-A1

Référence:	Description:	hors TVA	TVA incl.
KHA20x180	Burin plat HEX, 20 x 180 mm	€10,07	€12,19
KHA20x220	Burin plat HEX, 20 x 220 mm	€21,11	€25,54
KHA40x180	Burin plat HEX, 40 x 180 mm	€10,07	€12,19
KHA40x220	Burin plat HEX, 40 x 220 mm	€18,24	€22,07
KHAP180	Burin plat HEX, longueur: 180 mm	€7,57	€9,16
KHAP220	Burin pointu HEX, longueur: 220 mm	€21,11	€25,54
PAT2002	Système de maintien	€37,16	€44,96
PAT2001/2	2 x Ressort standard	€2,68	€3,25
KNS-A1	Antirouille	€53,16	€64,33

KAG5109F-A1



Puissance:	0,75cv
Vitesse:	10900rpm
Longueur:	246mm
Poids:	1,40kg
Diamètre de la meule:	Ø125mm
Consommation:	133l/min



Ø125mm

PRIX TARIF
€478,15
hors TVA

PRIX DE VENTE
€341,53
hors TVA

PRIX DE VENTE
€413,26
TVA incl.

KAG776M-A1



Puissance:	1,0cv
Vitesse:	7600rpm
Longueur:	300mm
Poids:	3,0kg
Diamètre de la meule:	Ø180mm
Consommation:	223l/min



Ø180mm

PRIX TARIF
€688,19
hors TVA

PRIX DE VENTE
€491,56
hors TVA

PRIX DE VENTE
€594,79
TVA incl.

KPS008E-A1



COUPLE DE SERRAGE RÉGLABLE

Couple:	5-12Nm
Vitesse:	550rpm
Longueur:	215mm
Poids:	1,28kg
Raccord:	6,4mm
Consommation:	140l/min

PRIX TARIF
€231,13
hors TVA

PRIX DE VENTE
€165,10
hors TVA

PRIX DE VENTE
€199,77
TVA incl.

KPS018E-A1



COUPLE DE SERRAGE RÉGLABLE

Couple:	5-12Nm
Vitesse:	1800rpm
Longueur:	215mm
Poids:	1,23kg
Raccord:	6,4mm
Consommation:	140l/min

PRIX TARIF
€231,13
hors TVA

PRIX DE VENTE
€165,10
hors TVA

PRIX DE VENTE
€199,77
TVA incl.

KDR118KL-A1



Vitesse:	1800rpm
Longueur:	203mm
Poids:	1,12kg
Raccord:	3/8"
Consommation:	140l/min

PRIX TARIF
€138,42
hors TVA

PRIX DE VENTE
€98,87
hors TVA

PRIX DE VENTE
€119,64
TVA incl.

KDR208KL-A1



Vitesse:	800rpm
Longueur:	235mm
Poids:	1,95kg
Raccord:	3/8"
Consommation:	140l/min

PRIX TARIF
€218,07
hors TVA

PRIX DE VENTE
€155,77
hors TVA

PRIX DE VENTE
€188,48
TVA incl.

KMS-A1



Puissance:	0,45cv
Vitesse:	2600rpm
Longueur:	240mm
Poids:	1,0kg
Épaisseur de coupe:	Acier : 1,2 mm Aluminium : 1,6 mm
Consommation:	85L/min

PRIX TARIF
€138,87
hors TVA

PRIX DE VENTE
€99,19
hors TVA

PRIX DE VENTE
€120,02
TVA incl.

KSC-A1



Puissance:	0,45cv
Vitesse:	2600rpm
Longueur:	290mm
Poids:	1,05kg
Épaisseur de coupe:	Acier : 1,2 mm Aluminium : 1,6 mm
Consommation:	85L/min

PRIX TARIF
€166,92
hors TVA

PRIX DE VENTE
€119,23
hors TVA

PRIX DE VENTE
€144,26
TVA incl.

KOS331C-A1



Puissance:	0,25cv
Vitesse:	10 000rpm
Dimensions patin de ponçage:	75x110mm
Type de vide:	Central-Vac
Consommation:	71l/min

PRIX TARIF	PRIX DE VENTE	PRIX DE VENTE
€288,58	€206,13	€249,42
hors TVA	hors TVA	TVA incl.

KOS332C-A1



Puissance:	0,25cv
Vitesse:	10 000rpm
Dimensions patin de ponçage:	81x133mm
Type de vide:	Central-Vac
Consommation:	71l/min

PRIX TARIF	PRIX DE VENTE	PRIX DE VENTE
€295,83	€211,31	€255,68
hors TVA	hors TVA	TVA incl.

KOS333C-A1



Puissance:	0,25cv
Vitesse:	10 000rpm
Dimensions patin de ponçage:	100x148mm
Type de vide:	Central-Vac
Consommation:	71l/min

PRIX TARIF	PRIX DE VENTE	PRIX DE VENTE
€299,45	€213,89	€258,81
hors TVA	hors TVA	TVA incl.

KOS256HC



Puissance:	0,45cv
Vitesse:	10 000rpm
Dimensions patin de ponçage:	Ø152mm
Type de vide:	Central-Vac
Consommation:	140l/min

PRIX TARIF	PRIX DE VENTE	PRIX DE VENTE
€265,65	€189,75	€229,60
hors TVA	hors TVA	TVA incl.

KOS256GRC



LOW-RPM

Puissance:	0,45cv
Vitesse:	900rpm
Dimensions patin de ponçage:	Ø152mm
Type de vide:	Central-Vac
Consommation:	93,5L/min

PRIX TARIF	PRIX DE VENTE	PRIX DE VENTE
€453,99	€324,28	€392,38
hors TVA	hors TVA	TVA incl.

KOS258HC



Puissance:	0,45cv
Vitesse:	10 000rpm
Dimensions patin de ponçage:	Ø203mm
Type de vide:	Central-Vac
Consommation:	93,5L/min

PRIX TARIF	PRIX DE VENTE	PRIX DE VENTE
€513,17	€366,55	€443,53
hors TVA	hors TVA	TVA incl.

KOS258GRC



LOW-RPM

Puissance:	0,45cv
Vitesse:	900rpm
Dimensions patin de ponçage:	Ø203mm
Type de vide:	Central-Vac
Consommation:	93,5L/min

PRIX TARIF
€480,46
hors TVA

PRIX DE VENTE
€343,19
hors TVA

PRIX DE VENTE
€415,25
TVA incl.

KBT10/330-A1



INCLUS



2 x BANDE ABRASIVE

Vitesse:	20 000rpm
Dimensions bande abrasive:	10x330mm
Poids:	0,82kg
Consommation:	92l/min

PRIX TARIF
€290,03
hors TVA

PRIX DE VENTE
€207,16
hors TVA

PRIX DE VENTE
€250,67
TVA incl.

KOS156S-A2



INCLUS



SAC POUSSIÈRE

Puissance:	0,25cv
Vitesse:	12 000rpm
Dimensions patin de ponçage:	Ø152mm
Type de vide:	Central-Vac
Consommation:	57l/min
Poids:	0,72kg

PRIX TARIF
€313,80
hors TVA

PRIX DE VENTE
€224,14
hors TVA

PRIX DE VENTE
€271,21
TVA incl.

KSAW10-A2



Vitesse:	9000rpm
Longueur de coupe:	10mm
Poids:	0,65kg
Consommation:	55L/min

PRIX TARIF
€246,33
hors TVA

PRIX DE VENTE
€175,95
hors TVA

PRIX DE VENTE
€212,90
TVA incl.

ACCESSOIRES



Référence:

Pour KBT10/330-A1

2042700000100/10

2042700000200/10

2042700000300/10

Pour KOS156S-A2

2280100139011

Pour KSAW10-A2

1233E20247011/10

1233E20247021/10

1233E20247031/10

Description:

Bande abrasive

Bande abrasive

Bande abrasive

Pad caoutchouc, Ø150mm 6 trous

Lame de scie

Lame de scie

Lame de scie

Type:

G60

G80

G100

18TPI

24TPI

32TPI

Numéro
pièces:

10

10

10

1

10

10

10

hors
TVA

€31,22

€31,22

€31,22

€35,44

€27,70

€27,70

€27,70

TVA
incl.

€37,77

€37,77

€37,77

€42,89

€33,52

€33,52

€33,52

KCT-A1



Puissance:	0,45cv
Vitesse:	21 000rpm
Longueur:	193mm
Poids:	0,8kg
Diamètre de la meule:	3" Ø76mm
Consommation:	85L/min

PRIX TARIF	PRIX DE VENTE	PRIX DE VENTE
€143,67	€102,62	€124,17
hors TVA	hors TVA	TVA incl.

KG210R-B1



Puissance:	0,45cv
Vitesse:	20 000rpm
Longueur:	178mm
Poids:	0,6kg
Collet:	Ø3-6mm
Consommation:	85L/min

PRIX TARIF	PRIX DE VENTE	PRIX DE VENTE
€159,31	€113,80	€137,69
hors TVA	hors TVA	TVA incl.

INCLUS



KIT DE MEULEUSES

KG215R-A1



Puissance:	0,45cv
Vitesse:	21 000rpm
Longueur:	280mm
Poids:	0,8kg
Collet:	Ø3-6mm
Consommation:	85L/min

PRIX TARIF	PRIX DE VENTE	PRIX DE VENTE
€249,71	€178,37	€215,82
hors TVA	hors TVA	TVA incl.

KG220R-A1



Puissance:	0,45cv
Vitesse:	18 000rpm
Longueur:	178mm
Poids:	0,8kg
Collet:	Ø3-6mm
Consommation:	85L/min

PRIX TARIF	PRIX DE VENTE	PRIX DE VENTE
€144,30	€103,07	€124,72
hors TVA	hors TVA	TVA incl.

KG222R-A1



90°

Puissance:	0,45cv
Vitesse:	15 000rpm
Longueur:	188mm
Poids:	0,8kg
Collet:	Ø3-6mm
Consommation:	85L/min

PRIX TARIF	PRIX DE VENTE	PRIX DE VENTE
€149,23	€106,60	€128,98
hors TVA	hors TVA	TVA incl.

KG230R-A1



115°

Puissance:	0,45cv
Vitesse:	18 000rpm
Longueur:	178mm
Poids:	0,75kg
Collet:	Ø3-6mm
Consommation:	85L/min

PRIX TARIF	PRIX DE VENTE	PRIX DE VENTE
€161,79	€115,56	€139,83
hors TVA	hors TVA	TVA incl.

GENEREMORE
RENSON
LARIUS
FEMI
DREHMANN
DRELUX
BDS
ZECO
TRX
KITPRO
PUJMA
AR
DEWALT

PAT6315K

Pince à rivets
en coffret 4,8mm
3/16", 72Nm,
85L/min,
6,5bar



PRIX TARIF €199,29
PRIX DE VENTE €142,35
PRIX DE VENTE €172,24

PAT6217

Pince à rivets
6,2mm 1/4"
150Nm
120L/min,
6,5bar



PRIX TARIF €367,17
PRIX DE VENTE €262,27
PRIX DE VENTE €317,34

PAT5055

Clé racagnac
1/4", 250rpm, 20Nm,
80L/min, 6,5bar



PRIX TARIF €110,11
PRIX DE VENTE €78,65
PRIX DE VENTE €95,17

PAT2012K/H

Burineur en coffret
+ jeu de 5 burins
3000blows/min
280L/min,
6,5bar



PRIX TARIF €108,83
PRIX DE VENTE €77,73
PRIX DE VENTE €94,06

PAT2011/H

Burineur, HEX
4500blows/min
280L/min,
6,5bar



PRIX TARIF €42,25
PRIX DE VENTE €34,46
PRIX DE VENTE €41,70

PAT2004/H

Jeu de 5 burins
Medium
HEX



PRIX TARIF €40,02
PRIX DE VENTE €28,58
PRIX DE VENTE €34,59

PAT2003/H

Jeu de 4 burins
pour AT-2011/H



PRIX TARIF €17,98
PRIX DE VENTE €12,84
PRIX DE VENTE €15,54

PAT2308

Jeu de 3 burins
pour AT-2051



PRIX TARIF €1347,54
PRIX DE VENTE €962,53
PRIX DE VENTE €1164,66

PAT4069K

Foreuse en coffret
23-69Nm, 170L/min,
10000rpm,
6,5bar



PRIX TARIF €359,18
PRIX DE VENTE €256,56
PRIX DE VENTE €310,44

PAT4035

Foreuse angulaire
10mm, 1900rpm
170L/min,
6,5bar



PRIX TARIF €198,32
PRIX DE VENTE €141,66
PRIX DE VENTE €171,40

PAT2500

Marteau à aiguilles
3000 blows/min
113L/min,
6,3bar



PRIX TARIF €277,62
PRIX DE VENTE €198,30
PRIX DE VENTE €239,95

PAT6025

Rogneuse
1,4mm,
3500rpm,
170L/min,
6,5bar



PRIX TARIF €131,79
PRIX DE VENTE €94,14
PRIX DE VENTE €113,90

PAT6040

Pistolet à silicone
6L/min,
6,5bar



PRIX TARIF €53,42
PRIX DE VENTE €38,16
PRIX DE VENTE €46,17

PAT6036BK

Jeu pompe à
graisse manuelle
+ pneumatique
pour cartouches
6,5bar



PRIX TARIF €82,01
PRIX DE VENTE €58,58
PRIX DE VENTE €70,88

PS0101

Jeu de 2 ventouses



PRIX TARIF €139,45
PRIX DE VENTE €99,61
PRIX DE VENTE €120,53

PS0102

Ventouse simple



PRIX TARIF €26,84
PRIX DE VENTE €19,17
PRIX DE VENTE €23,20



PISTOLET A PEINDRE



Référence:	Embout:	hors TVA	TVA incl.
Pist. à peindre, rés. 1000ml, 280L/min, 3,5-5bar			
PAS1040-1.6	1,6mm	€89,18	€107,91
PAS1040-1.8	1,8mm	€89,18	€107,91
PAS1040-2.0	2,0mm	€89,18	€107,91

PISTOLET A PEINDRE



**H.V.L.P.
BASSE PRESSION**

Référence:	Embout:	hors TVA	TVA incl.
Pist. à peindre, rés. 600ml, 120L/min, 1,3-4,8bar			
PAS1005-1.3	1,3mm	€148,14	€179,25
PAS1005-1.5	1,5mm	€148,13	€179,24
PAS1005-1.7	1,7mm	€148,14	€179,25
PAS1005-1.9	1,9mm	€148,13	€179,24
PAS1005-2.2	2,2mm	€148,13	€179,24

PMA1000G



Puissance:	1/8cv
Air aspiré:	15L/min
Pression max.:	2bar
Voltage	220V, 50Hz

PRIX TARIF €240,50 hors TVA	PRIX DE VENTE €171,78 hors TVA	PRIX DE VENTE €207,86 TVA incl.
-----------------------------------	--------------------------------------	---------------------------------------

PAS1080



Contenu:	10L
Air aspiré:	280-360L/min
Pression max.:	3,5bar

PRIX TARIF €467,04 hors TVA	PRIX DE VENTE €333,60 hors TVA	PRIX DE VENTE €403,66 TVA incl.
-----------------------------------	--------------------------------------	---------------------------------------

PDC-07



12V

Puissance:	1/2cv
Air aspiré:	45L/min
Pression max.:	8bar

PRIX TARIF €713,50 hors TVA	PRIX DE VENTE €509,65 hors TVA	PRIX DE VENTE €616,67 TVA incl.
-----------------------------------	--------------------------------------	---------------------------------------

PAB1004



Embout de l'aerographe:	0,3mm
Consomation:	10L/min
Pression:	1-5bar

PRIX TARIF €105,09 hors TVA	PRIX DE VENTE €75,06 hors TVA	PRIX DE VENTE €90,82 TVA incl.
-----------------------------------	-------------------------------------	--------------------------------------

GENERATOR RENSON LARIUS FEML DREHMANN DREIX BUS ZECO TRX KITPRO PUMA AR DEWALT

AR1509EM-HOT

1~230V/50HZ



Pompe TRIPLEX à pistons en céramique

Pression de travail max.:	150bar
Débit maximal:	500L/h
Puissance:	2500W
Vitesse:	2800rpm
Temp. max. eau:	90°C
Longueur tuyau:	8m
Poids:	53,0kg
Température de l'eau:	Non réglable

PRIX TARIF hors TVA	PRIX DE VENTE hors TVA	PRIX DE VENTE TVA incl.
€2150,05	€1535,75	€1858,26



Hot Water



For frequent usage



Professional accessories

INCLUS



Tuyau renforcé (3520550)



Pistolet 3/8"(M), M22x1,5mm (41047)



Lance sans buse (50690)

AR1509PRO-EM-HOT

1~230V/50HZ



Pompe TRIPLEX à pistons en céramique

Pression de travail max.:	150bar
Débit maximal:	500L/h
Puissance:	2500W
Vitesse:	2800rpm
Temp. max. eau:	90°C
Longueur tuyau:	10m
Poids:	86,0kg
Température de l'eau:	Réglable

PRIX TARIF hors TVA	PRIX DE VENTE hors TVA	PRIX DE VENTE TVA incl.
€2997,57	€2141,12	€2590,75



Hot Water



For frequent usage



Professional accessories

INCLUS



Tuyau renforcé (3160160)



Pistolet 3/8"(M), M22x1,5mm (41047)



Lance sans buse (40826)

AR1510N

1~230V/50HZ



Pompe TRIPLEX à pistons en céramique

Pression de travail max.:	150bar
Débit maximal:	600L/h
Puissance:	3000W
Vitesse:	1450rpm
Temp. max. eau:	100°C
Longueur tuyau:	10m
Poids:	82,0kg
Température de l'eau:	Réglable

PRIX TARIF hors TVA	PRIX DE VENTE hors TVA	PRIX DE VENTE TVA incl.
€3479,00	€2485,00	€3006,85



Hot Water



For frequent usage



Professional accessories

INCLUS



Tuyau renforcé (3160950)



Pistolet 3/8"(M), M22x1,5mm (46203)



Lance sans buse (46221)

AR1713

Pompe TRIPLEX à pistons en céramique

Pression de travail max.:	170bar
Débit maximal:	780L/h
Puissance:	5500W
Vitesse:	1400rpm
Temp. max. eau:	150°C
Longueur tuyau:	10m
Poids:	85,0kg
Température de l'eau:	Réglable

 PRIX TARIF
€3977,08
 hors TVA

 PRIX DE VENTE
€2840,77
 hors TVA

 PRIX DE VENTE
€3437,33
 TVA incl.

Hot Water

 For frequent
usage

 Professional
accessorie

INCLUS

Tuyau renforcé (3160160)



Pistolet 3/8"(M), M22x1,5mm (41089)



Lance sans buse (40826)

AR2015N

Pompe TRIPLEX à pistons en céramique

Pression de travail max.:	200bar
Débit maximal:	900L/h
Puissance:	7500W
Vitesse:	1400rpm
Temp. max. eau:	150°C
Longueur tuyau:	10m
Poids:	98,0kg
Température de l'eau:	Réglable

 PRIX TARIF
€4847,18
 hors TVA

 PRIX DE VENTE
€3462,27
 hors TVA

 PRIX DE VENTE
€4189,35
 TVA incl.

Hot Water

 For frequent
usage

 Professional
accessorie

INCLUS

Tuyau renforcé (3160160)



Pistolet 3/8"(M), M22x1,5mm (41089)



Lance sans buse (40826)

AR2021N

Pompe TRIPLEX à pistons en céramique

Pression de travail max.:	200bar
Débit maximal:	1280L/h
Puissance:	9300W
Vitesse:	1400rpm
Temp. max. eau:	150°C
Longueur tuyau:	10m
Poids:	135,0kg
Température de l'eau:	Réglable

 PRIX TARIF
€6240,03
 hors TVA

 PRIX DE VENTE
€4457,16
 hors TVA

 PRIX DE VENTE
€5393,17
 TVA incl.

Hot Water

 For frequent
usage

 Professional
accessorie

INCLUS

Tuyau renforcé (3160170)



Pistolet 3/8"(M), M22x1,5mm (41089)



Lance sans buse (50690)

GENERATOR RENSON LARIUS FEMT DREHMANN DREIX BUS ZECO TRX KITPRO PUMA AR DEWALT

ARPRO0672

1~230V/50HZ



Pompe triplex avec pistons en céramique et système de bielle avec tête de pompe en laiton

Pression de travail max.:	150bar
Débit maximal:	630L/h
Puissance:	2900W
Vitesse:	3000rpm
Longueur tuyau:	8m
Poids:	23,6kg

TSS[®]
Total Stop
SYSTEM

4CV

INCLUS



Tuyau renforcé (43515)



Pistolet 3/8"(M), M22x1,5mm (40925)



Lance HI/LOW (49956)



PRIX TARIF €623,48 hors TVA	PRIX DE VENTE €445,34 hors TVA	PRIX DE VENTE €538,86 TVA incl.
-----------------------------------	--------------------------------------	---------------------------------------

OPTIONS



PRIX TARIF €98,99 hors TVA
PRIX DE VENTE €70,71 hors TVA
PRIX DE VENTE €85,55 TVA incl.

Lance rotative
AR40169



PRIX TARIF €171,94 hors TVA
PRIX DE VENTE €122,82 hors TVA
PRIX DE VENTE €148,61 TVA incl.

Chariot
AR46469



ARPRO0672 + option chariot

AR1120

3~400V/50HZ



Pompe TRIPLEX à pistons en céramique

Pression de travail max.:	200bar
Débit maximal:	1260L/h
Puissance:	9300W
Vitesse:	1450rpm
Temp. max. eau:	60°C
Longueur tuyau:	10m
Poids:	135,0kg
Température de l'eau:	Réglable

NEW



TSS[®]
Total Stop
SYSTEM

INCLUS



Tuyau renforcé (50247)



Pistolet 3/8"(M), M22x1,5mm (41847)



Lance sans buse (46221)

PRIX TARIF €4163,60 hors TVA	PRIX DE VENTE €2974,00 hors TVA	PRIX DE VENTE €3598,54 TVA incl.
------------------------------------	---------------------------------------	----------------------------------------



AR-K-PRO1511RLW

230V/50HZ



Pompe TRIPLEX à pistons en céramique

Pression de travail max.:	150bar
Débit maximal:	630L/h
Puissance:	3000W
Vitesse:	1450rpm
Longueur tuyau:	15m
Poids:	53,0kg

PRIX TARIF hors TVA	PRIX DE VENTE hors TVA	PRIX DE VENTE TVA incl.
€1715,87	€1225,62	€1483,00



INCLUS



Pistolet 3/8"(M), M22x1,5mm (40925)



Lance HI/LOW (43509)



Nozzle set

- *BLACK NOZZLE: 3600400
- *RED NOZZLE: 3600350
- *GREEN NOZZLE: 3600370
- *YELLOW NOZZLE: 3600360
- *WHITE NOZZLE: 3600380

AR-K-PRO1515RLW

3~400V/50HZ



Pompe TRIPLEX à pistons en céramique

Pression de travail max.:	150bar
Débit maximal:	900L/h
Puissance:	5000W
Vitesse:	1450rpm
Longueur tuyau:	15m
Poids:	55,2kg

PRIX TARIF hors TVA	PRIX DE VENTE hors TVA	PRIX DE VENTE TVA incl.
€1901,71	€1358,36	€1643,62



INCLUS



Pistolet 3/8"(M), M22x1,5mm (41045)



Lance pour clicknozzles PRO (3600650)



Nozzle set

- *BLACK NOZZLE: 3600400
- *RED NOZZLE: 3600720
- *GREEN NOZZLE: 3600740
- *YELLOW NOZZLE: 3600760
- *WHITE NOZZLE: 3600750

AR-K-PRO2015RLW

3~400V/50HZ



Pompe TRIPLEX à pistons en céramique

Pression de travail max.:	200bar
Débit maximal:	900L/h
Puissance:	5000W
Vitesse:	1450rpm
Longueur tuyau:	15m
Poids:	55,2kg

PRIX TARIF hors TVA	PRIX DE VENTE hors TVA	PRIX DE VENTE TVA incl.
€2202,16	€1572,97	€1903,30



INCLUS



Pistolet 3/8"(M), M22x1,5mm (41045)



Lance pour clicknozzles PRO (3600650)









































Nozzle set

- *BLACK NOZZLE: 3600400
- *RED NOZZLE: 3600480
- *GREEN NOZZLE: 3600500
- *YELLOW NOZZLE: 3600490
- *WHITE NOZZLE: 3600510

GENERATOR RENSON LARIUS FEML DREHMANN DREIX BUS ZECO TRX KITPRO PUMA AR DEWALT

ACCESSOIRES

	Référence:	Description:	DXPW002M-E	DXPW003CE	DXPW003(CE)(KART)	DXPW003E	DXPW004	DXPW005	DXPW006	DXPW007	DXPW008	DXPW010	AR-PRO 672	AR-PRO151IRLW	AR-PRO151SRLW	AR-PRO2015RLW	AR-HOT1509EM	AR-HOT1509PRO EM	AR-HOT1310 EM	AR-HOT1713	AR-HOT2015N	AR-HOT2021N	hors TVA	TVA inclus	
	40169	Lance rotative											O										€66,39	€80,33	
	41983			O	O	O																		€41,20	€49,85
	41984						O																	€41,20	€49,85
	41985								O															€67,07	€81,15
	41986	Lance rotative						O		O		O											€67,07	€81,15	
	41987										O													€67,07	€81,15
	41050											O						O	O					€100,59	€121,71
	40803															O	O				O	O		€64,19	€77,67
	40964																			O				€64,19	€77,67
	40968														O									€64,19	€77,67
	40965																						O	€64,19	€77,67
	41988		Lance mousse	O	O	O	O	O	O	O	O	O	O	O	O	O	O	O	O	O	O	O	O	O	€67,32
	41989	Détergent vélo et moto 1L		O	O	O	O	O	O	O	O	O	O	O	O	O	O	O	O	O	O	O	O	€14,86	€17,98
	41990			O	O	O	O	O	O	O	O	O	O	O	O	O	O	O	O	O	O	O	O	€14,86	€17,98
	41991			O	O	O	O	O	O	O	O	O	O	O	O	O	O	O	O	O	O	O	O	€14,86	€17,98
	41992	Double lance	O	O	O	O	O	O	O	O	O	O	O	O	O	O	O	O	O	O	O	O	€54,28	€65,68	
	41993	Kit de sablage	O	O	O	O							O	O									€143,72	€173,90	
	41994						O	O			O													€143,72	€173,90
	41995										O	O												€143,72	€173,90
	43413	sable de sablage 5Kg	O	O	O	O	O	O	O	O	O												€15,33	€18,55	
	41770	sable de sablage 25Kg	O	O	O	O	O	O	O	O	O												€21,08	€25,51	
	41577	Brosse droite																					€12,92	€15,63	
	43415	Brosse rotative																					€20,12	€24,35	
	43416	Brosse rotative	O	O	O	O					O	O											€83,35	€100,85	
	43417							O	O	O		O												€83,35	€100,85
	43418	patio de Luxe Chem avec Raccord rapide																					€62,27	€75,35	
	43419	Patio avec raccord rapide	O	O	O	O					O	O											€198,32	€239,97	
	43420							O	O	O														€198,32	€239,97
	1272520	Deboucheur 8m	O	O	O	O	O	O	O	O	O	O	O	O	O	O	O	O	O	O	O	O	€95,80	€115,92	
	43421	Deboucheur 16m	O	O	O	O							O	O									€54,62	€66,09	
	43422	Deboucheur 20 m						O	O	O	O	O											€340,11	€411,53	
	43423	Click raccord rapide	O	O	O	O	O	O	O	O	O	O	O	O	O	O	O	O	O	O	O	O	€29,70	€35,94	
	43424			O	O	O	O	O	O	O	O	O	O	O	O	O	O	O	O	O	O	O	O	€60,36	€73,04
	43425	lance RE90	O	O	O	O	O	O	O	O	O	O	O	O	O	O	O	O	O	O	O	O	€19,16	€23,18	
	43426	lance RE120	O	O	O	O	O	O	O	O	O	O	O	O	O	O	O	O	O	O	O	O	€24,93	€30,17	
	43427	lance RE150									O	O	O		O	O	O	O	O	O	O	O	€31,61	€38,25	
	43428	lance RE170									O	O	O		O	O	O	O	O	O	O	O	€31,61	€38,25	
	43429	lance RE200										O	O		O	O	O	O	O	O	O	O	€36,41	€44,06	
	43430	Deboucheur avec soutien							O	O	O												€544,18	€658,46	
	43431	Tuyau HP 10 m Ø 1/4"	O	O	O	O	O					O	O										€65,15	€78,83	
	43432	Tuyau HP 15 m Ø 5/16"							O	O	O												€181,07	€219,09	
	41663	Filtre d'eau inline(3st)											S	S	S								€12,92	€15,63	
	43522	Filtre d'eau	O	O	O	O	O	O	O	O	O	O	O	O	O	O							€12,45	€15,06	
	43504	Pistolet avec gachette	S	S	S	S	S																€28,75	€34,79	
	43505								S	S	S	S												€38,32	€46,37
	40925												S	S										€21,08	€25,51
	41045														S	S								€24,93	€30,17
	41047																	S	S					€27,78	€33,61
	41089																			S	S	S	S	€54,13	€65,50
41847																						€38,32	€46,37		

	Référence:	Description:	DXPW002M-E	DXPW003CE	DXPW003(CE)(KART)	DXPW003E	DXPW004	DXPW005	DXPW006	DXPW007	DXPW008	DXPW010	AR-PRO 672	AR-PRO1511RLW	AR-PRO1515RLW	AR-PRO2015RLW	AR-HOT1509EM	AR-HOT1509PRO EM	AR-HOT1310EM	AR-HOT1713	AR-HOT2015N	AR-HOT2021N	Hors TVA	TVA inclus		
	43506	Lance réglables																						€23,95	€28,98	
	43507																								€23,95	€28,98
	43508																								€23,95	€28,98
	43956													S											€23,95	€28,98
	46062	Lance HI/LOW		S	S	S																		€23,95	€28,98	
	43509						S								S									€23,95	€28,98	
	43510							S																€23,95	€28,98	
	43511								S															€23,95	€28,98	
	43512									S														€43,11	€52,16	
	40826	Lance sans buse 1/4" MEG								S	S							S	S	S	S	S		€21,08	€25,51	
	46221																							€21,08	€25,51	
	50690																	S						€11,02	€13,33	
	41996		Jicleur bas pression						O	O	O	O	O	O	O	O	O	O	O	O	O	O	O	O	€15,33	€18,55
	3082(1504)	Jicleur haute pression 1/4" MEG																		S			€14,37	€17,39		
	3084(1506)																						S	€14,37	€17,39	
	3086(15045)																				S	S		€14,37	€17,39	
	3089																						O	€14,37	€17,39	
	3104(1503)																	S	S					€15,33	€18,55	
	41997											O												€15,33	€18,55	
	41998								O		O													€15,33	€18,55	
	41999												O											€15,33	€18,55	
43412								O														€15,33	€18,55			
	3600650	Lance pour buses click PRO												S	S	S							€22,02	€26,64		
	3600400	Click buses PRO												S	S	S							€11,49	€13,90		
	3600350													S									€11,49	€13,90		
	3600720														S								€11,49	€13,90		
	3600480															S							€11,49	€13,90		
	3600370													S									€11,49	€13,90		
	3600740														S								€11,49	€13,90		
	3600500															S							€11,49	€13,90		
	3600360													S									€11,49	€13,90		
	3600730														S								€11,49	€13,90		
	3600490															S							€11,49	€13,90		
	3600380	Tuyau HP 8m												S									€11,49	€13,90		
	3600750														S								€11,49	€13,90		
	3600510															S							€11,49	€13,90		
	3520550			S		S								S										€81,43	€98,53	
	43515				S																			€47,90	€57,96	
	50655		Tuyau HP 10m			S																		€167,66	€202,87	
	50689																							€83,84	€101,45	
3160160	Tuyau 15m						S	S											S	S	S	S		€98,68	€119,40	
43516								S	S															€57,48	€69,55	
40641															S	S								€133,17	€161,14	
40106																S							€172,93	€209,25		
43517								O	O	O	O											€100,59	€121,71			
	41739	Kit mural		O	O	O							O										€137,96	€166,93		
	41738	Devidoir sans tuyau		O	O	O							O										€88,61	€107,22		
	51290	Devidoir universel	O	O	O	O	O	O	O	O	O	O	O	O	O	O	O	O	O	O	O	O	€433,99	€525,13		
	50272		O	O	O	O	O	O	O	O	O	O	O	O	O	O	O	O	O	O	O	O	O	€433,99	€525,13	
	50273		O	O	O	O	O	O	O	O	O	O	O	O	O	O	O	O	O	O	O	O	O	€433,99	€525,13	
	41766	Devidoir avec tuyau 10m												O	O	O							€208,24	€251,97		
	41879	Devidoir avec tuyau 15m																					€85,48	€103,43		
	40377																						€202,15	€244,60		
	40340																						€202,15	€244,60		

ACTDPW007E

3~400V/50HZ



Pompe TRIPLEX à pistons en céramique

Pression de travail max.:	230bar
Débit maximal:	840L/h
Puissance:	7400W
Vitesse:	1450rpm
Temp. max. eau:	60°C
Longueur tuyau:	10m
Poids:	53,0kg

PRIX TARIF €1851,14 hors TVA	PRIX DE VENTE €1322,24 hors TVA	PRIX DE VENTE €1599,91 TVA incl.
------------------------------------	---------------------------------------	----------------------------------------



INCLUS



Tuyau renforcé 10m(DXPW43517)



Pistolet 3/8", M22x1,5mm(M/F) (DXPW43505)



Lance HI/LOW (DXPW43512)



Lance rotative (DXPW46303)

ACTDPW008E

HONDA MOTOR



Pompe TRIPLEX à pistons en céramique

Pression de travail max.:	190bar
Débit maximal:	600L/h
Puissance:	4000W (5,5cv)
Vitesse:	3400rpm
Maximale temp. wateraanvoer:	60°C
Longueur tuyau:	10m
Poids:	35,0kg

PRIX TARIF €1979,32 hors TVA	PRIX DE VENTE €1413,80 hors TVA	PRIX DE VENTE €1710,70 TVA incl.
------------------------------------	---------------------------------------	----------------------------------------

POWERED by
HONDA



INCLUS



Tuyau renforcé 10m (DXPW43517)



Pistolet 3/8", M22x1,5mm(M/F) (DXPW43505)



Lance HI/LOW (DXPW43513)



Lance rotative (DXPW41987)

ACTDPW010E

HONDA MOTOR



Pompe TRIPLEX à pistons en céramique

Pression de travail max.:	250bar
Débit maximal:	900L/h
Puissance:	8600W (11,7cv)
Vitesse:	17500rpm
Maximale temp. wateraanvoer:	60°C
Longueur tuyau:	10m
Poids:	58,5kg

PRIX TARIF €3656,41 hors TVA	PRIX DE VENTE €2611,72 hors TVA	PRIX DE VENTE €3160,18 TVA incl.
------------------------------------	---------------------------------------	----------------------------------------

POWERED by
HONDA



INCLUS



Tuyau renforcé 10m (DXPW43517)



Pistolet 3/8", M22x1,5mm(M/F) (DXPW43505)



Lance HI/LOW (DXPW43514)



Lance rotative (DXPW46303)

GENEREMORE
RENSON
LARTUS
FERMI
DREHMANN
DRELUX
BDS
ZECO
TRX
KITPRO
PUJMA
AR
DEWALT

ACTDXPW004E

230V/50HZ



Pompe TRIPLEX à pistons en céramique

Pression de travail max.:	150bar
Débit maximal:	600L/h
Puissance:	3000W
Vitesse:	1450rpm
Maximale temp. wateraanvoer:	60°C
Longueur tuyau:	10m
Poids:	42,0kg

PRIX TARIF €1491,42 hors TVA	PRIX DE VENTE €1065,30 hors TVA	PRIX DE VENTE €1289,01 TVA incl.
------------------------------------	---------------------------------------	----------------------------------------



INCLUS



ACTDXPW005E

3~400V/50HZ



Pompe TRIPLEX à pistons en céramique

Pression de travail max.:	200bar
Débit maximal:	810L/h
Puissance:	5000W
Vitesse:	1450rpm
Maximale temp. wateraanvoer:	60°C
Longueur tuyau:	10m
Poids:	46,0kg

PRIX TARIF €1637,54 hors TVA	PRIX DE VENTE €1169,67 hors TVA	PRIX DE VENTE €1415,30 TVA incl.
------------------------------------	---------------------------------------	----------------------------------------



INCLUS



ACTDXPW006E

3~400V/50HZ



Pompe TRIPLEX à pistons en céramique

Pression de travail max.:	170bar
Débit maximal:	900L/h
Puissance:	5000W
Vitesse:	1450rpm
Maximale temp. wateraanvoer:	60°C
Longueur tuyau:	10m
Poids:	46,0kg

PRIX TARIF €1729,73 hors TVA	PRIX DE VENTE €1235,52 hors TVA	PRIX DE VENTE €1494,80 TVA incl.
------------------------------------	---------------------------------------	----------------------------------------



INCLUS



ACT DXPW003CE

230V/50HZ



Pompe TRIPLEX à pistons en céramique

Pression de travail max.:	150bar
Débit maximal:	630L/h
Puissance:	2900W
Vitesse:	2800rpm
Temp. max. eau:	60°C
Longueur tuyau:	8m
Poids:	19,5kg



INCLUS



Tuyau renforcé 8m (DXPW43515)



Pistolet 3/8", M22x1,5mm(M/F) (DXPW43504)



Lance HI/LOW (DXPW46064)



Lance rotative (DXPW41981)

PRIX TARIF
€777,77
hors TVA

PRIX DE VENTE
€555,55
hors TVA

PRIX DE VENTE
€672,21
TVA incl.

ACT DXPW003CE KART

230V/50HZ



Pompe TRIPLEX à pistons en céramique

Pression de travail max.:	150bar
Débit maximal:	630L/h
Puissance:	2900W
Vitesse:	2800rpm
Temp. max. eau:	60°C
Longueur tuyau:	8m
Poids:	29,0kg



INCLUS



Tuyau renforcé 10m (DXPW43516)



Pistolet 3/8", M22x1,5mm(M/F) (DXPW43504)



Lance HI/LOW (DXPW46064)



Lance rotative (DXPW41981)

PRIX TARIF
€986,52
hors TVA

PRIX DE VENTE
€704,66
hors TVA

PRIX DE VENTE
€852,64
TVA incl.

ACT DXPW003FE

230V/50HZ



Pompe TRIPLEX à pistons en céramique

Pression de travail max.:	160bar
Débit maximal:	630L/h
Puissance:	2900W
Vitesse:	2800rpm
Temp. max. eau:	60°C
Longueur tuyau:	8m
Poids:	27,4kg



INCLUS



Tuyau renforcé 8m (DXPW43515)



Pistolet 3/8", M22x1,5mm(M/F) (DXPW43504)



Lance HI/LOW (DXPW43509)



Lance rotative (DXPW41981)

PRIX TARIF
€885,89
hors TVA

PRIX DE VENTE
€632,78
hors TVA

PRIX DE VENTE
€765,66
TVA incl.

GENERMOIRE
RENSON
LARTUS
FERMI
DREHMANN
DRELUX
BDS
ZECO
TRX
KITPRO
PUJMA
AR
DEWALT

ACTDPXW002M-F

230V/50Hz





				
220/240	480	150	50	2500

Pression de travail max.:	150bar
Débit maximal :	480l/u
Puissance:	2500W
Lo x La x H:	360x350x805mm
Temp. max. alimentation de l'eau	50°
Longueur tuyau:	10m
Poids:	23kg

PRIX TARIF €623,48 <small>hors TVA</small>	PRIX DE VENTE €445,34 <small>hors TVA</small>	PRIX DE VENTE €538,86 <small>TVA incl.</small>
--------------------------------------------------	-----------------------------------------------------	------------------------------------------------------

INCLUS

	
Lance réglable (DXPW46529)	Kit mousse (DXPW46666)
	
Pistolet (DXPW46664)	

Renseignez-vous sur nos promotions actuelles

 Turbo-lance à rotation (DXPW46672)

WOBBLE PLATE
BRASS HEAD

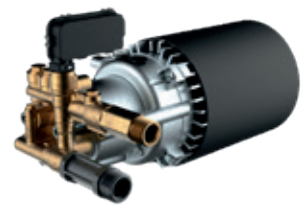

			
-------------------------------------------------------------------------------------	-------------------------------------------------------------------------------------	-------------------------------------------------------------------------------------	-------------------------------------------------------------------------------------



GENERATOR
RENSON
LARIUS
FEMI
DREHMANN
DREIX
BUS
ZECO
TRX
KTRPRO
PUMA
AR
DEWALT

GENERATORE
RENSON
LARIUS
FEMI
DREHMANN
DRELUX
BDS
ZECO

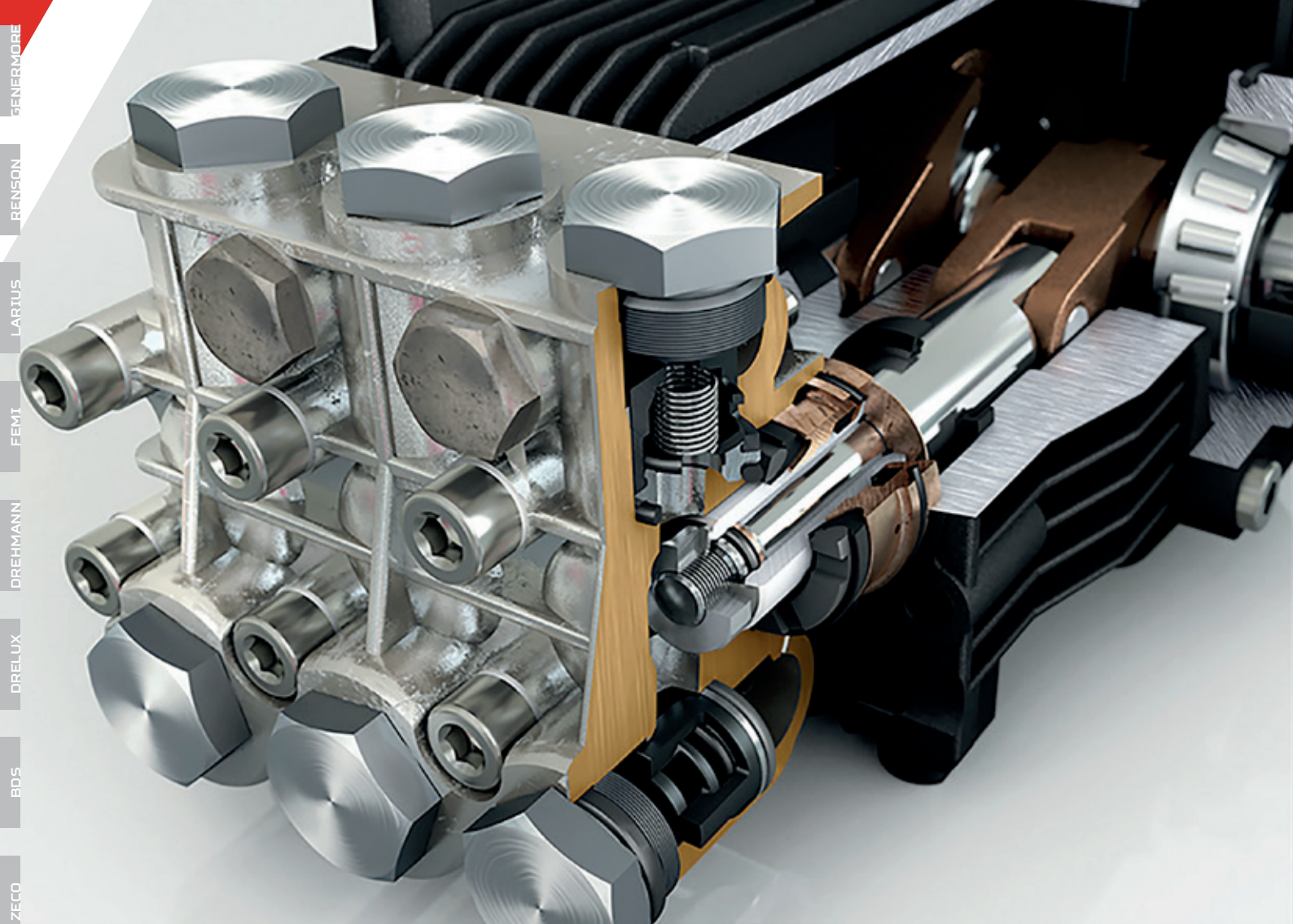

TRX
KITPRO
PUMA
AR
DEWALT



DEALER

TRX
PROFESSIONAL GEAR

WWW.TOUREX.BE



02 378 36 70
SALES@TOUREX.BE
SPOORWEGSTRAAT 7
1601 RUISBROEK



Sous réserve de modifications techniques, de prix et d'images. Les prix, en euros et sans recupel ni bebat, sont valables jusqu'au 30/09/2023. Les images ne sont pas contractuelles. Les spécifications des articles peuvent être modifiées sans préavis. Jusqu'à épuisement des stocks. Sous réserve d'erreurs d'impression. DeWalt® est la marque commerciale de Stanley Black & Decker inc, utilisée sous licence. Tous droits réservés.

FR