



# SERVICE MANUAL

HF/VHF  
ALL MODE TRANSCEIVER

## IC-7400

---

---

---

---

---

S-14610XZ-C1  
Jul. 2009

Icom Inc.

---

## INTRODUCTION

This service manual describes the latest technical information for the **IC-7400 HF/VHF ALL MODE TRANSCEIVER** at the time of publication.

MODEL	VERSION	CARRIER POWER
IC-7400	EUR	100W
	FRA	
	DEN	
	ITR	
	ESP	
	KOR	

## CAUTION

**NEVER** connect the transceiver to an AC outlet or to a DC power supply that uses more than specified. This will ruin the transceiver.

**DO NOT** expose the transceiver to rain, snow or any liquids.

**DO NOT** reverse the polarities of the power supply when connecting the transceiver.

**DO NOT** apply an RF signal of more than 20 dBm (100 mW) to the antenna connector. This could damage the transceiver's front-end.

To upgrade quality, any electrical or mechanical parts and internal circuits are subject to change without notice or obligation.



## ORDERING PARTS

Be sure to include the following four points when ordering replacement parts:

1. 10-digit Icom parts numbers
2. Component name
3. Equipment model name and unit name
4. Quantity required

### <ORDER EXAMPLE>

1110003491	S.I.C	TA31136FNG	IC-7400	MAIN UNIT	5 pieces
8820001210	Screw	2438 screw	IC-7400	Top cover	10 pieces

Addresses are provided on the inside back cover for your convenience.

## REPAIR NOTES

1. Make sure that the problem is internal before disassembling the transceiver.
2. **DO NOT** open the transceiver until the transceiver is disconnected from its power source.
3. **DO NOT** force any of the variable components. Turn them slowly and smoothly.
4. **DO NOT** short any circuits or electronic parts. An insulated tuning tool **MUST** be used for all adjustments.
5. **DO NOT** keep power ON for a long time when the transceiver is defective.
6. **DO NOT** transmit power into a Standard Signal Generator or a Sweep Generator.
7. **ALWAYS** connect a 50 dB to 60 dB attenuator between the transceiver and a Deviation Meter or Spectrum Analyzer when using such test equipment.
8. **READ** the instructions of test equipment thoroughly before connecting a test equipment to the transceiver.

---

## TABLE OF CONTENTS

---

**SECTION 1 SPECIFICATIONS**

**SECTION 2 INSIDE VIEWS**

**SECTION 3 DISASSEMBLY INSTRUCTION**

**SECTION 4 CIRCUIT DESCRIPITON**

4-1	RECEIVER CIRCUITS.....	4-1
4-2	TRANSMITTER CIRCUITS.....	4-2
4-3	PLL CIRCUITS.....	4-3
4-4	ANTENNATUNER CIRCUITS.....	4-4
4-5	POWER SUPPLYCIRCUITS.....	4-5

**SECTION 5 ADJUSTMENT PROCEDURES**

5-1	PREPARATION BEFORE SERVICING.....	5-1
5-2	PLL ADJUSTMENTS.....	5-2
5-3	TRANSMIT ADJUSTMENT.....	5-3
5-4	RECEIVE ADJUSTMENT.....	5-4
5-5	ADJUSTMENTMODE.....	5-5

**SECTION 6 PARTS LIST**

**SECTION 7 MECHANICAL PARTS**

**SECTION 8 SEMI-CONDUCTOR INFORMATION**

**SECTION 9 BOARD LAYOUTS**

**SECTION 10 BLOCK DIAGRAM**

**SECTION 11 WIRING DIAGRAM**

**SECTION 12 VOLTAGE DIAGRAM**

FRONT UNIT.....	12-1
S-LOGIC UNIT.....	12-3
MAIN UNIT.....	12-4
RF UNIT.....	12-7
CTRL UNIT.....	12-9
TUNER UNIT.....	12-10
PA UNIT.....	12-11
DSP UNIT.....	12-13

## • General

• Frequency coverage	:	(Unit: MHz)
Receive	:	0.030– 60.000000 <sup>*1*2</sup> 144.000– 146.000000
Transmit	:	1.800– 1.999999 <sup>*2</sup> 3.500– 3.999999 <sup>*2</sup> 7.000– 7.300000 <sup>*2</sup> 10.100– 10.150000 <sup>*2</sup> 14.000– 14.350000 <sup>*2</sup> 18.068– 18.168000 <sup>*2</sup> 21.000– 21.450000 <sup>*2</sup> 24.890– 24.990000 <sup>*2</sup> 28.000– 29.700000 <sup>*2</sup> 50.000– 54.000000 <sup>*2</sup> 144.000– 146.000000

\*1Some frequency ranges are not guaranteed.

\*2Depending on version.

- Mode : USB, LSB, CW, RTTY, AM, FM
- No. of memory ch. : 102 (99 regular, 2 scan edges and 1 call)
- Antenna connector : SO-239×3 (2 for HF/50 MHz and 1 for 144 MHz; 50 Ω)
- Operating temp. range : –10°C to +60°C ; +14°F to +140°F
- Frequency stability : Less than ±7 ppm from 1 min. to 60 min. after power ON. After that, rate of stability is less than ±1 ppm/hr. at 25°C (+77°F). Temperature fluctuations 0°C to +50°C (+20°F to +122°F) less than ±5 ppm.
- Frequency resolution : 1 Hz
- Power supply : 13.8 V DC ±15% (negative ground)
- Power consumption :
 

Transmit	Max. power	23.0 A
Receive	Standby	2.2 A
	Max. audio	3.0 A
- Dimensions : 287(W)×120(H)×316.5(D) mm (projections not incl.)  
13<sup>5</sup>/<sub>16</sub>(W)×4<sup>23</sup>/<sub>32</sub>(H)×12<sup>15</sup>/<sub>32</sub>(D) in
- Weight (approx.) : 9.0 kg; 19 lb 13 oz
- ACC 1 connector : 8-pin DIN connector
- ACC 2 connector : 7-pin DIN connector
- DATA connector : Mini DIN 6-pin
- CI-V connector : 2-conductor 3.5 (d) mm (1/8")

## • Transmitter

- Output power (continuously adjustable):
 

SSB/CW/RTTY/FM	Less than 5 to 100 W
AM	Less than 5 to 40 W
- Modulation system :
 

SSB	PSN modulation
AM	Low power modulation
FM	Phase modulation
- Spurious emission : 50 dB (HF bands)  
60 dB (50/144 MHz)
- Carrier suppression : 40 dB
- Unwanted sideband suppression : 55 dB
- ΔTX variable range : ±9.99 kHz
- Mic. connector : 8-pin connector (600 Ω)
- ELEC-KEY connector : 3-conductor 6.35(d) mm (1/4")
- KEY connector : 3-conductor 6.35(d) mm (1/4")
- SEND connector : Phono (RCA)
- ALC connector : Phono (RCA)

## • Receiver

- Receive system : Triple conversion superheterodyne system
- Intermediate frequencies:
 

1st	64.455 MHz
2nd	455 kHz
3rd	36 kHz
- Sensitivity (typical) :
 

SSB, CW, RTTY (10 dB S/N)	0.16 μV <sup>*1</sup> (1.80–29.99 MHz) 0.13 μV <sup>*2</sup> (50 MHz) 0.11 μV <sup>*3</sup> (144 MHz)
AM (10 dB S/N)	13 μV (0.5–1.799 MHz) 2 μV <sup>*1</sup> (1.80–29.99 MHz) 1 μV (50 <sup>*2</sup> /144 <sup>*3</sup> MHz)
FM (12 dB SINAD)	0.5 μV <sup>*1</sup> (28.0–29.99 MHz) 0.25 μV <sup>*2</sup> (50 MHz) 0.18 μV <sup>*3</sup> (144 MHz)
- \*1Pre-amp 1 is ON, \*2Pre-amp 2 is ON, \*3Pre-amp is ON
- Squelch sensitivity (Pre-amp: OFF):
 

SSB, CW, RTTY	Less than 5.6 μV
FM	Less than 1.0 μV
- Selectivity :
 

SSB (BW: 2.4 kHz)	More than 2.4 kHz/–6 dB Less than 3.6 kHz/–60 dB
CW (BW: 500 Hz)	More than 500 Hz/–6 dB Less than 700 Hz/–60 dB
RTTY (BW: 350 Hz)	More than 360 Hz/–6 dB Less than 650 Hz/–60 dB
AM (BW: 6 kHz)	More than 6.0 kHz/–6 dB Less than 15.0 kHz/–60 dB
FM (BW: 15 kHz)	More than 12.0 kHz/–6 dB Less than 20.0 kHz/–60 dB
- Spurious and image rejection ratio:
 

HF/50 MHz	More than 70 dB (except IF through on 50 MHz band)
144 MHz	More than 60 dB
- AF output power : More than 2.0 W at 10% distortion with an 8 Ω load
- RIT variable range : ±9.99 kHz
- PHONES connector : 3-conductor 6.35 (d) mm (1/4")
- Ext. SP connector : 2-conductor 3.5 (d) mm (1/8")/8 Ω

## • Antenna tuner

- Matching impedance range:
 

HF bands	16.7 to 150 Ω unbalanced (Less than VSWR 3:1)
50 MHz band	20 to 125 Ω unbalanced (Less than VSWR 2.5:1)
- Minimum operating input power : 8 W (HF bands)  
15 W (50 MHz band)
- Tuning accuracy : VSWR 1.5:1 or less
- Insertion loss : Less than 1.0 dB (after tuning)

All stated specifications are typical and subject to change without notice or obligation.

# SECTION 2

# INSIDE VIEWS

## • MAIN AND RF UNITS

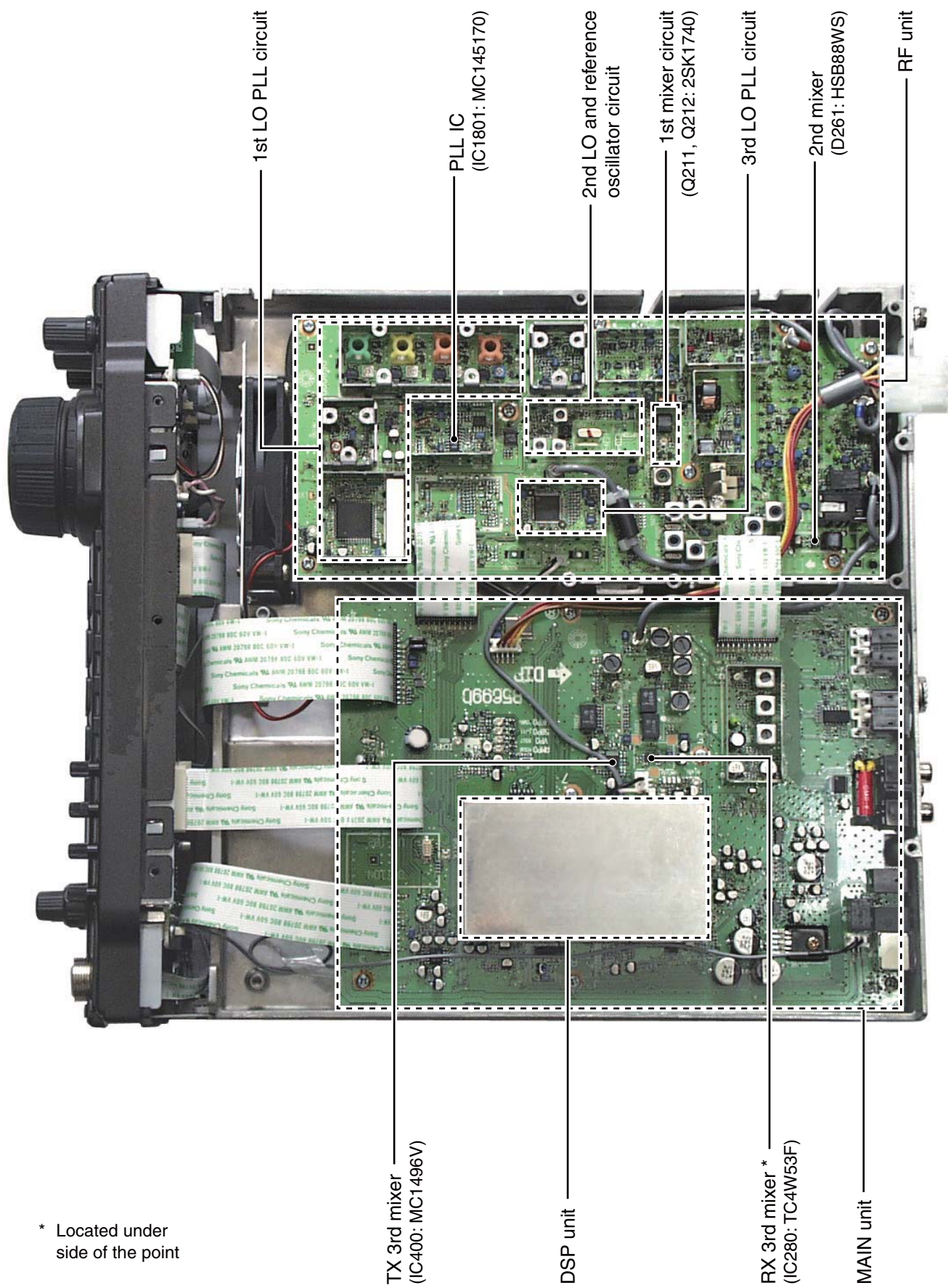

\* Located under side of the point

TX 3rd mixer  
(IC400: MC1496V)

DSP unit

RX 3rd mixer\*  
(IC280: TC4W53F)

MAIN unit

1st LO PLL circuit

PLL IC  
(IC1801: MC145170)

2nd LO and reference  
oscillator circuit

1st mixer circuit  
(Q211, Q212: 2SK1740)

3rd LO PLL circuit

2nd mixer  
(D261: HSB88WS)

RF unit

• PA AND CTRL UNITS

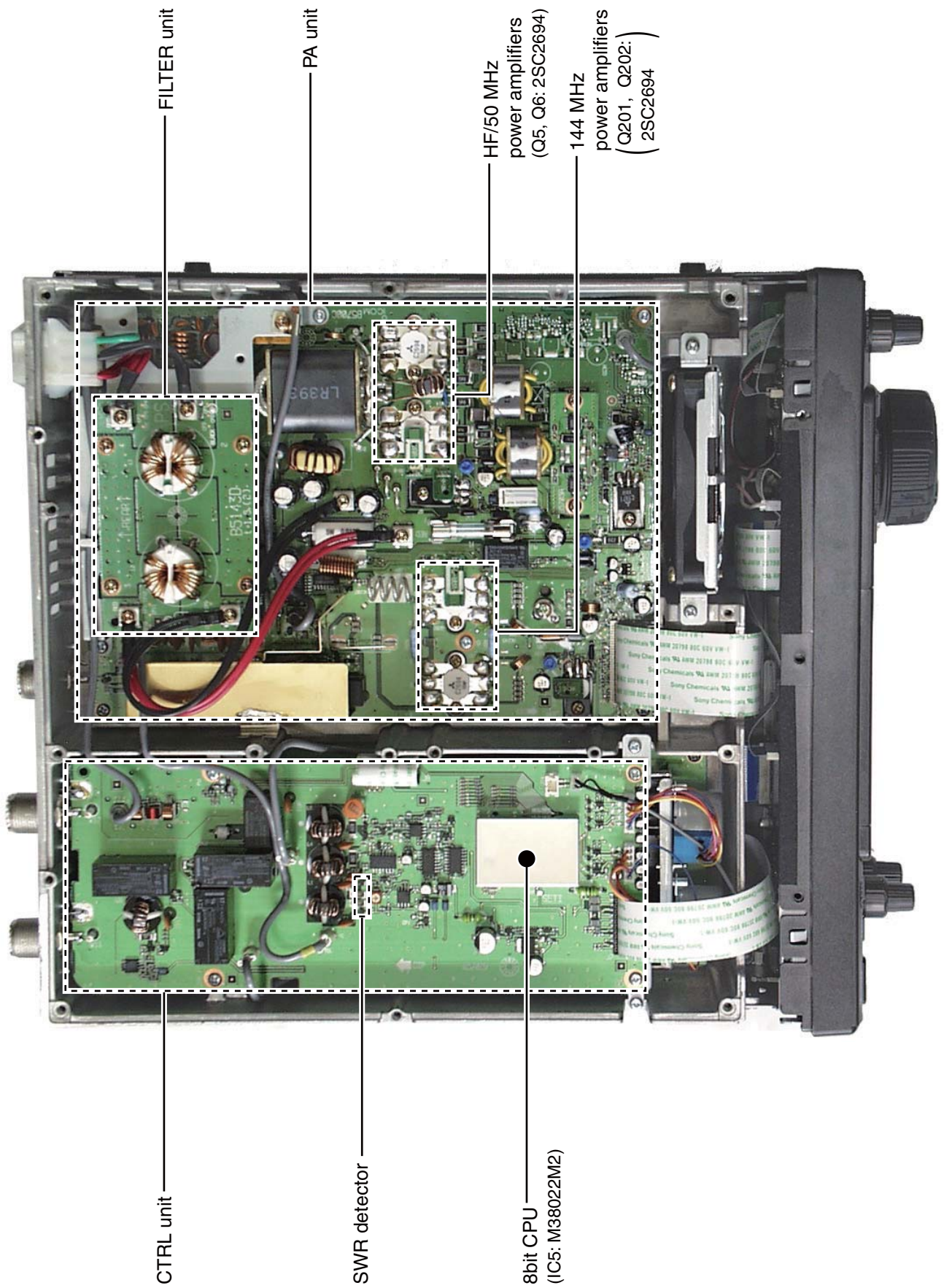

## SECTION 3 DISASSEMBLY AND OPTION INSTALLATIONS

### • Opening the transceiver's case

Follow the case and cover opening procedures shown here when you want to install an optional unit or adjust the internal units, etc.

**CAUTION: DISCONNECT** the DC power cable from the transceiver before performing any work on the transceiver. Otherwise, there is danger of electric shock and/or equipment damage.

- ① Remove the 2 screws from the left side of the transceiver to remove the carrying handle as shown at right.
- ② Remove the 6 screws from the top of the transceiver and the 6 screws from the sides, then lift up the top cover.
- ③ Turn the transceiver upside down.
- ④ Remove 6 screws from the bottom of the transceiver, then lift up the bottom cover.

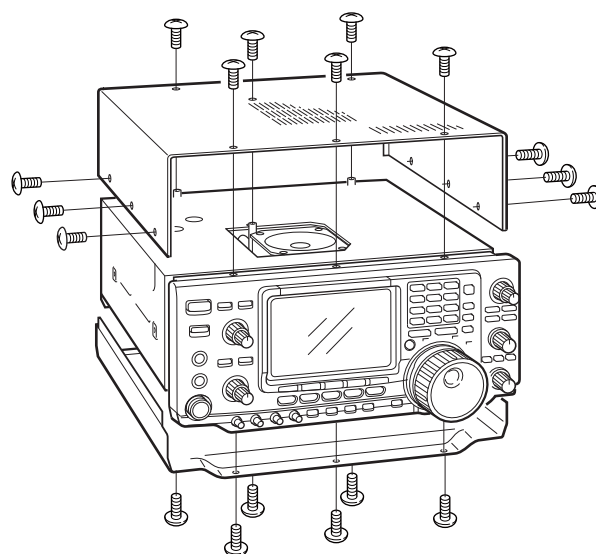
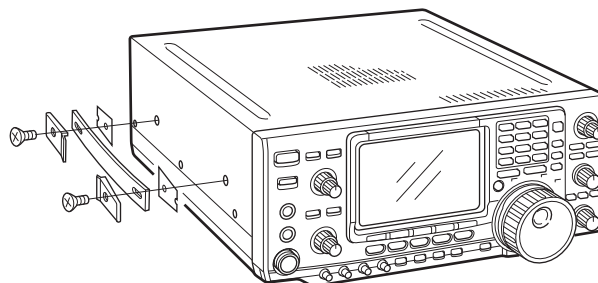

### • UT-102 VOICE SYNTHESIZER UNIT

The UT-102 announces the accessed readout's frequency, mode, etc. (S-meter level can also be announced) in a clear, electronically-generated voice, in English (or Japanese).

➤ Push [LOCK/SPCH] for 1 sec. to announce the frequency, etc.

- ① Remove the top and bottom covers as shown above.
- ② Remove the protective paper attached to the bottom of the UT-102 to expose the adhesive strip.
- ③ Plug UT-102 into J1920 on the MAIN unit as shown in the diagram at right.
- ④ Adjust the trimmer, SPCH LVL: R1925 on the MAIN unit, to set the speech level if desired. Refer to the illustration at right.
- ⑤ Return the top and bottom covers to their original positions.

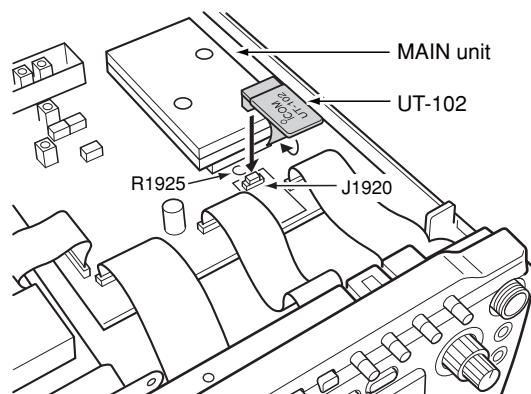

**• CR-338 HIGH STABILITY CRYSTAL UNIT**

By installing the CR-338, the total frequency stability of the transceiver will be improved.

- ① Remove the bottom cover as shown on the previous page.
- ② Remove the 4 screws from the shield cover of the RF unit, and disconnect P2 (CHASSIS) from J761 (MAIN unit), then lift up the shield cover.
  - There is an earth spring on the shield cover, so be careful not to lose it when removing the cover.

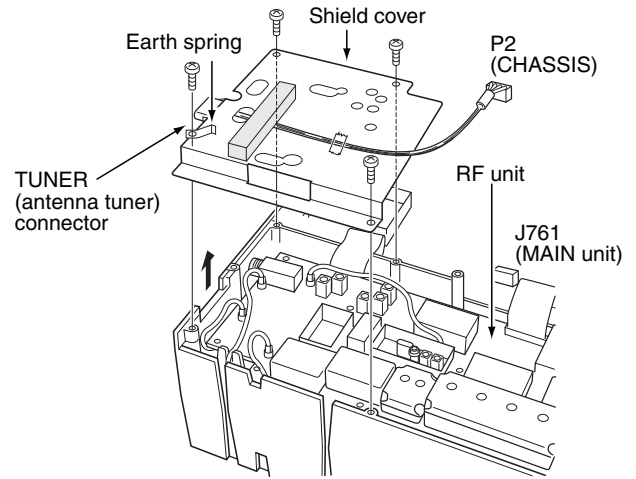

- ③ Remove the 8 screws from the RF unit, disconnect J1, J121 and J151, then remove the RF unit.
- ④ Remove the supplied internal crystal and replace with the CR-338.
- ⑤ Return the RF unit, J1, J121 and J151 to their original positions.

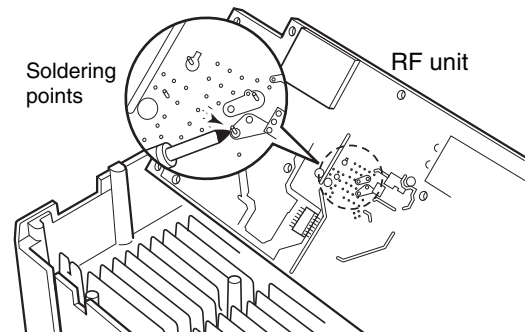
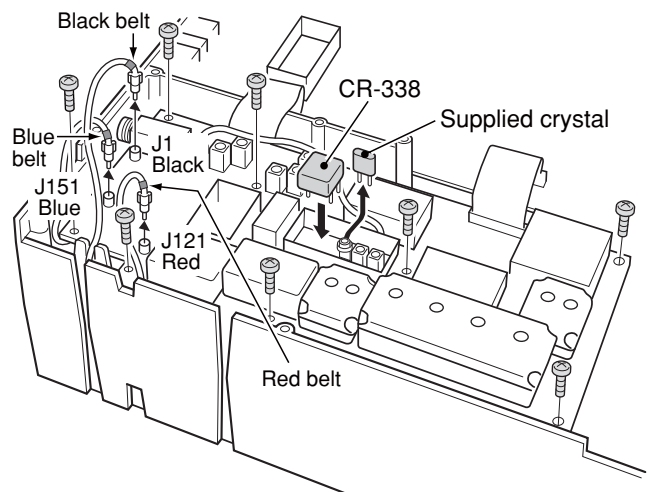

- ⑥ Connect a frequency counter to the J262, 2LO IN, then adjust the reference frequency to be 64.00000 MHz with the L1901 on the RF unit.
- ⑦ Return the J262, shield cover, earth spring and bottom covers to their original positions.

Connect a frequency counter, then adjust the frequency to be 64.00000 MHz.

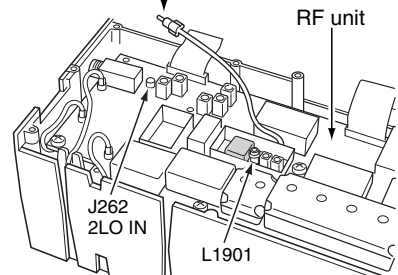



## 4-1 RECEIVER CIRCUITS

### 4-1-1 RF SWITCHING CIRCUIT (CTRL, RF AND PA UNITS)

The RF switching circuit leads receive signals to bandpass filters from an antenna connector while receiving. However, the circuit leads the signal from the RF power amplifier to the antenna connector while transmitting.

RF signals (on HF/6 m bands) from [ANT 1] or [ANT 2] pass through the antenna selector (CTRL unit; RL3), tuner switching relays (CTRL unit; RL1, RL2), transmit/receive switching relay (CTRL unit; RL4), and low-pass filter (CTRL unit; L27, L28, L35, C63–C67, C105, C115–C117), and are then applied to the RF unit via J2 (P2).

The signals from the CTRL unit bypass or pass through the 20 dB attenuator (RF unit; RL1, R1, R2). By selecting the attenuator, 0 (bypass) and 20 dB attenuations are obtained. The signals are then applied to the RF filters.

While operating on the 144 MHz band, the RF signals from the [144 MHz ANT] are passed through the low-pass filter (PA unit; L601–L603, C602, C604–C609) and transmit/receive switching relay (PA unit; RL601), then applied to the RF unit via J601 (P601).

### 4-1-2 RF FILTER CIRCUIT (RF UNIT)

The RF filter circuit contains 8 bandpass and 2 low-pass filters. Bandpass filters pass only the desired band signals and suppress any undesired band signals.

#### (1) 0.03–1.6 MHz

The signals are applied to the attenuator and low-pass filter directly (see above at right).

#### (2) 1.6–60 MHz

The signals pass through the high-pass filter (L2–L4, C4–C7) to suppress excessively strong signals below 1.6 MHz. The filtered signals are applied to a low-pass or one of 8 bandpass filters (see above at right).

#### (3) 108–174 MHz

The 144 MHz band signals are bypassed or passed through the attenuator (R122), then applied to the tunable bandpass filter (see above at right).

The filtered signals are applied to the pre-amplifier circuit.

#### • Used RF filter

Frequency range	Control signal	Input diode	Filter component
0.03–1.6 MHz	B0	D3	L11, L12, R11–R13, C12–C14, C17
1.6–2 MHz	B1	D21	L21–L23, C21–C25
2–4 MHz	B2	D31	L31–L33, C31–C35
4–8 MHz	B3	D41	L41–L43, C41–C45
8–11 MHz	B4	D51	L51–L53, C51–C55
11–15 MHz	B5	D61	L61–L63, C61–C65
15–22 MHz	B6	D71	L71–L73, C71–C75
22–30 MHz	B7	D81	L81–L84, C81–C85
30–50 MHz	B8W	D101	L101–L103, C101–C105
50–54 MHz	B8	D91	L91–L96, C90–C100
54–60 MHz	B8W	D101	L101–L103, C101–C105
108–174 MHz	B9R	None (via C500)	D501, L501, L502

### 4-1-3 PRE-AMPLIFIER CIRCUITS (RF UNIT)

A total of 3 pre-amplifier circuits are employed in this transceiver. 2 for HF/6 m bands and 1 for 144 MHz band operation.

When the pre-amplifier operation is turned OFF, the RF signals bypass this circuit.

When [P.AMP1] is selected, the filtered signals are applied to the pre-amplifier 1 circuit (Q181, Q182), which has 10 dB gain for the 1.8–54 MHz range, and when [P.AMP2] is selected, the signals are applied to the pre-amplifier 2 circuit (IC191), which has 16 dB gain for the 21–60 MHz range. The pre-amplified signals are applied to the 60 MHz cut-out low-pass filter (L210–L212, C211–215, C234).

During 144 MHz band operation, the filtered signals are pre-amplified at the VHF pre-amplifier (Q502) when the [P.AMP] is turned ON, and passed through the tunable bandpass filter (D502–D504, L503–L504).

The filtered signals are applied to the 1st mixer circuit.

#### • Receiver construction

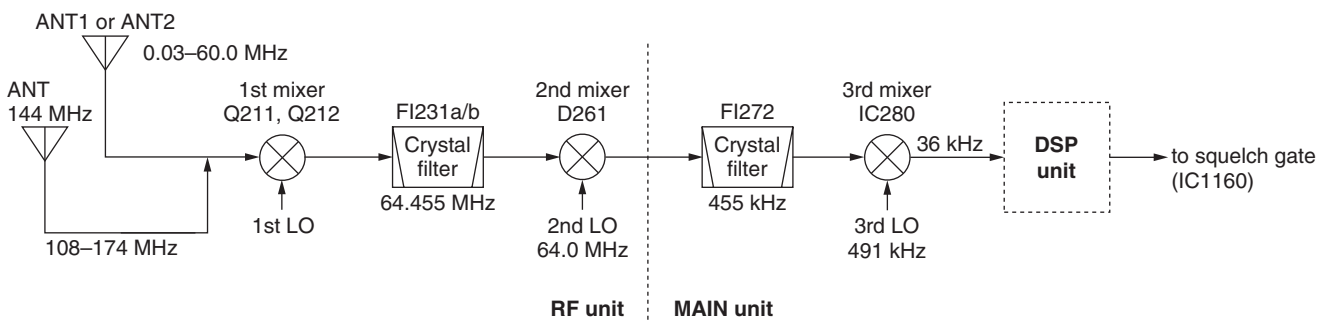

#### 4-1-4 1ST MIXER AND 1ST IF CIRCUITS (RF UNIT)

The 1st mixer circuit mixes the received signals with the 1st LO signal to convert the received signals into a fixed 64.455 MHz 1st IF signal.

The signals from the pre-amplifier circuit, or signals which bypass the pre-amplifier circuit, are applied to the 1st mixer (Q211, Q212) and mixed with the 1st LO signal (64.485–238.455 MHz) coming from the 1st LO PLL circuit via the LO amplifier (Q301) and low-pass filter.

The mixed 1st IF signal is passed through the MCFs (Monolithic Crystal Filter: FI231a/b) to suppress out-of-band signals. The filtered signal is amplified at the IF amplifier (Q241), and then applied to the 2nd mixer circuit.

When the bandscope function is activated, the 1st LO sweeping signal is supplied to the 1st mixer circuit.

#### 4-1-5 2ND MIXER CIRCUIT (RF UNIT)

The 2nd mixer circuit converts the 1st IF signal into the 2nd IF frequency by mixing with the 2nd LO signal (64.00 MHz).

The 1st IF signal from the IF amplifier (Q241) is applied and converted into a 455 kHz 2nd IF signal at the 2nd mixer circuit (D261) by mixing with a fixed 64 MHz 2nd LO signal.

The 2nd IF signal is passed through the low-pass filter (L263, C262–C264) to suppress undesired signals such as the 2nd LO signal, and the applied to the MAIN unit via J261.

The 2nd LO signal is a doubled reference frequency, generated at the reference oscillator (X1901: 32.0 MHz) and doubled at Q1903 and Q1904.

#### 4-1-6 NOISE BLANKER CIRCUIT (MAIN UNIT)

The noise blanker circuit detects pulse-type noise, and turns OFF the signal line when the noise appears.

The 2nd IF signal from the RF unit is applied to the noise blanker gate (D252, D253). A portion of the 2nd IF signal from RF unit is amplified at the noise amplifiers (Q200–Q203), and is then detected at the noise detector (D200) to convert the noise components to DC voltages.

The signal is then applied to the noise blanker switch (Q206, Q207). At the moment detected voltage exceeds Q206's threshold level, Q207 outputs a blanking signal to close the noise blanker gate (D252, D253). The PLL unlock signal are also applied to Q207 to control the noise blanker gate.

Some DC voltage from the noise detector circuit is fed back to the noise amplifiers (Q200, Q201) via the DC amplifiers

(Q204, Q205). The DC amplifiers function as an AGC circuit to reduce average noise. Therefore, the noise blanker function shuts off pulse-type noise only.

#### 4-1-7 2ND IF CIRCUIT (MAIN UNIT)

The 2nd IF circuit amplifies and filters the 2nd IF signal, and applies the 2nd IF signal to the 3rd mixer circuit.

The 2nd IF signal from the noise blanker gate (D252, D253) is amplified at the 2nd IF amplifier (Q250) and passed through the ceramic filters (FI271, FI272). The filtered signal is applied to the 3rd mixer circuit.

#### 4-1-8 3RD MIXER AND 3RD IF CIRCUITS (MAIN UNIT)

The 3rd mixer circuit mixes the 2nd IF signal with the 3rd LO signal to obtain the 3rd IF (36 kHz) signal.

The 2nd IF signal from the ceramic filters (FI271, FI272) is applied to the 3rd mixer circuit (IC280, pin 1). The 3rd LO signal from the 3rd LO PLL circuit is also applied to the 3rd mixer (IC280, pin 5). The mixed signal is output from pin 6.

The 3rd IF signal is passed through the low-pass filter (IC1460a) and amplified at the 3rd IF amplifier (IC1460b). The filtered and amplified signal is then applied to the DSP unit via DRIF line.

#### 4-1-9 DSP RECEIVER CIRCUIT

The DSP (Digital Signal Processor) circuit enables digital IF filter, digital noise reduction, PSN (Phase Shift Network)/Low Power/Phase demodulation, digital automatic notch, and etc.

The 36 kHz 3rd IF signal from the 3rd IF amplifier (MAIN unit; IC1460b) is amplified at the differential amplifiers (IC651a/b), and is then applied to the A/D converter section in the CODEC IC (IC501). At the same time, the converted signal is level-shifted 5V to 3.3 V in the IC (IC501).

The level-shifted signal is applied to the DSP IC (IC301) for the digital IF filter, demodulator, automatic notch and noise reduction, etc.

The output signal from the DSP IC is applied to the D/A converter section in the CODEC IC (IC501) to convert into the analog audio signals. Also the signals are level-shifted 3.3 V to 5V at the level converter section in the IC (IC501).

The level-shifted audio signals are passed through the active filter (IC701a), and then applied to the MAIN unit via J901 (pin 17) as the DRAF signal.

#### • DSP receiver circuit

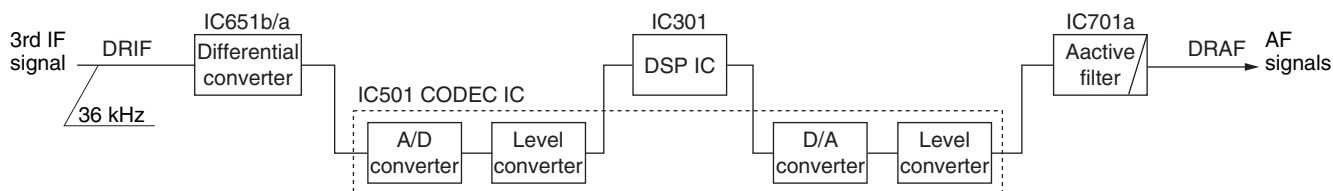

MAIN unit

#### 4-1-10 TWIN PBT CIRCUIT

General PBT (Passband Tuning) circuit shifts the center frequency of IF signal to electronically narrow the passband width. This transceiver uses the DSP circuit for the digital PBT function and actually shifts the both lower and higher passbands of 3rd IF filter within  $\pm 1.8$  kHz.

The twin PBT circuit in DSP IC (IC301) controlled by the [TWIN PBT] controller adjusts the 3rd IF passband width and rejects interference.

#### 4-1-11 AGC CIRCUIT

The AGC (Automatic Gain Control) circuit reduces IF amplifier gain and attenuates IF signal to keep the audio output at a constant level.

The receiver gain is determined by the voltage on the AGC line (MAIN unit; IC1401, pin 14). The D/A converter for AGC (IC102) supplies control voltage to the AGC line and sets the receiver gain with the [RF/SQL] control.

The 3rd IF signal from the CODEC IC (IC501) is detected at the AGC detector section in the DSP IC (IC301). The output signal from the DSP IC (IC301) is level-shifted at the level converter (IC101) and applied to the D/A converter (IC102). The AGC voltage is amplified at the buffer amplifier section in IC102 and is applied to the MAIN unit to control the AGC line.

When receiving strong signals, the detected voltage increases and the AGC voltage decreases via the buffer amplifier (IC102). As the AGC voltage is used for the bias voltage of the IF amplifiers (RF unit; Q241, MAIN unit; Q250), IF amplifier gain is decreased.

#### 4-1-12 SQUELCH CIRCUIT (MAIN UNIT)

The squelch circuit mutes audio output when the S-meter signal is lower than the [RF/SQL] setting level.

The NSQL or VSQL signal from the DSP unit is applied to the main CPU (IC1500) and is compared with the threshold level set by the [RF/SQL] control. The [RF/SQL] setting signal is passed through the sub CPU (DISPLAY board; IC1001, pin 91), and then applied to the main CPU. The main CPU analyzes the compared signal and outputs control signal to the squelch gate (IC1160, pin 5) to open or close the squelch as the SQLS signal.

#### 4-1-13 AF AMPLIFIER CIRCUIT (MAIN UNIT)

The AF amplifier amplifies the audio signals to a suitable driving level for the speaker.

The AF signals (DRAF) from the DSP unit are passed through the squelch gate (IC1160) and amplified at the AF amplifier section of IC1180 (pins 2, 4), and volume is controlled by the AFGV signal at the VCA section (pins 7–9). The volume controlled AF signals are passed through the AF mute gate (IC1220, pins 7, 1), then applied to the AF power amplifier (IC1240, pin 1) via the ripple filter (Q1280).

The amplified audio signals are passed through the [PHONES] and [EXT SP] jacks then applied to the internal speaker when no plug is connected to the jacks.

The AF mute gate is controlled by the [AF] control via the sub and main CPUs.

#### 4-1-14 TONE SQUELCH CIRCUIT (MAIN UNIT)

A portion of the detected FM audio signals from the DSP unit via the MONI line are amplified at the AF amplifier (IC1060). The amplified signals are applied to the low-pass filter (IC1001) to cut-out the 300 Hz or higher audio components, and subaudible tone signals only pass through. The filtered signal (subaudible tone) is then applied to the main CPU (IC1500, pin 108).

The main CPU detects the frequency of the applied subaudible tone signal and releases the audio mute when a matched tone frequency signal is detected.

#### • AF amplifier circuit

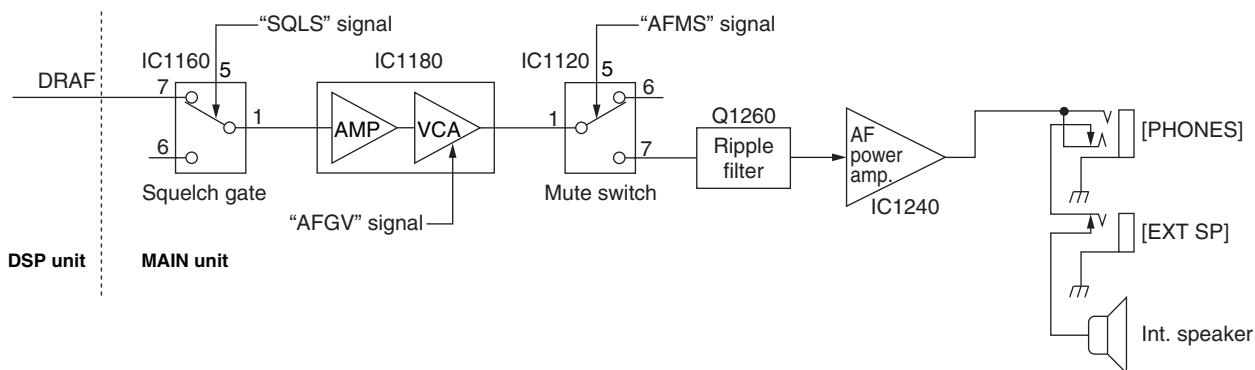

## 4-2 TRANSMITTER CIRCUITS

### 4-2-1 MICROPHONE AMPLIFIER CIRCUIT (MAIN UNIT)

The microphone amplifier circuit amplifies microphone audio signals to a level needed for the DSP circuit.

Audio signals from the [MIC] connector (MIC board; J1, pin 1) are amplified at the audio amplifier section in IC1400 (pins 2, 4), and then applied to the VCA section (IC1400, pin 7). The gain controlled signals are output from (IC1400, pin 9) and amplified at the AF amplifier (IC1401, pins 1–3) and passed through the low-pass filters (IC1401, pins 5–9) and analog switch (IC1310, pins 12, 14). The signals are then applied to the DSP circuit as the DTAF signal.

The VCA section in IC1400 (pins 7–9) controls microphone input gain according to the [MIC GAIN] control level using the MIGV signal coming from the main CPU via the I/O expander (IC502, pin 3).

### 4-2-2 VOX CIRCUIT (MAIN UNIT)

The VOX (Voice-Operated-Transmission) circuit sets transmitting conditions according to voice input.

When the VOX function is activated, a portion of the microphone signals are amplified at the VOX amplifier (IC1280 pins 3, 1) and applied to main CPU (IC1500, pin 109) via the VOXL line. A portion of the power amplified AF signals from the AF power amplifier (IC1240) are amplified at the anti-VOX amplifier (IC1121, pins 6, 7) and applied to the main CPU (IC1500, pin 110) via the AVXL line. Then the main CPU compares these and controls the transmitter circuit.

### 4-2-3 DSP TRANSMITTER CIRCUIT (DSP UNIT)

The DSP (Digital Signal Processor) circuit enables PSN (Phase Shift Network)/Low Power/Phase modulation, transmitter monitor, side tone, and etc.

The microphone audio signals from the MAIN unit via the DTAF line are amplified at the differential amplifiers (IC601a/b), and are then applied to the A/D converter section in the CODEC IC (IC501). At the same time, the converted signals are level-shifted 5 V to 3.3 V in the IC (IC501).

The level-shifted signal are applied to the DSP IC (IC301) and modulated at the DSP IC to produce the 36 kHz transmitter IF signal.

The modulated IF signal from the DSP IC is applied to the D/A converter section in the CODEC IC (IC501) to convert into the analog IF signal. Also the signal is level-shifted 3.3 V to 5V at the level converter section in the IC (IC501).

The level-shifted IF signal is passed through the active filter (IC701b), and then applied to the MAIN unit via J901 (pin 22) as the DTIF signal.

### 4-2-4 SPEECH COMPRESSOR CIRCUIT (DSP UNIT)

The speech compressor compresses the transmitter audio input signals to increase the average output level (average talk power).

When the speech compressor function is ON, the level-shifted signal from the CODEC IC (IC501) is applied to the DSP IC (IC301) and compressed at the DSP IC to obtain an average audio level.

At the same time, the compressed signals are modulated at the DSP IC and applied to the D/A converter section in the CODEC IC (IC501).

### 4-2-5 IF AMPLIFIER AND MIXER CIRCUITS (MAIN AND RF UNITS)

The modulated 3rd IF signal from the DSP unit (DTIF: 36 kHz) is amplified at the 3rd IF amplifier (MAIN unit; IC1120a) and passed through the low-pass filters (MAIN unit; IC1120b/c). The filtered signal is applied to the 3rd mixer circuit (MAIN unit; IC400, pin 1). The applied 3rd IF signal is mixed with the 3rd LO signal from the DDS circuit (RF unit; IC1601) to produce a 455 kHz 2nd IF signal.

The 2nd IF signal is output from pin 6 and passed through the ceramic bandpass filter (MAIN unit; FI381) for unwanted signals are suppressed. The filtered 2nd IF signal is amplified at the 2nd IF amplifier (MAIN unit; Q330). The amplified signal is applied to the 2nd mixer circuit on the RF unit via J250.

The 2nd IF signal is mixed with the 64 MHz 2nd LO signal, coming from the PLL circuit, at the 2nd mixer circuit (RF unit; D261) to obtain a 64.455 MHz 1st IF signal. The 1st IF signal is passed through the MCFs (RF unit; FI231b/a) to cut-off the undesired signals, and is then amplified at the 1st IF amplifier (RF unit; Q271) via the T/R switch (RF unit; D251). The amplified 1st IF signal is applied to the 1st IF mixer circuit (RF unit; D271) via the attenuator (RF unit; D272) and low-pass filter circuit.

#### • Transmitter construction

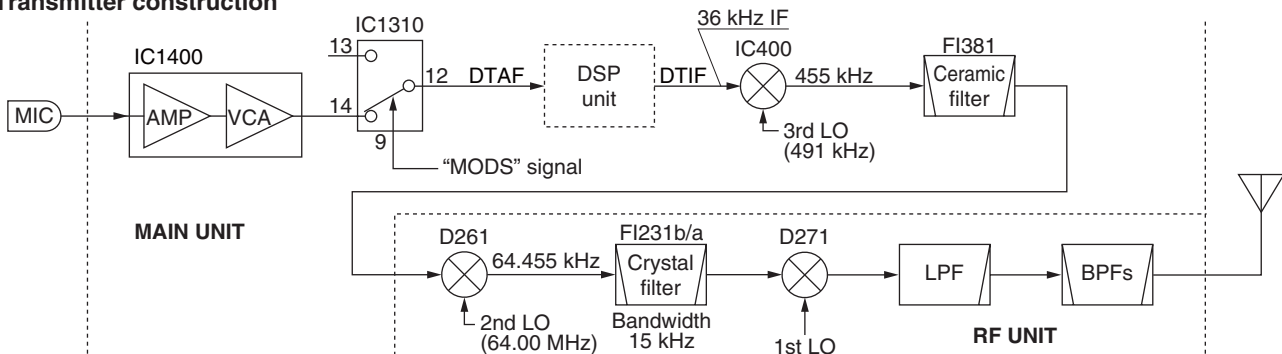

The operating (transmitting) frequency is produced at the 1st IF mixer circuit (RF unit; D271) by mixing the 1st IF and 1st LO signals. The mixed signal is then applied to the RF circuit.

#### 4-2-6 RF CIRCUIT (RF AND PA UNITS)

The RF circuit amplifies operating (transmitting) frequency to obtain 100 W of RF output.

The signal from the 1st IF mixer is passed through one of the low-pass or bandpass filters (Refer to page 4-1 for bandpass filters used) and high-pass filters after passing through the low-pass filter (RF unit; L285, L286, C286–C289, C291). The filtered RF signal is amplified at the wide-band YGR amplifier (RF unit; IC151), and is then applied to the PA unit via J151.

The signal applied from the RF unit is amplified at the 2 pre-drive (PA unit; Q1, Q2) and drive (DRV board; Q1, Q2) amplifiers. These amplifiers cover all HF, 50 MHz and 144 MHz band amplifying operation.

When operating on the HF or 50 MHz band, the signal from the drive amplifier is power amplified at the HF/50 MHz power amplifier (PA unit; Q5, Q6) via the band switching relay (PA unit; RL2). However, the 144 MHz signal is power amplified at the 144 MHz power amplifier (PA unit; Q201, Q202) to obtain a stable 100 W of RF output power.

The amplified signal is applied to the desired antenna connector via one of 8 low-pass filters.

#### 4-2-7 ALC CIRCUIT (MAIN UNIT)

The ALC (Automatic Level Control) circuit controls the gain of IF amplifiers in order for the transceiver to output a constant RF power set by the [RF PWR] control even when the supplied voltage shifts, etc.

The RF power level is detected at the SWR detector circuit (HF/50 MHz bands: CTRL unit; D2, 144 MHz band: PA unit; D602) to be converted into DC voltage and applied to the MAIN unit as the FOR (HF/50 MHz) or VFOR (144 MHz) signal.

The FOR or VFOR signal is applied to the comparator (IC300, pin 6). The POCV signal, controlled by the [RF PWR] control via the I/O expander (IC502, pin 4), is also applied to the other input (pin 5) for reference. The compared signal is output from pin 7 and applied to the IF amplifiers in the MAIN (Q330) and RF (Q271) units to control amplifying gain.

When the FOR or VFOR signal exceeds the POCV voltage, ALC bias voltage from the comparator controls the IF amplifiers. This adjusts the output power to a specified level from the [RF PWR] control until the FOR (VFOR) and POCV voltages are equalized.

In AM mode, the comparator operates as an averaging ALC amplifier. Q304 turns ON and the POCV voltage is shifted for 40 W AM output power (maximum) through R320.

The ALC bias voltage is also applied to the ALC meter amplifier (IC300, pin 2) to obtain an ALC meter signal (ALCL). The amplified signal is passed through the analog switch (IC1900, pins 5, 4) and applied to the main CPU (IC1500, pin 107) to drive the S/RF meter via the sub CPU (IC1001) on the DISPLAY board.

An external ALC input from the [ALC] jack or [ACC] sockets is applied to the buffer amplifier (Q307). External ALC operation is identical to that of the internal ALC.

The FOR or VFOR signal is also applied to the power meter amplifier (IC360, pin 3). The amplified signal is applied to the main CPU (IC1500) after being switched by the analog switch (IC1900, pins 12, 14) as an FORL signal to drive the S/RF meter via the sub CPU (DISPALY board; IC1001).

#### 4-2-8 APC CIRCUIT (MAIN UNIT)

The APC (Automatic Power Control) circuit protects the power amplifiers on the PA unit from high SWR and excessive current.

The reflected wave signal appears and increases when the connected antenna is mismatched to 50 Ω. The SWR detector circuit (HF/50 MHz bands: CTRL unit; D1, 144 MHz band: PA unit; D603) detects the reflected signal, and applies it to the APC circuit (IC300, pin 9) as a REF (HF/50 MHz) or VREF (144 MHz) signal.

When the REF or VREF signal level increases, the APC circuit decreases the ALC voltage to activate the APC.

For the current APC, the power transistor current is obtained by detecting the voltages (ICH and ICL) which appear at both terminals of the current detector (PA unit; R28). The detected voltages are applied to the differential amplifier (IC300, pins 12, 13). When the current of transistors is increased, the amplifier controls the ALC line to prevent excessive current flow.

A portion of the REF or VREF signal is applied to the SWR meter amplifier (IC360, pin 5). The amplified signal is applied to the main CPU (IC1500) after being switched by the analog switch (IC1900, pins 2, 15) as an REFL signal to drive the SWR meter.

#### • DSP receiver circuit

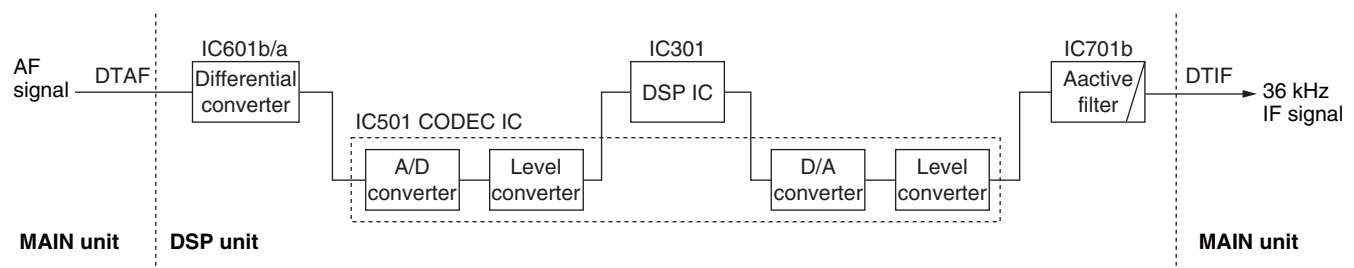

## 4-2-9 TEMPERATURE PROTECTION CIRCUIT (MAIN AND RF UNITS)

The cooling fan (CHASSIS; MF1) is activated while transmitting or when the temperature of the power amplifier exceeds the preset value. The temperature protection circuit consists of Q801, Q802 and D802 (MAIN unit), IC1101 and Q2003–Q2005 (RF unit), and VARISTOR-A/B/C/D boards.

While transmitting, IC1101 (RF unit) outputs FANL signal to Q2003 (RF unit). Then Q2003 (RF unit) is turned ON, Q801, Q802 (MAIN unit) provide a voltage to the cooling fan to rotate at low speed. The VARISTOR-B board, detects the temperature of Q6; PA unit (VARISTOR-D board for Q202; PA unit), and IC1101 (RF unit) outputs FANM signal and activates Q2004 (RF unit) to accelerate the cooling fan at medium speed when the detected temperature exceeds 70°C (158°F). When the detected temperature is at 80°C (176°F) or more, IC1101 (RF unit) outputs FANH signal and activates Q20065 (RF unit), the cooling fan rotates at high speed.

The temperature protection circuit keeps the cooling fan rotating even while receiving until the Q6 (PA unit) or Q202's (PA unit) temperature drops to 60°C (140°F) or below.

## 4-2-10 MONITOR CIRCUIT (DSP UNIT AND MAIN UNIT)

The microphone audio signals can be monitored to check voice characteristics.

### (1) When FM/AM modes (MAIN UNIT)

A portion of the microphone audio signals are passed through the DSP unit, and then applied to the AF amplifier circuit as the MONI signal.

### (2) When SSB/RTTY modes (DSP UNIT)

A portion of the transmit IF signal from the DSP IC (IC301) is mixed with a 36 kHz LO signal to demodulate into the AF signals. The demodulated signals are level-shifted 3.3 V to 5 V at the level converter (IC101) and then applied to the D/A converter (IC102) to convert into the analog AF signal. The AF signals are then applied to the MAIN unit as the MONI signal.

The MONI signal from the DSP unit is amplified at the AF amplifier (MAIN unit; IC1060, pins 5, 7) and passed through the analog switch (MAIN unit; IC1040) and then applied to IC1180 (MAIN unit). The applied signal is amplified at the AF amplifier section (pins 2, 4) and volume controlled at the VCA section (pins 7, 9). The volume controlled AF signals is applied to the AF amplifier circuit (MAIN unit; IC1240).

## 4-3 PLL CIRCUITS

### 4-3-1 GENERAL

The PLL circuits generate a reference frequency (32.000 MHz); 1st LO frequencies (64.485–238.455 MHz); 2nd LO frequency (64 MHz), 3rd LO frequency (419.000 kHz).

The 1st LO PLL adopts a mixer-less dual loop PLL system and has 4 VCO circuits which cover from 30 kHz to 174 MHz. The 1st LO and 3rd LO use DDSs, while the 2nd LO uses the fixed frequency of the crystal oscillator.

## 4-3-2 1ST LO PLL CIRCUIT (RF UNIT)

The 1st LO PLL contains a main and reference loop as a dual loop system.

The reference loop generates an approximate 10.8 MHz frequency using a DDS circuit, and the main loop generates a 64.485 to 238.455 MHz frequency using the reference loop frequency.

### (1) REFERENCE LOOP PLL

The oscillated signal at the reference VCO (Q1301, D1301) is amplified at the amplifiers (Q1302, Q1102) and is then applied to the DDS IC (IC1101, pin 46). The signal is then divided and detected on phase with the DDS generated frequency.

The detected signal output from the DDS IC (pin 56) is converted into DC voltage (lock voltage) at the loop filter (R1135, R1138, C1121) and then fed back to the reference VCO circuit (Q1301, D1301).

### (2) MAIN LOOP PLL

The oscillated signal at one of the main loop VCOs (VCO board, Q1201, D1201, Q1221, D1221, Q1241, D1241, Q1261, D1261) is amplified at the buffer amplifiers (PLL board, IC1802, Q1281) and is then applied to the PLL IC (IC1801, pin 4). The signal is then divided and detected on phase with the reference loop output frequency.

The detected signal output from the PLL IC (pin 13) is converted into a DC voltage (lock voltage) at the loop filter and then fed back to one of the VCO circuits (VCO board, Q1201, D1201, Q1221, D1221, Q1241, D1241, Q1261, D1261).

The oscillated signal from the buffer amplifier (IC1802) is also applied to the MAIN unit as a 1st LO signal after being doubled or passed through the low-pass filter.

### • Using VCO and 1st LO frequencies

Operating frequency	Using VCO	1st LO frequency
0.03–7.999999 MHz	Q1201, D1201	64.4850–72.454999 MHz
8.0–21.999999 MHz	Q1221, D1221	72.4550–86.454999 MHz
22.0–39.999999 MHz	Q1241, D1241	86.4550–104.454999 MHz
40.0–60.000000 MHz	Q1261, D1261	104.4550–124.455000 MHz
108.0–143.999999 MHz	Q1241, D1241	172.4550–208.454999 MHz (with doubler)
144.0–174.000000 MHz	Q1261, D1261	208.4550–238.455000 MHz (with doubler)

## 4-3-3 2ND LO AND REFERENCE OSCILLATOR CIRCUITS (RF UNIT)

The reference oscillator (X1901, Q1901) generates a 32.0 MHz frequency for the 2 DDS circuits as a system clock and for the LO output. The oscillated signal is doubled at the doubler circuit (Q1903, Q1904) and the 64.0 MHz frequency is picked up at the double tuned filter (L1903, L1904). The 64.0 MHz signal is applied to the RF circuit as a 2nd LO signal.

### 4-3-4 3RD LO CIRCUIT (RF UNIT)

The DDS IC (IC1601) generates a 10-bit digital signal using the 32 MHz system clock. The digital signal is converted into an analog wave signal at the D/A converter (R1601–R1620). The converted analog wave is passed through the bandpass filter (L1602, L1603, L1605, C1609–C1613, C1615–C1617) and then applied to the MAIN unit as the 3rd LO signal (491.000 kHz).

### 4-3-5 MARKER CIRCUIT (RF UNIT)

The signal divided at the DDS circuit (IC1101) is used for the marker signals.

The reference signal for the DDS circuit (32.0 MHz) is divided by 2 to produce an acceptable frequency signal, 16 MHz, with the programmable divider then divided again by 160 to obtain 100 kHz cycle square-wave signals.

The generated marker signals are output from pin 49 of the DDS IC (IC1101) and then applied to the 1st mixer circuit (Q211, Q212) via the marker switch (IC1081) as the MKR signal.

## 4-4 ANTENNA TUNER CIRCUITS

### 4-4-1 MATCHING CIRCUIT (TUNER UNIT)

The matching circuit is a T-network. Using 2 tuning motors, the matching circuit obtains rapid overall tuning speed.

Using relays (RL1–RL15), the relay control signals from the antenna tuner CPU (CTRL unit; IC5) via the buffer amplifier (Q1–Q15) ground one of the taps of L3–L9, L11, L12 and add capacitors (C34–C43). After selecting the coils and capacitors, 2 motors (MF1, MF2) adjust C44 and C45 using the antenna tuner CPU (CTRL unit; IC5) and the motor driver circuit (CTRL unit; Q211–Q218) to obtain a low SWR (Standing Wave Ratio).

### 4-4-2 DETECTOR CIRCUITS (CTRL UNIT)

#### (1) SWR detector

Forward and reflected power are picked up by a current transformer (L1), detected by D1 and D2, and then amplified at IC1b and IC1a, respectively. The amplified voltages are applied to the antenna tuner CPU (IC5, pins 2, 3). The antenna tuner CPU detects the SWR.

#### (2) Reactance components detector

Reactance components are picked up by comparing the phases of the RF current and RF voltage. The RF current is detected by L4 and R16, and rectified at D5. The rectified current is amplified at the C-MOS inverter amplifier (IC14e) and buffer amplifier (IC2a). The amplified signal is then applied to the phase comparator (IC3a). RF voltage is detected by C12–C14 and rectified at D4. The rectified voltage is amplified at the C-MOS inverter amplifier (IC14c) and buffer amplifier (IC2b). The amplified signal is then applied to the phase comparator (IC3b).

The output signal from the phase comparator (IC3a, pin 6 for RF current, IC3b pin 7 for RF voltage) is rectified at D7 and D6 for conversion into DC voltage. The rectified voltages are combined, and amplified at IC4b, then applied to the antenna tuner CPU (IC5, pin 64).

A C-MOS inverter IC is used for the buffer-amplifier (IC14) to improve functional sensitivity. The C-MOS inverter amplifier is very responsive, and ensure quick and stable signal detection, even at a low RF signal level input.

#### (3) Resistance components detector

Resistance components are picked up by L8, and detected by D8, D9 and Q5. The detected resistance components are amplified at the amplifier (IC4a), and then applied to the antenna tuner CPU (IC5, pin 1).

### 4-4-3 MOTOR CONTROL CIRCUIT

The control circuit of the internal antenna tuner consists of the CPU, EEPROM\*, tuning motors and tuning relays.

\*Electronically-Erasable Programmable Read Only Memory

#### • PLL circuit

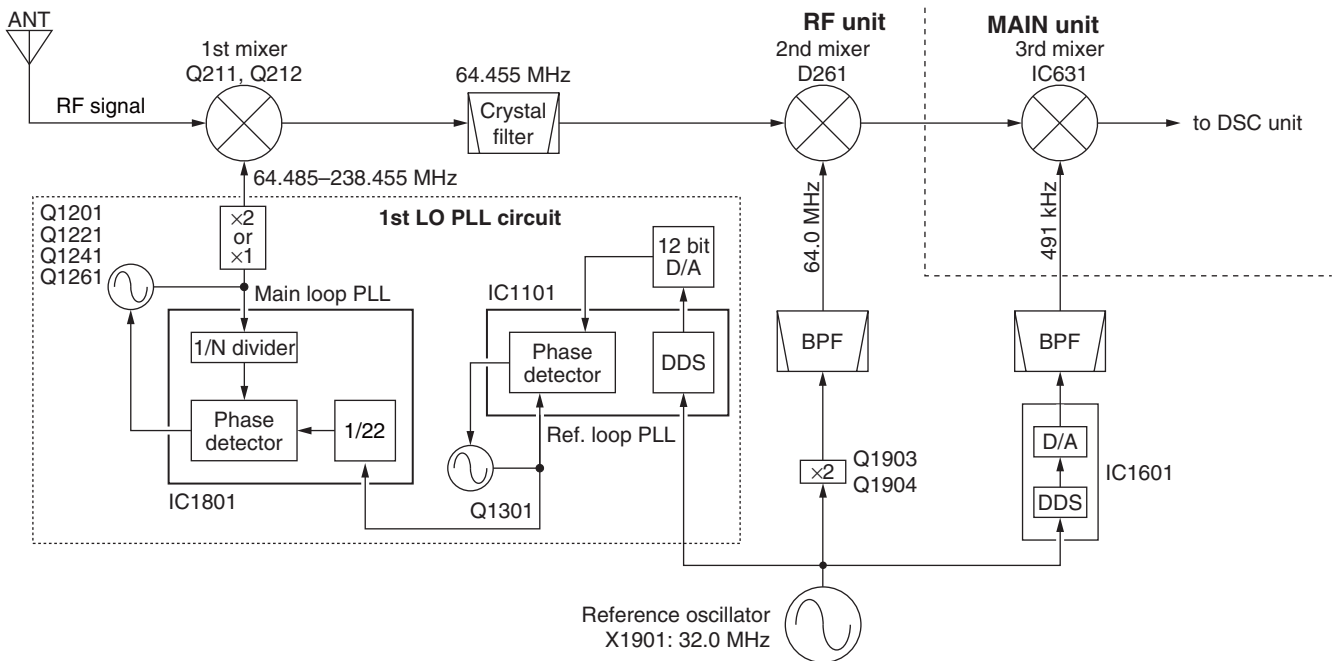

### (1) CPU and EEPROM (CTRL unit)

The antenna tuner CPU (IC5) controls the tuning motors via the motor driver circuit (Q211–Q218) and tuning relays directly, and memorizes the best preset position in 100 kHz steps. The memory contents are stored in the EEPROM (IC6) without a backup battery.

### (2) Tuning motors (CTRL unit)

The motor driver circuit (Q211–Q218) rotates the tuning motors (MF1, MF2) to obtain a low SWR.

### (3) Tuning relays (TUNER unit)

According to the operating frequency band and antenna condition, tuning relays select the capacitors (C34–C43) and coils (L3–L9, L11, L12).

## 4-4-4 ANTENNA TUNER CPU PORT ALLOCATION (CTRL unit; IC5)

Pin number	Port name	Description
1	AN2	Input port for the resistance components detection voltage.
2	AN1	Input port for the reflected RF power voltage.
3	AN0	Input port for the forward RF power voltage.
4	PWRS	Input port for the transceiver power OFF.
7	SET1	Input port for the reference voltage setting.
13	CIKY	Outputs tuner data signal.
15	CIST	Input port for the serial signal.
17	THRU	Outputs the [TUNER] ON/OFF signal.
19	CDRS	Input port for reset signal.
21	TRC	Input port for the TX/RX switching signal.
22, 23	XIN, XOUT	Input ports for the antenna tuner CPU system clock.
25, 34–36, 38–40	NVHF, CO3, CO2, CO1, CI3, CI2, CI1	Output the capacitor selection signals.
26–32	VHF, 24M, 18M, 14M, 10M, 7M, 4M	Output the coil selection signals.
41–44	P07–P04	Output ports for the tuning motor (MF2) drive signals.
45–48	P03–P00	Output ports for the tuning motor (MF1) drive signals.
64	AN3	Input port for the reactance components detection voltage.

## 4-5 POWER SUPPLY CIRCUITS

### 4-5-1 PA UNIT

Line	Description
H14V	The voltage from an external power supply via the common filter circuit (FILTER board, L1).
HV	The same voltage as the H14V line passed through a fuse.
14VS	The same voltage as the HV line passed through the switching relay (RL1).
14V	The same voltage as the 14VS line passed through coils (L22, L23).
8V	Common 8 V converted from the 14V line and regulated by the +8 regulator circuit (IC3).
5V	Common 5 V converted from the 14V line and regulated by the +5 regulator circuit (IC2).
H5V	Common 5 V converted from the HV line and regulated by the +5 regulator circuit (IC1).

### 4-5-2 S-LOGIC BOARD

Line	Description
–8 V	Common –8 V converted from the 14V line and regulated by the –8 V DC-DC converter (IC401).

### 4-5-3 MAIN UNIT

Line	Description
R8V	Receive 8 V converted from the 14V line and regulated by the R8V regulator circuit (Q451, Q453).
T8V	Transmit 8 V converted from the 14V line and regulated by the T8V regulator circuit (Q450, Q452).

### 4-5-4 PLL UNIT

Line	Description
5VPLL	Common 5 V converted from the 8V line and regulated by the 5 V regulator circuit (IC1051).



# SECTION 5 ADJUSTMENT PROCEDURES

## 5-1 PREPARATION BEFORE SERVICING

### ■ REQUIRED TEST EQUIPMENT

EQUIPMENT	GRADE AND RANGE	EQUIPMENT	GRADE AND RANGE
DC power supply	Output voltage : 13.8 V DC Current capacity : 30 A or more	Audio generator	Frequency range : 300–3000 Hz Measuring range : 1–500 mV
RF power meter (terminated type)	Measuring range : 10–200 W Frequency range : 1.8–200 MHz Impedance : 50 Ω SWR : Less than 1.2 : 1	Standard signal generator (SSG)	Frequency range : 0.1–200 MHz Output level : 0.1 μV to 32 mV (–127 to –17 dBm)
Frequency counter	Frequency range : 0.1–200 MHz Frequency accuracy : ±1 ppm or better Sensitivity : 100 mV or better	Digital multimeter	Input impedance : 10 MΩ/DC or better
RF voltmeter	Frequency range : 0.1–200 MHz Measuring range : 0.01–10 V	AC millivoltmeter	Measuring range : 10 mV–10 V
FM deviation meter	Frequency range : DC–200 MHz Measuring range : 0 to ±5 kHz	DC voltmeter	Input impedance : 50 kΩ/V DC or better
Modulation analyzer	Frequency range : At least 200 MHz Measuring range : 0–100 %	DC ammeter	Measurement capability: 1 A/30 A
Distortion meter	Frequency range : 1 kHz ±10 % Measuring range : 1–100 %	Spectrum analyzer	Frequency range : At least 90 MHz Spectrum bandwidth : 100 kHz or more
Oscilloscope	Frequency range : DC–20 MHz Measuring range : 0.01–20 V	Attenuator	Power attenuation : 50 or 60 dB Capacity : 150 W or more
		External speaker	Input impedance : 8 Ω Capacity : 5 W or more
		Terminator	Resistance : 50 Ω and 100 or 25 Ω Capacity : 150 W or more

### ■ CONNECTIONS

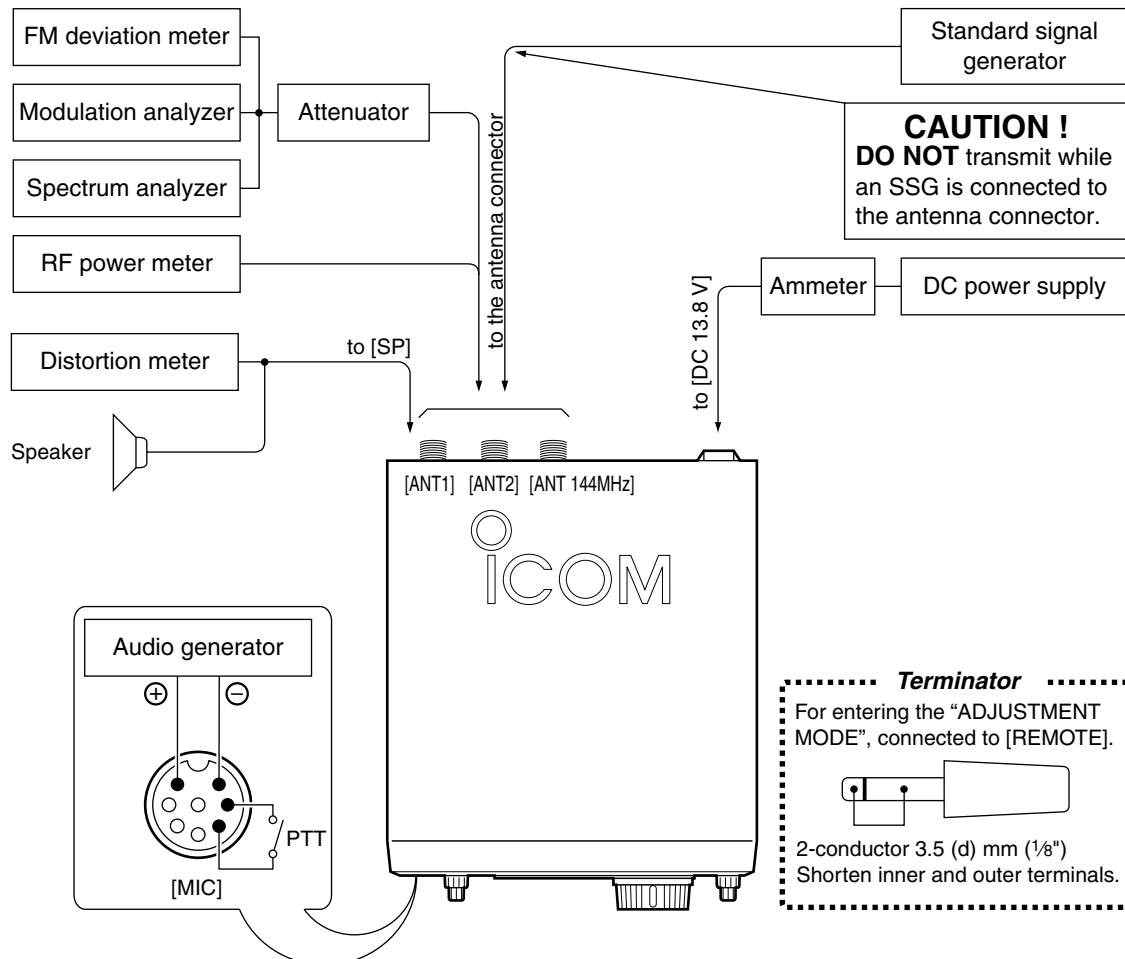

## 5-2 PLL ADJUSTMENTS

ADJUSTMENT	ADJUSTMENT CONDITION	MEASUREMENT		VALUE	ADJUSTMENT POINT	
		UNIT	LOCATION		UNIT	ADJUST
REFERENCE FREQUENCY	1 <ul style="list-style-type: none"> <li>• Displayed freq. : Any</li> <li>• Preset R1032 (RF unit) to the center position.</li> <li>• Preset L1902 (RF unit) approximate 1.5 mm downside from top of the coil's case.</li> <li>• Receiving</li> </ul>	RF	Connect an RF voltmeter to the check point P1901.	Maximum level (0 dBm or more)	RF	L1903, L1904
	2 <ul style="list-style-type: none"> <li>• Receiving</li> </ul>		Connect a frequency counter to the check point P1901.			64.000000 MHz
LPL LOCK VOLTAGE	1 <ul style="list-style-type: none"> <li>• Displayed freq. : 0.030000 MHz</li> <li>• Mode : USB</li> <li>• Receiving</li> </ul>	RF	Connect a digital multimeter or oscilloscope to the check point CP1101 (LV1).	1.0 V	RF	C1303
VCO LOCK VOLTAGE	1 <ul style="list-style-type: none"> <li>• Displayed freq. : 7.999999 MHz</li> <li>• Mode : USB</li> <li>• Receiving</li> </ul>	RF	Connect a digital multimeter or oscilloscope to the check point CP1801 (LV2).	4.0 V	RF	C1208
	2 <ul style="list-style-type: none"> <li>• Displayed freq. : 21.999999 MHz</li> <li>• Mode : USB</li> <li>• Receiving</li> </ul>					C1228
	3 <ul style="list-style-type: none"> <li>• Displayed freq. : 39.999999 MHz</li> <li>• Mode : USB</li> <li>• Receiving</li> </ul>					C1248
	4 <ul style="list-style-type: none"> <li>• Displayed freq. : 60.000000 MHz</li> <li>• Mode : USB</li> <li>• Receiving</li> </ul>					C1268
1LO OUTPUT LEVEL	1 <ul style="list-style-type: none"> <li>• Displayed freq. : 0.500000 MHz, 7.999999 MHz, 8.000000 MHz, 21.999999 MHz, 22.000000 MHz, 39.999999 MHz, 40.000000 MHz, 50.000000 MHz, 54.000000 MHz, 144.000000 MHz, 148.000000 MHz</li> <li>• Receiving</li> </ul>	RF	Connect an RF voltmeter to the check point CP1500.	-7 dBm or more		Verify
3LO OUTPUT LEVEL	1 <ul style="list-style-type: none"> <li>• Displayed freq. : Any</li> <li>• Mode : USB</li> <li>• Receiving</li> </ul>	RF	Connect an RF voltmeter to the check point CP1601.	-25 dBm or more		Verify
MARKER OUTPUT LEVEL	1 <ul style="list-style-type: none"> <li>• Displayed freq. : 14.100000 MHz</li> <li>• Mode : CW</li> <li>• Marker : ON</li> <li>• Receiving</li> </ul>	FRONT	Display	S3 or more (S-meter level)		Verify

**R1032**  
Reference frequency  
adjustment

**P1901**  
Reference frequency  
check point

**CP1500**  
1st LO outoput level  
check point

Reference  
frequency  
adjustment

**L1904**  
**L1901**  
**L1902**  
**L1903**

VCO lock  
voltage  
adjustment

**C1268**  
**C1248**  
**C1228**  
**C1208**

**CP1801 (LV2)**  
VCO lock voltage  
check point

**C1303**  
LPL lock voltage  
adjustment

**CP1101 (LV1)**  
LPL lock voltage  
check point

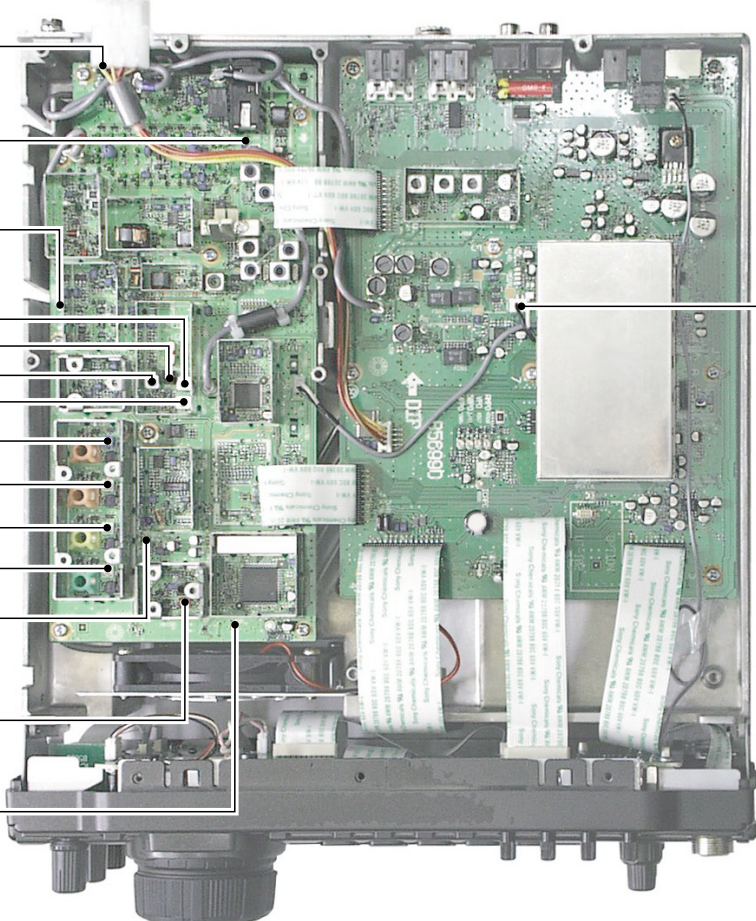

**CP1601**  
3rd LO output level  
check point

## 5-3 TRANSMITTER ADJUSTMENTS

ADJUSTMENT	ADJUSTMENT CONDITION	MEASUREMENT		VALUE	ADJUSTMENT POINT				
		UNIT	LOCATION		UNIT	ADJUST			
IDLING CURRENT  (for driver)  (for HF/50 MHz band final amplifier)  (for 144 MHz band final amplifier)	1	<ul style="list-style-type: none"> <li>Displayed freq. : 14.100000 MHz</li> <li>Mode : USB</li> <li>[MIC GAIN] : Max. CCW</li> <li>[RF POWER] : Max. CW</li> <li>[TUNER] : OFF</li> <li>Preset R11, R18, R109, R204, R215 (PA unit) to max. counter clockwise.</li> <li>Transmitting</li> </ul>	PA	Connect an ammeter between the power supply and the transceiver.	Measure the driving current, and note it as the "initial value."	PA	-		
	2	<ul style="list-style-type: none"> <li>Transmitting</li> </ul>						+1.5 A more than initial value	R11
	3	<ul style="list-style-type: none"> <li>Transmitting</li> </ul>						+500 mA more than step "2"	R18
	4	<ul style="list-style-type: none"> <li>Transmitting</li> </ul>						+500 mA more than step "3"	R109
	5	<ul style="list-style-type: none"> <li>Displayed freq. : 144.000000 MHz</li> <li>Mode : USB</li> <li>Transmitting</li> </ul>						+500 mA more than step "4"	R204
	6	<ul style="list-style-type: none"> <li>Transmitting</li> </ul>		+500 mA more than step "5"	R215				
After adjustment, disconnect the ammeter between the power supply and the transceiver.									
144 M PEAK	1	<ul style="list-style-type: none"> <li>Displayed freq. : 146.000000 MHz</li> <li>Mode : RTTY</li> <li>Transmitting</li> </ul>	Rear panel	Connect an RF power meter to the [ANT 144MHz] connector.	Maximum output power	PA	C202		
TX PEAK	1	<ul style="list-style-type: none"> <li>Displayed freq. : 145.000000 MHz</li> <li>Mode : USB</li> <li>Set following controls as: <ul style="list-style-type: none"> <li>[RF POWER] : Max. CW</li> <li>[MIC GAIN] : Center</li> <li>[KEY SPEED] : Center</li> <li>[PITCH] : Center</li> </ul> </li> <li>Disconnect P1 (PA unit) from J151 (RF unit).</li> <li>Connect an audio generator to [MIC] connector and set as: <ul style="list-style-type: none"> <li>Frequency : 1.5 kHz</li> <li>Level : 1 mVrms</li> </ul> </li> <li>Transmitting</li> </ul>	RF	Connect a digital multimeter or oscilloscope to the check point J151.	Maximum output Level	RF	Adjust in sequence L253, L252, L251, L272 several times.		
	After adjustment, re-connect P1 (PA unit) to J151 (RF unit).								
	2	<ul style="list-style-type: none"> <li>Displayed freq. : 14.100000 MHz</li> <li>Mode : USB</li> <li>Connect an audio generator as: <ul style="list-style-type: none"> <li>Frequency : 1.5 kHz</li> <li>Level : 1 mVrms</li> </ul> </li> <li>Transmitting</li> </ul>	Rear panel	Connect an RF power meter to the [ANT1] connector.	50 W	Front panel	[MIC GAIN] control		
3	<ul style="list-style-type: none"> <li>Transmitting</li> </ul>		Max. output power		MAIN	L330			
TRANSMITTER TOTAL GAIN	1	<ul style="list-style-type: none"> <li>Displayed freq. : 14.100000 MHz</li> <li>Mode : USB</li> <li>[MIC GAIN] : Center</li> <li>Connect an audio generator to [MIC] connector and set as: <ul style="list-style-type: none"> <li>Frequency : 1.5 kHz</li> <li>Level : 1 mVrms</li> </ul> </li> <li>Transmitting</li> </ul>	Rear panel	Connect an RF power meter to [ANT1] connector.	50 W	MAIN	R331		
Ic APC	1	<ul style="list-style-type: none"> <li>Mode : RTTY</li> <li>Connect CP300 to GND.</li> <li>Transmitting on the maximum TX current band.</li> </ul>	Rear panel	Connect an ammeter between power supply and the transceiver.	23 A	MAIN	R555		

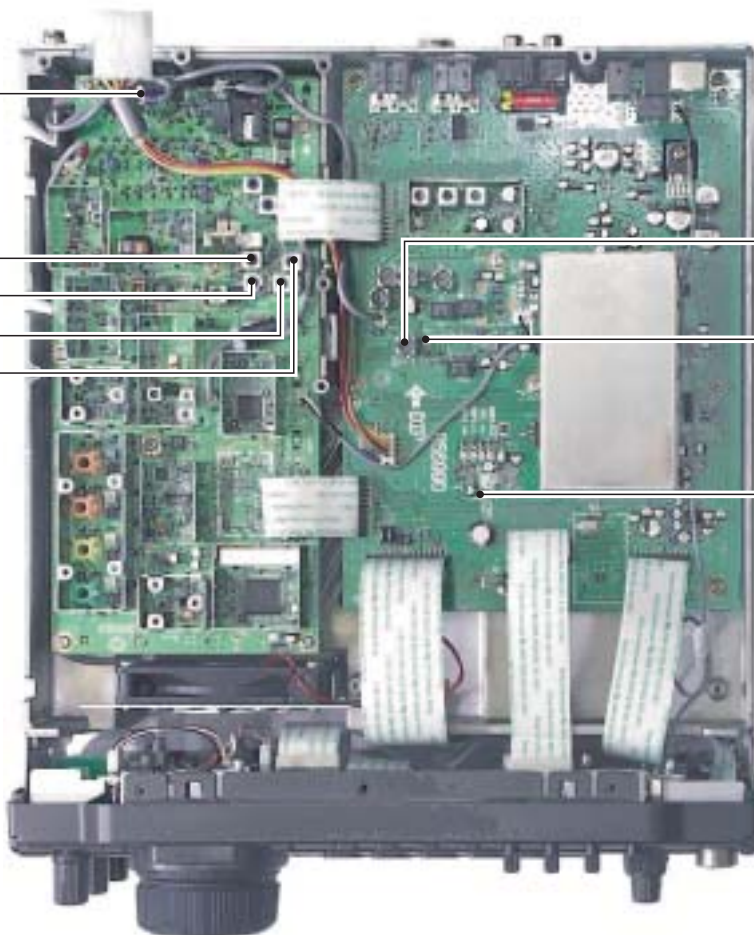

## TRANSMITTER ADJUSTMENTS—continued

ADJUSTMENT		ADJUSTMENT CONDITION	MEASUREMENT		VALUE	ADJUSTMENT POINT	
			UNIT	LOCATION		UNIT	ADJUST
HF BANDS OUTPUT POWER	1	<ul style="list-style-type: none"> <li>• Displayed freq. : 14.10000 MHz</li> <li>• Mode : RTTY</li> <li>• [RF POWER] : Max. CW</li> <li>• [TUNER] : OFF</li> <li>• Transmitting</li> </ul>	Rear panel	Connect an RF power meter to [ANT1] connector.	100 W	MAIN	R306
50 M BAND OUTPUT POWER	1	<ul style="list-style-type: none"> <li>• Displayed freq. : 51.00000 MHz</li> <li>• Mode : RTTY</li> <li>• [RF POWER] : Max. CW</li> <li>• [TUNER] : OFF</li> <li>• Transmitting</li> </ul>	Rear panel	Connect an RF power meter to [ANT1] connector.	100 W	MAIN	R311
144 M BAND OUTPUT POWER	1	<ul style="list-style-type: none"> <li>• Displayed freq. : 145.00000 MHz</li> <li>• Mode : RTTY</li> <li>• [RF POWER] : Max. CW</li> <li>• [TUNER] : OFF</li> <li>• Transmitting</li> </ul>	Rear panel	Connect an RF power meter to [ANT 144MHz] connector.	100 W	MAIN	R317
AM CARRIER	1	<ul style="list-style-type: none"> <li>• Displayed freq. : 14.10000 MHz</li> <li>• Mode : AM</li> <li>• [RF POWER] : Max. CW</li> <li>• [MIC GAIN] : Center</li> <li>• Apply no audio signals to [MIC] connector.</li> <li>• Transmitting</li> </ul>	Rear panel	Connect an RF power meter to [ANT 144MHz] connector.	40 W	MAIN	R320
AM MODULATION	1	<ul style="list-style-type: none"> <li>• Displayed freq. : 14.10000 MHz</li> <li>• Mode : AM</li> <li>• [MIC GAIN] : Center</li> <li>• [RF POWER] : Max. CCW</li> <li>• Connect an audio generator to [MIC] connector and set as: Frequency : 1 kHz Level : 10 mVrms</li> <li>• Transmitting</li> </ul>	Rear panel	Connect a modulation analyzer to [ANT1] connector through an attenuator.	100% or less		Verify
FM DEVIATION	1	<ul style="list-style-type: none"> <li>• Displayed freq. : 28.50000 MHz</li> <li>• Mode : FM</li> <li>• Tone : OFF</li> <li>• [RF POWER] : Max. CW</li> <li>• [MIC GAIN] : Center</li> <li>• Connect an audio generator to [MIC] connector and set as: Frequency : 1 kHz Level : 10 mVrms</li> <li>• Transmitting</li> </ul>	Rear panel	Connect an FM deviation meter to [ANT1] connector through an attenuator.	4.5 kHz $\pm$ 0.3 kHz		Verify
RESIDUAL AM	1	<ul style="list-style-type: none"> <li>• Displayed freq. : 145.00000 MHz</li> <li>• Mode : FM</li> <li>• Tone : OFF</li> <li>• [RF POWER] : Max. CW</li> <li>• [MIC GAIN] : Center</li> <li>• Connect an audio generator to [MIC] connector and set as: Frequency : 1 kHz Level : 4.5 kHz deviation at the connected deviation meter.</li> <li>• Transmitting</li> </ul>	Rear panel	Connect an FM deviation meter to [ANT 144MHz] connector through an attenuator.	Minimum RESIDUAL AM level	RF	L252, L251
SWR DETECTOR		<ul style="list-style-type: none"> <li>• Displayed freq. : 29.70000 MHz</li> <li>• Mode : FM</li> <li>• [RF POWER] : Max. CW</li> <li>• [TUNER] : OFF (Through)</li> <li>• Connect CP7 (SET1) on the CTRL unit to GND.</li> <li>• Connect a 50 <math>\Omega</math> dummy load or an RF power meter to [ANT1] connector.</li> <li>• Transmitting</li> </ul>	CTRL	Connect a digital multimeter or oscilloscope to the check point CP1.	Minimum voltage	CTRL	C3
After adjustment, disconnect CP7 (CTRL unit) from GND.							

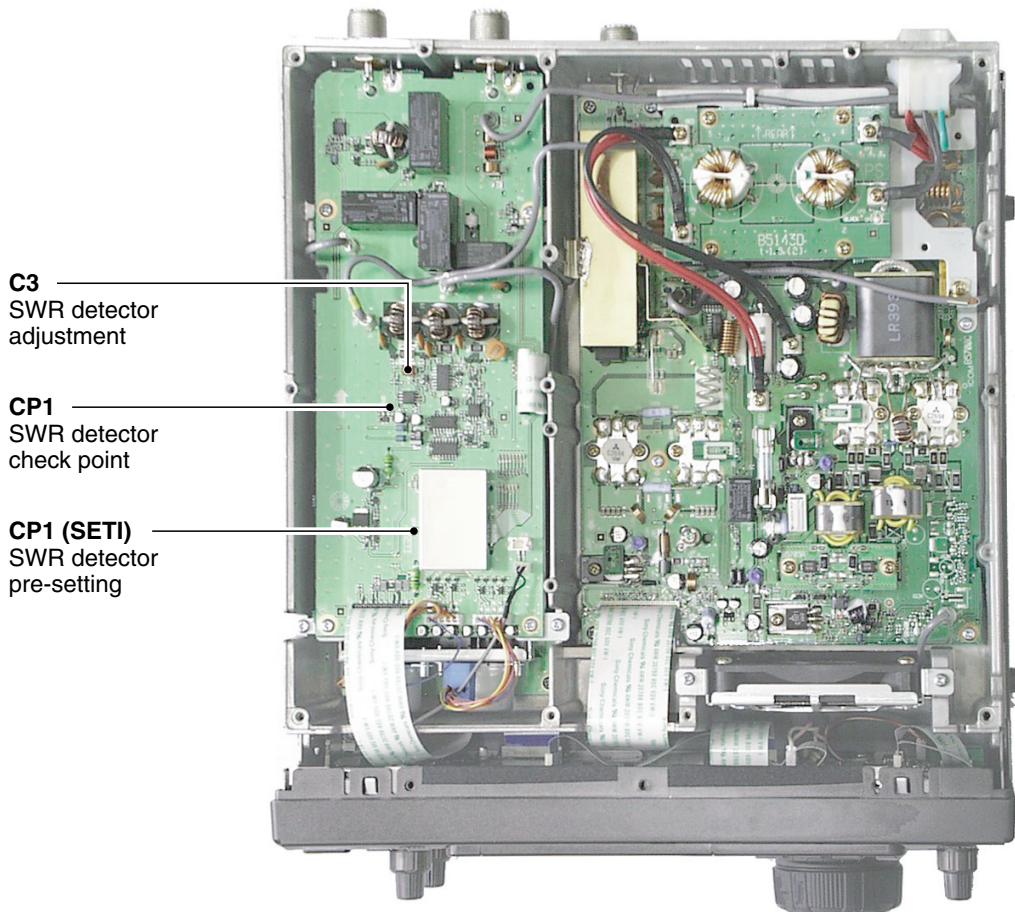
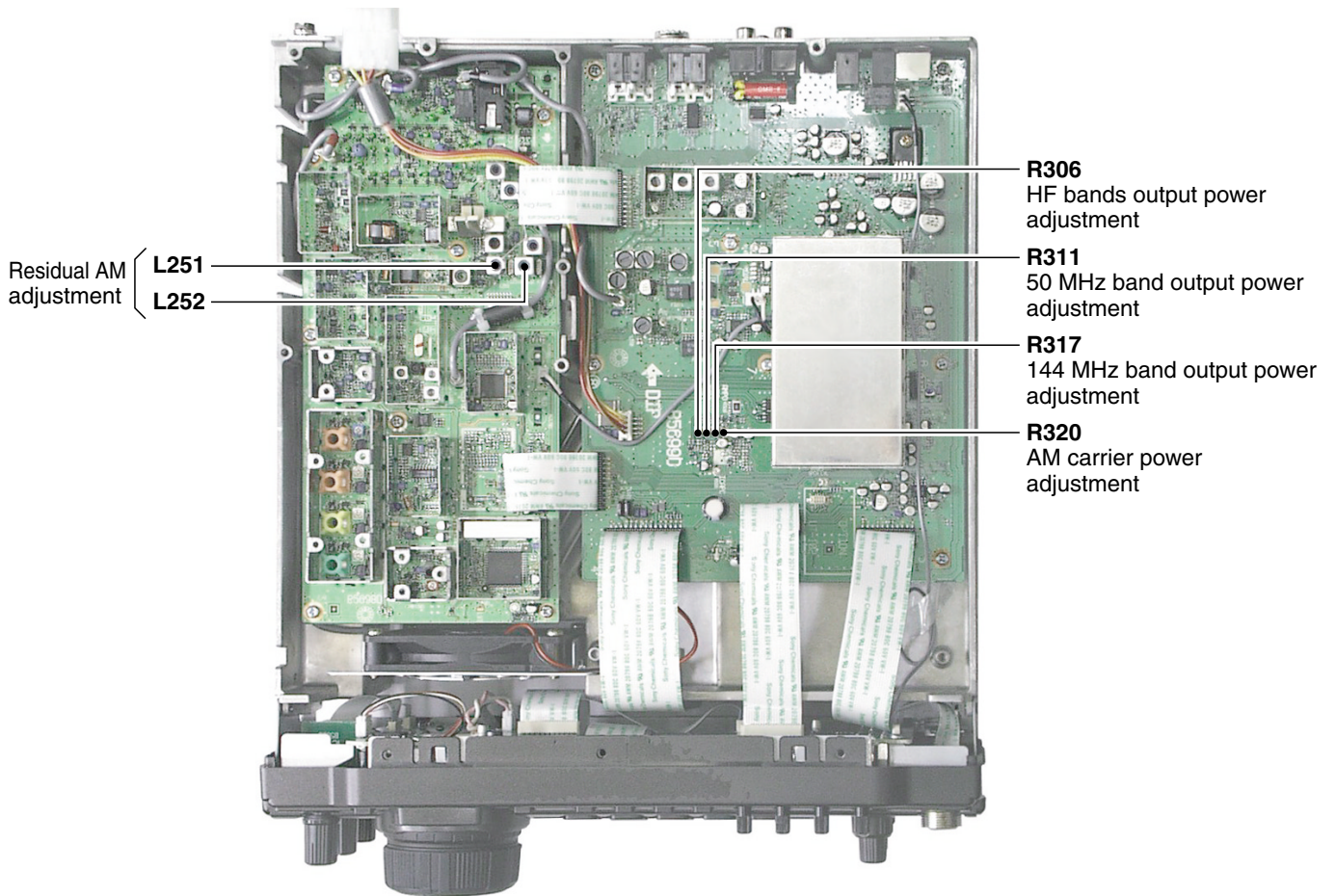

## 5-4 RECEIVER ADJUSTMENTS

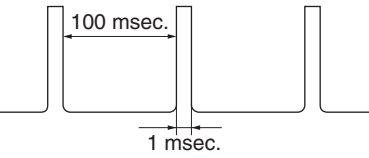





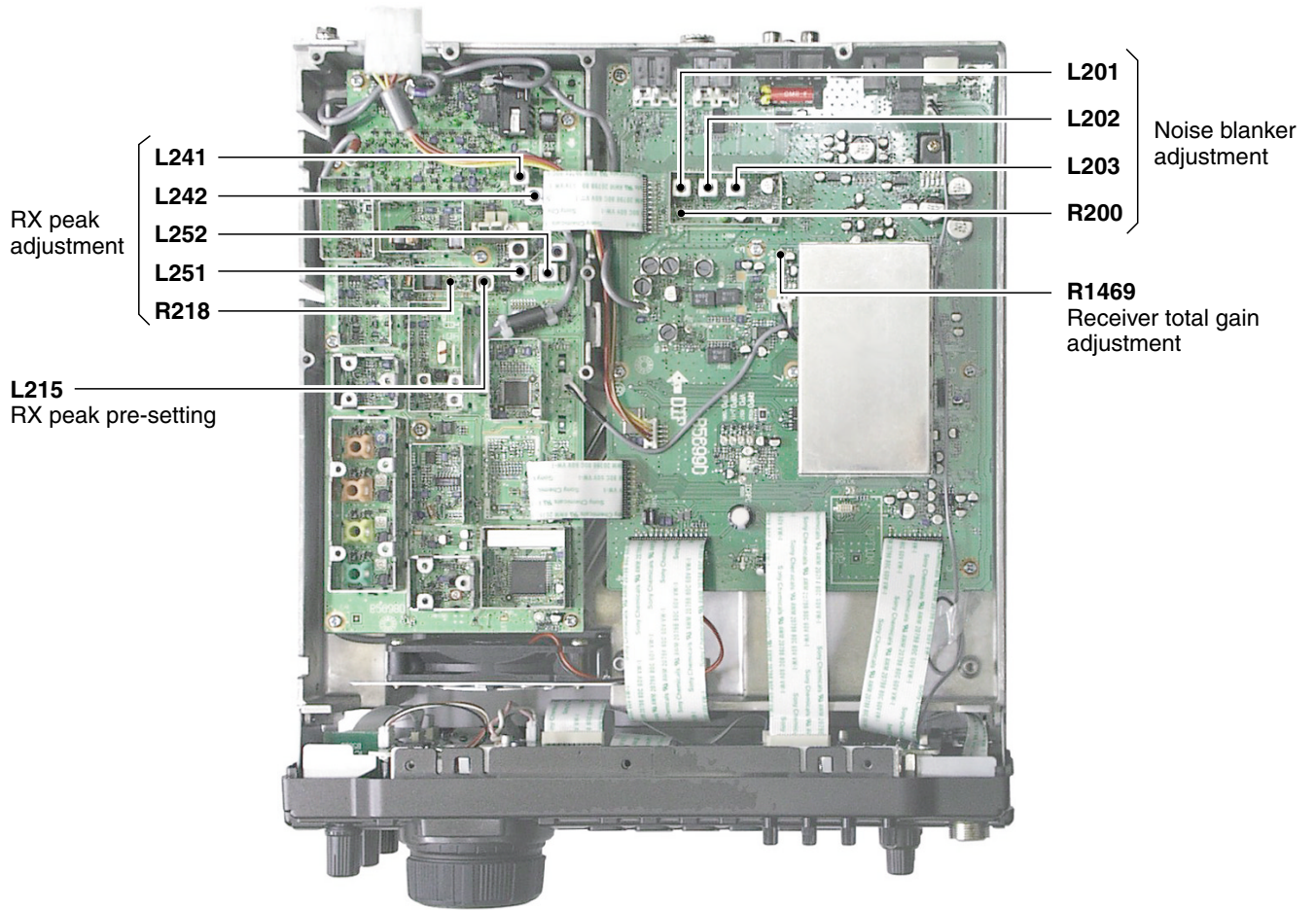





ADJUSTMENT	ADJUSTMENT CONDITION	MEASUREMENT		VALUE	ADJUSTMENT POINT	
		UNIT	LOCATION		UNIT	ADJUST
RX PEAK	1 <ul style="list-style-type: none"> <li>Displayed freq. : 14.100000 MHz</li> <li>Mode : USB</li> <li>Set following selections, controls and functions as: <ul style="list-style-type: none"> <li>[RF/SQL] : Center</li> <li>[PITCH] : Center</li> <li>[AGC]: OFF , [ATT] : OFF</li> <li>[NB] : OFF , [RIT] : OFF</li> <li>PBT1 : Center, PBT2 : Center</li> <li>[P.AMP] : P.AMP1</li> <li>IF Filter : 2.4 kHz</li> <li>[NR] switch : OFF</li> <li>[NOTCH] switch: OFF</li> </ul> </li> <li>Preset L215 (RF unit) to 2 rotation downside from top of the coil's case.</li> <li>Connect an SSG to [ANT1] connector and set as: <ul style="list-style-type: none"> <li>Frequency : 14.101500 MHz</li> <li>Level : 10 <math>\mu</math>V* (-87 dBm)</li> <li>Modulation : 1 kHz/<math>\pm</math>3.5 kHz dev.</li> </ul> </li> <li>Receiving</li> <li>Filter : 15 kHz</li> <li>Set an SSG as : <ul style="list-style-type: none"> <li>Frequency : 14.100000 MHz</li> <li>Level : 1 mV* (-47 dBm)</li> <li>Modulation : 1 kHz/<math>\pm</math>5.0 kHz Dev.</li> </ul> </li> <li>Receiving</li> </ul>	Rear panel	Connect an AC millivolt meter to [EXT SP] connector with an 8 $\Omega$ load.	Maximum audio output level	RF	L242, L241
	3 <ul style="list-style-type: none"> <li>Displayed freq. : 0.03000 MHz</li> <li>Set an SSG as : <ul style="list-style-type: none"> <li>Level : OFF</li> </ul> </li> <li>Receiving</li> </ul>					Connect an AC millivolt meter to [EXT SP] connector with an 8 $\Omega$ load.
RECEIVER TOTAL GAIN	1 <ul style="list-style-type: none"> <li>Displayed freq. : 14.100000 MHz</li> <li>Mode : USB</li> <li>Filter : 2.4 kHz</li> <li>[P.AMP] : OFF</li> <li>Set an SSG as : <ul style="list-style-type: none"> <li>Frequency : 14.101500 MHz</li> <li>Level : 160 mV* (-3 dBm)</li> <li>Modulation : 1 kHz/<math>\pm</math>5.0 kHz dev.</li> </ul> </li> <li>Receiving</li> </ul>	MAIN	Connect an oscilloscope to the check point CP1460.	4.0 Vp-p	MAIN	R1469
NOISE BLANKER	1 <ul style="list-style-type: none"> <li>Displayed freq. : 14.100000 MHz</li> <li>Mode : USB</li> <li>[P.AMP] : P.AMP1</li> <li>[NB] : OFF</li> <li>[NB LEVEL] : 50%</li> <li>Set an SSG as : <ul style="list-style-type: none"> <li>Frequency : 14.101500 MHz</li> <li>Level : 18 <math>\mu</math>V* (-82 dBm)</li> <li>Modulation : OFF</li> </ul> </li> <li>and apply following signal to [ANT1] connector.</li> </ul>  <ul style="list-style-type: none"> <li>Preset R200 (MAIN unit) to the 12 o'clock position.</li> <li>Receiving</li> </ul>	MAIN	Connect an oscilloscope to the check point CP200.	Maximum noise level	MAIN	L201, L202, L203
	2 <ul style="list-style-type: none"> <li>[NB] : ON</li> <li>Receiving</li> </ul>					At the point where the voltage just reduces.

\*This output level of a standard signal generator (SSG) is indicated as SSG's open circuit.





## 5-5 ADJUSTMENT MODE





ADJUSTMENT	ADJUSTMENT CONDITION	DISPLAY	OPERATION
ENTERING ADJUSTMENT MODE	1 <ul style="list-style-type: none"> <li>Enter the adjustment mode: <ol style="list-style-type: none"> <li>Turn power OFF.</li> <li>Terminate the [REMOTE] jack with a 3.5(d) mm mini-plug.</li> <li>While pushing [MENU] and [SSB], turn power ON.</li> </ol> </li> </ul>	 D163E 0.70-0 TX RX 1.40-0	Push [F1 (TX)] or [F2 (RX)] to select each adjustment mode.  Once entering adjustment mode, use [F2 (▼)] to skip items, or [F1 (▲)] to return the opening display.
	<b>CAUTION:</b> <b>NEVER</b> select adjustment items [F-1 (TX)] while transceiver is connected to an SSG. Because transceiver automatically transmits when most transmit items in the [F-1 (TX)] is selected.		
TX ADJUSTMENT	1 <ul style="list-style-type: none"> <li>Connect an RF power meter to [ANT1] connector and [ANT144M] connector.</li> <li>Connect a 100 Ω or 25 Ω dummy load to [ANT2] connector.</li> <li>Connect an audio generator to [MIC] connector and set as:  Frequency : 1.5 kHz  Level : 10 mVrms</li> </ul>	 D163E 0.70-0 TX RX 1.40-0	Push [F1 (TX)] to enter the TX adjustment.
	2	 ▲ ▼ chk SET	Push [F5 (SET)] to set and to step next.
	3	 ▲ ▼ chk SET	Set the output power to 10 W using [MAIN DIAL]. Then push [F5 (SET)] to store the "POWER HF Tuner" meter into memory, and to step next.
	4	 ▲ ▼ chk SET	Set the output power to 20 W using [MAIN DIAL]. Then push [F5 (SET)] to store the "POWER HF 20%" meter into memory, and to step next.
	5	 ▲ ▼ chk SET	Set the output power to 50 W using [MAIN DIAL]. Then push [F5 (SET)] to store the "POWER HF 50%" meter into memory, and to step next.
	6	 ▲ ▼ chk SET	Set the output power to 90 W using [MAIN DIAL]. Then push [F5 (SET)] to store the "POWER HF 100%" meter into memory, and to step next.
	7	 ▲ ▼ chk SET	Set the output power to 10 W using [MAIN DIAL]. Then push [F5 (SET)] to store the "POWER 50M Tuner" meter into memory, and to step next.
	8	 ▲ ▼ chk SET	Push [F5 (SET)] to set and to step next.
	9	 ▲ ▼ chk SET	Set the output power to 20 W using [MAIN DIAL]. Then push [F5 (SET)] to store the "POWER 144M 20%" meter into memory, and to step next.
	10	 ▲ ▼ chk SET	Set the output power to 50 W using [MAIN DIAL]. Then push [F5 (SET)] to store the "POWER 144M 50%" meter into memory, and to step next.
	11	 ▲ ▼ chk SET	Set the output power to 90 W using [MAIN DIAL]. Then push [F5 (SET)] to store the "POWER 144M 100%" meter into memory, and to step next.

## ADJUSTMENT MODE—continued

ADJUSTMENT		ADJUSTMENT CONDITION	DISPLAY	OPERATION
TX ADJUSTMENT	11		ALC ▲ ▼ chk SET	Push [F5 (SET)] to set and to step next.
	12		DRIVE HF/50M ▲ ▼ chk SET	Push [F5 (SET)] to set and to step next.
	13		DRIVE 144M ▲ ▼ chk SET	Push [F5 (SET)] to set and to step next.
	14		SWR HF/50M ▲ ▼ chk SET	Push [F5 (SET)] to set and to step next.
	15		SWR 144M-1 ▲ ▼ chk SET	Push [F5 (SET)] to set and to step next.
	16	• Connect a 100 Ω or 25 Ω dummy load to [ANT144M] connector.	SWR 144M-2 ▲ ▼ chk SET	Push [F5 (SET)] to set, then push [F2] to return the opening display.
RX ADJUSTMENT	1	• Connect an SSG to [ANT1] connector.	D163E 0.70-0 TX RX 1.40-0	Push [F2 (RX)] to enter the TX adjustment.
	2	• Set an SSG as: Frequency : 14.151500 MHz Level : 50 μV (-73 dBm) and OFF Modulation : OFF • Connect an AC millivolt meter to [EXT SP] connector with an 8 Ω load. • Receiving	Total Gain ▲ ▼ chk SET	Set the RX total gain to 30 dB level difference between SSG ON and OFF using [MAIN DIAL]. Then push [F5 (SET)] to store into memory, and to step next.
	3	• Set an SSG as: Level : OFF • Receiving	S0 Level ▲ ▼ chk SET	Push [F5 (SET)] to store the “S0” level into memory, and to step next. <b>NOTE:</b> While RX METER adjustment, <b>NEVER</b> change the connected SSG’s level until transceiver emits “Pi Pi” and changes indication.
	4	• Set an SSG as: Level : 50 μV (-73 dBm) Modulation : OFF • Receiving	S9 Level ▲ ▼ chk SET	Push [F5 (SET)] to store the “S9” level into memory, and to step next.
	5	• Set an SSG as : Level : 32 mV (-17 dBm) Modulation : OFF • Receiving	S9+60 Level ▲ ▼ chk SET	Push [F5 (SET)] to store the “S9+60” level into memory, and to step next.

\*This output level of a standard signal generator (SSG) is indicated as SSG’s open circuit.

## ADJUSTMENT MODE—continued

ADJUSTMENT	ADJUSTMENT CONDITION	DISPLAY	OPERATION
RX ADJUSTMENT	6 • Connect an SSG to [ANT 144M] connector and set as: Frequency : 108.021500 MHz Level : 3.2 $\mu$ V (–97 dBm) Modulation : OFF • Receiving	 Tuned BPF-1 ↓      ▾      chk SET	Push [[F5 (SET)]] to tune the “BPF-1”, and to step next.
	7 • Set an SSG as: Frequency : 143.981500 MHz Level : 3.2 $\mu$ V (–97 dBm) Modulation : OFF • Receiving	 Tuned BPF-2 ↓      ▾      chk SET	Push [[F-5 (SET)]] to tune the “BPF-2”, and to step next.
	8 • Set an SSG as: Frequency : 144.021500 MHz Level : 3.2 $\mu$ V (–97 dBm) Modulation : OFF • Receiving	 Tuned BPF-3 ↓      ▾      chk SET	Push [[F-5 (SET)]] to tune the “BPF-3”, and to step next.
	9 • Set an SSG as: Frequency : 173.981500 MHz Level : 3.2 $\mu$ V (–97 dBm) Modulation : OFF • Receiving	 Tuned BPF-4 ↓      ▾      chk SET	Push [[F-5 (SET)]] to tune the “BPF-4”, and return to the opening display.

\*This output level of a standard signal generator (SSG) is indicated as SSG's open circuit.

# SECTION 6

# PARTS LIST

## [FRONT UNIT]

REF NO.	ORDER NO.	DESCRIPTION	
W19	8900009271	CAB	OPC-912A (P1,N22,L70) <TJM>
W20	8900015160	CAB	OPC-916A (P1,N22,L120) <TJM>
W21	8900009271	CAB	OPC-912A (P1,N22,L70) <TJM>
W22	8900009271	CAB	OPC-912A (P1,N22,L70) <TJM>
W24	8900009231	CAB	OPC-908A (P1,N10,L60) <TJM>
W25	8900009660	CAB	OPC-964 (P=1 N=10 L=60)
W26	8900009231	CAB	OPC-908A (P1,N10,L60) <TJM>
W27	8900009231	CAB	OPC-908A (P1,N10,L60) <TJM>
EP1	0880000950	UNI	EX-2500 #01 SENSOR
EP2	6450001230	E.O	HLJ0999-01-480 2
EP3	6450001230	E.O	HLJ0999-01-480 2

## [S-LOGIC UNIT]

REF NO.	ORDER NO.	DESCRIPTION	
IC101	1130013470	S.IC	CD4071BNSR
IC102	1130011130	S.IC	BU4030BF-E2
IC401	1110006250	S.IC	NJM2360AM-TE1-#ZZZB
IC571	1130004171	S.IC	TC4S01F(TE85R,F)
Q301	1530002060	S.TRA	2SC4081 T106 R
Q302	1520000651	S.TRA	2SB1201S-TL-E
Q303	1530003301	S.TRA	2SC3647S-TD-E
Q304	1530003301	S.TRA	2SC3647S-TD-E
D301	1730000591	S.ZEN	RD3.0M-T2B-A B2
D402	1790001471	S.DIO	SB10-05P-TD-E
D573	1750000370	S.DIO	DA221 TL
L301	6180000990	COI	LAL 04NA 101K
L302	6190001191	S.COI	D10F-#A814AY-101K
L303	6190001181	S.COI	#D818HN-1107
L401	6190001201	S.COI	D10F-#A814AY-681K
L402	6190001211	S.COI	D10F-#A814AY-221K
L403	6190001201	S.COI	D10F-#A814AY-681K
L601	6200007031	S.COI	SLF7032T-101MR45-2PF
R1	7210002890	VAR	RK161221005J/RV-308
R2	7030003440	S.RES	ERJ3GEYJ 102 V (1K)
R3	7030003440	S.RES	ERJ3GEYJ 102 V (1K)
R4	7210002890	VAR	RK161221005J/RV-308
R5	7030003440	S.RES	ERJ3GEYJ 102 V (1K)
R6	7030003440	S.RES	ERJ3GEYJ 102 V (1K)
R7	7210003210	VAR	EVU-FLAED7B14
R8	7030003440	S.RES	ERJ3GEYJ 102 V (1K)
R9	7210003210	VAR	EVU-FLAED7B14
R10	7030003440	S.RES	ERJ3GEYJ 102 V (1K)
R11	7210003210	VAR	EVU-FLAED7B14
R12	7030003440	S.RES	ERJ3GEYJ 102 V (1K)
R13	7210003210	VAR	EVU-FLAED7B14
R14	7030003440	S.RES	ERJ3GEYJ 102 V (1K)
R15	7030003540	S.RES	ERJ3GEYJ 682 V (6.8K)
R16	7030003480	S.RES	ERJ3GEYJ 222 V (2.2K)
R17	7030003520	S.RES	ERJ3GEYJ 472 V (4.7K)
R18	7030003580	S.RES	ERJ3GEYJ 153 V (15K)
R101	7030003680	S.RES	ERJ3GEYJ 104 V (100K)
R102	7030003720	S.RES	ERJ3GEYJ 224 V (220K)
R103	7030003680	S.RES	ERJ3GEYJ 104 V (100K)
R104	7030003800	S.RES	ERJ3GEYJ 105 V (1M)
R105	7030003680	S.RES	ERJ3GEYJ 104 V (100K)
R106	7030003720	S.RES	ERJ3GEYJ 224 V (220K)
R107	7030003680	S.RES	ERJ3GEYJ 104 V (100K)
R108	7030003800	S.RES	ERJ3GEYJ 105 V (1M)
R111	7030003580	S.RES	ERJ3GEYJ 153 V (15K)
R112	7030003640	S.RES	ERJ3GEYJ 473 V (47K)
R113	7030003580	S.RES	ERJ3GEYJ 153 V (15K)
R301	7030003540	S.RES	ERJ3GEYJ 682 V (6.8K)
R302	7030003620	S.RES	ERJ3GEYJ 333 V (33K)
R303	7030000300	S.RES	MCR10EZJH 220 (221)
R304	7030003500	S.RES	ERJ3GEYJ 332 V (3.3K)
R305	7030003500	S.RES	ERJ3GEYJ 332 V (3.3K)
R306	7510001380	S.THE	NTCG20 3JH 472JT
R307	7070001280	RES	ERG1SJ 120 (12)
R401	7030004050	S.RES	ERJ3GEYJ 1R0 V (1)
R402	7030004050	S.RES	ERJ3GEYJ 1R0 V (1)
R403	7030006091	S.RES	ERA3YED 822V (8.2K)
R404	7030006461	S.RES	ERA3YED 152V (1.5K)
R571	7030003600	S.RES	ERJ3GEYJ 223 V (22K)
R576	7030003680	S.RES	ERJ3GEYJ 104 V (100K)
C1	4030006880	S.CER	C1608 JB 1H 472K-T
C2	4030006880	S.CER	C1608 JB 1H 472K-T
C3	4030006880	S.CER	C1608 JB 1H 472K-T
C4	4030006880	S.CER	C1608 JB 1H 472K-T
C5	4030006880	S.CER	C1608 JB 1H 472K-T
C6	4030006880	S.CER	C1608 JB 1H 472K-T
C7	4030006880	S.CER	C1608 JB 1H 472K-T
C8	4030006880	S.CER	C1608 JB 1H 472K-T
C9	4030011600	S.CER	C1608 JB 1E 104K-T
C101	4030006860	S.CER	C1608 JB 1H 102K-T
C102	4030006860	S.CER	C1608 JB 1H 102K-T
C111	4030011600	S.CER	C1608 JB 1E 104K-T
C112	4030006860	S.CER	C1608 JB 1H 102K-T
C113	4030006860	S.CER	C1608 JB 1H 102K-T
C114	4030006860	S.CER	C1608 JB 1H 102K-T
C115	4030011600	S.CER	C1608 JB 1E 104K-T
C302	4510008540	S.ELE	EEE1CA100SR
C303	4510008520	S.ELE	EEE1CA470SP
C304	4310001140	MYL	250 MMW 473K EF
C305	4030013860	S.CER	GRM42D1X3F120JY02L(GHM1038 SL)
C306	4510008550	S.ELE	EEE1HA010SR
C307	4510008540	S.ELE	EEE1CA100SR
C401	4030011600	S.CER	C1608 JB 1E 104K-T
C402	4510004591	ELE	16 ME 470 HC
C403	4030011600	S.CER	C1608 JB 1E 104K-T
C404	4510005000	ELE	16 ME 220 HC
C405	4030011280	S.CER	C1608 CH 1H 271J-T
C406	4510008830	S.ELE	EEE1CA221P

M.=Mounted side (T: Mounted on the Top side, B: Mounted on the Bottom side)  
S.=Surface mount

[S-LOGIC UNIT]

REF NO.	ORDER NO.	DESCRIPTION	
C407	4030011600	S.CER C1608 JB 1E 104K-T	
C408	4030011600	S.CER C1608 JB 1E 104K-T	
C409	4510008540	S.ELE EEE1CA100SR	
C571	4510008560	S.ELE EEE1HAR47SR	
C572	4030011600	S.CER C1608 JB 1E 104K-T	
C701	4030007130	S.CER C1608 CH 1H 101J-T	[EUR]
	4030007130	S.CER C1608 CH 1H 101J-T	[FRA]
	4030007130	S.CER C1608 CH 1H 101J-T	[DEN]
	4030007130	S.CER C1608 CH 1H 101J-T	[ITR]
	4030007130	S.CER C1608 CH 1H 101J-T	[ESP]
C702	4030007130	S.CER C1608 CH 1H 101J-T	[EUR]
	4030007130	S.CER C1608 CH 1H 101J-T	[FRA]
	4030007130	S.CER C1608 CH 1H 101J-T	[DEN]
	4030007130	S.CER C1608 CH 1H 101J-T	[ITR]
	4030007130	S.CER C1608 CH 1H 101J-T	[ESP]
C703	4030007130	S.CER C1608 CH 1H 101J-T	[EUR]
	4030007130	S.CER C1608 CH 1H 101J-T	[FRA]
	4030007130	S.CER C1608 CH 1H 101J-T	[DEN]
	4030007130	S.CER C1608 CH 1H 101J-T	[ITR]
	4030007130	S.CER C1608 CH 1H 101J-T	[ESP]
C704	4030007130	S.CER C1608 CH 1H 101J-T	[EUR]
	4030007130	S.CER C1608 CH 1H 101J-T	[FRA]
	4030007130	S.CER C1608 CH 1H 101J-T	[DEN]
	4030007130	S.CER C1608 CH 1H 101J-T	[ITR]
	4030007130	S.CER C1608 CH 1H 101J-T	[ESP]
C705	4030007130	S.CER C1608 CH 1H 101J-T	
J301	6510019991	S.CON 52808-2271(2291)	
J302	6510019991	S.CON 52808-2271(2291)	
J303	6510003401	CON B04B-EH-S(LF)(SN)	[EUR]
	6510003401	CON B04B-EH-S(LF)(SN)	[FRA]
	6510003400	CON B04B-EH-S	[DEN]
	6510003401	CON B04B-EH-S(LF)(SN)	[ITR]
	6510003401	CON B04B-EH-S(LF)(SN)	[ESP]
	6510003400	CON B04B-EH-S	[KOR]
J501	6510019971	S.CON 52808-1071	
J502	6510019971	S.CON 52808-1071	
J507	6510019971	S.CON 52808-1071	
J508	6510019971	S.CON 52808-1071	
J601	6510019991	S.CON 52808-2271(2291)	
J604	6510003401	CON B04B-EH-S(LF)(SN)	[EUR]
	6510003401	CON B04B-EH-S(LF)(SN)	[FRA]
	6510003400	CON B04B-EH-S	[DEN]
	6510003401	CON B04B-EH-S(LF)(SN)	[ITR]
	6510003401	CON B04B-EH-S(LF)(SN)	[ESP]
	6510003400	CON B04B-EH-S	[KOR]
S1	2260001890	S.SWI SKQDPA	
S2	2260001890	S.SWI SKQDPA	
S3	2260001890	S.SWI SKQDPA	
S4	2260001890	S.SWI SKQDPA	
S5	2260001890	S.SWI SKQDPA	
S6	2260001890	S.SWI SKQDPA	
S7	2260001890	S.SWI SKQDPA	
S8	2260001890	S.SWI SKQDPA	
S9	2260001890	S.SWI SKQDPA	
S10	2260001890	S.SWI SKQDPA	
S11	2260001890	S.SWI SKQDPA	
S601	2260001890	S.SWI SKQDPA	
EP701	6910013310	S.BEA MMZ1608D121B	
EP703	6910013310	S.BEA MMZ1608D121B	

[PHONE UNIT]

REF NO.	ORDER NO.	DESCRIPTION	
L1	6200003950	S.COI HF50ACC 322513-T	
L2	6200003950	S.COI HF50ACC 322513-T	
R1	7030006240	S.RES ERJ12YJ181U (180)	
R2	7030006240	S.RES ERJ12YJ181U (180)	
R3	7030003440	S.RES ERJ3GEYJ 102 V (1K)	
C1	4030006880	S.CER C1608 JB 1H 472K-T	
C2	4030006880	S.CER C1608 JB 1H 472K-T	
C3	4030006880	S.CER C1608 JB 1H 472K-T	
J1	6450001891	CON HLJ2305-0130909	
J2	6450001791	CON HLJ7000-016010	
J3	6510019971	S.CON 52808-1071	

M.=Mounted side (T: Mounted on the Top side, B: Mounted on the Bottom side)  
S.=Surface mount

**[MIC UNIT]**

REF NO.	ORDER NO.	DESCRIPTION
L1	6200003261	S.COI NLV32T-101J
L3	6200003261	S.COI NLV32T-101J
L4	6200003261	S.COI NLV32T-101J
L6	6200003261	S.COI NLV32T-101J
C1	4030006880	S.CER C1608 JB 1H 472K-T
C2	4030006880	S.CER C1608 JB 1H 472K-T
C3	4030006880	S.CER C1608 JB 1H 472K-T
C4	4030006880	S.CER C1608 JB 1H 472K-T
C5	4030006880	S.CER C1608 JB 1H 472K-T
C6	4030006880	S.CER C1608 JB 1H 472K-T
C7	4030007130	S.CER C1608 CH 1H 101J-T
J1	6510000191	CON FM214-8SS(P)-1
J2	6510019971	S.CON 52808-1071

**[MODE UNIT]**

REF NO.	ORDER NO.	DESCRIPTION
J1	6510019991	S.CON 52808-2271(2291)

M.=Mounted side (T: Mounted on the Top side, B: Mounted on the Bottom side)  
S.=Surface mount

[TEN-KEY UNIT]

REF NO.	ORDER NO.	DESCRIPTION
R1	7030003540	S.RES ERJ3GEYJ 682 V (6.8K)
R2	7030003540	S.RES ERJ3GEYJ 682 V (6.8K)
R3	7030003540	S.RES ERJ3GEYJ 682 V (6.8K)
R4	7030003480	S.RES ERJ3GEYJ 222 V (2.2K)
R5	7030003480	S.RES ERJ3GEYJ 222 V (2.2K)
R6	7030003480	S.RES ERJ3GEYJ 222 V (2.2K)
R7	7030003520	S.RES ERJ3GEYJ 472 V (4.7K)
R8	7030003520	S.RES ERJ3GEYJ 472 V (4.7K)
R9	7030003520	S.RES ERJ3GEYJ 472 V (4.7K)
R10	7030003580	S.RES ERJ3GEYJ 153 V (15K)
R11	7030003580	S.RES ERJ3GEYJ 153 V (15K)
R12	7030003580	S.RES ERJ3GEYJ 153 V (15K)
R15	7030003540	S.RES ERJ3GEYJ 682 V (6.8K)
R16	7030003480	S.RES ERJ3GEYJ 222 V (2.2K)
R17	7030003520	S.RES ERJ3GEYJ 472 V (4.7K)
R18	7030003580	S.RES ERJ3GEYJ 153 V (15K)
R19	7030003540	S.RES ERJ3GEYJ 682 V (6.8K)
R20	7030003480	S.RES ERJ3GEYJ 222 V (2.2K)
R21	7030003520	S.RES ERJ3GEYJ 472 V (4.7K)
R22	7030003580	S.RES ERJ3GEYJ 153 V (15K)
R23	7030003540	S.RES ERJ3GEYJ 682 V (6.8K)
R24	7030003480	S.RES ERJ3GEYJ 222 V (2.2K)
R25	7030003520	S.RES ERJ3GEYJ 472 V (4.7K)
C1	4030011600	S.CER C1608 JB 1E 104K-T
C2	4030011600	S.CER C1608 JB 1E 104K-T
C3	4030011600	S.CER C1608 JB 1E 104K-T
C4	4030011600	S.CER C1608 JB 1E 104K-T
C5	4030011600	S.CER C1608 JB 1E 104K-T
C7	4030011600	S.CER C1608 JB 1E 104K-T
J1	6510019991	S.CON 52808-2271(2291)
DS1	5040002360	S.LED CL-220HR-C-TU
DS2	5040002220	S.LED CL-220YG-C-TU
DS3	5040002360	S.LED CL-220HR-C-TU
DS4	5040002220	S.LED CL-220YG-C-TU
DS5	5040002220	S.LED CL-220YG-C-TU

[PBT UNIT]

REF NO.	ORDER NO.	DESCRIPTION
R2	7030003560	S.RES ERJ3GEYJ 103 V (10K)
R3	7030003560	S.RES ERJ3GEYJ 103 V (10K)
R4	7030003560	S.RES ERJ3GEYJ 103 V (10K)
R5	7030003560	S.RES ERJ3GEYJ 103 V (10K)
R6	7030003560	S.RES ERJ3GEYJ 103 V (10K)
R7	7030003560	S.RES ERJ3GEYJ 103 V (10K)
J1	6510019971	S.CON 52808-1071
S1	2250000440	ENC TP90N00E20-22.5F-2494
S2	2250000410	ENC TP90D96E20-30F-2178-1

M.=Mounted side (T: Mounted on the Top side, B: Mounted on the Bottom side)  
S.=Surface mount



[RIT UNIT]

REF NO.	ORDER NO.	DESCRIPTION
J1	6510019971	S.CON 52808-1071
S1	2250000340	ENC EVQ-VCJF0324B

[DISPLAY UNIT]

REF NO.	ORDER NO.	DESCRIPTION
IC1001	1140010372	S.IC HD6433833SD95HV(SX-2494C-1)
IC1002	1130007810	S.IC BU4051BCF-E2
IC1005	1110000960	S.IC NJM4558M-TE1-#FMZB
IC1006	1130009121	S.IC S1D15206F00A200
IC1007	1130014400	S.IC T6B66BFG(C)
IC1008	1130014390	S.IC T6B65AFG(C)
IC1009	1130014390	S.IC T6B65AFG(C)
IC1013	1110000960	S.IC NJM4558M-TE1-#FMZB
D1001	1790001251	S.DIO MA2S1110GL
D1002	1790001251	S.DIO MA2S1110GL
D1003	1750000370	S.DIO DA221 TL
D1004	1750000370	S.DIO DA221 TL
X1001	6050009870	S.XTA CR-567 SMD-49 9.8304 MHz <KDS>
R531	7030003440	S.RES ERJ3GEYJ 102 V (1K)
R532	7030003440	S.RES ERJ3GEYJ 102 V (1K)
R533	7030003440	S.RES ERJ3GEYJ 102 V (1K)
R534	7030003440	S.RES ERJ3GEYJ 102 V (1K)
R535	7030003440	S.RES ERJ3GEYJ 102 V (1K)
R536	7030003440	S.RES ERJ3GEYJ 102 V (1K)
R537	7030003440	S.RES ERJ3GEYJ 102 V (1K)
R538	7030003440	S.RES ERJ3GEYJ 102 V (1K)
R539	7030003440	S.RES ERJ3GEYJ 102 V (1K)
R540	7030003480	S.RES ERJ3GEYJ 222 V (2.2K)
R541	7030003420	S.RES ERJ3GEYJ 681 V (680)
R542	7030003480	S.RES ERJ3GEYJ 222 V (2.2K)
R543	7030003420	S.RES ERJ3GEYJ 681 V (680)
R544	7030003420	S.RES ERJ3GEYJ 681 V (680)
R551	7030003540	S.RES ERJ3GEYJ 682 V (6.8K)
R552	7030003480	S.RES ERJ3GEYJ 222 V (2.2K)
R553	7030003520	S.RES ERJ3GEYJ 472 V (4.7K)
R554	7030003580	S.RES ERJ3GEYJ 153 V (15K)
R555	7030003440	S.RES ERJ3GEYJ 102 V (1K)
R556	7030003440	S.RES ERJ3GEYJ 102 V (1K)
R557	7030003440	S.RES ERJ3GEYJ 102 V (1K)
R558	7030003440	S.RES ERJ3GEYJ 102 V (1K)
R559	7030003440	S.RES ERJ3GEYJ 102 V (1K)
R560	7030003440	S.RES ERJ3GEYJ 102 V (1K)
R1001	7030003800	S.RES ERJ3GEYJ 105 V (1M)
R1002	7030003680	S.RES ERJ3GEYJ 104 V (100K)
R1003	7030003680	S.RES ERJ3GEYJ 104 V (100K)
R1004	7030003680	S.RES ERJ3GEYJ 104 V (100K)
R1005	7030003680	S.RES ERJ3GEYJ 104 V (100K)
R1006	7030003680	S.RES ERJ3GEYJ 104 V (100K)
R1007	7030003560	S.RES ERJ3GEYJ 103 V (10K)
R1008	7030003560	S.RES ERJ3GEYJ 103 V (10K)
R1009	7030003700	S.RES ERJ3GEYJ 154 V (150K)
R1012	7030003680	S.RES ERJ3GEYJ 104 V (100K)
R1013	7030003400	S.RES ERJ3GEYJ 471 V (470)
R1014	7030003710	S.RES ERJ3GEYJ 184 V (180K)
R1017	7030003680	S.RES ERJ3GEYJ 104 V (100K)
R1018	7030003400	S.RES ERJ3GEYJ 471 V (470)
R1019	7030003520	S.RES ERJ3GEYJ 472 V (4.7K)
R1020	7030003520	S.RES ERJ3GEYJ 472 V (4.7K)
R1021	7030003520	S.RES ERJ3GEYJ 472 V (4.7K)
R1022	7030003520	S.RES ERJ3GEYJ 472 V (4.7K)
R1036	7030003810	S.RES ERJ3GEYJ 125 V (1.2M)
R1037	7030003840	S.RES ERJ3GEYJ 225 V (2.2M)
R1038	7030003790	S.RES ERJ3GEYJ 824 V (820K)
R1039	7030003650	S.RES ERJ3GEYJ 563 V (56K)
R1040	7030003800	S.RES ERJ3GEYJ 105 V (1M)
R1041	7030003840	S.RES ERJ3GEYJ 225 V (2.2M)
R1042	7030003790	S.RES ERJ3GEYJ 824 V (820K)
R1043	7030003650	S.RES ERJ3GEYJ 563 V (56K)
R1044	7030003560	S.RES ERJ3GEYJ 103 V (10K)
R1045	7030003520	S.RES ERJ3GEYJ 472 V (4.7K)
R1046	7510001420	S.THE NTCG20 3SH 223JT
R1047	7030003680	S.RES ERJ3GEYJ 104 V (100K)
R1048	7030003640	S.RES ERJ3GEYJ 473 V (47K)
R1049	7030003720	S.RES ERJ3GEYJ 224 V (220K)
R1050	7030003620	S.RES ERJ3GEYJ 333 V (33K)
R1053	7030003640	S.RES ERJ3GEYJ 473 V (47K)
R1054	7030003640	S.RES ERJ3GEYJ 473 V (47K)
R1055	7030003640	S.RES ERJ3GEYJ 473 V (47K)
R1056	7030003640	S.RES ERJ3GEYJ 473 V (47K)
R1058	7030003680	S.RES ERJ3GEYJ 104 V (100K)
R1101	7030003440	S.RES ERJ3GEYJ 102 V (1K)
R1102	7030003440	S.RES ERJ3GEYJ 102 V (1K)
R1103	7030003440	S.RES ERJ3GEYJ 102 V (1K)
R1104	7030003440	S.RES ERJ3GEYJ 102 V (1K)
R1105	7030003440	S.RES ERJ3GEYJ 102 V (1K)
R1106	7030003440	S.RES ERJ3GEYJ 102 V (1K)
R1107	7030003440	S.RES ERJ3GEYJ 102 V (1K)
R1108	7030003440	S.RES ERJ3GEYJ 102 V (1K)
R1109	7030003440	S.RES ERJ3GEYJ 102 V (1K)
R1110	7030003440	S.RES ERJ3GEYJ 102 V (1K)
R1111	7030003440	S.RES ERJ3GEYJ 102 V (1K)
R1112	7030003440	S.RES ERJ3GEYJ 102 V (1K)
R1113	7030003440	S.RES ERJ3GEYJ 102 V (1K)
R1114	7030003440	S.RES ERJ3GEYJ 102 V (1K)
R1115	7030003440	S.RES ERJ3GEYJ 102 V (1K)
R1116	7030003640	S.RES ERJ3GEYJ 473 V (47K)
R1117	7030003640	S.RES ERJ3GEYJ 473 V (47K)
R1118	7030003480	S.RES ERJ3GEYJ 222 V (2.2K)
R1119	7030003440	S.RES ERJ3GEYJ 102 V (1K)
R1120	7030003440	S.RES ERJ3GEYJ 102 V (1K)
R1121	7030003440	S.RES ERJ3GEYJ 102 V (1K)
R1122	7030003440	S.RES ERJ3GEYJ 102 V (1K)
R1123	7030003440	S.RES ERJ3GEYJ 102 V (1K)

M.=Mounted side (T: Mounted on the Top side, B: Mounted on the Bottom side)  
S.=Surface mount

## [DISPLAY UNIT]

REF NO.	ORDER NO.	DESCRIPTION
R1131	7030003440	S.RES ERJ3GEYJ 102 V (1K)
R1132	7030003680	S.RES ERJ3GEYJ 104 V (100K)
R1133	7030003440	S.RES ERJ3GEYJ 102 V (1K)
R1134	7030003440	S.RES ERJ3GEYJ 102 V (1K)
R1135	7030003440	S.RES ERJ3GEYJ 102 V (1K)
R1136	7030003640	S.RES ERJ3GEYJ 473 V (47K)
R1137	7030003440	S.RES ERJ3GEYJ 102 V (1K)
R1138	7030003640	S.RES ERJ3GEYJ 473 V (47K)
R1201	7030003440	S.RES ERJ3GEYJ 102 V (1K)
R1202	7030003440	S.RES ERJ3GEYJ 102 V (1K)
R1203	7030003440	S.RES ERJ3GEYJ 102 V (1K)
R1204	7030003440	S.RES ERJ3GEYJ 102 V (1K)
R1205	7030003440	S.RES ERJ3GEYJ 102 V (1K)
R1206	7030003440	S.RES ERJ3GEYJ 102 V (1K)
R1207	7030003440	S.RES ERJ3GEYJ 102 V (1K)
R1208	7030003440	S.RES ERJ3GEYJ 102 V (1K)
R1209	7030003670	S.RES ERJ3GEY 823 V (82K)
R1210	7030003860	S.RES ERJ3GE JPW V
R1211	7030003730	S.RES ERJ3GEYJ 274 V (270K)
W1020	7030003860	S.RES ERJ3GE JPW V
C531	4030006880	S.CER C1608 JB 1H 472K-T
C532	4030006880	S.CER C1608 JB 1H 472K-T
C533	4030006880	S.CER C1608 JB 1H 472K-T
C534	4030006880	S.CER C1608 JB 1H 472K-T
C535	4030006880	S.CER C1608 JB 1H 472K-T
C536	4030006880	S.CER C1608 JB 1H 472K-T
C537	4030006880	S.CER C1608 JB 1H 472K-T
C538	4030006880	S.CER C1608 JB 1H 472K-T
C539	4030006880	S.CER C1608 JB 1H 472K-T
C540	4030006880	S.CER C1608 JB 1H 472K-T
C541	4030006880	S.CER C1608 JB 1H 472K-T
C542	4030006880	S.CER C1608 JB 1H 472K-T
C543	4030006880	S.CER C1608 JB 1H 472K-T
C544	4030006880	S.CER C1608 JB 1H 472K-T
C551	4030011600	S.CER C1608 JB 1E 104K-T
C552	4030006880	S.CER C1608 JB 1H 472K-T
C553	4030006880	S.CER C1608 JB 1H 472K-T
C554	4030006880	S.CER C1608 JB 1H 472K-T
C555	4030006880	S.CER C1608 JB 1H 472K-T
C556	4030006880	S.CER C1608 JB 1H 472K-T
C557	4030006880	S.CER C1608 JB 1H 472K-T
C1001	4030011600	S.CER C1608 JB 1E 104K-T
C1002	4030007020	S.CER C1608 CH 1H 120J-T
C1003	4030007020	S.CER C1608 CH 1H 120J-T
C1004	4030011600	S.CER C1608 JB 1E 104K-T
C1005	4030011600	S.CER C1608 JB 1E 104K-T
C1006	4030011600	S.CER C1608 JB 1E 104K-T
C1009	4510008540	S.ELE EEE1CA100SR
C1010	4510008540	S.ELE EEE1CA100SR
C1011	4030011600	S.CER C1608 JB 1E 104K-T
C1012	4030011600	S.CER C1608 JB 1E 104K-T
C1013	4030011600	S.CER C1608 JB 1E 104K-T
C1014	4030011600	S.CER C1608 JB 1E 104K-T
C1015	4550006250	S.TAN TEESVA 1A 106M8R
C1101	4030006880	S.CER C1608 JB 1H 472K-T
C1201	4030006880	S.CER C1608 JB 1H 472K-T
C1202	4030006880	S.CER C1608 JB 1H 472K-T
C1203	4030006880	S.CER C1608 JB 1H 472K-T
C1204	4030006880	S.CER C1608 JB 1H 472K-T
C1205	4030006880	S.CER C1608 JB 1H 472K-T
C1206	4030006880	S.CER C1608 JB 1H 472K-T
C1207	4030006880	S.CER C1608 JB 1H 472K-T
C1208	4030006880	S.CER C1608 JB 1H 472K-T
J503	6510019991	S.CON 52808-2271(2291)
J505	6510019991	S.CON 52808-2271(2291)
J1001	6510019991	S.CON 52808-2271(2291)
J1002	6510019991	S.CON 52808-2271(2291)
DS1001	5030002150	LCD DLC-83006S4GT
DS1002	5080000420	CFL HMB S 3 A1W 70N/AZ ASSY
EP1	8930046361	LCD SRCN-2072-SP-N-W-1 (SHJ)

## [RF UNIT]

REF NO.	ORDER NO.	DESCRIPTION
WS1	8970023952	SX2494 1.5+0.8DB (3)RF
IC151	1110001890	S.IC UPC1678G-E2
IC161	1110004101	S.IC TA4001F (TE85L,F)
IC191	1110003970	S.IC UPC1658G-E1
IC321	1130011760	S.IC CD4094BPWR
IC322	1130011760	S.IC CD4094BPWR
IC323	1160000131	S.IC TD62783AFG(5,S,EL)
IC324	1160000131	S.IC TD62783AFG(5,S,EL)
IC1001	1130011760	S.IC CD4094BPWR
IC1051	1180000421	S.IC TA78L05F(TE12R,F)
IC1081	1130006441	S.IC TC7S08F(TE85R,F)
IC1101	1140007881	S.IC TC190G08EFG0046JDZ/SC1246A
IC1102	1130006441	S.IC TC7S08F(TE85R,F)
IC1601	1140014960	S.IC TC190G02EFG-0058/SC1287A
IC1801	1110005220	S.IC MC145170D2R2
IC1802	1110001890	S.IC UPC1678G-E2
Q1	1590002310	S.TRA DTC114EE TL
Q2	1590002310	S.TRA DTC114EE TL
Q121	1590002310	S.TRA DTC114EE TL
Q161	1590001870	S.TRA DTA114EE TL
Q162	1590002310	S.TRA DTC114EE TL
Q163	1590002310	S.TRA DTC114EE TL
Q181	1560000721	S.FET 2SK2171-4-TD-E
Q182	1560000721	S.FET 2SK2171-4-TD-E
Q211	1560000641	S.FET 2SK1740-4/5-TB-E
Q212	1560000641	S.FET 2SK1740-4/5-TB-E
Q231	1560000721	S.FET 2SK2171-4-TD-E
Q241	1580000620	S.FET 3SK131-T2 MAS
Q242	1590001870	S.TRA DTA114EE TL
Q243	1590002310	S.TRA DTC114EE TL
Q271	1560000561	S.FET 2SK882-GR(TE85L,F)
Q301	1530003151	S.TRA 2SC4673D-TD-E
Q302	1590001870	S.TRA DTA114EE TL
Q303	1590002310	S.TRA DTC114EE TL
Q324	1590002310	S.TRA DTC114EE TL
Q325	1590002310	S.TRA DTC114EE TL
Q328	1590002310	S.TRA DTC114EE TL
Q501	1590002310	S.TRA DTC114EE TL
Q502	1580000450	S.FET 3SK177-T1 U72
Q541	1590002420	S.TRA UMD3N TR
Q1003	1590002420	S.TRA UMD3N TR
Q1051	1530002060	S.TRA 2SC4081 T106 R
Q1101	1530002060	S.TRA 2SC4081 T106 R
Q1102	1530002060	S.TRA 2SC4081 T106 R
Q1103	1530002060	S.TRA 2SC4081 T106 R
Q1201	1560000491	S.FET 2SK508-T2B-A K52
Q1202	1530003091	S.TRA 2SC4213-B(TE85R,F)
Q1221	1560000491	S.FET 2SK508-T2B-A K52
Q1222	1530003091	S.TRA 2SC4213-B(TE85R,F)
Q1241	1560000491	S.FET 2SK508-T2B-A K52
Q1242	1530003091	S.TRA 2SC4213-B(TE85R,F)
Q1261	1560000491	S.FET 2SK508-T2B-A K52
Q1262	1530003091	S.TRA 2SC4213-B(TE85R,F)
Q1281	1530002571	S.TRA 2SC4405-3-TL-E
Q1301	1560000331	S.FET 2SK210-GR(TE85R,F)
Q1302	1530002060	S.TRA 2SC4081 T106 R
Q1401	1530002920	S.TRA 2SC4226-T1 R25
Q1402	1590001870	S.TRA DTA114EE TL
Q1521	1590002420	S.TRA UMD3N TR
Q1561	1590002420	S.TRA UMD3N TR
Q1581	1590002420	S.TRA UMD3N TR
Q1601	1530002060	S.TRA 2SC4081 T106 R
Q1801	1590002420	S.TRA UMD3N TR
Q1901	1530002561	S.TRA 2SC4403-3-TL-E
Q1902	1530002060	S.TRA 2SC4081 T106 R
Q1903	1530002060	S.TRA 2SC4081 T106 R
Q1904	1530002561	S.TRA 2SC4403-3-TL-E
Q2003	1590000720	S.TRA DTA144EUA T106
Q2004	1590000720	S.TRA DTA144EUA T106
Q2005	1590000720	S.TRA DTA144EUA T106
D1	1750000351	S.DIO 1SV252(TE85L,F)
D2	1750000351	S.DIO 1SV252(TE85L,F)
D3	1750000851	S.DIO MMBV3700LT1G
D4	1750000851	S.DIO MMBV3700LT1G
D11	1790000620	S.DIO MA77(TX)
D21	1750000851	S.DIO MMBV3700LT1G
D22	1790000620	S.DIO MA77(TX)
D31	1750000851	S.DIO MMBV3700LT1G
D32	1790000620	S.DIO MA77(TX)
D41	1750000851	S.DIO MMBV3700LT1G
D42	1790000620	S.DIO MA77(TX)
D51	1750000851	S.DIO MMBV3700LT1G
D52	1790000620	S.DIO MA77(TX)
D61	1750000851	S.DIO MMBV3700LT1G
D62	1790000620	S.DIO MA77(TX)
D71	1750000851	S.DIO MMBV3700LT1G
D72	1790000620	S.DIO MA77(TX)
D81	1750000851	S.DIO MMBV3700LT1G
D82	1790000620	S.DIO MA77(TX)
D91	1750000851	S.DIO MMBV3700LT1G
D92	1790000620	S.DIO MA77(TX)
D101	1750000851	S.DIO MMBV3700LT1G
D102	1790000620	S.DIO MA77(TX)
D111	1750000851	S.DIO MMBV3700LT1G
D112	1790000620	S.DIO MA77(TX)
D121	1750000301	S.DIO 1SS302(TE85R,F)
D122	1750000301	S.DIO 1SS302(TE85R,F)
D123	1790000620	S.DIO MA77(TX)

M.=Mounted side (T: Mounted on the Top side, B: Mounted on the Bottom side)  
S.=Surface mount

[RF UNIT]

REF NO.	ORDER NO.	DESCRIPTION	
D124	1790000620	S.DIO	MA77(TX)
D136	1790000620	S.DIO	MA77(TX)
D137	1790000620	S.DIO	MA77(TX)
D151	1750000441	S.DIO	1SV263-TL-E
D152	1790001261	S.DIO	MA2S077G0L
D153	1790001261	S.DIO	MA2S077G0L
D154	1790001261	S.DIO	MA2S077G0L
D161	1790000620	S.DIO	MA77(TX)
D162	1790000620	S.DIO	MA77(TX)
D163	1790000620	S.DIO	MA77(TX)
D164	1750000520	S.DIO	DAN222TL
D165	1750000520	S.DIO	DAN222TL
D171	1790000620	S.DIO	MA77(TX)
D172	1790000620	S.DIO	MA77(TX)
D181	1790000620	S.DIO	MA77(TX)
D182	1790000620	S.DIO	MA77(TX)
D183	1790000620	S.DIO	MA77(TX)
D184	1790000620	S.DIO	MA77(TX)
D211	1790000620	S.DIO	MA77(TX)
D251	1790000620	S.DIO	MA77(TX)
D252	1790000620	S.DIO	MA77(TX)
D253	1790000620	S.DIO	MA77(TX)
D254	1790000620	S.DIO	MA77(TX)
D255	1790000620	S.DIO	MA77(TX)
D256	1790000620	S.DIO	MA77(TX)
D261	1750000431	S.DIO	HSB88WSTR-E
D271	1750000431	S.DIO	HSB88WSTR-E
D272	1750000531	S.DIO	1SV271(TPH3,F)
D281	1790000620	S.DIO	MA77(TX)
D301	1790000620	S.DIO	MA77(TX)
D302	1790000620	S.DIO	MA77(TX)
D303	1790000620	S.DIO	MA77(TX)
D304	1790000620	S.DIO	MA77(TX)
D305	1790000620	S.DIO	MA77(TX)
D306	1790000620	S.DIO	MA77(TX)
D307	1750000520	S.DIO	DAN222TL
D308	1790000620	S.DIO	MA77(TX)
D501	1720000681	S.VAR	1SV262(TPH2,F)
D502	1720000681	S.VAR	1SV262(TPH2,F)
D503	1720000681	S.VAR	1SV262(TPH2,F)
D504	1720000681	S.VAR	1SV262(TPH2,F)
D541	1790000620	S.DIO	MA77(TX)
D542	1750000741	S.VAR	1SV314(TPH3,F)
D543	1790000620	S.DIO	MA77(TX)
D544	1750000741	S.VAR	1SV314(TPH3,F)
D545	1790000620	S.DIO	MA77(TX)
D546	1750000741	S.VAR	1SV314(TPH3,F)
D547	1790000620	S.DIO	MA77(TX)
D548	1750000741	S.VAR	1SV314(TPH3,F)
D1003	1750000520	S.DIO	DAN222TL
D1004	1750000520	S.DIO	DAN222TL
D1201	1790000540	S.VAR	MA338(TX)
D1221	1790000540	S.VAR	MA338(TX)
D1241	1720000831	S.VAR	KV1770STL-G
D1261	1720000831	S.VAR	KV1770STL-G
D1301	1720000590	S.VAR	MA357(TX)
D1302	1790000491	S.DIO	HSM88ASTR-E
D1303	1790000491	S.DIO	HSM88ASTR-E
D1401	1750000231	S.DIO	1SS315(TPH3,F)
D1402	1790000620	S.DIO	MA77(TX)
D1403	1750000231	S.DIO	1SS315(TPH3,F)
D1502	1750000211	S.DIO	1SV237(TE85R,F)
D1503	1790000620	S.DIO	MA77(TX)
D1504	1750000211	S.DIO	1SV237(TE85R,F)
D1505	1750000520	S.DIO	DAN222TL
D1801	1790000620	S.DIO	MA77(TX)
D1901	1720000590	S.VAR	MA357(TX)
FI231	2010002470	XTA	64M15B1 64.45500 MHz (FL-315)
FI1101	2020001690	S.CER	SFECY10M8TF00-R0 (CFEC10.8MD11)
X1901	6050007351	XTA	CR-337A HC-49/U 32.000 MHz
L1	6200003241	S.COI	NLV32T-221J
L2	6200003241	S.COI	NLV32T-221J
L3	6180000860	COI	LAL 03NA 5R6K
L4	6180000850	COI	LAL 03NA 4R7K
L5	6200009690	S.COI	LQH43CN101K03L
L6	6200009690	S.COI	LQH43CN101K03L
L11	6180000680	COI	LAL 02NA 4R7K
L12	6180001900	COI	LAL 02NA 6R8K
L14	6200003241	S.COI	NLV32T-221J
L21	6180001860	COI	LAL 02NA 3R9K
L22	6180001300	COI	LAL 02NA 100K
L23	6180001860	COI	LAL 02NA 3R9K
L31	6180002380	COI	LAL 02NA 2R2K
L32	6180001940	COI	LAL 02NA 3R3K
L33	6180002380	COI	LAL 02NA 2R2K
L41	6180002300	COI	LAL 02NA 1R2K
L42	6180003270	COI	LAL 02NA 2R7K
L43	6180002300	COI	LAL 02NA 1R2K
L51	6180002190	COI	LAL 02NA R47K
L52	6180002380	COI	LAL 02NA 2R2K
L53	6180002190	COI	LAL 02NA R47K
L61	6180002520	COI	LAL 02NA R27K
L62	6180002380	COI	LAL 02NA 2R2K
L63	6180002520	COI	LAL 02NA R27K
L71	6180000670	COI	LAL 02NA R22K
L72	6180002791	COI	EL0606SKI-1R2J-PF
L73	6180000670	COI	LAL 02NA R22K

[RF UNIT]

REF NO.	ORDER NO.	DESCRIPTION	
L81	6200001471	S.COI	NLV32T-R12J
L82	6180002781	COI	EL0606SKI-1R0J-PF
L83	6200001471	S.COI	NLV32T-R12J
L91	6200001831	S.COI	NLV32T-100J
L92	6200008410	S.COI	LQH31HNR21J03L
L93	6200008100	S.COI	LQH31HNR14J03L
L94	6200008100	S.COI	LQH31HNR14J03L
L95	6200008100	S.COI	LQH31HNR14J03L
L96	6200008100	S.COI	LQH31HNR14J03L
L101	6200003011	S.COI	NLV32T-R27J
L102	6200003001	S.COI	NLV32T-R22J
L103	6200003011	S.COI	NLV32T-R27J
L112	6200003421	S.COI	NLV32T-R15J
L113	6200003421	S.COI	NLV32T-R15J
L114	6200003421	S.COI	NLV32T-R15J
L115	6200003331	S.COI	NLV32T-1R0J
L121	6200003440	S.COI	ELJNC 39NK-F
L122	6200004741	S.COI	NLV25T-1R2J
L128	6200002150	S.COI	ELJNC 56NK-F
L129	6200004741	S.COI	NLV25T-1R2J
L151	6200003241	S.COI	NLV32T-221J
L152	6200001711	S.COI	NLV32T-220J
L160	6200009351	S.COI	ELJRE R22GFA
L171	6200003241	S.COI	NLV32T-221J
L172	6200003261	S.COI	NLV32T-101J
L180	6200001981	S.COI	NLV25T-1R0J
L181	6140003530	COI	LR-395
L182	6180000850	COI	LAL 03NA 4R7K
L183	6180000850	COI	LAL 03NA 4R7K
L184	6140003690	COI	LR-408A
L191	6200003261	S.COI	NLV32T-101J
L192	6200003261	S.COI	NLV32T-101J
L210	6200012460	S.COI	0.30-1.7-8TL 54N <COMO>
L211	6200013000	S.COI	0.25-1.9-13TL 135N <COMO>
L212	6200013000	S.COI	0.25-1.9-13TL 135N <COMO>
L213	6140003530	COI	LR-395
L214	6200003431	S.COI	NLV32T-R10J
L215	6150005160	COI	LS-544
L216	6200003331	S.COI	NLV32T-1R0J
L217	6200001981	S.COI	NLV25T-1R0J
L231	6200005011	S.COI	NLV25T-100J
L232	6200010080	S.COI	LQH31HNR50J03L
L233	6200001981	S.COI	NLV25T-1R0J
L241	6150004280	COI	LS-484B (C-14927)
L242	6150004280	COI	LS-484B (C-14927)
L251	6150005110	COI	LS-540
L252	6150004270	COI	LS-483A (C-14924)
L253	6150005110	COI	LS-540
L261	6140002810	S.COI	LR-317
L262	6140003530	COI	LR-395
L263	6200003041	S.COI	NLV32T-R68J
L271	6200005190	S.COI	MLF1608D R56K-T
L272	6150000991	COI	LS-424
L285	6200004021	S.COI	NLV32T-039J
L286	6180002981	S.COI	NLV32T-056J
L288	6200003421	S.COI	NLV32T-R15J
L289	6140003210	S.COI	LR-358
L290	6140003210	S.COI	LR-358
L301	6200003001	S.COI	NLV32T-R22J
L302	6200003021	S.COI	NLV32T-R33J
L303	6200003331	S.COI	NLV32T-1R0J
L304	6200001760	S.COI	ELJNC 22NK-F
L305	6200002581	S.COI	NLV25T-033J
L306	6200001770	S.COI	ELJNC 47NK-F
L307	6200002421	S.COI	NLV25T-068J
L308	6200001981	S.COI	NLV25T-1R0J
L311	6200001981	S.COI	NLV25T-1R0J
L401	6200003261	S.COI	NLV32T-101J
L501	6200007230	S.COI	LQW2BHN15NJ03L
L502	6200012990	S.COI	0.25-1.9-9TL 84.0N <COMO>
L503	6200001981	S.COI	NLV25T-1R0J
L504	6200013080	S.COI	0.25-1.9-10TL 97.0N <COMO>
L505	6200013080	S.COI	0.25-1.9-10TL 97.0N <COMO>
L506	6200012990	S.COI	0.25-1.9-9TL 84.0N <COMO>
L507	6200007700	S.COI	LQW2BHN22NJ03L
L510	6200003281	S.COI	NLV25T-2R2J
L1051	6200001831	S.COI	NLV32T-100J
L1101	6200001831	S.COI	NLV32T-100J
L1201	6200008911	S.COI	1812CS-122XJLC
L1202	6190001441	COI	#E526GN-110504
L1203	6200008911	S.COI	1812CS-122XJLC
L1204	6200005011	S.COI	NLV25T-100J
L1221	6200008911	S.COI	1812CS-122XJLC
L1222	6190001421	COI	#E526GN-110502
L1223	6200008911	S.COI	1812CS-122XJLC
L1224	6200005011	S.COI	NLV25T-100J
L1241	6200008911	S.COI	1812CS-122XJLC
L1242	6190001411	COI	#E526GN-110501
L1243	6200008911	S.COI	1812CS-122XJLC
L1244	6200005011	S.COI	NLV25T-100J
L1261	6200008911	S.COI	1812CS-122XJLC
L1262	6190001411	COI	#E526GN-110501
L1263	6200008911	S.COI	1812CS-122XJLC
L1264	6200005011	S.COI	NLV25T-100J
L1281	6200001831	S.COI	NLV32T-100J
L1291	6200004590	S.COI	MLF1608D R18K-T
L1301	6130002970	COI	LB-343
L1302	6200001831	S.COI	NLV32T-100J
L1401	6200002961	S.COI	NLV32T-4R7J
L1402	6140002810	S.COI	LR-317
L1403	6200003041	S.COI	NLV32T-R68J
L1406	6200003041	S.COI	NLV32T-R68J
L1408	6200003261	S.COI	NLV32T-101J
L1410	6200003440	S.COI	ELJNC 39NK-F

M.=Mounted side (T: Mounted on the Top side, B: Mounted on the Bottom side)  
S.=Surface mount

[RF UNIT]

REF NO.	ORDER NO.		DESCRIPTION
L1412	6200004590	S.COI	MLF1608D R18K-T
L1521	6200002150	S.COI	ELJNC 56NK-F
L1522	6200001940	S.COI	ELJNC 27NK-F
L1523	6200001760	S.COI	ELJNC 22NK-F
L1530	6200003440	S.COI	ELJNC 39NK-F
L1561	6200001630	S.COI	ELJNC R10K-F
L1562	6200001630	S.COI	ELJNC R10K-F
L1563	6200001630	S.COI	ELJNC R10K-F
L1581	6200002150	S.COI	ELJNC 56NK-F
L1582	6200002160	S.COI	ELJNC 82NK-F
L1583	6200002160	S.COI	ELJNC 82NK-F
L1584	6200003540	S.COI	MLF1608D R22K-T
L1601	6200001831	S.COI	NLV32T-100J
L1602	6200005491	S.COI	NLV32T-331J
L1603	6200008641	S.COI	NLV32T-391J
L1605	6200008641	S.COI	NLV32T-391J
L1801	6200003021	S.COI	NLV32T-R33J
L1802	6200001770	S.COI	ELJNC 47NK-F
L1804	6140002220	COI	LR-270 (TR6X3X2 3A9)
L1805	6200003261	S.COI	NLV32T-101J
L1806	6200004770	S.COI	ELJNC R56J-F
L1901	6130001100	COI	LB-146
L1902	6150004521	S.COI	LS-508-LF
L1903	6150004831	S.COI	LS-509-LF
L1904	6150004831	S.COI	LS-509-LF
L1905	6200001831	S.COI	NLV32T-100J
L1908	6200003590	S.COI	EXCCL3225U1
R1	7030003390	S.RES	ERJ3GEYJ 391 V (390)
R2	7030003290	S.RES	ERJ3GEYJ 560 V (56)
R3	7030003200	S.RES	ERJ3GEYJ 100 V (10)
R4	7030006260	S.RES	ERJ12YJ471U (470)
R5	7030003520	S.RES	ERJ3GEYJ 472 V (4.7K)
R6	7030006260	S.RES	ERJ12YJ471U (470)
R7	7030003460	S.RES	ERJ3GEYJ 152 V (1.5K)
R11	7030003320	S.RES	ERJ3GEYJ 101 V (100)
R12	7030003310	S.RES	ERJ3GEYJ 820 V (82)
R13	7030003320	S.RES	ERJ3GEYJ 101 V (100)
R15	7030006260	S.RES	ERJ12YJ471U (470)
R21	7030003320	S.RES	ERJ3GEYJ 101 V (100)
R31	7030003320	S.RES	ERJ3GEYJ 101 V (100)
R41	7030003320	S.RES	ERJ3GEYJ 101 V (100)
R51	7030003320	S.RES	ERJ3GEYJ 101 V (100)
R61	7030003320	S.RES	ERJ3GEYJ 101 V (100)
R71	7030003320	S.RES	ERJ3GEYJ 101 V (100)
R81	7030003320	S.RES	ERJ3GEYJ 101 V (100)
R91	7030003320	S.RES	ERJ3GEYJ 101 V (100)
R101	7030003320	S.RES	ERJ3GEYJ 101 V (100)
R111	7030003320	S.RES	ERJ3GEYJ 101 V (100)
R112	7030003220	S.RES	ERJ3GEYJ 150 V (15)
R113	7030003440	S.RES	ERJ3GEYJ 102 V (1K)
R121	7030006260	S.RES	ERJ12YJ471U (470)
R122	7030003380	S.RES	ERJ3GEYJ 331 V (330)
R123	7030003280	S.RES	ERJ3GEYJ 470 V (47)
R124	7030006260	S.RES	ERJ12YJ471U (470)
R151	7030003440	S.RES	ERJ3GEYJ 102 V (1K)
R152	7030003360	S.RES	ERJ3GEYJ 221 V (220)
R153	7030003230	S.RES	ERJ3GEYJ 180 V (18)
R154	7030003290	S.RES	ERJ3GEYJ 560 V (56)
R155	7030003230	S.RES	ERJ3GEYJ 180 V (18)
R156	7030003380	S.RES	ERJ3GEYJ 331 V (330)
R157	7030003200	S.RES	ERJ3GEYJ 100 V (10)
R158	7030003320	S.RES	ERJ3GEYJ 101 V (100)
R159	7030003400	S.RES	ERJ3GEYJ 471 V (470)
R160	7030003200	S.RES	ERJ3GEYJ 100 V (10)
R161	7030003400	S.RES	ERJ3GEYJ 471 V (470)
R162	7030003440	S.RES	ERJ3GEYJ 102 V (1K)
R163	7030004040	S.RES	ERJ3GEYJ 4R7 V (4.7)
R164	7030004040	S.RES	ERJ3GEYJ 4R7 V (4.7)
R165	7030003370	S.RES	ERJ3GEYJ 271 V (270)
R166	7030003380	S.RES	ERJ3GEYJ 331 V (330)
R171	7030006260	S.RES	ERJ12YJ471U (470)
R172	7030003320	S.RES	ERJ3GEYJ 101 V (100)
R173	7030003320	S.RES	ERJ3GEYJ 101 V (100)
R181	7030003320	S.RES	ERJ3GEYJ 101 V (100)
R182	7030003280	S.RES	ERJ3GEYJ 470 V (47)
R183	7030003280	S.RES	ERJ3GEYJ 470 V (47)
R184	7030003320	S.RES	ERJ3GEYJ 101 V (100)
R185	7030003320	S.RES	ERJ3GEYJ 101 V (100)
R186	7030003320	S.RES	ERJ3GEYJ 101 V (100)
R191	7030003320	S.RES	ERJ3GEYJ 101 V (100)
R192	7030003420	S.RES	ERJ3GEYJ 681 V (680)
R193	7030003340	S.RES	ERJ3GEYJ 151 V (150)
R194	7030003270	S.RES	ERJ3GEYJ 390 V (39)
R195	7030003340	S.RES	ERJ3GEYJ 151 V (150)
R196	7030003320	S.RES	ERJ3GEYJ 101 V (100)
R202	7030003480	S.RES	ERJ3GEYJ 222 V (2.2K)
R211	7030006260	S.RES	ERJ12YJ471U (470)
R212	7030003410	S.RES	ERJ3GEYJ 561 V (560)
R213	7030003410	S.RES	ERJ3GEYJ 561 V (560)
R214	7030006260	S.RES	ERJ12YJ471U (470)
R215	7030003400	S.RES	ERJ3GEYJ 471 V (470)
R216	7030003560	S.RES	ERJ3GEYJ 103 V (10K)
R217	7030003280	S.RES	ERJ3GEYJ 470 V (47)
R218	7310005580	S.TRI	TMC3ADCS3X (4.7K)
R219	7030003440	S.RES	ERJ3GEYJ 102 V (1K)
R231	7030003280	S.RES	ERJ3GEYJ 470 V (47)
R233	7030003470	S.RES	ERJ3GEYJ 182 V (1.8K)
R241	7030003280	S.RES	ERJ3GEYJ 470 V (47)
R242	7030003280	S.RES	ERJ3GEYJ 470 V (47)
R243	7030003560	S.RES	ERJ3GEYJ 103 V (10K)
R244	7030003480	S.RES	ERJ3GEYJ 222 V (2.2K)
R245	7030003600	S.RES	ERJ3GEYJ 223 V (22K)

[RF UNIT]

REF NO.	ORDER NO.		DESCRIPTION
R246	7030003300	S.RES	ERJ3GEYJ 680 V (68)
R248	7030003280	S.RES	ERJ3GEYJ 470 V (47)
R249	7030003480	S.RES	ERJ3GEYJ 222 V (2.2K)
R250	7030003490	S.RES	ERJ3GEYJ 272 V (2.7K)
R251	7030003480	S.RES	ERJ3GEYJ 222 V (2.2K)
R252	7030003440	S.RES	ERJ3GEYJ 102 V (1K)
R253	7030003440	S.RES	ERJ3GEYJ 102 V (1K)
R254	7030003440	S.RES	ERJ3GEYJ 102 V (1K)
R255	7030003480	S.RES	ERJ3GEYJ 222 V (2.2K)
R261	7030003370	S.RES	ERJ3GEYJ 271 V (270)
R262	7030003230	S.RES	ERJ3GEYJ 180 V (18)
R263	7030003370	S.RES	ERJ3GEYJ 271 V (270)
R264	7030003440	S.RES	ERJ3GEYJ 102 V (1K)
R271	7030003520	S.RES	ERJ3GEYJ 472 V (4.7K)
R272	7030003470	S.RES	ERJ3GEYJ 182 V (1.8K)
R273	7030003340	S.RES	ERJ3GEYJ 151 V (150)
R274	7030003600	S.RES	ERJ3GEYJ 223 V (22K)
R275	7030003320	S.RES	ERJ3GEYJ 101 V (100)
R276	7030003370	S.RES	ERJ3GEYJ 271 V (270)
R277	7030003370	S.RES	ERJ3GEYJ 271 V (270)
R278	7030003500	S.RES	ERJ3GEYJ 332 V (3.3K)
R279	7030003390	S.RES	ERJ3GEYJ 391 V (390)
R289	7030003440	S.RES	ERJ3GEYJ 102 V (1K)
R291	7030003400	S.RES	ERJ3GEYJ 471 V (470)
R301	7030003310	S.RES	ERJ3GEYJ 820 V (82)
R302	7030003420	S.RES	ERJ3GEYJ 681 V (680)
R303	7030003520	S.RES	ERJ3GEYJ 472 V (4.7K)
R304	7030003200	S.RES	ERJ3GEYJ 100 V (10)
R305	7030003280	S.RES	ERJ3GEYJ 470 V (47)
R306	7030003400	S.RES	ERJ3GEYJ 471 V (470)
R307	7030003400	S.RES	ERJ3GEYJ 471 V (470)
R308	7030003280	S.RES	ERJ3GEYJ 470 V (47)
R309	7030003440	S.RES	ERJ3GEYJ 102 V (1K)
R310	7030003440	S.RES	ERJ3GEYJ 102 V (1K)
R311	7030006260	S.RES	ERJ12YJ471U (470)
R312	7030006260	S.RES	ERJ12YJ471U (470)
R313	7030003480	S.RES	ERJ3GEYJ 222 V (2.2K)
R314	7030003680	S.RES	ERJ3GEYJ 104 V (100K)
R315	7030003520	S.RES	ERJ3GEYJ 472 V (4.7K)
R316	7030003260	S.RES	ERJ3GEYJ 330 V (33)
R321	7030003560	S.RES	ERJ3GEYJ 103 V (10K)
R322	7030003560	S.RES	ERJ3GEYJ 103 V (10K)
R324	7030003560	S.RES	ERJ3GEYJ 103 V (10K)
R325	7030004040	S.RES	ERJ3GEYJ 4R7 V (4.7)
R326	7030004040	S.RES	ERJ3GEYJ 4R7 V (4.7)
R327	7030003640	S.RES	ERJ3GEYJ 473 V (47K)
R328	7030003640	S.RES	ERJ3GEYJ 473 V (47K)
R329	7030003640	S.RES	ERJ3GEYJ 473 V (47K)
R330	7030003640	S.RES	ERJ3GEYJ 473 V (47K)
R331	7030003640	S.RES	ERJ3GEYJ 473 V (47K)
R332	7030003640	S.RES	ERJ3GEYJ 473 V (47K)
R333	7030003640	S.RES	ERJ3GEYJ 473 V (47K)
R334	7030003640	S.RES	ERJ3GEYJ 473 V (47K)
R335	7030003200	S.RES	ERJ3GEYJ 100 V (10)
R336	7030003200	S.RES	ERJ3GEYJ 100 V (10)
R337	7030003200	S.RES	ERJ3GEYJ 100 V (10)
R338	7030003200	S.RES	ERJ3GEYJ 100 V (10)
R339	7030003200	S.RES	ERJ3GEYJ 100 V (10)
R340	7030003200	S.RES	ERJ3GEYJ 100 V (10)
R341	7030003200	S.RES	ERJ3GEYJ 100 V (10)
R342	7030003200	S.RES	ERJ3GEYJ 100 V (10)
R343	7030003640	S.RES	ERJ3GEYJ 473 V (47K)
R344	7030003640	S.RES	ERJ3GEYJ 473 V (47K)
R345	7030003640	S.RES	ERJ3GEYJ 473 V (47K)
R346	7030003640	S.RES	ERJ3GEYJ 473 V (47K)
R347	7030003640	S.RES	ERJ3GEYJ 473 V (47K)
R348	7030003640	S.RES	ERJ3GEYJ 473 V (47K)
R349	7030003640	S.RES	ERJ3GEYJ 473 V (47K)
R350	7030003640	S.RES	ERJ3GEYJ 473 V (47K)
R351	7030003200	S.RES	ERJ3GEYJ 100 V (10)
R352	7030003200	S.RES	ERJ3GEYJ 100 V (10)
R353	7030003200	S.RES	ERJ3GEYJ 100 V (10)
R354	7030003200	S.RES	ERJ3GEYJ 100 V (10)
R355	7030003200	S.RES	ERJ3GEYJ 100 V (10)
R356	7030003200	S.RES	ERJ3GEYJ 100 V (10)
R357	7030003200	S.RES	ERJ3GEYJ 100 V (10)
R358	7030003200	S.RES	ERJ3GEYJ 100 V (10)
R359	7030003560	S.RES	ERJ3GEYJ 103 V (10K)
R501	7030003680	S.RES	ERJ3GEYJ 104 V (100K)
R502	7030003400	S.RES	ERJ3GEYJ 471 V (470)
R503	7030003610	S.RES	ERJ3GEYJ 273 V (27K)
R504	7030003680	S.RES	ERJ3GEYJ 104 V (100K)
R505	7030003300	S.RES	ERJ3GEYJ 680 V (68)
R506	7030003250	S.RES	ERJ3GEYJ 270 V (27)
R507	7030003680	S.RES	ERJ3GEYJ 104 V (100K)
R508	7030003470	S.RES	ERJ3GEYJ 182 V (1.8K)
R509	7030003680	S.RES	ERJ3GEYJ 104 V (100K)
R510	7030003680	S.RES	ERJ3GEYJ 104 V (100K)
R511	7030003440	S.RES	ERJ3GEYJ 102 V (1K)
R541	7030003560	S.RES	ERJ3GEYJ 103 V (10K)
R542	7030003680	S.RES	ERJ3GEYJ 104 V (100K)
R543	7030003560	S.RES	ERJ3GEYJ 103 V (10K)
R544	7030003680	S.RES	ERJ3GEYJ 104 V (100K)
R545	7030003560	S.RES	ERJ3GEYJ 103 V (10K)
R546	7030003680	S.RES	ERJ3GEYJ 104 V (100K)
R547	7030003560	S.RES	ERJ3GEYJ 103 V (10K)
R548	7030003680	S.RES	ERJ3GEYJ 104 V (100K)
R549	7030003680	S.RES	ERJ3GEYJ 104 V (100K)
R1000	7030003440	S.RES	ERJ3GEYJ 102 V (1K)
R1002	7030003440	S.RES	ERJ3GEYJ 102 V (1K)
R1003	7030003440	S.RES	ERJ3GEYJ 102 V (1K)
R1004	7030003440	S.RES	ERJ3GEYJ 102 V (1K)
R1005	7030003440	S.RES	ERJ3GEYJ 102 V (1K)
R1006	7030003440	S.RES	ERJ3GEYJ 102 V (1K)

M.=Mounted side (T: Mounted on the Top side, B: Mounted on the Bottom side)  
S.=Surface mount

## [RF UNIT]

REF NO.	ORDER NO.	DESCRIPTION
R1007	7030003440	S.RES ERJ3GEYJ 102 V (1K)
R1008	7030003440	S.RES ERJ3GEYJ 102 V (1K)
R1009	7030003440	S.RES ERJ3GEYJ 102 V (1K)
R1011	7030003640	S.RES ERJ3GEYJ 473 V (47K)
R1012	7030003640	S.RES ERJ3GEYJ 473 V (47K)
R1013	7030003640	S.RES ERJ3GEYJ 473 V (47K)
R1014	7030003640	S.RES ERJ3GEYJ 473 V (47K)
R1015	7030003640	S.RES ERJ3GEYJ 473 V (47K)
R1016	7030003640	S.RES ERJ3GEYJ 473 V (47K)
R1017	7030003640	S.RES ERJ3GEYJ 473 V (47K)
R1018	7030003640	S.RES ERJ3GEYJ 473 V (47K)
R1019	7030003640	S.RES ERJ3GEYJ 473 V (47K)
R1020	7030003640	S.RES ERJ3GEYJ 473 V (47K)
R1025	7030003440	S.RES ERJ3GEYJ 102 V (1K)
R1026	7030003440	S.RES ERJ3GEYJ 102 V (1K)
R1027	7030003440	S.RES ERJ3GEYJ 102 V (1K)
R1031	7030003440	S.RES ERJ3GEYJ 102 V (1K)
R1032	7310003820	TRI EVN-D2AA03 B14
R1033	7030003440	S.RES ERJ3GEYJ 102 V (1K)
R1051	7030003440	S.RES ERJ3GEYJ 102 V (1K)
R1052	7030003450	S.RES ERJ3GEYJ 122 V (1.2K)
R1081	7030003320	S.RES ERJ3GEYJ 101 V (100)
R1082	7030003480	S.RES ERJ3GEYJ 222 V (2.2K)
R1101	7030007220	S.RES ERA3YED 202V (2K)
R1102	7030007220	S.RES ERA3YED 202V (2K)
R1103	7030007230	S.RES ERA3YED 102V (1K)
R1104	7030007220	S.RES ERA3YED 202V (2K)
R1105	7030007230	S.RES ERA3YED 102V (1K)
R1106	7030007220	S.RES ERA3YED 202V (2K)
R1107	7030007230	S.RES ERA3YED 102V (1K)
R1108	7030007220	S.RES ERA3YED 202V (2K)
R1109	7030007230	S.RES ERA3YED 102V (1K)
R1110	7030007220	S.RES ERA3YED 202V (2K)
R1111	7030007230	S.RES ERA3YED 102V (1K)
R1112	7030007220	S.RES ERA3YED 202V (2K)
R1113	7030007230	S.RES ERA3YED 102V (1K)
R1114	7030007220	S.RES ERA3YED 202V (2K)
R1115	7030007210	S.RES ERA3YEB 102V (1K)
R1116	7030007200	S.RES ERA3YEB 202V (2K)
R1117	7030007210	S.RES ERA3YEB 102V (1K)
R1118	7030007200	S.RES ERA3YEB 202V (2K)
R1119	7030007210	S.RES ERA3YEB 102V (1K)
R1120	7030007200	S.RES ERA3YEB 202V (2K)
R1121	7030007210	S.RES ERA3YEB 102V (1K)
R1122	7030007200	S.RES ERA3YEB 202V (2K)
R1123	7030007210	S.RES ERA3YEB 102V (1K)
R1124	7030007200	S.RES ERA3YEB 202V (2K)
R1125	7030003400	S.RES ERJ3GEYJ 471 V (470)
R1127	7030003320	S.RES ERJ3GEYJ 101 V (100)
R1128	7030003640	S.RES ERJ3GEYJ 473 V (47K)
R1129	7030003360	S.RES ERJ3GEYJ 221 V (220)
R1130	7030003280	S.RES ERJ3GEYJ 470 V (47)
R1132	7030003640	S.RES ERJ3GEYJ 473 V (47K)
R1133	7030003360	S.RES ERJ3GEYJ 221 V (220)
R1134	7030003280	S.RES ERJ3GEYJ 470 V (47)
R1135	7030010390	S.RES ERA3YED 821V (820)
R1136	7030003440	S.RES ERJ3GEYJ 102 V (1K)
R1137	7030003440	S.RES ERJ3GEYJ 102 V (1K)
R1138	7030010600	S.RES ERA3YHD 150V (15)
R1139	7030003640	S.RES ERJ3GEYJ 473 V (47K)
R1140	7030003370	S.RES ERJ3GEYJ 271 V (270)
R1142	7030003440	S.RES ERJ3GEYJ 102 V (1K)
R1144	7030006091	S.RES ERA3YED 822V (8.2K)
R1147	7030003360	S.RES ERJ3GEYJ 221 V (220)
R1148	7030003440	S.RES ERJ3GEYJ 102 V (1K)
R1149	7030003440	S.RES ERJ3GEYJ 102 V (1K)
R1150	7030003440	S.RES ERJ3GEYJ 102 V (1K)
R1151	7030003440	S.RES ERJ3GEYJ 102 V (1K)
R1152	7030003440	S.RES ERJ3GEYJ 102 V (1K)
R1153	7030003440	S.RES ERJ3GEYJ 102 V (1K)
R1154	7030003440	S.RES ERJ3GEYJ 102 V (1K)
R1155	7030003440	S.RES ERJ3GEYJ 102 V (1K)
R1156	7030003440	S.RES ERJ3GEYJ 102 V (1K)
R1157	7030003440	S.RES ERJ3GEYJ 102 V (1K)
R1159	7030003440	S.RES ERJ3GEYJ 102 V (1K)
R1202	7030003280	S.RES ERJ3GEYJ 470 V (47)
R1203	7030003380	S.RES ERJ3GEYJ 331 V (330)
R1204	7030003560	S.RES ERJ3GEYJ 103 V (10K)
R1222	7030003280	S.RES ERJ3GEYJ 470 V (47)
R1223	7030003380	S.RES ERJ3GEYJ 331 V (330)
R1224	7030003560	S.RES ERJ3GEYJ 103 V (10K)
R1242	7030003280	S.RES ERJ3GEYJ 470 V (47)
R1243	7030003380	S.RES ERJ3GEYJ 331 V (330)
R1244	7030003560	S.RES ERJ3GEYJ 103 V (10K)
R1262	7030003280	S.RES ERJ3GEYJ 470 V (47)
R1263	7030003380	S.RES ERJ3GEYJ 331 V (330)
R1264	7030003560	S.RES ERJ3GEYJ 103 V (10K)
R1281	7030003280	S.RES ERJ3GEYJ 470 V (47)
R1282	7030003470	S.RES ERJ3GEYJ 182 V (1.8K)
R1283	7030003480	S.RES ERJ3GEYJ 222 V (2.2K)
R1284	7030003440	S.RES ERJ3GEYJ 102 V (1K)
R1301	7030003560	S.RES ERJ3GEYJ 103 V (10K)
R1302	7030003680	S.RES ERJ3GEYJ 104 V (100K)
R1303	7030003320	S.RES ERJ3GEYJ 101 V (100)
R1304	7030003340	S.RES ERJ3GEYJ 151 V (150)
R1305	7030003680	S.RES ERJ3GEYJ 104 V (100K)
R1306	7030003340	S.RES ERJ3GEYJ 151 V (150)
R1307	7030003640	S.RES ERJ3GEYJ 473 V (47K)
R1308	7030003320	S.RES ERJ3GEYJ 101 V (100)
R1309	7030003360	S.RES ERJ3GEYJ 221 V (220)
R1310	7030003220	S.RES ERJ3GEYJ 150 V (15)
R1311	7030003220	S.RES ERJ3GEYJ 150 V (15)
R1312	7030003220	S.RES ERJ3GEYJ 150 V (15)
R1402	7030003340	S.RES ERJ3GEYJ 151 V (150)

## [RF UNIT]

REF NO.	ORDER NO.	DESCRIPTION
R1403	7030003340	S.RES ERJ3GEYJ 151 V (150)
R1404	7030003450	S.RES ERJ3GEYJ 122 V (1.2K)
R1405	7030003500	S.RES ERJ3GEYJ 332 V (3.3K)
R1406	7030003280	S.RES ERJ3GEYJ 470 V (47)
R1407	7030003280	S.RES ERJ3GEYJ 470 V (47)
R1416	7030003440	S.RES ERJ3GEYJ 102 V (1K)
R1417	7030003370	S.RES ERJ3GEYJ 271 V (270)
R1418	7030003230	S.RES ERJ3GEYJ 180 V (18)
R1419	7030003370	S.RES ERJ3GEYJ 271 V (270)
R1501	7030003300	S.RES ERJ3GEYJ 680 V (68)
R1502	7030003440	S.RES ERJ3GEYJ 102 V (1K)
R1506	7030003440	S.RES ERJ3GEYJ 102 V (1K)
R1521	7030003640	S.RES ERJ3GEYJ 473 V (47K)
R1524	7030003440	S.RES ERJ3GEYJ 102 V (1K)
R1561	7030003640	S.RES ERJ3GEYJ 473 V (47K)
R1562	7030003440	S.RES ERJ3GEYJ 102 V (1K)
R1581	7030003640	S.RES ERJ3GEYJ 473 V (47K)
R1582	7030003440	S.RES ERJ3GEYJ 102 V (1K)
R1601	7030007200	S.RES ERA3YEB 202V (2K)
R1602	7030007210	S.RES ERA3YEB 102V (1K)
R1603	7030007200	S.RES ERA3YEB 202V (2K)
R1604	7030007210	S.RES ERA3YEB 102V (1K)
R1605	7030007200	S.RES ERA3YEB 202V (2K)
R1606	7030007210	S.RES ERA3YEB 102V (1K)
R1607	7030007200	S.RES ERA3YEB 202V (2K)
R1608	7030007210	S.RES ERA3YEB 102V (1K)
R1609	7030007200	S.RES ERA3YEB 202V (2K)
R1610	7030007210	S.RES ERA3YEB 102V (1K)
R1611	7030007220	S.RES ERA3YED 202V (2K)
R1612	7030007230	S.RES ERA3YED 102V (1K)
R1613	7030007220	S.RES ERA3YED 202V (2K)
R1614	7030007230	S.RES ERA3YED 102V (1K)
R1615	7030007220	S.RES ERA3YED 202V (2K)
R1616	7030007230	S.RES ERA3YED 102V (1K)
R1617	7030007220	S.RES ERA3YED 202V (2K)
R1618	7030007230	S.RES ERA3YED 102V (1K)
R1619	7030007220	S.RES ERA3YED 202V (2K)
R1620	7030007220	S.RES ERA3YED 202V (2K)
R1621	7030003440	S.RES ERJ3GEYJ 102 V (1K)
R1622	7030003440	S.RES ERJ3GEYJ 102 V (1K)
R1623	7030003440	S.RES ERJ3GEYJ 102 V (1K)
R1624	7030003440	S.RES ERJ3GEYJ 102 V (1K)
R1626	7030003370	S.RES ERJ3GEYJ 271 V (270)
R1627	7030003640	S.RES ERJ3GEYJ 473 V (47K)
R1630	7030003480	S.RES ERJ3GEYJ 222 V (2.2K)
R1632	7030003360	S.RES ERJ3GEYJ 221 V (220)
R1802	7030003560	S.RES ERJ3GEYJ 103 V (10K)
R1803	7030003400	S.RES ERJ3GEYJ 471 V (470)
R1805	7030007490	S.RES MCR03EZJH 10 M (106)
R1806	7030003440	S.RES ERJ3GEYJ 102 V (1K)
R1808	7030003400	S.RES ERJ3GEYJ 471 V (470)
R1809	7030003200	S.RES ERJ3GEYJ 100 V (10)
R1810	7030003400	S.RES ERJ3GEYJ 471 V (470)
R1817	7030009651	S.RES ERA3YHD 820V (82)
R1818	7030006581	S.RES ERA3YED 122V (1.2K)
R1820	7030003440	S.RES ERJ3GEYJ 102 V (1K)
R1821	7030003440	S.RES ERJ3GEYJ 102 V (1K)
R1822	7030003440	S.RES ERJ3GEYJ 102 V (1K)
R1823	7030003440	S.RES ERJ3GEYJ 102 V (1K)
R1824	7030003200	S.RES ERJ3GEYJ 100 V (10)
R1904	7030003640	S.RES ERJ3GEYJ 473 V (47K)
R1905	7030003320	S.RES ERJ3GEYJ 101 V (100)
R1906	7030003580	S.RES ERJ3GEYJ 153 V (15K)
R1907	7030003520	S.RES ERJ3GEYJ 472 V (4.7K)
R1908	7030003400	S.RES ERJ3GEYJ 471 V (470)
R1909	7030003470	S.RES ERJ3GEYJ 182 V (1.8K)
R1910	7030003480	S.RES ERJ3GEYJ 222 V (2.2K)
R1911	7030003320	S.RES ERJ3GEYJ 101 V (100)
R1912	7030003440	S.RES ERJ3GEYJ 102 V (1K)
R1913	7030003640	S.RES ERJ3GEYJ 473 V (47K)
R1914	7030003320	S.RES ERJ3GEYJ 101 V (100)
R1915	7030003370	S.RES ERJ3GEYJ 271 V (270)
R1916	7030003600	S.RES ERJ3GEYJ 223 V (22K)
R1917	7030003560	S.RES ERJ3GEYJ 103 V (10K)
R1918	7030003370	S.RES ERJ3GEYJ 271 V (270)
R1919	7030003200	S.RES ERJ3GEYJ 100 V (10)
R1922	7030003360	S.RES ERJ3GEYJ 221 V (220)
R1923	7030003320	S.RES ERJ3GEYJ 101 V (100)
R1924	7030003440	S.RES ERJ3GEYJ 102 V (1K)
R2004	7030003570	S.RES ERJ3GEYJ 123 V (12K)
R2005	7030003620	S.RES ERJ3GEYJ 333 V (33K)
R2006	7030003530	S.RES ERJ3GEYJ 562 V (5.6K)
W2	7030008240	S.RES ERJ12Y0R00U
W151	7030003860	S.RES ERJ3GE JPW V
W201	7030003860	S.RES ERJ3GE JPW V
W221	7030003860	S.RES ERJ3GE JPW V
W222	7030003860	S.RES ERJ3GE JPW V
W223	7030003860	S.RES ERJ3GE JPW V
W224	7030003860	S.RES ERJ3GE JPW V
W225	7030003860	S.RES ERJ3GE JPW V
W231	7030003860	S.RES ERJ3GE JPW V
W241	7030008240	S.RES ERJ12Y0R00U
W242	7030003860	S.RES ERJ3GE JPW V
W243	7030003860	S.RES ERJ3GE JPW V
W255	7030003860	S.RES ERJ3GE JPW V
W256	7030003860	S.RES ERJ3GE JPW V
W257	7030003860	S.RES ERJ3GE JPW V
W271	7030003860	S.RES ERJ3GE JPW V
W302	7030008240	S.RES ERJ12Y0R00U
W303	7030008240	S.RES ERJ12Y0R00U
W304	7030008240	S.RES ERJ12Y0R00U
W305	7030003860	S.RES ERJ3GE JPW V

M.=Mounted side (T: Mounted on the Top side, B: Mounted on the Bottom side)  
S.=Surface mount

[RF UNIT]

REF NO.	ORDER NO.	DESCRIPTION
W306	7030008240	S.RES ERJ12Y0R00U
W307	7030003860	S.RES ERJ3GE JPW V
W502	7030003860	S.RES ERJ3GE JPW V
W520	7030003860	S.RES ERJ3GE JPW V
W521	7030003860	S.RES ERJ3GE JPW V
W532	7030003860	S.RES ERJ3GE JPW V
W533	7030003860	S.RES ERJ3GE JPW V
W536	7030008240	S.RES ERJ12Y0R00U
W537	7030008240	S.RES ERJ12Y0R00U
W1001	7030009300	S.RES ERJ1WY0R00U
W1002	7030009300	S.RES ERJ1WY0R00U
W1003	7030009300	S.RES ERJ1WY0R00U
W1004	7030009300	S.RES ERJ1WY0R00U
W1081	7030003860	S.RES ERJ3GE JPW V
W1082	7030003860	S.RES ERJ3GE JPW V
W1403	7030003860	S.RES ERJ3GE JPW V
W1404	7030003860	S.RES ERJ3GE JPW V
W1405	7030003860	S.RES ERJ3GE JPW V
W1406	7030003860	S.RES ERJ3GE JPW V
W1407	7030003860	S.RES ERJ3GE JPW V
W1408	7030003860	S.RES ERJ3GE JPW V
W1601	7030003860	S.RES ERJ3GE JPW V
W1604	7030003860	S.RES ERJ3GE JPW V
W1605	7030003860	S.RES ERJ3GE JPW V
W1902	7030003860	S.RES ERJ3GE JPW V
W2001	7030003860	S.RES ERJ3GE JPW V
C1	4030011600	S.CER C1608 JB 1E 104K-T
C2	4030011600	S.CER C1608 JB 1E 104K-T
C3	4030011600	S.CER C1608 JB 1E 104K-T
C4	4030011600	S.CER C1608 JB 1E 104K-T
C5	4030008470	S.CER C1608 JB 1H 272K-T
C6	4030009880	S.CER C1608 JB 1H 682K-T
C7	4030009980	S.CER C1608 JB 1H 152K-T
C8	4030006860	S.CER C1608 JB 1H 102K-T
C9	4030011600	S.CER C1608 JB 1E 104K-T
C10	4030006860	S.CER C1608 JB 1H 102K-T
C11	4030011600	S.CER C1608 JB 1E 104K-T
C12	4030008650	S.CER C1608 JB 1H 332K-T
C13	4030011330	S.CER C1608 CH 1H 391J-T
C14	4030008650	S.CER C1608 JB 1H 332K-T
C15	4030006860	S.CER C1608 JB 1H 102K-T
C16	4030009000	S.CER C2012 JB 1C 224K-T
C17	4030011600	S.CER C1608 JB 1E 104K-T
C21	4030011600	S.CER C1608 JB 1E 104K-T
C22	4030017840	S.CER C2012 CH 1H 222J-T
C23	4030017810	S.CER C1608 CH 1H 102J-T
C24	4030017840	S.CER C2012 CH 1H 222J-T
C25	4030011600	S.CER C1608 JB 1E 104K-T
C31	4030011600	S.CER C1608 JB 1E 104K-T
C32	4030017830	S.CER C2012 CH 1H 152J-T
C33	4030017810	S.CER C1608 CH 1H 102J-T
C34	4030017830	S.CER C2012 CH 1H 152J-T
C35	4030011600	S.CER C1608 JB 1E 104K-T
C41	4030011600	S.CER C1608 JB 1E 104K-T
C42	4030009580	S.CER C1608 JB 1H 681K-T
C43	4030011830	S.CER C1608 CH 1H 301J-T
C44	4030009580	S.CER C1608 JB 1H 681K-T
C45	4030011600	S.CER C1608 JB 1E 104K-T
C51	4030011600	S.CER C1608 JB 1E 104K-T
C52	4030009580	S.CER C1608 JB 1H 681K-T
C53	4030007150	S.CER C1608 CH 1H 151J-T
C54	4030009580	S.CER C1608 JB 1H 681K-T
C55	4030011600	S.CER C1608 JB 1E 104K-T
C61	4030011600	S.CER C1608 JB 1E 104K-T
C62	4030017800	S.CER C1608 CH 1H 561J-T
C63	4030007110	S.CER C1608 CH 1H 680J-T
C64	4030017800	S.CER C1608 CH 1H 561J-T
C65	4030011600	S.CER C1608 JB 1E 104K-T
C71	4030011600	S.CER C1608 JB 1E 104K-T
C72	4030011330	S.CER C1608 CH 1H 391J-T
C73	4030007110	S.CER C1608 CH 1H 680J-T
C74	4030011330	S.CER C1608 CH 1H 391J-T
C75	4030011600	S.CER C1608 JB 1E 104K-T
C81	4030011600	S.CER C1608 JB 1E 104K-T
C82	4030010760	S.CER C1608 CH 1H 331J-T
C83	4030007080	S.CER C1608 CH 1H 390J-T
C84	4030010760	S.CER C1608 CH 1H 331J-T
C85	4030011600	S.CER C1608 JB 1E 104K-T
C88	4030009000	S.CER C2012 JB 1C 224K-T
C89	4030007040	S.CER C1608 CH 1H 180J-T
C90	4030007040	S.CER C1608 CH 1H 180J-T
C91	4030011600	S.CER C1608 JB 1E 104K-T
C92	4030007110	S.CER C1608 CH 1H 680J-T
C93	4030007040	S.CER C1608 CH 1H 180J-T
C94	4030007120	S.CER C1608 CH 1H 820J-T
C95	4030007040	S.CER C1608 CH 1H 180J-T
C96	4030007090	S.CER C1608 CH 1H 470J-T
C97	4030007090	S.CER C1608 CH 1H 470J-T
C98	4030007090	S.CER C1608 CH 1H 470J-T
C99	4030011600	S.CER C1608 JB 1E 104K-T
C100	4030011280	S.CER C1608 CH 1H 271J-T
C101	4030011600	S.CER C1608 JB 1E 104K-T
C102	4030007100	S.CER C1608 CH 1H 560J-T
C103	4030007110	S.CER C1608 CH 1H 680J-T
C104	4030007100	S.CER C1608 CH 1H 560J-T
C105	4030011600	S.CER C1608 JB 1E 104K-T
C109	4030011600	S.CER C1608 JB 1E 104K-T
C110	4030011600	S.CER C1608 JB 1E 104K-T
C111	4030006880	S.CER C1608 JB 1H 472K-T
C112	4030006860	S.CER C1608 JB 1H 102K-T
C113	4030006980	S.CER C1608 CH 1H 070D-T
C114	4030009560	S.CER C1608 CH 1H R75B-T

[RF UNIT]

REF NO.	ORDER NO.	DESCRIPTION
C115	4030009920	S.CER C1608 CH 1H 050B-T
C116	4030009560	S.CER C1608 CH 1H R75B-T
C117	4030006980	S.CER C1608 CH 1H 070D-T
C118	4030006880	S.CER C1608 JB 1H 472K-T
C119	4030006860	S.CER C1608 JB 1H 102K-T
C120	4030011600	S.CER C1608 JB 1E 104K-T
C121	4030007040	S.CER C1608 CH 1H 180J-T
C122	4030006860	S.CER C1608 JB 1H 102K-T
C123	4030006860	S.CER C1608 JB 1H 102K-T
C124	4030006860	S.CER C1608 JB 1H 102K-T
C143	4030007090	S.CER C1608 CH 1H 470J-T
C144	4030007120	S.CER C1608 CH 1H 820J-T
C146	4030006860	S.CER C1608 JB 1H 102K-T
C150	4030006860	S.CER C1608 JB 1H 102K-T
C151	4030006860	S.CER C1608 JB 1H 102K-T
C152	4030011600	S.CER C1608 JB 1E 104K-T
C153	4030011600	S.CER C1608 JB 1E 104K-T
C154	4030011600	S.CER C1608 JB 1E 104K-T
C155	4030011600	S.CER C1608 JB 1E 104K-T
C156	4030006880	S.CER C1608 JB 1H 472K-T
C157	4030011600	S.CER C1608 JB 1E 104K-T
C161	4030011600	S.CER C1608 JB 1E 104K-T
C171	4030011600	S.CER C1608 JB 1E 104K-T
C172	4030011600	S.CER C1608 JB 1E 104K-T
C173	4030007010	S.CER C1608 CH 1H 100D-T
C174	4030011600	S.CER C1608 JB 1E 104K-T
C181	4030011600	S.CER C1608 JB 1E 104K-T
C182	4030011600	S.CER C1608 JB 1E 104K-T
C183	4030011600	S.CER C1608 JB 1E 104K-T
C185	4030011600	S.CER C1608 JB 1E 104K-T
C191	4030011600	S.CER C1608 JB 1E 104K-T
C192	4030011600	S.CER C1608 JB 1E 104K-T
C193	4030011600	S.CER C1608 JB 1E 104K-T
C194	4030011600	S.CER C1608 JB 1E 104K-T
C195	4030011600	S.CER C1608 JB 1E 104K-T
C196	4030011600	S.CER C1608 JB 1E 104K-T
C197	4030011600	S.CER C1608 JB 1E 104K-T
C198	4030009920	S.CER C1608 CH 1H 050B-T
C201	4030007170	S.CER C1608 CH 1H 221J-T
C211	4030007100	S.CER C1608 CH 1H 560J-T
C212	4030007070	S.CER C1608 CH 1H 330J-T
C213	4030007120	S.CER C1608 CH 1H 820J-T
C214	4030007030	S.CER C1608 CH 1H 150J-T
C215	4030007100	S.CER C1608 CH 1H 560J-T
C216	4030011600	S.CER C1608 JB 1E 104K-T
C217	4030011600	S.CER C1608 JB 1E 104K-T
C218	4030011600	S.CER C1608 JB 1E 104K-T
C219	4030009530	S.CER C1608 CH 1H 030B-T
C220	4030006880	S.CER C1608 JB 1H 472K-T
C221	4030011600	S.CER C1608 JB 1E 104K-T
C222	4030007010	S.CER C1608 CH 1H 100D-T
C224	4030011600	S.CER C1608 JB 1E 104K-T
C225	4030006860	S.CER C1608 JB 1H 102K-T
C226	4030006860	S.CER C1608 JB 1H 102K-T
C228	4030006860	S.CER C1608 JB 1H 102K-T
C229	4030007020	S.CER C1608 CH 1H 120J-T
C230	4030007010	S.CER C1608 CH 1H 100D-T
C231	4030006880	S.CER C1608 JB 1H 472K-T
C232	4030011600	S.CER C1608 JB 1E 104K-T
C233	4030007040	S.CER C1608 CH 1H 180J-T
C234	4030007130	S.CER C1608 CH 1H 101J-T
C235	4030006860	S.CER C1608 JB 1H 102K-T
C236	4030007070	S.CER C1608 CH 1H 330J-T
C240	4030006860	S.CER C1608 JB 1H 102K-T
C241	4030006880	S.CER C1608 JB 1H 472K-T
C242	4030006860	S.CER C1608 JB 1H 102K-T
C243	4030006880	S.CER C1608 JB 1H 472K-T
C244	4030007020	S.CER C1608 CH 1H 120J-T
C245	4030006880	S.CER C1608 JB 1H 472K-T
C246	4030006880	S.CER C1608 JB 1H 472K-T
C247	4030006880	S.CER C1608 JB 1H 472K-T
C248	4030006880	S.CER C1608 JB 1H 472K-T
C249	4030007010	S.CER C1608 CH 1H 100D-T
C250	4030006860	S.CER C1608 JB 1H 102K-T
C251	4030006880	S.CER C1608 JB 1H 472K-T
C252	4030011770	S.CER C1608 CH 1H 060B-T
C253	4030006980	S.CER C1608 CH 1H 070D-T
C254	4030011770	S.CER C1608 CH 1H 060B-T
C255	4030006880	S.CER C1608 JB 1H 472K-T
C256	4030006880	S.CER C1608 JB 1H 472K-T
C257	4030006880	S.CER C1608 JB 1H 472K-T
C258	4030009910	S.CER C1608 CH 1H 040B-T
C261	4030011340	S.CER C1608 CH 1H 471J-T
C262	4030011330	S.CER C1608 CH 1H 391J-T
C263	4030007110	S.CER C1608 CH 1H 680J-T
C264	4030011330	S.CER C1608 CH 1H 391J-T
C265	4030006880	S.CER C1608 JB 1H 472K-T
C271	4030006880	S.CER C1608 JB 1H 472K-T
C272	4030006860	S.CER C1608 JB 1H 102K-T
C273	4030006860	S.CER C1608 JB 1H 102K-T
C275	4030011770	S.CER C1608 CH 1H 060B-T
C276	4030006880	S.CER C1608 JB 1H 472K-T
C277	4030006880	S.CER C1608 JB 1H 472K-T
C278	4030006880	S.CER C1608 JB 1H 472K-T
C286	4030011600	S.CER C1608 JB 1E 104K-T
C287	4030007060	S.CER C1608 CH 1H 270J-T
C288	4030011770	S.CER C1608 CH 1H 060B-T
C289	4030007030	S.CER C1608 CH 1H 150J-T
C290	4030011600	S.CER C1608 JB 1E 104K-T
C291	4030007030	S.CER C1608 CH 1H 150J-T
C292	4030007100	S.CER C1608 CH 1H 560J-T
C293	4030007100	S.CER C1608 CH 1H 560J-T
C296	4030006980	S.CER C1608 CH 1H 070D-T
C298	4030009920	S.CER C1608 CH 1H 050B-T

M.=Mounted side (T: Mounted on the Top side, B: Mounted on the Bottom side)  
S.=Surface mount

## [RF UNIT]

REF NO.	ORDER NO.	DESCRIPTION
C300	4030006860	S.CER C1608 JB 1H 102K-T
C301	4030007080	S.CER C1608 CH 1H 390J-T
C302	4030007170	S.CER C1608 CH 1H 221J-T
C303	4030006880	S.CER C1608 JB 1H 472K-T
C304	4030011600	S.CER C1608 JB 1E 104K-T
C305	4030006860	S.CER C1608 JB 1H 102K-T
C306	4030007050	S.CER C1608 CH 1H 220J-T
C307	4030011770	S.CER C1608 CH 1H 060B-T
C308	4030007070	S.CER C1608 CH 1H 330J-T
C309	4030009520	S.CER C1608 CH 1H 020B-T
C310	4030006860	S.CER C1608 JB 1H 102K-T
C311	4030011600	S.CER C1608 JB 1E 104K-T
C312	4030006880	S.CER C1608 JB 1H 472K-T
C313	4030007070	S.CER C1608 CH 1H 330J-T
C314	4030007020	S.CER C1608 CH 1H 120J-T
C315	4030007090	S.CER C1608 CH 1H 470J-T
C316	4030009920	S.CER C1608 CH 1H 050B-T
C317	4030007080	S.CER C1608 CH 1H 390J-T
C318	4030006860	S.CER C1608 JB 1H 102K-T
C319	4030006860	S.CER C1608 JB 1H 102K-T
C320	4030006860	S.CER C1608 JB 1H 102K-T
C321	4030011600	S.CER C1608 JB 1E 104K-T
C322	4030011600	S.CER C1608 JB 1E 104K-T
C323	4030011600	S.CER C1608 JB 1E 104K-T
C324	4030011600	S.CER C1608 JB 1E 104K-T
C325	4030006860	S.CER C1608 JB 1H 102K-T
C326	4030006860	S.CER C1608 JB 1H 102K-T
C327	4030006860	S.CER C1608 JB 1H 102K-T
C328	4030006860	S.CER C1608 JB 1H 102K-T
C329	4030006860	S.CER C1608 JB 1H 102K-T
C330	4030006860	S.CER C1608 JB 1H 102K-T
C331	4030006860	S.CER C1608 JB 1H 102K-T
C401	4030006880	S.CER C1608 JB 1H 472K-T
C402	4030006860	S.CER C1608 JB 1H 102K-T
C403	4030006860	S.CER C1608 JB 1H 102K-T
C500	4030007130	S.CER C1608 CH 1H 101J-T
C501	4030007030	S.CER C1608 CH 1H 150J-T
C503	4030006860	S.CER C1608 JB 1H 102K-T
C504	4030006860	S.CER C1608 JB 1H 102K-T
C505	4030006860	S.CER C1608 JB 1H 102K-T
C507	4030006860	S.CER C1608 JB 1H 102K-T
C508	4030006860	S.CER C1608 JB 1H 102K-T
C509	4030006860	S.CER C1608 JB 1H 102K-T
C510	4030007020	S.CER C1608 CH 1H 120J-T
C511	4030006860	S.CER C1608 JB 1H 102K-T
C512	4030006860	S.CER C1608 JB 1H 102K-T
C513	4030009560	S.CER C1608 CH 1H R75B-T
C514	4030007030	S.CER C1608 CH 1H 150J-T
C515	4030006860	S.CER C1608 JB 1H 102K-T
C517	4030009500	S.CER C1608 CH 1H 0R5B-T
C518	4030007030	S.CER C1608 CH 1H 150J-T
C519	4030006860	S.CER C1608 JB 1H 102K-T
C521	4030006860	S.CER C1608 JB 1H 102K-T
C528	4030006860	S.CER C1608 JB 1H 102K-T
C529	4030006860	S.CER C1608 JB 1H 102K-T
C530	4030006860	S.CER C1608 JB 1H 102K-T
C541	4030006860	S.CER C1608 JB 1H 102K-T
C542	4030007090	S.CER C1608 CH 1H 470J-T
C543	4030006860	S.CER C1608 JB 1H 102K-T
C544	4030007090	S.CER C1608 CH 1H 470J-T
C545	4030006860	S.CER C1608 JB 1H 102K-T
C546	4030007090	S.CER C1608 CH 1H 470J-T
C547	4030006860	S.CER C1608 JB 1H 102K-T
C548	4030007090	S.CER C1608 CH 1H 470J-T
C550	4030007000	S.CER C1608 CH 1H 090D-T
C1001	4030006880	S.CER C1608 JB 1H 472K-T
C1002	4510008540	S.ELE EEE1CA100SR
C1003	4030006880	S.CER C1608 JB 1H 472K-T
C1004	4510008540	S.ELE EEE1CA100SR
C1008	4030006880	S.CER C1608 JB 1H 472K-T
C1010	4030006860	S.CER C1608 JB 1H 102K-T
C1011	4030006880	S.CER C1608 JB 1H 472K-T
C1012	4030006880	S.CER C1608 JB 1H 472K-T
C1013	4030006880	S.CER C1608 JB 1H 472K-T
C1014	4030006880	S.CER C1608 JB 1H 472K-T
C1031	4030006880	S.CER C1608 JB 1H 472K-T
C1032	4030006880	S.CER C1608 JB 1H 472K-T
C1051	4030006880	S.CER C1608 JB 1H 472K-T
C1052	4510008540	S.ELE EEE1CA100SR
C1053	4030006880	S.CER C1608 JB 1H 472K-T
C1054	4510008540	S.ELE EEE1CA100SR
C1055	4030006880	S.CER C1608 JB 1H 472K-T
C1057	4030006880	S.CER C1608 JB 1H 472K-T
C1059	4510008540	S.ELE EEE1CA100SR
C1075	4030006860	S.CER C1608 JB 1H 102K-T
C1081	4030011600	S.CER C1608 JB 1E 104K-T
C1082	4030006880	S.CER C1608 JB 1H 472K-T
C1083	4030007090	S.CER C1608 CH 1H 470J-T
C1101	4510008540	S.ELE EEE1CA100SR
C1102	4030011600	S.CER C1608 JB 1E 104K-T
C1103	4030011600	S.CER C1608 JB 1E 104K-T
C1104	4030011600	S.CER C1608 JB 1E 104K-T
C1105	4030011600	S.CER C1608 JB 1E 104K-T
C1106	4030011600	S.CER C1608 JB 1E 104K-T
C1107	4030011600	S.CER C1608 JB 1E 104K-T
C1108	4030011600	S.CER C1608 JB 1E 104K-T
C1109	4030011600	S.CER C1608 JB 1E 104K-T
C1110	4030011600	S.CER C1608 JB 1E 104K-T
C1111	4030011600	S.CER C1608 JB 1E 104K-T
C1112	4030011600	S.CER C1608 JB 1E 104K-T
C1113	4030011600	S.CER C1608 JB 1E 104K-T
C1114	4030011600	S.CER C1608 JB 1E 104K-T
C1115	4030011600	S.CER C1608 JB 1E 104K-T
C1116	4030011600	S.CER C1608 JB 1E 104K-T

## [RF UNIT]

REF NO.	ORDER NO.	DESCRIPTION
C1117	4030011600	S.CER C1608 JB 1E 104K-T
C1118	4030011600	S.CER C1608 JB 1E 104K-T
C1119	4030006880	S.CER C1608 JB 1H 472K-T
C1120	4030011600	S.CER C1608 JB 1E 104K-T
C1121	4550006250	S.TAN TEESVA 1A 106M8R
C1122	4030006880	S.CER C1608 JB 1H 472K-T
C1131	4030011600	S.CER C1608 JB 1E 104K-T
C1141	4030006880	S.CER C1608 JB 1H 472K-T
C1151	4030006880	S.CER C1608 JB 1H 472K-T
C1155	4030007090	S.CER C1608 CH 1H 470J-T
C1161	4030006880	S.CER C1608 JB 1H 472K-T
C1162	4030006880	S.CER C1608 JB 1H 472K-T
C1163	4030006880	S.CER C1608 JB 1H 472K-T
C1164	4030006880	S.CER C1608 JB 1H 472K-T
C1165	4030006880	S.CER C1608 JB 1H 472K-T
C1166	4030006880	S.CER C1608 JB 1H 472K-T
C1167	4030006880	S.CER C1608 JB 1H 472K-T
C1191	4030011600	S.CER C1608 JB 1E 104K-T
C1202	4030007130	S.CER C1608 CH 1H 101J-T
C1203	4030006880	S.CER C1608 JB 1H 472K-T
C1204	4030011340	S.CER C1608 CH 1H 471J-T
C1205	4030006880	S.CER C1608 JB 1H 472K-T
C1206	4030009540	S.CER C1608 CH 1H 1R5B-T
C1207	4030006880	S.CER C1608 JB 1H 472K-T
C1208	4610001830	S.TRI TZB4S100AB10R00(TZBX4N100BA110)
C1209	4030007020	S.CER C1608 CH 1H 120J-T
C1211	4030006860	S.CER C1608 JB 1H 102K-T
C1222	4030010760	S.CER C1608 CH 1H 331J-T
C1223	4030006880	S.CER C1608 JB 1H 472K-T
C1224	4030011340	S.CER C1608 CH 1H 471J-T
C1225	4030006880	S.CER C1608 JB 1H 472K-T
C1226	4030009540	S.CER C1608 CH 1H 1R5B-T
C1227	4030006880	S.CER C1608 JB 1H 472K-T
C1228	4610001830	S.TRI TZB4S100AB10R00(TZBX4N100BA110)
C1229	4030009920	S.CER C1608 CH 1H 050B-T
C1231	4030006860	S.CER C1608 JB 1H 102K-T
C1242	4030007080	S.CER C1608 CH 1H 390J-T
C1243	4030006880	S.CER C1608 JB 1H 472K-T
C1244	4030011340	S.CER C1608 CH 1H 471J-T
C1245	4030006880	S.CER C1608 JB 1H 472K-T
C1246	4030009540	S.CER C1608 CH 1H 1R5B-T
C1247	4030006880	S.CER C1608 JB 1H 472K-T
C1248	4610001830	S.TRI TZB4S100AB10R00(TZBX4N100BA110)
C1249	4030006990	S.CER C1608 CH 1H 080D-T
C1251	4030006860	S.CER C1608 JB 1H 102K-T
C1262	4030007060	S.CER C1608 CH 1H 270J-T
C1263	4030006880	S.CER C1608 JB 1H 472K-T
C1264	4030011340	S.CER C1608 CH 1H 471J-T
C1265	4030006880	S.CER C1608 JB 1H 472K-T
C1266	4030009510	S.CER C1608 CH 1H 010B-T
C1267	4030006880	S.CER C1608 JB 1H 472K-T
C1268	4610001860	S.TRI TZB4Z060AB10R00(TZBX4Z060BA110)
C1269	4030009530	S.CER C1608 CH 1H 030B-T
C1271	4030006860	S.CER C1608 JB 1H 102K-T
C1281	4030006880	S.CER C1608 JB 1H 472K-T
C1282	4030006880	S.CER C1608 JB 1H 472K-T
C1284	4030006880	S.CER C1608 JB 1H 472K-T
C1291	4030007060	S.CER C1608 CH 1H 270J-T
C1292	4030007120	S.CER C1608 CH 1H 820J-T
C1293	4030007080	S.CER C1608 CH 1H 390J-T
C1301	4030007070	S.CER C1608 CH 1H 330J-T
C1302	4030009910	S.CER C1608 CH 1H 040B-T
C1303	4610001850	S.TRI TZB4R200AB10R00(TZBX4R200BA110)
C1304	4030016550	S.CER CM105 CH 151G 50AT
C1305	4510008540	S.ELE EEE1CA100SR
C1306	4030006880	S.CER C1608 JB 1H 472K-T
C1307	4030006880	S.CER C1608 JB 1H 472K-T
C1308	4030016550	S.CER CM105 CH 151G 50AT
C1309	4030016550	S.CER CM105 CH 151G 50AT
C1310	4030007010	S.CER C1608 CH 1H 100D-T
C1311	4030006880	S.CER C1608 JB 1H 472K-T
C1312	4030011600	S.CER C1608 JB 1E 104K-T
C1408	4030006880	S.CER C1608 JB 1H 472K-T
C1409	4030006880	S.CER C1608 JB 1H 472K-T
C1410	4030006880	S.CER C1608 JB 1H 472K-T
C1411	4030006880	S.CER C1608 JB 1H 472K-T
C1412	4030006880	S.CER C1608 JB 1H 472K-T
C1422	4030007040	S.CER C1608 CH 1H 180J-T
C1423	4030007030	S.CER C1608 CH 1H 150J-T
C1424	4030007060	S.CER C1608 CH 1H 270J-T
C1425	4030007130	S.CER C1608 CH 1H 101J-T
C1426	4030006880	S.CER C1608 JB 1H 472K-T
C1427	4030006880	S.CER C1608 JB 1H 472K-T
C1428	4030007120	S.CER C1608 CH 1H 820J-T
C1429	4030007130	S.CER C1608 CH 1H 101J-T
C1501	4030006880	S.CER C1608 JB 1H 472K-T
C1502	4030006880	S.CER C1608 JB 1H 472K-T
C1503	4030006880	S.CER C1608 JB 1H 472K-T
C1520	4030006860	S.CER C1608 JB 1H 102K-T
C1521	4030006880	S.CER C1608 JB 1H 472K-T
C1522	4030007030	S.CER C1608 CH 1H 150J-T
C1523	4030007070	S.CER C1608 CH 1H 330J-T
C1524	4030007000	S.CER C1608 CH 1H 090D-T
C1525	4030007030	S.CER C1608 CH 1H 150J-T
C1526	4030009530	S.CER C1608 CH 1H 030B-T
C1527	4030007050	S.CER C1608 CH 1H 220J-T
C1528	4030009920	S.CER C1608 CH 1H 050B-T
C1529	4030007030	S.CER C1608 CH 1H 150J-T
C1530	4030007130	S.CER C1608 CH 1H 101J-T
C1531	4030007040	S.CER C1608 CH 1H 180J-T
C1561	4030006880	S.CER C1608 JB 1H 472K-T
C1562	4030007080	S.CER C1608 CH 1H 390J-T
C1563	4030007010	S.CER C1608 CH 1H 100D-T
C1564	4030007080	S.CER C1608 CH 1H 390J-T

M.=Mounted side (T: Mounted on the Top side, B: Mounted on the Bottom side)  
S.=Surface mount

## [RF UNIT]

REF NO.	ORDER NO.	DESCRIPTION	
C1565	4030006980	S.CER	C1608 CH 1H 070D-T
C1567	4030007060	S.CER	C1608 CH 1H 270J-T
C1581	4030006880	S.CER	C1608 JB 1H 472K-T
C1582	4030007070	S.CER	C1608 CH 1H 330J-T
C1583	4030006980	S.CER	C1608 CH 1H 070D-T
C1584	4030007060	S.CER	C1608 CH 1H 270J-T
C1585	4030009920	S.CER	C1608 CH 1H 050B-T
C1586	4030007050	S.CER	C1608 CH 1H 220J-T
C1587	4030007070	S.CER	C1608 CH 1H 330J-T
C1601	4510008540	S.ELE	EEE1CA100SR
C1602	4030011600	S.CER	C1608 JB 1E 104K-T
C1603	4030011600	S.CER	C1608 JB 1E 104K-T
C1604	4030011600	S.CER	C1608 JB 1E 104K-T
C1605	4030011600	S.CER	C1608 JB 1E 104K-T
C1606	4030006880	S.CER	C1608 JB 1H 472K-T
C1607	4030011600	S.CER	C1608 JB 1E 104K-T
C1608	4030011600	S.CER	C1608 JB 1E 104K-T
C1609	4030011340	S.CER	C1608 CH 1H 471J-T
C1610	4030007120	S.CER	C1608 CH 1H 820J-T
C1611	4030009580	S.CER	C1608 JB 1H 681K-T
C1612	4030007070	S.CER	C1608 CH 1H 330J-T
C1613	4030010040	S.CER	C1608 JB 1H 561K-T
C1615	4030011280	S.CER	C1608 CH 1H 271J-T
C1616	4030006860	S.CER	C1608 JB 1H 102K-T
C1617	4030011280	S.CER	C1608 CH 1H 271J-T
C1630	4030011600	S.CER	C1608 JB 1E 104K-T
C1801	4030006880	S.CER	C1608 JB 1H 472K-T
C1802	4030006880	S.CER	C1608 JB 1H 472K-T
C1803	4030007010	S.CER	C1608 CH 1H 100D-T
C1804	4030007060	S.CER	C1608 CH 1H 270J-T
C1805	4030007040	S.CER	C1608 CH 1H 180J-T
C1806	4030006880	S.CER	C1608 JB 1H 472K-T
C1807	4030007130	S.CER	C1608 CH 1H 101J-T
C1809	4030011600	S.CER	C1608 JB 1E 104K-T
C1810	4030011600	S.CER	C1608 JB 1E 104K-T
C1811	4550006480	S.TAN	TEESVA 1C 475M8R
C1812	4560000160	CER	D33Y5V 1H 103Z21(MARUWA)
C1814	4030007030	S.CER	C1608 CH 1H 150J-T
C1816	4030006880	S.CER	C1608 JB 1H 472K-T
C1817	4030006880	S.CER	C1608 JB 1H 472K-T
C1818	4030011340	S.CER	C1608 CH 1H 471J-T
C1819	4030007100	S.CER	C1608 CH 1H 560J-T
C1820	4030009580	S.CER	C1608 JB 1H 681K-T
C1856	4030011340	S.CER	C1608 CH 1H 471J-T
C1857	4550006480	S.TAN	TEESVA 1C 475M8R
C1858	4030011600	S.CER	C1608 JB 1E 104K-T
C1904	4030008070	S.CER	C1608 TH 1H 470J-T
C1905	4030006880	S.CER	C1608 JB 1H 472K-T
C1906	4030006880	S.CER	C1608 JB 1H 472K-T
C1908	4030006880	S.CER	C1608 JB 1H 472K-T
C1909	4030008070	S.CER	C1608 TH 1H 470J-T
C1916	4030006880	S.CER	C1608 JB 1H 472K-T
C1917	4030006880	S.CER	C1608 JB 1H 472K-T
C1918	4030006880	S.CER	C1608 JB 1H 472K-T
C1919	4030006880	S.CER	C1608 JB 1H 472K-T
C1920	4030007170	S.CER	C1608 CH 1H 221J-T
C1921	4030007050	S.CER	C1608 CH 1H 220J-T
C1922	4030006880	S.CER	C1608 JB 1H 472K-T
C1923	4030009510	S.CER	C1608 CH 1H 010B-T
C1924	4030007050	S.CER	C1608 CH 1H 220J-T
C1925	4030006880	S.CER	C1608 JB 1H 472K-T
C1926	4030006880	S.CER	C1608 JB 1H 472K-T
C1927	4030006880	S.CER	C1608 JB 1H 472K-T
C1928	4030006880	S.CER	C1608 JB 1H 472K-T
C1931	4030011600	S.CER	C1608 JB 1E 104K-T
C2004	4030006860	S.CER	C1608 JB 1H 102K-T
C2005	4510008540	S.ELE	EEE1CA100SR
RL1	6330001320	REL	AHY103
J1	6510007020	CON	TMP-J01X-V6
J2	6510022591	S.CON	22FMN-BMTTR-A-TBT(LF)(SN)
J121	6510007020	CON	TMP-J01X-V6
J151	6510007020	CON	TMP-J01X-V6
J262	6510007020	CON	TMP-J01X-V6
J401	6450001491	CON	HLJ7001-016010
J1001	6510022591	S.CON	22FMN-BMTTR-A-TBT(LF)(SN)
W213	7120000490	JUM	ERD25T0
W252	7120000490	JUM	ERD25T0
W254	7120000470	JUM	ERDS2T0
EP4	6910012350	S.BEA	MMZ1608Y 102BT
EP5	6910012350	S.BEA	MMZ1608Y 102BT
EP6	6910012350	S.BEA	MMZ1608Y 102BT
EP7	6910012350	S.BEA	MMZ1608Y 102BT
EP8	6910012350	S.BEA	MMZ1608Y 102BT
EP9	6910012350	S.BEA	MMZ1608Y 102BT
EP10	6910012350	S.BEA	MMZ1608Y 102BT
EP11	6910012350	S.BEA	MMZ1608Y 102BT
EP120	6910012350	S.BEA	MMZ1608Y 102BT
EP150	6910012350	S.BEA	MMZ1608Y 102BT
EP180	6910012350	S.BEA	MMZ1608Y 102BT
EP214	6910012350	S.BEA	MMZ1608Y 102BT
EP216	6910012350	S.BEA	MMZ1608Y 102BT
EP217	6910012350	S.BEA	MMZ1608Y 102BT
EP242	6910012350	S.BEA	MMZ1608Y 102BT
EP301	6910012350	S.BEA	MMZ1608Y 102BT
EP302	6910012350	S.BEA	MMZ1608Y 102BT
EP303	6910012350	S.BEA	MMZ1608Y 102BT

## [RF UNIT]

REF NO.	ORDER NO.	DESCRIPTION	
EP304	6910012350	S.BEA	MMZ1608Y 102BT
EP305	6910012350	S.BEA	MMZ1608Y 102BT
EP306	6910012350	S.BEA	MMZ1608Y 102BT
EP358	6910012350	S.BEA	MMZ1608Y 102BT
EP401	6910012350	S.BEA	MMZ1608Y 102BT
EP402	6910012350	S.BEA	MMZ1608Y 102BT
EP501	6910012350	S.BEA	MMZ1608Y 102BT
EP502	6910012350	S.BEA	MMZ1608Y 102BT
EP503	6910012350	S.BEA	MMZ1608Y 102BT
EP504	6910012350	S.BEA	MMZ1608Y 102BT
EP510	6910012350	S.BEA	MMZ1608Y 102BT
EP548	6910012350	S.BEA	MMZ1608Y 102BT
EP549	6910012350	S.BEA	MMZ1608Y 102BT
EP1010	6910012350	S.BEA	MMZ1608Y 102BT
EP1031	6910012350	S.BEA	MMZ1608Y 102BT
EP1081	6910012350	S.BEA	MMZ1608Y 102BT
EP1082	6910012350	S.BEA	MMZ1608Y 102BT
EP1201	6910012350	S.BEA	MMZ1608Y 102BT
EP1221	6910012350	S.BEA	MMZ1608Y 102BT
EP1241	6910012350	S.BEA	MMZ1608Y 102BT
EP1242	6910012350	S.BEA	MMZ1608Y 102BT
EP1261	6910012350	S.BEA	MMZ1608Y 102BT
EP1401	6910012350	S.BEA	MMZ1608Y 102BT
EP1501	6910012350	S.BEA	MMZ1608Y 102BT
EP1502	6910012350	S.BEA	MMZ1608Y 102BT

M.=Mounted side (T: Mounted on the Top side, B: Mounted on the Bottom side)  
S.=Surface mount



## [MAIN UNIT]

REF NO.	ORDER NO.		DESCRIPTION	
IC200	1110003870	S.IC	NJM2058M-TE1-#ZZZB	
IC280	1130005641	S.IC	TC4W53F(TE12L,F)	
IC281	1130003611	S.IC	TC4SU69F(TE85R,F)	
IC282	1130003611	S.IC	TC4SU69F(TE85R,F)	
IC300	1110003870	S.IC	NJM2058M-TE1-#ZZZB	
IC360	1110000960	S.IC	NJM4558M-TE1-#FMZB	
IC400	1110004840	S.IC	NJM1496V-TE1-#ZZZB	
IC502	1110004310	S.IC	M62352GP 75EC	
IC1001	1110002700	S.IC	NJM2904M-TE1-#FMZB	
IC1040	1130005641	S.IC	TC4W53F(TE12L,F)	
IC1060	1110000960	S.IC	NJM4558M-TE1-#FMZB	
IC1080	1110003300	S.IC	M5282FP 70CD	
IC1120	1110005061	S.IC	UPC4574G2-E1-A	
IC1160	1130005641	S.IC	TC4W53F(TE12L,F)	
IC1180	1110003300	S.IC	M5282FP 70CD	
IC1220	1130005641	S.IC	TC4W53F(TE12L,F)	
IC1240	1110003091	IC	LA4425A-E	
IC1280	1110000960	S.IC	NJM4558M-TE1-#FMZB	
IC1300	1110003870	S.IC	NJM2058M-TE1-#ZZZB	
IC1310	1140013200	S.IC	CD4053BPWR	
IC1400	1110003300	S.IC	M5282FP 70CD	
IC1401	1110003870	S.IC	NJM2058M-TE1-#ZZZB	
IC1460	1110005420	S.IC	BA15532F-E2	
IC1500	1140010431	S.IC	HD6432357A26FV(SX-2494A)	
IC1560	1110005771	S.IC	S-80942CNMC-G9CT2G	
IC1580	1140009241	S.IC	R1EX24128ASA00A	[EUR]
	1140009240	S.IC	HN58X24128FPI	[FRA]
	1140009241	S.IC	R1EX24128ASA00A	[DEN]
	1140009240	S.IC	HN58X24128FPI	[ITR]
	1140009240	S.IC	HN58X24128FPI	[ESP]
	1140009241	S.IC	R1EX24128ASA00A	[KOR]
IC1900	1140013200	S.IC	CD4053BPWR	
IC1940	1130005721	S.IC	TC7W04F(TE12L,F)	
IC2040	1130003831	S.IC	TC7S04F(TE85R,F)	
Q200	1560000561	S.FET	2SK882-GR(TE85L,F)	
Q201	1560000561	S.FET	2SK882-GR(TE85L,F)	
Q202	1560000561	S.FET	2SK882-GR(TE85L,F)	
Q203	1530002060	S.TRA	2SC4081 T106 R	
Q204	1530002060	S.TRA	2SC4081 T106 R	
Q205	1510000510	S.TRA	2SA1576A T106R	
Q206	1530002060	S.TRA	2SC4081 T106 R	
Q207	1590003431	S.TRA	UNR911HG0L	
Q208	1590001960	S.TRA	XP4311(TX)	
Q250	1580000620	S.FET	3SK131-T2 MAS	
Q300	1590000680	S.TRA	DTC114EUA T106	
Q301	1590000680	S.TRA	DTC114EUA T106	
Q302	1590000680	S.TRA	DTC114EUA T106	
Q303	1510000510	S.TRA	2SA1576A T106R	
Q304	1590000680	S.TRA	DTC114EUA T106	
Q305	1590002150	S.TRA	DTC144TE TL	
Q306	1590000680	S.TRA	DTC114EUA T106	
Q307	1510000510	S.TRA	2SA1576A T106R	
Q308	1510000510	S.TRA	2SA1576A T106R	
Q309	1590002150	S.TRA	DTC144TE TL	
Q330	1560000561	S.FET	2SK882-GR(TE85L,F)	
Q381	1590001960	S.TRA	XP4311(TX)	
Q450	1530002060	S.TRA	2SC4081 T106 R	
Q451	1530002060	S.TRA	2SC4081 T106 R	
Q452	1540000441	S.TRA	2SD1619T-TD-E	
Q453	1540000441	S.TRA	2SD1619T-TD-E	
Q511	1530002060	S.TRA	2SC4081 T106 R	
Q700	1530002060	S.TRA	2SC4081 T106 R	
Q720	1590000680	S.TRA	DTC114EUA T106	
Q721	1530002060	S.TRA	2SC4081 T106 R	
Q722	1530002060	S.TRA	2SC4081 T106 R	
Q740	1590000680	S.TRA	DTC114EUA T106	
Q780	1530002060	S.TRA	2SC4081 T106 R	
Q782	1540000441	S.TRA	2SD1619T-TD-E	
Q783	1590001870	S.TRA	DTA114EE TL	
Q784	1590000680	S.TRA	DTC114EUA T106	
Q785	1540000441	S.TRA	2SD1619T-TD-E	
Q786	1540000441	S.TRA	2SD1619T-TD-E	
Q787	1590000680	S.TRA	DTC114EUA T106	
Q788	1590000680	S.TRA	DTC114EUA T106	
Q790	1590001870	S.TRA	DTA114EE TL	
Q801	1520000651	S.TRA	2SB1201S-TL-E	
Q802	1530002691	S.TRA	2SC4116-GR(TE85R,F)	
Q810	1530002060	S.TRA	2SC4081 T106 R	
Q1140	1560000841	S.FET	2SK1829(TE85R,F)	
Q1260	1540000471	S.TRA	2SD1801S-TL-E	
Q1261	1590000680	S.TRA	DTC114EUA T106	
Q1860	1590000680	S.TRA	DTC114EUA T106	
Q1880	1590000680	S.TRA	DTC114EUA T106	
Q1940	1510000510	S.TRA	2SA1576A T106R	
Q1941	1530002060	S.TRA	2SC4081 T106 R	
D200	1790001211	S.DIO	1SS375-TL-E	
D202	1790001251	S.DIO	MA2S1110GL	
D250	1790001621	S.DIO	1SV308(TPL3,F)	
D251	1790001621	S.DIO	1SV308(TPL3,F)	
D252	1790001621	S.DIO	1SV308(TPL3,F)	
D253	1790001621	S.DIO	1SV308(TPL3,F)	
D303	1790001611	S.DIO	1SS385(TE85L,F)	
D305	1790001251	S.DIO	MA2S1110GL	
D310	1730002341	S.ZEN	MAZ8047GML	
D311	1790001331	S.ZEN	MAZ8036GML	
D312	1750000520	S.DIO	DAN222TL	
D360	1790001611	S.DIO	1SS385(TE85L,F)	
D361	1790001241	S.DIO	MA2S7280GL	
D362	1790001251	S.DIO	MA2S1110GL	
D363	1790001251	S.DIO	MA2S1110GL	

## [MAIN UNIT]

REF NO.	ORDER NO.		DESCRIPTION	
D364	1790001241	S.DIO	MA2S7280GL	
D380	1790000620	S.DIO	MA77(TX)	
D381	1790000620	S.DIO	MA77(TX)	
D382	1790000620	S.DIO	MA77(TX)	
D383	1790000620	S.DIO	MA77(TX)	
D450	1750000370	S.DIO	DA221 TL	
D451	1750000370	S.DIO	DA221 TL	
D550	1750000520	S.DIO	DAN222TL	
D551	1750000520	S.DIO	DAN222TL	
D552	1790001251	S.DIO	MA2S1110GL	
D553	1790001251	S.DIO	MA2S1110GL	
D700	1790001251	S.DIO	MA2S1110GL	
D720	1750000520	S.DIO	DAN222TL	
D721	1750000520	S.DIO	DAN222TL	
D722	1790001251	S.DIO	MA2S1110GL	
D723	1790001251	S.DIO	MA2S1110GL	
D740	1750000520	S.DIO	DAN222TL	
D781	1790001251	S.DIO	MA2S1110GL	
D782	1790001251	S.DIO	MA2S1110GL	
D783	1790001251	S.DIO	MA2S1110GL	
D784	1750000520	S.DIO	DAN222TL	
D801	1790001171	S.ZEN	MAZ8068GML	
D810	1790001251	S.DIO	MA2S1110GL	
D1300	1790001611	S.DIO	1SS385(TE85L,F)	
D1822	1790001251	S.DIO	MA2S1110GL	[EUR]
	1790001251	S.DIO	MA2S1110GL	[FRA]
	1790001251	S.DIO	MA2S1110GL	[DEN]
	1790001251	S.DIO	MA2S1110GL	[ITR]
	1790001251	S.DIO	MA2S1110GL	[ESP]
D1840	1750000370	S.DIO	DA221 TL	
D1841	1750000370	S.DIO	DA221 TL	
D1880	1750000370	S.DIO	DA221 TL	
D1881	1750000370	S.DIO	DA221 TL	
D1900	1790001670	S.DIO	RB706F-40T106	
D1901	1790001670	S.DIO	RB706F-40T106	
D1940	1790001251	S.DIO	MA2S1110GL	
D2000	1790001611	S.DIO	1SS385(TE85L,F)	
FI271	2020001740	CER	CFWLB455KDFA-B0 (CFWM455D)	
FI272	2020001740	CER	CFWLB455KDFA-B0 (CFWM455D)	
FI381	2020001740	CER	CFWLB455KDFA-B0 (CFWM455D)	
X1500	6050009520	S.XTA	CR-520 SMD-49 19.6608 MHz <KDS>	
L120	2040000490	COI	EXC-ELDR25C	
L121	2040000490	COI	EXC-ELDR25C	
L122	6200001831	S.COI	NLV32T-100J	
L123	6200001831	S.COI	NLV32T-100J	
L124	6200001831	S.COI	NLV32T-100J	
L125	6200001831	S.COI	NLV32T-100J	
L126	6200001831	S.COI	NLV32T-100J	
L127	6200003950	S.COI	HF50ACC 322513-T	
L128	6200003950	S.COI	HF50ACC 322513-T	
L129	6200003950	S.COI	HF50ACC 322513-T	
L130	6200003950	S.COI	HF50ACC 322513-T	
L140	6200003950	S.COI	HF50ACC 322513-T	
L141	6200003950	S.COI	HF50ACC 322513-T	
L142	6200003950	S.COI	HF50ACC 322513-T	
L143	6200003950	S.COI	HF50ACC 322513-T	
L144	6200001831	S.COI	NLV32T-100J	
L145	6200001831	S.COI	NLV32T-100J	
L181	6200009690	S.COI	LQH43CN101K03L	
L200	6180001000	COI	LAL 04NA 102K	
L201	6150002291	COI	LS-450	
L202	6150002291	COI	LS-450	
L203	6150002291	COI	LS-450	
L250	6200005491	S.COI	NLV32T-331J	
L251	6150004080	COI	LS-468 (C-13958)	
L252	6150004080	COI	LS-468 (C-13958)	
L253	6150004080	COI	LS-468 (C-13958)	
L254	6150004080	COI	LS-468 (C-13958)	
L280	6200003261	S.COI	NLV32T-101J	
L281	6200003261	S.COI	NLV32T-101J	
L330	6150004090	COI	LS-469 (C-13969)	
L400	6200003261	S.COI	NLV32T-101J	
L402	6200003261	S.COI	NLV32T-101J	
L700	6200003261	S.COI	NLV32T-101J	
L701	6200003261	S.COI	NLV32T-101J	
L702	6200003261	S.COI	NLV32T-101J	
L703	6200003590	S.COI	EXCL3225U1	
L704	6200003261	S.COI	NLV32T-101J	
L740	6200003950	S.COI	HF50ACC 322513-T	
L741	6200003950	S.COI	HF50ACC 322513-T	
L742	6200003950	S.COI	HF50ACC 322513-T	
L760	6200003241	S.COI	NLV32T-221J	
L761	6200003241	S.COI	NLV32T-221J	
L762	6200008820	S.COI	HF70ACC 635050-T	
L763	6200008820	S.COI	HF70ACC 635050-T	
L780	6200003950	S.COI	HF50ACC 322513-T	
L781	6200003261	S.COI	NLV32T-101J	
L782	6200003950	S.COI	HF50ACC 322513-T	
L783	6200003261	S.COI	NLV32T-101J	
L784	6200003261	S.COI	NLV32T-101J	
L785	6200003950	S.COI	HF50ACC 322513-T	
L786	6200003261	S.COI	NLV32T-101J	
L787	6200003261	S.COI	NLV32T-101J	
L788	6200003261	S.COI	NLV32T-101J	
L789	6200003950	S.COI	HF50ACC 322513-T	
L790	6200003950	S.COI	HF50ACC 322513-T	
L791	6200003950	S.COI	HF50ACC 322513-T	
L792	6200003950	S.COI	HF50ACC 322513-T	

M.=Mounted side (T: Mounted on the Top side, B: Mounted on the Bottom side)  
S.=Surface mount

[MAIN UNIT]

REF NO.	ORDER NO.	DESCRIPTION
L793	6200003950	S.COI HF50ACC 322513-T
L794	6200003950	S.COI HF50ACC 322513-T
L795	6200003950	S.COI HF50ACC 322513-T
L796	6200003950	S.COI HF50ACC 322513-T
L1241	6180003640	COI SZW1012T-142-0.3
L1401	6200001831	S.COI NLV32T-100J
L1880	6200001831	S.COI NLV32T-100J
L1881	6200001831	S.COI NLV32T-100J
L2020	6200003331	S.COI NLV32T-1R0J
L2060	6200001831	S.COI NLV32T-100J
L2061	6200003331	S.COI NLV32T-1R0J
R100	7030003440	S.RES ERJ3GEYJ 102 V (1K)
R101	7030003440	S.RES ERJ3GEYJ 102 V (1K)
R102	7030003320	S.RES ERJ3GEYJ 101 V (100)
R103	7030003440	S.RES ERJ3GEYJ 102 V (1K)
R104	7030003320	S.RES ERJ3GEYJ 101 V (100)
R105	7030003320	S.RES ERJ3GEYJ 101 V (100)
R120	7030003320	S.RES ERJ3GEYJ 101 V (100)
R121	7030003320	S.RES ERJ3GEYJ 101 V (100)
R122	7030003320	S.RES ERJ3GEYJ 101 V (100)
R123	7030003440	S.RES ERJ3GEYJ 102 V (1K)
R124	7030003440	S.RES ERJ3GEYJ 102 V (1K)
R140	7030003440	S.RES ERJ3GEYJ 102 V (1K)
R141	7030003440	S.RES ERJ3GEYJ 102 V (1K)
R142	7030003440	S.RES ERJ3GEYJ 102 V (1K)
R143	7030003440	S.RES ERJ3GEYJ 102 V (1K)
R160	7030003440	S.RES ERJ3GEYJ 102 V (1K)
R180	7030003440	S.RES ERJ3GEYJ 102 V (1K)
R181	7030003440	S.RES ERJ3GEYJ 102 V (1K)
R182	7030003360	S.RES ERJ3GEYJ 221 V (220)
R183	7030003360	S.RES ERJ3GEYJ 221 V (220)
R184	7030003440	S.RES ERJ3GEYJ 102 V (1K)
R200	7310005040	S.TRI RH03ADCJ4X (22K)
R202	7030003400	S.RES ERJ3GEYJ 471 V (470)
R203	7030003320	S.RES ERJ3GEYJ 101 V (100)
R204	7030003600	S.RES ERJ3GEYJ 223 V (22K)
R205	7030003400	S.RES ERJ3GEYJ 471 V (470)
R206	7030003320	S.RES ERJ3GEYJ 101 V (100)
R207	7030003600	S.RES ERJ3GEYJ 223 V (22K)
R208	7030003520	S.RES ERJ3GEYJ 472 V (4.7K)
R209	7030003320	S.RES ERJ3GEYJ 101 V (100)
R210	7030003600	S.RES ERJ3GEYJ 223 V (22K)
R211	7030003600	S.RES ERJ3GEYJ 223 V (22K)
R212	7030003440	S.RES ERJ3GEYJ 102 V (1K)
R213	7030003680	S.RES ERJ3GEYJ 104 V (100K)
R215	7030003640	S.RES ERJ3GEYJ 473 V (47K)
R216	7030003640	S.RES ERJ3GEYJ 473 V (47K)
R217	7030003840	S.RES ERJ3GEYJ 225 V (2.2M)
R218	7030003380	S.RES ERJ3GEYJ 331 V (330)
R219	7030003540	S.RES ERJ3GEYJ 682 V (6.8K)
R220	7030003540	S.RES ERJ3GEYJ 682 V (6.8K)
R221	7030003280	S.RES ERJ3GEYJ 470 V (47)
R222	7030003560	S.RES ERJ3GEYJ 103 V (10K)
R223	7030003600	S.RES ERJ3GEYJ 223 V (22K)
R250	7030000340	S.RES MCR10EZHH 470 (471)
R251	7030003440	S.RES ERJ3GEYJ 102 V (1K)
R252	7030003680	S.RES ERJ3GEYJ 104 V (100K)
R253	7030000310	S.RES MCR10EZHH 270 (271)
R254	7030003440	S.RES ERJ3GEYJ 102 V (1K)
R255	7030003400	S.RES ERJ3GEYJ 471 V (470)
R256	7030003560	S.RES ERJ3GEYJ 103 V (10K)
R257	7030003460	S.RES ERJ3GEYJ 152 V (1.5K)
R258	7030003280	S.RES ERJ3GEYJ 470 V (47)
R259	7030003300	S.RES ERJ3GEYJ 680 V (68)
R260	7030003460	S.RES ERJ3GEYJ 152 V (1.5K)
R261	7030003200	S.RES ERJ3GEYJ 100 V (10)
R263	7030003460	S.RES ERJ3GEYJ 152 V (1.5K)
R264	7030003560	S.RES ERJ3GEYJ 103 V (10K)
R280	7030003460	S.RES ERJ3GEYJ 152 V (1.5K)
R281	7030003800	S.RES ERJ3GEYJ 105 V (1M)
R282	7030003560	S.RES ERJ3GEYJ 103 V (10K)
R300	7030009920	S.RES ERJ3GEYJ 335 V (3.3M)
R301	7030003840	S.RES ERJ3GEYJ 225 V (2.2M)
R302	7030009930	S.RES ERJ3GEYJ 825 V (8.2M)
R306	7310005590	S.TRI TMC3ADCJ5X (220K)
R307	7030003560	S.RES ERJ3GEYJ 103 V (10K)
R308	7030003680	S.RES ERJ3GEYJ 104 V (100K)
R310	7030003600	S.RES ERJ3GEYJ 223 V (22K)
R311	7310005590	S.TRI TMC3ADCJ5X (220K)
R313	7030003680	S.RES ERJ3GEYJ 104 V (100K)
R314	7030003720	S.RES ERJ3GEYJ 224 V (220K)
R316	7030003820	S.RES ERJ3GEYJ 155 V (1.5M)
R317	7310005590	S.TRI TMC3ADCJ5X (220K)
R318	7030003380	S.RES ERJ3GEYJ 331 V (330)
R319	7030003600	S.RES ERJ3GEYJ 223 V (22K)
R320	7310005590	S.TRI TMC3ADCJ5X (220K)
R321	7030003760	S.RES ERJ3GEYJ 474 V (470K)
R322	7030003560	S.RES ERJ3GEYJ 103 V (10K)
R323	7030003680	S.RES ERJ3GEYJ 104 V (100K)
R324	7030003520	S.RES ERJ3GEYJ 472 V (4.7K)
R326	7030009720	S.RES ERJ12YJ102U (1K)
R327	7030003600	S.RES ERJ3GEYJ 223 V (22K)
R328	7030003560	S.RES ERJ3GEYJ 103 V (10K)
R330	7030003440	S.RES ERJ3GEYJ 102 V (1K)
R331	7310005580	S.TRI TMC3ADC3X (4.7K)
R332	7030003320	S.RES ERJ3GEYJ 101 V (100)
R333	7030003560	S.RES ERJ3GEYJ 103 V (10K)
R334	7030003600	S.RES ERJ3GEYJ 223 V (22K)
R335	7030003560	S.RES ERJ3GEYJ 103 V (10K)
R336	7030003680	S.RES ERJ3GEYJ 104 V (100K)
R337	7510001530	S.THE NTCG20 3NH 103JT
R360	7030003680	S.RES ERJ3GEYJ 104 V (100K)

[MAIN UNIT]

REF NO.	ORDER NO.	DESCRIPTION
R361	7030003680	S.RES ERJ3GEYJ 104 V (100K)
R363	7030003680	S.RES ERJ3GEYJ 104 V (100K)
R364	7030003560	S.RES ERJ3GEYJ 103 V (10K)
R365	7030003560	S.RES ERJ3GEYJ 103 V (10K)
R366	7030003360	S.RES ERJ3GEYJ 221 V (220)
R367	7030003360	S.RES ERJ3GEYJ 221 V (220)
R368	7030003620	S.RES ERJ3GEYJ 333 V (33K)
R369	7030003620	S.RES ERJ3GEYJ 333 V (33K)
R370	7030003740	S.RES ERJ3GEYJ 334 V (330K)
R380	7030003520	S.RES ERJ3GEYJ 472 V (4.7K)
R381	7030003510	S.RES ERJ3GEYJ 392 V (3.9K)
R382	7030003560	S.RES ERJ3GEYJ 103 V (10K)
R383	7030003360	S.RES ERJ3GEYJ 221 V (220)
R384	7030003560	S.RES ERJ3GEYJ 103 V (10K)
R385	7030003320	S.RES ERJ3GEYJ 101 V (100)
R386	7030003480	S.RES ERJ3GEYJ 222 V (2.2K)
R387	7030003560	S.RES ERJ3GEYJ 103 V (10K)
R388	7030003360	S.RES ERJ3GEYJ 221 V (220)
R389	7030003510	S.RES ERJ3GEYJ 392 V (3.9K)
R390	7030003320	S.RES ERJ3GEYJ 101 V (100)
R400	7030003560	S.RES ERJ3GEYJ 103 V (10K)
R404	7030003440	S.RES ERJ3GEYJ 102 V (1K)
R405	7030003440	S.RES ERJ3GEYJ 102 V (1K)
R406	7030003530	S.RES ERJ3GEYJ 562 V (5.6K)
R407	7030003360	S.RES ERJ3GEYJ 221 V (220)
R408	7030003500	S.RES ERJ3GEYJ 332 V (3.3K)
R409	7030003510	S.RES ERJ3GEYJ 392 V (3.9K)
R410	7030003440	S.RES ERJ3GEYJ 102 V (1K)
R411	7030003420	S.RES ERJ3GEYJ 681 V (680)
R412	7030003500	S.RES ERJ3GEYJ 332 V (3.3K)
R413	7030003320	S.RES ERJ3GEYJ 101 V (100)
R414	7030003520	S.RES ERJ3GEYJ 472 V (4.7K)
R415	7030003440	S.RES ERJ3GEYJ 102 V (1K)
R450	7030006210	S.RES ERJ12YJ4R7U (4.7)
R451	7030003440	S.RES ERJ3GEYJ 102 V (1K)
R452	7030003560	S.RES ERJ3GEYJ 103 V (10K)
R453	7030006210	S.RES ERJ12YJ4R7U (4.7)
R454	7030003440	S.RES ERJ3GEYJ 102 V (1K)
R455	7030003520	S.RES ERJ3GEYJ 472 V (4.7K)
R500	7030003640	S.RES ERJ3GEYJ 473 V (47K)
R501	7030003680	S.RES ERJ3GEYJ 104 V (100K)
R502	7030003680	S.RES ERJ3GEYJ 104 V (100K)
R503	7030003400	S.RES ERJ3GEYJ 471 V (470)
R504	7030003440	S.RES ERJ3GEYJ 102 V (1K)
R505	7030003440	S.RES ERJ3GEYJ 102 V (1K)
R506	7030003440	S.RES ERJ3GEYJ 102 V (1K)
R507	7030009891	S.RES ERA3YED 151V (150)
R508	7030009851	S.RES ERA3YED 271V (270)
R511	7030003440	S.RES ERJ3GEYJ 102 V (1K)
R512	7030003440	S.RES ERJ3GEYJ 102 V (1K)
R521	7030003640	S.RES ERJ3GEYJ 473 V (47K)
R522	7030003680	S.RES ERJ3GEYJ 104 V (100K)
R523	7030003680	S.RES ERJ3GEYJ 104 V (100K)
R524	7030003640	S.RES ERJ3GEYJ 473 V (47K)
R525	7030003680	S.RES ERJ3GEYJ 104 V (100K)
R526	7030003680	S.RES ERJ3GEYJ 104 V (100K)
R527	7030003440	S.RES ERJ3GEYJ 102 V (1K)
R528	7030003440	S.RES ERJ3GEYJ 102 V (1K)
R550	7030003640	S.RES ERJ3GEYJ 473 V (47K)
R551	7030003660	S.RES ERJ3GEYJ 683 V (68K)
R552	7030003640	S.RES ERJ3GEYJ 473 V (47K)
R553	7030003620	S.RES ERJ3GEYJ 333 V (33K)
R554	7030003680	S.RES ERJ3GEYJ 104 V (100K)
R555	7310005540	S.TRI TMC3ADC14X (10K)
R556	7030003680	S.RES ERJ3GEYJ 104 V (100K)
R557	7030003500	S.RES ERJ3GEYJ 332 V (3.3K)
R558	7030003620	S.RES ERJ3GEYJ 333 V (33K)
R559	7030003840	S.RES ERJ3GEYJ 225 V (2.2M)
R560	7030003800	S.RES ERJ3GEYJ 105 V (1M)
R561	7510001420	S.THE NTCG20 3SH 223JT
R562	7510001420	S.THE NTCG20 3SH 223JT
R700	7030003580	S.RES ERJ3GEYJ 153 V (15K)
R701	7030003620	S.RES ERJ3GEYJ 333 V (33K)
R702	7030003520	S.RES ERJ3GEYJ 472 V (4.7K)
R703	7030003520	S.RES ERJ3GEYJ 472 V (4.7K)
R720	7030003620	S.RES ERJ3GEYJ 333 V (33K)
R721	7030003580	S.RES ERJ3GEYJ 153 V (15K)
R722	7030003620	S.RES ERJ3GEYJ 333 V (33K)
R723	7030003580	S.RES ERJ3GEYJ 153 V (15K)
R724	7030003520	S.RES ERJ3GEYJ 472 V (4.7K)
R725	7030003520	S.RES ERJ3GEYJ 472 V (4.7K)
R726	7030003520	S.RES ERJ3GEYJ 472 V (4.7K)
R727	7030003520	S.RES ERJ3GEYJ 472 V (4.7K)
R740	7030003200	S.RES ERJ3GEYJ 100 V (10)
R780	7030003520	S.RES ERJ3GEYJ 472 V (4.7K)
R781	7030003620	S.RES ERJ3GEYJ 333 V (33K)
R782	7030003580	S.RES ERJ3GEYJ 153 V (15K)
R783	7030003520	S.RES ERJ3GEYJ 472 V (4.7K)
R785	7030003420	S.RES ERJ3GEYJ 681 V (680)
R786	7030003560	S.RES ERJ3GEYJ 103 V (10K)
R787	7030003480	S.RES ERJ3GEYJ 222 V (2.2K)
R788	7030003480	S.RES ERJ3GEYJ 222 V (2.2K)
R789	7030003560	S.RES ERJ3GEYJ 103 V (10K)
R790	7030003200	S.RES ERJ3GEYJ 100 V (10)
R791	7030003420	S.RES ERJ3GEYJ 681 V (680)
R792	7030003420	S.RES ERJ3GEYJ 681 V (680)
R793	7030003420	S.RES ERJ3GEYJ 681 V (680)
R794	7030003420	S.RES ERJ3GEYJ 681 V (680)
R795	7030003420	S.RES ERJ3GEYJ 681 V (680)
R796	7030003560	S.RES ERJ3GEYJ 103 V (10K)
R797	7030003560	S.RES ERJ3GEYJ 103 V (10K)
R801	7030007190	S.RES ERJ12YJ220U (22)
R802	7030003560	S.RES ERJ3GEYJ 103 V (10K)
R803	7030003400	S.RES ERJ3GEYJ 471 V (470)

M.=Mounted side (T: Mounted on the Top side, B: Mounted on the Bottom side)  
S.=Surface mount

**[MAIN UNIT]**

REF NO.	ORDER NO.	DESCRIPTION
R804	7030007190	S.RES ERJ12YJ220U (22)
R811	7030003520	S.RES ERJ3GEYJ 472 V (4.7K)
R812	7030003620	S.RES ERJ3GEYJ 333 V (33K)
R813	7030003580	S.RES ERJ3GEYJ 153 V (15K)
R814	7030003520	S.RES ERJ3GEYJ 472 V (4.7K)
R1000	7030003780	S.RES ERJ3GEYJ 684 V (680K)
R1001	7030003780	S.RES ERJ3GEYJ 684 V (680K)
R1002	7030003670	S.RES ERJ3GEYJ 823 V (82K)
R1003	7030003670	S.RES ERJ3GEYJ 823 V (82K)
R1004	7030003670	S.RES ERJ3GEYJ 823 V (82K)
R1005	7030003690	S.RES ERJ3GEYJ 124 V (120K)
R1006	7030003670	S.RES ERJ3GEYJ 823 V (82K)
R1007	7030003760	S.RES ERJ3GEYJ 474 V (470K)
R1008	7030003840	S.RES ERJ3GEYJ 225 V (2.2M)
R1009	7030003800	S.RES ERJ3GEYJ 105 V (1M)
R1013	7030003320	S.RES ERJ3GEYJ 101 V (100)
R1020	7030003500	S.RES ERJ3GEYJ 332 V (3.3K)
R1021	7030003600	S.RES ERJ3GEYJ 223 V (22K)
R1022	7030003680	S.RES ERJ3GEYJ 104 V (100K)
R1023	7030003680	S.RES ERJ3GEYJ 104 V (100K)
R1040	7030003440	S.RES ERJ3GEYJ 102 V (1K)
R1061	7030003760	S.RES ERJ3GEYJ 474 V (470K)
R1062	7030003650	S.RES ERJ3GEYJ 563 V (56K)
R1063	7030003780	S.RES ERJ3GEYJ 684 V (680K)
R1064	7030003320	S.RES ERJ3GEYJ 101 V (100)
R1065	7030003320	S.RES ERJ3GEYJ 101 V (100)
R1080	7030003680	S.RES ERJ3GEYJ 104 V (100K)
R1081	7030003640	S.RES ERJ3GEYJ 473 V (47K)
R1082	7030003680	S.RES ERJ3GEYJ 104 V (100K)
R1083	7030003680	S.RES ERJ3GEYJ 104 V (100K)
R1084	7030003640	S.RES ERJ3GEYJ 473 V (47K)
R1085	7030003320	S.RES ERJ3GEYJ 101 V (100)
R1086	7030003610	S.RES ERJ3GEYJ 273 V (27K)
R1087	7030003550	S.RES ERJ3GEYJ 822 V (8.2K)
R1088	7030003480	S.RES ERJ3GEYJ 222 V (2.2K)
R1100	7030003560	S.RES ERJ3GEYJ 103 V (10K)
R1101	7030003550	S.RES ERJ3GEYJ 822 V (8.2K)
R1102	7030003610	S.RES ERJ3GEYJ 273 V (27K)
R1103	7030003440	S.RES ERJ3GEYJ 102 V (1K)
R1104	7030003440	S.RES ERJ3GEYJ 102 V (1K)
R1105	7030003440	S.RES ERJ3GEYJ 102 V (1K)
R1106	7030003440	S.RES ERJ3GEYJ 102 V (1K)
R1107	7030003440	S.RES ERJ3GEYJ 102 V (1K)
R1108	7030003720	S.RES ERJ3GEYJ 224 V (220K)
R1109	7030003320	S.RES ERJ3GEYJ 101 V (100)
R1110	7030003320	S.RES ERJ3GEYJ 101 V (100)
R1126	7030003640	S.RES ERJ3GEYJ 473 V (47K)
R1140	7030003480	S.RES ERJ3GEYJ 222 V (2.2K)
R1141	7030003560	S.RES ERJ3GEYJ 103 V (10K)
R1160	7030003320	S.RES ERJ3GEYJ 101 V (100)
R1161	7030003320	S.RES ERJ3GEYJ 101 V (100)
R1162	7030003440	S.RES ERJ3GEYJ 102 V (1K)
R1180	7030003580	S.RES ERJ3GEYJ 153 V (15K)
R1181	7030003480	S.RES ERJ3GEYJ 222 V (2.2K)
R1182	7030003440	S.RES ERJ3GEYJ 102 V (1K)
R1183	7030003440	S.RES ERJ3GEYJ 102 V (1K)
R1184	7030003440	S.RES ERJ3GEYJ 102 V (1K)
R1185	7030003640	S.RES ERJ3GEYJ 473 V (47K)
R1186	7030003560	S.RES ERJ3GEYJ 103 V (10K)
R1187	7030003520	S.RES ERJ3GEYJ 472 V (4.7K)
R1188	7030003640	S.RES ERJ3GEYJ 473 V (47K)
R1189	7030003320	S.RES ERJ3GEYJ 101 V (100)
R1190	7030003730	S.RES ERJ3GEYJ 274 V (270K)
R1191	7030003670	S.RES ERJ3GEYJ 823 V (82K)
R1192	7030003600	S.RES ERJ3GEYJ 223 V (22K)
R1193	7030003680	S.RES ERJ3GEYJ 104 V (100K)
R1220	7030003680	S.RES ERJ3GEYJ 104 V (100K)
R1221	7030003320	S.RES ERJ3GEYJ 101 V (100)
R1222	7030003320	S.RES ERJ3GEYJ 101 V (100)
R1240	7030003560	S.RES ERJ3GEYJ 103 V (10K)
R1241	7030003440	S.RES ERJ3GEYJ 102 V (1K)
R1242	7030003400	S.RES ERJ3GEYJ 471 V (470)
R1260	7030003280	S.RES ERJ3GEYJ 470 V (47)
R1280	7030003510	S.RES ERJ3GEYJ 392 V (3.9K)
R1281	7030003540	S.RES ERJ3GEYJ 682 V (6.8K)
R1282	7030003720	S.RES ERJ3GEYJ 224 V (220K)
R1283	7030003700	S.RES ERJ3GEYJ 154 V (150K)
R1284	7030003720	S.RES ERJ3GEYJ 224 V (220K)
R1285	7030003530	S.RES ERJ3GEYJ 562 V (5.6K)
R1286	7030003680	S.RES ERJ3GEYJ 104 V (100K)
R1287	7030003560	S.RES ERJ3GEYJ 103 V (10K)
R1288	7030003600	S.RES ERJ3GEYJ 223 V (22K)
R1289	7030003680	S.RES ERJ3GEYJ 104 V (100K)
R1300	7030003320	S.RES ERJ3GEYJ 101 V (100)
R1301	7030003320	S.RES ERJ3GEYJ 101 V (100)
R1302	7030003580	S.RES ERJ3GEYJ 153 V (15K)
R1303	7030003590	S.RES ERJ3GEYJ 183 V (18K)
R1304	7030003680	S.RES ERJ3GEYJ 104 V (100K)
R1305	7030003680	S.RES ERJ3GEYJ 104 V (100K)
R1306	7030003680	S.RES ERJ3GEYJ 104 V (100K)
R1307	7030003780	S.RES ERJ3GEYJ 684 V (680K)
R1308	7030003680	S.RES ERJ3GEYJ 104 V (100K)
R1309	7030003680	S.RES ERJ3GEYJ 104 V (100K)
R1310	7030003700	S.RES ERJ3GEYJ 154 V (150K)
R1311	7030003680	S.RES ERJ3GEYJ 104 V (100K)
R1312	7030003680	S.RES ERJ3GEYJ 104 V (100K)
R1313	7030003680	S.RES ERJ3GEYJ 104 V (100K)
R1314	7030003720	S.RES ERJ3GEYJ 224 V (220K)
R1315	7030003560	S.RES ERJ3GEYJ 103 V (10K)
R1400	7030003520	S.RES ERJ3GEYJ 472 V (4.7K)
R1401	7030003680	S.RES ERJ3GEYJ 104 V (100K)
R1402	7030003640	S.RES ERJ3GEYJ 473 V (47K)
R1403	7030003200	S.RES ERJ3GEYJ 100 V (10)
R1404	7030003680	S.RES ERJ3GEYJ 104 V (100K)

**[MAIN UNIT]**

REF NO.	ORDER NO.	DESCRIPTION
R1406	7030003640	S.RES ERJ3GEYJ 473 V (47K)
R1407	7030003560	S.RES ERJ3GEYJ 103 V (10K)
R1408	7030003560	S.RES ERJ3GEYJ 103 V (10K)
R1409	7030003560	S.RES ERJ3GEYJ 103 V (10K)
R1410	7030003560	S.RES ERJ3GEYJ 103 V (10K)
R1411	7030003720	S.RES ERJ3GEYJ 224 V (220K)
R1412	7030003540	S.RES ERJ3GEYJ 682 V (6.8K)
R1413	7030003440	S.RES ERJ3GEYJ 102 V (1K)
R1414	7030003600	S.RES ERJ3GEYJ 223 V (22K)
R1415	7030003600	S.RES ERJ3GEYJ 223 V (22K)
R1416	7030003600	S.RES ERJ3GEYJ 223 V (22K)
R1417	7030003600	S.RES ERJ3GEYJ 223 V (22K)
R1418	7030003600	S.RES ERJ3GEYJ 223 V (22K)
R1419	7030003560	S.RES ERJ3GEYJ 103 V (10K)
R1420	7030003320	S.RES ERJ3GEYJ 101 V (100)
R1423	7030003320	S.RES ERJ3GEYJ 101 V (100)
R1424	7030003420	S.RES ERJ3GEYJ 681 V (680)
R1425	7030003360	S.RES ERJ3GEYJ 221 V (220)
R1460	7030003200	S.RES ERJ3GEYJ 100 V (10)
R1461	7030003680	S.RES ERJ3GEYJ 104 V (100K)
R1462	7030006461	S.RES ERA3YED 152V (1.5K)
R1463	7030003200	S.RES ERJ3GEYJ 100 V (10)
R1464	7030006461	S.RES ERA3YED 152V (1.5K)
R1465	7030006461	S.RES ERA3YED 152V (1.5K)
R1466	7510001581	S.THE NTCG16 4BH 153JT
R1467	7030008061	S.RES ERA3YED 222V (2.2K)
R1468	7030008061	S.RES ERA3YED 222V (2.2K)
R1469	7310005090	S.TRI RH03ADC13X (1K)
R1470	7030003680	S.RES ERJ3GEYJ 104 V (100K)
R1480	7030003320	S.RES ERJ3GEYJ 101 V (100)
R1481	7030003320	S.RES ERJ3GEYJ 101 V (100)
R1500	7030003360	S.RES ERJ3GEYJ 221 V (220)
R1501	7030003360	S.RES ERJ3GEYJ 221 V (220)
R1502	7030003360	S.RES ERJ3GEYJ 221 V (220)
R1503	7030003360	S.RES ERJ3GEYJ 221 V (220)
R1504	7030003360	S.RES ERJ3GEYJ 221 V (220)
R1505	7030003360	S.RES ERJ3GEYJ 221 V (220)
R1506	7030003360	S.RES ERJ3GEYJ 221 V (220)
R1507	7030003360	S.RES ERJ3GEYJ 221 V (220)
R1508	7030003360	S.RES ERJ3GEYJ 221 V (220)
R1509	7030003360	S.RES ERJ3GEYJ 221 V (220)
R1510	7030003360	S.RES ERJ3GEYJ 221 V (220)
R1511	7030003360	S.RES ERJ3GEYJ 221 V (220)
R1512	7030003360	S.RES ERJ3GEYJ 221 V (220)
R1560	7030003640	S.RES ERJ3GEYJ 473 V (47K)
R1561	7030003640	S.RES ERJ3GEYJ 473 V (47K)
R1562	7030003640	S.RES ERJ3GEYJ 473 V (47K)
R1580	7030003600	S.RES ERJ3GEYJ 223 V (22K)
R1581	7030003560	S.RES ERJ3GEYJ 103 V (10K)
R1620	7030003640	S.RES ERJ3GEYJ 473 V (47K)
R1621	7030003640	S.RES ERJ3GEYJ 473 V (47K)
R1622	7030003640	S.RES ERJ3GEYJ 473 V (47K)
R1623	7030003640	S.RES ERJ3GEYJ 473 V (47K)
R1700	7030003440	S.RES ERJ3GEYJ 102 V (1K)
R1701	7030003440	S.RES ERJ3GEYJ 102 V (1K)
R1702	7030003640	S.RES ERJ3GEYJ 473 V (47K)
R1703	7030003640	S.RES ERJ3GEYJ 473 V (47K)
R1720	7030003440	S.RES ERJ3GEYJ 102 V (1K)
R1721	7030003640	S.RES ERJ3GEYJ 473 V (47K)
R1740	7030003440	S.RES ERJ3GEYJ 102 V (1K)
R1741	7030003440	S.RES ERJ3GEYJ 102 V (1K)
R1742	7030003640	S.RES ERJ3GEYJ 473 V (47K)
R1743	7030003640	S.RES ERJ3GEYJ 473 V (47K)
R1760	7030003440	S.RES ERJ3GEYJ 102 V (1K)
R1780	7030003440	S.RES ERJ3GEYJ 102 V (1K)
R1800	7030003440	S.RES ERJ3GEYJ 102 V (1K)
R1801	7030003440	S.RES ERJ3GEYJ 102 V (1K)
R1802	7030003440	S.RES ERJ3GEYJ 102 V (1K)
R1803	7030003440	S.RES ERJ3GEYJ 102 V (1K)
R1804	7030003440	S.RES ERJ3GEYJ 102 V (1K)
R1820	7030003440	S.RES ERJ3GEYJ 102 V (1K)
R1821	7030003440	S.RES ERJ3GEYJ 102 V (1K)
R1822	7030003440	S.RES ERJ3GEYJ 102 V (1K)
R1823	7030003320	S.RES ERJ3GEYJ 101 V (100)
R1824	7030003440	S.RES ERJ3GEYJ 102 V (1K)
R1825	7030003440	S.RES ERJ3GEYJ 102 V (1K)
R1826	7030003440	S.RES ERJ3GEYJ 102 V (1K)
R1827	7030003440	S.RES ERJ3GEYJ 102 V (1K)
R1828	7030003640	S.RES ERJ3GEYJ 473 V (47K)
R1840	7030003640	S.RES ERJ3GEYJ 473 V (47K)
R1841	7030003560	S.RES ERJ3GEYJ 103 V (10K)
R1842	7030003560	S.RES ERJ3GEYJ 103 V (10K)
R1843	7030003440	S.RES ERJ3GEYJ 102 V (1K)
R1844	7030003440	S.RES ERJ3GEYJ 102 V (1K)
R1845	7030003440	S.RES ERJ3GEYJ 102 V (1K)
R1846	7030003440	S.RES ERJ3GEYJ 102 V (1K)
R1847	7030003440	S.RES ERJ3GEYJ 102 V (1K)
R1850	7030003640	S.RES ERJ3GEYJ 473 V (47K)
R1851	7030003640	S.RES ERJ3GEYJ 473 V (47K)
R1852	7030003600	S.RES ERJ3GEYJ 223 V (22K)
R1853	7030003640	S.RES ERJ3GEYJ 473 V (47K)
R1860	7030003440	S.RES ERJ3GEYJ 102 V (1K)
R1861	7030003440	S.RES ERJ3GEYJ 102 V (1K)
R1862	7030003440	S.RES ERJ3GEYJ 102 V (1K)
R1863	7030003640	S.RES ERJ3GEYJ 473 V (47K)
R1864	7030003640	S.RES ERJ3GEYJ 473 V (47K)
R1880	7030003440	S.RES ERJ3GEYJ 102 V (1K)
R1881	7030003440	S.RES ERJ3GEYJ 102 V (1K)
R1882	7030003800	S.RES ERJ3GEYJ 105 V (1M)
R1883	7030003640	S.RES ERJ3GEYJ 473 V (47K)
R1900	7030003600	S.RES ERJ3GEYJ 223 V (22K)
R1901	7030003800	S.RES ERJ3GEYJ 105 V (1M)
R1902	7030003440	S.RES ERJ3GEYJ 102 V (1K)
R1903	7030003440	S.RES ERJ3GEYJ 102 V (1K)

M.=Mounted side (T: Mounted on the Top side, B: Mounted on the Bottom side)  
S.=Surface mount

[MAIN UNIT]

REF NO.	ORDER NO.	DESCRIPTION
R1904	7030003440	S.RES ERJ3GEYJ 102 V (1K)
R1905	7030003440	S.RES ERJ3GEYJ 102 V (1K)
R1906	7030003440	S.RES ERJ3GEYJ 102 V (1K)
R1907	7030003440	S.RES ERJ3GEYJ 102 V (1K)
R1908	7030003600	S.RES ERJ3GEYJ 223 V (22K)
R1909	7030003440	S.RES ERJ3GEYJ 102 V (1K)
R1910	7030003600	S.RES ERJ3GEYJ 223 V (22K)
R1911	7030003600	S.RES ERJ3GEYJ 223 V (22K)
R1912	7030003680	S.RES ERJ3GEYJ 104 V (100K)
R1913	7030003680	S.RES ERJ3GEYJ 104 V (100K)
R1920	7030003640	S.RES ERJ3GEYJ 473 V (47K)
R1921	7030003440	S.RES ERJ3GEYJ 102 V (1K)
R1922	7030003440	S.RES ERJ3GEYJ 102 V (1K)
R1923	7030003440	S.RES ERJ3GEYJ 102 V (1K)
R1924	7030003440	S.RES ERJ3GEYJ 102 V (1K)
R1925	7310005540	S.TRI TMC3ADC14X (10K)
R1940	7030003680	S.RES ERJ3GEYJ 104 V (100K)
R1941	7030003680	S.RES ERJ3GEYJ 104 V (100K)
R1942	7030003640	S.RES ERJ3GEYJ 473 V (47K)
R1943	7030003540	S.RES ERJ3GEYJ 682 V (6.8K)
R1944	7030003580	S.RES ERJ3GEYJ 153 V (15K)
R1945	7030003620	S.RES ERJ3GEYJ 333 V (33K)
R1960	7030003640	S.RES ERJ3GEYJ 473 V (47K)
R1961	7030003640	S.RES ERJ3GEYJ 473 V (47K)
R1962	7030003640	S.RES ERJ3GEYJ 473 V (47K)
R1963	7030003640	S.RES ERJ3GEYJ 473 V (47K)
R1964	7030003440	S.RES ERJ3GEYJ 102 V (1K)
R1965	7030003440	S.RES ERJ3GEYJ 102 V (1K)
R1966	7030003440	S.RES ERJ3GEYJ 102 V (1K)
R1967	7030003440	S.RES ERJ3GEYJ 102 V (1K)
R1968	7030003440	S.RES ERJ3GEYJ 102 V (1K)
R1969	7030003440	S.RES ERJ3GEYJ 102 V (1K)
R1970	7030003440	S.RES ERJ3GEYJ 102 V (1K)
R1971	7030003440	S.RES ERJ3GEYJ 102 V (1K)
R1972	7030003440	S.RES ERJ3GEYJ 102 V (1K)
R1980	7030003640	S.RES ERJ3GEYJ 473 V (47K)
R1981	7030003640	S.RES ERJ3GEYJ 473 V (47K)
R1982	7030003640	S.RES ERJ3GEYJ 473 V (47K)
R1983	7030003640	S.RES ERJ3GEYJ 473 V (47K)
R1984	7030003640	S.RES ERJ3GEYJ 473 V (47K)
R1985	7030003440	S.RES ERJ3GEYJ 102 V (1K)
R1986	7030003440	S.RES ERJ3GEYJ 102 V (1K)
R1987	7030003440	S.RES ERJ3GEYJ 102 V (1K)
R1988	7030003440	S.RES ERJ3GEYJ 102 V (1K)
R1989	7030003440	S.RES ERJ3GEYJ 102 V (1K)
R1990	7030003440	S.RES ERJ3GEYJ 102 V (1K)
R1991	7030003440	S.RES ERJ3GEYJ 102 V (1K)
R2000	7030003640	S.RES ERJ3GEYJ 473 V (47K)
R2040	7030003680	S.RES ERJ3GEYJ 104 V (100K)
R2041	7030003680	S.RES ERJ3GEYJ 104 V (100K)
R2042	7030003440	S.RES ERJ3GEYJ 102 V (1K)
W120	7030003860	S.RES ERJ3GE JPW V
W180	7030003860	S.RES ERJ3GE JPW V
W200	7030003860	S.RES ERJ3GE JPW V
W270	7030003860	S.RES ERJ3GE JPW V
W300	7030003860	S.RES ERJ3GE JPW V
W304	7030003860	S.RES ERJ3GE JPW V
W331	7030003860	S.RES ERJ3GE JPW V
W361	7030003860	S.RES ERJ3GE JPW V
W362	7030003860	S.RES ERJ3GE JPW V
W380	7030003860	S.RES ERJ3GE JPW V
W400	7030003860	S.RES ERJ3GE JPW V
W740	7030003860	S.RES ERJ3GE JPW V
W760	7030003860	S.RES ERJ3GE JPW V
W1120	7030003860	S.RES ERJ3GE JPW V
W1220	7030003860	S.RES ERJ3GE JPW V
W1240	7030003860	S.RES ERJ3GE JPW V
W1401	7030003860	S.RES ERJ3GE JPW V
W1600	7030003860	S.RES ERJ3GE JPW V
		[EUR]
		[FRA]
		[ITR]
W1601	7030003860	S.RES ERJ3GE JPW V
W1602	7030003860	S.RES ERJ3GE JPW V
W1603	7030003860	S.RES ERJ3GE JPW V
		[ESP]
		[KOR]
W1604	7030003860	S.RES ERJ3GE JPW V
W1605	7030003860	S.RES ERJ3GE JPW V
		[EUR]
		[FRA]
		[DEN]
W1606	7030003860	S.RES ERJ3GE JPW V
		[EUR]
		[FRA]
		[ITR]
		[KOR]
W1608	7030003860	S.RES ERJ3GE JPW V
W1609	7030003860	S.RES ERJ3GE JPW V
		[EUR]
		[DEN]
W1610	7030003860	S.RES ERJ3GE JPW V
		[EUR]
		[DEN]
		[ITR]
		[ESP]
		[KOR]
W1940	7030003860	S.RES ERJ3GE JPW V
W1941	7030003860	S.RES ERJ3GE JPW V
C100	4030006880	S.CER C1608 JB 1H 472K-T
C101	4030006880	S.CER C1608 JB 1H 472K-T
C102	4030006880	S.CER C1608 JB 1H 472K-T
C103	4030006880	S.CER C1608 JB 1H 472K-T
C104	4030006880	S.CER C1608 JB 1H 472K-T
C105	4030006880	S.CER C1608 JB 1H 472K-T
C106	4030006880	S.CER C1608 JB 1H 472K-T

[MAIN UNIT]

REF NO.	ORDER NO.	DESCRIPTION
C107	4030006880	S.CER C1608 JB 1H 472K-T
C108	4030007130	S.CER C1608 CH 1H 101J-T
C109	4030007130	S.CER C1608 CH 1H 101J-T
C110	4030007130	S.CER C1608 CH 1H 101J-T
C111	4030006860	S.CER C1608 JB 1H 102K-T
C120	4030006880	S.CER C1608 JB 1H 472K-T
C122	4030006880	S.CER C1608 JB 1H 472K-T
C123	4030006880	S.CER C1608 JB 1H 472K-T
C124	4030006880	S.CER C1608 JB 1H 472K-T
C125	4030006880	S.CER C1608 JB 1H 472K-T
C126	4030006880	S.CER C1608 JB 1H 472K-T
C129	4030006880	S.CER C1608 JB 1H 472K-T
C131	4030007130	S.CER C1608 CH 1H 101J-T
C132	4030007130	S.CER C1608 CH 1H 101J-T
C133	4030007130	S.CER C1608 CH 1H 101J-T
C134	4030006880	S.CER C1608 JB 1H 472K-T
C135	4030006880	S.CER C1608 JB 1H 472K-T
C136	4030006880	S.CER C1608 JB 1H 472K-T
C140	4030006880	S.CER C1608 JB 1H 472K-T
C141	4030006880	S.CER C1608 JB 1H 472K-T
C142	4030006880	S.CER C1608 JB 1H 472K-T
C143	4030006880	S.CER C1608 JB 1H 472K-T
C144	4030007170	S.CER C1608 CH 1H 221J-T
C145	4030007170	S.CER C1608 CH 1H 221J-T
C146	4030006880	S.CER C1608 JB 1H 472K-T
C147	4030006880	S.CER C1608 JB 1H 472K-T
C148	4030006880	S.CER C1608 JB 1H 472K-T
C149	4030006880	S.CER C1608 JB 1H 472K-T
C160	4510004601	ELE 16 ME 1000 HC
C161	4030006880	S.CER C1608 JB 1H 472K-T
C162	4030006880	S.CER C1608 JB 1H 472K-T
C163	4030006880	S.CER C1608 JB 1H 472K-T
C164	4030006880	S.CER C1608 JB 1H 472K-T
C180	4030006880	S.CER C1608 JB 1H 472K-T
C183	4030006880	S.CER C1608 JB 1H 472K-T
C184	4030006880	S.CER C1608 JB 1H 472K-T
C185	4030006880	S.CER C1608 JB 1H 472K-T
C188	4030006880	S.CER C1608 JB 1H 472K-T
C189	4030006880	S.CER C1608 JB 1H 472K-T
C190	4030006880	S.CER C1608 JB 1H 472K-T
C191	4030006880	S.CER C1608 JB 1H 472K-T
C192	4030006880	S.CER C1608 JB 1H 472K-T
C193	4510008510	S.ELE EEE1CA471P
C196	4030007130	S.CER C1608 CH 1H 101J-T
C197	4030007130	S.CER C1608 CH 1H 101J-T
C198	4030007130	S.CER C1608 CH 1H 101J-T
C199	4030007130	S.CER C1608 CH 1H 101J-T
C200	4030011600	S.CER C1608 JB 1E 104K-T
C201	4030011600	S.CER C1608 JB 1E 104K-T
C203	4030011600	S.CER C1608 JB 1E 104K-T
C204	4030011600	S.CER C1608 JB 1E 104K-T
C208	4030011600	S.CER C1608 JB 1E 104K-T
C209	4030006880	S.CER C1608 JB 1H 472K-T
C210	4030011600	S.CER C1608 JB 1E 104K-T
C211	4030006870	S.CER C1608 JB 1H 222K-T
C212	4030006850	S.CER C1608 JB 1H 471K-T
C214	4510008520	S.ELE EEE1CA470SP
C215	4030011600	S.CER C1608 JB 1E 104K-T
C216	4510008520	S.ELE EEE1CA470SP
C217	4030009000	S.CER C2012 JB 1C 224K-T
C218	4510005000	ELE 16 ME 220 HC
C250	4030011600	S.CER C1608 JB 1E 104K-T
C251	4030006880	S.CER C1608 JB 1H 472K-T
C253	4030006880	S.CER C1608 JB 1H 472K-T
C255	4030011600	S.CER C1608 JB 1E 104K-T
C256	4030011600	S.CER C1608 JB 1E 104K-T
C257	4510008500	S.ELE EEE1CA101WP
C259	4030006880	S.CER C1608 JB 1H 472K-T
C260	4030006860	S.CER C1608 JB 1H 102K-T
C261	4030011600	S.CER C1608 JB 1E 104K-T
C263	4030011600	S.CER C1608 JB 1E 104K-T
C264	4030006880	S.CER C1608 JB 1H 472K-T
C265	4030011600	S.CER C1608 JB 1E 104K-T
C280	4030011600	S.CER C1608 JB 1E 104K-T
C281	4030011600	S.CER C1608 JB 1E 104K-T
C282	4030011600	S.CER C1608 JB 1E 104K-T
C283	4030011600	S.CER C1608 JB 1E 104K-T
C284	4510008540	S.ELE EEE1CA100SR
C285	4510008540	S.ELE EEE1CA100SR
C286	4030006860	S.CER C1608 JB 1H 102K-T
C300	4030011600	S.CER C1608 JB 1E 104K-T
C301	4030011600	S.CER C1608 JB 1E 104K-T
C302	4030006880	S.CER C1608 JB 1H 472K-T
C304	4030006860	S.CER C1608 JB 1H 102K-T
C305	4510008860	S.ELE EEE1AA100NR
C307	4510008550	S.ELE EEE1HA010SR
C308	4030007010	S.CER C1608 CH 1H 100D-T
C330	4030011600	S.CER C1608 JB 1E 104K-T
C331	4030012610	S.CER C2012 JB 1C 474K-T
C332	4030011600	S.CER C1608 JB 1E 104K-T
C333	4030006880	S.CER C1608 JB 1H 472K-T
C334	4030006880	S.CER C1608 JB 1H 472K-T
C360	4030011600	S.CER C1608 JB 1E 104K-T
C361	4030011600	S.CER C1608 JB 1E 104K-T
C362	4510008540	S.ELE EEE1CA100SR
C363	4510008540	S.ELE EEE1CA100SR
C364	4030006880	S.CER C1608 JB 1H 472K-T
C380	4030011600	S.CER C1608 JB 1E 104K-T
C381	4030011600	S.CER C1608 JB 1E 104K-T
C382	4030011600	S.CER C1608 JB 1E 104K-T
C383	4030011600	S.CER C1608 JB 1E 104K-T
C400	4030006880	S.CER C1608 JB 1H 472K-T
C401	4030011600	S.CER C1608 JB 1E 104K-T
C402	4510008540	S.ELE EEE1CA100SR

M.=Mounted side (T: Mounted on the Top side, B: Mounted on the Bottom side)  
S.=Surface mount

## [MAIN UNIT]

REF NO.	ORDER NO.	DESCRIPTION
C403	4510008540	S.ELE EEE1CA100SR
C404	4030011600	S.CER C1608 JB 1E 104K-T
C405	4030011600	S.CER C1608 JB 1E 104K-T
C406	4030006880	S.CER C1608 JB 1H 472K-T
C407	4030011600	S.CER C1608 JB 1E 104K-T
C408	4510008540	S.ELE EEE1CA100SR
C409	4030011600	S.CER C1608 JB 1E 104K-T
C450	4030012610	S.CER C2012 JB 1C 474K-T
C451	4030012610	S.CER C2012 JB 1C 474K-T
C500	4030011600	S.CER C1608 JB 1E 104K-T
C501	4030011600	S.CER C1608 JB 1E 104K-T
C502	4510008540	S.ELE EEE1CA100SR
C503	4030006900	S.CER C1608 JB 1H 103K-T
C700	4030006880	S.CER C1608 JB 1H 472K-T
C701	4030006880	S.CER C1608 JB 1H 472K-T
C702	4030006880	S.CER C1608 JB 1H 472K-T
C703	4030006880	S.CER C1608 JB 1H 472K-T
C704	4030006880	S.CER C1608 JB 1H 472K-T
C705	4030006880	S.CER C1608 JB 1H 472K-T
C706	4030006880	S.CER C1608 JB 1H 472K-T
C740	4030006880	S.CER C1608 JB 1H 472K-T
C741	4030006880	S.CER C1608 JB 1H 472K-T
C742	4030007130	S.CER C1608 CH 1H 101J-T
C760	4030006880	S.CER C1608 JB 1H 472K-T
C761	4030006880	S.CER C1608 JB 1H 472K-T
C762	4030006880	S.CER C1608 JB 1H 472K-T
C763	4030007130	S.CER C1608 CH 1H 101J-T
C783	4030006880	S.CER C1608 JB 1H 472K-T
C784	4030006880	S.CER C1608 JB 1H 472K-T
C785	4030006880	S.CER C1608 JB 1H 472K-T
C786	4030006880	S.CER C1608 JB 1H 472K-T
C787	4030006880	S.CER C1608 JB 1H 472K-T
C788	4030006880	S.CER C1608 JB 1H 472K-T
C789	4030006880	S.CER C1608 JB 1H 472K-T
C790	4030006880	S.CER C1608 JB 1H 472K-T
C791	4030006880	S.CER C1608 JB 1H 472K-T
C792	4030006880	S.CER C1608 JB 1H 472K-T
C793	4030006880	S.CER C1608 JB 1H 472K-T
C794	4030008770	S.CER C1608 JB 1H 562K-T
C795	4030006880	S.CER C1608 JB 1H 472K-T
C796	4030006880	S.CER C1608 JB 1H 472K-T
C801	4510008500	S.ELE EEE1CA101WP
C802	4030006860	S.CER C1608 JB 1H 102K-T
C803	4030006860	S.CER C1608 JB 1H 102K-T
C804	4510008540	S.ELE EEE1CA100SR
C810	4030006880	S.CER C1608 JB 1H 472K-T
C1001	4030008910	S.CER C1608 JB 1H 393K-T
C1002	4030011600	S.CER C1608 JB 1E 104K-T
C1003	4030009980	S.CER C1608 JB 1H 152K-T
C1004	4510008860	S.ELE EEE1AA100NR
C1005	4030011600	S.CER C1608 JB 1E 104K-T
C1006	4030007130	S.CER C1608 CH 1H 101J-T
C1007	4030006880	S.CER C1608 JB 1H 472K-T
C1008	4030011600	S.CER C1608 JB 1E 104K-T
C1020	4030011600	S.CER C1608 JB 1E 104K-T
C1021	4030006860	S.CER C1608 JB 1H 102K-T
C1040	4030011600	S.CER C1608 JB 1E 104K-T
C1041	4030011600	S.CER C1608 JB 1E 104K-T
C1060	4510008540	S.ELE EEE1CA100SR
C1061	4510008540	S.ELE EEE1CA100SR
C1062	4510008540	S.ELE EEE1CA100SR
C1063	4030011600	S.CER C1608 JB 1E 104K-T
C1064	4030011600	S.CER C1608 JB 1E 104K-T
C1065	4510008860	S.ELE EEE1AA100NR
C1080	4510008540	S.ELE EEE1CA100SR
C1081	4030012610	S.CER C2012 JB 1C 474K-T
C1082	4030011600	S.CER C1608 JB 1E 104K-T
C1083	4030006850	S.CER C1608 JB 1H 471K-T
C1084	4510008540	S.ELE EEE1CA100SR
C1085	4510008540	S.ELE EEE1CA100SR
C1086	4510008540	S.ELE EEE1CA100SR
C1087	4510008540	S.ELE EEE1CA100SR
C1100	4030010020	S.CER C1608 JB 1H 122K-T
C1102	4030009980	S.CER C1608 JB 1H 152K-T
C1103	4030011330	S.CER C1608 CH 1H 391J-T
C1104	4030008470	S.CER C1608 JB 1H 272K-T
C1106	4030011280	S.CER C1608 CH 1H 271J-T
C1107	4510008540	S.ELE EEE1CA100SR
C1108	4030011600	S.CER C1608 JB 1E 104K-T
C1109	4030011600	S.CER C1608 JB 1E 104K-T
C1110	4510008540	S.ELE EEE1CA100SR
C1140	4030012600	S.CER C2012 JB 1A 105M-T
C1141	4030008920	S.CER C1608 JB 1H 473K-T
C1160	4510008540	S.ELE EEE1CA100SR
C1161	4510008540	S.ELE EEE1CA100SR
C1180	4030012610	S.CER C2012 JB 1C 474K-T
C1181	4030012610	S.CER C2012 JB 1C 474K-T
C1182	4030012610	S.CER C2012 JB 1C 474K-T
C1183	4030012610	S.CER C2012 JB 1C 474K-T
C1184	4510008530	S.ELE EEE1HA2R2SR
C1185	4030006870	S.CER C1608 JB 1H 222K-T
C1186	4510008540	S.ELE EEE1CA100SR
C1187	4510008540	S.ELE EEE1CA100SR
C1188	4510008540	S.ELE EEE1CA100SR
C1189	4510008550	S.ELE EEE1HA010SR
C1190	4510008510	S.ELE EEE1CA471P
C1191	4510008550	S.ELE EEE1HA010SR
C1192	4510008550	S.ELE EEE1HA010SR
C1220	4510008540	S.ELE EEE1CA100SR
C1221	4510008540	S.ELE EEE1CA100SR
C1240	4510008540	S.ELE EEE1CA100SR
C1241	4030006870	S.CER C1608 JB 1H 222K-T
C1242	4510008510	S.ELE EEE1CA471P
C1243	4510008510	S.ELE EEE1CA471P

## [MAIN UNIT]

REF NO.	ORDER NO.	DESCRIPTION
C1244	4030011600	S.CER C1608 JB 1E 104K-T
C1245	4030006880	S.CER C1608 JB 1H 472K-T
C1246	4030007130	S.CER C1608 CH 1H 101J-T
C1247	4510004601	ELE 16 ME 1000 HC
C1260	4510008500	S.ELE EEE1CA101WP
C1261	4510008510	S.ELE EEE1CA471P
C1280	4030011600	S.CER C1608 JB 1E 104K-T
C1281	4510008540	S.ELE EEE1CA100SR
C1282	4030007130	S.CER C1608 CH 1H 101J-T
C1283	4030006860	S.CER C1608 JB 1H 102K-T
C1284	4030008900	S.CER C1608 JB 1H 333K-T
C1285	4030011600	S.CER C1608 JB 1E 104K-T
C1286	4030011600	S.CER C1608 JB 1E 104K-T
C1300	4030011600	S.CER C1608 JB 1E 104K-T
C1301	4030011600	S.CER C1608 JB 1E 104K-T
C1302	4510008540	S.ELE EEE1CA100SR
C1303	4510008540	S.ELE EEE1CA100SR
C1304	4030012610	S.CER C2012 JB 1C 474K-T
C1305	4030011600	S.CER C1608 JB 1E 104K-T
C1306	4030011600	S.CER C1608 JB 1E 104K-T
C1307	4030011600	S.CER C1608 JB 1E 104K-T
C1308	4030011600	S.CER C1608 JB 1E 104K-T
C1309	4030007170	S.CER C1608 CH 1H 221J-T
C1310	4030007140	S.CER C1608 CH 1H 121J-T
C1400	4510008600	S.ELE EEE1CA4R7NR
C1401	4510008530	S.ELE EEE1HA2R2SR
C1402	4030006850	S.CER C1608 JB 1H 471K-T
C1403	4510008540	S.ELE EEE1CA100SR
C1404	4510008530	S.ELE EEE1HA2R2SR
C1405	4510008540	S.ELE EEE1CA100SR
C1406	4510009080	S.ELE EEE1HAR22SR
C1407	4510008530	S.ELE EEE1HA2R2SR
C1408	4510008530	S.ELE EEE1HA2R2SR
C1409	4510008530	S.ELE EEE1HA2R2SR
C1410	4030006870	S.CER C1608 JB 1H 222K-T
C1411	4030011280	S.CER C1608 CH 1H 271J-T
C1412	4030006850	S.CER C1608 JB 1H 471K-T
C1413	4030008470	S.CER C1608 JB 1H 272K-T
C1414	4030009580	S.CER C1608 JB 1H 681K-T
C1415	4030007120	S.CER C1608 CH 1H 820J-T
C1416	4030006880	S.CER C1608 JB 1H 472K-T
C1417	4030010020	S.CER C1608 JB 1H 122K-T
C1418	4030010040	S.CER C1608 JB 1H 561K-T
C1419	4030007010	S.CER C1608 CH 1H 100D-T
C1420	4030012610	S.CER C2012 JB 1C 474K-T
C1421	4510008540	S.ELE EEE1CA100SR
C1422	4030006880	S.CER C1608 JB 1H 472K-T
C1423	4510008540	S.ELE EEE1CA100SR
C1426	4030006880	S.CER C1608 JB 1H 472K-T
C1427	4030006880	S.CER C1608 JB 1H 472K-T
C1428	4510008500	S.ELE EEE1CA101WP
C1429	4030011600	S.CER C1608 JB 1E 104K-T
C1460	4510008540	S.ELE EEE1CA100SR
C1461	4510008540	S.ELE EEE1CA100SR
C1462	4340000230	S.MYL ECHU 1H 272JB5
C1463	4340000200	S.MYL ECHU 1H 271JX5
C1464	4340000240	S.MYL ECHU 1C 682JX5
C1465	4340000220	S.MYL ECHU 1H 681JB5
C1466	4340000210	S.MYL ECHU 1H 331JX5
C1467	4340000190	S.MYL ECHU 1H 101JX5
C1468	4030011600	S.CER C1608 JB 1E 104K-T
C1469	4030011600	S.CER C1608 JB 1E 104K-T
C1470	4340000250	S.MYL ECHU 1C 104JX5
C1480	4510008540	S.ELE EEE1CA100SR
C1481	4510008540	S.ELE EEE1CA100SR
C1500	4030011600	S.CER C1608 JB 1E 104K-T
C1501	4030011600	S.CER C1608 JB 1E 104K-T
C1502	4030011600	S.CER C1608 JB 1E 104K-T
C1503	4030011600	S.CER C1608 JB 1E 104K-T
C1504	4030011600	S.CER C1608 JB 1E 104K-T
C1505	4030006900	S.CER C1608 JB 1H 103K-T
C1506	4030007020	S.CER C1608 CH 1H 120J-T
C1507	4510008540	S.ELE EEE1CA100SR
C1508	4030007020	S.CER C1608 CH 1H 120J-T
C1509	4030011600	S.CER C1608 JB 1E 104K-T
C1510	4030006900	S.CER C1608 JB 1H 103K-T
C1511	4030011600	S.CER C1608 JB 1E 104K-T
C1512	4030011600	S.CER C1608 JB 1E 104K-T
C1560	4030006880	S.CER C1608 JB 1H 472K-T
C1561	4030006900	S.CER C1608 JB 1H 103K-T
C1580	4030006900	S.CER C1608 JB 1H 103K-T
C1620	4030007130	S.CER C1608 CH 1H 101J-T
C1621	4030007130	S.CER C1608 CH 1H 101J-T
C1622	4030007130	S.CER C1608 CH 1H 101J-T
C1623	4030007130	S.CER C1608 CH 1H 101J-T
C1624	4030007130	S.CER C1608 CH 1H 101J-T
C1700	4030006880	S.CER C1608 JB 1H 472K-T
C1701	4030006880	S.CER C1608 JB 1H 472K-T
C1720	4030006880	S.CER C1608 JB 1H 472K-T
C1760	4030006880	S.CER C1608 JB 1H 472K-T
C1780	4030006880	S.CER C1608 JB 1H 472K-T
C1800	4030006880	S.CER C1608 JB 1H 472K-T
C1801	4030006880	S.CER C1608 JB 1H 472K-T
C1802	4030006880	S.CER C1608 JB 1H 472K-T
C1803	4030006880	S.CER C1608 JB 1H 472K-T
C1804	4030006880	S.CER C1608 JB 1H 472K-T
C1820	4030006880	S.CER C1608 JB 1H 472K-T
C1821	4030006880	S.CER C1608 JB 1H 472K-T
C1822	4030006880	S.CER C1608 JB 1H 472K-T
C1823	4030006880	S.CER C1608 JB 1H 472K-T
C1824	4030006880	S.CER C1608 JB 1H 472K-T
C1825	4030006880	S.CER C1608 JB 1H 472K-T
C1826	4030006880	S.CER C1608 JB 1H 472K-T
C1827	4030006880	S.CER C1608 JB 1H 472K-T

M.=Mounted side (T: Mounted on the Top side, B: Mounted on the Bottom side)  
S.=Surface mount

**[MAIN UNIT]**

REF NO.	ORDER NO.	DESCRIPTION	
C1840	4030006880	S.CER	C1608 JB 1H 472K-T
C1841	4030006880	S.CER	C1608 JB 1H 472K-T
C1842	4030006880	S.CER	C1608 JB 1H 472K-T
C1844	4030006880	S.CER	C1608 JB 1H 472K-T
C1845	4030006880	S.CER	C1608 JB 1H 472K-T
C1846	4030006880	S.CER	C1608 JB 1H 472K-T
C1860	4030006880	S.CER	C1608 JB 1H 472K-T
C1861	4030006880	S.CER	C1608 JB 1H 472K-T
C1862	4030006880	S.CER	C1608 JB 1H 472K-T
C1880	4030006880	S.CER	C1608 JB 1H 472K-T
C1881	4030006880	S.CER	C1608 JB 1H 472K-T
C1900	4030006880	S.CER	C1608 JB 1H 472K-T
C1901	4030006880	S.CER	C1608 JB 1H 472K-T
C1902	4030006880	S.CER	C1608 JB 1H 472K-T
C1904	4030006880	S.CER	C1608 JB 1H 472K-T
C1906	4030006880	S.CER	C1608 JB 1H 472K-T
C1907	4030008920	S.CER	C1608 JB 1H 473K-T
C1908	4030011600	S.CER	C1608 JB 1E 104K-T
C1920	4030006880	S.CER	C1608 JB 1H 472K-T
C1921	4030006900	S.CER	C1608 JB 1H 103K-T
C1940	4030006900	S.CER	C1608 JB 1H 103K-T
C1980	4030006880	S.CER	C1608 JB 1H 472K-T
C1981	4030006880	S.CER	C1608 JB 1H 472K-T
C1982	4030006880	S.CER	C1608 JB 1H 472K-T
C1983	4030006880	S.CER	C1608 JB 1H 472K-T
C1984	4030006880	S.CER	C1608 JB 1H 472K-T
C1985	4030006880	S.CER	C1608 JB 1H 472K-T
C1986	4030006880	S.CER	C1608 JB 1H 472K-T
C2000	4030006880	S.CER	C1608 JB 1H 472K-T
C2020	4510008540	S.ELE	EEE1CA100SR
C2021	4030011600	S.CER	C1608 JB 1E 104K-T
C2022	4030011600	S.CER	C1608 JB 1E 104K-T
C2040	4030011600	S.CER	C1608 JB 1E 104K-T
C2041	4030006880	S.CER	C1608 JB 1H 472K-T
RL740	6330001320	REL	AHY103
RL781	6330000540	REL	2-1419131-2(OMR-109F)
CP200	6910009670	S.CHE	HK3-S-T
CP300	6910009670	S.CHE	HK3-S-T
CP1460	6910009670	S.CHE	HK3-S-T
J100	6510022591	S.CON	22FMM-BMTTR-A-TBT(LF)(SN)
J120	6510022601	S.CON	30FMM-BMTTR-A-TBT(LF)(SN)
J140	6510022591	S.CON	22FMM-BMTTR-A-TBT(LF)(SN)
J160	6510022591	S.CON	22FMM-BMTTR-A-TBT(LF)(SN)
J180	6510022591	S.CON	22FMM-BMTTR-A-TBT(LF)(SN)
J250	6510007020	CON	TMP-J01X-V6
J400	6510018961	S.CON	B2B-PH-SM4-TB(LF)(SN)
J700	6450001841	CON	TCS7568-4320177
J740	6450000140	CON	HSJ0807-01-010
J741	6510018961	S.CON	B2B-PH-SM4-TB(LF)(SN)
J760	6450000140	CON	HSJ0807-01-010
J761	6510018971	S.CON	B4B-PH-SM4-TB(LF)(SN)
J780	6510023661	CON	TCS4470-0141577
J781	6510023671	CON	TCS4480-0141577
J782	6450001130	CON	JPJ2042-01-110
J802	6510018961	S.CON	B2B-PH-SM4-TB(LF)(SN)
J1000	6510021651	CON	IMSA-9180B-30B-PT1
J1001	6510022811	CON	IMSA-9180B-22B-PT1
J1920	6510019191	S.CON	52365-0871
EP2	0880000890	UNI	EX-2432 #01 #2432DSP
EP101	6910012350	S.BEA	MMZ1608Y 102BT
EP102	6910012350	S.BEA	MMZ1608Y 102BT
EP120	6910012350	S.BEA	MMZ1608Y 102BT
EP181	6910013310	S.BEA	MMZ1608D121B
EP182	6910013310	S.BEA	MMZ1608D121B
EP760	6910012350	S.BEA	MMZ1608Y 102BT
EP761	6910012350	S.BEA	MMZ1608Y 102BT
EP780	6910012350	S.BEA	MMZ1608Y 102BT
EP781	6910012350	S.BEA	MMZ1608Y 102BT
EP782	6910012350	S.BEA	MMZ1608Y 102BT
EP783	6910012350	S.BEA	MMZ1608Y 102BT
EP784	6910012350	S.BEA	MMZ1608Y 102BT
EP786	6910012350	S.BEA	MMZ1608Y 102BT
EP788	6910012350	S.BEA	MMZ1608Y 102BT
EP790	6910012350	S.BEA	MMZ1608Y 102BT

**[PA UNIT]**

REF NO.	ORDER NO.	DESCRIPTION	
WS1	8970022760	SX1876 J(1)/PA	
WS2	8970023991	SX2494 1.5D-1 (2)/PA	
IC1	1180000421	S.IC TA78L05F(TE12R,F)	
IC2	1110002021	IC TA7805S(Q)	
IC3	1110002031	IC TA7808S(Q)	
IC501	1160000131	S.IC TD62783AFG(5,S,EL)	
IC502	1130007700	S.IC BU4094BCF-E2	
Q1	1560001020	S.FET 2SK2973 (MTS101P)	
Q2	1530004080	TRA 2SC1971 (ASI) <STKE>	
Q5	1560001640	FET RD100HHF1C-103	
Q6	1560001640	FET RD100HHF1C-103	
Q9	1590003281	S.TRA UNR9211G0L	
Q14	1590000680	S.TRA DTC114EUA T106	
Q15	1590000680	S.TRA DTC114EUA T106	
Q16	1590001330	S.TRA DTA114EUA T106	
Q201	1560001591	FET RD70HVF1C-121	
Q202	1560001591	FET RD70HVF1C-121	
Q204	1590000680	S.TRA DTC114EUA T106	
Q205	1590001330	S.TRA DTA114EUA T106	
Q602	1590000680	S.TRA DTC114EUA T106	
Q604	1590001330	S.TRA DTA114EUA T106	
Q605	1590000680	S.TRA DTC114EUA T106	
D4	1790000700	DIO DSA3A1	
D5	1790000700	DIO DSA3A1	
D7	1160000140	S.DIO DAP222 TL	
D8	1790000700	DIO DSA3A1	
D11	1160000140	S.DIO DAP222 TL	
D13	1160000060	S.DIO DAN202U T106	
D14	1160000060	S.DIO DAN202U T106	
D101	1160000080	S.DIO DAP202K T146	
D601	1160000140	S.DIO DAP222 TL	
D602	1720000361	S.DIO HSU88TRF-E	
D603	1720000361	S.DIO HSU88TRF-E	
D605	1750000971	S.DIO CPH5513-TL-E	
D620	1790001141	S.ZEN MAZ8039GLL	
L1	6140003070	COI LR-355	
L2	6200001831	S.COI NLV32T-100J	
L6	6140002220	COI LR-270 (TR6X3X2 3A9)	
L7	6140003680	COI LR-410 4KBL	
L8	2040000490	COI EXC-ELDR25C	
L9	6110001690	COI LA-255	
L10	6140003670	COI LR-411	
L11	20400000490	COI EXC-ELDR25C	
L13	6140003670	COI LR-411	
L17	6140000610	COI LR-83	
L18	6140003510	COI LR-393	
L19	6140002030	COI LR-230 (SK-10M-15Y 120)	
L20	6110001730	COI LA-262	
L21	6200003261	S.COI NLV32T-101J	
L22	20400000490	COI EXC-ELDR25C	
L23	2040000490	COI EXC-ELDR25C	
L202	6110001730	COI LA-262	
L203	6110001730	COI LA-262	
L204	6110001360	COI LA-179	
L205	6170000340	COI LW-33	
L206	6110002060	COI LA-300	
L208	6110001750	COI LA-264	
L501	6140002570	COI LR-294 (T50-2)	
L502	6140002580	COI LR-295 (T50-2)	
L503	6140001800	COI LR-216 (T50-2)	
L504	6140001780	COI LR-214 (T50-2)	
L505	6140001800	COI LR-216 (T50-2)	
L506	6140001800	COI LR-216 (T50-2)	
L507	6140002560	COI LR-293 (T50-10)	
L508	6140002560	COI LR-293 (T50-10)	
L509	6110002920	COI LA-481	
L510	6110003580	COI LA-551	
L511	6140003460	COI LR-388 (T50-10)	
L512	6140003460	COI LR-388 (T50-10)	
L513	6200003261	S.COI NLV32T-101J	
L515	6200003261	S.COI NLV32T-101J	
L517	6200003261	S.COI NLV32T-101J	
L518	6200001831	S.COI NLV32T-100J	
	6200001831	S.COI NLV32T-100J	
	6200003261	S.COI NLV32T-101J	
	6200001831	S.COI NLV32T-100J	
	6200001831	S.COI NLV32T-100J	
	6200003261	S.COI NLV32T-101J	
L519	6200003261	S.COI NLV32T-101J	
L521	6200001831	S.COI NLV32T-100J	
L522	6200001831	S.COI NLV32T-100J	
L523	6200001831	S.COI NLV32T-100J	
L524	6200001831	S.COI NLV32T-100J	
L528	6140002560	COI LR-293 (T50-10)	
L529	6110003570	COI LA-550	
L530	6110003540	COI LA-548 (LA-215A)	
L531	6110003550	COI LA-547 (LA-214A)	
L532	6200001831	S.COI NLV32T-100J	
L533	6200001831	S.COI NLV32T-100J	
L534	6140003450	COI LR-387 (T50-10)	
L601	6110001340	COI LA-177	
L602	6110001340	COI LA-177	
L603	6110001330	COI LA-176	
L604	6200004741	S.COI NLV25T-1R2J	
L605	6200004741	S.COI NLV25T-1R2J	

[EUR]  
[FRA]  
[DEN]  
[ITR]  
[ESP]  
[KOR]

[PA UNIT]

REF NO.	ORDER NO.	DESCRIPTION
R1	7030003520	S.RES ERJ3GEYJ 472 V (4.7K)
R2	7030003360	S.RES ERJ3GEYJ 221 V (220)
R3	7030006060	S.RES ERJ12YJ100U (10)
R4	7030003400	S.RES ERJ3GEYJ 471 V (470)
R5	7030003390	S.RES ERJ3GEYJ 391 V (390)
R6	7030003360	S.RES ERJ3GEYJ 221 V (220)
R7	7030006190	S.RES ERJ12YJ2R2U (2.2)
R8	7030003380	S.RES ERJ3GEYJ 331 V (330)
R9	7030003400	S.RES ERJ3GEYJ 471 V (470)
R10	7030003480	S.RES ERJ3GEYJ 222 V (2.2K)
R11	7310005220	TRI VM5CK-PVB 500
R12	7030010410	S.RES ERJ1TYJ 220U (22)
R16	7030000020	S.RES MCR10EZJH 1 (010)
R17	7070000511	RES ERG1SJ 180 (18)
R18	7310005200	TRI VM5CK-PVB 2K
R26	7030003480	S.RES ERJ3GEYJ 222 V (2.2K)
R27	7030003480	S.RES ERJ3GEYJ 222 V (2.2K)
R28	7100000890	RES RWL5 0R012J
R29	7030003440	S.RES ERJ3GEYJ 102 V (1K)
R31	7030003440	S.RES ERJ3GEYJ 102 V (1K)
R32	7030010260	S.RES ERJ1TYJ 3R3 U
R33	7030010260	S.RES ERJ1TYJ 3R3 U
R34	7030010260	S.RES ERJ1TYJ 3R3 U
R35	7030010260	S.RES ERJ1TYJ 3R3 U
R38	7030010570	S.RES ERJ1TYJ 4R7U (4.7)
R41	7030011220	S.RES ERJ1TY 180U (18)
R42	7030011220	S.RES ERJ1TY 180U (18)
R44	7070000681	RES ERX3SJ 3R9 (3.9)
R61	7030003530	S.RES ERJ3GEYJ 562 V (5.6K)
R63	7010007360	RES PSD1/4 220
R71	7030004050	S.RES ERJ3GEYJ 1R0 V (1)
R73	7030004040	S.RES ERJ3GEYJ 4R7 V (4.7)
R74	7030003360	S.RES ERJ3GEYJ 221 V (220)
R81	7030010570	S.RES ERJ1TYJ 4R7U (4.7)
R82	7030010570	S.RES ERJ1TYJ 4R7U (4.7)
R101	7030006101	S.RES ERA3YED 183V (18K)
R103	7030006101	S.RES ERA3YED 183V (18K)
R104	7030005971	S.RES ERA3YKD 683V (68K)
R105	7030011220	S.RES ERJ1TY 180U (18)
R106	7030011220	S.RES ERJ1TY 180U (18)
R107	7030010410	S.RES ERJ1TYJ 220U (22)
R108	7030003430	S.RES ERJ3GEYJ 821 V (820)
R109	7310005200	TRI VM5CK-PVB 2K
R110	7030010410	S.RES ERJ1TYJ 220U (22)
R111	7030003430	S.RES ERJ3GEYJ 821 V (820)
R121	7510001571	S.THE NTCG16 4LH 104JT
R122	7510001571	S.THE NTCG16 4LH 104JT
R202	7070000381	RES ERG2SJ 100 (10)
R204	7310005200	TRI VM5CK-PVB 2K
R209	7030010410	S.RES ERJ1TYJ 220U (22)
R210	7030003480	S.RES ERJ3GEYJ 222 V (2.2K)
R211	7030003520	S.RES ERJ3GEYJ 472 V (4.7K)
R212	7030010410	S.RES ERJ1TYJ 220U (22)
R213	7030003480	S.RES ERJ3GEYJ 222 V (2.2K)
R214	7030003520	S.RES ERJ3GEYJ 472 V (4.7K)
R215	7310005200	TRI VM5CK-PVB 2K
R221	7510001571	S.THE NTCG16 4LH 104JT
R222	7510001571	S.THE NTCG16 4LH 104JT
R251	7030006101	S.RES ERA3YED 183V (18K)
R401	7030003400	S.RES ERJ3GEYJ 471 V (470)
R402	7030003400	S.RES ERJ3GEYJ 471 V (470)
R403	7030003400	S.RES ERJ3GEYJ 471 V (470)
R404	7030003400	S.RES ERJ3GEYJ 471 V (470)
R501	7030003640	S.RES ERJ3GEYJ 473 V (47K)
R502	7010007350	RES PSD1/4 4.7
R503	7030000140	S.RES MCR10EZJH 10 (100)
R535	7030010250	S.RES ERJ1TYJ 0R00U
R601	7030000250	S.RES MCR10EZJH 82 (820)
R602	7030000250	S.RES MCR10EZJH 82 (820)
R603	7030003440	S.RES ERJ3GEYJ 102 V (1K)
R604	7030003530	S.RES ERJ3GEYJ 562 V (5.6K)
R605	7030003360	S.RES ERJ3GEYJ 221 V (220)
R606	7030003560	S.RES ERJ3GEYJ 103 V (10K)
R614	7030000230	S.RES MCR10EZJH 56 (560)
R615	7030000230	S.RES MCR10EZJH 56 (560)
R616	7030000230	S.RES MCR10EZJH 56 (560)
R617	7030000220	S.RES MCR10EZJH 47 (470)
R618	7030000340	S.RES MCR10EZJH 470 (471)
R619	7030006260	S.RES ERJ12YJ471U (470)
R620	7030000260	S.RES MCR10EZJH 100 (101)
R621	7030003680	S.RES ERJ3GEYJ 104 V (100K)
R622	7030000230	S.RES MCR10EZJH 56 (560)
R701	7030003380	S.RES ERJ3GEYJ 331 V (330)
R702	7030003220	S.RES ERJ3GEYJ 150 V (15)
R703	7030003380	S.RES ERJ3GEYJ 331 V (330)
W1	7030003860	S.RES ERJ3GE JPW V
W3	7030003860	S.RES ERJ3GE JPW V
W504	7030003860	S.RES ERJ3GE JPW V
C1	4030011600	S.CER C1608 JB 1E 104K-T
C2	4030006860	S.CER C1608 JB 1H 102K-T
C3	4030011600	S.CER C1608 JB 1E 104K-T
C4	4030006860	S.CER C1608 JB 1H 102K-T
C5	4030011600	S.CER C1608 JB 1E 104K-T
C6	4030011600	S.CER C1608 JB 1E 104K-T
C7	4030006860	S.CER C1608 JB 1H 102K-T
C8	4030011600	S.CER C1608 JB 1E 104K-T
C9	4030006860	S.CER C1608 JB 1H 102K-T
C11	4030008920	S.CER C1608 JB 1H 473K-T
C12	4030011600	S.CER C1608 JB 1E 104K-T
C13	4030006860	S.CER C1608 JB 1H 102K-T

[PA UNIT]

REF NO.	ORDER NO.	DESCRIPTION
C14	4030006880	S.CER C1608 JB 1H 472K-T
C15	4030011600	S.CER C1608 JB 1E 104K-T
C16	4030006860	S.CER C1608 JB 1H 102K-T
C18	4030011600	S.CER C1608 JB 1E 104K-T
C19	4030011600	S.CER C1608 JB 1E 104K-T
C20	4510004591	ELE 16 ME 470 HC
C24	4030011600	S.CER C1608 JB 1E 104K-T
C29	4030018780	S.CER C3225 JB 2J 473K-T
C30	4030011600	S.CER C1608 JB 1E 104K-T
C31	4030018780	S.CER C3225 JB 2J 473K-T
C32	4030018780	S.CER C3225 JB 2J 473K-T
C33	4030018780	S.CER C3225 JB 2J 473K-T
C35	4030011740	S.CER GRM32N2C2H201JV01L(GRM42-2 CH)
C39	4510004601	ELE 16 ME 1000 HC
C40	4510004601	ELE 16 ME 1000 HC
C41	4030011600	S.CER C1608 JB 1E 104K-T
C42	4030006880	S.CER C1608 JB 1H 472K-T
C43	4030006880	S.CER C1608 JB 1H 472K-T
C44	4030006880	S.CER C1608 JB 1H 472K-T
C45	4030005110	S.CER C2012 JB 1E 473K-T
C46	4510004601	ELE 16 ME 1000 HC
C47	4030011600	S.CER C1608 JB 1E 104K-T
C48	4030011600	S.CER C1608 JB 1E 104K-T
C49	4510008520	S.ELE EEE1CA470SP
C52	4030011600	S.CER C1608 JB 1E 104K-T
C53	4030011600	S.CER C1608 JB 1E 104K-T
C54	4510008520	S.ELE EEE1CA470SP
C65	4510008500	S.ELE EEE1CA101WP
C66	4030011600	S.CER C1608 JB 1E 104K-T
C67	4030011600	S.CER C1608 JB 1E 104K-T
C68	4510008500	S.ELE EEE1CA101WP
C69	4510008540	S.ELE EEE1CA100SR
C70	4030011600	S.CER C1608 JB 1E 104K-T
C71	4030011600	S.CER C1608 JB 1E 104K-T
C72	4510008540	S.ELE EEE1CA100SR
C73	4030006880	S.CER C1608 JB 1H 472K-T
C74	4510008540	S.ELE EEE1CA100SR
C75	4030011600	S.CER C1608 JB 1E 104K-T
C76	4030011600	S.CER C1608 JB 1E 104K-T
C77	4510008540	S.ELE EEE1CA100SR
C78	4030011600	S.CER C1608 JB 1E 104K-T
C79	4030011600	S.CER C1608 JB 1E 104K-T
C80	4030006880	S.CER C1608 JB 1H 472K-T
C81	4030006880	S.CER C1608 JB 1H 472K-T
C82	4030006880	S.CER C1608 JB 1H 472K-T
C83	4030006880	S.CER C1608 JB 1H 472K-T
C84	4030006880	S.CER C1608 JB 1H 472K-T
C85	4030006880	S.CER C1608 JB 1H 472K-T
C86	4030006880	S.CER C1608 JB 1H 472K-T
C87	4030006880	S.CER C1608 JB 1H 472K-T
C88	4030006880	S.CER C1608 JB 1H 472K-T
C89	4030006880	S.CER C1608 JB 1H 472K-T
C90	4030006880	S.CER C1608 JB 1H 472K-T
C91	4030006880	S.CER C1608 JB 1H 472K-T
C92	4510004601	ELE 16 ME 1000 HC
C95	4030011600	S.CER C1608 JB 1E 104K-T
C98	4030006850	S.CER C1608 JB 1H 471K-T
C99	4030011240	S.CER GRM31M2C2H470JV01L(GRM42-6 CH)
C100	4030017890	S.CER ERF22X 6C2H 101J D01L (GRM111)
C102	4030007170	S.CER C1608 CH 1H 221J-T
C103	4030007170	S.CER C1608 CH 1H 221J-T
C107	4030011600	S.CER C1608 JB 1E 104K-T
C110	4030011740	S.CER GRM32N2C2H201JV01L(GRM42-2 CH)
C111	4030011740	S.CER GRM32N2C2H201JV01L(GRM42-2 CH)
C114	4030011740	S.CER GRM32N2C2H201JV01L(GRM42-2 CH)
C115	4030011740	S.CER GRM32N2C2H201JV01L(GRM42-2 CH)
C116	4030011740	S.CER GRM32N2C2H201JV01L(GRM42-2 CH)
C117	4030006880	S.CER C1608 JB 1H 472K-T
C118	4030018750	S.CER C3225 CH 2J 682K-T
C119	4030018750	S.CER C3225 CH 2J 682K-T
C120	4510008520	S.ELE EEE1CA470SP
C121	4030018750	S.CER C3225 CH 2J 682K-T
C122	4030018750	S.CER C3225 CH 2J 682K-T
C123	4030008920	S.CER C1608 JB 1H 473K-T
C124	4030011600	S.CER C1608 JB 1E 104K-T
C125	4030008920	S.CER C1608 JB 1H 473K-T
C126	4030011600	S.CER C1608 JB 1E 104K-T
C201	4030011120	S.CER GRM31M2C2H100JV01L(GRM42-6 CH)
C202	4610002270	TRI CVE50-41KR-PB
C204	4030011730	S.CER GRM31M2C2H101JV01L(GRM42-6 CH)
C205	4030011550	S.CER GRM31M2C2H680JV01L(GRM42-6 CH)
C206	4030017880	S.CER ERF22X 6C2H 560J D01L (GRM111)
C208	4030001310	S.MIC UC342H 2000J-T
C210	4030011120	S.CER GRM31M2C2H100JV01L(GRM42-6 CH)
C211	4030001270	S.MIC UC232H 0470F-T
C212	4030011120	S.CER GRM31M2C2H100JV01L(GRM42-6 CH)
C213	4030008920	S.CER C1608 JB 1H 473K-T
C214	4030007170	S.CER C1608 CH 1H 221J-T
C215	4030007170	S.CER C1608 CH 1H 221J-T
C224	4030011550	S.CER GRM31M2C2H680JV01L(GRM42-6 CH)
C225	4030011550	S.CER GRM31M2C2H680JV01L(GRM42-6 CH)
C226	4030011550	S.CER GRM31M2C2H680JV01L(GRM42-6 CH)
C229	4030011550	S.CER GRM31M2C2H680JV01L(GRM42-6 CH)
C230	4030011550	S.CER GRM31M2C2H680JV01L(GRM42-6 CH)
C231	4030011550	S.CER GRM31M2C2H680JV01L(GRM42-6 CH)
C233	4030011180	S.CER GRM31M2C2H220JV01L(GRM42-6 CH)
C234	4030011290	S.CER GRM31M2C2H240JV01L(GRM42-6 CH)
C235	4030011180	S.CER GRM31M2C2H220JV01L(GRM42-6 CH)
C237	4030011120	S.CER GRM31M2C2H100JV01L(GRM42-6 CH)
C241	4030009590	S.CER C2012 JF 1C 2252-T
C243	4030011060	S.CER GRM31M2C2H4R0CY21L(GRM42-6 CH)
C245	4030017810	S.CER C1608 CH 1H 102J-T
C247	4030017810	S.CER C1608 CH 1H 102J-T
C248	4030012620	S.CER GRM55R2C2H102JV01L(GRM44-1)

M.=Mounted side (T: Mounted on the Top side, B: Mounted on the Bottom side)  
S.=Surface mount

[PA UNIT]

REF NO.	ORDER NO.	DESCRIPTION
C249	4030012620	S.CER GRM55R2C2H102JV01L(GRM44-1)
C401	4030007090	S.CER C1608 CH 1H 470J-T
C402	4030007090	S.CER C1608 CH 1H 470J-T
C403	4030007090	S.CER C1608 CH 1H 470J-T
C404	4030007090	S.CER C1608 CH 1H 470J-T
C502	4010008260	CER HM74TJ SL 151J 500V
C503	4010005370	CER HM11SJ SL 331J 500V
C505	4010008250	CER HM74TJ SL 121J 500V
C507	4010005370	CER HM11SJ SL 331J 500V
C508	4010008240	CER HM60TJ SL 101J 500V
C510	4010008160	CER HM13SJ SL 431J 500V
C512	4010005810	CER HM74SJ SL 111J 500V
C514	4010005930	CER HM11SJ SL 391J 500V
C515	4010008290	CER HM95TJ SL 271J 500V
C516	4010008270	CER HM95TJ SL 181J 500V
C517	4010008290	CER HM95TJ SL 271J 500V
C518	4010008240	CER HM60TJ SL 101J 500V
C520	4010005370	CER HM11SJ SL 331J 500V
C521	4010008290	CER HM95TJ SL 271J 500V
C522	4010008350	CER HM60TJ SL 220J 500V
C523	4010005370	CER HM11SJ SL 331J 500V
C524	4010005370	CER HM11SJ SL 331J 500V
C525	4010005370	CER HM11SJ SL 331J 500V
C528	4010008250	CER HM74TJ SL 121J 500V
C529	4030011070	S.CER GRM31M2C2H5R0CY21L(GRM42-6 CH)
C530	4010005810	CER HM74SJ SL 111J 500V
C531	4010008260	CER HM74TJ SL 151J 500V
C532	4010008240	CER HM60TJ SL 101J 500V
C533	4010008360	CER HM60TJ SL 180J 500V
C534	4010008280	CER HM95TJ SL 221J 500V
C535	4010008210	CER HM60TJ SL 560J 500V
C536	4010008230	CER HM60TJ SL 820J 500V
C537	4010008250	CER HM74TJ SL 121J 500V
C538	4010005580	CER HM60SJ SL 070D 500V
C539	4010008240	CER HM60TJ SL 101J 500V
C540	4010005690	CER HM60SJ SL 300J 500V
C541	4010008330	CER HM60TJ SL 330J 500V
C542	4030006880	S.CER C1608 JB 1H 472K-T
C543	4030006880	S.CER C1608 JB 1H 472K-T
C544	4030006880	S.CER C1608 JB 1H 472K-T
C545	4030006880	S.CER C1608 JB 1H 472K-T
C546	4030006880	S.CER C1608 JB 1H 472K-T
C547	4030006880	S.CER C1608 JB 1H 472K-T
C548	4030006880	S.CER C1608 JB 1H 472K-T
C549	4030006880	S.CER C1608 JB 1H 472K-T
C550	4030006880	S.CER C1608 JB 1H 472K-T
C551	4030006880	S.CER C1608 JB 1H 472K-T
C552	4030006880	S.CER C1608 JB 1H 472K-T
C553	4030006880	S.CER C1608 JB 1H 472K-T
C554	4010008280	CER HM95TJ SL 221J 500V
C555	4010005630	CER HM60SJ SL 150J 500V
C557	4010008250	CER HM74TJ SL 121J 500V
C558	4010008250	CER HM74TJ SL 121J 500V
C561	4010008310	CER HM60TJ SL 470J 500V
C563	4010008320	CER HM60TJ SL 390J 500V
C565	4010008230	CER HM60TJ SL 820J 500V
C566	4010005370	CER HM11SJ SL 331J 500V
C567	4010008290	CER HM95TJ SL 271J 500V
C568	4010008290	CER HM95TJ SL 271J 500V
C569	4010008250	CER HM74TJ SL 121J 500V
C570	4030011160	S.CER GRM31M2C2H150JV01L(GRM42-6 CH)
C572	4010005930	CER HM11SJ SL 391J 500V
C573	4010005930	CER HM11SJ SL 391J 500V
C574	4010007510	CER HM17SJ SL 821J 500V
C575	4010007510	CER HM17SJ SL 821J 500V
C577	4010008350	CER HM60TJ SL 220J 500V
C578	4010008320	CER HM60TJ SL 390J 500V
C579	4010008320	CER HM60TJ SL 390J 500V
C581	4010008230	CER HM60TJ SL 820J 500V
C582	4010008350	CER HM60TJ SL 220J 500V
C583	4010005550	CER RT-HM60SK SL 040C 500V
C585	4010008390	CER HM60TJ SL 100D 500V
C586	4010008350	CER HM60TJ SL 220J 500V
C587	4030006880	S.CER C1608 JB 1H 472K-T
C588	4030006880	S.CER C1608 JB 1H 472K-T
C589	4010008320	CER HM60TJ SL 390J 500V
C590	4010008340	CER HM60TJ SL 270J 500V
C591	4010008330	CER HM60TJ SL 330J 500V
C597	4010007650	CER HM17SJ SL 102J 500V
C598	4010007650	CER HM17SJ SL 102J 500V
C599	4010007650	CER HM17SJ SL 102J 500V
C600	4010007650	CER HM17SJ SL 102J 500V
C601	4030006860	S.CER C1608 JB 1H 102K-T
C602	4030011170	S.CER GRM31M2C2H180JV01L(GRM42-6 CH)
C604	4030011020	S.CER GRM31M4C2H1R0CY21L(GRM42-6 CK)
C605	4030011210	S.CER GRM31M2C2H330JV01L(GRM42-6 CH)
C606	4030011050	S.CER GRM31M3C2H3R0CY21L(GRM42-6 CJ)
C607	4030011190	S.CER GRM31M2C2H270JV01L(GRM42-6 CH)
C608	4030011120	S.CER GRM31M2C2H100JV01L(GRM42-6 CH)
C609	4030011170	S.CER GRM31M2C2H180JV01L(GRM42-6 CH)
C610	4010005790	CER HM60SJ YB 102K 500V
C611	4030007170	S.CER C1608 CH 1H 221J-T
C612	4030007170	S.CER C1608 CH 1H 221J-T
C613	4030007170	S.CER C1608 CH 1H 221J-T
C614	4030007170	S.CER C1608 CH 1H 221J-T
C616	4030006860	S.CER C1608 JB 1H 102K-T
C618	4030011600	S.CER C1608 JB 1E 104K-T
C620	4030011600	S.CER C1608 JB 1E 104K-T
C621	4030006860	S.CER C1608 JB 1H 102K-T
C622	4030006860	S.CER C1608 JB 1H 102K-T
C623	4030006860	S.CER C1608 JB 1H 102K-T
C624	4030006880	S.CER C1608 JB 1H 472K-T
C625	4030006880	S.CER C1608 JB 1H 472K-T
C626	4030006880	S.CER C1608 JB 1H 472K-T

[PA UNIT]

REF NO.	ORDER NO.	DESCRIPTION
C627	4030006880	S.CER C1608 JB 1H 472K-T
RL1	6330001550	REL JV-12-KT
RL2	6330001430	REL NA-12W-K
RL501	6330001510	REL TB1-160
RL502	6330001510	REL TB1-160
RL503	6330001510	REL TB1-160
RL504	6330001510	REL TB1-160
RL505	6330001510	REL TB1-160
RL506	6330001510	REL TB1-160
RL507	6330001510	REL TB1-160
RL508	6330001510	REL TB1-160
RL509	6330001510	REL TB1-160
RL510	6330001510	REL TB1-160
RL511	6330001510	REL TB1-160
RL512	6330001510	REL TB1-160
RL513	6330001330	REL AG 201344
RL514	6330001330	REL AG 201344
RL601	6330001530	REL NR-HD(5V) AE5349
J1	6510007020	CON TMP-J01X-V6
J5	6510020001	S.CON 52808-3071(3090)
J10	6510003081	CON RT01T-1.0B(LF)
J21	6510021531	CON IMSA-9230B-1-04Z024-PT1
J22	6510021531	CON IMSA-9230B-1-04Z024-PT1
J23	6510021531	CON IMSA-9230B-1-04Z024-PT1
J24	6510021531	CON IMSA-9230B-1-04Z024-PT1
F1	5210000061	FUS FGB 5A PBF (FGB0 125V)
F2	5220000230	HOL S-N5054 #01
F3	5220000230	HOL S-N5054 #01
W7	7120000490	JUM ERD25T0
W8	7120000490	JUM ERD25T0
W29	9040401015	WIR 74/98/045/X98/X98
W601	7120000490	JUM ERD25T0
W602	7120000490	JUM ERD25T0
EP2	6910000610	BEA FSRH050100RN000B (FSOH050RN01)
EP3	6910000610	BEA FSRH050100RN000B (FSOH050RN01)
EP6	6910011330	TER OT-009 M3
EP7	6910011330	TER OT-009 M3

M.=Mounted side (T: Mounted on the Top side, B: Mounted on the Bottom side)  
S.=Surface mount



[TUNER UNIT]

REF NO.	ORDER NO.	DESCRIPTION
WS1	8970022710	SX1876 1.5D (2)/TU
Q1	1590000680	S.TRA DTC114EUA T106
Q2	1590000680	S.TRA DTC114EUA T106
Q3	1590000680	S.TRA DTC114EUA T106
Q4	1590000680	S.TRA DTC114EUA T106
Q5	1590000680	S.TRA DTC114EUA T106
Q6	1590000680	S.TRA DTC114EUA T106
Q7	1590000680	S.TRA DTC114EUA T106
Q8	1590000680	S.TRA DTC114EUA T106
Q9	1590000680	S.TRA DTC114EUA T106
Q10	1590000680	S.TRA DTC114EUA T106
Q11	1590000680	S.TRA DTC114EUA T106
Q12	1590000680	S.TRA DTC114EUA T106
Q13	1590000680	S.TRA DTC114EUA T106
Q14	1590000680	S.TRA DTC114EUA T106
Q15	1590000680	S.TRA DTC114EUA T106
D1	1750000370	S.DIO DA221 TL
D2	1750000370	S.DIO DA221 TL
D3	1750000370	S.DIO DA221 TL
D4	1750000370	S.DIO DA221 TL
D5	1750000370	S.DIO DA221 TL
D6	1750000370	S.DIO DA221 TL
D7	1750000370	S.DIO DA221 TL
D8	1750000370	S.DIO DA221 TL
D9	1750000370	S.DIO DA221 TL
D10	1750000370	S.DIO DA221 TL
D11	1750000370	S.DIO DA221 TL
D12	1750000370	S.DIO DA221 TL
D13	1750000370	S.DIO DA221 TL
D14	1750000370	S.DIO DA221 TL
D15	1750000370	S.DIO DA221 TL
L1	6200003950	S.COI HF50ACC 322513-T
L3	6110003600	COI LA-555
L4	6110003590	COI LA-554
L5	6110003020	COI LA-489
L6	6110003030	COI LA-490
L7	6110003020	COI LA-489
L8	6110003030	COI LA-490
L9	6110003481	COI LA-536A
L11	6110003610	COI LA-565
L12	6110003610	COI LA-565
L13	6180003291	COI BM27-400-6A-LF
L14	6180003291	COI BM27-400-6A-LF
L15	6180003291	COI BM27-400-6A-LF
L16	6180003291	COI BM27-400-6A-LF
L17	6180003291	COI BM27-400-6A-LF
L18	6180003291	COI BM27-400-6A-LF
L19	6180003291	COI BM27-400-6A-LF
L20	6180003291	COI BM27-400-6A-LF
C1	4030006880	S.CER C1608 JB 1H 472K-T
C2	4030006880	S.CER C1608 JB 1H 472K-T
C3	4030006880	S.CER C1608 JB 1H 472K-T
C4	4030006880	S.CER C1608 JB 1H 472K-T
C5	4030006880	S.CER C1608 JB 1H 472K-T
C6	4030006880	S.CER C1608 JB 1H 472K-T
C7	4030006880	S.CER C1608 JB 1H 472K-T
C8	4030006880	S.CER C1608 JB 1H 472K-T
C11	4030006880	S.CER C1608 JB 1H 472K-T
C12	4030006880	S.CER C1608 JB 1H 472K-T
C13	4030006880	S.CER C1608 JB 1H 472K-T
C14	4030006880	S.CER C1608 JB 1H 472K-T
C15	4030006880	S.CER C1608 JB 1H 472K-T
C16	4030006880	S.CER C1608 JB 1H 472K-T
C17	4030006880	S.CER C1608 JB 1H 472K-T
C18	4030006880	S.CER C1608 JB 1H 472K-T
C19	4030006880	S.CER C1608 JB 1H 472K-T
C20	4030006880	S.CER C1608 JB 1H 472K-T
C21	4030006880	S.CER C1608 JB 1H 472K-T
C22	4030006880	S.CER C1608 JB 1H 472K-T
C23	4030006880	S.CER C1608 JB 1H 472K-T
C24	4030006880	S.CER C1608 JB 1H 472K-T
C25	4030006880	S.CER C1608 JB 1H 472K-T
C26	4030006880	S.CER C1608 JB 1H 472K-T
C27	4030006880	S.CER C1608 JB 1H 472K-T
C28	4030006880	S.CER C1608 JB 1H 472K-T
C29	4030006880	S.CER C1608 JB 1H 472K-T
C30	4030006880	S.CER C1608 JB 1H 472K-T
C31	4030006880	S.CER C1608 JB 1H 472K-T
C32	4030006880	S.CER C1608 JB 1H 472K-T
C33	4030006880	S.CER C1608 JB 1H 472K-T
C34	4010008550	CER DEA1X3F390JC3B (DE0607SL390J)
C35	4010008550	CER DEA1X3F390JC3B (DE0607SL390J)
C36	4010004800	CER DEC1X3J820JC4B (DE1210SL820J)
C37	4010004250	CER DE1007 SL 101J 3KV
C38	4010004830	CER DEC1X3J151JC4B (DE1510SL151J)
C39	4010008560	CER DEA1X3F151JA3B (DE1107SL151J)
C40	4010004250	CER DE1007 SL 101J 3KV
C41	4010004250	CER DE1007 SL 101J 3KV
C42	4010004250	CER DE1007 SL 101J 3KV
C43	4010004250	CER DE1007 SL 101J 3KV
C44	4620000160	VAR KV-150-05 150P
C45	4620000160	VAR KV-150-05 150P
C46	4030006880	S.CER C1608 JB 1H 472K-T
C47	4030006880	S.CER C1608 JB 1H 472K-T
C48	4030006880	S.CER C1608 JB 1H 472K-T
C49	4030006880	S.CER C1608 JB 1H 472K-T

[TUNER UNIT]

REF NO.	ORDER NO.	DESCRIPTION
C50	4030006880	S.CER C1608 JB 1H 472K-T
C51	4030006880	S.CER C1608 JB 1H 472K-T
C52	4030006880	S.CER C1608 JB 1H 472K-T
C53	4030006880	S.CER C1608 JB 1H 472K-T
C55	4030006880	S.CER C1608 JB 1H 472K-T
C56	4030006880	S.CER C1608 JB 1H 472K-T
C57	4030006880	S.CER C1608 JB 1H 472K-T
C58	4030006880	S.CER C1608 JB 1H 472K-T
C59	4030006880	S.CER C1608 JB 1H 472K-T
C60	4030006880	S.CER C1608 JB 1H 472K-T
C61	4030006880	S.CER C1608 JB 1H 472K-T
RL1	6330001610	REL NY-12W-K-IE
RL2	6330001610	REL NY-12W-K-IE
RL3	6330001610	REL NY-12W-K-IE
RL4	6330001610	REL NY-12W-K-IE
RL5	6330001520	REL VE-12HM-K
RL6	6330001520	REL VE-12HM-K
RL7	6330001520	REL VE-12HM-K
RL8	6330001520	REL VE-12HM-K
RL9	6330001520	REL VE-12HM-K
RL10	6330001610	REL NY-12W-K-IE
RL11	6330001610	REL NY-12W-K-IE
RL12	6330001610	REL NY-12W-K-IE
RL13	6330001610	REL NY-12W-K-IE
RL14	6330001610	REL NY-12W-K-IE
RL15	6330001610	REL NY-12W-K-IE
J5	6510022591	S.CON 22FMN-BMTTR-A-TBT(LF)(SN)
MF1	2710000800	MOT MP24ZA
MF2	2710000800	MOT MP24ZA
W5	8900015420	CAB OPC-1630
W6	8900015420	CAB OPC-1630

M.=Mounted side (T: Mounted on the Top side, B: Mounted on the Bottom side)  
S.=Surface mount

[CTRL UNIT]

REF NO.	ORDER NO.	DESCRIPTION
WS1	8600036850	SX2494 P03*J13CT
WS2	8970023961	SX2494 1.5DA (1)/CT
IC1	1110000960	S.IC NJM4558M-TE1-#FMZB
IC2	1120002252	S.IC TC74ACT32(F)
IC3	1120002242	S.IC TC74AC112(F)
IC4	1110000960	S.IC NJM4558M-TE1-#FMZB
IC5	1140004120	S.IC M38022M2-138FP
IC6	1130011081	S.IC R1EX24016ASA00A
IC9	1110002690	S.IC NJM2903M-TE1-#FMZB
IC10	1130003921	S.IC TC4S69F(TE85R,F)
IC13	1180001071	S.IC TA7805F(TE16L,Q)
IC14	1120002301	S.IC TC74AC04(F) S
Q5	1560000871	S.FET 2SK515-T1B-A (X33)
Q12	1590000680	S.TRA DTC114EUA T106
Q14	1590000680	S.TRA DTC114EUA T106
Q16	1590000680	S.TRA DTC114EUA T106
Q21	1590000680	S.TRA DTC114EUA T106
Q23	1590000680	S.TRA DTC114EUA T106
Q24	1590001330	S.TRA DTA114EUA T106
Q25	1530003091	S.TRA 2SC4213-B(TE85R,F)
Q211	1590000680	S.TRA DTC114EUA T106
Q212	1590000680	S.TRA DTC114EUA T106
Q213	1590000680	S.TRA DTC114EUA T106
Q214	1590000680	S.TRA DTC114EUA T106
Q215	1590000680	S.TRA DTC114EUA T106
Q216	1590000680	S.TRA DTC114EUA T106
Q217	1590000680	S.TRA DTC114EUA T106
Q218	1590000680	S.TRA DTC114EUA T106
D1	1790000491	S.DIO HSM88ASTR-E
D2	1790000491	S.DIO HSM88ASTR-E
D3	1750000201	S.DIO 1SS319(TE85R,F)
D4	1750000121	S.DIO DWA010-TE-E
D5	1790000691	S.DIO HSM88ASTR-E
D6	1790000491	S.DIO HSM88ASTR-E
D7	1790000491	S.DIO HSM88ASTR-E
D8	1790000491	S.DIO HSM88ASTR-E
D9	1790000491	S.DIO HSM88ASTR-E
D10	1750000121	S.DIO DWA010-TE-E
D11	1730000411	S.ZEN RD5.1M-T2B-A B2
D12	1730000031	S.ZEN RD5.6M-T2B-A B2
D13	1710000780	S.DIO MA114(TX)
D15	1790000491	S.DIO HSM88ASTR-E
D16	1750000370	S.DIO DA221 TL
D17	1750000370	S.DIO DA221 TL
D18	1750000370	S.DIO DA221 TL
D20	1750000370	S.DIO DA221 TL
D21	1750000851	S.DIO MMBV3700LT1G
D22	1750000851	S.DIO MMBV3700LT1G
D23	1790000491	S.DIO HSM88ASTR-E
D24	1790000620	S.DIO MA77(TX)
D25	1750001360	S.DIO L709CER (9401)
	1750001360	S.DIO L709CER (9401)
	1750001360	S.DIO L709CER (9401)
	1750001360	S.DIO L709CER (9401)
	1750001390	S.ZEN DAM1MA33
	1750001360	S.DIO L709CER (9401)
D26	1750001360	S.DIO L709CER (9401)
	1750001360	S.DIO L709CER (9401)
	1750001360	S.DIO L709CER (9401)
	1750001360	S.DIO L709CER (9401)
	1750001360	S.DIO L709CER (9401)
	1750001390	S.ZEN DAM1MA33
	1750001360	S.DIO L709CER (9401)
D211	1750000201	S.DIO 1SS319(TE85R,F)
D213	1750000201	S.DIO 1SS319(TE85R,F)
D215	1750000201	S.DIO 1SS319(TE85R,F)
D217	1750000201	S.DIO 1SS319(TE85R,F)
X1	6050009890	S.XTA CR-569 SMD-49 6.144 MHz <KDS>
L1	6140003270	COI LR-364 (TR10X5X5 3A6)
L2	6200001831	S.COI NLV32T-100J
L3	6200003261	S.COI NLV32T-101J
L4	6140003270	COI LR-364 (TR10X5X5 3A6)
L5	6180001220	COI LAL 04NA 100K
L8	6140003270	COI LR-364 (TR10X5X5 3A6)
L9	6180003300	COI T6-222J (2.2M)
L10	6200003261	S.COI NLV32T-101J
L11	6200003261	S.COI NLV32T-101J
L13	6180000990	COI LAL 04NA 101K
L22	6140003270	COI LR-364 (TR10X5X5 3A6)
L25	6200003261	S.COI NLV32T-101J
L27	6110001680	COI LA-254
L28	6110001640	COI LA-247
L29	6200003950	S.COI HF50ACC 322513-T
L31	6200003950	S.COI HF50ACC 322513-T
L32	6200003950	S.COI HF50ACC 322513-T
L35	6110001650	COI LA-248
R1	7030001040	S.RES MCR50JZHJ 18 (180)
R2	7030001040	S.RES MCR50JZHJ 18 (180)
R3	7030003560	S.RES ERJ3GEYJ 103 V (10K)
R4	7030003560	S.RES ERJ3GEYJ 103 V (10K)
R5	7030003720	S.RES ERJ3GEYJ 224 V (220K)
R6	7030003720	S.RES ERJ3GEYJ 224 V (220K)
R7	7030003720	S.RES ERJ3GEYJ 224 V (220K)

[EUR]  
[FRA]  
[DEN]  
[ITR]  
[ESP]  
[KOR]  
[EUR]  
[FRA]  
[DEN]  
[ITR]  
[ESP]  
[KOR]

[CTRL UNIT]

REF NO.	ORDER NO.	DESCRIPTION
R8	7030003720	S.RES ERJ3GEYJ 224 V (220K)
R9	7030003800	S.RES ERJ3GEYJ 105 V (1M)
R10	7030003790	S.RES ERJ3GEYJ 824 V (820K)
R13	7030003440	S.RES ERJ3GEYJ 102 V (1K)
R14	7030003440	S.RES ERJ3GEYJ 102 V (1K)
R15	7030003320	S.RES ERJ3GEYJ 101 V (100)
R16	7030010540	S.RES ERJ1TYJ 330U (33)
R17	7030003320	S.RES ERJ3GEYJ 101 V (100)
R26	7030003280	S.RES ERJ3GEYJ 470 V (47)
R27	7030003280	S.RES ERJ3GEYJ 470 V (47)
R28	7030003500	S.RES ERJ3GEYJ 332 V (3.3K)
R29	7030003480	S.RES ERJ3GEYJ 222 V (2.2K)
R30	7030003360	S.RES ERJ3GEYJ 221 V (220)
R31	7030003480	S.RES ERJ3GEYJ 222 V (2.2K)
R32	7030003680	S.RES ERJ3GEYJ 104 V (100K)
R33	7030003530	S.RES ERJ3GEYJ 562 V (5.6K)
R34	7030003530	S.RES ERJ3GEYJ 562 V (5.6K)
R35	7030003670	S.RES ERJ3GEYJ 823 V (82K)
R36	7030003820	S.RES ERJ3GEYJ 155 V (1.5M)
R37	7030003560	S.RES ERJ3GEYJ 103 V (10K)
R38	7030003560	S.RES ERJ3GEYJ 103 V (10K)
R39	7030003680	S.RES ERJ3GEYJ 104 V (100K)
R40	7030003680	S.RES ERJ3GEYJ 104 V (100K)
R41	7030010550	S.RES ERJ1TYJ 820U (82)
R42	7030003560	S.RES ERJ3GEYJ 103 V (10K)
R43	7030003560	S.RES ERJ3GEYJ 103 V (10K)
R44	7030003800	S.RES ERJ3GEYJ 105 V (1M)
R45	7030003560	S.RES ERJ3GEYJ 103 V (10K)
R46	7030003520	S.RES ERJ3GEYJ 472 V (4.7K)
R47	7030003440	S.RES ERJ3GEYJ 102 V (1K)
R48	7030003560	S.RES ERJ3GEYJ 103 V (10K)
R49	7030003680	S.RES ERJ3GEYJ 104 V (100K)
R50	7030003540	S.RES ERJ3GEYJ 682 V (6.8K)
R51	7030003540	S.RES ERJ3GEYJ 682 V (6.8K)
R52	7030003680	S.RES ERJ3GEYJ 104 V (100K)
R53	7030003820	S.RES ERJ3GEYJ 155 V (1.5M)
R54	7030003560	S.RES ERJ3GEYJ 103 V (10K)
R55	7030003560	S.RES ERJ3GEYJ 103 V (10K)
R56	7030003680	S.RES ERJ3GEYJ 104 V (100K)
R57	7030003680	S.RES ERJ3GEYJ 104 V (100K)
R58	7540000130	ABS 2P-50A-301
R59	7030003560	S.RES ERJ3GEYJ 103 V (10K)
R60	7030003560	S.RES ERJ3GEYJ 103 V (10K)
R61	7030003680	S.RES ERJ3GEYJ 104 V (100K)
R62	7030003680	S.RES ERJ3GEYJ 104 V (100K)
R63	7030003680	S.RES ERJ3GEYJ 104 V (100K)
R64	7030003680	S.RES ERJ3GEYJ 104 V (100K)
R65	7030003440	S.RES ERJ3GEYJ 102 V (1K)
R66	7030003650	S.RES ERJ3GEYJ 563 V (56K)
R67	7030003440	S.RES ERJ3GEYJ 102 V (1K)
R69	7030003320	S.RES ERJ3GEYJ 101 V (100)
R71	7030003440	S.RES ERJ3GEYJ 102 V (1K)
R76	7030003560	S.RES ERJ3GEYJ 103 V (10K)
R83	7030001040	S.RES MCR50JZHJ 18 (180)
R84	7030003560	S.RES ERJ3GEYJ 103 V (10K)
R86	7030003720	S.RES ERJ3GEYJ 224 V (220K)
R87	7030003660	S.RES ERJ3GEYJ 683 V (68K)
R88	7030003660	S.RES ERJ3GEYJ 683 V (68K)
R89	7030003840	S.RES ERJ3GEYJ 225 V (2.2M)
R90	7030003720	S.RES ERJ3GEYJ 224 V (220K)
R92	7030003440	S.RES ERJ3GEYJ 102 V (1K)
R93	7030003560	S.RES ERJ3GEYJ 103 V (10K)
R98	7030003440	S.RES ERJ3GEYJ 102 V (1K)
R99	7030003440	S.RES ERJ3GEYJ 102 V (1K)
R100	7030003650	S.RES ERJ3GEYJ 563 V (56K)
R101	7030003650	S.RES ERJ3GEYJ 563 V (56K)
R102	7030003570	S.RES ERJ3GEYJ 123 V (12K)
R103	7030003680	S.RES ERJ3GEYJ 104 V (100K)
R105	7030003440	S.RES ERJ3GEYJ 102 V (1K)
R106	7030003440	S.RES ERJ3GEYJ 102 V (1K)
R107	7030003680	S.RES ERJ3GEYJ 104 V (100K)
R108	7030003440	S.RES ERJ3GEYJ 102 V (1K)
R109	7030003440	S.RES ERJ3GEYJ 102 V (1K)
R110	7030003440	S.RES ERJ3GEYJ 102 V (1K)
R111	7030003440	S.RES ERJ3GEYJ 102 V (1K)
R112	7030003440	S.RES ERJ3GEYJ 102 V (1K)
R113	7030003440	S.RES ERJ3GEYJ 102 V (1K)
R114	7030003440	S.RES ERJ3GEYJ 102 V (1K)
R115	7030003440	S.RES ERJ3GEYJ 102 V (1K)
R116	7030003440	S.RES ERJ3GEYJ 102 V (1K)
R117	7030003440	S.RES ERJ3GEYJ 102 V (1K)
R118	7030003440	S.RES ERJ3GEYJ 102 V (1K)
R119	7030003440	S.RES ERJ3GEYJ 102 V (1K)
R120	7030003440	S.RES ERJ3GEYJ 102 V (1K)
R121	7030003440	S.RES ERJ3GEYJ 102 V (1K)
R136	7030003560	S.RES ERJ3GEYJ 103 V (10K)
R137	7030003280	S.RES ERJ3GEYJ 470 V (47)
R138	7030003440	S.RES ERJ3GEYJ 102 V (1K)
R139	7030003560	S.RES ERJ3GEYJ 103 V (10K)
R140	7030003280	S.RES ERJ3GEYJ 470 V (47)
R141	7030003440	S.RES ERJ3GEYJ 102 V (1K)
R142	7030003280	S.RES ERJ3GEYJ 470 V (47)
R143	7030003440	S.RES ERJ3GEYJ 102 V (1K)
R144	7030003280	S.RES ERJ3GEYJ 470 V (47)
R145	7030003440	S.RES ERJ3GEYJ 102 V (1K)
R146	7030003280	S.RES ERJ3GEYJ 470 V (47)
R147	7030003440	S.RES ERJ3GEYJ 102 V (1K)
R149	7030003680	S.RES ERJ3GEYJ 104 V (100K)
R150	7030000330	S.RES MCR10EZHZJ 390 (391)
R151	7030000400	S.RES MCR10EZHZJ 1.5K (152)
R152	7030003520	S.RES ERJ3GEYJ 472 V (4.7K)
R153	7030003520	S.RES ERJ3GEYJ 472 V (4.7K)
R154	7030003440	S.RES ERJ3GEYJ 102 V (1K)
R155	7030003390	S.RES ERJ3GEYJ 391 V (390)

M.=Mounted side (T: Mounted on the Top side, B: Mounted on the Bottom side) S.=Surface mount

## [CTRL UNIT]

REF NO.	ORDER NO.	DESCRIPTION
R156	7030000400	S.RES MCR10EZJH 1.5K (152)
R157	70300003560	S.RES ERJ3GEYJ 103 V (10K)
R158	70300003560	S.RES ERJ3GEYJ 103 V (10K)
R159	70300003520	S.RES ERJ3GEYJ 472 V (4.7K)
R160	7030000220	S.RES MCR10EZJH 47 (470)
R161	70300003440	S.RES ERJ3GEYJ 102 V (1K)
R211	70300003380	S.RES ERJ3GEYJ 331 V (330)
R212	70300003380	S.RES ERJ3GEYJ 331 V (330)
R213	70300003380	S.RES ERJ3GEYJ 331 V (330)
R214	70300003380	S.RES ERJ3GEYJ 331 V (330)
R215	70300003380	S.RES ERJ3GEYJ 331 V (330)
R216	70300003380	S.RES ERJ3GEYJ 331 V (330)
R217	70300003380	S.RES ERJ3GEYJ 331 V (330)
R218	70300003380	S.RES ERJ3GEYJ 331 V (330)
W4	70300003860	S.RES ERJ3GE JPW V
C1	4010005530	CER HM60SJ SL 020C 500V
C2	4030007090	S.CER C1608 CH 1H 470J-T
C3	4610001850	S.TRI TZB4R200AB10R00(TZBX4R200BA110)
C4	4010005530	CER HM60SJ SL 020C 500V
C5	4030007100	S.CER C1608 CH 1H 560J-T
C6	4030006860	S.CER C1608 JB 1H 102K-T
C7	4030006860	S.CER C1608 JB 1H 102K-T
C8	4030006880	S.CER C1608 JB 1H 472K-T
C9	4030006880	S.CER C1608 JB 1H 472K-T
C10	4030006880	S.CER C1608 JB 1H 472K-T
C11	4030006880	S.CER C1608 JB 1H 472K-T
C12	4010005540	CER HM60SJ SL 030C 500V
C13	4030007070	S.CER C1608 CH 1H 330J-T
C14	4030007070	S.CER C1608 CH 1H 330J-T
C15	4030007070	S.CER C1608 CH 1H 330J-T
C16	4030006880	S.CER C1608 JB 1H 472K-T
C17	4030007120	S.CER C1608 CH 1H 820J-T
C20	4030006880	S.CER C1608 JB 1H 472K-T
C21	4030006880	S.CER C1608 JB 1H 472K-T
C22	4550003120	S.TAN TEESVD2 1A 476M12R
C23	4030006880	S.CER C1608 JB 1H 472K-T
C24	4030007170	S.CER C1608 CH 1H 221J-T
C25	4030007170	S.CER C1608 CH 1H 221J-T
C26	4030006880	S.CER C1608 JB 1H 472K-T
C27	4030006880	S.CER C1608 JB 1H 472K-T
C30	4030007170	S.CER C1608 CH 1H 221J-T
C31	4030011340	S.CER C1608 CH 1H 471J-T
C32	4010005530	CER HM60SJ SL 020C 500V
C33	4030007110	S.CER C1608 CH 1H 680J-T
C34	4030007110	S.CER C1608 CH 1H 680J-T
C35	4030006880	S.CER C1608 JB 1H 472K-T
C36	4030006860	S.CER C1608 JB 1H 102K-T
C37	4030006880	S.CER C1608 JB 1H 472K-T
C38	4030006880	S.CER C1608 JB 1H 472K-T
C39	4030006880	S.CER C1608 JB 1H 472K-T
C40	4030006880	S.CER C1608 JB 1H 472K-T
C43	4030007170	S.CER C1608 CH 1H 221J-T
C44	4030011340	S.CER C1608 CH 1H 471J-T
C45	4030011600	S.CER C1608 JB 1E 104K-T
C46	4030011600	S.CER C1608 JB 1E 104K-T
C47	4030009990	S.CER C1608 CH 1H 200J-T
C48	4030009990	S.CER C1608 CH 1H 200J-T
C49	4030006880	S.CER C1608 JB 1H 472K-T
C50	4510008520	S.ELE EEE1CA470SP
C51	4030006860	S.CER C1608 JB 1H 102K-T
C52	4030006880	S.CER C1608 JB 1H 472K-T
C53	4030006880	S.CER C1608 JB 1H 472K-T
C54	4030006880	S.CER C1608 JB 1H 472K-T
C55	4030006860	S.CER C1608 JB 1H 102K-T
C56	4030006880	S.CER C1608 JB 1H 472K-T
C57	4030006880	S.CER C1608 JB 1H 472K-T
C58	4030006880	S.CER C1608 JB 1H 472K-T
C59	4030006880	S.CER C1608 JB 1H 472K-T
C60	4030006880	S.CER C1608 JB 1H 472K-T
C62	4030006880	S.CER C1608 JB 1H 472K-T
C63	4030007040	S.CER C1608 CH 1H 180J-T
C64	4030007120	S.CER C1608 CH 1H 820J-T
C65	4030007090	S.CER C1608 CH 1H 470J-T
C66	4030007120	S.CER C1608 CH 1H 820J-T
C67	4030007030	S.CER C1608 CH 1H 150J-T
C69	4510008540	S.ELE EEE1CA100SR
C70	4510008540	S.ELE EEE1CA100SR
C71	4030011600	S.CER C1608 JB 1E 104K-T
C72	4510008870	S.ELE EEE1AA471UP
C73	4030006880	S.CER C1608 JB 1H 472K-T
C74	4030006880	S.CER C1608 JB 1H 472K-T
C75	4030006880	S.CER C1608 JB 1H 472K-T
C76	4030006880	S.CER C1608 JB 1H 472K-T
C77	4030006880	S.CER C1608 JB 1H 472K-T
C78	4030006880	S.CER C1608 JB 1H 472K-T
C79	4030006880	S.CER C1608 JB 1H 472K-T
C80	4030006880	S.CER C1608 JB 1H 472K-T
C81	4030006880	S.CER C1608 JB 1H 472K-T
C82	4030006880	S.CER C1608 JB 1H 472K-T
C83	4030006880	S.CER C1608 JB 1H 472K-T
C84	4030006880	S.CER C1608 JB 1H 472K-T
C85	4030006880	S.CER C1608 JB 1H 472K-T
C86	4030006880	S.CER C1608 JB 1H 472K-T
C90	4510008550	S.ELE EEE1HA010SR
C91	4510008550	S.ELE EEE1HA010SR
C92	4510008550	S.ELE EEE1HA010SR
C93	4510008550	S.ELE EEE1HA010SR
C94	4510008550	S.ELE EEE1HA010SR
C95	4510008550	S.ELE EEE1HA010SR
C96	4510008550	S.ELE EEE1HA010SR

## [CTRL UNIT]

REF NO.	ORDER NO.	DESCRIPTION
C97	4510008550	S.ELE EEE1HA010SR
C98	4510008500	S.ELE EEE1CA101WP
C99	4030007010	S.CER C1608 CH 1H 100D-T
C100	4030007110	S.CER C1608 CH 1H 680J-T
C101	4030006880	S.CER C1608 JB 1H 472K-T
C102	4510008540	S.ELE EEE1CA100SR
C105	4030007070	S.CER C1608 CH 1H 330J-T
C107	4010005550	CER RT-HM60SK SL 040C 500V
C109	4030011600	S.CER C1608 JB 1E 104K-T
C110	4030011600	S.CER C1608 JB 1E 104K-T
C111	4030006880	S.CER C1608 JB 1H 472K-T
C112	4030006880	S.CER C1608 JB 1H 472K-T
C113	4030006880	S.CER C1608 JB 1H 472K-T
C114	4030006880	S.CER C1608 JB 1H 472K-T
C116	4030007020	S.CER C1608 CH 1H 120J-T
C117	4030007100	S.CER C1608 CH 1H 560J-T
C118	4030011600	S.CER C1608 JB 1E 104K-T
C203	4030006880	S.CER C1608 JB 1H 472K-T
C209	4030006900	S.CER C1608 JB 1H 103K-T
C210	4030006900	S.CER C1608 JB 1H 103K-T
C211	4010005520	CER HM60SJ SL 010C 500V
C212	4030007020	S.CER C1608 CH 1H 120J-T
C213	4030007050	S.CER C1608 CH 1H 220J-T
C214	4030006860	S.CER C1608 JB 1H 102K-T
C215	4030005040	S.CER C2012 CH 1H 271J-T
C216	4030011600	S.CER C1608 JB 1E 104K-T
RL1	6330001460	REL FTR-F1CA012V
RL2	6330001460	REL FTR-F1CA012V
RL3	6330001460	REL FTR-F1CA012V
RL4	63300000470	REL NR-HD (12V) AE5343
CP7	6910009670	S.CHE HK3-S-T
J1	6510007020	CON TMP-J01X-V6
J3	6510007020	CON TMP-J01X-V6
J4	6510007020	CON TMP-J01X-V6
J7	6510022591	S.CON 22FMN-BMTTR-A-TBT(LF)(SN)
J8	6510022591	S.CON 22FMN-BMTTR-A-TBT(LF)(SN)
J10	6510003411	CON B05B-EH-S(LF)(SN)
	6510003411	CON B05B-EH-S(LF)(SN)
	6510003410	CON B05B-EH-S
	6510003411	CON B05B-EH-S(LF)(SN)
	6510003411	CON B05B-EH-S(LF)(SN)
	6510003410	CON B05B-EH-S
	6510003410	CON B05B-EH-S(LF)(SN)
	6510003411	CON B05B-EH-S(LF)(SN)
	6510003411	CON B05B-EH-S(LF)(SN)
	6510003410	CON B05B-EH-S
J11	6510003411	CON B05B-EH-S(LF)(SN)
	6510003411	CON B05B-EH-S(LF)(SN)
	6510003411	CON B05B-EH-S(LF)(SN)
	6510003410	CON B05B-EH-S
	6510003411	CON B05B-EH-S(LF)(SN)
	6510003411	CON B05B-EH-S(LF)(SN)
J14	6510018961	S.CON B2B-PH-SM4-TB(LF)(SN)
W3	7120000490	JUM ERD25T0
W11	7120000490	JUM ERD25T0
W12	7120000490	JUM ERD25T0

[EUR]  
[FRA]  
[DEN]  
[ITR]  
[ESP]  
[KOR]  
[EUR]  
[FRA]  
[DEN]  
[ITR]  
[ESP]  
[KOR]

M.=Mounted side (T: Mounted on the Top side, B: Mounted on the Bottom side)  
S.=Surface mount

[FILTER UNIT]

REF NO.	ORDER NO.	DESCRIPTION	
L1	6140003440	COI	LR-386 (FK-100E-5003H)
L2	6140003440	COI	LR-386 (FK-100E-5003H)
C1	4030004740	S.CER	C2012 JB 1H 472K-T
C2	4030008960	S.CER	C2012 JB 1C 104K-T
C5	4030004740	S.CER	C2012 JB 1H 472K-T
C6	4030004740	S.CER	C2012 JB 1H 472K-T
C7	4030008960	S.CER	C2012 JB 1C 104K-T
C8	4030008960	S.CER	C2012 JB 1C 104K-T
C9	4030008960	S.CER	C2012 JB 1C 104K-T
C10	4030004740	S.CER	C2012 JB 1H 472K-T
C12	4030008960	S.CER	C2012 JB 1C 104K-T
C13	4030004740	S.CER	C2012 JB 1H 472K-T
C15	4030008960	S.CER	C2012 JB 1C 104K-T
C16	4030004740	S.CER	C2012 JB 1H 472K-T
C18	4030008960	S.CER	C2012 JB 1C 104K-T
C19	4030004740	S.CER	C2012 JB 1H 472K-T
EP2	6910011330	TER	OT-009 M3
EP3	6910011330	TER	OT-009 M3
EP4	6910011330	TER	OT-009 M3
EP5	6910011330	TER	OT-009 M3

[DRV UNIT]

REF NO.	ORDER NO.	DESCRIPTION	
Q1	1560001030	S.FET	2SK2975 (MTS103)
Q2	1560001030	S.FET	2SK2975 (MTS103)
R1	7030000020	S.RES	MCR10EZHZ 1 (010)
R2	7030000020	S.RES	MCR10EZHZ 1 (010)
R3	7030000020	S.RES	MCR10EZHZ 1 (010)
R4	7030000020	S.RES	MCR10EZHZ 1 (010)
R5	7030000260	S.RES	MCR10EZHZ 100 (101)
R6	7030000260	S.RES	MCR10EZHZ 100 (101)
R7	7030010970	S.RES	ERJ1TYJ 151U
R8	7030010970	S.RES	ERJ1TYJ 151U
C1	4030008960	S.CER	C2012 JB 1C 104K-T
C2	4030008960	S.CER	C2012 JB 1C 104K-T
C3	4030011180	S.CER	GRM31M2C2H220JV01L(GRM42-6 CH)

M.=Mounted side (T: Mounted on the Top side, B: Mounted on the Bottom side)  
S.=Surface mount

# SECTION 7

# MECHANICAL PARTS

## [FRONT UNIT]

REF NO.	ORDER NO.	DESCRIPTION	QTY.
W19	8900009271	OPC-912A	1
W20	8900015160	OPC-916A	1
W21	8900009271	OPC-912A	1
W22	8900009271	OPC-912A	1
W24	8900009231	OPC-908A	1
W25	8900009660	OPC-964	1
W26	8900009231	OPC-908A	1
W27	8900009231	OPC-908A	1
EP1	0880000950	EX-2500 #01	1
EP2	6450001230	HLJ0999-01-480 (SNAP PLATE)	1
EP3	6450001230	HLJ0999-01-480 (SNAP PLATE)	1
MP1	8210018270	2072 FRONT PANEL (B)-1	1
MP2	8010017294	2072 SUB CHASSIS-4	1
MP3	8310052470	2072 WINDOW PLATE (A)	1
MP4	8930056340	2072 TEN KEY (A)	1
MP5	8930056260	2072 MODE KEY (A)	1
MP6	8930056270	2072 P-KEY (A)	1
MP7	8930045430	2072 T-A KEY	1
MP8	8930045440	2072 N-A KEY	1
MP9	8930045450	2072 S-L KEY	1
MP10	8930045460	2072 4-KEY	1
MP11	8610011120	KNOB N-273 (C)	2
MP12	8610010260	KNOB N-252 (incl. MP24)	2
MP13	8610010620	KNOB N-253 (A) (incl. MP24)	2
MP14	8610010633	KNOB N-268 BASE-3 (incl. MP15,MP16,MP18,MP20)	1
MP15	8930041391	1876 D-RUBBER-1	1
MP16	8610010040	KNOB N-239 FINGER REST	1
MP17	8930027470	1296 BRAKE PAD	1
MP18	8930037111	1691 BRAKE SHEET-1	1
MP19	8930041060	1876 BRAKE PLATE	1
MP20	8930032340	1424 N-SPRING	1
MP23	8610007420	KNOB SPRING NO.6601	3
MP24	8610007420	KNOB SPRING NO.6601	2
MP25	8820000771	1296 SCREW-1	1
MP26	8810008661	SCREW BT B0 3X8 NI-ZC3 (BT)	5
MP27	8810008661	SCREW BT B0 3X8 NI-ZC3 (BT)	2
MP28	8810009181	OTAP 1FLAT WASHER B0 2X5 NI-ZC3 (BT)	2
MP29	8810009181	OTAP 1FLAT WASHER B0 2X5 NI-ZC3 (BT)	5
MP30	8810009181	OTAP 1FLAT WASHER B0 2X5 NI-ZC3 (BT)	1
MP31	8810009181	OTAP 1FLAT WASHER B0 2X5 NI-ZC3 (BT)	2
MP32	8810009181	OTAP 1FLAT WASHER B0 2X5 NI-ZC3 (BT)	2
MP33	8810009181	OTAP 1FLAT WASHER B0 2X5 NI-ZC3 (BT)	2
MP34	8810009181	OTAP 1FLAT WASHER B0 2X5 NI-ZC3 (BT)	3
MP35	8810009391	SCREW BT B0 3X18NI-ZC3 (BT)	1
MP36	8930007840	THERMAL SHEET (K)	4
MP37	8930047080	SPONGE (FR)	1
MP38	8930047060	SPONGE (FS)	1
MP39	8930056531	THERMALLY SHEET (AA)-1	1
MP40	8610011130	KNOB N-273 (D)	1
MP41	8610010730	KNOB N-252 (A)	1

## [S-LOGIC UNIT]

REF NO.	ORDER NO.	DESCRIPTION	QTY.
J301*	6510019991	52808-2271	1
J302*	6510019991	52808-2271	1
J303*	6510003401	B04B-EH-S (LF) (SN)	1
J501*	6510019971	52808-1071	1
J502*	6510019971	52808-1071	1
J507*	6510019971	52808-1071	1
J508*	6510019971	52808-1071	1
J601*	6510019991	52808-2271	1
J604*	6510003401	B04B-EH-S (LF) (SN)	1
S1*	2260001890	SKQDPA	1
S2*	2260001890	SKQDPA	1
S3*	2260001890	SKQDPA	1
S4*	2260001890	SKQDPA	1
S5*	2260001890	SKQDPA	1
S6*	2260001890	SKQDPA	1
S7*	2260001890	SKQDPA	1
S8*	2260001890	SKQDPA	1
S9*	2260001890	SKQDPA	1
S10*	2260001890	SKQDPA	1
S11*	2260001890	SKQDPA	1
S601*	2260001890	SKQDPA	1
MP1	8510001082	117 SHIELD CASE (A)-2	1
MP2	8510001101	SHIELD CASE (A) COVER (A)-1	1
MP3	8510005980	724 SHIELD CASE	1
MP4	8510005990	724 SHIELD CASE COVER	1
MP5	8930076790	THERMALLY SHEET (BO)	1

## [PHONE BOARD]

REF NO.	ORDER NO.	DESCRIPTION	QTY.
J1	6450001891	HLJ2305-0130909	1
J2	6450001791	HLJ7000-016010 (HONTAINOMI)	1
J3*	6510019971	52808-1071	1

## [MIC BOARD]

REF NO.	ORDER NO.	DESCRIPTION	QTY.
J1	6510000191	FM214-8SS (P)-1	1
J2*	6510019971	52808-1071	1

## [PBT BOARD]

REF NO.	ORDER NO.	DESCRIPTION	QTY.
J1*	6510019971	52808-1071	1
S1	2250000440	TP90N00E20-22.5-2494	1
S2	2250000410	TP90D96E20-30F-2178-1	1

## [RIT BOARD]

REF NO.	ORDER NO.	DESCRIPTION	QTY.
J1*	6510019971	52808-1071	1
S1	2250000340	EVQ-VCJF0324B	1

## [DISPLAY BOARD]

REF NO.	ORDER NO.	DESCRIPTION	QTY.
J503*	6510019991	52808-2271	1
J505*	6510019991	52808-2271	1
J1001*	6510019991	52808-2271	1
J1002*	6510019991	52808-2271	1
DS1001	5030002150	DLC-83006S4GT	1
DS1002	5080000421	MBS 3 UA1W 70N ASSY	1
EP1	8930046361	SRCN-2072-SP-N-W-1	2
MP1	8930045491	2072 LCD HOLDER-1	1
MP2	8210015251	2072 REFLECTOR-1	1
MP3	8930046520	2072 LCD FILTER	1
MP4	8930046790	THERMAL SHEET (BT)	2

\*: Refer to "BOARD LAYOUTS" for the location.

\*\* : Refer to "GENERAL WIRING" for the connection

**Screw abbreviations** A, B0, BT: Self-tapping PH: Pan head ZK: Black NI-ZU: Nickel-Zinc SUS: Stainless

[CHASSIS PARTS]

REF NO.	ORDER NO.	DESCRIPTION	QTY.
J1	6510001920	1490R	1
J5	6510000370	MR-DS	1
J6	6510000370	MR-DS	1
J7	6510000370	MR-DS	1
P1	5610000360	LLR-06V (Incl. W2, W4, W5, EP1, EP2)	1
P2	6510018990	PHR-4	1
P3	6510018980	PHR-2	1
P51	6510003240	TMP-P01X-A1	1
P52	6510003240	TMP-P01X-A1	1
SP1	2510000761	SM-C77KY0208	1
MF1	2710000630	FBA08T12HC	1
WS1	8600036212	SX2072 P01CH-2	1
WS2	8600036222	SX2072 P02*J01CH-2 (Incl. J1, P2, W6-9, EP5, MP70)	1
WS3	8600036232	SX2072 P03CH-2	1
WS4	8970023980	SX2494 1.5Dcoax cable (1)/CH	1
W1	9020720210	11/02/050/B03/X99	1
W2	9020720210	11/02/050/B03/X99	1
W3	9020720200	11/00/050/B03/X99	1
W4	9020720200	11/00/050/B03/X99	1
W5	9009630450	13/05/050/B03/B03	1
W6	9020720090	15/01/220/A08/B11	1
W7	9020720100	15/02/220/A08/B11	1
W8	9020720110	15/03/220/A08/B11	1
W9	9020720120	15/04/220/A08/B11	1
W10	9020720170	51/99/090/B11Y/W19A	1
W11	9012410001	WIRE 00 A	1
W12	8900007160	OPC-700	1
W13	8900007170	OPC-701	1
W14	8900009271	OPC-912A	1
W15	8900009271	OPC-912A	1
W16	8900015500	OPC-1113A	1
W17	8900015510	OPC-1114A	1
W18	8900015160	OPC-916A	1
W23	8900015160	OPC-916A	1
W50	9024940010	62/99/420/C31/C31	1
W51	9086700300	WIRE 8	1
EP1	6510015940	2-S3.3	1
EP2	6510015940	2-S3.3	1
EP3	6910000340	P101 KD*	1
EP4	6910000310	B312D*	1
EP5	6910000640	FSOH090RN	1
EP6	6910020820	SR TUBE 2.9X4 CP L=60MM	1
MP1	8010017225	2072 CHASSIS-5	1
MP2	8110006361	2072 T-COVER-1 (incl. MP12)	1
MP3	8110006351	2072 L-COVER-1	1
MP4	8110006371	2072 SHIELD COVER-1	1
MP5	8930045172	2072 A-PLATE-2	1
MP6	8930041351	1876 MAIN STAND-1	2
MP7	8930041341	1876 SUB STAND-1	2
MP8	8930029731	1413 FAN HOLDER-1	1
MP9	8930037001	1691 EARTH PLATE-1	3
MP10	8930018520	TR(A) CLIP	2
MP12	8930036070	1528 SP NET	1
MP13	8810005771	SCREW BIH M3X8 ZK3	12
MP14	8810005771	SCREW BIH M3X8 ZK3	6
MP15	8810008661	SCREW BT B0 3X8 NI-ZC3 (BT)	8
MP16	8810008661	SCREW BT B0 3X8 NI-ZC3 (BT)	8
MP17	8810008661	SCREW BT B0 3X8 NI-ZC3 (BT)	10
MP18	8810008661	SCREW BT B0 3X8 NI-ZC3 (BT)	7
MP19	8810008661	SCREW BT B0 3X8 NI-ZC3 (BT)	4
MP20	8810008661	SCREW BT B0 3X8 NI-ZC3 (BT)	4
MP21	8810008661	SCREW BT B0 3X8 NI-ZC3 (BT)	11
MP22	8810008661	SCREW BT B0 3X8 NI-ZC3 (BT)	2
MP23	8810008661	SCREW BT B0 3X8 NI-ZC3 (BT)	6
MP24	8810008661	SCREW BT B0 3X8 NI-ZC3 (BT)	1
MP25	8810005771	SCREW BIH M3X8 ZK3	2
MP26	8810003171	SETSCREW (A) 3X8 ZC3	9
MP27	8810000421	SCREW PH M4X18 ZC3	4
MP28	8810009311	SCREW B0 3X6 NI-ZC3 (BT)	4
MP29	8930042690	RUBBER REG (L)	2
MP30	8930017190	EARTH SPRING (F)	1
MP31	8810008661	SCREW BT B0 3X8 NI-ZC3 (BT)	2
MP32	8820000530	FLANGE BOLT M4X8 NI	1
MP33	8930077650	3073 SIDE HANDLE	1
MP34	8810003371	SETSCREW (C) 3X8 ZC3	2
MP35	8810003171	SETSCREW (A) 3X8 ZC3	1
MP36	8810010870	SCREW M4X12 ZK3	2
MP37	8930046120	RUBBER REG (M)	2
MP38	8930046120	RUBBER REG (M)	2
MP39	8850000430	S-WASHER M4 NI	1
MP40	8850000140	FLAT WASHER M4 BS NI	1
MP41	8810003161	SETSCREW (A) 3X6 ZC3	2
MP42	8810003161	SETSCREW (A) 3X6 ZC3	4
MP43	8810003161	SETSCREW (A) 3X6 ZC3	4
MP50	8930043800	DOUBLESIDED TAPE (S)	1
MP51	8930046642	2072 RF PLATE-2	1
MP53	8810008661	SCREW BT B0 3X8 NI-ZC3 (BT)	4
MP55	8930015640	(SX-713)	1
MP56	8930047291	2072 A-FILTER PLATE-1	1
MP58	8810003161	SETSCREW (A) 3X6 ZC3	1
MP59	8930046720	2072 BUSH	1

[CHASSIS PARTS]

REF NO.	ORDER NO.	DESCRIPTION	QTY.
MP60	8930007840	THERMAL SHEET (K)	2
MP63	8930047220	SPONGE (FT)	1
MP64	8850001710	SEALING WASHER (R)	4
MP65	8930047100	2072 SP SPONGE	1
MP66	8930047090	SPONGE (FP)	1
MP67	8930047070	SPONGE (FQ)	1
MP68	8930047050	THERMAL SHEET (BU)	1
MP70	8950000180	CABLE TIE -80	1
MP71	8930025070	SPONGE (CW)	1
MP72	8930004070	EARTH SPRING (C) (SX-166)	1
MP73	8930038820	ALUMINIUM SHEET (V)	1
MP75	8930055981	SHIELD SPONGE (F)-1	1
MP76	8930055981	SHIELD SPONGE (F)-1	1
MP77	8930054521	SHIELD SPONGE (E)-1	1
MP78	8930058140	SPONGE (GX)	1
MP81	8930043800	DOUBLESIDED TAPE (S)	1

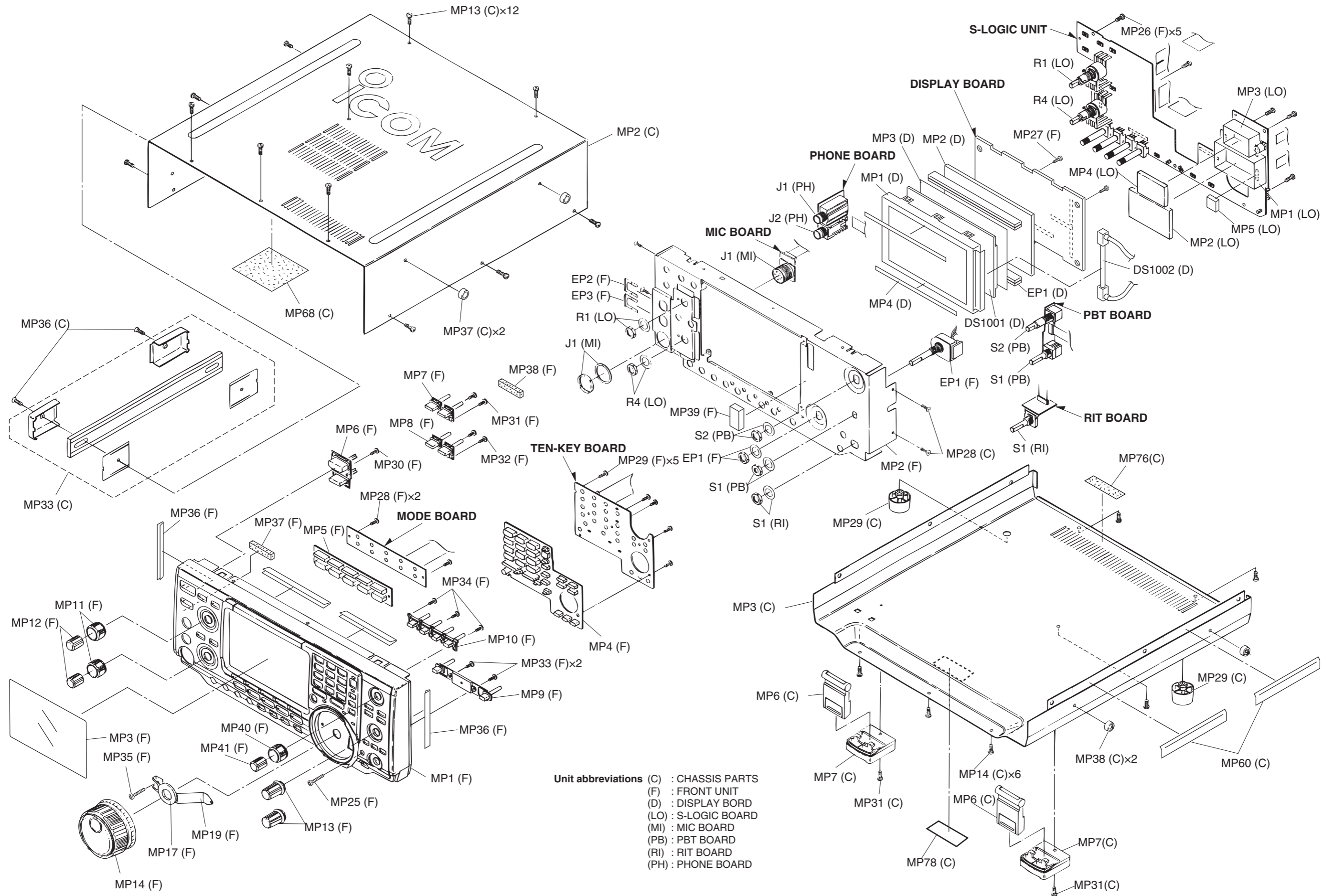

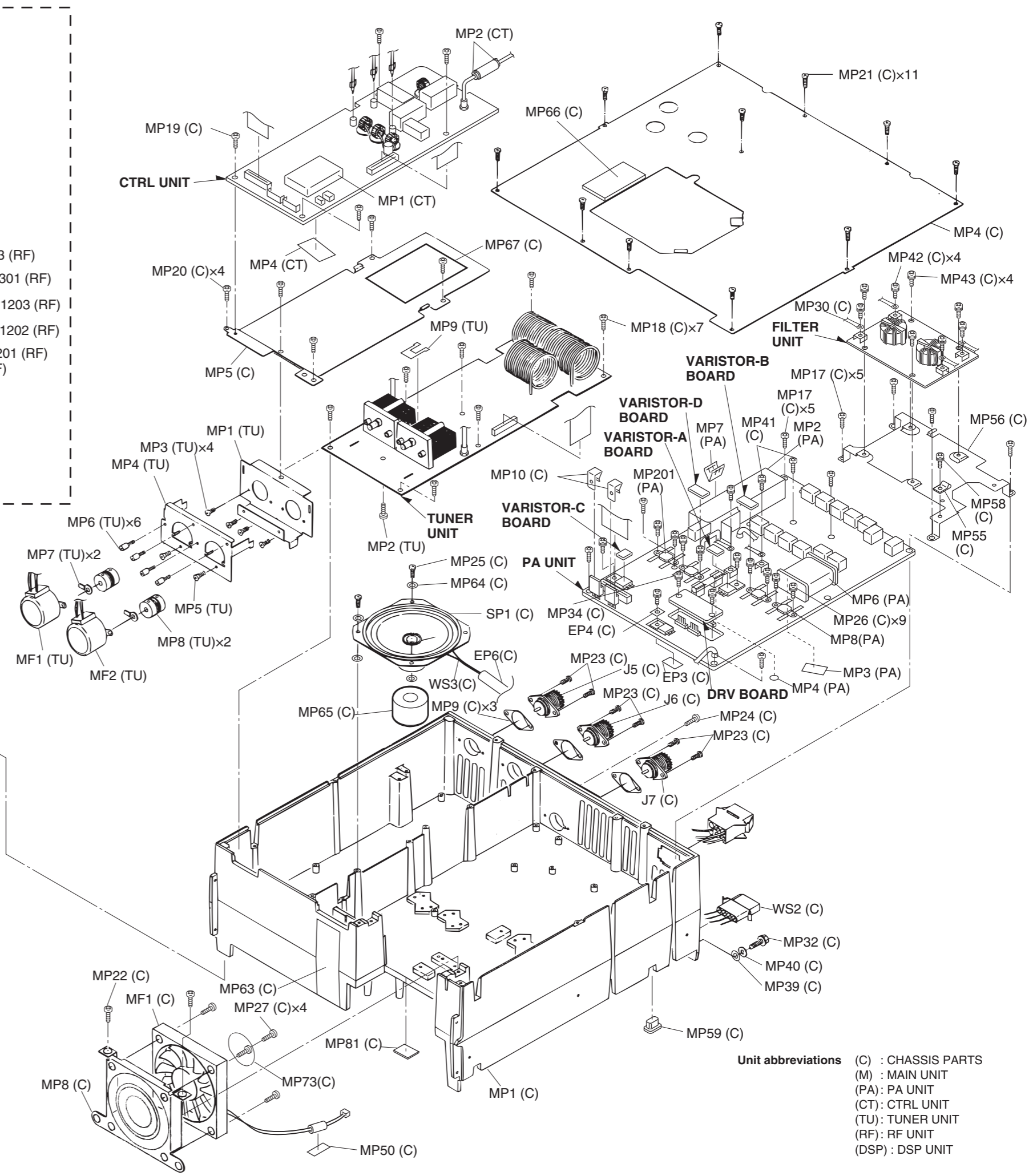
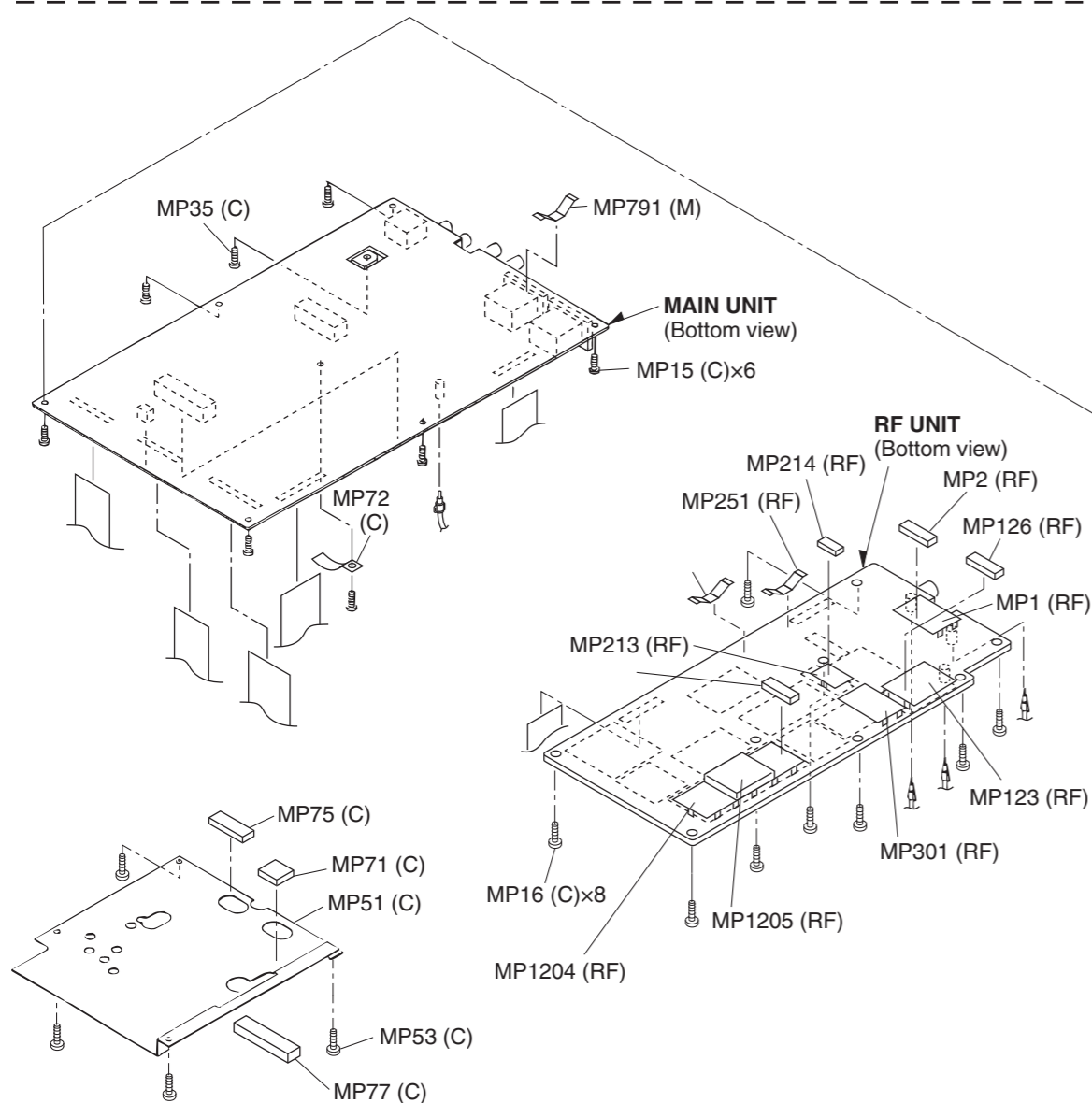
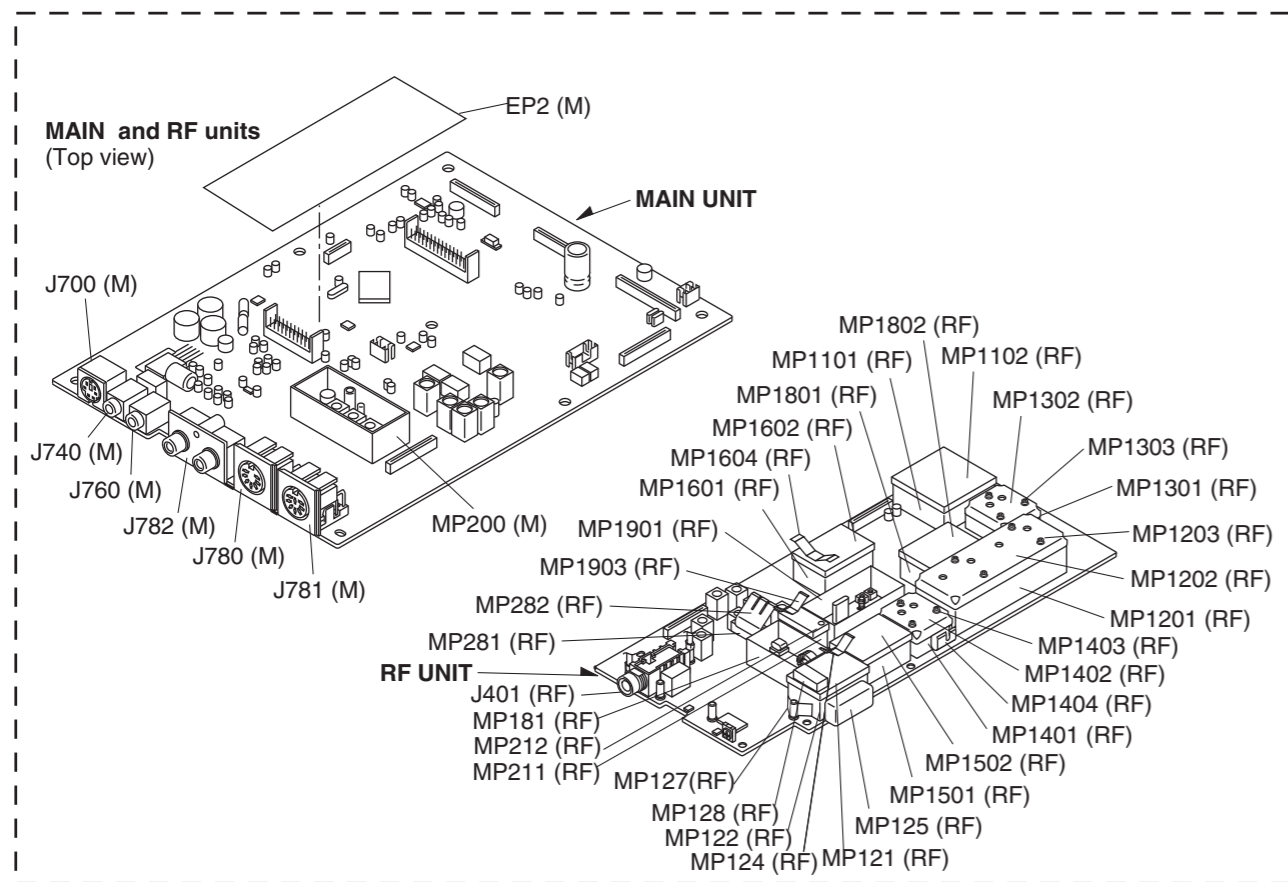

**Unit abbreviations**  
 (C) : CHASSIS PARTS  
 (M) : MAIN UNIT  
 (PA) : PA UNIT  
 (CT) : CTRL UNIT  
 (TU) : TUNER UNIT  
 (RF) : RF UNIT  
 (DSP) : DSP UNIT



[RF UNIT]

REF NO.	ORDER NO.	DESCRIPTION	QTY.
RL1	6330001320	AHY103	1
J1*	6510007020	TMP-J01X-V6	1
J2*	6510022591	22FMN-BMTTR-A-TBT (LF) (SN)	1
J121*	6510007020	TMP-J01X-V6	1
J151*	6510007020	TMP-J01X-V6	1
J261	6510007900	TBP-P01X-A1	1
J262*	6510007020	TMP-J01X-V6	1
J401*	6450001491	HLJ7001-016010 (HONTAINOMI)	1
J1001*	6510022591	22FMN-BMTTR-A-TBT (LF) (SN)	1
J1601	6510009870	PD054-02M	1
J1901	6510007900	TBP-P01X-A1	1
P261	6510003240	TMP-P01X-A1	1
P1601	6510018980	PHR-2	1
P1901	6510003240	TMP-P01X-A1	1
WS1	8970023952	SX2494 1.5+0.8DB (3)/RF (Incl. J261, 1601, 1901, P261, 1601, 1901, W261, 262, 1651, 1652, 1951, 1952, EP2, MP1902, 1905)	1
W213	7120000490	ERD25T0	1
W252	7120000490	ERD25T0	1
W254	7120000470	ERDS2T0	1
W261	9014130400	62/99/150/C24/C31	1
W262	9086700300	WIRE 8	1
W1651	9023550130	61/99/180/B11/D33	1
W1652	9086700300	WIRE 8	1
W1951	9014130400	62/99/150/C24/C31 (incl. J1901,P1901,W1952,EP2,MP1902)	1
W1952	9086700300	WIRE 8	1
EP2	6910000630	FSOH070RN	1
EP261	6910000630	FSOH070RN	1
MP1	8510000210	194 SHIELD PLATE	1
MP2	8930055981	SHIELD SPONGE (F)-1	1
MP121	8510005980	724 SHIELD CASE	1
MP122	8510005990	724 SHIELD CASE COVER	1
MP123	8510000180	117 SHIELD PLATE	1
MP124	8930014140	EARTH SPRING (D)	1
MP125	8930054521	SHIELD SPONGE (E)-1	1
MP126	8930055981	SHIELD SPONGE (F)-1	1
MP127	8930014140	EARTH SPRING (D)	1
MP128	8930058170	SHIELD SPONGE (O)	1
MP181	8510005980	724 SHIELD CASE	1
MP211	8510005150	602 SHIELD CASE	1
MP212	8510005160	602 SHIELD CASE COVER	1
MP213	8510002280	VCOSHIELD PLATE (A) (FX-15)	1
MP214	8930052271	SHIELD SPONGE (D)-1	1
MP231	8930005320	FILTER SPACER	2
MP251	8930014140	EARTH SPRING (D)	1
MP261	8510013560	2355 U-L PLATE	1
MP281	8510012400	2177 D/A CASE	1
MP282	8930057760	2494 RF SPRING	1
MP301	8510000210	194 SHIELD PLATE	1
MP1101	8510010760	1876 DDS CASE	1
MP1102	8510010770	1876 DDS COVER	1
MP1103	8510005330	COIL CASE (SX-644)	1
MP1201	8510011511	2072 VCO CASE-1	1
MP1202	8510011521	2072 VCO COVER-1	1
MP1203	8810003961	SETSCREW (A) 2.6X5 ZC3	4
MP1204	8510011710	2072 VCO SHIELD	1
MP1205	8930013520	SPONGE (BJ)	1
MP1207	8930055981	SHIELD SPONGE (F)-1	1
MP1208	8930027891	946 EARTH SPRING-1	1
MP1301	8510010052	1691 SHIELD CASE-2	1
MP1302	8510010062	1691 SHIELD COVER-2	1
MP1303	8810003961	SETSCREW (A) 2.6X5 ZC3	3
MP1401	8510010052	1691 SHIELD CASE-2	1
MP1402	8510010062	1691 SHIELD COVER-2	1
MP1403	8810003961	SETSCREW (A) 2.6X5 ZC3	3
MP1404	8930027891	946 EARTH SPRING-1	1
MP1501	8510005980	724 SHIELD CASE	1
MP1502	8510005990	724 SHIELD CASE COVER	1
MP1601	8510005980	724 SHIELD CASE	1
MP1602	8510005990	724 SHIELD CASE COVER	1
MP1603	8930014140	EARTH SPRING (D)	1
MP1604	8930014140	EARTH SPRING (D)	1
MP1801	8510005980	724 SHIELD CASE	1
MP1802	8510005990	724 SHIELD CASE COVER	1
MP1901	8510000231	220 SHIELD CASE-1	1
MP1902	8950000180	CABLE TIE -80	2
MP1903	8930014140	EARTH SPRING (D)	1
MP1905	8950000180	CABLE TIE -80	2

[MAIN UNIT]

REF NO.	ORDER NO.	DESCRIPTION	QTY.
RL740*	6330001320	AHY103	1
RL781*	6330000540	OMR-109F	1
CP200*	6910009670	HK3-S-T	1
CP300*	6910009670	HK3-S-T	1
CP1460*	6910009670	HK3-S-T	1
J100*	6510022591	22FMN-BMTTR-A-TBT (LF) (SN)	1
J120*	6510022601	30FMN-BMTTR-A-TBT (LF) (SN)	1
J140*	6510022591	22FMN-BMTTR-A-TBT (LF) (SN)	1
J160*	6510022591	22FMN-BMTTR-A-TBT (LF) (SN)	1
J180*	6510022591	22FMN-BMTTR-A-TBT (LF) (SN)	1
J250*	6510007020	TMP-J01X-V6	1
J400*	6510018961	B2B-PH-SM4-TB (LF) (SN)	1
J700*	6450001841	TCS7568-4320177	1
J740*	6450000140	HSJ0807-01-010	1
J741*	6510018961	B2B-PH-SM4-TB (LF) (SN)	1
J760*	6450000140	HSJ0807-01-010	1
J761*	6510018971	B4B-PH-SM4-TB (LF) (SN)	1
J780*	6510023661	TCS4470-0141577	1
J781*	6510023671	TCS4480-0141577	1
J782*	6450001130	JPJ2042-01-110	1
J802*	6510018961	B2B-PH-SM4-TB (LF) (SN)	1
J1000*	6510021651	IMSA-9180B-30B-PT1	1
J1001*	6510022811	IMSA-9180B-22B-PT1	1
J1920*	6510019191	52365-0871	1
EP2	0880000890	EX-2432 #01	1
MP200	8510000231	220 SHIELD CASE-1	1
MP791	8930014140	EARTH SPRING (D)	1

[PA UNIT]

REF NO.	ORDER NO.	DESCRIPTION	QTY.
RL1*	6330001550	JV-12-KT	1
RL2*	6330001430	NA-12W-K	1
RL501*	6330001510	TB1-160	1
RL502*	6330001510	TB1-160	1
RL503*	6330001510	TB1-160	1
RL504*	6330001510	TB1-160	1
RL505*	6330001510	TB1-160	1
RL506*	6330001510	TB1-160	1
RL507*	6330001510	TB1-160	1
RL508*	6330001510	TB1-160	1
RL509*	6330001510	TB1-160	1
RL510*	6330001510	TB1-160	1
RL511*	6330001510	TB1-160	1
RL512*	6330001510	TB1-160	1
RL513*	6330001330	AG201344	1
RL514*	6330001330	AG201344	1
RL601*	6330001530	AE5349 (NR-HD 5V)	1
J1*	6510007020	TMP-J01X-V6	1
J5*	6510020001	52808-3071	1
J10*	6510003081	RT01T-1.0B (LF)	1
J21*	6510021531	IMSA-9230B-1-04Z024-PT1	1
J22*	6510021531	IMSA-9230B-1-04Z024-PT1	1
J23*	6510021531	IMSA-9230B-1-04Z024-PT1	1
J24*	6510021531	IMSA-9230B-1-04Z024-PT1	1
J502	6510007900	TBP-P01X-A1	1
J601	6510007900	TBP-P01X-A1	1
P501	6510003240	TMP-P01X-A1	1
P601	6510003240	TMP-P01X-A1	1
F1*	5210000061	FGB 5A PBF	1
F2*	5220000230	S-N5054 #01	1
F3*	5220000230	S-N5054 #01	1
WS1	8970022760	SX1876 J(1)/PA (Incl. W14)	1
WS2	8970023991	SX2494 1.5D-1 (2)/PA (Incl. J502, P501, 602, W550, 650)	1
W1*	7030003860	ERJ3GE-JPW	1
W3*	7030003860	ERJ3GE-JPW	1
W7	7120000490	ERD25T0	1
W8	7120000490	ERD25T0	1
W14	9016910440	23/06/050/D21/W05	1
W29	9040401015	74/98/045/X98/X98	1
W504*	7030003860	ERJ3GE-JPW	1
W550	9009130242	62/99/320/C24/C31	1
W551	9086700300	WIRE 8	1
W601	7120000490	ERD25T0	1
W602	7120000490	ERD25T0	1
W650	9009130030	62/99/300/C24/C31	1
W651	9086700300	WIRE 8	1
EP2*	6910000610	FSOH050RN01	1
EP3*	6910000610	FSOH050RN01	1
EP6	6910011330	OT-009 M3	1
EP7	6910011330	OT-009 M3	1
EP650	6910000630	FSOH070RN	1
MP2	8930046570	2072 PA PLATE	1

**[PA UNIT]**

REF NO.	ORDER NO.	DESCRIPTION	QTY.
MP3	8930047110	RUBBER SHEET (AP)	1
MP4	8930047120	RUBBER SHEET (AQ)	1
MP7	8930001180	EARTH PLATE (FX-22)	1
MP8	8860001450	2178 RUG	2
MP201	8860001450	2178 RUG	2

**[TUNER UNIT]**

REF NO.	ORDER NO.	DESCRIPTION	QTY.
RL1*	6330001610	NY-12W-K-IE	1
RL2*	6330001610	NY-12W-K-IE	1
RL3*	6330001610	NY-12W-K-IE	1
RL4*	6330001610	NY-12W-K-IE	1
RL5*	6330001520	VE-12HM-K	1
RL6*	6330001520	VE-12HM-K	1
RL7*	6330001520	VE-12HM-K	1
RL8*	6330001520	VE-12HM-K	1
RL9*	6330001520	VE-12HM-K	1
RL10*	6330001610	NY-12W-K-IE	1
RL11*	6330001610	NY-12W-K-IE	1
RL12*	6330001610	NY-12W-K-IE	1
RL13*	6330001610	NY-12W-K-IE	1
RL14*	6330001610	NY-12W-K-IE	1
RL15*	6330001610	NY-12W-K-IE	1
J3	6510007900	TBP-P01X-A1	1
J4*	6510007900	TBP-P01X-A1	1
J5*	6510022591	22FMN-BMTTR-A-TBT (LF) (SN)	1
P3	6510003240	TMP-P01X-A1	1
P4	6510003240	TMP-P01X-A1	1
MF1	2710000800	MP24ZA	1
MF2	2710000800	MP24ZA	1
WS1	8970022710	SX1876 1.5D (2)/TU (Incl. J3, P3)	1
W1	9018760110	62/99/190/C24/C31	1
W2	9086700300	WIRE 8	1
W3	9018760110	62/99/190/C24/C31	1
W4	9086700300	WIRE 8	1
W5	8900015420	OPC-1630	1
W6	8900015420	OPC-1630	1
MP1	8930041091	1876 A-ANGLE-1	1
MP2	8810008661	SCREW BT B0 3X8 NI-ZC3 (BT)	1
MP3	8810009061	SCREW M3X6 ZK3	4
MP4	8930041111	1876 B-ANGLE-1	1
MP5	8810009061	SCREW M3X6 ZK3	2
MP6	8820000881	1528 SCREW-1	4
MP7	8930030112	1414 PLATE-2	2
MP8	8950003200	UJ6-5 (UNIVERSAL COUPLINGS)	2
MP9	8930051580	2178 TUNER PLATE	1

**[CTRL UNIT]**

REF NO.	ORDER NO.	DESCRIPTION	QTY.
RL1*	6330001460	FTR-F1 CA012V	1
RL2*	6330001460	FTR-F1 CA012V	1
RL3*	6330001460	FTR-F1 CA012V	1
RL4*	6330000470	AE5343 (NR-HD 12V)	1
J1*	6510007020	TMP-J01X-V6	1
J2	6510007900	TBP-P01X-A1	1
J3*	6510007020	TMP-J01X-V6	1
J4*	6510007020	TMP-J01X-V6	1
J7*	6510022591	22FMN-BMTTR-A-TBT (LF) (SN)	1
J8*	6510022591	22FMN-BMTTR-A-TBT (LF) (SN)	1
J10*	6510003411	B05B-EH-S (LF) (SN)	1
J11*	6510003411	B05B-EH-S (LF) (SN)	1
J13	6510009870	PD054-02M	1
J14*	6510018961	B2B-PH-SM4-TB (LF) (SN)	1
P2	6510003240	TMP-P01X-A1	1
P3	6510018980	PHR-2	1
WS1	8600036850	SX2494 P03*J13CT (Incl. J13, P3, W13, 14)	1
WS2	8970023961	SX2494 1.5DA (1)/CT (Incl. J2, P2, W51, 52, EP2, MP2)	1
W3	7120000490	ERD25T0	1
W11	7120000490	ERD25T0	1
W12	7120000490	ERD25T0	1
W13	9020720140	51/99/530/B11A/D33A	1
W14	9011130780	WIRE 00 A A	1
W51	9009130167	62/99/420/C24/C31	1
W52	9086700300	WIRE 8	1
EP2	6910000630	FSOH070RN	1
MP1	8510014440	2494 SHIELD CASE	1
MP2	8950000180	CABLE TIE -80	2
MP4	8510005521	VCOSHIELD PLATE (A)-1 (SX-644)	1

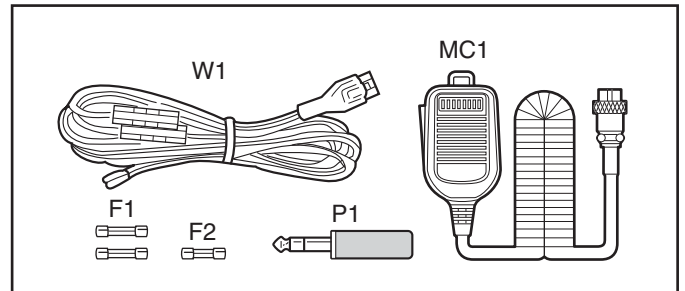

**[ACCESSORY]**

REF NO.	ORDER NO.	DESCRIPTION	QTY.
P1	5610000410	AP-319	1
MC1	(Optional)	HM-36-1	1
F1	5210000090	FGB 30A	2
F2	5210000061	FGB 5A PBF	1
W1	8900006490	OPC-025D	1





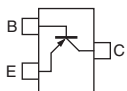
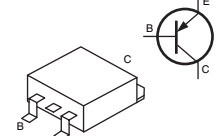
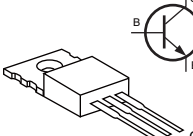
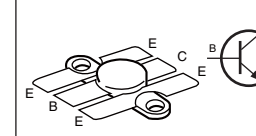
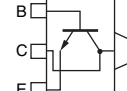
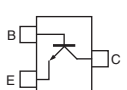
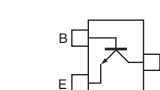
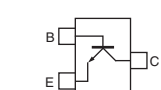
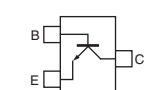
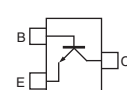
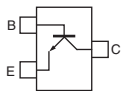
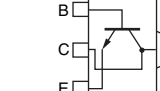
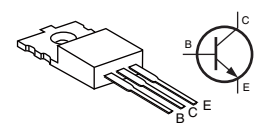
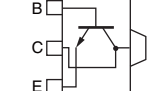
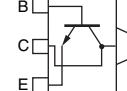

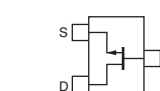
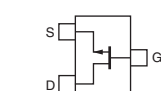
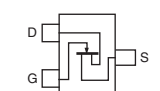
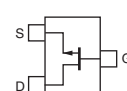
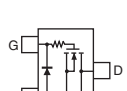
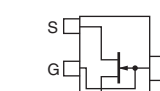
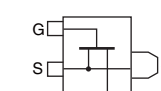
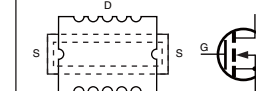
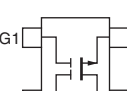
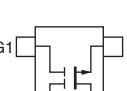
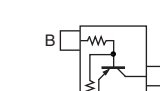
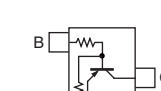
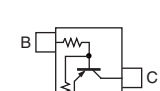
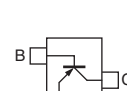
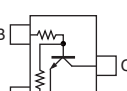
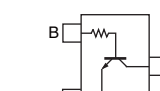
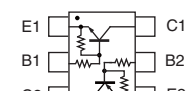
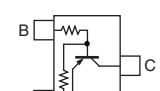
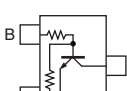



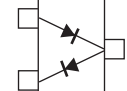

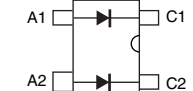
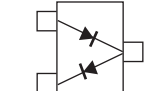
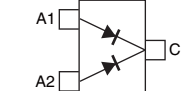
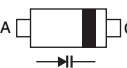
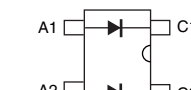
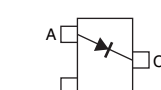
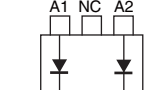
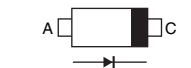

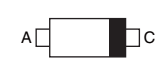

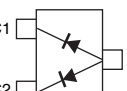
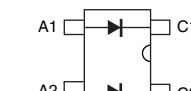
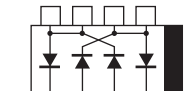
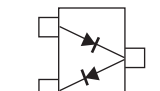
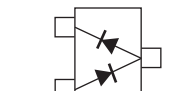

# SECTION 8 SEMI-CONDUCTOR INFORMATION

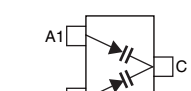
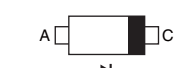
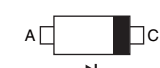
## • TRANSISTORS AND FET'S

<b>2SA1576A T106 R</b> (Symbol: FR) 	<b>2SB1201 S</b> (Symbol: B1201) 	<b>2SC1971</b> (Symbol: None) 	<b>2SC2694</b> (Symbol: None) 	<b>2SC3647 S TD</b> (Symbol: CC) 
<b>2SC4081 T107 R</b> (Symbol: BR) 	<b>2SC4116 GR</b> (Symbol: LG) 	<b>2SC4213 B</b> (Symbol: AB) 	<b>2SC4226 T2 R25</b> (Symbol: R25) 	<b>2SC4403 3 TL</b> (Symbol: LY3) 
<b>2SC4405 3 TL</b> (Symbol: OY3) 	<b>2SC4673 D TD</b> (Symbol: CO) 	<b>2SD1585 K</b> (Symbol: None) 	<b>2SD1619 T TD</b> (Symbol: DB) 	<b>2SD1801 S TL</b> (Symbol: CE) 
<b>2SK210 GR</b> (Symbol: YG) 	<b>2SK508 K52 T2B</b> (Symbol: K52) 	<b>2SK515 T1B</b> (Symbol: X33) 	<b>2SK882 GR</b> (Symbol: TGR) 	<b>2SK1740</b> (Symbol: IJ) 
<b>2SK1829</b> (Symbol: K1) 	<b>2SK2171 4 TD</b> (Symbol: KM) 	<b>2SK2973</b> (Symbol: K1) 	<b>2SK2975</b> (Symbol: K2975) 	<b>3SK131 T2 MAS</b> (Symbol: V11) 
<b>3SK177 T1B U73</b> (Symbol: U73) 	<b>DTA114 EE TL</b> (Symbol: 14) 	<b>DTA114EUA T106</b> (Symbol: 14) 	<b>DTA144EUA T106</b> (Symbol: 16) 	<b>DTC114 EE TL</b> (Symbol: 24) 
<b>DTC114EUA T106</b> (Symbol: 24) 	<b>DTC144 TE</b> (Symbol: 06) 	<b>UMD3 N TL</b> (Symbol: D3) 	<b>UN911H</b> (Symbol: 6P) 	<b>UN9211</b> (Symbol: 8A) 

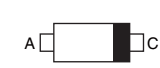
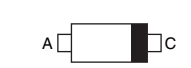
## • DIODES

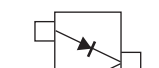
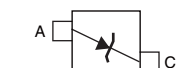
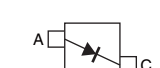
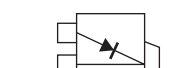
<b>1SS302</b> (Symbol: C3) 	<b>1SS315</b> (Symbol: S2) 	<b>1SS319</b> (Symbol: A4) 	<b>1SS375-TL</b> (Symbol: FH) 	<b>1SS385</b> (Symbol: 09) 
<b>1SV217</b> (Symbol: T6) 	<b>1SV237</b> (Symbol: BB) 	<b>1SV263 TL</b> (Symbol: JV) 	<b>1SV265 TL</b> (Symbol: LV) 	<b>1SV271</b> (Symbol: TG) 
<b>1SV308</b> (Symbol: TX) 	<b>1SV314</b> (Symbol: V6) 	<b>DA221 TL</b> (Symbol: K) 	<b>DAN222TL</b> (Symbol: N) 	<b>DAP202K T146</b> (Symbol: P) 
<b>DAP222 TL</b> (Symbol: P) 	<b>DWA010 TE</b> (Symbol: W8) 	<b>HSB88WSTR</b> (Symbol: Silver line) 	<b>HSM88AS TR</b> (Symbol: C1) 	<b>HSM88ASR TR</b> (Symbol: C3) 
<b>HSU88TRF</b> (Symbol: 9) 	<b>KV1470 TL</b> (Symbol: F7) 	<b>MA2S111 (Symbol: A)</b> <b>MA2S728 (Symbol: B)</b> 	<b>MA30-(TX)</b> (Symbol: 3B) 	<b>MA77</b> (Symbol: 4B) 
<b>MA114</b> (Symbol: 1E) 	<b>MA338</b> (Symbol: 6H) 	<b>MA357</b> (Symbol: 7K) 	<b>MA729</b> (Symbol: 2B) 	<b>MA8039 L (Symbol: 3_9)</b> <b>MA8068 M (Symbol: 6-8)</b> 
<b>MMBV3700LT1</b> (Symbol: 4R) 	<b>RB706F-40 T106</b> (Symbol: 3J) 	<b>RD3.0M T2B2 (Symbol: 302)</b> <b>RD5.1M T2B2 (Symbol: 512)</b> <b>RD5.6M T2B2 (Symbol: 562)</b> 	<b>SB07-03C</b> (Symbol: J) 	<b>SB10 05PCP TD</b> (Symbol: SA) 

# SECTION 9

# BOARD LAYOUTS

The combination of top side and bottom side of this page shows the actual configuration of P.C. board.

• S-LOGIC UNIT (TOP VIEW)

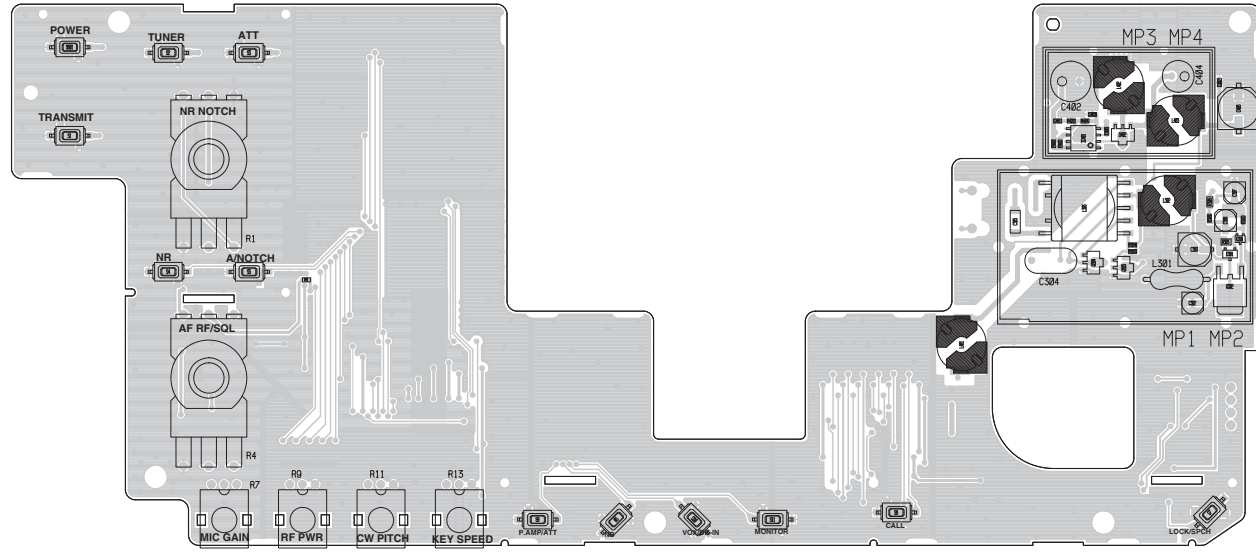

• RF UNIT (TOP VIEW)

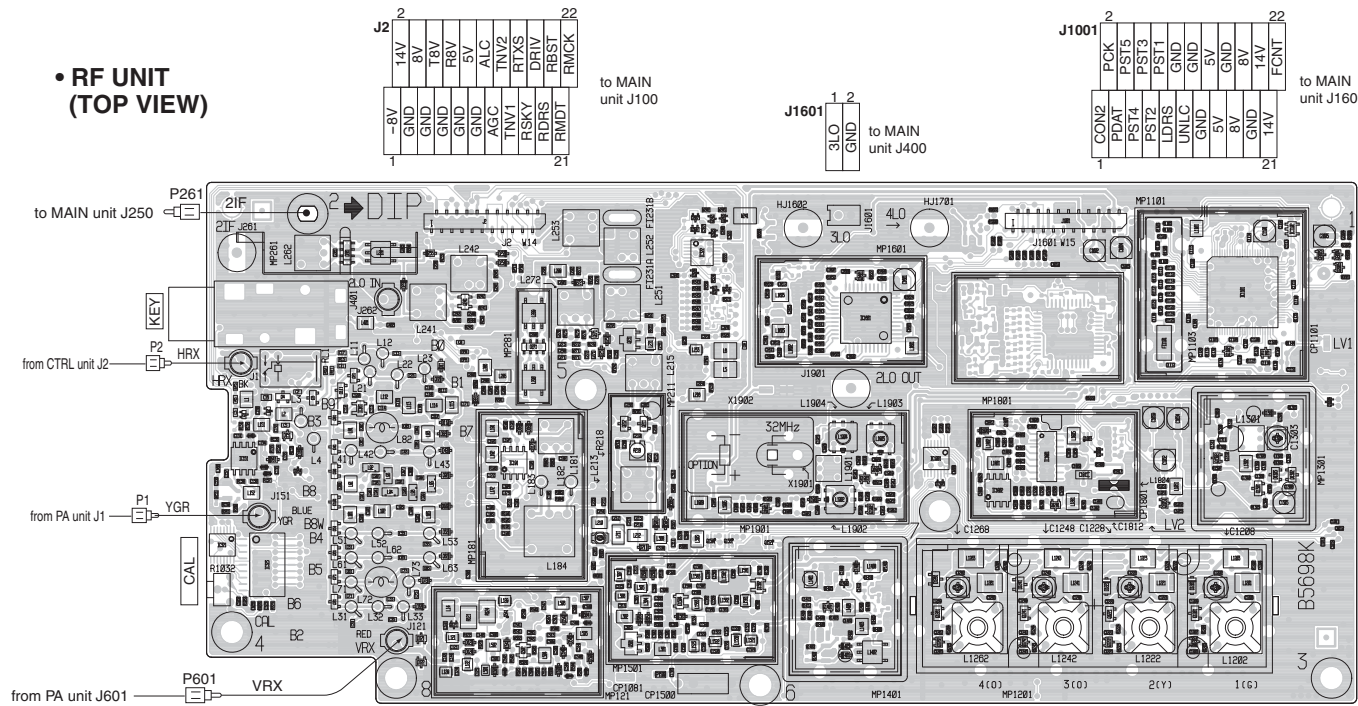

• PA UNIT (TOP VIEW)

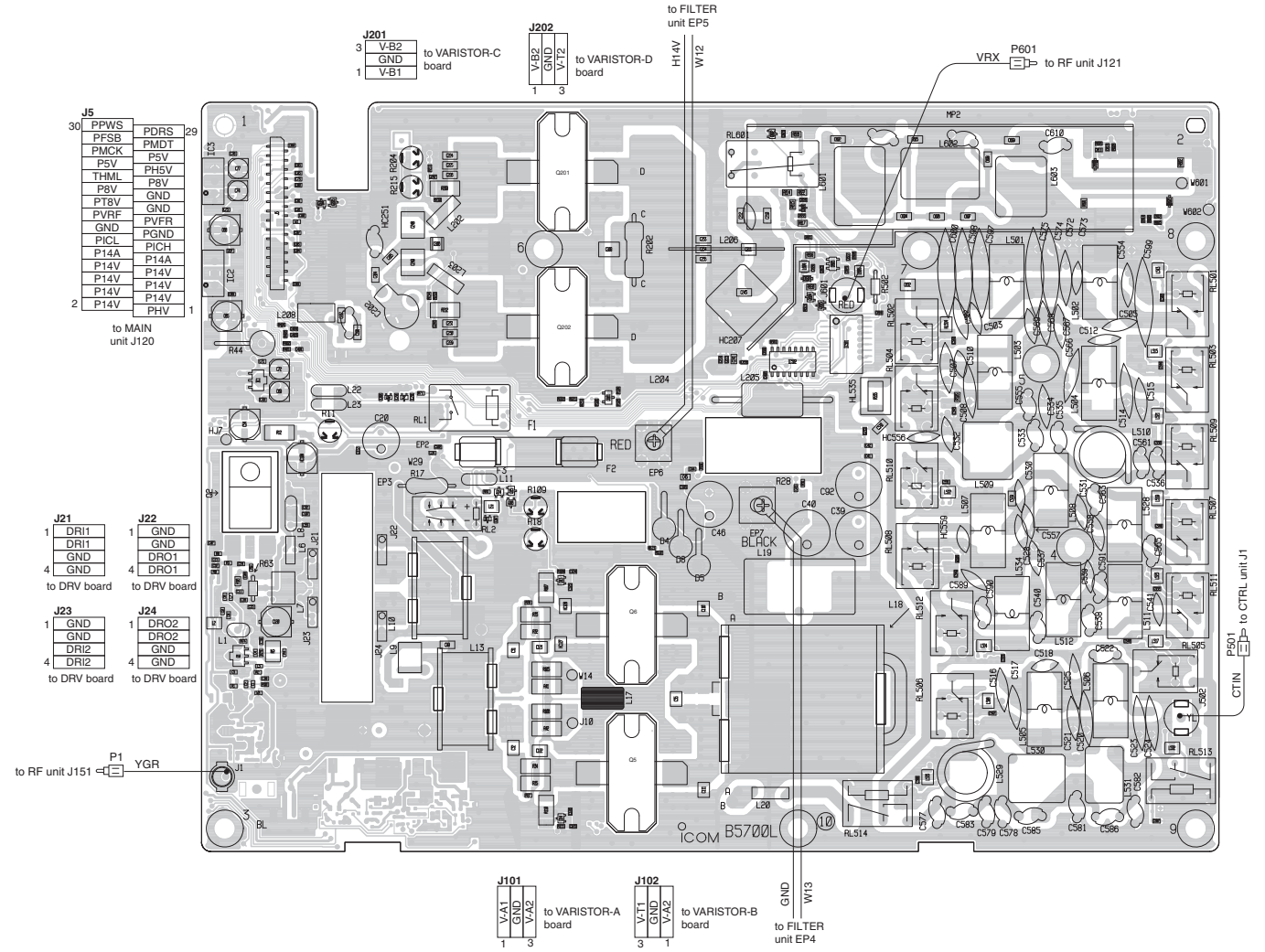

• PA UNIT  
(BOTTOM VIEW)

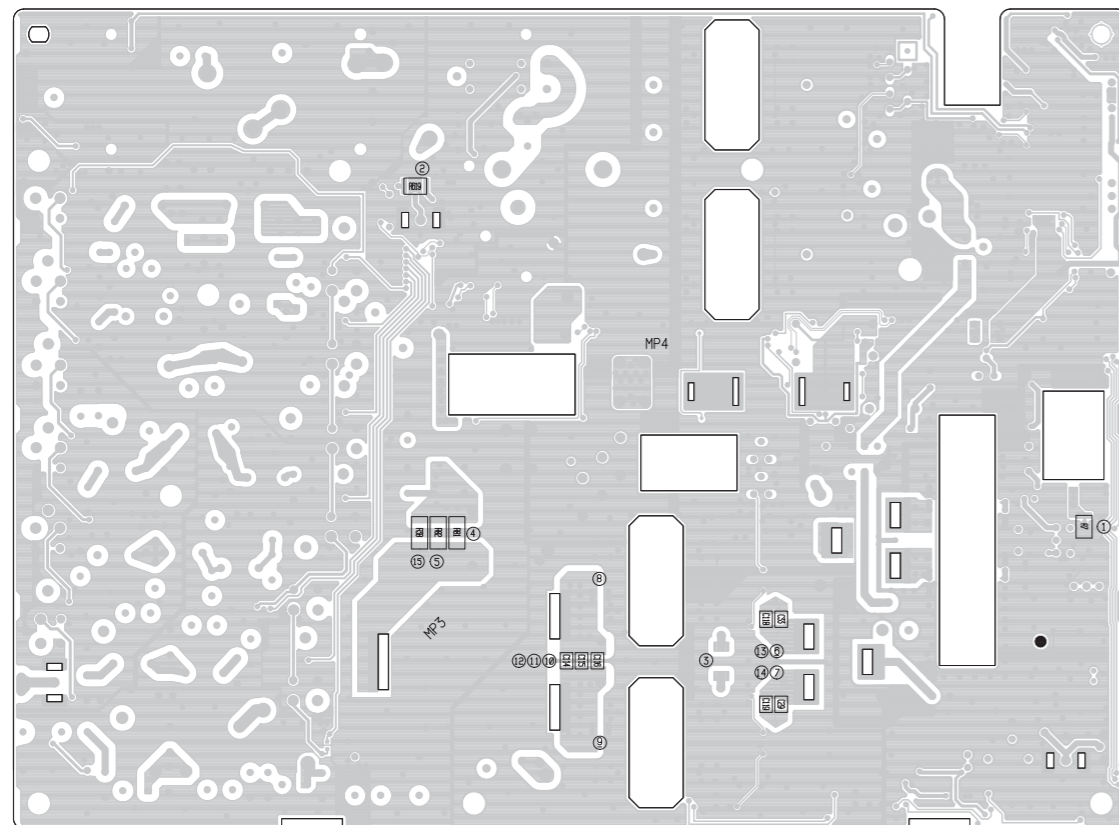

• S-LOGIC UNIT  
(BOTTOM VIEW)

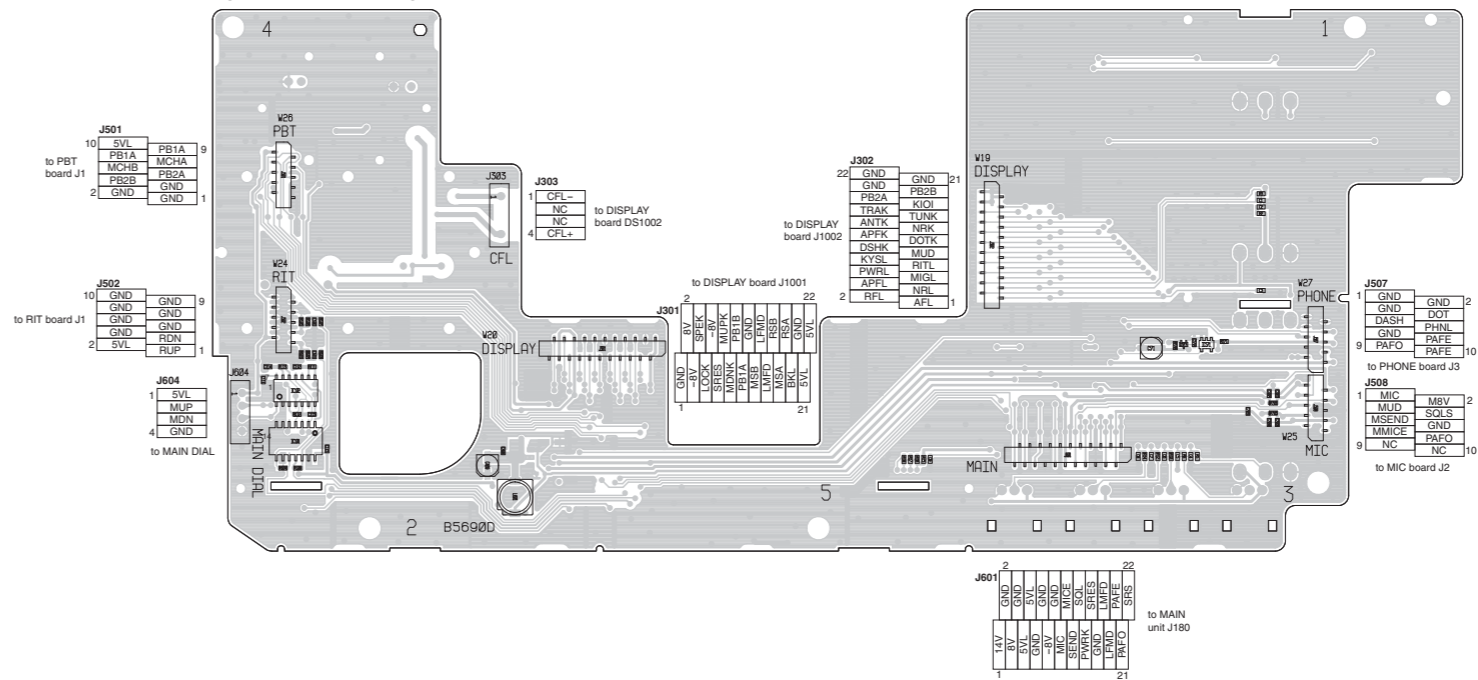

• RF UNIT  
(BOTTOM VIEW)

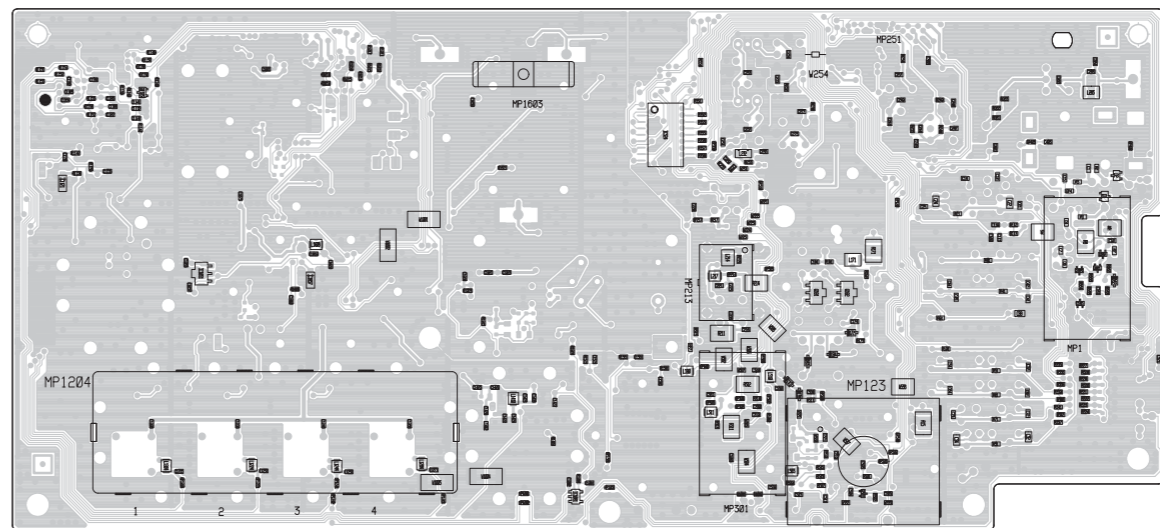

• DISPLAY BOARD  
(TOP VIEW)

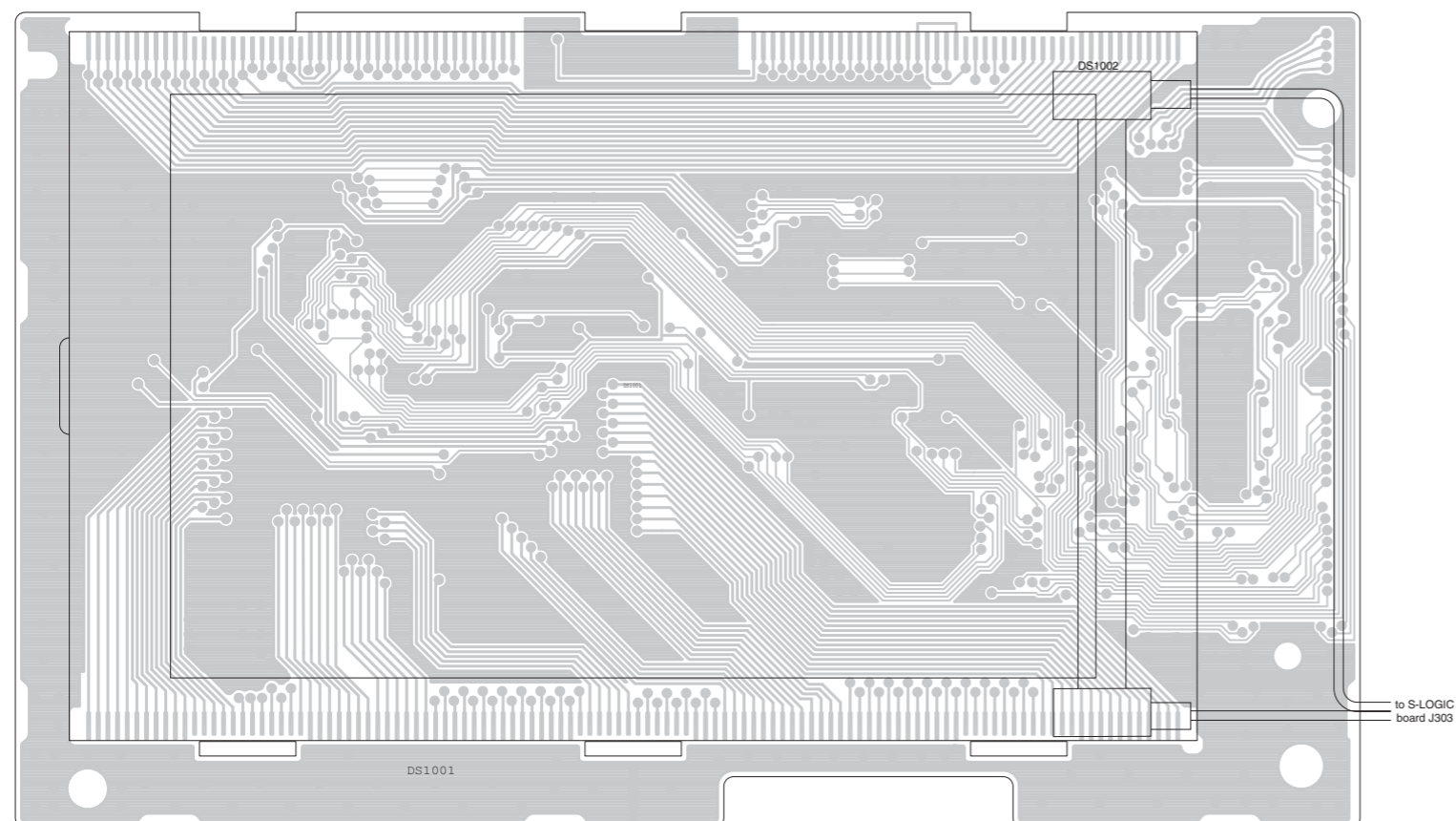

• DRV BOARD  
(TOP VIEW)

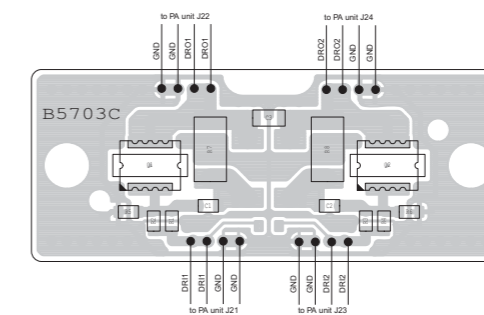

• TEN-KEY BOARD  
(TOP VIEW)

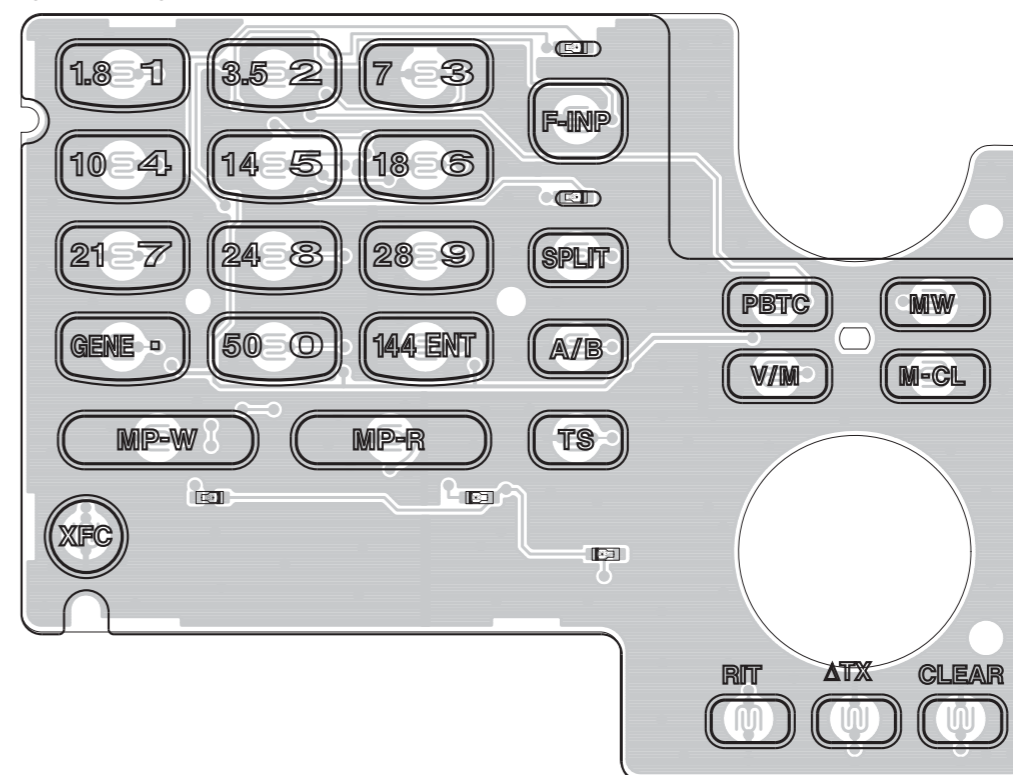

• MODE BOARD  
(TOP VIEW)

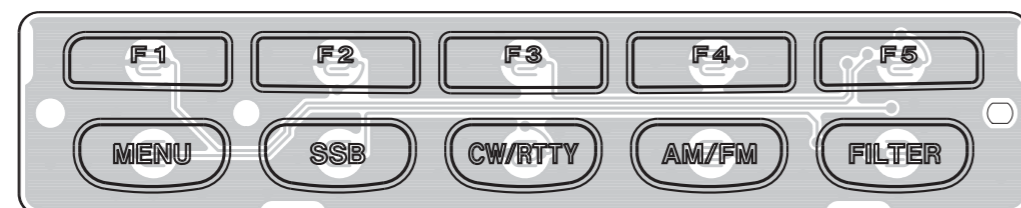

• DRV BOARD (BOTTOM VIEW)

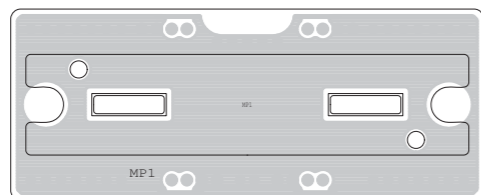

• DISPLAY BOARD (BOTTOM VIEW)

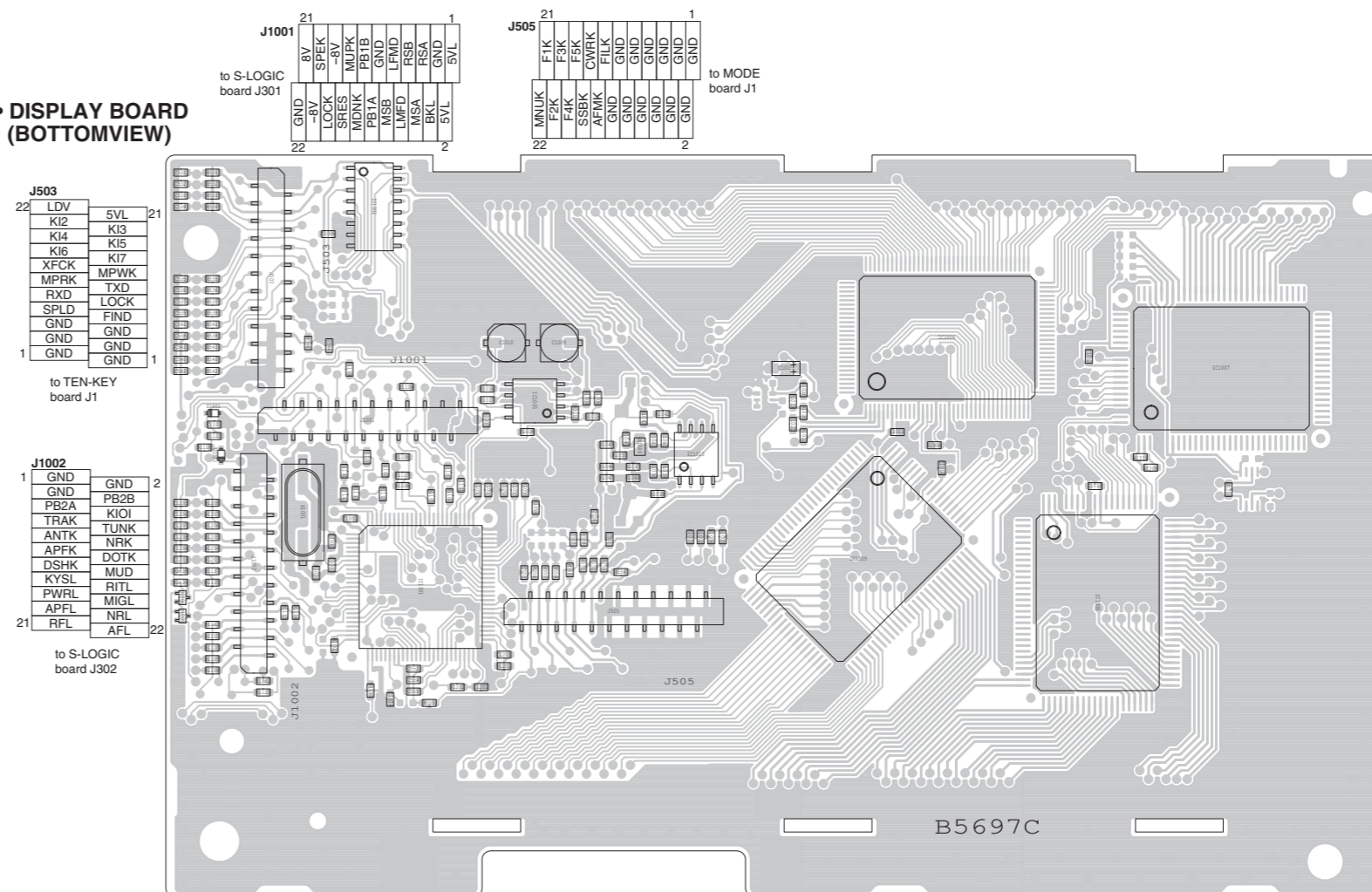

• TEN-KEY BOARD (BOTTOM VIEW)

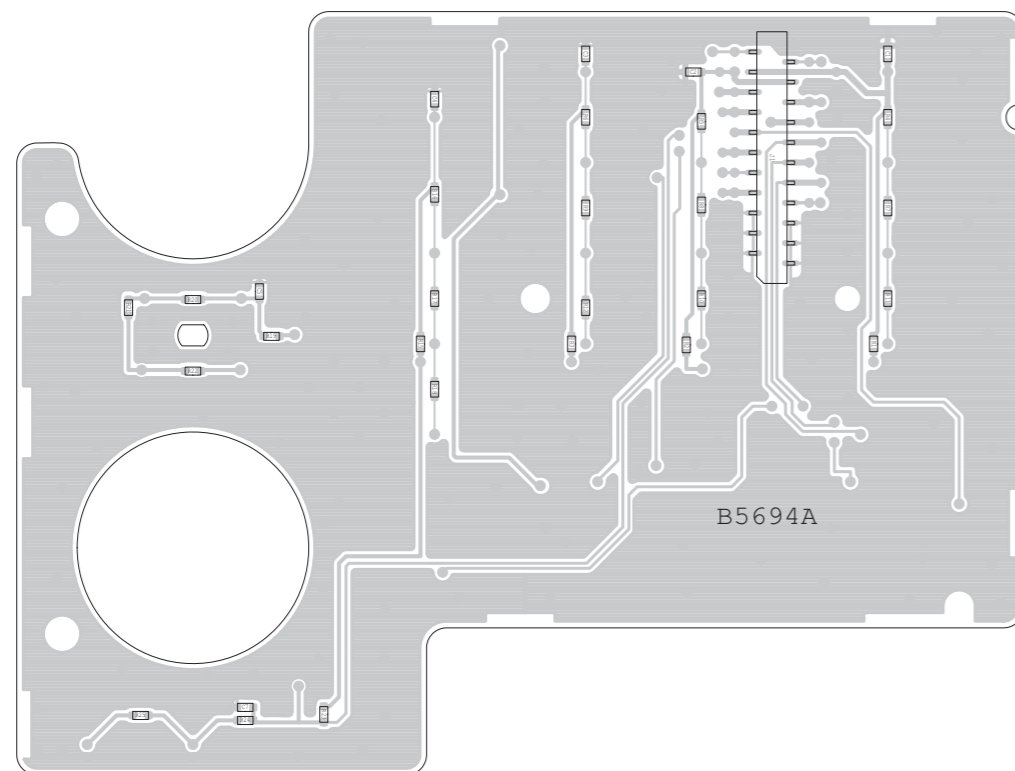

J1		to DISPLAY board J503	
1	LDV	2	5V
	K12		K13
	K14		K15
	K16		K17
	XFCK		MPWK
	MPRK		TXD
	RXD		LOCK
	SPLD		FIND
	GND		GND
	GND		GND
21	GND	22	GND

• MODE BOARD (BOTTOM VIEW)

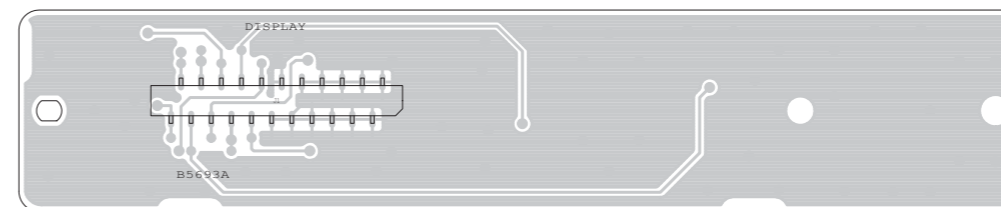

J1		to DISPLAY board J505	
1	MNUK	2	F1K
	F2K		F3K
	F4K		F5K
	SSBK		CWRK
	AFWK		FLK
	GND		GND
	GND		GND
	GND		GND
	GND		GND
	GND		GND
	GND		GND
	GND		GND
21	GND	22	GND

• MAIN UNIT  
(TOP VIEW)

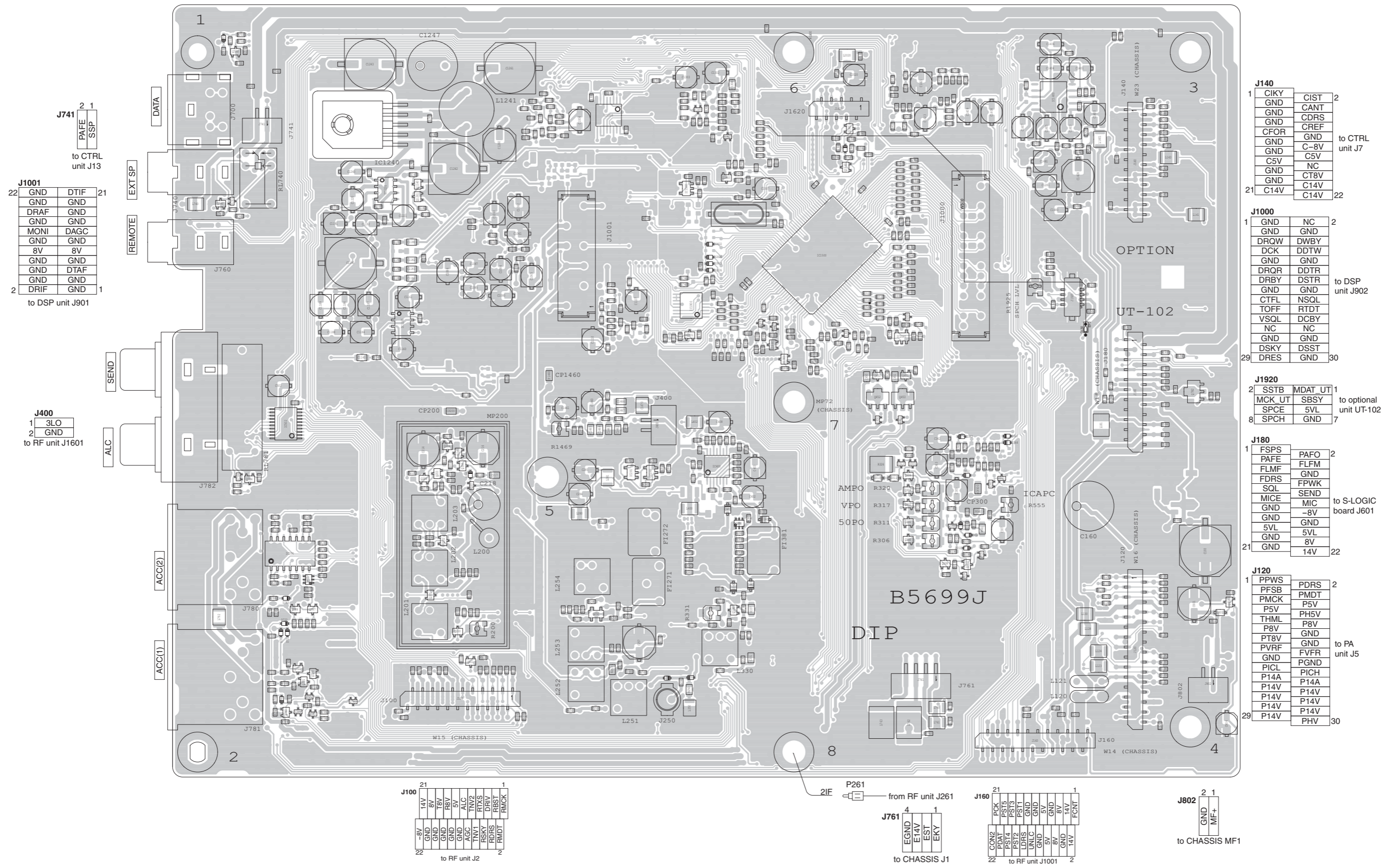

**J741**

2	PAFE	1
1	SSP	

to CTRL unit J13

**J1001**

22	GND	DTIF	21
	GND	GND	
	DRAF	GND	
	GND	GND	
	MONI	DAGC	
	GND	GND	
	8V	8V	
	GND	GND	
	GND	DTAF	
	GND	GND	
2	DRIF	GND	1

to DSP unit J901

**J400**

1	3LO	
2	GND	

to RF unit J1601

**J140**

1	CIKY	CIST	2
	GND	CANT	
	GND	CDRS	
	GND	CREF	
	CFOR	GND	
	GND	C-8V	
	GND	C5V	
	CSV	NC	
	GND	CT8V	
	GND	C14V	
21	C14V	C14V	22
		C14V	

to CTRL unit J7

**J1000**

1	GND	NC	2
	GND	GND	
	DRQW	DWBY	
	DCK	DDTW	
	GND	GND	
	DRQR	DDTR	
	DRBY	DSTR	
	GND	GND	
	CTFL	NSQL	
	TOFF	RTDT	
	VSQI	DCBY	
	NC	NC	
	GND	GND	
	DSKY	DSST	
29	DRES	GND	30

to DSP unit J902

**J1920**

2	SSTB	MDAT	UT	1
	MCK	UT	SBSY	
	SPCE	5VL		
8	SPCH	GND		7

to optional unit UT-102

**J180**

1	FSPS	PAFO	2
	PAFE	FLFM	
	FLMF	GND	
	FDRS	FPWK	
	SQL	SEND	
	MICE	MIC	
	GND	-8V	
	GND	GND	
	5VL	5VL	
	GND	8V	
21	GND	14V	22

to S-LOGIC board J601

**J120**

1	PPWS	PDRS	2
	PFSB	PMDT	
	PMCK	P5V	
	P5V	PH5V	
	THML	P8V	
	P8V	GND	
	PT8V	GND	
	PVRF	FVFR	
	GND	PGND	
	PICL	PICH	
	P14A	P14A	
	P14V	P14V	
	P14V	P14V	
	P14V	P14V	
29	P14V	PHV	30

to PA unit J5

**J100**

21	14V		1
	8V		
	GND	T8V	
	GND	FBV	
	GND	5V	
	GND	ALC	
	GND	AGC	
	TW1	TW2	
	R1AS	R1AS	
	RDRS	RDRS	
	RBSV	RBSV	
	RMDT	RMDT	
	FMCK	FMCK	
2			2

to RF unit J2

**J761**

4	EGND	1
	E14V	
	EST	
	EKY	

to CHASSIS J1

**J160**

21	PCK		1
	PDAT		
	PS15		
	PS14		
	PS13		
	PS12		
	PS11		
	LDRS	GND	
	UNLC	GND	
	GND	5V	
	5V	GND	
	8V	GND	
	GND	14V	
	GND	14V	
22		FCNT	2

to RF unit J1001

**J802**

2	GND	1
	MF+	

to CHASSIS MF1



• MAIN UNIT  
(BOT VIEW)

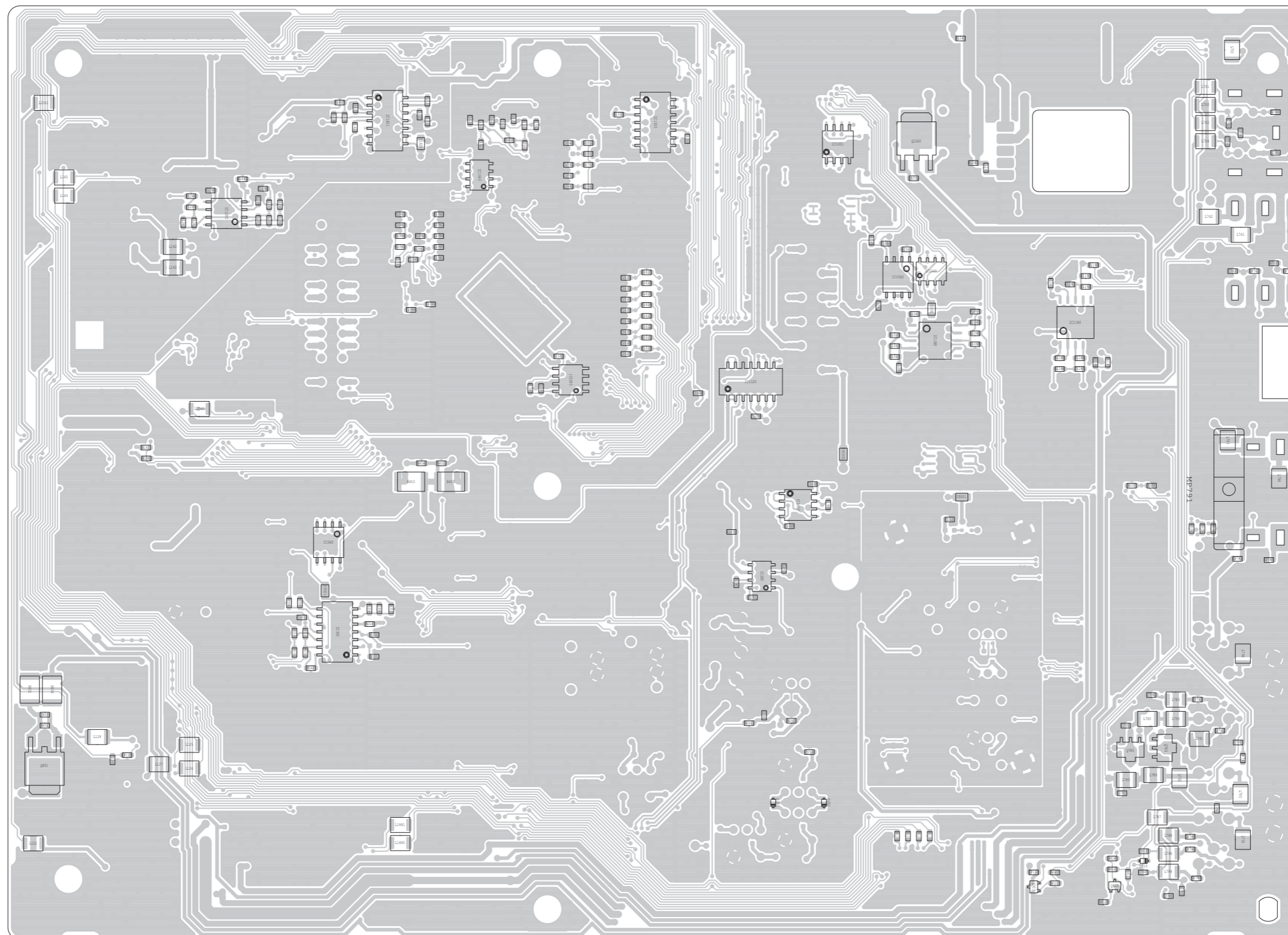

• CTRL UNIT (TOP VIEW)

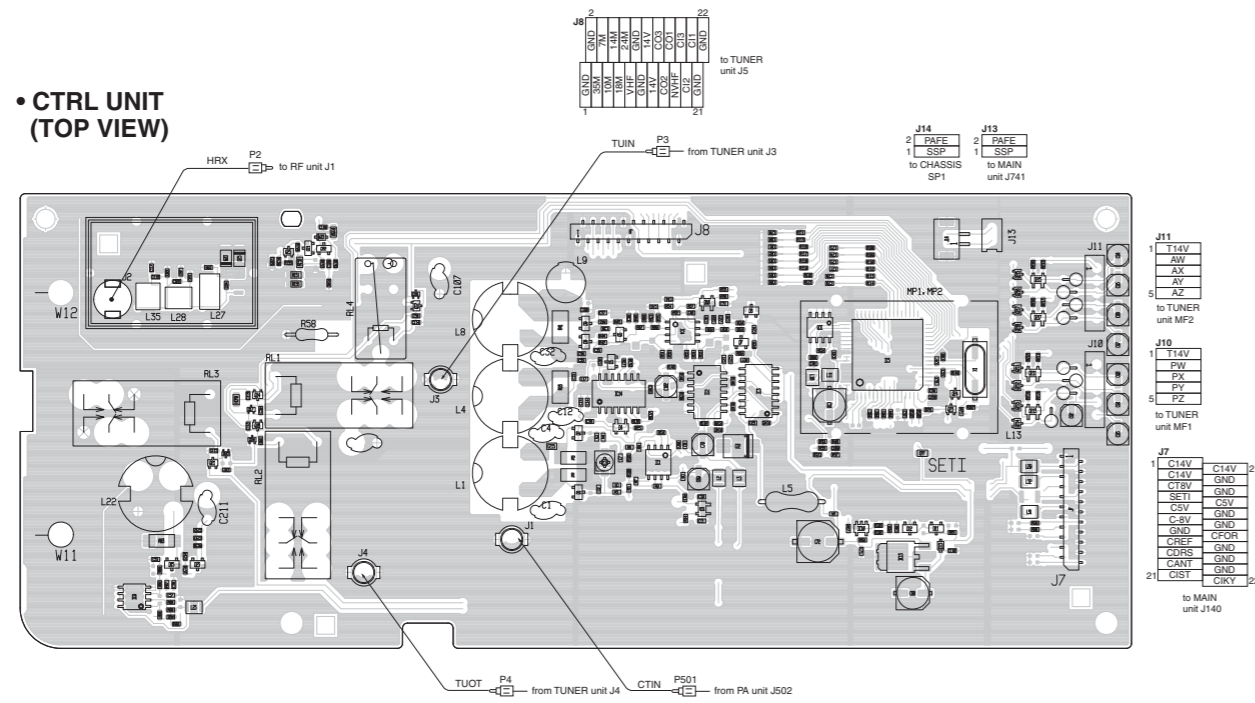

• TUNER UNIT (TOP VIEW)

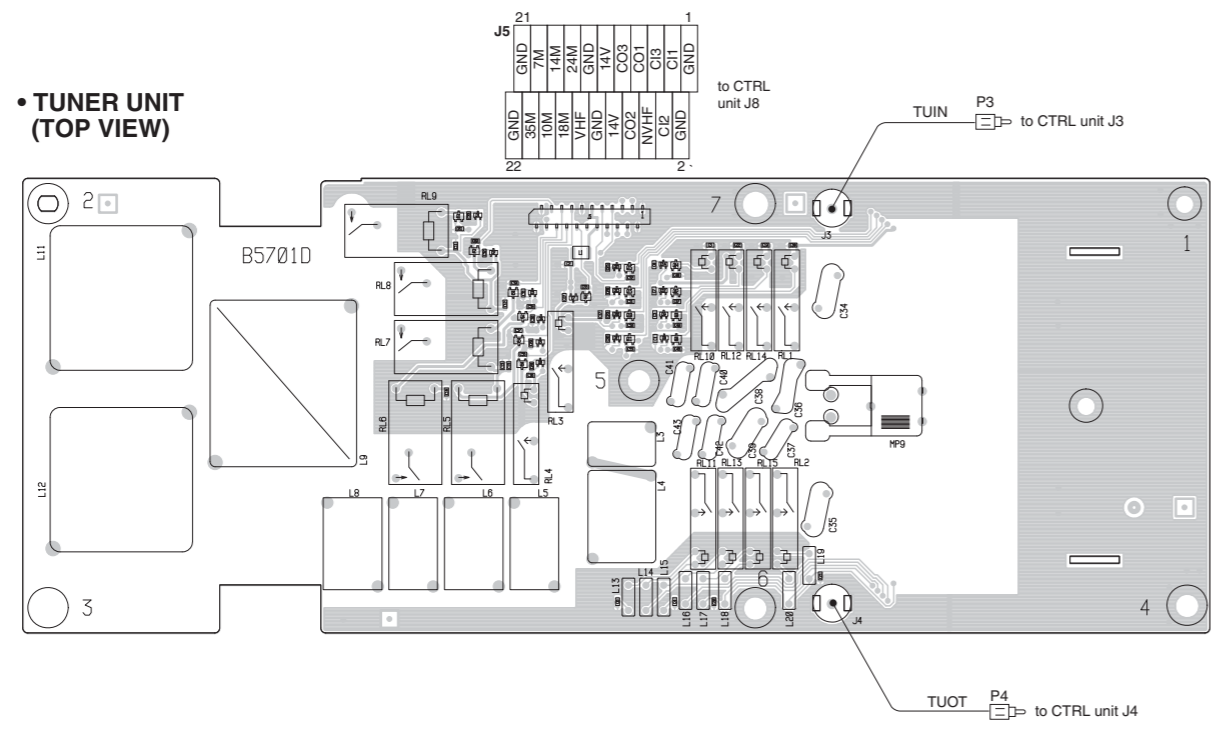

• FILTER BOARD (TOP VIEW)

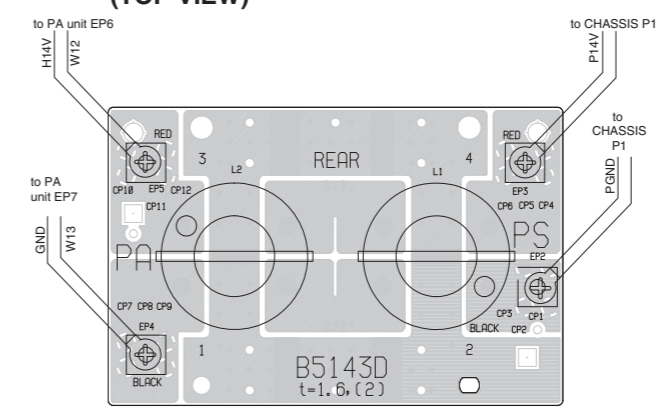

• PHONE BOARD (TOP VIEW)

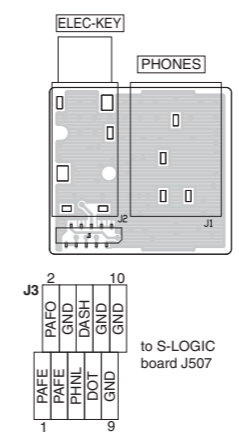

• PBT BOARD (TOP VIEW)

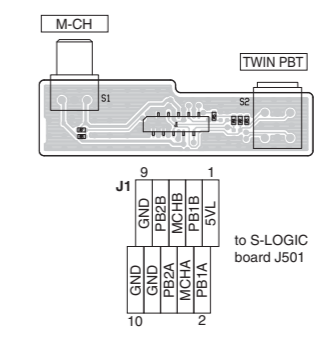

• RIT BOARD (TOP VIEW)

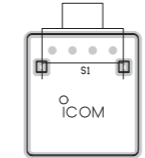

• MIC BOARD (TOP VIEW)

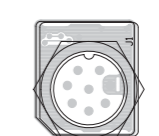

• FILTER BOARD  
(BOTTOM VIEW)

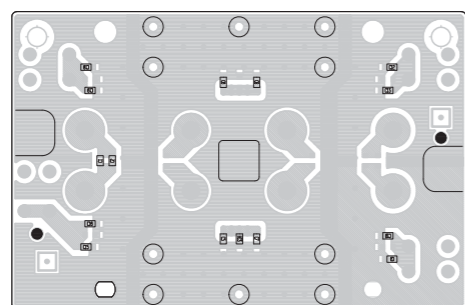

• CTRL UNIT  
(BOTTOM VIEW)

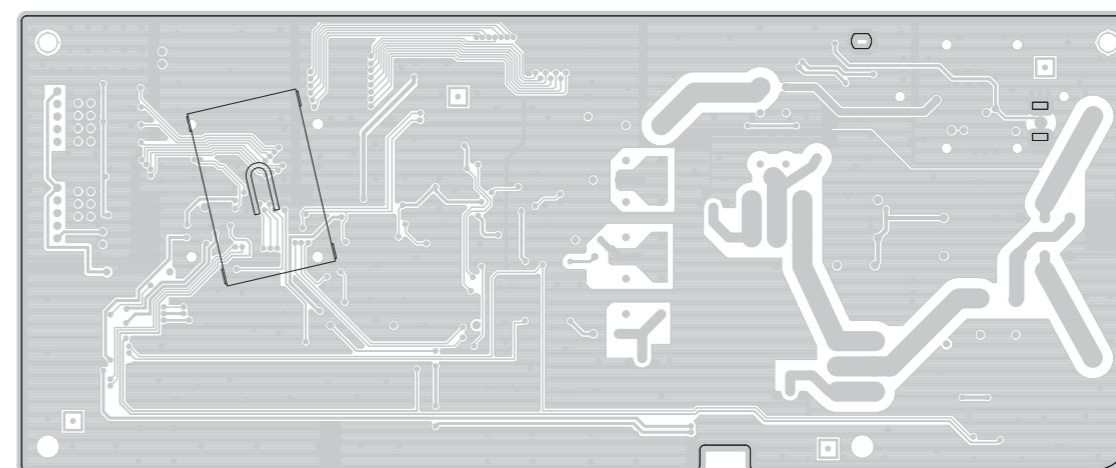

• PBT BOARD  
(BOTTOM VIEW)



• PHONE BOARD  
(BOTTOM VIEW)



• TUNER UNIT  
(BOTTOM VIEW)

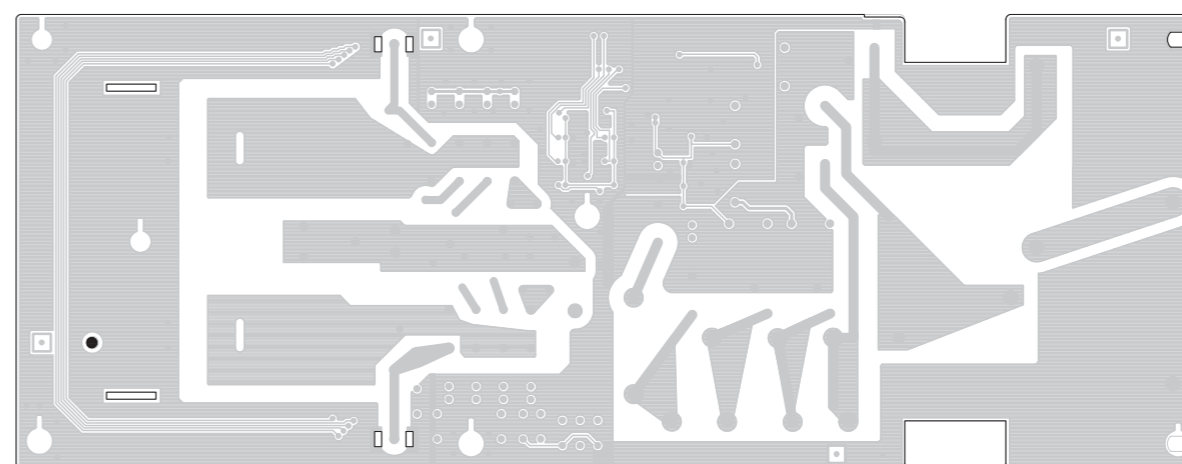

• MIC BOARD  
(BOTTOM VIEW)

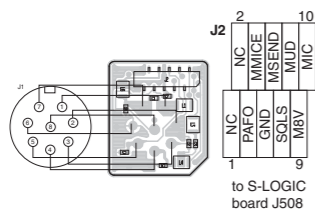

• RIT BOARD  
(BOTTOM VIEW)

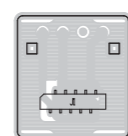

# SECTION 10

# BLOCK DIAGRAM

## • BLOCK DIAGRAM (1/2)

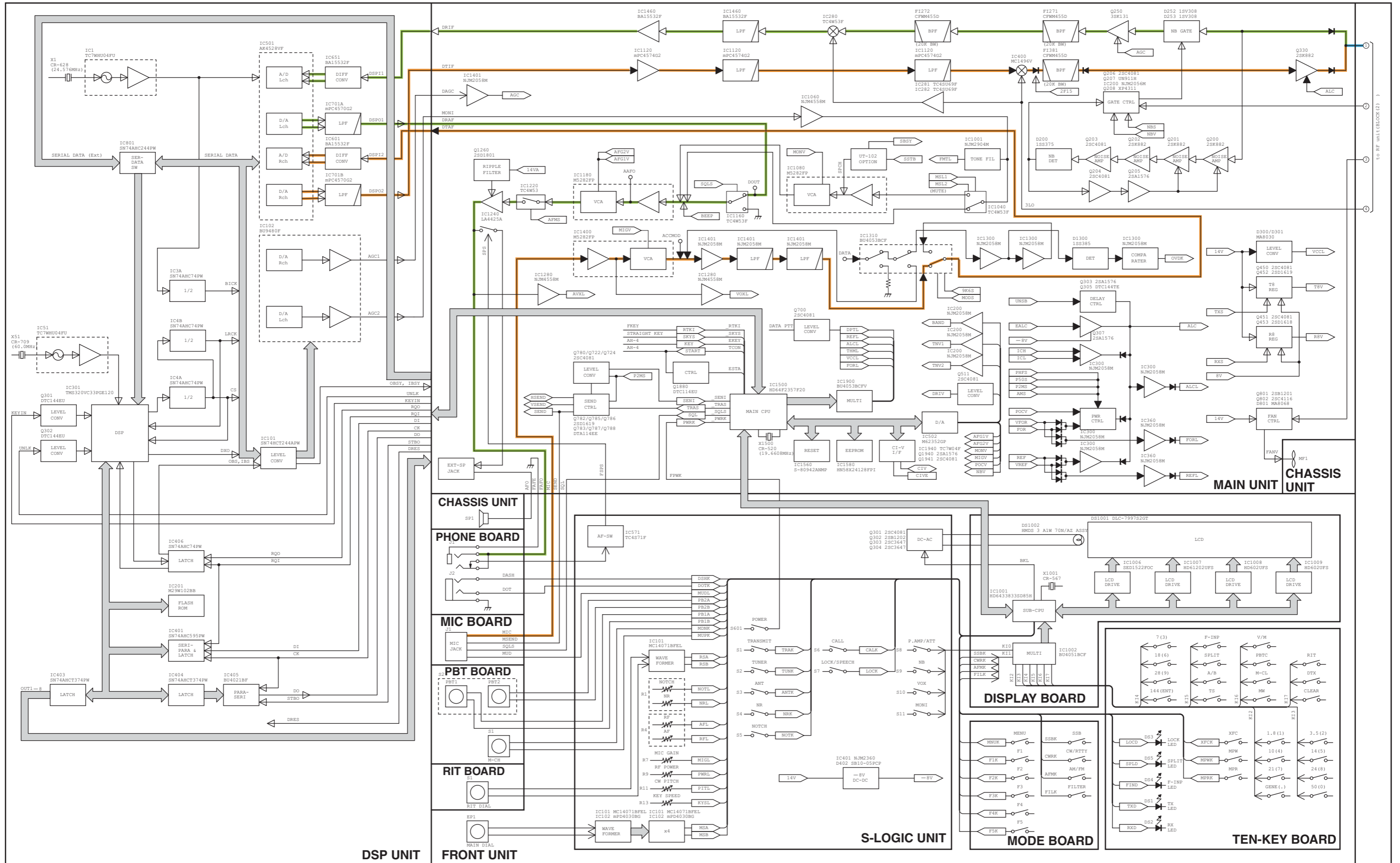

• BLOCK DIAGRAM (2/2)

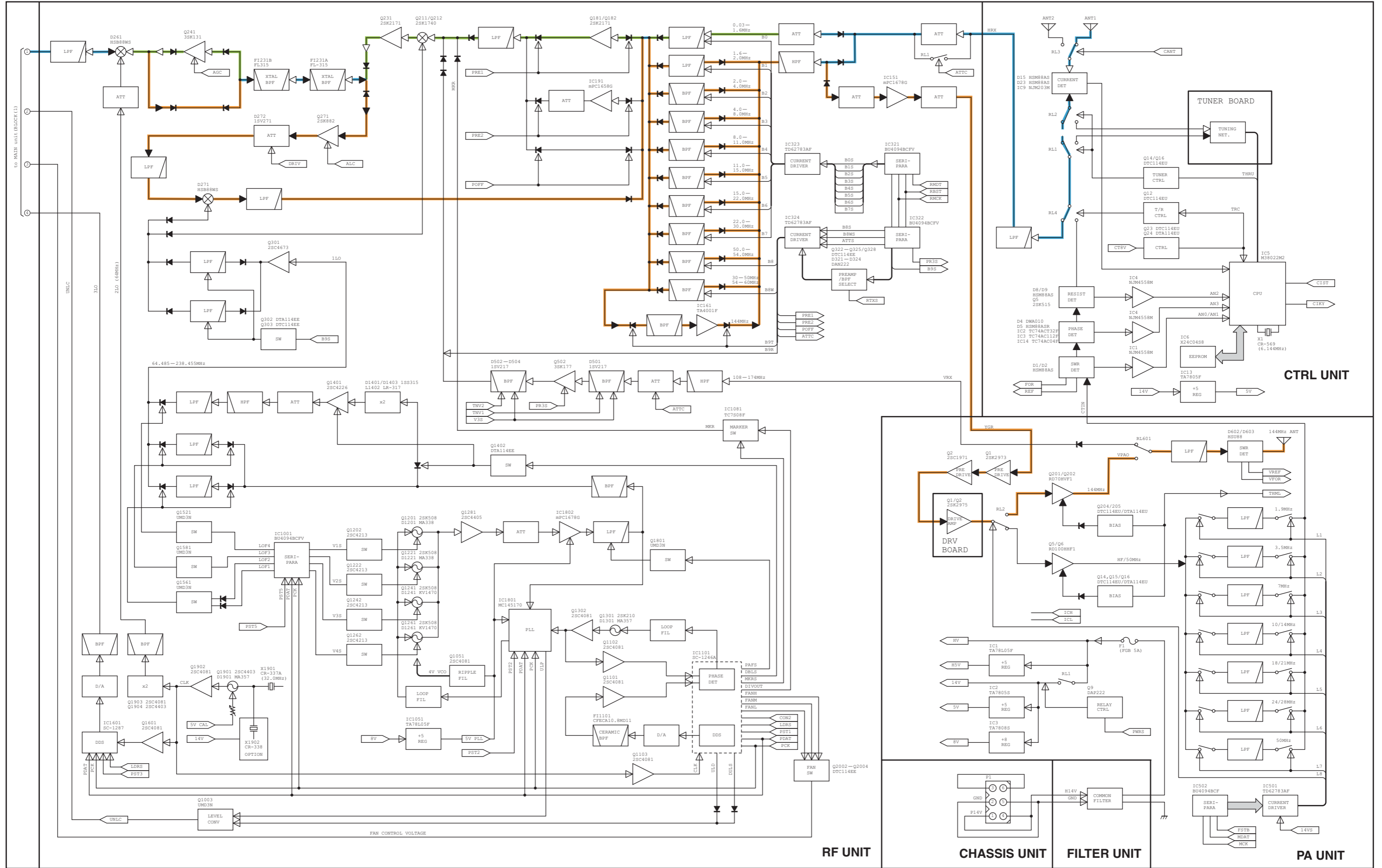

# SECTION 11

# GENERAL WIRING

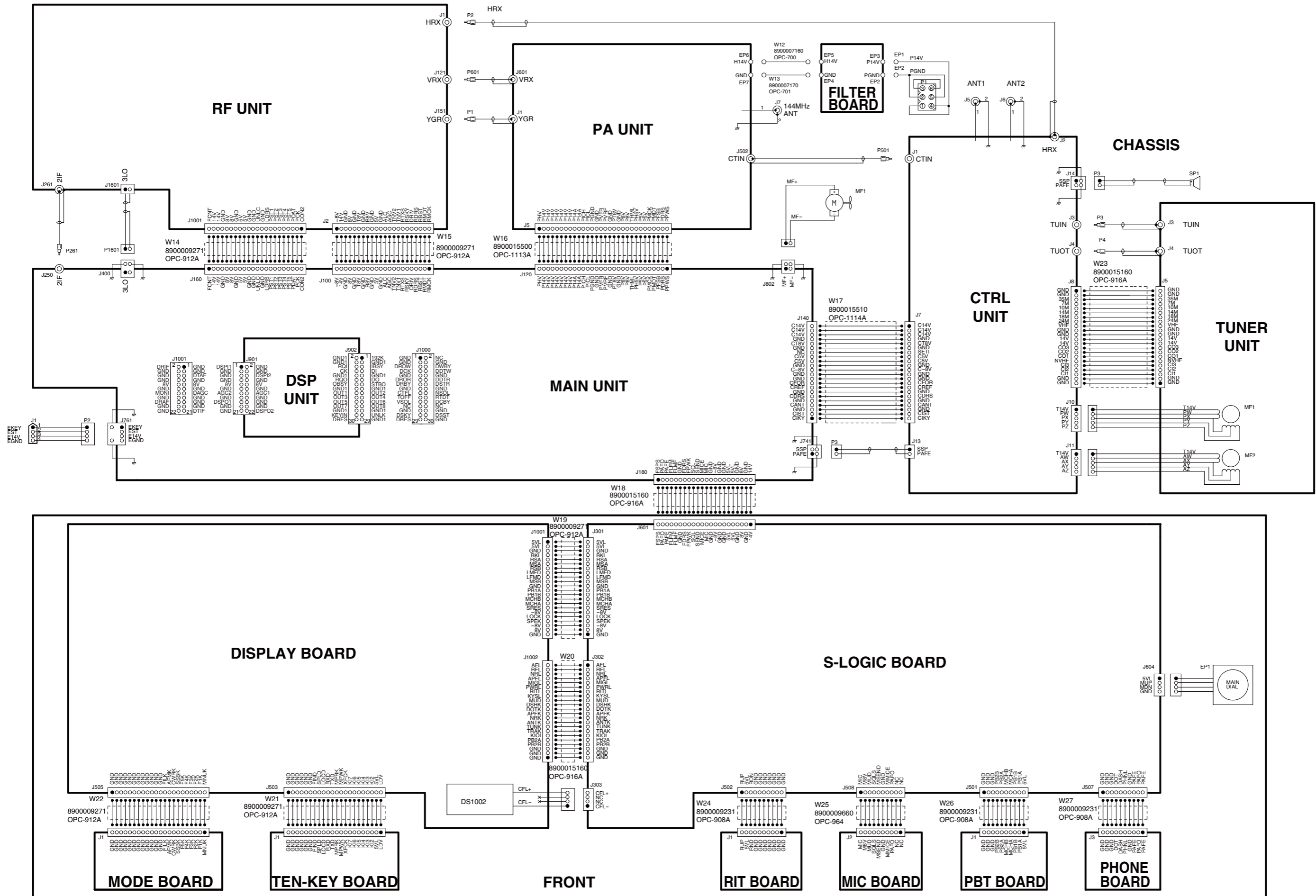

• FRONT UNIT (1/2)

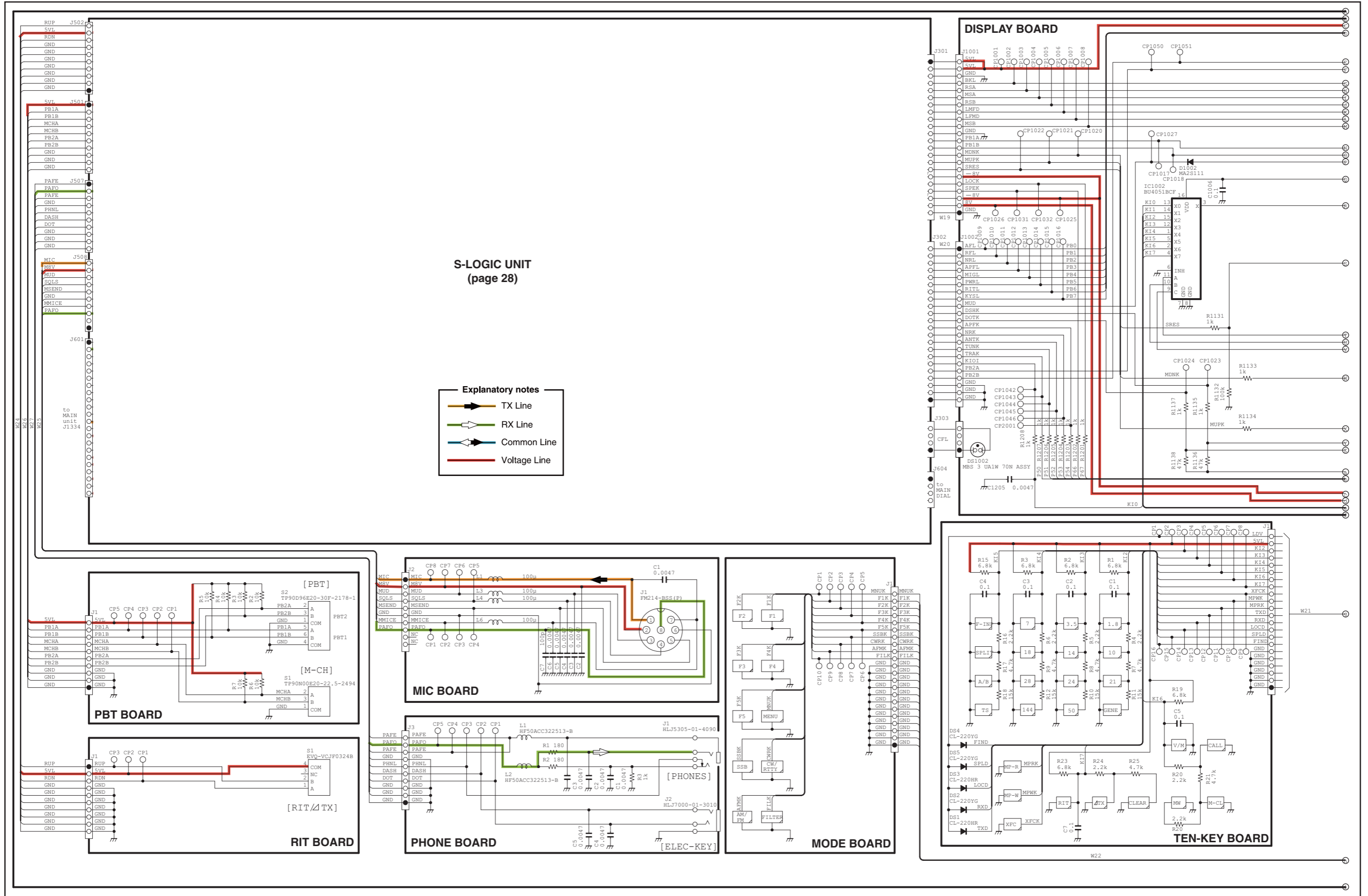

NOTICE: Refer to the PARTS LIST for the value and name of each component.

• FRONT UNIT (2/2)

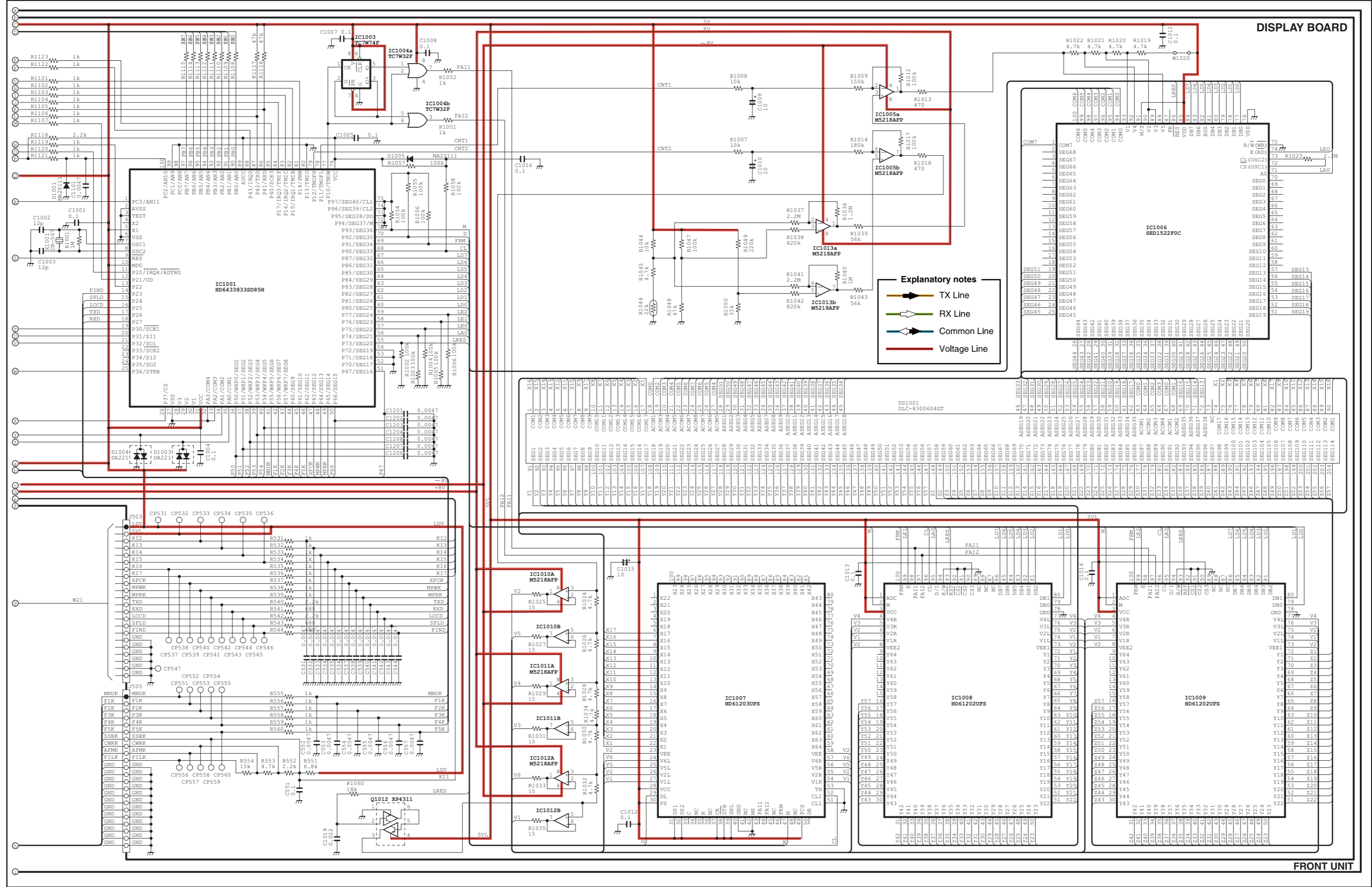

NOTICE: Refer to the PARTS LIST for the value and name of each component.



• S-LOGIC UNIT

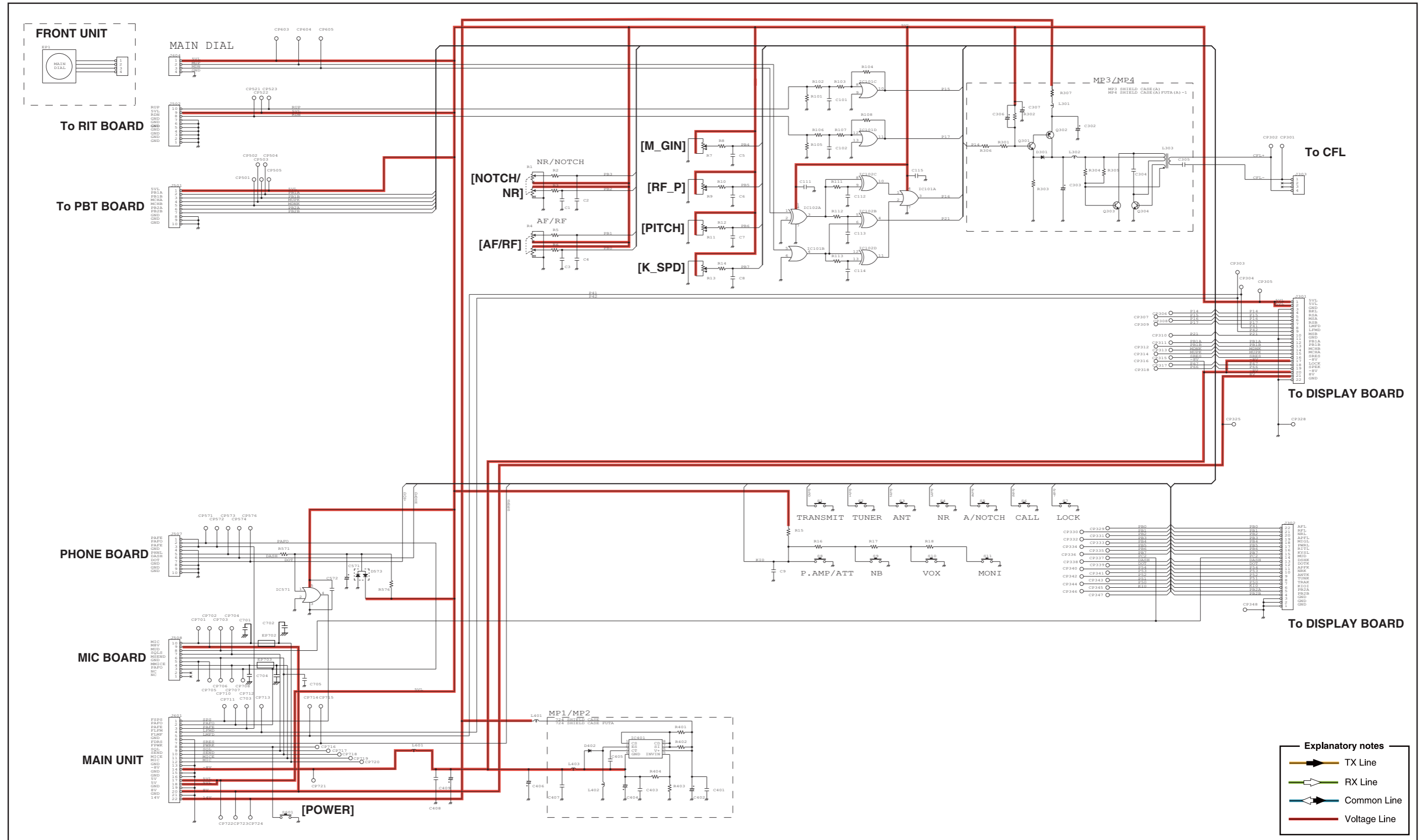

NOTICE: Refer to the PARTS LIST for the value and name of each component.

• MAIN UNIT (1/3)

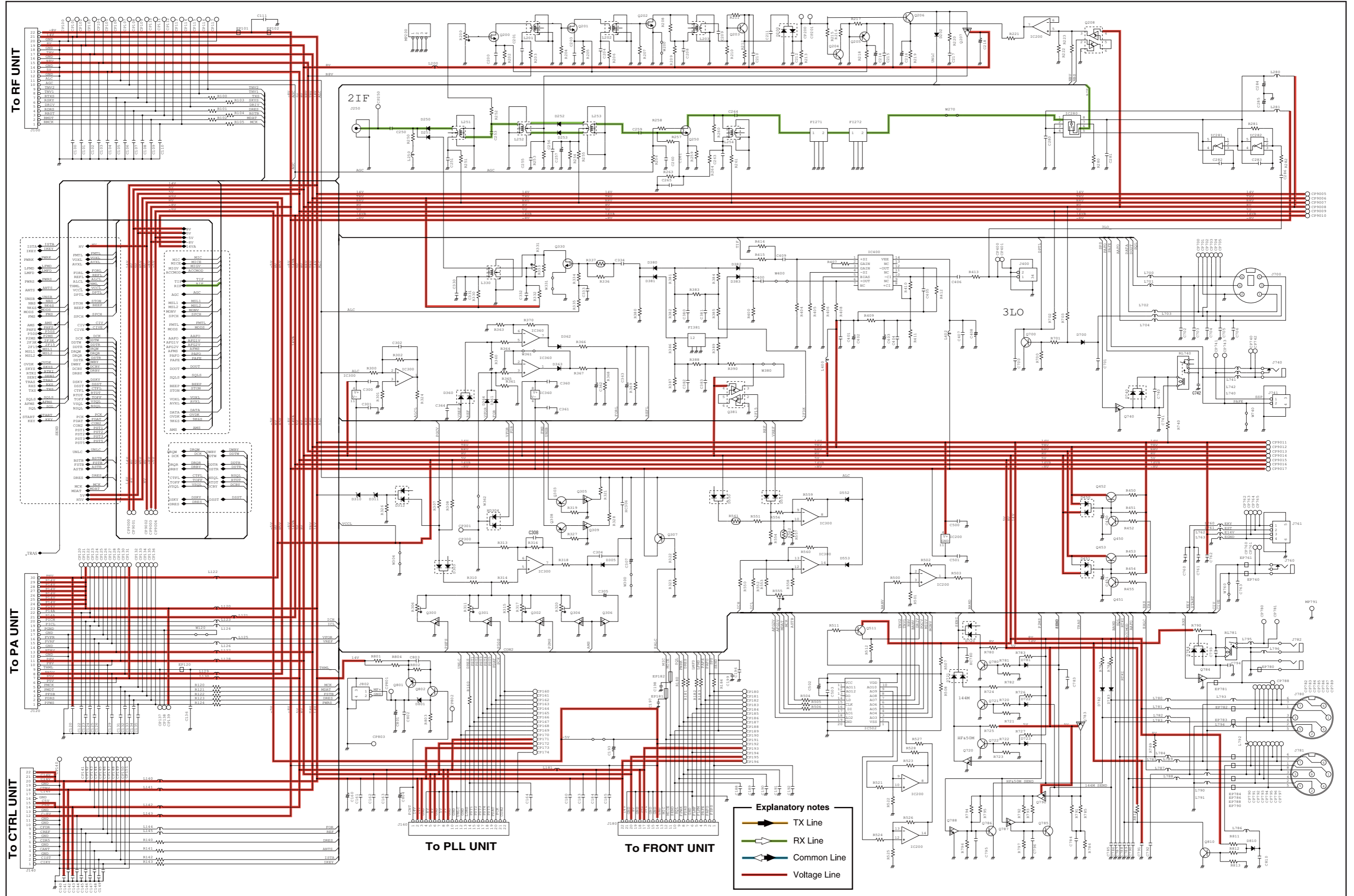

NOTICE: Refer to the PARTS LIST for the value and name of each component.

• MAIN UNIT (2/3)

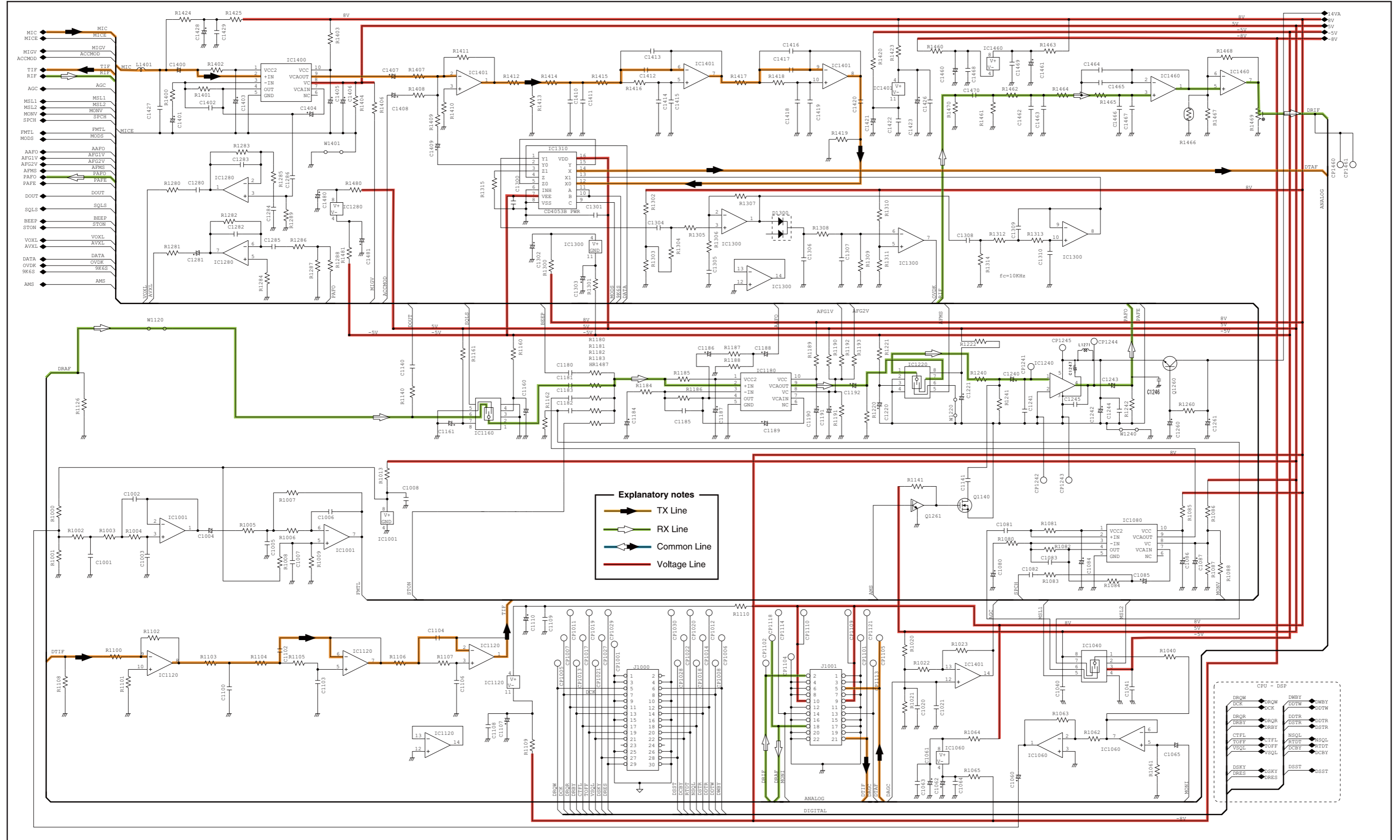

NOTICE: Refer to the PARTS LIST for the value and name of each component.

• MAIN UNIT (3/3)

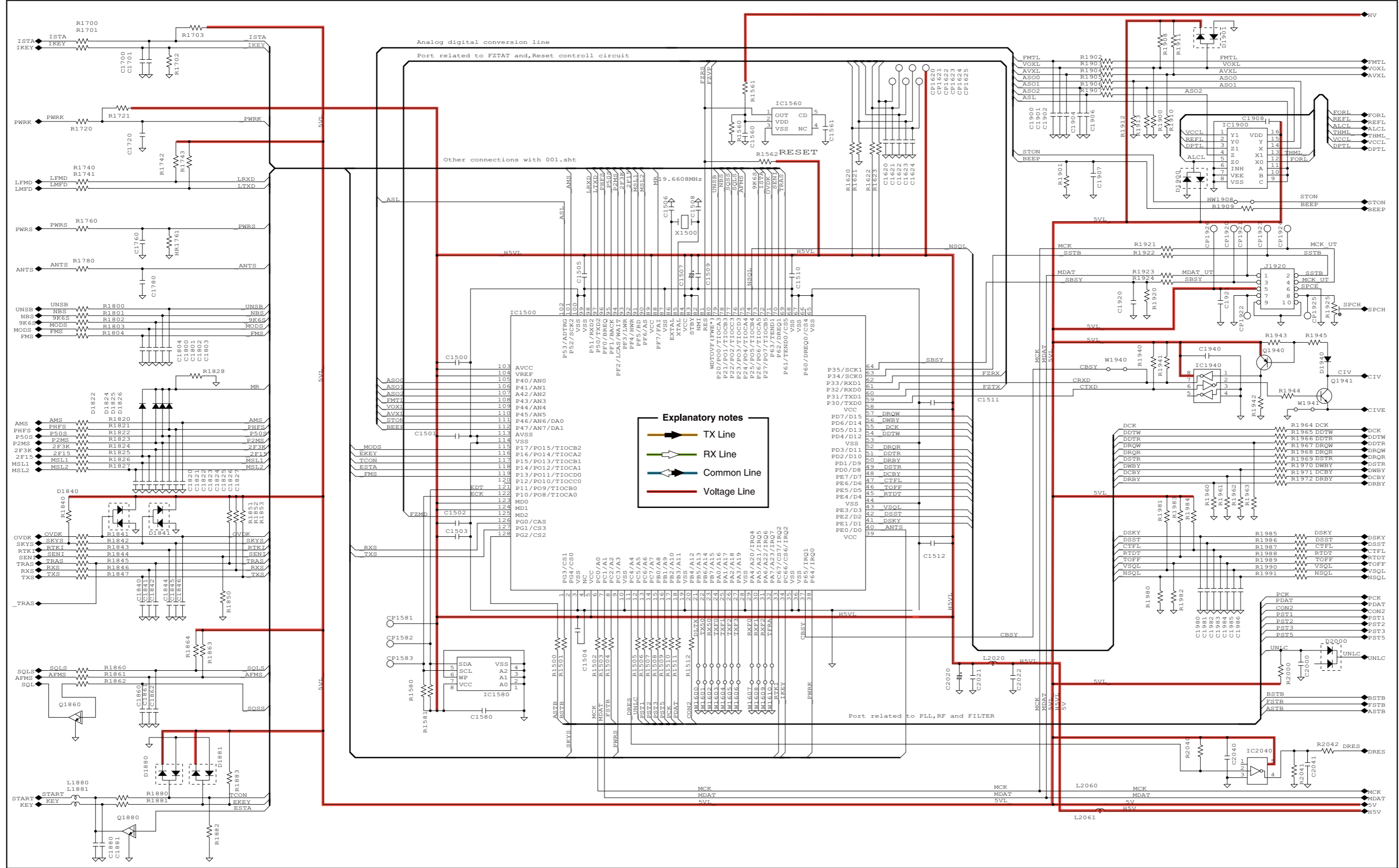

NOTICE: Refer to the PARTS LIST for the value and name of each component.

• RF UNIT (1/2)

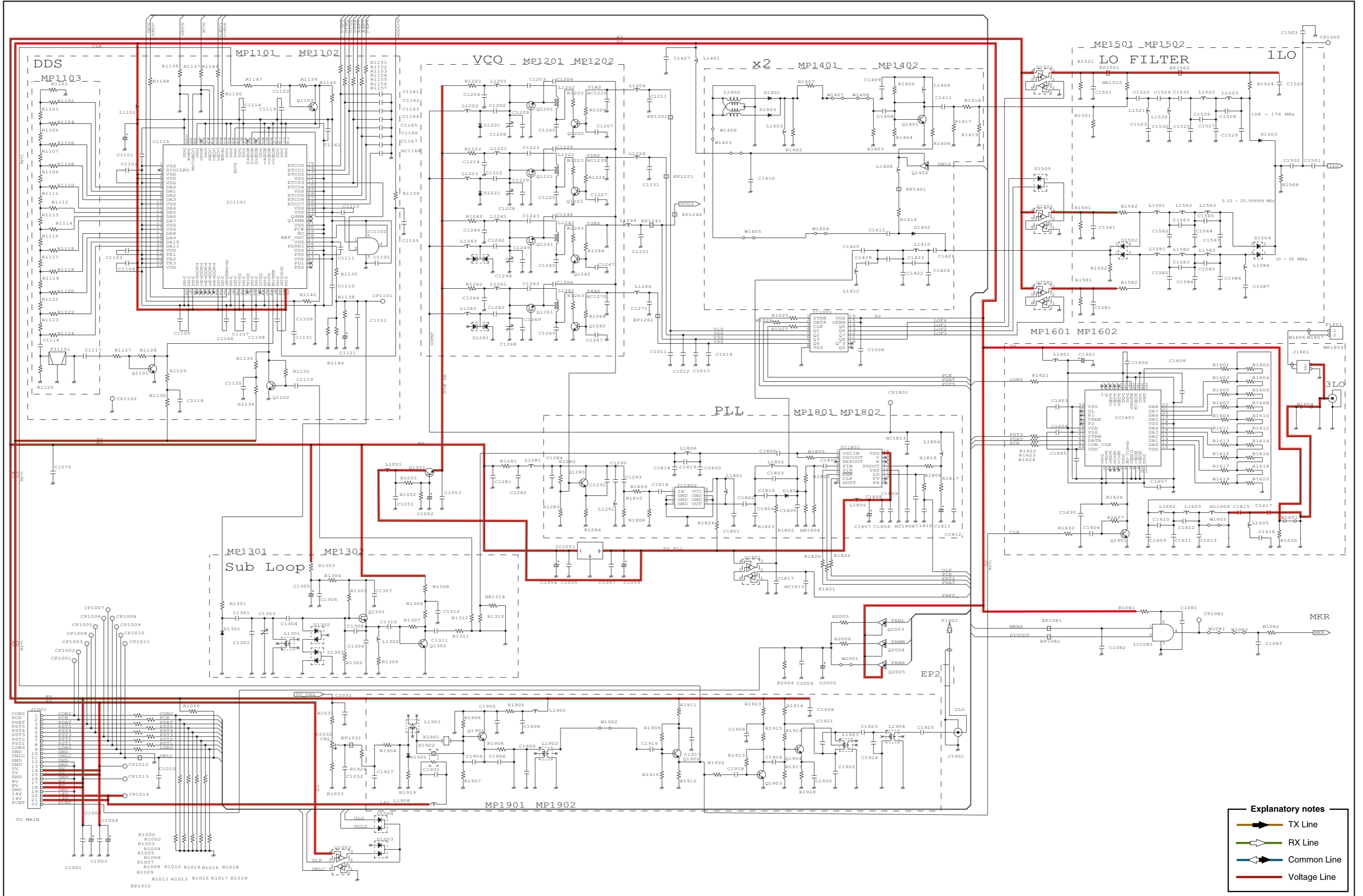

NOTICE: Refer to the PARTS LIST for the value and name of each component.

• RF UNIT (2/2)

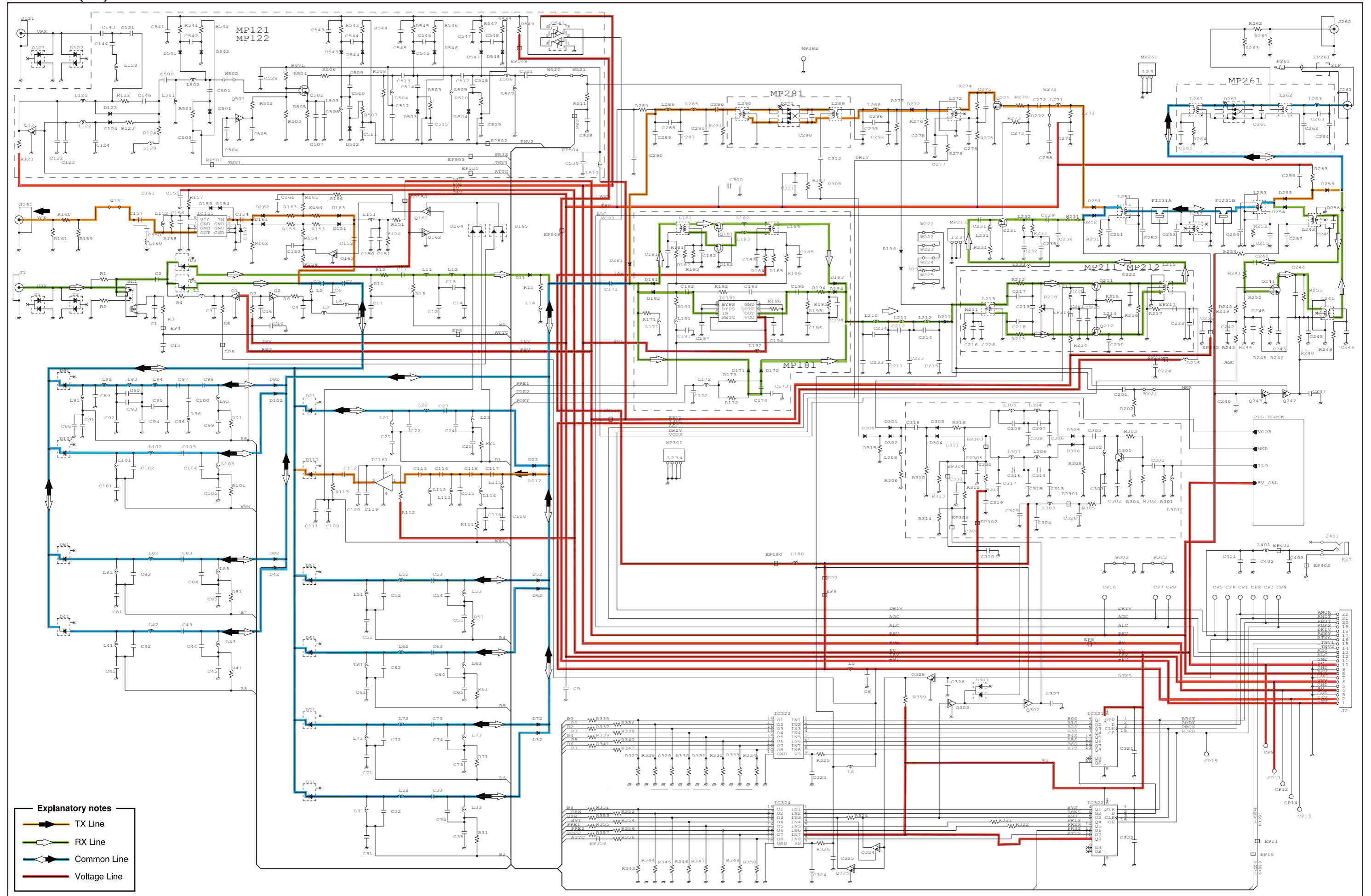

NOTICE: Refer to the PARTS LIST for the value and name of each component.

• CTRL UNIT

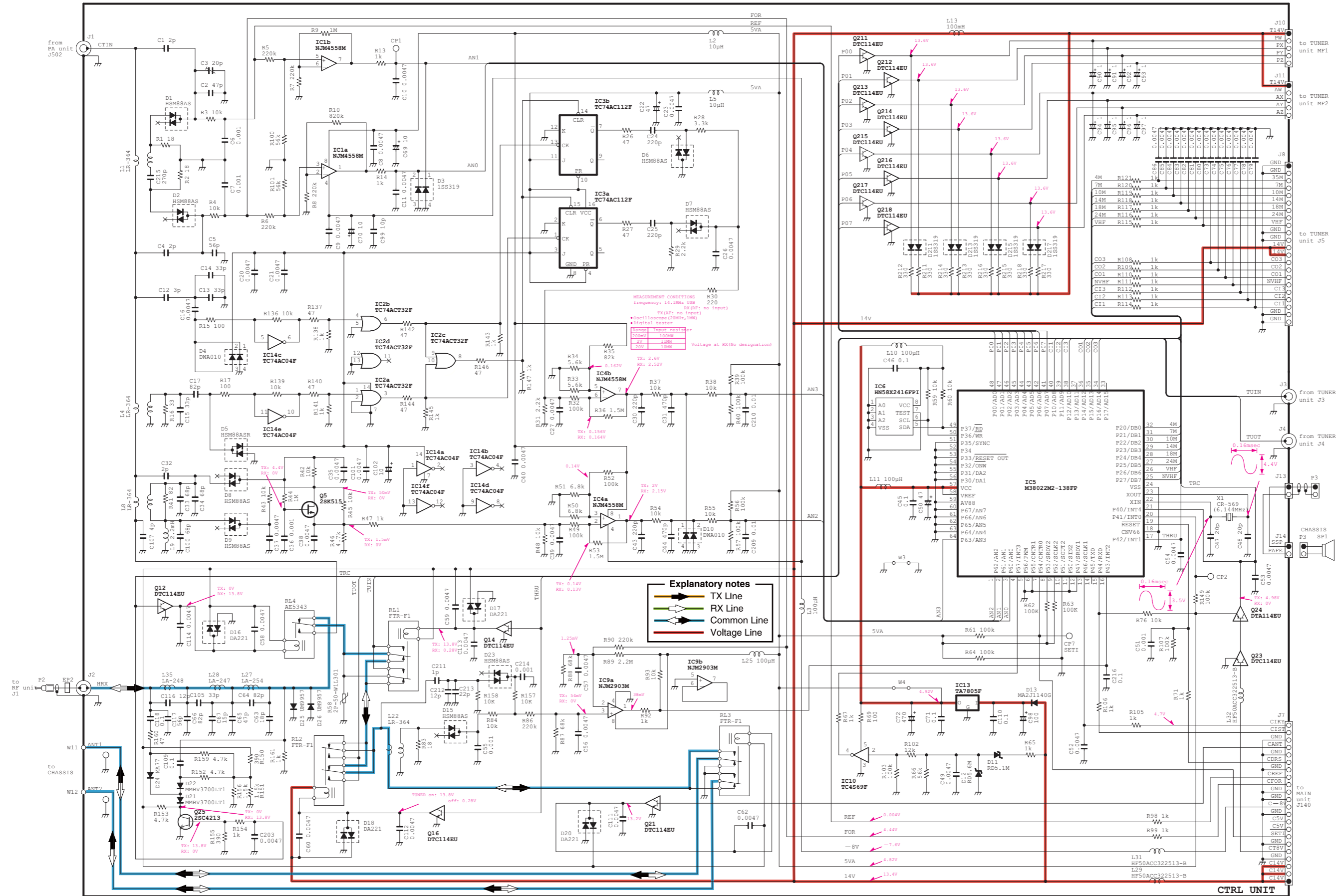

NOTICE: Refer to the PARTS LIST for the value and name of each component.

• TUNER UNIT

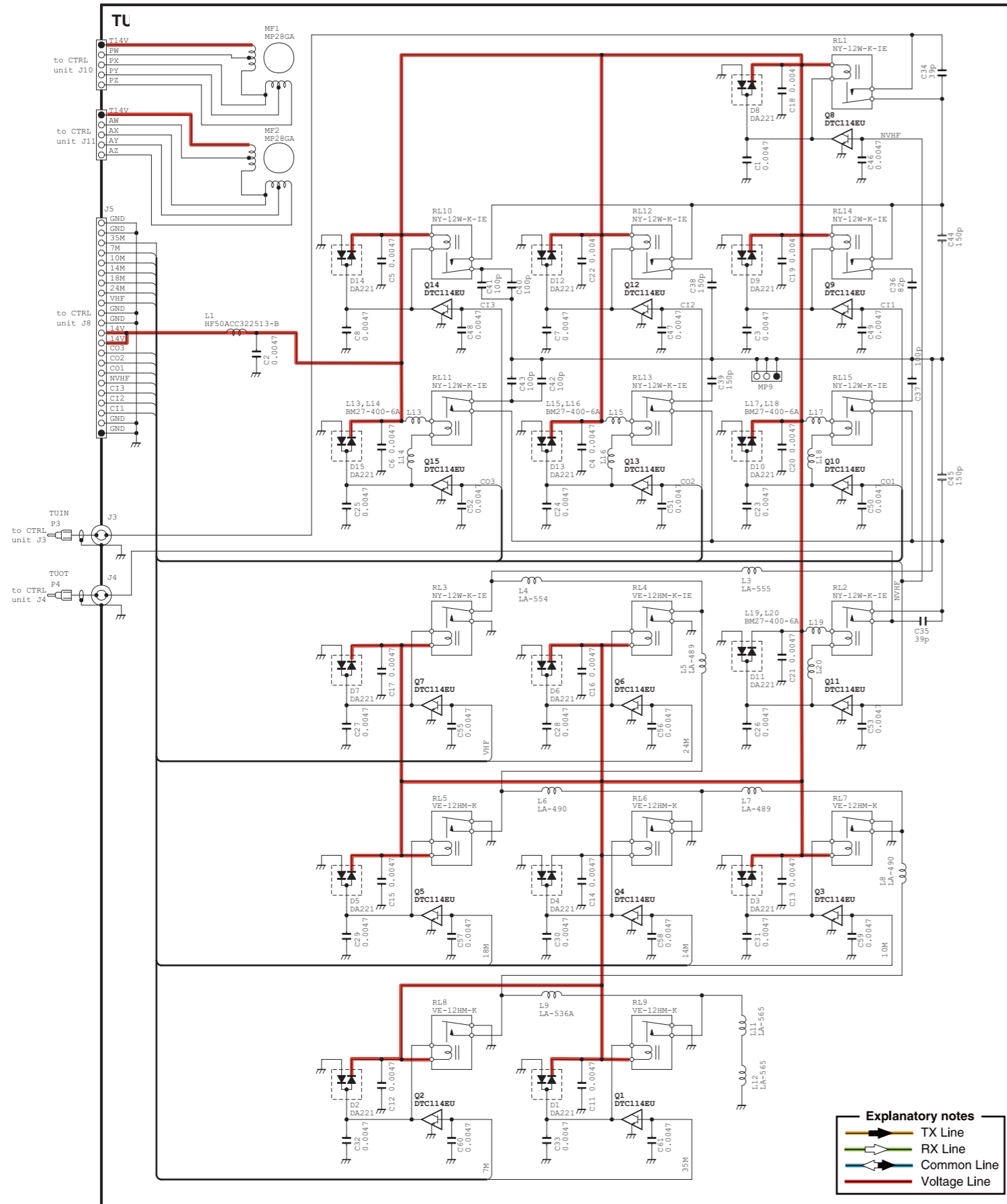

NOTICE: Refer to the PARTS LIST for the value and name of each component.



• PA UNIT (1/2)

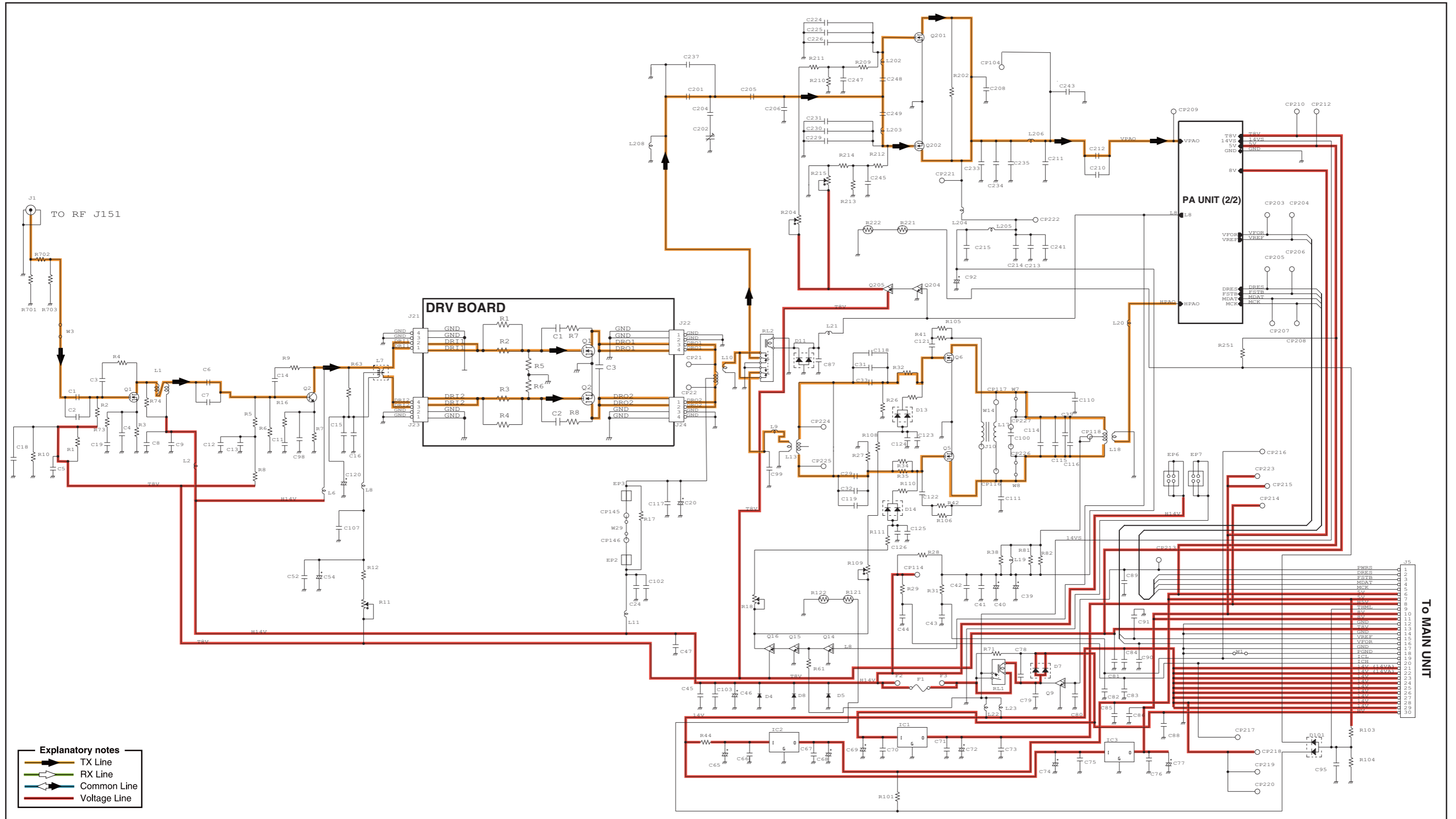

NOTICE: Refer to the PARTS LIST for the value and name of each component.

• PA UNIT (2/2)

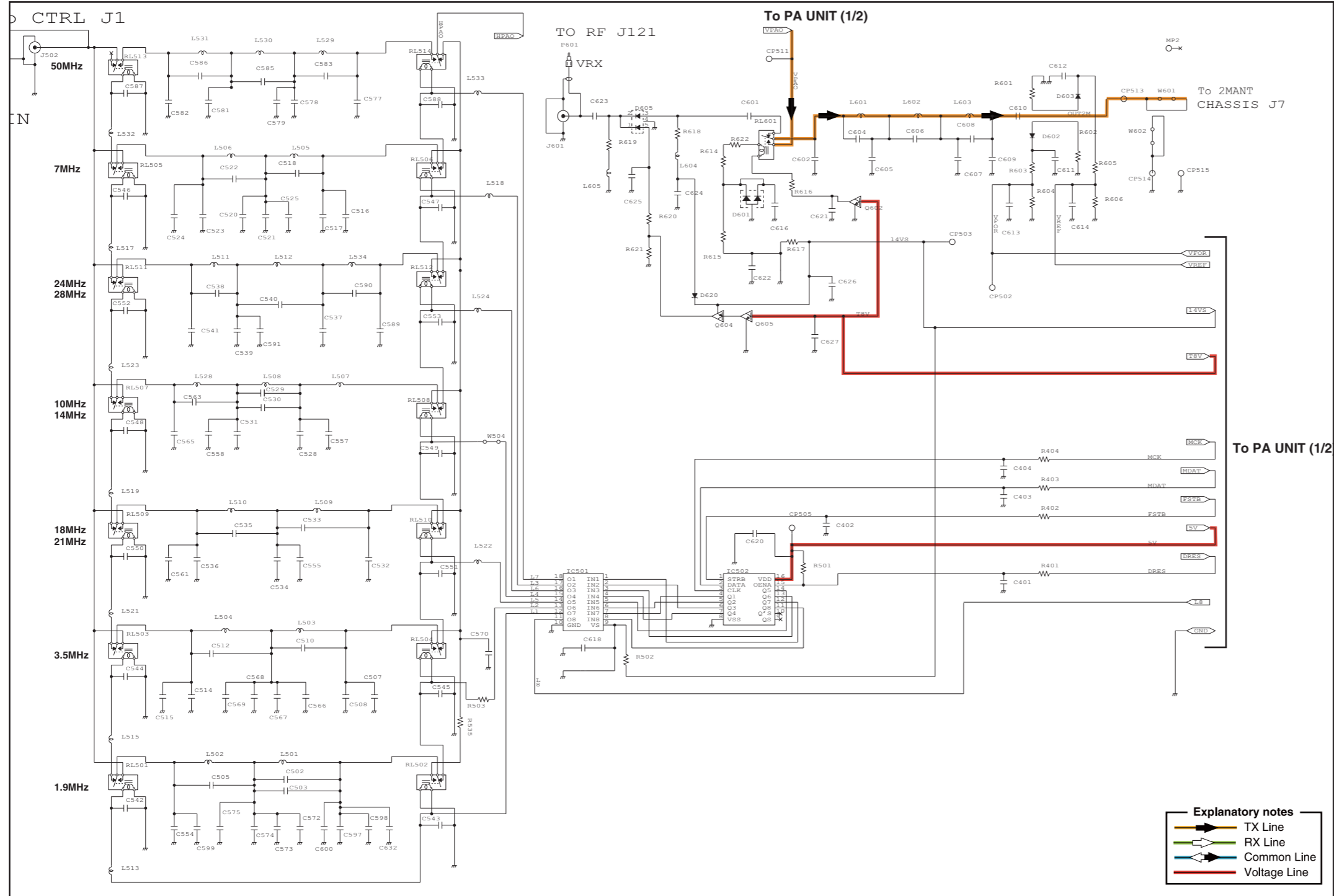

NOTICE: Refer to the PARTS LIST for the value and name of each component.

## Icom Inc.

1-1-32, Kamiminami, Hirano-ku, Osaka 547-0003, Japan  
Phone : +81 (06) 6793 5302  
Fax : +81 (06) 6793 0013  
URL : <http://www.icom.co.jp/world/index.html>

### Icom America Inc.

<Corporate Headquarters>  
2380 116th Avenue N.E., Bellevue, WA 98004, U.S.A.  
Phone : +1 (425) 454-8155 Fax : +1 (425) 454-1509  
URL : <http://www.icomamerica.com>  
E-mail : [sales@icomamerica.com](mailto:sales@icomamerica.com)  
<Customer Service>  
Phone : +1 (425) 454-7619

### Icom Canada

Glenwood Centre #150-6165  
Highway 17 Delta, B.C., V4K 5B8, Canada  
Phone : +1 (604) 952-4266 Fax : +1 (604) 952-0090  
URL : <http://www.icomcanada.com>  
E-mail : [info@icomcanada.com](mailto:info@icomcanada.com)

### Icom (Australia) Pty. Ltd.

Unit 1 / 103 Garden Road, Clayton VIC 3168 Australia  
Phone : +61 (03) 9549-7500 Fax : +61 (03) 9549-7505  
URL : <http://www.icom.net.au>  
E-mail : [sales@icom.net.au](mailto:sales@icom.net.au)

### Icom New Zealand

146A Harris Road, East Tamaki,  
Auckland, New Zealand  
Phone : +64 (09) 274 4062 Fax : +64 (09) 274 4708  
URL : <http://www.icom.co.nz>  
E-mail : [inquiries@icom.co.nz](mailto:inquiries@icom.co.nz)

### Beijing Icom Ltd.

10C07, Long silver Mansion, No.88, Yong Ding  
Road, Haidian District, Beijing, 100039, China  
Phone : +86 (010) 5889 5391/5392/5393  
Fax : +86 (010) 5889 5395  
E-mail : [bjicom@bjicom.com](mailto:bjicom@bjicom.com)  
URL : <http://www.bjicom.com>

### Icom (Europe) GmbH

Communication Equipment  
Auf der Krautweide 24  
65812 Bad Soden am Taunus, Germany  
Phone : +49 (6196) 76685-0 Fax : +49 (6196) 76685-50  
URL : <http://www.icomeurope.com>  
E-mail : [info@icomeurope.com](mailto:info@icomeurope.com)

### Icom Spain S.L

Ctra. Rubi, No. 88 Bajos A 08174, Sant Cugat del Valles, Barcelona, Spain  
Phone : +34 (93) 590 26 70 Fax : +34 (93) 589 04 46  
URL : <http://www.icomspain.com>  
E-mail : [icom@icomspain.com](mailto:icom@icomspain.com)

### Icom (UK) Ltd.

Unit 9, Sea St., Herne Bay, Kent, CT6 8LD, U.K.  
Phone : +44 (01227) 741741 Fax : +44 (01227) 741742  
URL : <http://www.icomuk.co.uk>  
E-mail : [info@icomuk.co.uk](mailto:info@icomuk.co.uk)

### Icom France s.a.s.

Zac de la Plaine  
1 Rue Brindejonc des Moulinais BP 5804  
31505 Toulouse Cedex, France  
Phone : +33 (5) 61 36 03 03 Fax : +33 (5) 61 36 03 00  
URL : <http://www.icom-france.com>  
E-mail : [icom@icom-france.com](mailto:icom@icom-france.com)

### Asia Icom Inc.

6F No.68, Sec. 1 Cheng-Teh Road, Taipei, Taiwan, R.O.C.  
Phone : +886 (02) 2559 1899 Fax : +886 (02) 2559 1874  
URL : <http://www.asia-icom.com>  
E-mail : [sales@asia-icom.com](mailto:sales@asia-icom.com)

### Icom Polska

81-850 Sopot, ul. 3 Maja 54, Poland  
Phone : +48 (58) 550 7135 Fax : +48 (58) 551 0484  
E-mail : [icompolaska@icompolaska.com.pl](mailto:icompolaska@icompolaska.com.pl)

**Count on us!**

**Icom Inc.**

1-1-32, Kamiminami, Hirano-ku, Osaka 547-0003, Japan

S-14610XZ-C1  
© 2002–2009 Icom Inc.