



**DON  
LEA**

**DON LEA LUMBER LTD.**

INTERIOR DOORS • MOULDINGS • HARDWARE

Email: [info@donlealumber.com](mailto:info@donlealumber.com)

Tel: 905.428.0197

Fax: 905.428.0546

1062 Copperstone Drive,  
Pickering, Ontario L1W3V8

# Full Scale Moulding Catalogue



OCTOBER - 2016



info@donlealumber.com  
tel: 905.428.0197  
fax: 905.428.0546





info@donlealumber.com  
tel: 905.428.0197  
fax: 905.428.0546

# Table of Contents

## Section 1

- Baseboard

## Section 2

- Casing
- Back Band

## Section 3

- Door Stop
- Bead Mould
- Quarter Round

## Section 4

- Header Cap
- Bead Mould
- Architrave
- Jamb
- Astragal
- Plinth
- Corner Blocks

## Section 5

- Sill
- Apron

## Section 6

- Crown Mould
- Cove Mould

## Section 7

- Chair Rail

## Section 8

- Panel Mould
- Decorative Moulds
- Burlap
- Half Round
- Outside Corner

## Section 9

- Floor Mouldings
- Reducer
- Nosing

## Section 10

- Handrail
- Shoe Rail

## Section 11

- Tongue & Groove
- Cap Moulding

## Section 12

- Miscellaneous

## Section 13

- D4S
- Flexible/Curved
- Custom Mouldings
- Custom Curves



info@donlealumber.com  
tel: 905.428.0197  
fax: 905.428.0546

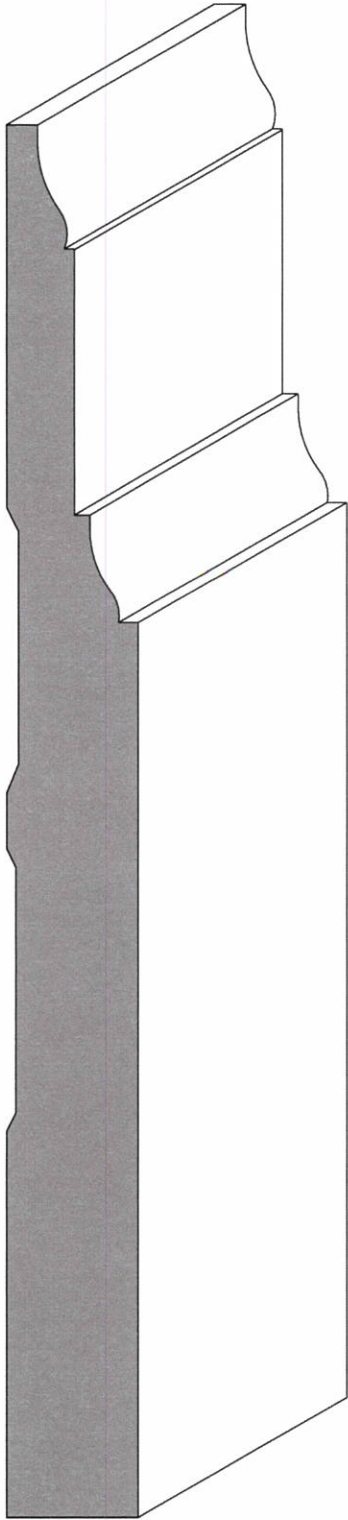

BAS-701  
7-1/4 2-Step Base

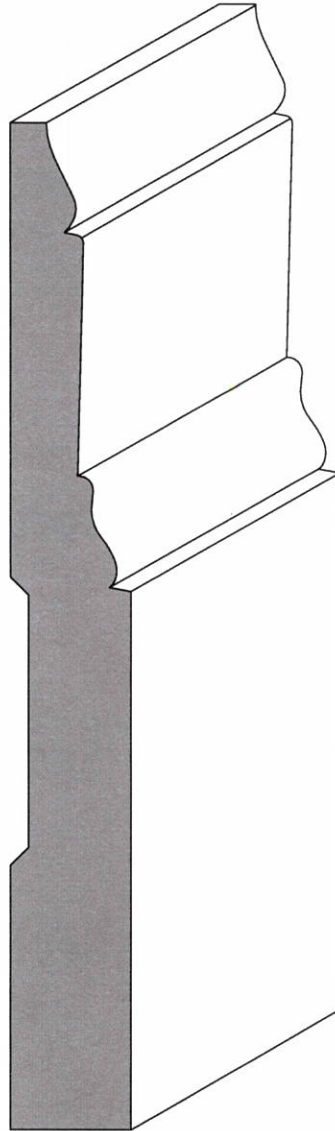

BAS-509  
5-1/4 2-Step Base

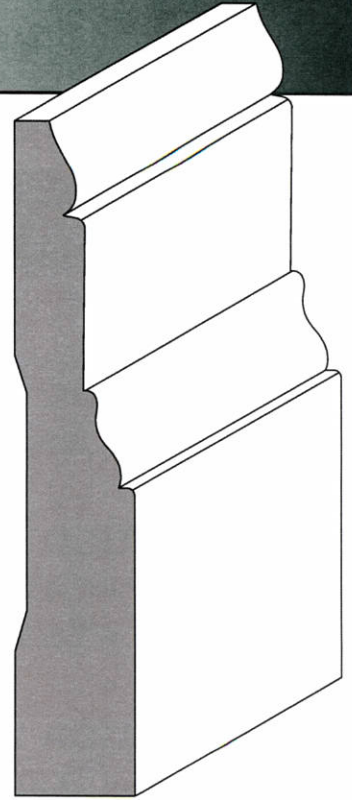

BAS-306  
3-1/2 2-Step Base

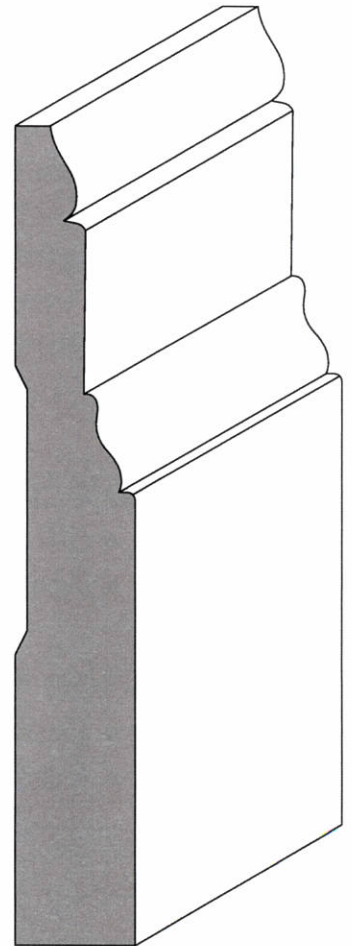

BAS-412  
4-1/4 2-Step Base





**DON  
LEA**

info@donlealumber.com

tel: 905.428.0197

fax: 905.428.0546

S1 - P2

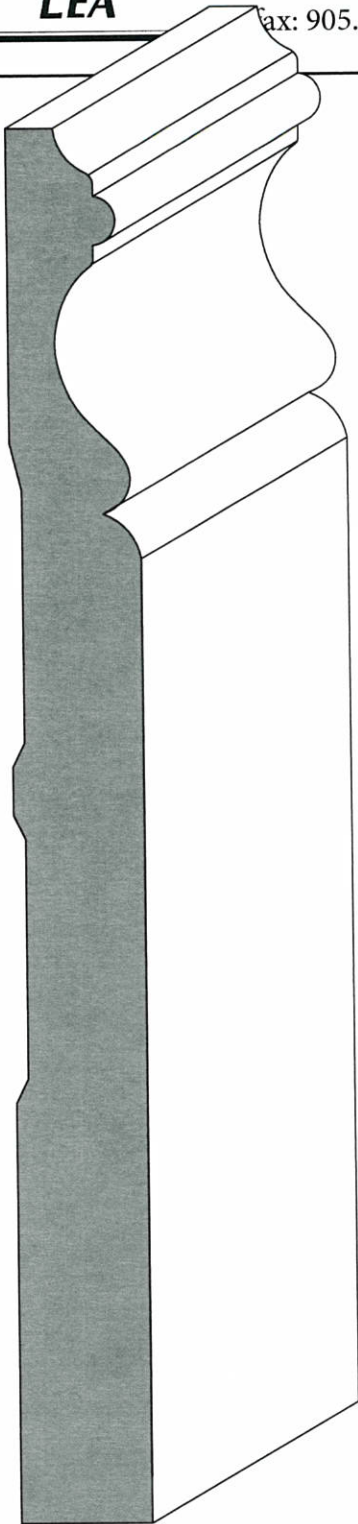

**BAS-704**  
7-1/4 Colonial Base

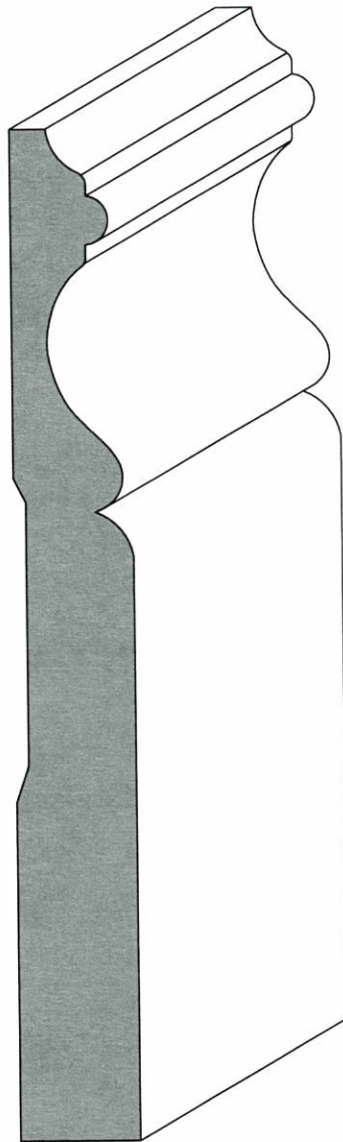

**BAS-503**  
5-1/4 Colonial Base

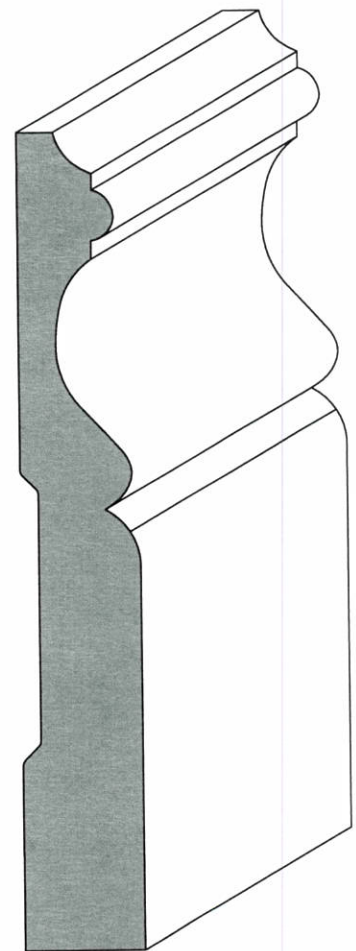

**BAS-400**  
4-1/4 Colonial Base



info@donlealumber.com

tel: 905.428.0197

fax: 905.428.0546

S1 - P3

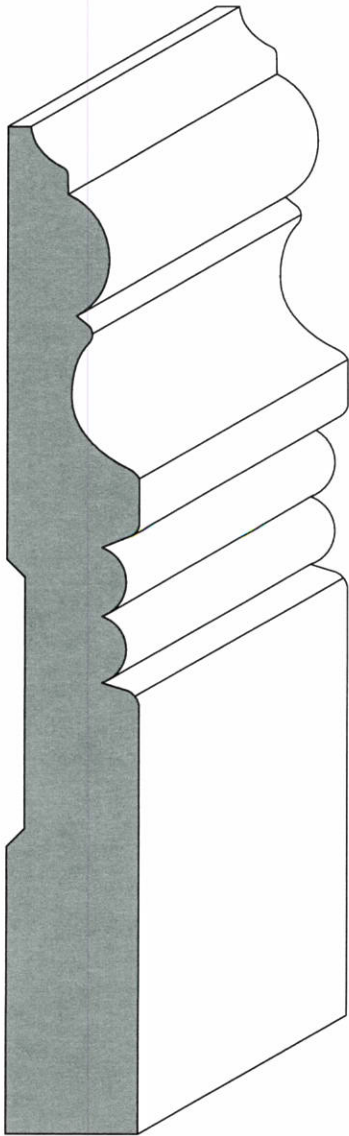

BAS-518  
5-1/4 1867 Base

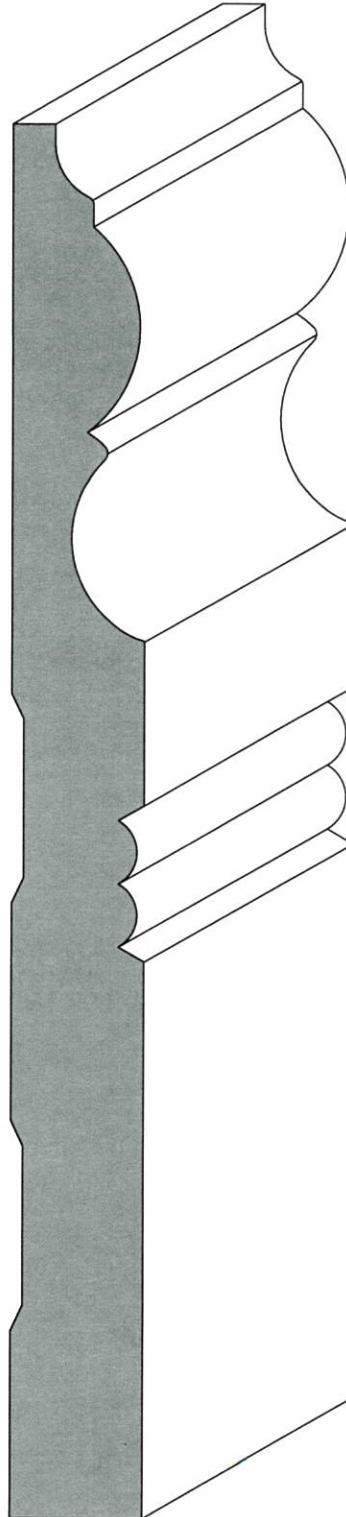

BAS-702  
7-1/4 1867 Base

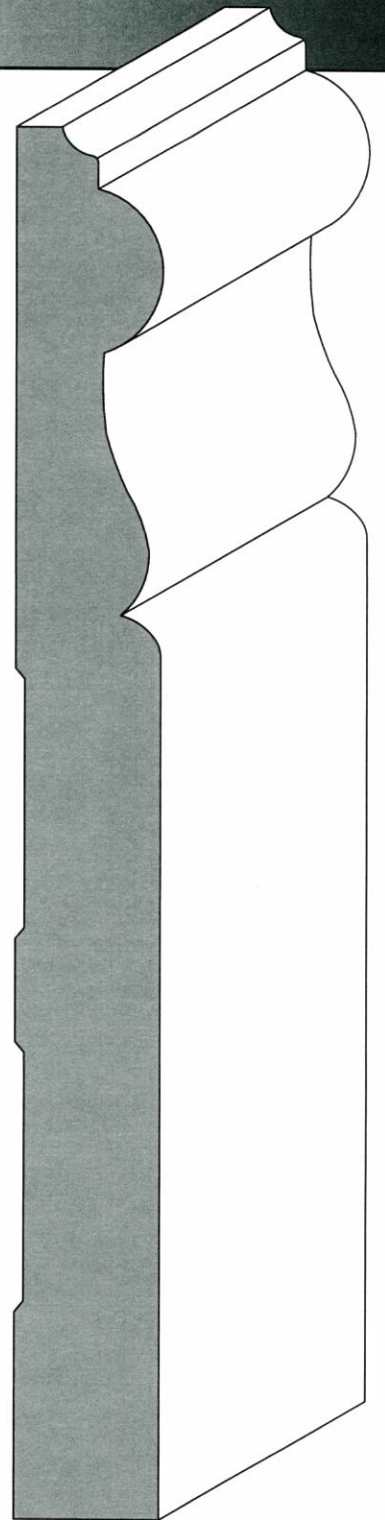

BAS-785  
7-1/4 Antique Base





**DON  
LEA**

info@donlealumber.com

tel: 905.428.0197

fax: 905.428.0546

S1 - P4

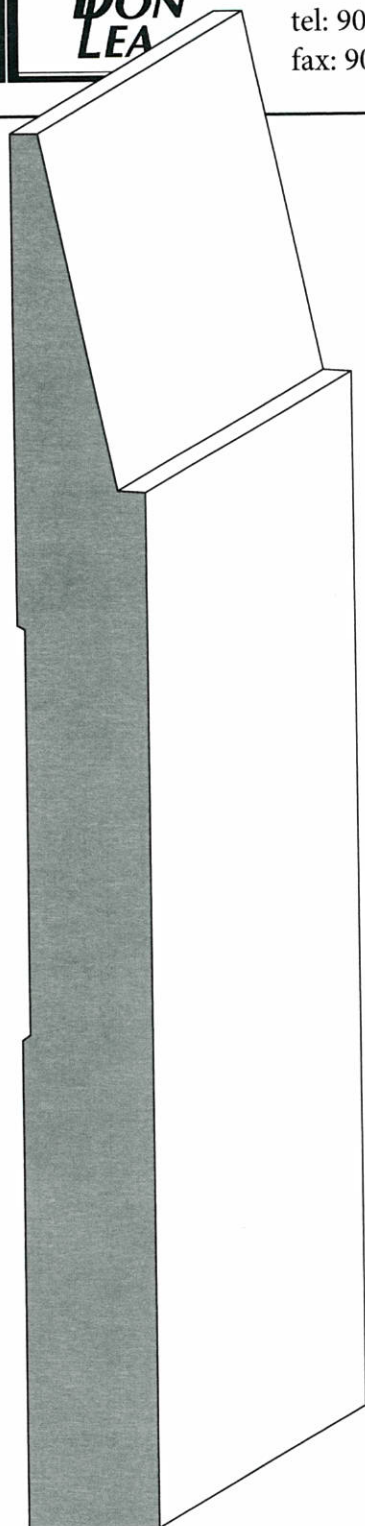

**BAS-7A7**  
7-1/4 Contemporary Base

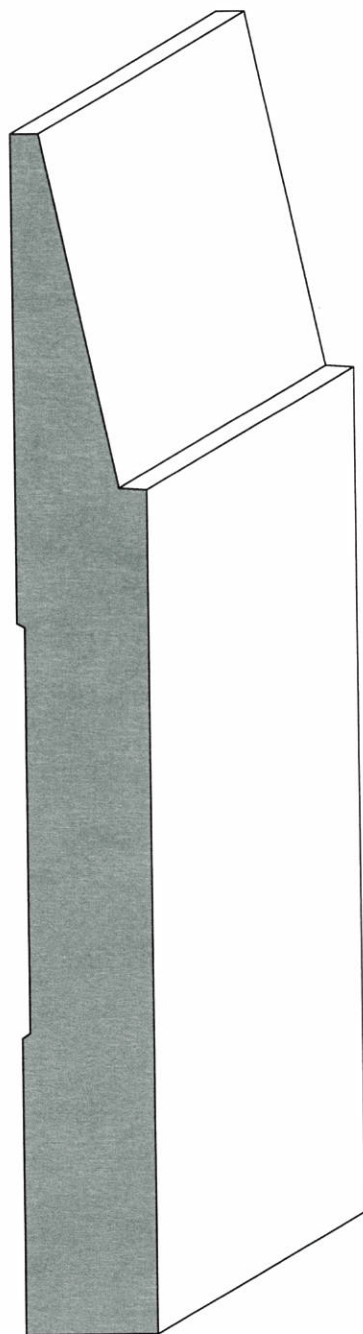

**BAS-647**  
6-1/4 Contemporary Base

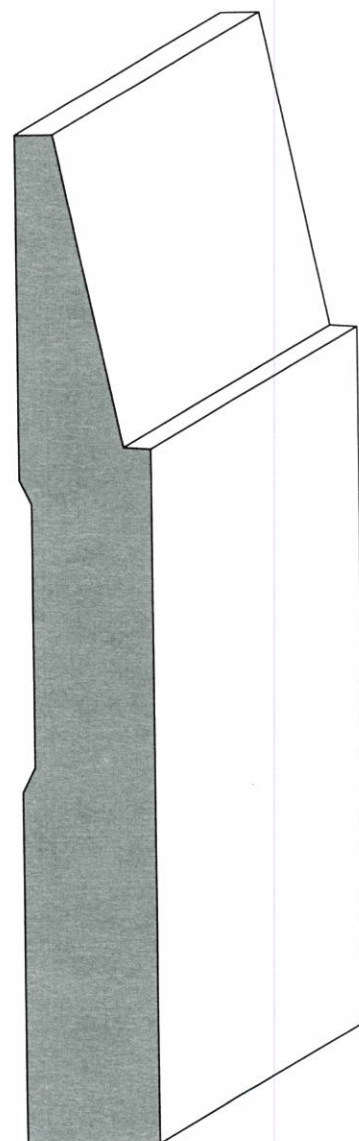

**BAS-5M7**  
5-1/4 Contemporary Base



info@donlealumber.com

tel: 905.428.0197

fax: 905.428.0546

S1 - P5

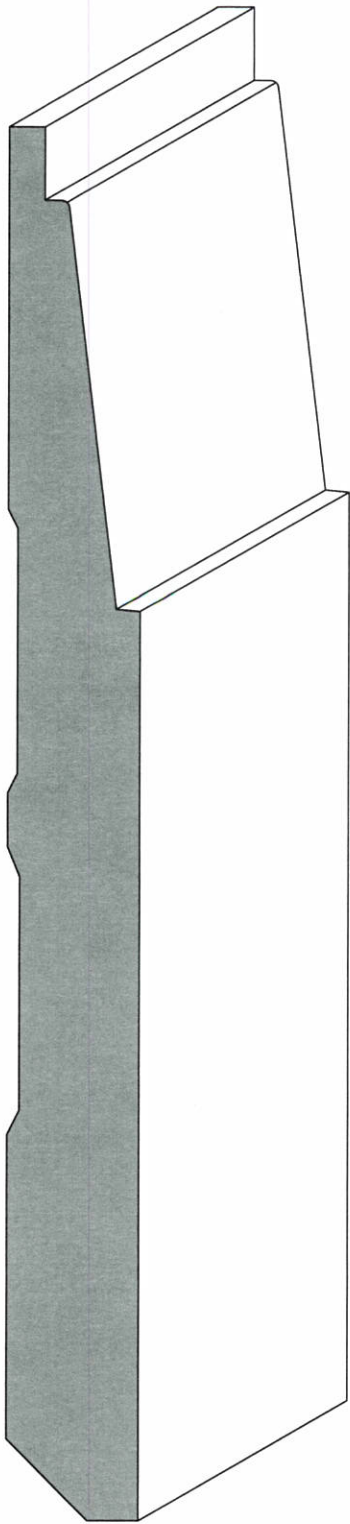

BAS-7K3  
7-1/4 Contemporary Base

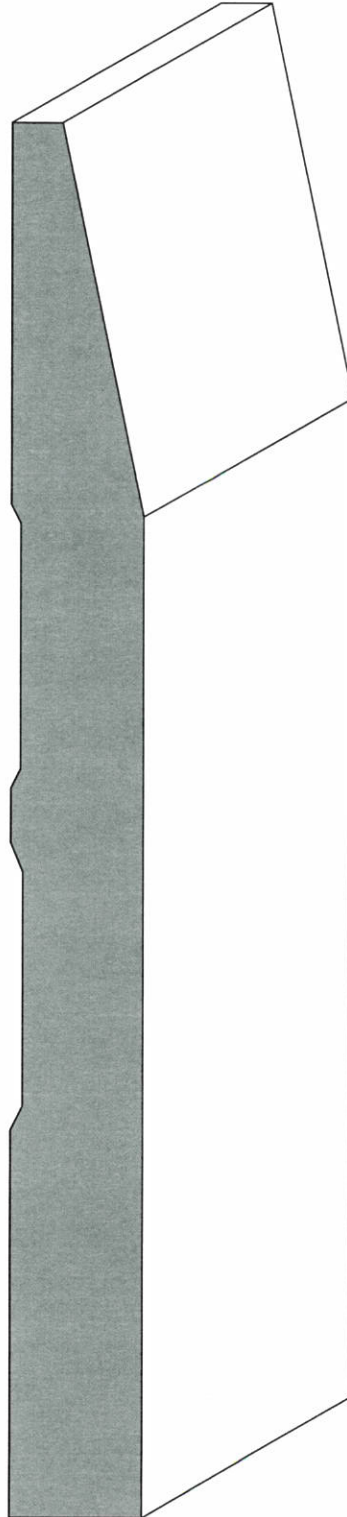

BAS-732  
7-1/4 Bevel Base

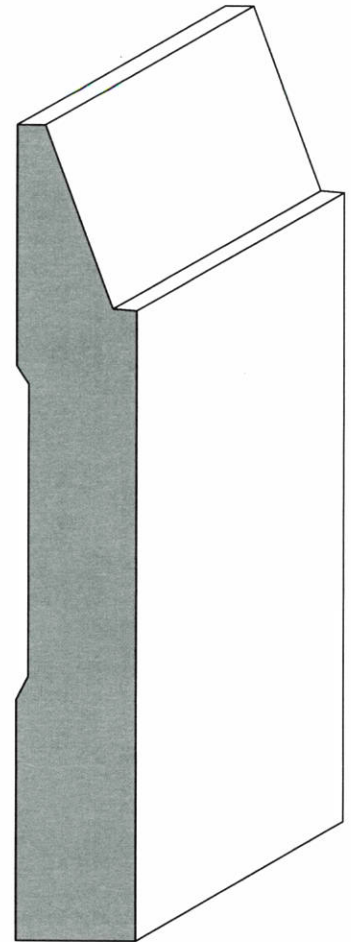

BAS-405  
4-1/4 Contemporary Base





**DON  
LEA**

info@donlealumber.com

tel: 905.428.0197

fax: 905.428.0546

S1 - P6

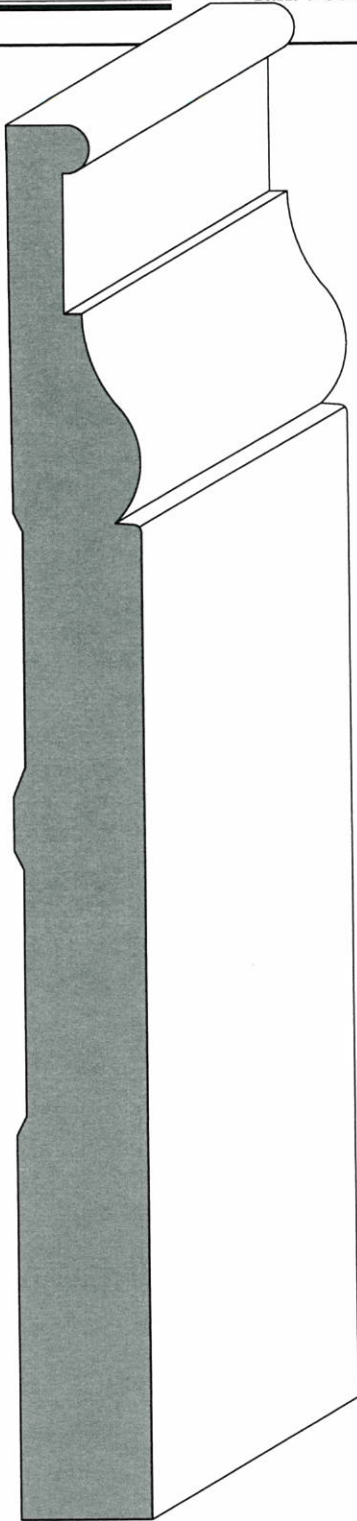

**BAS-7A1**  
7-1/4 Regal Base

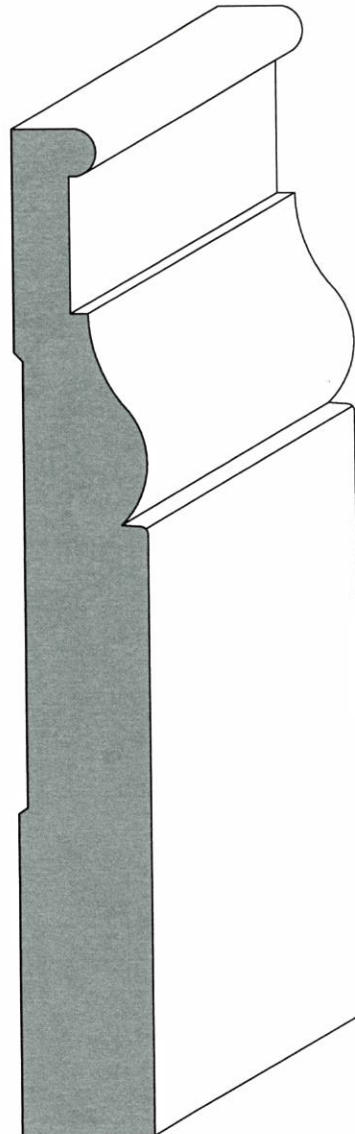

**BAS-5C9**  
5-1/4 Regal Base

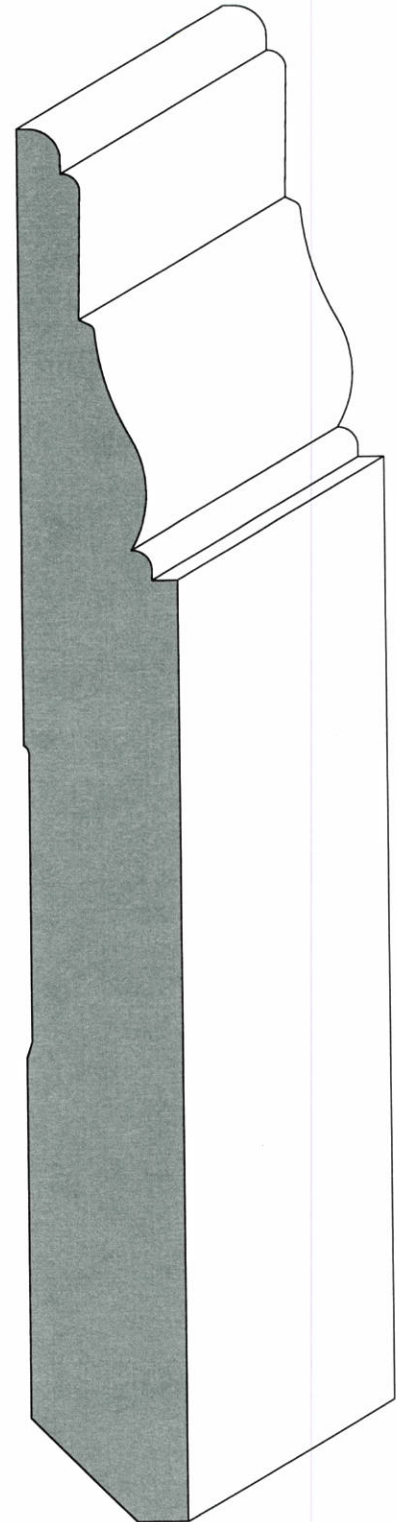

**BAS-773**  
7-1/4 Ornamental Base

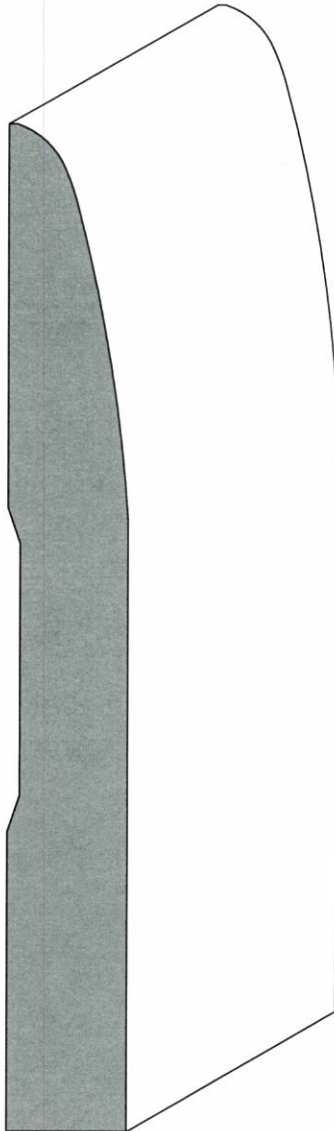

**BAS-508**  
5-1/4 Bevel Base

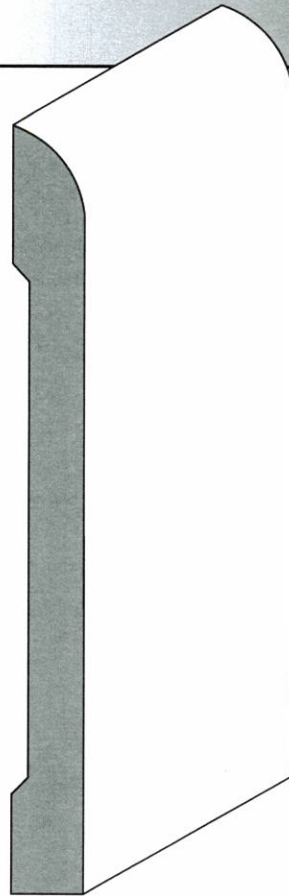

**BAS-411**  
4" Flat Base

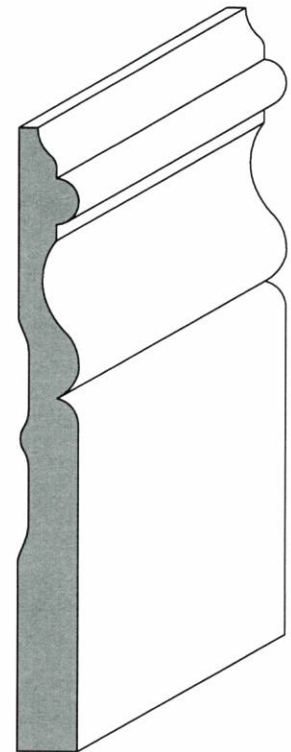

**BAS-300**  
3-1/4 Thin Colonial Base

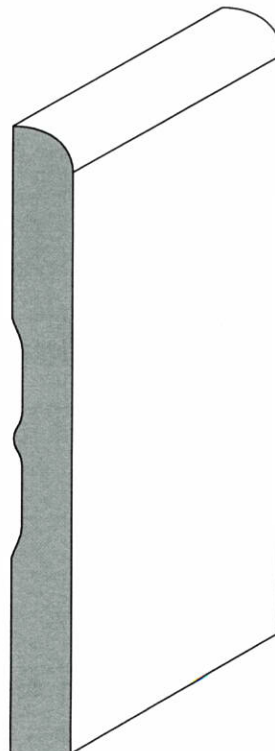

**BAS-301**  
3-1/4 Flat Base





**DON  
LEA**

info@donlealumber.com

tel: 905-709-197

fax: 905-709-546

S1 - P8

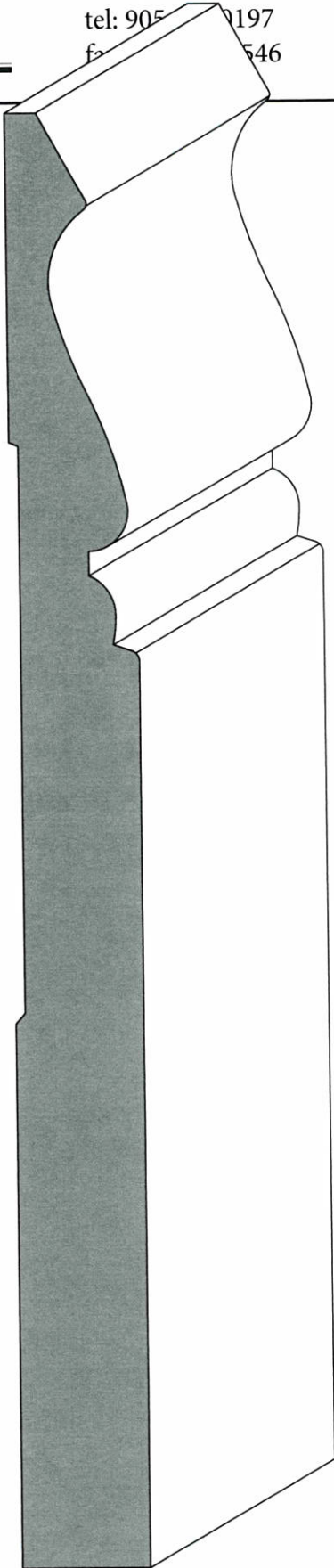

**BAS-803**  
8-1/2 Prestige Base

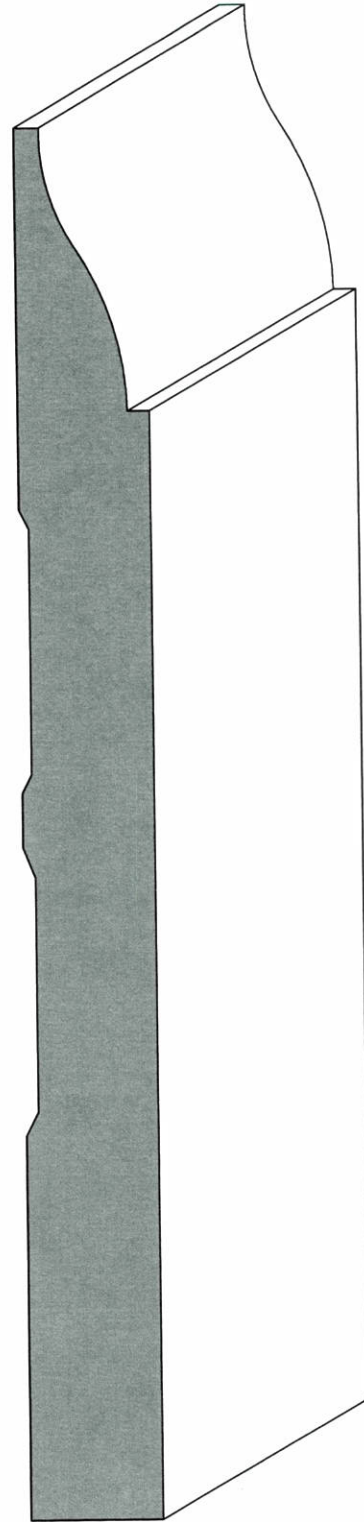

**BAS-7K2**  
7-1/4 Ogee Base

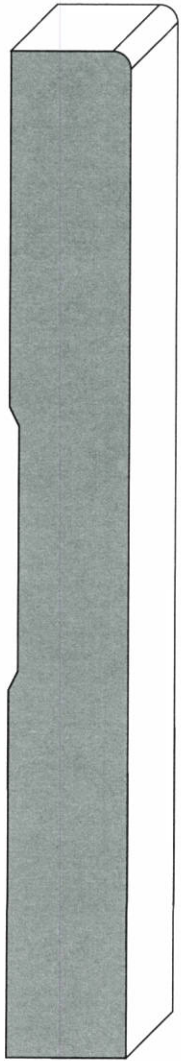

BAS-5AR  
5-1/4 Plain Base

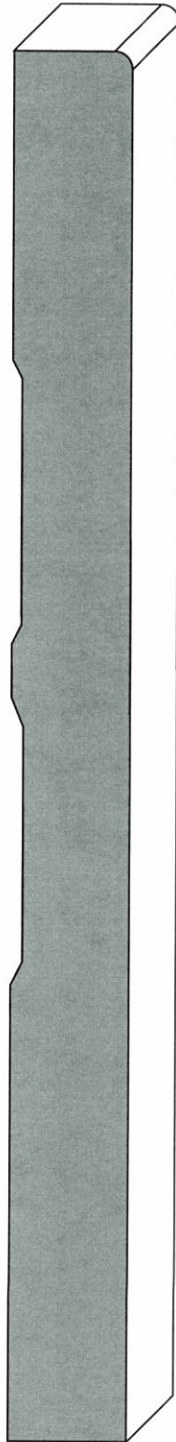

BAS-7T2  
7-1/4 Plain Base

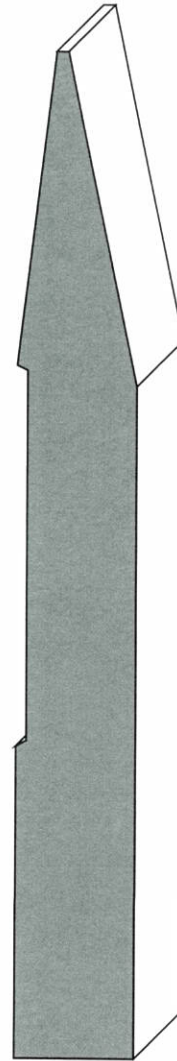

BAS-5CN  
5-1/4 Bevel Base





**DON  
LEA**

info@donlealumber.com

tel: 905.428.0197

fax: 905.428.0546

S2 - P10

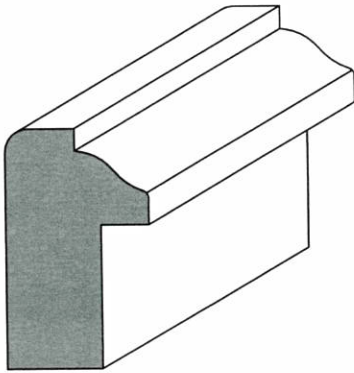

**BAC-102**  
1-1/4 Back Band

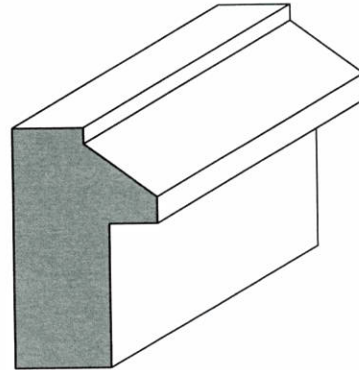

**BAC-154**  
1-1/4 Contemporary Back Band

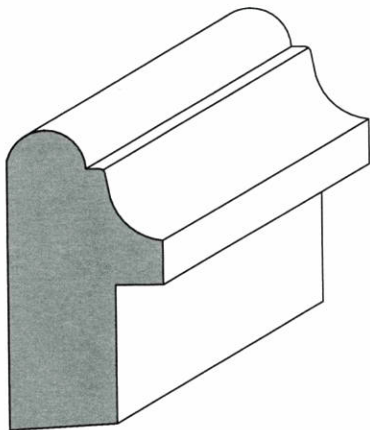

**BAC-121**  
1-9/16 Back Band

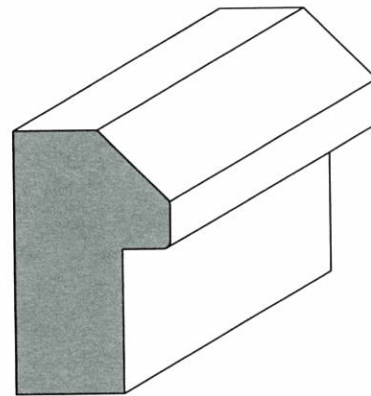

**BAC-1D2**  
1-3/8 Bevel Back Band

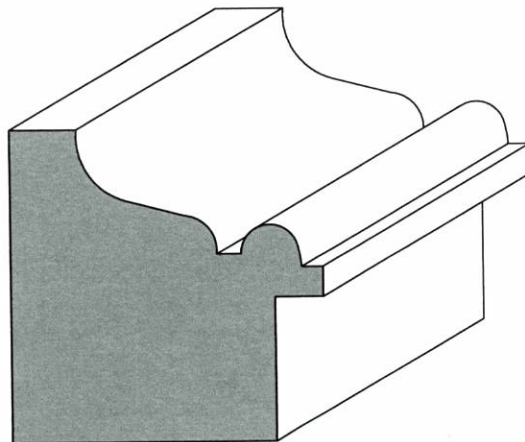

**BAC-174**  
1-5/8 Back Band



info@donlealumber.com

tel: 905.428.0197

fax: 905.428.0546

S2 - P11

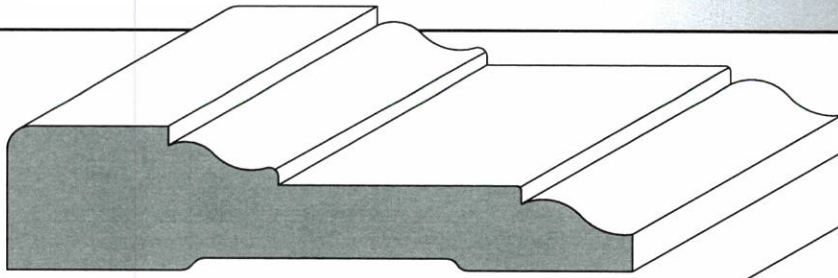

CAS-300  
3-1/4 2-Step Casing

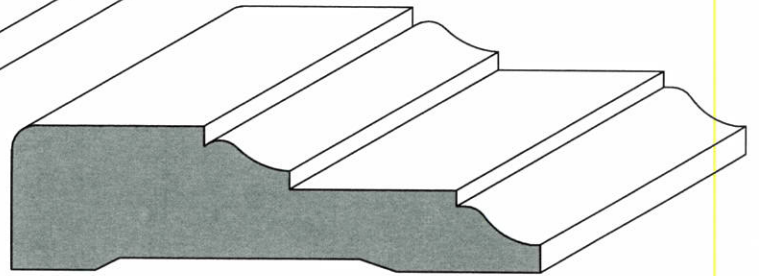

CAS-219  
2-3/4 2-Step Casing

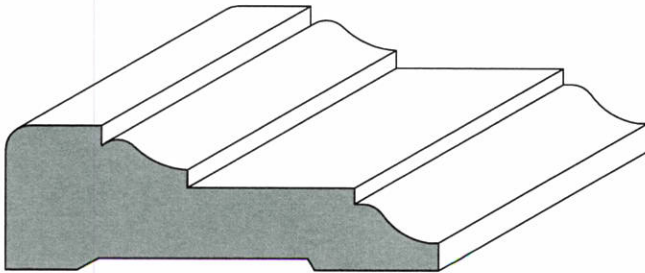

CAS-213  
2-1/4 2-Step Casing

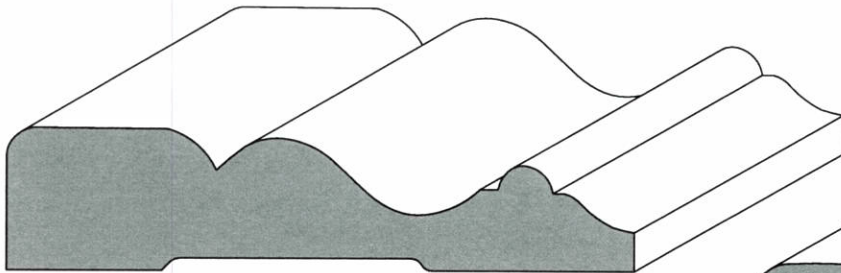

CAS-314  
3-1/4 Colonial Casing

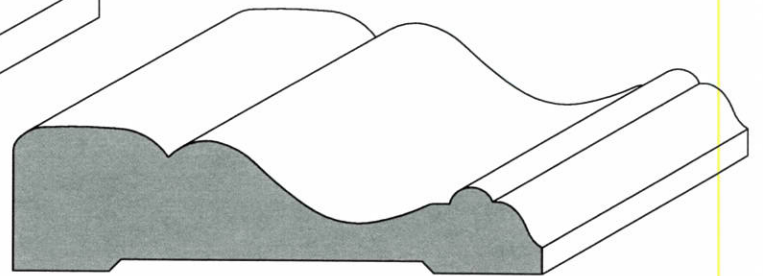

CAS-255  
2-3/4 Colonial Casing

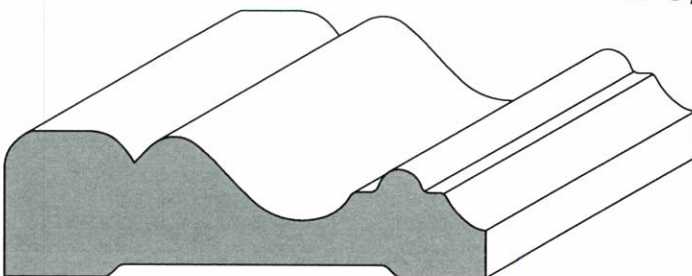

CAS-206  
2-1/2 Colonial Casing



**DON  
LEA**

info@donlealumber.com

tel: 905.428.0197

fax: 905.428.0546

S2 - P12

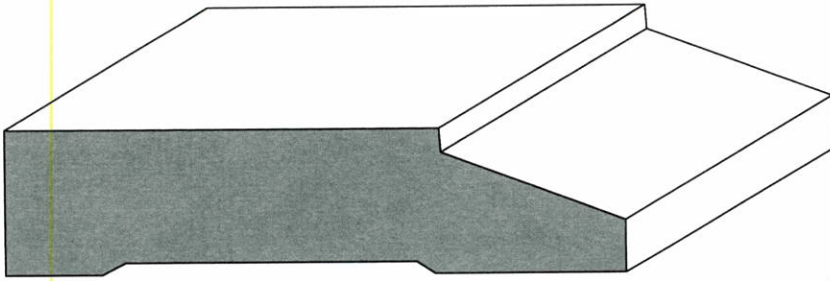

CAS-302  
3-1/4 Contemporary Casing

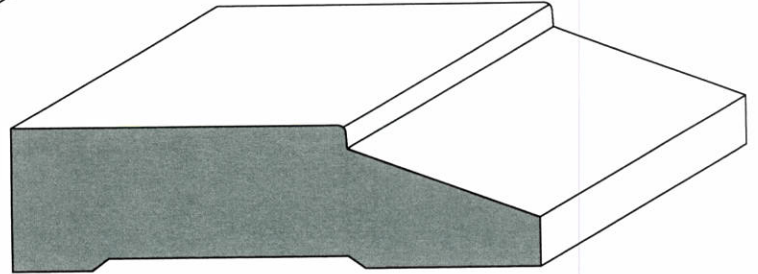

CAS-2M4  
2-3/4 Contemporary Casing

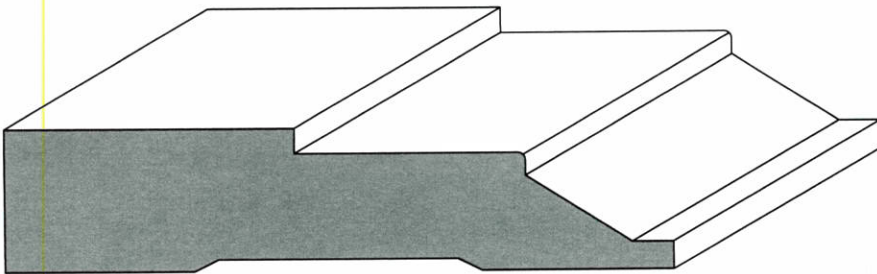

CAS-3X8  
3-1/2 Contemporary Casing

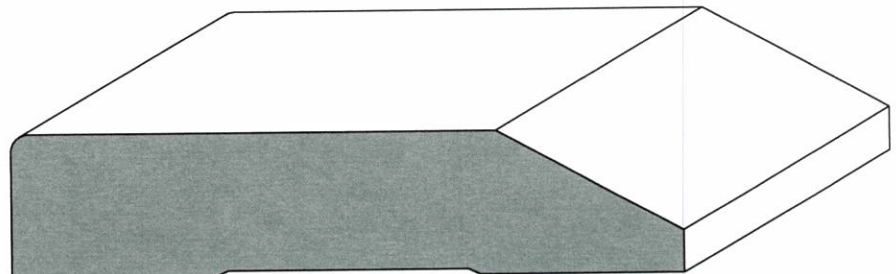

CAS-3T2  
3-1/2 Bevel Casing

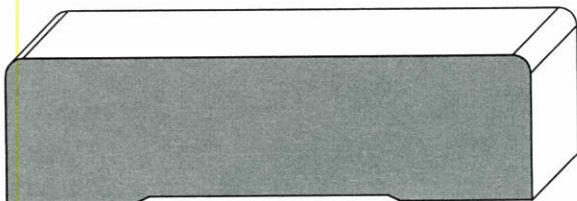

CAS-2X5  
2-3/4 Plain Casing

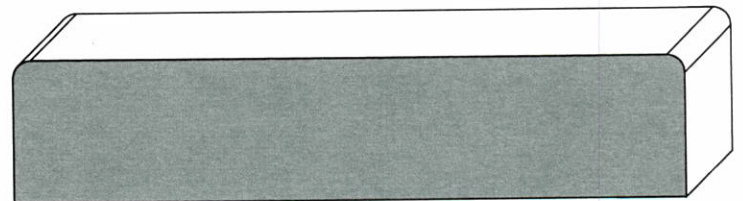

CAS-3EW  
3-1/2 Plain Casing



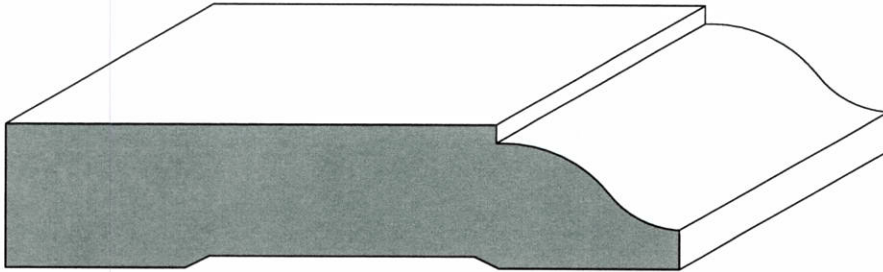

CAS-3V6  
3-1/2 Ogee Casing

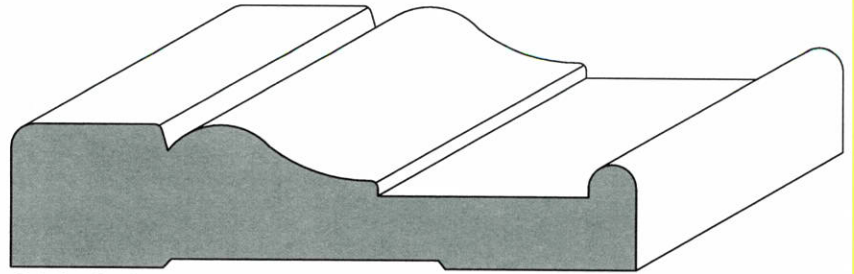

CAS-3J8  
3-1/4 Regal Casing

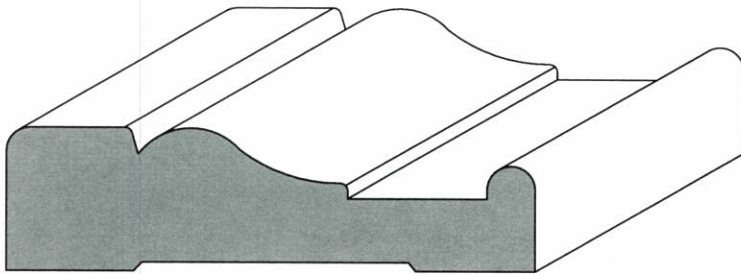

CAS-2F2  
2-3/4 Regal Casing

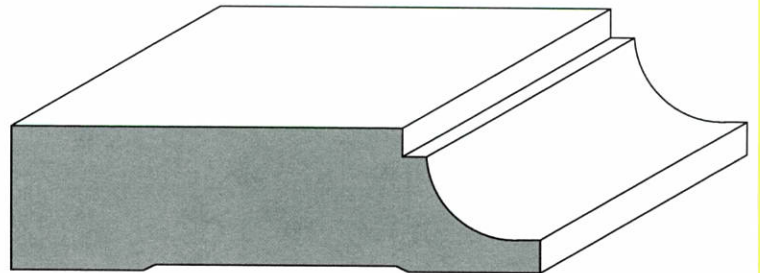

CAS-2F3  
2-3/4 Casing



**DON  
LEA**

info@donlealumber.com

tel: 905.428.0197

fax: 905.428.0546

S2 - P14

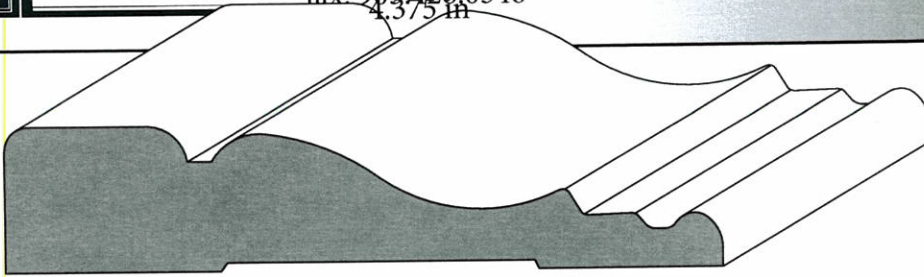

CAS-3F6  
3-3/4 Prestige Casing

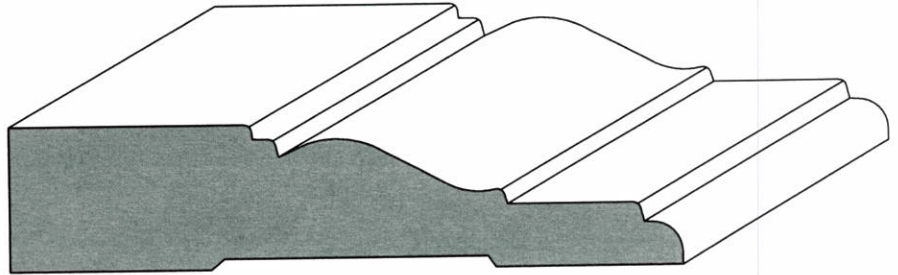

CAS-3F5  
3-1/2 Ornamental Casing

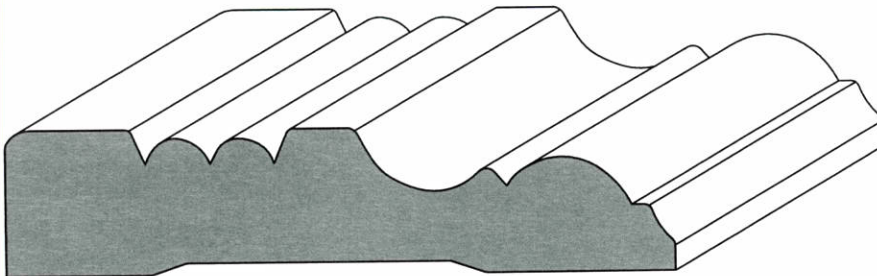

CAS-318  
3-1/2 1867 Casing

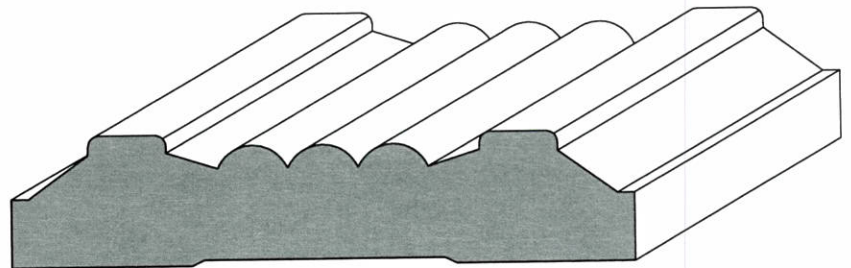

CAS-305  
3-1/4 Symmetrical Casing

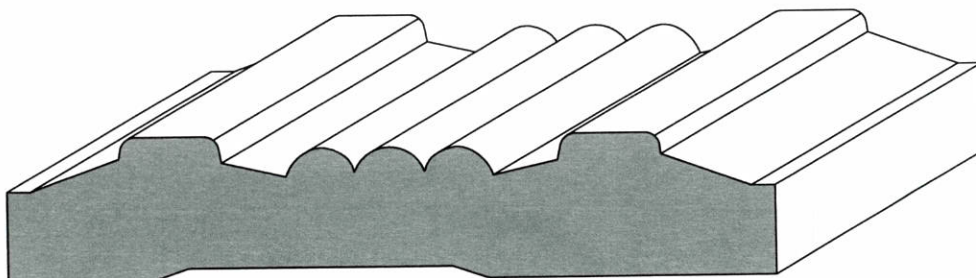

CAS-400  
4" Symmetrical Casing



info@donlealumber.com  
tel: 905.428.0197  
fax: 905.428.0546

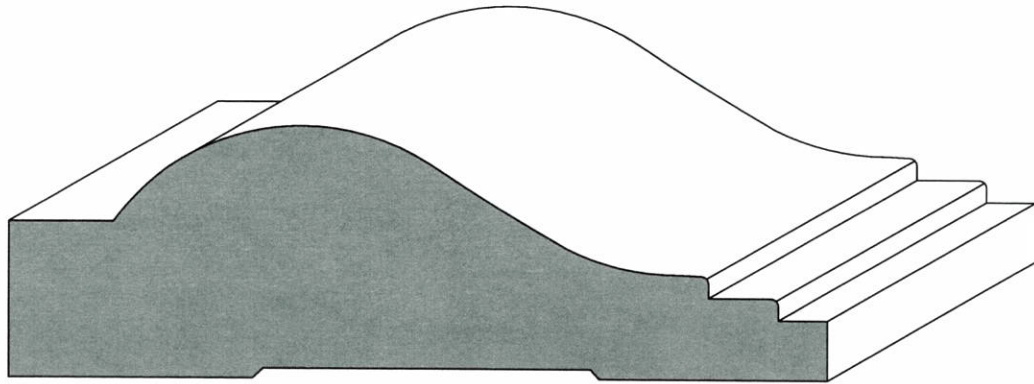

CAS-445  
4-1/4 Antique Casing

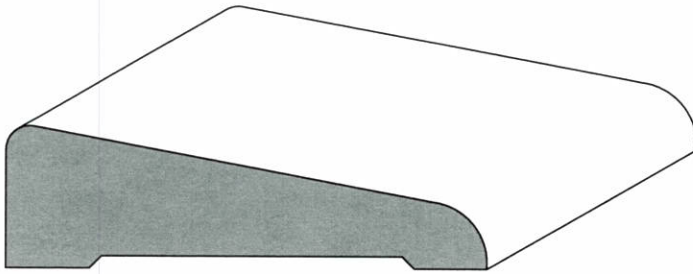

CAS-214  
2-1/2 Bevel Casing

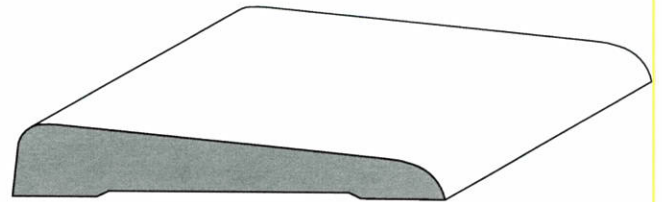

CAS-208  
2-1/4 Flat Casing

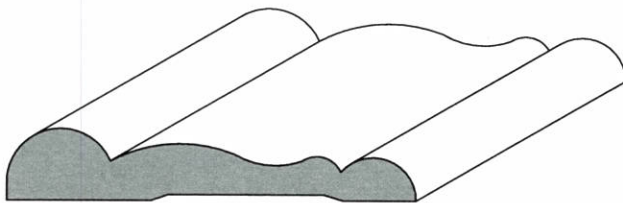

CAS-203  
2-1/8 Thin Colonial Casing



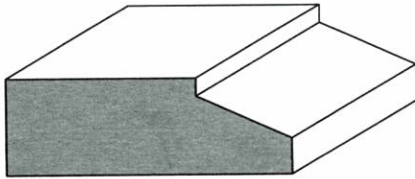

STO-174  
1-1/2 Contemporary Stop

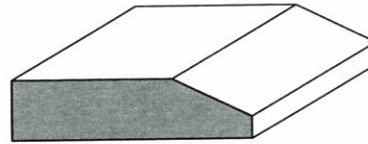

STO-139  
1-1/4 Bevel Stop

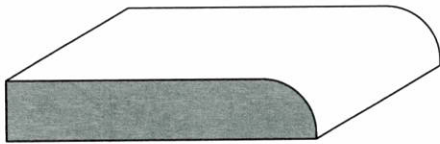

STO-112  
1-5/8 Bullnose Stop

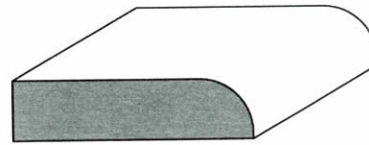

STO-111  
1-1/4 Bullnose Stop

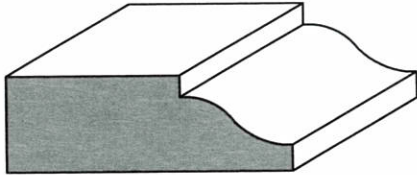

STO-102  
1-1/2 Colonial Stop

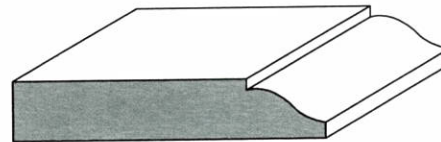

STO-101  
1-5/8 Colonial Stop

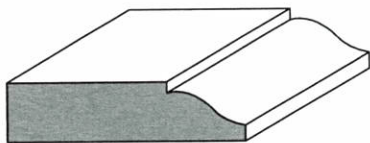

STO-100  
1-1/4 Colonial Stop

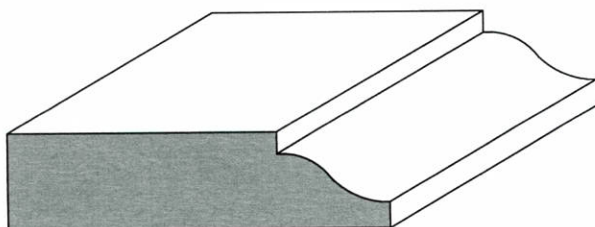

BAC-200  
2" Backer Strip

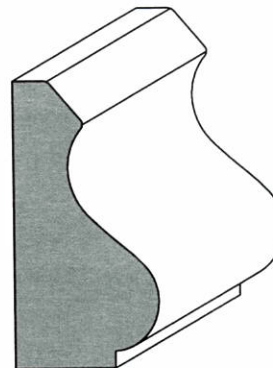

BAS-100  
1-1/2 Base Cap

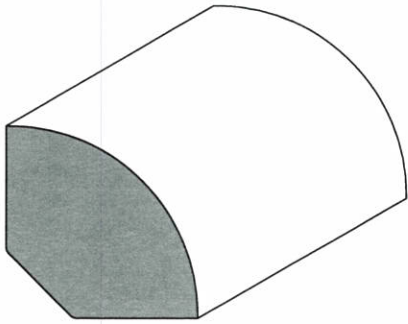

QUA-102  
1" Quarter Round

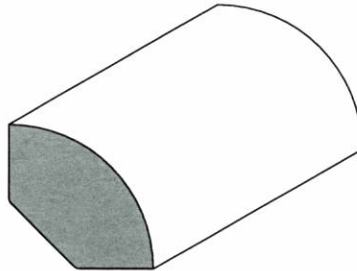

QUA-009  
3/4 Quarter Round

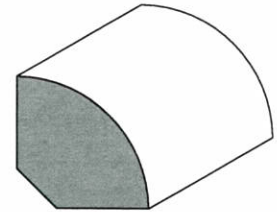

QUA-004  
11/16 Quarter Round

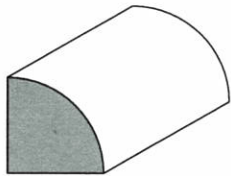

QUA-006  
1/2 Quarter Round

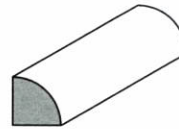

QUA-001  
1/4 Quarter Round

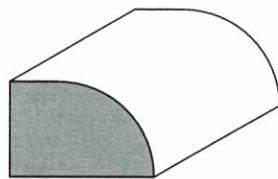

SHO-001  
3/4 Shoe Mould

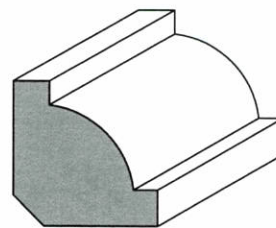

QUA-003  
3/4 Vintage Quarter Round



**DON  
LEA**

info@donlealumber.com

tel: 905.428.0197

fax: 905.428.0546

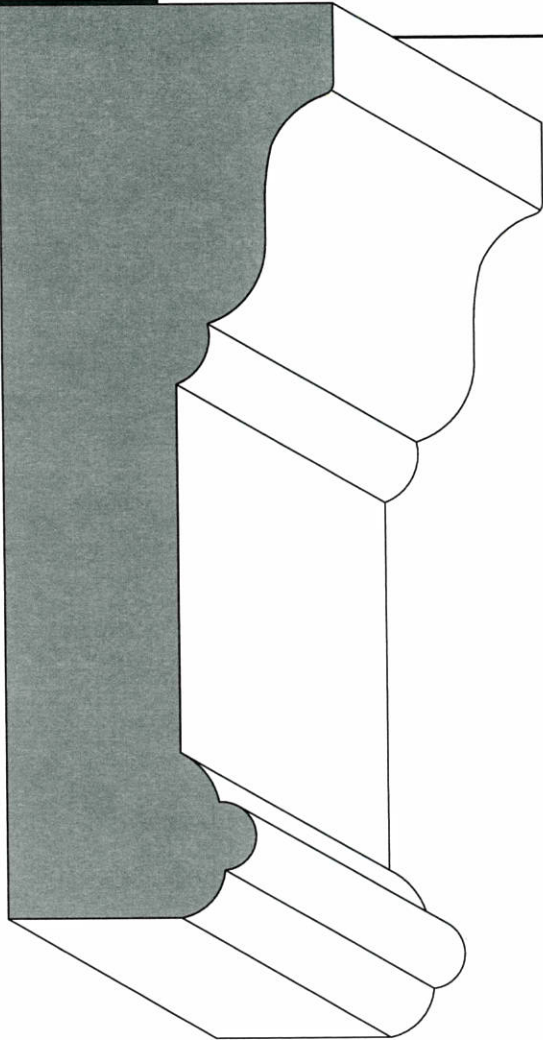

ARC-401  
4-3/4 Architrave

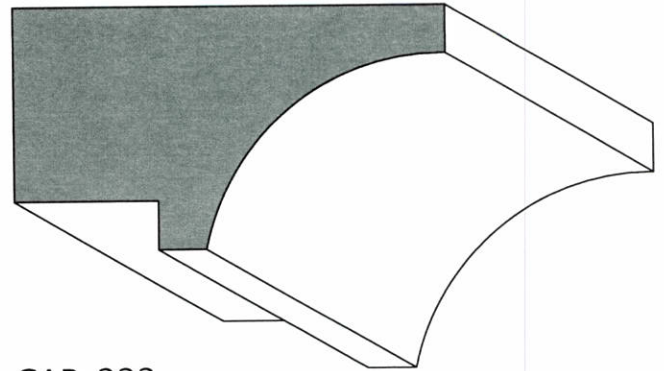

CAP-222  
2-1/4 Contemporary Header Cap

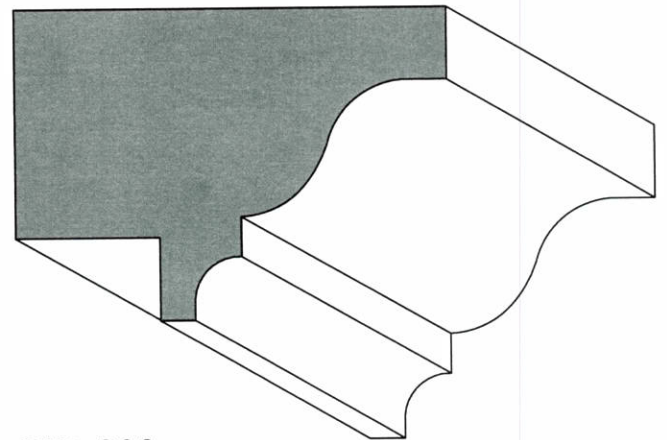

CAP-200  
2-1/4 Colonial Header Cap

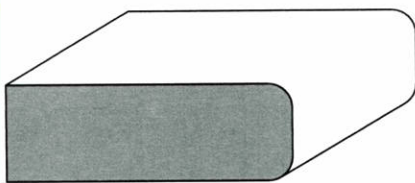

BEA-116  
1-1/2 Contemporary  
Bead Mould

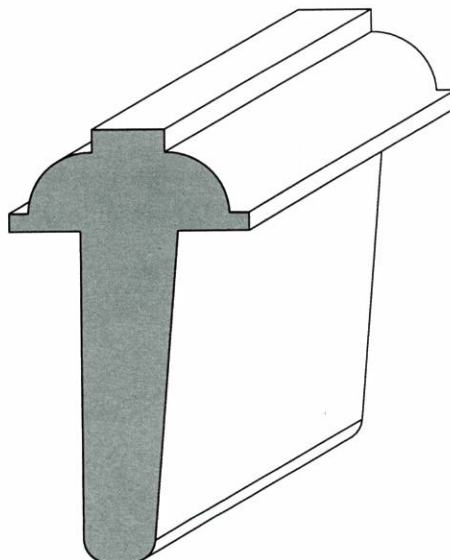

AST-200  
2-1/4 Atrigal

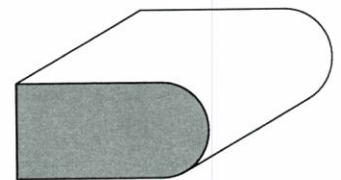

BEA-100  
1" Bead Mould





info@donlealumber.com  
tel: 905.428.0197  
fax: 905.428.0546

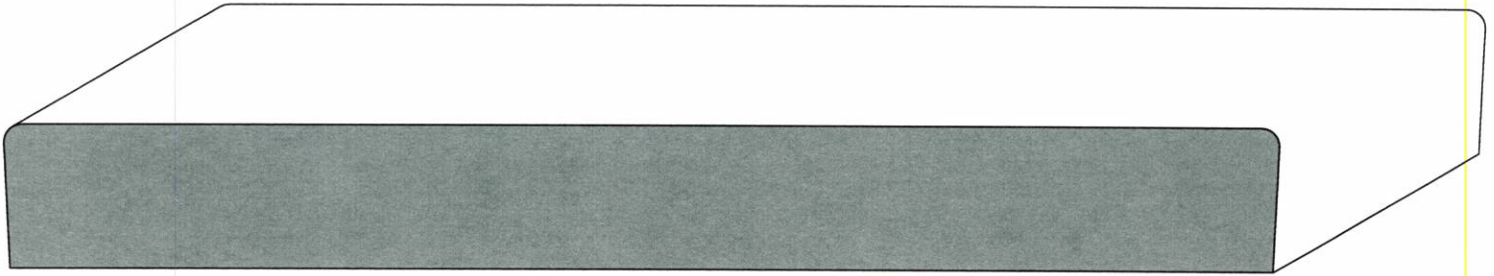

JAM-600  
6-5/8 Bevelled Door Jamb

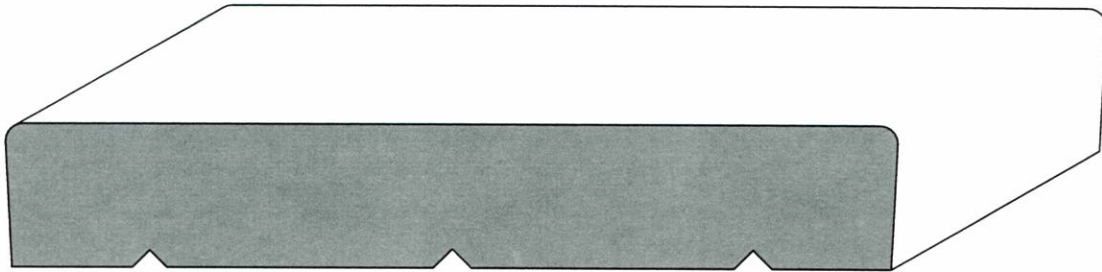

JAM-402  
4-5/8 Bevelled Door Jamb

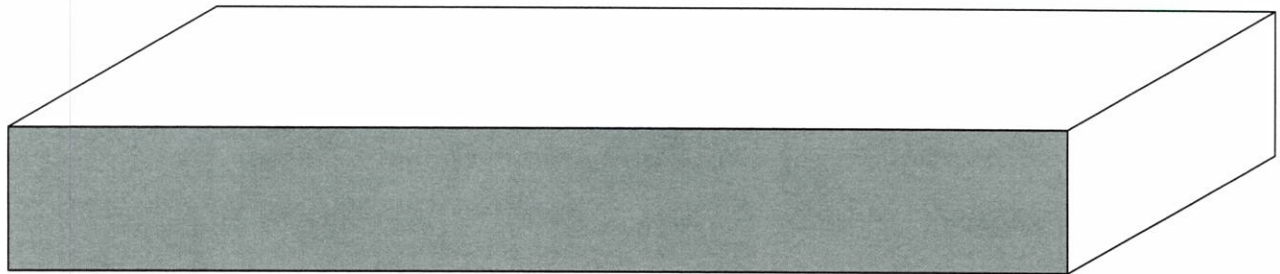

JAM-1X6  
5-1/2 Door Jamb

Door Jambs	
JAM-1X5	3/4 x 4-5/8
JAM-1X6	3/4 x 5-1/2
JAM-1X7	3/4 x 6-5/8



info@donlealumber.com  
tel: 905.428.0197  
fax: 905.428.0546

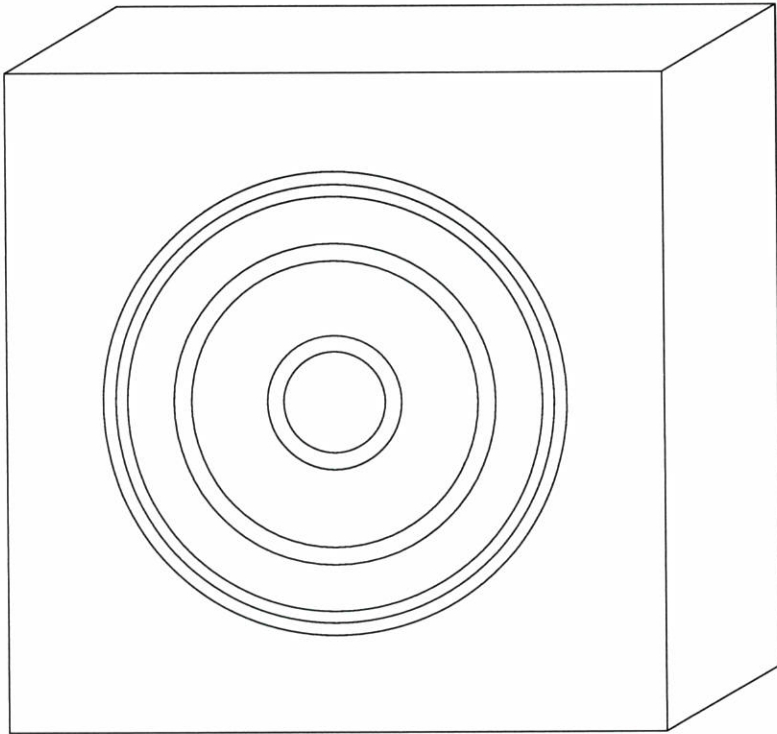

### Corner Blocks

COR-200	9/16 x 2-1/2
COR-222	7/8 x 2-7/8
COR-301	7/8 x 3-1/8
COR-306	7/8 x 3-5/8
COR-400	7/8 x 4-1/4

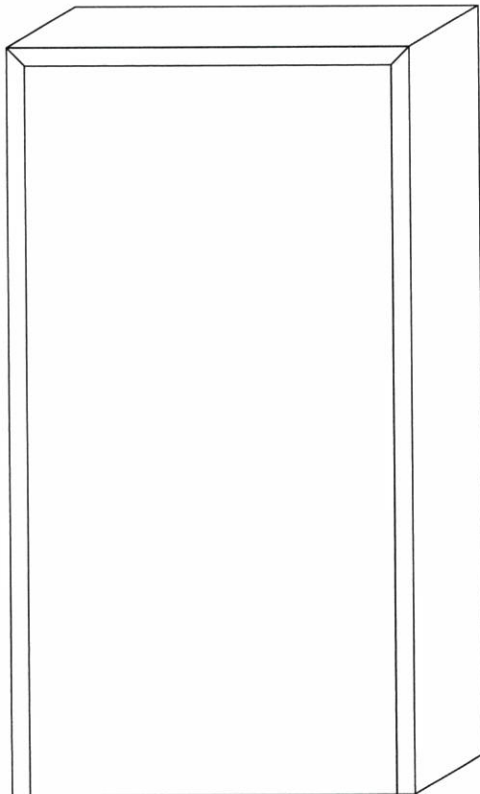

### Plinth Blocks

PLI-222	7/8 x 2-7/8 x 6'
PLI-306	7/8 x 3-5/8 x 8'
PLI-400	7/8 x 4-1/4 x 8'



info@donlealumber.com  
tel: 905.428.0197  
fax: 905.428.0546

7-1/4 Wide

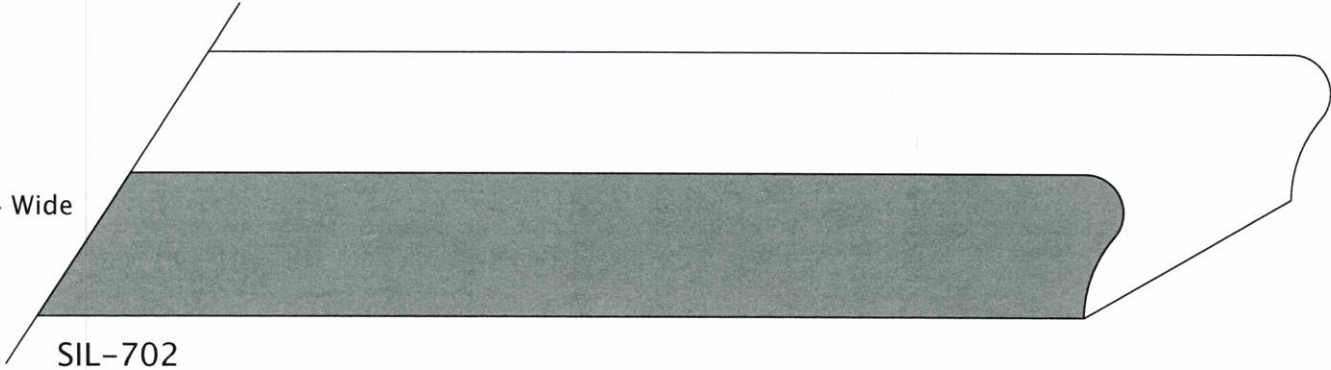

SIL-702  
7-1/4 Sill

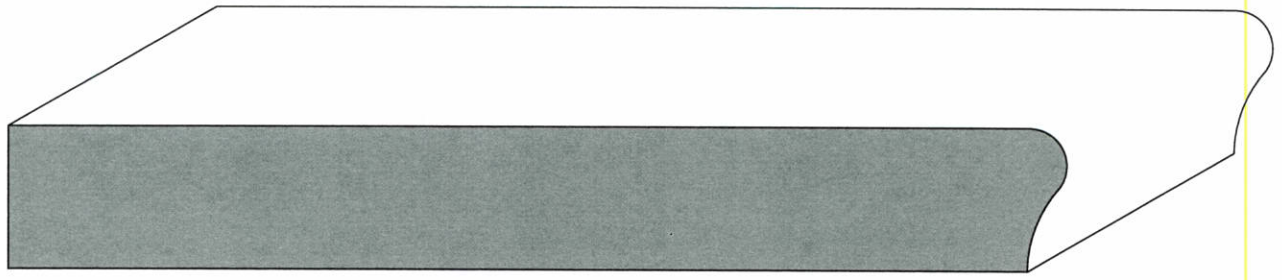

SIL-502  
5-1/2 Sill

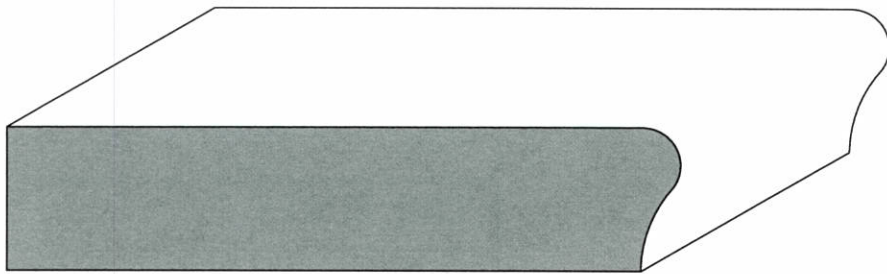

SIL-305  
3-1/2 Sill

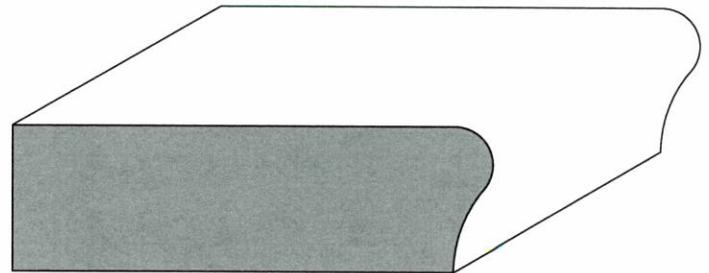

SIL-203  
2-1/2 Sill



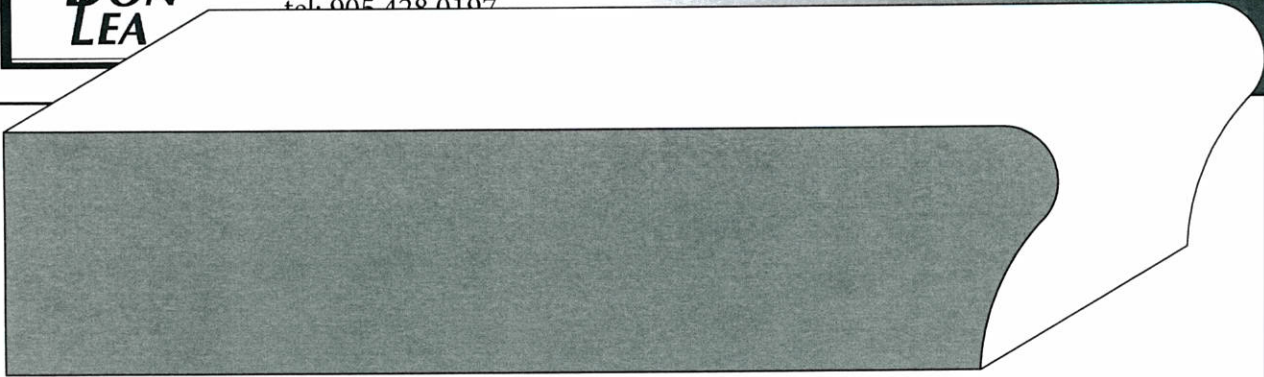

SIL-503  
5-1/2 Sill

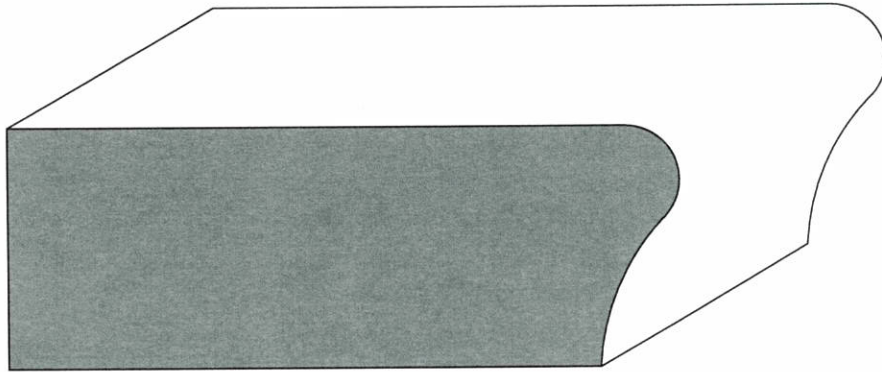

SIL-306  
3-1/2 Sill

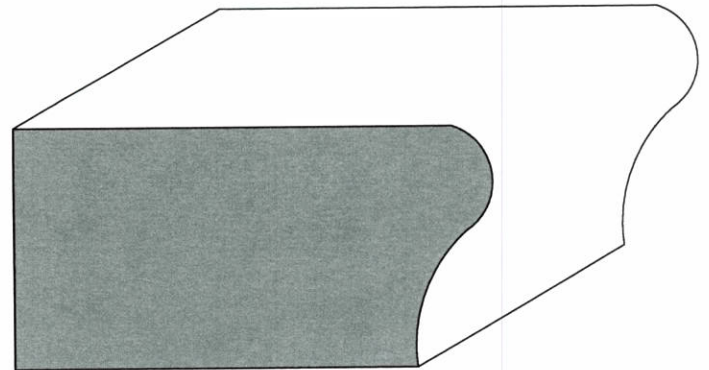

SIL-202  
2-1/2 Sill

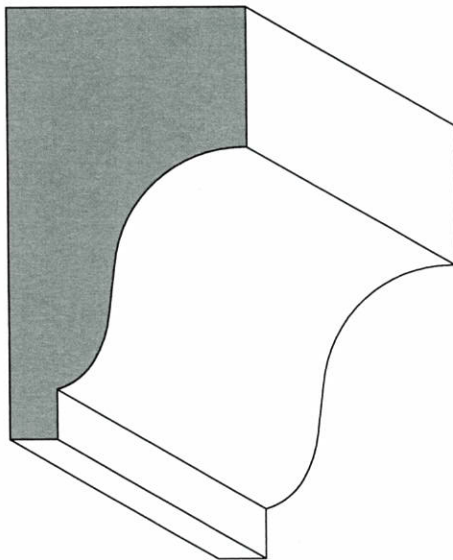

SHI-203  
2-1/4 Shingle Mould

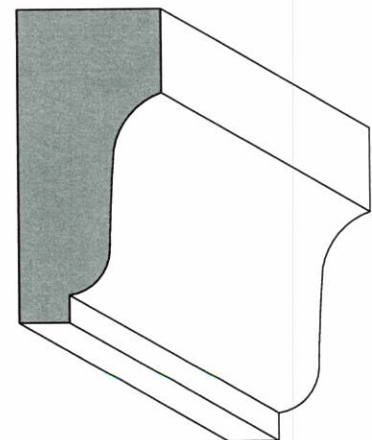

SHI-101  
1-5/8 Shingle Mould



info@donlealumber.com  
tel: 905.428.0197  
fax: 905.428.0546

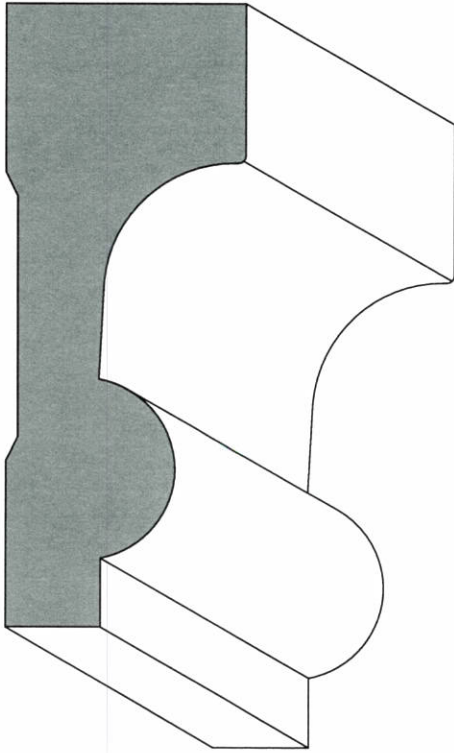

SHI-308  
3-1/4 Shingle Mould

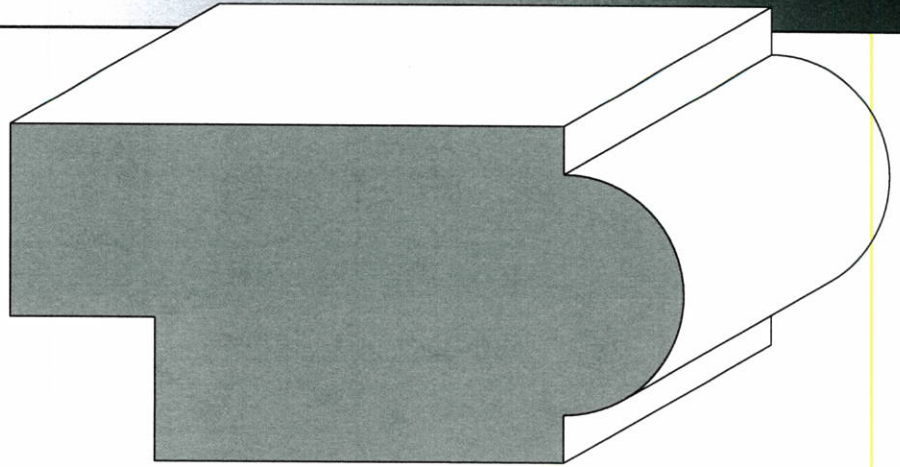

SIL-302  
3-1/2 Sill

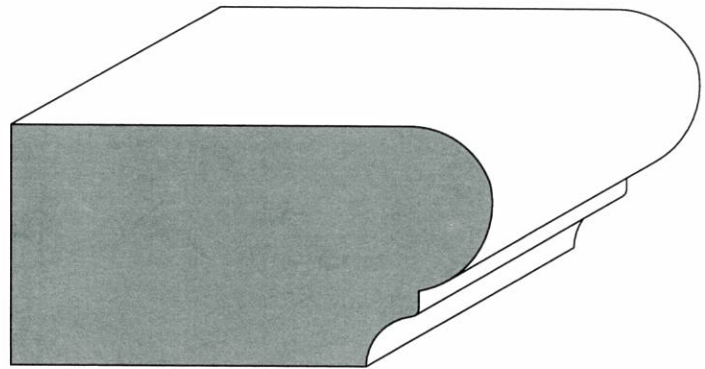

SIL-219  
2-1/2 Decorative Sill

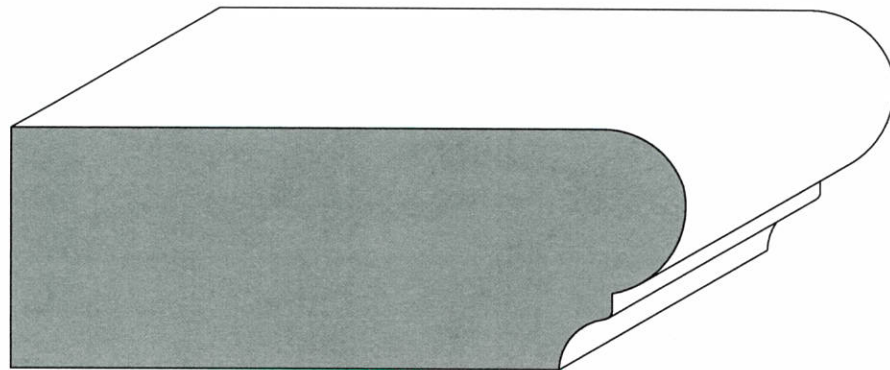

SIL-304  
3-1/2 Decorative Sill



info@donlealumber.com  
tel: 905.428.0197  
fax: 905.428.0546

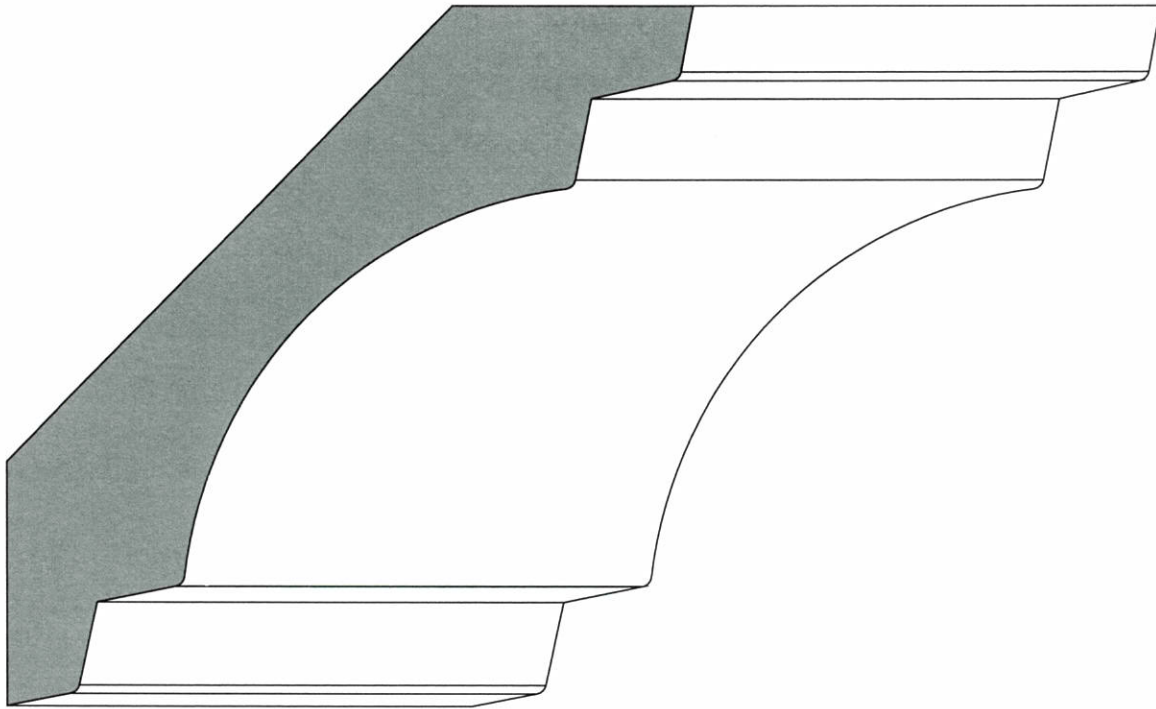

COV-314  
3-1/2 Cove Mould

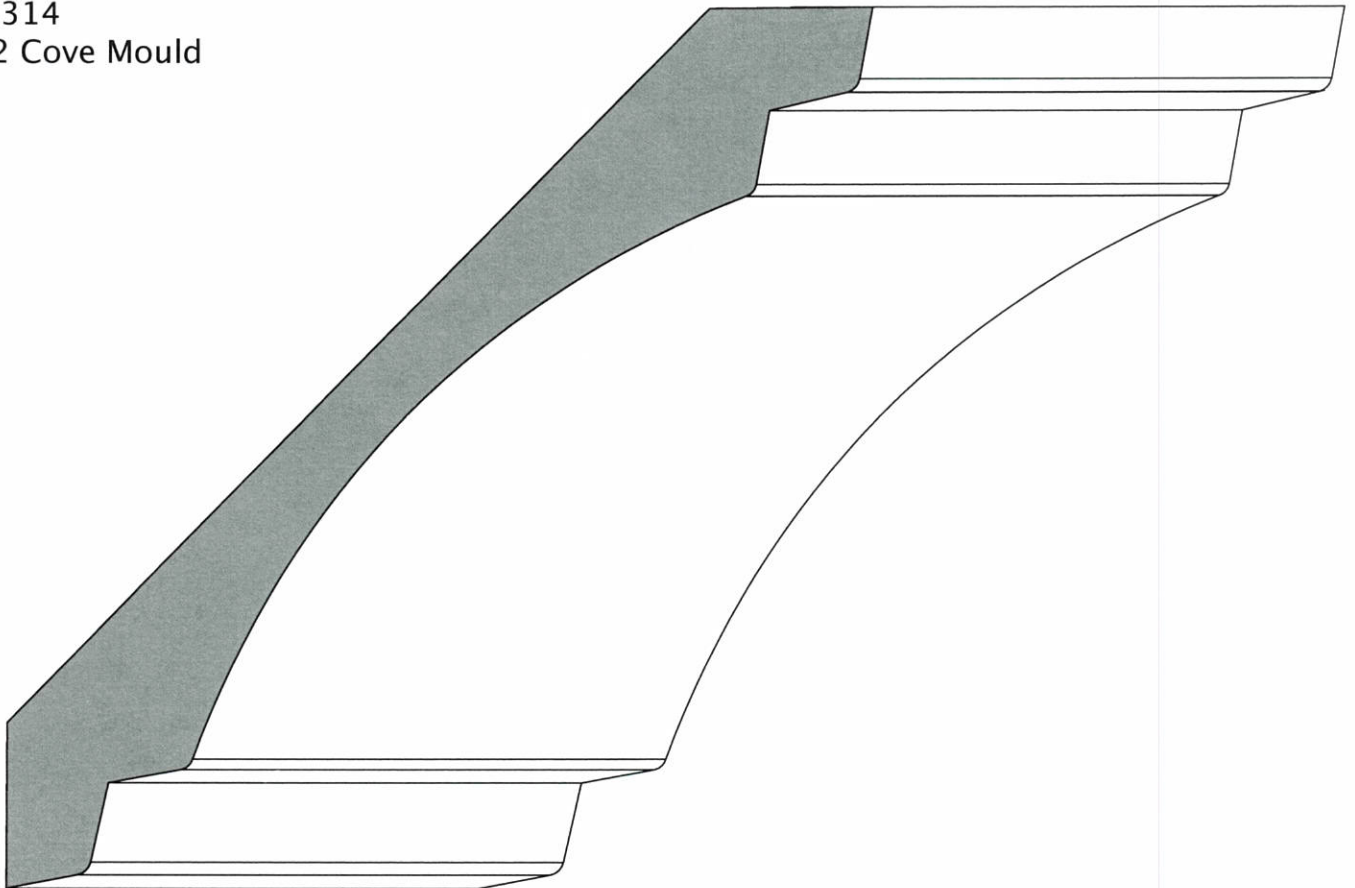

COV-509  
5-1/4 Cove Mould





info@donlealumber.com  
tel: 905.428.0197  
fax: 905.428.0546

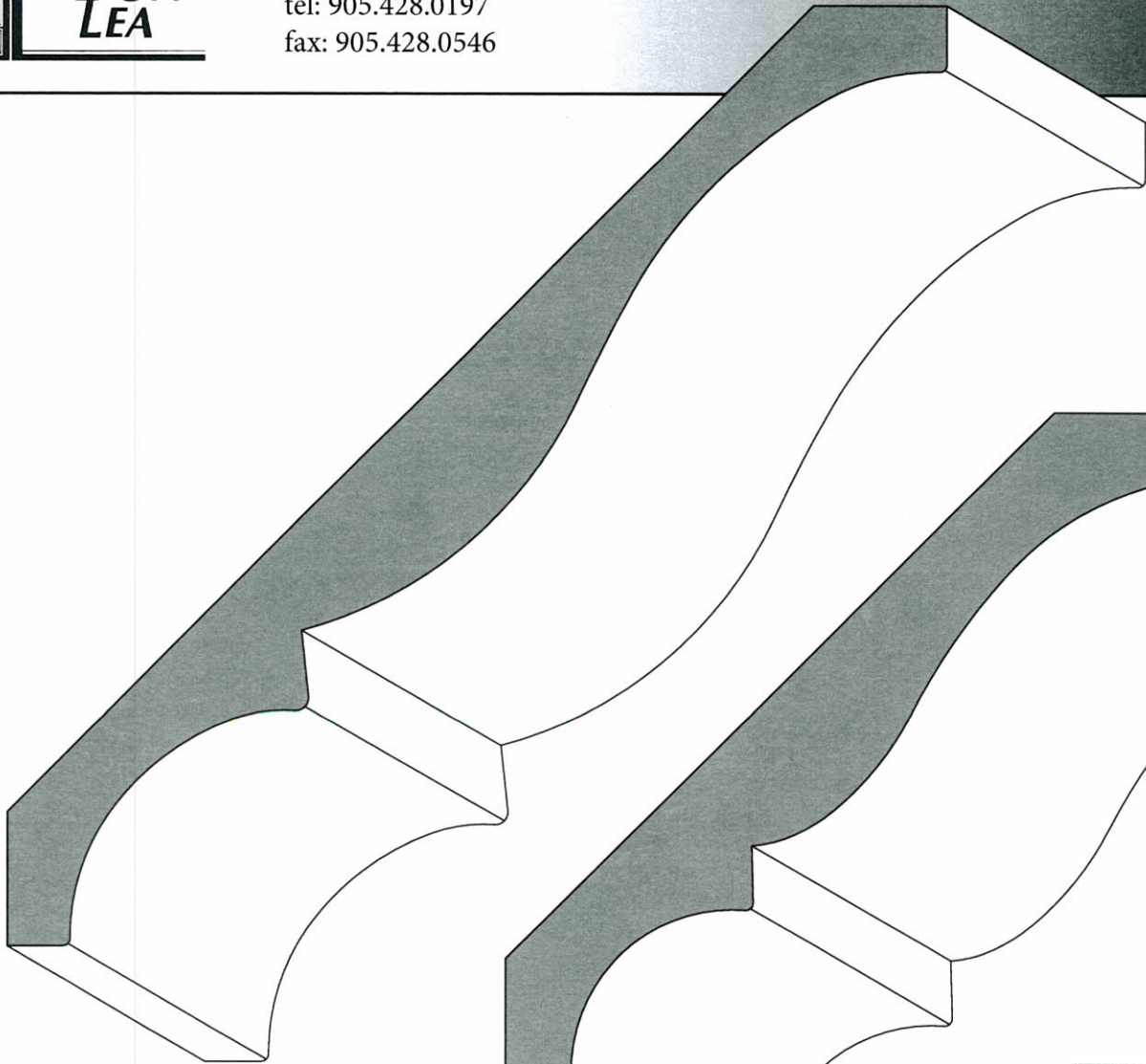

CRO-702  
7-1/4 Crown Mould

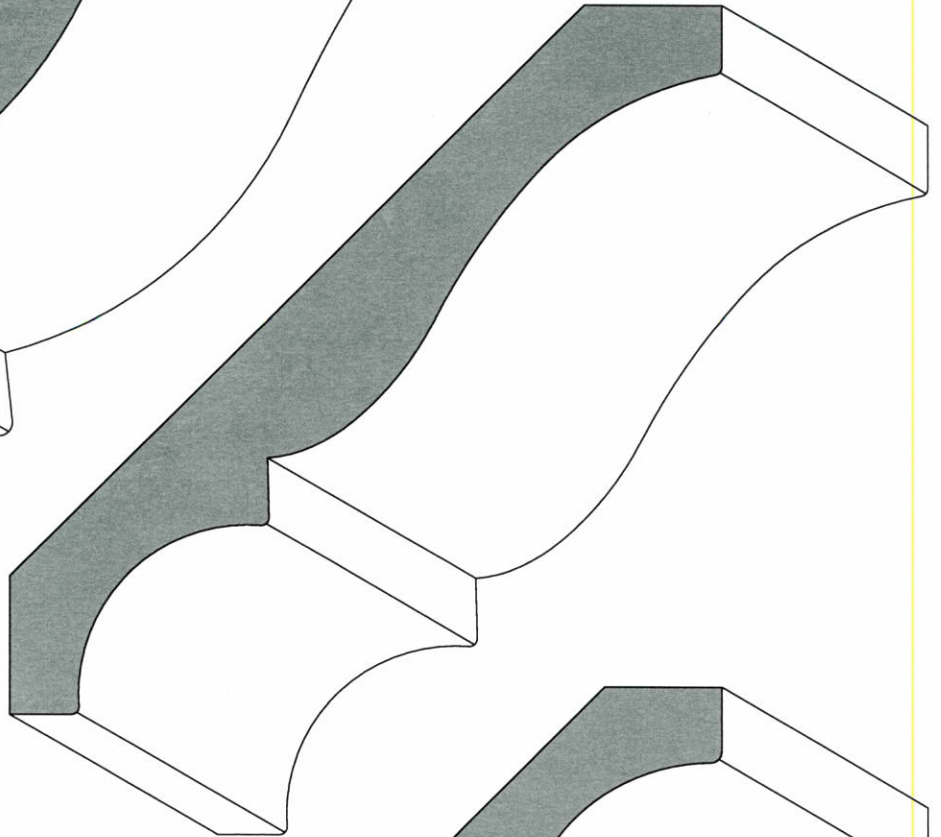

CRO-500  
5-1/4 Crown Mould

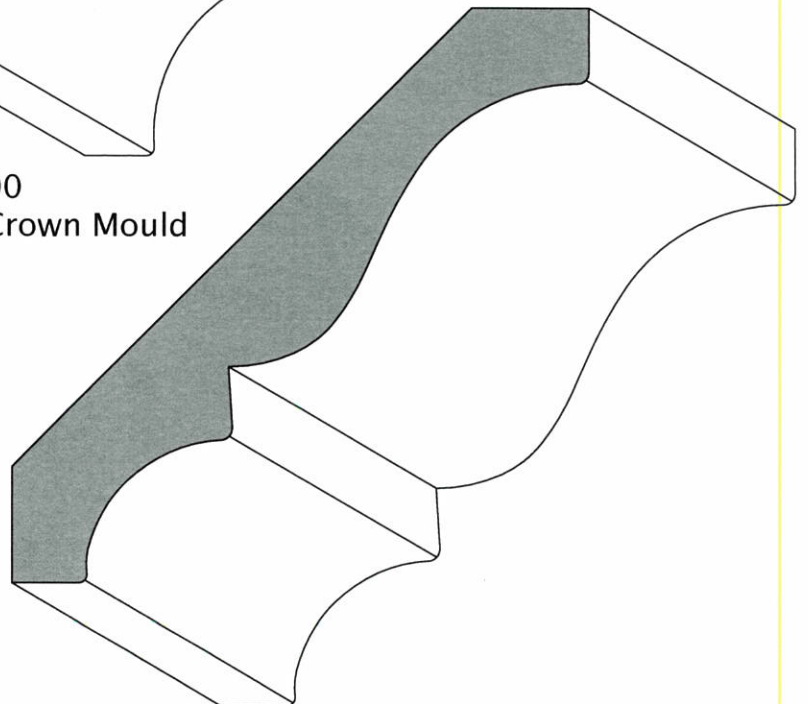

CRO-400  
4-1/4 Crown Mould

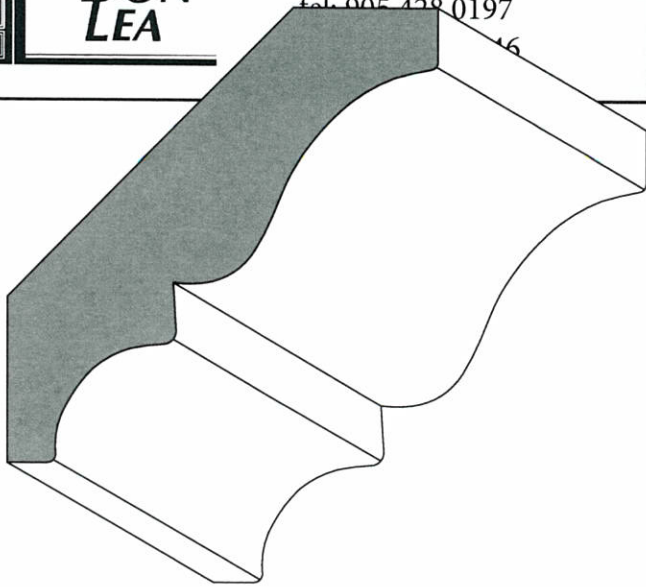

CRO-302  
3-1/4 Crown Mould

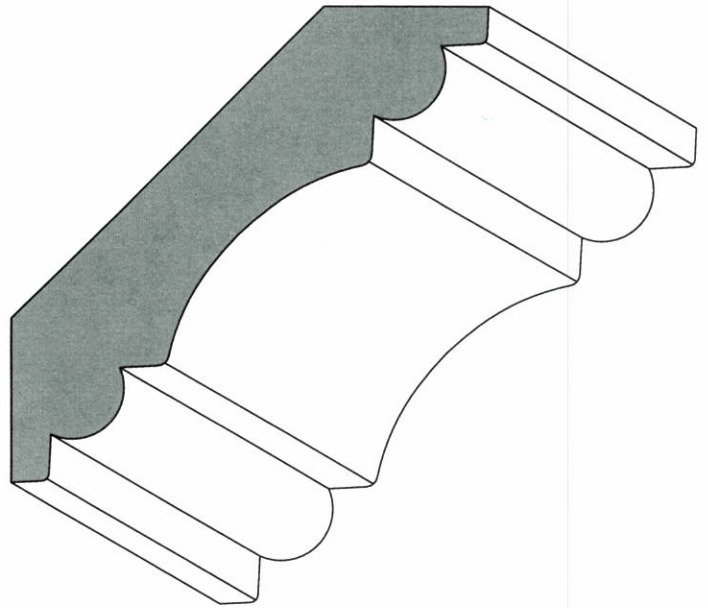

CRO-300  
3-1/2 Symmetrical Crown Mould

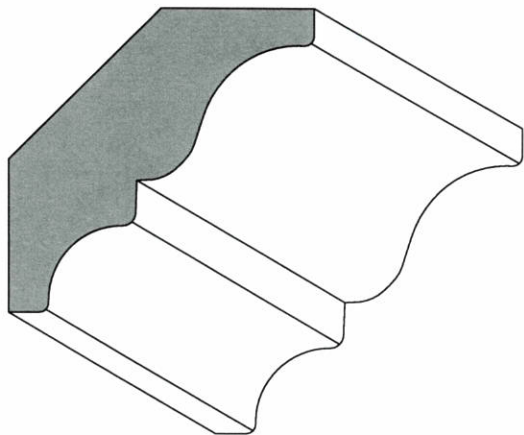

CRO-202  
2-1/4 Crown Mould

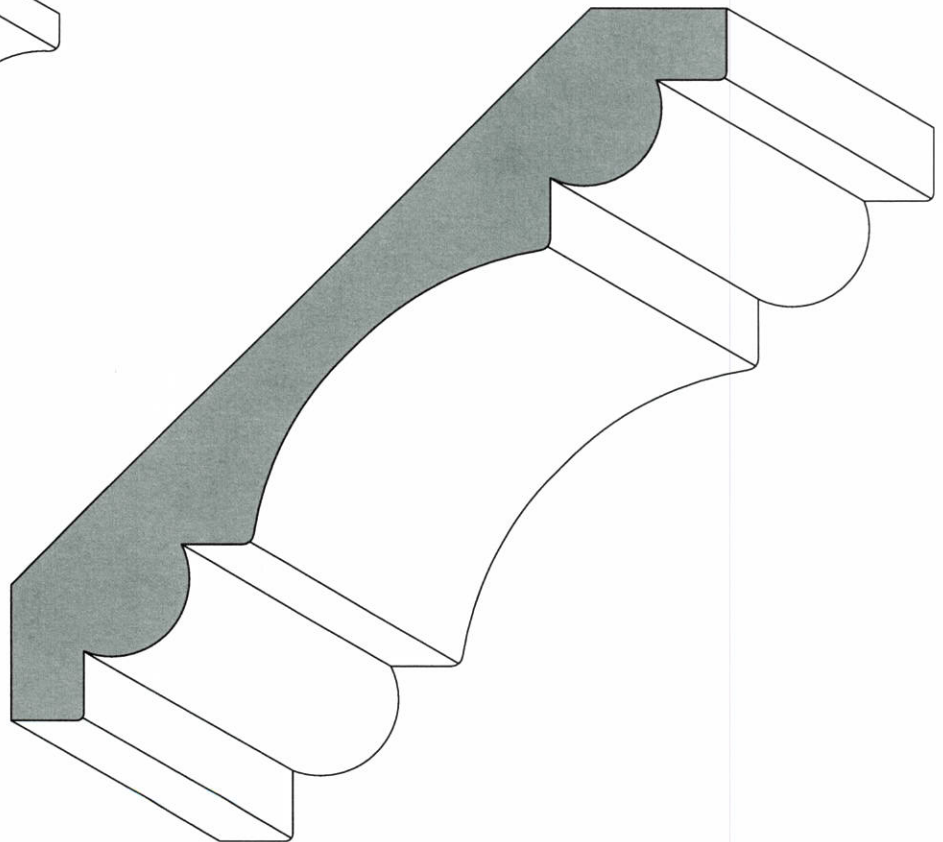

CRO-501  
5-1/4 Symmetrical Crown Mould

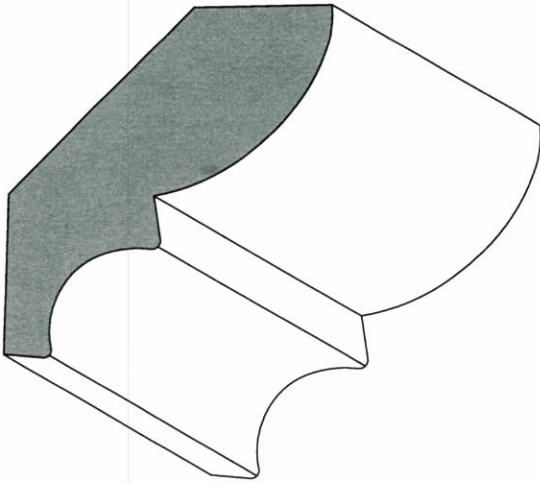

BED-201  
2-1/2 Bed Mould

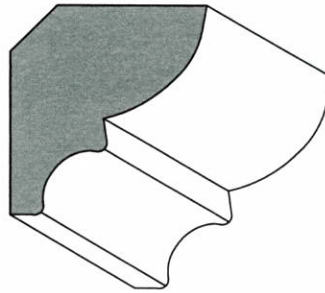

BED-100  
1-1/2 Bed Mould

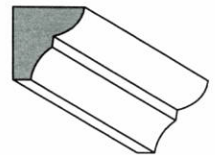

BED-001  
3/8 Bed Mould

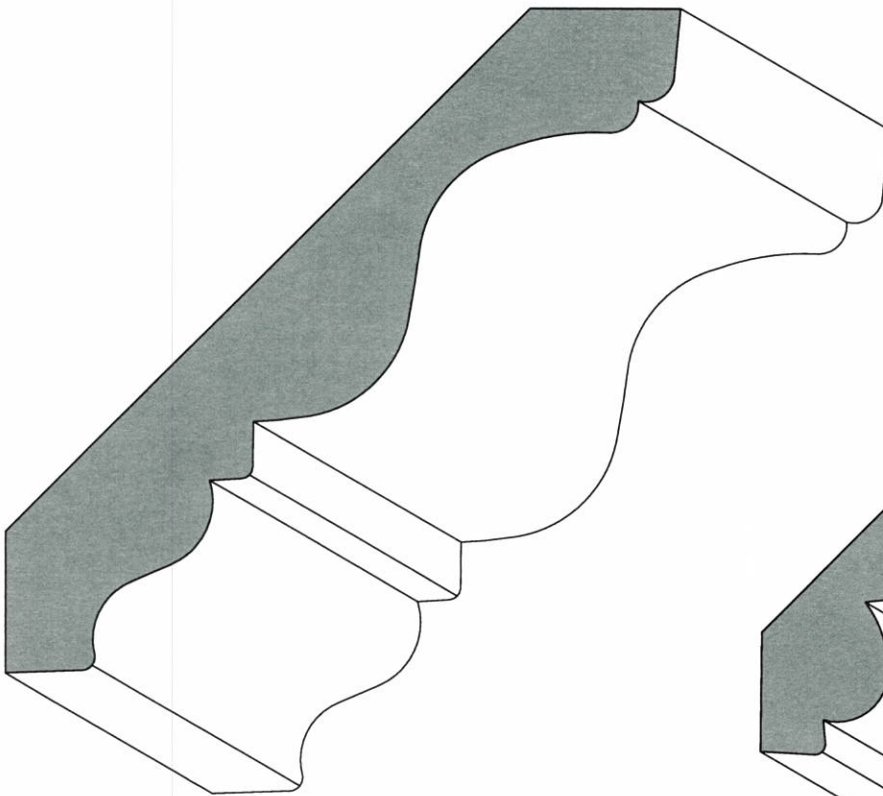

CRO-402  
4-15/16 Decorative Crown Mould

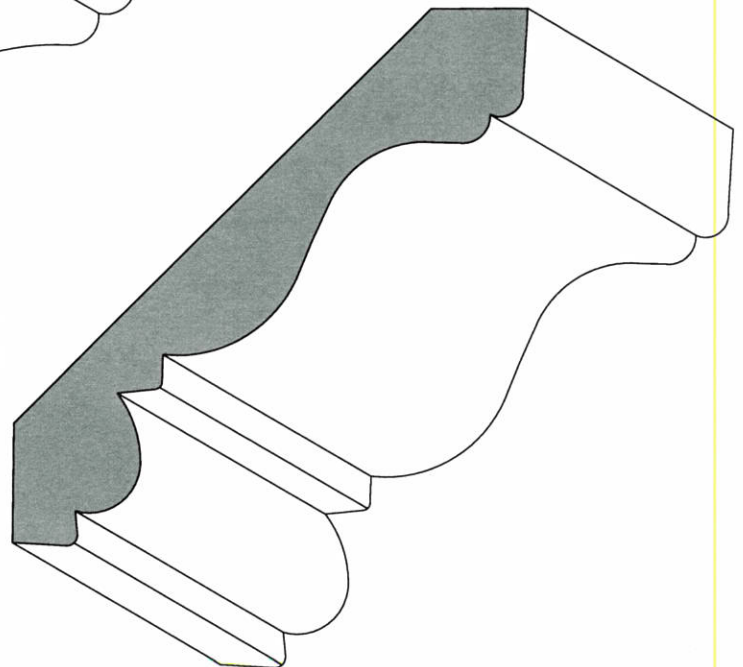

CRO-301  
3-7/8 Decorative Crown Mould





info@donlealumber.com  
tel: 905.428.0197  
fax: 905.428.0546

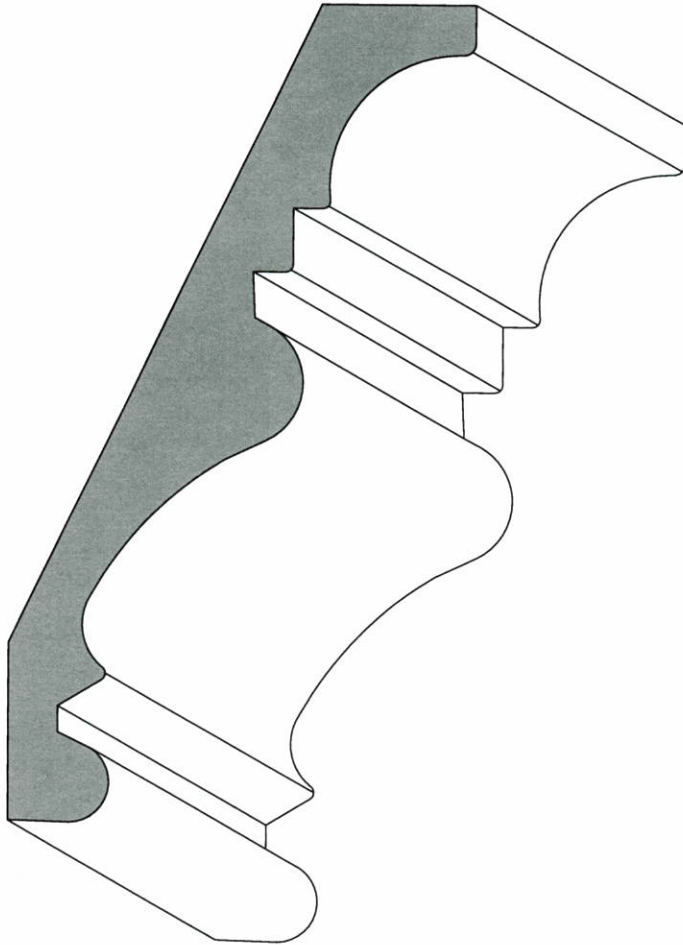

CRO-425  
4-7/8 Decorative Crown Mould

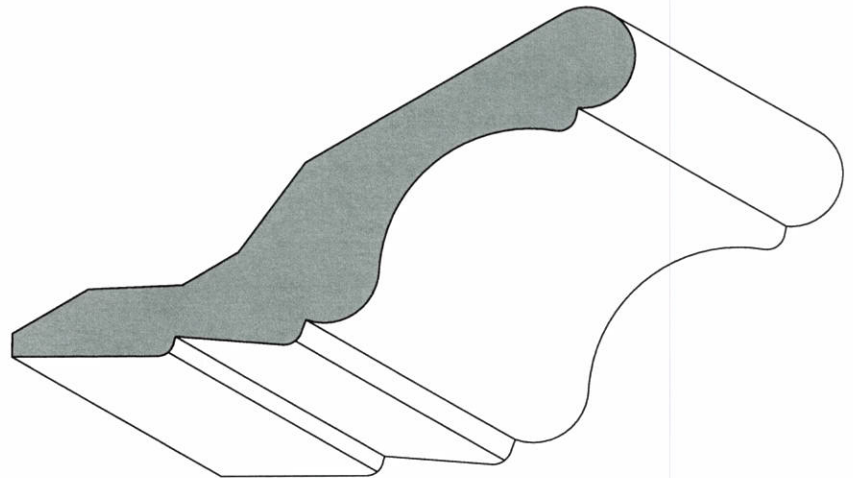

CRO-317  
3-5/8 Cabinet Crown Mould

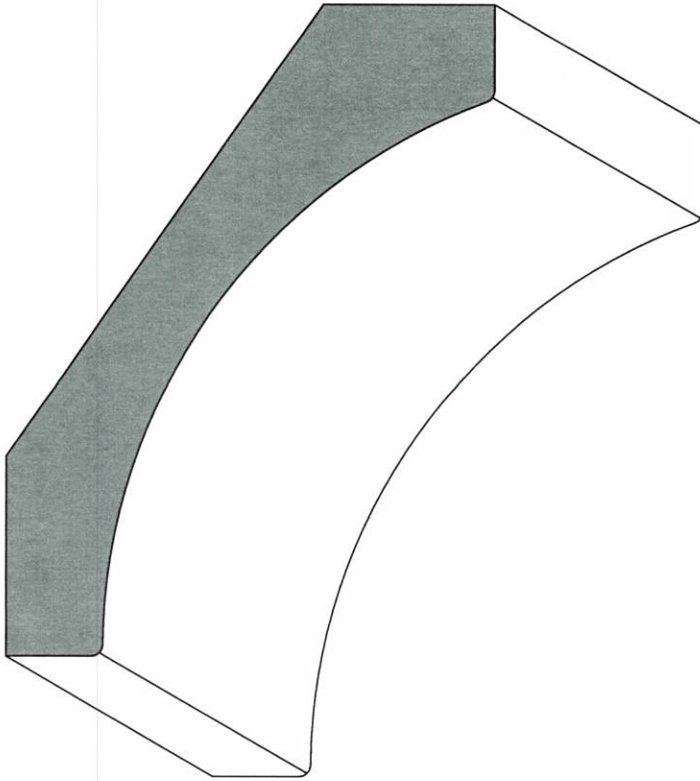

COV-401  
4-1/4 Cove Mould

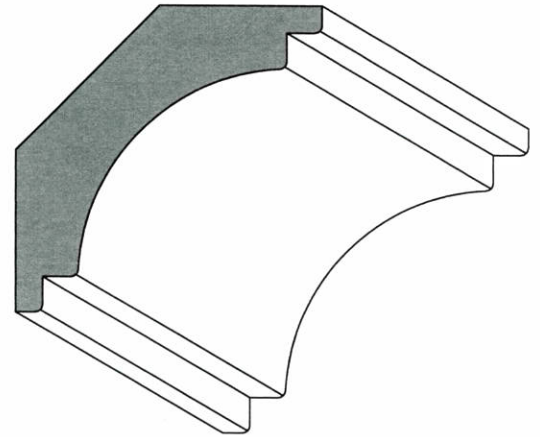

COV-221  
2-1/4 Decorative Cove

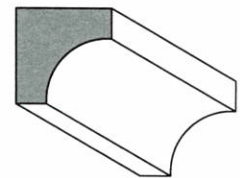

COV-001  
1/2 Cove Mould

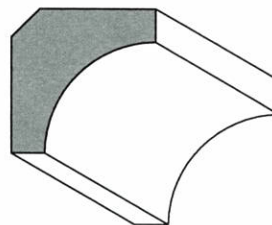

COV-003  
3/4 Cove Mould

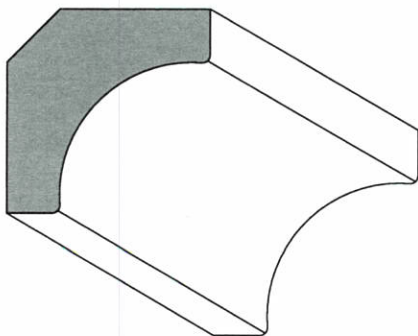

COV-103  
1-1/16 Cove Mould



**DON  
LEA**

info@donlealumber.com

tel: 905.428.0197

fax: 905.428.0546

S7 - P30

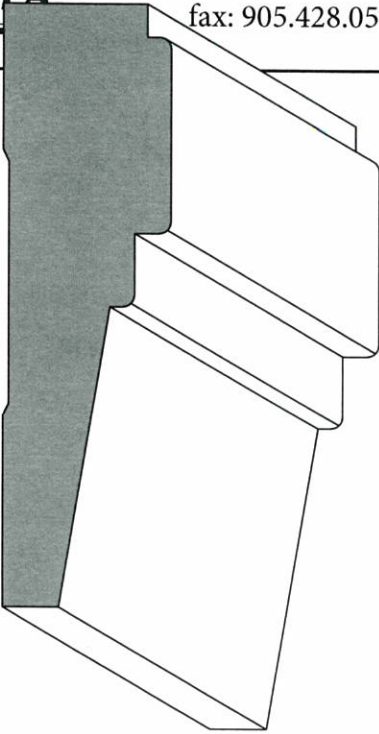

CHA-334  
3-1/8 Contemporary Chair Rail

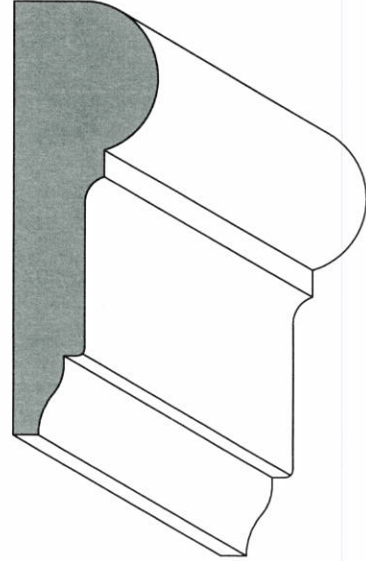

CHA-209  
2-1/4 Chair Rail

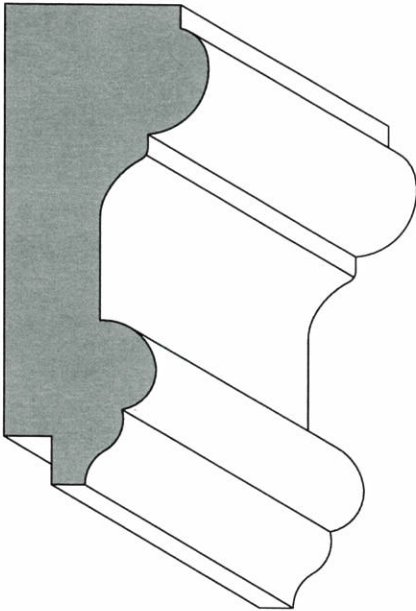

CHA-224  
2-1/2 Chair Rail

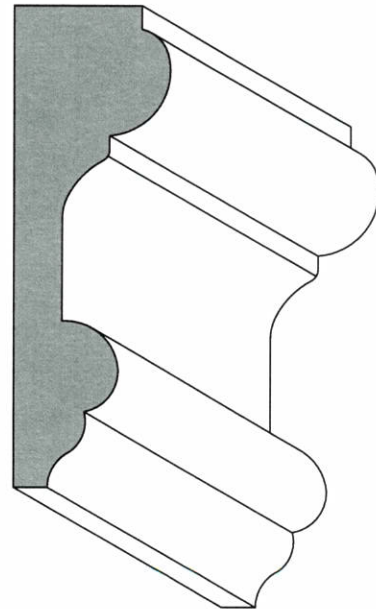

CHA-204  
2-1/2 Chair Rail



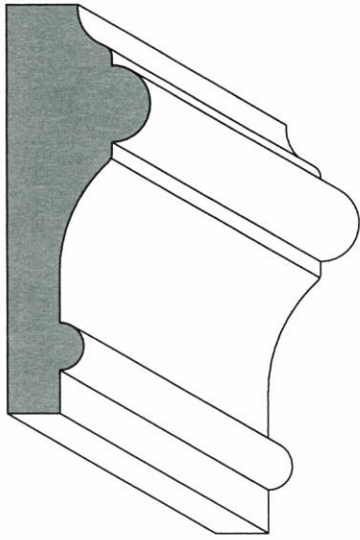

CHA-202  
2-1/8 Chair Rail

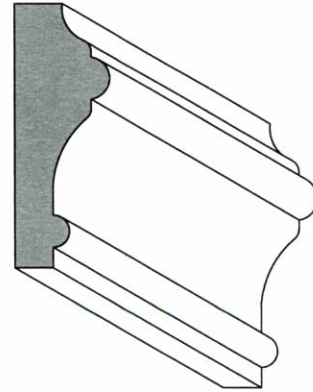

CHA-106  
1-3/8 Chair Rail

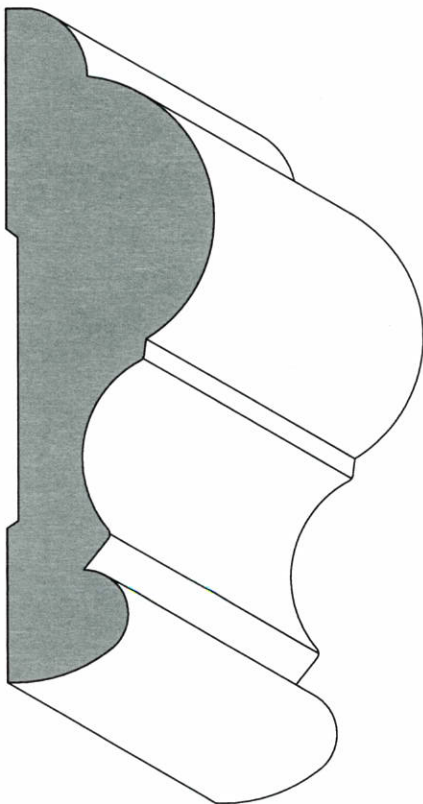

CHA-308  
3-1/2 Chair Rail

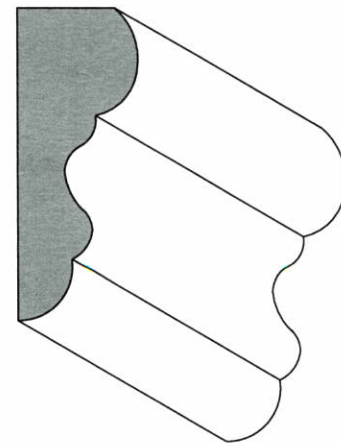

CHA-110  
1-5/8 Chair Rail



info@donlealumber.com  
tel: 905.428.0197  
fax: 905.428.0546

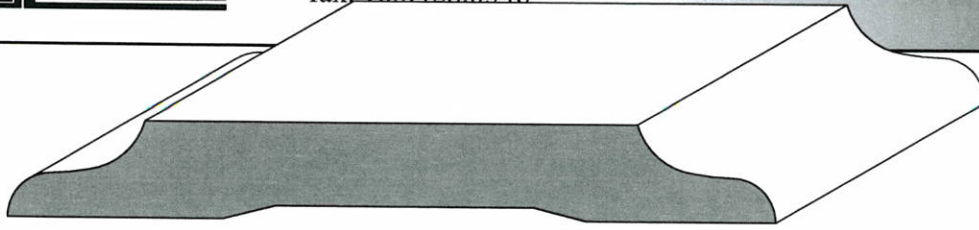

BAC-405  
4" Back Mould

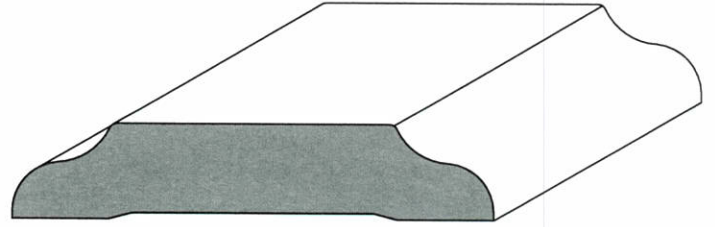

BAC-205  
2-1/2 Back Mould

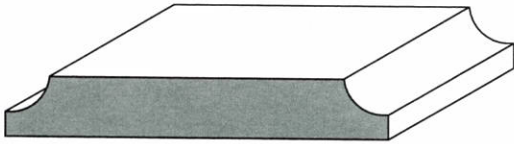

BUR-201  
2" Colonial Burlap

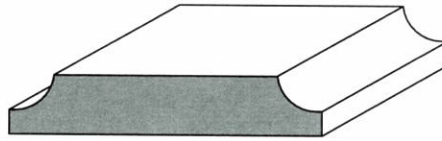

BUR-102  
1-5/8 Colonial Burlap

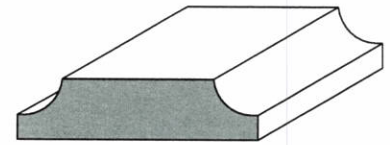

BUR-101  
1-1/4 Colonial Burlap

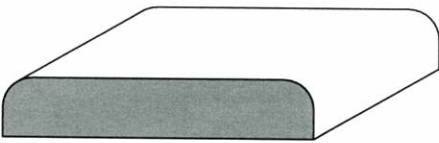

BUR-106  
1-5/8 Bullnose Burlap

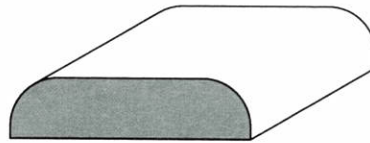

BUR-105  
1-1/4 Bullnose Burlap

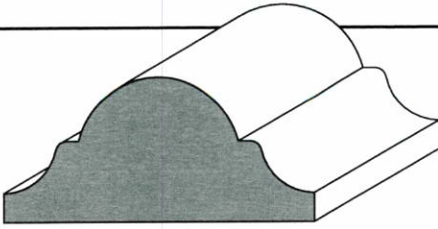

DEC-105  
 1-5/8 Symmetrical  
 Decorative Mould

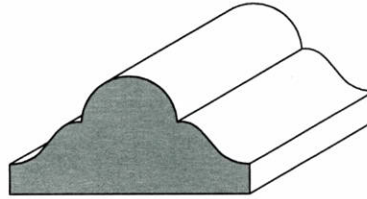

DEC-102  
 1-1/4 Symmetrical  
 Decorative Mould

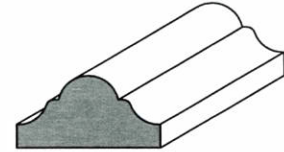

DEC-005  
 3/4 Symmetrical  
 Decorative Mould

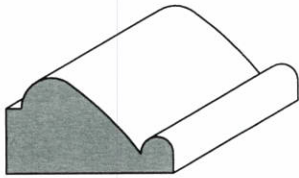

DEC-007  
 7/8 Inset Panel Mould

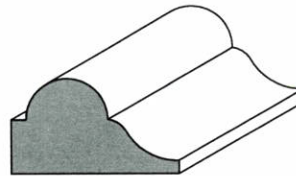

DEC-065  
 7/8 Decorative Mould

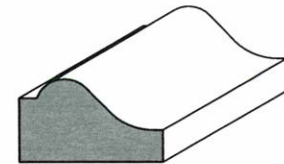

DEC-006  
 3/4 Decorative Mould

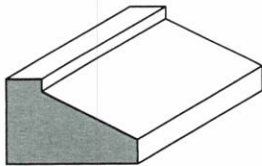

DEC-066  
 11/16 Contemporary  
 Decorative Mould

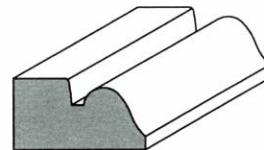

DEC-022  
 11/16 Decorative Mould

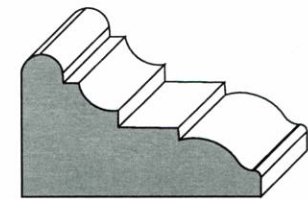

DEC-123  
 1-1/4 Decorative Mould

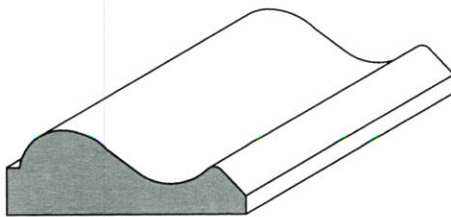

PRO-104  
 1-1/4 Provincial Mould

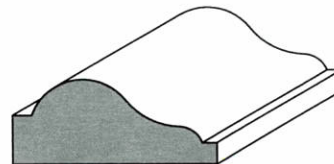

DEC-103  
 1-1/16 Inset Decorative Mould

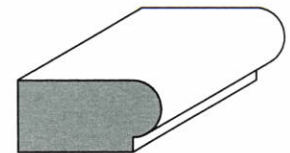

BEA-001  
 3/4 Bead Mould



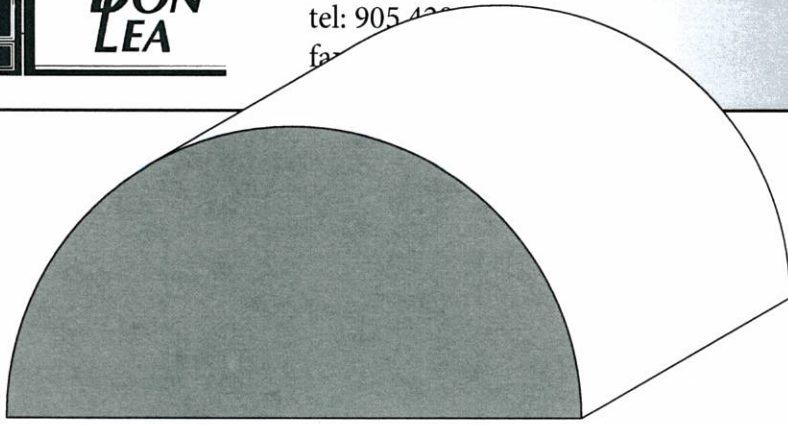

HAL-300  
3" Half Round

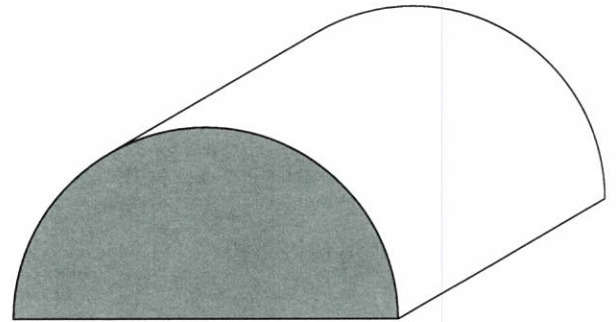

HAL-200  
2" Half Round

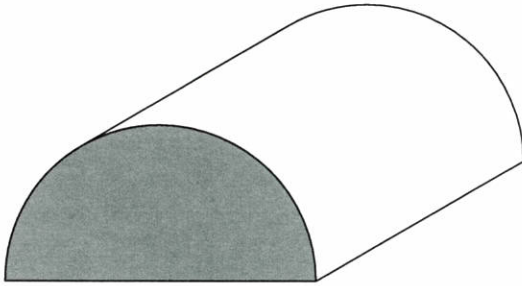

HAL-102  
1-5/8 Half Round

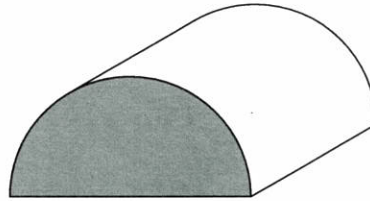

HAL-101  
1-1/4 Half Round

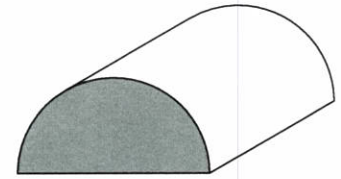

HAL-100  
1" Half Round

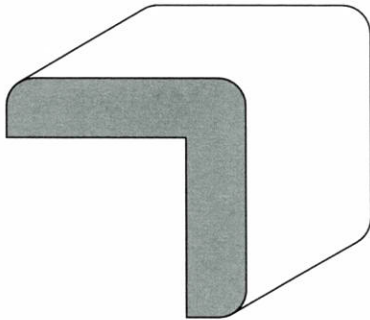

OUT-105  
1-1/4 Outside Corner

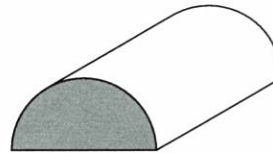

HAL-001  
3/4 Half Round

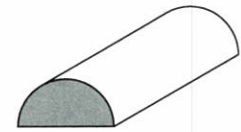

HAL-005  
1/2 Half Round

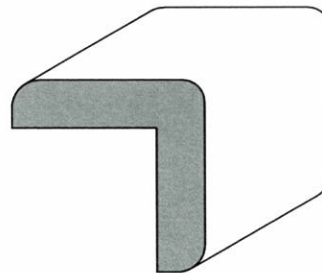

OUT-007  
1" Outside Corner

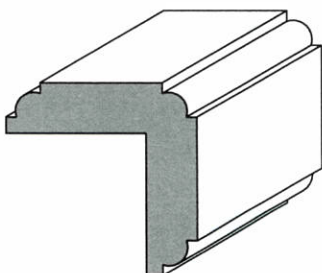

OUT-008  
1" Decorative  
Outside Corner

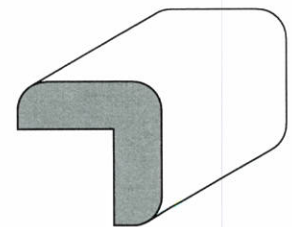

OUT-001  
3/4 Outside Corner

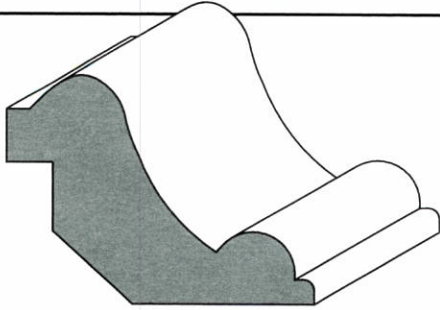

PAN-103  
 3/4" Offset Panel Mould

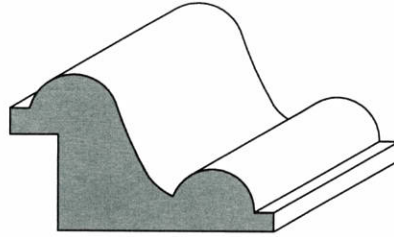

PAN-101  
 1/2" Offset Panel Mould

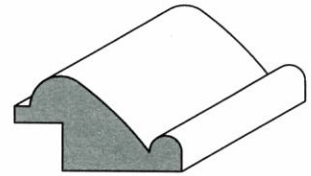

PAN-001  
 1/4" Offset Panel Mould

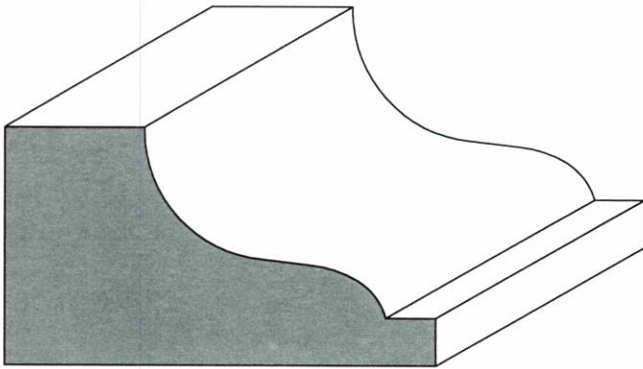

SHI-203  
 2-1/4 Shingle Mould

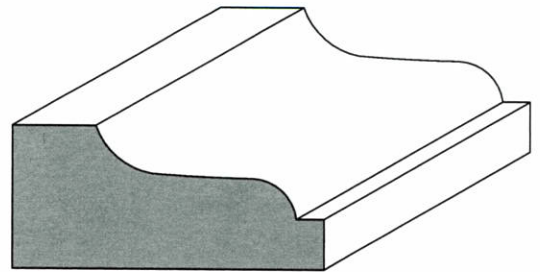

SHI-101  
 1-5/8 Shingle Mould

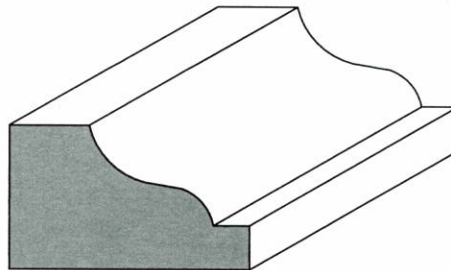

SHI-102  
 1-1/4 Shingle Mould

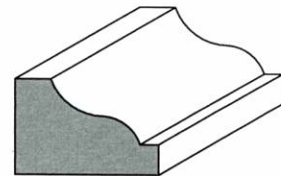

SHI-002  
 3/4 Shingle Mould

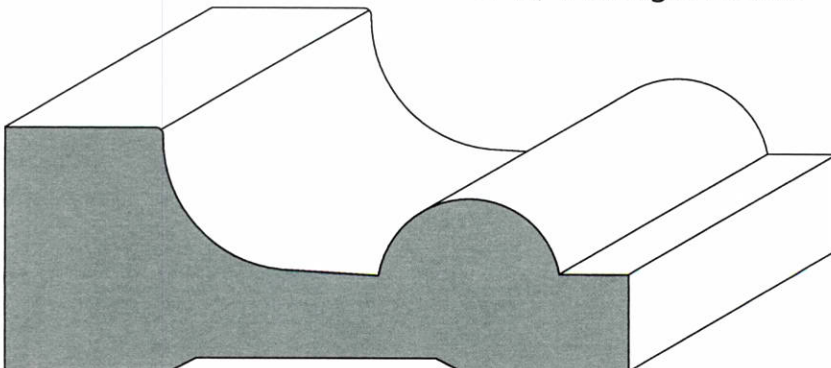

SHI-308  
 3-1/4 Shingle Mould



info@donlealumber.com

tel: 905.428.0197

fax: 905.428.0546

S9 - P36

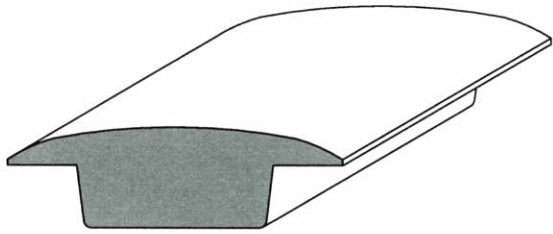

RED-116  
1-3/4 "T" Reducer

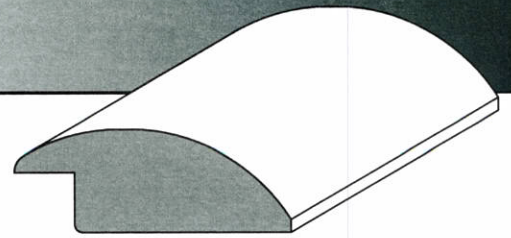

RED-114  
1-7/16 Laminate Reducer

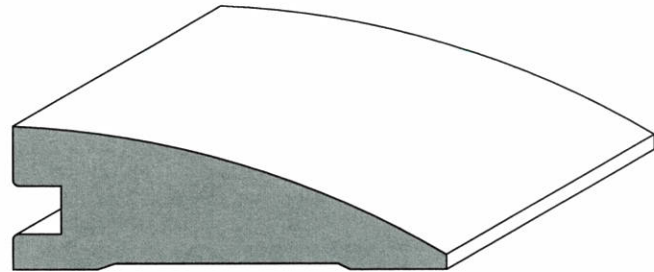

RED-202  
2-1/4 Reducer

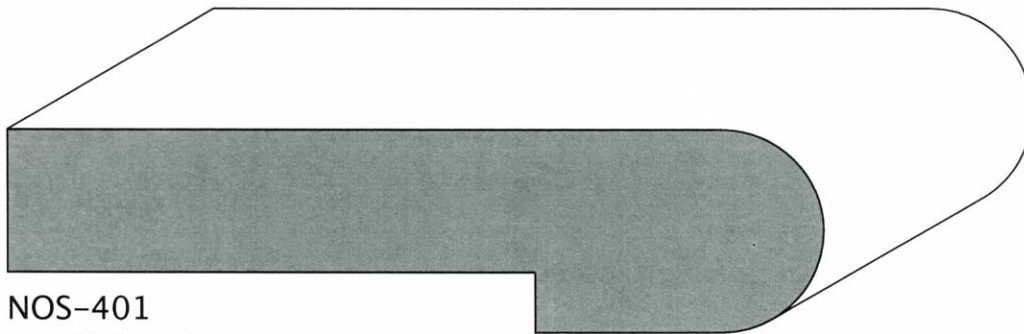

NOS-401  
4-1/4 Stair Nosing

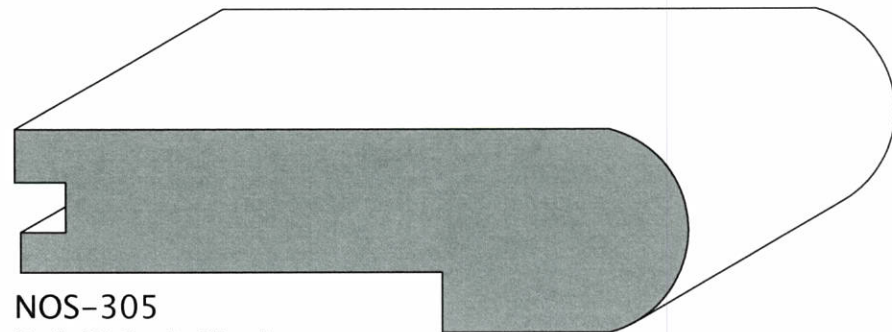

NOS-305  
3-1/2 Stair Nosing

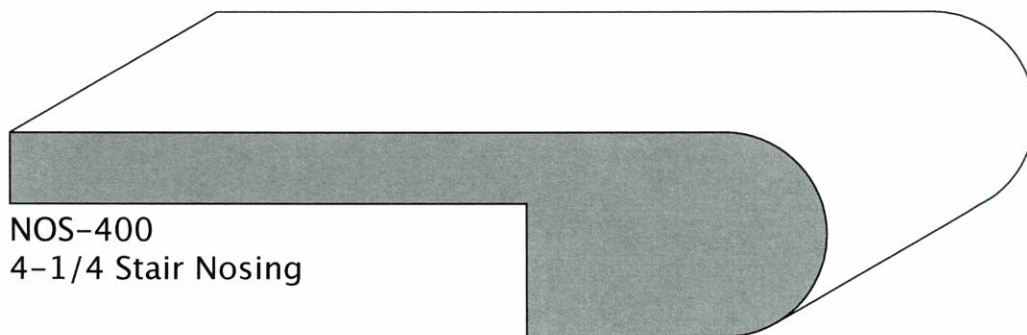

NOS-400  
4-1/4 Stair Nosing





info@donlealumber.com  
tel: 905.428.0197  
fax: 905.428.0546

S10 - P37

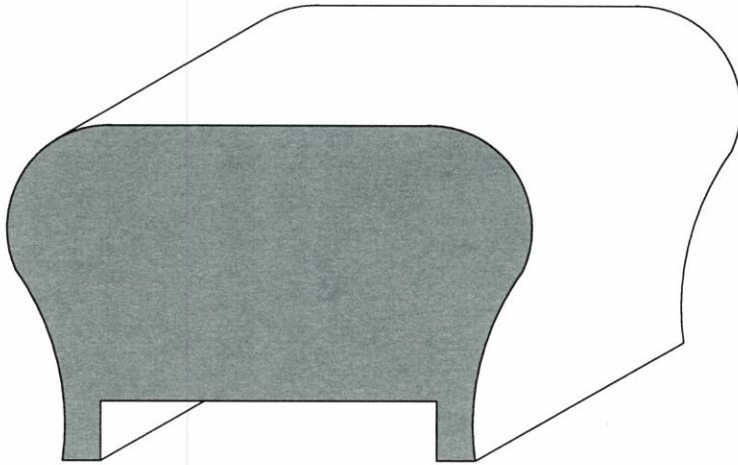

HAN-297  
2-3/4 Plain Handrail  
1-3/4 Cutout

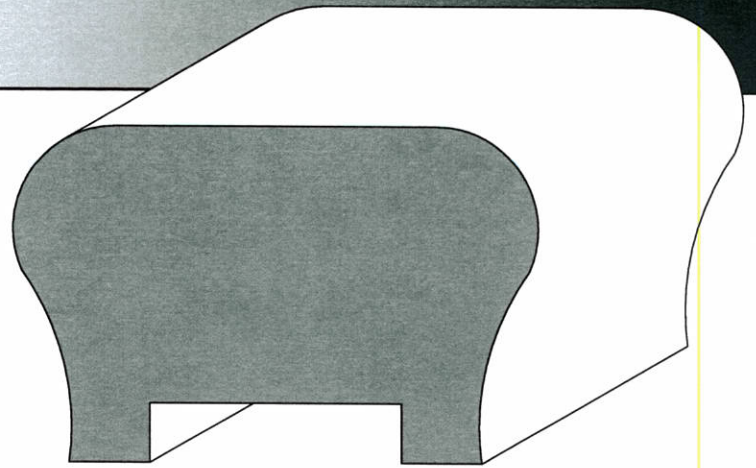

HAN-289  
2-3/4 Plain Handrail  
1-5/16 Cutout

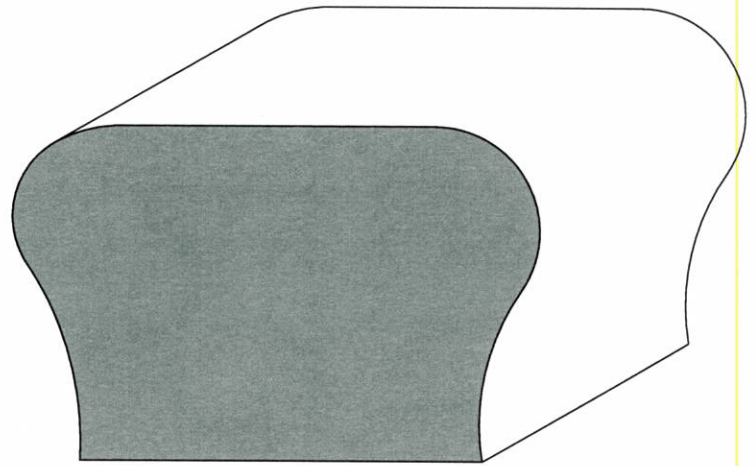

HAN-248  
2-3/4 Plain Handrail

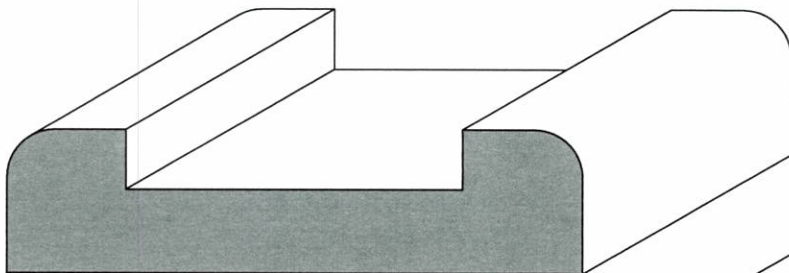

SHO-305  
3" Shoe Rail  
1-3/4 Cutout

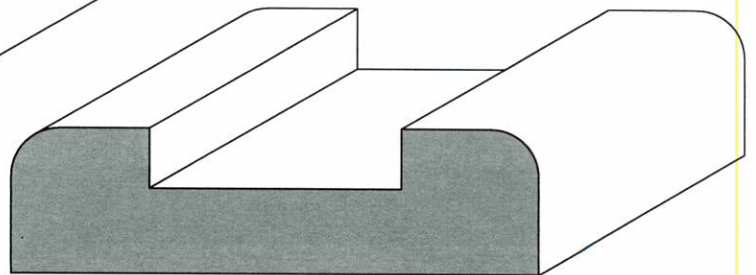

SHO-206  
2-3/4 Shoe Rail  
1-5/16 Cutout



info@donlealumber.com  
tel: 905.428.0197  
fax: 905.428.0546

S10 - P38

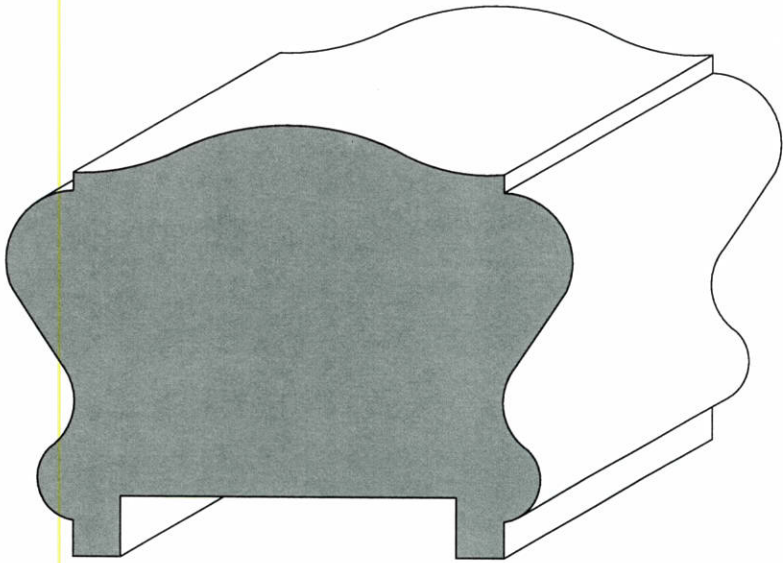

HAN-301  
3" Decorative Handrail  
1-3/4 Cutout

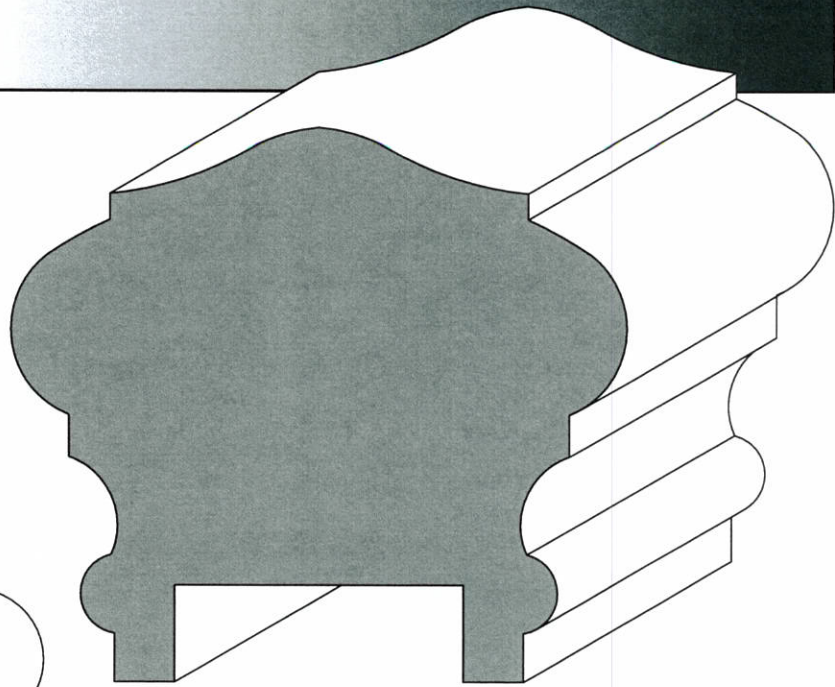

HAN-302  
3-1/4 Decorative Handrail  
1-1/2 Cutout

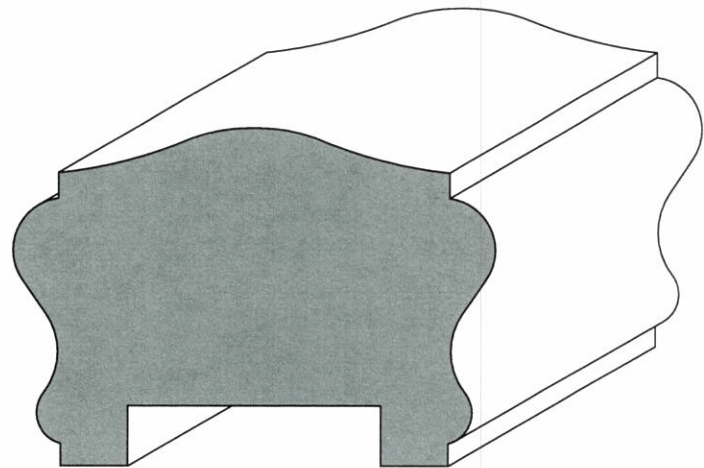

HAN-205  
2-1/2 Decorative Handrail  
1-5/16 Cutout

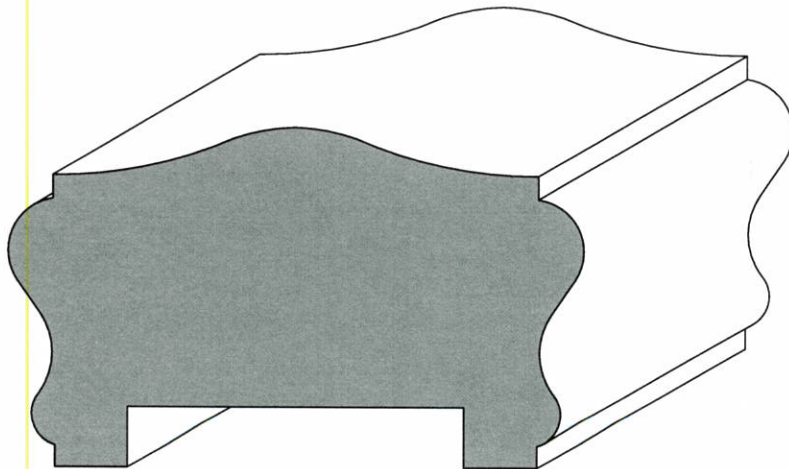

HAN-305  
3" Decorative Handrail  
1-3/4 Cutout

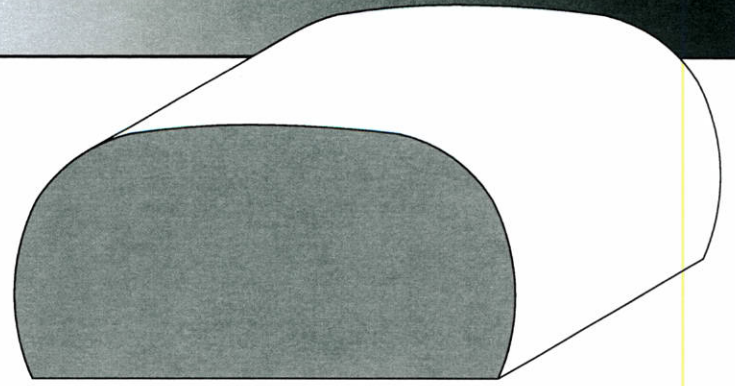

HAN-229  
2-5/8 Oval Handrail

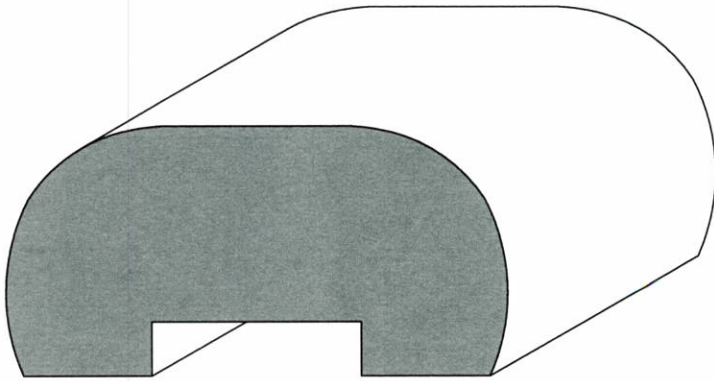

HAN-206  
2-5/8 Oval Handrail  
1-1/16 Cutout

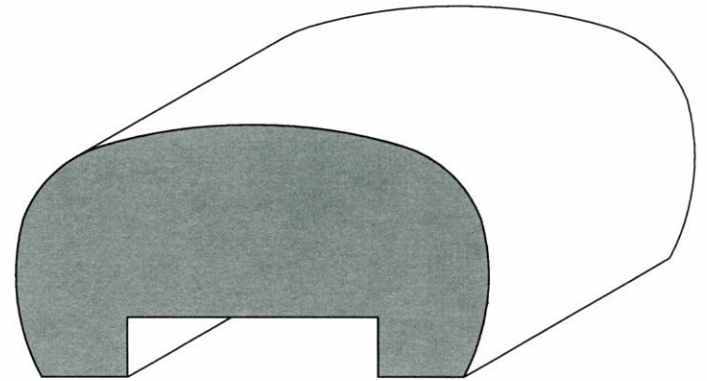

HAN-209  
2-1/2 Oval Handrail  
1-5/16 Cutout

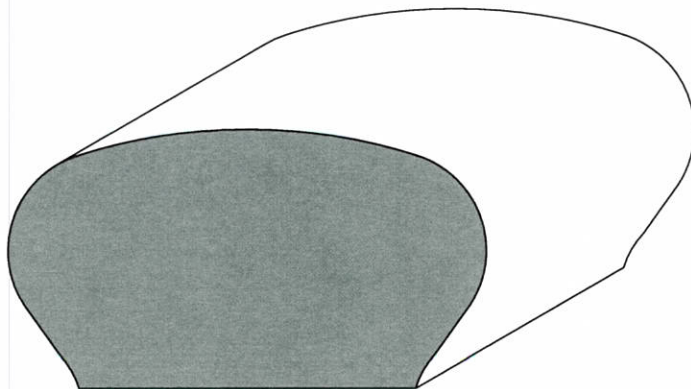

HAN-200  
2-1/2 Plain Handrail



## Paneling is reversible

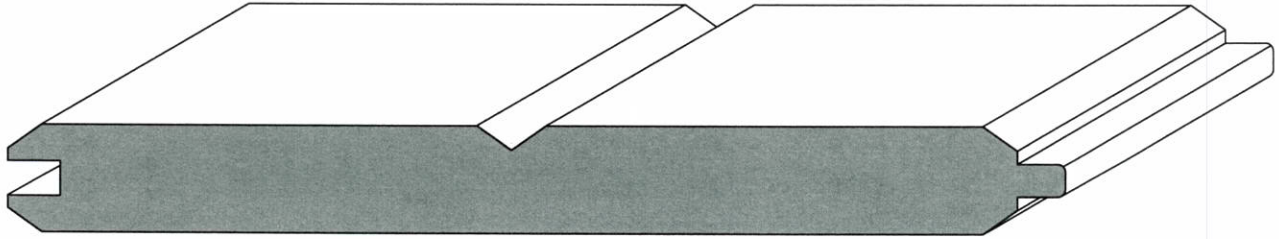

T&G-500  
5-1/4" Face - Center "V" / "V" Joint

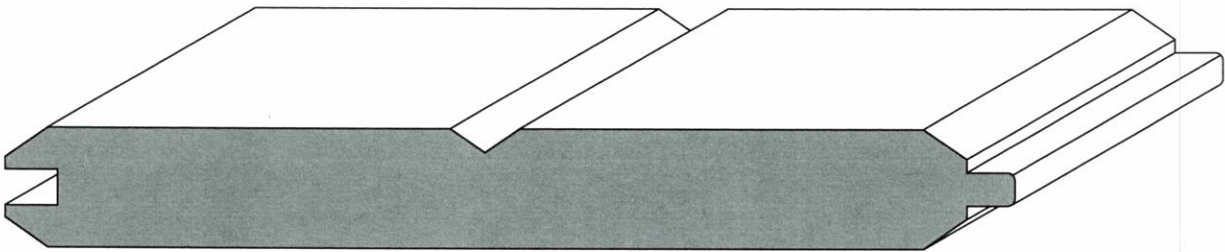

T&G-537  
5" Face - Center "V" / "V"  
Joint

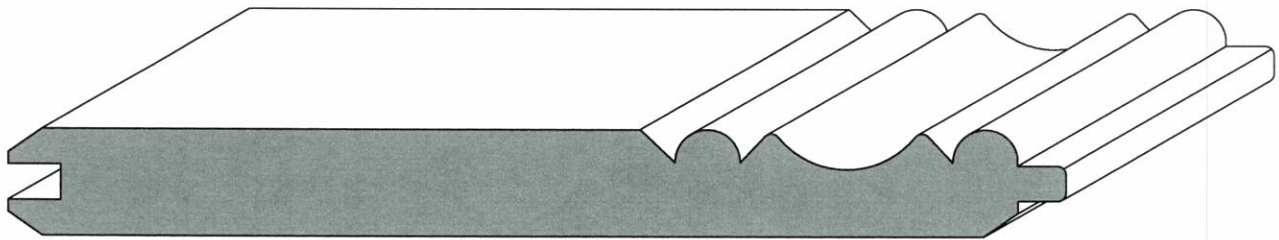

T&G-502  
5-1/4" Face - Pickwick / "V" Joint

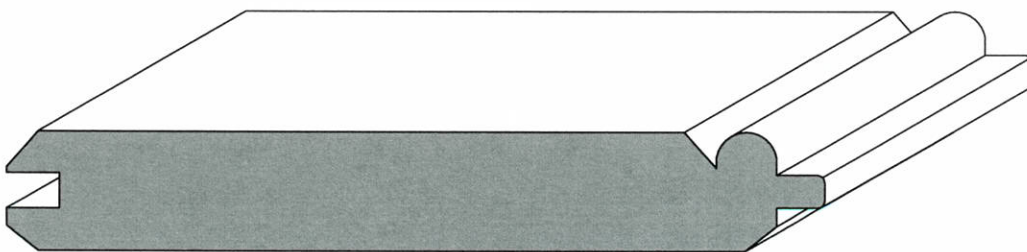

T&G-409  
4" Face - Single Bead / "V" Joint



info@donlealumber.com  
tel: 905.428.0197  
fax: 905.428.0546

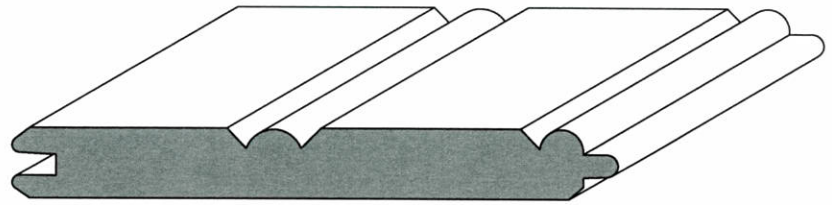

T&G-303  
3" Face - Double Bead  
Pre-Packaged Paneling

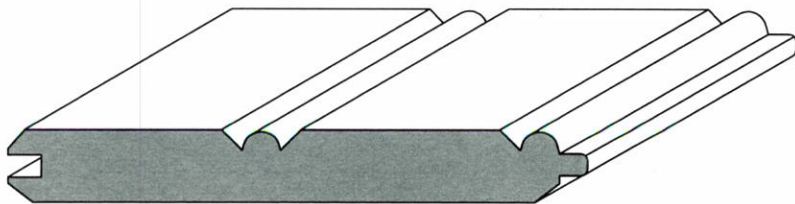

T&G-300  
2-7/8 Face - Double Bead / "V" Joint

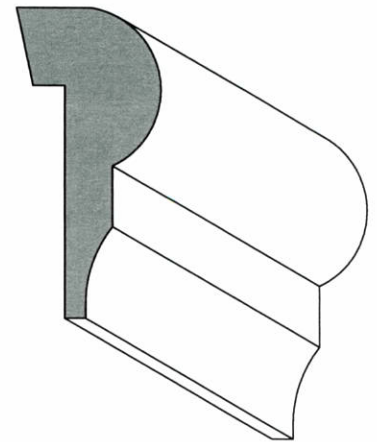

CAP-109  
1-5/8 Cap Mould

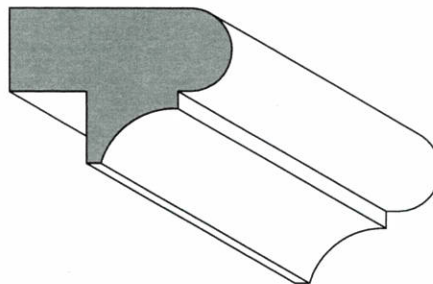

CAP-100  
1-1/8 Colonial Cap Mould

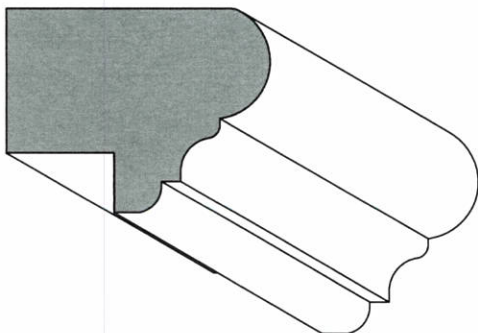

CAP-104  
1-3/8 Colonial Cap Mould



**DON  
LEA**

info@donlealumber.com  
tel: 905.428.0197  
fax: 905.428.0546

S12 - P42

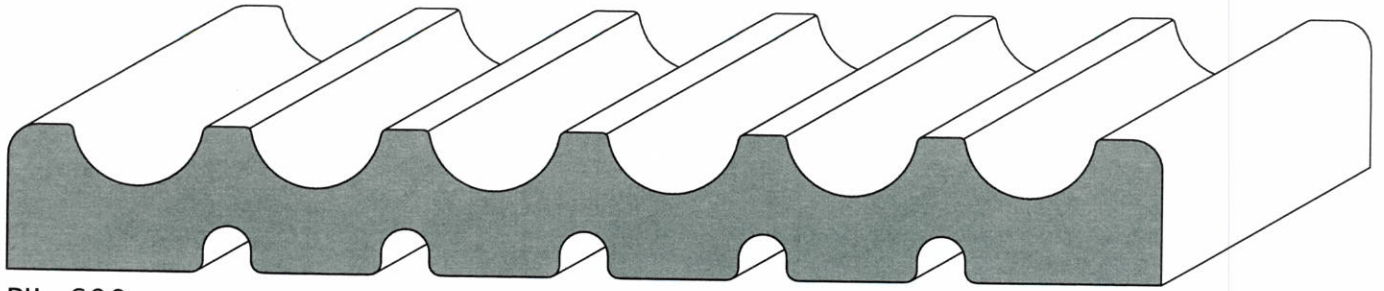

PIL-600  
6" Fluted Pilaster

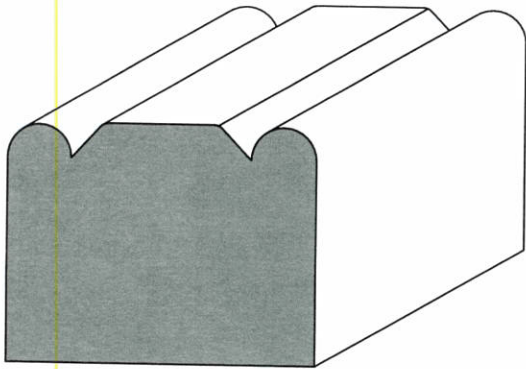

BRI-103  
1-5/8 Brick Mould

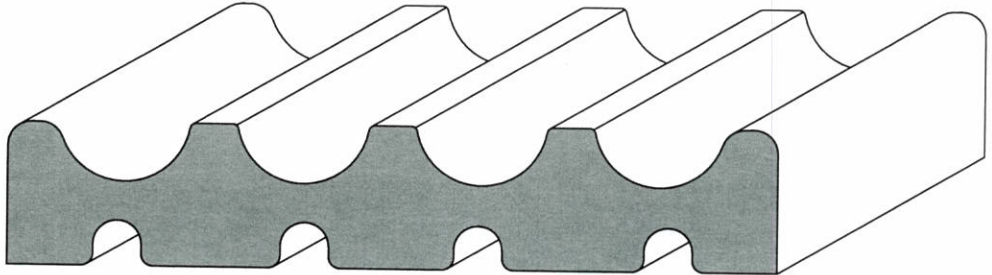

PIL-400  
4" Fluted Pilaster

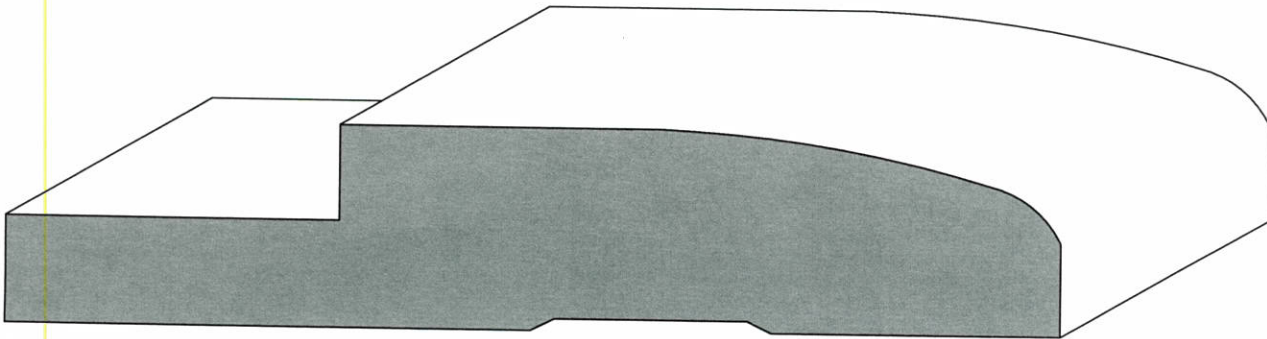

THR-500  
5-1/2 Threshold

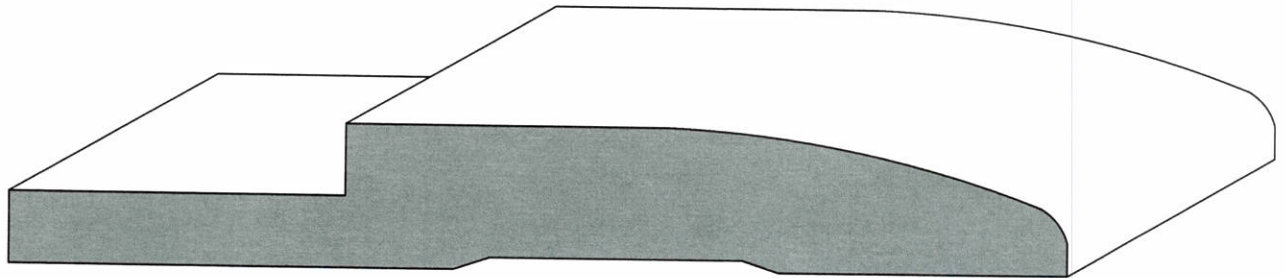

THR-501  
5-1/2 Threshold





info@donlealumber.com

tel: 905.428.0197

fax: 905.428.0546

S12 - P43

BAR-501  
5-1/4 Bar Rail



BAR-301  
3-5/8 Bar Rail

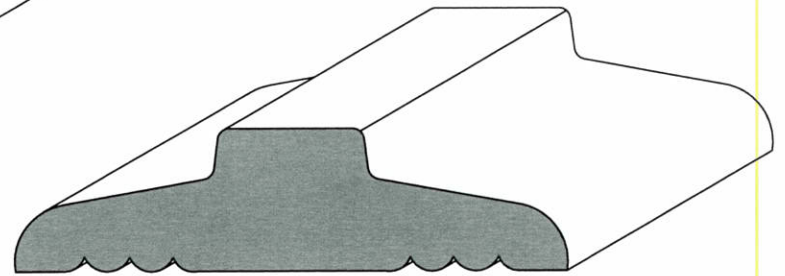
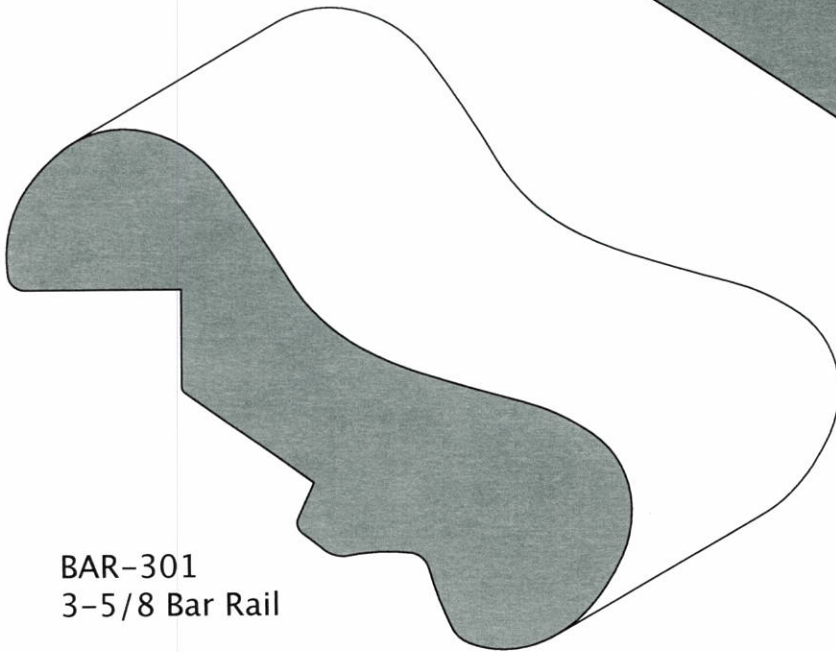

WIN-200  
2-7/8 Wine Glass Holder

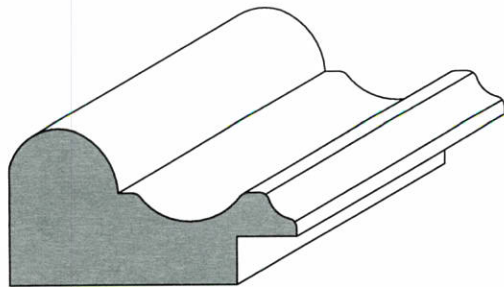

PIC-102  
1-1/2 Picture Frame

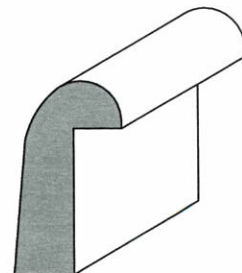

STO-103  
1" Glass Stop



info@donlealumber.com  
 tel: 905.428.0197  
 fax: 905.428.0546

S13 - P44

D4S SIZE	PAINT GRADE	KNOTTY PINE	CLEAR PINE	OAK	MAPLE	CHERRY	Primed FJ Poplar
1/4 x 3/4				•	•		
1/4 x 7/8					•		
5/16 x 1-5/16	•		•	•			
5/16 x 1-3/4	•		•	•	•	•	
1/4 x 2-1/2	•		•	•	•		
1/4 x 3-1/2	•		•	•	•		
1/4 x 5-1/2	•		•	•	•		
1/4 x 7-1/4			•	•			
1/2 x 1/2	•			•	•		
3/4	•		•	•		•	
1-1/2	•		•	•	•		
2	•		•	•	•		
2-1/2	•	•	•	•	•		
3-1/2	•	•	•	•	•		
5-1/2	•	•	•	•	•		
7-1/4		•	•	•	•		
3/4 x 3/4	•		•		•		
1-1/2	•	•	•	•	•	•	
1-3/4			•	•	•		
2			•	•	•	•	
2-1/2	•	•	•	•	•	•	•
3-1/2	•	•	•	•	•	•	•
4-5/8	•	•	•	•	•	•	•
5-1/2	•	•	•	•	•	•	•
6-5/8	•		•	•	•		•
7-1/4	•	•	•	•	•		
9-1/4	•	•	•	•	•	•	•
11-1/4	•	•	•	•	•		
1 x 1	•		•				
1-1/4 x 1-1/4		•		•	•		
2-1/2		•		•	•		
3-1/2	•	•		•	•		
5-1/2	•	•		•	•		
7-1/4	•	•		•	•		
1-5/8 x 1-5/8	•	•	•	•	•		
2-1/2	•		•	•	•		
3-1/2	•	•	•	•	•		
5-1/2	•	•	•	•	•		
7-1/4	•	•	•	•	•		
9-1/4		•	•	•	•		
11-1/4		•	•	•			
3-1/2 x 3-1/2*	•	•		•			

**Ultra Flex**

3/4 x 3-1/2 • 10' pc

3/4 x 5-1/2 • 10' pc

3/4 x 7-1/4 • 10' pc





**DON  
LEA**

**DON LEA LUMBER LTD.**

INTERIOR DOORS • MOULDINGS • HARDWARE

Email: [info@donlealumber.com](mailto:info@donlealumber.com)

Tel: 905.428.0197

Fax: 905.428.0546

1062 Copperstone Drive,  
Pickering, Ontario L1W3V8

- PRE-HUNG INTERIOR DOORS
- INTERIOR TRIM PRODUCTS
- DOOR HARDWARE
- INTERIOR AND EXTERIOR COLUMNS
- CURVED MOULDINGS
- CUT TO SIZE MDF AND PLYWOOD
- CUSTOM MADE, UNFINISHED MANTLES AND CABINETS



OCTOBER - 2016