



**Leonardt**

Specialists in Precision Presswork and  
Contract Finishing of Metal Components

**GENERAL HARDWARE CATALOGUE**

# Contents

03	Introduction
05	Trouser Hooks & Bars
13	Brace Fittings
21	Suspender & Garter Fittings
25	Eyelets
29	Split Rings & Key Rings
37	D and O Rings
45	Loops
51	Slides
57	Pressed Roller Buckles
63	Wire Roller Buckles
67	Sliding Bar Buckles
71	Buckles-general
79	Hooks
85	Spears
89	Cheney Hardware

# Introduction

Established in 1856 in the West Midlands, Leonardt Ltd is an expert in precision presswork and metal finishing. Today, we are a market leader in the manufacture of a vast range of metal components, supplying a comprehensive range of parts to customers in a variety of industries - promotional products, clothing, equestrian/pet, safety and medical products, musical instrument cases are just some of the sectors we serve.

Preserving and promoting UK manufacturing is extremely important to us – the vast majority of products in our range are manufactured at our Shropshire factory. To complement the range, we also import from trusted international partners – products are handpicked and checked to meet our own high quality standards. The company is extremely proud to have a number of high profile companies as customers.

This catalogue will take you through our core product range. Large stocks are held in our Shropshire warehouse and we can offer next day delivery for most orders. The list of products listed here is not exhaustive – Our In-house manufacture means that Leonardt can offer bespoke solutions, including personalisation on a selection of products. We are also able to offer lots of our products in different finishes to match individual customer requirements. A note on the core finishes offered:

- » Nickel – A silvery/white, lustrous metal finish - Our decorative nickel plating is hard and ductile. It provides excellent resistance to corrosion. Available in bright/matt options.
- » Nickel Free / White Bronze – White Bronze is a tri-alloy with a composition of 55% Copper, 30% Tin & 15% Zinc. A similar silver colour & corrosion resistant finish to nickel, White Bronze is becoming increasingly popular on items where nickel is prohibited such as clothing/jewellery.
- » Gold – Genuine 23.5 carat gold plating – This hard wearing, luxury finish offers the ultimate in lustre and resistance to corrosion.
- » Brass – Our imitation gold – a more economical gold coloured finish.
- » Zinc – An economical, silvery/blue metal finish that offers excellent corrosion resistance.
- » Black – Our “Black Magic” coating provides a uniform semi-matt black finish.
- » Antique Finishes – Bespoke finishes to give items an aged/ weathered look.

Other Finishes such as powder coating (any colour!) – Available upon request.

Leonardt is also the UK distributor for Duraflex plastic hardware – this means we are able to offer plastic material equivalents of lots the products offered in this catalogue. These products can be accessed here: <https://www.duraflexgroup.com/>

For all orders & enquiries, or for more information about our products - please get in touch with our sales team via email or telephone.

enquiries@leonardt.com  
+44 1746 861203

**Leonardt Ltd**  
Main Road  
WV16 6NN Highley, Shropshire, UNITED KINGDOM

is granted authorisation according to STANDARD 100 by OEKO-TEX® to use the STANDARD 100 by OEKO-TEX® mark, based on our test report **59553**



Email: [enquiries@leonardt.com](mailto:enquiries@leonardt.com)

Telephone: 01746 861203



## Trouser Hooks & Bars

### PRODUCT ITEM

Code: MN987

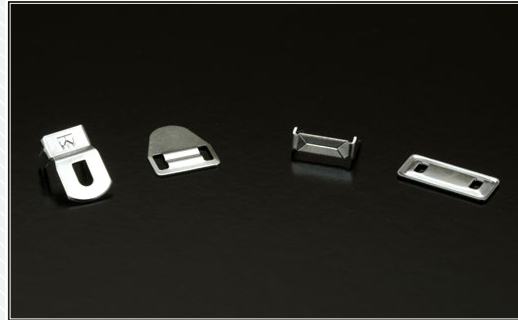

### PRODUCT DETAILS

Available Sizes in (in mm):

N/A

Standard finishes:

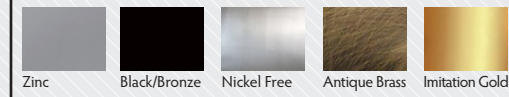

### NOTES:

- » Product supplied as 4 piece set
- » Sets made from steel or brass
- » Longer leg hook/staple available
- » Other finishes available on request
- » Compliant to Oeko-Tex Standard 100

Code: SMN987



Available Sizes in (in mm):

N/A

Standard finishes:



### NOTES:

- » Product supplied as 4 piece set
- » Sets made from steel or brass
- » Longer leg hook/staple available
- » Other finishes available on request
- » Compliant to Oeko-Tex Standard 100

Code: MAS9X87



Available Sizes in (in mm):

N/A

Standard finishes:



### NOTES:

- » Product supplied as 4 piece set
- » Sets made from steel or brass
- » Other finishes available on request
- » Compliant to Oeko-Tex Standard 100
- » Commonly used on Ladies Clothing

### OTHER EXAMPLE FINISHES

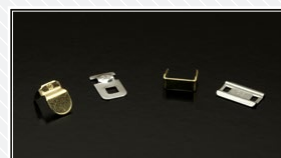

## Tooling Die-Sets

### PRODUCT ITEM

Code: N/A



### PRODUCT DETAILS

Available Sizes in (in mm):

N/A

Standard finishes:

N/A

### NOTES:

- » Tooling available for all fittings
- » Conversion tooling available to suit any machine
- » Tooling available for double & side-by-side application

### PRODUCT ITEM

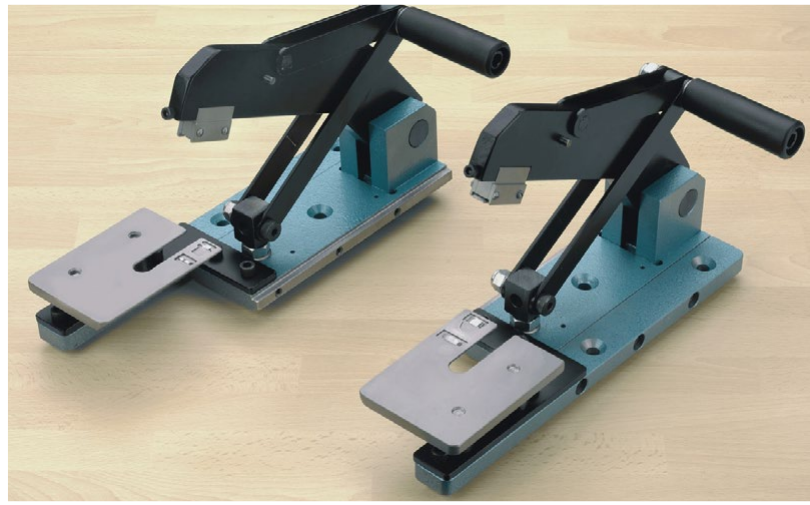

### PRODUCT DETAILS

#### RAPIDE 500

#### NOTES:

- » Hand Loaded
- » Hand Closure
- » Mens and Ladies fittings
- » Single Hook/Bar
- » Duplex Tool
- » Mandrel Application
- » Simple conversion Mens/Ladies Garments
- » Production output: circa 50/hr

#### RAPIDE 3000:

Air operated machine with Power Head

#### NOTES:

- » Hand Loaded
- » Power Head on top tool
- » Air operated closure
- » Mens and Ladies fittings
- » Single Hook/Bar or Double Hook/Bar
- » Duplex Tooling
- » Mandrel Application
- » Table Mounted
- » Circa 150/hr for single hook/single bar
- » Circa 125/hr for double hook/double bar

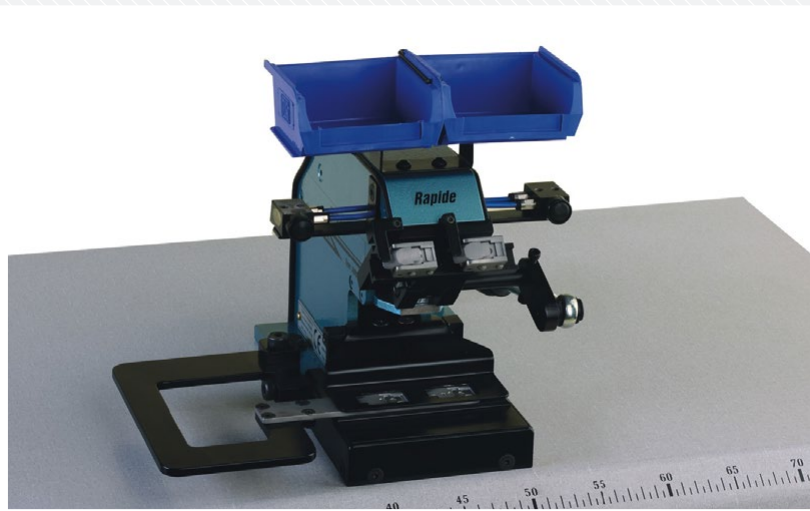

### PRODUCT ITEM

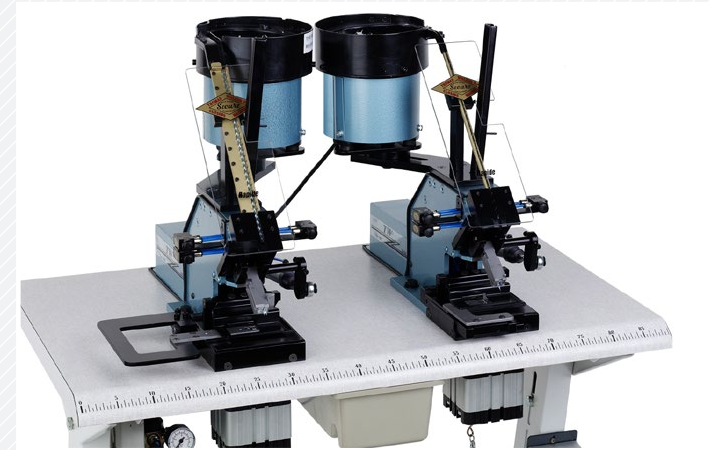

### PRODUCT DETAILS

#### RAPIDE 5000:

Fully automatic machine with Power Head

#### NOTES:

- » Auto Loaded Backplate & Washer/Bowl Fed Hook & Bar
- » Power Head on top tool
- » Air operated closure
- » Mens fittings
- » Single Hook/Bar or Double Hook/Bar
- » Mandrel Application
- » Table Mounted
- » Circa 250 per hour for single hook/single bar
- » Circa 200 per hour for double hook/double bar





PRODUCT ITEM

Code: TA9044



PRODUCT DETAILS

Available Sizes in (in mm):

19mm

Standard finishes:

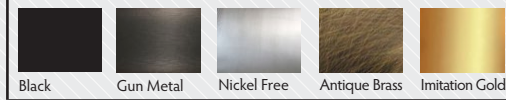

NOTES:

- » Commonly used on waistcoats
- » Other finishes available on request

Code: TA4500



Available Sizes in (in mm):

19mm

Standard finishes:

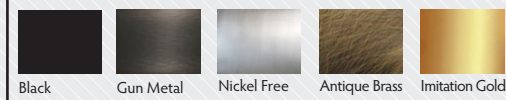

NOTES:

- » Commonly used on waistcoats
- » Other finishes available on request

Code: TA9002



Available Sizes in (in mm):

19mm

Standard finishes:

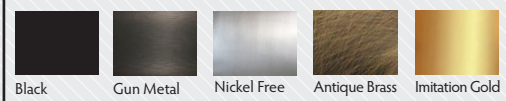

NOTES:

- » Commonly used on waistcoats
- » Other finishes available on request

OTHER EXAMPLE FINISHES



PRODUCT ITEM

Code: BE7001



PRODUCT DETAILS

Available Sizes in (in mm):

19mm

Standard finishes:



NOTES:

- » Webbing tip end commonly used on belts etc.



Email: [enquiries@leonardt.com](mailto:enquiries@leonardt.com)

Telephone: 01746 861203



## Brace Adjusters

### PRODUCT ITEM

Code: BR6020



Code: BR6010



### PRODUCT DETAILS

Available Sizes in (in mm):

35, 38

Standard finishes:



#### NOTES:

- » Made from mild/carbon steel
- » Front of adjuster is hardened and polished to high standard
- » UK Manufactured
- » Other finishes available on request
- » Sizes quoted refer to internal width e.g. 35mm adjuster suitable for 35mm webbing
- » Option for personalisation (see third image)

Available Sizes in (in mm):

35

Standard finishes:



#### NOTES:

- » Made from mild/carbon steel
- » Front of adjuster is hardened and polished to high standard
- » Solid brass version also available - hand polished for high quality finish
- » With teeth for extra grip
- » UK Manufactured
- » Other finishes available on request
- » Sizes quoted refer to internal width e.g. 35mm adjuster suitable for 35mm webbing
- » Option for personalisation (see third image)

## Brace Adjusters

### PRODUCT ITEM

Code: BR6030



Code: BR6040



### PRODUCT DETAILS

Available Sizes in (in mm):

30, 35

Standard finishes:



#### NOTES:

- » Made from mild/carbon steel
- » Front of adjuster is hardened and polished to high standard
- » UK Manufactured
- » Other finishes available on request
- » Sizes quoted refer to internal width e.g. 35mm adjuster suitable for 35mm webbing
- » Option for personalisation

Available Sizes in (in mm):

35

Standard finishes:



#### NOTES:

- » Made from mild/carbon steel
- » Front of adjuster is hardened and polished to high standard
- » With teeth for extra grip
- » UK Manufactured
- » Other finishes available on request
- » Sizes quoted refer to internal width e.g. 35mm adjuster suitable for 35mm webbing
- » Option for personalisation



## Brace Adjusters

### PRODUCT ITEM

Code: BR3347



### PRODUCT DETAILS

Available Sizes in (in mm):

19, 25

Standard finishes:



### NOTES:

- » Made from mild/carbon steel
- » Front of adjuster is hardened and polished to high standard
- » With teeth for extra grip
- » UK Manufactured
- » Other finishes available on request
- » Sizes quoted refer to internal width e.g. 25mm adjuster suitable for 25mm webbing

## Solid Brass Adjusters

### PRODUCT ITEM

Code: BR3211



### PRODUCT DETAILS

Available Sizes in (in mm):

32, 38, 41

Standard finishes:

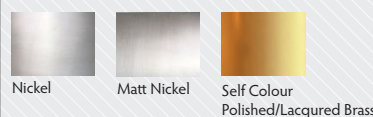

### NOTES:

- » Made from solid brass
- » Front of adjuster is hand polished to high quality finish
- » UK Manufactured
- » Sizes quoted refer to internal width e.g. 38mm adjuster suitable for 38mm webbing
- » Option for personalisation

## Brace Clips

### PRODUCT ITEM

Code: BR6222



### PRODUCT DETAILS

Available Sizes in (in mm):

19, 22, 25, 30, 35, 38

Standard finishes:

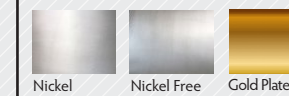

### NOTES:

- » Made from mild/carbon steel
- » Front of clip is hardened and polished to high standard
- » UK Manufactured
- » Other finishes available on request
- » Sizes quoted refer to internal width e.g. 35mm clip suitable for 35mm webbing

### PRODUCT ITEM

Code: BR6300



### PRODUCT DETAILS

Available Sizes in (in mm):

19, 25, 28

Standard finishes:



### NOTES:

- » Made from mild/carbon steel
- » Front of clip is hardened and polished to high standard
- » UK Manufactured
- » Other finishes available on request
- » Sizes quoted refer to internal width e.g. 25mm clip suitable for 25mm webbing

## Brace Clips

Code: BR6225



Available Sizes in (in mm):

19, 25, 28

Standard finishes:



### NOTES:

- » Made from mild/carbon steel
- » Front of clip is hardened and polished to high standard
- » UK Manufactured
- » Other finishes available on request
- » Sizes quoted refer to internal width e.g. 25mm clip suitable for 25mm webbing

## Brace Loops

PRODUCT ITEM

Code: BR0055



PRODUCT DETAILS

Available Sizes in (in mm):

19, 25, 29, 32, 35, 38, 41

Standard finishes:



### NOTES:

- » Made from mild steel
- » UK Manufactured
- » Other finishes available on request
- » Sizes quoted refer to internal width e.g. 35mm loop suitable for 35mm webbing

Code: BR6050



Available Sizes in (in mm):

35

Standard finishes:

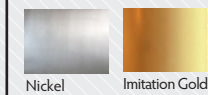

### NOTES:

- » Made from mild steel
- » Other finishes available on request
- » Sizes quoted refer to internal width e.g. 35mm loop suitable for 35mm webbing

VARIATION



## Brace Loops

PRODUCT ITEM

Code: BR0284



PRODUCT DETAILS

Available Sizes in (in mm):

25

Standard finishes:

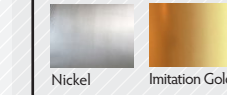

### NOTES:

- » Made from mild steel
- » Other finishes available on request
- » Sizes quoted refer to internal width e.g. 25mm loop suitable for 25mm webbing

## Brace Backs

PRODUCT ITEM

Code: BR6281



PRODUCT DETAILS

Available Sizes in (in mm):

25

Standard finishes:

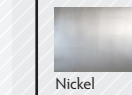

### NOTES:

- » Made from mild steel
- » Sizes quoted refer to internal width e.g. 25mm back suitable for 25mm webbing

Variation

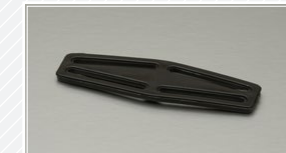

Code: BR6207

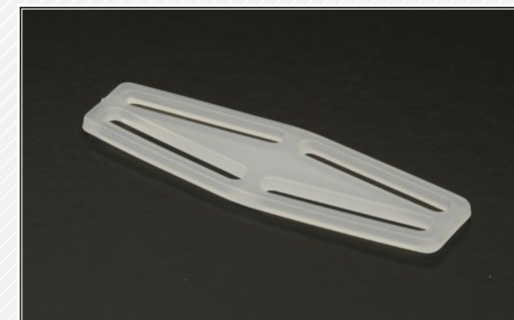

Available Sizes in (in mm):

25, 35

Standard finishes:



### NOTES:

- » Made from plastic
- » Sizes quoted refer to internal width e.g. 25mm back suitable for 25mm webbing







## Suspender End

### PRODUCT ITEM

Code: SU0672



### PRODUCT DETAILS

Available Sizes in (in mm):

25

Standard finishes:



Zinc

#### NOTES:

- » Frame made from mild steel
- » Cotton pad with plastic button
- » Pad and button available in black or white
- » UK Manufactured
- » Other finishes available on request
- » Sizes quoted refer to internal width e.g. 25mm suspender end suitable for 25mm webbing

## Garter Sets

### PRODUCT ITEM

Code: TA0332



### PRODUCT DETAILS

Available Sizes in (in mm):

25

Standard finishes:



Nickel

#### NOTES:

- » Made from mild steel
- » UK Manufactured
- » Typically supplied as 3 part set
- » Sizes quoted refer to internal width e.g. 25mm loop suitable for 25mm webbing

## Garter Sets

### PRODUCT ITEM

Code: SU0270

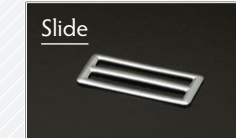
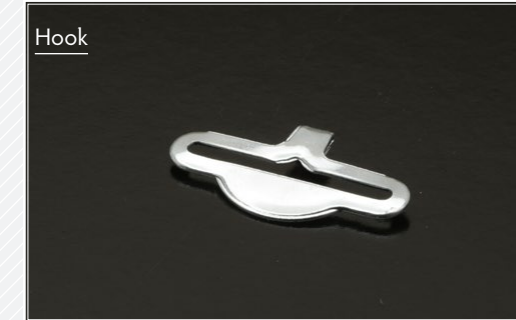

Code: MI8013



### PRODUCT DETAILS

Available Sizes in (in mm):

25

Standard finishes:



Zinc



Imitation Gold

#### NOTES:

- » Made from mild steel
- » Typically supplied as 3 part set
- » Sizes quoted refer to internal width e.g. 25mm loop suitable for 25mm webbing
- » Can be supplied as 5 part set with addition button and PVC pad

Available Sizes in (in mm):

19

Standard finishes:



Nickel

#### NOTES:

- » Made from mild steel
- » Other finishes available on request
- » Sizes quoted refer to internal width e.g. 19mm slide suitable for 19mm webbing





# Eyelets

## PRODUCT ITEM

Code: Various



## PRODUCT DETAILS

Available Sizes in (in mm):

See table on the right

Standard finishes:



### NOTES:

- » Eyelet/Washer sets made from brass
- » Can also be produced in steel or stainless steel
- » UK Manufactured
- » Other finishes available on request

# Eyelets

## EYELET SIZES – FOR REFERENCE ONLY

PART NUMBER	DESCRIPTION	A - DIAMETER	B - FLANGE HEIGHT	C - HOLE DIAMETER	D - HEIGHT
E0800100	00 SHEET EYELET BRASS	10 MM	1 MM	4.5 MM	4 MM
E08000183	00 SHEET EYELET BRASS BLACK	10 MM	1 MM	4.5 MM	4 MM
E0600200	0 GROMMET EYELET BRASS	17 MM	2 MM	8.5 MM	6 MM
E06002183	0 GROMMET EYELET BRASS BLACK	17 MM	2 MM	8.5 MM	6 MM
E0600300	1 GROMMET EYELET BRASS	20 MM	2 MM	9.5 MM	6.5 MM
E0600500	2 GROMMET EYELET BRASS	22 MM	2 MM	11 MM	8.5 MM
E06005005	2 GROMMET EYELET BRASS NICKEL PLATED	22 MM	2 MM	11 MM	8.5 MM
E06005183	2 GROMMET EYELET BRASS BLACK	22 MM	2 MM	11 MM	8.5 MM
E0602005	2 GROMMET EYELET STEEL NICKEL PLATED	22 MM	2 MM	11 MM	8.5 MM
E0600600	3 GROMMET EYELET BRASS	25 MM	2 MM	12.5 MM	9 MM
E0601000	4 GROMMET EYELET BRASS	28 MM	2.5MM	14.5 MM	10 MM

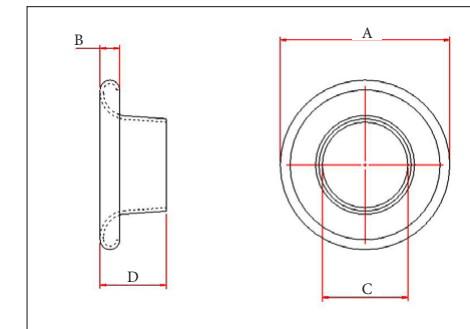

## WASHER SIZES – FOR REFERENCE ONLY

PART NUMBER	DESCRIPTION	A - DIAMETER	B - FLANGE HEIGHT	C - HOLE DIAMETER	D - TEETH DIAMETER
E0700000	000 GROMMET WASHER BRASS	10 MM	1.5 MM	6 MM	8 MM
E07000183	000 GROMMET WASHER BRASS BLACK	10 MM	1.5 MM	6 MM	8 MM
E0700200	0 GROMMET WASHER BRASS	16 MM	2 MM	10 MM	14 MM
E07002183	0 GROMMET WASHER BRASS BLACK	16 MM	2 MM	10 MM	14 MM
E0700300	1 GROMMET WASHER BRASS	20 MM	3 MM	12 MM	16 MM
E0700500	2 GROMMET WASHER BRASS	22 MM	2 MM	12.5 MM	18.5 MM
E07005005	2 GROMMET WASHER BRASS NICKEL PLATED	22 MM	2 MM	12.5 MM	18.5 MM
E07005183	2 GROMMET WASHER BRASS BLACK	22 MM	2 MM	12.5 MM	18.5 MM
E0702005	2 GROMMET WASHER STEEL NICKEL PLATED	22 MM	2 MM	12.5 MM	18.5 MM
E0700400	3 GROMMET WASHER BRASS	24 MM	3 MM	14.5 MM	20 MM
E0701000	4 GROMMET WASHER BRASS	28 MM	3 MM	17 MM	24 MM

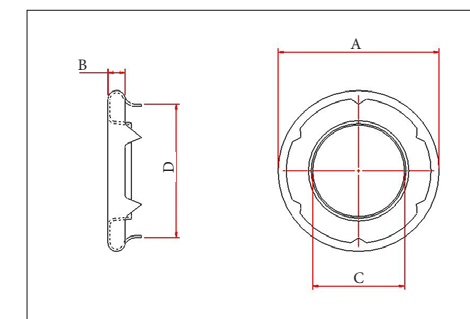





Email: [enquiries@leonardt.com](mailto:enquiries@leonardt.com)

Telephone: 01746 861203

## Round Wire Split Rings

### PRODUCT ITEM

Code: Various



### PRODUCT DETAILS

Available Sizes in (in mm):

See table below

Standard finishes:

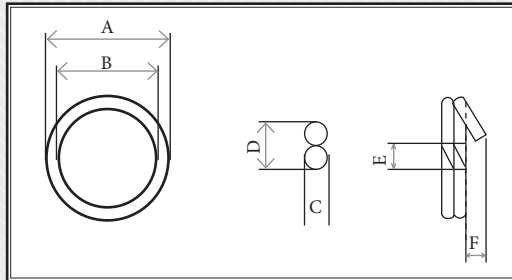
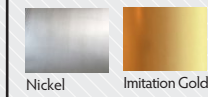

#### NOTES:

- » Made from carbon steel wire, heat treated, nickel plated.
- » UK Manufactured
- » All rings produced to below specifications.
- » Other finishes available upon request

### VARIATIONS



## TECHNICAL SPECIFICATION

RING SIZE O/D "A" mm	RING SIZE I/D "B" mm	WIRE DIAMETER "C" mm	TOTAL THICKNESS "D" mm	LEAD GAP "E" mm	SPRING BACK "F" mm	WEIGHT/1,000 Kg
ROUND						
5.8	4.4	0.71	1.4	2.0	1.5	0.10
7.0	5.5	0.71	1.4	2.0	1.5	0.13
9.8	8.0	0.91	1.8	2.5	2.0	0.28
11.0	9.2	0.91	1.8	2.5	2.0	0.33
13.0	11.2	0.91	1.8	2.5	4.0	0.38
16.0	13.6	1.22	2.4	3.0	5.0	0.85
20.0	17.1	1.37	2.6	4.0	6.0	1.30
24.0	20.8	1.52	2.8	5.0	7.5	1.98
25.0	21.3	1.83	3.2	5.0	7.5	2.89
28.0	24.6	1.63	2.9	6.0	8.0	2.61
30.0	26.0	1.98	3.6	7.0	9.0	4.17
32.0	27.8	1.98	3.6	7.0	9.5	4.44
35.0	30.8	1.98	3.7	7.0	11.0	4.82
38.0	33.8	1.98	3.7	7.0	12.5	5.32
51.0	46.0	2.34	4.4	8.0	15.0	10.20
76.0	71.0	2.69	4.6	12.0	15.0	20.40

ALL DIMENSIONS IN MM - APPROXIMATE SIZES FOR REFERENCE ONLY

## Round Wire Split Rings

### PRODUCT ITEM

Code: BKSR24SS



### PRODUCT DETAILS

Available Sizes in (in mm):

16, 24, 32

Standard finishes:



#### NOTES:

- » Medical / marine / fishing applications.
- » UK Manufactured

## Flat Split Rings

### PRODUCT ITEM

Code: Various

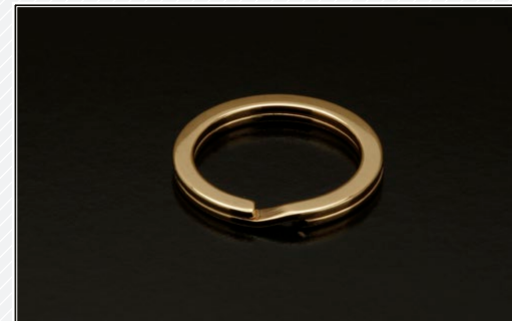

### PRODUCT DETAILS

Available Sizes in (in mm):

28, 30, 33, 38, see table below

Standard finishes:



Code: Various

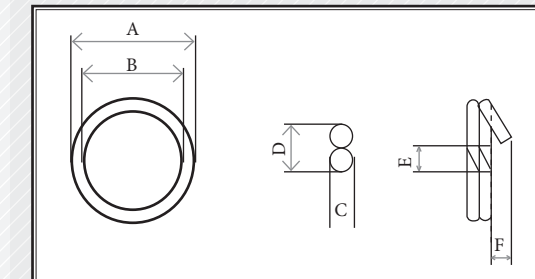

#### NOTES:

- » Made from carbon steel wire, heat treated, premium quality polish/plate
- » UK Manufactured
- » Other finishes available upon request

## TECHNICAL SPECIFICATION

RING SIZE O/D "A" mm	RING SIZE I/D "B" mm	WIRE DIAMETER "C" mm	TOTAL THICKNESS "D" mm	LEAD GAP "E" mm	SPRING BACK "F" mm	WEIGHT/1,000 Kg
FLAT						
28.0	21.8	1.37 x 2.8	2.6	6.0	8.0	4.50
30.0	24.0	1.37 x 2.8	2.6	6.0	8.0	4.85
33.0	26.7	1.62 x 3.11	3.2	8.0	9.0	6.82
38.0	30.0	1.62 x 3.82	3.2	8.0	8.0	9.80

ALL DIMENSIONS IN MM - APPROXIMATE SIZES FOR REFERENCE ONLY

## Personalised Rings

### PRODUCT ITEM

Code: N/A



Code: N/A



### PRODUCT DETAILS

Available Sizes in (in mm):

28, 30, 33, 38

Standard finishes:

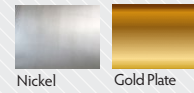

#### NOTES:

- » Made from carbon steel wire, heat treated, premium quality polish/plate
- » UK Manufactured
- » Stamping Option 1 or 2 sided
- » Standard lettering or bespoke artwork

## Connectors, Triangles, Jumps

### PRODUCT ITEMS

Code: BKJ8X056NB



Code: BKO19X048NB



Code: BKW214TR10NB



Code: BKWTR15NB



Code: BKJ11X048NB



Code: BKW216TR12NB



Code: BKW252NB



### PRODUCT DETAILS

Standard finishes:

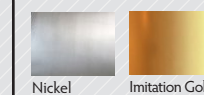

#### NOTES:

- » For Keyring fixing/attachment applications
- » Various sizes



## Keyfob Medallions

### PRODUCT ITEM

BKP220NB - Long Medallion



### PRODUCT DETAILS

Available Sizes in (in mm):  
20mm x 45mm

Standard finishes:

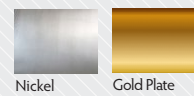

### NOTES:

- » Medallion for use with leather keyfob
- » Recess for insert / encapsulation

BKP171NB - Square Landscape Medallion



Available Sizes in (in mm):  
26mm x 23mm

Standard finishes:

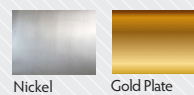

### NOTES

- » Medallion for use with leather keyfob
- » Recess for insert / encapsulation

BKP184NB - Square Portrait Medallion



Available Sizes in (in mm):  
23mm x 26mm

Standard finishes:

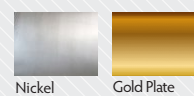

### NOTES:

- » Medallion for use with leather keyfob
- » Recess for insert / encapsulation

BKP168NB and BKP179NB - Round Medallion



Available Sizes in (in mm):  
27mm  
25mm

Standard finishes:

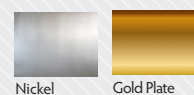

### NOTES:

- » Medallion for use with leather keyfob
- » Recess for insert / encapsulation

## Keyfob Medallions

### PRODUCT ITEM

Code: BKP189NB



### PRODUCT DETAILS

Available Sizes in (in mm):  
25mm

Standard finishes:

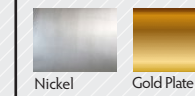

### NOTES:

- » Medallion for use with leather keyfob
- » Recess for insert / encapsulation

## Keyring — Miscellaneous

### PRODUCT ITEM

BKP212NB - Bottle Opener



### PRODUCT DETAILS

Standard finishes:

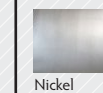

### NOTES:

- » Requires plastic overmold

BKBK108 - Chain Keyring



Standard finishes:

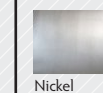

### NOTES:

- » Chain keyring for various uses and attachments
- » 5 x chain links

Keyring Box





Email: [enquiries@leonardt.com](mailto:enquiries@leonardt.com)

Telephone: 01746 861203

## Wire D Rings - Standard

### PRODUCT ITEM

Code: BKW103 and EN0254



### PRODUCT DETAILS

Available Sizes (in mm):  
10, 12, 16, 19, 25, 32, 37, 50

#### Standard finishes:



#### NOTES:

- » Made from mild steel
- » Open/Unwelded
- » UK Manufactured
- » Sizes quoted refer to internal width e.g. 25mm D Ring suitable for 25mm webbing
- » Other finishes available on request

Code: BKW105 and EN0254



Available Sizes (in mm):  
10, 12, 16, 19, 25, 32, 37, 50

#### Standard finishes:



#### NOTES:

- » Made from mild steel
- » Welded for extra strength
- » UK Manufactured
- » Sizes quoted refer to internal width e.g. 25mm D Ring suitable for 25mm webbing
- » Other finishes available on request

## High Sided Wire D Rings

### PRODUCT ITEM

Code: EN1204



### PRODUCT DETAILS

Available Sizes (in mm):  
19, 22, 25, 32, 38, 44, 50

#### Standard finishes:

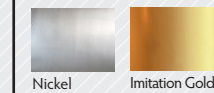

#### NOTES:

- » High-sided D Ring
- » Made from mild steel
- » Can be supplied open or welded
- » UK Manufactured
- » Sizes quoted refer to internal width e.g. 25mm D Ring suitable for 25mm webbing
- » Other finishes available on request

Code: BKW410



Available Sizes (in mm):  
25

#### Standard finishes:

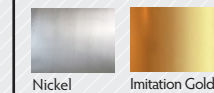

#### NOTES:

- » High-sided D Ring
- » Made from mild steel
- » Welded for extra strength
- » UK Manufactured
- » Sizes quoted refer to internal width e.g. 25mm D Ring suitable for 25mm webbing
- » Other finishes available on request

Code: BKW237



Available Sizes (in mm):  
25

#### Standard finishes:

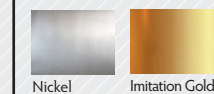

#### NOTES:

- » High-sided D Ring
- » Made from mild steel
- » Welded for extra strength
- » UK Manufactured
- » Sizes quoted refer to internal width e.g. 25mm D Ring suitable for 25mm webbing
- » Other finishes available on request



## High Sided Wire D Rings

### PRODUCT ITEM

Code: BKW295



### PRODUCT DETAILS

Available Sizes (in mm):

50

Standard finishes:

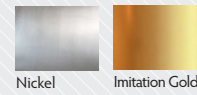

### NOTES:

- » High-sided D Ring
- » Made from mild steel
- » Welded for extra strength
- » UK Manufactured
- » Sizes quoted refer to internal width e.g. 25mm D Ring suitable for 25mm webbing
- » Other finishes available on request

## Tiny D Ring

### PRODUCT ITEM

Code: BKW227 and EN0866



### PRODUCT DETAILS

Available Sizes (in mm):

10

Standard finishes:

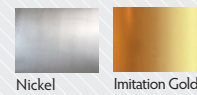

### NOTES:

- » Made from mild steel
- » Open/Unwelded
- » UK Manufactured
- » Sizes quoted refer to internal width e.g. 25mm D Ring suitable for 25mm webbing
- » Other finishes available on request

## Stainless Steel D Rings

### PRODUCT ITEM

Code: BKB0145



### PRODUCT DETAILS

Available Sizes (in mm):

25, 30, 35, 38, 46, 50

Standard finishes:

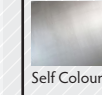

### NOTES:

- » Made from stainless steel
- » Welded for extra strength
- » UK Manufactured
- » Sizes quoted refer to internal width e.g. 25mm D Ring suitable for 25mm webbing

## Pressed/Stamped D Rings

### PRODUCT ITEM

Code: BKP215 and EN0250



### PRODUCT DETAILS

Available Sizes (in mm):

10, 12, 16, 19, 22, 25

Standard finishes:



### NOTES:

- » Made from mild steel sheet
- » Stamped out for added strength - no need for weld
- » UK Manufactured
- » Sizes quoted refer to internal width e.g. 25mm D Ring suitable for 25mm webbing
- » Other finishes available on request

## Aluminium D Rings

### PRODUCT ITEM

Code: EA0021



### PRODUCT DETAILS

Available Sizes (in mm):

25

Standard finishes:



Black Anodized

### NOTES:

- » Made from Aluminium sheet
- » UK Manufactured
- » Sizes quoted refer to internal width e.g. 25mm D Ring suitable for 25mm webbing
- » Other finishes available on request

## D Ring with plate attachment

### PRODUCT ITEM

Code: GS101



### PRODUCT DETAILS

Available Sizes (in mm):

10, 12

Standard finishes:



Nickel



Imitation Gold

### NOTES:

- » Commonly used for picture hanging
- » UK Manufactured
- » Other finishes available on request

## Plate Attachment

### PRODUCT ITEM

Code: EN0624



### PRODUCT DETAILS

Available Sizes (in mm):

12, 16

Standard finishes:



Nickel



Imitation Gold



Stainless Steel

### NOTES:

- » UK Manufactured
- » Other finishes available on request
- » Made from mild steel

## O Rings

### PRODUCT ITEM

Code: BKW367, BKW403, BKW225 and EN0253



### PRODUCT DETAILS

Available Sizes (in mm):

12, 16, 19, 22, 25, 32, 40, 50

Standard finishes:



Nickel



Imitation Gold

### NOTES:

- » Made from mild steel
- » Welded offered as standard. Some rings are available open/unwelded
- » Various wire gauges
- » Other finishes available upon request
- » Sizes quoted refer to internal diameter
- » Stainless steel rings also available on request





Email: [enquiries@leonardt.com](mailto:enquiries@leonardt.com)

Telephone: 01746 861203

## Round Ended Loops

### PRODUCT ITEM

Code: BKW101, BR0055 and EN0399



### PRODUCT DETAILS

Available Sizes in (in mm):

19, 25, 29, 32, 35, 38, 41, 50, 63, 76

Standard finishes:

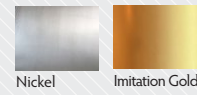

### NOTES:

- » Made from mild steel round wire
- » Some sizes available in solid brass wire
- » UK Manufactured
- » Other finishes available on request
- » Option for welded/unwelded
- » Sizes quoted refer to internal width e.g. 25mm loop suitable for 25mm webbing

## Square Ended Loops

### PRODUCT ITEM

Code: EN0564



### PRODUCT DETAILS

Available Sizes in (in mm):

12, 16, 19, 22, 25, 32, 38, 50

Standard finishes:

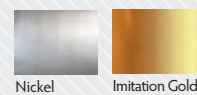

### NOTES:

- » Made from mild steel round wire
- » UK Manufactured
- » Other finishes available on request
- » **Option for welded/unwelded**
- » Sizes quoted refer to internal width e.g. 25mm loop suitable for 25mm webbing

### VARIATIONS



## Square Ended Loops

### PRODUCT ITEM

Code: EN0578, EN1084 and BKW369



### VARIATION



Code: EN0830 and BKW154



### PRODUCT DETAILS

Available Sizes in (in mm):

9, 12, 16, 19, 22, 25, 32, 38

Standard finishes:



### NOTES:

- » Made from mild steel D profile wire
- » UK Manufactured
- » Other finishes available on request
- » Unwelded
- » Sizes quoted refer to internal width e.g. 25mm loop suitable for 25mm webbing

Available Sizes in (in mm):

12, 16, 19, 25, 38, 50

Standard finishes:



### NOTES:

- » Made from mild steel D profile wire
- » UK Manufactured
- » Other finishes available on request
- » Unwelded
- » Sizes quoted refer to internal width e.g. 25mm loop suitable for 25mm webbing



## Brass loop with roller

### PRODUCT ITEM

Code: BKW423



### PRODUCT DETAILS

Available Sizes in (in mm):

19

Standard finishes:



Nickel

#### NOTES:

- » Made from solid brass
- » UK Manufactured
- » Other finishes available on request
- » Size quoted refer to internal width

## Pram Loops

### PRODUCT ITEM

Code: EN0246



### PRODUCT DETAILS

Available Sizes in (in mm):

22, 25

Standard finishes:



Nickel

#### NOTES:

- » Made from mild steel
- » UK Manufactured
- » Other finishes available on request
- » Size quoted refer to internal width

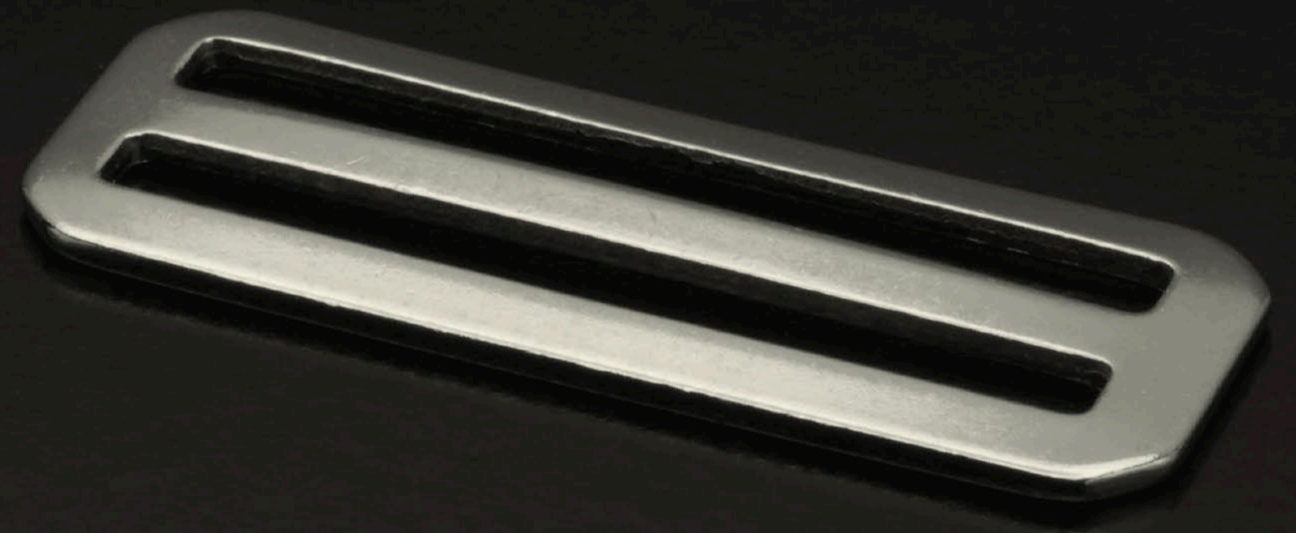

Email: [enquiries@leonardt.com](mailto:enquiries@leonardt.com)

Telephone: 01746 861203



## 3 Bar Slides/Triglides

### PRODUCT ITEM

Code: BKP100 and EN0924



### PRODUCT DETAILS

Available Sizes in (in mm):

38, 50, 57, 63, 75

Standard finishes:

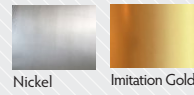

#### NOTES:

- » Made from mild steel
- » Raised middle bar
- » UK Manufactured
- » Other finishes available on request
- » Sizes quoted refer to internal width e.g. 50mm slide suitable for 50mm webbing

Code: EN0537



Available Sizes in (in mm):

25, 28, 32, 38, 50

Standard finishes:

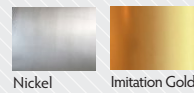

#### NOTES:

- » Made from mild steel
- » UK Manufactured
- » Other finishes available on request
- » Sizes quoted refer to internal width e.g. 50mm slide suitable for 50mm webbing

Code: EN192 and EN1375



Available Sizes in (in mm):

50

Standard finishes:

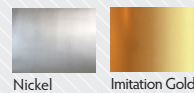

#### NOTES:

- » Made from mild steel
- » Commonly used on Horse Blankets/Rugs
- » UK Manufactured
- » Other finishes available on request
- » Sizes quoted refer to internal width e.g. 50mm slide suitable for 50mm webbing

## 3 Bar Slides/Triglides

### PRODUCT ITEM

Code: BKP152 and EN0539



### PRODUCT DETAILS

Available Sizes in (in mm):

44, 57

Standard finishes:

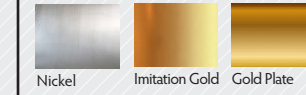

#### NOTES:

- » Made from mild steel
- » Commonly used on regalia/uniforms - gold finish in particular
- » UK Manufactured
- » Other finishes available on request
- » Sizes quoted refer to internal width e.g. 50mm slide suitable for 50mm webbing

Code: MI8013



Available Sizes in (in mm):

19

Standard finishes:

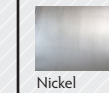

#### NOTES:

- » Made from mild steel
- » Other finishes available on request
- » Sizes quoted refer to internal width e.g. 19mm slide suitable for 19mm webbing

## Stainless Steel Slides

### PRODUCT ITEM

Code: BKB520



### PRODUCT DETAILS

Available Sizes in (in mm):

20, 25, 30, 40, 45

Standard finishes:



#### NOTES:

- » Made from 316 grade SS
- » UK Manufactured
- » Sizes quoted refer to internal width e.g. 25mm slide suitable for 25mm webbing

## Aluminium Slides

### PRODUCT ITEM

Code: EA0022

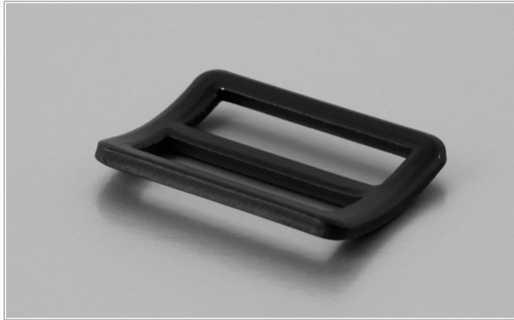

### PRODUCT DETAILS

Available Sizes in (in mm):

25

Standard finishes:



Black Anodized

#### NOTES:

- » Made from Aluminium
- » UK Manufactured
- » Other finishes available on request
- » Sizes quoted refer to internal width e.g. 25mm slide suitable for 25mm webbing

Code: EA0014



Available Sizes in (in mm):

25

Standard finishes:



Black Anodized

#### NOTES:

- » Made from Aluminium
- » Raised middle bar
- » UK Manufactured
- » Other finishes available on request
- » Sizes quoted refer to internal width e.g. 25mm slide suitable for 25mm webbing





Email: [enquiries@leonardt.com](mailto:enquiries@leonardt.com)

Telephone: 01746 861203

## Pressed/Stamped Frame Roller Buckles

### PRODUCT ITEM

Code: EN0700, EN0214 and 0768



### PRODUCT DETAILS

Available Sizes in (in mm):

10, 12, 16, 19, 22, 25, 32

Standard finishes:

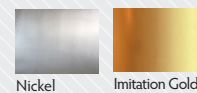

### NOTES:

- » Made from mild steel
- » UK Manufactured
- » Other finishes available on request
- » Sizes quoted refer to internal width e.g. 25mm buckle suitable for 25mm webbing
- » Available in 2 x frame thicknesses. EN0214 is heavier gauge

## Pressed Frame Buckles without roller

### PRODUCT ITEM

Code: EN0304



### PRODUCT DETAILS

Available Sizes in (in mm):

12, 16, 19, 25

Standard finishes:

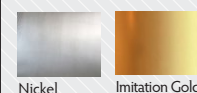

### NOTES:

- » Made from mild steel
- » UK Manufactured
- » Other finishes available on request
- » Sizes quoted refer to internal width e.g. 25mm buckle suitable for 25mm webbing

## Mini Pressed Frame Buckles without roller

### PRODUCT ITEM

Code: EN0358

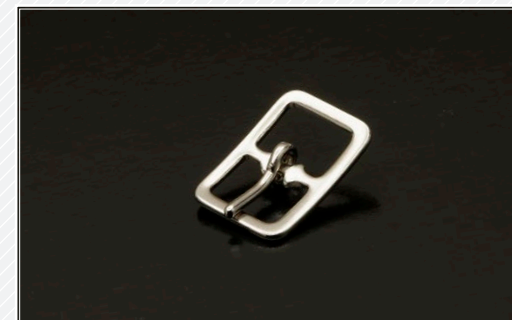

### PRODUCT DETAILS

Available Sizes in (in mm):

9, 11

Standard finishes:

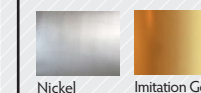

### NOTES:

- » Made from mild steel
- » UK Manufactured
- » Other finishes available on request
- » Sizes quoted refer to internal width e.g. 9mm buckle suitable for 9mm webbing

## Pressed Frames without roller/tong

### PRODUCT ITEM

Code: EN0304 and FHT304



### PRODUCT DETAILS

Available Sizes in (in mm):

12, 16, 19, 25

Standard finishes:

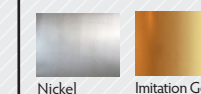

### NOTES:

- » Made from mild steel
- » UK Manufactured
- » Other finishes available on request
- » Sizes quoted refer to internal width e.g. 25mm buckle suitable for 25mm webbing

## Other Stamped Roller Buckles

### PRODUCT ITEM

Code: EN0658



### PRODUCT DETAILS

Available Sizes in (in mm):

9, 12, 16

Standard finishes:

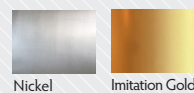

### NOTES:

- » Made from mild steel
- » UK Manufactured
- » Other finishes available on request
- » Sizes quoted refer to internal width e.g. 16mm buckle suitable for 16mm webbing

Code: EN0249



Available Sizes in (in mm):

9, 12, 16, 19, 25

Standard finishes:

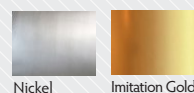

### NOTES:

- » Made from mild steel
- » UK Manufactured
- » Other finishes available on request
- » Sizes quoted refer to internal width e.g. 16mm buckle suitable for 16mm webbing

## Watch Strap Buckle

### PRODUCT ITEM

Code: EN1639



### PRODUCT DETAILS

Available Sizes in (in mm):

6, 9, 11

Standard finishes:

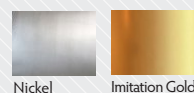

### NOTES:

- » Made from mild steel
- » UK Manufactured
- » Other finishes available on request
- » Sizes quoted refer to internal width e.g. 9mm buckle suitable for 9mm webbing





Email: [enquiries@leonardt.com](mailto:enquiries@leonardt.com)

Telephone: 01746 861203

## Wire Roller Buckles

### PRODUCT ITEM

Code: EN0423



### PRODUCT DETAILS

Available Sizes in (in mm):

9, 12, 16, 19, 25, 32, 38

Standard finishes:

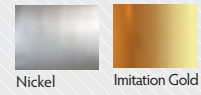

### NOTES:

- » Made from mild steel
- » Other finishes available on request
- » Sizes quoted refer to internal width e.g. 25mm buckle suitable for 25mm webbing

Code: EN0960



Available Sizes in (in mm):

19, 25, 32

Standard finishes:

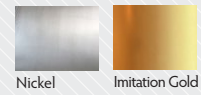

### NOTES:

- » Thicker gauge than EN0423
- » Made from mild steel
- » Other finishes available on request
- » Sizes quoted refer to internal width e.g. 25mm buckle suitable for 25mm webbing

## Weightlifter Buckles

### PRODUCT ITEM

Code: EN1126 and BKBW372



### PRODUCT DETAILS

Available Sizes in (in mm):

19, 25, 32, 38, 50

Standard finishes:

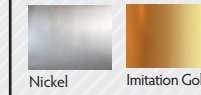

### NOTES:

- » Made from mild steel
- » Other finishes available on request
- » Sizes quoted refer to internal width e.g. 25mm buckle suitable for 25mm webbing

Code: EN112650NP02 and W429



Available Sizes in (in mm):

50

Standard finishes:

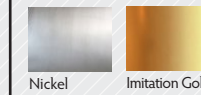

### NOTES:

- » Made from mild steel
- » Other finishes available on request
- » Sizes quoted refer to internal width e.g. 50mm buckle suitable for 50mm webbing



Email: [enquiries@leonardt.com](mailto:enquiries@leonardt.com)

Telephone: 01746 861203



## Pressed Frame Sliding Bar Buckles

### PRODUCT ITEM

Code: BKP103



### PRODUCT DETAILS

Available Sizes in (in mm):

25,

Standard finishes:



Nickel

#### NOTES:

- » Made from mild steel
- » UK Manufactured
- » Other finishes available on request
- » Sizes quoted refer to internal width e.g. 25mm buckle suitable for 25mm webbing

Code: BKP104



Available Sizes in (in mm):

25, 38

Standard finishes:



Nickel

#### NOTES:

- » Made from mild steel
- » UK Manufactured
- » Other finishes available on request
- » Sizes quoted refer to internal width e.g. 25mm buckle suitable for 25mm webbing

## Pressed Frame Sliding Bar Buckles

### PRODUCT ITEM

Code: BKP185



### PRODUCT DETAILS

Available Sizes in (in mm):

19

Standard finishes:



Nickel



Black

#### NOTES:

- » Made from mild steel
- » UK Manufactured
- » Other finishes available on request
- » Sizes quoted refer to internal width e.g. 19mm buckle suitable for 19mm webbing

Code: SG3770



Available Sizes in (in mm):

19

Standard finishes:



Nickel



Black

#### NOTES:

- » Made from solid brass
- » Other finishes available on request
- » Sizes quoted refer to internal width e.g. 19mm buckle suitable for 19mm webbing



Email: [enquiries@leonardt.com](mailto:enquiries@leonardt.com)

Telephone: 01746 861203

## Horse Blanket Buckle Sets

### PRODUCT ITEM

Code: P191/EN1375



### PRODUCT DETAILS

Available Sizes in (in mm):

50

Standard finishes:



Nickel

### NOTES:

- » Typically used on Horse Rugs/Blankets
- » Made from mild steel
- » UK Manufactured
- » Other finishes available on request
- » Sizes quoted refer to internal width e.g. 50mm buckle suitable for 50mm webbing

## Nurse Clasp Buckle

### PRODUCT ITEM

Code: P113



### PRODUCT DETAILS

Available Sizes in (in mm):

50

Standard finishes:



Nickel



Imitation Gold

### NOTES:

- » Typically used on uniforms
- » Made from mild steel
- » UK Manufactured
- » Other finishes available on request
- » Sizes quoted refer to internal width e.g. 50mm buckle suitable for 50mm webbing

## Belt Buckle

### PRODUCT ITEM

Code: BE7492



### PRODUCT DETAILS

Available Sizes in (in mm):

32

Standard finishes:



Nickel



Nickel Free

### NOTES:

- » Typically used on belts
- » Made from mild steel
- » UK Manufactured
- » Other finishes available on request
- » Sizes quoted refer to internal width e.g. 32mm buckle suitable for 32mm webbing

## Roko Buckle

### PRODUCT ITEM

Code: P112/EN0543



### PRODUCT DETAILS

Available Sizes in (in mm):

19, 25, 32, 38

Standard finishes:



Nickel



Zinc

### NOTES:

- » Used on various strapping applications
- » Made from mild steel
- » UK Manufactured
- » Other finishes available on request
- » Sizes quoted refer to internal width e.g. 32mm buckle suitable for 32mm webbing



## Cam Buckles

### PRODUCT ITEM

Code: BKBCAM



### PRODUCT DETAILS

Available Sizes in (in mm):

20, 25, 38, 50

Standard finishes:

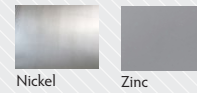

#### NOTES:

- » Used on various strapping applications
- » Zinc Die-Cast
- » Various breaking strengths available to suit different loads
- » Other finishes available on request
- » Sizes quoted refer to internal width e.g. 25mm buckle suitable for 25mm webbing

## Dog Collar Buckles

### PRODUCT ITEM

Code: BKB1DOG



### PRODUCT DETAILS

Available Sizes in (in mm):

16, 20, 25

Standard finishes:

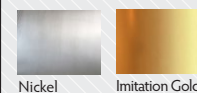

#### NOTES:

- » Typically used on pet collars
- » Zinc or Brass Casting
- » Option for flat or raised back bar
- » Other finishes available on request
- » Sizes quoted refer to internal width e.g. 32mm buckle suitable for 32mm webbing

## Helmet Buckles

### PRODUCT ITEM

Code: W450



### PRODUCT DETAILS

Available Sizes in (in mm):

20

Standard finishes:



Black

#### NOTES:

- » Typically used on helmet strapping
- » Outer shell is plastic molding. Wire and roller are made from stainless steel
- » UK Manufactured
- » Sizes quoted refer to internal width e.g. 20mm buckle suitable for 20mm webbing

Code: P468



Available Sizes in (in mm):

20

Standard finishes:



Self Colour

#### NOTES:

- » Typically used on helmet strapping
- » Made from stainless steel
- » UK Manufactured
- » Sizes quoted refer to internal width e.g. 20mm buckle suitable for 20mm webbing

Code: P174



Available Sizes in (in mm):

20

Standard finishes:



Nickel



Gold Plate

#### NOTES:

- » Typically used on helmet strapping
- » Made from mild steel
- » UK Manufactured

## LadderLock

### PRODUCT ITEM

Code: P132



### PRODUCT DETAILS

Available Sizes in (in mm):

25

Standard finishes:



Self Colour

#### NOTES:

- » Used on various strapping applications
- » Made from stainless steel
- » UK Manufactured
- » Sizes quoted refer to internal width e.g. 25mm buckle suitable for 25mm webbing

## Other Strapping buckles

### PRODUCT ITEM

Code: EN2092



### PRODUCT DETAILS

Available Sizes in (in mm):

25

Standard finishes:



Black



Stainless Steel

#### NOTES:

- » Used on various strapping applications
- » Made from stainless steel
- » UK Manufactured
- » Sizes quoted refer to internal width e.g. 25mm buckle suitable for 25mm webbing

Code: EN2079



Available Sizes in (in mm):

25

Standard finishes:



Black

#### NOTES:

- » Used on various strapping applications
- » Made from stainless steel
- » UK Manufactured
- » Sizes quoted refer to internal width e.g. 25mm buckle suitable for 25mm webbing

## Safety Harness Buckles

### PRODUCT ITEM

Code: BKB530/532



### PRODUCT DETAILS

Available Sizes in (in mm):

45, 50

Standard finishes:



Self Colour

#### NOTES:

- » Typically used on safety harnesses
- » Made from Stainless Steel and over molded.
- » UK Manufactured
- » Sizes quoted refer to internal width e.g. 50mm buckle suitable for 50mm webbing





## Spring Hooks

### PRODUCT ITEM

Code: EN0323



### PRODUCT DETAILS

Available Sizes in (in mm):

28, 38, 50

Standard finishes:

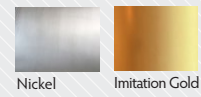

#### NOTES:

- » Made from carbon steel
- » Other finishes available on request
- » Sizes quoted refer to overall length

Code: BKBW377

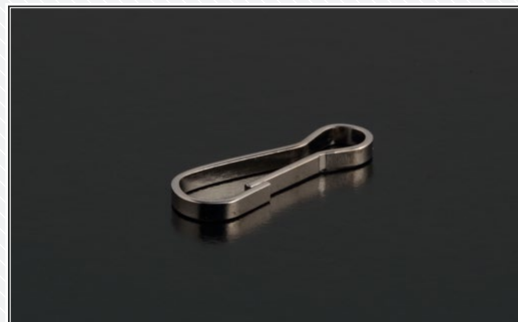

Available Sizes in (in mm):

20, 23.5

Standard finishes:



#### NOTES:

- » Made from carbon steel
- » Other finishes available on request
- » Sizes quoted refer to overall length

## Spring Hooks with attachments

### PRODUCT ITEM

Code: Various



### PRODUCT DETAILS

Available Sizes in (in mm):

Hooks in...28, 38, 50

Swivels in...6, 9, 16, 19, 22, 25, 28, 38,

Standard finishes:

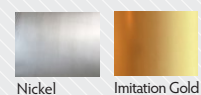

#### NOTES:

- » Made from mild/ carbon steel
- » Other finishes available on request
- » Size of hook refers to overall length (hook part only)
- » Size of swivel refers to internal width. e.g. 25mm swivel suitable for 25mm webbing

## Triggerhooks—Square Eye

### PRODUCT ITEM

Code: Various



### PRODUCT DETAILS

Available Sizes in (in mm):

13, 16, 19, 25, 38, 50,

Standard finishes:

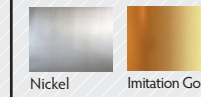

#### NOTES:

- » Die-cast triggerhooks commonly used in pet & equestrian markets
- » Size refers to internal width. e.g. 25mm swivel suitable for 25mm webbing

## Triggerhooks—Round Eye

### PRODUCT ITEM

Code: Various



### PRODUCT DETAILS

Available Sizes in (in mm):

10, 13, 16, 19, 25,

Standard finishes:

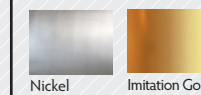

#### NOTES:

- » Die-cast triggerhooks commonly used in pet & equestrian markets
- » Size refers to internal width. e.g. 25mm swivel suitable for 25mm webbing

## Lanyard Swivel Hook

### PRODUCT ITEM

Code: BKBK384



### PRODUCT DETAILS

Available Sizes in (in mm):

10 x 40

Standard finishes:

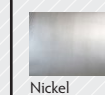

#### NOTES:

- » Swivel Hook commonly used on lanyards
- » Size: 10mm refers to internal width of swivel. 40mm is overall length

## Other Hooks

### PRODUCT ITEM

Code: EA0057



### PRODUCT DETAILS

Available Sizes in (in mm):

25

Standard finishes:

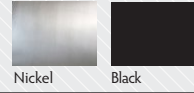

#### NOTES:

- » Made from solid brass
- » Size refers to internal width. e.g. 25mm hook suitable for 25mm webbing

Available Sizes in (in mm):

25

Standard finishes:



#### NOTES:

- » Made from mild/spring steel
- » Size refers to internal width. e.g. 25mm hook suitable for 25mm webbing

Code: EN1364







## Wire Spears

### PRODUCT ITEM

Code: Various



### PRODUCT DETAILS

Available Sizes in (in mm):

40, 50, 80, 100

Standard finishes:



Self-colour

### NOTES:

- » Made from mild steel
- » Planished at one end
- » UK manufactured
- » Commonly used for toy/model soldier market
- » No finish is applied as spears are painted by end users
- » Sizes quoted refer to overall length of spear



As used for wargame model miniatures



Email: [enquiries@leonardt.com](mailto:enquiries@leonardt.com)

Telephone: 01746 861203

## Catches and Locks

### PRODUCT ITEM

Code: 420



Code: 419



### PRODUCT DETAILS

Available Sizes in (in mm):

55.2x27

Standard finishes:

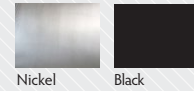

#### NOTES:

- » Typically used on musical instrument cases
- » Made from mild steel
- » UK manufactured
- » Other finishes available upon request

Available Sizes in (in mm):

55.2x27

Standard finishes:

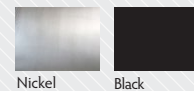

#### NOTES:

- » Typically used to close cases/cabinets
- » Typically used on musical instrument cases
- » As 420 catch but with locking mechanism - supplied with key
- » Made from mild steel
- » UK manufactured
- » Other finishes available upon request

## Catches and Locks

### PRODUCT ITEM

Code: 416



Code: 415

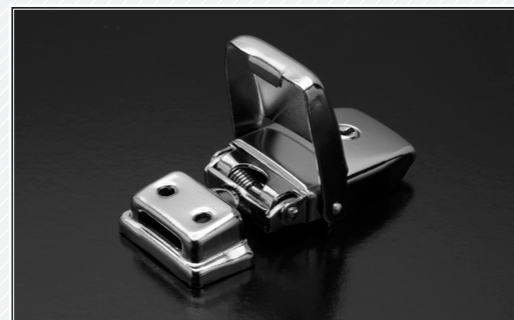

### PRODUCT DETAILS

Available Sizes in (in mm):

61x30

Standard finishes:

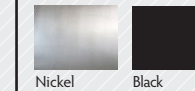

#### NOTES:

- » Typically used to close cases/cabinets
- » Made from mild steel
- » UK manufactured
- » Other finishes available upon request

Available Sizes in (in mm):

61x30

Standard finishes:

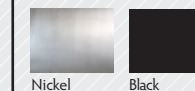

#### NOTES:

- » Typically used to close cases/cabinets
- » As 416 catch but with locking mechanism - supplied with key
- » Made from mild steel
- » UK manufactured
- » Other finishes available upon request



## Catches and Locks

### PRODUCT ITEM

Code: 3417



Code: 3427



### PRODUCT DETAILS

Available Sizes in (in mm):

75x40

Standard finishes:

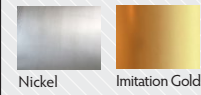

#### NOTES:

- » Typically used on cases/trunks
- » Made from mild steel
- » Other finishes available upon request

Available Sizes in (in mm):

90x50

Standard finishes:

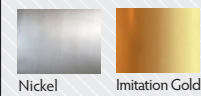

#### NOTES:

- » Typically used on cases/ trunks
- » Made from mild steel
- » Other finishes available upon request
- » Loop added for padlock use

## Catches and Locks

### PRODUCT ITEM

Code: 3333



Code: 333A



### PRODUCT DETAILS

Available Sizes in (in mm):

45x30

Standard finishes:

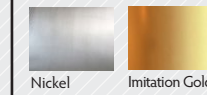

#### NOTES:

- » Typically used on cases/trunks
- » Made from mild steel
- » Other finishes available upon request

Available Sizes in (in mm):

45x30

Standard finishes:

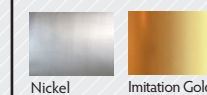

#### NOTES:

- » Typically used on cases/trunks
- » Made from mild steel
- » Other finishes available upon request

## Catches and Locks

### PRODUCT ITEM

Code: 3407



### PRODUCT DETAILS

Available Sizes in (in mm):

32x26

Standard finishes:

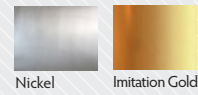

### NOTES:

- » Typically used on cases/trunks
- » Made from mild steel
- » Other finishes available upon request

Code: 3408



Available Sizes in (in mm):

39x29

Standard finishes:

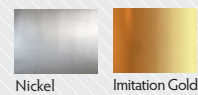

### NOTES:

- » Typically used on cases/ trunks
- » Made from mild steel
- » Other finishes available upon request

## Catches and Locks

### PRODUCT ITEM

Code: 3410

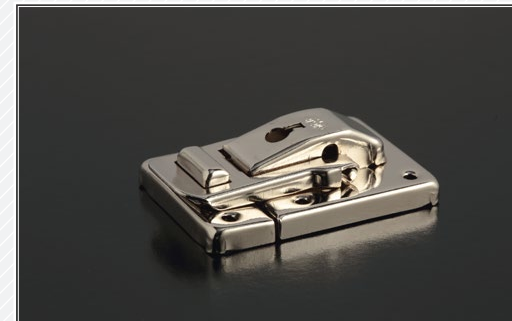

### PRODUCT DETAILS

Available Sizes in (in mm):

N/A

Standard finishes:

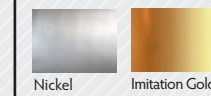

### NOTES:

- » Typically used on cases/trunks
- » Made from mild steel
- » Other finishes available upon request
- » Supplied with key

Code: 69

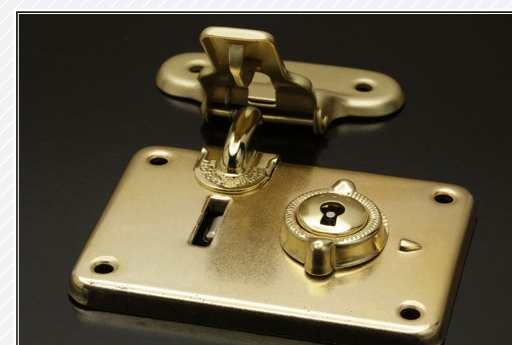

Available Sizes in (in mm):

N/A

Standard finishes:

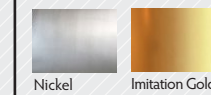

### NOTES:

- » Typically used on cases/trunks
- » Made from mild steel
- » Other finishes available upon request
- » Supplied with key
- » Left and right versions available - normally sold in pairs



## Catches and Locks

### PRODUCT ITEM

Code: 1800



### PRODUCT DETAILS

Available Sizes in (in mm):

N/A

Standard finishes:



Nickel

#### NOTES:

- » Typically used on cases/trunks
- » Made from mild steel
- » Other finishes available upon request
- » Supplied with key

## Hinges

### PRODUCT ITEM

Code: 4274



Code: 4374



Code: 4279

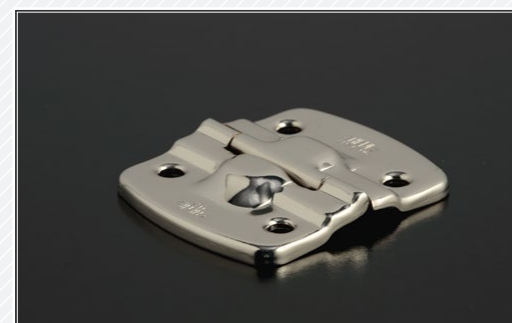

### PRODUCT DETAILS

Available Sizes in (in mm):

25x40

Standard finishes:

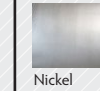

Nickel



Imitation Gold

#### NOTES:

- » Typically used on cases/trunks
- » Made from mild steel
- » Other finishes available upon request
- » Supplied with key

Available Sizes in (in mm):

26x20

Standard finishes:

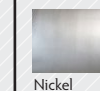

Nickel



Imitation Gold

#### NOTES:

- » Typically used on cases/trunks
- » Made from mild steel
- » Other finishes available upon request
- » Supplied with key

Available Sizes in (in mm):

50x40

Standard finishes:

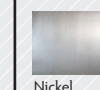

Nickel



Imitation Gold

#### NOTES:

- » Typically used on cases/trunks
- » Made from mild steel
- » Other finishes available upon request
- » Supplied with key



## Handles

### PRODUCT ITEM

Code: 5600



### PRODUCT DETAILS

Available Sizes in (in mm):

N/A

Standard finishes:



Nickel Free

### NOTES:

- » Typically used on briefcases etc.
- » Supplied complete with cover plate as per image
- » Made from mild steel
- » Other finishes available upon request

## Handle Plates

### PRODUCT ITEM

Code: 6625



### PRODUCT DETAILS

Available Sizes in (in mm):

N/A

Standard finishes:



Nickel

### NOTES:

- » Typically used on music cases/briefcases etc.
- » To complement above 5600 handle
- » Made from mild steel
- » Other finishes available upon request

Code: 6225



Available Sizes in (in mm):

N/A

Standard finishes:



Nickel

### NOTES:

- » Typically used on music cases/briefcases etc.
- » Small Handle Plate
- » Made from mild steel
- » Other finishes available upon request

## Handle Plates

### PRODUCT ITEM

Code: 6227



### PRODUCT DETAILS

Available Sizes in (in mm):

N/A

Standard finishes:



Nickel

### NOTES:

- » Typically used on music cases/briefcases etc.
- » Large Handle Plate
- » Made from mild steel
- » Other finishes available upon request

## Bumper Feet

### PRODUCT ITEM

Code: 6309



### PRODUCT DETAILS

Available Sizes in (in mm):

N/A

Standard finishes:



Nickel



Imitation Gold

### NOTES:

- » Feet typically used on music cases/briefcases etc.
- » Made from mild steel
- » Other finishes available upon request

Code: 1050



Available Sizes in (in mm):

N/A

Standard finishes:



Nickel



Imitation Gold

### NOTES:

- » Feet typically used on music cases/briefcases etc.
- » Made from mild steel
- » Other finishes available upon request

Leonardt Ltd  
New Road  
Highley  
Bridgnorth  
Shropshire  
WV16 6NN

To contact us or to place an order  
please call or email  
Telephone: 01746 861203  
enquiries@leonardt.com

ISO 9001:2015 certified  
ISO 14001:2015 certified  
ISO 45001:2018 certified

[www.leonardt.com](http://www.leonardt.com)



**Leonardt**