

NAVAIR 01-90KDB-1

NATOPS FLIGHT MANUAL

NAVY MODEL

T-34B AIRCRAFT

THIS MANUAL SUPERSEDES NAVAIR 01-90KDB-1 DATED
1 MAY 1967, CHANGED 1 DECEMBER 1978.

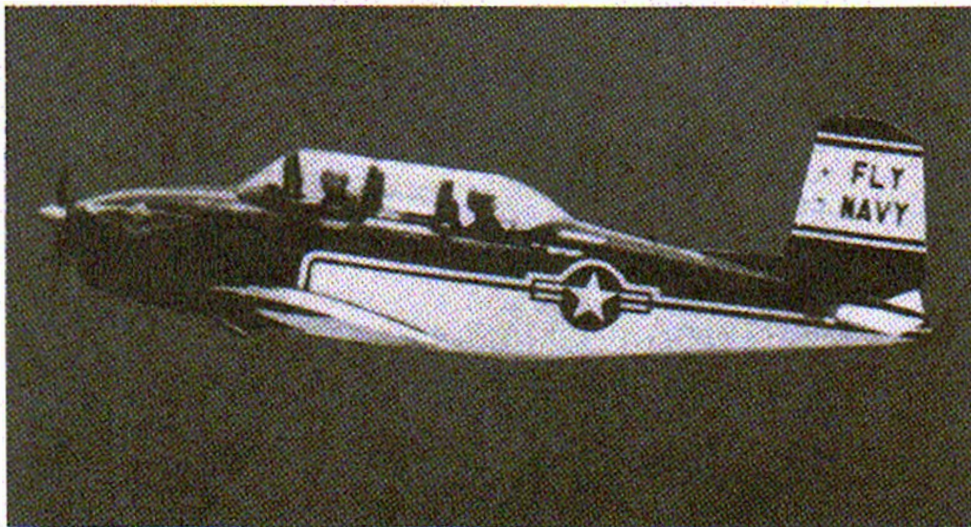

I AIRCRAFT

II INDOCT

III NORMAL
PROCD

IV FLIGHT
CHARAC

V EMERG
PROCD

VI ALL WTHR
OPERATION

VII COMM
PROCD

VIII WEAPON
SYSTEMS

IX FLT CREW
COORD

X NATOPS
EVAL

XI PERFORM
DATA

Change Notice 2 March 1981

Reproduction for non-military use of the information or illustrations contained in this publication is not permitted without specific approval of the Commander, Naval Air Systems Command.

LIST OF EFFECTIVE PAGES

Dates of issue for original and change pages are:

Original (0) 1 Mar 81

TOTAL NUMBER OF PAGES IN THIS PUBLICATION IS 164 CONSISTING OF THE FOLLOWING:

<i>Page No.</i>	<i>Issue</i>
Title0
A - C0
Letter of Promulgation0
i - vi0
1-1 - 1-400
1-41/(1-42 blank)0
1-43 - 1-480
2-1 - 2-20
2-3/(2-4 blank)0
3-1 - 3-160
3-17/(3-18 blank)0
3-19 - 3-260
4-1 - 4-60
5-1 - 5-120
6-1 - 6-60
6-7/(6-8 blank)0
7-1/(7-2 blank)0
8-1/(8-2 blank)0
9-1/(9-2 blank)0
10-1 - 10-120
11-1 - 11-240
Index-1 - Index-60

INTERIM CHANGE SUMMARY

The following Interim Changes have been canceled or previously incorporated in this manual:

INTERIM CHANGE NUMBER(S)	REMARKS/PURPOSE
1 thru 22	

The following Interim Changes have been incorporated in this Change/Revision:

INTERIM CHANGE NUMBER	REMARKS/PURPOSE
23	Baggage compartment, low altitude engine failure

Interim Changes Outstanding - To be maintained by the custodian of this manual:

INTERIM CHANGE NUMBER	ORIGINATOR/DATE (or DATE/TIME GROUP)	PAGES AFFECTED	REMARKS/PURPOSE

SUMMARY OF APPLICABLE TECHNICAL DIRECTIVES

Information relating to the following recent technical directives has been incorporated in this manual

CHANGE NUMBER	DESCRIPTION	PLANNED METHOD OF INCORPORATION
45	Installation of Fuel Injector System	PAR
48	Installation of Additional Engine Oil System Cooler	PAR
50	Installation of Emergency Fuel System	
51	Installation of ARC 101 Receiver/Transmitter to Replace ARC 12 (in selected aircraft only)	
53	Incorporation of Fuel System Micronic Filter Assembly	Depot Field Team/PAR
58	Installation of AIMS Transponder	Depot Field Team
59 Amend 1	Removal of Nose Gear Doors	
60	Installation of Bendix VHF/VOR to Replace ARC 12	Depot Field Team

Information relating to the following recent technical directives will be incorporated in a future change

CHANGE NUMBER	DESCRIPTION	PLANNED METHOD OF INCORPORATION



DEPARTMENT OF THE NAVY
OFFICE OF THE CHIEF OF NAVAL OPERATIONS
WASHINGTON, D.C. 20350

1 March 1981

LETTER OF PROMULGATION

1. The Naval Air Training and Operating Procedures Standardization Program (NATOPS) is a positive approach toward improving combat readiness and achieving a substantial reduction in the aircraft accident rate. Standardization, based on professional knowledge and experience, provides the basis for development of an efficient and sound operational procedure. The standardization program is not planned to stifle individual initiative, but rather to aid the Commanding Officer in increasing his unit's combat potential without reducing his command prestige or responsibility.

2. This manual standardizes ground and flight procedures but does not include tactical doctrine. Compliance with the stipulated manual procedure is mandatory except as authorized herein. In order to remain effective, NATOPS must be dynamic and stimulate rather than suppress individual thinking. Since aviation is a continuing, progressive profession, it is both desirable and necessary that new ideas and new techniques be expeditiously evaluated and incorporated if proven to be sound. To this end, Commanding Officers of aviation units are authorized to modify procedures contained herein, in accordance with the waiver provisions established by OPNAVINST 3510.9 series, for the purpose of assessing new ideas prior to initiating recommendations for permanent changes. This manual is prepared and kept current by the users in order to achieve maximum readiness and safety in the most efficient and economical manner. Should conflict exist between the training and operating procedures found in this manual and those found in other publications, this manual will govern.

3. Checklists and other pertinent extracts from this publication necessary to normal operations and training should be made and may be carried in Naval Aircraft for use therein. It is forbidden to make copies of this entire publication or major portions thereof without specific authority of the Chief of Naval Operations.

A handwritten signature in black ink, appearing to read "W. L. McDonald", with a long horizontal flourish extending to the right.

W. L. McDONALD
Vice Admiral, USN
Deputy Chief of Naval Operations
(Air Warfare)

Table of Contents

SECTION	I	THE AIRCRAFT	1-1
SECTION	II	INDOCTRINATION	2-1
SECTION	III	NORMAL PROCEDURES	3-1
SECTION	IV	FLIGHT CHARACTERISTICS	4-1
SECTION	V	EMERGENCY PROCEDURES	5-1
SECTION	VI	ALL-WEATHER OPERATIONS	6-1
SECTION	VII	COMMUNICATIONS PROCEDURES	7-1
SECTION	VIII	WEAPONS SYSTEMS	8-1
SECTION	IX	FLIGHT CREW COORDINATION	9-1
SECTION	X	NATOPS EVALUATION	10-1
SECTION	XI	PERFORMANCE DATA	11-1
ALPHABETICAL INDEX			Index-1

FOREWORD

SCOPE

The NATOPS Flight Manual is issued by the authority of the Chief of Naval Operations and under the direction of Commander, Naval Air Systems Command in conjunction with the Naval Air Training and Operating Procedures Standardization (NATOPS) Program. This manual contains information on all aircraft systems, performance data, and operating procedures required for safe and effective operations. However, it is not a substitute for sound judgement. Compound emergencies, available facilities, adverse weather or terrain, or considerations affecting the lives and property of others may require modification of the procedures contained herein. Read this manual from cover to cover. It's your responsibility to have a complete knowledge of its contents.

APPLICABLE PUBLICATIONS

The following applicable publications complement this manual:

- NAVAIR 01-90KDB-1B (Pilot's Pocket Checklist)
- NAVAIR 01-90KDB-1F (Functional Check-flight Checklist)

HOW TO GET COPIES

Each flight crewmember is entitled to personal copies of the NATOPS Flight Manual and appropriate applicable publications.

Automatic Distribution

To receive future changes and revisions to this manual or any other NAVAIR aeronautical publication automatically, a unit must be established on an automatic distribution list maintained by the Naval Air Technical Services Facility (NATSF). To become established on the list or to change existing NAVAIR publication requirements, a unit must submit the appropriate tables from NAVAIR 00-25DRT-1 (Naval Aeronautic Publications Automatic Distribution Requirement Tables) to NATSF, Code 321, 700 Robbins Avenue Philadelphia, PA 19111. Publication requirements should be reviewed

periodically and each time requirements change, a new NAVAIR 00-25DRT-1 should be submitted. NAVAIR 00-25DRT-1 only provides for future issues of basic, changes, or revisions and will not generate supply action for the issuance of publications from stock. For additional instructions, refer to NAVAIRINST 5605.4 series and Introduction to Navy Stocklist of Publications and Forms NAVSUP Publication 2002 (S/N 0535-LP-004-0001).

Additional Copies

Additional copies of this manual and changes thereto may be procured by submitting DD Form 1348 to NAVPUBFORMCEN Philadelphia in accordance with Introduction to Navy Stocklist of Publications and Forms NAVSUP Publication 2002.

UPDATING THE MANUAL

To ensure that the manual contains the latest procedures and information, NATOPS review conferences are held in accordance with OPNAVINST 3510.9 series.

CHANGE RECOMMENDATIONS

Recommended changes to this manual or other NATOPS publications may be submitted by anyone in accordance with OPNAVINST 3510.9 series.

Routine change recommendations are submitted directly to the Model Manager on OPNAV Form 3500-22 shown on the next page. The address of the Model Manager of this aircraft is:

Navy Recruiting Command
Aviation QA Team
Air Operations (AOMR)
Naval Air Station Pensacola
Pensacola, Florida 32508
ATTN: T-34B Model Manager

Change recommendations of an URGENT nature (safety of flight, etc.,) should be submitted directly to the NATOPS Advisory Group Member in the chain of command by priority message.

NATOPS/TACTICAL CHANGE RECOMMENDATION
 OPNAV FORM 3500/22 (5-69) 0107-722-2002

DATE _____

TO BE FILLED IN BY ORIGINATOR AND FORWARDED TO MODEL MANAGER

FROM (originator)		Unit			
TO (Model Manager)		Unit			
Complete Name of Manual/Checklist	Revision Date	Change Date	Section/Chapter	Page	Paragraph
Recommendation (be specific)					

CHECK IF CONTINUED ON BACK

Justification

Signature	Rank	Title
Address of Unit or Command		

TO BE FILLED IN BY MODEL MANAGER (Return to Originator)

FROM	DATE
------	------

TO _____

REFERENCE

(a) Your Change Recommendation Dated _____

Your change recommendation dated _____ is acknowledged. It will be held for action of the review conference planned for _____ to be held at _____.

Your change recommendation is reclassified URGENT and forwarded for approval to _____ by my DTG _____.

/s/ _____	MODEL MANAGER	_____	AIRCRAFT
-----------	---------------	-------	----------

YOUR RESPONSIBILITY

NATOPS Flight Manuals are kept current through an active manual change program. Any corrections, additions, or constructive suggestions for improvement of its content should be submitted by routine or urgent change recommendation, as appropriate, at once.

NATOPS FLIGHT MANUAL INTERIM CHANGES

Flight Manual Interim Changes are changes or corrections to the NATOPS Flight Manuals promulgated by CNO or NAVAIRSYSCOM. Interim Changes are issued either as printed pages, or as a naval message. The Interim Change Summary page is provided as a record of all interim changes. Upon receipt of a change or revision, the custodian of the manual should check the updated Interim Change Summary to ascertain that all outstanding interim changes have been either incorporated or canceled; those not incorporated shall be recorded as outstanding in the section provided.

CHANGE SYMBOLS

Revised text is indicated by a black vertical line in either margin of the page, adjacent to the affected text, like the one printed next to this paragraph. The change symbol identifies the addition of either new information, a changed procedure, the correction of an error, or a rephrasing of the previous material.

WARNINGS, CAUTIONS, AND NOTES

The following definitions apply to "WARNINGS", "CAUTIONS", and "NOTES" found through the manual.

WARNING

An operating procedure, practice, or condition, etc., which may result in injury or death if not carefully observed or followed.

CAUTION

An operating procedure, practice, or condition, etc., which may result in damage to equipment if not carefully observed or followed.

Note

An operating procedure, practice, or condition, etc., which is essential to emphasize.

WORDING

The concept of word usage and intended meaning which has been adhered to in preparing this Manual is as follows:

"Shall" has been used only when application of a procedure is mandatory.

"Should" has been used only when application of a procedure is recommended.

"May" and "need not" have been used only when application of a procedure is optional.

"Will" has been used only to indicate futurity, never to indicate any degree of requirement for application of a procedure.

Left Blank Intentionally

T-34B

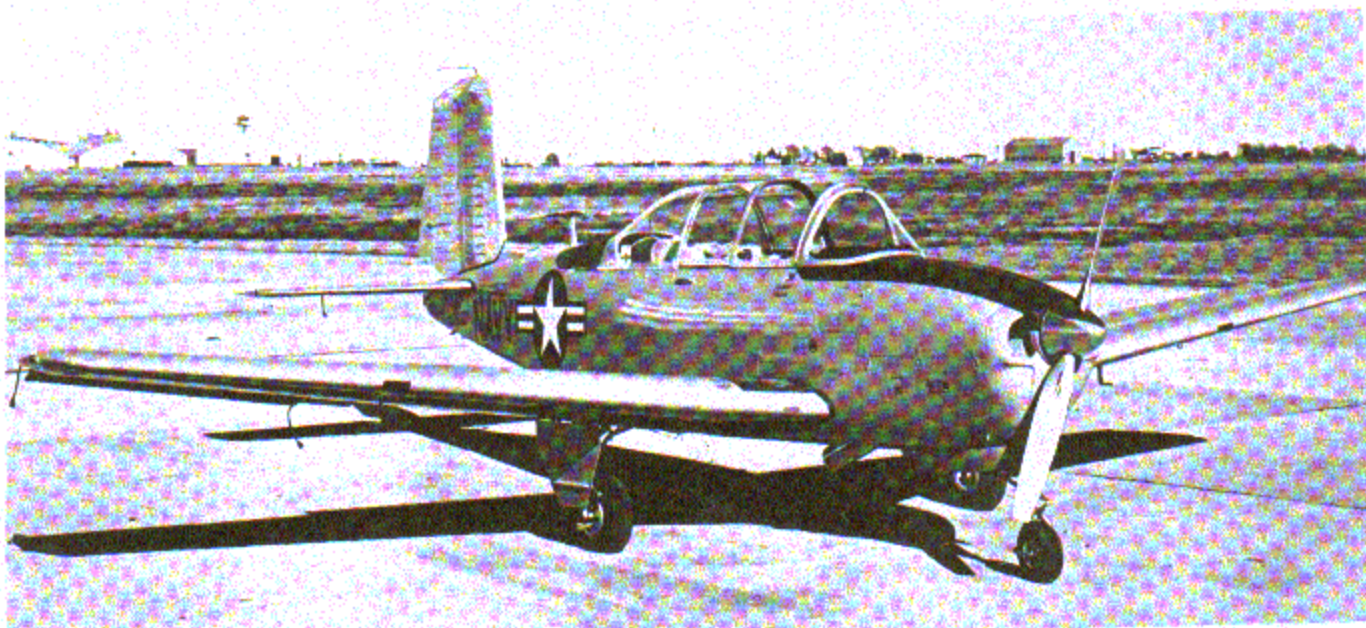
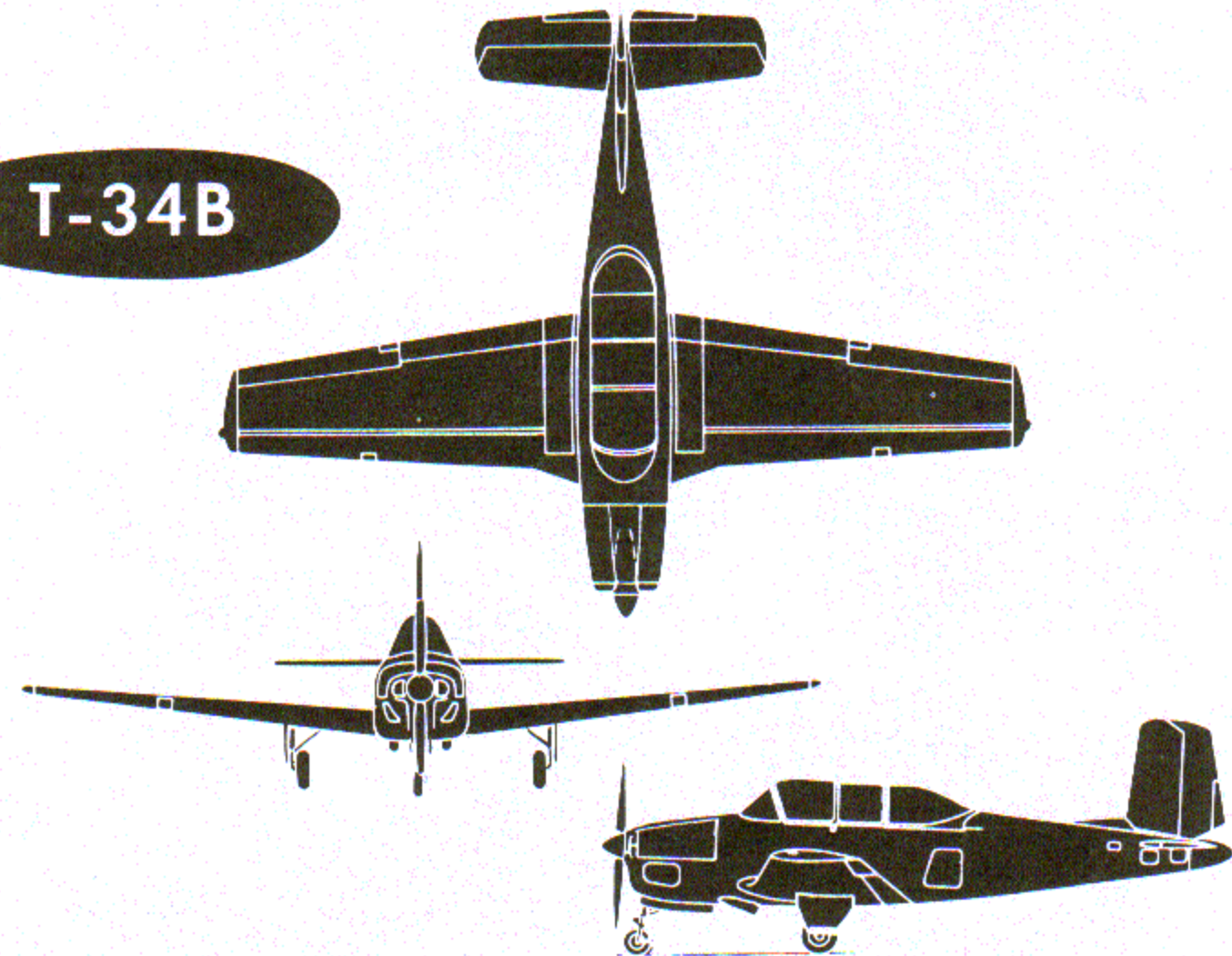

Figure 1-1. T-34B Aircraft

SECTION I - THE AIRCRAFT

Table of Contents

PART 1 — GENERAL DESCRIPTION	1-1	Aims (Transponder Identification System)	1-35
The Aircraft	1-1	Exterior Lighting	1-36
Engine	1-2	Interior Lighting	1-38
		Baggage Compartment	1-38
		Miscellaneous Equipment	1-38
PART 2 — SYSTEMS	1-12		
Engine	1-12	PART 3 — AIRCRAFT SERVICING	1-39
Ignition	1-14	General Information	1-39
Starter	1-14		
Propeller	1-14	PART 4 — AIRCRAFT OPERATING LIMITATIONS	1-43
Oil System	1-14	General Limitations	1-43
Fuel System	1-16	Minimum Crew Requirements	1-43
Electrical Power Supply System	1-21	Engine Limitations	1-43
Flight Control System	1-23	Propeller Limitations	1-43
Landing Gear System	1-23	Weight Limitations	1-43
Wheel Brake System	1-26	Airspeed Limitations	1-43
Instruments	1-26	Acceleration Limitations	1-43
Emergency Equipment	1-29	Maneuvers	1-43
Canopy	1-29	Center-of-Gravity Limitations	1-43
Seats	1-30	Limitations Card	1-48
Heating and Ventilating System	1-31		
Communications and Associated Electronic Equipment	1-31		

PART 1 - GENERAL DESCRIPTION

THE AIRCRAFT

The T-34B aircraft, manufactured by Beech Aircraft Corporation, is a two-place tandem trainer equipped with dual flight controls, tricycle landing gear, constant speed propeller, and duplicate instrumentation in both cockpits. This aircraft meets all the requirements of a primary trainer and also possesses many of the flight characteristics and operating systems to be found in higher-performance aircraft. Although dual flight controls are provided for student training, solo flight must be accomplished from the front cockpit

only. See figures 1-3 through 1-11 for general and interior arrangement.

DIMENSIONS AND MATERIALS.

The T-34B is primarily constructed of aluminum alloy. Magnesium alloy is lighter but its brittleness confines its use to limited areas in the ailerons, elevators, rudder, and stabilizers. These parts, including their skins, are nearly all magnesium. The corrugated appearance of these surfaces is a design feature which reduces skin flutter and increases skin strength. See figure 1-2.

Section I
Part 1

NAVAIR 01-90KDB-1

The overall dimensions of the aircraft are:

- Wing span 32 ft. 9-7/8 in.
- Wing area 178 sq. ft.
- Mean aerodynamic chord 64.6 in.
(71.8 in. to 136.4 in. aft of datum)
- Length 25 ft. 10-4/5 in.
- Height (at rest) 9 ft. 7-1/5 in.
- Tread 9 ft. 7-1/5 in.

Normal gross weight (varying) 2,775 to 2,975 pounds

ENGINE.

The aircraft is powered by a Continental six cylinder, air-cooled, horizontally-opposed engine developing 225 horsepower at 2,600 rpm at sea level. The engine is equipped with a direct drive starter, Bendix RS5BD-1 fuel injection system, and obtains slight additional thrust and greatly improved cooling from an augmentor type exhaust system. Model designation of the engine is O-470-4.

GROSS WEIGHT

Maximum gross weight for takeoff and landing 3,050 pounds

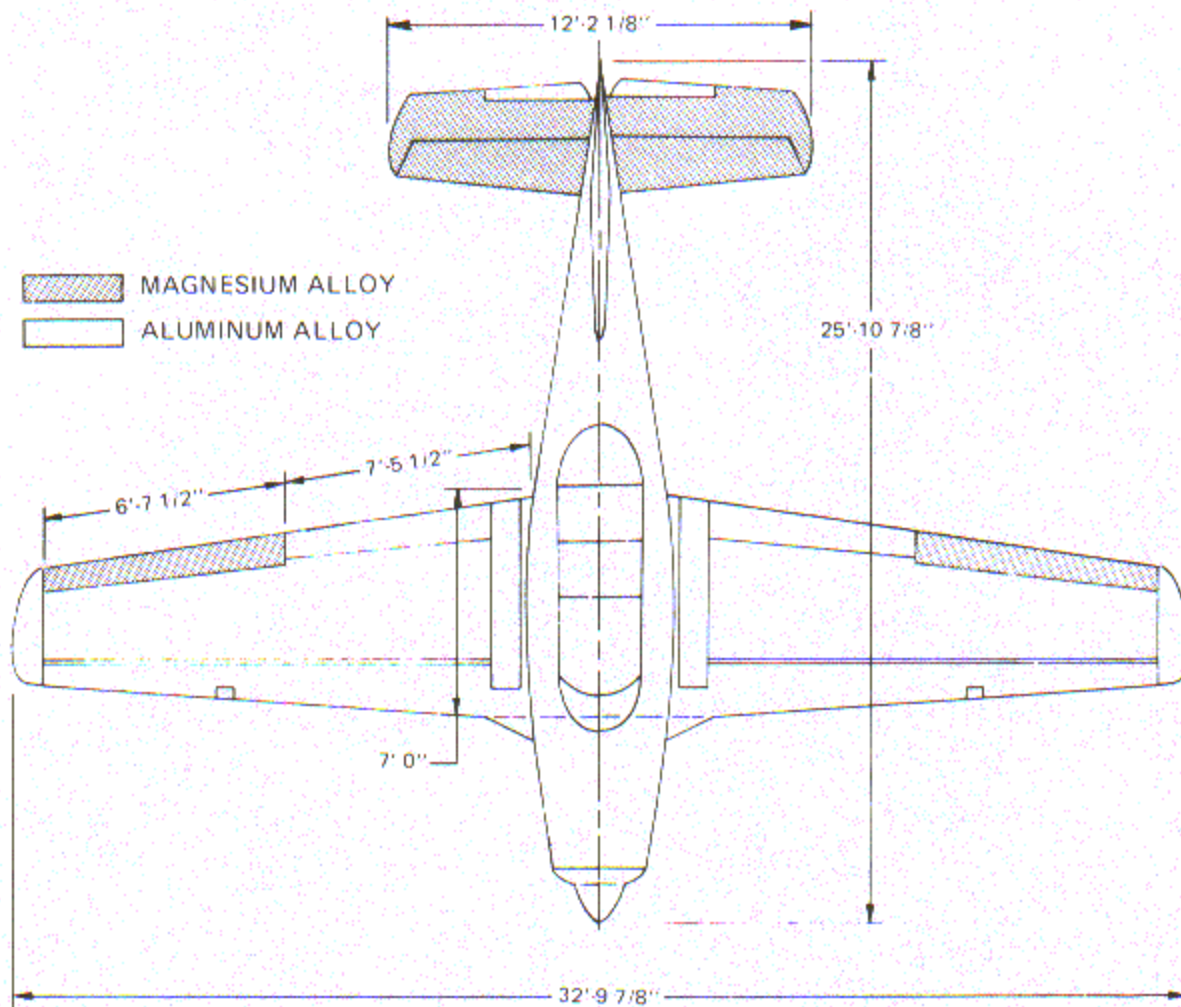

Figure 1-2. Dimensions and Materials

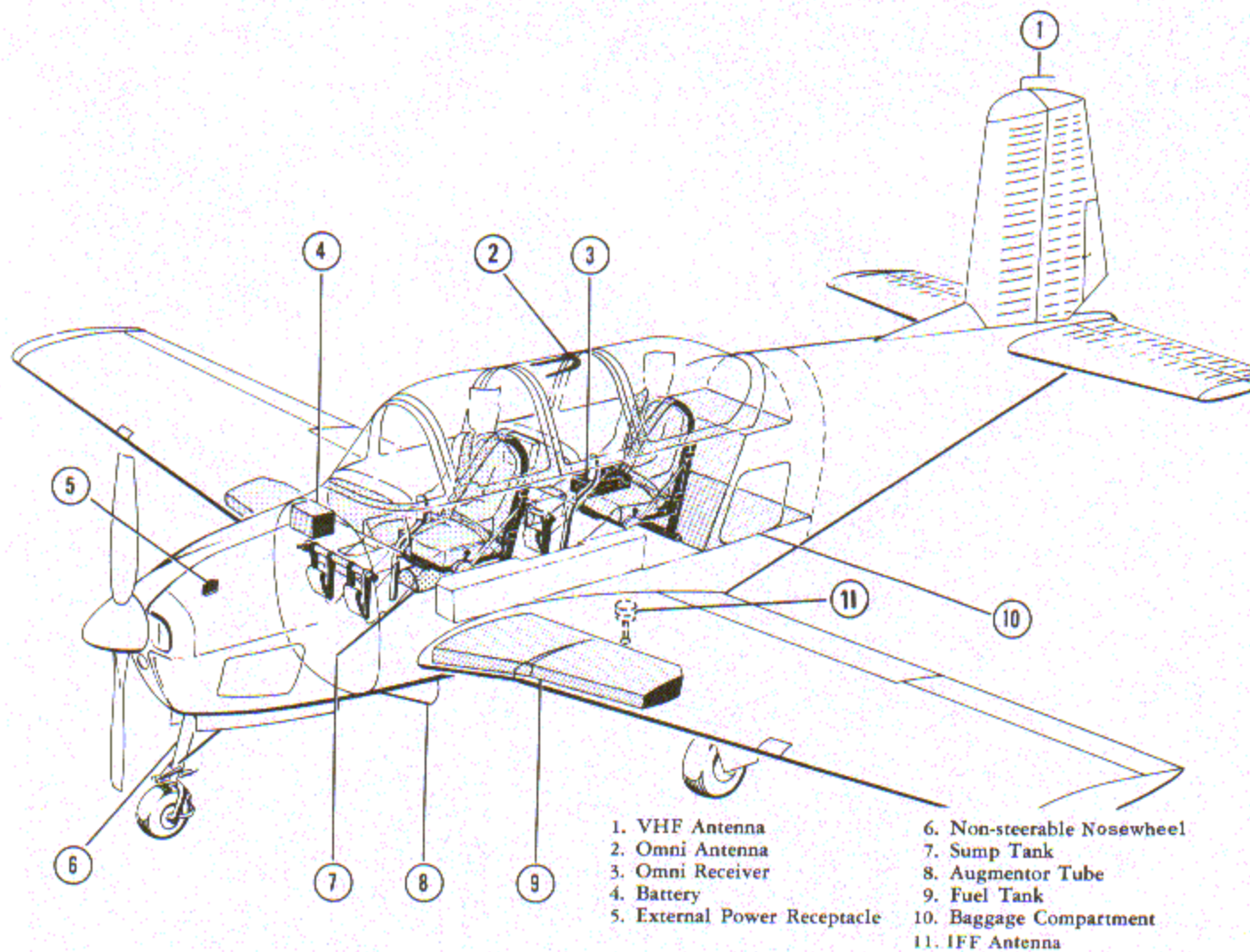
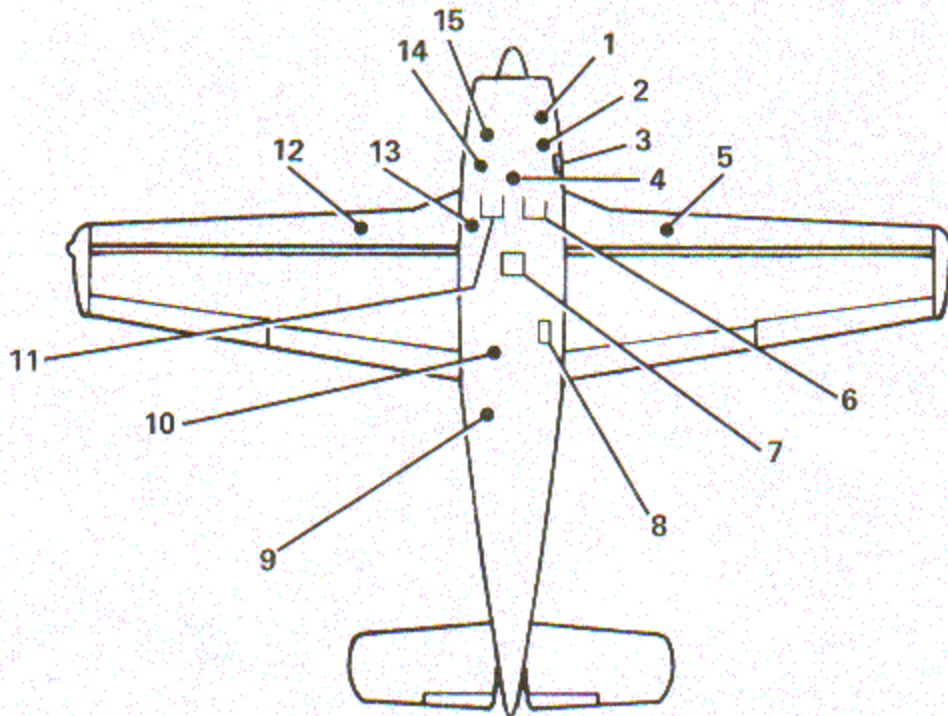
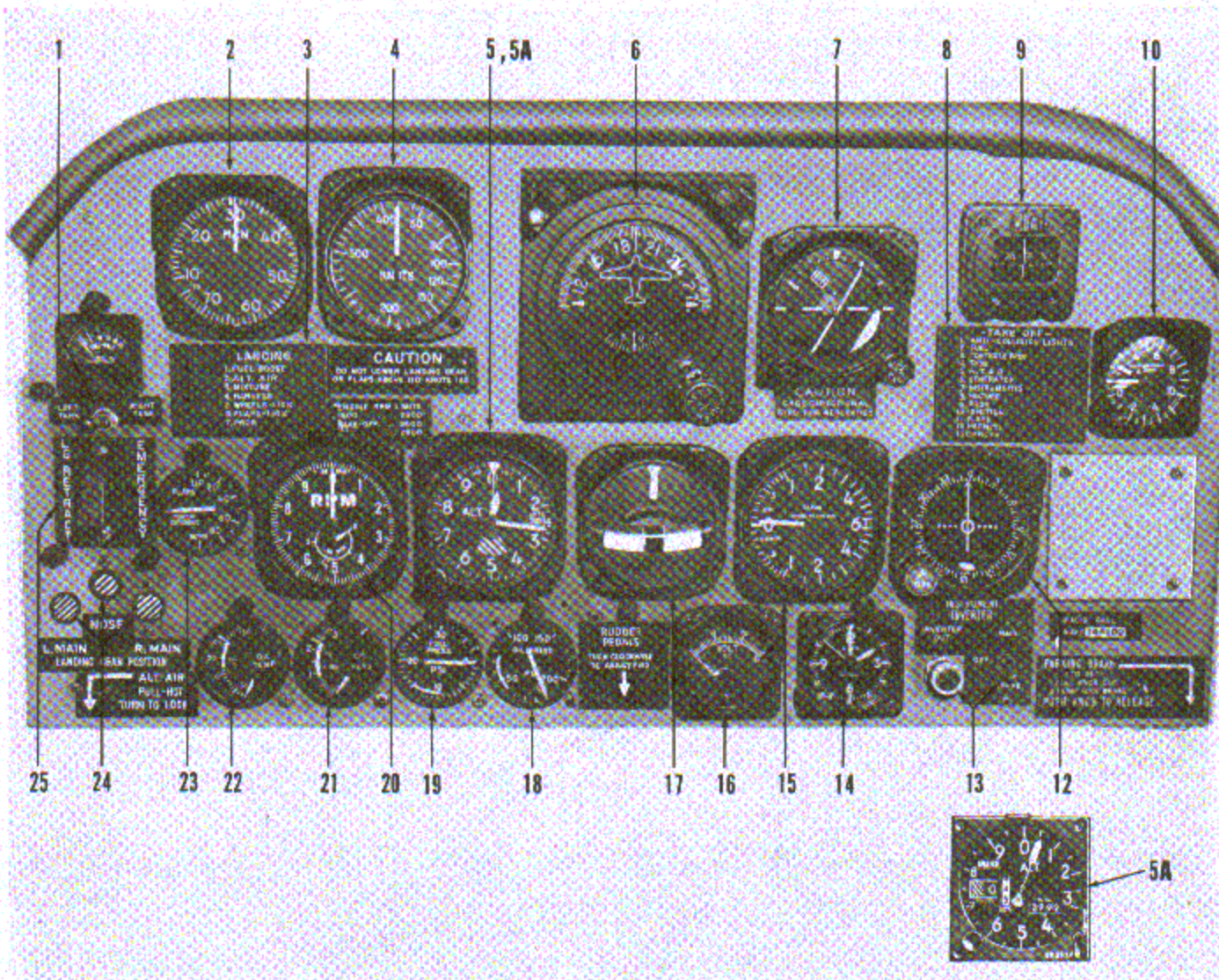

Figure 1-3. General Arrangements



1. Gang Drain -- Fuel only during sampling. Fuel at other times indicates a leak in the flow divider or at the engine-driven fuel pump.
2. Oil Tank Drain -- Oil only if overserviced.
3. Oil Tank Drain -- Oil leak indicates defective drain valve.
4. Hydraulic Reservoir Overflow Drain -- Hydraulic fluid if overserviced.
5. Fuel Cell Siphon Breaker Valve -- No fuel leak.
6. Oil Tank Check Valve (Port Augmenter Tube) -- No oil leak.
7. Fuel Sump Drain (Access Panel 4) -- No fuel leak.
8. Main Fuel Strainer Valve (Access Panel 7) -- No fuel leak.
9. Instrument Static Drain -- Should be capped.
10. Fuel Cell Vent -- Fuel drip after fueling or acrobatic maneuvers not uncommon.
11. Engine Breather (Starboard Augmenter Tube) -- Oil drip normal.
12. Fuel Cell Siphon Breaker Valve -- No fuel leak.
13. Battery Vent -- No leakage.
14. Engine Compartment Scupper Drain -- No leak. If leaks observed, investigate security of engine accessory section.
15. Air Scoop Drain -- Possible fuel if engine flooded.

Figure 1-4. Vents and Drains (Bottom View)



- | | |
|---------------------------------------|---|
| 1. Fuel Gage and Tank Selector Switch | 13. Inverter Switch and Failure Light |
| 2. Manifold Pressure Gage | 14. Clock |
| 3. Edge Lighted Checklist | 15. Rate of Climb Indicator |
| 4. Airspeed Indicator | 16. Voltmeter |
| 5. Altimeter | 17. Turn and Slip Indicator |
| 5A. Altimeter/Encoder (After AFC 58) | 18. Oil Pressure Gage |
| 6. Heading Indicator | 19. Fuel Pressure Gage |
| 7. Attitude Indicator | 20. Tachometer |
| 8. Edge Lighted Checklist | 21. Cylinder Head Temperature Gage |
| 9. Magnetic Compass | 22. Oil Temperature Gage |
| 10. Accelerometer | 23. Flap Position Indicator |
| 11. Deleted | 24. Landing Gear Position Indicator |
| 12. VOR-LOC Indicator | 25. Landing Gear Emergency Retract Switch |

Figure 1-5. Instrument Panel (Typical)

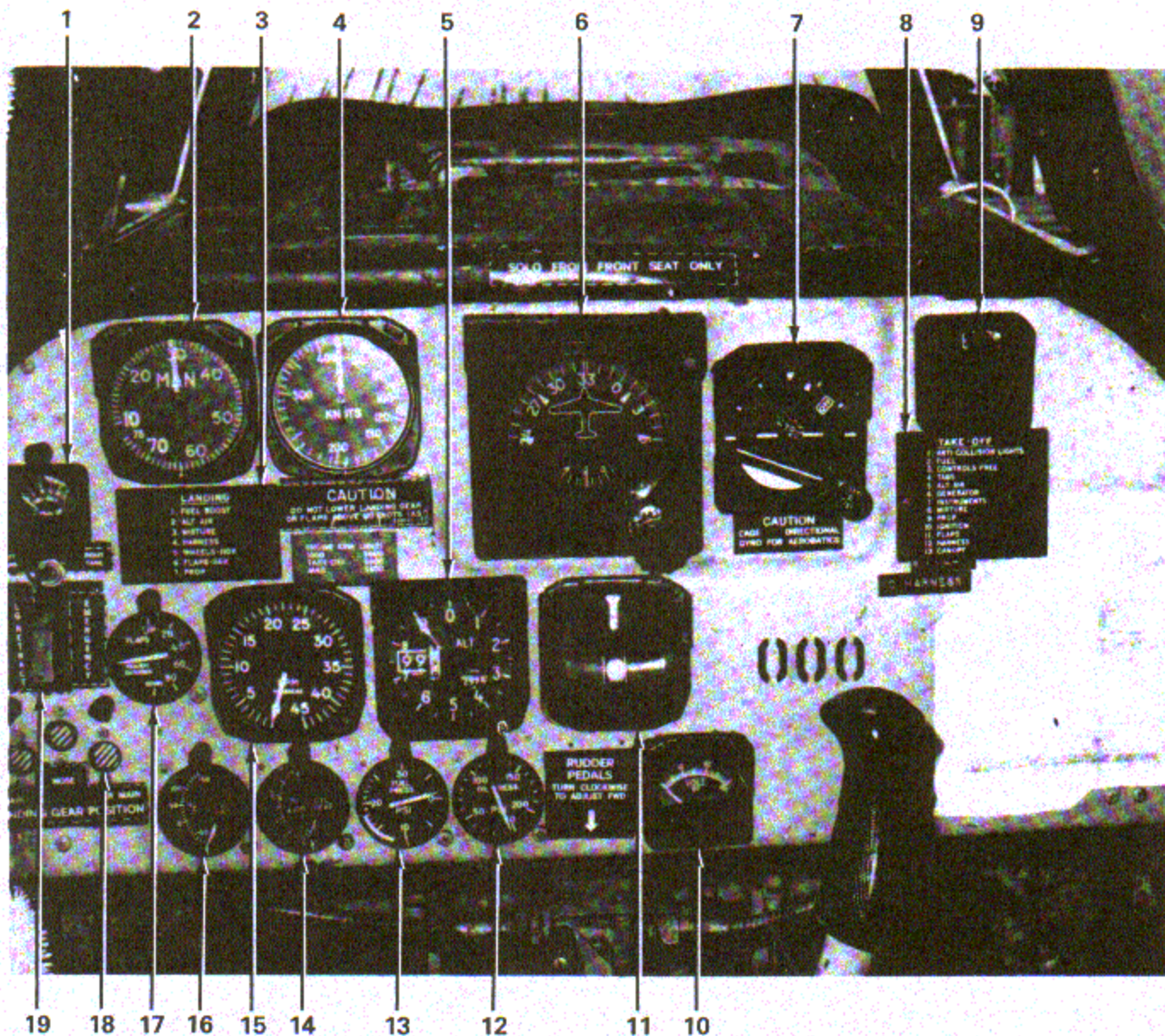

- | | |
|---------------------------------------|---|
| 1. Fuel Gage and Tank Selector Switch | 11. Turn and Slip Indicator |
| 2. Manifold Pressure Gage | 12. Oil Pressure Gage |
| 3. Edge Lighted Checklist | 13. Fuel Pressure Gage |
| 4. Airspeed Indicator | 14. Cylinder Head Temperature Gage |
| 5. Altimeter | 15. Tachometer |
| 6. Heading Indicator | 16. Oil Temperature Gage |
| 7. Attitude Indicator | 17. Flap Position Indicator |
| 8. Edge Lighted Checklist | 18. Landing Gear Position Indicator |
| 9. Magnetic Compass | 19. Landing Gear Emergency Retract Switch |
| 10. Voltmeter | |

Figure 1-6. Aft Instrument Panel (Typical, Subsequent to Incorporation of T-34 AFC 58)

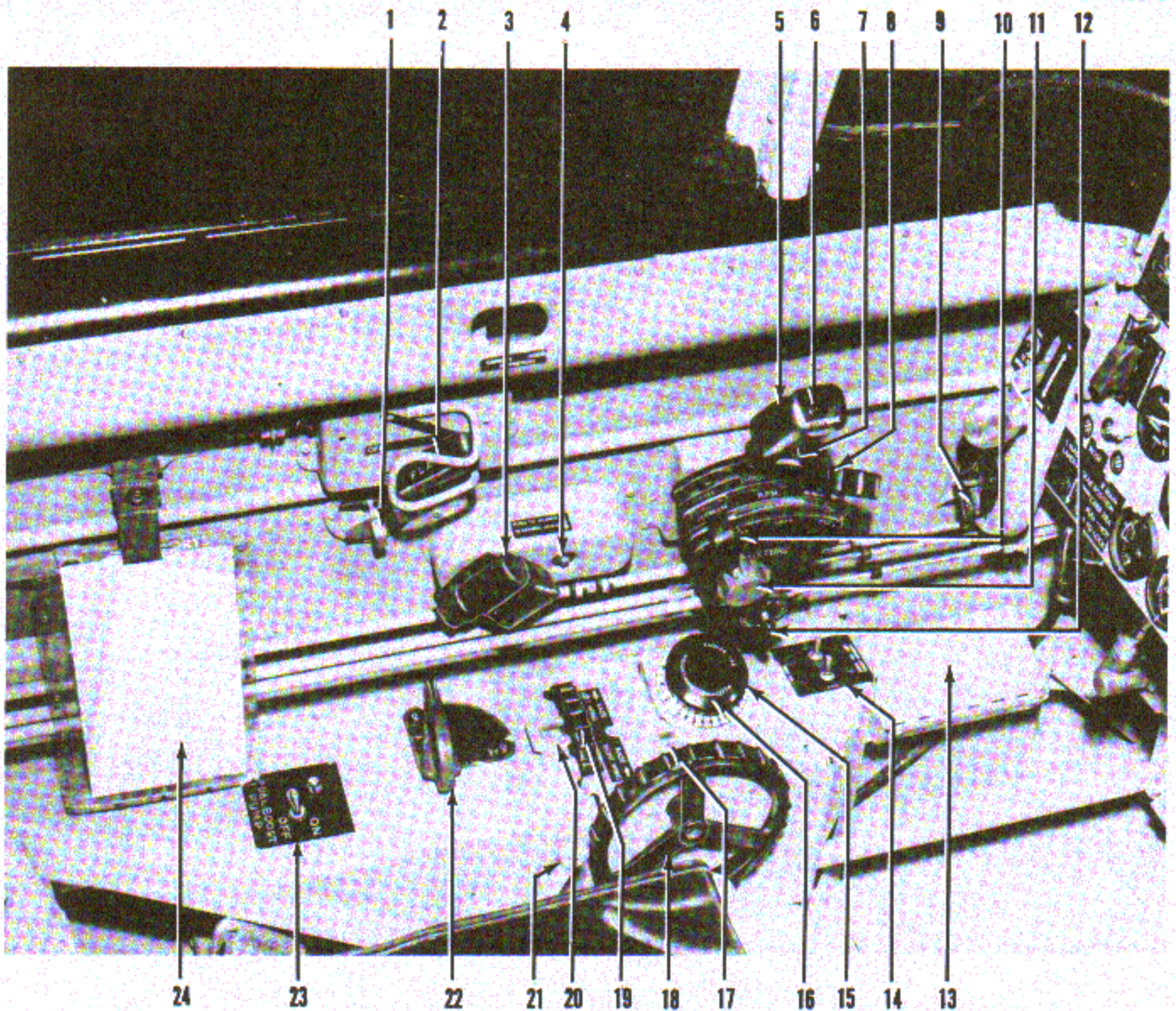

- 1. Cockpit Air Outlet
- 2. Flap Lever and Guard
- 3. Console Light
- 4. Warning Horn Silencer Button
- 5. Throttle
- 6. Interphone Button
- 7. Transmitter Button
- 8. Propeller Lever
- 9. Ignition Switch
- 10. Mixture Lever Idle Cutoff Lock
- 11. Mixture Lever
- 12. Engine Control Quadrant Friction Lock Knob
- 13. Spare Lamp Case (Before AFC 55)
- 13A. IFF Transponder (After AFC 58)
- 14. Landing Light Switches
- 15. Rudder Trim Tab Position Indicator

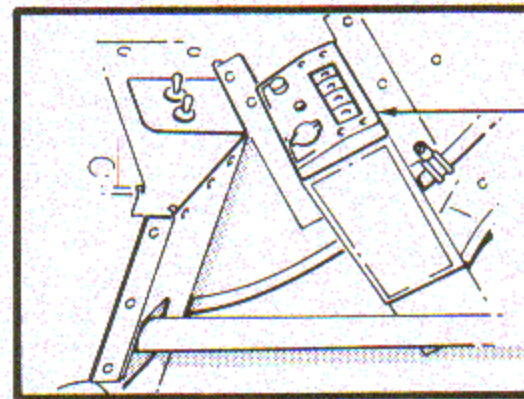

- 16. Rudder Trim Tab Knob
- 17. Elevator Trim Tab Position Indicator
- 18. Elevator Trim Tab Wheel
- 19. Aileron Trim Tab Wheel
- 20. Aileron Trim Tab Position Indicator
- 21. Inertia Reel Lock Handle
- 22. Fuel Shutoff Valve Handle
- 23. Fuel Boost Pump Switch
- 24. Pilots Checklist Holder

Figure 1-7. Front Cockpit Left Side (Typical)

COCKPIT CIRCUIT BREAKERS

FORWARD COCKPIT ONLY

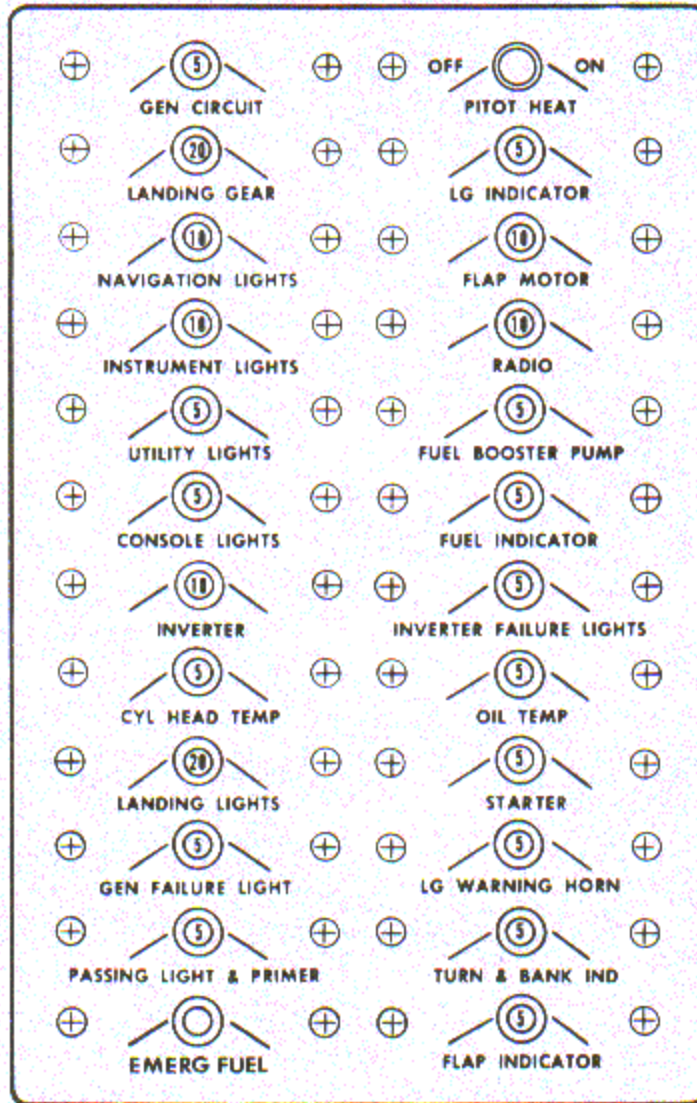

Cockpit Circuit Breakers

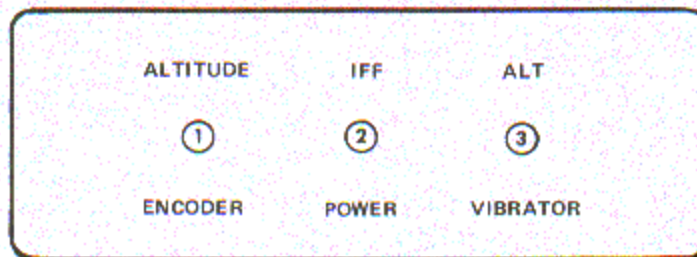
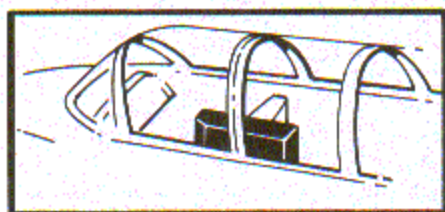
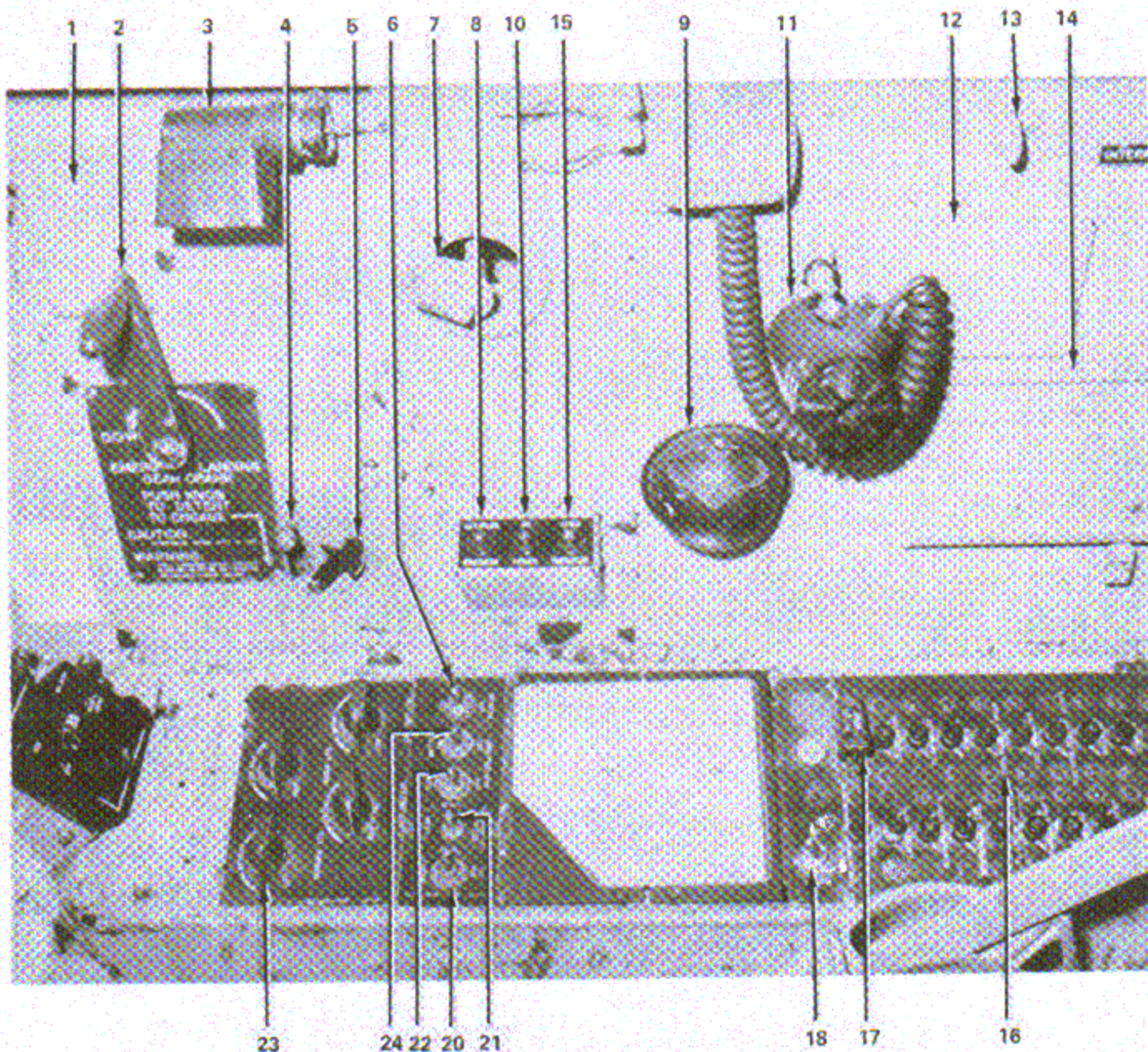
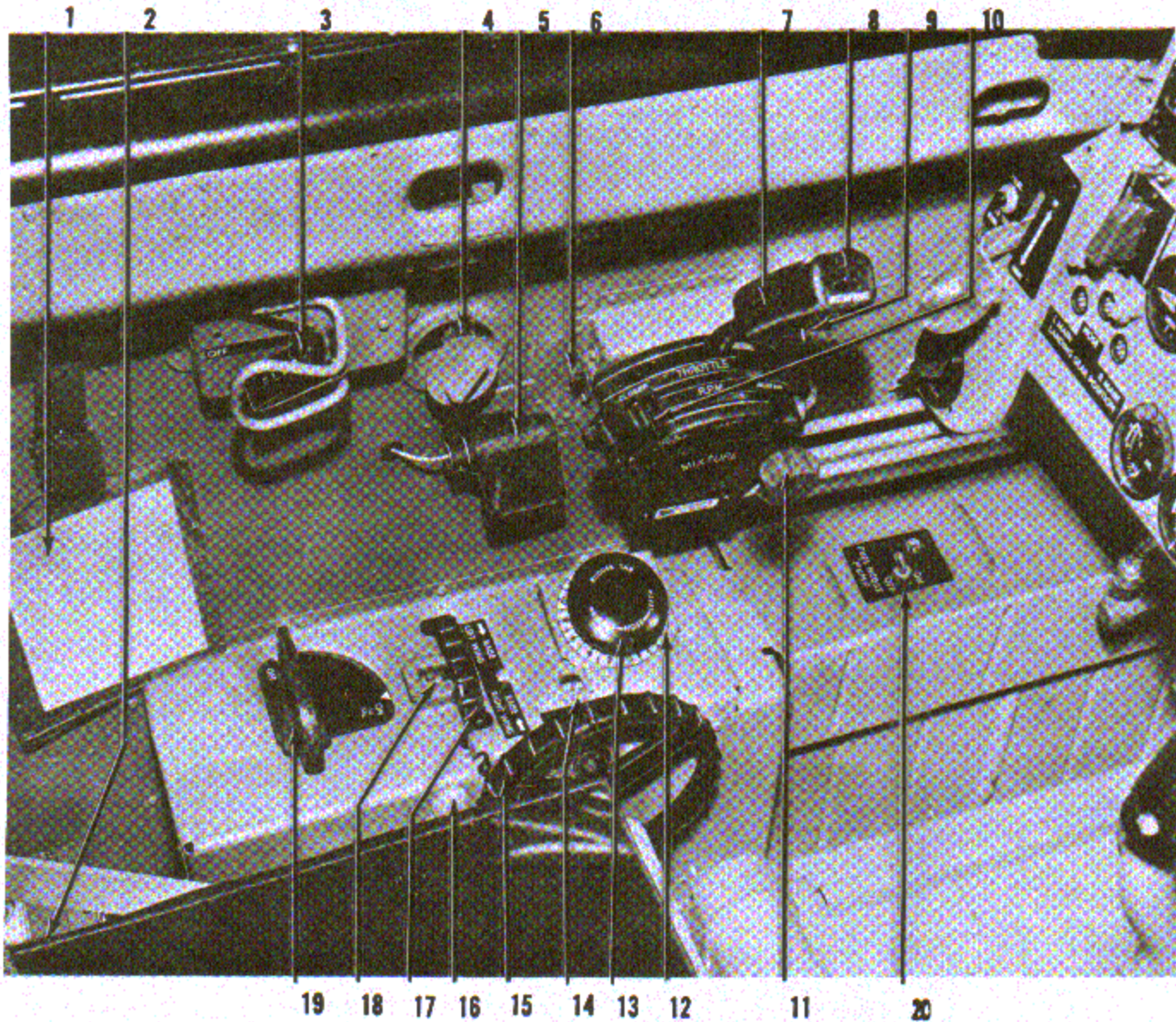

Figure 1-8. Cockpit Circuit Breakers



- | | |
|---|--|
| 1. Compass Deviation Card | 10. IFF Power Circuit Breaker |
| 2. Emergency Landing Gear Crank | 11. Utility Light |
| 3. Console Light | 12. VHF Transmitting Frequencies Card |
| 4. Emergency Landing Gear Handcrank Cluth Knob | 13. Hand Held Microphone Hook |
| 5. Emergency Landing Gear Handcrank Cluth Knob Lock | 14. Map Case |
| 6. Passing Light Switch | 15. Altimeter Vibrator Circuit Breaker |
| 7. Cockpit Air Outlet | 16. Circuit Breaker Panel |
| 8. Altimeter Encoder Circuit Breaker | 17. Pitot Heater Switch |
| 9. Ash Tray | 18. Radio Master Switch |
| | 19. Deleted |
| | 20. Navigation Lights Intensity Switch |
| | 21. External Master Switch |
| | 22. Top Anti-Collision Light Switch |
| | 23. Interior Lights Control Panel |
| | 24. Bottom Anti-Collision Light Switch |

Figure 1-9. Front Cockpit Right Side (Typical, after Incorporation of AFC 58)



1. Pilot's Checklist Envelope
2. VHF Transmitter
3. Flap Lever and Guard
4. Cockpit Air Outlet
5. Console Light
6. Interphone Override Button
7. Throttle
8. Interphone Button
9. Transmitter Button
10. Propeller Lever
11. Mixture Lever
12. Rudder Trim Tab Position Indicator
13. Rudder Trim Tab Knob
14. Elevator Trim Tab Position Indicator

15. Elevator Trim Tab Wheel
16. Inertia Reel Lock Handle
17. Aileron Trim Tab Wheel
18. Aileron Trim Tab Indicator
19. Fuel Shutoff Valve Handle
20. Fuel Boost Pump Switch

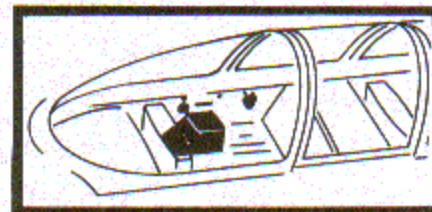
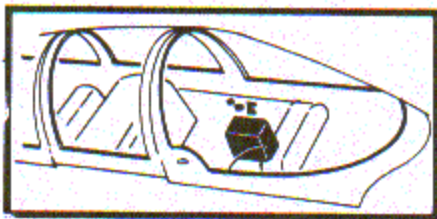
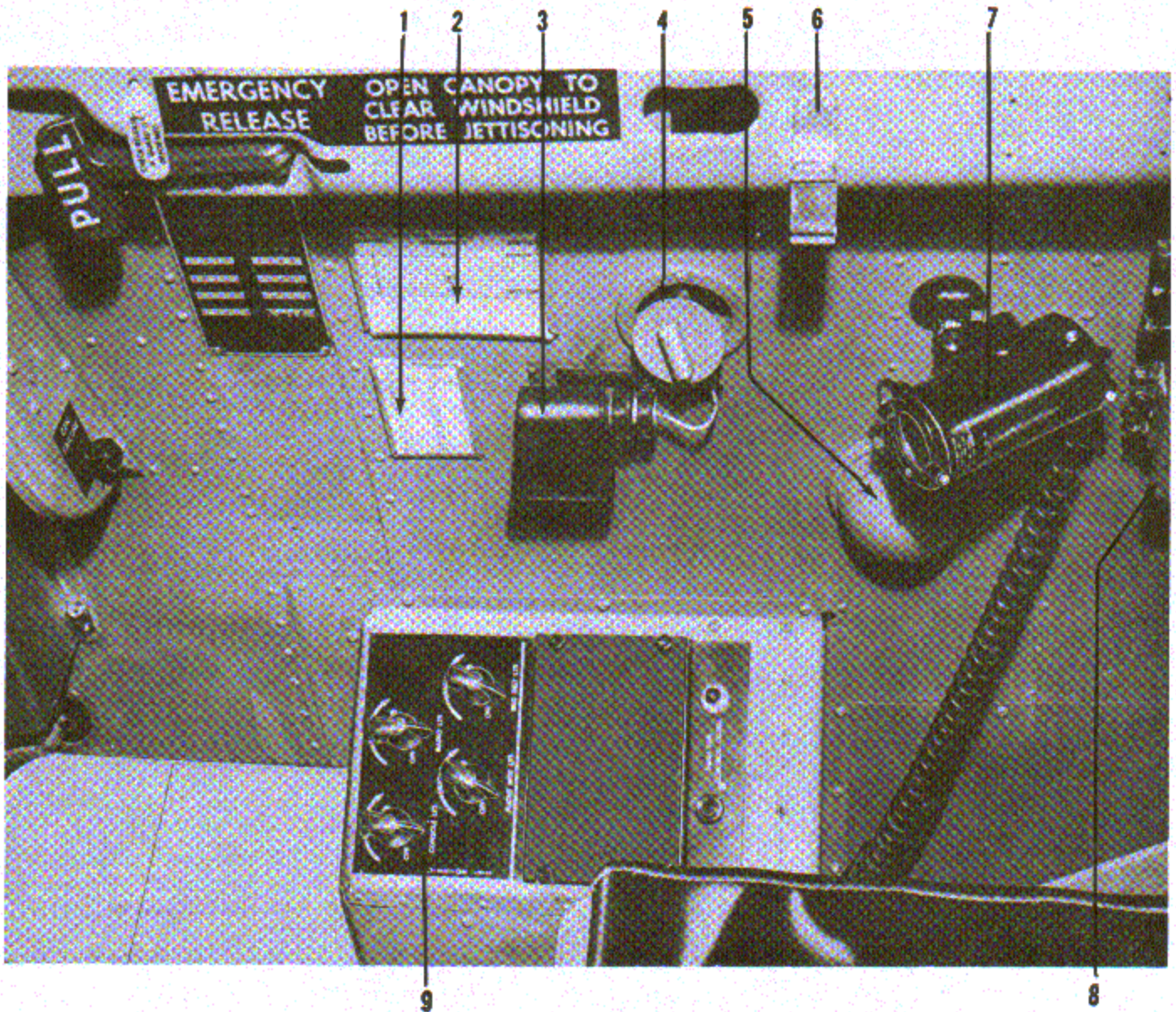

Figure 1-10. Rear Cockpit Left Side (Typical)



- | | |
|---------------------------|----------------------------------|
| 1. Compass Deviation Card | 6. Headset Hook |
| 2. VFH Transmitting Card | 7. Utility Light |
| 3. Console Light | 8. Radio Junction Box |
| 4. Cockpit Air Outlet | 9. Interior Lights Control Panel |
| 5. Ash Tray | |

Figure 1-11. Rear Cockpit Right Side (Typical)

PART 2 - SYSTEMS

ENGINE.

Proper operation and consideration of the loads imposed on the engine are of prime importance in maintaining flight in a single-engine aircraft. The power settings for takeoff, climb, and maximum continuous power are identical for this engine which enables the employment of the maximum power available at any time for maximum rate of climb. This does not imply that the engine is designed to operate wide open at all times. Continued use of extremely high power settings materially shortens engine life by increasing wear. The prime factors to consider in maintaining greatest efficiency from the engine are proper lubrication and the loads imposed. Frequent attention to instruments, such as oil pressure and cylinder head temperature gages, will instill a habit of checking often on the existing operating conditions in the power plant. Some engine operation practices to keep in mind include:

1. Change in power setting — When reducing power, always reduce throttle first, then reduce rpm to avoid creating excessively high pressure in the cylinders. When increasing power, an inverse procedure is followed; i.e., increase the rpm first, then the throttle.
2. Mixture lever — Maintain mixture lever in FULL RICH position during all flight operations.
3. Fuel control icing — The possibility of fuel control icing is very remote since the temperature drop of induction air through this fuel control is less than usual, and fuel is not mixed with the air until after it has left the fuel control. However, when icing conditions exist, it is possible for ice, due to moist impact air, to collect on the air inlet filter at the front of the engine which will eventually shut off induction system air flow. The use of alternate air heat will supply an alternate source of air but will have no effect on the ice accumulation on the filter. If icing conditions are severe enough to cause ice to form on the filter, wing and propeller icing will also occur; therefore, an attempt should be made to get out of the icing area or land immediately.

ENGINE CONTROLS.

The throttle, mixture, and propeller levers are located in the quadrants (figures 1-7 and 1-10) on the left side of each cockpit. There are interconnected to move simultaneously from either the forward or aft cockpit. A quadrant

friction lock knob (6, figure 1-12) on the forward quadrant, will increase friction and prevent creeping of the controls when rotated clockwise.

THROTTLE

The throttle lever (1, figure 1-12) located on the outboard side of each quadrant, is placarded OPEN and CLOSED. A desired manifold pressure may be obtained by placing the throttle in any intermediate position. Incorporated into the throttle handgrip are the interphone and radio transmission buttons (2 and 3, figure 1-12). Retarding the throttle to a position corresponding to a manifold pressure of approximately 12 inches Hg sounds the landing gear warning horn any time the landing gear is not down and locked.

PROPELLER LEVER.

The propeller lever (4, figure 1-12), located in the center of each control quadrant, is used for selection of the desired engine speed. Any engine speed down to the minimum "power on" operating speed of 1,600 rpm can be maintained by moving the lever aft from the FULL INCREASE position. Minimum "power on" operating speed is obtained when the propeller lever comes in contact with the detent (figure 1-12). Movement of the propeller lever past the detent (1,600 rpm) results in a positive high pitch and an engine speed of approximately 700 rpm. Movement of the propeller lever past the detent with power on is prohibited in order to avoid the development of excessively high internal cylinder pressures.

MIXTURE LEVER.

The mixture lever (5, figure 1-12), located on the inboard face of each quadrant, controls the fuel-air ratio delivered by the fuel control to the engine. The fuel control is not equipped with an automatic mixture control. For altitude compensation, leave the mixture control in the FULL RICH position during all flight operations. Movement of the mixture lever full aft to IDLE CUTOFF shuts off all fuel flow at the fuel control. The mixture lever may be moved from IDLE CUTOFF to FULL RICH and from FULL RICH to IDLE CUTOFF from either cockpit.

ENGINE INSTRUMENTS.

Engine indicators, shown in figure 1-5, are installed on the instrument panels in each cockpit. The oil pressure

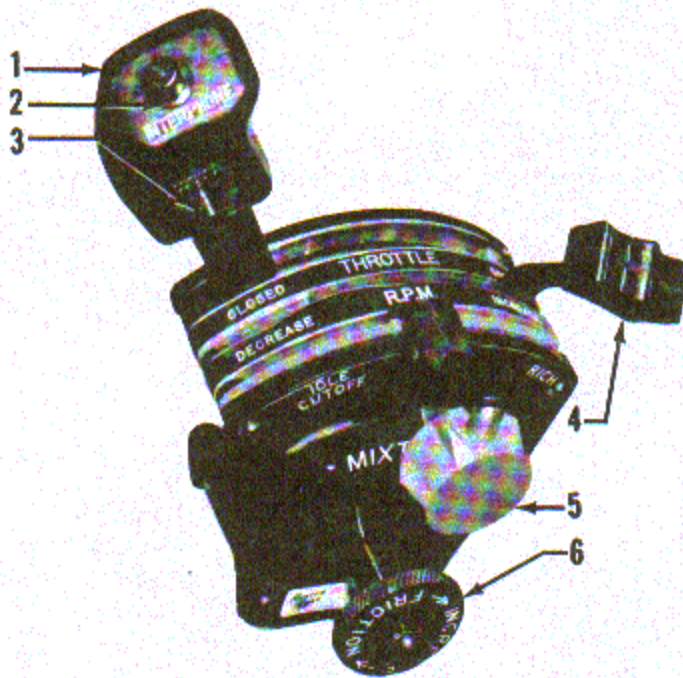

NOTE:
FRICTION LOCK (6) INSTALLED IN
FRONT COCKPIT ONLY.

1. Throttle
2. Interphone Button
3. Transmitter Button
4. Propeller Lever
5. Mixture Lever
6. Engine Control Quadrant
Friction Lock Knob

PROPELLER LEVER DETENT



MINIMUM LOW RPM POSITION



POSITIVE HIGH PITCH POSITION

MIXTURE LEVER

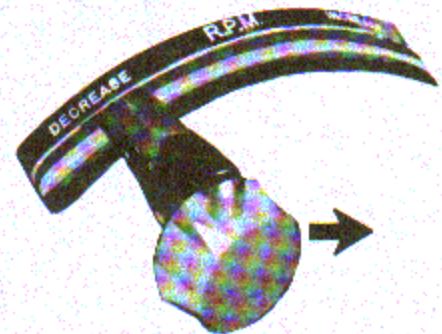

TO ENRICH MIXTURE PUSH LEVER FORWARD



TO STOP ENGINE, MOVE LEVER TO IDLE CUT-OFF.

Figure 1-12. Engine Control Quadrant

gages are calibrated in pounds-per-square-inch (psi) and are mechanically operated by pressure directly from the engine, while the fuel pressure gages, also calibrated in psi, are operated by pressure directly from the fuel control. When the engine is inoperative, the manifold pressure gage, reading in inches of mercury (Hg), corresponds to barometric pressure. The tachometer, calibrated in hundreds of rpm, is energized by an engine-driven tachometer generator and is independent of the aircraft's electrical system. Cylinder head and oil temperature are registered in degrees centigrade by the cylinder head and oil temperature gages in each cockpit.

Cylinder head temperature is detected by an electrically operated temperature resistance bulb, installed at number one cylinder for the gage in the front cockpit and at number two cylinder for the gage in the rear cockpit. The oil temperature gage is operated by an electrical temperature resistance bulb located at the oil pressure pump. The oil temperature gage registers temperatures of oil as it flows into the engine. Electrical power for operation of these gages is supplied directly from the dc electrical system, and protection against overloads is provided by push-pull type circuit breakers located on the main circuit breaker panel.

FUEL CONTROL.

The aircraft is equipped with a Bendix Pressure Type RS5BD-1 fuel injector system. This system does not incorporate an automatic mixture control, nor does it incorporate an auto-lean position within the system.

ALTERNATE AIR.

The alternate air handle is located on the left subpanel in the front cockpit only (figure 1-13) and provides for the selection of an alternate source of warm air from the engine compartment to the fuel control. With the handle full IN, ram air enters the fuel control through the air intake located below the propeller spinner. Pulling the handle full OUT operates a butterfly valve in the duct system which shuts off the normal ram air and admits warm air from the engine compartment. A mixture of warm and cold air may be obtained by adjusting the handle to any intermediate position.

ENGINE COOLING.

Automatic control of engine cooling is provided by an augmentor tube exhaust system (figure 1-14) which employs the velocity of exhaust gases to vary the flow of cooling air around the engine. Two collectors, one in each bank of cylinders, eject exhaust gases into the mouths of the augmentor tubes which creates a venturi effect in the tubes and allows the air to be drawn from the engine compartment. Tight baffling controls the air flow around the cylinders. When power is increased, the greater blast effect of the exhaust draws a larger volume of air through the baffled engine, thereby increasing the cooling effect and automatically compensating for the additional heat generated by the greater power being developed. No cowl flaps or other engine cooling accessories are required.

IGNITION.

Ignition for the engine is supplied by dual magnetos which automatically provide a retarded and intensified spark for engine starting by operation of the ignition switch (figure 1-13) on the left subpanel in each cockpit. Normal operation is obtained with the switch turned to BOTH; however, by turning the switch to L or R an operational check of either left or right magneto respectively is provided, by grounding the opposite magneto. Turning the switch to OFF cuts out magneto operation by grounding both magnetos.

STARTER.

The direct-cranking electric starter is automatically engaged and disengaged by operation of the PUSH and RELEASE button (figure 1-15) on the right subpanel.



Figure 1-13. Left Subpanel

PROPELLER.

The engine drives a Beech-designed, hydraulically operated, two-blade, all metal, constant-speed propeller with a blade diameter of 84 inches. A governor system maintains a selected engine speed by varying the pitch of the blades to compensate for varying engine loads, regardless of aircraft attitude. A setting introduced into the governor by the pilot determines the engine speed to be maintained and the governor then controls the flow of engine oil, boosted to high pressure by the governing pump, to or from a piston in the propeller hub. Centrifugal twisting forces acting on the propeller tend to turn the blades toward low pitch, and oil pressure moving the piston forward is translated through linkage into rotation of the blades toward high pitch. The normal operating governed range of the propeller is from 2,600 to 1,600 rpm. Governor action can be bypassed by overriding a detent in the control quadrant which results in a positive high pitch and a minimum rpm of approximately 700. This positive high pitch increases power-off gliding distance approximately 30 percent.

OIL SYSTEM.

The engine employs a dry-sump, pressure lubrication system incorporating engine-driven circulating and scavenging pumps, an oil radiator, and an oil tank with a

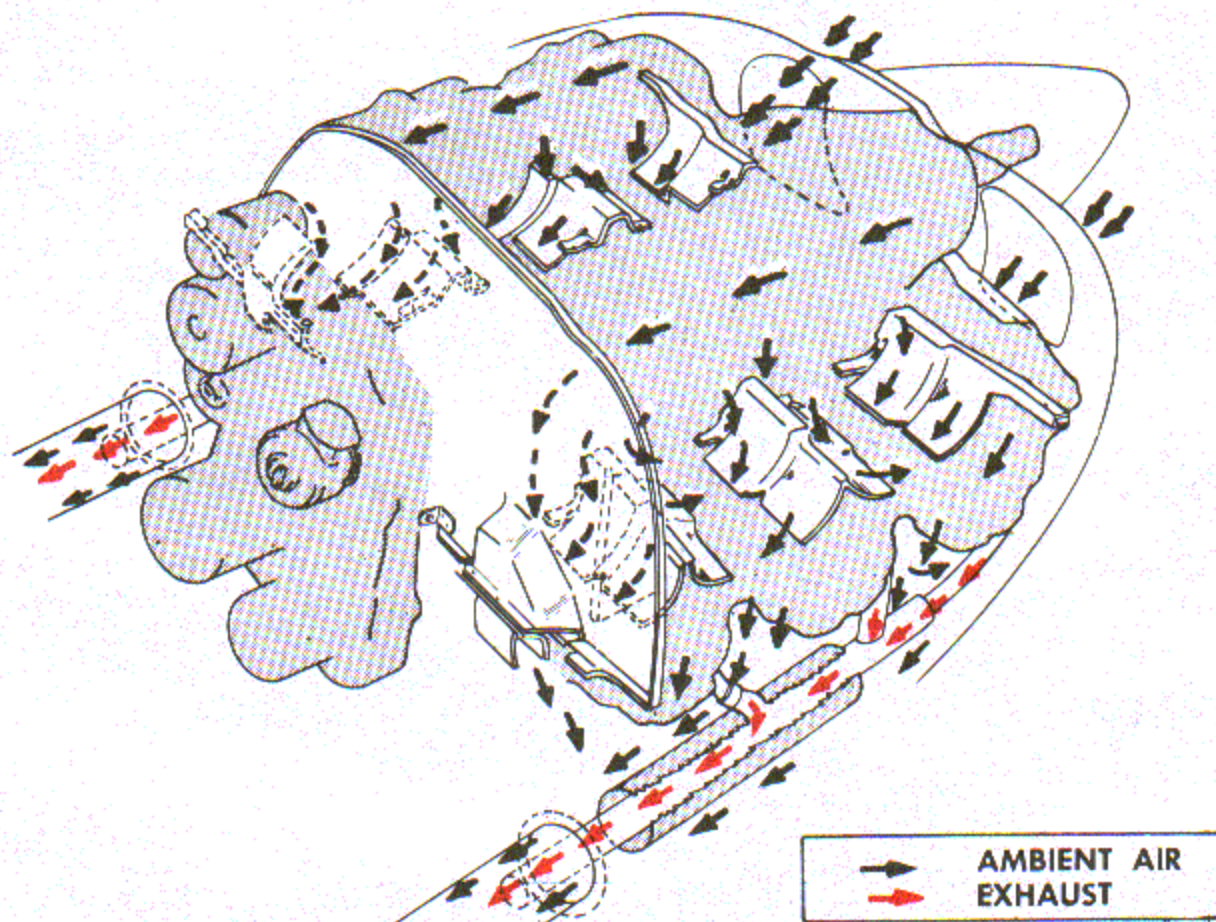

Figure 1-14. Engine Cooling

capacity of 3 U.S. gallons plus 1/2 gallon expansion space. See figure 1-16, sheet 1 of 2. A continuous supply of oil from the tank to the circulating pump is provided during inverted or negative g flight by a weighted pendulum oil pickup tube which remains submerged in the oil reservoir at all times due to gravitational forces.

CAUTION

- Never exceed 15 seconds of inverted or negative g flight as entire oil quantity is recirculated every 20 seconds and oil is not returned to the tank in this flight attitude.
- The aircraft must be maintained in normal attitude for about 30 seconds to allow complete scavenging of the oil from the crankcase sump before resuming inverted flight.

Oil from the tank is directed by the circulating pump, under pressure, to the engine and propeller. While operating with the oil temperature below 65°C, a bypass valve opens allowing all of the oil to bypass the core of the radiator. The valve will begin to close when the temperature reaches approximately 65°C. When the oil temperature reaches 85°C the valve is completely closed, allowing all of the oil to flow through the radiator core. For oil specifications, see figure 1-32. No oil dilution provisions are installed.

Note

For hot weather and continuous operation at high power settings, a secondary oil cooler is provided on aircraft, with S.C 48 installed (figure 1-16, sheet 2 of 2). The secondary cooler allows the engine to be operated at high power settings for extended periods of time without the oil temperature exceeding the normal operating limits. The secondary oil cooler is provided with a bypass control

THE ONLY ITEMS ON THE RIGHT SUBPANEL IN THE REAR COCKPIT ARE THE GENERATOR FAILURE LIGHT AND EMERGENCY FUEL CONTROL SWITCH



Figure 1-15. Right Subpanel Front Cockpit

Note

handle, located in the front cockpit only (figure 1-15). For normal operations the handle will remain in the IN position. During warmup however, the handle may be pulled OUT, thus allowing some of the oil to bypass the secondary oil cooler and reduce the time required for the engine to reach normal operating temperatures.

FUEL SYSTEM.

The aircraft is equipped with a series-type fuel system (figure 1-17, sheet 1 of 2). Major components of the system are two 25-gallon fuel tanks, one located in each inboard wing leading edge; a sump tank, incorporating an electrically operated fuel booster pump; an engine-driven fuel pump; and a pressure type fuel control. Fuel tanks are filled through individual filler necks located in each inboard wing leading edge (6, figure 1-30). The fuel flows by gravity force from each wing simultaneously and is unitized at the centrally located sump tank beneath the

front cockpit, thereby maintaining an equal fuel level in both tanks at all times. Fuel is pumped from the sump tank by the fuel boost pump, through the fuel shutoff valve, to the engine driven fuel pump, and thence to the fuel control. A pressure relief and bypass valve incorporated in the engine-driven fuel pump regulates the output fuel pressure of the pump and in the event of engine-driven fuel pump failure, allows fuel, pumped by the booster pump, to be bypassed to the fuel control. The only indication of booster pump failure with the engine running will be a slight drop in the pressure, indicated on the fuel pressure gage, due to the difference in pressure settings between the fuel booster pump and the engine-driven pump.

Note

On aircraft with AFC 53 incorporated, a ten-micron filter is installed in the fuel supply line, between the engine-driven fuel pump and the fuel control, to provide a finer degree of filtration than is provided by the seventy-four micron strainer installed in the fuel control.

It is characteristic of the Bendix RS5BD-1 fuel control that in its normal operation a certain quantity of unused fuel and vapor is returned to the fuel tank. The return flow on this aircraft is approximately 3 gallons per hour at cruising speeds and is returned from the fuel control through the sump, where it is vented in turn to the left wing tank.

EMERGENCY FUEL SYSTEM.

The aircraft is also equipped with an emergency fuel system when AFC 50 has been installed (Figure 17, sheets 1 and 2). The emergency fuel system can be activated from either cockpit by an electrically operated switch located on the right subpanel. When activated, an electrically operated solenoid valve opens allowing fuel to bypass the fuel control when the exception of the fuel strainer, and gives continuous full power operation. Fuel to the strainer is then unmeasured and throttle adjustments will control only air intake. For this reason, power reductions below 25" and 2200 rpm could result in an over rich condition and possibly a rough running engine.

The only limiting factor involved in the operation of the emergency fuel system is rpm at the time of initiation. With the aircraft in a clean configuration, established in a 90 knot power off glide, engine rpm is approximately 1650. Aircraft tests have shown that emergency fuel activation at 1000 rpm (approximately 60 knots power off) and above should result in immediate full power

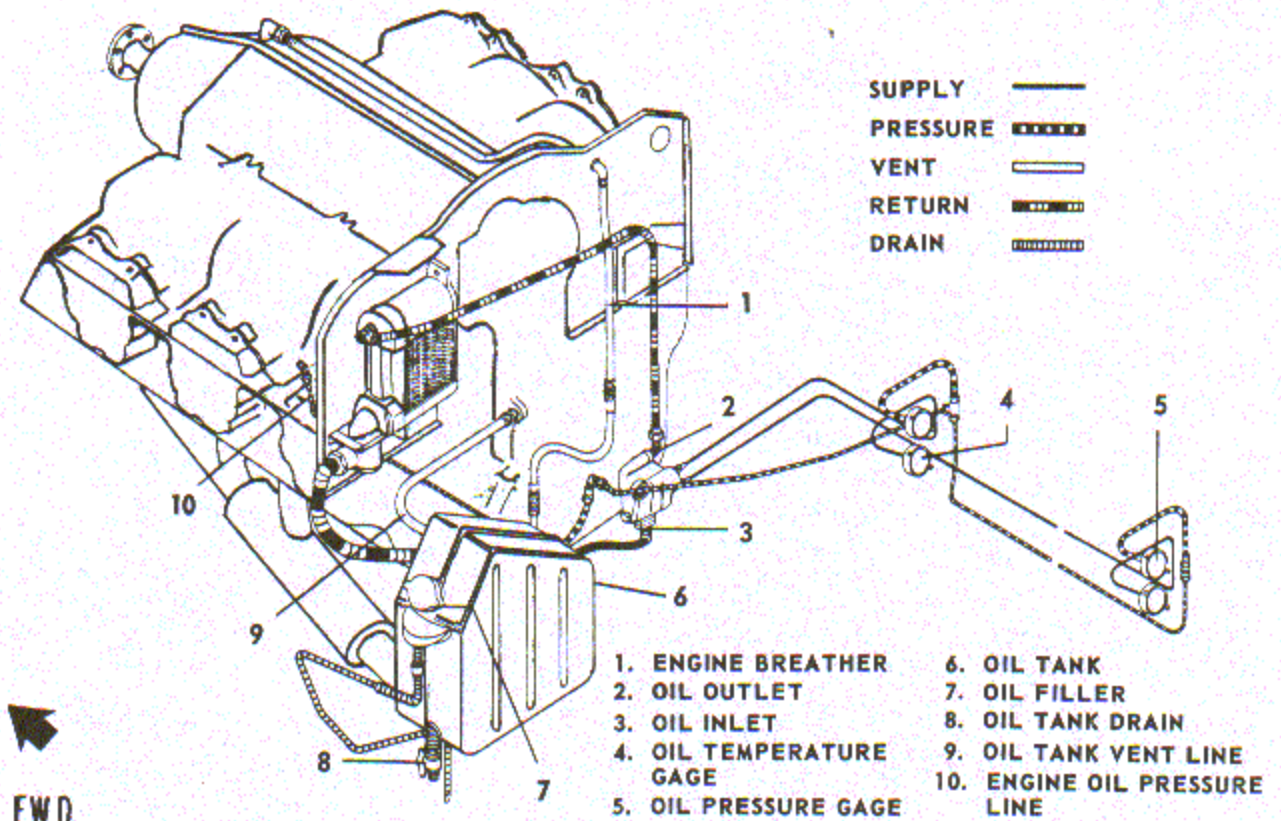
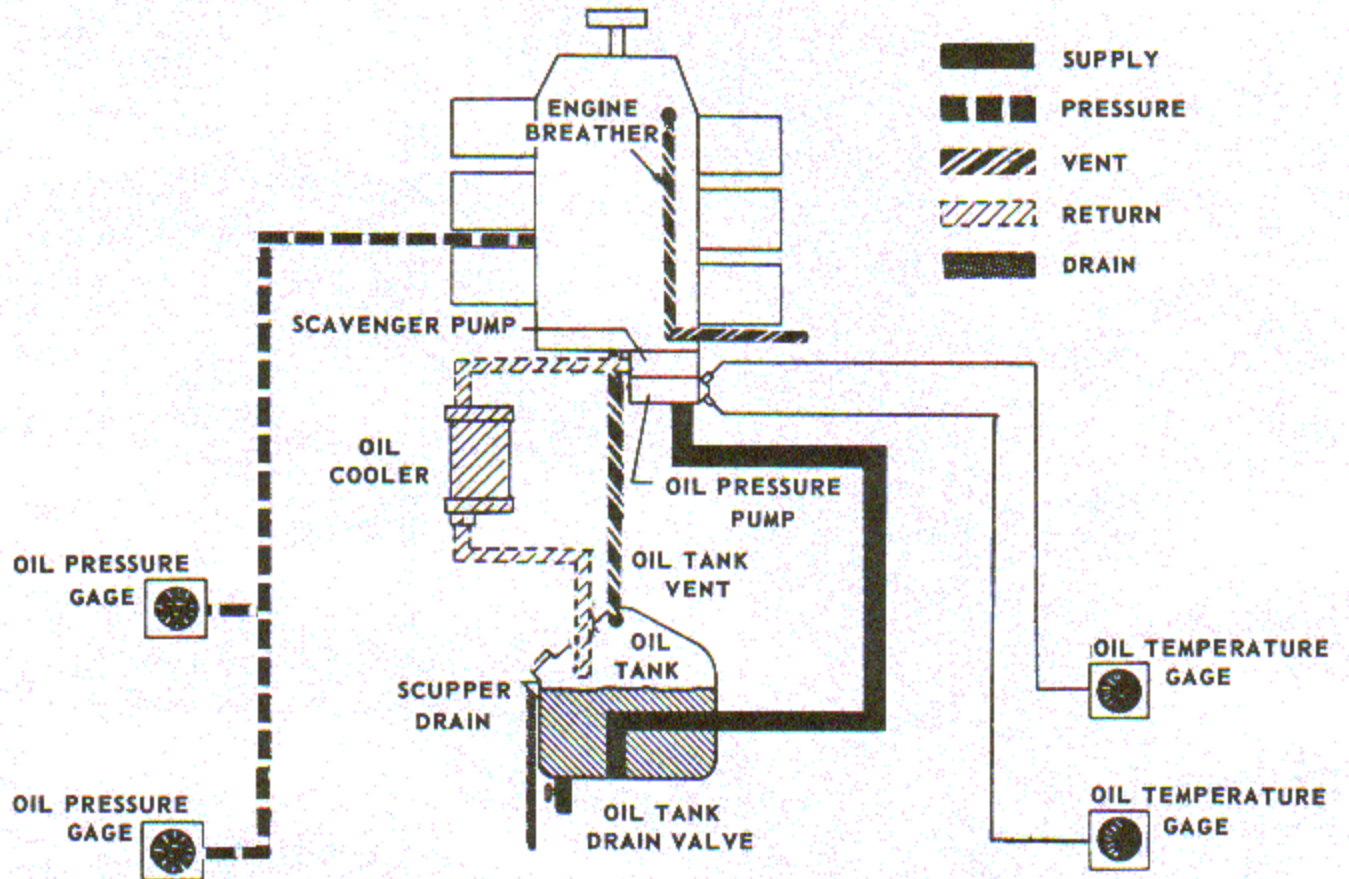

Figure 1-16. Oil System (Sheet 1 of 2)

S.C. 48 INCORPORATED

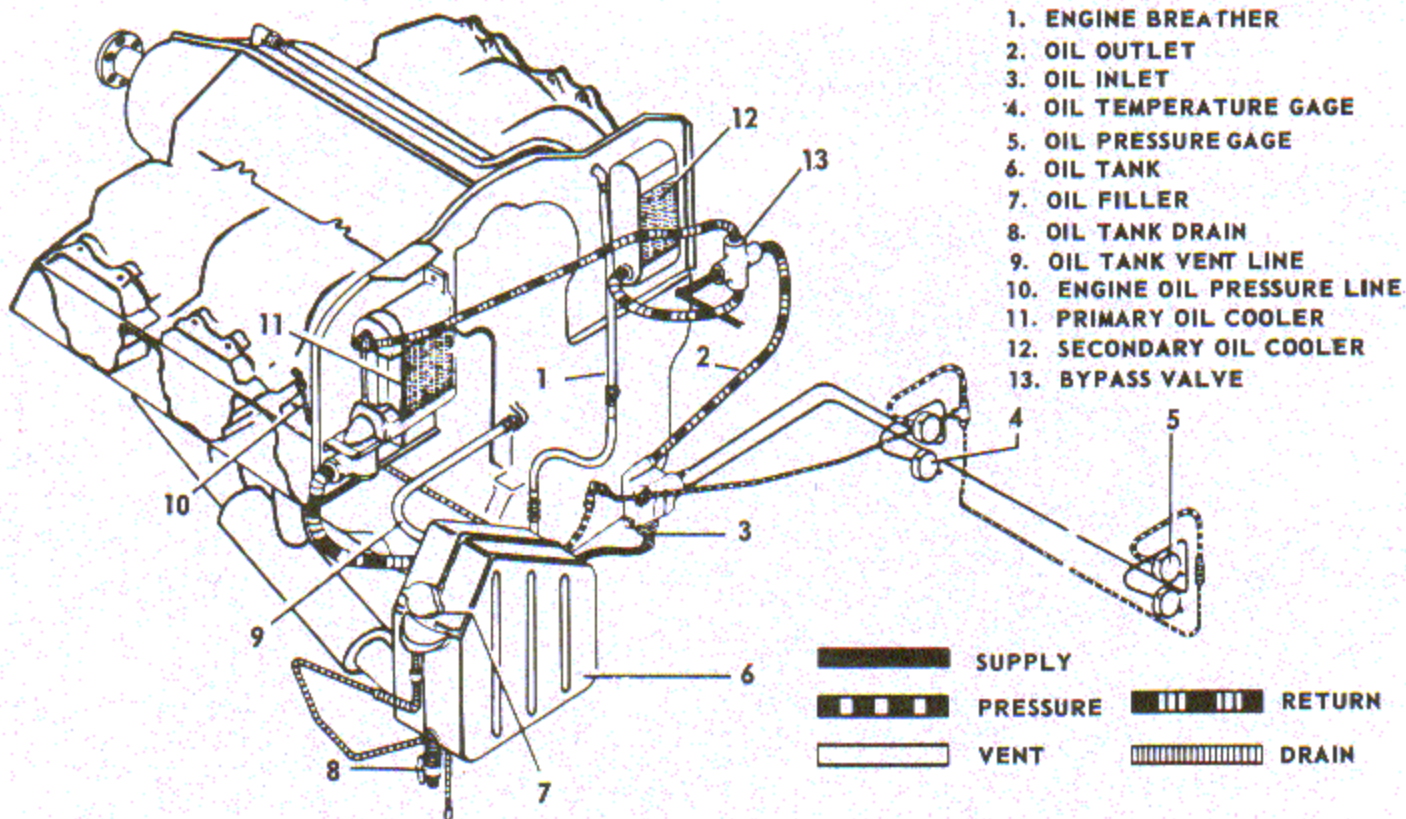
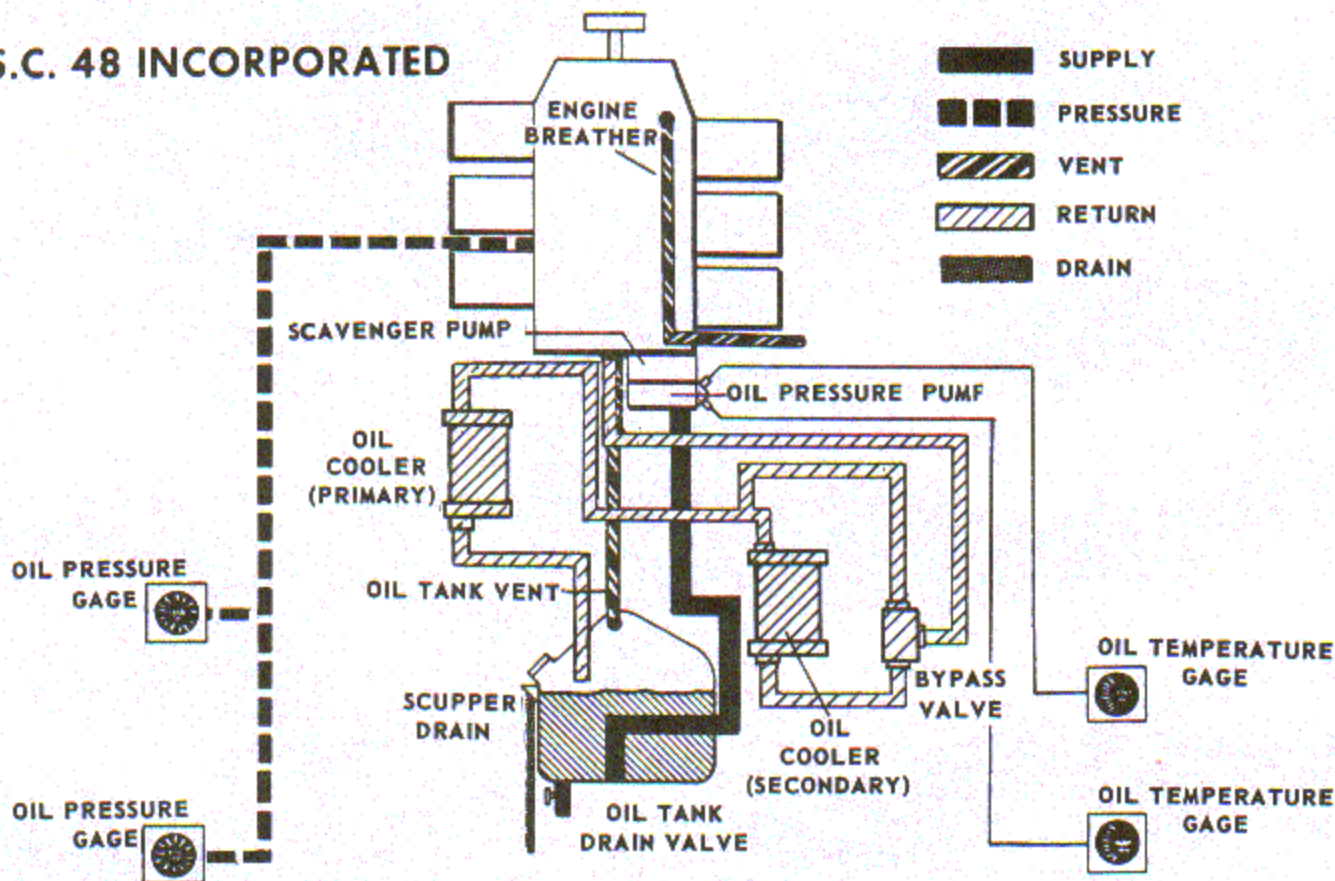
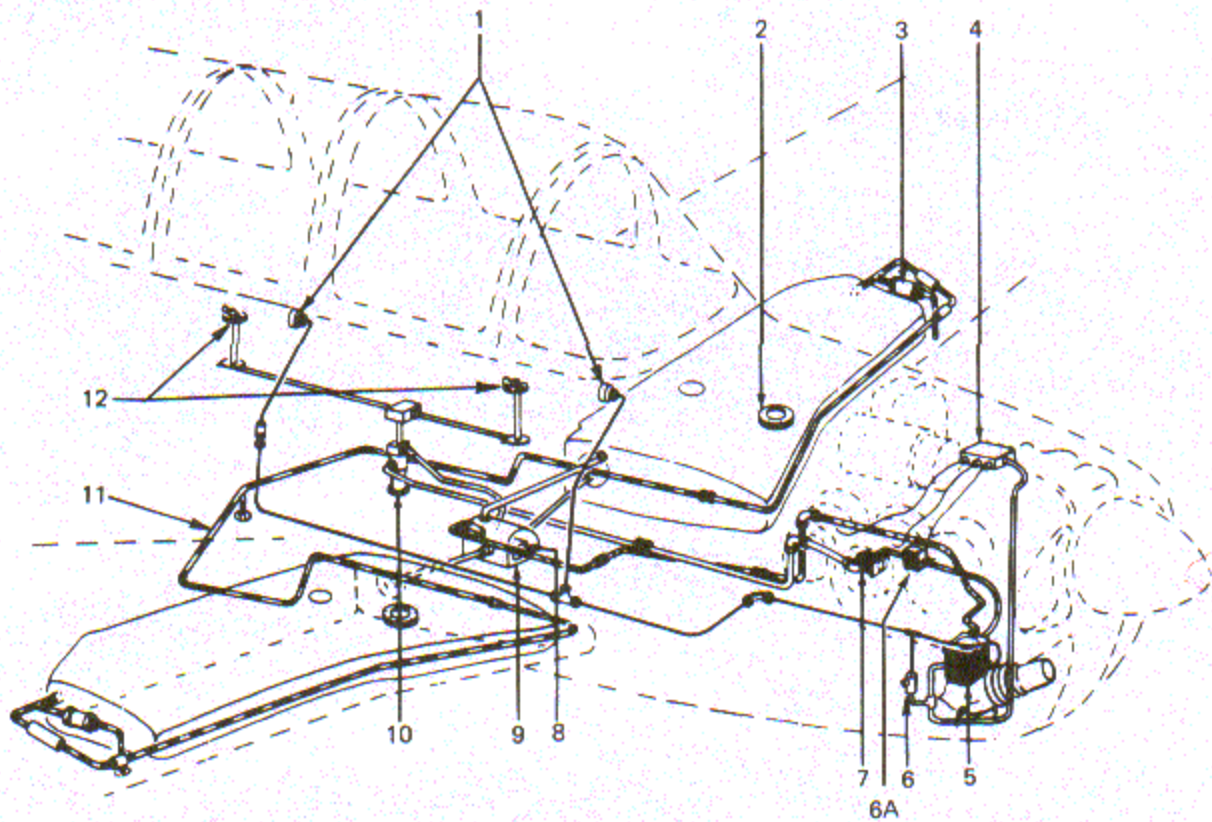

Figure 1-16. Oil System (Sheet 2 of 2)

AFC 50 AND 53 INCORPORATED



1. FUEL PRESSURE GAGES
2. FUEL CELL FILLER NECK
3. SIPHON BREAK VENT
4. FLOW DIVIDER
5. FUEL CONTROL
6. EMERGENCY FUEL SOLENOID
- 6A. FUEL FILTER ASSEMBLY
7. ENGINE-DRIVEN FUEL PUMP
8. BOOSTER PUMP
9. SUMP TANK
10. FUEL SHUTOFF VALVE
11. FUEL OVERBOARD VENT LINE
12. FUEL SHUTOFF VALVE HANDLES

LEGEND





	SUPPLY
	PRESSURE
	RETURN
	VENT

Figure 1-17. Fuel System (Sheet 1 of 2)

AFC 50 AND 53 INCORPORATED

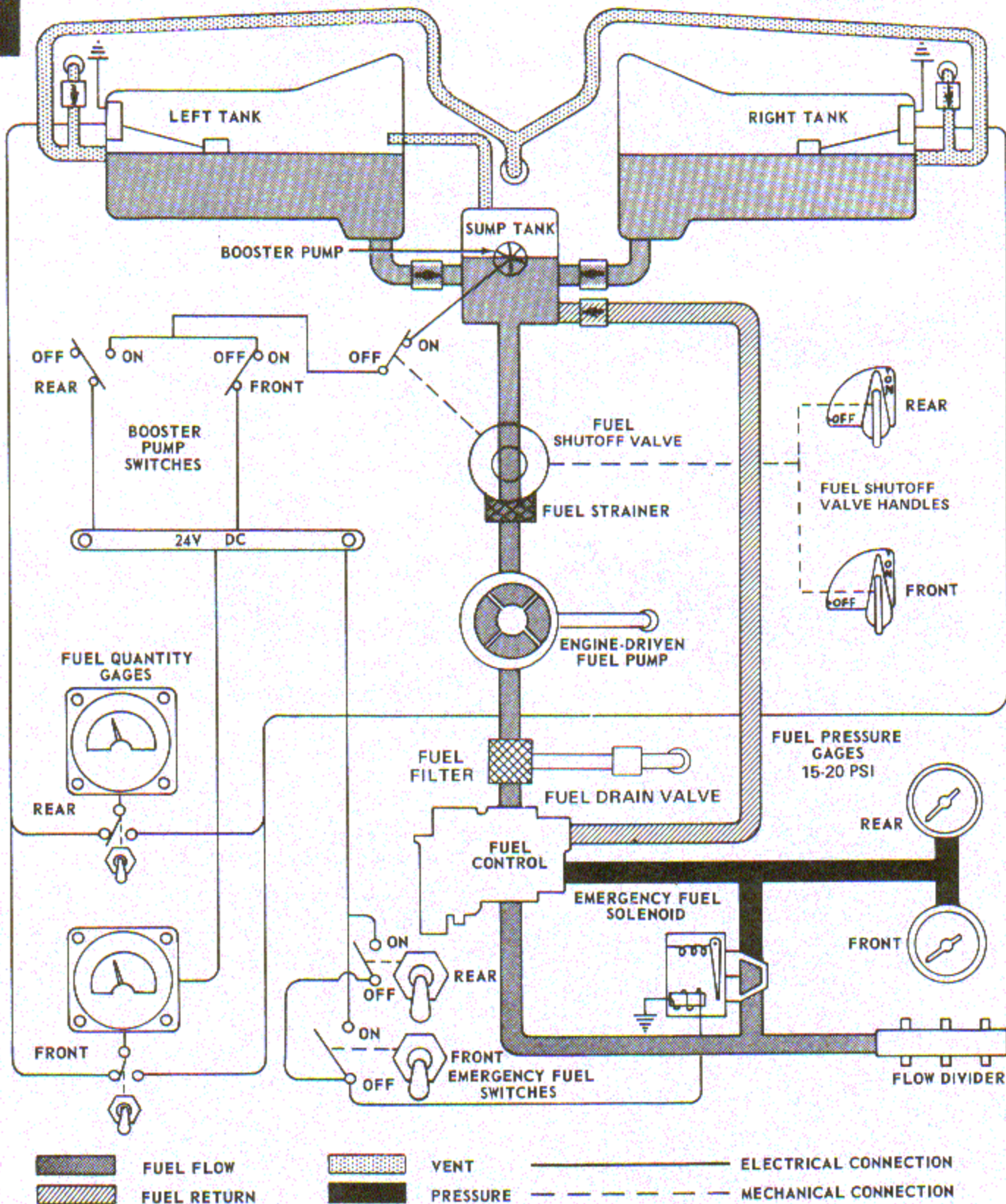

Figure 1-17. Fuel System (Sheet 2 of 2)

operation. However, in some aircraft, activation below 1000 rpm may not result in a restart of the engine. The procedures for operating the emergency fuel system are described in Section V (See High Altitude Engine Failure/Partial Engine Failure).

Note

DC electrical power is required to activate and operate the emergency fuel system.

FUEL SHUTOFF VALVE HANDLE.

The fuel shutoff valve handle (22, figure 1-7; 19, figure 1-10) has two placarded positions, ON and OFF. Positioning the handle at ON allows fuel flow from the sump tank through the engine-driven fuel pump to the fuel control. Return fuel flow is also routed to this sump. Positioning the handle at OFF stops all flow of fuel from the sump tank.

FUEL BOOSTER PUMP SWITCH AND INDICATOR LIGHT.

The booster pump ON — OFF switch (23, figure 1-7; 20, figure 1-10), provides for pilot selection of fuel boost for starting and subsequent operation during takeoff, climbout, and landing. An indicator light, adjacent to the fuel booster pump switch, remains illuminated as long as the fuel booster pump switch remains on, and is not to be used for booster pump failure indication. Electrical power to the boost pump is interrupted when the fuel shutoff valve handle is turned to the OFF position.

FUEL QUANTITY GAGE.

The fuel quantity gage (1, figure 1-5) on each instrument panel provides an approximate indication of gallons of fuel remaining in each tank. A more accurate determination of fuel consumption can be obtained based on known operating conditions. (See Section XI).

CAUTION

If the gage indicates a split of 10 gallons between the tanks, it is indicative of an obstruction or malfunction within the fuel system.

ELECTRICAL POWER SUPPLY SYSTEM.

Electrical energy is supplied by direct current (dc) and alternating current (ac) systems (figure 1-18). The 28-volt

system is powered by a 75-ampere engine driven generator and a 24-volt storage battery. A carbon pile voltage regulator maintains generator voltage at 27.7 to 28.5 volts. A reverse current and generator control relay disconnects the generator from the circuit when generator output drops to 4 volts below battery voltage (as during low rpm ground operation) to prevent the battery current from running the generator as a motor. The generator automatically cuts in at 900 rpm and reaches full rated output at 1,300 rpm. When insufficient current is generated to open the generator failure light relay, the GEN FAILURE light on the right subpanel in each cockpit (figure 1-15) remains illuminated. Direct current can also be supplied to the aircraft through an external power receptacle. Alternating current for operation of the attitude and directional indicators is supplied by either of two 100-volt-ampere inverters, one in normal use and the other installed as a standby. Warning lights indicate inverter failure and changeover is accomplished manually by operation of the inverter switch (13, figure 1-5).

EXTERNAL POWER RECEPTACLE.

For starting the engine or for electrical ground checks, an external power source can be connected to the external power receptacle (1, figure 1-30) on the right side of the engine compartment. With external power plugged in, the main bus is energized regardless of battery switch position.

BATTERY SWITCH.

The battery is connected to the power distribution system through a two-position ON-OFF BATTERY switch (figure 1-15) on the right subpanel in the front cockpit only. Placing the switch in OFF removes battery power from the bus but does not affect generator operation. The switch should be OFF while external power is connected.

GENERATOR SWITCH.

In the event of generator failure, the generator can be disconnected from the system electrically by a two-position ON-OFF generator switch (figure 1-15) on the right subpanel in the front cockpit only. The switch is guarded ON.

DC POWER SUPPLY SYSTEM INDICATORS.

A voltmeter (16, figure 1-5) on each instrument panel indicates generator output voltage. Normal indication is 27.7 to 28.5 volts.

INVERTER FAILURE LIGHT.

The INVERTER OUT warning light (13, figure 1-5) mounted on the instrument panel in each cockpit

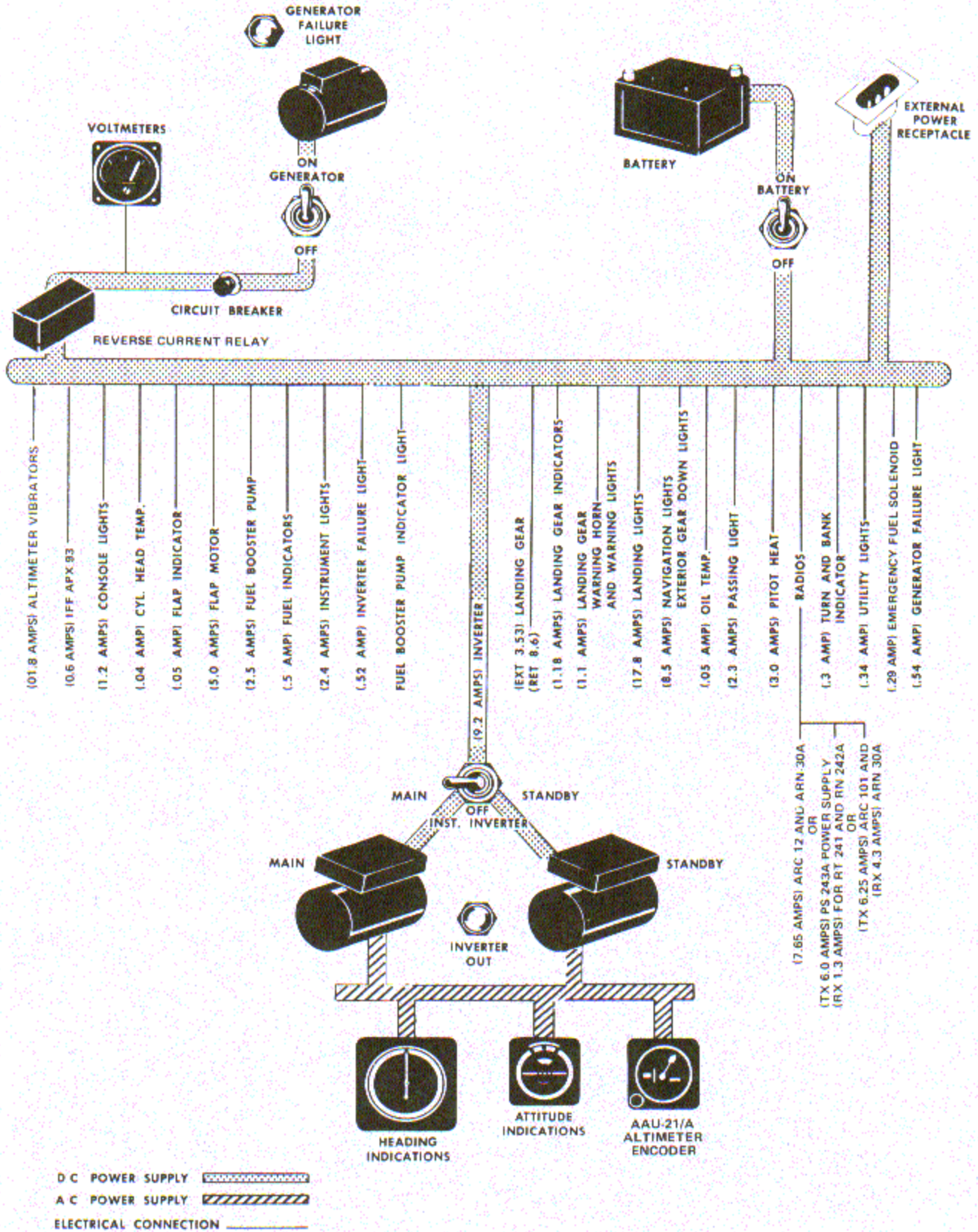

Figure 1-18. Electrical System

illuminates any time the electrical system is energized and the inverters are inoperative. In this condition, the directional and attitude indicators will not be operative. Should the main inverter fail, the light will illuminate. If the light goes out when the switch is moved to STANDBY, ac power is being supplied by the standby inverter. Subsequent failure of the standby inverter will cause the light to illuminate.

FLIGHT CONTROL SYSTEM.

The primary flight control surfaces (ailerons, rudder, and elevator) may be operated from either cockpit by conventional stick and rudder pedal controls. Trim tabs are installed on all flight control surfaces, and all except the right aileron tab are controllable from either cockpit. Rudder pedals, which are also used to apply brakes, are adjustable fore and aft. All primary controls can be locked in the neutral position by a flight controls lock in the front cockpit (figure 1-20).

FLIGHT CONTROLS.

RUDDER PEDALS.

Dual rudder pedals (figure 1-19), linked in tandem, provide rudder control and braking action from either cockpit. The pedals are adjustable fore and aft in both cockpits by means of a handcrank (1, figure 1-19) located below the instrument panel. Turning the crank clockwise adjusts the pedals forward and counterclockwise rotation permits adjustment aft. After desired adjustment has been obtained, mechanical linkage will prevent slippage and pedals will remain secure in the position selected.

CONTROL STICK.

The control sticks in both cockpits are interconnected to enable control of the ailerons and elevator from either cockpit.

FLIGHT CONTROLS LOCK.

Positive locking of all flight controls is provided by a flight controls lock (figure 1-20) located on the floor of the front cockpit only. The controls lock consists of a triangular brace pivoted at two points and held against the floor by a spring-loaded latch assembly. To lock the controls, follow the procedure shown in figure 1-20. To unlock the controls, disengage lock from pin on control stick and return it to the stowed position on the floor of cockpit.

TRIM TABS.

Trim tabs are installed on all flight control surfaces and all except the right aileron tab are controlled manually

from either cockpit. The right aileron tab is adjusted on the ground only. Two wheels and a knob for adjusting the elevator, aileron, and rudder tabs are located on the left console (16, 18, and 19, figure 1-7; 13, 15, and 17, figure 1-10) in each cockpit. An indicator is integral with the rudder trim tab knob while the other trim tab positions are indicated by a window adjacent to each wheel. The rudder trim tab is of the anti-servo type. As the rudder is displaced from neutral, the tab moves in the same direction, thereby increasing effective rudder area and the force required to displace it. Both aileron tabs incorporate servo action. As each aileron deflects from neutral, its tab moves in the opposite direction.

WING FLAPS.

Electrically operated, slot-type wing flaps extend from the fuselage to the aileron on each wing. The flaps are operable from either cockpit and a flap position indicator is provided on each instrument panel. No emergency system is provided for operation of the flaps in the event of electrical failure.

FLAP LEVER.

The flaps are operated by a wing flap lever (2, figure 1-7; 3, figure 1-10) on the left side of each cockpit. The handle is shaped in the form of an airfoil for easy recognition by feel and is guarded to prevent inadvertent operation. Lifting the lever UP raises the flaps; moving the lever DOWN lowers them. Moving the lever to the OFF (center) position will stop the flaps at any intermediate position. Otherwise they will continue until full UP or DOWN travel is reached, at which time limit switches shut off the motor whether or not the switch is moved to OFF.

WING FLAP POSITION INDICATOR.

Position of the flaps in terms of percent of extension (not in degrees) is indicated by a flap position indicator (23, figure 1-7) on each instrument panel. Full pointer deflection of 100 percent indicates full flap extension of 30 degrees.

LANDING GEAR SYSTEM.

The electrically operated tricycle landing gear is fully retractable. The main wheels retract inboard into the wings and the nose wheel retracts aft into the fuselage. Fairing doors, operated by gear movement, fully cover the main wheels when retracted. The main gear inboard doors open during the gear extension and close again when the gear is fully extended. All gear are actuated by a single dc motor and gear mechanism, located under the front cockpit, through a push-pull rod to each main gear side brace and the nose gear drag brace. Individual

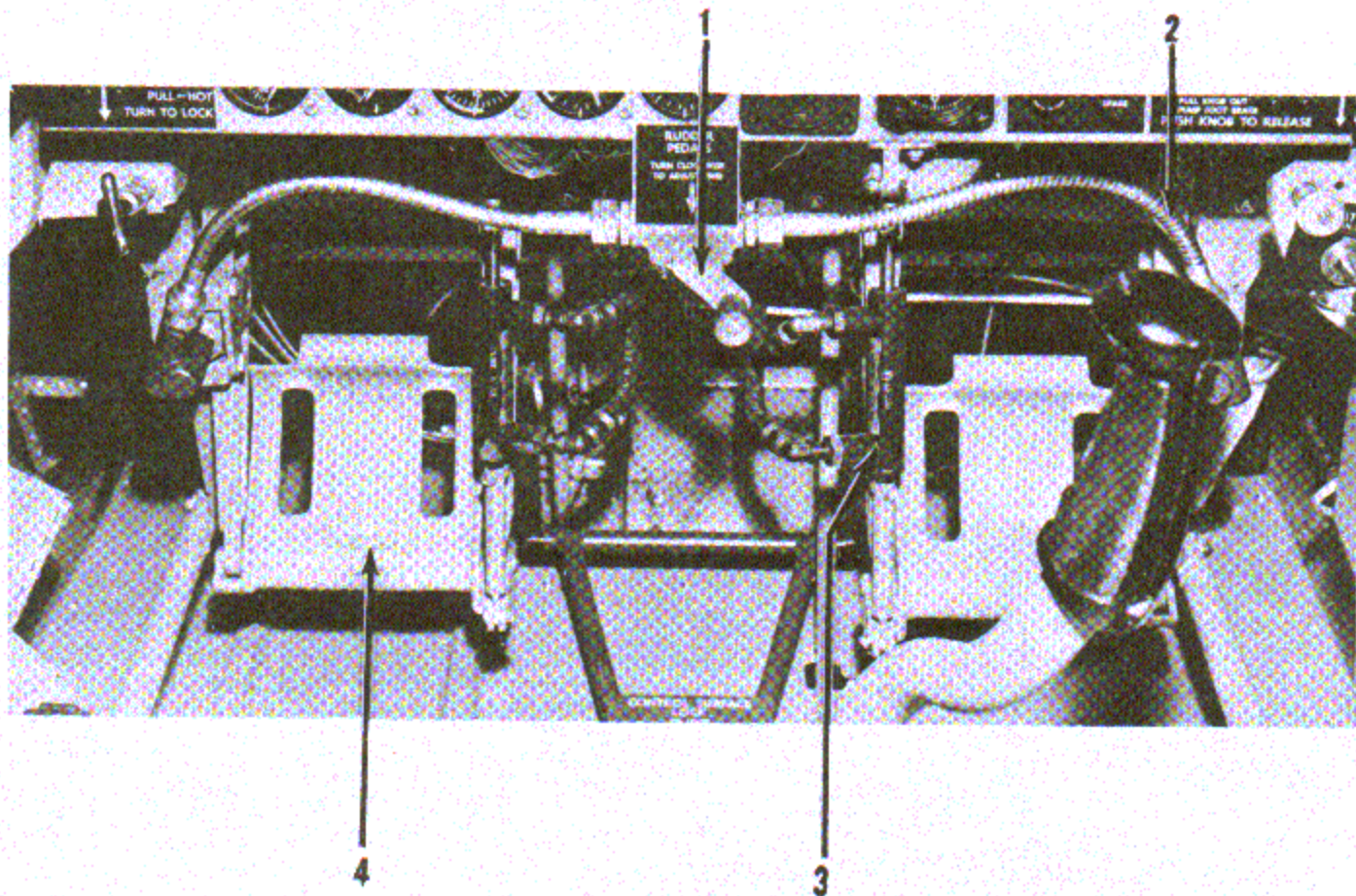

- | | |
|----------------------------------|--------------------------|
| 1. Rudder Pedal Adjustment Crank | 3. Master Brake Cylinder |
| 2. Rudder Pedal Adjustment Cable | 4. Rudder Pedal |

Figure 1-19. Rudder Pedal Controls

uplocks actuated by the retraction system lock the gear positively in the retracted position. No downlocks are provided since the overcenter pivot of the linkage provides a geometric locking effect when fully extended. The linkage is spring-loaded to the locked position. A safety switch on the right main strut prevents accidental gear retraction on the ground; however, provisions are made for emergency on-the-ground retraction. In flight, the gear may be manually extended, but not retracted, in an emergency. All landing gear electrical circuits, including warning circuits, are operable only with the battery switch ON, when external power is connected, or when generator output is applied.

CAUTION

- Due to minimum tolerances between tires and wheel well, landing gear retraction must never be attempted with a deflated shock strut.

CAUTION

- The landing gear will normally retract in 7 to 9 seconds, with 12 seconds being a maximum. An excessive retraction time could be an indication of an impending gear motor failure or an electrical system malfunction.

LANDING GEAR HANDLE.

The landing gear handle (figure 1-13) is located on the left subpanel in each cockpit. Moving the handle to UP or DOWN actuates a switch which controls the reversible motor that retracts or extends the gear. The handle is formed in the shape of a wheel and is made of clear plastic with a red warning light installed inside which illuminates the entire handle any time landing gears are in any position not corresponding to that of the handle. Weight of the aircraft on the landing gear actuates a

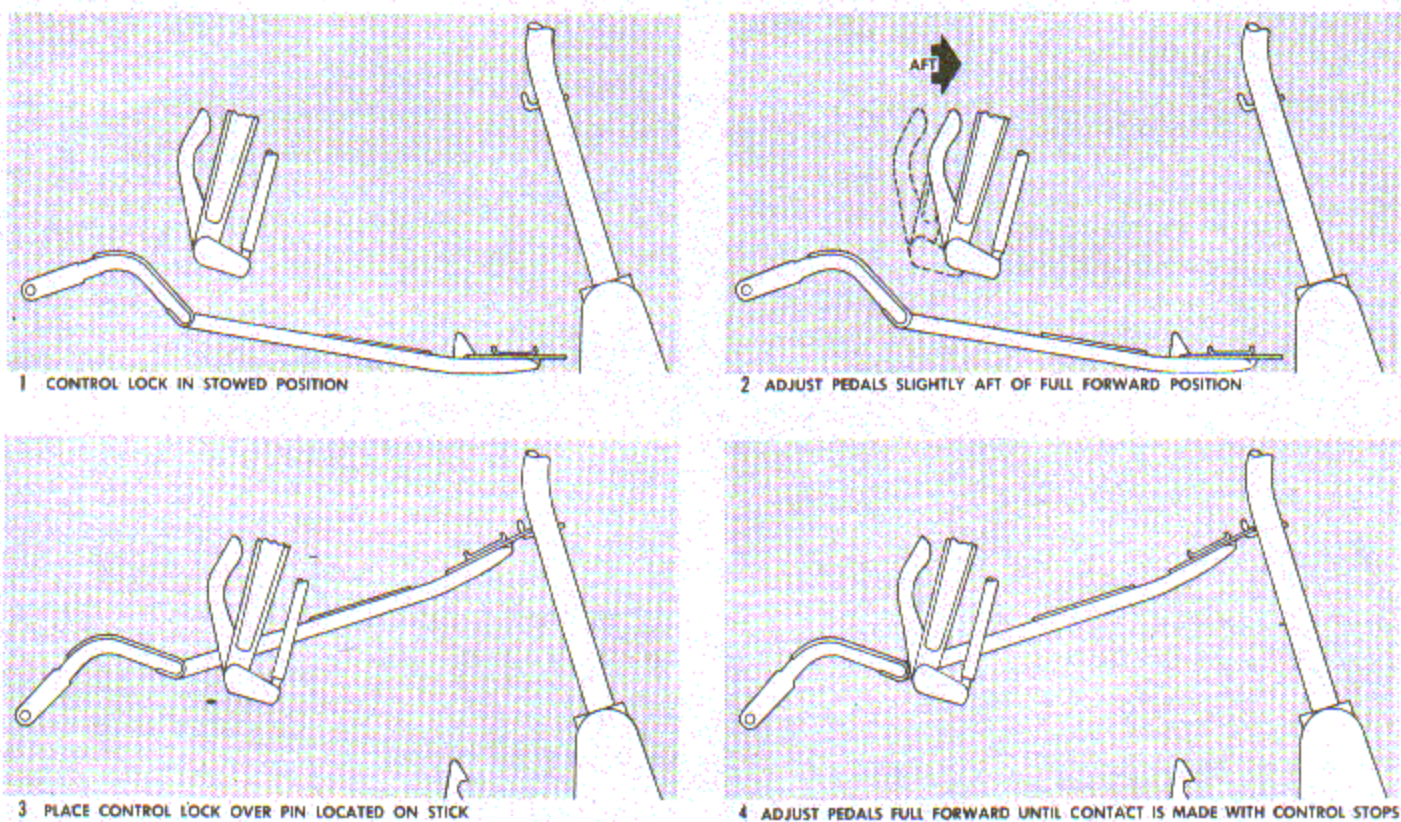

Figure 1-20. Flight Controls Lock

safety switch on the right main strut which renders the gear-up control circuit inoperative and a similar switch on the left main strut sounds a warning horn if the landing gear handle is moved to UP. When the weight of the aircraft is removed from the strut as the aircraft leaves the ground, the gear-up circuit is restored and the gear can be retracted.

LANDING GEAR SYSTEM INDICATORS.

LANDING GEAR POSITION INDICATORS.

Position of the landing gear is shown by three individual indicators (24, figure 1-7), one for each gear, located on the instrument panel in both cockpits. Each indicator shows crosshatching if the related gear is in any unlocked condition, the word UP appears if the gear is up and locked, and crosshatching shows on the indicators whenever the electrical system is not energized. A wheel shows on each indicator when all gear are down and locked.

LANDING GEAR WARNING LIGHT AND TEST BUTTON.

A PRESS TO TEST WARN LIGHT pushbutton switch (figure 1-13) is located to the left of the landing gear

handle on the left subpanel. If the landing gear handle fails to illuminate when the momentary contact button is pressed, the warning light is inoperative.

Note

If the light fails to illuminate in normal operation but illuminates when the test button is pressed, the indicator circuits are at fault and the gear position indicators will not be reliable.

LANDING GEAR WARNING HORN AND SILENCING BUTTON

A warning horn behind the forward seat sounds if the landing gear handle is moved to up when the aircraft is on the ground. In flight, retarding the throttle to a range of 18 inches to 12 inches of manifold pressure (Hg) with any gear not fully extended will sound the horn and illuminate the landing gear warning light. During prolonged throttle-off maneuvers, the horn may be silenced by pressing the horn silencing button (4, figure 1-7) on the left side of the front cockpit only. Subsequent advancement of the throttle will reset the circuit and retarding the throttle will again illuminate the light and re-sound the horn.

When the horn silencing button is pressed, the landing gear warning light will be extinguished simultaneously with the silencing of the warning horn.

EXTERNAL GEAR DOWN INDICATOR LIGHTS.

To aid in determining gear position from the ground at night, a white light is installed on the underside of each wing just forward of each main wheel well. Each light illuminates only when the related gear is down and locked and the navigation lights switch is ON. No external indicator light is installed for the nose gear.

EMERGENCY LANDING GEAR SYSTEM.

LANDING GEAR EMERGENCY RETRACT SWITCH.

The landing gear emergency retract switch (25, figure 1-5) located on each instrument panel, is used for emergency retraction of the gear while the aircraft is on the ground. The switch is a two-position UP and DOWN switch and is safetied in the DOWN position. When the switch is moved to UP position, the ground safety switch is bypassed and the gear will retract. The switch will only be operative when external power is applied or either the battery switch or the generator switch is ON and supplying dc power to the switch.

LANDING GEAR EMERGENCY HANDCRANK AND HANDCRANK CLUTCH KNOB.

A landing gear emergency handcrank (2, figure 1-8) in the front cockpit only, is provided for emergency extension of the gear. The crank, when engaged, drives the normal gear actuation system through a flexible shaft. Approximately 37 turns of the crank are required to fully extend the gear.

CAUTION

The landing gear emergency extension system is designed and stressed only for emergency extension and must never be used to retract the gear.

The handcrank clutch knob (4, figure 1-8 and figure 5-3), adjacent to the handcrank, is pushed DOWN to engage the crank with the flexible drive shaft for emergency extension. The clutch knob is provided with a lock which must be disengaged by moving it aft; this releases the clutch knob for manual operation.

WARNING

The handcrank must be disengaged from the drive shaft after extending the gear manually, otherwise, subsequent operation of the gear electrically will cause the crank to spin rapidly with possible injury to personnel.

WHEEL BRAKE SYSTEM.

The main landing wheels are equipped with hydraulic brakes (figure 1-21) operated by toe pressure on the rudder pedals in either cockpit. Fluid from a reservoir aft of the firewall supplies a master cylinder at each pedal. Toe action actuating the cylinder applies brake pressure to the corresponding wheel. For hydraulic fluid specifications, see figure 1-32.

PARKING BRAKE HANDLE.

A parking brake handle (figure 1-15) is located on the right subpanel in the front cockpit only. The parking brakes are set by first pulling the handle then depressing the toe brakes. To release the brakes, push the handle forward.

INSTRUMENTS.

All instruments, except the free air temperature gage located at the top of the windshield, and the canopy air pressure gage located behind the rear seat adjacent to the first aid kit, are installed on the instrument panels (figure 1-5). A majority of the flight instruments and all of the engine instruments are duplicated in both cockpits. Colors utilized for instrument markings are red radials for operating limits and white arcs for normal operating ranges.

Instruments that operate on dc power from the electrical system are cylinder head temperature gage, oil temperature gage, wing flap and landing gear position indicators, voltmeter, and turn and slip indicator.

The heading and attitude indicators are operated by ac current supplied by the inverters. On aircraft with T-34 AFC 58 incorporated, the altimeter/encoder (forward cockpit) operates on ac current supplied by the inverters. The altimeter/encoder and the altimeter (aft cockpit) require dc power for internal vibrator operation.

ACCELEROMETER.

The accelerometer (10, figure 1-5) is installed on the forward instrument panel and indicates positive and

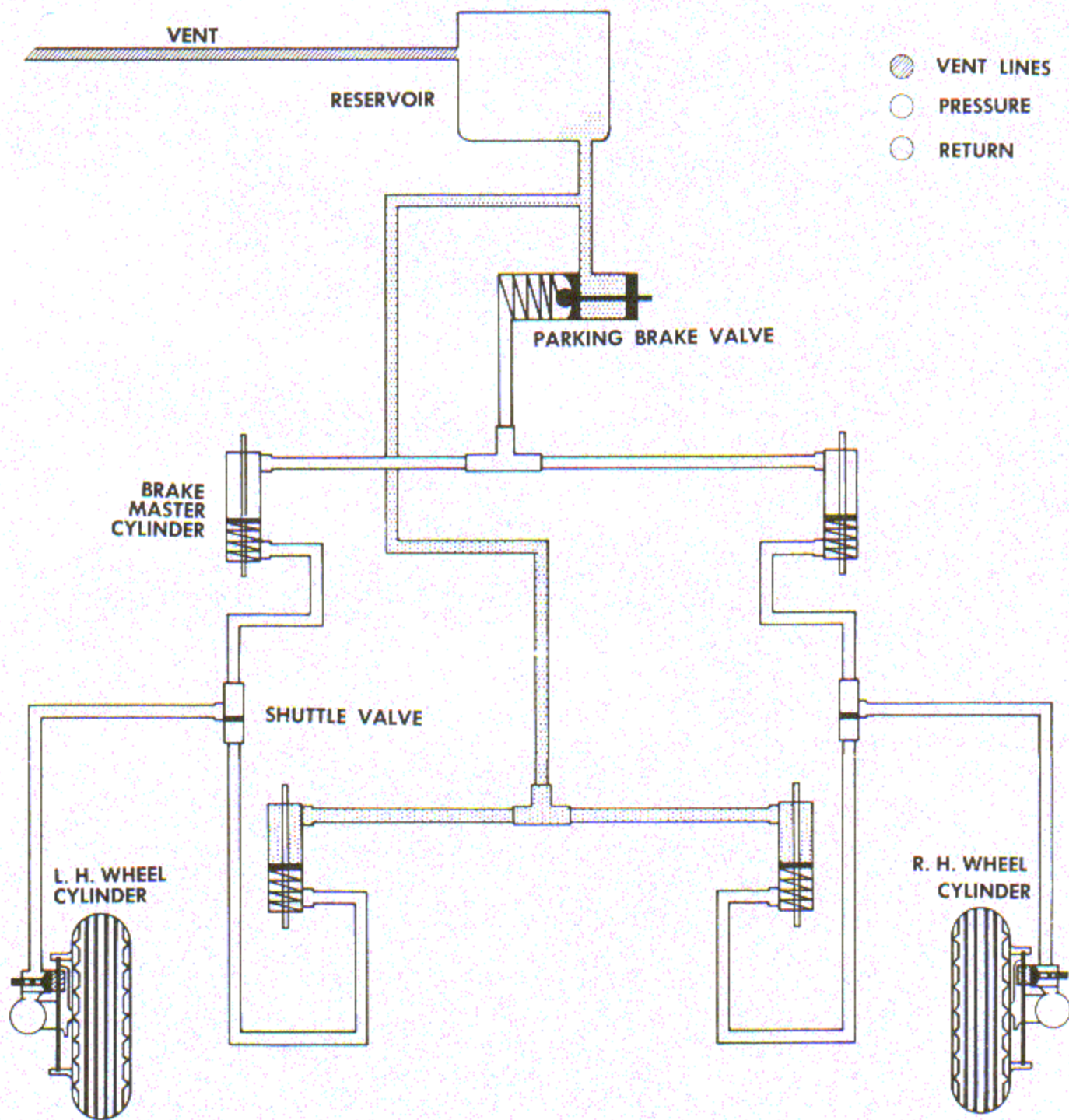

Figure 1-21. Wheel Brake System

negative g-loads imposed on the aircraft. The indicator has three pointers, one main pointer for indicating instantaneous accelerations and two auxiliary pointers for indicating maximum positive and negative accelerations. The auxiliary pointers combine and coincide with the main pointer throughout maximum positive and negative travel ranges and serve as positive recording indicators since they remain at the maximum respective deflections of the main pointer. The auxiliary pointers can be returned to the normal (1-g) position by pressing the knob provided on the lower left corner of the instrument. Refer to Section I, Part 4 for Acceleration Limitations.

TURN AND SLIP INDICATOR.

The turn and slip indicator (17, figure 1-5) operates directly from the aircraft's dc electrical system and provides a visual indication of the rate and coordination of a turn. The indicator has a pointer which indicates the rate of turn and an inclinometer tube and ball for indicating the linear alignment of the craft in straight flight and in turns. No adjustment or caging knobs are required to operate the turn and slip indicator.

HEADING INDICATOR.

The heading indicator (6, figure 1-5) is operated by 115 volts ac which is supplied by either the main or standby inverter. The indicator has one combination dial which incorporates a heading dial and a reciprocal dial. A combination knob is used as a "Push to Cage" device or it can be rotated in either direction, while the instrument is caged, to set the dial at a desired heading. This indicator is not equipped with a "Caged" or "Off" indicating flag. The gyro must be in operation for 5 to 8 minutes to allow it to come up to full speed to provide accurate indications. The indicator is normally left uncaged.

CAUTION

To prevent tumbling or damage to the mechanism, the heading indicator should be caged before performing acrobatics or any maneuver exceeding the indicator's roll and pitch limits (60 degrees climb or dive from level flight, 60 degrees left or right angle of bank).

ATTITUDE INDICATOR.

The type MB-1 attitude indicator (7, figure 1-5) operates on 115 volts ac from either inverter. A fixed symbol in front of the face of the indicator represents the aircraft, and a movable bar and pitch scale behind the fixed symbol represents the aircraft's attitude in relation to the

horizon. The pitch scale is calibrated in degrees and provides a visual flight reference for control of the aircraft. With the aircraft in level flight attitude, the aircraft symbol is superimposed on the horizon bar. With the aircraft in a nose-up attitude, the horizon bar lowers and the pitch scale registers the degree of pitch. In a bank to the right, the horizon bar tilts to the left and the aircraft symbol appears to have banked to the right. The aircraft symbol may be adjusted vertically by means of a small knob at the lower left corner of the indicator to correct for variations in level flight attitude. Whenever the aircraft approaches a vertical climb or dive attitude, as it would in a loop, the gyro precesses a controlled 180 degrees; this action is momentary and does not interfere with the indications. Thus the pilot reads the same face of the sphere regardless of attitude. A manual caging device provides for quick erection on the ground and for correcting in-flight bank or pitch errors. However, the instrument need not be caged for maneuvers. Because of acceleration forces which act upon the erection mechanism during turns, up to 5-degree errors may be noted in pitch and/or bank upon return to straight-and-level flight. The indicator begins to correct this lag immediately, but manual caging may be used for quick erection. If errors greater than the 5-degree allowable tolerance are encountered, the instrument should be replaced. An OFF indicator flag comes into view whenever power is not being supplied or the gyro is not up to speed.

PITOT STATIC SYSTEM.

The airspeed indicator, altimeter, and rate-of-climb indicators are operated by the pitot static system (figure 1-22). This system consists of an electrically heated pitot tube, a pitot system drain mounted on the underside of the left wing, and static air pressure ports located in the lower skin area on both sides of the fuselage aft of the rear cockpit. The altimeter and rate-of-climb indicators are connected to the static ports and function on static pressure alone. On aircraft with T-34 AFC 58 incorporated, the altimeter/encoder (forward cockpit) requires ac and dc power and the altimeter (aft cockpit) requires dc power for operation, in addition to the static pressure supplied by the pitot static system. The airspeed indicator is actuated by pressure differential between pitot tube impact pressure and static pressure and is calibrated in knots. Whenever the aircraft is parked, a cover is placed over the pitot tube to keep the pressure tube opening clean.

Note

Ensure pitot drain valve is properly seated (down) prior to flight to avoid erroneous airspeed indications.

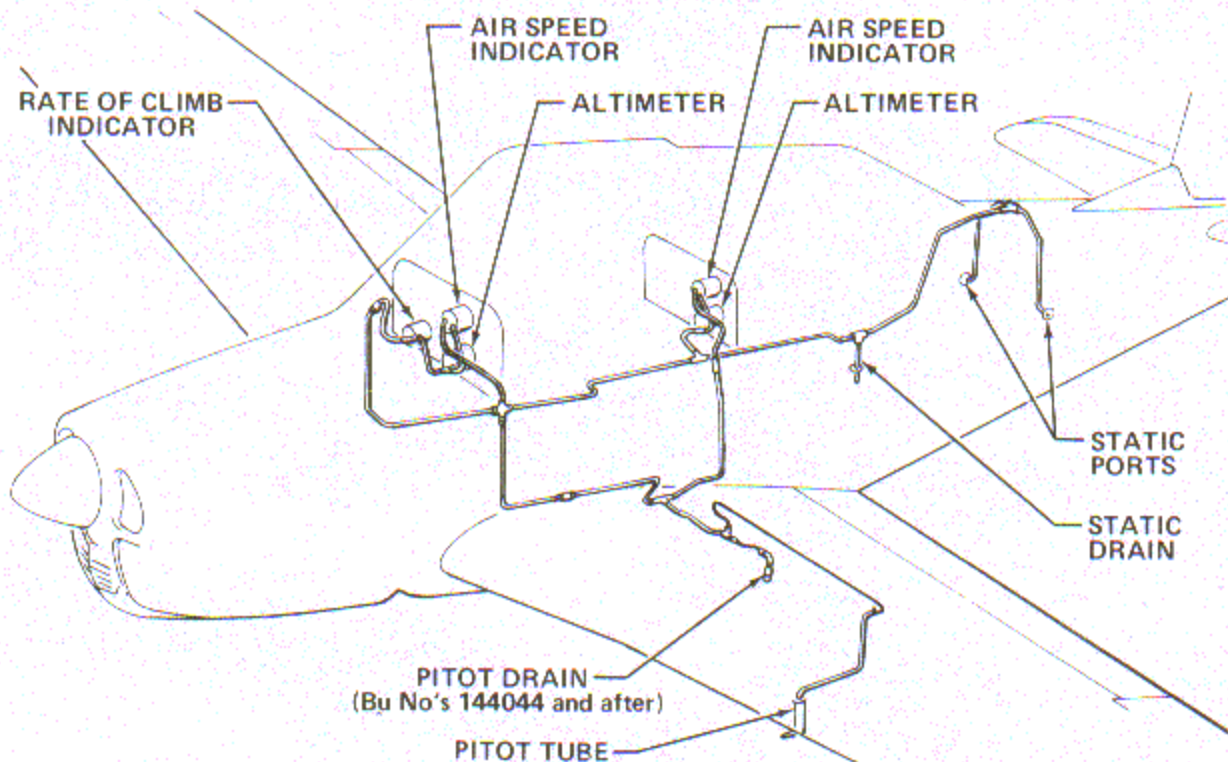

Figure 1-22. Static Air System Schematic

PITOT HEAT.

The electric heater in the pitot tube is controlled by an ON-OFF switch-type circuit breaker on the circuit breaker panel (17, figure 1-8) on the right side of the front cockpit.

CAUTION

Avoid any prolonged operation of the pitot heater when the aircraft is on the ground since the absence of a cooling airstream may cause the unit to overheat.

EMERGENCY EQUIPMENT.

The only emergency equipment carried in the aircraft is a first aid kit located in the small recess behind the back of the aft seat. It is accessible from the rear cockpit only. No engine fire extinguisher system is installed.

CANOPY.

The canopy is in three sections, a manually operated sliding section over each cockpit and a rigid center section between. Each sliding section opens aft and can be operated independently. Interior and exterior canopy locking handles located on the left side of each sliding section (figure 1-23) are turned to lock or unlock the

canopy from either the inside or the outside and are utilized to open the canopies. To aid in opening and closing the canopy from the cockpit, inside handles are provided on each sliding section (figure 1-23).

EMERGENCY CANOPY OPEN HANDLE.

Both sections of the canopy may be opened simultaneously in an emergency by pulling the red EMERGENCY CANOPY OPEN handle which is located on the right side of each cockpit (figure 1-24). Operation of this handle from either cockpit actuates the canopy opening system which operates by compressed nitrogen under 2,300 to 3,000 pounds pressure.

Note

The canopy, once opened, will remain open under pressure of the system and cannot be closed until the actuator valve has been bled of pressure on the ground.

Compressed nitrogen for the system is supplied by the canopy emergency air bottle located in the baggage compartment (5, figure 1-30). An air pressure gage (4, figure 1-30) for the canopy opening system is located on the rear deck, behind the aft seat back, adjacent to the first aid kit. For emergency entrance to the cockpit, an external canopy open handle, on the right side of the fuselage at the front cockpit, opens both canopies.

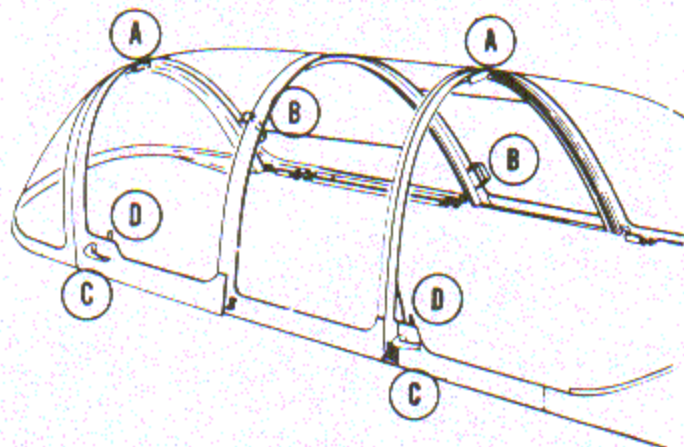
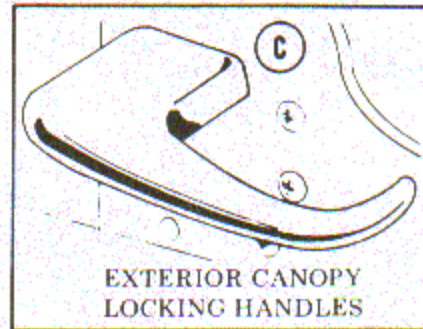
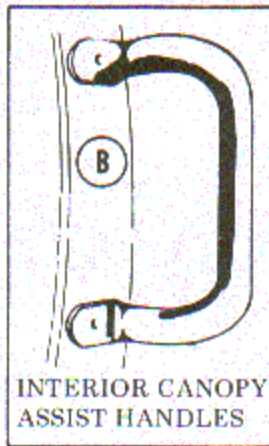
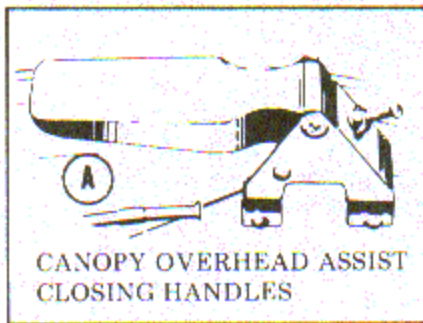

Figure 1-23. Canopy Handles

Note

Although it is possible for the canopy to be operated several times on one charge, it is recommended that the air bottle be fully charged after any flight in which the system was actuated. This servicing can be accomplished at the time that system pressure is being bled to enable closing of the canopy after emergency operation.

SEATS.

The seat in each cockpit is adjustable five inches vertically in one-inch increments. The seat is positioned

by pulling the spring-loaded handle (22, figure 1-9), moving the seat to the desired height, then releasing the handle to lock the seat in position. There are no horizontal adjustments in these seats. Seat-to-pedal adjustments are accomplished with the rudder pedal crank (1, figure 1-19). A safety belt and shoulder harness with inertia reel are installed at each seat.

INERTIA REEL LOCK HANDLE.

The shoulder harness inertia reel is locked or unlocked by movement of the inertia reel lock handle (21, figure 1-7; 16, figure 1-10) at the left of the seat. The handle is spring-loaded to either the locked or unlocked position. When the handle is unlocked (aft), the inertia reel

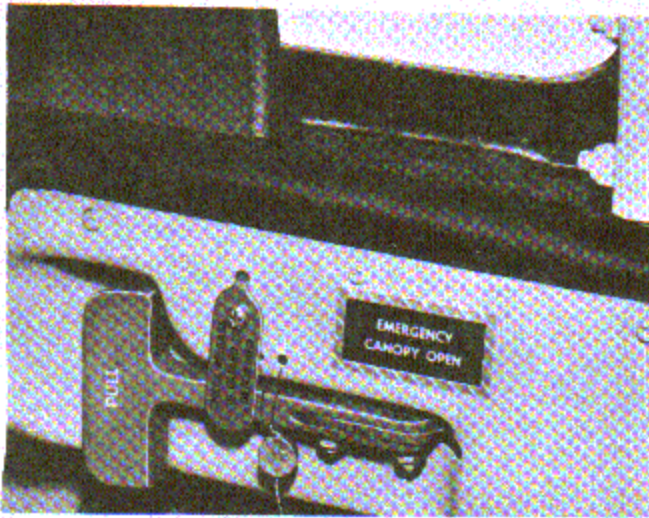

Figure 1-24. Emergency Canopy Open Handle

maintains a slight tension on the harness but permits the pilot to lean forward to reach the controls. When the handle is moved to the locked (forward) position, the inertia reel locks the harness in successive positions as the pilot leans back. Before the inertia reel can be unlocked, all tension must be removed from the harness by leaning full-back in the seat. The inertia reel locks automatically when the airplane is under a linear deceleration of 2g's or more, as in a crash landing.

HEATING AND VENTILATING SYSTEM.

This system (figure 1-25) supplies heated ram air through a system of ducts for cockpit heating, ventilation, and windshield defogging. Cold ram air is picked up through the engine compartment air intakes and routed into heater exhaust shrouds. Ventilating air enters through the cold air intakes in each wing leading edge and is directed to the manually controlled air mixer valves. After passing through the exhaust shrouds, the heated ram air enters the manually controlled hot air overflow valves which regulate the flow reaching the air mixer valves by dumping excess hot air overboard. The hot air is mixed with the cold air at the air mixer valves and the resultant tempered air enters each cockpit through two adjustable air outlets on each cockpit side wall. Tempered air is also routed to individual foot warmer outlets at the forward and aft rudder pedals and to the windshield defogging system.

HEATING AND VENTILATING SYSTEM CONTROLS.

The COCKPIT COLD AIR handle (figure 1-25) operates the air mixer valve to regulate cold air flow, and the COCKPIT HOT AIR handle regulates hot air flow through

the hot air valves. With the handles full-out, all air flow is shut off. A satisfactory air flow and temperature is obtained by adjusting both handles in for the desired condition. Rotating each handle locks it in position. The cockpit air outlet diffusers may be turned to direct the air flow into the cockpit as desired, but cannot be turned off. No separate control or diffuser is installed for the foot warmers or for windshield defogging.

COMMUNICATIONS AND ASSOCIATED ELECTRONIC EQUIPMENT.

Communication equipment installed in the aircraft is the RT-241A. Navigational equipment is the RN-242A.

The radio MASTER switch (figure 1-8), must be turned ON before it is possible to operate any radio equipment. Provisions for using headsets with attached lip microphones are installed in each cockpit. A jack (figure 1-8) for using a hand held microphone is also provided.

The VHF communications antenna (figure 1-3) is a rod type antenna located on top of the vertical stabilizer. The omni receiver uses a fixed wire antenna (figure 1-3) located in the canopy. Microphone keying is accomplished by an interphone or transmit button (figures 1-7 and 1-10).

TABLE OF COMMUNICATIONS AND ASSOCIATED ELECTRONIC EQUIPMENT.

All equipment installed in the aircraft is tabulated in figure 1-26.

INTERPHONE PROVISIONS.

With the RT-241A communication equipment, interphone operation utilizes a separate ICS amplifier located on the right side of the aft cockpit (figure 1-27). Once the radio MASTER switch (figure 1-8) is turned on, interphone operation is activated by pressing the button (figures 1-7 and 1-10) on top of the throttle.

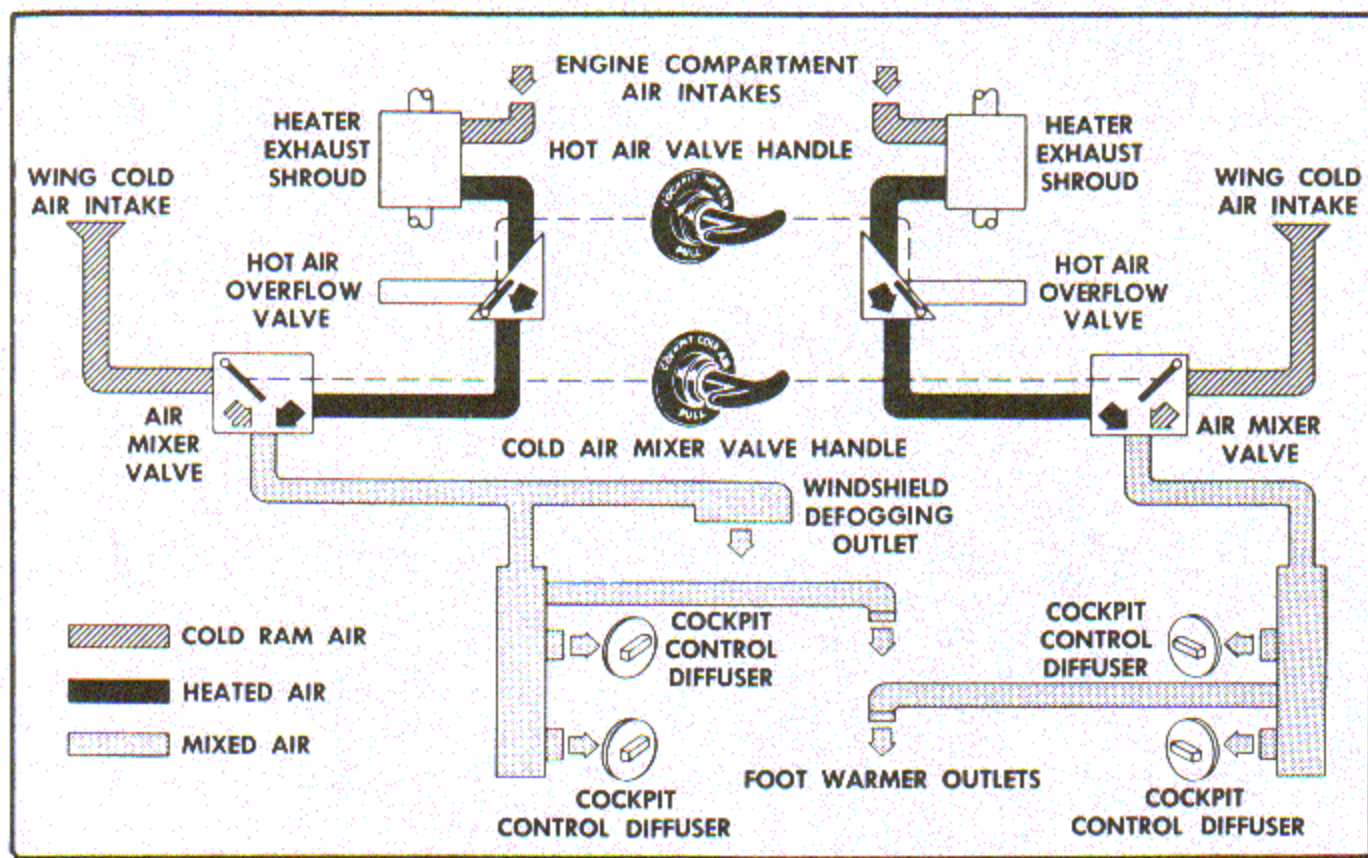
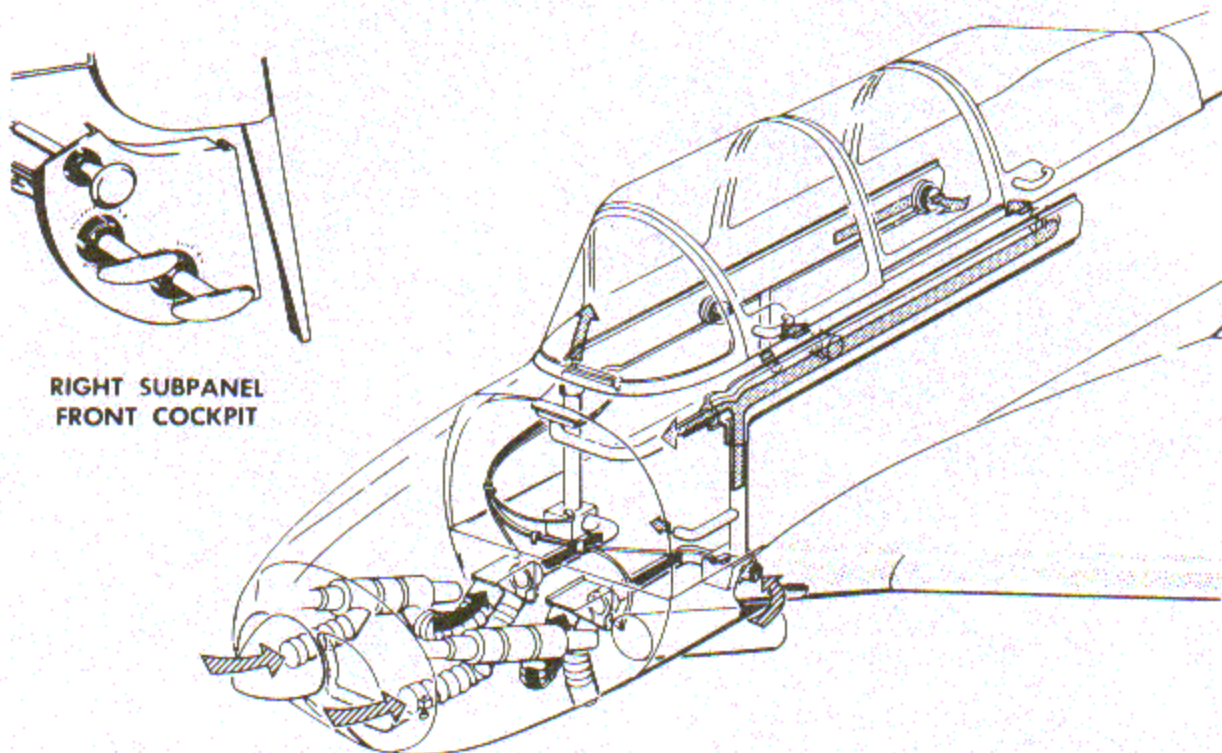
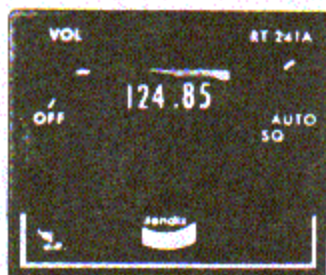

Figure 1-25. Heating and Ventilating System



RT-241A



RN-242A



VOR-LOC INDICATOR

	VHF TRANSMITTER/RECEIVER	NAVIGATIONAL RECEIVER
TYPE EQUIPMENT	RT-241A	RN-242A
USE	TWO WAY COMMUNICATION	OMNI-LOC NAVIGATION
RANGE	LINE-OF-SIGHT	LINE-OF-SIGHT

Figure 1-26. Communications and Associated Electronic Equipment (After Incorporation of AFC 60)

VHF COMMUNICATIONS EQUIPMENT.

RT-241A VHF Communications Transceiver (figure 1-26) provides two-way voice communication in the frequency range of 118.00 to 135.95 megacycles with 50 kilocycles channel spacing (covering 360 communication channels). All operating controls/indicators are located on the face of the transceiver and perform the following functions:

VOL/OFF — Clockwise rotation from OFF (past the detent) applies dc power, further rotation adjusts the audio volume.

SQ/AUTO — In the maximum counterclockwise position (past the detent click) the system operates with automatic squelch. This eliminates the need to continuously monitor the squelch threshold adjustments. The squelch threshold is automatically adjusted to open on readable signals. Rotating the knob clockwise past the detent provides a means of manually setting the squelch threshold for testing or listening to very weak signals.

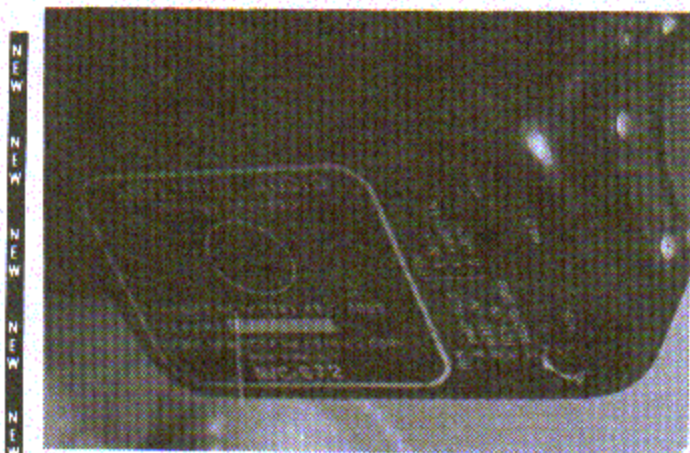

Figure 1-27. ICS Amplifier

FREQUENCY SELECTORS — Rotating the two lower large knobs selects the desired operating frequency. Left-hand knob selects whole megacycle frequency; right-hand knob selects fractional megacycle frequency.

FREQUENCY INDICATOR — Displays selected frequency.

TRANSMIT LIGHT — When lit, this light indicates a keyed transmitter condition. During transmissions the intensity of this light will vary, indicating the presence of voice modulation.

OPERATION OF RT-241A VHF COMMUNICATIONS TRANSCEIVER.

1. Radio MASTER switch ON.
2. Rotate VOL/OFF control knob clockwise to turn transceiver on. Allow 1 minute for warmup.
3. Rotate the two lower large knobs until desired operating frequency is displayed on readout indicator.
4. Position SQ/AUTO control knob fully counterclockwise for automatic squelch operation.
5. Adjust VOL/OFF control knob for desired volume.
6. To transmit, press button on throttle (figures 1-7 and 1-10). TRANSMIT LIGHT should illuminate and vary in intensity during transmission. Release button after transmission to restore receiver operation.

Note

If hand-held microphone is used, press button on microphone instead of the throttle handle button.

7. To turn transceiver OFF, rotate VOL/OFF control knob fully counterclockwise and position radio MASTER switch to OFF.

VHF OMNIRANGE EQUIPMENT.

RN-242A AND IN-244A NAVIGATIONAL RECEIVING EQUIPMENT CONTROLS AND INDICATORS.

RN-242A VHF Navigation Receiver (figure 1-26) receives and processes VOR and localizer signals within the frequency range of 108.00 to 117.95 megacycles in 50 kilocycle increments (160 VOR and 40 localizer channels).

In addition, the receiver contains 200 communication receiver channels within the frequency range of 118.00 to 127.95 megacycles which may be used as a "back-up" communication receiver. In VOR operation, the receiver provides the following information to the IN-244A VOR/LOC indicator (figure 1-26): (1) left/right deviation of the aircraft with respect to the preset course; (2) TO/FROM indication which informs pilot whether the course set on indicator is a bearing to or from the station; and (3) NAV warning flag operation which informs the pilot on an unreliable navigational signal reception.

All operating controls/indicator are located on the face of the receiver or indicator and perform the following functions:

VOL/OFF — Clockwise rotation from OFF past the detent applies dc power. Further rotation adjusts the audio volume.

VOICE/IDENT/TEST — VOICE position allow reception of voice signals while attenuating the 1020 cycle identification tone.

IDENT position allows equal reception of voice and the 1020 cycle identification tone.

TEST position is spring loaded and checks VOR centering on VOR/LOC indicator.

FREQUENCY SELECTORS — Rotating the two lower large knobs selects the desired operating frequency. Left-hand knob selects whole megacycle frequency; right hand knob selects fractional megacycle frequency.

FREQUENCY INDICATOR — Displays selected frequency.

OBS — Selects a desired course to fly toward a station.

OPERATION OF VHF NAVIGATION RECEIVING EQUIPMENT RN-242A AND IN-244A

1. Turn radio MASTER switch ON.
2. Rotate VOL/OFF knob clockwise past detent to turn receiver ON. Allow 1 minute for warmup.
3. Select desired station by rotating two lower large knobs until station frequency appears on frequency indicators.
4. Place VOICE/IDENT/TEST switch in IDENT or VOICE position as desired.
5. Adjust volume to desired level.

Note

Visual indications are independent of audio circuits and therefore are not affected by position of the volume control. Volume should be maintained high enough to hear ident/audio signals and to avoid inadvertently navigating by a wrong station.

To operate on omnidirectional ranges:

1. Set heading indicator using OBS knob on IN-244A indicator to desired course. Keep in mind whether it is a course to or from the station.
2. Observe deflection of course deviation needle and steer accordingly to intercept desired course.

Note

If the NAV warning flag is visible on the IN-244A indicator, the course data displayed is unreliable and should not be utilized for navigation.

3. As desired course is intercepted and deviation needle moves to center, turn to course heading as required by TO or FROM indication.

To accomplish self test of RN-242A receiver and IN-244A indicator.

1. Set OBS knob on IN-244A to 0 degrees.
2. Hold VOICE/IDENT/TEST switch on RN-242A in TEST position.
3. Observe that course deviation needle centers, FROM flag is in view and NAV warning flag is not visible.

Note

Receiver frequency setting is immaterial when accomplishing self test. Station signals are interrupted by operation of TEST switch.

AIMS (TRANSPONDER IDENTIFICATION SYSTEM).

The acronym AIMS is derived from the following:

ATCRBS (air traffic control radar beacon system) IFF (identification, friend or foe) MARK XII Identification System.

On aircraft with T-34 AFC 58 incorporated, the AIMS installation provides the aircraft with coded identification and automatic altitude reporting capabilities.

The AIMS installation consists of the following components (figure 1-29): RT-1001/APX-93(V) Receiver-Transmitter, AAU-21/A Altimeter/Encoder, AAU-24/A Altimeter and an AS-2555/APX-93(V) Antenna (11, figure 1-3).

The RT-1001/APX-93(V) receiver-transmitter (13A, figure 1-7) is located on the left-hand side of the forward cockpit. Power for the RT-1001/APX-93(V) is provided by the aircraft 28 vdc main bus through a 2 ampere circuit breaker (10, figure 1-9) located on the forward cockpit right side panel. The RT-1001/APX-93(V) may be used as part of the AIMS installation or it may be operated separately as an IFF system. Only the forward pilot has control of the RT-1001/APX-93(V).

OPERATION OF THE RT-1001/APX-93(V) AS A SEPARATE IFF SYSTEM.

1. Engage the IFF POWER circuit breaker.
2. Position the OFF-STY-ON-LO switch to ON.
3. Position the ALT switch to OFF.
4. Select the desired reply code with the four thumb wheel selectors. When a Mode 3/A challenge signal is received, the transponder circuits are activated and a reply is transmitted. The identification code contained in the reply is controlled by the previously set thumb wheel selectors.

The AAU-21/A altimeter/encoder (5A, figure 1-5) replaces the original barometric altimeter, AN5760L4BD, in the forward instrument panel. The barometric pressure is set into the AAU-21/A by the forward pilot to provide an accurate indication of pressure altitude, corrected to sea level. The baroset knob does not affect the barometric setting of the encoded altitude which is always at 29.92 inches Hg. Power requirements for the AAU-21/A altimeter/encoder are 28 vdc to operate its internal vibrator and 115 vac to operate its altitude encoder. The 28 vdc is provided through the ALTIMETER VIBRATOR circuit breaker (15, figure 1-9) and the 115 vac is provided through the ALTIMETER ENCODER circuit breaker (8, figure 1-9). Both circuit breakers are located on the forward cockpit right side panel. The AAU-21/A altimeter/encoder utilizes the original static port system of the aircraft as the source of static air pressure. The AAU-24/A altimeter (5, figure 1-6) replaces the original barometric altimeter, AN5760L4BD, in the aft instrument

panel. The barometric pressure is set into the AAU-24/A altimeter by the aft pilot to provide an accurate indication of pressure altitude, corrected to sea level. The 28 vdc power required to operate the AAU-24/A altimeter internal vibrator is provided through the ALTIMETER VIBRATOR circuit breaker (15, figure 1-9) located on the forward cockpit right side panel. The AAU-24/A altimeter utilizes the original static port system of the aircraft as the source of static air pressure.

The AS-255/APX-93(V) antenna (11, figure 1-3) is located on the underside of the aircraft at fuselage station 105. It is used to receive challenge signals and transmit replies made by the RT-1001/APX-93(V) receiver transmitter.

The AIMS installation may be used to provide identification replies, as previously described, and automatic reporting replies.

OPERATION OF THE AIMS SYSTEM.

Note

The ALTIMETER VIBRATOR circuit breaker should be engaged during all use of the altimeters.

1. Engage the ALTITUDE ENCODER and the IFF POWER circuit breakers.
2. Position the OFF-STY-ON-LO switch to ON.
3. Position the ALT switch to ON.
4. When enabled thus, the transponder will reply to a Mode 3/A challenge signal by transmitting an identification code controlled by the four thumb wheel selectors. The transponder will reply to a Mode C challenge signal by transmitting a pulse train coded by the AAU-21/A altimeter/encoder to report the aircraft's present altitude, corrected to an atmospheric pressure of 29.92 inches Hg at sea level.
5. The only indication to the pilot that he is being challenged for identification or altitude information is the illumination of a REPLY lamp on the face of the transponder during reply transmissions.

EXTERIOR LIGHTING.

Exterior lighting includes a recessed landing light in the leading edge of each wing, a red passing light in the nose, navigation lights on the wing tips and tail cone, and a white light by each wheel well for ground observation of the landing gear position. Anti-collision lights consisting of a rotating beacon on top of the fuselage and a strobe

light on the bottom, are operated by the anti-collision light switches (25, 27, figure 1-8, and figure 1-28). Control of navigation and fuselage lights is provided by the EXT MASTER switch (24, figure 1-8, and figure 1-28), located on the right console in the front cockpit only. The switch is placarded FLASH-OFF-STEADY and provides for operation corresponding to its position. Placing the switch in the OFF position cuts off dc power to all navigation and fuselage lights. Should the flasher unit fail, lights will automatically revert to the STEADY operation.

WARNING

- To prevent visual impairment to personnel, do not operate strobe lights on the ground at night.
- Turn off strobe lights/rotating beacons in flight if reflection from fog, rain etc. cause pilot disorientation.

NEW

LANDING LIGHT SWITCHES.

Left and right landing lights are turned on and off by two switches (14, figure 1-7, and figure 1-28) on the left console in the front cockpit only. Each switch has three positions which are marked ON, OFF, and MOM ON (momentary contact). When in the MOM ON position, the switch is spring-loaded to OFF.

CAUTION

Due to the lack of air cooling, landing lights should not be continuously operated on the ground. If landing lights are required during taxi operations, alternating between left and right lights at least every 30 seconds is recommended.

PASSING LIGHT SWITCH.

The passing light is controlled by an ON-OFF toggle switch (6, figure 1-8, and figure 1-28), on the right console in the front cockpit only.

NAVIGATION LIGHTS SWITCH.

Operation of the navigation lights is provided by a three-position toggle switch (23, figure 1-8 and figure 1-28), located adjacent to the EXT MASTER switch. This switch is placarded BRIGHT-OFF-DIM and is used to control the intensity of the navigation lights. Placing the switch in the OFF position cuts off dc power to the

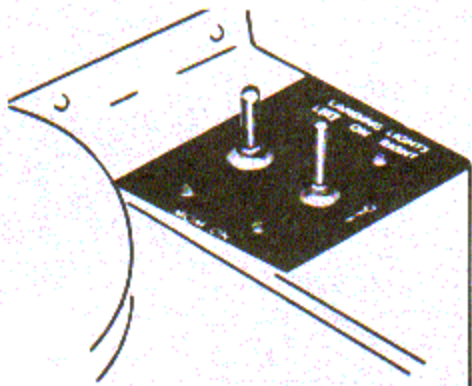

LEFT CONSOLE FRONT COCKPIT

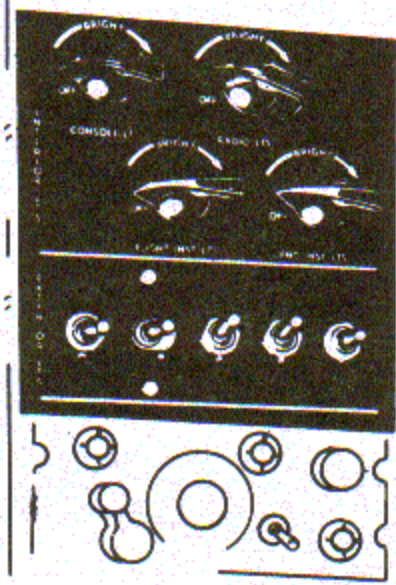

RIGHT CONSOLE FRONT COCKPIT

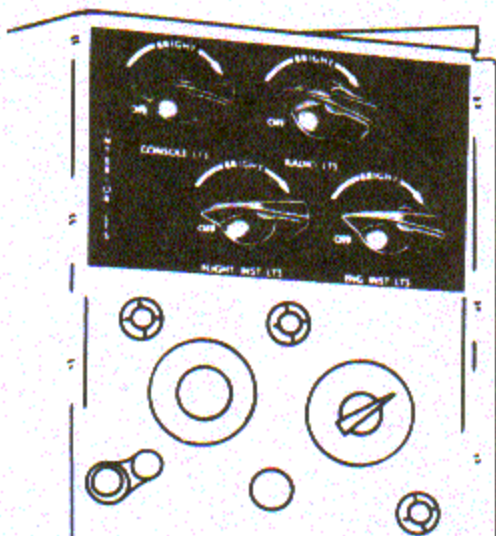

RIGHT CONSOLE REAR COCKPIT

Figure 1-28. Lighting Controls

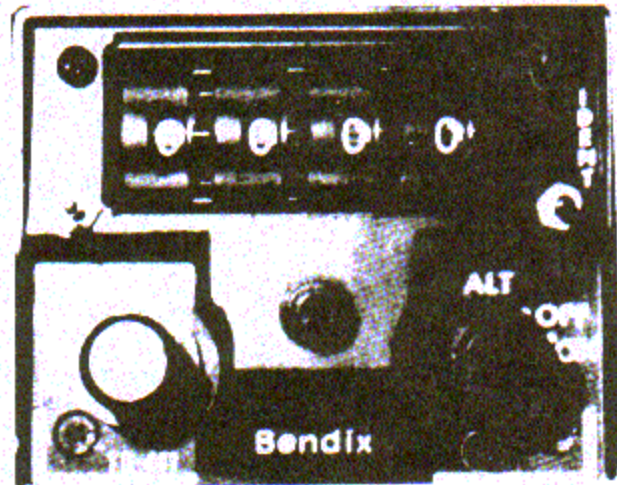

RT-1001/APX-93(V) Receiver-Transmitter

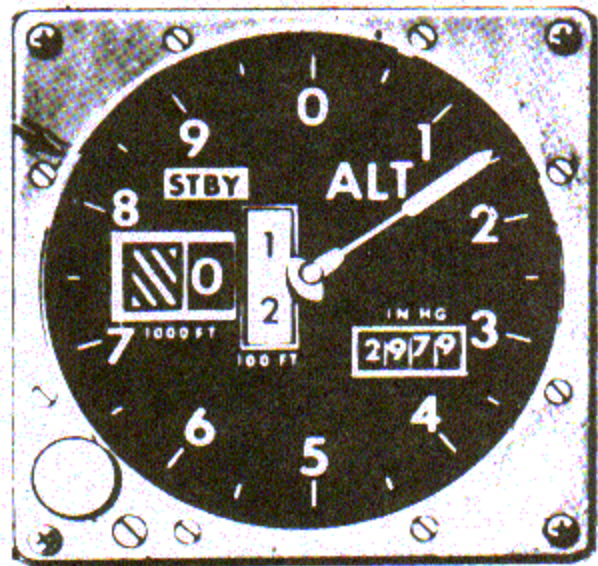

AAU-21/A Altimeter-Encoder

Figure 1-29. AIMS Installation Components

navigation lights. With the navigation lights switch ON, the external gear-down indicator lights will illuminate when the main wheels are fully extended.

INTERIOR LIGHTING.

Interior lighting in both cockpits is identical and each cockpit is equipped as follows: all instruments are individually lighted, a light is installed over each console, and a utility light is installed on the right sidewall. The instrument panel checklist and radio control panel are edge-lighted.

INTERIOR LIGHTING CONTROLS.

Four rheostats (figure 1-28) on the right console in each cockpit control all lighting in the cockpit except the utility light, which has a switch integral with its use. Each rheostat is OFF in the full counterclockwise position. Rotating the rheostat clockwise first turns the lights

on dim and then progressively increases them to full brilliance. The checklist edge lighting is controlled by either the CONSOLE LTS rheostat or by the RADIO LTS rheostat. Radio panel lighting is independent of the radio controls.

BAGGAGE COMPARTMENT.

A baggage compartment (10, figure 1-3) behind the rear cockpit is accessible through a door on the left side of the fuselage. For baggage compartment loading limitations refer to Section I, Part 4.

MISCELLANEOUS EQUIPMENT.

The following miscellaneous equipment is installed: a rearview mirror in the front cockpit, map case and flight report holder in the front cockpit integral with the left and right sidewalls respectively, and a relief tube under each seat.

PART 3 - AIRCRAFT SERVICING

GENERAL SERVICING INFORMATION.

The servicing data contained in this part will assist crewmembers during transit maintenance operations in

the event the maintenance crews are unfamiliar with the aircraft. For detailed maintenance servicing instructions, refer for Handbook Maintenance Instructions, NAVWEPS 01-90KDB-502. See figures 1-30, 1-31 and 1-32 for general servicing information.

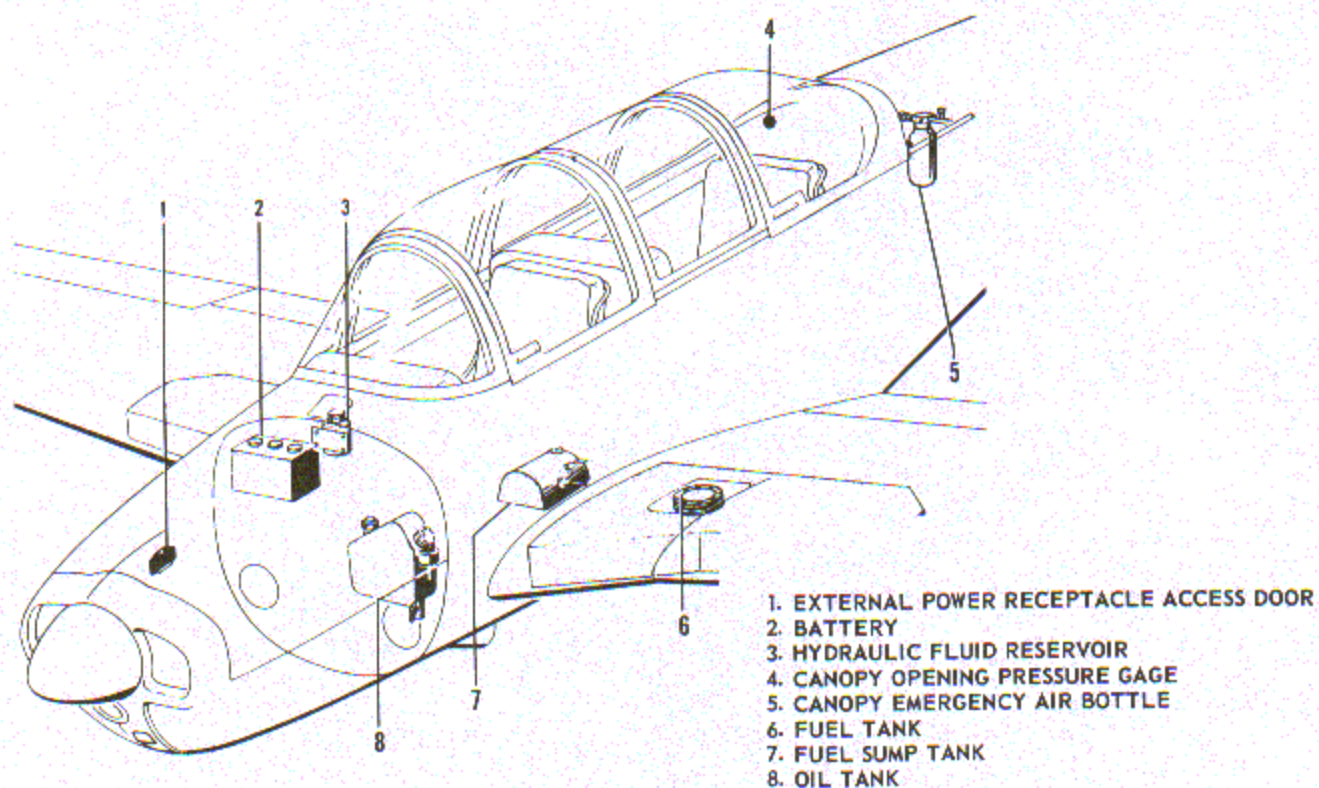
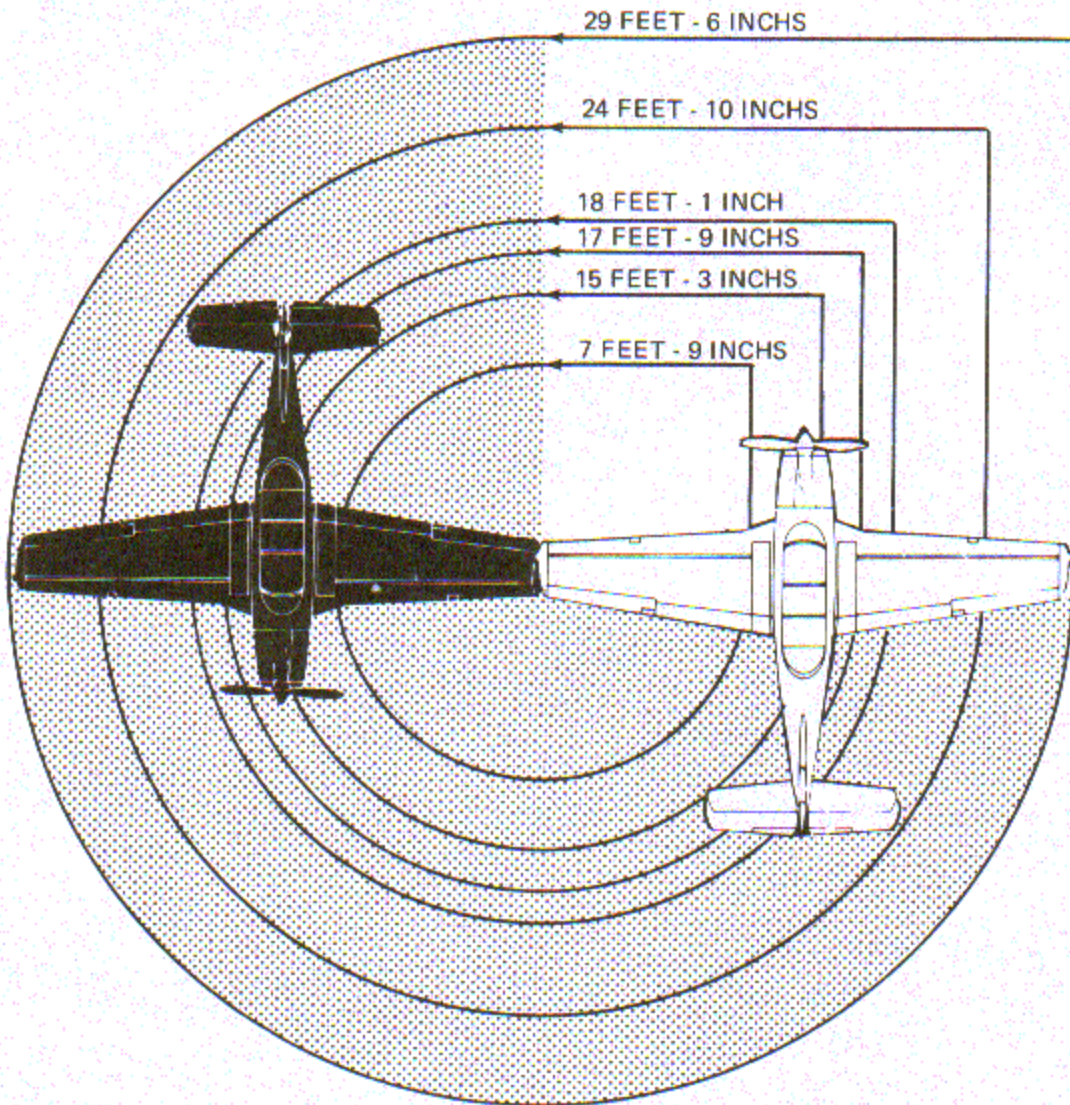

Figure 1-30. Servicing Diagram



CAUTION

THE NOSE WHEEL IS LIMITED TO 30 DEGREES OF TURN EITHER SIDE OF CENTER.

Figure 1-31. Aircraft Turning Radii

	MIL SPEC OR TYPE	QUANTITY OR PRESSURE
FUEL CAUTION Alternate grade fuels, if used continuously, will cause extensive plug fouling, fuel nozzle coating, shorten plug life, contaminate the oil, and may shorten engine life.	MIL-F-5572** Grade 80/87, 100LL Alternate Grades: 100/130, 115/145	50 Gallons (usable fuel, both tanks)
ENGINE OIL	MIL-L-22851 (TYPE II)**	3 Gallons
HYDRAULIC FLUID (Commercial hydraulic fluid, other than listed below, is not compatible and will deteriorate seals. Carriage of spare can of fluid on cross-country flights to commercial fields recommended.)	MIL-H-83282 (Primary) MIL-H-5606 (Alternate)**	1 Pint Fill brake reservoir to within 3/4-inch of the bottom of the reservoir neck.
LANDING GEAR STRUTS HYDRAULIC FLUID NITROGEN*	MIL-H-5606** BB-N-411	—
TIRES DRY COMPRESSED AIR OR NITROGEN MAIN NOSE	—	35 psi 40 psi
CANOPY EMERG AIR BOTTLE NITROGEN	BB-N-411	2,300 - 3,000 psi
BATTERY	Distilled Water	Electrolyte must cover plates.

*If necessary, on a cross country flight, air may be used on a one time basis. Since air is corrosive, the system shall be returned to nitrogen at the next stop or home base as applicable. An appropriate yellow sheet entry shall be made when air is substituted.

**Commercial - Fuel: 80/87, 100LL; alt: 100/130 or 115/145; Oil: EXXON Aviation Oil E120 or E100, EXXON Aviation Oil AD100, Aeroshell W120 or W100, Mobil AVREX 106 type 120, Mobil AERO Oil 120 or 100, Chevron AERO Oil Grade 120 or 100, Texaco Aircraft Eng. Oil Premium AD120 or AD100 (Lower viscosity aviation grade oils may be utilized during cold weather operations); Hydraulic Fluid: EXXON UNIVIS J43, Mobile AERO HFB, Aeroshell Fluid 4.

Figure 1-32. Servicing Chart

PART 4 - AIRCRAFT OPERATING LIMITATIONS

GENERAL LIMITATIONS

Most operating limitations are covered by the instrument markings shown in figure 1-33. The red radials indicate operating limits while the white arcs show normal operating conditions. Other limitations and conditions contributing to their requirements are discussed in the following paragraphs.

MINIMUM CREW REQUIREMENTS.

The aircraft can be safely and efficiently operated by one pilot. Solo flight must be from the front cockpit only.

ENGINE LIMITATIONS

All engine limitations are illustrated in figure 1-33; no additional engine dive overspeed limitation is allowed. If airspeed is maintained within limits, propeller control range is adequate to prevent overspeed. The engine is not to be operated at speeds below 1,600 rpm, with power on, to preclude developing excessive internal engine stresses. Engine overspeeds (2,700-3,200 rpm) require inspection in accordance with appropriate engine bulletins. Engine speeds above 3,200 rpm require an engine change. Report any overspeed in the Aircraft Yellow Sheet.

PROPELLER LIMITATIONS

Propeller limitations for this aircraft are confined to propeller overspeed, which is defined as not exceeding 3,380 rpm at any time. This limitation, although it exceeds the 3,200 rpm overspeed limitation of the engine, is to be observed. Overspeed beyond engine limits and above 3,380 rpm will result in the need for replacement of both the propeller and engine. Propeller inspection is required between 3,050 - 3,380 rpm.

WEIGHT LIMITATIONS

The maximum recommended gross weight for this aircraft is:

Field takeoff and landing — 3,050 pounds.

AIRSPEED LIMITATIONS

In smooth or moderately turbulent air:

With landing gear and wing flaps retracted and canopy open or closed — 240 KIAS.

With landing gear and/or wing flaps extended — 110 KIAS.

In severe turbulence, indicated airspeeds in the range from 120 to 165 knots are recommended.

ACCELERATION LIMITATIONS

The maximum permissible accelerations for flight in smooth air at all gross weights are shown in figure 1-34. Because rolling pullouts impose additional stress on the aircraft, the maximum permissible acceleration is 2.5g's.

Note

If acceleration limits are exceeded, land as soon as practicable and note overstress in the Aircraft Yellow Sheet.

MANEUVERS

The T-34B is fully aerobatic within its g-loading limitations. Inverted flight shall not exceed 15 seconds.

CAUTION



Never exceed 15 seconds of inverted or negative "g" flight as entire oil quantity is recirculated every 20 seconds and oil is not returned to the tank in this flight attitude.

CENTER OF GRAVITY LIMITATIONS

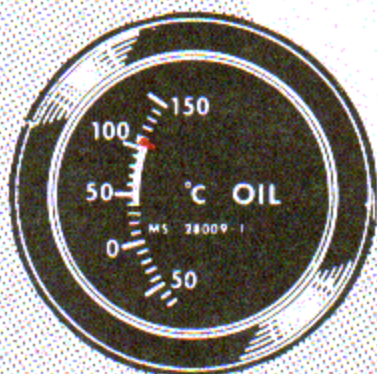
The location of the center of gravity (CG) of the aircraft is expressed in terms of inches aft of the reference datum, or percent mean aerodynamic chord (MAC). At 2,775 pounds or less, the forward CG limit is 84.1 inches aft of datum (19.0 percent MAC). From 2,775 pounds the forward CG limit follows a straight line which slopes up to 3,050 pounds at 88.9 inches (26.5 percent MAC). The aft CG limit for 3,050 pounds is 89.8 inches (27.9 percent MAC). The aft limit slopes down to 2,675 pounds at 90.8 inches (29.4 percent MAC) and remains at 90.8 inches for all weights less than 2,675. See figure 1-35 for a graphic



OIL TEMPERATURE

-  40°C to 107°C — Normal operating range
-  107° C — Maximum

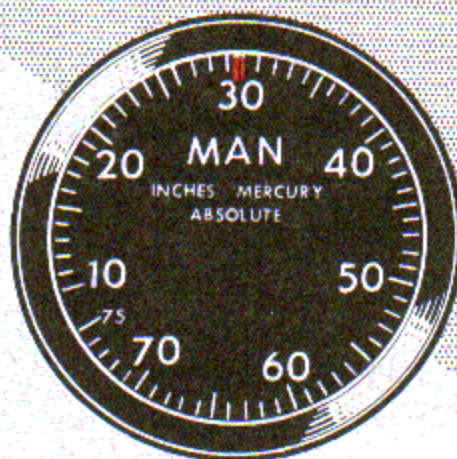

MANIFOLD PRESSURE

-  29.6 in. Hg — Maximum
(FULL THROTTLE)

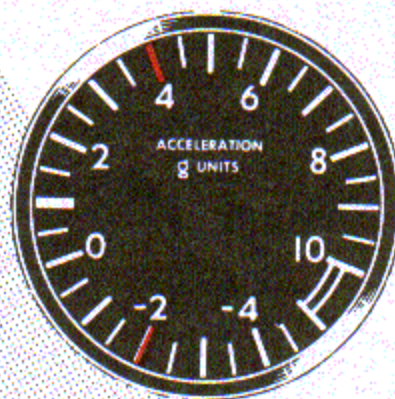



ACCELEROMETER

-  + 4 G's Positive limits
-  - 2 G's Negative limits

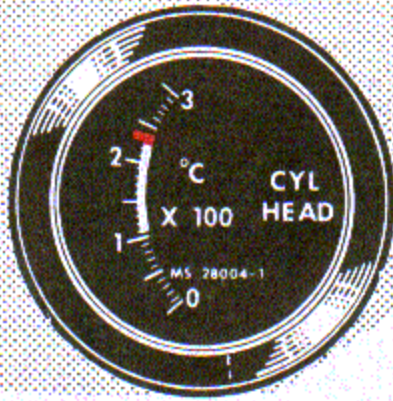
Figure 1-33. Instrument Markings (Sheet 1 of 2)



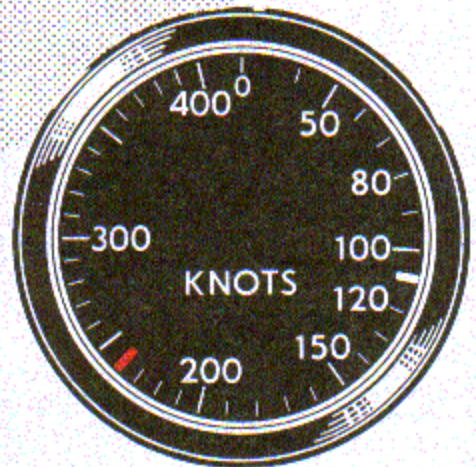

CYLINDER HEAD TEMPERATURE

-  107° to 240° C — Normal Operating Range
-  240° C — Maximum Continuous
-  240° C — Maximum (Takeoff)





AIRSPEED

-  240 Knots — Maximum Permissible Indicated Airspeed
-  110 Knots — Landing Gear and Wing Flap Extension Airspeed



OIL PRESSURE

-  30-80 psi — Normal Operating Range
-  10 psi — Minimum at idle rpm
-  80 psi — Maximum

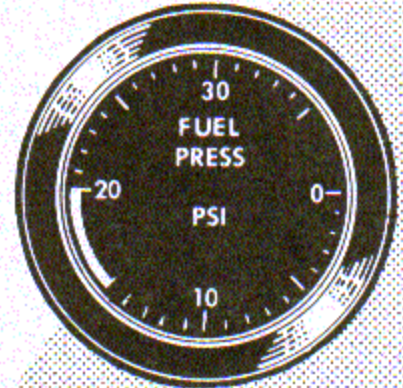

FUEL PRESSURE

-  15-20 psi — Continuous Operation

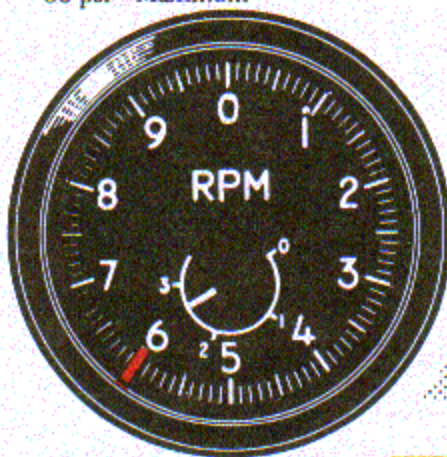

TACHOMETERS

-  2600 rpm — Takeoff

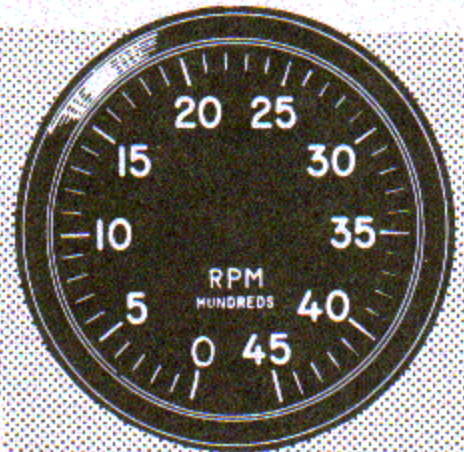

BASED ON FUEL GRADE 80/87

Figure 1-33. Instrument Markings (Sheet 2 of 2)

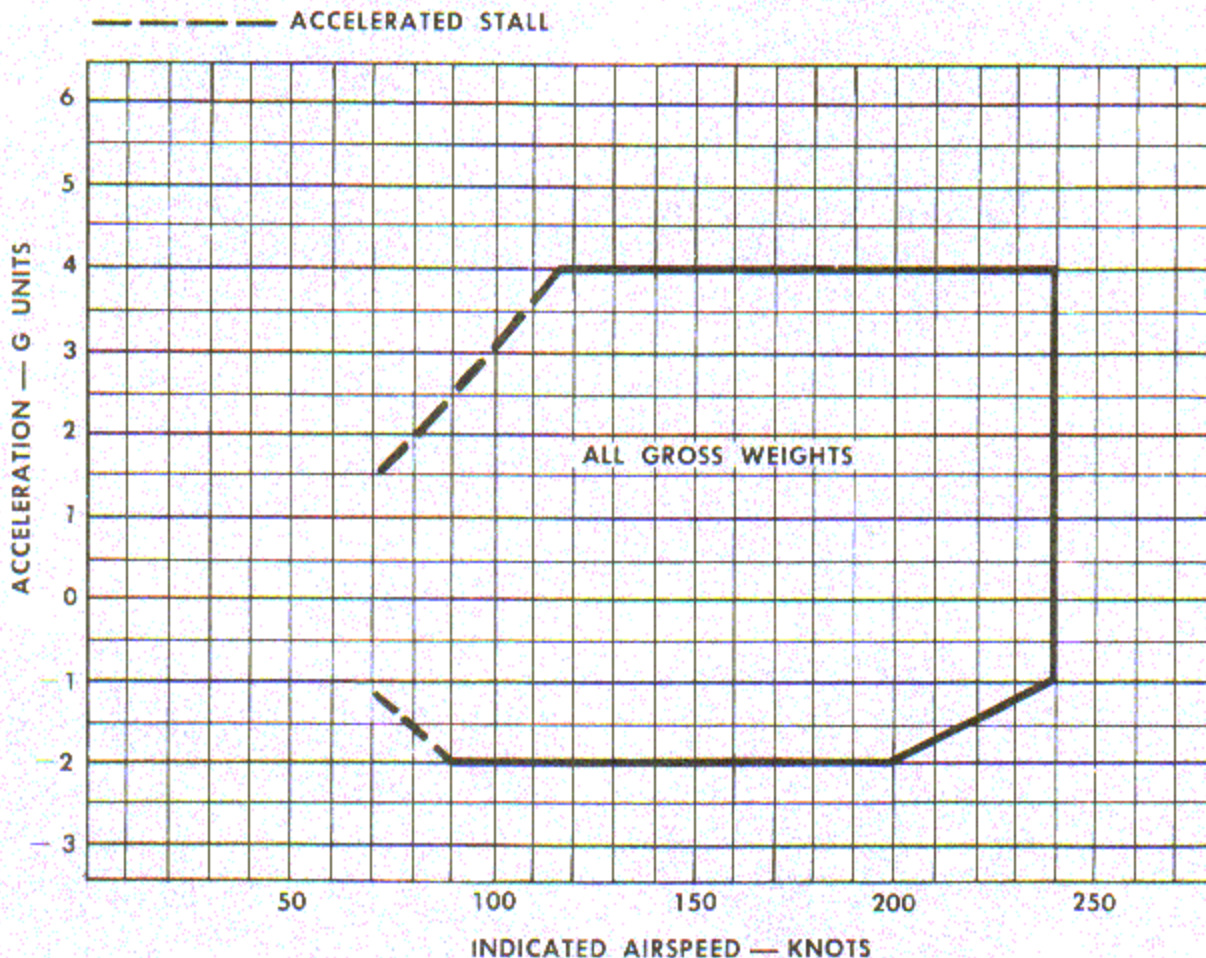

Figure 1-34. Acceleration Limits

representation of CG limits, and the Weight and Balance Handbook, AN-01-1B-40, for further information and data.

WARNING

- All load carried in addition to fuel, oil, and crew is carried in the baggage compartment, which is limited to a maximum allowable load of 100 pounds with the rear cockpit unoccupied. No baggage is permitted with the rear seat occupied due to marginal CG conditions.

WARNING

- In some aircraft, particular combinations of pilot and co-pilot weights will be critical or actually exceed CG limitations. The pilot in command must be familiar with the weight and balance specifications of his particular aircraft.

LIMITATIONS CARD

The limitations card, figure 1-36, provides a ready reference for pilots to determine when an aircraft should be UP or DOWN on the yellow sheet.

	<u>MIN</u>	<u>MAX</u>
MAP SPLIT.		1.5"
OIL TEMP (normal range)	40°C	107°C
OIL PRESSURE (in flight)	30 psi	80 psi
OIL PRESSURE (idle)	10 psi	
OIL CONSUMPTION (1.0 hour normal cruise)		1.5 qts
CYL. HEAD TEMP (normal range)	107°C	240°C
CHT SPLIT.		30°C
FUEL PRESSURE (start)	8 psi	(normal) 15-20 psi
FUEL SPLIT (must be dipped)		10 gals
RPM SPLIT.		20 rpm
RPM FLUX.		+25 rpm
RPM (full power on deck)	2400 rpm	2550 rpm
RPM (takeoff)	2570 rpm	2630 rpm
RPM (idle at operating temp)	600 rpm	750 rpm
VOLTMETER (at 1700 rpm)	27.7 V	28.5 V
ALTIMETER SPLIT (below 2000')		100 ft
AIRSPEED SPLIT.		4 kts
STALL SPEED (gear, flaps down, power off)		49+3 kts
STALL SPEED (clean, power off)		59+3 kts
GEAR WARNING HORN BLOWING.	12"	18"
LANDING GEAR RUN TIME (retract)	7-9 sec	12 sec
FLAP RUN TIME (extension)		15 sec
BRAKE PUCK WEAR.		3, 16"
AILERON TRIM (normal cruise)		4°
IDLE MIXTURE CHECK		5-10 rpm rise
CRUISE MIXTURE RISE		0-40 rpm rise
MAGNETO DROP		100 rpm
MAGNETO SPLIT		50 rpm
MAXIMUM AIRSPEED (clean)		240 kts
ROLLING PULLOUT		2.5 g. s
GEAR DOWN.		110 kts
"G" METER LIMITATION		+4, -2
CANOPY AIR.	2300 psi	3000 psi

NOTE: IF A READING IS BELOW THE MINIMUM OR ABOVE THE MAXIMUM, THE AIRCRAFT IS DOWN ON THE YELLOW SHEET.

Figure 1-36. Limitations Card

SECTION II — INDOCTRINATION

TABLE OF CONTENTS

Ground Training Syllabus	2-1	Personal Flying Equipment	2-2
Flight Training Syllabus	2-2	Flight Time Requirements	2-2
Flight Crew Requirements	2-2		

GROUND TRAINING SYLLABUS.

TRANSITION GROUND TRAINING SYLLABUS

SYLLABUS PERIOD	DESCRIPTION	HOURS
MOD 1.1	NATOPS PROCEDURES AND OPERATIONS	2.0
MOD 1.2	INTRODUCE NATOPS PRE-FLIGHT AND POST FLIGHT INSPECTION	1.0
MOD 1.3	BAILOUT TRAINING	0.5
MOD 1.4	COCKPIT FAMILIARIZATION	0.5
MOD 2.1	NORMAL EMERGENCY PROCEDURES REVIEW	1.0
MOD 3.1	RECRUITING COMMAND T-34B PROGRAM LECTURE	1.5
MOD 4.1	AIRCRAFT SYSTEMS LECTURE	4.0
MOD 5.1	FAA REGULATIONS AND CIVILIAN OPERATING ENVIRONMENT	1.0
MOD 5.2	LOW LEVEL FLIGHT PLANNING AND NAVIGATION	1.0
MOD 6.1	OPEN BOOK NATOPS EXAM	1.0
MOD 6.2	CLOSED BOOK NATOPS EXAM	1.0

FLIGHT TRAINING SYLLABUS.**TRANSITION FLIGHT SYLLABUS**

SYLLABUS PERIOD	DESCRIPTION	HOURS
T-1/DUAL	INTRODUCE TAXI, RUN-UP, SLOW FLIGHT, SPIN, POWER-OFF STALL, HIGH ALTITUDE EMERGENCY, LOW ALTITUDE EMERGENCY, EMERGENCY LANDING PATTERN, FULL AND NO FLAP LANDINGS.	1.6
T-2/DUAL	PRACTICE ALL ITEMS FROM T-1	1.6
T-3/DUAL	INTRODUCE AND PRACTICE WING-OVER BARREL ROLL, LOOP, HALF CUBAN EIGHT, UNUSUAL ATTITUDES. REVIEW ITEMS FROM PREVIOUS FLIGHT.	1.6
T-4/DUAL	POST MAINTENANCE CHECK FLIGHT PROFILE FLIGHT, REVIEW HIGH WORK AND LANDINGS.	1.6
T-5/DUAL	ROUND ROBIN CROSS COUNTRY LOCAL AREA TO INCLUDE FULL-STOP AT CIVILIAN FIELD AND PATTERN ENTRY AT UNCONTROLLED FIELD.	2.0
T-6/DUAL	NATOPS CHECK FLIGHT TO COVER ALL STALL MANEUVERS, HIGH ALTITUDE EMERGENCY, LOW ALTITUDE EMERGENCY, EMERGENCY LANDING PATTERN, FULL AND NO FLAP LANDINGS.	1.6

FLIGHT CREW REQUIREMENTS.

The two-place aircraft may be flown either dual or solo, but if flown solo, it must be flown from the front seat only.

PERSONAL FLYING EQUIPMENT.

1. Flying equipment will be utilized by all personnel engaged in flights as set forth in OPNAVINST 3710.7 series.

2. Other survival equipment appropriate to the climate of the area will be used.

3. All survival equipment will be secured in such a manner that it is easily accessible and will not be lost during bailout or landing.

4. Additional survival information is available in:

a. Survival Training Guide (NAVWEPS 00-80T-56).

b. Safety and Survival Equipment for Naval Aviation (NAVAER 00-80T-52).

FLIGHT TIME REQUIREMENTS.

The pilot qualifications listed in figure 2-1 apply for the type of mission contemplated; however, reporting custodians may waive certain time minimums as deemed appropriate when the pilot assigned is considered capable of performing the scheduled flight.

	TOTAL HOURS IN MODEL	LANDINGS
DAY	Minimum of 4 hours within the last 30 days and minimum of 20 hours per calendar quarter	5 landings within the last 30 days (2 full stop)
NIGHT	Day current in model. Complete initial dual night familiarization. Minimum of 6 hours every 6 months	Day current plus 5 night landings in model
POST MAINTENANCE CHECK PILOT	50 hours	

NOTE: Pilots who fail to meet the above requirements shall be considered no longer currently qualified and are required to requalify in accordance with OPNAVINST 3710.7 series and the T-34B NATOPS Flight Manual.

Figure 2-1. Flight Time Requirements

SECTION III — NORMAL PROCEDURES

TABLE OF CONTENTS

PART 1 — SHORE-BASED PROCEDURES		Landing Checklist	3-13
Scheduling	3-1	Landings	3-13
Briefing	3-1	Waveoff	3-15
Aircraft Yellow Sheets	3-2	After Landing	3-15
Daily Preflight Inspection	3-2	Discrepancy Reporting	3-17
Prestart Procedures	3-2		
Starting Engine	3-7	PART 2 — CARRIER-BASED PROCEDURES	
Pretakeoff Procedures	3-7	(Not Applicable)	3-17
Takeoff Procedures	3-9		
Normal Climb	3-11	PART 3 — FUNCTIONAL CHECKFLIGHT PRO-	
Normal Cruise	3-11	CEDURES	
Slow Flight	3-11	General	3-19
Normal Descent	3-13	Conditions Requiring Functional	
Acrobatic Cruise	3-13	Checkflights	3-19
Formation	3-13	Procedures	3-19
Normal Break Entry	3-13		

PART 1 — SHORE-BASED PROCEDURES

SCHEDULING.

The commanding officer or his designated representative is responsible for the promulgation of the flight schedule, which becomes an order of the commanding officer. Variations require the approval of the commanding officer or his designated representative. Shipboard scheduling is not applicable to this aircraft.

BRIEFING.

The briefing will be conducted using a briefing guide and the appropriate syllabus card. The briefing guide will include the following:

1. General.
 - a. Aircraft assigned and call signs.
 - b. Engine start, taxi, and takeoff times.
 - c. Visual signals and rendezvous instructions.
2. Mission.
 - a. Primary.
 - b. Operating area.
3. Communications.
 - a. Frequencies.
 - b. Radio procedure and discipline.
 - c. Navigational aids.
 - d. Identification and ADIZ procedures (when appropriate).
4. Weather.
 - a. Local area.
 - b. Local area or destination forecast.

5. Navigation.
6. Emergencies.
 - a. Aborts.
 - b. Divert fields.
 - c. Emergency fuel.
 - d. Radio failure.
 - e. Loss of visual contact with flight.
 - f. Downed pilot and aircraft emergencies.
 - g. System failures.
7. Special Instructions.
 - a. The flight leader will inspect all flight members for the proper flight gear.

AIRCRAFT YELLOW SHEETS

At least the last ten discrepancy portions of the Aircraft Yellow Sheet will be made available to the pilot for his examination prior to his acceptance of the aircraft for flight. Any additional discrepancies should also be brought to the pilot's attention. When the pilot in command is satisfied with the Aircraft Yellow Sheet information he will sign applicable portions for acceptance of the aircraft.

DAILY PREFLIGHT INSPECTION

The pilot will conduct a thorough preflight inspection of the aircraft prior to each flight. In addition the pilot will perform a thorough daily preflight inspection of the aircraft prior to the first flight of the day. Items to be checked on the daily are preceded by an asterisk (*) and can be omitted on subsequent flights that day. See figure 3-1.

AIRCRAFT EXTERIOR

At unmanned fields or fields where ground support personnel are not normally available, the pilot will ensure that the aircraft wheel chocks and tiedowns are removed and the location of the nearest fire bottle is noted.

ENTERING AIRCRAFT

Enter the aircraft from the left side, since canopy handles and rear cockpit step are on the left side only. The front cockpit is accessible from the wing and a kick-in step on

the side of the fuselage facilitates access to the rear cockpit from the left wing. To open canopy, rotate the canopy handle clockwise and pull canopy aft with the handle.

CAUTION

Do not step on canopy rails since damage to the rails could prevent proper canopy operation.

PRESTART PROCEDURES.

PRESTART CHECKLIST.

Immediately on entering the cockpit, perform the following checks:

1. Seat and rudder pedals — ADJUSTED.
 2. Harness — FASTENED.
 3. Inertia reel lock — CHECKED.
 4. Wing flap lever — OFF.
 5. Landing lights — OFF.
 6. Alternate air — IN.
 7. Inverter — OFF.
 8. Generator — ON.
 9. Cockpit air handles — SET.
 10. Landing gear emergency handcrank — DISENGAGED (clutch knob UP and LOCKED).
 11. Light switches and rheostats — SET.
(The anti-collision switches will normally remain in the ON position at all times).
 12. Radios — OFF.
 13. Pitot heat — OFF.
 14. Circuit breakers — IN.
- The following steps are performed only on night flights:
15. External power (for lights and gyros) — PLUGGED IN (if not available, turn battery switch ON).
 16. Instrument and console lights — ON.
 17. Landing lights, passing light, and pitot heat — CHECK (test operation by turning on momentarily).

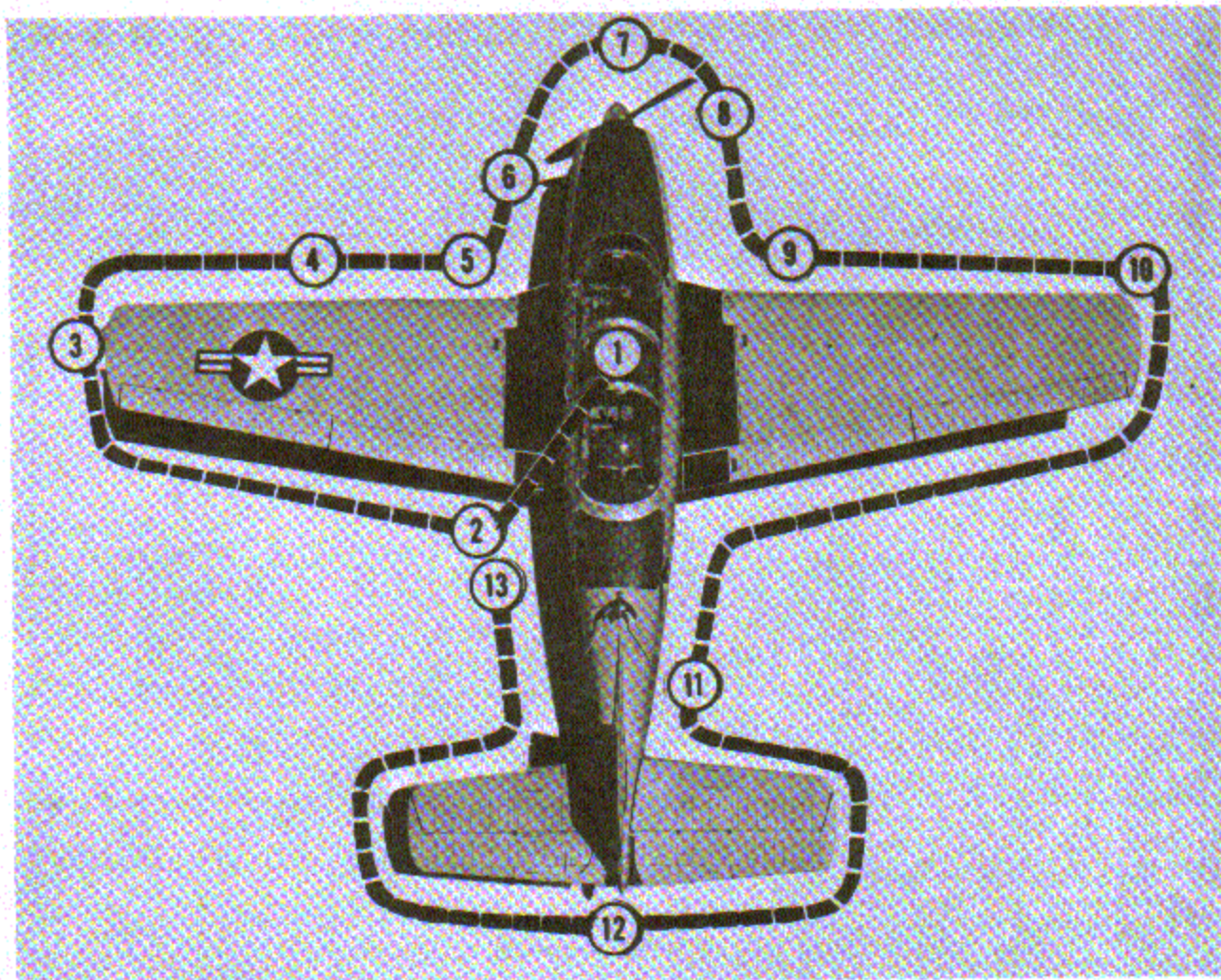

IN A CLOCKWISE PATH, CHECK THE FOLLOWING ITEMS:

① **COCKPIT INSPECTION**

FORWARD COCKPIT

Before performing the exterior inspection, conduct the following check:

1. Boost pump — OFF.
2. Fuel shutoff valve handle — OFF.
3. Trim tabs — 0 DEGREES.
4. Mixture — IDLE CUTOFF.
5. Ignition — OFF.
6. Landing gear handle — DOWN.
7. Emergency landing gear retract switch — OFF (WIRED)
8. Accelerometer limits — +4.0 to -2.0
9. Emergency fuel switch — OFF.
10. Battery — OFF.
11. Controls — UNLOCKED.
- *12. Lap belt and shoulder harness:
 - a. Webbing — CHECK FOR CUTS.
 - b. Release buckle — OPERATION.
13. Parachute/lanyard — CONDITION/CONNECTED.
- *14. Cockpit/equipment — CLEAN/SECURED AND STOWED
- *15. Canopy and windshield — CHECK FOR CRAZING.
- *16. Canopy seal — SECURITY.
- *17. Canopy actuating mechanism (handles, rollers, and tracks) — CHECK PROPER OPERATION.

REAR COCKPIT

1. Boost pump — OFF.

Figure 3-1. Preflight Inspection (Sheet 1 of 4)

2. Emergency landing gear retract switch -- WIRED.
3. Emergency fuel switch -- OFF.
4. Canopy air pressure -- 2300-3000 PSI.
5. First Aid kit -- SECURED.
- *6. Lap belt and shoulder harness:
 - a. Webbing -- CHECK FOR CUTS.
 - b. Release buckle -- OPERATION.
7. Parachute/lanyard -- CONDITION/CONNECTED.
8. Inspect for loose gear.
- *9. Canopy -- CHECK FOR CRAZING.
- *10. Canopy seal -- SECURITY.
- *11. Canopy actuating mechanism -- CHECK PROPER OPERATION.

If Solo Flight:

12. Shoulder harness, seat belt, seat cushion, parachute and any loose equipment -- SECURED.
13. Radio extension cord -- SECURED.
14. Gyro -- CAGED.
15. Instrument panel -- SECURED.
16. Canopy -- CLOSED AND LOCKED.

② TRAILING EDGE, PORT WING

1. Top and underside of wing for cracks, deep scratches, tears, wrinkles, popped rivets, and bulges.
2. Movement of aileron, servo action of aileron trim tabs, aileron bellcrank, and trim tab linkage.
3. Trim tab hinge pin anchored to hinge pin hole, actuator bolt nut cotter-keyed.
4. Flaps for obvious damage.
5. Static discharge wicks for fraying, deterioration, and proper attachment (min. length 6" overall, 1" exposed).

③ PORT WING TIP

Dents, scratches, and condition of navigational light.

④ LEADING EDGE, PORT WING

1. Breaks, bulges, and proper contour.
2. Landing light for security of lens and bulb.
3. Pitot tube -- ensure that pitot tube cover is removed and tube is aligned, secure and unobstructed.

4. Visually check fuel quantity, check chain secure at both ends, and check O ring for deterioration. Replace cap securely.
5. Cockpit air intake screen for obstructions.
6. Undersurface for evidence of fuel leakage.
7. Spar cap for corrosion, adjacent wing skin for bulges.

⑤ PORT MAIN LANDING GEAR

1. Condition of main gear doors. Ensure that wheel well is free of obstructions.
2. Uplock bracket spring is attached to uplock bracket and rib of wing.
3. Check small spring inside canvas dust cover attached to uplock cable and the uplock bracket.
4. Uplock mechanism for distortion and security.
5. Roller on landing gear brace for freedom of movement.
6. Shock strut for scoring and pitting; piston for evidence of leakage. Check for approximately 3 inches of polished strut showing.
- *7. Clean exposed area with a clean cloth moistened with hydraulic fluid, leaving a thin film of fluid.
8. Hydraulic fittings for condition and leaks.
9. Brake disc for freedom of movement (parking brake off).
10. Brake puck pin for 3/16" clearance maximum.
11. Check wheel nut dust cap free to turn.
12. Tire for condition and proper inflation.

FUEL SAMPLES

1. Open port engine compartment cowl.
2. Front cockpit fuel shutoff valve handle to ON.
3. Boost pump switch to ON.
4. Battery switch to ON.
5. Take fuel sample from AFC 53 drain.
6. Open access panel 4, take fuel sample from fuel sump and close access panel.
7. Open access panel 7, take fuel sample from main fuel strainer drain and close access panel.
8. Battery switch, boost pump, and fuel shutoff valve handle to OFF.

Figure 3-1. Preflight Inspection (Sheet 2 of 4)

6 PORT ENGINE COMPARTMENT

1. Apron beneath engine nacelle for excessive gasoline, oil, or fluid leakage. Underside of fuselage for excessive oil leakage.
2. Fuel filter if AFC 53 installed. Fuel drain switch in closed position, red plunger flush with top of filter assembly, and prop governor control line not chafing on filter mounting bracket.

WARNING

If the fuel drain switch is not in the closed position, fuel will be pumped overboard when the battery switch is turned on. Fuel discharge will continue in flight, cause rapid depletion and could result in fuel starvation within 20 minutes.

3. Oil level — minimum of 10 quarts for cold engine, 11 quarts for hot engine.

WARNING

Before re-installing oil filler cap, ensure retaining chain is not broken and is attached at both ends.

4. Engine for loose fittings and leaks.
5. Alternate air door for security.
6. Obstructions in augmentor tube.
7. Ensure that cowling is latched after engine inspection.

7 NOSE SECTION

1. Wheel centering mechanism, nose gear bracket and retract arm for looseness.
2. Nose gear centering roller free to move.
3. Uplock mechanism for distortion and security.
- *4. Nose gear shimmy damper for evidence of leakage and 1/16 to 1/32 inch of polished rod showing when nose wheel is turned to stops in both directions.
5. Shock strut scoring, pitting or leakage and approximately 5 inches of extension.
- *6. Clean exposed area of strut with clean cloth moistened with hydraulic fluid, then wipe clean leaving a thin film of hydraulic fluid.
7. Mud scraper for security and obvious damage.

8. Grounding wire for security and touching the deck.
9. Nose tire for condition and proper inflation.
10. Propeller for cracks, nicks, pits, and evidence of oil leakage. Inspect security of spinner retention nut.
11. Airscoop screen and hot air overboard inlets for cleanliness and obstructions. Lock fasteners firmly secured.
12. Check passing light for security.

8 STARBOARD ENGINE SECTION

1. Same as check for port engine section except for oil quantity. Check for double clamp on generator capacitor.
2. Security of external canopy release handle.
- *3. Battery for electrolyte leakage, warps and bulges.
- *4. Battery and connectors for security.
- *5. Vent tubes for obstructions. Ensure vent tube is properly connected to vent elbow.
- *6. Drain jar for evidence of contamination.

9 STARBOARD MAIN LANDING GEAR

Same as port main landing gear.

10 STARBOARD WING

Same as port wing.

11 FUSELAGE, STARBOARD SIDE

1. Fuel vent standpipe for dents and for a forward slant of approximately 15 degrees with bias cut facing forward.
2. Wrinkled skin and popped rivets.
3. VOR antenna for security.
4. Static air vent clear.

12 EMPENNAGE

1. All tail surfaces for cracks, corrosion, dents and tears; control surfaces for freedom of movement, looseness and excessive play between elevators.
2. All visible control linkages and hinge fittings for cracks and security. Rudder trim tab for anti-servo action.
- *3. Retaining nut on VHF antenna for security. Antenna for cracks, dents, corrosion and security.

Figure 3-1. Preflight Inspection (Sheet 3 of 4)

- *4. Navigation lights and tail cone for security and cracks.
- *5. Static discharge wicks for fraying, deterioration and proper attachment. (Min. length 6", 1" exposed wick).

13 FUSELAGE, PORT SIDE

Same as starboard side except for ensuring that the baggage compartment is checked and securely latched.

WARNING

The baggage compartment must be checked empty for dual flights. A maximum of 100 pounds may be carried in the baggage compartment on solo flights.

Figure 3-1. Preflight Inspection (Sheet 4 of 4)

18. Navigation lights — ON (checked by outside observer).

19. External gear-down indicator lights — CHECKED (by outside observer).

STARTING ENGINE.

The engine can be started from the front seat only. Prior to starting, the pilot will ensure the engine and propeller areas are clear; and when ground support personnel are available, will receive and acknowledge their ALL CLEAR. Starting procedure is as follows:

1. Canopy — OPEN.
2. Mixture — IDLE CUTOFF.
3. Fuel shutoff valve handle — ON.
4. Fuel boost pump — ON.
5. Throttle — SET.
6. Propeller control — FULL FORWARD.
7. Parking brake — SET.
8. Battery — ON (OFF if external power is used).

Note

Flight with a dead battery is not recommended due to the possibility of a complete electrical failure in the event generator power is lost.

9. Fuel pressure — CHECK.
10. Propeller area — CLEAR.
11. Starter — ENGAGED. (count 4 blades)

Note

Check for possible hydraulic lock as engine makes first two revolutions. If hydraulic lock is suspected or encountered, discontinue starting attempt and have lower spark plugs removed to drain fluid from cylinders before a restart is attempted.

12. Ignition — BOTH.
13. Mixture — SLOWLY TO RICH.
14. Starter — RELEASE (when engine fires).

CAUTION

Starting a warm engine in a strong tailwind could cause a stack fire. Ensure proper shutdown procedures are employed, and check for indications of fuel in the augmentor tubes on preflight and postflight inspections.

15. Throttle — 1200 TO 1400 RPM.
16. Oil pressure — CHECK (if no rise within 10 seconds or 30 psi in 30 seconds, secure engine).
17. External power (if used) - DISCONNECT; Battery — ON.
18. Radios/AIMS — ON/STBY.

If engine fails to start after 15 seconds:

19. Mixture — IDLE CUTOFF (discontinue cranking).
20. Throttle — FULL OPEN.
21. Ignition — OFF.
22. Crank for 5 seconds to clear engine, then repeat steps 5 through 14. If engine fails to start after 10 seconds, perform steps 23 through 29.
23. Mixture — IDLE CUTOFF (discontinue cranking).
24. Boost pump — OFF.
25. Battery — OFF.
26. Ignition — OFF.
27. Fuel shutoff valve handle — OFF.
28. Allow starter to cool for 5 minutes, then repeat steps 2 through 14 of normal starting procedure above.
29. If engine still fails to start, secure engine and request assistance.

PRETAKEOFF PROCEDURES.

WARMUP.

Warm up engine at the lowest speed between 1,200 and 1,400 rpm at which smooth operation is obtained until the oil temperature shows a rise, or until the oil pressure is stabilized. Do not exceed 1,400 rpm until oil temperature has reached 40 degrees.

PRETAXI CHECKLIST.

Before taxi, perform the following:

1. Generator warning light and generator voltage — **OUT AT GENERATOR CUT-IN SPEED** (approximately 900 engine rpm), 27.7-28.5 VOLTS.
2. Flaps — **CYCLED** and indicating UP.
3. Trim tabs — **SET 6 R, 3 UP, 0.**
4. Landing gear warning light — **CHECKED.**
5. Landing gear indicators — **DOWN.**
6. Fuel quantity — **NOTED.**
7. Altimeter and clock — **SET.**
8. Inverters — **CHECKED** and on MAIN.
9. Gyros — **UNCAGED AND SET.**
10. Communications equipment — **CHECK OPERATION.** (Set 1300 rpm for maximum generator output.)
11. Instruments — **CHECK FOR CORRECT INDICATIONS.**
12. Idle speed — **THROTTLE CLOSED, 600-750 RPM.**
13. Ignition ground — **CHECKED.**

TAXI

1. Check parking brake off and apply throttle necessary to start aircraft moving.
2. Check for adequate braking action.
3. When clear of obstructions adjust throttle to 800 to 1,000 rpm.
4. Make wide radius turns to prevent stress on the nosewheel. When performing runup, make certain that the nosewheel is straight to prevent excessive stress on the nose gear.
5. Check turn-and-slip indicator and directional gyro for proper tracking.

ENGINE RUNUP.

Before turning onto the runway, turn as near into the wind as practical, stop the aircraft with the nosewheel straight, and perform the following checks:

1. Instruments — **CHECK FOR CORRECT INDICATIONS.**
2. Propeller (recheck) — **FULL INCREASE.**
3. Mixture (recheck) — **FULL RICH.**

Propeller Governor Check:

4. Throttle — **ADVANCE TO 1,800 RPM.**
5. Propeller lever — **AFT TO DETENT.** (Drop to 1,600-1,650 rpm should be obtained. Cycle 6 times for the first flight of the day and 4 times for each succeeding flight.)
6. Propeller lever — **RETURN TO FULL INCREASE.**

Exercise propeller by repeating this procedure.

Ignition System Check:

7. Throttle — **ADVANCE TO 2,000 RPM.**
8. Ignition switch — **R (Right).** (Note rpm drop, then switch to **BOTH** until rpm stabilizes.)
9. Ignition switch — **L (Left).** (Note rpm drop, then switch to **BOTH.** Do not take off if drop on either magneto is greater than 100 rpm, or if the variance between the left and right magneto drop is greater than 50 rpm.)

CAUTION

If the ignition switch is accidentally turned off during the system check, close the throttle and move the mixture to **IDLE CUTOFF**, then perform normal start. Turning the ignition switch back on without taking these precautions could result in a backfire or a stack fire.

Alternate Air Check:

10. Throttle — **2,000 RPM.**
11. Alternate air handle — **FULL OUT (Hot).** (Check for approximately 1/2 inch drop in manifold pressure.)
12. Alternate air handle — **FULL IN (Cold).**
13. Throttle — **SMOOTHLY TO FULL OPEN** (obtain 2,475 (±75) rpm)

Note

This rpm setting is based on a no-wind, sea level condition; therefore, a 25 rpm variance over normal tolerance is not unusual and may be experienced due to the effects of wind, temperature, and/or barometric pressure.

14. Acceleration and deceleration should be smooth without backfire or roughness.

CAUTION

Run engine up to full power only on paved areas to avoid damage to the propeller and aircraft from loose gravel. If no paved surface is available, full power and acceleration checks shall be made on the initial portion of the takeoff run.

15. Fuel boost pump — OFF AT 1,700 RPM; CHECK FUEL PRESSURE FOR FLUCTUATION.

16. Fuel boost pump — ON; CHECK FOR 15-20 PSI.

17. Idle mixture:

Throttle — CLOSED (600-750 rpm idle speed).

Mixture control — RETARD TO IDLE CUTOFF; CHECK FOR 5-10 RPM RISE. (As soon as rpm starts to fall off, rapidly advance mixture control to FULL RICH.)

GROUND BURNOUT

If, after extended taxi or idle time, the ignition system checks out of limits, proceed as follows.

1. Propeller — FULL INCREASE.
2. Mixture — FULL RICH.
3. Throttle — ADVANCE TO 2,000 RPM.
4. Mixture — LEAN TO 50 RPM DROP BELOW BEST POWER.
5. Mixture — RETURN TO RICH AFTER 1 MINUTE.
6. Ignition system — RECHECK.
7. If system does not check out — DOWN THE AIRCRAFT.

Note

Out of limits ignition system checks could be indicative of serious ignition problems. If after one burnout the system does not check out, the problem is probably something other than fouled plugs and the aircraft should be downed until the source of the problem is found. Repeated burnouts may result in a positive system check, but in the process hide symptoms of impending failure. A burnout required before every flight may be indicative of an idle mixture setting which is too rich.

TAKEOFF PROCEDURES**TAKEOFF CHECKLIST.**

Prior to takeoff, perform the following:

1. Anti-collision lights — ON.
2. Fuel — ON; CHECK:
Fuel boost pump switch — ON.
Fuel shutoff valve handle — ON.
Fuel pressure — NORMAL.
Fuel quantity — CHECK.
Fuel caps — LOCKED.
3. Flight controls — FREE.
4. Trim tabs — 6 R, 3 UP, 0.
5. Alternate air — OFF.
6. Generator — OPERATING.
7. Instruments — CHECKED AND SET.
8. Mixture — RICH.
9. Propeller — FULL INCREASE.
10. Ignition — CHECKED ON BOTH.
11. Flaps — SET.
12. Harness — LOCKED.
13. Canopy:
Front — LOCKED (Open/Closed)
Rear — LOCKED (Closed).

Note

The flag will still be visible on the face of the MB-1 attitude indicator if it has not yet erected.

14. Radios — SET
15. AIMS — ON.

TAKEOFF.

Upon completion of the takeoff checklist and after takeoff clearance is obtained, align the aircraft on the runway. Apply full throttle to commence the takeoff run, and at 50-55 knots place the nose slightly above the taxi attitude. Fly the aircraft smoothly off the ground. When positively airborne and a safe landing can no longer be made on the runway, raise the gear. Maintain takeoff attitude until the airspeed reaches 100 knots and establish the 100-knot normal climb.

AFTER TAKEOFF CHECKLIST.

1. Landing gear — UP.
2. Flaps — UP.
3. Fuel caps — SECURE. (Visually check)

MINIMUM RUN TAKEOFF.

For a minimum run takeoff (figure 3-2) use 75 percent flaps, line up on the end of the runway, apply brakes, and smoothly apply full power. With full power applied, release the brakes but do not assume a nose high attitude until reaching approximately 50 knots. At this time pull

back on the stick rapidly but smoothly to assume nose high (takeoff) attitude so the runway may be cleared as soon as minimum flying airspeed (approximately 55 knots) is reached. When clear of the ground, retract the gear and accelerate to climb speed. Continue with the normal takeoff and climb procedure.

OBSTACLE CLEARANCE TAKEOFF.

Use the same procedures as for a minimum run takeoff (figure 3-2) to the point of assuming a nose high attitude. Do not assume the nose high takeoff attitude until reaching approximately 55 knots. When clear of the ground, retract the gear. Accelerate to, and maintain, 70 knots IAS for maximum angle of climb until obstacle is cleared. Accelerate to 100 knots IAS, retract flaps, and continue normal climb.

Note

With normal speeds and the engine developing full power, no particular caution need be exercised in retracting the flaps since acceleration will be sufficient to offset any tendency for the aircraft to sink. Under conditions of minimum airspeed and/or less than full power, caution should be exercised and the flaps raised in increments of 25 to 30 percent.

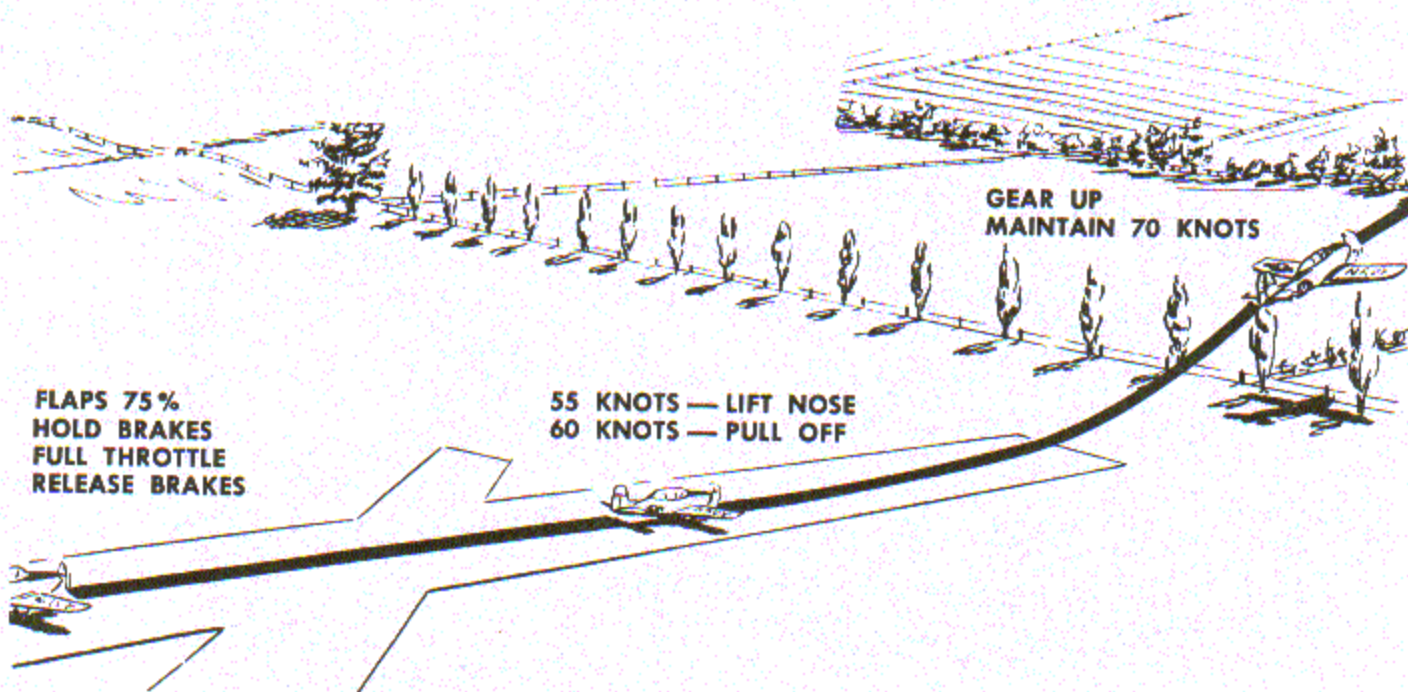

Figure 3-2. Obstacle Clearance Takeoff (Sheet 1 of 2)

CROSSWIND TAKEOFF.

In a crosswind takeoff, directional control may be more difficult to maintain; therefore, the following procedure should be used. See figure 3-3 for finding recommended takeoff speeds.

1. Advance throttle to takeoff power setting and maintain directional control with rudder. Continue as in a normal takeoff, applying sufficient aileron pressure to maintain level attitude. If unable to maintain directional control at start of takeoff roll, some use of brakes may be necessary. If possible, use of brakes should be avoided after takeoff roll is underway since every application of brakes will lengthen the takeoff run.
2. Hold nose wheel on ground longer than in a normal takeoff and use aileron to hold wings level.
3. Make the pulloff definite, as flying speed is reached, to avoid sideskipping as the aircraft starts to become airborne.
4. When definitely airborne, correct for drift by making a coordinated turn into the wind.

NORMAL CLIMB.

Climb is done at 100 knots, full increase (2,600) rpm, and full throttle.

NORMAL CRUISE.

The aircraft is flown at 120 knots and 2,000 rpm (20 to 23 inches MAP).

SLOW FLIGHT

1. From normal cruise, close throttle, advance propeller control to full-low pitch, and maintain altitude and heading.
2. At 110 knots, lower landing gear. When gear indicates down, advance throttle to 15 inches MAP and lower flaps.
3. At 70 knots, advance throttle to approximately 19 to 21 inches MAP to maintain altitude and 70 knots.
4. To return to normal cruise, apply full throttle and raise gear. When gear indicates up, raise flaps. At 120 knots, reduce power to normal cruise settings.

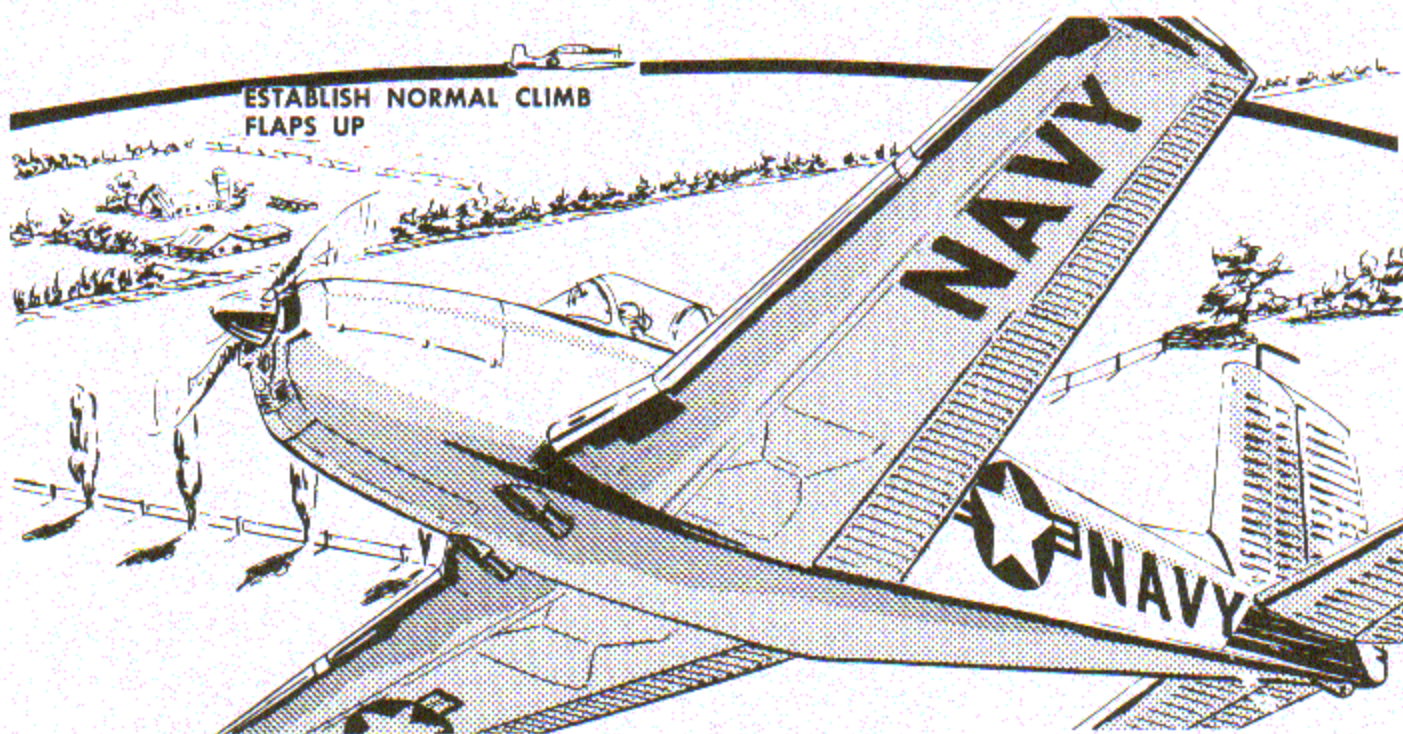
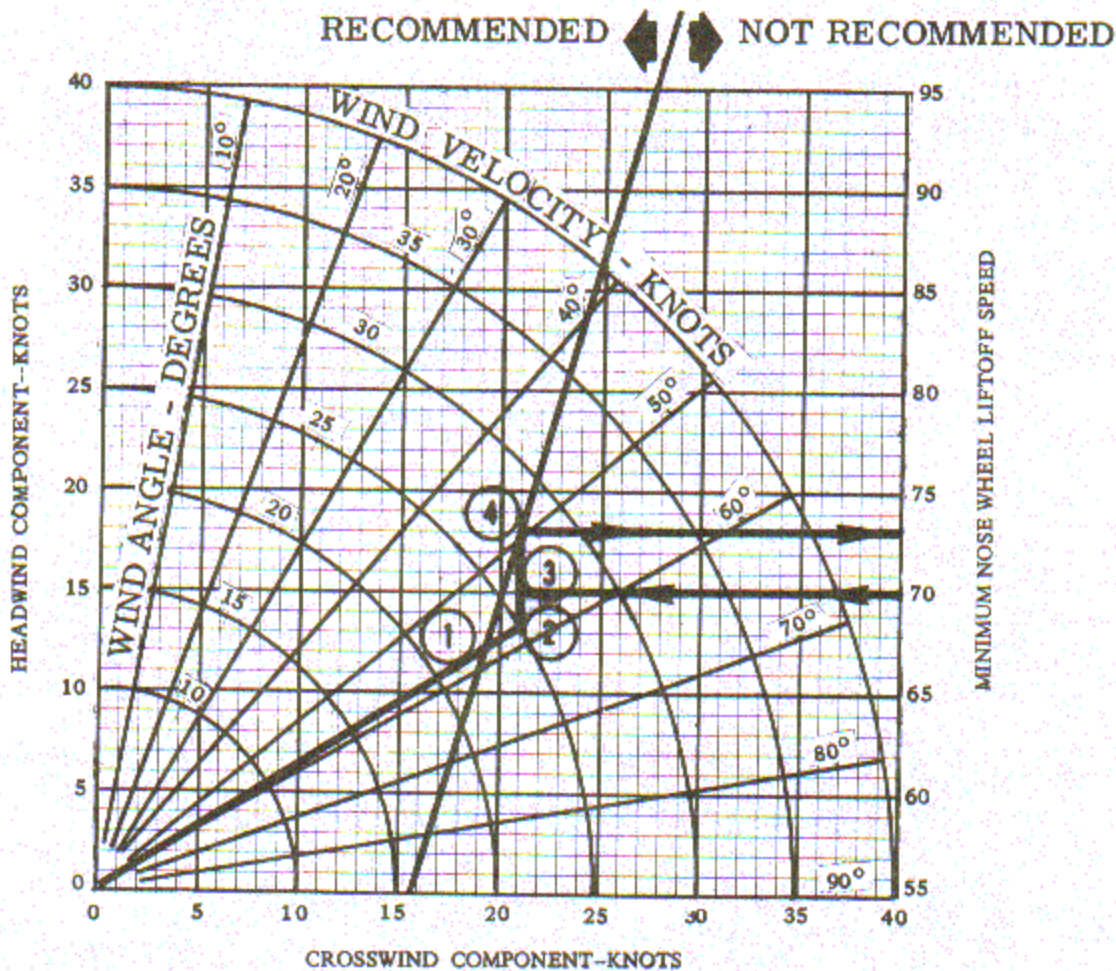

Figure 3-2. Obstacle Clearance Takeoff (Sheet 2 of 2)

MODEL T-34B

TAKEOFF CROSSWIND CHART

ENGINE: (1)
NO. 0-470-4



SAMPLE PROBLEM:

KNOWN:
TAKEOFF RUNWAY - 2
WIND - 078°/25 KNOTS

DETERMINE:
IF TAKEOFF IS RECOMMENDED AT
TAKEOFF SPEED OF 70 KNOTS IAS.

NOTE

- MAXIMUM NOSEWHEEL LIFT-OFF SPEED IS 90 KNOTS IAS.
- ENTER CHART AT MAXIMUM GUST VELOCITY.

SOLUTION:

- ① WIND ANGLE IS $78^\circ - 20^\circ = 58^\circ$ WIND ANGLE TO RUNWAY HEADING.
- ② AT WIND VELOCITY OF 25 KNOTS AND 58° WIND ANGLE TO RUNWAY HEADING, FIND CROSSWIND COMPONENT OF 21 KNOTS AND HEADWIND COMPONENT OF 13 KNOTS.
- ③ PROCEED VERTICALLY TO PREDICTED TAKEOFF SPEED OF 70 KNOTS IAS AND DETERMINE TAKEOFF AS NOT RECOMMENDED.
- ④ CONTINUE VERTICALLY AND DETERMINE THAT TAKEOFF SPEED MUST BE 73 KNOTS IAS BEFORE TAKEOFF IS RECOMMENDED.

DATA BASED ON: FLIGHT TEST

FUEL GRADE: 80/87
FUEL DENSITY: 6 LB/GAL

Figure 3-3. Takeoff Crosswind Chart

NORMAL DESCENTS.

Normal descents are made at 90 knots with power off or 120 knots using 13 inches MAP. During prolonged power-off descents, the engine should be cleared at least every 500 feet. Clearing the engine has a twofold purpose:

1. To keep cylinder head temperatures within the normal operating range.
2. To prevent the engine from becoming "loaded up".

Note

The throttle should be applied smoothly and evenly during the clearing process to prevent "killing" the engine due to an over-rich condition.

ACROBATIC CRUISE.

Acrobatic cruise is flown at 2,400 rpm, with manifold pressure as necessary to maintain 130 knots (approximately 23 inches).

FORMATION.

The fundamentals of formation flying are not described in this manual. It is imperative, however, that each aviator be briefed on his particular part in the flight.

NORMAL BREAK ENTRY.

Approach the break in a wings-level attitude with 120 knots. At the break, roll into a 30-degree bank and close throttle, lower wheels at 110 knots; adjust turn to roll out with a wing-tip distance from landing runway. Add power, as necessary, to maintain 90 knots. On downwind leg, complete Landing Checklist prior to reaching 180 degrees position.

Note

The horn silencing button should not be activated when the aircraft is in the landing pattern.

LANDING CHECKLIST.

1. Fuel boost pump — ON.
2. Alt air — IN.
3. Mixture — RICH.

4. Harness — LOCKED.
5. Landing gear — DOWN.
6. Flaps — AS REQUIRED.
7. Propeller — FULL INCREASE.

LANDINGS.**FULL-FLAP LANDING.**

This approach is designed for an optimum altitude of 1,000 feet actual altitude; therefore, any deviation from this altitude will require minor changes in power settings and attitudes throughout the approach. See figure 3-4 for Typical Landing Pattern.

Just prior to reaching a position abeam the point of intended landing, reduce throttle as necessary, lower full flaps, and slow to 80 knots. When abeam the point of intended landing, start approach and reduce throttle as necessary to make an oval or rectangular approach pattern over the ground to intercept the landing line with 600-800 feet of straightaway and 100-125 feet of altitude and 70 knots. At an altitude of 5 to 10 feet, smoothly reduce throttle as necessary and assume landing attitude.

TOUCH AND GO-LANDINGS.

After touchdown, take off in normal manner, climbing out at 70 knots. At 200 feet actual altitude, raise flaps and establish an 80-knot climb. At 250 feet actual altitude, turn to the downwind leg.

NO-FLAP LANDING.

This approach is very similar to the full-flap landing with the following exceptions: Maintain 85 knots during the initial part of the approach, rolling out on final with 80 knots airspeed. Touch-and-go climbout is made at 80 knots.

LANDING ROLL.

Use rudder for directional control. Take advantage of runway length to save brakes. The preferred use of brakes is short, intermittent applications to improve deceleration and extend brake life.

MINIMUM RUN LANDING.

Touch down at the lowest safe speed to shorten the landing roll. Since this is a maximum performance maneuver with the aircraft barely above stalling speed, care must be exercised in handling of the flight controls. Abrupt stick movements could cause a stall and allowing

NEW

NEW

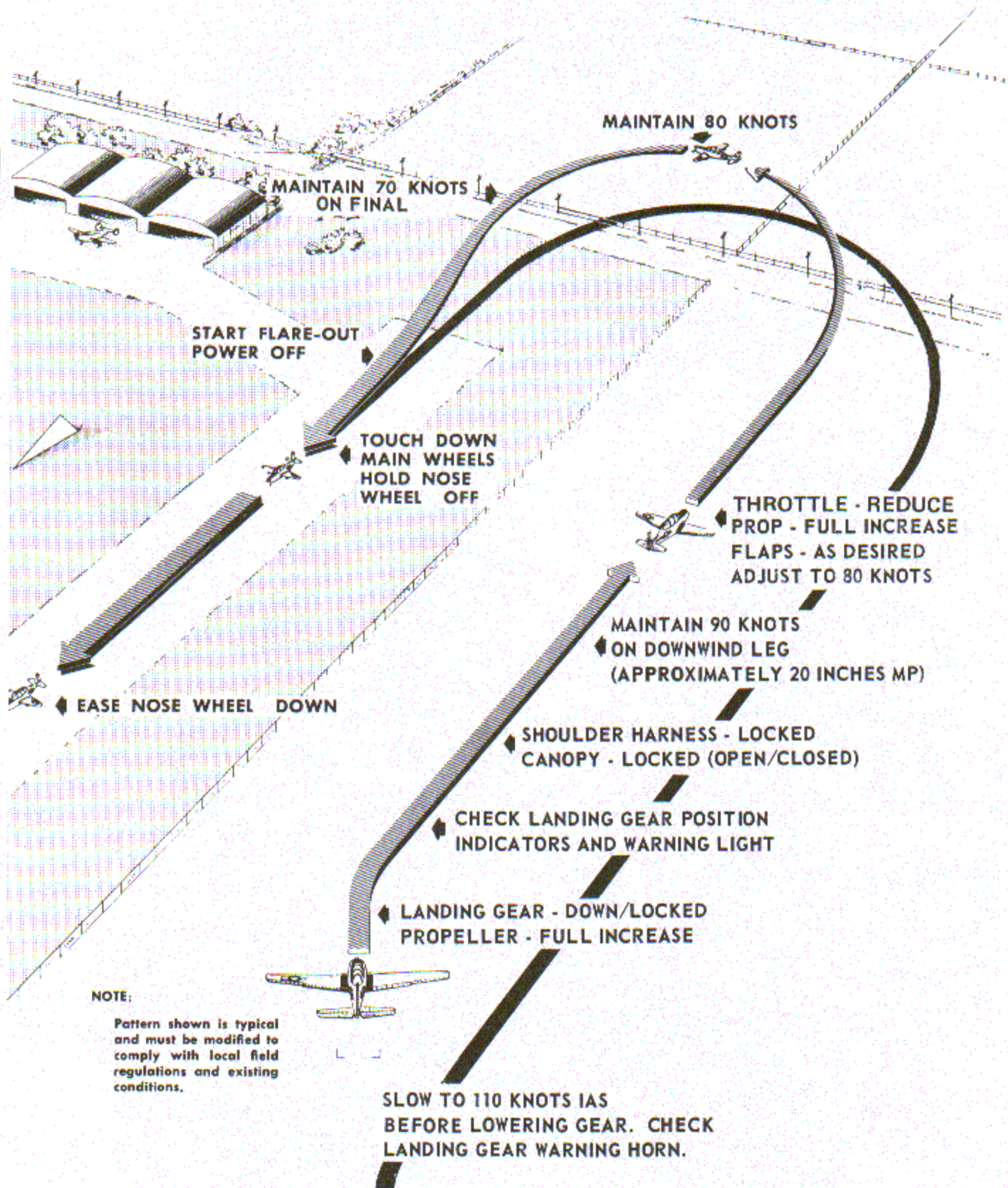

Figure 3-4. Typical Full-Flap Landing Pattern

the aircraft to yaw will increase the tendency to roll with the stall. Execute a minimum run landing as follows:

1. After turn onto final approach, flaps — DOWN.
2. Slow aircraft to 50 knots and control rate of descent with power.
3. Plan to land as short as possible.
4. Keep power on until touchdown since slower flying speed is possible only with power.
5. Close throttle immediately at touchdown, lower nose wheel smoothly to runway, and apply brakes.

Note

Do not use brakes before letting nose wheel down; doing so can cause nose gear damage.

CROSSWIND LANDING.

Landing in a crosswind presents no special problems. See figure 3-5 for crosswind landing data.

LANDING ON UNPREPARED SURFACES.

When landing on unprepared surfaces, touch down as smoothly as possible to minimize shock loads on the landing gear. Avoid the use of full flaps on loose gravel to prevent damage to the flaps by particles thrown up by the wheels. Do not use hard braking, as it tends to dig the nose wheel into the ground. Observe the additional precautions listed in After Landing, in this section.

WAVEOFF.

Make the decision to go around as early as possible in the landing approach to provide a safe margin of airspeed and altitude. The waveoff is a normal maneuver and does not become an emergency procedure unless it is started too late.

1. Smoothly add full power.
2. Level wings.
3. Establish a positive rate of climb.
4. Gear — AS REQUIRED.
5. Flaps — UP WHEN SPEED AND ALTITUDE ATTAINED.

NEW
NEW
NEW
NEW
NEW

AFTER LANDING.

After landing roll, clear the runway expeditiously. If landing is made on unprepared runway, observe the following additional precautions and ensure that landing lights and transponder are off.

1. Retract flaps as soon as nose wheel touches down, if practical, to reduce possibility of damage to flaps.
2. Use caution when taxiing over uneven or soft terrain. Avoid severe bumps or hard braking. Use a minimum of throttle in loose gravel or sand.

SECURE CHECKLIST.

Park the aircraft with the nose wheel straight and make the following checks:

1. Throttle — 800-1,000 RPM.
2. Flaps — UP.
3. Radios — OFF.
4. Inverters — OFF.
5. Engine instruments — WITHIN LIMITS/TEMPS STABILIZED.
6. Throttle — CLOSED (check idle rpm 600-750).
7. Ignition — GROUND-CHECK.
8. Fuel boost pump switch — OFF.
9. Mixture — IDLE CUTOFF.

Note

If engine should fail to stop when mixture is moved to IDLE CUTOFF, leave ignition at BOTH, open throttle slightly, and turn fuel shutoff valve handle OFF; then proceed with step 11.

After propeller stops:

10. Fuel shutoff valve handle — OFF.
11. Ignition — OFF.
12. Lights — OFF.
13. Battery — OFF.

LANDING CROSSWIND CHART

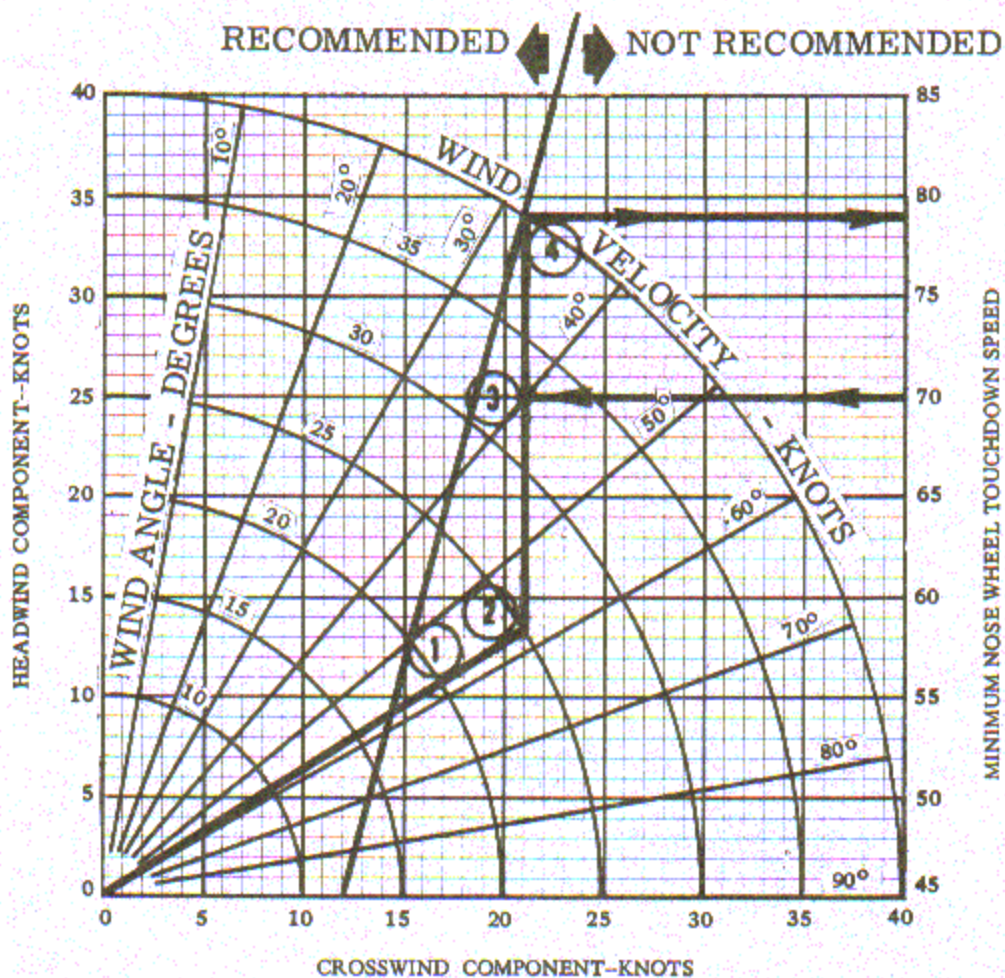

SAMPLE PROBLEM:

KNOWN:

LANDING RUNWAY - 2
WIND - 078°/25 KNOTS

DETERMINE:

IF LANDING IS RECOMMENDED AT
LANDING SPEED OF 70 KNOTS IAS.

NOTE

- MAXIMUM NOSEWHEEL TOUCHDOWN SPEED IS 90 KNOTS IAS.
- ENTER CHART AT MAXIMUM GUST VELOCITY.

SOLUTION:

- ① WIND ANGLE IS $78^\circ - 20^\circ = 58^\circ$ WIND ANGLE TO RUNWAY HEADING.
- ② AT WIND VELOCITY OF 25 KNOTS AND 58° WIND ANGLE TO RUNWAY HEADING, FIND CROSSWIND COMPONENT OF 21 KNOTS AND HEADWIND COMPONENT OF 13 KNOTS.
- ③ PROCEED VERTICALLY TO PREDICTED LANDING SPEED OF 70 KNOTS IAS AND DETERMINE LANDING AS NOT RECOMMENDED.
- ④ CONTINUE VERTICALLY AND DETERMINE THAT LANDING SPEED MUST BE 79 KNOTS IAS BEFORE LANDING IS RECOMMENDED.

DATA BASED ON: FLIGHT TEST

FUEL GRADE: 80/87
FUEL DENSITY: 6 LB/GAL

Figure 3-5. Landing Crosswind Chart

BEFORE LEAVING AIRCRAFT.

1. Flight controls — LOCKED.
2. Wheels — CHOCKED.
3. Parking brake — RELEASED.
4. Canopy — CLOSED.

POSTFLIGHT EXTERNAL INSPECTION.

A postflight inspection should be made by the pilot following each flight. This inspection is a general visual inspection of the landing gear, wings, control surfaces,

fuselage, propeller, tail assembly, and engine compartment to discover any discrepancies not previously noted.

DISCREPANCY REPORTING.

Immediately following each flight, the pilot shall complete all items on the Aircraft Yellow Sheet, noting each discrepancy in detail. To aid in discrepancy analysis, specific information such as position of controls, movement of controls and results, instrument readings, etc., should be reported on the yellow sheet. Maintenance troubleshooters should be available for consultation. The pilot will ensure that he has conveyed his complete knowledge of the discrepancy both orally and in writing.

PART 2 — CARRIER-BASED PROCEDURES

(NOT APPLICABLE TO THIS AIRCRAFT)

PART 3 — FUNCTIONAL CHECKFLIGHT PROCEDURES

GENERAL.

CHECKFLIGHT CREW.

The checkflight crew shall consist of a qualified check pilot and a qualified crew member as deemed necessary by the Maintenance Officer or higher authority.

CREWMEMBERS.

Crewmembers on checkflights shall be qualified to perform prescribed tests including the test to determine the presence of carbon monoxide contamination.

CHECK PILOT.

Pilots performing checkflights shall have the following qualifications:

1. Be NATOPS qualified in T-34B aircraft.
2. Be designated in writing by the Commanding Officer as qualified to perform checkflights.

CHECKFLIGHTS AND FORMS.

Checkflights will be performed when directed by, and in accordance with OPNAVINST 4709.2 series and the directions of NAVAIRSYSCOM Type Commanders, or other appropriate authority. Functional checkflight requirements and applicable minimums are described below. Functional checkflight checklists are promulgated separately.

CONDITIONS REQUIRING FUNCTIONAL CHECKFLIGHTS.

Checkflights are required under the following conditions (after the necessary ground check and prior to release of the aircraft for operational use):

- A — After the completion of calendar inspection, aircraft rework, or when the aircraft has not flown for a period of 30 days, the minimum checks required are prefixed by letter A.
- B — After the installation of a new or overhauled engine, the minimum checks required are prefixed by letter B.

C — After the installation or reinstallation of a propeller, propeller governor, or fuel control, the minimum checks required are prefixed by the letter C.

D — After installation of a new or overhauled cylinder or reinstallation of an engine, the minimum checks required are prefixed by letter D.

E — After rigging or installation of primary controls or fixed flight surfaces, the minimum checks required are prefixed by letter E.

F — Installation or reinstallation of an engine exhaust system or anytime carbon monoxide is suspected, a carbon monoxide check will be performed in accordance with applicable instructions. The minimum checks required are prefixed by letter F.

The determination that a checkflight is required under circumstances other than those specified above is to be made by the Maintenance Officer, based on the scope of the maintenance accomplished and the effect on maintenance, safety and reliability of operations. When training or other operational commitments require, combined operational and checkflights may be made, provided all requirements of the checkflight are satisfactorily completed before commencing the operational portion.

PROCEDURES.

NATOPS procedures will apply during the entire checkflight unless specific deviation is required by the functional check to record data or ensure proper operation within the approved aircraft envelope. A daily inspection is required prior to the checkflight.

The following items provide a detailed description of the functional checks sequenced in the order in which they should be performed. In order to complete the required checks in the most efficient and logical order, a flight profile has been established for each checkflight condition and identified by the letter corresponding to the purpose for which the checkflight is being flown; i.e., A through F above. The applicable letter identifying the profile, prefixes each check both in the following text and in the Functional Checkflight Checklist. Checkflight personnel will familiarize themselves with these requirements prior to the flight.

PROFILE

A

A

A

AB D F

PRETAKEOFF.

1. Brakes.
At 1,400 rpm, apply and release pressure on brakes until firm positive response is attained, then reduce power.
2. Magnetic Compass.
Checked for proper indication and freedom of movement.
3. Turn and Bank Indicator.
Check that needle moves in direction of turn and ball is free.
4. Carbon Monoxide Contamination Check.
At 1,400 rpm with canopy closed, perform carbon monoxide check using heat full on, then again with heat turned off. Air samples shall be taken at the heater outlets and at face level.

If carbon monoxide contamination is suspected proceed as follows:
 - a. Canopy — OPEN.
 - b. Cockpit air handle — PULL OUT.
 - c. Cockpit hot air handle — PULL OUT.

WARNING

When carbon monoxide contamination is suspected, or the presence of exhaust fumes is noted in the cockpit at any time during the flight, the flight should be terminated as soon as practicable.

ENGINE RUNUP.

When oil temperature has reached 40°C and cylinder head temperature 107°C commence engine runup.

ABCD

5. Propeller.
 - a. Place prop lever forward.
 - b. Set rpm at 1,800 with throttle.
 - c. Exercise prop lever a minimum of six times.
 - d. Upon last movement, retard prop lever to detent and rpm should stabilize between 1,600 and 1,650 rpm.

ABCD

6. Positive High Pitch Check.
 - a. Place prop lever forward.
 - b. Set rpm at 1,800 with throttle.
 - c. Retard prop lever to detent.
 - d. Momentarily move prop lever around detent to check that prop governor will stabilize at approximately 1,450 rpm before prop continues to positive high pitch.

Note

Return prop lever to low pitch (full forward) as soon as possible to minimize lugging of engine.

ABCD

7. Magneto Check.
 - a. Place prop lever forward.
 - b. Set rpm at 2,000 with throttle.
 - c. Perform magneto check, maximum drop 100 rpm, maximum split 50 rpm.

PROFILE

ABCD

8. Alternate Air Check.
 - a. Set rpm at 2,000 with throttle.
 - b. Alternate air handle full out (hot)
 - c. Check for approximately 1/2 inch drop in manifold pressure
 - d. Alternate air handle full in (cold).

ABCD

9. Full Power.
 - a. Apply brakes.
 - b. Apply full power; rpm should reach 2,475 \pm 75 rpm.

ABCD

10. Emergency Fuel System.
 - a. Place mixture in IDLE CUTOFF.
 - b. Actuate emergency fuel switch.
 - c. Place mixture in FULL RICH.
 - d. Place emergency fuel switch to OFF.
 - e. Crewman in rear cockpit will repeat steps a through d.

Note

The emergency fuel system cannot be adequately checked unless the engine stops prior to activation of emergency system.

ABCD

11. Fuel Boost Pump.
 - a. Place prop lever full forward.
 - b. Set rpm at 1,700 and set front cockpit fuel boost switch to OFF and crewmember will set the rear cockpit fuel boost pump switch to ON.
 - c. Check for fluctuation in pressure.
 - d. Set rear cockpit fuel boost pump switch to OFF and front cockpit fuel boost pump switch to ON.

ABCD

12. Cruise Metering.
 - a. Set alternate air IN.
 - b. Set mixture to RICH.
 - c. Set propeller to full INCREASE (Low pitch).
 - d. Set throttle to 1,700 rpm.
 - e. Retard mixture control and check for 0-40 rise.

Note

The best power indication can be noted when there is no increase in rpm and the rpm does not follow initial mixture control movement. If the rpm increase exceeds 40 rpm, the fuel control is metering too rich and the aircraft should be downed. A rich operating fuel control is not detrimental to engine life; however, it can cause a loss of power. An rpm drop in unison with initial mixture control movement is an indication of a lean fuel control. A fuel control metering lean should be changed. The RS-5BD-1 fuel injector system does not come equipped with a fuel primer and the above indications may be considered reliable only if the mixture control is rigged properly.

PROFILE

ABCD

13. Mixture.
 - a. Conduct mixture check at idle rpm.
 - b. Move mixture control to IDLE CUTOFF with a smooth steady movement and observe a 5-10 rpm rise.

TAKEOFF.

A

14. Landing Gear Retraction.
Landing gear should retract in 7-9 seconds (12 max.).

CAUTION

The landing gear will normally retract in 7 to 9 seconds, with 12 seconds being the maximum. An excessive retraction time could be an indication of an impending gear motor failure or an electrical system malfunction.

ABCD

15. Engine Performance.
Record instruments indications during takeoff:
 - a. Rpm 2,600.
 - b. Manifold pressure.
 - c. Oil temperature 40°C to 107°C.
 - d. Cylinder head temperature 107°C to 240°C.
 - e. Fuel pressure 15 to 20 psi.
 - f. Oil pressure 30 to 80 psi.
 - g. Indicated airspeed.

Note

During takeoff and climb out, particular attention should be given to the rpm. It is often necessary to control the prop manually to maintain rpm below 2,630 during the first few minutes of a check flight on aircraft just out of check or prop system maintenance. The fuel caps should also be checked for streaming fuel immediately after takeoff.

CLIMB.

Profile ABCDE — 4,500 Feet; Profile F — 2,500 Feet. For Profile B, climb 2,400 rpm, 25 inches MAP.

AB D F

16. Carbon Monoxide Check.
Perform carbon monoxide check while climbing at full power with canopy closed.
 - a. Perform check with heat full on.
 - b. Perform check with heat off.

ABCD

17. Record following during climb between 3,000 and 4,500 feet:
 - a. Engine rpm.
 - b. Manifold pressure.
 - c. Oil temperature.

PROFILE

- d. Cylinder head temperature.
- e. Fuel pressure.
- f. Oil pressure.
- g. Voltmeter.
- h. Indicated airspeed.

A E

18. Trim Check.
- a. Continue climb to 4,500 feet.
 - b. Observe aerodynamic characteristics and necessary rudder trim for 100-knot climb.

A E

19. Flap Operation.
- Lower flaps to check for proper actuation and indications.

A

20. Emergency Landing Gear Operation.
- a. Pull out landing gear circuit breaker.
 - b. Place landing gear handle down.
 - c. Unlock clutch knob.
 - d. Push knob down to engage hand crank.
 - e. Crank gear down approximately 37 turns until handle cannot be moved further.
 - f. Disengage hand crank.
 - g. Push circuit breaker in.
 - h. Raise gear normally.

A

21. Landing Gear Operation and Limit Switches
- a. Lower gear normally.
 - b. Pull landing gear circuit breaker.
 - c. Engage emergency gear clutch and rotate handle in direction of gear movement.
 - d. Check for 1/8 to 1/4 rotation of handle.
 - e. Disengage clutch.
 - f. Push in landing gear circuit breaker.
 - g. Raise gear and repeat steps b through f.

LEVEL 4500 FEET.

B

22. Engine Run-In.
- After takeoff, reduce power to 2,400 rpm and 25 inches MAP and climb to 4,000 feet or above (step climb if necessary). Follow steps in item 22 (A-O) in the Functional Check Flight Checklist (FCFC) and adhere strictly to engine settings and time limits. The checkflight will be flown for a minimum of one hour and care should be taken to ensure that temperatures and pressures remain within normal limits. The engine controls should be moved smoothly, keeping a constant watch for any unusual indications on the engine instruments.

A E

23. Trim Check.
- a. Place aircraft in dirty configuration.
 - b. Check rudder trim for slow flight, 6 to 12 degrees right rudder.

A E

24. Dirty Stall.
- a. Close throttle.
 - b. Check aircraft for stalling speed, 49 ± 3 knots.

PROFILE

A E

25. Clean Stall.
Clean stall at or above 4,500 feet.
- Place aircraft in clean configuration and rudder trim set at 0-degree.
 - Perform clean stall, noting stall airspeed 59 ± 3 knots.

A E

26. Spins.
- Enter a normal spin to the left. Recover after the completion of two turns.
 - Check aerodynamic characteristics during spin and recovery.
 - Upon recovery, ensure oil pressure is within limits, then apply throttle smoothly and slowly while observing rpm for proper governor operations
 - Climb to a minimum of 4,500 feet AGL and repeat a through c for a normal spin to the right.

A E

27. Airspeed Check.
- Perform wing-over to a descent, noting airspeed through range from 70 to 170 knots.
 - Compare front and rear cockpit airspeed indications at 10-knot increments. Tolerances throughout range are ± 4 knots.

A

28. Landing Gear Up Lock Check.
- At 170 knots, commence 3-G loop and check rpm stability.
 - Gear indicators for up and locked indications.
 - Aerodynamic reaction of control surfaces.

AB D

29. Oil Tank Pickup.
- Roll to the right and hold a negative g inverted attitude for 3 to 5 seconds to check for proper operation of oil tank pickup.
 - Close the throttle to prevent blowing seals and excessive dumping of oil, then continue roll to the right to the normal attitude.
 - Maintain normal attitude for a minimum of 30 seconds to completely scavenge engine.
 - Repeat a through c, rolling to the left.

CAUTION

Observe rpm and oil pressure during inverted flight. If oil pressure is lost, retard throttle and roll upright. Ensure that oil pressure is at operating pressure prior to applying full throttle.

ABCD

30. Emergency Fuel System.
Full power and boost pump on.
- Place mixture in IDLE CUTOFF.
 - Actuate emergency fuel switch.
 - Place emergency fuel switch OFF.
 - Place mixture in FULL RICH.

PROFILE

ABCD

DESCENT.

31. Engine Performance Descent Check.
Perform a 90-knot, 2,000-foot, throttle off letdown.
- Set throttle at idle.
 - Place prop in positive high pitch (low rpm) and check for rpm stability between 600-800 rpm.
 - Return prop to full increase.
 - At completion of letdown, apply full throttle smoothly.

CAUTION

The power off descent will be terminated any time the CHT decreases to 107°C.

LEVEL 2500 NORMAL CRUISE.

AB D F

32. Carbon Monoxide Check.
- Check with heat full on.
 - Check with heat turned off.

ABCD

33. Propeller Vibration Check.
Cycle prop between 2,000 rpm and 2,400 rpm.

A E

34. Trim Check.
- Observe aerodynamic characteristics.
 - Zero degree rudder trim is ideal for balanced flight in normal cruise.

ABCD

35. Instrument Indication.
Record the following instrument indications at normal cruise.
- Engine rpm.
 - Manifold pressure.
 - Oil temperature
 - Cylinder head temperature.
 - Fuel pressure.
 - Oil pressure.
 - Voltmeter.
 - Indicated airspeed.

A

36. Fuel Quantity Gage.
Check for even fuel flow between tanks, split of 10 gallons maximum allowed.

AB D

37. Landing Gear Horn and Light Check.
Check Landing gear warning horn and light 18 to 12 inches MAP.

A E

38. Flight Instruments.
- Check attitude gyros for proper operation.
 - Check directional indicators for proper operation.
 - Check vertical speed indicators for proper operation.

A

39. Navigation Instruments.
- Check VOR equipment.
 - Check AIMS equipment.

PROFILE

A

ABCD

ABCD

AB D

ABCDE

POST LANDING.

- 40. Brakes.
- 41. Idle rpm (Record)
- 42. Idle Mixture Check (Record).
- 43. Ignition Ground Check.

AFTER FLIGHT.

- 44. Conduct Postflight Inspection:
 - a. Check G-meter reading.
 - b. Excessive oil leaks.
 - c. Fuel leaks.
 - d. Control and flight surfaces, for distortion, popped rivets or other indications of over stress.

SECTION IV — FLIGHT CHARACTERISTICS

TABLE OF CONTENTS

General Flight Characteristics	4-1	Flight Control	4-3
Stall Characteristics	4-1	Maneuvering Flight	4-3
Practice Stall Maneuvers	4-1	Acrobatics	4-3
Spins	4-2	Aircraft Idiosyncrasies	4-4

GENERAL FLIGHT CHARACTERISTICS.

The aircraft has excellent stability and handling characteristics and high maneuverability. When properly trimmed, it tends to maintain straight and level flight. Controls are effective throughout the speed range from stall to maximum diving speed.

STALL CHARACTERISTICS.

Stalls in this aircraft (figure 4-1) are characterized by an exceptionally clean break and extremely rapid recovery. It is difficult to stall the aircraft accidentally, except as the result of acceleration, since the stall attitude is very steep. Very little aerodynamic warning precedes the stall and the best indications of an approaching stall condition are attitude, airspeed, and rapid increase in control sloppiness. The stall itself is characterized by an immediate pitch-down. If the aircraft is allowed to yaw, a roll will develop which may continue up to 30 to 40 degrees and then stop. This roll is easily corrected with coordinated control during recovery. Position of the landing gear has little or no effect on stall characteristics.

PRACTICE STALL MANEUVERS.

The stall checklist will be performed prior to any practice stall maneuver, as follows:

1. Fuel boost pump — ON.
2. Harness — TIGHT AND LOCKED.
3. Propeller — FULL INCREASE.

4. Canopy — CLOSED AND LOCKED.

5. Directional indicator — CAGED.

6. Loose gear — STOWED.

Clearing turns will be performed prior to any stall, spin, or acrobatic maneuver. Clearing turns shall consist of at least two 90-degree turns or one 180-degree turn using a 45-degree angle of bank clean or 30-degree angle of bank dirty. The last turn should be made in the same direction in which the maneuver is to be performed. Minimum altitude for recovery from any stall maneuver is 3,000 feet AGL.

POWER-ON STALLS.

As the aircraft decelerates, right rudder must be added to counteract torque and maintain straight flight. Yaw present at the break of the stall will cause the aircraft to roll. This roll is most pronounced with flaps down. After the nose drops through the horizon, rudder and aileron are both effective in returning the wings to level.

POWER-OFF STALLS.

With power off, the stall occurs at slightly higher airspeed than with power on. Stall characteristics are not materially affected, except there is less tendency for a roll to develop should the aircraft be allowed to yaw. With gear and flaps down (landing configuration), buffet occurs at 2 or 3 knots above stalling speed.

KNOTS

GROSS WEIGHT LB.	POWER ON (MAX. CONTINUOUS POWER)				POWER OFF (WINDMILLING PROP)			
	LEVEL	DEGREE OF BANK			LEVEL	DEGREE OF BANK		
		15°	30°	45°		15°	30°	45°
2775	52	53	56	62	56	57	60	67
2900	53	54	57	63	57	58	61	68
2975	54	55	58	64	58	59	62	69
3050	55	56	59	65	59	60	63	70



GEAR & FLAPS UP

GROSS WEIGHT LB.	POWER ON (APPROACH POWER)				POWER OFF (WINDMILLING PROP)			
	LEVEL	DEGREE OF BANK			LEVEL	DEGREE OF BANK		
		15°	30°	45°		15°	30°	45°
2775	44	45	47	52	47	48	51	56
2900	45	46	48	54	48	49	52	57
2975	46	47	49	55	49	50	53	58
3050	47	48	50	56	50	51	54	59

GEAR & FLAPS DOWN
100% FLAPS

30-DEGREE FLAPS

Figure 4-1. Indicated Stalling Speeds

STALL RECOVERY (NORMAL).

Altitude permitting, stall recovery will normally be made as follows:

1. Release back pressure on stick immediately and smoothly advance throttle.
2. Roll wings level and return to level flight. Avoid pulling back too severely, as a secondary stall or excessive g-loads may result.
3. When level flight is resumed, reduce throttle to cruising power.

STALL RECOVERY (LOW ALTITUDE).

Low altitude stall recovery differs from normal recovery as follows:

1. Use power to hold the altitude loss to a minimum. The nose of the aircraft should be allowed to drop only slightly below the horizon.
2. Use coordinated aileron and rudder to roll the wings level and return to level flight as rapidly as possible.
3. When control is regained, establish climb.

SKIDDED TURN STALL.

The skidded turn stall (right or left) in this aircraft is characterized by an extremely fast stall unaccompanied by the usual prestall indications. The post stall

characteristics generally carry the aircraft through 90 to 360 degrees of roll depending on entry configuration, air speed, and the amount of control pressure applied. The high rate of roll is also accompanied by an extreme loss of altitude with the possibility of disorientation. An immediate execution of recovery procedures is necessary due to the rapidity of the stall/post stall sequence and the potential for an extreme loss of altitude. Stall recovery will be made as follows:

1. Immediately apply full throttle while neutralizing the controls.
2. Roll the aircraft in the shortest direction to the level flight altitude.
3. Raise the nose to stop the loss of altitude.

WARNING

Failure to neutralize the controls prior to an attempt to stop the roll may result in a secondary stall and roll in the opposite direction.

SPINS.

The spin characteristics of the aircraft depend largely on the abruptness of entry, attitude, speed, and power at the moment of entry. In general, normal spins are characterized by a very definite forward force on the stick with some stick buffet and moderate rudder buffet after

three turns. The aircraft completes one full turn in approximately three seconds and loses approximately 440 feet per turn. During one-half of the turn, the nose-down attitude steepens and the turn rate speeds up to one-and-one-half the average rate of turn. During the next half of the turn, the nose rises to approximately 25 degrees below the horizon and the turn rate slows down to half the average rate. This cycle increases in intensity during the first three or four turns and continues throughout the spin. Recovery can be effected at any point in the cycle. Spins with gear and flaps down are considerably milder, with a slower rotation rate, however, altitude loss is approximately 560 feet per turn.

Spins can be initiated out of any stall by holding full back stick and full rudder in the desired direction of rotation. If the spin is entered from a power-on stall condition, close the throttle immediately on entering the spin. Spin characteristics are not greatly aggravated by power, but airspeed during the spin and recovery will be considerably higher with excessive loss of altitude. All practice spins should be started at altitudes which will permit recovery 3,000 feet above the ground. During a two-turn spin and recovery, using a constant 4g pullout, altitude loss will be approximately 1,000 to 1,500 feet. Allow 500 feet more altitude for each additional turn.

WARNING

Do not enter a spin below 4,500 feet AGL. Recover after a maximum of two turns in any spin.

SPIN RECOVERY.

Recovery from normal spins is effected most rapidly if started at the beginning of the steep half of the turn. Recovery is equally positive in the shallow portion, but is somewhat slower. All that is necessary in a spin recovery is to release the flight controls, and the aircraft immediately recovers in a nose-down attitude at normal CG loadings. Normal spin recovery should be practiced as follows:

1. Apply opposite rudder to the neutral position followed by forward stick to the neutral position.
2. When the rotation stops, level the wings. The aircraft will be in a 60 to 80 degree dive. Start a pullout immediately to keep the altitude loss to a minimum, but avoid entering an accelerated stall.
3. With gear and flaps down, make pullout tight enough to keep from exceeding 100 knots IAS.

INVERTED SPINS.

No adverse characteristics are encountered in inverted spins. The aircraft must be held in the spin with full forward stick and full rudder into the spin. Acceleration during the spin varies between 2.1g's negative and 3.8g's positive. The spin will not normally continue more than 1 to 1-1/2 turns, after which it tends to deteriorate into a high-speed spiral. Recovery can be made from either the spin or the spiral by neutralizing the controls and rolling out the resulting inverted dive.

Note

The oil pressure gage should always be checked before adding power when recovering from a spin or an inverted maneuver.

FLIGHT CONTROL.

Control forces are moderate to light and response is positive. Elevator and rudder control forces are very light and the aircraft is very sensitive to movement of these controls. Rudder feel is enhanced by the use of an anti-servo trim tab, which increases rudder pedal forces proportionate to the displacement of the rudder from neutral. Elevator tabs are conventional, their position being determined only by adjustment from the cockpit. Aileron forces are reduced by servo trim tabs and, although the aircraft is sensitive to aileron deflection and has a very high rate of roll, aileron stick forces remain high to provide excellent feel. Only very slight trim tab adjustment is needed for changes caused by landing gear position, fuel quantity, or canopy position in the normal operating speed range, and the aircraft can be trimmed for "hands-off" flight down to 70 knots IAS.

MANEUVERING FLIGHT.

The relatively light elevator and rudder forces and rapid response of the aircraft to control movement provide excellent acrobatic characteristics. Due to the light elevator forces, it is not recommended that the elevators be trimmed to reduce stick forces during maneuvers, as only slight additional stick forces would then be required to exceed the acceleration limits. The aircraft is relatively clean and picks up speed rapidly with the nose down. Light rudder forces permit holding the aircraft straight in a dive without rudder trim.

ACROBATICS.

Acrobatics are basically the same for all aircraft with the exception of power settings and airspeeds; therefore, they are not discussed in detail. Power settings and airspeed are contained in figure 4-2.

	ENTRY AIRSPEED	RECOVERY AIRSPEED
WINGOVER	130 knots IAS. Airspeed should be 70 knots IAS after completing 90° of turn.	Recover 180° from original heading with 130 knots IAS.
BARREL ROLL	130 knots IAS. When inverted and after 90° of heading change, airspeed should be 60-70 knots.	Recover on original heading with 130 knots IAS.
LOOP	150 knots IAS.	150 knots IAS.
HALF CUBAN EIGHT	150 knots IAS.	Recover 180° from original heading at 150 knots IAS.
IMMELMANN	170 knots IAS.	
SPLIT-S	90 knots or less. When inverted wings level, close throttle.	Recover on opposite heading, 140 knots or less.

Figure 4-2. Acrobatic Maneuvers

ACROBATIC CHECKLIST.

Prior to performing acrobatics, complete the following:

1. Fuel boost pump — ON.
2. Harness — TIGHT AND LOCKED.
3. Propeller — 2,400 RPM.
4. Canopy — CLOSED AND LOCKED.
5. Directional indicator — CAGED.
6. Loose gear — STOWED.

Note

Complete all acrobatic maneuver recoveries above 3,000 feet AGL.

DIVING.

Care should be exercised not to exceed the limit diving airspeed and maximum engine operating speed. Observe the following precautions in long or steep dives:

1. Mixture lever — FULL RICH. Retard throttle to avoid exceeding limit dive airspeed.
2. Observe tachometer to forestall possible engine overspeed. As the aircraft picks up speed, the governor must continue increasing propeller pitch to hold a constant rpm. When the blades reach full high pitch, any increase in speed will then cause rpm to increase also, regardless of the position of the propeller lever. The propeller pitch range is sufficient to keep the rpm within limits normally at speeds up to limit diving speed; but if an overspeed should occur, reduce airspeed either by reducing throttle or pulling out of dive.

ALTITUDE LOSS IN DIVE RECOVERY.

The effect of initial altitude, dive speed, and dive angle on altitude loss during dive recovery is shown in figure 4-3.

AIRCRAFT IDIOSYNCRASIES.

The following idiosyncrasies peculiar to this aircraft are noted for the pilot's information:

1. No provision is made for pilot control of engine operating temperatures. As a result, the aircraft is very

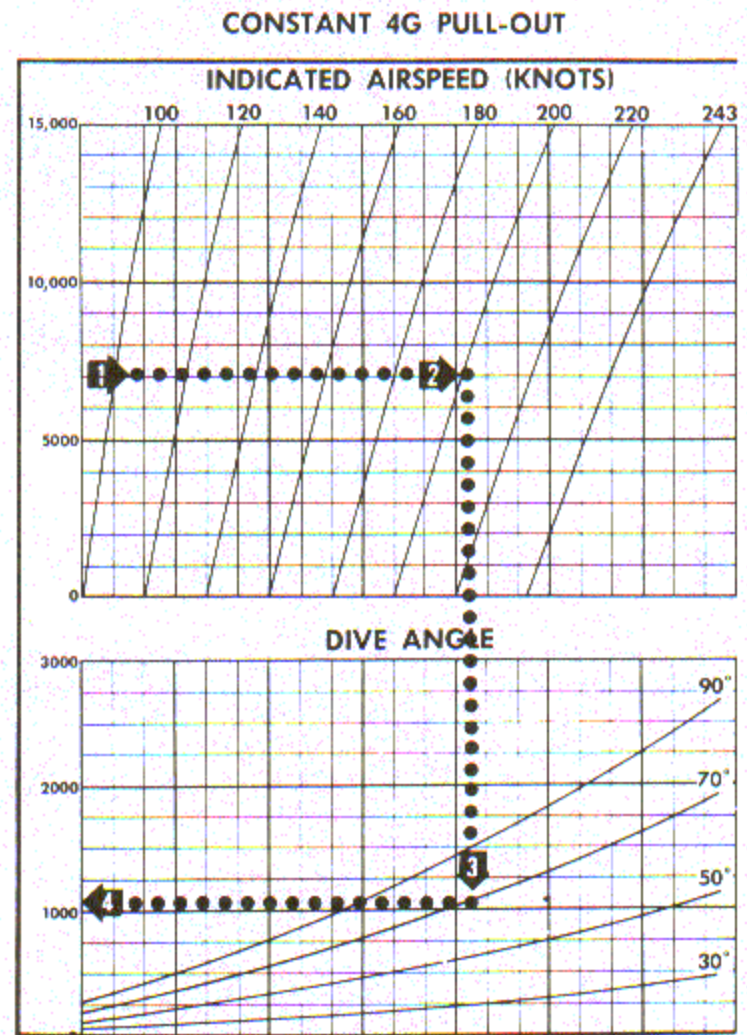
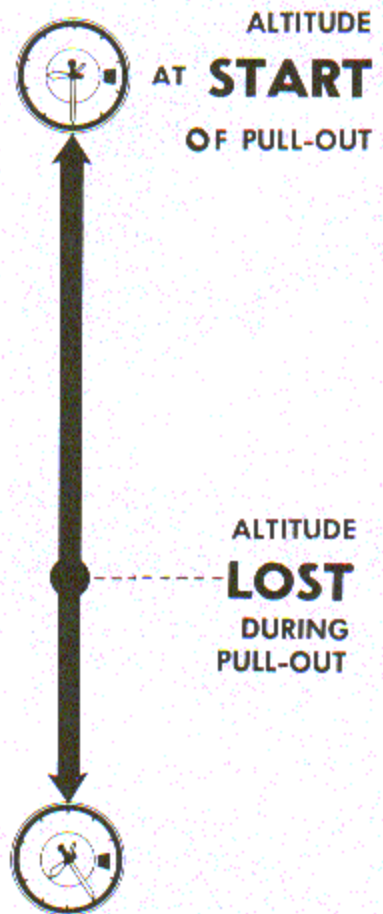

EXAMPLE USE OF CHART

- | | |
|---|--|
| <p>1 ENTER CHART AT ALTITUDE AT START OF PULL-OUT (7000 ft.).</p> <p>2 SIGHT HORIZONTALLY TO AIRSPEED AT START OF PULL-OUT (200 KNOTS).</p> | <p>3 SIGHT VERTICALLY TO DIVE ANGLE (70).</p> <p>4 SIGHT ACROSS TO READ ALTITUDE LOSS. SUBTRACT FROM INITIAL ALTITUDE TO FIND RECOVERY ALTITUDE.</p> |
|---|--|

Figure 4-3. Altitude Loss in Dive Recovery

slow to warm up to minimum temperatures. In addition, pilots must be cautious when operating the aircraft in the touch-and-go landing pattern since maximum operating temperatures can be readily exceeded.

2. Be extremely cautious when adding power immediately after aircraft has been flown in inverted flight. Oil starvation in the propeller governor is possible and a sudden application of power may result

in engine overspeed with resultant loss of propeller. Check oil pressure and add power slowly when recovering from inverted flight.

CAUTION

In order to prevent possible damage to the empennage, hammerhead stalls are prohibited.

SECTION V — EMERGENCY PROCEDURES

TABLE OF CONTENTS

INTRODUCTION	5-1	Propeller Failure	5-7
GROUND EMERGENCIES	5-1	Fuel Pump Failure	5-8
Engine Fire During Start	5-1	DC Power Failure	5-8
Engine Fire After Start	5-2	AC Power Failure	5-8
Fuel Pressure Drop — Engine		Wing Flap Emergency Operation	5-8
Operating Normally	5-2	Canopy Emergency Operation	5-8
Emergency Entrance	5-2	Lost Plane Procedures	5-8
IN-FLIGHT EMERGENCIES	5-2	Downed Aircraft	5-8
Emergency Distress		Airborne Damaged Aircraft	5-9
Radio Transmission	5-2	Bailout	5-9
Engine Failure — General	5-2	Ditching	5-9
High Altitude Engine Failure/		TAKEOFF AND LANDING	
Partial Engine Failure	5-3	EMERGENCIES	5-10
Low Altitude Engine Failure	5-5	Aborted Takeoff	5-10
Maximum Glide	5-5	Landing Gear Emergency Retraction	5-10
Propeller Operation With No		Landing Gear Emergency Extension	5-10
Power	5-5	Landing Gear Emergencies	
Engine Fire During Flight	5-5	General	5-11
Electrical Fire During Flight	5-5	Landing With Gear Up	5-11
Wing Fire During Flight	5-6	Landing With One Main Gear	
Fuselage Fire During Flight	5-7	Retracted	5-11
Smoke Elimination	5-7	Landing With Nose Gear	
Carbon Monoxide	5-7	Retracted	5-11
Fuel Pressure Drop — Engine		Flat Tire	5-12
Operating Normally	5-7	Brake Failure	5-12
Fuel Leak/Fuel Fumes	5-7	Hard Landings	5-12

INTRODUCTION.

Mechanical failures requiring emergency procedures seldom occur; however, the possibility of such a failure should never be overlooked. Every emergency that can reasonably be expected is described in this Section.

THE BEST TIME TO KNOW PROCEDURES AND THE WORST TIME TO STUDY THEM IS IN AN EMERGENCY.

Note

Procedural steps marked with an asterisk shall be committed to memory.

GROUND EMERGENCIES.

ENGINE FIRE DURING STARTING.

Note

No engine fire extinguishing system is installed on this aircraft.

During starting, engine fire can occur in the induction system or in the exhaust system. However, pilot technique is the same in combating both types. When fire occurs, keep the engine turning in an attempt to clear or start the engine, as the fire may be blown out the exhaust or drawn through the engine and extinguished.

WARNING

If fire is other than exhaust or induction fire, discontinue starting attempt and fight fire with all available fire extinguishers.

Engine fire is not readily apparent from the cockpit, since the exhaust augmentor tubes are at the underside of the fuselage. Should a fire occur during starting, leave throttle set and proceed as follows:

- *1. Mixture — IDLE CUTOFF.
- *2. Fuel shutoff valve handle — OFF.
- *3. Throttle — FULL FORWARD.
- *4. Continue cranking to clear engine, attempting a start.

If no start:

- *5. Ignition — OFF.
- *6. Battery — OFF.
- *7. ABANDON AIRCRAFT.

ENGINE FIRE AFTER STARTING.

If engine fire occurs after starting, proceed as follows:

- *1. Mixture — IDLE CUTOFF.
- *2. Fuel shutoff valve handle — OFF.
- *3. Throttle — FULL FORWARD.
- *4. Ignition — OFF.
- *5. Battery — OFF.
- *6. ABANDON AIRCRAFT.

FUEL PRESSURE DROP — ENGINE OPERATING NORMALLY.

If fuel pressure should drop below operating minimum while the engine is operating normally on the ground, shut down the engine and have a fire guard stand by. Do not take off until the cause has been determined and corrected.

EMERGENCY ENTRANCE.

To open the canopy from the outside in an emergency, pull the CANOPY OPEN EMERGENCY handle located on the right side of the fuselage and just below the forward end of the front canopy rail. Pulling this handle actuates the canopy opening system which opens both front and rear canopies simultaneously.

IN-FLIGHT EMERGENCIES.**EMERGENCY DISTRESS RADIO TRANSMISSION.**

If it becomes necessary for the pilot operating singly to make a forced landing or bailout, the following procedure will be used:

1. Transmit MAYDAY three times on guard.
2. Time permitting, broadcast the following:

Identification

Position

Altitude

Difficulty

Intentions.

3. Follow ditching or bailout procedures as outlined in this manual.

ENGINE FAILURE — GENERAL.

Engine failures fall into two main categories: those occurring instantly, and those giving ample warning. The instant failure is rare and usually occurs only if ignition or fuel flow completely fails. Failure due to carelessness or improper operating techniques is not infrequent and should be guarded against by constant attention to such items as cylinder head temperature, oil pressure, sound of the engine, manifold pressure, rpm, and by strict observance of the operating limitations described in Section I, Part 4. Since most engine failures are gradual, the alert pilot has ample indication that he may expect a failure. When indications point to an engine failure, the pilot should land immediately. The most probable cause of an engine malfunction is a problem with the fuel control. The emergency fuel system installed in the T-34B is designed to bypass the fuel control and give spontaneous full power when activated. However, if both systems are operated at the same time the engine will not function because of an overrich condition.

Note

The emergency fuel system will only be effective if the cause of the engine failure was due to a malfunction of the fuel control unit.

**HIGH ALTITUDE ENGINE FAILURE/
PARTIAL ENGINE FAILURE.**

If a total power loss should occur above 1000 feet AGL or a partial power loss should occur at any time in flight, perform the following:

- *1. Assume a safe flight attitude.
- *2. Select the best available landing area and turn to intercept the emergency landing pattern at the maximum altitude practicable. If power is available, climb to an altitude from which the aircraft can glide to a high key position. See figure 5-1.
- *3. Gear and flaps — AS DESIRED (aircraft clean will extend glide).

Perform airstart as follows:

- *4. Fuel boost pump — ON.
- *5. Fuel shutoff valve handle — ON.
- *6. Mixture — RICH.
- *7. Propeller — FULL INCREASE.
- *8. Throttle — FULL FORWARD.
- *9. Ignition — ON, BOTH.

If the engine is still not running or if altitude cannot be maintained, activate the emergency fuel system as follows:

- *10. Emergency fuel switch — ON.
- *11. Mixture — IDLE CUTOFF.

The emergency fuel system is designed for optimum operation at full power. After the engine is running at full power, it may be reduced to 25 inches MAP and 2200 rpm.

CAUTION

Do not reduce power below 25 inches MAP or 2200 rpm. Lower power settings will produce an overrich mixture, resulting in a rough-running or stalled engine.

When operating on the emergency fuel system, execute a precautionary emergency landing, turning the emergency fuel switch OFF at high key. If power is required during the pattern, place the emergency fuel switch in the ON position until a landing is assured, then return the switch to the OFF position.

WARNING

DC electrical power is required to activate and operate the emergency fuel system.

CAUTION

When using this procedure the throttle shall remain full forward.

If the engine does not start, carry out the appropriate emergency landing, ditching, or bailout procedure. Accomplish the following prior to landing or ditching:

- *12. Fuel shutoff valve handle — OFF.
- *13. Propeller — AS REQUIRED.
- *14. Ignition — OFF.
- *15. Emergency fuel switch — OFF.
- *16. Gear — AS REQUIRED.
- *17. Flaps — AS DESIRED.
- 18. Transmit appropriate radio call.
- *19. Battery — OFF.
- *20. Generator — OFF.
- *21. Canopy — BLOWN.
- *22. Harness — LOCKED.

WARNING

When landing with gear down on unprepared surfaces, the nose gear may collapse from contact with rough terrain and may cause the aircraft to invert making egress difficult. When the condition of the landing surface is in doubt, it is recommended that the landing gear remain in the up position.

- TO BE USED FOR:**
- ENGINE FAILURE OR MALFUNCTION
 - PRECAUTIONARY EMERGENCY LANDING
 - SIMULATED ENGINE FAILURE

* **1** DESCENT. Maintain 90 KIAS. Gear – UP, Flaps – UP, Canopy – CLOSED (Open prior to high key.) Attempt air start.
 ★ If unsuccessful place prop in positive high pitch position for maximum range.

Complete landing checklist prior to touchdown

* **2**

HIGH KEY. 1500 feet AGL, 90 KIAS, over intended point of landing. Begin turn to Low Key, Gear down for prepared surfaces. Transition to 85 KIAS. Gear up for unprepared surfaces or water. Maintain 90 KIAS.

* **3** **LOW KEY.** At least 1000 feet AGL, 85 KIAS (if gear down), 90 KIAS (if gear up), wingtip distance abeam intended point of landing.

Aim for point one-third down the runway.

* **5** **FINAL.** 800 feet straightaway, 200 feet AGL. Canopy – BLOW OPEN ★ Battery and generator off (for unprepared surface or water).

* **4**

90- DEGREE. 500-600 feet AGL, complete Landing Checklist, flaps-AS DESIRED. Adjust to 75 KIAS with flaps down.

★ Only for actual engine failure

*Memory items

Figure 5-1. Emergency Landing Pattern

LOW ALTITUDE ENGINE FAILURE

If the engine should fail at or below 1000 feet AGL, perform the following:

- *1. Assume a safe gliding attitude.
- *2. Select the best available landing area and turn to intercept the emergency landing pattern at the maximum altitude practicable.

WARNING

If failure occurs on takeoff with insufficient runway remaining to land, do not try to turn back to the field. Land straight ahead, changing direction only enough to miss obstacles.

- *3. Emergency fuel switch — ON.

Note

If power is regained, land as soon as possible using the emergency landing pattern. The limitations, cautions and warnings concerning emergency fuel operation found in the High Altitude Engine Failure/Partial Engine Failure section apply.

If power is not regained, execute the following prior to landing:

- *4. Gear — AS DESIRED.
- *5. Flaps — AS DESIRED.
- *6. Fuel shutoff valve handle — OFF.
- *7. Battery — OFF.
- *8. Canopy — BLOWN.
- *9. Harness — LOCKED.

MAXIMUM GLIDE.

If the engine fails during flight, the greatest gliding distance can be attained by leaving the gear and flaps up, canopy closed, pulling the propeller lever to full decrease (positive high pitch) position, and maintaining 90 knots IAS. At design gross weight and with a no-wind condition, the glide ratio of approximately 13 to 1 can be attained (see figure 5-2). To obtain positive high pitch, bypass the

detent and pull the propeller lever to the full extent of quadrant travel. With the propeller in this full aft position, the glide distance can be increased approximately 30 percent over that attained with the propeller windmilling in the low pitch position. The maximum glide ratio which may be attained without placing the propeller in positive high pitch is approximately 10 to 1.

PROPELLER OPERATION WITH NO POWER.

In the event of engine failure, provided there is oil pressure, sufficient propeller control is available to establish and maintain positive high pitch operation for maximum glide.

ENGINE FIRE DURING FLIGHT.

The decision to bail out will depend on judgment of the seriousness of the fire. Never attempt to land the aircraft with a serious fire that cannot be extinguished if there is sufficient altitude to bail out. If unable to extinguish an engine fire in flight, proceed as follows:

- *1. Mixture — IDLE CUTOFF.
- *2. Fuel shutoff valve handle — OFF.
- *3. Throttle — CLOSED.
- *4. Ignition — OFF.
- *5. Battery — OFF.
- *6. Generator — OFF.

After the engine is secured, do not attempt a restart; execute an emergency landing. If fire persists, bail out.

Note

If a forced landing is possible on a runway, turn battery switch on long enough to extend the gear, if it appears reasonably safe; otherwise extend the gear manually or land with gear up.

ELECTRICAL FIRE DURING FLIGHT.

All circuits except starter relays are protected by circuit breakers which isolate most electrical circuits and automatically interrupt power to prevent a fire when a short occurs. If necessary, however, turn OFF all switches to remove power from all electrical circuits and land as soon as possible. If electrical power is essential,

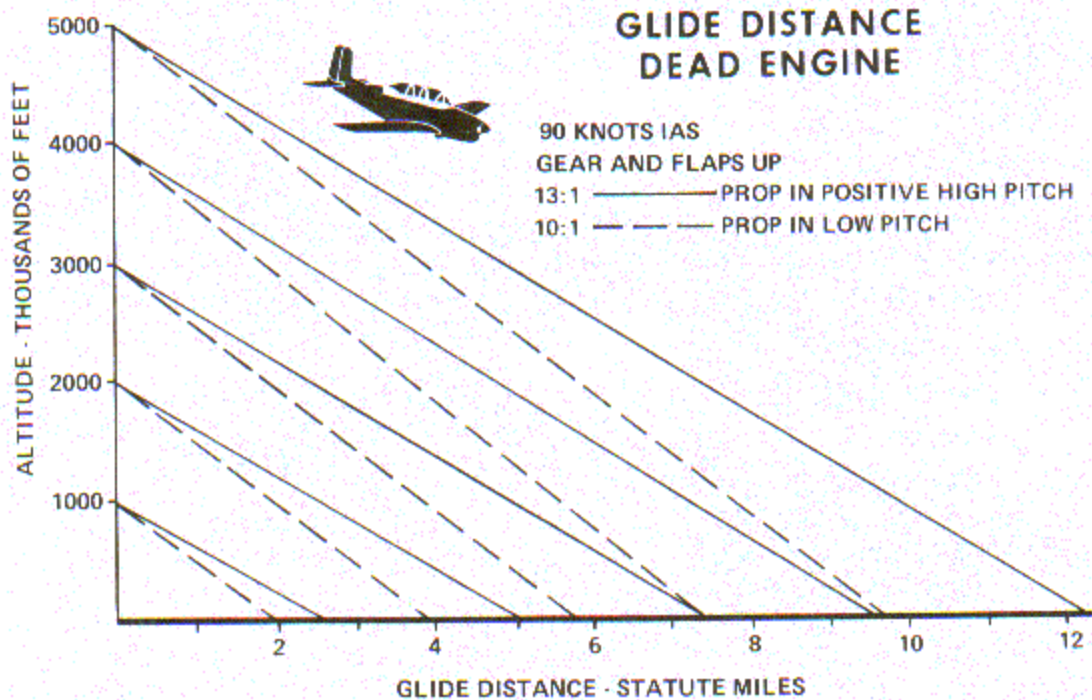

Figure 5-2. Glide Distance Dead Engine

an attempt to identify and isolate the shorted circuit may be accomplished as follows:

- *1. Battery — OFF.
- *2. Generator — OFF.
- 3. All circuit breakers — PULLED.
- 4. All radio/electrical equipment — OFF.

If fire persists:

- 5. Make emergency landing or bail out.

Isolate faulty circuit:

- 6. Generator circuit breaker — IN.
- 7. Generator — ON (If faulty, turn OFF and continue to check for other faulty circuits.)
- 8. Battery — ON.
- 9. Check each necessary circuit one at a time by pushing IN circuit breaker and turning ON radio/electrical equipment it services.
- 10. Secure unnecessary radio/electrical equipment to conserve battery if generator is secured.

Note

Due to electrical system problem, it may be necessary to lower the gear manually.

WING FIRE DURING FLIGHT

A fire in the wing could be caused by fuel leakage and/or defective electrical wiring. Perform the following procedure:

- *1. Battery and generator switches — OFF.
- *2. Attempt to extinguish the fire by slipping aircraft away from the fire.
- *3. If fire does not extinguish or is obviously fed by aircraft fuel — BAIL OUT.

WARNING

A landing should not be attempted with any serious uncontrollable fire if there is sufficient altitude to bail out.

FUSELAGE FIRE DURING FLIGHT.

Should a fuselage fire occur in flight:

- *1. Reduce airspeed.
- *2. Canopy — CLOSED (to minimize draft through cockpit).
- *3. Cockpit air handles — FULL OUT (air shut off).
- *4. Battery and generator switches — OFF.

If fire persists:

- *5. MAKE EMERGENCY LANDING OR BAIL OUT.

SMOKE ELIMINATION.

To clear the cockpit of smoke and fumes, proceed as follows:

- *1. Airspeed — REDUCE (to minimize spreading of possible fire).
- *2. Canopy — OPEN.
- *3. Cockpit air handles — FULL OUT.
- *4. Determine source of smoke and execute appropriate emergency procedures.

Note

Cockpit hot air valves should be left FULL OUT. If the duct system has been damaged by the fire, the hot air ducts may direct additional smoke to the cockpit.

CARBON MONOXIDE.

If carbon monoxide contamination is suspected, or the presence of exhaust fumes is noted in the cockpit, at anytime during the flight, the flight shall be terminated as soon as practicable. Proceed as follows:

- *1. Canopy — OPEN.
- *2. Cockpit air handles — FULL OUT.

FUEL PRESSURE DROP — ENGINE OPERATING NORMALLY.

A drop in fuel pressure reading with continued normal engine operation in flight may be the result of one or more of the following:

- 1. Clogged pressure line.
- 2. Instrument failure.
- 3. Line leakage.
- 4. Failure of engine-driven pump.

If the low pressure gage reading is the result of a clogged pressure line, faulty instrument or engine-driven pump, normal engine operation can be continued. However, a landing should be made as soon as practicable using the emergency landing pattern. When a leak is suspected follow the procedures for fuel leak/fuel fumes.

FUEL LEAK/FUEL FUMES.

Should a fuel leak be suspected or fuel fumes become evident in flight, check fuel system for secondary indications and proceed as follows:

- *1. Maintain present airspeed.
- *2. Land as soon as practicable.
- *3. Canopy — OPEN.
- *4. Cockpit air handles — FULL OUT.
- *5. Battery and generator switches — OFF.
- *6. Landing gear — Utilize landing gear emergency extension system.

Note

A straight-in-no-flap approach is preferable.

- *7. Accomplish landing, clear runway, secure engine, and ABANDON AIRCRAFT.

PROPELLER FAILURE.

Failure of either the governing system or the propeller control linkage will result in the propeller going to full low pitch (high rpm). The governor control arm is spring-loaded to full low pitch position and any other failure resulting in loss of oil flow or oil pressure to the propeller hub will also result in full low pitch. Under power-on conditions, full low pitch may result in engine overspeeding. Should a run-way propeller condition occur, proceed as follows:

- *1. Adjust throttle to maintain safe flight while minimizing overspeed.
- *2. Climb to put load on propeller.

*3. Manipulate propeller control in an attempt to restore governing.

*4. Land as soon as possible.

FUEL PUMP FAILURE.

In the event of engine-driven fuel pump failure a continuous supply of fuel will be provided when the electric fuel booster pump is ON.

DC POWER FAILURE.

If generator failure occurs, illuminating the GEN FAILURE light, or if generator voltage consistently exceeds 30 volts, turn GENERATOR switch OFF. All nonessential electrical equipment should be turned off to conserve battery power for gear extension. In the event of a complete electrical failure, or if it becomes necessary to secure both generator and battery, the primary flight attitude instruments will be inoperative and the gear must be lowered manually.

AC POWER FAILURE.

If the INVERTER OUT light illuminates, indicating failure of the main inverter, position the inverter switch to STANDBY. If the light remains on, no ac power is available and the gyros will be inoperative. Instrument flight is still possible with ac power failure by using the rate instruments (airspeed, altimeter, turn-and-slip indicator), but with a complete electrical power failure, instrument flight is not advisable since the turn-and-slip indicator will be inoperative. See figure 1-14 for a list of the electrically operated equipment.

WING FLAP EMERGENCY OPERATION.

No emergency operation of the wing flaps is provided.

CANOPY EMERGENCY OPERATION.

For canopy emergency operation, see figure 5-3. For emergency operation of the canopy from the outside, refer to EMERGENCY ENTRANCE, this section.

Note

If canopy emergency opening system is actuated, the canopy, once opened, will remain open under pressure of the system and cannot be closed until the actuator valve has been bled of pressure on the ground.

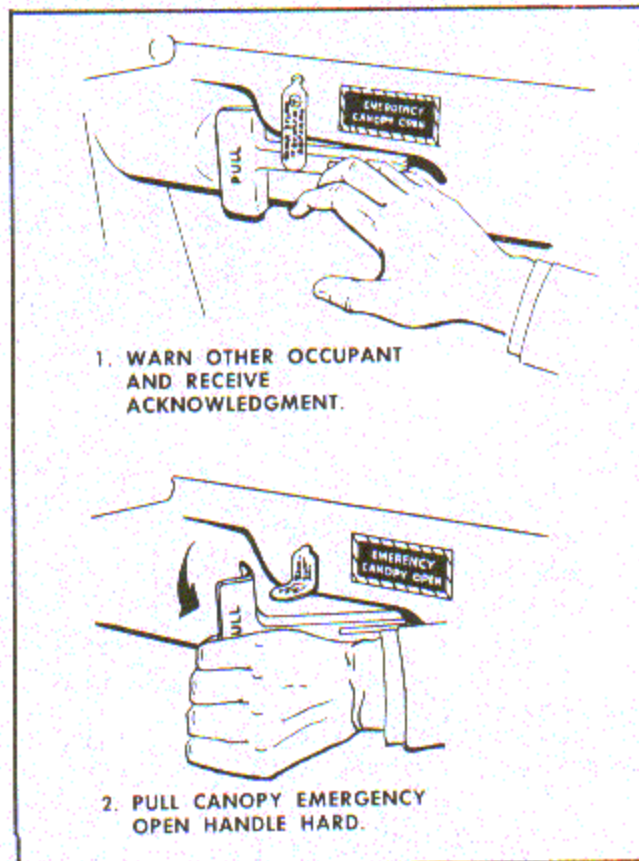

Figure 5-3. Canopy Emergency Opening Procedure

LOST PLANE PROCEDURES.

The primary requirements when lost are as follows:

1. Confess.
2. Communicate.
3. Climb.
4. Conserve.
5. Comply with procedures in the en route supplement.
6. Know any peculiar local area procedures.

DOWNED AIRCRAFT.

Whenever a downed aircraft is observed, the most important considerations are to maintain visual contact with survivors, alert rescue facilities as quickly as possible, and give any assistance possible at the scene until rescue is effected.

AIRBORNE DAMAGED AIRCRAFT

1. Aircraft controllable — Climb to at least 5000 feet.
2. Communicate — State difficulty and request visual inflight inspection.
3. Check flight characteristics in landing configuration at a minimum airspeed of 85 knots. If flaps are damaged or suspected to be damaged, maintain a minimum airspeed of 90 knots with flaps up during tests.

WARNING

DO NOT STALL THE AIRCRAFT.

4. Fly a wide or straight in approach; if control problems exist, maintain at least 10 knots above minimum obtained during flight characteristics check.

BAILOUT.

Make the decision to abandon the aircraft while there is still plenty of altitude and, when possible, power and directional control. Bail out, using the following procedures:

- *1. Make radio distress call, transmit emergency IFF code, time permitting.
- *2. Warn other pilot - receive acknowledgement.
- *3. Reduce airspeed as much as practicable, with flaps extended, trim slightly nose-down, and head for uninhabited area.
- *4. Radio cords — DISCONNECT.
- *5. Emergency canopy open handle — PULL.
- *6. Raise seat — FULL UP.
- *7. Check parachute straps — TIGHT.
- *8. Seat belt and shoulder harness — RELEASE.
- *9. Assume crouch position on seat.
- *10. Dive for trailing edge of wing.
- *11. When clear of aircraft — PULL. D-RING.

WARNING

- In a spin, both pilots should bail out toward the outside of the spin to minimize the possibility of being stuck by the aircraft.
- Minimum recommended bailout altitude — 1,500 feet AGL.

DITCHING.

The aircraft should be ditched only as a last resort. However, if for some reason ditching is unavoidable, proceed as follows:

1. Plan to touch down before all fuel is exhausted, to have power for a controlled approach.
2. Make radio distress call. Transmit emergency IFF code.
3. Radio cords — DISCONNECT.
4. Harness — LOCK.
5. Parachute straps — UNBUCKLE.
6. Emergency canopy open — PULL.
7. Landing gear — UP.
8. Flaps — DOWN.
9. Battery — OFF.
10. Make normal approach with power, if possible. Approach the stall attitude at a speed under which full control of the aircraft can be maintained. Plan landing direction as follows:
 - Calm sea — Into wind.
 - Moderate swells — Parallel to swells.
 - High swells (25 knots of wind or more) — Into wind, attempting to land on upwind side of swell.
11. Release safety belt only after aircraft stops.
12. Abandon aircraft.

TAKEOFF AND LANDING EMERGENCIES.

ABORTED TAKEOFF.

*1. Throttle — CLOSED.

*2. Brakes — APPLIED

If unable to stop on runway:

*3. Canopy — BLOW OPEN.

*4. Mixture — IDLE CUTOFF.

*5. Fuel shutoff valve handle — OFF.

*6. Ignition — OFF.

*7. Battery — OFF.

*8. ABANDON AIRCRAFT after it stops.

Note

If the aircraft is going to depart the runway onto an unprepared surface, the pilot may elect to use the landing gear emergency retract switch to retract the landing gear. The battery or generator switch must be on and supplying dc power to the switch in order for it to be operative.

LANDING GEAR EMERGENCY RETRACTION.

To retract the landing gear on the ground in an emergency, move the guarded landing gear emergency retract switch UP. The emergency retract switch will only retract the gear if external power is applied, the battery switch is on, or the generator is supplying dc power to the switch.

LANDING GEAR EMERGENCY EXTENSION.

Lower the gear manually as shown in figure 5-4. Fully engage the clutch knob before attempting to crank the gear down.

Note

Regardless of the availability of electrical power, the crank should be operated until it cannot be moved further. Check the landing gear position indicators for fully extended indications if power is available.

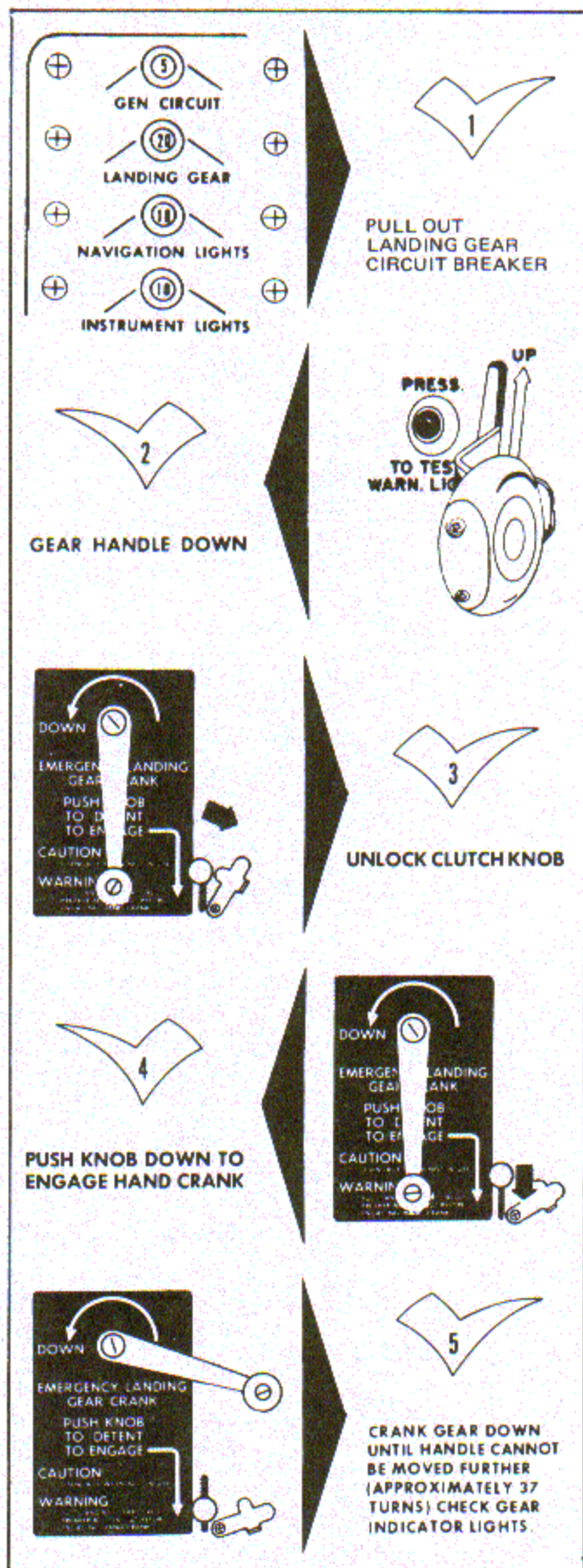

Figure 5-4. Landing Gear Emergency Extension

LANDING GEAR EMERGENCIES GENERAL

If the gear cannot be lowered successfully, proceed with the emergency procedures for the appropriate gear malfunction.

CAUTION

- If an unsafe gear indication existed and the gear have been successfully lowered, do not attempt to raise the gear.
- Raising the gear after a malfunction could cause further damage.

LANDING WITH GEAR UP.

If the gear fails to extend, a wheels-up landing can be made on either hard or soft ground; however, a hard surface is preferable since sod tends to roll up into chunks, damaging the underside of the fuselage. To accomplish a gear-up landing, proceed as follows:

1. Make normal approach — FULL FLAPS.
2. Emergency canopy open handle — PULL.
3. Harness — LOCKED.

After touchdown:

4. Mixture — IDLE CUTOFF.
5. Fuel shutoff valve handle — OFF
6. Battery — OFF
7. ABANDON AIRCRAFT as soon as it stops.

LANDING WITH ONE MAIN GEAR RETRACTED.

A gear-up landing is preferred to a landing with one main gear retracted. However, if such a landing cannot be avoided, proceed as follows:

1. Have gear position checked visually by another pilot or by the tower on a fly-by, if possible.
2. If verified that one gear is not fully extended and an attempt to retract it is unsuccessful, execute a normal approach with full flaps and power on to reduce landing speed, carrying the wing slightly lower on the down and locked side.

3. Emergency canopy open handle — PULL.
4. Touch down smoothly on the down and locked gear. Hold the opposite wing up with aileron as long as possible after the nose wheel touches down.
5. When wingtip strikes the ground, apply maximum opposite brake pressure.

Note

If landing area permits, a turn into the retracted gear will reduce groundspeed before wingtip strikes the ground.

6. As soon as aircraft stops:

Mixture — IDLE CUTOFF.

Fuel shutoff valve handle — OFF.

Battery — OFF.

7. ABANDON AIRCRAFT.

LANDING WITH NOSE GEAR RETRACTED.

Should the nose gear fail to extend:

1. Make a normal approach.
2. Emergency canopy open handle — PULL.
3. After touching main wheels down, hold the nose up as long as possible with full nose-down elevator trim and full backstick.
4. Before nose settles onto the ground:
 - Mixture — IDLE CUTOFF.
 - Fuel shutoff valve handle — OFF.
 - Battery — OFF.
5. ABANDON AIRCRAFT as soon as it stops.

Should the nose gear fail to extend fully:

If the nose gear fails to extend fully and is free-swinging, it is possible to move it to the overcenter position by using the following procedures:

1. Lower gear and full flaps.
2. Assume slow flight (70 knots).

3. Make gentle pitching oscillations using centrifugal force to swing the nose gear into the down position.

CAUTION

When landing, touch the nosewheel to the deck very gently and smoothly apply forward stick to maintain pressure on the nose gear. DO NOT allow the nosewheel to bounce on the runway.

FLAT TIRE.

A flat tire on a main wheel will act as a brake when on the ground, tending to turn the aircraft into the flat. Touch down well over the opposite side of the runway to allow room for a swerve and hold directional control with opposite brake. A flat nose wheel tire will reduce wheel stability and hard applications of brake should be avoided. After landing with a flat tire, perform the Secure Checklist when the aircraft comes to a complete stop, and have the aircraft towed clear of the landing area. Do not taxi with a flat tire.

BRAKE FAILURE.

If no brake pressure was evident during the landing pattern brake check, land the aircraft as short as possible

using full flaps to shorten the landing roll. After touchdown, secure the engine. When the aircraft comes to a complete stop, complete the remaining items on the Secure Checklist, and have the aircraft towed clear of the landing area.

CAUTION

Do not taxi without brakes.

HARD LANDINGS.

In the event of a hard landing where possibility of gear structural damage is suspected proceed as follows:

1. If on the runway — Execute a full stop, runway permitting. Do not attempt to taxi the aircraft.
2. If airborne — Leave the landing gear down and have gear inspected by another aircraft, or the tower. If the inspection reveals no visible damage, execute a normal full flap landing and proceed as in step 1. If visual damage is confirmed, execute appropriate emergency procedure.

SECTION VI — ALL WEATHER OPERATION

TABLE OF CONTENTS

Introduction	6-1	Night Flight	6-5
Instrument Flight	6-1	Cold Weather Operation	6-5
Ice and Rain	6-2	Hot Weather and Desert Procedures	6-6
Turbulence and Thunderstorms	6-2	High Density Altitude Procedures	6-7

INTRODUCTION.

Except for some repetition necessary for emphasis, clarity, or continuity of thought, this section contains only those procedures that differ from or are in addition to the normal operating instructions covered in Section III. Systems operations are covered in Section I.

INSTRUMENT FLIGHT.

Flying the aircraft under actual instrument conditions is not recommended. However, the stability, inflight structural limits, instruments, and communications equipment are sufficient for limited instrument flying under actual instrument weather conditions, if necessary. Flight in icing conditions should not be attempted since there are no provisions for wing and empennage deicing.

PREFLIGHT.

Complete the normal preflight check, with special emphasis on the following:

1. Check rate-of-climb indicator needle at zero.
2. Check operation of all radio equipment and set VHF receiver on station to be used after takeoff.
3. Uncage gyros and check turn-and-slip and heading indicators for proper operation during taxiing by observing indicators during turns.
4. Ensure that fuel control is clear of ice before takeoff. A drop in manifold pressure or rpm and

engine roughness are good indications of icing. Adjust alternate air handle to supply heat for deicing prior to takeoff and return to normal position just before starting takeoff roll.

5. If conditions warrant use of pitot heat (heavy rain or icing), turn pitot heat switch ON just before rolling into position for takeoff.

CAUTION

Avoid any prolonged operation of the pitot heater when the aircraft is on the ground.

6. Align aircraft with runway and set brakes.
7. Set heading indicator to runway heading.
8. Align attitude indicator miniature aircraft with the normal flight reference line.

Note

To be certain of proper operation of the gyro instruments, allow 5 to 8 minutes for them to reach full operating speed.

9. Recheck altimeter setting.

DURING INSTRUMENT CRUISING FLIGHT.

Pitot heat and alternate air should be used when flying through visible moisture; i. e., cloud, fog, etc. For windshield defrosting it may be necessary to adjust the cold and hot air handles for maximum heat even though the temperature may become slightly warm in the cockpit. No other adjustment for windshield defrosting is provided since this equipment is installed primarily for defogging.

WARNING

Icing conditions should be avoided because no wing and empennage deicing equipment is installed.

RADIO NAVIGATION EQUIPMENT.

Radio navigation equipment installed on the aircraft are an Omni receiver, VHF receiver, VHF transmitter and transponder.

DESCENT.

Slow the aircraft to the desired airspeed before commencing descent. It is easier to keep operating temperatures within limits if descents are made at 110 knots IAS or less. Prior to beginning descent, make the following checks:

1. Mixture — RICH.
2. Alternate air, pitot heat, and windshield heat — AS REQUIRED.

HOLDING.

Slow the aircraft to 110 knots clean configuration. For safety and ease of handling, never exceed 20 degrees of bank in turns.

INSTRUMENT APPROACHES.

The aircraft is equipped for instrument approaches as shown in figures 6-1 and 6-2.

ICE AND RAIN.

Ice and rain may affect operation of the engine, weight of the aircraft, airflow over the lifting surfaces, and the pilot's visibility. Ice on the runway may render the brakes useless and ice chunks or slush may be thrown up by the wheels or propeller, damaging the under surfaces of the aircraft.

The only installations on the aircraft for combating the various icing problems are pitot heat, alternate air, and windshield defogging. Entering any icing conditions is very dangerous, so it is imperative that icing be avoided. If ice is encountered, attempt to get out of the icing area by turning back and/or changing altitude.

Note

If ice accumulates on the propeller resulting in rough engine operation, it can sometimes be eliminated by rapidly increasing and decreasing the proper rpm.

TURBULENCE AND THUNDERSTORMS.

Flight in heavy turbulence or thunderstorms should be avoided whenever possible. Avoiding these turbulent areas may become difficult under night or instrument flight conditions. The most reliable instrument in turbulence is the attitude indicator. If the proper turbulence penetration airspeed is established (120 to 165 knots IAS) and the power adjusted to maintain this attitude and airspeed prior to entering the turbulent area, most difficulties are minimized.

Note

If the storm area is not visible, the intensity of radio static is usually an indication of an approaching thunderstorm.

In flying through turbulent air, the most difficult single factor is the maintaining of constant airspeed. Often the airspeed and other pressure reading instruments will give a very false indication of actual conditions because of the great pressure variation within the storm area. Maintaining a pre-established attitude and power setting will result in a fairly constant airspeed in spite of indicated airspeed fluctuations.

Other procedures to be accomplished in preparing to enter a turbulent area are:

1. Loose gear — STOWED.
2. No smoking.
3. Harness — LOCKED.
4. All pilot compartment lights — ON.
5. Pitot heater — ON.

When operating in turbulent air, make no unnecessary turns or attitude changes. Use the least control pressure necessary for the required change.

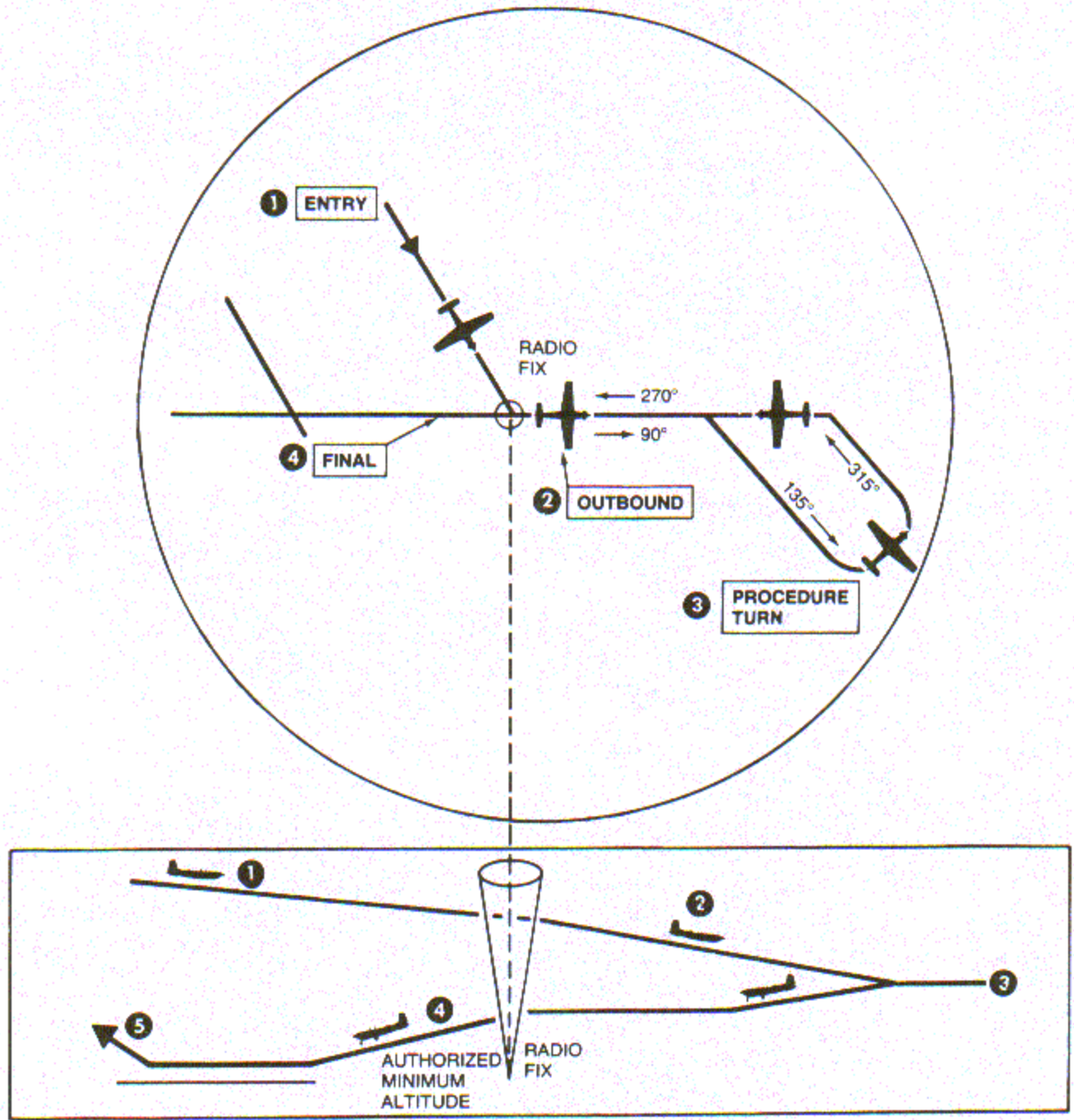

- | | | |
|--|---|---|
| <p>1. Initial approach altitude: All landing checks complete except for landing gear, prop, and flaps.</p> <p>2. Initial approach over VOR:</p> <p>Gear - UP
Flaps - UP
Prop - 2200 rpm
Throttle - 13" MAP
Speed - 110 knots
(500 fpm descent)</p> | <p>3. Procedure turn, when inbound:</p> <p>Gear - DOWN
Prop - 2200 rpm
Throttle - 20" MAP
Speed - 90 knots</p> <p>4. Final approach:</p> <p>Gear - DOWN
Flaps - As desired
Prop - FULL INCREASE
Throttle - As required
Speed - 90 knots
(500 fpm descent)</p> | <p>5. In the event of a missed approach:</p> <p>Prop - FULL INCREASE
Throttle - FULL FORWARD
Follow normal wave-off procedures.</p> |
|--|---|---|

Figure 6-1. Typical Instrument Approach

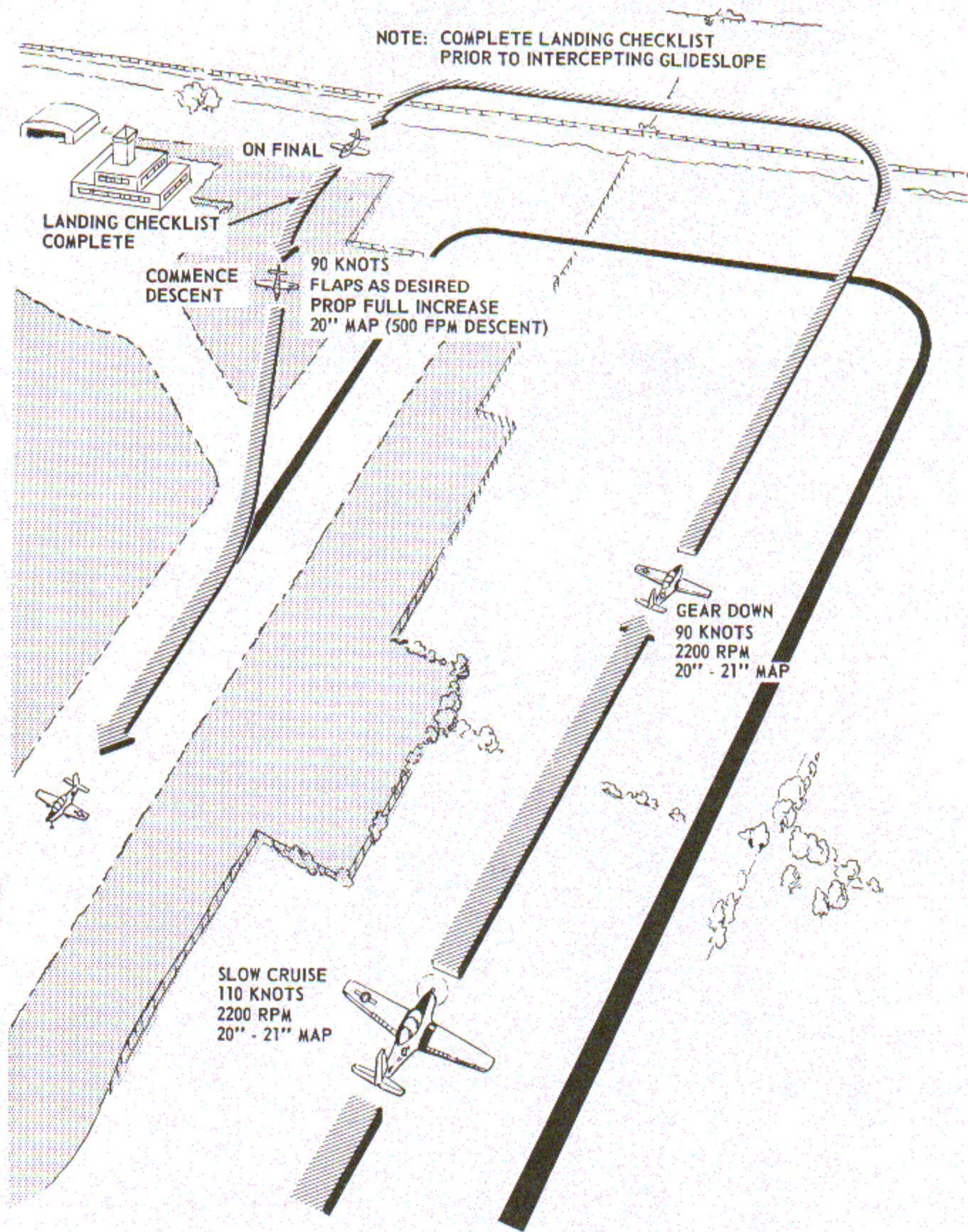

Figure 6-2. T-34B ASR/PAR Approach Pattern

NIGHT FLIGHT.

Night flight presents the same problems as instrument flight except for the following additional precautions due to interior and exterior lighting:

1. The landing gear handle red warning light is bright enough to cause temporary blindness to the pilot if he looks at the handle while the gear is going up or down.
2. When the landing lights are turned on at night they cause a glare in the cockpit.
3. Make certain navigation lights are set on DIM for formation night flying to avoid a distracting glare.

COLD WEATHER OPERATION.

Proper servicing of the aircraft is very important to cold weather operation. Since the aircraft is not equipped with an oil dilution system, it is important that it be parked in a warm area if possible. If it must remain outside, remove the battery and stow in a warm place.

CAUTION

Batteries not in use deteriorate rapidly if not removed from the aircraft during extreme cold.

BEFORE ENTERING THE AIRCRAFT.

In addition to the normal exterior inspection, perform the following:

1. Remove ice, snow, and frost from the wings, empennage, control surfaces and hinges, propeller, windshield, pitot tube, and fuel and oil tank caps and vents.
2. Test fuel and oil drains for free flow. Apply heated air if necessary.
3. Check that battery is properly installed.
4. Remove all covers and preheaters.
5. Check that external power is plugged in for starting and warmup.

Note

Prior to attempting a start at temperatures below 0° F (-18° C), the engines should be heated sufficiently to obtain fuel vaporization, permit proper engine valve clearance and seating, and ensure proper engine lubrication.

ON ENTERING THE AIRCRAFT

Check the flight controls for complete freedom of movement. Complete the prestart checklist and have the propeller pulled through at least two blades before engaging the starter.

STARTING ENGINE.

The normal engine starting procedures should be used. Cold starts normally require a more retarded throttle. If any warm air is reaching the engine compartment, alternate air may be useful.

CAUTION

If there is no oil pressure within 30 seconds, or if pressure drops to below normal after the engine is running, shut down and check for blown oil lines, radiators, or congealed oil or ice in drains.

Note

Moisture forms quickly on the spark plug electrodes during cold weather starts. After three or four unsuccessful attempts, have at least one plug removed from each cylinder, heat to dry the electrodes, replace and attempt starting immediately after replacing.

WARMUP AND GROUND OPERATION.

Generally, warmup procedures will be the same as those under normal operating procedures, with the following exceptions:

1. Use external power to supply electrical current for operation of the gyros and other electrical equipment being used during warmup. This permits engine rpm to be held to a minimum until the oil warms enough to prevent extremely high oil pressures encountered at generator cut-in speed.

Note

Ground warmup of oil temperature to 40°C is recommended to assure warmup of the entire oil supply. If starting temperatures are at or below freezing, use preheat. During winter months, secondary oil cooler intake air side may be taped over.

2. Disconnect external power and turn the battery switch ON, maintaining an engine speed sufficient for generator operation.

3. When subject to excessive drain, storage batteries deteriorate rapidly in cold weather; therefore, if external power is not available, only essential equipment should be used until the generator is supplying current.

4. Under extremely cold conditions, it is possible to get better vaporization of fuel by using alternate air. This results in smoother engine operation during warmup.

5. Operate the propeller through several complete cycles to replace the oil in the propeller system with warm engine oil.

TAXIING.

WARNING

Make certain that all instruments have warmed up enough to operate normally. Check for sluggish instruments during taxi. Normally it takes 5 to 8 minutes for the heading indicator to reach proper operating speed.

Do not taxi through water or slush if it can be avoided. Water or slush splashed on the wing and tail surfaces will freeze, increasing weight and drag and perhaps limiting control surface movement. Use brakes sparingly and taxi slowly for best control and to protect aircraft from flying water, slush, and possibly ice.

BEFORE TAKEOFF.

Run up engine prior to takeoff using alternate air to eliminate any possible fuel control ice, then complete the normal TAKEOFF CHECKLIST with special emphasis on the following:

1. Alternate air handle — IN (cold).
2. Pilot heat — AS REQUIRED.
3. Cabin heat and windshield defogging — SET.

TAKEOFF.

Make normal takeoff. Be prepared to use alternate air as soon as full power is no longer necessary.

DURING FLIGHT.

Use alternate air as needed. Cycle the propeller periodically to keep warm oil in the propeller system.

DESCENT AND APPROACH.

During descent, engine overcooling may be avoided by maintaining 110 knots IAS or less and descending gradually. If overcooling occurs, the gear and flaps should be lowered and the rpm increased, keeping as much power applied as possible. Use alternate air as needed until reaching the landing pattern.

LANDING PATTERN AND LANDING.

Complete the LANDING CHECKLIST. Make a normal landing, using pitot heat as needed.

Note

Fuel control icing could be severe enough to demand the use of alternate air in the traffic pattern and while landing; however, be prepared to return to the use of normal air if a go-around or some other reason for the use of full power should occur.

As soon as the aircraft is on the ground, retract the flaps and use the brakes sparingly on icy runways. Use alternate air while taxiing if necessary.

PARKING AND BEFORE LEAVING THE AIRCRAFT.

If at all possible, the aircraft should be hangared in a warm area. If this is impossible, remove the battery and stow in a warm place until the aircraft is to be used again.

After servicing, drain water from fuel and oil drains to prevent them from clogging with ice.

Cover the aircraft for protection against freezing rain, frost, and snow.

HOT WEATHER AND DESERT PROCEDURES.

PRETAKEOFF.

Remove any dust or sand found on the aircraft prior to flight.

TAKEOFF.

During hot weather conditions, the aircraft will require a longer than normal takeoff run. The performance of both

aircraft and engine is dependent upon air density. Density of the air varies with the temperature and barometric pressure. These varying conditions can be corrected to standard and expressed as density altitude. Refer to figure 11-2, Density Altitude Chart. Density altitude is the altitude at which air of a given density exists in the standard atmosphere.

PARKING.

Leave at least one aperture open when parking in the sun so temperature inside will not become excessive.

CAUTION

High temperatures can cause fluid in the compasses to boil away, dry out electrical insulation, and cause inside paint to blister.

Note

Protect all airscoops, vents, operating mechanisms, and the cockpits from blowing sand and dust. Sand and dust in the airscoops and vents might restrict airflow during operation.

HIGH DENSITY ALTITUDE PROCEDURES

Operating the aircraft at high density altitude affects both airframe performance (lift component) and engine performance (thrust component). Additionally, the emergency fuel system may cause the engine to run

excessively rich. The following procedures are recommended for continued safe operation at fields where density altitudes exceed 5000 feet:

1. Both canopies should be closed prior to takeoff to reduce drag.
2. Sink rates in excess of 1000 fpm may be encountered in a full flap power off landing. Flaring prior to touchdown may not produce enough lift to arrest this excessive sink rate. Caution should be exercised.

Note

Manifold pressures are limited at high density altitudes. Cruise settings of full throttle and 2200 rpm may produce an indicated airspeed lower than normal 120 knots cruise.

TOUCH AND GO LANDING PROCEDURES AT HIGH DENSITY ALTITUDES

While practicing touch and go landings the following procedures are recommended:

1. Canopy closed to reduce drag.
2. Flaps raised during rollout prior to liftoff.
3. Landing gear raised once airborne and safe landing cannot be made.
4. Landing gear down at abeam position.
5. Landing checklist completed in full beyond abeam position each time around the pattern.

SECTION VII — COMMUNICATIONS PROCEDURES

TABLE OF CONTENTS

Introduction	7-1	Visual Signals	7-1
Radio Communications	7-1		

INTRODUCTION.

Flight leaders and pilots must be familiar with standard radio and visual signals, doctrine, and procedures. The selection of the communication system will depend upon the urgency of the situation, security, and reliability of the communication system.

RADIO COMMUNICATIONS.

The T-34B may be equipped with one of three different VHF communication systems: (1) ARC-12, (2) ARC-101,

or (3) RT-241A. In addition, an AIMS transponder identification system is installed. A complete description and table of communications and associated equipment and their use and limitations may be found in Section I, Part 2.

VISUAL SIGNALS.

Visual signals, such as aircraft handling signals, signals between aircraft, and rescue and emergency signals are covered in detail in NWP 41, Naval Air Operating Procedures, and are not duplicated in this manual.

SECTION VIII — WEAPONS SYSTEM

NOT APPLICABLE TO THIS AIRCRAFT

SECTION IX — FLIGHT CREW COORDINATION

NOT APPLICABLE TO THIS AIRCRAFT

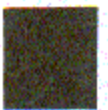

SECTION X - T-34B

NATOPS Evaluation

TABLE OF CONTENTS

Concept	10-1	Final Grade Determination	10-7
Definitions	10-1	Records and Reports	10-7
Implementation	10-2	NATOPS Evaluation Question Bank	10-9
Ground Evaluation	10-2	NATOPS Evaluation Forms	10-9
Flight Evaluation	10-2		

CONCEPT

The standard operating procedures prescribed in this manual represent the optimum method of operating the T-34B aircraft. The NATOPS Evaluation is intended to evaluate compliance with NATOPS procedures by observing and grading individuals and units. This evaluation is tailored for compatibility with various operational commitments and missions of both Navy and Marine Corps units. The prime objective of the NATOPS Evaluation program is to assist the unit commanding officer in improving unit readiness and safety through constructive comment. Maximum benefit from the NATOPS Evaluation Program is achieved only through the vigorous support of the program by the commanding officers as well as the flight crewmembers.

DEFINITIONS.

The following terms, used throughout this section, are defined as to their specific meaning within the NATOPS program.

NATOPS EVALUATION

A periodic evaluation of individual pilot standardization consisting of an open book examination, a closed book examination, an oral examination, and a flight evaluation.

NATOPS RE-EVALUATION

A partial NATOPS Evaluation administered to a flight crewmember who has been placed in an Unqualified status by receiving an Unqualified grade for any of his ground examinations or the flight evaluation. Only those

areas in which an unsatisfactory level was noted need be observed during a re-evaluation.

QUALIFIED

That degree of standardization demonstrated by a very reliable flight crewmember who has a good knowledge of standard operating procedures and a thorough understanding of aircraft capabilities and limitations.

CONDITIONALLY QUALIFIED

That degree of standardization demonstrated by a flight crewmember who meets the minimum acceptable standards. He is considered safe enough to fly as pilot in command or to perform normal duties without supervision, but more practice is needed to become Qualified.

UNQUALIFIED.

That degree of standardization demonstrated by a flight crewmember who fails to meet minimum acceptable criteria. He should receive supervised instruction until he has achieved a grade of Qualified or Conditionally Qualified.

AREA.

A routine of preflight, flight, or postflight.

SUBAREA.

A performance subdivision within an area, which is observed and evaluated during an evaluation flight.

CRITICAL AREA.

Any area or subarea which covers items of significant importance to the overall mission requirements or the marginal performance of which would jeopardize safe conduct of the flight.

EMERGENCY.

An aircraft component or system failure, or conditions which requires instantaneous recognition, analysis, and proper action.

MALFUNCTION.

An aircraft component or system failure, or conditions which requires recognition and analysis, but which permits more deliberate action than that required for an emergency.

IMPLEMENTATION.

The NATOPS Evaluation program shall be carried out in every unit operating naval aircraft. Pilots desiring to attain/retain qualification in the T-34B shall be evaluated initially in accordance with OPNAVINST 3510.9 series, and at least once during the 12 months following initial and subsequent evaluations. Individuals and unit NATOPS Evaluations will be conducted annually; however, instruction in and observation of adherence to NATOPS procedures must be on a daily basis within each unit to obtain maximum benefits from the program. The NATOPS Coordinators, Evaluators, and Instructors shall administer the program as outlined in OPNAVINST 3510.9 series. Evaluatees who receive a grade of Unqualified on a ground or flight evaluation shall be allowed 30 days in which to complete a re-evaluation. A maximum of 60 days may elapse between the date the initial ground evaluation was commenced and the date the flight evaluation is satisfactorily completed.

GROUND EVALUATION.

Prior to commencing the flight evaluation, an evaluatee must achieve a minimum grade of Qualified on the open book and closed book examinations. The oral examination is also part of the ground evaluation but may be conducted as part of the flight evaluation. To assure a degree of standardization between units, the NATOPS Instructors may use the bank of questions contained in this section in preparing portions of the written examinations.

OPEN BOOK EXAMINATION.

A maximum of 50 percent of the questions used may be taken from the question bank. The number of questions

on the examinations will not exceed 40 or be less than 20. The purpose of the open book portion of the written examination is to evaluate the pilot's knowledge of appropriate publications and the aircraft.

CLOSED BOOK EXAMINATION.

A maximum of 50 percent of the closed book examination may be taken from the question bank and shall include questions concerning normal and emergency procedures and aircraft limitations. The number of questions on the examination will not exceed 40 or be less than 20. Questions designated critical will be so marked. An incorrect answer to any question in the critical category will result in a grade of Unqualified being assigned to the examination.

ORAL EXAMINATION.

The questions may be taken from this manual and drawn from the experience of the Instructor/Evaluator. Such questions should be direct and positive and should in no way be opinionated.

GRADING INSTRUCTIONS.

Examination grades shall be computed on a 4.0 scale and converted to an adjective grade of Qualified or Unqualified.

OPEN BOOK EXAMINATION.

To obtain a grade of Qualified, an evaluatee must obtain a minimum score of 3.5.

CLOSED BOOK EXAMINATION.

To obtain a grade of Qualified, an evaluatee must obtain a minimum score of 3.3.

**ORAL EXAMINATION AND OFT
PROCEDURE CHECK (If conducted).**

A grade of Qualified or Unqualified shall be assigned by the Instructor/Evaluator.

FLIGHT EVALUATION.

The number of flights required to complete the flight evaluation should be kept to a minimum; normally one flight. The areas and subareas to be observed and graded on an evaluation flight are outlined in the grading criteria, with critical areas indicated by an asterisk (*). Subarea grades will be assigned in accordance with the grading criteria. These subarea grades shall be combined to arrive at the overall grade for the flight. Area grades, if desired, shall also be determined in this manner.

FLIGHT EVALUATION GRADING CRITERIA.

Only those subareas observed or required will be graded. The grade assigned for a subarea shall be determined by comparing the degree of adherence to standard operating procedures with adjectival ratings listed below. Momentary deviations from standard operating procedures should not be considered as unqualifying provided such deviations do not jeopardize flight safety and the evaluatee applies prompt corrective action.

Note

An asterisk (*) indicates a critical area unless otherwise indicated. A grade of Unqualified for a critical area requires that a grade of Unqualified be awarded for the entire flight.

1. Mission Planning.**a. Personal Flying Equipment.**

Qualified	Possessed all required flying clothing, identification tags, and survival equipment as listed in this manual and the current edition of OPNAVINST 3710.7, and had good knowledge of their use.
Conditionally Qualified	Possessed the necessary equipment and checked presence, readiness, and security of all other required safety equipment, and had satisfactory knowledge of its use.
Unqualified	Lacked necessary equipment or was not familiar with use of equipment.

b. Flight Preparation.

Qualified	Sound working knowledge and use of flight publications, NOTAMS, weather, departure procedures, and airport facilities available in the selection of route, altitude, destination and alternate and/or emergency airports. Correctly completed flight log and filed flight plan.
Conditionally Qualified	Limited knowledge and use of flight publications, NOTAMS, weather, departure procedures, and airport facilities available in selection of route, altitude, destination, and alternate airports. Minor errors in flight plan/log.
Unqualified	Definite lack of knowledge and use of flight publications, NOTAMS, weather, departure procedures, and airport facilities available in the selection of route, altitude, destination and alternate airports.

***c. Crew/Passenger Briefing.**

Qualified	Conducted a thorough, detailed, and professional briefing for the dual pilot/passenger, covering route, altitude, destination, weather factors, use of personal and emergency equipment, emergency procedures, smoking privileges, etc., in accordance with current directives.
Conditionally Qualified	Conducted a briefing that was too informal with several omissions of items listed above. Successful, effective action of dual pilot/passenger resulting from briefing was in doubt.
Unqualified	Conducted no briefing, or failed to cover emergency procedures to the extent necessary to permit effective action during emergencies.

d. Aircraft Takeoff Data (Not applicable.)

2. Preflight.

a. Aircraft Inspection.

Qualified

Completed all aircraft inspections thoroughly, completely and effectively.

Conditionally Qualified

Completed aircraft inspection with minor omissions in areas which did not affect the safety of the proposed flight.

Unqualified

Failed to conduct aircraft inspection properly and omitted several important items which precluded crew and aircraft safety.

b. Checklists.

Qualified

Used checklists in an accurate manner with no omissions.

Conditionally Qualified

Made minor omissions to checklists or hurried through the checklists without making adequate inspection of each item.

Unqualified

Did not use checklists or failed to make complete checks.

3. Pretakeoff.

a. Start.

Qualified

Had complete knowledge and proficiency in normal and emergency procedures during engine start, including proper operational sequence and limitations.

Conditionally Qualified

Had limited knowledge and proficiency in normal and emergency procedures during engine start. Was unsure of operational sequence and limitations, but did not jeopardize crew and aircraft safety.

Unqualified

Lacked knowledge and proficiency in normal procedures, and emergency procedures during engine start, jeopardizing crew and aircraft safety.

b. Checklists.

Qualified

Demonstrated thoroughness in completion of checklists. Completely checked and properly set the communication/navigation equipment that was required for the successful completion of the flight.

Conditionally Qualified

Omitted minor items in checklists. Checked and set the minimal communication/navigation equipment required for successful completion of the flight.

Unqualified

Omitted major items in checklists. Failed to check or set the communications equipment.

c. Taxi.

Qualified

Safely handled aircraft. Satisfactory technique in the use of power and brakes. Followed hand signals.

Conditionally Qualified

Roughly handled aircraft. Improper use of brakes. Did not follow hand signals. Taxied fast.

Unqualified

Taxied too fast, did not maintain proper lookout.

*d. Engine Runup.

Qualified	Safely positioned aircraft for runup. Complete knowledge of runup procedures, limitations, and required systems checks. Completed takeoff checklist.
Conditionally Qualified	Careless positioning of aircraft for runup, i.e., nosewheel cocked, etc. Limited knowledge of runup procedures and limitations. Completed takeoff checklist.
Unqualified	Unsafe positioning of the aircraft for runup. Did not know runup procedures, limitations, or systems checks. Doubtful if malfunctions serious enough to abort aircraft flight would have been recognized. Failed to complete takeoff checklist.

4. Takeoff.

*a. Takeoff Procedures.

Qualified	Takeoff checklist completed prior to entry onto the runway. Aligned aircraft properly with runway, taking into consideration crosswind. Maintained directional control with proper use of rudder. Used aileron properly in crosswind conditions. Proper application of power.
Conditionally Qualified	Erratic directional control, but able to correct with rudder.
Unqualified	Takeoff checklist not completed prior to entry onto the runway. Failed to align. Had to use brakes to correct swerve or to maintain directional control.

*b. Transition.

Qualified	Assumed proper takeoff attitude and flew aircraft smoothly into air. Maintained balanced flight. Maintained runway track. Operated gear/flaps in accordance with NATOPS procedures.
Conditionally Qualified	Rough rotational technique. Drifted off runway track. Aircraft in unbalanced flight. Retracted gear with sufficient runway left for safe gear-down landing. Forgot gear but did not exceed airspeed limitations.
Unqualified	Dangerous rotational technique. Aircraft allowed to settle after lift-off, or aircraft assumed excessive attitude and airspeed decreased after lift-off. Retracted gear before safely airborne. Forgot gear and exceeded limitations.

5. Basic Airwork.

- a. Altitude Control.
- b. Airspeed Control.
- c. Heading Control.

The following criteria apply to altitude, airspeed, and heading control:

Qualified	Maintained altitude within 100 feet, heading within 15 degrees, and airspeed within 10 knots.
Conditionally Qualified	Maintained altitude within 200 feet, heading within 15 degrees, and airspeed within 10 knots.
Unqualified	Altitude, heading, and airspeed not held within limits stated above.

d. Transitions

Qualified	Altitude held within 100 feet, heading within 10 degrees, and airspeed within 5 knots.
Conditionally Qualified	Altitude held within 200 feet, heading within 15 degrees, and airspeed within 10 knots.
Unqualified	Altitude, heading, and airspeed not held within limits stated above.

6. Emergencies.

*a. Engine Failure.

*b. Fire Inflight.

*c. System Failure.

The following criteria apply to all emergencies evaluated:

Qualified	Followed correct emergency procedures as listed in NATOPS Flight Manual.
Conditionally Qualified	Did not follow correct procedures, but deviations were minor and safety was not jeopardized.
Unqualified	Used incorrect procedures that were unsafe.

7. Instrument Procedures. (Not applicable)

8. Landing.

*a. Checklists.

Qualified	Used checklists in an accurate manner with no omissions.
Conditionally Qualified	Made minor omissions to checklists or hurried through the checklists without making adequate inspection of each item.
Unqualified	Did not use checklists or failed to make complete checks.

*b. Descent.

Qualified	Planned and executed descent so as to arrive at the desired entry point at the proper altitude with only minor deviations that did not restrict the effectiveness of the procedure.
Conditionally Qualified	Slow to react to instructions and directives. Arrived at pattern entry point with insufficient/excessive altitude and/or airspeed.
Unqualified	Ignored instructions and directives. Arrived at pattern entry point with insufficient/excessive altitude and/or airspeed.

*c. Pattern

Qualified	Conformed to field traffic pattern with no more than 100 feet deviation in altitude, plus or minus 5 knots airspeed.
-----------	--

Conditionally Qualified	Deviation in pattern but not sufficient to interfere with safety of flight. Plus or minus 200 feet deviation in altitude, plus or minus 10 knots airspeed.
Unqualified	Serious deviations in pattern that interfered with normal traffic or other deviations that jeopardized flight safety. Exceeded 200 feet deviation in altitude and 10 knots airspeed.

*d. Landing and Rollout.

Qualified	Aircraft aligned within runway limits throughout final approach. Slight variations in rate of descent and airspeed. Smooth flareout and touchdown in first third of runway. Maintained directional control through proper use of aileron and rudder. Reduced to safe speed prior to clearing runway.
Conditionally Qualified	Had difficulty aligning aircraft with runway, rough handling of aircraft, and used poor technique throughout final and touchdown. Landed on first third of runway. Erratic directional control but able to correct with rudder. Aircraft slightly fast on turnoff. Did not hazard aircraft or crew.
Unqualified	Did not align aircraft with runway, erratic rate of descent. Allowed airspeed to go below minimum safe approach speed. Touchdown dangerously short or long. Improper use of aileron, rudder, or brakes. Aircraft not slowed sufficiently prior to turnoff.

9. Postflight.

a. Engine Shutdown.

Qualified	Secured engine and aircraft in accordance with Flight Handbook/NATOPS Manual.
Unqualified	Failed to secure engine, aircraft, and associated equipment properly.

FLIGHT EVALUATION GRADE DETERMINATION

The following procedure shall be used in determining the flight evaluation grade. A grade of Unqualified in any critical area will result in an overall grade of Unqualified for the flight. Otherwise, flight evaluation (or area) grades shall be determined by assigning the following numerical equivalents to the adjective grade for each subarea. Only the numerals 0, 2, or 4 will be assigned in subareas; no interpolation is allowed.

Unqualified	— 0.0
Conditionally Qualified	— 2.0
Qualified	— 4.0

To determine the numerical grade for each area and the overall grade for the flight, add all the points assigned to the subareas and divide this sum by the number of subareas graded. The adjective grade shall then be determined on the basis of the following scale:

0.00 to 2.19	— Unqualified
2.2 to 2.99	— Conditionally Qualified
3.0 to 4.0	— Qualified

Example: (Add subarea numerical values)

$$\frac{4 + 2 + 4 + 2 + 4}{5} = \frac{16}{5} = 3.20 = \text{Qualified}$$

FINAL GRADE DETERMINATION

The final NATOPS Evaluation grade shall be the same as the grade assigned to the Evaluation flight. A pilot who receives an unqualified on any ground examination or on the flight evaluation shall be placed in an unqualified status until he achieves a grade of Conditionally Qualified or Qualified for those sections on a re-evaluation.

RECORDS AND REPORTS.

A NATOPS Evaluation Report (OPNAV Form 3510-8, Figure 10-1) shall be completed for each evaluation and forwarded to the evaluatee's commanding officer via the operations/training officer. This report shall be filed in the individual flight training record and retained therein for 18 months. In addition, an entry shall be made in the pilot's flight log book under "Qualifications and Achievements" as follows:

NATOPS EVALUATION REPORT
 OPNAV FORM 3510-8 (8-85) 0107-723-0000

NAME (Last, first initial)		GRADE	SERVICE NUMBER	
SQUADRON/UNIT	AIRCRAFT MODEL		CREW POSITION	
TOTAL PILOT/FLIGHT HOURS	TOTAL HOURS IN MODEL		DATE OF LAST EVALUATION	
NATOPS EVALUATION				
REQUIREMENT	DATE COMPLETED	GRADE		
		Q	CQ	U
OPEN BOOK EXAMINATION				
CLOSED BOOK EXAMINATION				
ORAL EXAMINATION				
*EVALUATION FLIGHT				
FLIGHT DURATION	AIRCRAFT BUND	OVERALL FINAL GRADE		
REMARKS OR EVALUATOR/INSTRUCTOR				

SAMPLE

CHECK IF CONTINUED ON REVERSE SIDE

GRADE, NAME OF EVALUATOR/INSTRUCTOR	SIGNATURE	DATE
GRADE, NAME OF EVALUEE	SIGNATURE	DATE
REMARKS OF UNIT COMMANDER		

RANK, NAME OF UNIT COMMANDER	SIGNATURE	DATE
------------------------------	-----------	------

*RST, OPT, COT, or cockpit check in accordance with OPNAVINST 3510.9 (effective edition).

Figure 10-1. NATOPS Evaluation Report (OPNAV Form 3510-8)

QUALIFICATION			DATE	SIGNATURE	
NATOPS EVAL.	T-34B	PILOT	(Date)	(Authenticating Signature)	(Unit which Administered Eval.

**NATOPS EVALUATION
QUESTION BANK.**

The bank of questions at the end of this section is intended to assist the unit NATOPS Instructor/Evaluator in the preparation of ground examinations and to provide an abbreviated study guide. The questions from the bank should be combined with locally originated questions as well as questions obtained from the Model Manager in the preparation of ground examinations.

**NATOPS EVALUATION
FORMS.**

In addition to the NATOPS Evaluation Report, a VT Pilot NATOPS Flight Evaluation Worksheet, OPNAV Form 3510/10, is provided for use by the Evaluator/Instructor during the evaluation flight. All of the flight areas and subareas are listed on this worksheet with space allowed for related notes.

PART I — ENGINEERING QUESTIONS.

(Items marked with an asterisk (*) are to be answered as either True or False.)

1. What is the maximum recommended takeoff weight of this aircraft?
2. Describe the proper warmup procedure.
3. What is the generator cut-in speed? At what rpm does the generator develop its rated output?
4. What are the "g" limits?
- NEW 5. What functions do the safety switches on the left and right main struts perform?
6. What instruments are operated by the pitot static system?
7. What aircraft systems are hydraulically operated?
8. With both cockpits occupied, what is the amount of weight that can be carried in the baggage compartment?
9. What is the capacity of the oil system and what grade of oil is specified for use?
10. What is the maximum glide ratio and how is it obtained?
11. What is the maximum allowable difference in fuel in the two wing tanks?
12. What unit(s) constitute the ac power system?
13. What is the maximum diving airspeed?
14. Describe the procedure to be followed in the event that an overspeed condition cannot be controlled by retarding the prop control lever.
15. What is the limitation on inverted flight?
16. Generator output is registered on what instrument?
17. What is the rated horsepower?
18. List the maximum, minimum, and normal oil temperatures and pressures.
19. What is the total usable fuel?
20. The propeller governor is checked at what rpm? It should drop to what rpm?
21. If an engine failure or loss of power occurs and it is necessary to activate the emergency system, what is the proper procedure?
22. What force is used to place the propeller in high pitch? In low pitch?
23. What is incorporated in the oil tank to ensure a supply of oil to the engine while inverted?
24. The boost pump is checked at what rpm?
25. If the engine-driven fuel pump fails, will the boost pump supply sufficient fuel to run the engine?

26. Describe the magneto check.
27. The landing gear can be extended in approximately how many turns?
28. Placing the propeller in positive high pitch results in what rpm?
29. List the maximum and minimum fuel pressures.
30. What is the normal range of idle rpm?
31. What type and color hydraulic fluid is used?
32. What type uplocks and downlocks are used in the landing gear?
33. The canopy air bottle pressure should be between what limits?
34. When the landing lights are in use on the ground, it is recommended that the pilot alternate between left and right lights every _____ during taxi.
35. Describe the proper sequence for an actual lowering of the gear by the emergency system.
36. The inertial reel locks automatically when the aircraft is under a linear deceleration of how many g's?
37. What is the maximum quantity of oil that should be consumed during one hour of normal cruise?
- *38. Minimum allowable oil pressure just after starting is 30 psi in 30 seconds.
- *39. The emergency landing gear retract switch bypasses the safety switch and allows the gear to be raised on the deck.
40. What are the limits on the idle mixture and the cruise mixture checks?
- *41. The emergency fuel system will continue to operate with a total electrical failure if it occurs after the emergency fuel system has been activated.
- *42. An overspeed of 2,900 rpm grounds the aircraft for inspection, and an overspeed of 3,380 rpm requires an engine and propeller change.
- *43. The takeoff rpm limits are 2,570 rpm to 2,600 rpm.
- *44. The engine is easily overboosted in positive high pitch.
- *45. If the AFC 53 fuel filter drain is not closed when the battery and fuel boost pump are on, the entire fuel quantity could be drained overboard in 20 minutes or less.
- *46. The directional gyro in the rear cockpit will be caged on all solo flights.
- *47. It is necessary to unlock the canopy prior to blowing it open with the emergency air bottle.
- *48. Low oil pressure will tend to cause a propeller overspeed.
- *49. Starting a warm engine in a strong tailwind could cause a stack fire.
- *50. The landing gear should not be retracted with a flat shock strut.

NEW

NEW

NEW
NEW
NEWNEW
NEW
NEW

NEW

NEW

NEW

PART II — PROCEDURES QUESTIONS.

1. The "S" turn used for power-off approaches should be completed leaving _____ feet straightaway and _____ feet actual altitude.
2. The engine should be cleared at least every _____ feet in a power off descent.
3. The airspeed should be _____ knots or less after rolling inverted and prior to pulling through in the split "S".
4. Airspeed for entering a barrel roll should be _____ knots.
5. The procedure for climbout during full-flap touch-and-go landing practice is _____ knots until flaps up at _____ feet actual altitude, then _____ knots until reaching 1,000 feet.
6. Approximately 1,000 feet of altitude is lost in each 360 degrees of turn in a 30-degree banked spiral. True or False.
7. What are the correct procedures to follow when engine failure occurs after takeoff? (Assume low altitude with emergency fuel system inoperative.)
8. For a minimum run landing, the flaps should be _____ and the airspeed on final should be _____.
9. When is the transition to the 80-knot descent started in full-flap approach?
10. What safety precautions must be observed before performing any stall?
11. Acrobatic cruise is flown at _____ knots, _____ rpm.
12. What instrument should always be checked before adding power when recovering from a spin or an inverted maneuver?
13. The maximum nosewheel touchdown speed is _____.
14. How is the precision spin recovery made?
15. List in order the procedures to be followed in the event of a high altitude engine failure.
16. Do not enter a precision spin under _____ feet.
17. The clean power off stall speed should be _____ 3 knots, while the gear and flaps down, power off stall speed should be _____ 3 knots.
18. What are the procedures for bailout and what is the minimum recommended altitude?
19. How many feet are lost per turn in a spin when the aircraft is clean? When the gear and flaps are down?
20. What is the airspeed on the straightaway during a no-flap landing?

SECTION XI — PERFORMANCE DATA

TABLE OF CONTENTS

Introduction	11-1	Nautical Miles Per Pound of Fuel	11-5
Use of Graphs and Example Flight Plan	11-1	Maximum Range Power Conditions vs. Gross Weight	11-5
Engine Operating Limits	11-2	Maximum Endurance	11-6
Engine Installation Consideration	11-3	Long-Range Prediction — Time — Distance	11-6
Takeoff Distance	11-3	Landing Distance	11-6
Climb Distance Curve	11-4		

INTRODUCTION

The flight performance charts in this section provide data for accurate preflight and inflight planning. Explanations of the use of each graph are included to better enable the pilot to extract flight operating data under varying flight conditions. Aircraft performance shown is representative of normal operation using 80/87 octane fuel. No conservation factors have been introduced to allow for wind, navigation error, combat or formation flight, or other contingencies. Appropriate allowances for such contingencies should be governed by local policy.

All information is based on NACA Standard Atmosphere and U.S. gallons. Fuel flow values are based on flight tests, and normal fuel density of 6.0 pounds per gallon is assumed. Since the airspeed installation error on this aircraft is one knot or less at any speed or configuration, the Airspeed Installation Graph is omitted. If it is desirable to establish a flight plan to which the level flight prediction and summary curves are not directly applicable, the miles-per-pound curves can be used. The graphs are calibrated from sea level to 10,000 feet in 5,000-foot increments. Gross weight parameters range from 2,475 pounds (minimum probable flight weight) to 2,975 pounds (maximum weight). Power settings shown will result in maximum overall operating economy from a standpoint of combined engine, propeller, and aircraft efficiencies. Fuel economy and power settings include the speed range from that recommended for maximum endurance operation to maximum cruising speed with best power.

Note

Fuel consumption curves were originally calculated based on carburetors and nose wheel doors being installed on the aircraft. Fuel controls have replaced carburetors, and nose wheel doors have been removed from all aircraft. Judicious use is recommended for all charts.

The Standard Altitude and Density Altitude Tables (figures 11-1 and 11-2) are included primarily for use with graphs that require this type of information. The altimeter from which pressure altitude is read to determine density altitude must be set at 29.92 inches Hg. Any other setting will result in a false indication of pressure altitude and an error in the determination of density altitude.

USE OF GRAPHS AND EXAMPLE FLIGHT PLAN

A sample problem is given below to clarify use of the charts and may or may not be typical of normal operation. Some flight plans will require more detailed study if maximum efficiency is to be obtained, and others, such as local training flights, will require considerably less planning.

Problem:

Plan a long range prediction mission which is to be flown at 5,000 feet. Takeoff to be made from a sea level field with no wind on a Standard Day.

Known Factors:

Weather	CAVU
Winds	Zero
Basic Weight	2,246 lb.
Personnel Weight (2 men @ 200 lb. each)	400 lb.
Fuel Weight (51 gal. @ 6.0 lb. per gal.)	306 lb.
Oil Weight (3 gal. @ 7.5 lb. per gal.)	23 lb.
TOTAL GROSS WEIGHT	2,975 lb.

Note

The weight at the start of the cruise minus the weight of the cruise fuel available equals the weight at the end of the cruise (i.e., 2,953 - 256 = 2,697).

Enter the graph at 2,697 pounds (weight at the end of cruise), and at the 5,000 feet line in the graph, read the final predicted distance of 910 nautical miles. Subtract the initial distance from the final distance to determine the cruise range (910 - 125 = 785 nautical miles).

TIME, FUEL, AND DISTANCE TO CLIMB.

When computing an actual flight plan, each condition must be treated as a separate problem after allowances have been made for taxi and warmup, climb, wind, and fuel reserve. The takeoff weight is determined by subtracting the fuel used in taxi and warmup (in this case 12 pounds or 2 gallons) from the total gross weight of 2,975 pounds, thus resulting in a takeoff weight of 2,963 pounds.

After weight is computed, it can be determined what fuel will be required, the distance flown, speed, and the time required to climb to the desired altitude by the following procedure:

1. Using the climb distance graph (figure 11-6), enter the climb curve at 2,963 pounds (gross takeoff weight) and follow parallel to guide lines to 5,000 foot position on graph. At this point, read 10 pounds of fuel required to climb to 5,000 feet. Read across to distance during climb and read 9 miles as distance flown during climb.
2. Enter time to climb graph (figure 11-7) at 2,963 pounds and read up to 5,000 feet altitude. Five minutes is the time required to climb to 5,000 feet.
3. Enter climb speed graph (figure 11-8) at sea level and at the 2,963 pound weight line, read 93 knots as the initial climb speed. Determine climb speed at 5,000 feet by entering chart at 5,000 feet and reading climb speed as 87 knots. (This results in a decrease of approximately 1 knot per 1,000 feet.)

LONG RANGE PREDICTION-DISTANCE.

Enter the long range prediction-distance graph (figure 11-15) at 2,953 pounds (weight at start of cruise) and read the initial predicted distance of 125 nautical miles.

LONG RANGE PREDICTION-TIME.

Enter the long range prediction-time graph (figure 11-14) at 2,953 pounds and follow the grid line up to 5,000 feet. Read the initial predicted time as 1 hour. Now enter the graph at 2,697 pounds and follow the grid line to 5,000 feet. Read the final time as 8.3 hours. Subtract the initial time from the final predicted time to obtain a final cruise predicted time of 7.3 hours to cruise 785 nautical miles (8.3 - 1 = 7.3 hours).

The computations, as determined in the preceding paragraphs, can be summarized as follows:

- Total distance flown equals the climb distance (9 miles) plus the cruise distance (785 miles) which equals 794 nautical miles.
- Total mission time equals the climb time (5 minutes) plus the cruise time (7.3 hours) which equals 7.4 hours.

POWER SETTINGS.

Enter the maximum range power vs. gross weight graph (figure 11-12) at the average cruise weight of 2,825 pounds. Read a velocity of 106 knots, an engine rpm of 1,910, and a manifold pressure of 18 inches Hg. Read fuel flow at 35 pounds per hour and nautical miles per pound of fuel at 3.07. (3.07 x 256 (cruise fuel available) = 785 nautical miles which is in agreement with the long range prediction graph).

For non-standard temperature conditions, performance may be approximated by using the density altitude, as determined from the standard altitude table, rather than pressure altitude.

ENGINE OPERATING LIMITS.

The engine operating limits graph (figure 11-3) is the manufacturer's calibration of the 0-470-4 engine. As such, it is the basic graph from which approved settings of the engine controls, within engine limitations, may be

determined for any operating condition. The graph is based on NACA Standard Day operating conditions as defined by the Standard Altitude Table and is directly applicable only with such conditions at the fuel control intake. Corrections for other atmospheric conditions and for "ram" may be made. These are applicable to all types of operation. In brief, the engine operating limits graph is divided into two major parts: sea level calibration and altitude calibration.

SAMPLE PROBLEM FOR ENGINE OPERATING LIMITS.

Known Factors:

Pressure altitude
Manifold pressure
RPM
Free air temperature

To find:

The actual horsepower, under non-standard conditions.

For a non-standard condition, to find the actual horsepower which the engine will develop when the above factors are known, use dotted line example in the engine operating limits graph (figure 11-3) as follows:

Locate position "A" on the altitude graph for the known rpm and manifold pressure. Locate "B" on the sea level graph for the same rpm and manifold pressure and transfer this position to "C" on the altitude graph. Draw a straight line from "C" through "A" and read the horsepower at the observed density altitude of flight (point "D" in the example). Correct the horsepower reading in accordance with the known free air temperature by adding one percent for each 6°C decrease from standard altitude temperature or subtracting one percent for 6°C increase from standard altitude temperature.

ENGINE INSTALLATION CONSIDERATION.

The engine operating limits graph is based on a zero ram calibration; that is, the calibration is made with ambient static pressure and temperature which exists at the fuel control inlet. The ducting required to install the engine in the aircraft alters these pressures slightly from the ambient conditions when the engine is run, as does the operating flight condition. This deviation from a standard calibration condition affects the altitude-power characteristics of the engine. This difference in performance is commonly referred to as a "ram" condition since normal flight speeds usually result in an

increase in fuel control inlet pressure over ambient static and thereby an increase in altitude at which full throttle occurs for a particular rpm setting. However, since the ram critical altitude in this aircraft, as determined by flight tests, is less than 200 feet, it may be disregarded in all normal operations.

TAKEOFF DISTANCE.

Aside from pilot technique, the major variables which will affect takeoff performance are gross weight, power available, altitude (field) and the ambient air temperature. In addition, rather large effects can be attributed to humidity and wind velocity. By adhering to the recommended takeoff procedure, the performance, shown by the takeoff distances graphs (figures 11-4 and 11-5), can be obtained. Normal takeoff distances and the distance to take off and clear a 50-foot obstacle are shown for various gross weights, altitude, specific humidity and wind conditions. Non-standard temperatures and conditions of high humidity have a decided effect on takeoff performance.

SAMPLE PROBLEM OF TAKEOFF DISTANCE

Known Factors:

Loaded gross weight — 2,787 pounds
Field pressure altitude — 1,000 feet
Air temperature — 20°C
Specific humidity — 0.01
Headwind — 10 knots
Runway — Hard level surface

To find:

The takeoff distance required under a normal operating procedure (figure 11-4).

To find the normal takeoff distance, subtract the warmup, taxi, and takeoff fuel allowance of 12 pounds from the loaded gross weight. This will result in a takeoff weight of 2,775 pounds. Use the broken line example in the takeoff distances graph (figure 11-4) and estimate the ground roll distance for a normal takeoff as follows:

Enter the chart at (1) 20°C and follow the grid lines vertically to (2) 1,000 feet pressure altitude. Read the field density altitude at (3) which is 1,800 feet. Follow the horizontal grid lines to the interpolated position of the takeoff weight line (4) 2,775 pounds, and read the standard ground roll distance at (5) 1,120 feet. Enter the specific humidity graph and proceed parallel to the guidelines to 0.01 specific humidity, then down to (6) where the ground roll with zero wind is 1,210 feet. Follow

the guide line to the 10-knot headwind position, then down to (7) where the corrected ground roll distance reads 980 feet.

To find:

The takeoff distance required to take off and clear a 50-foot obstacle (figure 11-5).

To find the takeoff distance required to clear a 50-foot obstacle, subtract the warmup, taxi, and takeoff fuel allowance of 12 pounds from the loaded gross weight. This will result in a take-off weight of 2,775 pounds. Use the broken line example in the obstacle clearance takeoff distances graph (figure 11-5) to estimate the distance required to clear a 50-foot obstacle for a normal takeoff as follows:

Enter the chart at (1) 20°C and follow the grid lines vertically to (2) 1,000 feet pressure altitude. Read the field density altitude at (3) which is 1,800 feet. Follow the horizontal grid lines to the interpolated position of the takeoff weight line at (4) 2,775 pounds, and read the standard distance to clear a 50-foot obstacle at (5) which is 1,520 feet. Enter the specific humidity graph and proceed parallel to the guide lines to 0.01 specific humidity then down to (6) where the distance of 1,640 feet with zero wind is read. Follow the guide line to the 10-knot headwind position then down to (7) where the corrected distance required to clear a 50-foot obstacle is read as 1,300 feet.

CLIMB DISTANCE CURVE.

The climb curves for time, speed, and distance, as shown in the climb distance graph (figure 11-6), the climb curve time graph (figure 11-7), and the climb speed graph (figure 11-8), give the time, fuel, and distance to climb at normal-rated power for all aircraft gross weights. The data shown represents the optimum performance which can be expected. This performance can be realized if the aircraft is flown in the clean configuration at the designated speed schedule. The effect of nonstandard temperatures on climb performance may be approximated by entering the graphs at density altitude.

SAMPLE PROBLEM OF CLIMB DISTANCE

Known Factors:

Loaded gross weight — 2,912 pounds
Field pressure altitude — sea level
(Standard Day)
Climb to 10,000 feet pressure altitude with the aircraft weight diminishing as fuel is consumed.

To find:

The distance flown during the climb to 10,000 feet pressure altitude at normal power (figure 11-6).

To find the climb distance at normal power, subtract the warmup, taxi, and takeoff fuel allowance of 12 pounds from the loaded gross weight to arrive at the takeoff weight of 2,900 pounds. Use the broken line example in the climb distance graph (figure 11-6) and compute the climb distance as follows:

Enter the distance graph at (1) 2,900 pounds takeoff weight and follow parallel to the guide lines to (2) 10,000 feet, where the gross weight reads 2,882 pounds. Follow the horizontal grid line to (3) and read distance during climb as 18 nautical miles.

SAMPLE PROBLEM OF CLIMB TIME

Known Factors:

Loaded gross weight — 2,912 pounds
Field pressure altitude — sea level
(Standard Day)
Climb to 10,000 feet pressure altitude with the weight of the aircraft diminishing as fuel is consumed.

To find:

The time required to climb to 10,000 feet pressure altitude (figure 11-7).

To find the time required to climb to 10,000 feet pressure altitude, subtract the warmup, taxi, and takeoff fuel allowance of 12 pounds from the loaded gross weight to arrive at the takeoff weight of 2,900 pounds. Use the broken line example in the climb time graph (figure 11-7) and compute the climb time as follows:

Enter the time graph at (1) 2,900 pounds, and follow parallel to the guide lines to (2) 10,000 feet. From this point follow the horizontal grid line to (3) and read the time elapsed during the climb which is 11.5 minutes.

SAMPLE PROBLEM OF CLIMB SPEED.

Known Factors:

Loaded gross weight — 2,912 pounds
Field pressure altitude — sea level
(Standard Day)
Climb to 10,000 feet pressure altitude with the aircraft weight diminishing as fuel is consumed.

To find:

The climb speed to be used at sea level, 5,000 feet, and 10,000 feet pressure altitude.

To find the climb speed at sea level, first subtract the warmup, taxi, and takeoff fuel allowance of 12 pounds from the loaded gross weight to arrive at the takeoff weight of 2,900 pounds. Using the broken line example in the climb speed graph (figure 11-8), compute the climb speed by entering the graph at (1) sea level, and following the grid horizontally to (2) 2,900 pounds. Read the climb speed at (2) which is 93 knots. For 5,000 feet, enter the graph at (3) and follow the grid line horizontally to (4) 2,891 pounds. Follow the vertical grid line to (5) and read 87 knots climb speed. For 10,000 feet, enter the graph at (6) and follow the grid line horizontally to (7) 2,882 pounds. Follow the vertical grid line to (8) and read 81 knots climb speed.

NAUTICAL MILES PER POUND OF FUEL.

The summary curve graphs included in this section can be used directly in the preparation of most types of flight plans as outlined in the previous problems. However, if it is desirable to establish a plan for operation to which these curves are not directly applicable, the nautical miles per pound of fuel curves can be used (figures 11-9, 11-10 and 11-11). These graphs provide data for altitudes at sea level, 5,000 feet and 10,000 feet. The gross weight parameters range from 2,475 pounds, the minimum probable gross weight, to 2,975 pounds, the maximum probable gross weight. Power settings shown will result in maximum overall operating economy from a standpoint of combined engine, propeller, and aircraft efficiencies. The specific fuel consumption in this section is based on a power setting using full RICH mixture. Some variations from the values shown may be expected as a result of the fuel control, which incorporates an altitude compensator that automatically leans the mixture to compensate for variations in altitude. Refer to the miles per pound of fuel curves for a comparison of maximum range power vs. gross weight (figure 11-12) and true airspeed values with those for the maximum endurance (figure 11-13) at various altitudes. Refer to long-range prediction graphs (figures 11-14 and 11-15) for a comparison of zero wind ranges available with various fuel loads, loaded gross weights, and cruising altitudes.

SAMPLE PROBLEM FOR NAUTICAL MILES PER POUND OF FUEL AT 5,000-FOOT ALTITUDE.

Known Factors:

Calibrated air speed — 140 knots
Altitude — 5,000 feet

To find:

The specific range in nautical miles per pound of fuel consumed at 5,000 foot altitude (figure 11-10).

Locate 140 knots, calibrated airspeed at (1), read into the graph along the broken vertical line to 2,775 pound gross weight curve, (2) which indicates a manifold pressure of 24.50 inches Hg., and 2,340 rpm engine speed. From position (2) read out of the graph along the broken horizontal line to (3) which shows 1.85 pounds of fuel per nautical mile.

MAXIMUM RANGE POWER CONDITIONS VS. GROSS WEIGHT

The maximum range cruise performance which can be obtained is a function of many variables, such as airspeed, gross weight, mixture setting, altitude and temperature. Each or all variables have an important effect on overall performance which can be expressed in terms of distance flown per unit of fuel used, or fuel economy, which is a direct measure of the efficiency with which the aircraft is being operated. The graphs, maximum range power conditions (figure 11-12) and maximum endurance (figure 11-13) are used to establish level flight cruise control procedures. The figures shown on the graphs represent stabilized values which can be expected in level flight. It is important that altitude be held constant in order to realize these speeds. In all cases, use aircraft gross weight and pressure altitude as the basis for power settings. Keep a log of fuel used in order to determine gross weight variations in flight and determine a power setting by using an engine speed which will result in the most economical performance of the aircraft. Level flight prediction and summary curves are presented for normal operation which include long range and maximum endurance.

SAMPLE PROBLEM FOR MAXIMUM RANGE POWER CONDITIONS.

Known Factors:

Gross weight — 2,775 pounds
Pressure altitude — 5,000 feet

To find:

The maximum range power conditions at 5,000 feet with a gross weight of 2,775 pounds at start of cruise. Use the broken line example in maximum range power conditions (figure 11-12) as follows:

Locate 2,775 pounds, initial gross weight at the start of the cruise at (1), read into the graph to (2) 5,000 foot altitude, then over to (3) which gives a calibrated airspeed of 105 knots. Continue reading up the vertical broken line to (4) and using the 5,000 foot altitude calibration, read across to (5) which indicates an engine speed of 1,900 rpm at this gross weight. Continue reading up the vertical broken line to (6) at 5,000 feet, then over to (7) which gives a manifold

pressure reading of 17.80 inches Hg. Fuel flow is determined by reading on up to (8) at 5,000 feet altitude and over to (9) which shows a pounds per hour fuel flow at 34.6 pounds. To determine specific fuel consumption read up the graph to (10), then over to (11) which shows 3.05 nautical miles per pound of fuel.

MAXIMUM ENDURANCE.

The maximum endurance cruising performance which can be obtained is a function of the same variables as those which affect the maximum range performance, except that the time flown per unit of fuel used is the measure of efficiency for this type of operation. This graphical presentation (figure 11-13) is representative of practical flight conditions which permit operation in mild to moderate turbulence. The extension of wing flaps will reduce the speed for maximum endurance, but it will also tend to decrease the endurance time available.

SAMPLE PROBLEM FOR MAXIMUM ENDURANCE.

Known Factors:

Gross weight — 2,775 pounds
Altitude — 5,000 feet

To find:

The maximum endurance at 5,000 feet with 2,775 pounds gross weight at start of the cruise. Use broken line example in maximum endurance (figure 11-13) as follows:

Locate 2,775 pounds, initial gross weight at start of cruise at (1) and read into the graph to (2) 5,000-foot altitude. From this point read over to (3) which gives a calibrated airspeed of 70 knots. Continue up the vertical broken line to (4) and then read across to (5) which indicates an engine speed of 1,900 rpm at this altitude and gross weight. Continue reading up the vertical broken line to (6) at 5,000 feet, then over to (7) which gives a manifold pressure reading of 15.80 inches Hg. Fuel flow is determined by reading on up to (8) at 5,000 feet altitude and over to (9) which shows a pounds per hour fuel flow of 29.6 pounds. All necessary flight operating data has now been determined.

LONG-RANGE PREDICTION — TIME — DISTANCE.

These graphs are to be coordinated and used in conjunction with long range performance graphs, maximum range (figure 11-12) and maximum endurance (figure 11-13). When the weight increments have been selected for a particular operation, it is desirable to use

power settings within these weight brackets corresponding to those shown on the graphs. This insures that average aircraft performance during such periods will closely resemble and correspond to predicted graph values for the weight increments chosen. With due consideration to all other variables, power settings should be chosen by using an engine speed which results in the most economical operation of the aircraft. However, 1,600 rpm is the lowest practical engine speed which should be used. The Long-Range Prediction — Time — Distance graphs (figures 11-14 and 11-15) are based on recommended cruising speeds shown on the nautical miles per pound of fuel graphs (figures 11-9, 11-10, and 11-11).

SAMPLE PROBLEM FOR LONG-RANGE PREDICTION — DISTANCE — TIME.

Known Factors:

Initial gross weight — 2,900 pounds.
Pressure altitude — 10,000 feet.
Allowable cruise fuel — 200 pounds.

To find:

The maximum range in distance and time with an initial gross weight of 2,900 pounds at 10,000 feet pressure altitude and 200 pounds of cruise fuel. The following is an example for standard conditions.

Enter the long range distance prediction graph (figure 11-15) at initial cruise weight (1) 2,900 pounds, then vertical to (2) 10,000 feet which is the cruise altitude, then follow the horizontal grid line to (3) and read 220 nautical miles. Now enter the distance chart at the final cruise weight (4) 2,700 pounds, then vertical to (2) 10,000 feet, and horizontal to (5) and read 800 nautical miles. Then 800 minus 220 is equal to the predicted long range distance of 580 miles. To find the long-range time prediction (figure 11-14), enter the chart at the initial cruise weight (1) 2,900 pounds, then vertical to (2) 10,000 feet which is the cruise altitude, then follow the horizontal grid line to (3) and read 1.70 hours. Now enter the time chart at the final cruise weight (4) 2,700 pounds, then vertical to (2) 10,000 feet and horizontal to (5) and read 6.70 hours. The difference, 6.70 minus 1.70 is equal to the predicted long-range time prediction of 5.00 hours.

LANDING DISTANCE.

Graphs showing normal landing ground distances for various gross weights, altitudes, and winds are shown in figure 11-16. Values given represent stopping distances which are obtainable if moderately hard wheel braking is used without allowing the tires to skid, and provided schedules shown are observed. A power-on approach procedure may be used to reduce touchdown speeds and

ground roll distances from those in the graph. A power-on approach procedure is not recommended unless warranted by an extremely short runway with a long, clear approach path.

SAMPLE PROBLEM FOR LANDING DISTANCE.

Known Factors:

Gross weight — 2,675 pounds.
Pressure altitude — 2,000 feet.

To find:

The landing distance using the above known values and assuming there is zero wind. Enter the pressure altitude graph of figure 11-16 at (1) 2,000 feet, and follow the grid line horizontally to the right to (2) 2,675 pounds gross weight. From this point, read down the broken line to (3) zero wind and continue on down to (4) which gives the ground roll distance of 406 feet with no wind. Assuming there is a 10-knot headwind, from (3) follow the guide line to (5) 10-knot headwind position, and on down to (6) which gives a ground roll distance of 287 feet with 10-knot headwind.

STANDARD ALTITUDE TABLE

Standard Sea Level Air:

T = 15° C.

W = .07651 lb./cu. ft.

= .002378 slugs/cu. ft.

P = 29.921 in. of Hg.

1" of Hg. = 70.732 lb./sq. ft. = 0.4912 lb./sq. in.

This table is based on NACA Technical Report No. 218 ao - 1116 ft./sec.

Altitude Feet	Density Ratio	σ	Temperature		Speed of Sound Ratio a/ao	Pressure	
			Deg. C	Deg. F		In. of Hg.	Ratio P/Po
0	1.0000	1.0000	15.000	59.000	1.0000	29.92	1.0000
1000	.9710	1.0148	13.019	55.434	.997	28.86	.9644
2000	.9428	1.0299	11.038	51.868	.993	27.82	.9298
3000	.9151	1.0454	9.056	48.301	.990	26.81	.8962
4000	.8881	1.0611	7.075	44.735	.986	25.84	.8636
5000	.8616	1.0773	5.094	41.169	.983	24.89	.8320
6000	.8358	1.0938	3.113	37.603	.979	23.98	.8013
7000	.8106	1.1107	1.132	34.037	.976	23.09	.7716
8000	.7859	1.1280	-0.850	30.471	.972	22.22	.7427
9000	.7619	1.1456	-2.831	26.904	.968	21.38	.7147
10000	.7384	1.1637	-4.812	23.338	.965	20.58	.6876
11000	.7154	1.1822	-6.793	19.772	.962	19.79	.6614
12000	.6931	1.2012	-8.774	16.206	.958	19.03	.6359
13000	.6712	1.2206	-10.756	12.640	.954	18.29	.6112
14000	.6499	1.2404	-12.737	9.074	.950	17.57	.5873
15000	.6291	1.2608	-14.718	5.507	.947	16.88	.5642
16000	.6088	1.2816	-16.699	1.941	.943	16.21	.5418
17000	.5891	1.3029	-18.680	-1.625	.940	15.56	.5202
18000	.5698	1.3247	-20.662	-5.191	.936	14.94	.4992
19000	.5509	1.3473	-22.643	-8.757	.932	14.33	.4790
20000	.5327	1.3701	-24.624	-12.323	.929	13.75	.4594
21000	.5148	1.3937	-26.605	-15.890	.925	13.18	.4405
22000	.4974	1.4179	-28.586	-19.456	.922	12.63	.4222
23000	.4805	1.4426	-30.568	-23.022	.917	12.10	.4045
24000	.4640	1.4681	-32.549	-26.588	.914	11.59	.3874
25000	.4480	1.4940	-34.530	-30.154	.910	11.10	.3709
26000	.4323	1.5209	-36.511	-33.720	.906	10.62	.3550
27000	.4171	1.5484	-38.493	-37.287	.903	10.16	.3397
28000	.4023	1.5768	-40.474	-40.853	.899	9.720	.3248
29000	.3879	1.6056	-42.455	-44.419	.895	9.293	.3106
30000	.3740	1.6352	-44.436	-47.985	.891	8.880	.2968
31000	.3603	1.6659	-46.417	-51.551	.887	8.483	.2834
32000	.3472	1.6971	-48.399	-55.117	.883	8.101	.2707
33000	.3343	1.7295	-50.379	-58.684	.879	7.732	.2583
34000	.3218	1.7628	-52.361	-62.250	.875	7.377	.2465
35000	.3098	1.7966	-54.342	-65.816	.871	7.036	.2352
36000	.2962	1.8374	-55.000	-67.000	.870	6.708	.2242
37000	.2824	1.8818	-55.000	-67.000	.870	6.395	.2137
38000	.2692	1.9273	-55.000	-67.000	.870	6.096	.2037
39000	.2566	1.9738	-55.000	-67.000	.870	5.812	.1943
40000	.2447	2.0215	-55.000	-67.000	.870	5.541	.1852
41000	.2332	2.0707	-55.000	-67.000	.870	5.283	.1765
42000	.2224	2.1207	-55.000	-67.000	.870	5.036	.1683
43000	.2120	2.1719	-55.000	-67.000	.870	4.802	.1605
44000	.2021	2.2244	-55.000	-67.000	.870	4.578	.1530
45000	.1926	2.2785	-55.000	-67.000	.870	4.364	.1458
46000	.1837	2.3332	-55.000	-67.000	.870	4.160	.1391
47000	.1751	2.3893	-55.000	-67.000	.870	3.966	.1325
48000	.1669	2.4478	-55.000	-67.000	.870	3.781	.1264
49000	.1591	2.5071	-55.000	-67.000	.870	3.604	.1205
50000	.1517	2.5675	-55.000	-67.000	.870	3.436	.1149

Figure 11-1. Standard Altitude Table

DENSITY ALTITUDE CHART

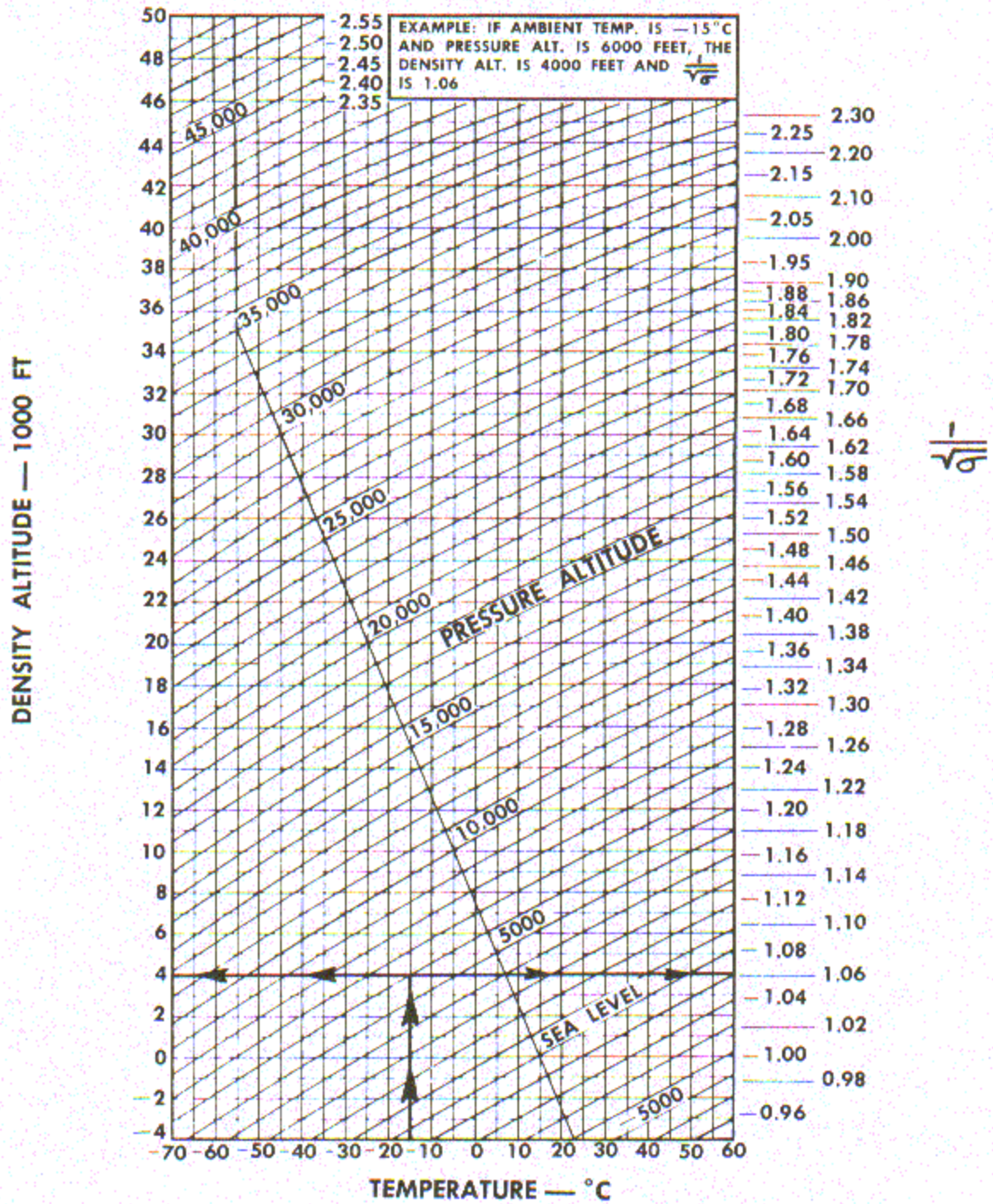

Figure 11-2. Density Altitude Chart

PSYCHROMETRIC CHART

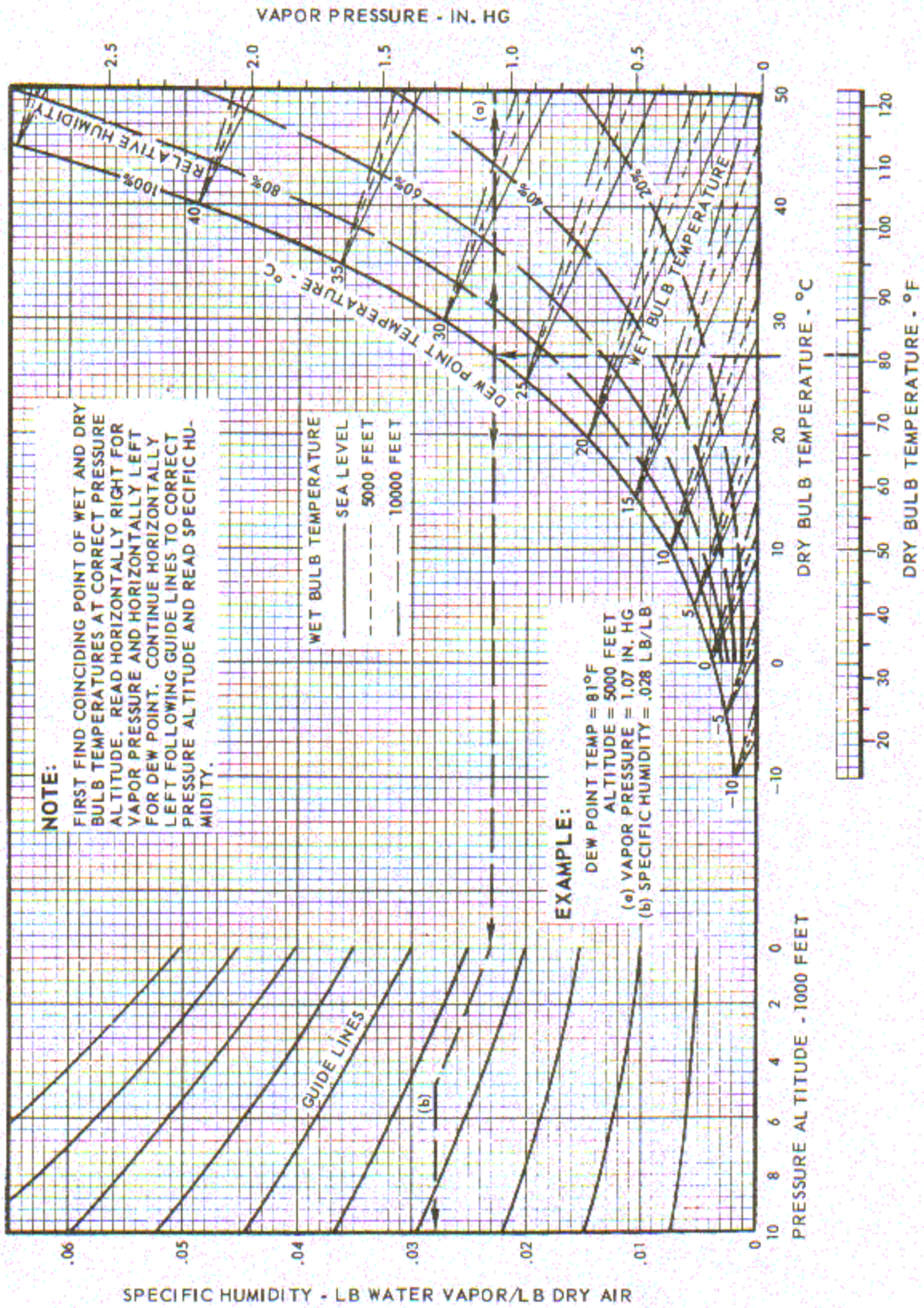

Figure 11-2A. Psychrometric Chart

ENGINE OPERATING LIMITS

SEA LEVEL PERFORMANCE

HORSEPOWER VS. MANIFOLD PRESSURE

TO FIND ACTUAL HP WHEN GIVEN PRESSURE, ALTITUDE, MANIFOLD PRESS., RPM & FREE AIR TEMP.

1. LOC. POSITION "A" ON ALT. CURVE FOR GIVEN RPM AND MANIFOLD PRESS.
2. LOC. "B" ON SEA LEVEL PERFORMANCE CURVE FOR SAME RPM & MAN. PRESS. TRANSFER POSITION TO "C."
3. DRAW STRAIGHT LINE FROM "C" THRU "A" & READ HP AT OBSERVED DENSITY ALT. OF FLIGHT (POINT "D" IN EXAMPLE).
4. CORRECT HP IN ACCORDANCE WITH FREE AIR TEMP BY APPLYING THE FOLLOWING:
 (A) ADD 1% FOR EACH 6°C DECREASE FROM TS
 (B) SUBTRACT 1% FOR EACH 6°C INCREASE FROM TS
 (TS = STANDARD ALTITUDE TEMP.)

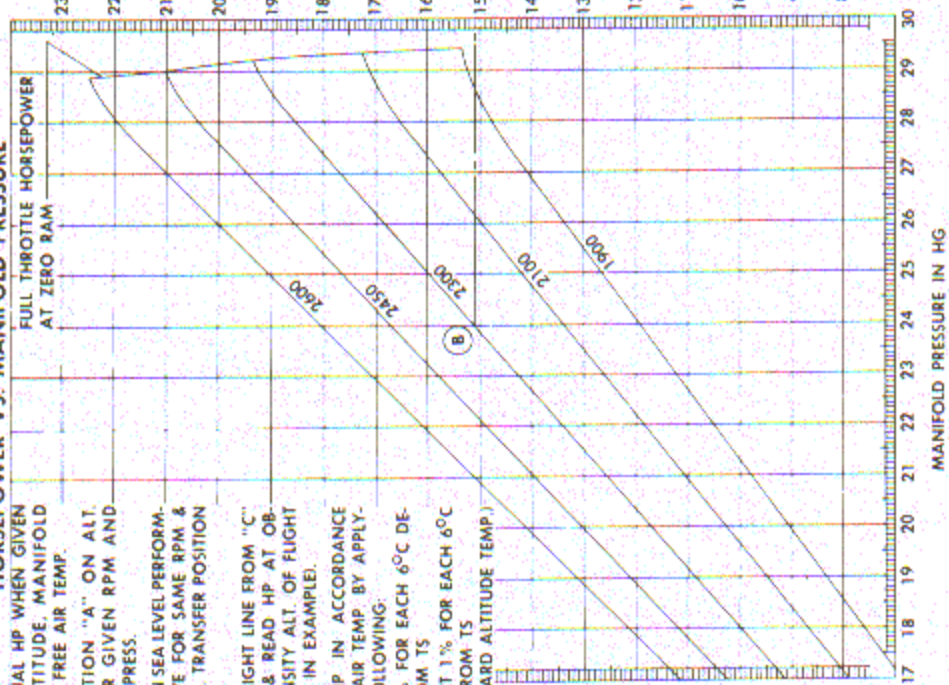

ALTITUDE PERFORMANCE

HORSEPOWER AND MANIFOLD PRESSURE WITHOUT RAM SUBJECT TO ±2½% VARIATION

ENGINE MODEL: 0-470-4
 PROP GEAR RATIO: 1:1
 FUEL METERING: P.S.5CD
 FUEL GRADE: 80/87

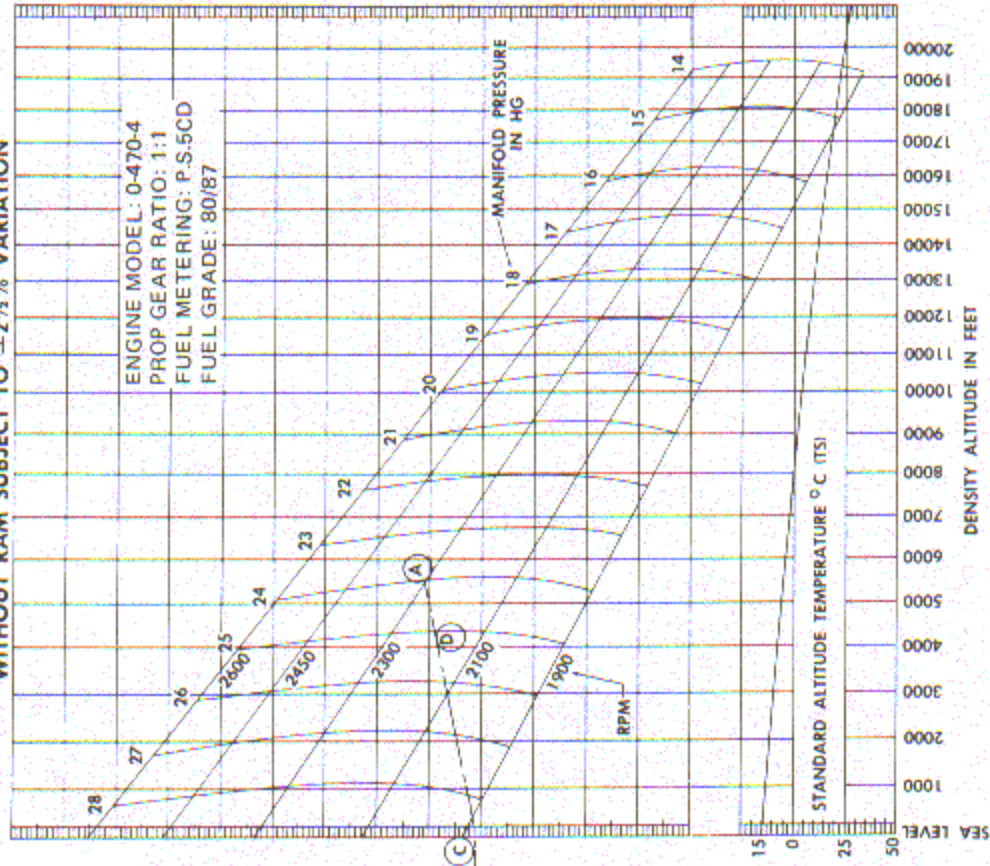

FUEL GRADE: 80/87
 FUEL DENSITY: 6 LB/GAL

DATA AS OF: FEBRUARY, 1954

DATA BASED ON: PHASE IV FLIGHT TESTS

Figure 11-3. Engine Operating Limits

TAKEOFF DISTANCES
HARD SURFACE RUNWAY
TAKE OFF POWER - 0% FLAPS

MODEL T-34B

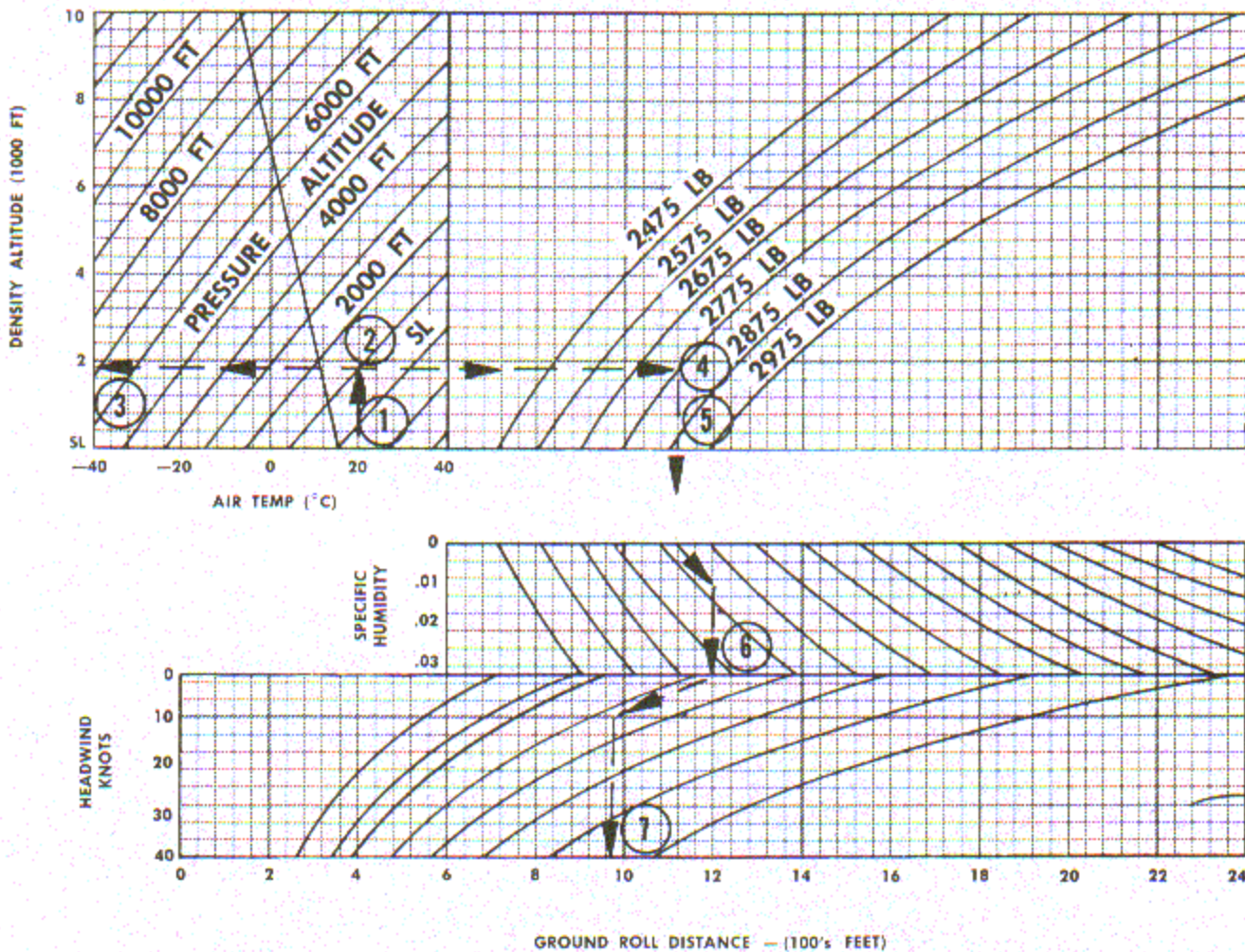
ENGINE: (1)
NO. 0-470-4**EXAMPLE:**

- ① OUTSIDE AIR TEMPERATURE (20° C)
- ② PRESSURE ALTITUDE (1000 FT)
- ③ DENSITY ALTITUDE (1800 FT)
- ④ TAKE OFF GROSS WEIGHT (2775 LB)
- ⑤ STANDARD GROUND ROLL (1120 FT)
- ⑥ GROUND ROLL WITH HUMIDITY POWER LOSS (1210 FT)
- ⑦ CORRECTED GROUND ROLL WITH WIND (980 FT)

REMARKS: HUMIDITY CORRECTION PORTION OF CHART IS VALID PER FULL THROTTLE ONLY.

DATA AS OF: FEBRUARY, 1954

FUEL GRADE: 80/87

DATA BASED ON: PHASE IV FLIGHT TESTS

FUEL DENSITY: 6 LB/GAL

Figure 11-4. Takeoff Distances

OBSTACLE CLEARANCE TAKEOFF DISTANCES

HARD SURFACE RUNWAY
TAKE OFF POWER - 0% FLAPS

MODEL T-34B

ENGINE: (1)
NO. 0-470-4

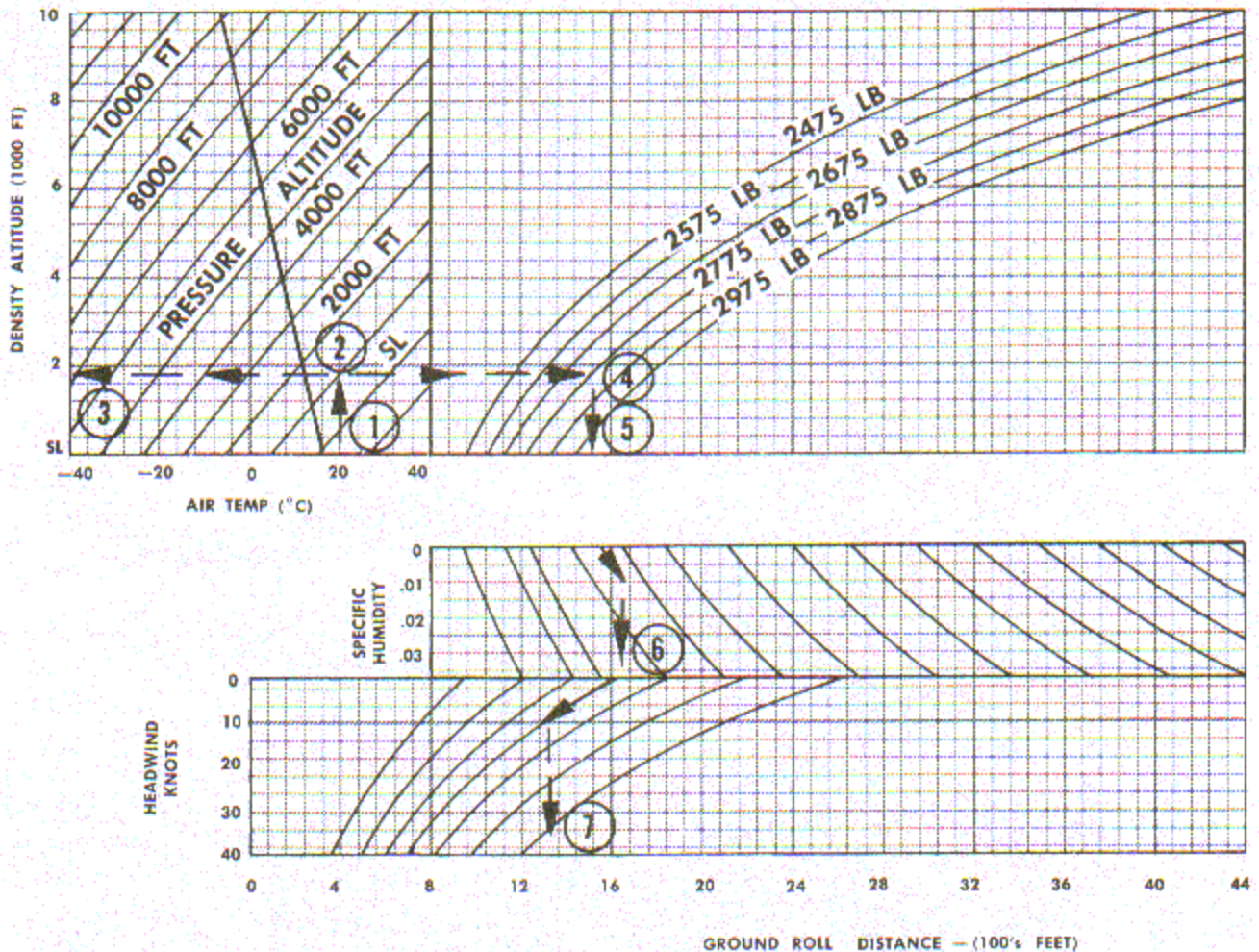

EXAMPLE:

- ① OUTSIDE AIR TEMPERATURE (20° C)
- ② PRESSURE ALTITUDE (1000 FT)
- ③ DENSITY ALTITUDE (1800 FT)
- ④ TAKE OFF GROSS WEIGHT (2775 LB)
- ⑤ STANDARD DISTANCE OVER 50-FT (1520 FT)
- ⑥ DISTANCE OVER 50-FT WITH HUMIDITY POWER LOSS (1640 FT)
- ⑦ CORRECTED DISTANCE OVER 50-FT WITH WIND (1300 FT)

REMARKS: HUMIDITY CORRECTION PORTION OF CHART IS VALID PER FULL THROTTLE ONLY.

DATA AS OF: FEBRUARY, 1954
DATA BASED ON: PHASE IV FLIGHT TESTS

FUEL GRADE: 80/87
FUEL DENSITY: 6 LB/GAL

Figure 11-5. Obstacle Clearance Takeoff Distances

**NORMAL RATED POWER CLIMB
DISTANCE
STANDARD DAY - CLEAN CONFIGURATION**

MODEL T-34B

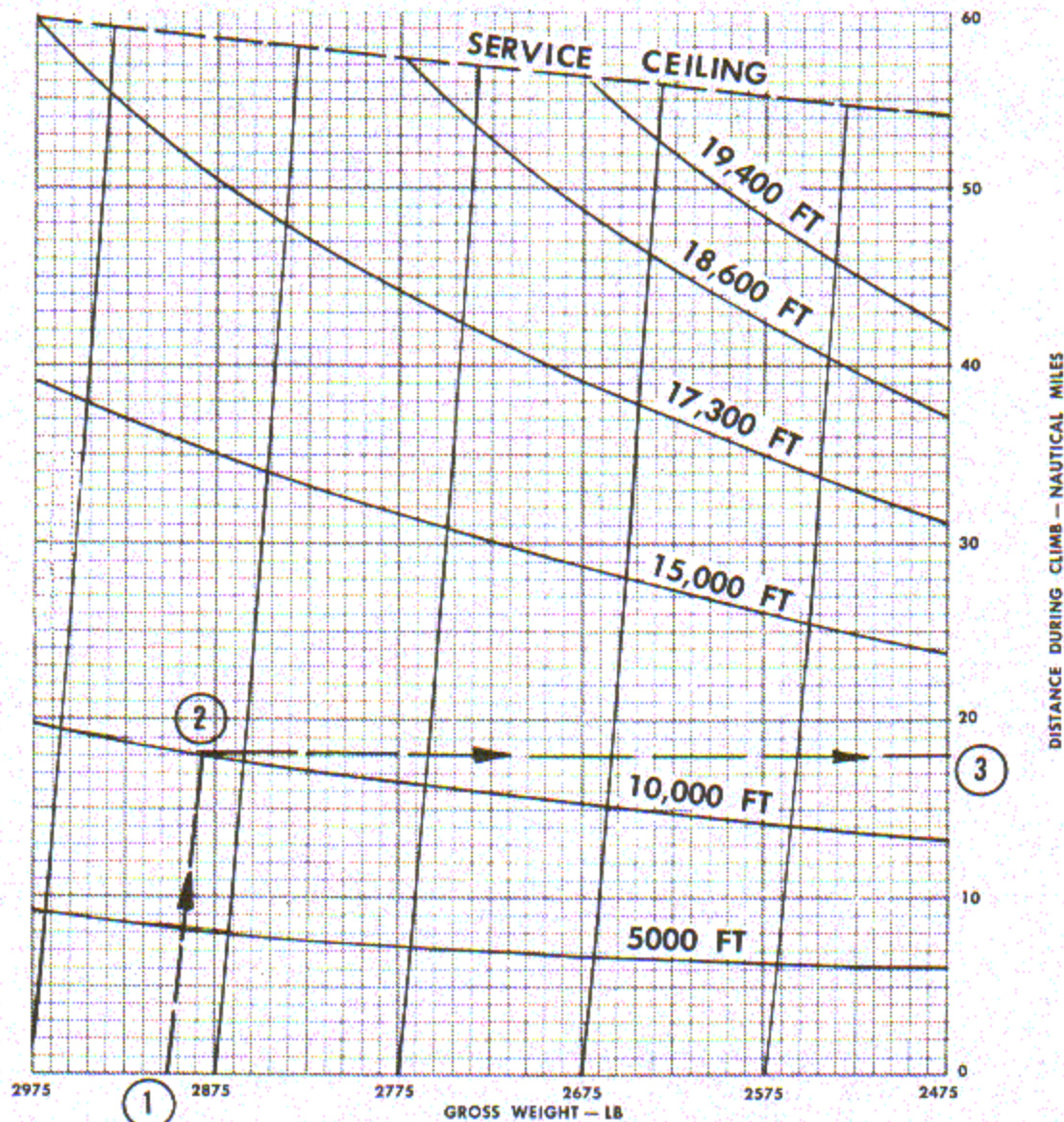
ENGINE: (1)
NO. 0-470-4

**EXAMPLE FOR CLIMB CURVE
(DISTANCE)**

- 1 TAKE OFF GROSS WEIGHT (2900 LB)
- 2 ALTITUDE (10,000 FT)
- 3 DISTANCE DURING CLIMB TO 10,000 FT (18 MI)

REMARKS: 1. FOR EACH 1° C HOTTER THAN STANDARD OAT, ADD 25 LB TO ACTUAL AIRPLANE GROSS WEIGHT TO OBTAIN AN EQUIVALENT WEIGHT FOR CLIMB DETERMINATION.

2. FOR CLIMB SPEEDS, SEE CLIMB SPEEDS CURVE.

DATA AS OF: FEBRUARY, 1954

DATA BASED ON: PHASE IV FLIGHT TESTS

FUEL GRADE: 80/87

FUEL DENSITY: 6 LB/GAL

Figure 11-6. Normal Rated Power Climb - Distance

**NORMAL RATED POWER CLIMB
TIME
STANDARD DAY - CLEAN CONFIGURATION**

MODEL T-34B

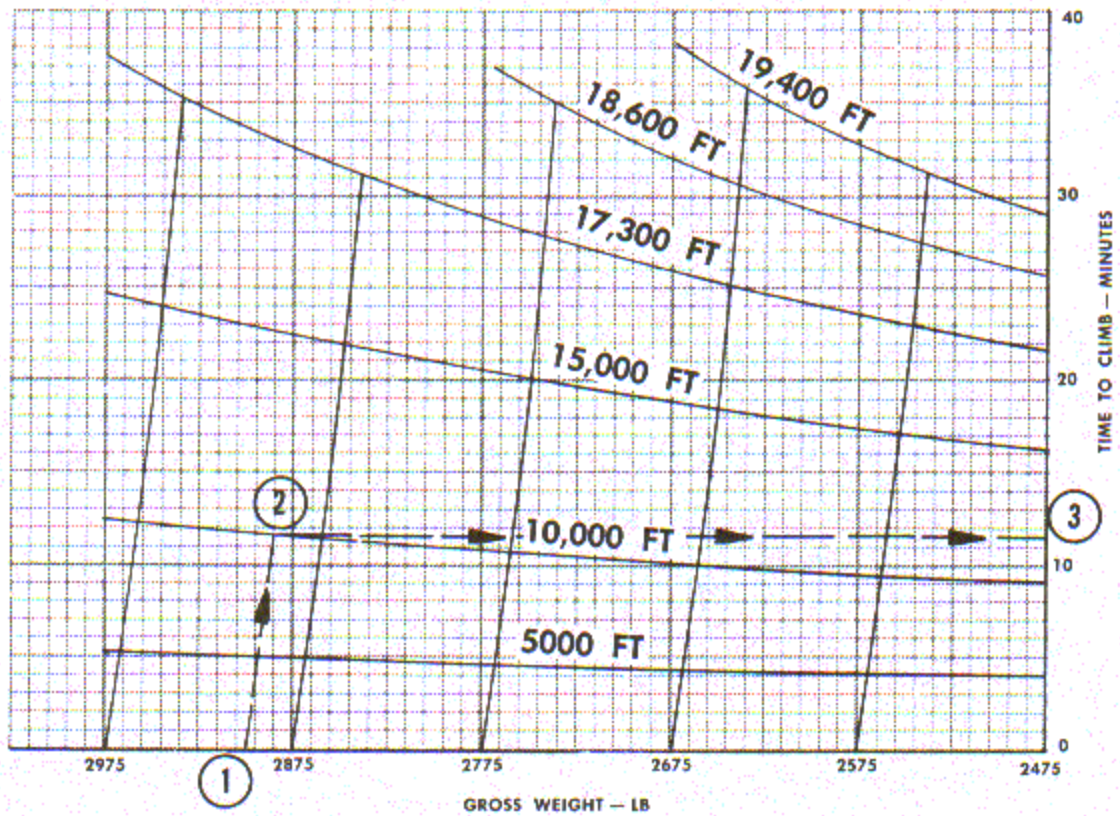
ENGINE: (1)
NO. 0-470-4**EXAMPLE FOR CLIMB CURVE (TIME)**

- ① TAKE OFF GROSS WEIGHT (2900 LB)
- ② ALTITUDE (10,000 FT)
- ③ TIME TO CLIMB TO 10,000 FT (11.5 MIN)

REMARKS: 1. FOR EACH 1° C HOTTER THAN STANDARD OAT, ADD 25 LB TO ACTUAL AIRPLANE GROSS WEIGHT TO OBTAIN AN EQUIVALENT WEIGHT FOR CLIMB DETERMINATION.

2. FOR CLIMB SPEEDS, SEE CLIMB SPEED CURVE.

DATA AS OF: FEBRUARY, 1954

FUEL GRADE: 80/87

DATA BASED ON: PHASE IV FLIGHT TESTS

FUEL DENSITY: 6 LB/GAL

Figure 11-7. Normal Rated Power Climb - Time

CLIMB SPEED

STANDARD DAY - CLEAN CONFIGURATION

MODEL T-34B

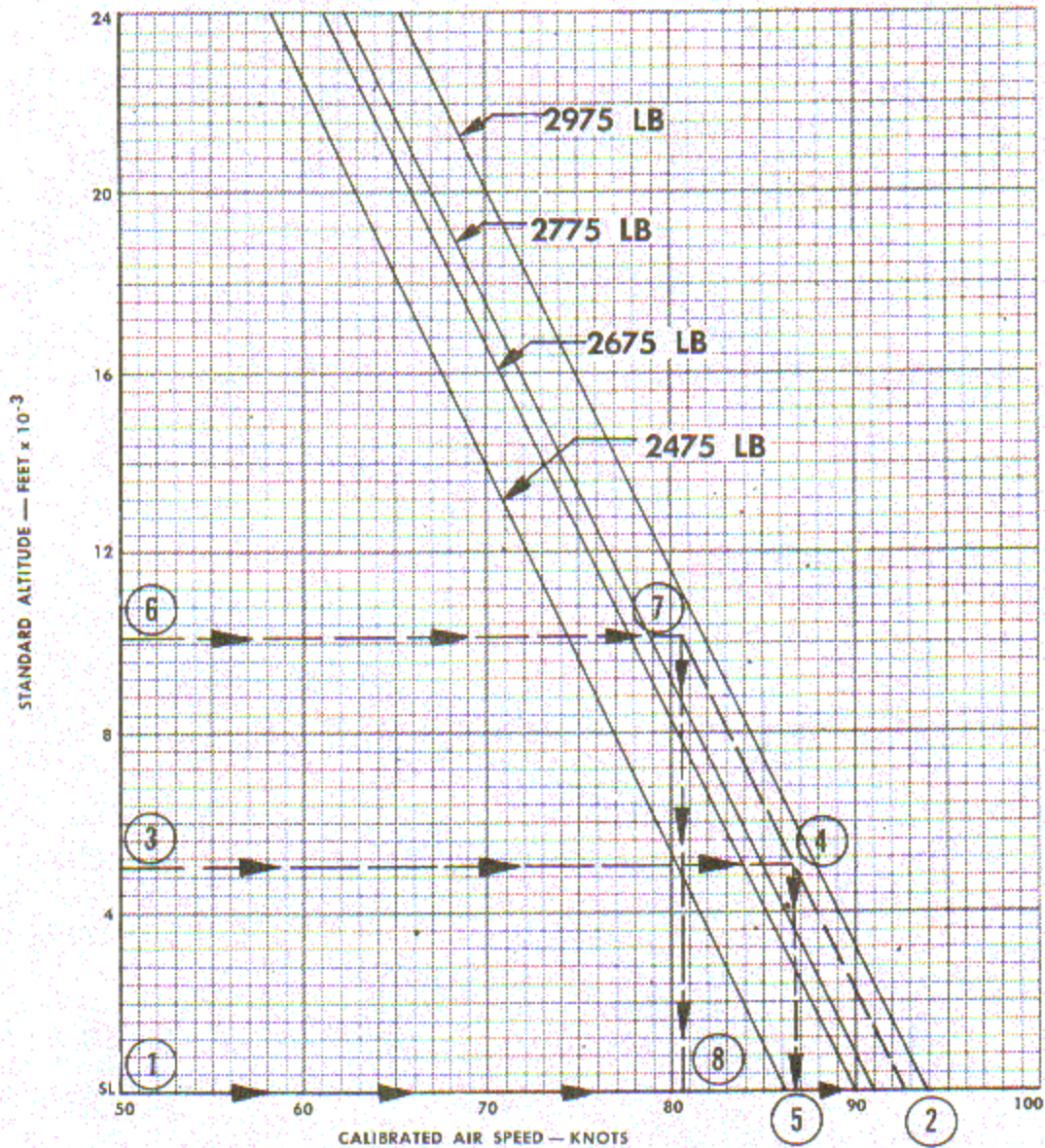
ENGINE: (1)
NO. 0-470-4

EXAMPLE FOR CLIMB CURVE (SPEED)

- | | |
|--|--|
| <ul style="list-style-type: none"> ① TAKE OFF ALTITUDE (SEA LEVEL) ② TAKE OFF GROSS WEIGHT (2900 LB) AND CLIMB VELOCITY AT SEA LEVEL (93 KNOTS) ③ ANY ALTITUDE (5000 FT IN THIS EXAMPLE) ④ CLIMB WEIGHT AT 5000 FT (2891 LB) | <ul style="list-style-type: none"> ⑤ CLIMB SPEED AT 5000 FT (87 KNOTS) ⑥ TOP OF CLIMB ALTITUDE (10,000 FT) ⑦ CLIMB WEIGHT AT 10,000 FT (2882 LB) ⑧ CLIMB SPEED AT 10,000 FT (81 KNOTS) |
|--|--|

REMARKS: 1. FOR EACH 1° C HOTTER THAN STANDARD OAT, ADD 25 LB TO ACTUAL AIRPLANE GROSS WEIGHT TO OBTAIN AN EQUIVALENT WEIGHT FOR CLIMB DETERMINATION.

DATA AS OF: FEBRUARY, 1954

DATA BASED ON: PHASE IV FLIGHT TESTS

FUEL GRADE: 80/87

FUEL DENSITY: 6 LB/GAL

Figure 11-8. Climb Speed

NAUTICAL MILES PER POUND OF FUEL
 STANDARD DAY - CLEAN CONFIGURATION
 ZERO WIND - SEA LEVEL

MODEL T-34B

ENGINE: (1)
 NO. 0-470-4

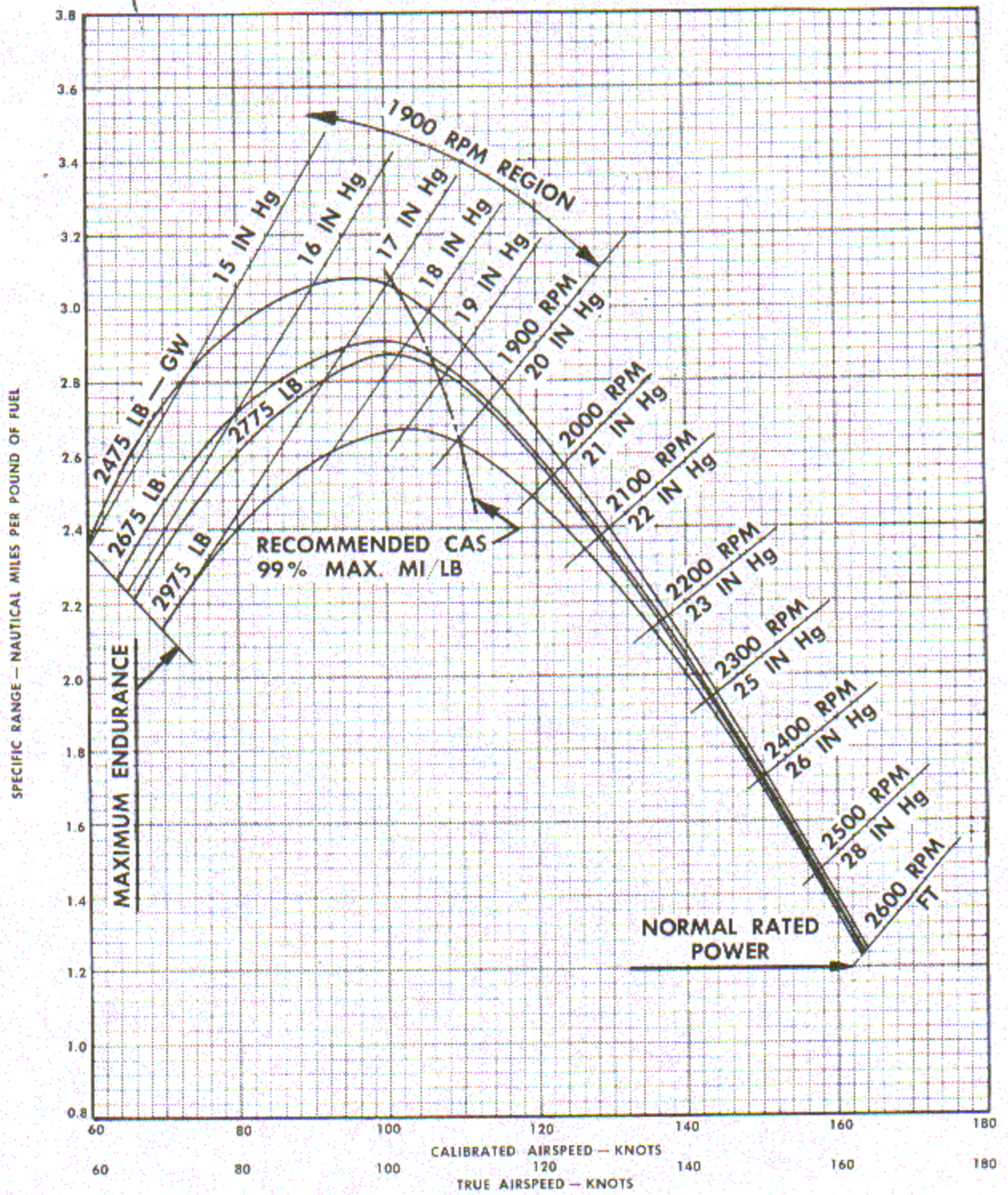

DATA AS OF: FEBRUARY, 1954

DATA BASED ON: PHASE IV FLIGHT TESTS

FUEL GRADE: 80/87

FUEL DENSITY: 6 LB/GAL

Figure 11-9. Nautical Miles Per Pound of Fuel (Sea Level)

NAUTICAL MILES PER POUND OF FUEL
 STANDARD DAY - CLEAN CONFIGURATION
 ZERO WIND - 5000 FT.

MODEL T-34B

ENGINE: (1)
 NO. 0-470-4

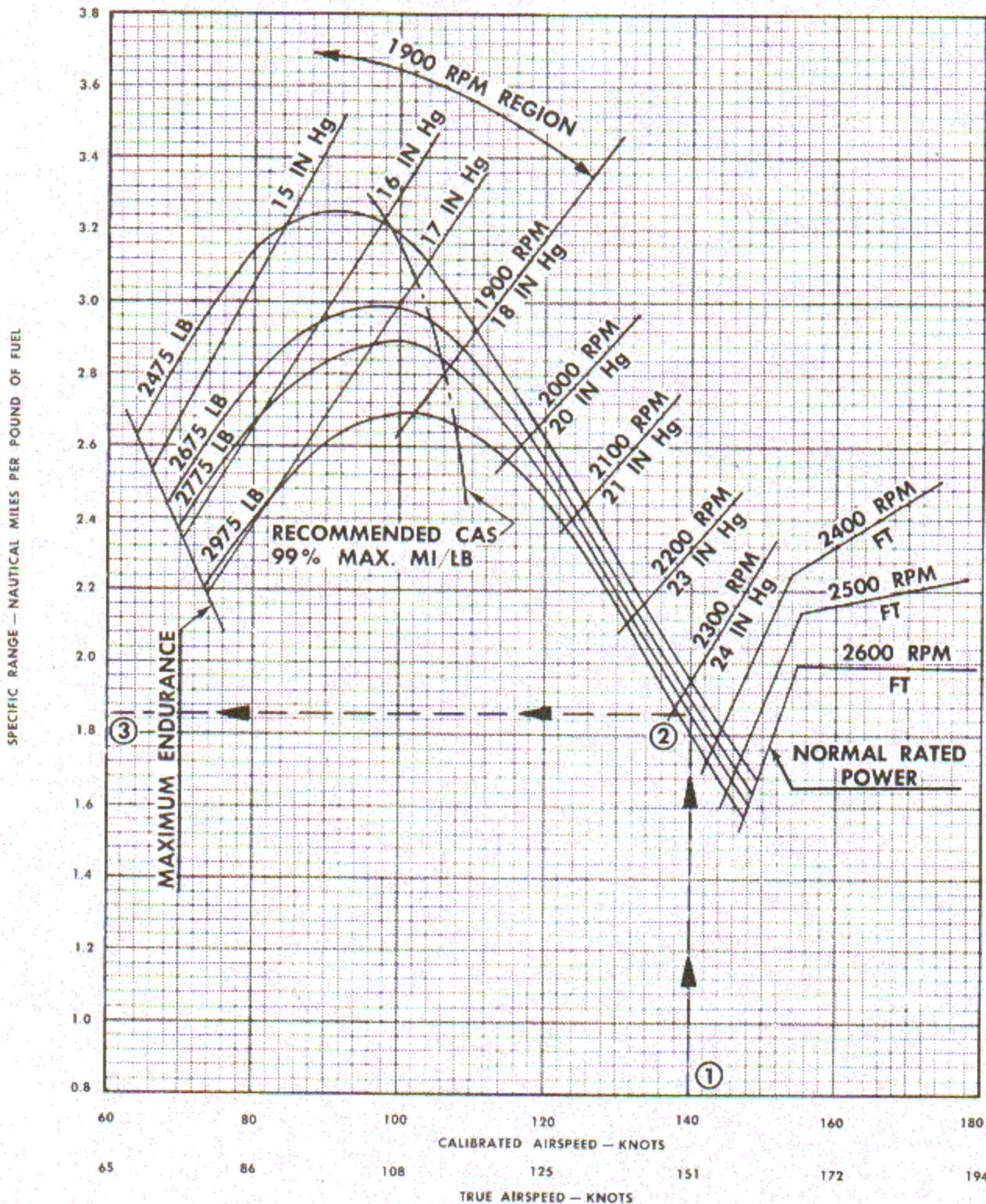

DATA AS OF: FEBRUARY, 1954

DATA BASED ON: PHASE IV FLIGHT TESTS

FUEL GRADE: 80/87

FUEL DENSITY: 6 LB/GAL

Figure 11-10. Nautical Miles Per Pound of Fuel (5,000 ft.)

NAUTICAL MILES PER POUND OF FUEL
 STANDARD DAY - CLEAN CONFIGURATION
 ZERO WIND - 10000 FT.

MODEL T-34B

ENGINE: (1)
 NO. 0-470-4

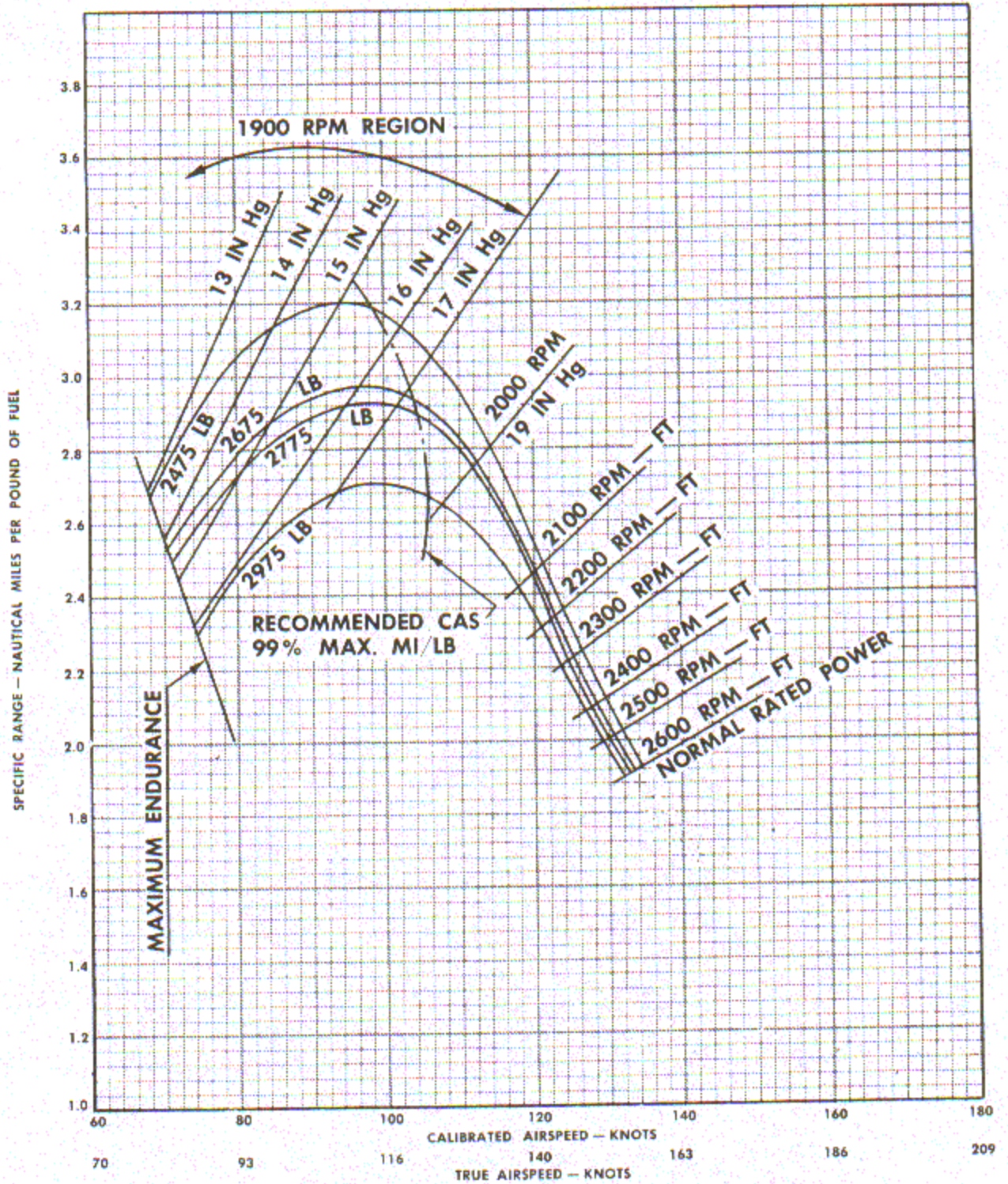

DATA AS OF: FEBRUARY, 1954
 DATA BASED ON: PHASE IV FLIGHT TESTS

FUEL GRADE: 80/87
 FUEL DENSITY: 6 LB/GAL

Figure 11-11. Nautical Miles Per Pound of Fuel (10,000 ft.)

MAXIMUM RANGE POWER CONDITIONS VS GROSS WEIGHT
STANDARD DAY - CLEAN CONFIGURATION

MODEL T-34B

ENGINE: (1)
NO. 0-470-4

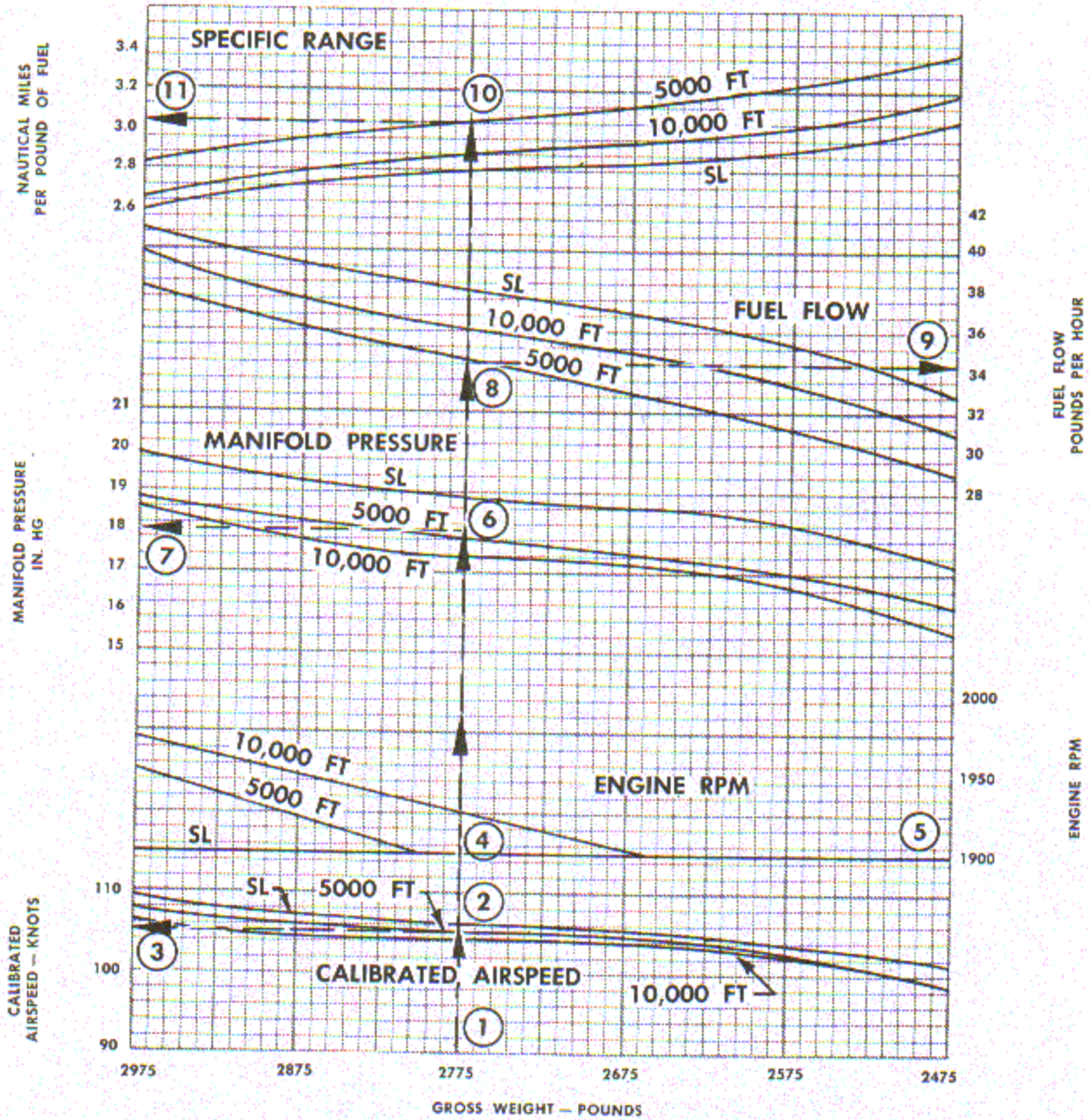

REMARKS: 1. BASED ON RECOMMENDED CRUISING SPEEDS AS SHOWN ON NAUTICAL MILES PER POUND OF FUEL.

DATA AS OF: FEBRUARY, 1954

DATA BASED ON: PHASE IV FLIGHT TESTS

FUEL GRADE: 80/87

FUEL DENSITY: 6 LB/GAL

Figure 11-12. Maximum Range Power Conditions vs. Gross Weight

MAXIMUM ENDURANCE
STANDARD DAY - CLEAN CONFIGURATION

MODEL T-34B

ENGINE: (1)
NO. 0-470-4

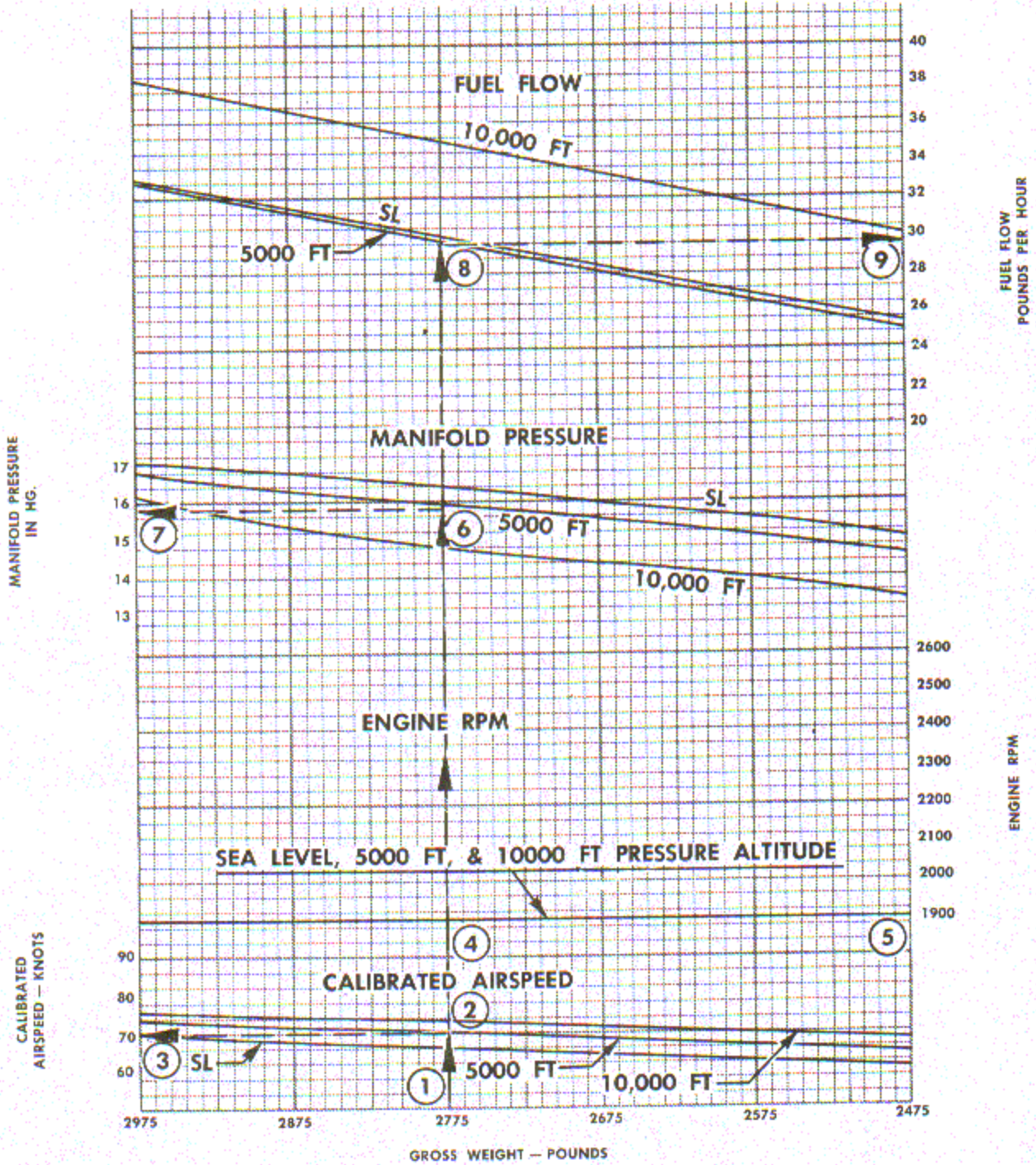

DATA AS OF: FEBRUARY, 1954

DATA BASED ON: PHASE IV FLIGHT TESTS

FUEL GRADE: 80/87

FUEL DENSITY: 6 LB/GAL

Figure 11-13. Maximum Endurance

LONG-RANGE PREDICTION — TIME
STANDARD DAY — CLEAN CONFIGURATION
NO WIND

MODEL T-34B

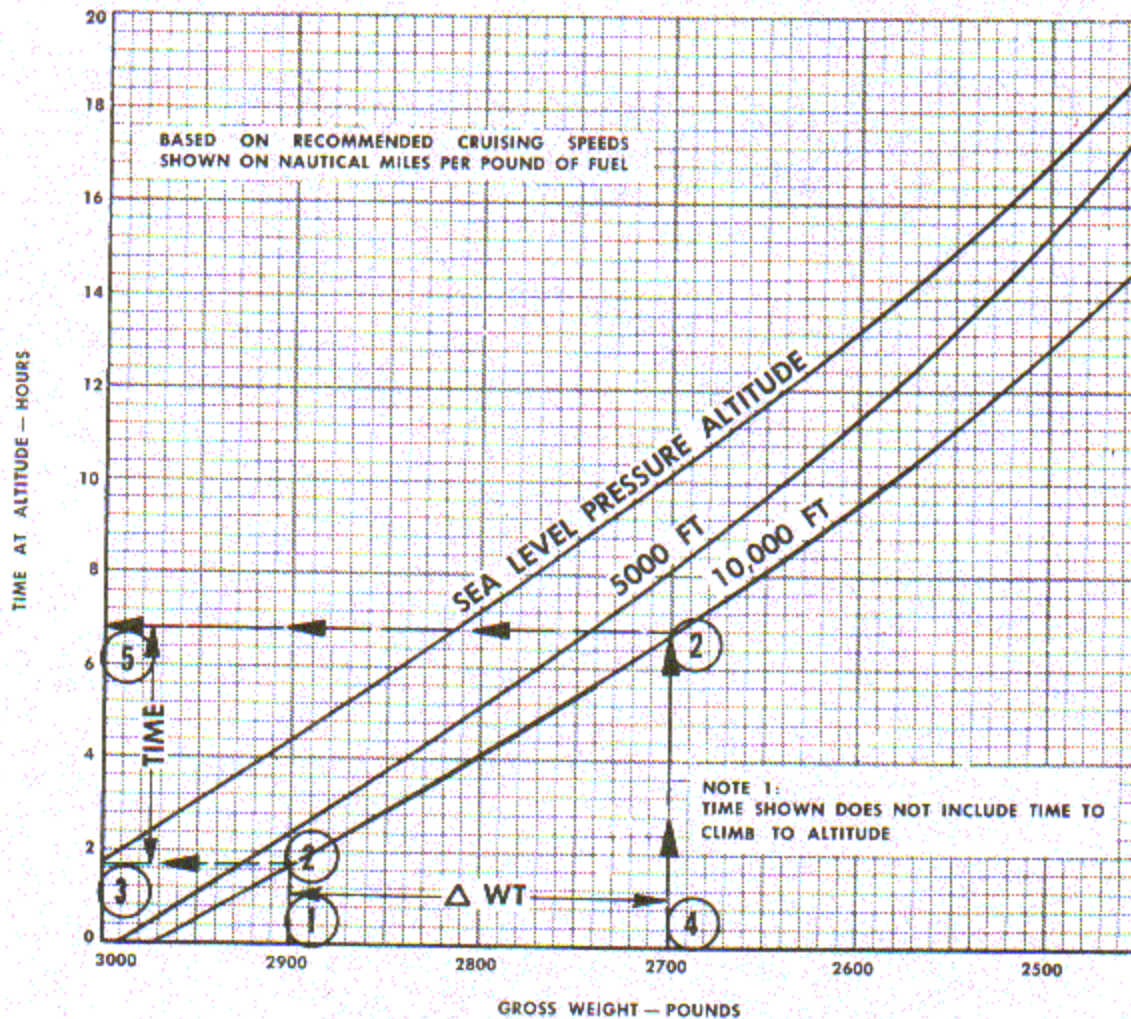
ENGINE: (1)
NO. 0-470-4**EXAMPLE:**

- | | |
|--|---|
| ① GROSS WEIGHT AT START OF CRUISE (2900 POUNDS) | ④ GROSS WEIGHT AT END OF CRUISE (2700 POUNDS) |
| ② PRESSURE ALTITUDE TO BE MAINTAINED DURING CRUISE (10,000 FEET) | ⑤ FINAL CHART TIME (6.70 HOURS) |
| ③ INITIAL CHART TIME (1.70 HOURS) | ①-④ FUEL USED DURING CRUISE (200 POUNDS) |
| | ⑤-③ TIME TO CRUISE (5.0 HOURS) |

DATA AS OF: FEBRUARY, 1954

DATA BASED ON: PHASE IV FLIGHT TESTS

FUEL GRADE: 80/87
FUEL DENSITY: 6 LB/GAL

Figure 11-14. Long Range Prediction - Time

LONG-RANGE PREDICTION — DISTANCE
STANDARD DAY — CLEAN CONFIGURATION
NO WIND

MODEL T-34B

ENGINE: (1)
 NO. 0-470-4

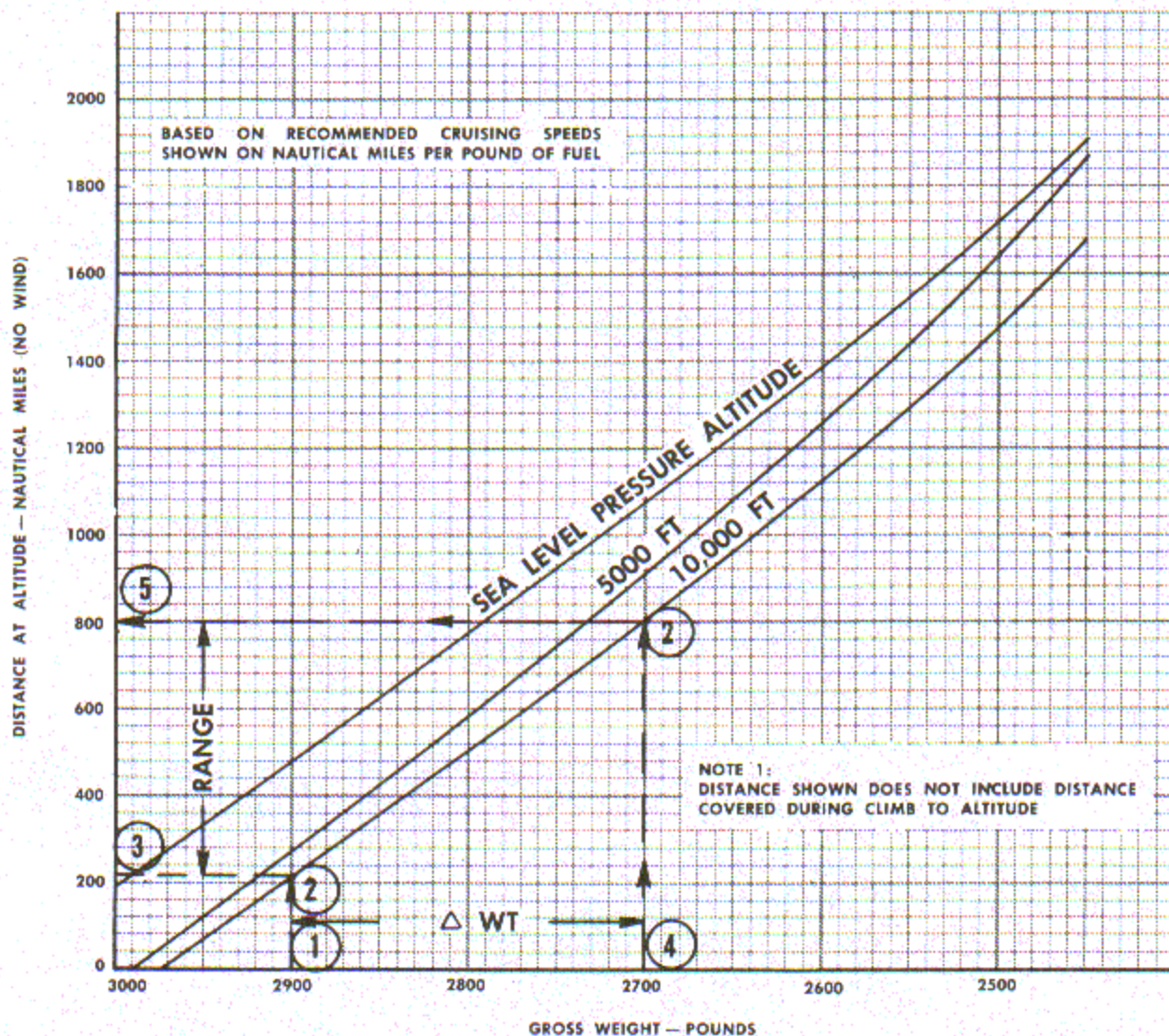

EXAMPLE:

- | | |
|---|---|
| <p>① GROSS WEIGHT AT START OF CRUISE (2900 POUNDS)</p> <p>② PRESSURE ALTITUDE TO BE MAINTAINED DURING CRUISE (10,000 FT)</p> <p>③ INITIAL CHART DISTANCE (220 NAUTICAL MILES)</p> | <p>④ GROSS WEIGHT AT END OF CRUISE (2700 POUNDS)</p> <p>⑤ FINAL CHART DISTANCE (800 NAUTICAL MILES)</p> <p>① — ④ FUEL USED DURING CRUISE (200 POUNDS)</p> <p>⑤ — ③ RANGE (580 NAUTICAL MILES)</p> |
|---|---|

DATA AS OF: FEBRUARY, 1954
 DATA BASED ON: PHASE IV FLIGHT TESTS

FUEL GRADE: 80/87
 FUEL DENSITY: 6 LB/GAL

Figure 11-15. Long Range Prediction - Distance

LANDING DISTANCE HARD SURFACE RUNWAY

MODEL T-34B

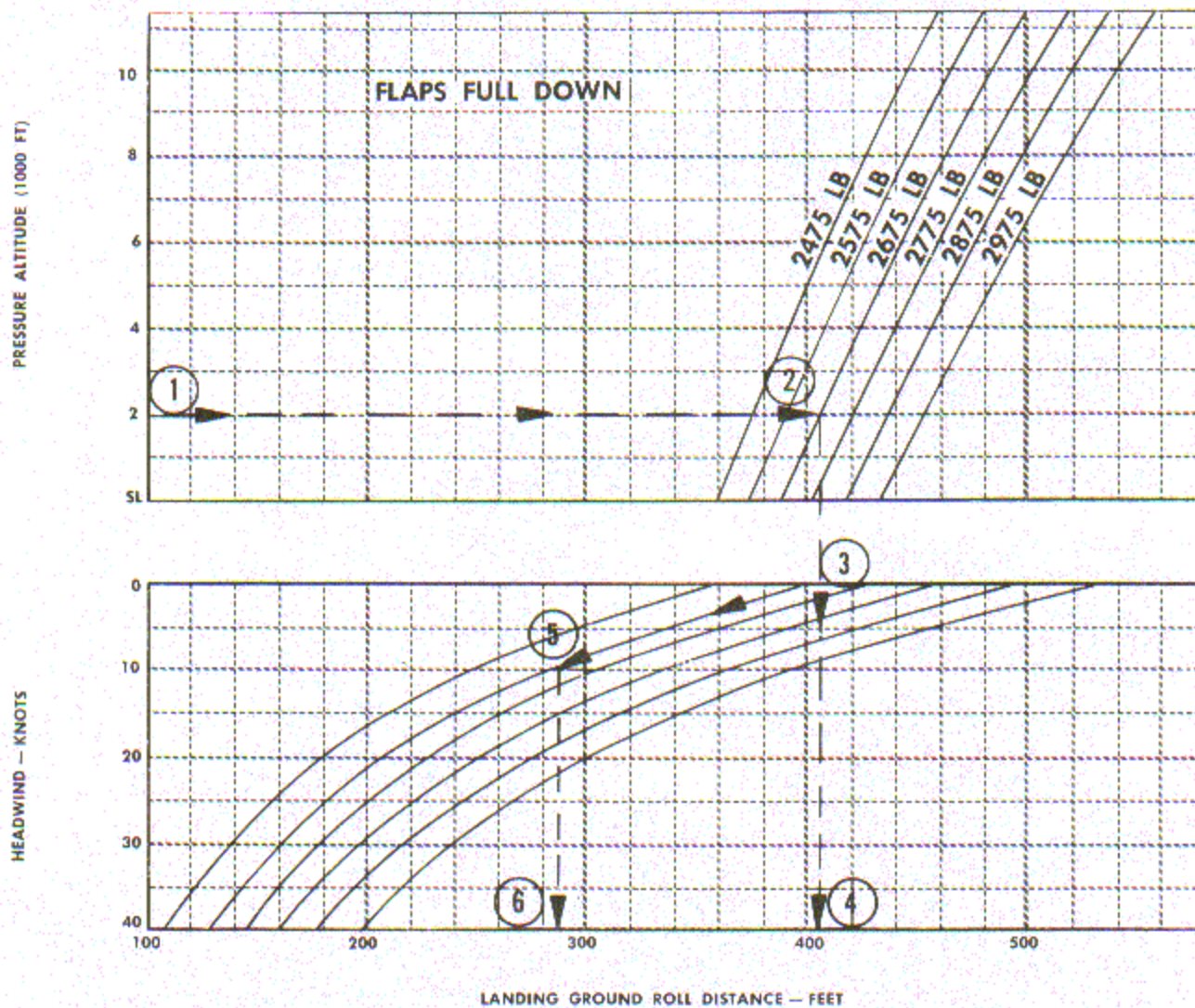
ENGINE: (1)
NO. 0-470-4

EXAMPLE:

- ① PRESSURE ALTITUDE (2000 FT)
- ② GROSS WEIGHT (2675 LB)
- ③ ZERO WIND
- ④ GROUND ROLL DISTANCE — ZERO WIND (406 FT)
- ⑤ HEADWIND (10 KNOTS)
- ⑥ GROUND ROLL DISTANCE — WITH WIND (287 FT)

REMARKS:

- 1 TOTAL DISTANCE TO CLEAR
50-FT OBSTACLE IS 175%
GROUND ROLL DISTANCE
- 2 NORMAL LANDING TECHNIQUE
(IDLE POWER)

DATA AS OF: FEBRUARY, 1954

DATA BASED ON: PHASE IV FLIGHT TESTS

FUEL GRADE: 80/87

FUEL DENSITY: 6 LB/GAL

Figure 11-16. Landing Distance

ALPHABETICAL INDEX

- A**
- Aborted Takeoff 5-10
- AC Power Failure 5-8
- Acceleration Limitations 1-43, 1-46*
- Accelerometer 1-26, 1-5*
- Acrobatics 4-3
checklist 4-4
- After Landing 3-15
- AIMS (Transponder Identification System) 1-35, 1-37*
- Aircraft 1-1
dimensions and materials 1-1
downed 5-8
exterior 3-2
gross weight 1-2
idiosyncrasies 4-4
turning radius 1-40*
yellow sheets 3-2
- Aircraft Entrance 3-2
- Aircraft Servicing 1-39
- Airspeed Limitations 1-43
- All Weather Operations 6-1
cold weather 6-5
hot weather and desert procedures 6-6
ice and rain 6-2
instrument flight 6-1
introduction 6-1
night flight 6-5
turbulence and thunderstorms 6-2
- Alternate Air 1-14
- Altitude Loss in Dive Recovery 4-4
- Approaches, Instrument 6-2
- Attitude Indicator 1-28, 1-5*
- B**
- Baggage Compartment 1-38, 1-3*
- Bailout 5-9
- Battery Switch 1-21, 1-16*
- Before
entering aircraft (cold weather) 6-5
leaving aircraft (normal and cold weather) 3-17, 6-6
starting (normal and cold weather) 6-5
takeoff (normal and cold weather) 6-6
- Brake Failure 5-12
- Briefing 3-1
- Button
horn silencing 1-25
landing gear warning light test 1-25
- C**
- Canopy 1-29
emergency open handle 1-29, 1-30*
emergency operation 5-8, 5-8*
- Carbon Monoxide 5-7
- Center-of-Gravity Limitations 1-43
- Characteristics
general flight 4-1
spins 4-2
stalls 4-1
- Checkflight Procedures, Functional 3-19
- Checklists
acrobatic 4-4
checkflights and forms 3-19
before leaving aircraft 3-17
landing 3-13
preflight 3-2, 3-3*
prestart 3-2
pretaxi 3-8
secure 3-15
takeoff 3-9
- Circuit Breakers, Cockpit 1-8*
- Climb, normal 3-11
- Clutch Knob, Landing Gear Emergency
Handcrank 1-26, 1-9,* 5-10*
- Cockpit Circuit Breakers 1-8
- Cold Weather Operation 6-5
before entering aircraft 6-5
before takeoff 6-6
descent and approach 6-6
during flight 6-6
landing pattern and landing 6-6
on entering aircraft 6-5
parking and before leaving aircraft 6-6
starting engine 6-5
takeoff 6-6
taxiing 6-6
warmup and ground operation 6-5

*Denotes Illustration Page

Index
Communications — Failure

NAVAIR 01-90KDB-1

Communications and Associated

Electronics Equipment	1-31, 1-33*
Communications Procedures	7-1
introduction	7-1
radio communications	7-1
visual signals	7-1
Compartment, Baggage	1-38, 1-3*
Control	
flight	4-3
stick	1-23
Controls	
engine	1-12, 1-13*
flight	1-23
heating and ventilating systems	1-31, 1-32*
interior lighting	1-38
lock	1-23
Crew Requirements	
flight	3-19, 2-2
minimum	1-43
Crosswind Landing	3-15, 3-16*
Crosswind Takeoff	3-10, 3-12*
Cruise	
acrobatic	3-13
instrument	6-2
normal	3-11

D

Daily Preflight Inspection	3-2, 3-3*
Damaged Aircraft, Airborne	5-9
DC Power Failure	5-8
DC Power Supply System	
Indicators	1-21, 1-5*
Dead Engine Landing	5-4*
Descent	
and approach (cold weather)	6-6
instrument flight	6-1
normal	3-13
Desert and Hot Weather Procedures	6-6
Dimensions and Materials	1-1, 1-2*
Discrepancy Reporting	3-17
Ditching	5-9
Diving	4-4
altitude loss in recovery	4-4
Downed Aircraft	5-8

E

Electrical Fire During Flight	5-5
Electrical Power Supply Emergency	
Operation	5-8
Electrical Power Supply System	1-21, 1-22*
Emergency	
canopy open handle	1-29, 1-31*
canopy operation	5-8, 5-8*

distress radio transmission	5-2
ditching	5-9
entrance	5-2
equipment	1-29
fuel system	1-16
high altitude engine failure	5-3
landing gear extension	5-10
landing gear, general	5-11
landing gear retraction	5-10
landing gear system	1-26
landings	5-10
low altitude engine failure	5-5
procedures	5-1
wing flap operation	5-8
Engine	1-2, 1-12
controls	1-12, 1-13*
cooling	1-14
failure, general	5-2
high altitude	5-3
low altitude	5-5
partial	5-3
fire	
ground	5-1
inflight	5-5
instruments	1-12
limitations	1-43, 1-44*, 11-2
runup	3-8, 3-20
starting	
cold weather	6-5
normal	3-7
Entering Aircraft	
cold weather	6-5
normal	3-2
Equipment	
communications and associated	
electronics	1-31, 1-33*
emergency	1-29
miscellaneous	1-38
personal flying	2-2
radio navigation	6-2
Evaluation, NATOPS	10-1
Example Flight Plan and Use	
of Graphs	11-1
Extension, Landing Gear Emergency	5-10
Exterior Inspection	3-2
Exterior Lighting	1-36, 1-37*
External Gear Down Indicator Lights	1-26
External Power Receptacle	1-21, 1-39*

F

Failure	
ac power	5-8
dc power	5-8
engine, general	5-2
high altitude	5-3

*Denotes Illustration Page

low altitude	5-5	limitations	1-43
fuel pump	5-8	Generator Switch	1-21, 1-16*
inverter failure light	1-21, 1-5*	Gross Weight	1-2
propeller	5-5, 5-7	limitations	1-43
wheel brake	5-12	Ground Training Syllabus	2-1
Fire			
electrical during flight	5-5	H	
engine	5-1, 5-5	Handcrank, Landing Gear Emergency	
after starting	5-2	and Clutch Knob	1-26, 1-9*, 5-9*
during flight	5-5	Heading Indicator	1-28, 1-6*
during starting	5-1	Heat, Pitot	1-29, 1-9*
fuselage in flight	5-7	Heating and Ventilating	
smoke elimination	5-7	controls	1-31, 1-32*
wing in flight	5-6	system	1-31, 1-32*
Flaps, Wing	1-23	High Altitude Engine Failure	5-3
lever	1-23, 1-7*, 1-10*	High Density Altitude	
position indicator	1-23, 1-6*	Procedures	6-7
emergency operation	5-8	High Density Altitudes, Touch	
Flat Tire, Emergency Landing	5-12	and Go Landing Procedures at	6-7
Flight			
characteristics	4-1	Holding, Instrument Flight	6-2
cold weather	6-5	Horn, Landing Gear Warning and	
control	4-3	Silencing Button	1-25, 1-4*
control system	1-23	Hot Weather and Desert Procedures	6-6
controls	1-23	parking	6-7
controls lock	1-23, 1-25*	pretakeoff	6-6
crew requirements	2-2	takeoff	6-6
during instrument cruising	6-2	I	
hot weather and desert	6-6	Ice and Rain	6-2
instrument operation	6-1	ICS Amplifier	1-33
maneuvering	4-3	Idiosyncrasies, Aircraft	4-4
night	6-5	Ignition	1-14, 1-14*
time requirements	2-2, 2-3*	Indicators	
training syllabus	2-2	accelerometer	1-26, 1-5*
Fuel			
boost pump	1-21	attitude	1-28, 1-5*
switch and indicator light	1-21, 1-4*, 1-10*	dc power supply system	1-21, 1-5*
emergency system	1-16	heading	1-28, 1-5*
fumes elimination	5-7	engine	1-12, 1-5*, 1-44*
pressure drop		landing gear position	1-25, 1-5*
in flight	5-7	landing gear system	1-23
on the ground	5-2	turn and slip	1-28, 1-5*
pump failure	5-8	wing flap position	1-23, 1-5*
quantity gage	1-21, 1-6*	Indoctrination	2-1
shutoff valve handle	1-21, 1-4*, 1-10*	Inertia Reel Handle	1-30, 1-7*, 1-10*
system	1-16, 1-16*	Inspection	
Functional Checkflight Procedures	3-19	exterior	3-2
Fuselage Fire During Flight	5-7	postflight external	3-17
G			
preflight	3-2, 3-3*	Instrument Flight	6-1
Gear Up Landing	5-11	approaches	6-2, 6-3*, 6-4*
General		cruising flight	6-2
arrangement	1-3*	descent	6-2
flight characteristics	4-1	holding	6-2

*Denotes Illustration Page

Index
Instruments — Oil System

NAVAIR 01-90KDB-1

preflight 6-1
 radio navigation equipment 6-2
 Instruments 1-26, 1-5*
 Interior Lighting 1-38
 Interphone Provisions 1-31
 Inverted Spins 4-3
 Inverter Failure Light 1-21, 1-5*

L

Landing Gear
 emergencies, general 5-11
 emergency extension 5-10
 emergency handcrank and handcrank
 clutch knob 1-26, 1-9*
 emergency retraction 5-10
 emergency retract switch 1-26, 1-5*
 emergency system 1-26
 handle 1-24, 1-14*
 position indicators 1-25, 1-5*
 system 1-23
 system indicators 1-25
 warning horn and silencing
 button 1-25, 1-7*
 warning light and test
 button 1-25, 1-14*
Landing Light Switches 1-36, 1-7*, 1-37*
Landing Pattern and Landing
 (Cold Weather) 6-6
Landing 3-13
 after 3-15
 crosswind 3-15, 3-16*
 dead engine 5-4*
 emergencies 5-10
 full-flap 3-13
 light switches 1-36, 1-7*, 1-37*
 minimum run 3-13
 no-flap 3-13
 normal break entry 3-13
 on unprepared surfaces 3-15
 roll 3-13
 touch-and-go 3-13
 with brake failure 5-12
 with flat tire 5-12
 with gear up 5-11
 with nose gear retracted 5-11
 with one main gear retracted 5-11
Levers
 flap 1-23, 1-7*, 1-10*
 mixture 1-12
 propeller 1-12, 1-13*
 throttle 1-12, 1-13*
Lights
 exterior 1-36, 1-37*
 external gear down indicator 1-26

interior 1-38
 inverter failure 1-21, 1-5*
 landing gear warning 1-25, 1-14*
Limitations, Aircraft Operating 1-43
 acceleration 1-43, 1-46*
 airspeed 1-43
 center-of-gravity 1-43
 engine 1-43, 1-44*
 general 1-43
 loading 1-43
 propeller 1-43
 weight 1-43
Limitations Card 1-46, 1-48*
Lock, Flight Controls 1-23
Lost Plane Procedures 5-8
Low Altitude Engine Failure 5-5

M

Maneuvering, Flight 4-3
Maneuvers 1-43
Maximum Glide 5-5, 5-6*
Minimum
 crew requirements 1-43
 run — landing 3-13
 run — takeoff 3-10, 3-10*
Mixture Lever 1-12

N

NATOPS Evaluation 10-1
 concept 10-1
 definitions 10-1
 evaluation forms 10-9
 final grade determination 10-7
 flight evaluation 10-3
 grade determination 10-7
 grading criteria 10-3
 ground evaluation 10-2
 closed book examination 10-2
 grading instructions 10-2
 implementation 10-2
 open book examination 10-2
 oral examination 10-2
 question bank 10-9
 records and reports 10-9
Navigation Lights Switches 1-36, 1-9*, 1-37*
Navigational Receiving Equipment
 Controls and Indicators 1-34
Night Flight 6-5
Normal break entry 3-13

O

Obstacle Clearance Takeoff 3-10, 3-10*
Oil System 1-14, 1-17*

*Denotes Illustration Page

Operating Under Instrument Flight
 Conditions 6-1
 Operations
 AIMS system 1-36
 canopy emergency 5-8, 5-8*
 cold weather 6-5
 landing gear emergency 5-10
 propeller — no power 5-7
 VHF communications equipment 1-33
 VHF receiving equipment 1-34
 wing flap emergency 5-8
 systems 1-12

P

Parking
 before leaving aircraft (cold weather) 6-6
 brake handle 1-26, 1-16*
 in hot weather 6-7
 Passing Light Switch 1-36, 1-9*, 1-37*
 Pattern
 descent and approach (cold weather) 6-6
 landing 3-14*, 6-6
 Performance Data 11-1
 climb distance curve 11-4
 climb speed 11-16*
 density altitude chart 11-9*
 engine operating limits 11-11*
 landing distance 11-24*
 long range prediction (time and
 distance) 11-22*, 11-23*
 maximum endurance 11-21*
 maximum range power conditions
 vs. gross weight 11-20*
 nautical miles per pound of fuel
 at sea level 11-17*
 at 5,000 feet 11-18*
 at 10,000 feet 11-19*
 normal rated power climb
 distance 11-14*
 time 11-15*
 obstacle clearance takeoff distances 11-13*
 standard altitude table 11-8*
 takeoff distances 11-12*
 use of graphs and example flight
 plan 11-1
 Personal Flying Equipment 2-2
 Pitot Heat 1-29, 1-9*
 Pitot Static System 1-28
 Postflight External Inspection 3-17
 Power Off Stalls 4-1
 Power on Stalls 4-1
 Preflight Inspection, Daily 3-2, 3-3*
 Prestart Procedures 3-2
 checklist 3-2

Pretakeoff Procedures 3-7
 engine runup 3-8
 pretaxi checklist 3-8
 taxi 3-8
 warmup 3-7
 Pretaxi Checklist 3-8
 Propeller 1-14
 failure 5-5, 5-7
 lever 1-12, 1-13*
 limitations 1-43
 operation — no power 5-5

R

Radio Communications 7-1
 Radio Navigation Equipment 6-2
 Receptacle, External Power 1-21, 1-39*
 Recovery
 altitude loss in dive 4-4, 4-5*
 spins 4-2
 stalls (low altitude) 4-2
 stalls (normal) 4-2
 Rudder Pedals 1-24*

S

Scheduling 3-1
 Seats 1-30
 Secure Checklist 3-15
 Servicing 1-39, 1-39*
 Smoke Elimination 5-7
 Spins
 characteristics 4-2*
 inverted 4-3
 recovery 4-3
 Stalls
 characteristics 4-1, 4-2*
 power off 4-1
 power on 4-1
 practice maneuvers 4-1
 recovery (low altitude) 4-2
 recovery (normal) 4-2
 skidded turn 4-2
 Starter 1-14
 Starting Engine
 cold weather 6-5
 normal 3-7
 Static Air System Schematic 1-29*
 Switches
 battery 1-21, 1-16*
 generator 1-21, 1-16*
 ignition 1-14, 1-14*
 landing gear emergency retract 1-26, 1-5*
 landing light 1-36, 1-7*, 1-37*
 navigation lights 1-36, 1-9*, 1-37*

*Denotes Illustration Page

Index**NAVAIR 01-90KDB-1****Systems—Wing Flaps**

passing light 1-36, 1-9*, 1-37*
 starter 1-14

Systems

electrical power supply 1-21, 1-22*
 emergency landing gear 1-26
 engine 1-12
 flight control 1-23
 fuel 1-16, 1-19*
 heating and ventilating 1-31, 1-33*
 ignition 1-14
 landing gear 1-23
 oil 1-14, 1-17*
 pitot static 1-28
 wheel brake 1-26, 1-27*

T

Tabs, Trim 1-23

Takeoff

aborted 5-10
 before 3-7
 checklist 3-9
 cold weather 6-6
 crosswind 3-11, 3-12*
 emergencies 5-10
 hot weather 6-6
 minimum run 3-10, 3-10*
 normal 3-10
 obstacle clearance 3-10, 3-10*

Taxiing

cold weather 6-6
 normal 3-8

Throttle 1-12, 1-13*

Training

flight 2-2
 ground 2-1

Transponder Identification System

AIMS 1-35

Trim Tabs 1-23

Turbulence and Thunderstorms 6-2

Turn and Slip Indicator 1-28, 1-5*

U**Use of Graphs and Example**

Flight Plan 11-1
 climb distance curve 11-4
 engine installation consideration 11-3
 engine operating limits 11-2
 landing distance 11-6
 long range prediction
 distance 11-2, 11-6
 time 11-2, 11-6
 maximum endurance 11-6
 maximum range power condition
 vs. gross weight 11-5
 nautical miles per pound of fuel 11-5
 power settings 11-2
 takeoff distance 11-3
 time, fuel, and distance to climb 11-2

V

Vents and Drains 1-4*

VHF Communications Equipment 1-33, 1-33*

 operation 1-34

VHF Omnidirectional Equipment 1-34

Visual Signals 7-1

W**Warmup**

cold weather 6-5

normal 3-7

Waveoff 3-15

Weight

gross 1-2

limitations 1-43

Wheel Brake System 1-26, 1-27*

Wing Fire During Flight 5-6

Wing Flaps 1-23

 emergency operation 5-8

*Denotes Illustration Page