

BARCELONA TEST LATEST

AUTOSPORT

MARK HUGHES' ANALYSIS

FEBRUARY 28 2013 • £3.50 • autosport.com

F1 2013 TESTING SPECIAL

Who's really quickest?



New Red Bull uncovered

- › Tech secrets of RB9
- › Test form in question
- › Who's the next Vettel?



Daytona drama
28 fans injured
in terrifying
NASCAR crash



SKY SPORTS F1® HD £5 EXTRA A MONTH

For first 6 months. £10.25 p/m thereafter

- Follow all 19 Grand Prix weekends only with Sky Sports F1® HD
- Watch every practice session, qualifying and race live
- Join or upgrade to Sky TV with HD and get Sky Sports F1® HD for just £5 extra a month

GO TO SKY.COM/F1 OR CALL **08442 411 381**

sky SPORTS F1 HD



Sky+HD: Sky TV with the HD pack from £26.50p/m for the first 6 months, £31.75p/m thereafter. Existing Sky TV customers upgrading to the HD Pack, £5 extra p/m for first 6 months, £10.25p/m extra thereafter. Not available in conjunction with any other offer. Offer ends 31st March. HD channels received depends on your Sky TV package. General: 12 month minimum subscriptions. Sky+ HD box and set up required. Prices for Direct Debit payments only. Continuous debit/credit card mandate costs 50p p/m. UK, Channel Islands and Isle of Man residential customers only. Further terms apply. Calls to Sky cost 5.1p per minute (plus 13.1p connection fee) for BT customers. Calls from other providers may vary. Correct at 12th February 2013. The F1 logo, F1, FORMULA 1, FIA FORMULA ONE WORLD CHAMPIONSHIP, GRAND PRIX and related marks are trade marks of Formula One Licensing BV, a Formula One group company. All rights reserved.

CONTENTS

February 28 2013 - vol 211 no 9



AUTOSPORT.COM

Up-to-the-minute news and reports from F1, WRC and more. Subscribe for must-read opinion, stats and images

"F1 is still going to be very loud, it will still be a violent event"

RENAULT F1 CHIEF JEAN-MICHEL JALANIER ON HIS NEW V6 TURBO

COVER IMAGES:
MAIN: GILHAM/
GETTY
INSET:
MARKLAND/GETTY



FEATURES & REPORTS

- 24 The team they all fear**
How Red Bull is shaping up as it bids for a fourth title
- 28 Red Bull's story of evolution**
Tracing Newey's babies from the RB5 to the new RB9
- 30 Ricciardo versus Vergne...**
...versus Webber. How the Toro Rosso young guns are shaping up in their bids to break into the Red Bull squad
- 34 ...versus da Costa**
And here's a Red Bull junior who's blazing his way to the top, after big wins last year in FR3.5, GP3 and the Macau F3 GP
- 38 The RB9 under the skin**
Our experts unravel the trick stuff on Vettel's new racer
- 40 Retro: F1's one-off fastest laps**
From Kling to de la Rosa via an upside-down Gugelmin
- 46 World of Sport**
NASCAR Nationwide Series; NASCAR Truck Series
- 52 Daytona 500**
Johnson breaks his jinx to take second 500 success
- 56 GT3 takes over the world**
How 'budget' class has taken motorsport by storm
- 60 Nissan returns to V8 Supercars**
The lowdown on the new Altima that's soon to make its debut, plus Bluebird and Skyline grunTERS of the past
- 65 V8 Supercar men to watch**
Likely pacesetters when it kicks off this weekend in Adelaide

NEWS

- 8 Button confident as McLaren looks strong**
Perez sets the fastest time at Barcelona, as Button declares optimism that 'clean-sheet' design will pay dividends
- 10 F1 test times: what do they all mean?**
Mark Hughes gets his abacus out to decode the relative performances compared to known fuel levels
- 12 Williams and Caterham run into trouble**
Two teams told that parts on their new cars are illegal
- 15 This week in F1**
What's been going on apart from all the testing
- 18 World champion Huff secures his place on WTCC grid**
It's full circle for the Brit, who will race a SEAT for Munnich Motorsport after leaving RML Chevrolet squad
- 20 Nissan eyes new attack on Le Mans glory**
Japanese manufacturer's new electric racer for 2014 could act as curtain raiser to LMP1 challenge
- 22 Mercedes leaves door open for Kubica**
Polish F1 hero won't be returning to the tracks in the DTM for now as he elects to focus short-term on his rallying

REGULARS

- 5 From the editor**
- 6 Snapshot**
- 16 Subscribe for a free gift**
- 17 Mark Hughes column**
- 88 Final drive**
Letters and latest gear
- 90 On track/on screen**
The best action in the next week
- 93 From the archive**
James Hylton wins Talladega NASCAR, 1972
- 94 Race of my life**
Phil Andrews, Benelux FF1600, Zandvoort, 1986

SPORTS EXTRA

- 81 Hodgetts secures Toyota ride in British GT**
Tin-top ace to race GT86, and hopes to stay on in Clio
- 82 New F4 series secures ITV4 deal**
It won't be live, but it does have a 'primetime' slot
- 86 Track test: Formula Ford 200**
Our office *pilote* gets down to business in EcoBoost racer

DAYTONA 500

February 18-25
NASCAR Sprint Cup Series

AT A GLANCE
→ Winner: Jimmie Johnson
→ Pole Position: Patrick Carpentier
→ Points Leader: Jimmie Johnson

Johnson goes low for second Daytona high

Track perfection tactics from the five-time champion earn him his second Daytona 500 victory for Chevrolet

RACE RATING
Single file racing is not what you expect - or want - in restrictor-plate racing

KEY MOMENT
Jimmie Johnson goes low to lead with 13 laps left

REPORT
DAYTONA 500

CHEVROLET SWINGS
reports

STORY
The one thing we know about Jimmie Johnson is that he's a winner. He's won the Daytona 500 twice before, and he's won the Sprint Cup Series three times. But this time, he's won it all. He's won the Daytona 500, the Sprint Cup Series, and the NASCAR All-Star Race. It's a historic achievement, and it's a testament to his skill and determination. Johnson's victory was a result of his perfect race strategy, which allowed him to maintain a lead that was nearly unassailable. He drove a clean, consistent race, and he finished with a comfortable margin over the rest of the field. This win solidifies Johnson's status as one of the greatest drivers in NASCAR history.

McLaren on top as final F1 test starts

MPLA's pre-season has not been fastidious, but Button is sure the car can surpass its predecessor. By IOD STAR

COVER STORY
TOONER

NEWS
PIT & PADDOCK

GET AUTOSPORT ON THE MOVE

| Team | Time (min) | Fuel (kg) | Distance (km) |
|-------------|------------|-----------|---------------|
| McLaren | 1:34.81 | 10.2 | 10.2 |
| Red Bull | 1:35.12 | 10.1 | 10.1 |
| Mercedes | 1:35.45 | 10.0 | 10.0 |
| Ferrari | 1:35.78 | 9.9 | 9.9 |
| Lotus | 1:36.10 | 9.8 | 9.8 |
| Williams | 1:36.42 | 9.7 | 9.7 |
| Caterham | 1:36.75 | 9.6 | 9.6 |
| Force India | 1:37.08 | 9.5 | 9.5 |
| Sauber | 1:37.40 | 9.4 | 9.4 |
| Virgin | 1:37.72 | 9.3 | 9.3 |

TEST TIMES

| Team | Time (min) | Fuel (kg) | Distance (km) |
|-------------|------------|-----------|---------------|
| McLaren | 1:34.81 | 10.2 | 10.2 |
| Red Bull | 1:35.12 | 10.1 | 10.1 |
| Mercedes | 1:35.45 | 10.0 | 10.0 |
| Ferrari | 1:35.78 | 9.9 | 9.9 |
| Lotus | 1:36.10 | 9.8 | 9.8 |
| Williams | 1:36.42 | 9.7 | 9.7 |
| Caterham | 1:36.75 | 9.6 | 9.6 |
| Force India | 1:37.08 | 9.5 | 9.5 |
| Sauber | 1:37.40 | 9.4 | 9.4 |
| Virgin | 1:37.72 | 9.3 | 9.3 |

Formula Ford gives you wings

The latest version of this entry-level single-seater series has undergone a dramatic makeover for the 2013 season. BY ANDREW WOOD

TECH SPEC

| Category | Specification |
|--------------|----------------|
| Engine | 1.8L EcoBoost |
| Transmission | 5-speed manual |
| Chassis | Carbon fibre |
| Wheels | 15" alloy |
| Tires | Pirelli P Zero |
| Weight | 600kg |
| Max Speed | 180km/h |
| 0-100 | 10.5s |
| Price | £15,000 |

STORY
The new Formula Ford 200 is a complete overhaul of the previous model. It features a new 1.8L EcoBoost engine, a carbon fibre chassis, and a host of other performance upgrades. The car is designed to provide a more engaging and competitive racing experience for its drivers. The new chassis is stiffer and more aerodynamic, which will help the car maintain its lead in the corners. The new engine is also more powerful and more efficient, which will help the car maintain its lead in the straights. The new Formula Ford 200 is a true racing machine, and it's a great choice for anyone looking for a challenge on the track.

TAKING **SERIOUS FUN** TO ANOTHER LEVEL



A new and exciting single make race series in the UK, featuring the sensational Ariel Atom.

- 8 Race weekends at the best tracks in the UK featuring 16 races
- Full hospitality with Absolute Taste, part of the McLaren Group
- MotorsTV coverage of all rounds
- Full factory support at all races
- Honda reliability
- Very attractive sign-up offers

For further details visit:

www.atomcup.co.uk

Teddington Studios, Broom Road, Teddington, Middlesex TW11 9BE, UK. Tel: +44 (0) 20 8267 5804 Fax: +44 (0) 20 8267 5922 E-mail: autosport.editorial@haynet.com Website: www.autosport.com

EDITOR-IN-CHIEF

Andrew van de Burt
andrew.vandeburg@haymarket.com ext.5974

EDITOR

Charles Bradley
charles.bradley@haymarket.com ext.5889

GROUP F1 EDITOR

Jonathan Noble ext.5810
jonathan.noble@haymarket.com

F1 EDITOR

Edd Straw ext.5887
edd.straw@haymarket.com

FEATURES EDITOR

Kevin Turner ext.5432
kevin.turner@haymarket.com

NEWS EDITOR

Glenn Freeman ext.5309
glenn.freeman@haymarket.com

REPORTS EDITOR

Jamie O'Leary ext.5811
jamie.oleary@haymarket.com

MANAGING EDITOR

Peter Hodges ext.5903
peter.hodges@haymarket.com

RALLIES EDITOR

David Evans
david.evans@haymarket.com

DEPUTY NEWS EDITOR

Sam Tremayne ext.5952
sam.tremayne@haymarket.com

SPECIAL CONTRIBUTORS

Mark Hughes Adam Cooper
Gary Watkins Gary Anderson
Marcus Pye Giorgio Piola
Mark Glendenning Alan Eldridge

CORRESPONDENTS

ARGENTINA Tony Watson
AUSTRALIA Phil Branagan
AUSTRIA Gerhard Kuntzsch
BELGIUM Gordon McKay
BRAZIL Lito Cavalcanti
FINLAND Esa Iiloinen
GERMANY Rene de Boer
GREECE Dimitris Papadopoulos
ITALY Roberto Chinchero
JAPAN Hiro Takahashi, Len Clarke
NEW ZEALAND Bernard Carpinter
RUSSIA Gregory Golyshev
SOUTH AFRICA Richard Asher
SPAIN Raimon Duran
SWEDEN Tege Formwall
USA Jonathan Ingram, Bruce

Martin, David Phillips, Diego Mejia, Robin Miller, Jeremy Shaw.
UK & EIRE David Addison, Jonathan Crawford, Kerry Dunlop, Leanne Fahy, Paul Healy, Paul Jurd, Paul Lawrence, Stephen Lickorish, Marc Orme, Graham Read, Hal Ridge, Peter Scherer, Ian Sooman, Oliver Timson, Ian Ticklemarsh, Matt Upton, Eddie Walder, Richard Young

ADVERTISING

Tel: +44 (0) 20 8267 5820
Fax: +44 (0) 20 8267 5850
E-mail: autosport.ads@haymarket.com

COMMERCIAL MANAGER

Rachel Brock
ext: 5820
rachel.brock@haymarket.com

DISPLAY ADVERTISING

Peter De Vries
ext: 5961
peter.devries@haymarket.com

ONLINE ADVERTISING

Alex Newberry
ext: 5244
alex.newberry@haymarket.com

CLASSIFIED ADVERTISING

Matt Simpkin
ext: 5560
matt.simpkin@haymarket.com

ADVERTISING DIRECTOR

Matthew Witham
ext: 5992
luka.ricketts@haymarket.com

PRODUCTION MANAGER

Alice Donovan
ext: 5639
alison.donovan@haymarket.com

SENIOR DISPLAY PRODUCTION CONTROLLER

Roxy Agius
ext: 5740
roxy.agijs@haymarket.com

PRODUCTION CONTROLLER

Marc Baker
ext: 5563
marc.baker@haymarket.com

SUBSCRIPTIONS

UK 0844 8488817
OVERSEAS +44 (0)1795 592 974
EMAIL
autosport@servicehelpline.co.uk
US & CANADA 1 866 918 1445
US & CANADA EMAIL
haymarket@usnews.com
AUTOSPORT, ISSN number 0269946X, is published weekly by Haymarket Media Group, Teddington Studios, Broom Road, Teddington TW11 9BE, United Kingdom. The US annual subscription price is \$235. Airfreight and mailing in

the USA by agent named Air Business Ltd, c/o Worldnet Shipping Inc, 156-15, 146th Avenue, 2nd Floor, Jamaica, NY 11434, USA. Periodicals postage paid at Jamaica NY 11434. Subscription records are maintained at Haymarket Media Group, Teddington Studios, Broom Road, Teddington TW11 9BE. Air Business Ltd is acting as our mailing agent.
BACK ISSUES
Tel: 0844 8488817
DIRECT MARKETING EXECUTIVE
Karen McCarthy, ext: 5658
karen.mccarthy@haymarket.com

MANAGEMENT

GROUP PUBLISHER

Rob Aherne

PUBLISHING MANAGER

Samantha Tompson

SPECIAL EVENTS MANAGER

Laura Coppin

DIGITAL SPECIAL PROJECT MANAGER

Simon Strang, ext: 5093
simon.strang@haymarket.com

DIGITAL PRODUCT MANAGER

Simon Grayson, ext: 5345
simon.grayson@haymarket.com

© 2013, HAYMARKET MEDIA GROUP LTD

Publishing, trade and further subscription details on www.autosport.com. While due care is taken to ensure the contents of AUTOSPORT are accurate, the publishers and printers cannot accept liability for errors and omissions. Advertisements are accepted for publication in AUTOSPORT only upon Haymarket Media Group Ltd's Standard Terms of Acceptance of Advertising, copies of which are available from the Advertising Sales Department of AUTOSPORT.

CIRCULATION TRADE ENQUIRIES

Frontline Ltd, Park House, 117 Park Road, Peterborough, Cambs, PE21 2TS. Tel: +44 (0)1753 551614. Printed in England by Wyndeham Heron Ltd. Cover and centre sections printed by CSM Impact, Basingstoke. Colour originalists: Colour Systems, 20-22 Pentonville Road, London N1 9HS (editorial and advertising). ISSN 0269-946X. AUTOSPORT, incorporating Autosport, is published weekly by Haymarket Consumer Media, Teddington Studios, Broom Road, Teddington, TW11 9BE, UK.

EDITORIAL DIRECTOR

Mark Payton

CREATIVE DIRECTOR

Paul Harpin

STRATEGY AND PLANNING DIRECTOR

Bob McDowell

PUBLISHING DIRECTOR

Patrick Fuller

MANAGING DIRECTOR

David Prosser

CHIEF EXECUTIVE

Kevin Costello

Haymarket is certified by BSI to environmental standard ISO14001



POLE POSITION



The spectacle must not outweigh safety

AS SOMEONE WHO HAS WATCHED STOCK car racing at Daytona from the very grandstand in which spectators were injured during Saturday's NASCAR Nationwide season-opener, it's clear that American oval racing faces a renewed challenge to keep its fans safe.

This was no 'freak' event: NASCAR uses highly restricted engines on superspeedways because of a huge crash that befell Bobby Allison at Talladega in 1987. At 'Dega in 2009, debris from Carl Edwards' somersaulting car near the finish line broke a spectator's jaw. And it's not just stock cars: in 1998/99, two IndyCar crashes (at Michigan and Charlotte) claimed six lives in total due to wheels flying into the grandstands.

Daytona's tri-oval frontstretch was designed purely with fans' sightlines in mind, and it's certainly one of the most exhilarating places to watch from. But is the attached degree of risk acceptable? NASCAR has made its cars incredibly strong – safer than ever.

Along with fellow sanctioning bodies and the tracks, they need to do their utmost to keep accidents restricted to the racing surface. Oval track walls were revolutionised by SAFER barriers; it must now happen with new debris fencing.

CHARLES BRADLEY EDITOR
charles.bradley@haymarket.com

Find us on



BAMBER'S WEEK

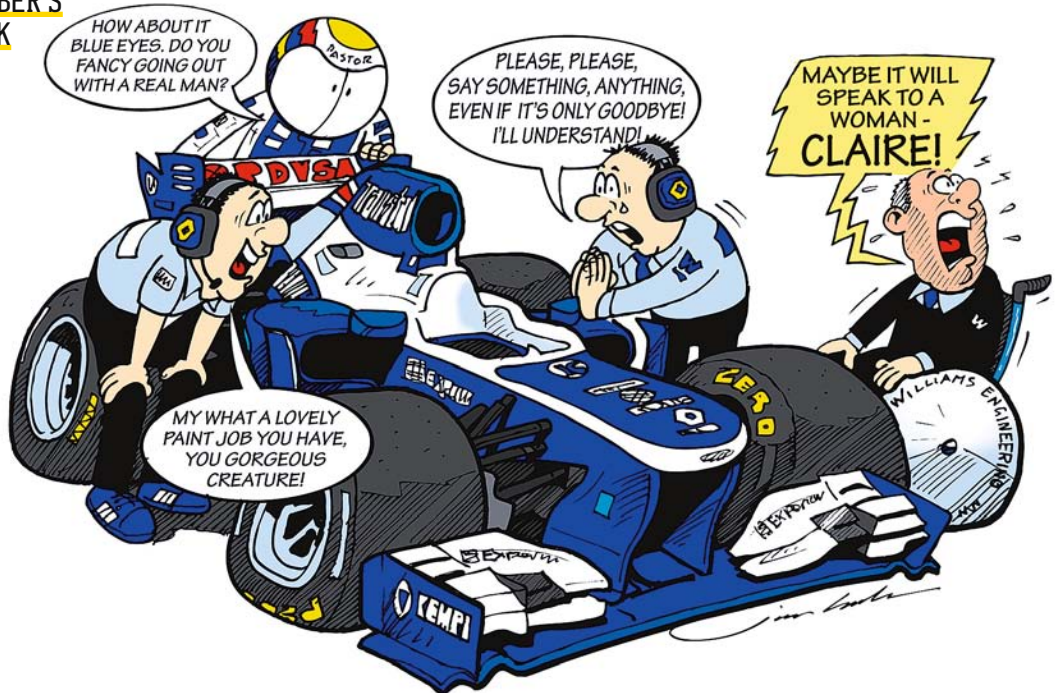

"We could not talk to our car," - Williams' team manager Dickie Stanford.





NASCAR NATIONWIDE

The moment a tragedy almost occurred

NASCAR Nationwide Series debutant Kyle Larson is about to hit the catchfencing in last Saturday's race at Daytona. The 20-year-old's engine, suspension and wheels were torn off in the impact, which took down a section of fencing and injured 28 racefans.

Pic: Graythen/Getty Images



McLaren on top as final F1 test starts

MP4-28's pre-season has not been faultless, but Jenson is sure the car can surpass its predecessor. By EDD STRAW

McLaren leads the pre-season war heading into Formula 1's crucial final pre-season test, which starts at Barcelona today (Thursday).

New recruit Sergio Perez set the fastest time overall during last week's test, and the car has shown flashes of prodigious pace during the eight days of testing so far. While there have been question marks over the consistency of the all-new MP4-28, team leader Jenson Button has no doubts that it can evolve into a title-challenging machine.

"If we started this year with last

year's car with a few changes to it, we could've had a very good car at the first race," he said. "Whether it would be better than the MP4-28 I don't know. It would be a very strong car.

"But I think after three or four races you would realise that you're at the end of the development curve with [the old car]. It's always important to change the car over the winter so we can see a new development direction over the course of the year.

"It's a long season. It's about being strong over the whole season, not just the first couple of races. I am still

hoping that we are competitive in Melbourne [scene of the season-opening grand prix on March 17]. It's a circuit I love and where I've been strong for several years.

"But there's a possibility that teams that kept the same car as last year and just developed it could also be strong [in the early races]."

Button has warned that the focus now is for the team to understand the car rather than getting carried away with throwing performance upgrades at it. This will give McLaren the baseline it needs to sustain a world

championship challenge after falling away last season.

"It's not been perfect," said Button of McLaren's pre-season so far. "We know we've got a lot of work to do. We need to spend more time out on the circuit to understand the car. We've got to concentrate on that and finding a good balance rather than just working on development throughout the year."

Button was also positive about the 2013 Pirelli tyres. Last year he struggled with the unpredictable rubber. Even though track conditions at last week's Barcelona test were, in the words of Red Bull's Mark Webber, the "worst-case scenario" for the Pirellis, Button did not have many problems with them.

"This year is more difficult in terms of gaining than last year," said the 2009 world champion. "But in terms of understanding the tyre it's a lot easier. You can get it in its working range and you know by lap three or four it's going to start gaining.

"Compared to last season, it's a fairer playing field."

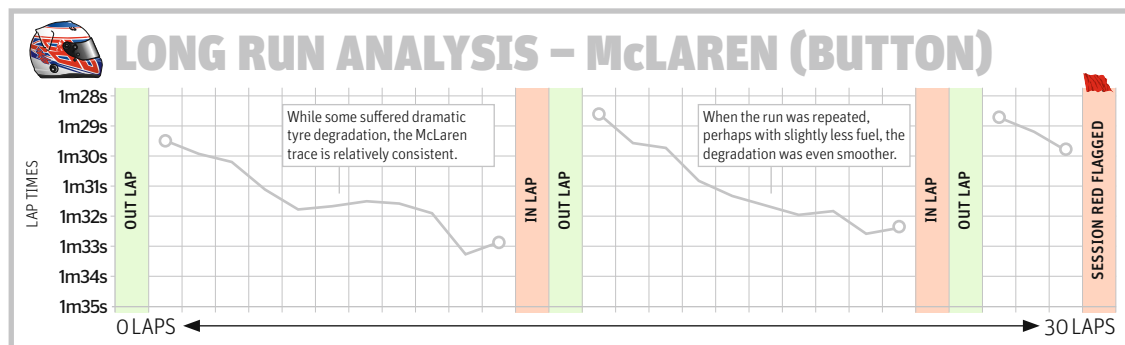



Button hustles the new McLaren at Barcelona

AUTOSPORT SAYS...

EDD STRAW
F1 EDITOR

@eddstrawF1



Prior to the abolition of refuelling during races at the end of 2009, reading testing times was less of a crapshoot. The Bridgestone rubber was more predictable and fuel loads significantly less variable thanks to the reduced capacity of the tanks.

Glance at the headline lap times from Barcelona and you will see that the leading quintet of cars – McLaren, Ferrari, Red Bull Sauber and Lotus – are separated by 0.349s. That equates to about 10kg of fuel. In other words, a car running only a little lighter than the others, even by a margin of 20kg, gains nigh on three-quarters of a second. And that's without considering tyre types and run programmes.

If you draw definite conclusions based on such information, you build your house of cards upon the dampest of sand foundations. And then there are rafts of upgrades anticipated in this week's final test at Barcelona.

All of which begs the question, just what should we take from testing? Above all, it looks seriously close. And that's what makes the final four days – from today [Thursday] – so critical.

So far, long runs and race simulations have been patchy, but this week we are going to get some data worthy of the name. Of course, we're also going to get a lot of drivers reiterating their collective catchphrase that "it's too early" to judge.

But with only four days of running left before Melbourne, it might in fact already be too late to react for those in trouble.

Guesswork is rife in modern testing



BARCELONA F1 TEST, FEBRUARY 19-22

| POS | DRIVER | CAR | TUESDAY | WEDNESDAY | THURSDAY | FRIDAY |
|-----|--------------------------|----------------------------|-----------|-----------|-----------|-----------|
| 1 | Sergio Perez (MEX) | McLaren-Mercedes MP4-28 | 1m24.124s | 1m21.848s | - | - |
| 2 | Fernando Alonso (E) | Ferrari F138 | 1m22.952s | 1m23.247s | 1m21.875s | - |
| 3 | Nico Hulkenberg (D) | Sauber-Ferrari C32 | - | 1m24.205s | 1m22.160s | - |
| 4 | Romain Grosjean (F) | Lotus-Renault E21 | - | - | 1m22.188s | 1m34.800s |
| 5 | Sebastian Vettel (D) | Red Bull-Renault RB9 | 1m22.965s | 1m22.197s | - | - |
| 6 | Nico Rosberg (D) | Mercedes F1 W04 | 1m22.616s | - | 1m22.611s | - |
| 7 | Kimi Raikkonen (FIN) | Lotus-Renault E21 | 1m22.623s | 1m22.697s | - | - |
| 8 | Pastor Maldonado (YV) | Williams-Renault FW35 | 1m23.733s | - | 1m22.675s | no time |
| 9 | Lewis Hamilton (GB) | Mercedes F1 W04 | - | 1m22.726s | - | 1m23.282s |
| 10 | Valtteri Bottas (FIN) | Williams-Renault FW35 | - | 1m23.561s | 1m22.826s | no time |
| 11 | Jenson Button (GB) | McLaren-Mercedes MP4-28 | - | - | 1m22.840s | 1m23.633s |
| 12 | Adrian Sutil (D) | Force India-Mercedes VJM06 | - | - | 1m22.877s | - |
| 13 | Mark Webber (AUS) | Red Bull-Renault RB9 | - | - | 1m23.024s | 1m27.616s |
| 14 | Jean-Eric Vergne (F) | Toro Rosso-Ferrari STR8 | - | - | 1m23.366s | 1m24.071s |
| 15 | Daniel Ricciardo (AUS) | Toro Rosso-Ferrari STR8 | 1m23.884s | 1m23.718s | - | - |
| 16 | Paul di Resta (GB) | Force India-Mercedes VJM06 | 1m24.144s | 1m23.971s | - | - |
| 17 | Max Chilton (GB) | Marussia-Cosworth MR02 | 1m26.747s | 1m25.115s | 1m25.690s | 1m29.902s |
| 18 | Esteban Gutierrez (MEX) | Sauber-Ferrari C32 | 1m25.124s | - | - | 1m26.239s |
| 19 | Jules Bianchi (F) | Force India-Mercedes VJM06 | - | - | - | 1m25.732s |
| 20 | Giedo van der Garde (NL) | Caterham-Renault CT03 | - | - | 1m26.177s | 1m27.429s |
| 21 | Charles Pic (F) | Caterham-Renault CT03 | 1m27.534s | 1m26.243s | - | - |
| 22 | Felipe Massa (BR) | Ferrari F138 | - | - | - | 1m27.563s |

PICS: FERRARI/LAT. GILHAM/GETTY

GET AUTOSPORT ON THE MOVE

● **DIGITAL EDITION NOW AVAILABLE FOR IPAD**

● **STUNNING HI-DEFINITION VIDEO CONTENT**

● **ON SALE ALL OVER THE WORLD FOR ONLY £2.99**



Download it now from the Apple Newsstand **AUTOSPORT**



Red Bull was consistent



Grosjean learned to look after the tyres

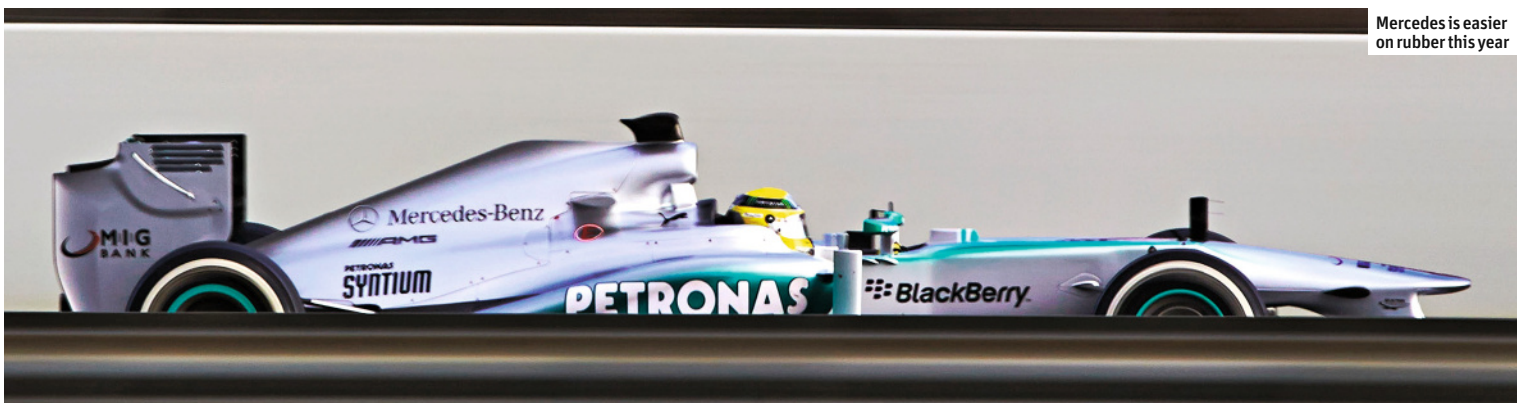

Mercedes is easier on rubber this year

The story behind the lap times



MARK HUGHES digs deeper into the clues from last week's second test

Last week's Barcelona test further refined the apparent competitive order among the Formula 1 teams, although with many provisos.

As ever in testing, the main uncertainty stems from the residual fuel levels each team chose to run with. Ferrari and Mercedes, for example, have historically run with a lower minimum fuel weight than Red Bull or McLaren. If one team always has at least 20kg in the tanks and another 30kg, that 10kg difference represents around 0.35s

around Barcelona — a hefty chunk given how close the spread of times is, and one which would completely skew the competitive picture.

Each team knows only its own fuel weight, and can make only educated guesses on everyone else's; hence their insistence that we won't know definitively until qualifying for the first race in Melbourne.

The other major proviso is that by the time you read this magazine, the final pre-season test will be underway. For this, many of the teams will have produced their

"Each team knows only its own fuel weight, and can make only educated guesses on everyone else's"

Melbourne-spec aero upgrades, the effectiveness of which would be expected to vary from team to team.

But even within these qualifications, the lap times from last week's test tell us something. Set during the two quickest days of Wednesday and Thursday



Final test starts on Thursday



LONG-RUN ANALYSIS – RED BULL (WEBBER)

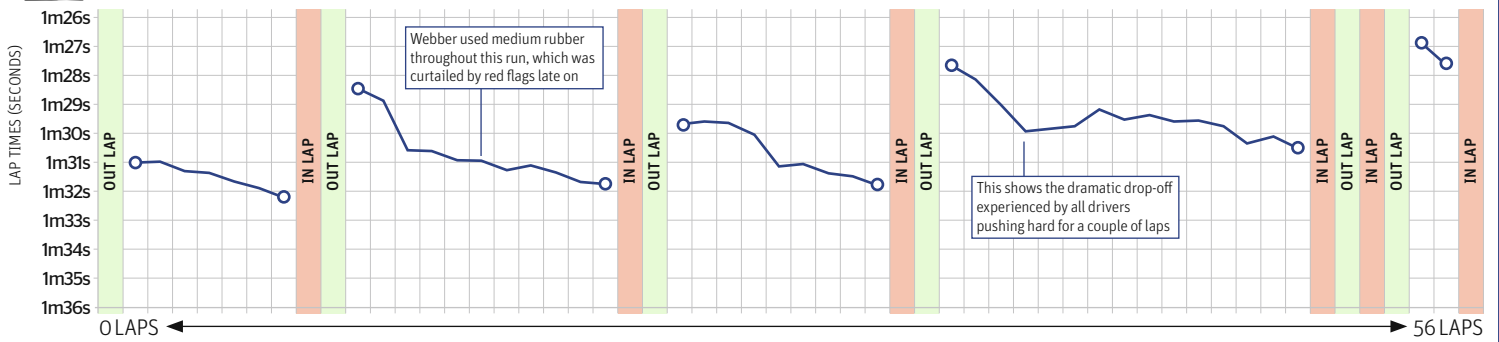

LONG-RUN ANALYSIS – LOTUS (GROSJEAN)

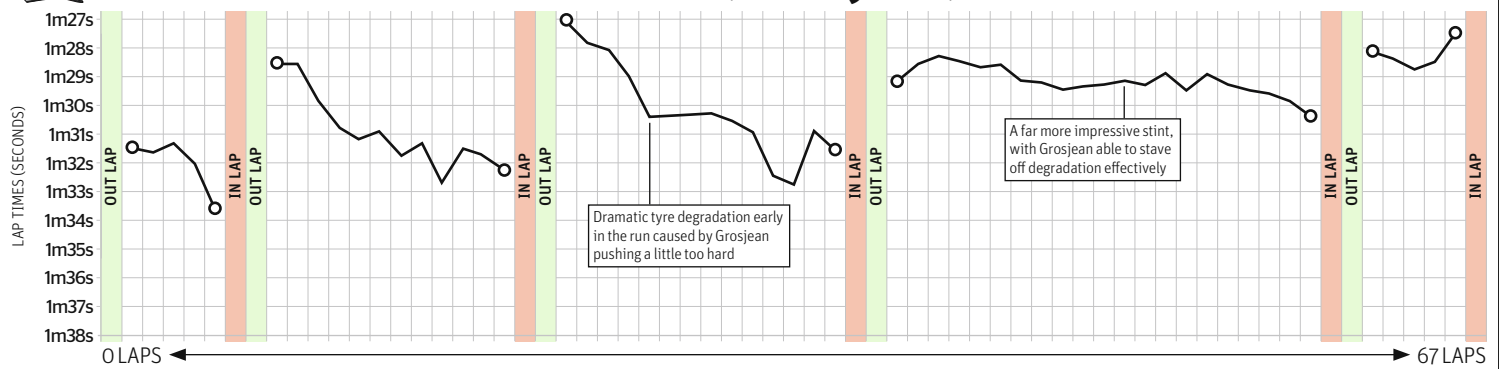

LONG-RUN ANALYSIS – MERCEDES (ROSBERG)

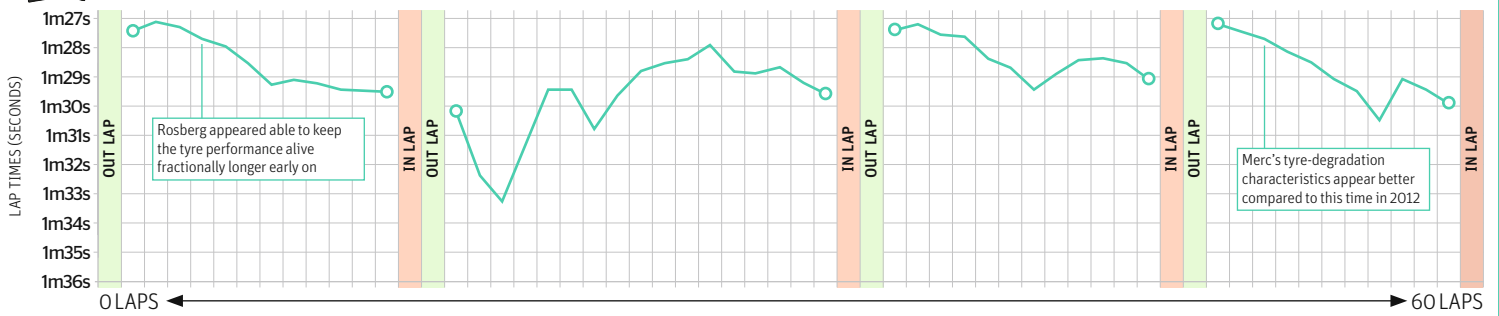

FUEL-CORRECTED FASTEST LAPS

| POS | DRIVER (TEAM) | TIME |
|-----|---------------------|------------|
| 1 | Alonso (Ferrari) | 1m21.526s* |
| 2 | Perez (McLaren) | 1m21.848s |
| 3 | Grosjean (Lotus) | 1m22.006s* |
| 4 | Hamilton (Mercedes) | 1m22.026s* |
| 5 | Rosberg (Mercedes) | 1m22.156s* |
| 6 | Hulkenberg (Sauber) | 1m22.160s |
| 7 | Vettel (Red Bull) | 1m22.197s |
| 8 | Raikkonen (Lotus) | 1m22.242s* |

*weight-adjusted time



Was Alonso in fact quickest last week?

TOTAL 2013 CAR MILEAGE

| POS | TEAM | MILES |
|-----|-------------|-------|
| 1 | Sauber | 2175 |
| 2 | Red Bull | 1955 |
| 3 | Toro Rosso | 1859 |
| 4 | Mercedes | 1855 |
| 5 | Ferrari | 1815 |
| 6 | Force India | 1800 |
| 7 | McLaren | 1834 |
| 8 | Caterham | 1725 |
| 9 | Lotus | 1463 |
| 10 | Marussia | 1302 |
| 11 | Williams | 1061 |

(on Tuesday, day one, the track was green while Friday, day four, was compromised by rain), the fastest times in the table above comprise either actual one-off fast laps or have been calculated based on the

number of laps they did in a run after setting a particular time. Alonso's best, for example, was a 1m21.875s but came at the beginning of a four-lap run. So we know there was at least 10.4kg

(enough for four laps at approximately 2.6kg/lap) of fuel on board when he set that time. With each 10kg worth around 0.35s of lap time at Barcelona, his calculated best lap is 1m 21.526s.

Other drivers – McLaren's Jenson Button and Red Bull ace Mark Webber, for example – were concentrating on long runs and did not set any competitive times, so are not included in this list.

Williams and Caterham parts 'illegal'

Designs aimed at getting more aerodynamic performance from the exhausts are unlikely to be allowed to race, according to the FIA

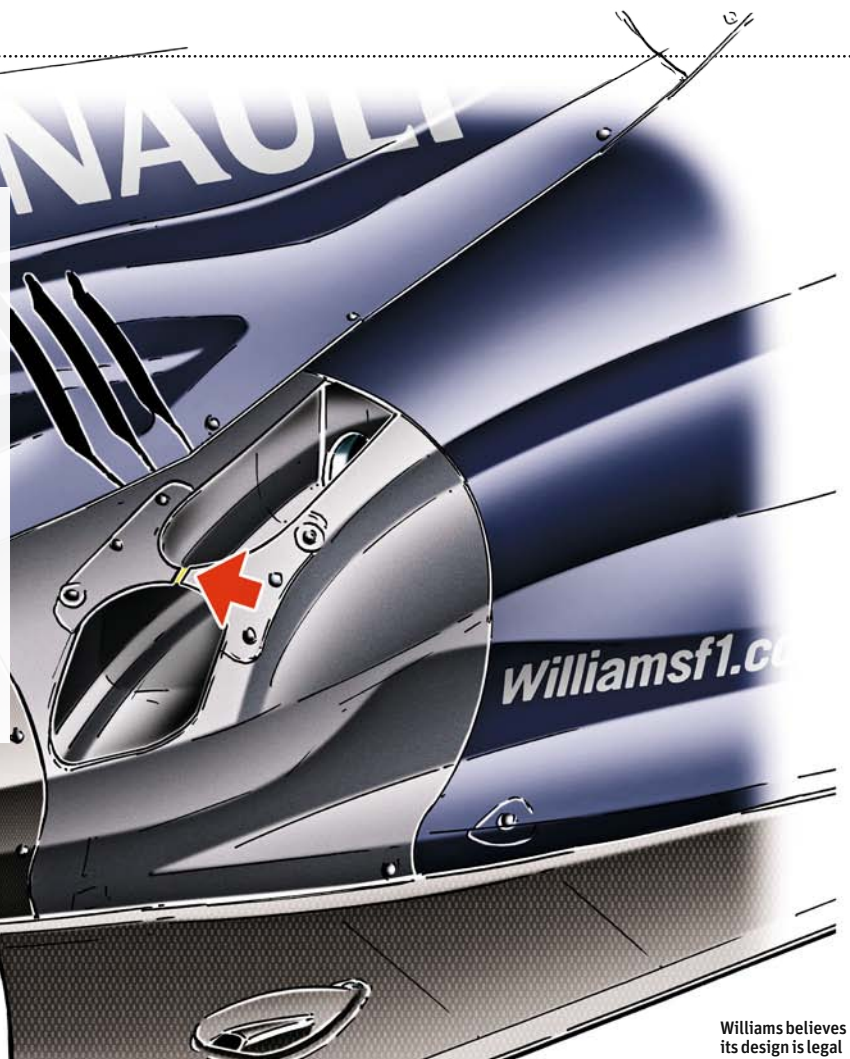

Williams believes its design is legal

The FIA informed the Williams and Caterham teams during last week's Barcelona test that the vanes situated in the Coanda channel of their 2013 machines are considered illegal.

The FIA's position is currently advisory, but it is a clear sign that any team running such a design will be referred to the stewards if they attempt to run them during a race weekend this year. The ruling is based on privately published technical directives, issued last year, that insist

the sides of the Coanda channel cannot converge. No additional technical directive has been issued.

This is designed to prevent the re-ingestion of exhaust gases into closed channels for aerodynamic gain. When this happens, the FIA believes that the line separating an exhaust with incidental aerodynamic effect from something with a primarily aerodynamic purpose is crossed.

This remains a grey area and either team could choose to argue the case. However, the overall benefit of the

vanes, designed to help the exhaust airflow to attach to the bottom of the channel, is not hugely significant.

Speaking at last week's test, Williams technical director Mike Coughlan was confident in the legality of his team's design.

"The Caterham one is really not allowed but ours is OK," he said. "If you look at ours, it's not a single piece – it's in two pieces."

Neither Williams nor Caterham have commented on whether they will continue to run the vanes.

FIA doesn't approve of Caterham's vanes



Drawing board

WILLIAMS BLOWN FRONT AXLES

The Williams FW35 features blown front axles, designed to channel air into the area inside the front wheels to the vicinity of the downforce-producing brake ducts. This design is considered legal, although Red Bull tried a similar concept with slightly different implementation last year (inset) that was not allowed.

GARY ANDERSON: "The Williams axle hole is stationary and does not

incorporate the wheelnut, whereas Red Bull's was rotating so outlawed under what is broadly called the ban on moveable aerodynamic devices.

"You try to use the low-pressure area behind the tyre to suck air through the brake duct, and by allowing additional air to be sucked through the hole in the axle, it should increase brake-duct efficiency and produce more downforce."

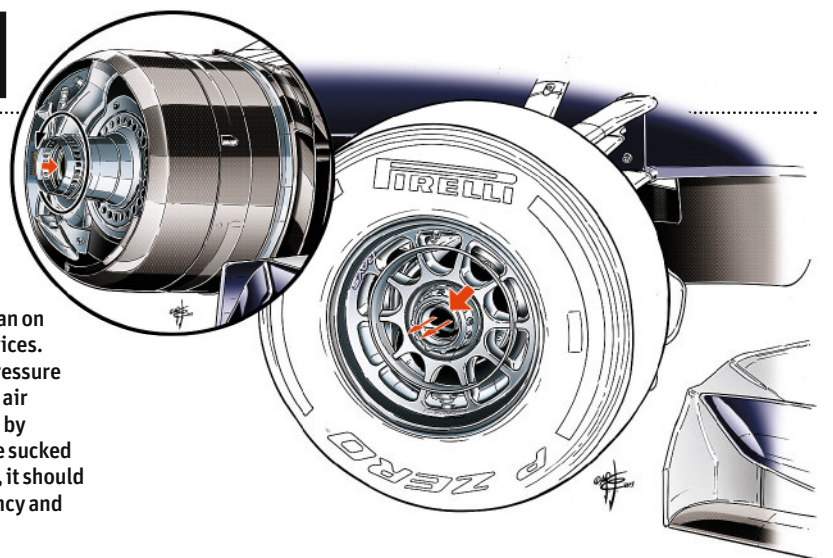

BARCELONA TEST SUMMARY

FERRARI



Fernando Alonso had his first taste of the Ferrari F138 after skipping the Jerez test and talked up his hopes of fighting for the championship, albeit with the caveat that the car still needs to improve.

"I fought for the championship last year with a car that was two seconds off the pace in the winter," said Alonso. "So we need to be positive and think that we will fight for the championship again this year if we improve the car a little bit."

One area ripe for improvement is the exhausts. On track, the Ferrari looks good but the rear end does appear to be prone to giving up fractionally earlier than that on some of the other leading teams. Even if it means sacrificing some engine power, the team considers it worth chasing more downforce.

"We are working on a different solution," said Ferrari engine boss Luca Marmorini. "We can afford to lose some horsepower if the car is quicker."

RED BULL



Ran race simulations with both Sebastian Vettel and Mark Webber. For an in-depth analysis of where Red Bull stands, see page 24.

LOTUS

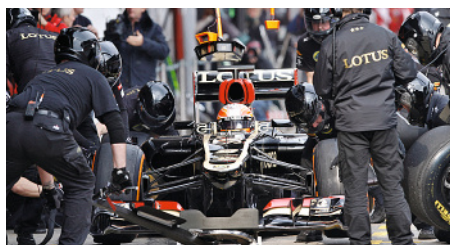

Suffered some problems at Barcelona, with Kimi Raikkonen losing track time with a loss of telemetry on day one and a gearbox problem on day two. But the car's pace continues to attract attention, with Sauber driver Nico Hulkenberg the latest to talk it up. The team also continued to experiment with its passive DRS.

MERCEDES



After some tyre difficulties during the first test at Jerez, Lewis Hamilton was much happier with his car at Barcelona.

"At the last test, the tyres didn't behave so well because the car wasn't behaving," he said. "Here it's much better."

The car has shown decent single-lap pace although the consensus is that it is still at a downforce disadvantage to the leading teams.



WILLIAMS



The 2013 FW35 ran for the first time last week, and it proved reliable after an extensive dyno-testing programme at the factory. Pastor Maldonado was effusive after his first taste of the machine, which he described as "a step forward" and "the best car I have driven, especially in the first test".

SAUBER



Ran its passive DRS for the first time, although more work is needed before it is considered race ready. Sauber is set to run some more development parts this week.

FORCE INDIA



Attention focused on the 'shoot-out' between Adrian Sutil and Jules Bianchi, although the decision will as much be driven by off-track concerns as performance. While Sutil showed that he still has it after not driving an F1 car since November 2011, Bianchi's day in the car was ruined by bad weather. "I've done everything I can and now it's up to them to decide," said Sutil.

TORO ROSSO



Started work on its upgrade programme after finding a good baseline with the car, which features a heavily-revised mechanical platform.



CATERHAM



Continues to look the most evil-handling car of all the 2013 challengers on track, as well as causing most red flags.

MARUSSIA



Problems shown up by the car being capable of lapping almost a second-and-a-half faster than last year in Barcelona were being worked through and the team was happy with the progress it was making.

pankl
RACING SYSTEMS



High Tech | High Speed | High Quality

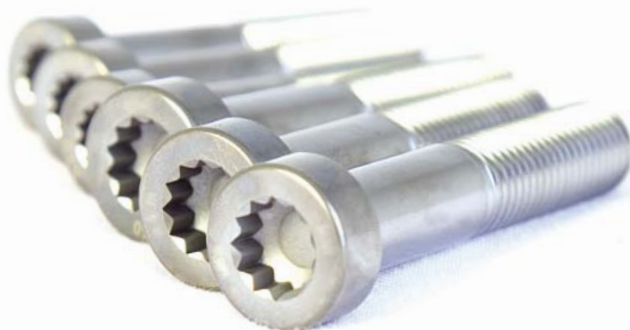

Pankl Engine Systems GmbH & Co KG

A member of Pankl Racing Systems

A-8600 Bruck/Mur, Kaltschmidstrasse 2-6

Phone: +43(0)3862 51 250-0

FAX: +43(0)3862 51 250-290

e-mail: engine@pankl.com

www.pankl.com

THIS WEEK IN F1



Dave Charlton 1936-2013

SIX-TIMES SOUTH AFRICAN FORMULA 1 champion Dave Charlton has died at the age of 76. Charlton contested 11 world championship grands prix, which included one-off outings for Team Lotus and Brabham. He failed to score a point, but dominated the South African domestic scene from 1970-1975.

You've got to remember the car was over a second off, sometimes two seconds off, last year and we've not caught up a second. And other teams will have put a second on over the winter. So we've not gained three seconds, that's a fact



Lewis Hamilton torpedoes rivals' suggestions that Mercedes could be a title threat in 2013

Ferrari still wants engine customers

Ferrari engine chief Luca Badoer has described customer teams as a "very important opportunity for an engine supplier" amid question marks over its 2014 supply. Ferrari is set to continue with Sauber, and is in talks to supply Force India if Toro Rosso moves to Renault.



Renault willing to supply five teams

Renault's F1 engine boss Jean-Michel Jalinier has admitted that Renault is willing to supply five teams with 1.6-litre V6 engines next year. Jalinier ruled out supplying six, and emphasised the he would be happier to supply three or four outfits.

Lowe set to leave McLaren for Merc

Paddy Lowe has been stood down as technical director of McLaren after agreeing to join Mercedes next year. Lowe remains under contract for the rest of the year at McLaren but will have no active role in the F1 programme. Next year, he is expected to take a senior role at Mercedes and has previously been linked with the team principal role.



Kimi and Pic in Race of Stars

Kimi Raikkonen and Charles Pic appeared in the Race of Stars ice racing event in Moscow last weekend. Caterham racer Pic beat the 2007 world champion in a head-to-head between the pair.



300

On Sunday, Felipe Massa is set to appear in his 300th official test day in F1. His first came in September 2001, driving for Sauber at Mugello

Wolff eyes superlicence

Susie Wolff plans to "look into" getting a superlicence having completed enough kilometres for Williams to apply for one. Wolff will attend all F1 races in 2013 and could be available as a reserve driver.



The 2013 Castrol EDGE Grand Prix Predictor launches today (Thursday). Test your F1 knowledge against expert panel Karun Chandhok, Timo Glock and triple WTCC champion Andy Priaulx by predicting the top 10 in each GP. Players who sign-up by March 11 will also be entered into a prize draw to win a 10" Samsung Tab 2 tablet device. Visit predictor.autosport.com to play.

FREE ADIDAS BAG

WHEN YOU SUBSCRIBE TO AUTOSPORT

**SAVE
23%
ON THE
COVER
PRICE**



**JUST
~~£3.50~~
£2.69
AN ISSUE**

Subscribe online at:

www.themagazineshop.com/ASPO/MO313P

Or call **08448 488 817** and quote MO313P

GREAT REASONS TO SUBSCRIBE:

- **FREE ADIDAS RACE BAG**
worth £39.99
- **SAVE 23%** on the cover price
- **SPREAD THE COST**
- just £34.99 every 13 issues with easy direct debit instalments
- **FREE P&P**
- every issue delivered direct to your door



Yes

AUTOSPORT

Yes, please start my subscription to AUTOSPORT paying just £34.99 every 13 issues by direct debit, saving 23% on the cover price. Please send me my FREE Adidas bag.

YOUR DETAILS - must be completed

(BLOCK CAPITALS PLEASE)

Title: Name:

Surname:

Address:

Postcode:

Telephone:

Mobile:

Email:

DIRECT DEBIT PAYMENT (UK ONLY)

To the manager, bank name:

Address:

Postcode:

Name of account holder(s):

Bank sort code - -

Bank/building society account number

Please pay Haymarket Media Group direct debits from the account detailed on this instruction subject to the standards assured by the direct debit guarantee. I understand that this instruction may remain with Haymarket Media Group and, if so, details will be passed electronically to my bank/building society.

Signature(s):

Date:

Please return this form to:

**AUTOSPORT
FREEPOST RSBY-ZLLA-SZZS
PO Box 326
Sittingbourne ME9 8FA**

Terms and conditions: This offer is open to UK residents only. Overseas rates are available on +44 (0) 1795 532 974 and residents of USA and Canada should call 1-866-918-1446 or visit www.imsnews.com for rates. Please allow 36 days for delivery of your gift and first issue. The gift will be sent under separate cover from the magazine. Should we run out of gifts, you may be offered an alternative gift - there is no cash alternative. Direct debit rates are valid for one year after which they are subject to change - should prices change we will inform you in writing. We ask that you enter into a direct debit agreement with the intention that your subscription will continue for a minimum period of 12 months even if the frequency of payment is for a shorter period; however, you will still have the right to cancel your direct debit in accordance with Direct Debit Guarantee. Should you wish to cancel your subscription it will be cancelled on expiry of the current term which will not be refundable other than in exceptional circumstances. If a gift is included as part of the subscription offer we reserve the right to request the return of the gift. Details of the Direct Debit Guarantee are available on request. Savings are based on the standard UK cover price of £350. Offer ends April 4, 2013. Haymarket Media Group Ltd uses a best-practice layered privacy policy to provide you with details about how we would like to use your personal information. To read the full privacy policy please visit our website www.haymarket.com/privacy or call us on 08448 482 800. Please ask if you have any questions as submitting your personal information indicates your consent for the time being that we and our partners may contact you about products and services that will be of interest to you via post, phone, e-mail and SMS. You can opt out at ANY time by emailing datacontroller@haymarket.com or by calling 08448 482 800.



MARK HUGHES GRAND PRIX EDITOR

Has Renault been caught out by a misunderstanding on engine-mapping regulations? And if so, does this mean Red Bull and Lotus will need to redesign their 2013 cars?

An interesting little controversy has emerged on the eve of the season regarding engine maps. As a result of the fuss surrounding Renault Sport's mapping in the Red Bull at Hockenheim last year, the FIA stipulated that henceforth teams would have to specify a 'baseline' map, which had to be one of those used by the team in the first four races of last season.

Renault Sport understood that for 2013 there would effectively be a reset and that teams would declare a new baseline map for the start of the season. In many ways it was a logical assumption – even though the mechanical specification of the engines is frozen by regulation, the designs of the cars are different. For example, one of the parameters of defining the ideal engine map for a car would be the design of the airbox and the route it imposes on the engine's incoming air.

But it seems there is to be no such reset; the baseline engine map for 2013 will be just a continuation of that specified by each team after Hockenheim last year. Renault Sport feels aggrieved by this.

PIC: COATES/LAT

Any plans it may have had to reintroduce the Hockenheim Red Bull map cannot now be actioned. Why that may be such a blow to Renault Sport and its teams has been speculated upon by Mercedes' Ross Brawn, who said: "Maybe their exhaust solution [regarding rear-bodywork design] was based on the idea that there would be more leeway with the mapping. [The Renault-engined] Red Bull's and Lotus's solution is problematic off-throttle, because in off-throttle mode there is less blowing from the exhaust and therefore less downforce contribution by the exhaust, which means that one has to rely more on the Coke bottle [profile of the rear bodywork]. But the Coke bottle on the Red Bull and Lotus is less pronounced because of their ramp behind the tailpipe. Therefore, their solution is inferior at corner entry compared to the solution pioneered by McLaren, and which all the teams except Red Bull and Lotus followed. It's possible that they wanted to compensate with clever engine mapping."

The design choice of exhaust layout is essentially whether or not to compromise the extent of the Coke bottle-style cut-in of the rear lower bodywork by partially blocking it with an exhaust-exit ramp that allows you to target the exhaust flow over the downforce-producing components to better effect. You can either have a McLaren-style sharply-defined Coke-bottle section that enhances the speed of the airflow along the flanks and over the brake ducts and diffuser top, but with compromised exhaust-enhanced downforce. Or you can go the Red Bull route and have ideal exhaust positioning at the

cost of compromised airflow from the Coke-bottle section. This would be expected to give you superior downforce to the McLaren layout on-throttle but less off-throttle.

At a key part of the rev range, Red Bull's Hockenheim 2012 engine map gave less torque on full throttle than the engine was capable of delivering, a side-effect of which was the driver could get on full throttle earlier into the corner. He would thereby get more downforce onto a rear end made wayward by the lack of off-throttle blowing and the compromised Coke-bottle section. That map was ideal for the Red Bull's bodywork configuration, in that it limited its weak point (off-throttle downforce) and enhanced its strong point (on-throttle downforce).

Later in the season, with that engine map banned, Red Bull minimised the corner entry downsides of the shortage of Coke bottle-derived downforce, making changes in the rear-suspension geometry that actually amplified slow-corner oversteer. Sebastian Vettel was very adept at using this to enhance the speed of direction change. The usual penalty for this is that the slide continues even after you've made the direction change and you lose more time than you've just gained. But the Red Bull's powerful on-throttle blowing and Vettel's acrobatics enabled him to halt that slide at the perfect moment by simply standing on the gas.

Impressive though Vettel's skills were, it was a scrappy solution technically. Better to get your entry speed via more downforce earlier in the corner – which the Hockenheim map would have provided. Will this latest ruling lead to reconfigured rear ends for Red Bull and Lotus? ❧



“Will engine map freeze mean Red Bull has to redesign RB9?”



FORMULA RENAULT 3.5

SNOW JOKE IN SPAIN

The second day of Formula Renault 3.5 testing at Aragon was cancelled last Saturday due to snow, after Fortec rookie Stoffel Vandoorne had topped the opening day. Series organisers will try to give teams an extra day of pre-season testing to compensate.

WTCC

Huff to race SEAT Leon in WTCC

World champion ends nine-year stint with RML to spearhead Munnich campaign. By JAMIE O'LEARY

Rob Huff will make a shock switch to new World Touring Car Championship squad Munnich Motorsport this year in a bid to defend his title.

The 33-year-old Briton won last year's title with Chevrolet, but was left without a drive in the wake of the US manufacturer's decision to withdraw from the series.

He has now secured a deal to drive one of the GT1 world champion

team's trio of SEAT Leon WTCCs alongside Marc Basseng and team owner Rene Munnich.

The deal has been made possible by Markus Winkelhock, who had originally been announced as one of Munnich's trio of drivers last December, deciding to stand down from his role in order to focus on his GT commitments with Audi. These will revolve around a Blancpain Endurance Series

programme in an R8 LMS ultra.

Huff's move brings to an end a nine-year stint in touring cars with the British RML squad, eight of which were spent in the WTCC as part of the Chevrolet line-up.

He said that his decision was made with one eye on the long-term future.

"It's no secret that [SEAT Sport boss] Jaime Puig is keen to bring the works team back in 2014 with the new rules," he told AUTOSPORT. "Being with a team that won the GT1 World Championship last year, and that is easily capable of running a works programme, could leave me in a very strong position 12 months from now."

Huff is aware that Munnich's Leons will not be the class of the field if RML, as expected, runs a pair of privateer Cruze 1.6Ts this year. SEATs have won just twice since the start of 2011, while Chevrolets have won 41 times.

"The Chevrolet is the best car and there's no reason for that to change this year, but I'm going to give it a

good go of trying to beat them," he added. "We have reversed grids, for example, and there's always a chance to exploit that as some other drivers have done in the past.

"Of course it will be a little bit strange not being with RML, because I've been there so long, it really feels like the end of an era. But I'm so excited about the season ahead and I'm raring to get going."

Team-mate Basseng, who is also the Munnich team manager, said that Huff's tin-top experience would be crucial in establishing the squad as a consistent front-runner.

"His experience is going to be vital to us as we learn about touring cars," he said. "It will be good to have someone with us who has just come from driving the quickest touring car on the grid last year. I'm sure that will be of value to us and the SEAT Sport engineers."

Huff was due to drive the Leon for the first time at Monza this week, but heavy snow forced the cancellation of the planned two-day test.

Huff's new colours



NASCAR

Johnson crew: NASCAR 'not boring'

JIMMIE JOHNSON'S CREW CHIEF

Chad Knaus does not believe that the lack of overtaking during this year's Daytona 500 ruined the spectacle for NASCAR fans.

After concerns grew over the number of processional events staged in the Cup series last year, NASCAR organisers had hoped that the new 'Gen-6' car would correct the shortcomings of its predecessor and lead to better racing.

While Daytona did not produce the desired effect, and instead staged a lot

of single-file racing, Knaus believes that there was still plenty of intrigue during the season-opening race.

"Just because you're not running side-by-side doesn't mean it's a bad race. There were a lot of stories going on other than the racing on the track," he said. "Racing is more than side-by-side and crashing. If you go back and look, there were different pit strategies, ways guys took the lead on pit road, two- or four-tyre strategies. If you go back and look at the nuts and bolts of it, the racing was pretty good."

Johnson, whose triumph ended a poor run of results in NASCAR's premier race, felt the race was exciting even if overtaking was hindered by the fact the circuit's high line was faster than the low line.

He said: "The game's changed a little bit. It used to be 'defend the bottom', now it's 'defend the top'. In the closing laps I didn't want to allow guys to set me up for a fall based on my lines, so I ran at the bottom and no one had a run. We were all single file, but it was an interesting race."



Cars ran single-file at Daytona

NASCAR

Patrick: judge me on results

DANICA PATRICK DOWNPLAYS

the significance of becoming the first woman to lead NASCAR's Daytona 500 last weekend.

The Stewart-Haas Chevrolet driver led five laps on the way to finishing eighth, bettering the 11th place recorded by Janet Guthrie in 1980.

While Patrick admitted she was proud of the achievement, she insisted she wanted to be defined by her achievements rather than her gender.

"Honestly when I say I wanted to lead at some point, it didn't really have to do with being a girl and leading," she said. "Only 13 people, including me now, have led the Indy 500 and Daytona. That was a much cooler stat."

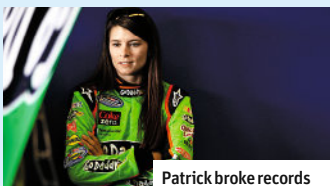

Patrick broke records

P52 DAYTONA REPORT



Larson's car broke up in huge shunt

NASCAR

NASCAR to review crash

NASCAR HAS PROMISED A comprehensive review into the Nationwide Series crash that left 28 spectators injured at Daytona last Saturday.

A last-lap accident resulted in Kyle Larson's Chevrolet flying into the safety fencing. One of his wheels was launched into the grandstand while his engine and suspension also pierced the fence. Fourteen fans were taken to local hospitals, with most released with minor injuries. Two spectators on the 'critical' list had been upgraded to 'stable' as AUTOSPORT closed for press. NASCAR's senior vice-

president of racing operations, Steve O'Donnell, said: "As with any of these incidents we'll conduct a thorough review. We'll work closely with the tracks as with all our events, learn what we can and see what we can apply in the future."

Daytona International Speedway president Joie Chitwood said he is confident that the venue's safety measures are up to standard.

"We've got very good safety protocols. Incidents do happen, but those are the exceptions," he said. "We've got a pretty good safety track record."

AUTOSPORT SAYS...

JAMIE O'LEARY
REPORTS EDITOR

@mrjamieoleary



Not too many news announcements come as a surprise in the AUTOSPORT office, but this week's revelation by world touring car champion Rob Huff certainly fell into the above category.

On the face of it, his decision to join Munnich Motorsport, a team with bags of experience in rallycross and GT racing, but crucially not touring cars, and in a car that even he admits is no match for his old Chevrolet Cruze, looks ever so slightly strange.

But look a little deeper and the justification for the Briton's defection from RML does seem all the more justified.

Firstly, he couldn't raise the budget to remain with Ray Mallock's team in the wake of Chevrolet's decision to end its works stint in the series that forced the squad to seek private financing for its programme. Secondly, Munnich didn't take long to get up to speed when it was new to GT racing and ended 2012 with the GT1 world teams' and drivers' titles to its name. And finally, as Huff has so pertinently stated, if SEAT comes back as a full manufacturer entrant in 2014, no other team would be placed so handily to pick up the contract to run the programme.

Drivers take a gamble every time they join a new team (or even remain with an existing one). Huff's latest gambit might just be a well-calculated one.

Huff is moving



REMEMBER WHEN...



MAY 3-4, 2003

Rob Huff first raced a SEAT? Huff made his Cupra Cup debut at Croft and won the second race of the weekend. He went on to take the title and the prize BTCC drive with SEAT that accompanied it.



WEC

NEW PORSCHE HITS TRACK

Porsche has released the first pictures of its new 991-shape 911 RSR from a Sebring test last year. Development of the new car, two works examples of which will race in the GTE Pro class of the WEC, were driven by Marc Lieb and Richard Lietz.

LE MANS

Nissan targets Le Mans victory

Experimental 2014 electric car may be precursor to LMP1 project for Japanese make. By GARY WATKINS

Nissan has set its sights on taking on Audi, Toyota and Porsche for outright victory at the Le Mans 24 Hours in the future with the electric-vehicle technology it pioneers in next year's race aboard a new experimental racer.

The Japanese manufacturer has been awarded the grid spot known as 'Garage 56', reserved for an experimental racer running outside the general classification, in 2014. It wants to prove the potential of electric powertrains so that they can be incorporated into the new energy-based LMP1 formula as a precursor to Nissan's first bid for overall Le Mans victory since 1999.

Nissan global motorsport director Darren Cox said: "The 2014 LMP1 rules written by the Automobile Club de l'Ouest [which organises Le Mans] and the FIA are the most relevant to manufacturers out there at the moment, so the potential second phase of this project is a return to LMP1.

"We want to show our drivetrain



Nissan's last Le Mans victory bid came with R391 in 1999

to the ACO and the FIA and to see if it is possible for them to include it in their rules in the future. If the technology works and all the parties agree, then potentially we can go back to LMP1 to try to win using a different drivetrain to Audi, Toyota and Porsche."

The 2014 P1 rules allocate cars a fixed amount of energy per lap, although the ACO is only allowing petrol and diesel fuels in the first year. It has left the door open to

other forms of energy, including electric power and hydrogen, in the future.

A statement from the ACO said: "The technical regulations that come into force in 2014 in the LMP1 category open the door to the inclusion of new technologies in motor racing, provided they can be measured and introduced while guaranteeing a level playing field for all entrants.

"If all the conditions are met, the

next step would be Nissan entering a car in LMP1 in the World Endurance Championship with technology derived from the 2014 'Garage 56' car."

No timescale has been set on any Nissan return to the top division at Le Mans.

"We will have to evaluate where we are after Le Mans in 2014," added Cox. "There can be no decisions until then."

Nissan has not released any technical details of its experimental electric Le Mans contender. Cox revealed that the thought process that led to the project started with the Nissan-backed DeltaWing that filled the 'Garage 56' entry at Le Mans last year.

Asked if he believed it will be possible to build an electric car capable of attaining a performance level akin to an LMP2 car in 2014, Cox said: "If we don't go and race at the highest level with breakthrough electric technology, we are never going to find out."

WEC

Toyota completes French '24-hour' test

TOYOTA HAS NOTCHED UP ITS MOST successful endurance test yet since its return to international sportscar racing with the TSO30 HYBRID.

The 2013 version of the petrol-electric LMP1 contender last week completed a distance at Paul Ricard equivalent to that run over the course of the Le Mans 24 Hours. The second-generation TSO30 did experience problems during the 36-hour test but none was a "race stopper", according to driver Anthony Davidson.

Davidson, who shared the solo new-spec TSO30 with the five other Toyota drivers, told AUTOSPORT: "I was very encouraged. There were a few things that delayed us, but none stopped the car out on the track.

"We have a few silly little things that were just teething problems with a new car. Some of the problems wouldn't have even stopped us in a race, but with a new car, it is better to take the time to fix them."

The Toyota Motorsport squad ran four simulations ahead of Le Mans last year and

failed to complete a race distance. Last week its technical boss Pascal Vasselon told AUTOSPORT that Toyota could not be considered favourites for the 24 Hours when it had failed to complete a Le Mans distance.

The team has a further three simulations, one at Aragon in Spain early next month and another at Ricard, planned prior to the start of the World Endurance Championship in April. Another endurance test is planned after the start of the WEC in April.



Toyota ran for 24 hours at Ricard

GP2

iSport to sell its GP2 entry

FORMER CHAMPION GP2 TEAM ISPORT International is to evaluate a project outside the Formula 1 feeder formula after deciding to sell its cars and entry ahead of the 2013 season.

Team principal Paul Jackson confirmed last week that it had failed to find fully-funded drivers, which means it will withdraw from the series after

trying "all workable solutions".

"It's a very sad situation," said Jackson, whose team won the 2007 title with Timo Glock. "I've had an offer for the cars and our entry, and I'm waiting to see if the deal goes through. We're keen to sort it out, in full co-operation with GP2, and then move on to a new project when we've cleared our heads."

iSport won at Monaco in '12



GRAND-AM

Ganassi slowed for Grand-Am season

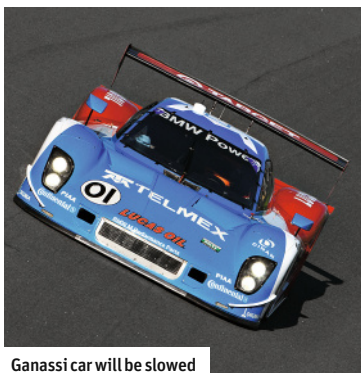

Ganassi car will be slowed

GRAND-AM HAS DENIED THAT PEGGING back the BMW engine that won last month's Daytona 24 Hours is an admission that the Chip Ganassi Racing Rileys had a power advantage at the season opener.

The Dinan-built BMW V8s used by the Ganassi team have had the length of their inlet trumpets reduced ahead of this weekend's second Grand-Am round at Austin, a move expected to reduce power by 10-15bhp. At the same time, the Chevrolet engine has had the air-restrictor it was given ahead of Daytona taken away.

A Grand-Am technical insider told

AUTOSPORT: "Daytona is a very specific type of track and now we have to balance the cars for the circuits coming up now. There was no mistake for Daytona, but readjustments are needed."

Ganassi managing director Mike Hull said: "We're contesting the remainder of the calendar with the assurance from Grand-Am that they will continue to equalise the various chassis downforce levels, plus the engines to allow us to race equally with each other in a sprint format."

Ganassi's Scott Pruett and Memo Rojas have won the past three Grand-Am titles.

IN BRIEF



Pizzonia is back

PIZZONIA'S GRAND-AM DEAL

Former grand prix driver Antonio Pizzonia will race full-time in the remainder of the Grand-Am Series, starting this weekend at Austin. The former Jaguar and Williams driver will race a second Michael Shank Racing Riley-Ford MkXXVI with Colombian Gustavo Yacaman.

LOLA RETURNS TO GRAND-AM

The Lola B08/70 Daytona Prototype will return to action after an absence of more than a season at this weekend's Austin Grand-Am round. The Ford-powered car, which has been renamed the Krohn Racing DP in the wake of a legal dispute with Lola, will be raced by team boss Tracy Krohn and long-time co-driver Nic Jonsson.

TK-S BACK TO LE MANS

Tom Kimber-Smith will return to Greaves Motorsport for the Le Mans 24 Hours and Sebring 12 Hours. The 28-year-old Briton is seeking a hat-trick of P2 wins at Le Mans after victories with Greaves in 2011 and Starworks in 2012 and will drive with Christian Zuegel and Eric Lux at Sebring.

LEVEL 5 RETURNS TO ALMS

Level 5 Motorsports will field both its HPD ARX-03b LMP2s at the opening round of the American Le Mans Series at Sebring next month. The chances of it defending its LMP2 title over the remainder of series appear slim, despite the arrival of Extreme Speed Motorsports as a class rival.

REID MOVES UP TO V8s

A1GP race winner and Porsche regular Jonny Reid will partner Tim Blanchard in Dick Johnson Racing's V8 Supercar team. The Kiwi replaces Steven Johnson, who has stepped down from driving duties to become the team's general manager.

KLIEN TO RACE AT ADELAIDE

Former Red Bull Formula 1 driver Christian Klien will make his Australian GT debut on the streets of Adelaide this weekend. The 30-year-old Austrian will drive the same Erebus Motorsport Mercedes SLS AMG GT3 that won the Bathurst 12 Hours.



Klien will race in Adelaide

GP2

FRIJNS TESTS GP2

Formula Renault 3.5 champion Robin Frijns made his GP2 test debut with Trident Racing at Jerez on Tuesday. The Sauber F1 reserve driver told AUTOSPORT he is chasing a drive in the series for this season.



DTM

Kubica still has options in DTM

Mercedes insists door will remain open to F1 racewinner, despite his decision to go rallying instead

Mercedes has left the door open to a potential DTM deal for Robert Kubica in the future, despite the F1 race winner's decision to focus on rallying this year.

Following a test in a C-coupe at Valencia by Kubica, the German manufacturer announced last week that the Polish driver would not be a part of its line-up this year, Ralf Schumacher instead keeping his seat at the crack HWA squad.

But new Mercedes motorsport boss Toto Wolff told AUTOSPORT that Kubica's performance at Valencia meant he would be seriously considered for a drive next year should he express an interest.

"We'll see what happens in the future," said Wolff about Kubica, who has only taken part in rallies since injuring his right hand and arm in a crash on the 2011 Ronde di Andora rally, and is now set to undertake a European championship campaign driving either a Citroen or M-Sport prepared Ford.

"Robert has to shake away the devils and that is up to him. He is very keen on continuing rallying and I can understand why he wants to do this, because he is a real driver. But if he decides at some point that he wants to continue in circuit racing, from a professional point of view I'd love to work with him."

LINE-UP 'FOR THE FUTURE'

Schumacher has been retained



Kubica will remain on Merc's DTM radar

alongside 2005 series champion Gary Paffett, Christian Vietoris, Roberto Merhi, Robert Wickens and newcomer Daniel Juncadella, last year's European Formula 3 and F3 Euro Series champion, in what is the predicted slimmed-down six-car roster of drivers. Persson Motorsport, which has run Mercedes in the series since 1993, will not be retained alongside the HWA and Mucke teams.

With Bruno Spengler and Jamie Green having departed to BMW

and Audi respectively over the past 18 months, Mercedes has only one driver — Paffett — with a DTM race win to his name.

But Wolff defended his line-up, claiming that focusing on the development of young drivers will pay off in the long-term.

"It's a different philosophy to what we've done in the past, in going into a year with a smaller group of drivers that we can build on for the future, rather than eight super-competitive guys," he said.

"At Mercedes we are always looking at building and having a proper junior programme in place for future roles. We have Dani [Juncadella] and Roberto [Merhi], the most recent two F3 Euro Series champions, and Robert [Wickens], who won the Formula Renault 3.5 series in 2011, so everything looks very consistent and positive for the future.

"At first glance the line-up is a junior one, but I'm confident all the guys will do a good job."

EUROPEAN F3

Hill joins Fortec for F3

FORMULA RENAULT RACE WINNER JOSH

Hill will graduate to the Formula 3 European Championship with Fortec Motorsport.

As predicted in AUTOSPORT (November 22), 22-year-old Hill will join Puerto Rican Felix Serralles and Brazilian Pipo Derani at Fortec, whose four-car squad of Dallara-Mercedes will be completed by Russian ex-GP3 racer Dmitry Suranovich.

Hill, who finished third with Fortec in the FRenault NEC standings last season before becoming a McLaren AUTOSPORT BRDC Award finalist, said: "It's a massive relief to get the plan for the year done and dusted. To be with a team like Fortec and a championship like European F3 is exciting.

"My initial goal, when I was aiming for British F3, was to go for the title in the first year because we knew it would be weaker. But looking at the grid for European F3, it's a bit like an all-star junior-driver line-up!

"I'm going to push hard straight away, but I've got to keep in mind there are a lot of second- and third-year drivers."

Both Hill and Caterham-backed Suranovich – who contested the Brasil F3



Hill raced for Fortec in FRenault last year

Open at Interlagos last month – get their first taste of the Dallara-Mercedes in next week's official test at Barcelona.

Fortec boss Richard Dutton said: "Josh really came on with us last year and he's ready to step up. Dmitry hasn't done any

mileage with us yet but he looks the part."

Hill also hopes to contest the four British F3 rounds if he can raise the budget.

● Digital channel Motors TV confirmed last week that it will screen the whole European championship live in the UK.

IN BRIEF

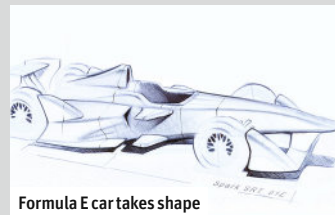

Formula E car takes shape

DALLARA JOINS FORMULA E

Dallara will work with Spark Racing Technology and McLaren on the chassis for the electric racing car series. Championship organisers also released sketches of the new-for-2014 racer.

SAINZ SETS GP3 PACE

MW Arden driver Carlos Sainz Jr topped last week's official GP3 test at Estoril after setting the pace on two of the three days. Britain's Lewis Williamson was fastest on the final day for the new Bamboo Engineering squad.

ZAMPARELLI JOINS MANOR

Dino Zamparelli was confirmed as Manor's first GP3 driver for 2013 ahead of last week's Estoril test. Toyota Racing Series champion Nick Cassidy and Vicky Piria joined him at Estoril while Roberto la Rocca firmed up his Bamboo race deal.

DOUBLE R'S EURO SWITCH

Double R Racing confirmed its switch from British Formula 3 to the European championship last week. Colombian teenager Tatiana Calderon has been confirmed alongside Sean Gelael and Antonio Giovinazzi.

DE JONG'S DUAL PROGRAMME

Daniel de Jong will supplement his GP2 campaign this year with a part-season in Auto GP for MP Motorsport. The team has signed Meindert van Buuren and Riccardo Agostini for the full series.

BRADLEY'S SUPER MOVE

Richard Bradley will graduate to Super Formula (nee F1Nippon) this season. The 21-year-old Briton, a regular podium finisher in Japanese F3 since 2011, tested for TOM'S at the end of last year.

AJ RETURNS TO INDYCAR

AJ Allmendinger made his single-seater return at Sebring last week when he tested an IndyCar for Team Penske. The former NASCAR Cup driver was 12th fastest, 0.671s slower than Rahal driver Takuma Sato, who set the pace.

'Dinger' tested for Penske



IN BRIEF



France '07: Duval's last time in a Citroen

DUVAL AIMS FOR CITROEN DRIVE

Francois Duval is closing on a deal to contest Rally Germany for Citroen. He hopes to drive a DS3 WRC on the Wallonie Rally as a shakedown in April. "I have to find some more budget," said the 32-year-old Belgian. "But it looks quite good."

ITALY'S TWO-DAY FORMAT

Rally Italy has been reduced to a two-day format running on June 20-21. Despite the reduction in days, the overall mileage remains similar to 2012 for what looks set to be Sardinia's final WRC round. The event moves back to the mainland next year.

HIGGINS WINS IN USA

Britain's David Higgins ended Ken Block's dominance of the 100 Acre Wood Rally last weekend. Reigning Rally America champion Higgins guided his Subaru Impreza to a nine-minute win on the snow-hit event in Missouri. Block's Ford Fiesta was sidelined with a mechanical problem.

CITROEN'S PRE-MEXICO TEST

Citroen driver Mikko Hirvonen completed his pre-Rally Mexico test in Portugal last week. His team-mate Dani Sordo's running was affected by rain on day two. PWRRC champion Benito Guerra tested the PH Sport DS3 WRC he will drive in Mexico, in France last week.

SCOTT'S RX PEUGEOT

Former motocrosser Andy Scott will make a full-time switch to the European Rallycross series this year. Scott will drive an Albatec Peugeot 208 alongside an as-yet unnamed driver. Fellow Brit Liam Doran will, as expected, be partnered by Andreas Bakkerud in his own LD Citroen team.

SOLBERG'S FULL RX PROGRAMME

Petter Solberg will complete a full European Rallycross campaign in a Citroen DS3 built and run by his own team. Solberg is one of 15 drivers to have signed centralised contracts with the series, which was launched at Lydden last week.



Solberg will tackle full RX programme



Ogier leads points

WRC

Wilson fears French assault

SEBASTIEN OGIER HAS BEEN TIPPED

to continue France's domination of the World Rally Championship, with M-Sport boss Malcolm Wilson fearing a decade of success by the Volkswagen driver.

Courtesy of Sebastien Loeb, no nation other than France has produced a drivers' world champion since Norwegian Petter Solberg took the 2003 title. And Wilson reckons there are few drivers equipped to stop Ogier making it 10 years of French success this season.

Wilson told *L'Equipe*: "This time, I'd better think of retiring, because we're about to start for another 10 years with another Seb. Ogier is going to dominate the sport in the same way that Loeb did."

Ogier leads Loeb in the points standings, although the nine-time champion will only contest just two more rounds this year.



RED BULL ON TARGET FOR FOURTH TITLE?

It's always difficult to judge form during testing, but *EDD STRAW* took a close look at Red Bull in Barcelona to see if Vettel and the team can win again

Red Bull plays its cards very close to its chest during pre-season testing. Fuel loads are usually pretty high and Sebastian Vettel and Mark Webber churn out the same old noncommittal comments. Any analysis of the race-simulation times so far hints that Red Bull might be a few tenths of a second off, but that's a margin insufficiently large to mean too much given the margins of error implicit with such an analysis.

Besides, with teams poised to throw on their Melbourne-specification upgrades during the final Barcelona test, which starts today (Thursday), it's too early to be sure of anything. But with the rules largely stable, anyone believing that

Red Bull and Sebastian Vettel won't be strong contenders is surely indulging in self-delusion.

From trackside, the car looks honest without taking the breath away, and with the RB9 a suspiciously cautious evolution of last year's car, superficially at least, don't be surprised if there are some major changes to come.

Vettel's verdict after finishing his two days of running at last week's Barcelona test was about as to-the-point as it gets: "We are pretty happy with the car, with the balance, how it feels. It's fairly difficult to read anyhow because the tyres are such a dominant factor but I think we are there or thereabouts. It's difficult to know what other people are doing

with fuel and tyres. Our main rivals will be the same as last year and I hope that we are amongst them. It will be very close again this year. I don't expect any difference in that but to be precise is impossible."

Not that Vettel is complaining about Red Bull's approach. Both he and team-mate Webber would like nothing more than to know just how much performance there is in the car, but realise there are far more effective ways to spend pre-season testing. That's particularly vital given the stability of the regulations, with Webber several times referring to the pre-season as the "21st race of 2012".

"We are quite disciplined in the way that we go testing," explains team principal Christian Horner. ▶

MG Live!

June 15th/16th

Silverstone 2013

In Partnership With



PBIS
PETER BEST INSURANCE



Welcoming all models of MG!

Full Racing Programme - Traders - Live Arena
Evening Entertainment - Camping - Concours - Sprint
Lifestyle Marquee - Kids Entertainment - California Cup
Auto solo - Air displays - Register Displays
Rocker Box Racing & Much More!

Visit
www.mglive.com
call 01235 555552
or drop into Kimber House, Abingdon



**WE ARE
MACMILLAN.
CANCER SUPPORT**

**practical
CLASSICS**

“I don't think you'll find any complacency here. It's not in our nature to take things for granted”

Christian Horner

◀ “We have got an awful lot of things that we want to get through in the 12 available days and we're working our way through that programme and ticking off a lot of boxes at the moment. It's very easy to get sucked into the timesheets, but the reality is that you're probably better turning off the monitors and just focusing on your own performance and programme.”

That said, there is a feeling that perhaps the RB9 is a little too evolutionary for its own good, particularly with the McLaren MP4-28 featuring so many step forwards in terms of detail. On average the McLaren was the fastest car over a single lap during last season, so Red Bull must at least match its step forward. The final Barcelona test will likely show whether Adrian Newey is pushing against the ceiling of what is possible with the car concept under the current regulations, or whether the bigger steps forward are still to come thanks to the delay in performance parts caused by the intense late-season development war in 2012.

“Because we were in such a tight championship battle, we had to keep pushing so we were introducing developments to the car right up to the penultimate race,” Newey revealed to AUTOSPORT in December. “That has made it difficult to introduce all of those and simultaneously develop [the 2013] car. If I'm honest, this has compromised the timescales of the new car more than we would have liked.

“It was the right trade at the time, because we managed to get the job done, but it means a busy winter trying to catch up again.”

This perhaps partly explains the relatively conservative step forward made by the RB9 so far. But as the team proved last year, it is capable of winning



Horner and Newey: no complacency

the world championship despite a slow start. Even the Australian Grand Prix might not show exactly where the car is.

“Unfortunately, if you are quick in Melbourne you're not [necessarily] quick everywhere,” said Webber last week. “You want to design a car for the majority of other tracks that make up most of the championship. We want to be strong in Melbourne and start the season very well and I'd absolutely love to go and win my home race. Melbourne can be a bit of a one-off circuit for what it requires, but we're more than capable of going there and going well.”

For a team that suffered from difficult starts that weakened its title challenges in 2009 and 2010, Red Bull has learned exactly what its priorities need to be and has left no stone unturned in preparing as effectively as it can. In Barcelona last week, it conducted two race simulations, one for each of its drivers, and Webber revelled in the fact that, operationally, the team was “the best I've seen them work for a long time”.

For all its successes, Red Bull is not a perfect team. Just as its star driver has a reputation for attention to detail when it comes to chasing performance, the team itself has shown an ability for self-improvement that has turned it from fast and flaky to one of the best-drilled outfits on the grid.

While it has had some controversial moments, notably its camber gamble at

Spa in 2011 and a willingness to push the boundaries of legality harder than anyone else, Red Bull is now established as an all-round powerhouse. This suggests there is no complacency in Milton Keynes. As Vettel's loose wheel on day two of the first Barcelona test showed, there's still room to improve.

“I don't think you will find any complacency here at all,” says Horner. “There is a lot of motivation to build on what we've already achieved and a triple double-championship success is an incredible feat for a team that has only just completed its eighth season.

“It's not in our nature to take things for granted. You are given nothing in F1 and the opposition is huge with iconic teams like Ferrari and McLaren, Mercedes and now Lotus. They are all great teams with big histories who are not standing still. We are always inward looking, asking where can we improve. If we win or lose a race, we still ask ourselves the same questions.”

With the advantage Red Bull has had in grasping (legal) flexible bodywork and the double DRS that helped it to improve its qualifying late last season now deleted, refining every last element could be decisive this season.

The days when Red Bull could rely on being 1.2s faster than anyone else, as it was in Hungary 2010, are behind it. The margins will be tighter than ever in 2013. ❄

RED BULL'S REASONS TO BE CHEERFUL

Only twice has a team won four consecutive constructors' championships. That F1 superteams Ferrari (six between 1999-2004) and McLaren (1988-1991), have achieved this tells you the standing that Red Bull will attain if it makes it four in a row this year. Most worryingly for the opposition, none of the reasons that traditionally cause a team's dominance to end are in play this year.

CONTINUITY

Red Bull has the same team principal, the same driver lineup, the same (frozen) engine, the same technical boss and the same healthy budget. The key ingredients that brought three world championships all remain in place.

TYRE EQUALITY

When Ferrari's title run ended, it was largely due to Bridgestone's disadvantage in

the no-pitstop formula of '05. Red Bull has identical Pirelli tyres to everyone else and no signs of any rubber trouble.

RULES STABILITY

When the regulations change, often the balance of power does too. Ferrari won back-to-back makes' titles in 2007/2008 but hasn't won since. Back in 1961, Cooper's run of titles ended because of a change of engine

formula. Save for the new torsional front-wing flexibility test, there are no significant changes to the rules this year.

STRONG DRIVERS

Vettel (right) has emerged as an irresistible force of nature since '09. In 2011 he showed he could dominate, but last year proved he could recover from a difficult start and still prevail. Webber is a heavy-scoring support act.



RACING EV

From the RB5 of 2009 – the year Red Bull became a grand prix winner – to this year's final V8-powered RB9,

2009

RB5

Constructors' position: 2nd
Wins: 6 (China, Great Britain, Germany, Japan, Brazil, Abu Dhabi)
Poles: 5 (China, Turkey, Great Britain, Germany, Japan)
Fastest laps: 6 (Great Britain, Hungary, Belgium, Japan, Brazil, Abu Dhabi)



Red Bull becomes a legitimate world title contender. Adrian Newey misses the boat on double-diffuser technology, but pullrod rear suspension sets future standard for rear-end treatment. B-spec car (with twin diffuser) from Silverstone onwards begins winning streak, although high tyre wear and engine life are concerns. Narrowly misses out to Brawn in standings.

2010

RB6

Constructors' position: 1st
Wins: 9 (Malaysia, Spain, Monaco, Europe, Great Britain, Hungary, Japan, Brazil, Abu Dhabi) **Poles:** 15 (Bahrain, Australia, Malaysia, China, Spain, Monaco, Turkey, Europe, Great Britain, Germany, Hungary, Belgium, Japan, Korea, Abu Dhabi)
Fastest laps: 6 (Australia, Malaysia, Monaco, Germany, Hungary, Japan)



Conceptualised around the double-diffuser, RB6 is F1's fastest car and enhances its rear-end downforce by using exhaust gases to scavenge yet more energy. Video of flexing front wing, and adjustable rideheight rumour, dogs car with illegality claims – none of which is proven. F-duct comes on-stream late, and adds yet more performance.

2011

RB7

Constructors' position: 1st
Wins: 12 (Australia, Malaysia, Turkey, Spain, Monaco, Europe, Belgium, Italy, Singapore, Korea, India, Brazil) **Poles:** 18 (Australia, Malaysia, China, Turkey, Spain, Monaco, Canada, Europe, Great Britain, Germany, Hungary, Belgium, Italy, Singapore, Japan, India, Abu Dhabi, Brazil)
Fastest laps: 10 (Malaysia, China, Turkey, Monaco, Europe, Belgium, Korea, India, Abu Dhabi, Brazil)



In terms of raw pace, most statistically dominant F1 car since Williams FW14B – another Newey/Renault creation. Weak KERS and lack of straightline speed are only chinks in armour, but enhanced diffuser blowing (with the double-deck concept now outlawed) gives devastating advantage, particularly in Vettel's hands. Car runs with more rake than ever.

2012

RB8

Constructors' position: 1st
Wins: 7 (Bahrain, Monaco, Great Britain, Singapore, Japan, Korea, India)
Poles: 8 (Bahrain, Monaco, Canada, Europe, Japan, Korea, India, USA)
Fastest laps: 7 (Bahrain, Canada, Hungary, Japan, Korea, Abu Dhabi, USA)



Despite FIA edicts to reduce exhaust-blowing and front-wing flexing, which clearly hampers early season, Newey works his diffuser magic with inlet tunnels working in tandem with its Coanda exhaust. When double DRS comes on-stream in Singapore, the final piece of the puzzle is complete – bringing 2011-level dominance in vital end-of-season races.

2013

RB9



Launched at Milton Keynes base on February 3, car is a logical successor to title-winning forebears. The main visible change is the removal of the letterbox slot on its stepped nose, with the inlet now positioned underneath. It retains the inlet tunnels ahead of the diffuser, and a Sauber-style rear-wing mount is included to pass loads to the chassis.

EVOLUTION

this is the timeline of an F1 worldbeater. CHARLES BRADLEY looks at the secrets of the team's success



PICS: THOMPSON/GILHAM/GETTY; FERRARO/LAT

The men out to steal Webber's A-list drive

Toro Rosso drivers Daniel Ricciardo and Jean-Eric Vergne will slug it out (again) to try to earn the right to join Red Bull Racing in 2014. *EDD STRAW* looks at two of the most under-pressure drivers on the grid

Daniel Ricciardo and Jean-Eric Vergne are very different characters, both inside and outside their Toro Rosso Formula 1 cars. Ricciardo is ever-smiling, Vergne brooding. Ricciardo is a silky-smooth driver, Vergne maximum-attack. Ricciardo is garrulous, Vergne a little more guarded.

What they have in common is that both are one step away from the prize that every grand prix aspirant fantasises about: a seat in what is currently the best team in Formula 1. But that enticing prospect, almost within touching distance, is twinned with career peril just half a step away in the other direction.

That's what makes Scuderia Toro Rosso more than just another midfield team. Last year, the former Minardi squad finished ninth in the constructors' championship and the objective is to climb to sixth this year. A team in that position can afford to be happy with two consistent, capable mid-grid drivers, and a good season would usually mean those in Ricciardo and Vergne's position would stay on.

But, as history has shown us, this isn't the case. Jaime Alguersuari and Sebastien Buemi were axed to make way for the pairing at the end of 2011 after both had enjoyed decent – but not outstanding – campaigns. To stay at Toro Rosso, you need to prove yourself capable of doing a title-

winning job for the Red Bull A-team.

The door is far from bolted. Mark Webber is an excellent team-mate for Sebastian Vettel, even though the past three years have shown he probably doesn't quite have what it takes to win the title alongside such a remarkable driver. During this three-year spell of dominance, Webber has won seven grands prix – two of them in Monaco – and notched up 73.1 per cent of Vettel's points. Assuming that Webber continues to perform to at least the same level this year, that is what Ricciardo and Vergne must prove they are able at least to replicate. It's tougher than it looks.

And if that wasn't pressure enough, it's almost inevitable that the next cab



STR's Ricciardo (left) and Vergne are targeting Webber's Red Bull (above)



off the rank in the Red Bull programme, the promising Antonio Felix da Costa (see page 34), will be ready for a Toro Rosso drive next year. Both drivers play down any extra pressure because of this, but are intensely aware that the best way to ensure their long-term F1 futures is to bump Webber, to in turn protect themselves from being ousted by the Portuguese rising star.

These are the two sides of the Red Bull junior programme. It will bankroll you, support you while you are successful. But if you come up even slightly short, even in difficult circumstances, that's it. Alguersuari is among the drivers spat out of Red Bull still struggling to come to terms with what happened.

"I had the luck to have a big backer that owned two teams and without them nothing would have been possible for my career, so I have to thank

them," says Alguersuari. "But on the other hand, I have to say I never understood why I was in F1 in 2009 so young, and without any mileage and experience. And I never understood why I was dropped."

The bar is set very high at Toro Rosso. So how can Ricciardo and Vergne make their case for a long-term Red Bull F1 future?

WHAT RICCIARDO NEEDS TO DO

The 23-year-old Aussie is the man who, at the moment, Red Bull would pick if it had to replace Webber. He's seriously quick – word is he's the fastest of all the Red Bull juniors who have been through the simulator – and he has a beautiful classical style reminiscent of an on-form Jenson Button. But there is a suspicion that the affable Ricciardo is a little "too nice" and lacks the ruthless edge that ▶



JEAN-ERIC VERGNE
AGE: 22

DANIEL RICCIARDO
AGE: 23

| | | |
|------|-----------------|-----|
| 20 | STARTS | 31 |
| 11TH | BEST QUALIFYING | 6TH |
| 8TH | BEST FINISH | 9TH |
| 16 | POINTS | 10 |



PICS: FERRARO/LAT, GILHAM, FOX, THOMPSON/GETTY

◀ makes the difference between the very good and the great. Throw him in a Red Bull tomorrow and he'd arguably be capable of dominating a race from pole, but he still needs to prove to the decision makers he can cut it in battle week in, week out. For that reason, keep a very close eye on whether Ricciardo is consciously a little more forceful on track this year than he was last. You can be sure he will have been made aware of this perception.

Overall, his 2012 campaign was impressive. He made a shaky start, despite having the advantage of 11 races with HRT a year earlier. There were some superb moments, for example passing Vergne on the chaotic last lap in Melbourne to nab a point, and probably the most remarkable qualifying lap of the whole season to take sixth in Bahrain. Not convinced? Bear in mind that, for three-quarters of the lap, he was actually faster than Vettel's pole time... That kind of pace, if delivered consistently, is a rare commodity.

But there were lows too, such as failing to react well to a slow getaway in Bahrain and finishing deep in the midfield. Post-August break, however, he improved dramatically and scored points in five of the last nine races.

“The confidence I got towards the end of last year is still there”

Daniel Ricciardo

The highlight of that was a superb defensive drive late in the race at Suzuka ahead of Michael Schumacher.

Ricciardo may have been outscored by Vergne – who finished in the top 10 on two fewer occasions but bagged a quartet of eight places compared to his team-mate's half-dozen ninth/10th places – it was a campaign in which Ricciardo impressed more. Most significantly, he destroyed Vergne 16-4 in qualifying, emphatically underlining the fact that he is a seriously quick driver.



Vergne's spectacular driving style remains

He says: “The confidence I got towards the end of last year is definitely still there. I just have to try to build on that as quick as I can. Every season I hear ‘this season is a big year’ or ‘it’s an important season’ but they all are. It’s got to the point now that I’ve gone through enough important seasons that no one is more important than the others. I’ve approached the last few seasons in the right way. There’s no radical mental training or any of that stuff. It’s just to go and do what you know,

keep on improving, let experience show you the way.”

The bottom line: His superb pace is a given, but what Ricciardo needs to show is consistent form and convince Red Bull he has the intensity and bite needed to be a world champion.

WHAT VERGNE NEEDS TO DO

Vergne headed into the 2012 season at a clear disadvantage compared to Ricciardo, who had half a season in an HRT under his belt. That in part explains his often-frustrating season, and it’s clear that the Frenchman needs to even out his performances this year. Having said that, there is a feeling within Red Bull that the feisty Vergne possibly has the all-round potential to be the better of the two.

He’s a confident driver, and showed at last week’s Barcelona test – when he was comfortably the most spectacular driver in wet conditions – that his attacking on-track style will remain. But when things go wrong that confidence doesn’t always appear to be enough to see him through, and the qualifying problems that blighted his 2012 season, so often as a consequence



Yes, Ricciardo does have the biggest grin



Christian Horner
Red Bull team principal



Ricciardo and Vergne could either be looking forward to driving for your team or facing the scrapheap at the end of the season. Isn't that probably the best way to simulate the pressure of being in a world championship fight?

Absolutely. F1 is a pressure business and when you get an opportunity you have to grab it. Sebastian [Vettel] got that opportunity and used it fully. If they can't cope with the pressure at Toro Rosso, they'll never cope with the pressure of competing for a championship. F1 is a tough environment, they have got an opportunity and it's down to them what they make of it. Other drivers have had this chance and very few of them have ended up in other teams.

How much interest can you take in the Toro Rosso drivers?

They are effectively still within the junior programme and we of course take interest in how they are performing. What we don't know are the strengths and weakness of their car, because it's not designed and built by Red Bull Racing.

But you can run them in the simulator...

We can and we have also tested them. They both performed extremely impressively in the young-driver tests so there's no question that they are both very talented guys. Daniel probably had the stronger season of the two last year, certainly in the last third, but we are expecting both to make a step this year and we will follow their progress with interest.

And if they perform, will they be promoted?

There is no precondition that they will be a Red Bull Racing driver. It's down to what they do, how they deliver. Our main objective is to have the best driver pairing we can and that has been Mark Webber and Sebastian Vettel for five years. We want to make sure that if we do need to change, we have a pool of talent to draw upon.

What are you looking for from them?

F1 is different to any other category of motorsport and people tend to underestimate the steepness of the learning curve. It takes 12 months for these guys to really grasp it. Daniel was consistent at the end of last year and Jean-Eric is probably the opposite in that he's overdriven and tried too hard. He's been very strong in the races, but is guilty of overdriving over a single lap on tyres that are particularly hard. They've been through their apprenticeship now and they are better prepared for this year. It's going to be a fascinating contest to see who comes out on top at the end of the season.

of attacking a little too much, didn't always set him off on the right foot in the races. But Vergne is adamant that a lack of understanding of the tyres, inevitable for a rookie, played a big part in that weakness and isn't expecting it to be a problem this year.

By and large, the 22-year-old's race pace has been good and he's shown a little more incisiveness in battle than Ricciardo, albeit tempered by some unnecessary incidents, such as his clash with Heikki Kovalainen in the European Grand Prix in Valencia. There were also some very eye-catching moments, for instance staying out on intermediate tyres longer than anyone else in Malaysia and starting the second half of the race seventh with a 'free' tyre change to rain rubber. There were also very strong race drives in Belgium and Korea – at Yeongam he beat Ricciardo, albeit with the pair on differing strategies.

All of this suggests qualifying is everything. One factor that should help Vergne is the fact that, under new technical director James Key, Toro Rosso has produced a far more driveable car with a more predictable rear end. On the other side of the coin,

the demise of HRT means there are now two drivers from the midfield teams who will not make the cut for Q2. The failure to get out of Q1 was one of the aspects that blighted Vergne's 2012 season.

He says: "I have no problem with Daniel, or the pressure. There has always been pressure. In karts I was never sure of doing the next season, I was never secure and I'm still in the same position. It's my life to be under pressure and I deal with it. My team-mate could be my worst enemy or my best friend and I don't care. When the time comes to work together to improve the car, we do it well. We are both clever people and our objective is to get the best car possible. We both understand this and when we need to work together, we will. Then it all comes down to on-track performance. I'm not scared about that."

The bottom line: Stop overdriving in qualifying, cut back on the incidents and channel the intensity into improving rather than allowing frustration to compromise his performances. ⚡

Red Bull's next big thing

Daniel Ricciardo and Jean-Eric Vergne aren't the only ones chasing a Red Bull F1 seat. Antonio Felix da Costa is determined to stake his claim, says *GLENN FREEMAN*



Felix da Costa: ready to stand up and be counted

Twelve months ago, Antonio Felix da Costa was seeking entry to the last-chance saloon. He didn't have a drive, and all he wanted was an opportunity to contest a make-or-break season for his career. Within six months he had ties to Formula 1's dominant team, and before the end of the year he was testing the Red Bull RB8 that was about to take Sebastian Vettel to a third straight world title.

Throw in a near-miss in the GP3 championship, four wins from the last five races of his part-season in Formula Renault 3.5 and a Macau F3 Grand Prix victory, and 2012 marked quite a turnaround in the Portuguese driver's life.

A season like da Costa enjoyed last year raises expectations. He was riding the crest of a wave in the second half of the campaign, and could seemingly do no wrong. Now, he will be expected to do no wrong. But with the prize for delivering the goods again almost certainly being a promotion to F1, that's a pressure worth dealing with.

"Things are pretty clear with Red Bull," he says. "If I do a good job, they'll take care of me. Obviously F1 has been in my head for many years, and now I am very close to my ultimate goal. I think it's pretty simple: if I have a good season, I will go to Formula 1."

Having a good season in Red Bull's eyes means winning the FR3.5 title with Arden Caterham. Da Costa outscored everyone in the championship last year over the six



Da Costa adapted quickly to FR3.5

DA COSTA CV

Born

August 31, 1991

From

Lisbon, Portugal

2012

3rd in GP3 (3 wins);

4th in Formula

Renault 3.5

(4 wins); F1 test

with Red Bull

2011 13th in GP3

(1 win); 8 races

in Formula 3

2010 7th in

F3 Euro Series

(3 wins); 4 starts

in GP3; F1 test

with Force India

2009 Formula

Renault NEC

champion (9 wins);

3rd in Formula

Renault Eurocup

(3 wins)

2008 2nd in

Formula Renault

NEC (1 win);

13th in Formula

Renault Eurocup;

races in Formula

Renault UK/Portugal

winter series

weekends he contested following his mid-season recruitment by Red Bull. But racing for a title is different.

"It's the most important season of my career, and it's what I do in World Series that is going to shape my future," he admits.

"I keep telling everyone that I'm not going to win all of the races. I know I am racing for a championship so I have to collect points, and if sometimes that means racing for seventh place then I will do that. You have to use your head."

Da Costa isn't used to his current situation. He doesn't normally spend the early months of the year with a deal in his pocket, knowing he will have a competitive car at his disposal and that if he delivers what he is capable of then good things will follow. And he is also attracting a lot more attention; his performances will be scrutinised both inside and outside of Red Bull.

"I go into this season knowing that everybody is looking at me, but that's fine, because I am looking back at them," he says. "I know what is expected of me from the first race of the year. I don't mind going into a season knowing that. I need to keep raising my game, because there are many fast drivers around and it is going to be a tough year. But everything feels good so I'm really confident."

The buzz surrounding Red Bull's latest recruit since his June 2012 arrival (following the unceremonial 'dismissal'

of Lewis Williamson after just five races) could cause some sleepless nights for the energy drinks firm's current F1 young guns, Daniel Ricciardo and Jean-Eric Vergne. But Vergne, who fought with da Costa (and eventual champion Albert Costa) for the Formula Renault Eurocup in 2009, shares the Portuguese driver's matter-of-fact approach to the cut-throat world of being a Red Bull driver.

"I'm not too worried about this," says the Frenchman. "It is the way Red Bull works. I have been in the same position as Antonio. He is a good driver, and if he keeps doing a good job he deserves a seat in F1. And if Daniel or myself is good enough to one day move up from Toro Rosso [to Red Bull's senior team] that will leave a free seat here. Everybody has to deserve a seat, so you always have to perform."

Da Costa is following in the footsteps of Vergne and Ricciardo, both of whom graduated to F1 after racing in FR3.5. So the two Toro Rosso drivers know how the Red Bull ladder works, and da Costa knows it will be the same for him if he can take his chance.

"It's always like this," says da Costa. "Those two are in the team now, and maybe they see me as a threat, but I don't think about that. I know that if I ever get there, then there will be ▶



2012: eight wins in three series

J R M **Design ■ Engineer ■ Deliver**

HPD ARX-03a LMP1 car

JRM Racing is pleased to offer its 2012 Honda Performance Development ARX-03a LMP1 car for sale (less engine).

Driven by Karun Chandok, David Brabham and Peter Dumbreck to a string of top six finishes, including 6th overall at the 2012 Le Mans 24 Hours.

Maintained regardless of cost, it is ideally suited as a front-running privateer or collector seeking a contemporary car with provenance and success at Le Mans.

A comprehensive spares package is available with the car. Technical support and set up data is also available by separate negotiation.



Serious parties should contact Mark Dexter, mdexter@jrm-group.com or +44 (0) 1327 307 164. www.jrm-group.com

Don't crack under pressure!

Call **NOW** for your 2013 Motorsport Insurance quotation

- > On Track
- > Off Track
- > Commercial
- > Driver and Team Personal Accident
- > 24/7 Service
- > Over 30 years Motorsport Insurance Experience
- > Quote "Autosport" for a 10% reduction from your on track premium

**ellis
clowes**

Ellis Clowes & Company Limited,
35 Great St Helens, London, EC3A 6HB
T: +44 (0) 207 220 0130 F: +44 (0) 207 220 0131
Ellis Clowes and Company Ltd is authorised
and regulated by the Financial Services Authority

Ellis Clowes (Commercial) Limited,
27 Horsefair, Banbury, Oxfordshire, OX16 0AE
T: +44 (0) 1295 221190 F: +44 (0) 1295 221191
Ellis Clowes (Commercial) Ltd is an Appointed
Representative of Ellis Clowes & Company Limited

We're ready, are you?

Email for advice and a quote now
at ontrack@ellisclowes.com or call 01295 221190

www.ellisclowes.com



Testing for Red Bull last year

◀ someone behind me, and if I don't perform then I will get kicked out. That's the way it should be in racing, and at the moment Red Bull is the only scheme like this that is putting drivers in F1 purely on talent. At the end of the day this is a job and you've got to succeed if you want to keep it."

Success is down to more than just ability though. Da Costa was highly rated following two competitive years in FRenault 2.0 after stepping up from karting, but in 2010-11 his career stalled (see panel below). So how, in 2012, did he get on such a roll? Looking at a timeline of his season it would be easy to assume that as soon as the



Near-miss for the GP3 title

boxes of Red Bull kit arrived in the post he stepped it up a notch, but he doesn't agree. After taking his first FR3.5 win in Hungary last September he admitted "it looks like Red Bull has given me wings" – a pun he fortunately hasn't repeated.

But he feels it was just a coincidence that his luck turned after he got 'the call' from Red Bull motorsport advisor Helmut Marko. As is so often the case with Red Bull juniors, da Costa was instantly given multiple programmes, combining FR3.5 with the Carlin GP3 deal he was already in the middle of. He also got permission from Red Bull to race in the Macau Grand Prix, which he won. Winning in three types of car in one season is rare to see on the single-seater ladder, and it's a good way to prove that success in one category is no fluke. Young drivers are of course accustomed to switching between cars as they work their way up the ranks, but da Costa believes it takes a certain set of skills to do it with such success.

"I've always felt that you have to be able to jump in cars at a moment's notice, sometimes not the best cars, and you have to make the most of it,"

"It can be hard to jump in cars at a moment's notice, and it requires using your head rather than your talent"

Antonio Felix da Costa

he says. "It takes a certain type of driver to be able to do that. I know some other drivers who can adapt very well, but I think it is one of my strong points. The first time I realised was when I had a prize test in World Series at the end of 2008. The car was much faster than [the FR2.0] I was used to, but it wasn't that difficult to find something within me to adapt.

"It can be hard, but I think it requires you to use your head rather than your talent to be adaptable – you have to adjust your mind to be able to deal with it."

Dealing with the pressure of being a Red Bull driver usually requires a fair bit of mind adjustment, too. Da Costa has handled it beautifully so far, and if he delivers under the added expectation of being a championship favourite, F1 beckons. ❧

BETTER LATE THAN NEVER

Antonio Felix da Costa brushed shoulders with future Formula 1 drivers Daniel Ricciardo, Jean-Eric Vergne and Valtteri Bottas shortly after stepping out of karting. Then, in the years that followed, he fell behind them all on the path to F1. But had the conclusion of the 2009 Formula Renault Eurocup season panned out differently, da Costa believes he would have been preparing for a full season in Formula Renault 3.5 in 2010, rather than 2013.

"When I lost the 2009 Eurocup I also lost the prize money [from Renault] to step up to World Series," he says. "I should have been starting [in FR3.5] in 2010. But I'm 21 now

and I'm a better driver. I'm more mature, and I understand things a lot better."

Da Costa's career momentum faltered as he stepped up to F3 with his Renault team Motopark Academy, which struggled to adapt to the competitive Euro Series in 2010. Good results were sporadic a year later in GP3, as Status GP's form fluctuated. Now he's recovered from the tailspin those years sent his career into, da Costa can see the positives of not getting too much success too soon.

"It's taken me a long time, but you see many drivers who get to F1 very quickly and then get kicked out quickly too," he says. "Look at Jaime Alguersuari – he's just one



Heartbreak in 2009 FR2.0

year older than me and he's already dropped out of F1 and finding it hard to get back in.

"It's taken me a few more years than some to get to this point, but it means I can arrive in F1 more prepared and that will be key."

Drawing board



After winning three consecutive world championships, only a repeat performance will be enough for the evolutionary Red Bull RB9. By GARY ANDERSON, EDD STRAW and GIORGIO PIOLA

Red Bull's chief technical officer, Adrian Newey, made it very clear at the launch of his new machine that there is nothing revolutionary about the RB9. The car that has run so far in testing has proved him to be as good as his word, with some questioning whether it's too conservative.

"It's an evolutionary car," said Newey. "There were no big regulation changes, so it's really been a case of refining the RB8. There are no huge changes. The devil has very much been in the detail with this car. We've tidied up some bits we felt could be improved on. Development is now key through the year."

LETTERBOX OF TRICKS

→ When last year's Red Bull RB8 was launched, the forward-facing 'letterbox' in the nose step attracted a great deal of attention. The slot was design to aid electrical cooling, but this year it has decided to emulate Sauber and have a rear-facing slot. This is attached to pipework which leads downwards to a hole in the underside of the nose. The low-pressure area at the entry to the slot in the top surface sucks air from under the chassis and onto the nose, helping to

accelerate the airflow off the front wing. This is designed to improve the airflow under the car, which is the key to its overall downforce.

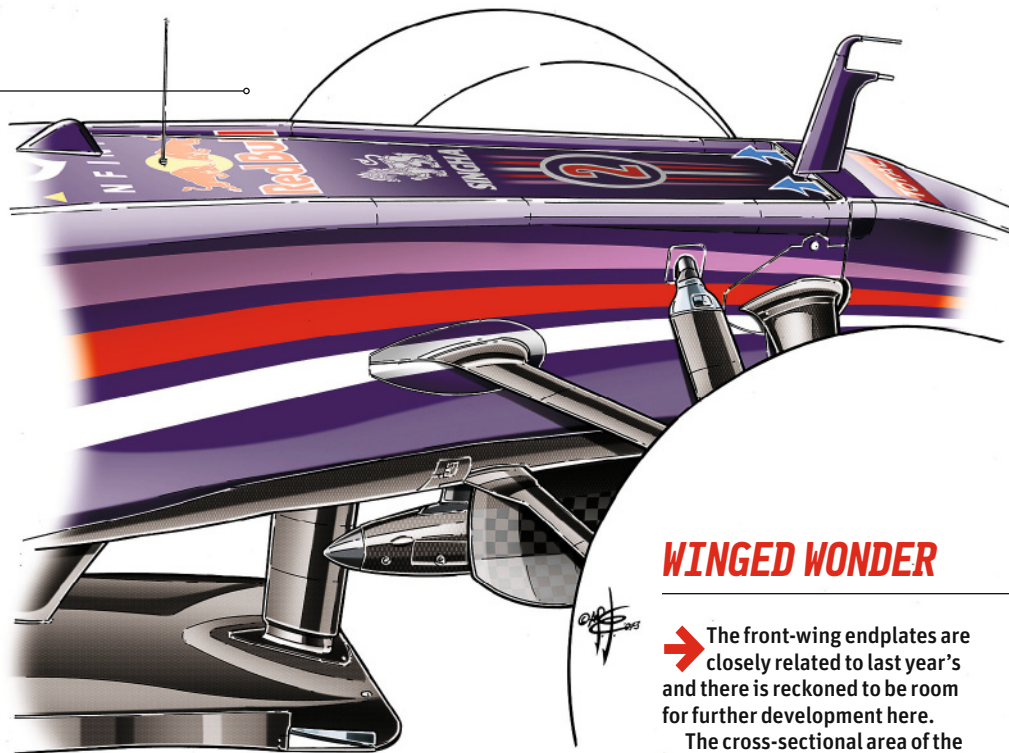

WINGED WONDER

→ The front-wing endplates are closely related to last year's and there is reckoned to be room for further development here.

The cross-sectional area of the nose has been minimised before it has to ramp up to the front bulkhead, creating the step. With the slot in the nose (arrow) helping to minimise airflow blockage behind the front wing, the pillars are designed as turning vanes. The pillars are slightly larger than they were last year to help direct the airflow in between the front wheels. There is still the little 'belly' between them. This is there to expand the airflow passing between the pillars and if it wasn't there, you'd end up with a boundary layer between the two pillars that would effectively reduce the width of the gap.

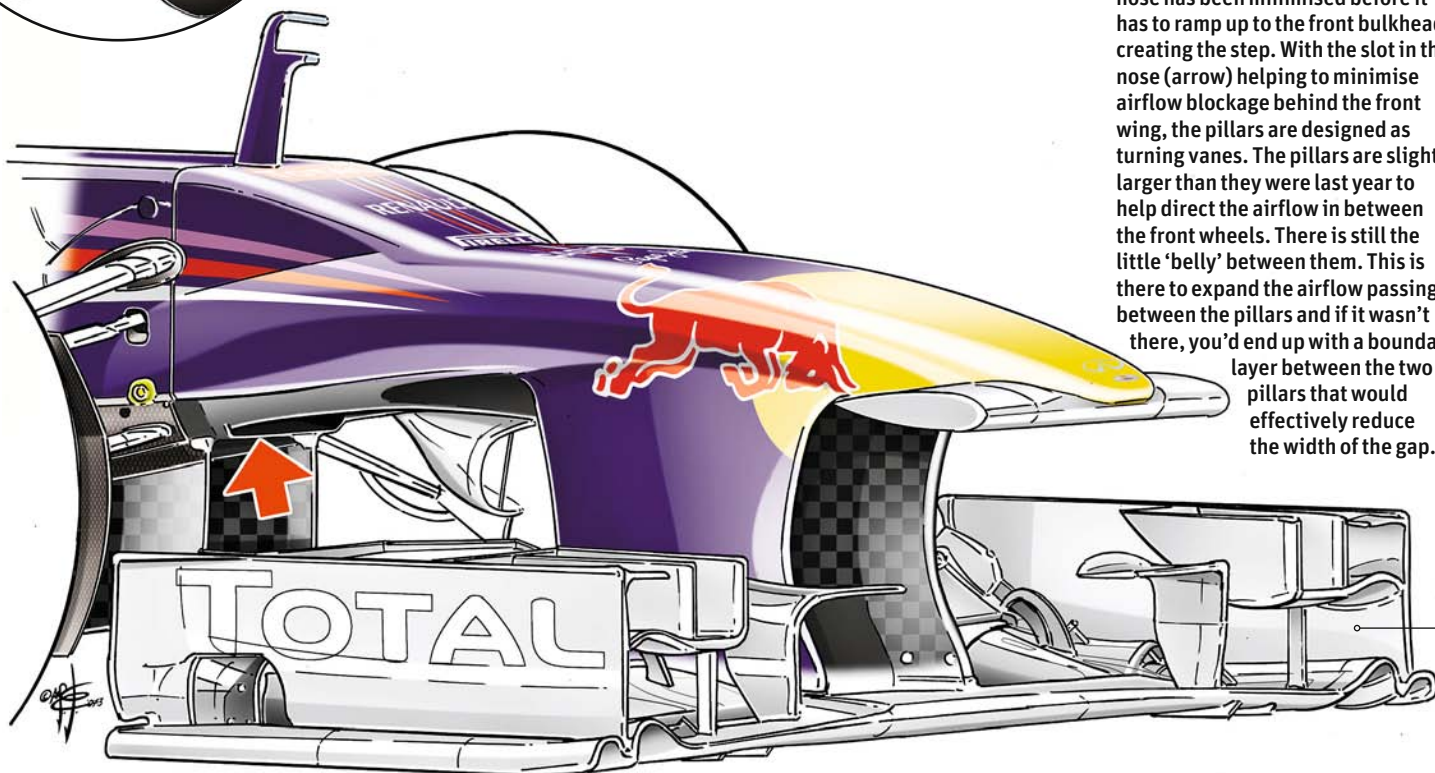

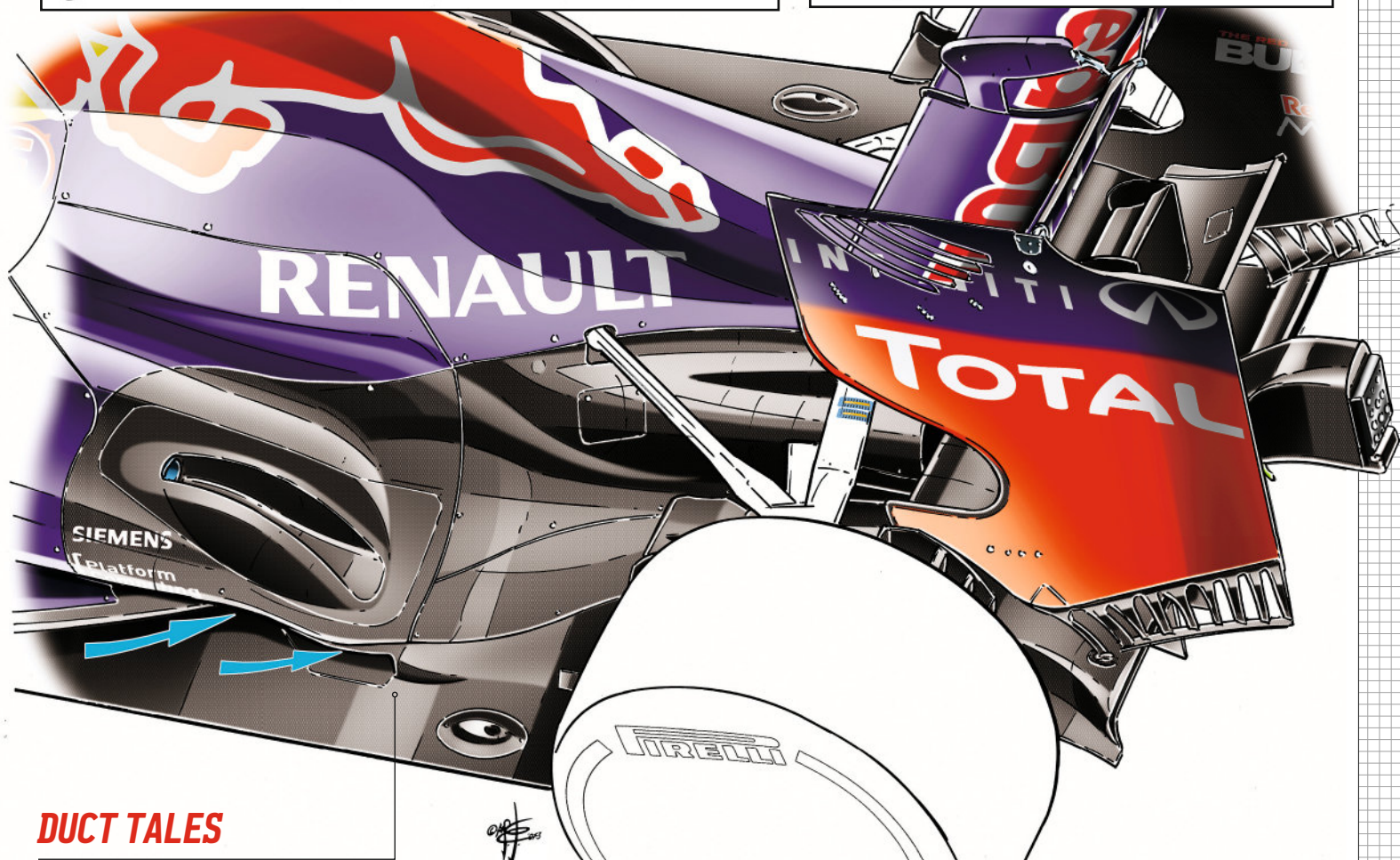
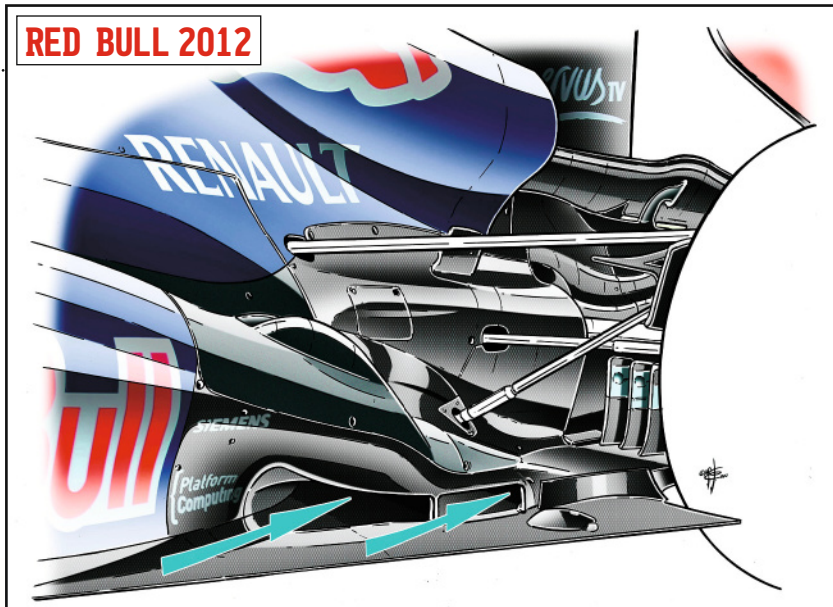

DUCT TALES

➔ Last year, Red Bull ran with a duct going underneath and into the diffuser. This year, the sidepods have been made a little shorter in order to start the Coke bottle earlier to hopefully produce more downforce. During 2012, the duct into the centre of the diffuser started out as a body profile with a hole in it. As time went on, Red Bull brought the trailing edge out to make it more of a duct because the airflow

wasn't going into it. As with much of the car, this is a refinement of that.

If you look at the rear wing endplates, there are some small detail changes compared with last year. The 2013 car appears to have adjustable slots in the endplates, which makes it easier to play around with rear downforce in testing.

Over the past few years, Red Bull's straightline speed has never been

the best so perhaps the team wants to be able to call upon a bit more rapid adjustment to unlock that speed. It has always maximised the downforce of the car, often qualified on pole position and tried to control

the race from the front, but now that you can't use the DRS freely in qualifying, you might end up having to spend much more time trading off downforce and straightline speed. This could be a key area, especially with even less chance of one team dominating this year.

There are some small tweaks to the louvres, but these are just minor changes designed to improve the overall efficiency of the package.

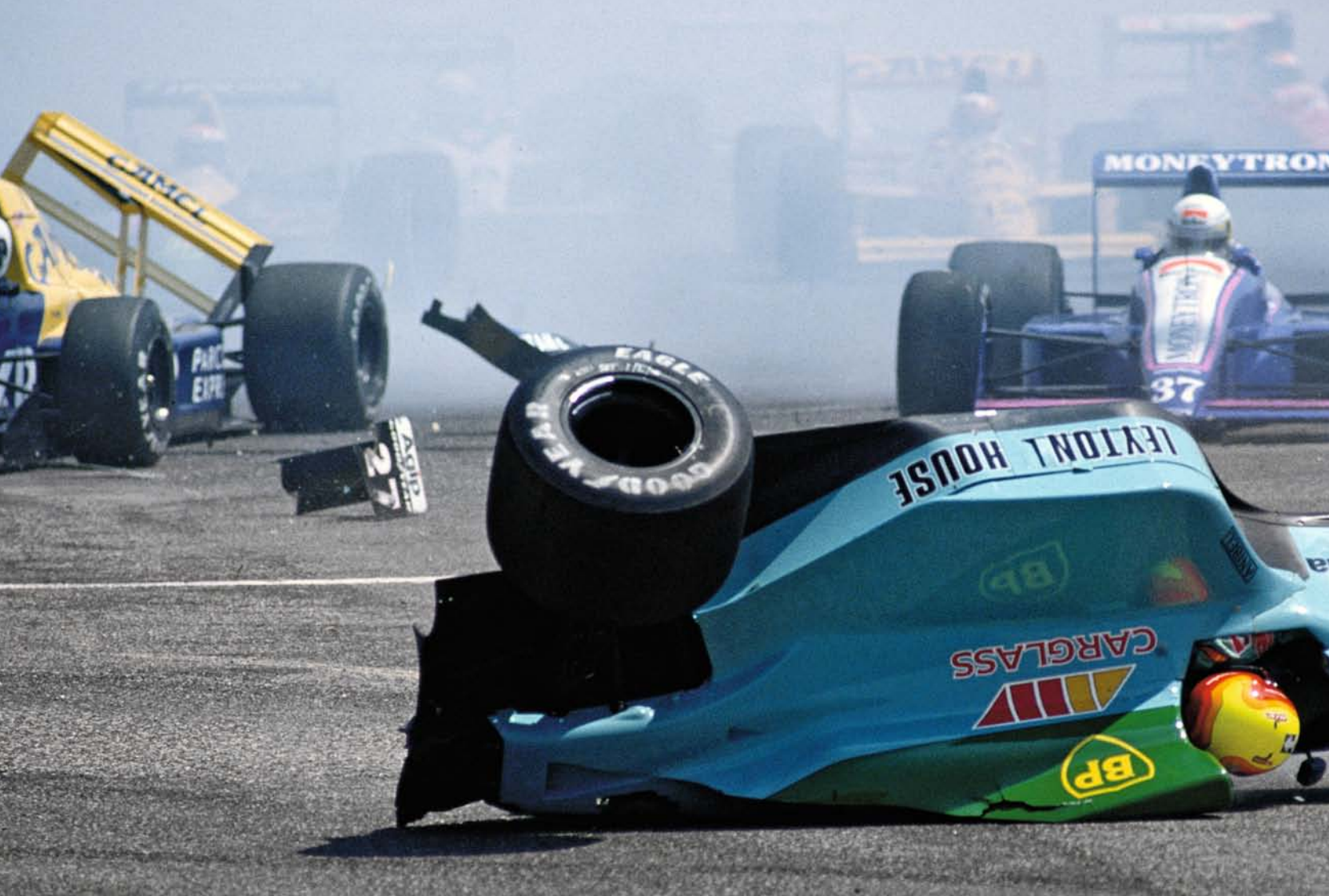

One-hit F1 wonders

Mauricio Gugelmin triggered this famous shunt at the (first) start of the 1989 French GP, then set the only fastest lap of his F1 career in the spare March. *KEVIN TURNER* looks back at that race, and a few others that produced some unlikely pacesetters

PART 3

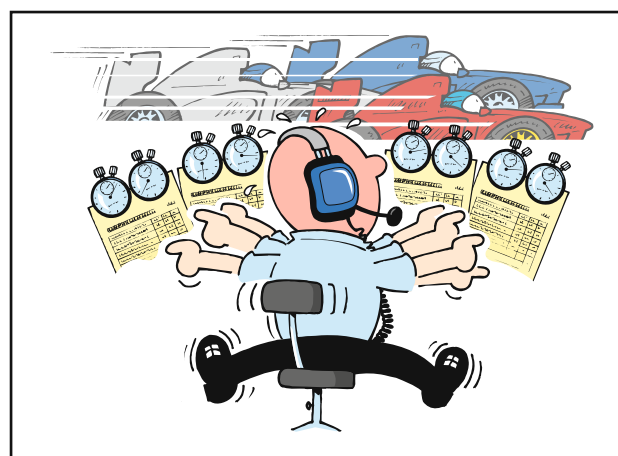

MAURICIO GUGELMIN March CG891 1989 French GP

His 1989 presence at Paul Ricard might be remembered more for the dramatic first-corner shunt he caused, but Gugelmin also managed to take the restart and set his sole fastest lap in F1.

The Marches were relatively competitive at the French GP – though not as strong as they would be the following year – and Gugelmin qualified 10th, a fraction ahead of team-mate Ivan Capelli. Unfortunately, Gugelmin locked up on the run into the first tight

right-hander, darted right, and ploughed into Thierry Boutsen's Williams and both Ferraris, causing a multi-car shunt and a red flag. His day, however, was not yet done.

"In some disbelief, we saw him walking quickly back to the pits after being released from the wreckage," wrote Nigel Roebuck in his *AUTOSPORT* report. "Yes, he told the team, he was fine, wanted to drive. And calmly he settled himself into the spare car."

Gugelmin started from the pitlane. Once a misfire was sorted he was able to set fastest lap, nearly half a second clear of everyone, before his



Gugelmin crashed and ran for the spare

clutch failed. The future Indycar star was thus an unclassified finisher after a dramatic day.

Two other solo fastest-lap setters came in 1989, both in tricky weather conditions. Jonathan Palmer scored his in the rain-hit Canadian GP before crashing, while Satoru Nakajima was fastest in the appallingly wet Australian GP. "This man who is ordinarily a drone in F1 suddenly began to drive like an ace," wrote Roebuck. "It may never happen again, but in Adelaide he was inspired."

Nakajima's reward on his day of days was fourth for Lotus, after qualifying on row 12!



Attwood broke lap record and took P2

RICHARD ATTWOOD

BRM P126 1968 Monaco GP

The Lotus 49 was the thing to have at Monaco in '68, Graham Hill taking pole in his B version, 0.6s ahead of Johnny Servoz-Gavin's Matra. Attwood, who had won the 1963 Monaco Formula Junior race, was 1.4s slower than Hill in sixth.

Servoz-Gavin, deputising for the injured Jackie Stewart, led from Hill at the start, with Attwood sixth. The Matra's suspension collapsed after Servoz-Gavin hit the barrier, leaving Hill leading Jo Siffert. Jochen Rindt

(Brabham) then crashed, Siffert's 49 failed and the Honda of John Surtees hit gearbox trouble. So, after just 18 of the 80 laps, only five cars were left and Attwood was now up to second.

The gap between Hill and Attwood was nine seconds, but Attwood kept chasing. "With 10 laps to go, Attwood launched his final onslaught," wrote Patrick McNally in *AUTOSPORT*. "Lap after lap he clipped fractions off the lap record as he closed on the Lotus."

That effort on the final tour was 0.1s faster than Hill's pole, but it was not enough. Hill took his fourth Monaco win by 2.2s from Attwood.



Nilsson mastered tricky Zolder in '77

GUNNAR NILSSON

Lotus 78 1977 Belgian GP

As Mario Andretti's number two at Lotus in 1977, Nilsson rarely got to steal the limelight, but in a tricky wet-dry-wet race at Zolder he had a day that put him in the record books.

The Lotus 78 was getting into its stride by round seven, as Colin Chapman prepared to move the F1 goalposts again, and Nilsson qualified third, albeit 1.81s down on Andretti. He then ran third behind John Watson's Brabham and Andretti at the wet start, only for the American to nudge the leader under braking, causing both to spin. Nilsson was delayed too, allowing Jody Scheckter (Wolf) to slip by.

Scheckter drew away before everyone started pitting for slicks, but then threw away the lead with a spin. That briefly allowed the Lec of David Purley into the

lead before he too stopped for a tyre change, handing the lead to Niki Lauda, Ferrari having performed one of the more rapid stops. At this point, Nilsson was back in seventh.

The Swede overtook Alan Jones and Vittorio Brambilla before drizzle brought some back into the pits for wet rubber. That brought Nilsson up to third, which became second when the McLaren of Jochen Mass went off, leaving just Lauda ahead of the Lotus.

"Now Lauda's lead was starting to look distinctly tenuous, for Nilsson was really pressing on," Nigel Roebuck wrote in *AUTOSPORT*. "He had no need of a dry track for, even in the drizzle, the leading Ferrari was getting bigger."

Nilsson finally took Lauda on lap 50 and pulled away, recording the fastest lap, to take a comfortable first F1 victory. Sadly, it was to be his last, Nilsson succumbing to cancer in 1978.



KARL KLING

Mercedes W196 1954 German GP

On more than one occasion in 1954, AUTOSPORT questioned the ability of various Mercedes drivers to strongly support number-one driver Juan Manuel Fangio. The issue would later be solved by the arrival of Stirling Moss, but there were moments before that when Fangio's was not the lone Mercedes at the front of a GP.

Karl Kling, having run with Fangio throughout the French event at Reims, put in perhaps his best F1 performance on home ground at the awesome Nurburgring Nordschleife. In front of an estimated audience of 300,000, Mercedes ran four cars, three with new open-wheel bodywork – for Kling, Hermann Lang

and Fangio – and a streamliner for Hans Herrmann.

Kling, who spotted a fuel leak before the off, had to start on the ninth and last row, but he rapidly made progress. During his early charge, he set fastest lap and passed pre-war ace Lang, who then spun, and went after Fangio.

Kling actually grabbed the lead from the great Argentinian champion for two laps before suspension problems struck, eventually limiting him to fourth place.

AUTOSPORT noted that: "Kling received a 'wiggling' from [team boss] Alfred Neubauer for needlessly dicing with Fangio. In any case, carrying less fuel than Juan Manuel, he had to stop again and could not have caught him."

However, many years later in an interview for ESPN, Kling expressed

a different view. "Every time when I passed the start/finish line I pointed to the seal at the back, but they didn't understand," he said.

"Normally the fuel would have been enough for the 500km, but I was losing fuel. I was trying to make up some time so I could make a pitstop to refuel."

Whatever, that German GP ended a three-race run of one-hit fastest lap wonders. On Mercedes' return to GP racing at the French GP, Herrmann had set fastest lap early on before his W196's engine blew up, while Argentinian Onofre Marimon (Maserati 250F) and Frenchman Jean Behra (Gordini 16) were two of seven drivers credited with fastest lap at the 1954 British GP. Timing for that event was only recorded to the nearest second.

Kling flew for Merc at the 'Ring in '54

HENRI PESCAROLO

March 711 1971 Italian GP

Better known for his sportscar racing successes, including four Le Mans victories, Pescarolo's sole fastest lap came in one of the most famous of all F1 races, the final classic slipstreamer at the pre-chicane Monza in 1971.

Team Lotus was absent to avoid any potential manslaughter charges from Jochen Rindt's fatal crash in 1970 and McLaren and only sent one M14, but there was still a 23-car field.

Pescarolo, driving a Frank Williams-entered March, qualified 10th, 1.37s off Chris Amon's polesitting Matra. That meant little in the race as much of the pack slipstreamed each other in a big swarm in the early stages.

Once a low-fuel-pressure problem cured itself, the Frenchman pushed

and was rewarded with a new lap record at 153.5mph. "I was altogether with a group of cars in a big pack as usual at Monza," remembers Pescarolo. "It was a question of being behind the group on one lap and being ahead on the next one, and ending up with fastest lap."

"The March that year was very good on fast circuits."

The 711 ran without the bodywork around the radiators at Monza, but Pescarolo says that wasn't a bid to find extra speed. "There was a big overheating problem with the March and Frank took some bodywork off the car," he adds. "It was to cure that problem rather than for top speed."

Pescarolo's pace went unrewarded, the March falling back and then retiring with suspension problems, denying him the chance to join the dramatic multi-car fight to the finish.



Pescarolo March: fast but fragile at Monza



'Mike The Bike' was fast in Formula 1, too

MIKE HAILWOOD

Surtees TS9B 1972 South African GP

It's easy to forget that bike hero Hailwood's transition to four wheels was pretty strong, if not as fantastic as his F1 team boss John Surtees.

At Kyalami, Hailwood was on the pace pretty quickly and qualified his Surtees fourth, 0.4s behind poleman Jackie Stewart. The Scot's Tyrrell soon overcame the fast-starting Denny Hulme and edged away as Hailwood chased the McLaren and Emerson Fittipaldi's Lotus in a fight for second.

As Hulme started suffering with an overheating DFV, Fittipaldi went by and started to close on Stewart. Faster than all three was Hailwood, however, who set the fastest lap after passing Hulme, then caught and

overtook Fittipaldi, and began to pressurise Stewart.

"It was great racing as Hailwood and Stewart flashed past the grandstands side by side on lap 27," said AUTOSPORT's race report. "The leaders were now well and truly lapping the backmarkers, and still Hailwood stuck to the tail of the Tyrrell."

It wasn't to last, however, as the Surtees suffered a rear-suspension failure and pitched Hailwood off. Given that Stewart soon retired and Fittipaldi hit tyre issues, Hailwood could well have scored his – and the team's – first world championship GP victory. As it was, both would have to settle for second best later on that season, Hailwood's TS9B finishing runner-up at that year's Italian GP at Monza.

MARC SURER

Ensign N180B 1981 Brazilian GP

Swiss driver Surer was a star in F2, taking the 1979 European title, but never really made a breakthrough in his 82 world championship F1 races. Like many, however, he did get the brief chance to show his abilities in a GP hit by bad weather.

As the top teams battled the ride-height rules attempting to ban ground effects, Surer's Ensign was left well behind in normal dry running. At Rio in 1981 he qualified 18th, some 3.5s slower than poleman Nelson Piquet's ground-hugging Brabham.

Come the race, though, the heavens opened and Surer made his presence felt. The Ensign dodged a multi-car incident, triggered by Gilles Villeneuve and Mario Andretti, to reach the first corner in ninth and

soon made good progress up the field.

Surer passed Keke Rosberg's Fittipaldi for seventh on lap 18 and got back ahead of Jarier when the Ligier ran wide 11 laps later. With Williams drivers Carlos Reutemann and Alan Jones dominating the race after Piquet decided to start on slicks, the Ensign now started pressuring John Watson's McLaren for fifth. The two Ligiers of Jarier and Jacques Laffite joined in to make the tussle the highlight of the race.

Finally, just after half-distance, Watson spun and Surer shot by. Unleashed, he immediately closed on the Lotus of Elio de Angelis, setting fastest lap, and moved into fourth with 14 laps to go. He ran out of time to catch the Arrows of Riccardo Patrese, but scored what would be Ensign's best result of the season after a fine drive.

Surer (left) and Ensign starred in the Rio rain



Donington
The heart of British motorsport

DUNLOP
MSA British Touring Car Championship

BTCC
British Touring Car Championship

BRITISH TOURING CARS

SATURDAY 20TH & SUNDAY 21ST APRIL

FAST AND FURIOUS COMES TO DONINGTON PARK

BTCC ROUND 2
2
BTCC ROUND 2



ADVANCE ADULT TICKETS*
SATURDAY £10 · SUNDAY £25 · WEEKEND £30
CHILDREN 13 & UNDER GO FREE!

BOOK YOUR TICKETS NOW

*Advance ticket prices end on Wednesday 17th April at 5pm

Telephone 01332 810048
www.donington-park.co.uk

Official Donington Park Racing



@DoningtonParkUK



PRE-SEASON MEDIA DAY

Thursday 21 March

First chance to see class of 2013

**MEDIA DAY:
FREE TO ATTEND
FROM MIDDAY**

ADRENALINE FILLED RACING THAT YOU DON'T WANT TO MISS!!



Irvine's only F1 FL came in Canada

EDDIE IRVINE

Ferrari F399 1999 Canadian GP

Although he fought Mika Hakkinen for the 1999 F1 title, Irvine was usually a contender for points rather than outright wins. At Montreal, though, the Irishman felt that only yellow flags had kept his Ferrari off the front row in qualifying.

He ran second in the race after team-mate Michael Schumacher crashed, and was in the hunt for victory before being punted into a spin by David Coulthard's McLaren.

"The car felt a bit peculiar for a bit, but soon it was fine again," said Irvine at the time and he duly started a recovery drive that would take him to third place, with fastest lap to boot.



Supersub de la Rosa: superquick at Sakhir

PEDRO DE LA ROSA

McLaren MP4-20 2005 Bahrain GP

"It may turn out that this was my last ever F1 race," said Pedro de la Rosa after the 2005 Bahrain GP, "and in a way I don't mind if it is because at least I proved a point with fastest lap."

De la Rosa would indeed get to start quite a few more GPs, but never in a machine as quick as McLaren's MP4-20. The car struggled with tyre warm-up, a hindrance in qualifying, but a benefit in the races during the one-set-of-tyres-per-race era.

Deputising for the injured Juan Pablo Montoya, de la Rosa outqualified team leader Kimi

Raikkonen, but proved to be race-rusty. The Spaniard, in his first F1 outing since 2002, was outfumbled in the early tussling and was then stuck behind Takuma Sato's BAR for many laps.

Once free of the Japanese racer, he proved quick, setting better in- and out-laps than Raikkonen. He eventually overcame Mark Webber's Williams to finish fifth, having secured the fastest lap along the way.

"De la Rosa had come into this race determined to make an impression," wrote Mark Hughes in AUTOSPORT's report. "His wheel-to-wheel skills may have been a bit suspect, but his speed was not."

THE COMPLETE LIST

Excluding the Indy 500s that counted for the world championship, here are the drivers who recorded just a single fastest lap...

- Piero Taruffi**
Ferrari 500 1952 Swiss GP
- Luigi Villorosi**
Ferrari 500 1953 Dutch GP
- Hans Herrmann**
Mercedes W196 1954 French GP
- Onofre Marimon**
Maserati 250F 1954 British GP
- Jean Behra**
Gordini 16 1954 British GP
- Karl Kling**
Mercedes W196 1954 German GP
- Roberto Mieres**
Maserati 250F 1955 Dutch GP
- Luigi Musso**
Lancia-Ferrari D50 1957 French GP
- Maurice Trintignant**
Cooper T51 1959 United States GP
- Innes Ireland**
Lotus 18 1960 Belgian GP
- Giancarlo Baghetti**
Ferrari 156 1961 Italian GP
- Ludovico Scarfiotti**
Ferrari 312 1966 Italian GP
- Richard Attwood**
BRM P126 1968 Monaco GP
- Pedro Rodriguez**
BRM P133 1968 French GP
- Jackie Oliver**
Lotus 49B 1968 Italian GP
- Henri Pescarolo**
March 711 1971 Italian GP
- Mike Hailwood**
Surtees TS9B 1972 South African GP
- Vittorio Brambilla**
March 751 1975 Austrian GP
- Gunnar Nilsson**
Lotus 78 1977 Belgian GP
- Marc Surer**
Ensign 180B 1981 Brazilian GP
- Brian Henton**
Tyrrell 011 1982 British GP
- Andrea de Cesaris**
Alfa Romeo 183T 1983 Belgian GP
- Jonathan Palmer**
Tyrrell 018 1989 Canadian GP
- Mauricio Gugelmin**
March CG891 1989 French GP
- Satoru Nakajima**
Lotus 101 1989 Australian GP
- Thierry Boutsen**
Williams FW13B 1990 German GP
- Bertrand Gachot**
Jordan 191 1991 Hungarian GP
- Roberto Moreno**
Benetton B191 1991 Belgian GP
- Alexander Wurz**
Benetton B198 1998 Argentinian GP
- Eddie Irvine**
Ferrari F399 1999 Canadian GP
- Pedro de la Rosa**
McLaren MP4-20 2005 Bahrain GP
- Jarno Trulli**
Toyota TF109 2009 Bahrain GP
- Timo Glock**
Toyota F109 2009 European GP
- Adrian Sutil**
Force India VJM02 2009 Italian GP
- Vitaly Petrov**
Renault R30 2010 Turkish GP
- Robert Kubica**
Renault R30 2010 Canadian GP
- Kamui Kobayashi**
Sauber C31 2012 Chinese GP
- Romain Grosjean**
Lotus E20 2012 Spanish GP
- Sergio Perez**
Sauber C31 2012 Monaco GP
- Bruno Senna**
Williams FW34 2012 Belgian GP
- Nico Hulkenberg**
Force India VJM05 2012 Singapore GP



Stewart dodges the wreck as Larson (32) prepares to fly

NASCAR NATIONWIDE SERIES DAYTONA (USA), FEBRUARY 23, RD 1/33

Stewart wins as dramatic crash mars finish

WHEN A RACE AT DAYTONA ends with a multi-car pile-up and an engine and wheel the wrong side of the protective catch-fencing, the focus is, understandably, upon the physical condition of the spectators rather than the identity of the victor.

That none of the 28 fans injured, after Kyle Larson's car was launched skywards on the approach to the finish line, were seriously hurt would have been of extreme comfort to race

winner Tony Stewart.

Stewart's Richard Childress Racing Chevrolet led as the pack began the final lap, but had been pushed back to third as Regan Smith and reigning Cup champion Brad Keselowski tandem-drafted past him on the inside.

On the run to the finish, Smith threw a block in his JR Motorsports Chevrolet on Penske Ford driver Keselowski, tagging the back of him, sending both

sideways and causing a chain reaction that led to Larson's Chevy hitting the debris fence. Sam Hornish Jr, Carl Edwards and Dale Earnhardt Jr were among the 12 drivers involved.

"We've always known since racing was started this was a dangerous sport, but we assume that risk, and it's hard when the fans get caught up in it," said Stewart, who can now number seven Daytona victories among his career total of 11 in

NASCAR's second tier.

"So as much as we want to celebrate now and as much as this is a big deal to us, I'm more worried about the drivers and the fans in the stands right now, because I could see it all in the mirror, and it didn't look good from where I was."

Such was the proximity of the accident to the finish line that Hornish was classified second under yellows, despite crossing the timing beam backwards. He is the points leader under rules that only allow drivers to score in one series, with Stewart focusing on the Sprint Cup.

The battle at the front of the field was unleashed with four laps to go after contact at Turn 1 between Michael Annett and Austin Dillon brought out a final caution.

Alex Bowman, starting only his fifth Nationwide race — and his first on a superspeedway — did not lead a lap, but did fight his way towards the front in time to get involved in the

final-lap fight for victory. His third-place finish was the best for a rookie.

New Joe Gibbs Racing team-mates Brian Vickers and Elliott Sadler were 19th and 15th in their Toyotas.

Polesitter Trevor Bayne retired with a transmission problem on his Roush Ford at two-thirds distance, while Danica Patrick's race ended early due to a faulty engine. Both had led during the earliest stages of the race.

● Dylan Jacobs

RESULTS

1 Tony Stewart (Chevrolet Camaro), 120 laps in 1h08m37s; **2 Sam Hornish Jr (Ford Mustang)**; **3 Alex Bowman (Toyota Camry)**; **4 Dale Earnhardt Jr (Chevy)**; **5 Parker Kligerman (Toyota)**; **6 Brian Scott (Chevy)**; **7 Justin Allgaier (Chevy)**; **8 Eric McClure (Toyota)**; **9 Robert Richardson Jr (Chevy)**; **10 Travis Pastrana (Ford)**. **Points** 1 Hornish, 42; 2 Bowman, 41; 3 Kligerman, 40; 4 Scott, 39; 5 Allgaier, 38; 6 McClure, 37; 7 Richardson, 35; 8 Pastrana, 34; 9 Nelson Piquet Jr, 33; 10 Kyle Larson, 32.



Larson's engine did big damage to fencing

International Motorsport Events: Race Tickets, Hospitality & Travel

SelectMotorRacing.com

● Formula One ● Le Mans 24hr ● MotoGP ● Superbikes ● Historic

Run by Fans for Fans

Free 2013 Brochure



LE MANS 24 HOUR

- Race Tickets & Hospitality
- Circuit Camping
- Self Drive Packages
- 15 Coach Tour options

HISTORIC TOURS

- Mille Miglia
- Goodwood Festival of Speed
- Goodwood Revival

FORMULA ONE GRAND PRIX TRAVEL PACKAGES

OUR UK TRAVEL TEAM WILL LOOK AFTER YOU THROUGHOUT THE TOUR

Coach Tours

- Executive Coach Travel
- Free Excursions
- Circuit Transfers each day

RACE TICKETS

- Grandstands
- Circuit Hospitality
- Paddock Club
- Monaco Yachts

Go By Air

- Choice of Hotels
- Airport meet and greet
- Return Hotel Transfers
- Circuit Transfers each day
- Free Excursions
- Free find a flight service

FORMULA ONE EVENTS

We are now the only UK Motorsports tour operator offering travel to ALL Formula One events

contact us on +44 (0) 1451 833 721 or email enquiry@selectmotorracing.com



www.selectmotorracing.com

Be part of our race



Driven Racing Oil – better than ever!

Driven Racing Oil has made a major technological leap by incorporating mPAO, the most innovative synthetic base oil available, into all of its engine oils. By using a mPAO base for creating its performance lubricants, Driven is able to create a lightweight motor oil that retains a high HTHS (High Temperature High Shear) viscosity to give you the best lubricant possible – an oil that's less sensitive to heat and doesn't break down under extreme friction.

Anglo American Oil Company

Distributor of:



+44 (0)1929 551557
info@aaoil.co.uk



Kleers Motorsport cleaning products – designed specifically for competition!

Recommended by some of the world's leading drivers, Kleers Crash Helmet Sanitiser is another unique and innovative product that has been produced to fulfil a real need. Using silver Ion technology, just a few pumps after a helmet is removed attacks the bacteria that can cause odours and leaves it smelling fresh the next time it's taken out of its bag.

Visit our website

winning formula!



Anglo American Oil Company

Proud supplier to:



MINI CHALLENGE



F3 CUP

GT CUP CHAMPIONSHIP

DUTCH SUPERCAR CHALLENGE



Masters HISTORIC RACING



Britcar Production CUP CHAMPIONSHIP

MSA British Endurance CHAMPIONSHIP

Britcar Production Sportscars RACES



AUTOSPORT.COM

**Who's in your team
for 2013?**



**Choose your drivers
and win £20,000 in prizes!**

autosport.fantasyleague.com

 **fantasy** THE ORIGINAL
league™ F1



Scan with your smartphone for details.

INTERNATIONAL RACES & RESULTS
NASCAR TRUCKS
Daytona (USA),
Rd 1/22

QUICK RESULTS
→ Winner **Johnny Sauter**
→ Pole **Brennan Newberry**
→ Laps led **Ty Dillon**
→ Points leader **Sauter**

RACE RATING Last-lap shunt denied a potential grandstand finish
★★★★☆

REPORTS
WORLD OF SPORT



Busch (51) could not pass Sauter

NASCAR TRUCK SERIES DAYTONA (USA), FEBRUARY 22, RD 1/22

Good Sauter makes it 'sorta good' for Toyota

JOHNNY SAUTER GAVE Toyota its 100th NASCAR Truck Series win after holding off a determined charge by Kyle Busch to win at Daytona last Friday night. Sauter, 34, effectively had his victory secured with a little under a lap left to run, when a 14-car pile-up at Turn 1 froze the field under caution. It was his seventh series win and his first at the Florida speedbowl. "It's a lot harder to win restrictor-plate races than you think," said ThorSport driver Sauter, who was spun out of the lead of last year's race on the penultimate lap. "I'm so proud of our effort. I'm speechless, even to this point. After last year, coming so close and getting taken out there toward the end of the race... we did everything right tonight."

Cup regular Busch was frustrated by the result, especially as he had been setting himself up to be in the ideal position to mount a final-lap move for the lead.



Truex (30) and others got together late on

"Damn," said the Kyle Busch Motorsports Toyota owner/driver. "Things had been pretty clean. I didn't really expect this to be a 99-lap race."

A largely uneventful race came to life when Ryan Truex, who had been shuffled back from second by getting himself stuck in the middle lane of the track,

lost control and triggered a five-truck shunt that eliminated 2012 title contender Timothy Peters's Red Horse Toyota.

That set up a five-lap run to the finish, with Sauter and Busch heading Todd Bodine and James Buescher as the train of cars became established in single file.

The final-lap wreck

involving defending series champion Buescher's Turner Scott Chevrolet, Joey Coulter, Jeff Agnew and last year's Daytona winner John King brought out the yellows and safeguarded Sauter's position at the front.

Buescher's team-mate Jeb Burton — whose father Ward won the 2002 Daytona 500 and whose uncle Jeff

completed in this year's event — was an impressive fifth on only his sixth start in the series. He finished in the wheeltracks of four-time champion Ron Hornaday and Justin Lofton.

Brennan Newberry caused a shock in qualifying as he took his maiden series pole — he had never qualified higher than 18th for any of his 10 previous starts in the championship. His NTS Chevy was classified 33rd after being eliminated in an early smash.

● Dylan Jacobs

RESULTS

1 Johnny Sauter (Toyota Tundra), 100 laps in 1h45m56s; **2 Kyle Busch (Toyota)**; **3 Ron Hornaday (Chevrolet Silverado)**; **4 Justin Lofton (Chevy)**; **5 Jeb Burton (Chevy)**; **6 Ty Dillon (Chevy)**; **7 Miguel Paludo (Chevy)**; **8 Ryan Blaney (Ford)**; **9 Matt Crafton (Toyota)**; **10 Ryan Sieg (Chevy)**. **Points** 1 Sauter, 47; 2 Hornaday, 41; 3 Lofton, 41; 4 Dillon, 40; 5 Burton, 39; 6 Paludo, 37; 7 Blaney, 36; 8 Crafton, 35; 9 Sieg, 34; 10 Todd Bodine, 34.

DAYTONA 500

USA

February 18-25
NASCAR SPRINT CUP
Round 1/36

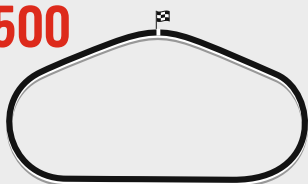

AT A GLANCE

- Winner **Jimmie Johnson**
- Pole **Danica Patrick**
- Most laps led **Matt Kenseth**
- Points leader **Johnson**



Yeley's first top-10 since 2008

Johnson goes low for second Daytona high

Track-position tactics from the five-time champion made sure of his second Daytona 500 victory for Chevrolet



... ending a seven-year wait for a second win

AS A SPECTACLE, THE 2013 edition of the Daytona 500 was as great a monument to single-file processions as you're ever likely to see. But in years to come it will be remembered for two things: Danica Patrick doing quite well and, in a somewhat distant second, Jimmie Johnson breaking a recent jinx at the track to win NASCAR's biggest event.

Johnson, whose win in the 2006 race was followed by a string of failures to crack the top 25 that was only broken last Sunday, ran among the leaders for most of the

afternoon. His decisive move came with 13 laps to go when he moved onto the low line after a restart and began to challenge then-leader Brad Keselowski.

This in itself seemed vaguely radical, with virtually the entire field having spent most of the previous 470-odd miles strung out in one long line along the top of the track. According to Johnson, this was a product of the aero characteristics of the new Gen-6 cars.

"The majority of the competitors wanted to

run the top," he said. "The draft really works in numbers. There's more there than the bottom. With the side drafting being as effective right now, you could really choke down the bottom lane and pin a guy against the line and slow him down, and then get away and have that long line of cars to surge you past.

"The game's changed a little bit. It used to be: defend the bottom; now it's defend the top. In the closing laps, we were all single file. I was leading and wanted to see what would

RACE RATING

★☆☆☆☆

Single-file racing is not what you expect - or want - in restrictor-plate racing

KEY MOMENT

Lap 187

Johnson goes low to challenge Keselowski for lead with 13 laps left

REPORT DAYTONA 500

CONNELL SANDERS JR
reports



Johnson led Earnhardt to a Hendrick one-two...

go on with the middle or bottom and not allow guys to set me up based on my lines. I ran the bottom and no one had a run or did anything."

After the race, Johnson told a TV crew that in restrictor-plate races like Daytona, "you can't just sit there and wait for something to happen." But from the outside, that's exactly what it looked like a lot of those around him were doing. As the laps ticked away, Johnson crept lower and lower on the track, and waited for a

challenge that never really came. He was helped a little by a late caution for debris, which reduced the amount of time available for his rivals to try to put some sort of move together, but on the whole the resistance seemed strangely muted.

Keselowski at least had some reason to be slightly trigger-shy. The series champion's car went into the final stages of the race carrying battle scars from two major incidents earlier in the race, one of which managed to neutralise many of the favourites in a single

Patrick was mobbed wherever she went



Kenseth led on Gibbs debut



Patrick (left) and Gordon on front row



stroke. That one began when Kyle Busch tagged Kasey Kahne into a spin on lap 33, triggering a chain reaction that ended with Kevin Harvick and Tony Stewart being eliminated on the spot.

Later, he was involved in another multi-car accident on lap 137 that began with him being hit by 2011 race winner Trevor Bayne. Keselowski was able to gather himself together and continue, but Bayne's car swung into the pack and took out several drivers including rookie Austin Dillon, who had run strongly early on, and Carl Edwards.

But there were rewards for those who pushed at the end. Keselowski was shuffled back to fourth when Dale Earnhardt Jr and Mark Martin worked together on the final lap to push themselves up to second and third.

"I couldn't have done much without Mark helping me here at the end," said Earnhardt, who had been back in seventh just before the final caution. "I was hoping he was thinking what I was thinking as we came off of turn two on that

last lap. I felt like we needed to make the move a little earlier than off [turn] four.

"Once we come off [turn] two, mashed the gas, got a run on Danica, side-drafted her a little bit... I don't know why those guys didn't pull down in front of me besides Jimmie, but we got through three and four with a pretty good run."

Martin said that the move had been cooked up following a conversation between his and Earnhardt's spotters during the final caution, but was convinced that the low line had been under-used throughout the whole race.

"The spotters did have a discussion before the restart," he said. "Obviously I knew Junior had a fast car and is one of the masters here; I certainly would trust his judgment. I was in a position where I needed to pass a bunch of cars in order to get in contention to win. So we did that. If things would have got crazy enough, maybe we could have got the big trophy.

"One of the things that made it hard to pass was nobody... they wouldn't get organised on the bottom.

I think you could, because there at the end when they got a good line organised, it got to be pretty dangerous."

Up to that point, Patrick was on target for what would have been a deserved podium finish after an afternoon spent almost entirely in the top 10. Her pole position was cancelled out almost immediately when Jeff Gordon passed her through Turns 1 and 2 at the start, but she redeemed herself later by taking the lead from Denny Hamlin on a restart on lap 90, becoming in the process the first female driver to lead the Daytona 500, and the first to lead a Sprint Cup race under green flag conditions (Janet Guthrie previously led five laps under caution at Ontario in 1979).

Her pit box's location at the far end of pitlane didn't help her, as she routinely lost a couple of places through being squeezed down onto the apron while trying to rejoin the track after a stop. But she also admitted that there were lessons to be learned in being shuffled from third back to eighth in just ▶

“We worked 35 days straight on the car that we raced in the Daytona 500. I know I put in personally one day of 38 hours straight. I actually sent Jimmie a text, saying I’ve seen 6:48 three times today and haven’t been to bed yet”

Jimmie Johnson’s crew chief Chad Knaus

MILESTONE

Johnson’s victory was his second at the Daytona 500, the first coming in 2006



Harvick (29) won first duel

HARVICK AND BUSCH TAKE DUELS

Kevin Harvick and Kyle Busch shared the wins in Thursday’s Daytona Duel qualifying races.

Each outing set half of the grid for Sunday’s race, and Harvick made good use of the inside line to draft past Trevor Bayne for the lead just before the pitstops. Having taken the advantage, Harvick relied on some slick pitwork to maintain it, and survived a late restart to secure the win. Polesitter Danica Patrick was passed at the start by Bayne, who went on to lead the first half of the race, but the 2011 Daytona 500 winner was one of several drivers to get caught up in the late-race crash that was started when Denny Hamlin glanced off the wall and

into Carl Edwards.

The second race, for cars that finished in even-numbered positions during qualifying a week earlier, was completed without the need for a caution period, but there was still ample room for drama. Jeff Gordon started from pole, and after being briefly passed by Ryan Newman, held the lead right up to the point where he was penalised for pitlane speeding.

That handed the lead to Busch, who successfully defended it from Kasey Kahne and Clint Bowyer. Kahne recovered to pass Matt Kenseth for second with a lap remaining, while Gordon rallied back from his pitlane indiscretion to finish 12th.

two miles at the end of the race.

“I would imagine that pretty much anyone would kick themselves and say, ‘what could I have/should I have done to give myself that opportunity to win?’” she admitted.

“I think that’s what I was feeling today; uncertainty as to how I was going to accomplish that. There was plenty of time while you were cruising along. I was talking to Tony [Stewart, team co-owner] and my spotter on the radio: ‘What do you see people doing, what’s working, what’s not?’ I was thinking in the car, ‘How am I going to do this?’ I didn’t know exactly.

“So maybe that’s just my inexperience. Maybe that’s me not thinking hard enough, not getting creative enough. I’m not sure. I definitely was a little uncertain about how I was going to be able to do it. I think Dale did a nice job and shows what happens when you plan it out, you drop back, get that momentum and you’re able to go to the front.”

It probably came as scant consolation that someone with considerably more experience got caught out in exactly the same way. Greg Biffle had been camped in second between Keselowski and Patrick before Earnhardt

and Martin made their move, and less than a minute later he found himself crossing the line in sixth and wondering what on earth had happened. It echoed a similar result at Talladega last year, when he greeted the white flag in second place behind Matt Kenseth and wound up getting passed by three cars before the finish.

“I figured the 48 [Johnson] and the 88 [Earnhardt] would side draft each other and I’d have a chance to pass both,” he said. “That’s what I was thinking would happen. That was my plan. I had it all figured out, but my plan didn’t quite come together.”

At least he took something from the afternoon. Gordon looked to be on track for a good day

when he led the opening 30 laps, overcoming an overheating scare along the way by nuzzling up behind the pace car during a caution to dislodge some debris that was blocking his radiator. However, water-pressure problems later in the race proved more difficult to overcome, and he was left to finish a frustrated 20th.

Anyone wanting to find someone more annoyed than Gordon after the race would have done well to seek out Joe Gibbs Racing. Matt Kenseth led 86 laps in the middle phase of the race and appeared largely untroubled, despite having earlier radioed to the pits to report a mysterious vibration on the right-side of the car. That was eventually dismissed as being too trivial to warrant a



Veteran Martin took third in 31st year of Sprint Cup

Three-wide racing was rare this year



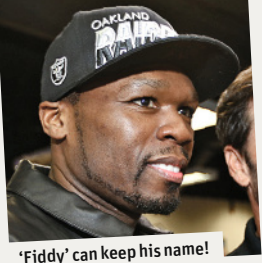

'Fiddy' can keep his name!

“We told 50 Cent if we won the race, he would have to change his game to 55 Cent for one day. I was trying really hard to get that name change”

Third-placed finisher Mark Martin, who drives car #55

5 REPORT DAYTONA 500

Number of times Ford driver Carl Edwards crashed at Daytona in as many days

visit to the pits, but a plume of smoke from under the bonnet was another matter altogether and he was forced to retire. Just a couple of minutes later, an engine problem brought team-mate Kyle Busch into the garage as well. Not so long beforehand, Gibbs's cars were running 1-2-3; the problems for Kenseth and Busch leaving Hamlin to fly the team's flag alone.

“There are pieces that are supposed to stay together,” said Busch. “And they didn't stay together.”

Hamlin looked strong for a while, leading for 33 laps, before fading to 14th. In keeping with the times, he vented his frustration on Twitter, claiming that Joey Logano's efforts to create a third lane in the middle of the track two-thirds of the

way through the race ruined things for the drivers trying to go low.

With the spectre of the last-lap accident in the previous day's Nationwide race that left several spectators injured by flying debris still looming large, several drivers later expressed their relief that the series' safety standards had not faced a similar test in the main event.

The ramifications of that incident will reverberate for some time yet, but in the meantime, the day belonged to Johnson and long-time crew chief Chad Knaus, who had missed Johnson's last Daytona win due to a suspension. There are still 35 races to go, but as a starting point, the five-time champion couldn't have wished for more. 🏆



McMurray (1) spins as Montoya and Harvick collide further up

RESULTS

NASCAR Sprint Cup, Daytona 500 (USA), February 24, round 1 of 36

| GRID | |
|--------------------------|-------------------------|
| 2 GORDON 196.292mph | 1 PATRICK 196.434mph |
| 3 HARVECK 194.742mph | 4 KYLE BUSCH 195.767mph |
| 5 BIFFLE 194.729mph | 6 KAHNE 195.852mph |
| 7 MONTOYA 195.508mph | 8 DILLON 195.385mph |
| 9 JOHNSON 195.084mph | 10 BOWYER 195.228mph |
| 11 KURT BUSCH 193.657mph | 12 KENSETH 195.725mph |
| 13 STEWART 195.925mph | 14 MARTIN 194.683mph |
| 15 KESELOWSKI 194.961mph | 16 MENARD 195.503mph |
| 17 MEARS 195.495mph | 18 BURTON 195.156mph |
| 19 EARNHARDT 195.584mph | 20 McMURRAY 195.042mph |
| 21 LOGANO 195.767mph | 22 RAGAN 194.616mph |
| 23 LABONTE 192.563mph | 24 AMBROSE 194.793mph |
| 25 GILLILAND 194.654mph | 26 ALMIROLA 194.742mph |
| 27 NEMECEK 190.046mph | 28 STENHOUSE 195.537mph |
| 29 WALTRIP 194.313mph | 30 BLANEY 192.996mph |
| 31 SPEED 193.540mph | 32 WISE 194.254mph |
| 33 BAYNE 195.976mph | 34 NEWMAN 195.946mph |
| 35 HAMLIN 195.771mph | 36 EDWARDS 195.240mph |
| 37 TRUEX 195.207mph | 38 McDOWELL 193.544mph |
| 39 T LABONTE 193.515mph | 40 SMITH 193.096mph |
| 41 YELEY 192.094mph | 42 REUTIMANN 190.339mph |
| 43 KVAPIL 190.142mph | |

| 200 LAPS, 500 MILES | | | | | |
|---------------------|--------------------------|---------------------------|--------------|---------------------|------|
| POS | NAME | TEAM | CAR | TIME | GRID |
| 1 | Jimmie Johnson (USA) | Hendrick Motorsports | Chevrolet SS | 3h08m23s | 9 |
| 2 | Dale Earnhardt Jr (USA) | Hendrick Motorsports | Chevrolet SS | +0.129s | 19 |
| 3 | Mark Martin (USA) | Michael Waltrip Racing | Toyota Camry | +0.255s | 14 |
| 4 | Brad Keselowski (USA) | Penske Racing | Ford Fusion | +0.359s | 15 |
| 5 | Ryan Newman (USA) | Stewart-Haas Racing | Chevrolet SS | +0.477s | 34 |
| 6 | Greg Biffle (USA) | Roush Fenway Racing | Ford Fusion | +0.524s | 5 |
| 7 | Regan Smith (USA) | Finch Racing | Chevrolet SS | +0.626s | 40 |
| 8 | Danica Patrick (USA) | Stewart-Haas Racing | Chevrolet SS | +0.658s | 1 |
| 9 | Michael McDowell (USA) | Phil Parsons Racing | Ford Fusion | +0.691s | 38 |
| 10 | JJ Yeley (USA) | Tommy Baldwin Racing | Chevrolet SS | +0.731s | 41 |
| 11 | Clint Bowyer (USA) | Michael Waltrip Racing | Toyota Camry | +0.827s | 10 |
| 12 | Ricky Stenhouse Jr (USA) | Roush Fenway Racing | Ford Fusion | +1.176s | 28 |
| 13 | Aric Almirola (USA) | Richard Petty Motorsports | Ford Fusion | +1.198s | 26 |
| 14 | Denny Hamlin (USA) | Joe Gibbs Racing | Toyota Camry | +1.279s | 35 |
| 15 | Bobby Labonte (USA) | JTG Daugherty Racing | Toyota Camry | +1.542s | 23 |
| 16 | David Reutimann (USA) | BK Racing | Toyota Camry | +2.273s | 42 |
| 17 | Dave Blaney (USA) | Tommy Baldwin Racing | Chevrolet SS | +5.306s | 30 |
| 18 | Marcos Ambrose (AUS) | Richard Petty Motorsports | Ford Fusion | +8.591s | 24 |
| 19 | Joey Logano (USA) | Penske Racing | Ford Fusion | +9.266s | 21 |
| 20 | Jeff Gordon (USA) | Hendrick Motorsports | Chevrolet SS | +11.216s | 2 |
| 21 | Paul Menard (USA) | Richard Childress Racing | Chevrolet SS | +18.220s | 16 |
| 22 | Michael Waltrip (USA) | Swan Racing | Toyota Camry | +19.788s | 29 |
| 23 | Scott Speed (USA) | Leavine Family Racing | Ford Fusion | +20.714s | 31 |
| 24 | Martin Truex Jr (USA) | Michael Waltrip Racing | Toyota Camry | +24.753s | 37 |
| 25 | Travis Kvapil (USA) | BK Racing | Toyota Camry | -1 lap | 43 |
| 26 | Terry Labonte (USA) | FAS Lane Racing | Ford Fusion | -1 lap | 39 |
| 27 | Trevor Bayne (USA) | Wood Brothers Racing | Ford Fusion | -2 laps | 33 |
| 28 | Kurt Busch (USA) | Furniture Row Racing | Chevrolet SS | -5 laps | 11 |
| 29 | Casey Mears (USA) | Germain Racing | Ford Fusion | -19 laps | 17 |
| 30 | Jeff Burton (USA) | Richard Childress Racing | Chevrolet SS | 176 laps-acc damage | 18 |
| 31 | Austin Dillon (USA) | Richard Childress Racing | Chevrolet SS | -25 laps | 8 |
| 32 | Jamie McMurray (USA) | Earnhardt Ganassi Racing | Chevrolet SS | -39 laps | 20 |
| 33 | Carl Edwards (USA) | Roush Fenway Racing | Ford Fusion | -41 laps | 36 |
| 34 | Kyle Busch (USA) | Joe Gibbs Racing | Toyota Camry | 151 laps-engine | 4 |
| 35 | David Ragan (USA) | Front Row Motorsports | Ford Fusion | 150 laps-accident | 22 |
| 36 | Kasey Kahne (USA) | Hendrick Motorsports | Chevrolet SS | -50 laps | 6 |
| 37 | Matt Kenseth (USA) | Joe Gibbs Racing | Toyota Camry | 149 laps-engine | 12 |
| 38 | David Gilliland (USA) | Front Row Motorsports | Ford Fusion | 144 laps-accident | 25 |
| 39 | Juan Pablo Montoya (CO) | Earnhardt Ganassi Racing | Chevrolet SS | -56 laps | 7 |
| 40 | Josh Wise (USA) | Front Row Motorsports | Ford Fusion | 137 laps-accident | 32 |
| 41 | Tony Stewart (USA) | Stewart-Haas Racing | Chevrolet SS | -82 laps | 13 |
| 42 | Kevin Harvick (USA) | Richard Childress Racing | Chevrolet SS | 47 laps-accident | 3 |
| 43 | Joe Nemechek (USA) | NEMCO Motorsports | Toyota Camry | 42 laps-engine | 27 |

| POINTS | | |
|--------|------------|-----|
| POS | DRIVER | PTS |
| 1 | Johnson | 47 |
| 2 | Earnhardt | 42 |
| 3 | Martin | 41 |
| 4 | Keselowski | 41 |
| 5 | Newman | 40 |
| 6 | Biffle | 38 |
| 7 | Patrick | 37 |
| 8 | McDowell | 35 |
| 9 | Yeley | 34 |
| 10 | Bowyer | 34 |

Winner's average speed: 159.25mph.

Rise of the GT3 machines

In difficult financial times, this sportscar class has bucked the trend and flourished since it started seven years ago. GARY WATKINS investigates



Spa 24 Hours 2012: 61 GT3 cars took the start

Like the British Empire of old, the sun never sets on GT3 racing. Just about every weekend for nine or 10 months of the year, cars from the category will be battling it out somewhere on the globe for victory in a major national or international series. The spread of the class around the world has been phenomenal and must make GT3 one of the biggest motorsport success stories of the past 10 years.

GT3 has become the default class for national GT racing over the years since its inception in 2006, but just as significant has been its adoption by a raft of important endurance races. You can win the 24-hour blue-ribbands at the Nurburgring and Spa with a GT3 car, and then have a go at more modern

classics such as the Dubai 24 Hours and the Bathurst 12 Hours.

The success of the category can also be measured in the number of cars built since its creation for the FIA GT3 European Championship. That's the number of types or models as well as the total production figure. No fewer than 17 marques have been represented with a total of 21 models, and there are more on the way including Bentley with its Continental GT. And the production total is so vast it's nigh on impossible to come up with an accurate number. The figure could be nudging 1000 cars and is, at the very least, 800.

The success of the GT3 division is its inclusiveness: it is inclusive because it's cheap compared with other forms of GT racing; the rules allow a disparate



Dubai 24 is a January highlight

range of machinery that has allowed so many manufacturers to be represented; and the cars are relatively easy to drive.

GT3 was conceived by Stephane Ratel. Of course it was. After all, he has been the central figure in world GT racing for the better part of 20 years.

GT3 cars have own class in...

International GT Open and GT Open Winter Series, Superstars GT Sprint Series, European Le Mans Series (as GTC), Asian Le Mans Series (as GTC), Challenge Endurance VdeV (GT/Touring), MSA British Endurance Championship, Dutch Supercar Challenge, Malaysian Super Series, Thai Supercar Series and GT Cup. The proposed City Challenge and Supercars International Series will be GT3-based championships. GT3 cars are also incorporated into the Grand-Am GT, SCCA World Challenge GT and Super GT (Japan) GT300 class.

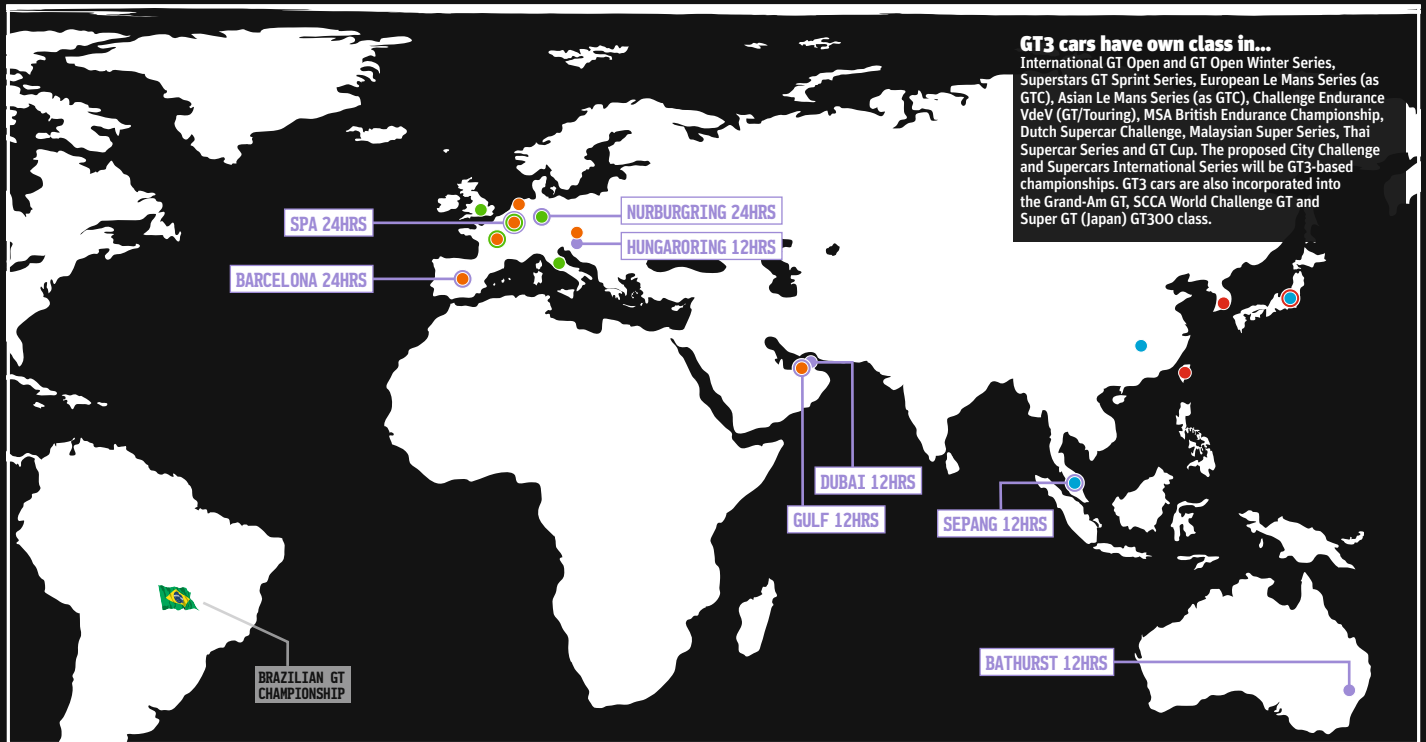

GT SERIES KEY

- **FIA GT SERIES**
France, Belgium, Netherlands, Slovakia, Spain, Abu Dhabi
- **BLANCPAIN ENDURANCE SERIES**
Italy, UK, France, Belgium, Germany
- **GT ASIA SERIES**
Japan, China, Malaysia
- **SUPER TAIKYU**
Japan, South Korea, Taiwan
- **ENDUROS**
Nurburgring 24 Hours, Dubai 24 Hours, Hungaroring 12

Hours, Barcelona 24 Hours, Sepang 12 Hours, Gulf 12 Hours, Bathurst 12 Hours

DOMESTIC SERIES

- BRITISH GT Championship**
- BRAZILIAN GT Championship**
- Langstreckenmeisterschaft**
- ADAC GT masters**
- ITALIAN GT Championship**
- FRENCH GT Championship**
- BELGIAN GT Championship**
- SPANISH GT Championship**
- SWEDISH GT Championship**

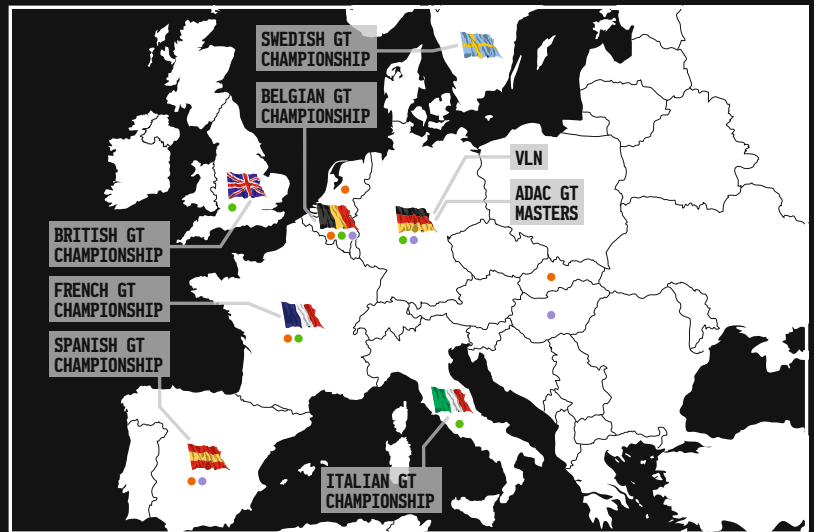

The catalyst for the start of this wildly successful class was the end of a largely-forgotten category. Ratel's Lamborghini Supertrophy one-make series had come to an end in 2002 and he couldn't find another manufacturer to fill the void. The Supertrophy Diablo GTR racer provided GT3's inspiration.

"That car was extremely fast and strong, and cost nothing to run," he recalls. "I remember some of my clients went to 20,000km on those cars without opening the engine. Next to that we had the FIA GT Championship with very expensive cars that required an engine rebuild every 5000km."

The Lambo was essentially a souped-up road car, built on the production line, with a standard six-litre V12 engine. It wasn't sophisticated, but

it was quick thanks to a power output of 600bhp that was as much as the sophisticated and low-mileage race engines powering the GT1 brigade in FIA GTs. Ratel thought that if Lamborghini could build a cheap and fast car, so could other manufacturers.

There had been two important staging posts on the road to the creation of GT3, the significance of which even Ratel didn't realise at the time. The first came in 1999 when he managed to persuade the FIA to do away with the rule that allowed only a manufacturer to homologate a car.

The FIA GT Championship was on its uppers and dominated by the ageing Chrysler Viper GTS-R, and there were no new cars on the horizon. Ratel hatched a plan to bring the Ferrari 550

Maranello into the series, but the only problem was that the Italian manufacturer stood in his way.

"I knew it was dead so long as Vipers were winning all the time," remembers Ratel. "I needed Ferrari back."

So much so that Ratel was ready to fund development of what was known as the 550 Millennio with Italian engineering specialist Italtecnica. But first he needed what he calls 'specialist tuners' to be allowed to homologate cars.

"I remember the session of the GT Commission," says Ratel of the meeting at which he put forward his ideas to the manufacturers. "They were all against me. I said, 'OK, fine, GT racing is dead'. I remember with the help of Gabriele Cadringer [then president of the FIA Manufacturers' Commission], we ▶



Mick Gardner Racing...official Öhlins Centre and suspension specialist for all types of GT Racing cars

Race winning technology and experience available in Öhlins latest TTX and TTR dampers

Features

- 4-way independant fully adjustable compression and rebound valving system.
- Extenal high and low speed 'zero' function.
- Change valving in close to one minute- no need to strip damper to change settings.
- Valve referencing programme.
- Race winning damper technology.

Benefits

- Accurate adjustments within a wide working range.
- Accurately match dampers and maintain reference click settings.
- Reduce time spent in test sessions on chassis setup.
- Quickly and reliably test new settings at the track without the need for a damper dyno.
- Proven reliability and performance.



If You're Looking For The Ultimate In Performance Dampers Or To Have Your Existing Dampers Serviced, Please Contact Öhlins Leading Uk Centre Mick Gardner Racing.
Mick Gardner Racing | Tel: 01226 240099 | E-mail: russwalton@mickgardnerracing.com | www.mickgardnerracing.com



THE BIGGEST **VODAFONE** DMAX CHAMPIONSHIPS YET!



Prices are £180 per Endurance Round and £165 per Heats Round
£280 to enter both

Cumulative Loyalty Discount of 2.5% for each round entered.

A full season of Heats Racing for £1476 or Enduro Racing for £1610 inc VAT

| | |
|----------|------------------|
| Feb 17th | Daytona MK |
| Mar 17th | Daytona SP |
| Apr 21st | PF International |
| May 19th | Rye House |
| Jun 16th | Lydd |
| Jul 21st | Bayford Meadows |
| Aug 18th | Whilton Mill |
| Sep 15th | Red Lodge |
| Oct 20th | Daytona MK |
| Nov 17th | Daytona SP |

Tel: 0845 644 5504
www.daytonamax.co.uk



◀ were able to push it through. That was the first victory on the road to GT3 and maybe the most important one.”

The second sea-change in thinking at the FIA that paved the way for GT3 came with the arrival of the always-controversial Maserati MC12 in FIA GTs at the end of 2004, against Ratel’s wishes it should be noted. He reckoned it was set to be 1996-97 all over again.

“I wanted to forbid the MC12,” he reveals. “We badly screwed up when we allowed the Porsche 911 GT1 in 1996 and that eventually destroyed GT racing. I didn’t want to make the same mistake twice.

“But Max Mosley [then FIA president] said, ‘Listen, refusing it will create such a storm. We are going to balance it and then everyone will realise that there is no point doing this kind of car because it will be no faster than a conventional car.’”

And so the concept that we know now as the Balance of Performance was born. The Maserati, quite literally, had its wings clipped and happily raced against the 550 Maranello, the Chevrolet Corvette (in C5-R and C6.R forms) and the Aston Martin DBR9.

The ingredients for GT3 were all there. Tuners could homologate cars, which would remain as standard as possible and then be balanced against one another using the BoP. And the indifference or even opposition of the manufacturers to Ratel’s proposal smoothed the path to its creation.

The rules are simple, or rather few and far between. A GT3 car isn’t built to a firm set of regulations; it is built to achieve a certain performance. And if it falls above or below that mark, the BoP comes into play.

“The success of GT3 comes down to the freedoms allowed,” explains Hans Reiter, whose eponymous company will shortly deliver its 100th Lamborghini Gallardo GT3 racer and who is now developing a Chevrolet Camaro for the class under the Sarni United banner. “The Gallardo and the Camaro are two different concepts, but we can achieve a similar level of performance.

“If you had rules like in GTE, it would take millions to make the Camaro competitive. It is really too big and too heavy to go racing, but we are

GT3 has given massive shot to national series, such as Britain

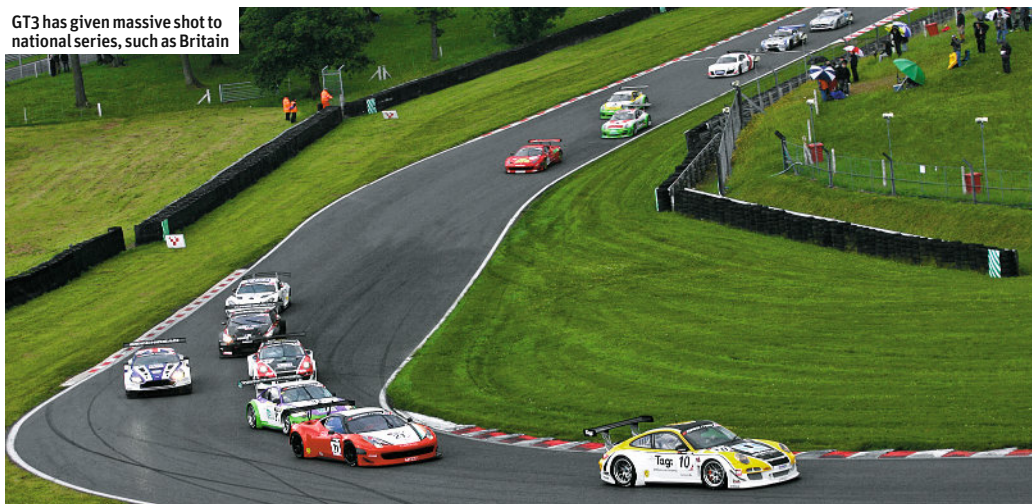

“Max Mosley said, ‘Refusing the Maserati MC12 will create a storm. We are going to balance it’”

Stephane Ratel recalls the seed of Balance of Performance

allowed to compensate – we are using bigger tyres and a bigger engine.”

Reiter points out that his Gallardo lacked downforce, but under the BoP was allowed a simple and cheap fix.

“We were allowed to bolt on a bigger rear wing,” he continues. “If we were racing in GTE we would have had to spend a lot of money going into the windtunnel to optimise the existing wing within the regulations.”

BMW, it should be pointed out, was allowed to put a V8 engine in its Z4 GT3 racer, even though you won’t find an eight-pot version of the car in your local dealership. The same freedoms should allow Bentley to produce a competitive car out of the Continental, which as a road car tips the scales at more than two tons.

It’s the same philosophy that makes GT3 cheap. Parts are not optimised in the same way as they would be in GTE, which means the purchase price is significantly lower: Aston Martin’s V12 Vantage GT3 will set you back £295,000 less taxes, its latest V8-powered Vantage GTE £475,000. The difference in running costs is possibly even greater.

“On the Lambo, everything is over-dimensioned,” explains Reiter. “Nothing is super-light and optimised to the last degree. That’s why the cars run and run.”

Reiter has worked out that the running costs per kilometre of his GT3 Gallardo are just 25 per cent of those of his old Murcielago GT1 contender.

The retention of the driver aids found on the road cars are part of the appeal of GT3, reckons the German who engineered the BMW V12 LMR that won the 1999 Le Mans 24 Hours.

“They allow the amateur drivers to be much closer to the pros in terms of lap time,” he says. “That has been important in its success.”

GT3 was conceived as a home for the kind of gentlemen racer who got his kicks in the old Lambo Supertrophy. There weren’t any amateurs in the winning Audis at the Nurburgring or Spa 24-hour events last year, but the majority of series running to its rules maintain the pro-am format introduced with the category in 2006.

Ratel conceived the driver-grading system. It was criticised back in 2006, but these days it’s an accepted part of the sportscar racing landscape and even has a place at the highest level in the FIA’s World Endurance Championship and at Le Mans.

But there is a cloud on the horizon. Last October, the FIA and the Le Mans organiser, the Automobile Club de l’Ouest, announced plans to try to bring GTE and GT3 together. That prompted a critical response from Ratel, who isn’t prone to coming out against the FIA.

“They are two different concepts, so convergence is impossible,” he argues. “By bringing them together, you will destroy one or the other.”

GT3’s statistics make a compelling argument for maintaining the status quo. The number of cars built and manufacturers represented, not to mention its spread around the world, bring you to an easy conclusion: if it ain’t broke, don’t fix it. ❄

European GT3 kicked off in 2006



NISSAN RETURNS TO OZ

The Japanese manufacturer has a rich history in Australian tin-tops. *MARK GLENDENNING* examines if the firm's new V8 Supercars project can add to the list of successes

With a little over a day to go before Rick Kelly eases his Nissan Altima V8 Supercar out of pitlane and into the Senna chicane for the start of the first practice session in Adelaide, the beginning of a new era in Australia's premier racing category is almost upon us. For years, V8 Supercars was a closed shop, restricted to Holden and Ford, but 2013 heralds the arrival of the Car of the Future, and with it, two new manufacturers.

The Kelly Racing team that Rick leads with brother Todd, and which has been rechristened Nissan Motorsport in its new incarnation as Nissan's works V8 effort, is an all-hands-on-deck operation: just before AUTOSPORT's call, 2006 series champion Rick was busy sticking up pitwall equipment.

"Chaotic" is a good description for what you'd see down here at the moment," says Kelly.

"There is stuff going on everywhere, and there's only three days until the truck has to be packed and sent away, so we're all frantically trying to make sure we're in good shape."

The arrival of Nissan and Mercedes (see panel, right) is the product of

changes in both the regulations and the culture of Australian motorsport. The new Car of the Future, which debuts this year, features more common components than its predecessor, and its introduction coincided with a retreat on the requirement that manufacturers produce a rear-wheel-drive V8 production model.

Meanwhile, the Holden/Ford rivalry around which the V8 Supercar category was conceived has been losing steam. Kelly believes this started when both brands scaled down their programmes a few years ago, leaving the grid with more 'independent' entries.

"When the manufacturer funding from Ford and Holden dropped back, so did the rivalry," he says. "From a fan point of view, it shifted more towards drivers and teams. And having the Altima and the AMG makes it a bit more relevant to what is on the road, because these days Commodores and Falcons aren't as common as they used to be. We need to open it up to the cars that people drive, and from that point of view the programme has been a success."

At some point, 'success' will need to be measured in a more tangible way. The team was encouraged when Kelly

Rick Kelly is raring to go with new Nissan



Altima joins class veterans Holden and Ford this year

was able to run in the top five at a recent test, although Nissan Australia motorsport manager Jeff Fisher is not getting too carried away.

"Rick's pace was encouraging, but I don't think we were really exposed to where some of the other teams are likely to be at," he admits. "So we're not reading too much into that. It was a great morale booster to see Rick do as well as he did, and it was a great message to send to the rest of the team and the fans, but ultimately it doesn't really point to anything of substance."

The main problem at the start of the season will be a lack of horsepower. Some reports have put the Nissan engine as much as 40bhp down on its rivals, although the Kellys dispute that figure. Rick admits that having power-dependent tracks like Symmons Plains and the non-championship races at Albert Park early in the calendar isn't ideal, but he's adamant that the disadvantage is surmountable.

"It's going to come down to the pitstops, and the fuel strategy, and dealing with the heat," he says. "Who



THE OTHER NEWCOMER **MERC AND EREBUS**

One door closes, another opens. The arrival of Erebus Motorsport on the V8 Supercar grid for 2013 brings with it a fleet of three Mercedes E63 AMG V8s for the first time.

However it also means that the Stone Brothers Racing logo will no longer be seen in pitlane, as team co-owners Ross and Jim Stone have sold their entries to flamboyantly tattooed Erebus owner Betty Klimenko. Ross will, however, remain on as general manager. When you consider that SBR was the team that took Marcos Ambrose to his two championships in 2003 and 2004, it's no inconsiderable loss.

But Erebus has big plans for its project.

Unlike Nissan's works effort, Erebus is running its Mercs on a customer basis, albeit with the hard-won blessing of Mercedes Australia. The entire operation has come together quickly – the cars were unveiled to the public 109 days after the programme was signed off – and development work has been split between the SBR in Queensland and AMG in Germany.

The team will field three cars for V8 Supercar regulars Lee Holdsworth and Tim Slade, and former DTM racer Maro Engel, and it will be interesting to see how high up the Mercs can get.



Three 'privateer' Merc E63 AMGs will appear

knows, it might rain. There are so many variables. We know the engine is going to cost us a little bit, but I'm pretty sure it won't just come down to that. We just have to make sure that we get all the other bits right."

Fisher is more restrained, claiming that he's approaching the first races as "an extended bedding-in for us; more of an extended shakedown". He's also playing it cautious with his

medium-term goals for the team.

"We haven't given the team any hard parameters," he says. "In the second half of the season we would hope that we are making strong inroads towards the top 10. But obviously nothing's assured, and we're not putting key performance indicators in front of them at the moment."

The 'long-game' approach will be reassuring news to the Kelly brothers

and team-mates Michael Caruso and James Moffat, who form Nissan's four-car line-up. But after months of working towards this weekend in Adelaide, Kelly – a former Clipsal 500 winner – is champing at the bit.

"I've been in the category for over 10 years now, and this is a very different feeling," he says. "We've been counting down to this for 18 months. I'm ready, mate. I'm absolutely ready to go." ▶

Trident
Racing Supplies



MS NAS AN

Unit 31 Silverstone Circuit Northants NN12 8TL UK
Tel: +44 (0)1327 857822 Fax: +44 (0)1327 858096
sales@tridentracing.co.uk www.tridentracing.co.uk



- 5 minute install
- Save £
- Reusable
- More power

Give Your Car The Best

The Original Cotton Performance Air Filter by K&N



Designed to Improve Engine Power.

Cotton – brought to you by Mother Nature and used for filtration by K&N, the leader in washable performance air filters. Cotton breathes easier than paper and that can help improve engine performance by reducing airflow restriction. Another natural feature of cotton is its durability. It can be washed again and again. That means a K&N stock replacement air filter can last for the life of your car reducing waste and saving money.

MILLION MILE LIMITED WARRANTY

OVER 40 YEARS OF EXPERIENCE

www.knfilters.co.uk



K&N Filters (Europe) Ltd. John Street, Warrington Cheshire, United Kingdom WA2 7UB,
Phone: 01925 636 950, Fax: 01925 418 948, E-mail: uk.sales@knfilters.com



2013 TESTING @ KNOCKHILL Semi Exclusive Saloon and Sports Car Testing

Knockhill are hosting a Semi Exclusive Car Testing day for Saloon & Sports Cars on Tuesday 19th March from 9am – 5pm. It's open session all day with a 1 hour lunch break. There will be a maximum of 15 cars.

This is the day after the Croft Test (Monday 18th), access will be available throughout the night on Monday to allow teams to travel from Croft (Security staff will allow access). Pitlane garages are available free of charge.

To guarantee your space please call 01383 723337 to book.

Tues 19th March

£300+vat

PER VEHICLE

(Limited to 15)

The trail to Godzilla

It's been a while, but Nissan has a great history in Australian tin-tops. Ahead of the company's return, we take a look back at some of the highlights from the 1980s and '90s



With the boost turned up on his Bluebird Turbo, George Fury gave Nissan its first Bathurst 1000 pole in 1984. The car was in with a shout of a podium in the race until it required a differential change and fell out of contention.

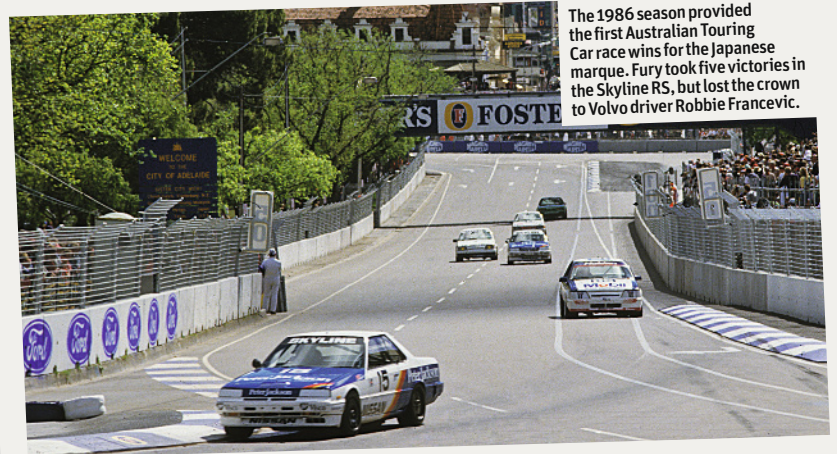

The 1986 season provided the first Australian Touring Car race wins for the Japanese marque. Fury took five victories in the Skyline RS, but lost the crown to Volvo driver Robbie Francevic.

The 1989 version of the Skyline wasn't a match for the best of the Ford Sierra RS500s, but it was still a capable performer and Nissan scored a three-four result at Bathurst. Jim Richards took Nissan's first Australian Touring Car title in '90.



Nissan made its big breakthrough with the famous R32-shape Skyline GT-R in 1991. Richards and Mark Skaife, seen here at Lakeside, won seven of the nine rounds, and teamed up to take the company's first Bathurst 1000 endurance victory.



Nissan's final iteration of the Skyline GT-R – 'Godzilla' – helped Skaife to his first Aussie title in 1992. He and Richards won a rain-shortened Bathurst, the last 'big-banger' Great Race win for a non-Ford or Holden, incurring the wrath of the partisan crowd.





AVAILABLE NOW

Originally built in 2010 on refurbished used chassis. Top deck: 3 car carrying capacity max height 1420mm. Lower deck: 1 car capacity max height 1,550mm, fitted workshop with Lista cabinets and storage cabinets, we can install a removable office at the rear if required. 11kva 1,500Rpm diesel generator, compressor, 8m x 13.5m Awning Co awning with a 4m x 8m hospitality area fitted on each end in 2012. The transporter can be sold as is or modified as required (we can install an office on the lower deck or modify the lower deck to carry 3 formula cars at additional cost) **£70,000+vat** or **£65,000+vat** without the hospitality sections on the awning.

2013 Pop-up roof 3 car transporters C-W office and workshops from **£350,000+vat**



We have 3 new 2013 low ride double deck chassis's in stock that can be finished internally and externally for June delivery & 50 2008 double deck trailers in stock that can be finished internally and externally to any specification from mid may delivery prices from **£52,000+vat!**



2013 CHASSIS



2008 CHASSIS

www.hopkinsmotorsport.com
 or call **01179 509294**



Ten aces to watch

The leading lights expected to fight it out during 2013. *MARK GLENDENNING* is your guide

1 Jamie Whincup

(Triple Eight, Holden)
**34 wins*, 31 poles,
4 championships**

An obvious choice, given that he has won the title four times in the past five years, although it will be interesting to see the extent to which the new car shakes things up.



finish the year in fourth. Winning the final race of the season at Homebush provided some consolation, and he'll be hoping to use that as the springboard to a more consistent 2013.

2 Craig Lowndes

(Triple Eight, Holden)
**43 wins, 31 poles,
3 championships**

It's hard to believe that his most recent championship came 14 seasons ago, but the fact that he was runner-up for the last two years suggests there is still plenty of fight in him yet.



7 Shane van Gisbergen

(Tekno Autosports, Holden)
2 wins, 1 pole

The talented 23-year-old's shock retirement at the end of last season has proven short-lived, with the Kiwi having returned to the series with Tekno Autosports. It will be intriguing to see whether the change of scenery pays off.



3 Mark Winterbottom

(Ford Performance Racing)
10 wins, 10 poles

Since moving over to FPR for the 2006 season, 'Frosty' has never finished outside the top five in the championship, and the works Ford team will again be looking to him as its best hope of securing the title.



8 Garth Tander

(Holden Racing Team)
**19 wins, 11 poles,
1 championship**

Tander remains a force to be reckoned with at Bathurst, although HRT has recently struggled to recapture its championship dominance of the early 2000s. Like team-mate James Courtney (below), consistency will be key.



4 Rick Kelly

(Nissan Motorsport)
**9 wins, 6 poles,
1 championship**

Kelly has had an up-and-down career since winning the title as a 23-year-old in 2006, but he embarks upon a whole new chapter this time around in joining brother Todd as the spearheads of Nissan's V8 Supercar effort.



9 James Courtney

(Holden Racing Team)
**3 wins, 3 poles,
1 championship**

It's always a sign of a good driver when you're surprised he has only won one championship, but consistency has not been Courtney's strong point over the past couple of seasons. Now is as good a time as any to turn things around.



5 Tim Slade

(James Rosenberg Racing/
Erebus, Mercedes)
0 wins, 1 pole

It's a tough pick between the Coulthard-jawed Slade and Lee Holdsworth, because there's not a lot between them on the track, but both will be worth watching as the focal points of Mercedes' first V8 Supercar appearance.



10 David Reynolds

(Rod Nash Racing/
Ford Performance Racing)
0 wins, 1 pole

The breakout driver of 2012 (right) with a string of great performances, culminating in his dogged pursuit of Whincup during the final stint at Bathurst. If he can build on it, there could be good things ahead.

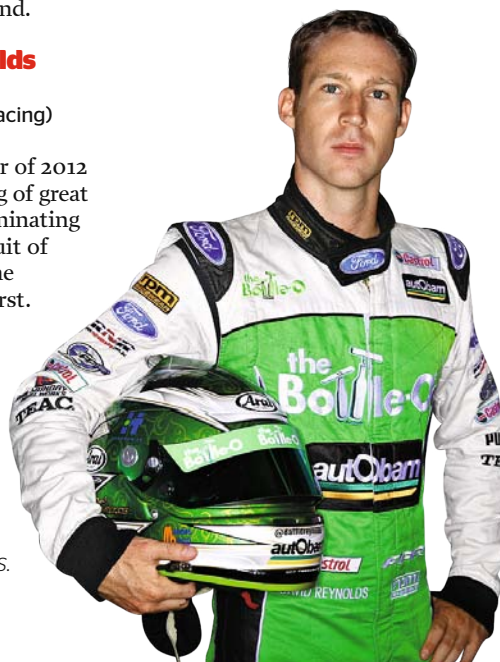

* Round wins counted, not individual race wins.

NEW RULES

In addition to the new car, there have been tweaks made to race formats, with a '60/60' format being introduced for the sprint rounds. This will deliver four 60km races across each sprint weekend. Double-file restarts will be used for the first time this year, and tyre compounds have been tweaked for several events. Finally, the requirement for an international co-driver at Surfers has been dropped, and teams can now use the same co-driver for this event, Bathurst and Sandown. The driver with the most points from the three enduro events will receive the new Endurance Cup.

PAST FIVE CHAMPIONS

| | |
|------|------------------------|
| 2012 | Jamie Whincup (Holden) |
| 2011 | Jamie Whincup (Holden) |
| 2010 | James Courtney (Ford) |
| 2009 | Jamie Whincup (Ford) |
| 2008 | Jamie Whincup (Ford) |

2013 CALENDAR

| | |
|----------------|----------------|
| March 2-3 | Adelaide |
| April 6-7 | Symmons Plains |
| April 13-14 | Pukekohe (NZ) |
| May 4-5 | Barbagallo |
| May 18-19 | Austin (USA) |
| June 15-16 | Hidden Valley |
| July 6-7 | Townsville |
| July 27-28 | Queensland |
| August 24-25 | Winton |
| September 15 | Sandown 500 |
| October 13 | Bathurst 1000 |
| October 26-27 | Gold Coast 600 |
| November 23-24 | Phillip Island |
| December 7-8 | Homebush |

6 Will Davison

(Ford Performance Racing)
8 wins, 6 poles

Davison led the points for a while in 2012, and on that basis was disappointed to



NEXT WEEK NEW LOOK

BIGGER!

Australian GP
Team by team
Red Bull
Fifteen more points in the bag
McLaren good value for the US
Ferrari's rear guard action
Lotus
Challenging the big three teams
McLaren good value for the US
Wing switch makes difference
McLaren good value for the US
A story of what might have been

NEW WRITERS

NEW FEATURES

The Secret Driver

Hidden truths from the paddock

When it comes to contract time, do you play it cool and hold out for the biggest paycheck possible, or do you stick?

"I started the team boss in the eye and his dressing gown fell open!"

When it comes to contract time, do you play it cool and hold out for the biggest paycheck possible, or do you stick? When it comes to contract time, do you play it cool and hold out for the biggest paycheck possible, or do you stick? When it comes to contract time, do you play it cool and hold out for the biggest paycheck possible, or do you stick?

The incredible cost of one day's racing

How much circuits have to budget for to allow you to go racing in Britain

£11000 + £2500 + £5000 + £10000 + £1500

£30,000 a day

Track fees are only a fraction of the outgoings
Travel requirements
Accommodation
Food and drink
Medical
Insurance
Repatriation
Repatriation
Repatriation

WHY TRACK COSTS DIFFER

IF A PROMOTER CAN pull in 300 drivers for a suitable event, they they've done well!

THE DIFFERENCE between a decent road and a decent boss is very close!

CLUB AUTOSPORT

NATIONAL RACING • HISTORICS • RALLY • RALLYCROSS • HILLCLIMBING

ORECA to build coupe for Speed EuroSeries

ORECA will build a new coupe for the Speed EuroSeries. The new car will be a two-seater, open-cockpit race car. It will be built in France. The car will be available in 2010. The car will be available in 2010. The car will be available in 2010.

THE NEW COUPES ARE MADE

THE NEW COUPES ARE MADE

THE NEW COUPES ARE MADE

AUTOSPORT

F1 2013 SEASON GUIDE



**EVERY TEAM
EVERY DRIVER
EVERY TRACK**



**ON SALE
MARCH 7**

WEB DIRECTORY

CAR BROKERAGE

RACING CARS FOR SALE
ALAN CORNOCK FCS
BUYING - SELLING - BROKERAGE
www.racingcarsforsale.co.uk
TEL: 01480 891212

DRIVER DEVELOPMENT

eugene **O'BR**ien.co.uk
DRIVER DEVELOPMENT
Tel: 0775 383 5629

EXHAUSTS

Stainless Steel Exhaust Specialists
SIMPSON
Race Exhausts
Tel: 01753 532222
www.simpsonraceexhausts.com

GEARBOXES

Rally & Race Gearboxes,
GearKits, LSD's and Driveshafts
Tel: 01782 280136 Fax: 01782 269913
Email: sales@eliteracingtransmissions.com
www.eliteracingtransmissions.com

GEARBOXES

Gearboxman.com
COMPETITION TRANSMISSION SERVICES
Gearboxes and Axles for Road, Race, Rally, and more
Telephone: 01582 840008, Fax: 01582 840007

HELMET GRAPHICS

Mike Fairholme Designs
Sole approved painter of Arai helmets.
Silver Birches, Corby Birkholme, Nr Grantham, Lincs NG33 4LE.
Tel: 01476 550630. Fax: 01476 550029.
email: fairholmedesigns@btconnect.com
www.fairholmedesigns.co.uk

MEMORABILIA

FINAL LAP
For Everything Formula One
www.finallap.net WE BUY AND SELL
+44 (0)1245 287588 / 07771 920345

MERCHANDISE

F1 Merchandise bought and sold.
Meadowhall, Sheffield
Tel: 0114 256 9835
www.theformula1shopandmore.co.uk

RACE PARTS

ARE DRY SUMP SYSTEMS
ARMSTRONG RACE ENGINEERING INC.
www.drysump.com (916) 652-5282

demon tweeks
MOTORSPORT Direct
www.demon-tweeks.co.uk

MARDI GRAS MOTORSPORT
www.mardigras.co.uk

msar LONDON
MOTORSPORT SHOWROOM
www.msar.co.uk

RACE PRODUCTS

PIPER
www.pipercams.co.uk

www.porscheshop.co.uk
PORSCHESHOP
+44 (0) 121 585 6088

SCHROTH RACING
www.schroth.com

Pit to Car Autotel
Radio solutions Digital Race Radio
0044(0)1508 528837
www.raceradio.co.uk

RACEWEAR

JJC race and rally
PASSIONATE ABOUT MOTORSPORT
www.jjcraceandrally.com

CROYDON RACE & RALLY CENTRE
www.croydonraceandrally.co.uk
220-222 Portland Road
South Norwood
London SE25 4QB
FORECOURT PARKING
For Racewear & Motorsport equipment
Tel: 020 8656 7031

GPR SPARCO ARAI BELL
SCHROTH HANS GERT
RACEWEAR | KARTWEAR | SIMULATION
www.gprdire.com

www.royalpurple.co.uk
ROYAL PURPLE
SYNTHETIC RACE OILS
01209 216 666

STORAGE

GARAGEPRIDE
Quality Storage for Home and Industry
www.garagestoragecabinets.co.uk
Tel: 0800-206-2303

TRAILERS & TRANSPORTERS

BRIAN JAMES TRAILERS CLUBMAN
Tel. 01327 308833
Web. www.brianjames.co.uk

PRG TRAILERS
www.prgtrailers.co.uk
Phone no: +44 (0) 1270 812402

WHEELS

Image Manufacturers of bespoke split rim alloy wheels
www.imagewheels.co.uk
IMAGE WHEELS INTERNATIONAL LTD

AUTOSPORT.COM

TO ADVERTISE IN THE WEB DIRECTORY PLEASE CALL
020 8267 5992 OR EMAIL: autosport.ads@haymarket.com

BRIAN JAMES TRAILERS

»» Connected to you



www.brianjames.co.uk

The degree of excellence

At **Brian James Trailers**, we are exceeding expectations. Combining British engineering with powerful design, quality manufacturing and reliable service – we understand your needs.

The model shown is a Race Transporter 4
374-0010 available from £ 7,099 (excl. VAT).

RACE TRANSPORTER

T +44 (0)1327 308 833

For more information and details of your local BJT dealer please call or visit our website.

TRAILERS & TRANSPORTERS

WOODFORD TRAILERS

Call Us Now! tel. 01327 263 384

www.woodfordtrailers.com sales@woodfordtrailers.com



RL 5000
£7,300 + vat



RL 6000
£9,500 + vat

ABL LOGISTICS

For hire for the 2013 season

Specialising in moving GT / LMP rally and road cars UK / Ireland / Europe Also offering our 2 tractor units and 18 ton 2 car transporter for short or long term hire with or without drivers



Contact James on 07973 746025 or email: james.goodwin5@yahoo.co.uk or Sean on 07766101845 or email: weeman.smg@hotmail.co.uk

SPECIALISTS IN CAR SHIPPING AND TRANSPORTATION
Worldwide export and import services



• Customs clearance • UK & European collection & delivery
• SAFE • SECURE • COMPETITIVE
t: 01394 695566 f: 01394 673031

www.rjjfreight.co.uk

kevin.lewis@rjjfreight.co.uk chinita@rjjfreight.co.uk Jeff.parslow@rjjfreight.co.uk



IVECO RACECAR TRANSPORTER, Hyd tail lift, takes saloon car, sleeper cab, professional coach built living area, TV/DVD, sleeps 6, toilet/shower, Belly lockers, large storage, tow bar, full awning, VGC, **£17900.00**

2007 GULFSTREAM INDEPENDANCE MOTORHOME, 3 slide outs with sun room, very luxurious living, toilet/shower, fully loaded, 240 elec, generator, air con, 4 point jacks, 6000 miles, 30 foot, excellent condition, **£41900.00**



PORSCHE 993 CARRERA 2 RACE CAR, top spec, top results, priced to sell; **£19950.00**

Ring Mark for full details on 07889 751660 or 01262 420210 or email.proctorplant2000@yahoo.co.uk

Currently in production. Tri-axle, step frame race transporter



Bespoke race transporters designed, built and refurbished to your requirements

- Will carry 4 cars
- Front living area with 2 pod
- Hydrovane compressor
- Honda generator



For further information, please contact Ian Green
Tel/Fax: 044 (0) 1454 227 191 Mob: 07766108873



Unit D16, Backfield Farm
Business Park, Wotton Road,
Iron Acton, Bristol, BS37 9XD

www.gbmotorsports.co.uk

PRG Trailers

All trailers now come with European COC certificate

optional colour finishes shown

PRG Trailers | Cheshire | UK | Tel: +44 (0) 1270 812402
Web: www.prgtrailers.co.uk | Email: info@prgtrailers.co.uk

DRIVES AVAILABLE FEATURE

2013 MSV F3 Cup Drive Available



- Fully Maintained, Race Ready
- Full Or Partial Season
- Dallara F307 - Toyota

**2012 F3 Cup 'Cup' Class Champion.
2012 F3 Cup Teams Champions.
Triple Monoposto Champions.**

Omicron Motorsport

Contact Tristan Cliffe on: 01508 570351
racing@omicronmotorsport.co.uk
www.omicronmotorsport.co.uk

Rollcentre Racing

Drives Available
01480 498640
sales@rollcentre.com



Ferrari 458 Challenge
BRITISH GT Cup Class
2012 race winning car
Aero kit
Suspension upgrades
Competitive Budget
One driver required



Mosler Super GT
Britcar, GT Cup,
Supercar Challenge,
24 Hour Races.
Superfast car, easy to
drive and win.



Toyota GT86
Britcar, 24 Hour races,
ABS, Traction Control,
Stability Control.
Superb Endurance car.
Drive or Sell.



Praga R1
Single seater handling
Carbon tub, 350bhp/ton
Supercar Challenge
Arrive and Drive

The Nordschleifen centre of excellence is looking for you!



We offer:

- "Arrive and Drive" packages in VLN, RCN and 24h-race at the Nurburgring Nordschleife – for both beginners and experienced drivers
- Full-Racing and trackday services for your race & trackday car (Porsche, BMW Ferrari, Maserati, Lamborghini,...)
- State of the art infrastructure near to the Ring
 - Modern workshop
 - All-wheel dyno
- An english-speaking team with over 20 years experience at the Nuerburgring, with class wins in both VLN and the 24h-race
- Engineering & Tuning
- Car-storage
- Airport-service



... success as a result of passion and determination.

DRIVES AVAILABLE FEATURE

NURBURGRING VLN Championship

Drive available -

In Saxon Motorsports BMW 135D GTR. This car competed in 6 VLN rounds last year, winning the class in all of them without a single mechanical problem.

If you want to join the team for 2013
 Email: nick@saxon-motorsport.co.uk
 or Tel: **01432 350157**



Race support services 2013

2012 championship winning team offer a range of Professional race support services for Customer owned cars from our Midlands based workshops just off M40. We will be supporting the BTCC,MSVR and Masters Championships.

In2Racing have a drive available in Radical SR3 Challenge and opportunities available in our Championship winning Porsche Carrera Cup GB & Porsche GT3 Challenge team.

Contact: Nick Dudfield Tel: 01789750567 or 07768548774
nick@in2racing.co.uk www.in2racing.co.uk



searching for
2 PILOTS ELITE
2 PILOTS OPEN
NATHALIE MAILLET
 +352 691 26 67 07
nmaillet@racingclubpartners.com



RACE & RALLY CARS

Ferrari 360 CH (NGT)

Ferrari 360 challenge car with extensive Michelotto modifications. One of two cars made outside of Michelotto using their parts.



Raced in the 2011 season of Britcar by the owner with class wins. This is a great handling car and on many occasions has out performed it's newer brother the 430 challenge car. The wide front bodywork and wheels overcome the inherent under steer problems associated with 360 & 430 challenge cars.

- Modifications:-**
- NGT complete carbon front wings
 - NGT carbon fibre doors
 - NGT carbon engine cover and front compartment
 - Michelotto centre lock wheels
 - Air jack system
 - 3 way adjustable Ohlins dampers
 - Brand New 360 Stradale engine and remapped Ecu's. 440bhp 315lbft torque (Completed one 2hr race July 2011)

- This is a great opportunity to own a very rare and genuine race car
- Perfect car for Britcar, Pirelli open or GT cup not to mention several european championships.
- Maintained regardless of cost and is sold ready to race and priced to sell.
- Viewing is by appointment at SB Race engineering.

£46,000.00 ONO no VAT

Please contact David Green on 07889707005 or david@giantfilm.tv

RACE CAR FOR SALE:

KODEWA Lola Lotus LMP2 Coupe

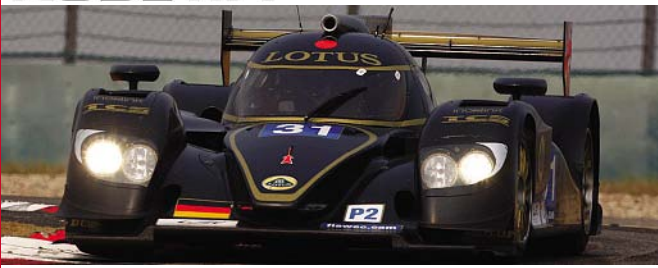

Lola Lotus LMP2 Coupe: The Lola Lotus B12/80 is a current car of the Lotus factory team in the World Endurance Championship. One of just two existing Lola Lotus sports cars is for sale. The vehicle is built in accordance with the latest regulations set by the ACO and is also eligible to participate in the World Endurance Championship, American Le Mans Series, European Le Mans Series and the 24 Hours of Le Mans. The race car is ready to start. The car package includes the complete electrical equipment and a multifunctional steering wheel with Megaline pedal shift. We also offer various spare parts for the sports car.

Further technical details about the race car and price are available on request.
 Telephone: +49 (0) 8463 602679 Email: info@kolles.biz

Ford Focus Touring Cars



- BTCC Race Ready Ford Focus, eligible for the Jack Sears Trophy.
- Each car comes complete and ready to race with Mountune NGTC spec engines, Motorbase data & set up information from 2011 & 2012. Spares kit available.

Contact Oly Collins or David Bartrum for more information on:
oly@motorbaseperformance.co.uk or 01732 822266



FOR SALE 3 2010 MYGALE FOMULA 3



- 1 F3 rolling chassis (VW Kit) € 50000
- 2011 aerokit
- 2012 Italian F3 Champion
- Excellent condition
- 2x complete F3 with Fiat engine: € 70000 each

For more information +33 (0)3 86 21 86 21 or email commercial@mygale.fr

New for 2013

Ferrari 458 Challenge Upgrade

The E2M Phase II kit comprises of:

- 1 New Anhedral Rear Wing
- 2 Billet Alloy Rear Wing Support
- 3 Carbon Ultra - Lite Doors - uses factory window and locks
- 4 Carbon Aero Vented Carbon Rear Bumper
- 5 Carbon Rear Diffusor
- 6 Carbon Aero Vented Front Wings
- 7 Carbon Aero Vented Louvered Bonnet
- 8 Carbon Aero Vented Front Bumper
- 9 Carbon Dive Planes
- 10 Carbon 100mm Front Splitter with Integral Carbon Floor and Strengthened Carrier
- 11 Power Upgrade to 625 BHP
- 12 4 Way Adjustable Suspension

Evolution 2 Motorsport now offers an all new for 2013 ultra lite performance aerokit, to both reduce weight and improve aerodynamic performance. With over 25 years of race winning experience, the aerokit has been designed and manufactured to factory standards. All parts use existing mounting points, with excellent fit, quality and finish.

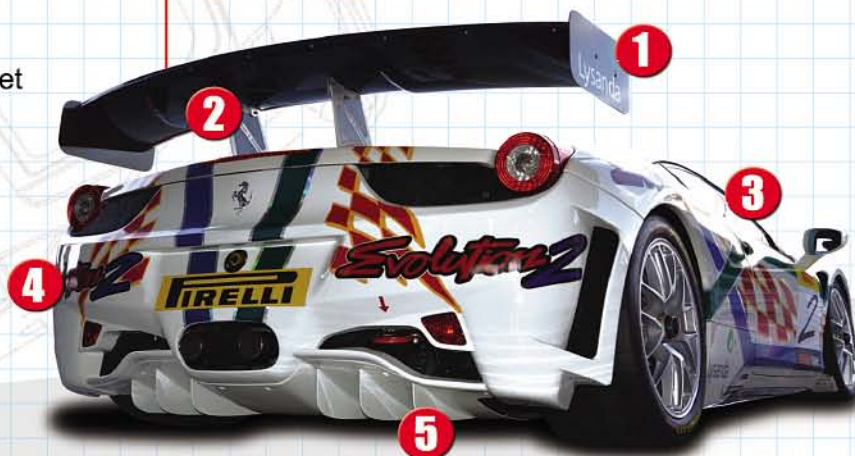

Visit the new Evolution 2 Motorsport website or call us for pricing and delivery times. Dealers wanted in USA

Evolution 2
MOTORSPORT

Email info@evolution2motorsport.com
Telephone +44 (0) 1753 885 453
www.evolution2motorsport.com

RACE & RALLY CARS

RACING CARS FOR SALE

1965 FIA Ford Mustang Saloon



Ford Mustang 289 saloon, 1965, LHD, race prepared by Rod Cattini Motorsport with FIA appendix K papers and 4727cc Steve Warrior professionally built race engine which has only 7 hours use. 4 spare wheels and tyres, Motordrive seat and many other features. Ready to be raced and enjoyed by the next owner. **£42,000**

Contact Roy on: +44 7785 230832



Rolling chassis sports racer. Alloy tub, Reynard suspension, transmission, steering, Reynard Hewland G/Box, 4 pots, many new parts, 8 mounted slicks, 4 mounted wets, centre lock wheels, complete with body moulds. Regular class winner. Space needed. **£6500-00 +VAT** May exchange race shuttle. BDG/BDA installation. Suitable for BRSCC open sports. Would make good sports 2000.

Woodcote Racing
Tel: 01327 858074
Fax: 01327 858235

How much
FASTER
can you go?

Racing Driver
1-to-1 Tuition
with Eugene O'Brien

any car, any driver... results guaranteed!

Tel: 07753 835629

www.eugene**O'BRIEN**.co.uk

MARKETPLACE

AUTOMOBILIA

F1 COLLECTORS .COM



#1 FOR F1 MEMORABILIA

We buy and sell F1 items
AYRTON SENNA specialists

Call CHRIS GRINT 01763 274448
email: sales@f1collectors.com

JMJ Automobilia

SUPPLIERS OF RACE
MEMORABILIA SINCE 1992

Florida, USA (609) 575-1143

email: JMJAUTO.COM
WWW.JMJAUTO.COM

CAR TYRES

FOR ALL YOUR

AVON
TYRES
MOTORSPORT

RACING TYRES

Inc. ACB 10 Formula Ford
Contact

BMTR LTD

Tel: 0121 331 1122

Fax: 0121 331 1144

email: sales@bmtr.co.uk

see our new web site at www.bmtr.co.uk

FLOORING

Kiwi Tiles

Interlocking Plastic Floor Tiles, as used by leading
race teams throughout Europe.



- Easy installation & removal
- Many colours
- Lightweight
- Strong and durable
- Compact & easy to store
- Top quality
- Value for money

Stock Colours:
Red, Blue, Green,
Yellow, Silver, Orange,
Grey, Black, White,
Dayglo Red

Ralt Engineering

Tel: 01865 883354 Fax: 01865 883789

Email: enquiries@kiwitiles.com
www.kiwitiles.com

AUTOSPORT.COM

FRANCHISES

Mac Tools
GREAT TO WORK WITH

Business for sale:

Mac Tools is part of StanleyBlack & Decker, an \$11+ billion global organisation and owner of the world famous Stanley Black & Decker and DeWalt brands. If you have the desire and passion to work for yourself, available cash of £15,000 and the ability to build relationships, our franchise businesses give you the power to drive your future with our training and support.



Call us on: 08450 6000 60
Email: franchise@mactools.co.uk
www.mactools.co.uk

GEARBOXES

RACING
TRANSMISSIONS

SPECIALISING IN
GEARBOX REBUILD,
REPAIR AND SERVICING
FOR GT, LMP, F3
AND MORE...

Hewland Specialist

Call 07976 877 612

jono@racing-transmissions.co.uk

www.racing-transmissions.co.uk

AUTOSPORT

MISSED AN ISSUE?

**THEN CALL OUR
BACK ISSUE HOTLINE**

0844 848 8817

MARKETPLACE

MOTORSPORT PREPARATION

STARTLINE SERVICES

FORMER CHAMPIONS OF
CLASSIC FORMULA 3 & MASTERS HISTORIC FORMULA 1

IN ASSOCIATION WITH
BROOKSPEED

WE HAVE CAPACITY TO RUN ADDITIONAL CARS IN 2013 IN
MASTERS & HSCC EVENTS

VISIT WWW.STARTLINESERVICES.CO.UK
OR CONTACT NICK FOY ON 07734156388

PORSCHE SPECIALISTS

PORSCHESHOP



Call: +44 (0)121 585 6088
Visit: www.porscheshop.co.uk



SERVICES

- Technical & Diagnostic
- Restoration
- Maintenance & Development
- Full Chassis-up & Engine Rebuilds



PARTS

Boxster, Cayman, Turbo, Historic, 911, 968, 944, GT3, RSR, Cup Car, 20,000 OEM Lines

MIDLANDS SHOWROOM

Just off M6 / M5 J3
Shenstone Trad Est, B63 3XB

PROPERTY TO RENT



PCM are pleased to offer a newly vacant business unit on their Long Buckby Site. Located 250 yards from the A5 and 10 minutes from J16 or 18 of the M1 Motorway, it is strategically located at the heart of the South Midlands. The accommodation has an existing trade counter and fully racked stores, workshop and offices. The total area including mezzanine being 5250 sq ft. It has car parking for up to 10 vehicles and for one large HGV. The building could be reconfigured and refurbished to your specification or let "as is" at a reduced rent. The overall site contains 8 other units and is fully security fenced. PCM are the site owners and therefore able to negotiate directly and quickly with potential clients.

Contact John Plant on: 01327 842808
or email: accounts@pcmfluidpower.co.uk

HOSPITALITY

SPIRES OF OXFORD



SUPPLIERS OF LUXURY HOSPITALITY MOTORHOMES
ON EVENT COMMUNICATION & MEDIA CENTERS
PROMOTIONAL ROADSHOWS

- INTERNATIONAL RACE CHAMPIONSHIP HOSPITALITY UNITS
- EXCLUSIVE CORPORATE HOSPITALITY & TEAM CATERING
- LOGISTICS & SECURE STORAGE

As specialists in the field of International motorsport, with vast experience in all levels of sports hospitality, promotional roadshows & corporate events, we can supply for hire or sale an exclusive purpose built, fully self contained event facility, ideal for all on circuit hospitality, championship/media centers, marketing, merchandising conferences product launches & roadshows, at any sporting event world-wide. Units vary in specification, and can include luxury lounges, office facilities, Commercial Kitchens, showers and full awning size options.

F1 SPEC MOTORHOMES & RV'S WITH AWNINGS



GENERAL SERVICES

- International race centers, VIP hospitality & team catering specialists
- Hospitality & shared team catering service at BES, Le Mans, WEC & ELMS
- Exclusive hospitality packages at all major events including, F1, WEC Touring Cars & Le Mans
- Sponsor/partner co-ordination, travel, accommodation, ticketing & VIP transfers to circuit
- Logistics on track marketing, merchandising, product sampling plus event support
- Management, logistics & operation of clients own units also undertaken
- Comprehensive world-wide insurance



Exclusive VIP Hospitality



Race & Test Team Motorhomes



Shared Team Catering

FOR UP TO DATE INFORMATION ON OUR SERVICES, UNITS AND EVENTS VISIT www.spiresofoxford.co.uk

TEL: +44 (0)1865 875539 • FAX: +44 (0)1865 875510 • MOBILE: +44 (0)7836 767619 • E-MAIL: info@spiresofoxford.co.uk

MARKETPLACE

RACE PRODUCTS

SCHROTH RACING

HARNESS THE POWER TO WIN



www.schroth.com

FIA APPROVED

• EXPERT ADVICE • MASSIVE STOCKS • RAPID DELIVERY



www.demon-tweeks.co.uk **QZ252A**

DON'T DELAY, CALL TODAY **0844 375 2196**

demon tweeks MOTORSPORT Direct

LOW CALL RATE CALLS MAY BE RECORDED FOR TRAINING PURPOSES

London Motorsport Showroom

www.msar.co.uk



msar UK agent for **SCHROTH RACING**

ORDER HOTLINE: 020 8655 7877

Logos: HONDA, ARAI, SHOWTRAX, METZGER, BELL, lifeline

WILLANS

LEADERS IN DRIVER SAFETY SINCE 1967

When only the best will do...



www.willans.com

Tel: 01488 669001

Fax: 01488 668141

sales@willans.com

MOCAL OIL COOLERS

- Winning races since 1967
- Wide Range of oil coolers and components
- British design and manufacture

For the best in Oil Cooling systems... make it MOCAL!!



WORLDWIDE ENQUIRIES visit: www.mocal.co.uk
phone: +44 0208 568 1172

USA ENQUIRIES visit: www.batinc.net

Anglian Fasteners

- Unbrako, Holokrome, Dormer and Loctite
- Next day delivery
- All the fasteners you'll ever need

Call: 01234 345641 or 01604 645341
Email: info@anglianfasteners.co.uk

TRADE COUNTERS IN BEDFORD AND NORTHAMPTON
www.anglianfasteners.co.uk

If it's threaded, call Anglian Fasteners!



Hayward Rotary

FOR ALL YOUR ROTARY ENGINED RACE CAR REQUIREMENTS CONTACT:

07877 632369 **01635 255545**

WWW.MAZDAROTARY.CO.UK



MARKETPLACE

RACE PRODUCTS



- FiA FT3 Certified Fuel Cells & Accessories
- Short Lead Times for Stock or Custom Parts
- Fitting Service Available
- Superior Seamless Construction Technology
- Special Large Capacity Fuel Cells for Endurance Events



Classic World Racing

www.classicworldracing.co.uk
Tel: +44(0)1527 521050

RESTORATION

carbonfibrerepair.com

BEFORE



AFTER



BEFORE



AFTER



- High quality carbon repairs
 - Competitive Pricing
 - Ultrasound testing facilities
- Contact us for a no-obligation quote
Tel: 01327 871847
Email: mail@carbonfibrerepair.com
- Please visit carbonfibrerepair.com for more details

RACEWEAR

Grand Prix Racewear

WWW.GPRDIRECT.COM

2013

CATALOGUE

AVAILABLE NOW

REQUEST YOUR COPY
GO ONLINE OR CALL US ON:

08435 070 858

RACEWEAR | KARTWEAR | SIMULATION



WEB DIRECTORY

TRAILERS & TRANSPORTERS

RACE & RALLY CARS

MARKETPLACE

MOTORSPORT JOBS

MARKETPLACE

RACEWEAR



CALL:
01327
858349



UNIT 6 SILVERSTONE TECHNOLOGY PARK, SILVERSTONE CIRCUIT, NORTHANTS

| FIA 3-LAYER RACE SUITS | | | HELMETS & SAFETY | |
|---|---|---|---|---|
|  TI-100 £310.94 |  TI-120 £391.00 |  TI-330 £676.18 |  HELMETS From £139.99 |  FIA HARNESSES From £149.99 |
| | | |  HANS DEVICE From £359.00 | |

| RACE BOOTS | | | SHOP ONLINE OR INSTORE | |
|---|---|---|---|--|
|  RS-100 £106.44 |  RS-200 £136.69 |  RS-400 £172.18 |   UNIT 6, SILVERSTONE TECH PARK, SILVERSTONE CIRCUIT, NORTHANTS NN12 8TN T: 01327 858 349 E: sales@moderacewear.com | |
| | | | | |

| RACE GLOVES | | |
|--|--|---|
|  FG-150 £46.96 |  FG-500 £99.13 |  FG-420 £114.78 |

| RACE UNDERWEAR | | |
|---|--|--|
|  BALACLAVAS/TOPS/PANTS FROM £28 | | |



Security
Car Park
WEST 6 Entrance

OPENING TIMES:
MONDAY - FRIDAY 9:00AM - 6:00PM
WEEKEND EVENTS PLEASE CALL FOR OPENING TIMES

www.moderacewear.com
All prices include VAT

SUSPENSION



ADVANCED SUSPENSION TECHNOLOGY
OHLINS HAVE WON OVER 200 WORLD CHAMPIONSHIPS
MICK GARDNER RACING



OFFICIAL DISTRIBUTION FOR ALL OHLINS PRODUCTS

Factory Trained Technicians // Large Stocks of Shocks, Springs and Parts
Official Sales and Service Centre // Fast Turnaround on Servicing, Revalving, etc.
Bespoke Shock Absorbers Built to Customer Spec

.....

CONTACT RUSS WALTON @ MICK GARDNER RACING NOW
E-mail: russwalton@mickgardnerracing.com
Website: www.mickgardnerracing.com
Telephone: 01226 240 099

RACE PRODUCTS

Tel:
+44 (0)121
522 2442



Image®
Wheels International Ltd

www.
imagewheels.
co.uk

- Custom made 2 and 3 piece wheels for road and competition use.
- All our wheels are made to order with a range of classic and modern styles available.
- Checkout our website for the full range of wheel styles...

Available from 10" to 22" diameter and widths from 3" to 16" wide.





MANUFACTURED IN ENGLAND SINCE 1987

MOTORSPORT JOBS

PUBLICATION DATE EVERY THURSDAY

CALL 020 8267 5820

FOR ALL AVAILABLE VACANCIES PLEASE GO TO THE JOBS SECTION OF AUTOSPORT.COM

BOOKING DEADLINE MIDDAY MONDAY PRIOR TO PUBLICATION
COPY DEADLINE MONDAY 5PM PRIOR TO PUBLICATION
ALL ADVERTS PLACED FEATURE IN THE APPOINTMENTS SECTION OF AUTOSPORT.COM FOR ONE WEEK

RACHEL.BROCK@HAYMARKET.COM



LOOKING TO RECRUIT FOR 2013? THE LATEST SELECTION OF MOTORSPORT JOB VACANCIES UPDATED EVERY WEEK.

- The Motorsport Jobs page of the website receives on average 200,000 page impressions per month
- The magazine you are looking at has a readership of 144,000 (Source: NRS Survey Q3)
- All appointment adverts placed in Autosport magazine are listed on the website.

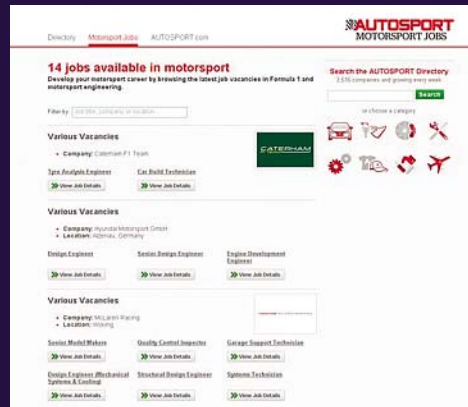

**WHERE
ARE YOU
ADVERTISING
YOUR
MOTORSPORT
JOB
VACANCIES?**



WE ARE CURRENTLY LOOKING TO RECRUIT THE FOLLOWING POSITION AT RED BULL TECHNOLOGY:

HR25021301 – TRACKSIDE IT SUPPORT ENGINEER

We have an exciting opportunity for an IT specialist to join our Trackside team.

You will be responsible for setting up, operating and supporting IT applications and underlying infrastructure used at the track.

The ideal candidate will have proven experience of working with various technologies including HP servers, NetApp storage, Cisco networking, VMWare, Microsoft Windows Server and a suite of business critical applications. Candidates will also have the necessary technical and people skills required to provide first level support, through to third level support in a pressurised and time critical environment.

The successful candidate must be self motivated, a team player and have excellent communications skills, along with the ability to think on their feet.

The position is based at Red Bull Technology's headquarters in Milton Keynes, however, there will be extensive travel required in this role.

To apply, please email recruitment@redbullracing.com quoting the above reference number and attaching your CV and covering letter including details of your current salary.

Closing date for applications – 14th March 2013

For details of available opportunities at Red Bull Technology and Red Bull Racing, please visit the recruitment page on our website www.infiniti-redbullracing.com

PLEASE NOTE: No Agencies please.



Entry Level Sales Executives Full-time position

Looking to start your career in media sales? Then Haymarket could have an opportunity for you. We are currently looking for entry level sales executives to join our expanding dynamic teams.

Haymarket publish a range of marketing leading magazine including What Car?, FourFourTwo, Stuff, AUTOSPORT, Practical Caravan and many more. We currently have vacancies across a few of our titles for entry level sales executives.

You will be given your own client base but will work within a team towards a team target. Your day to day tasks will include:

- Maintaining and developing existing relationships with clients
- Increasing sales revenue
- Sourcing leads from competitors
- Flat planning

Ideally you will already have some sales experience although this is not essential as a full professional development programme if provided.

We offer a competitive starting salary of £19k plus up to 40% commission, while those successful candidates who prove themselves will find many opportunities for development and promotion to regularly increase this salary.

To apply, please send you CV and covering letter to recruitment@haymarket.com



Porsche Carrera Cup GB and Porsche GT3 Cup Challenge GB

One organisation, two championships, 32 races: the 2013 race programme from the Motor Sport Department of Porsche Cars GB



Porsche Carrera Cup GB

The pinnacle of one-make racing in Britain, with 20 races on the BTCC supporting programme, live TV coverage and huge race day crowds. Heading into its eleventh season, the Carrera Cup GB remains the perfect platform for rising stars seeking a career as a professional racer as well as drivers wanting to race the superb 911 GT3 Cup on a level playing field with unrivalled manufacturer support.

For more information on the Porsche Carrera Cup GB, please contact Beth Phillips: Tel: 0118 925 2722 or e-mail: beth.phillips@porsche.co.uk

Porsche GT3 Cup Challenge GB

Running in parallel with the Carrera Cup GB will be the Porsche GT3 Cup Challenge GB for the 911 GT3 Cup cars from up to 2009. The six-event, 12-race schedule makes an attractive package for drivers without the experience or backing to tackle the Carrera Cup GB and the format is designed to fit comfortably around work and family commitments. Full support from Porsche Cars GB, including technical back-up and hospitality, completes an attractive package.

For more information on the Porsche Carrera Cup GB, please contact Darioush Gheissari: Tel: 0118 916 5012 or e-mail: darioush.gheissari@porsche.co.uk



Sports Extra

NATIONAL RACING • HISTORICS • CLUB • RALLY • RALLYCROSS • HILLCLIMB

Hodgetts lands Toyota drive

KX Academy ace targets British GT4 title and Clio Cup crown



TIN-TOP RACING ACE

Stefan Hodgetts has landed a Toyota seat in the British GT Championship after changes in the KX Academy driver-support scheme.

Hodgetts was supported by the Tesco-funded KX Academy in a part-season of the Renault Clio Cup last season and took four wins.

He was selected for a place on the scheme for underfunded drivers again this year (see AUTOSPORT, December 20-27) in the Clio Cup, but has now landed a drive in the GPRM-built Toyota GT86 for GT4.

Meanwhile, last year's Mazda MX5 Mk3 Cup champion Luke Herbert has lost his KX support. He planned to graduate to the Clio Cup but has failed to find the remainder of his budget.

Herbert (with mic) has lost KX Academy backing



DUAL CAMPAIGN?

Hodgetts, who had been confirmed at Scuderia Vittoria in the Clio Cup, is now targeting the GT4 title.

"I drove a GT86 in the Britcar 24 Hours, but the engine was just a standard lump with 197bhp," he said. "This one looks awesome and will have nearly double that. It's a proper full-on project and our focus is on winning GT4."

"It's exciting for me at this stage of my career, but I don't want to be categorised as a GT driver or a touring car driver. You need to be versatile and open to everything."

Although there are two clashes between British GT and the BTCC-supporting Clio Cup, Hodgetts is also hoping to continue as a KX member with Vittoria in the front-wheel-drive Renault.

"If I could, I'd be out in a racing car every day," he added. "It depends on clashes – we want to continue with Clios and KX if we can; their help has been invaluable."

"It'd be ace to win a front-wheel-drive championship and a rear-wheel-drive championship in the same year."

Hodgetts's British GT co-driver has yet to be confirmed.

HERBERT OUT

Herbert has not been able to take up his place on the Academy – and a seat alongside Hodgetts and Ant Whorton-Eales in Vittoria's Clio Cup team – due to funding issues.

"I took four or five weeks off work [to find sponsors], but had no luck," he said. "Coming from club to national racing is such a huge jump."

He still hopes to appear in the Clio Cup in a self-run car. "I'm going to try and get a car and run myself," he added. "It was always the plan if KX didn't come off."

Herbert confirmed a part-season was likely this year, ahead of a full challenge with the arrival of the latest-specification Clio in 2014.

BTCC star and KX mentor Jason Plato added: "It's a real disappointment about Luke; to have a driver from club racing was so exciting, but it yet again highlights the difficulty of obtaining funding."

AUTOSPORT SAYS...

BEN ANDERSON
NATIONAL
EDITOR



ben.anderson
@haymarket.com

THE SAD NEWS OF HOWARD

Strawford's sudden death (see page 83) immediately raised questions about what happens next at the Castle Combe circuit he saved from almost-certain extinction.

Combe is a much-loved racing venue, but has battled variously with safety and noise issues. What it needs is continued strong leadership to keep it on the right track.

Strawford rescued the circuit in 1976, but the obvious concern is that his immediate family may not wish to take the project on, which means the track would need a new owner to safeguard its future.

Most enthusiasts would probably tip Jonathan Palmer to take it under his wing. Palmer's MSV concern has transformed Brands Hatch, Cadwell Park, Oulton Park and Snetterton from run-down circuits into first-rate motorsport venues.

Is it coincidence that the racing arm of his business – MSVR – was already set to run an August race meeting at the Wiltshire venue? There is no doubt MSV would have the drive to keep Combe on the right course, and the funding to take its facilities to the next level.

Palmer has denied suggestions he is seeking to buy the circuit. The issue for his competitors is monopolisation. Rivals are already jittery about the power he wields as operator of four major UK circuits. They may see adding a fifth track to his portfolio as a bridge too far, and something that could raise voting-rights issues at the Association of Motor Racing Circuit Owners.

Of course this is just speculation for now. Whatever happens, keeping Castle Combe going has to be a top priority. This is surely what its late saviour would have wanted.

Extra contact details

Kevin Turner, features editor
kevin.turner@haymarket.com

CONTENTS

p86 TRACK TEST
FORMULA FORD 200



Formula 4

BRDC F4 secures ITV coverage

New single-seater series will feature its own highlights show on free-to-air television

TV deal is a coup for Palmer's new series

THE NEW BRDC Formula 4 Championship will be screened on free-to-air television during its first season.

All 24 races will be shown in a series of one-hour highlights programmes on ITV4, to be aired on Sunday evenings one week after each of the eight scheduled rounds.

The shows will include pre-race build-up, podium celebrations and

post-race interviews. Each edition will also include a profile feature on one of the competing drivers.

Notable motorsport personalities, including BRDC president Derek Warwick and fellow ex-F1 racer Mark Blundell, will make guest appearances on the programmes.

Series boss Jonathan Palmer said: "ITV4 is already established as one of the UK's leading channels for

motorsport coverage, screening British Touring Cars, British Superbikes and the DTM to big audiences. We're delighted to add BRDC F4 to this prestigious list, and to secure a prime-time Sunday-evening broadcast.

"Our objective from the outset was that BRDC Formula 4 should become the series of choice for those moving to single-seater racing on the path to

F1. With a full grid of 24 cars already confirmed and a superb TV package, we are well on target to achieve that ambition."

ITV director of sport Niall Sloane added: "This gives our viewers the opportunity to see the cream of young British single-seater driving talent in action and is another welcome addition to ITV4's portfolio of motorsports coverage."

Formula Renault

Albon's Renault return with Lotus

LONDON-BORN THAI ALEXANDER Albon has been signed to the Lotus F1 young-driver programme for his second year in the Formula Renault Eurocup.

The 16-year-old former European and World KF3 karting winner failed to score in the 2012 Eurocup and parted ways with long-time backer Red Bull.

Albon will switch from Epic Racing to KTR, where he will partner Ignazio d'Agosto and Yu Kanamaru.

Team boss Kurt Mollekens said: "Last year there were several factors that made it tough for him. But I am convinced that if we can get the best out of Alexander we'll be competitive.



Renault racer Albon has parted with Red Bull

"I don't think Lotus F1 has the habit of making wrong choices in their driving programmes. Winter testing, where we had Stoffel Vandoorne as driver coach, went much better."

Rival squad R-ace GP will become the ART Junior Team this year, strengthening its ties with Frederic Vasseur's squad. Its driver Esteban Ocon topped the first official test of 2013 at Aragon last weekend.

Historics

Gethin Jr to race Historic FF2000

NICK GETHIN, SON OF GRAND prix winner Peter, will start racing this season in Historic Formula Ford.

Gethin Jr tested a Historic FF2000 Royale RP27 prepared by Neil Fowler Motorsport at Thruxton last Thursday, the date of his late father's birthday.

He will make his race debut at the HSCC's Easter event at Thruxton, and plans "five or six races this season before maybe going over to Historic FF1600 later in the year.

"Neil's father was a mechanic for mine at Monza in 1971 [when Gethin Sr took his sole GP victory]. I met Neil at the Silverstone Classic last

year and the connection was there.

"We got on well and he's putting his faith in me to drive the Royale in FF2000. The car should be capable of winning with the right driver but I realise I have a lot to learn."



Gethin sampled Royale RP27 at Thruxton

IN BRIEF

ZOE WENHAM WILL stay with Century Motorsport for another

Wenham will return to GT4



assault on the GT4 class of British GT this season. The 2012 GT4 runner-up will partner Ginetta GT Supercup graduate Declan Jones in a Ginetta G50.

ARGENTINIAN KARTER Nicolas Maranzana will

drive for top team Jamun Racing in this year's British Formula Ford Championship. The 17-year-old car-racing rookie joins compatriot Juan Angel Rosso and Formula Ford veteran Luke Williams at the team.

SAKER SPORTSCARS will enter the British Endurance Championship this season. Fun Cup and Saker regulars Mark Burton and Graham Pattle, plus their driver coach Eugene O'Brien, will race as an invitation entry under the

Team O'BR moniker. O'BR won last year's Birkett Six Hour Relay with a Saker.

RENAULT CLIO CUP racer Rob Smith will return to the category for a second season in 2013. Smith, 20, was 17th

in the standings last year. He will remain with top team Total Control Racing.

Smith is back in Clio Cup UK



British GT

Nigerian team targets British GT with United Autosports Audi R8

A NIGERIAN NATIONAL TEAM HAS announced plans to contest the 2013 British GT Championship.

Team Nigeria Racing Eagle, which was launched last year (see AUTOSPORT, April 19 2012), is in the process of purchasing an Audi R8 LMS through the United Autosports team. It is planning to run with United in the opening two or three events before its own African-staffed team takes over.

The team had hoped to begin racing



Nigerian team is buying an Audi

last year with Nigerian drivers, but team boss Ribi Adeshokan has now decided to look further afield in Africa. South African Adrian Zaugg, an A1GP frontrunner, and Franco-Cameroonian Christian Ebong, who raced in the SEAT Supercopa, are scheduled to drive for the team.

Adeshokan said: "The project is coming together after we had some changes in the plan. We decided that Britain was the right place to start and that we should have African drivers from outside Nigeria who have more experience and can help bring the team to a wider audience."

Adeshokan explained that the team is aiming to upgrade to an R8 LMS ultra during 2013 and that the team also plans to contest the Gulf 12 Hours in Abu Dhabi and the Dubai 24 Hours next winter.

Porsche Carrera Cup GB

Stoneman confirms Porsche move

DEAN STONEMAN WILL RETURN to racing after confirming plans to contest the Porsche Carrera Cup GB with Redline Racing.

The 2010 Formula 2 champion's single-seater career was derailed by testicular cancer in '11. The 22-year-old raced powerboats last year and has tested Porsches twice with Redline in recent weeks. He now hopes to forge a career in GT and sportscar racing.

"I was in hospital for six months, on chemotherapy for 18 hours a day and had four operations," said Stoneman. "I've still got some issues, including trying to control testosterone levels. So we decided



Stoneman's Porsche Carrera Cup deal is done

to take a sidestep rather than going forward with single-seaters.

"Our aim this year is to win the Carrera Cup and then work towards the Supercup for 2014 and '15. It's a lot more money to do single-seaters and a one-in-a-million chance of getting to Formula 1."

Historics

Needell and Coombs to FF1600

TIFF NEEDELL AND BILL COOMBS will both contest the Historic FF1600 races at the Hampshire circuit's Easter Revival event on March 30-31.

Ex-F1 driver Needell tested his recently reacquired Lotus 69F - originally won in an AUTOSPORT



Needell tested his old Lotus 69F at Thruxton

competition - at Thruxton last Wednesday. The test came 38 years after he last raced a contemporary FF1600 car (a Crossle 25F) there.

Needell said: "I did 25 laps, 15 on new tyres. It was mega fun. The car's a joy to drive, but I'm worried about the engine. I was flat all round the back, but a second off the best time."

Thruxton boss Coombs, architect of the new HSCC meeting, is also returning to FF1600 and will race 2011 champion Benn Simms's Alexis Mk15. Simms (Jomo MRL7), ex-champ Nelson Rowe (Crossle 20F) and youngsters Josh West and Sam Mitchell (Merlyns) will also race.

MARCUS PYE

HUMBLE PYE

The voice of club motor racing



Strawford brought Castle Combe back from the brink

Howard Strawford's death at 77 last Saturday has robbed British motorsport of the visionary club-racing promoter who rescued Castle Combe from the brink of extinction.

The tenacious Welshman was hooked after the Principality's first race meeting at RAF Fairwood, near Swansea, in July 1952, two years after the inaugural event at the Wiltshire venue that was to become the hub of his business universe.

Strawford moved to Bristol in 1967 and became BRSCC South West's competition secretary. In '76 he and wife Pat had the foresight to buy Castle Combe, and thereafter fought the authorities relentlessly for permanent planning permission for racing, without which it could never have been viable.

After 20 years as chairman of the BRSCC - during which he and his associates evolved the place from WW2 airfield to splendid venue, and built its reputation - Howard claimed independence by launching the Castle Combe Racing Club.

He achieved many ambitions, including bringing back Formula 3 and hosting British GT. But club racing always tripped his trigger, and he made meetings unmissable.

That the track engendered spectacular action helped, even after the introduction of deviations ("they are not chicanes") to slow

cars in 1999, but the camaraderie and intrigue of Combe's own FF1600, Saloon and Sports GT series underpinned its success.

As King and Queen of Combe, Howard and Pat were inseparable, affable and approachable to all, even when Howard's health slowed him down. Fortunately, his acerbic wit, irreverent humour and zest for life saw him through 2012.

The couple had just enjoyed a five-week cruise when Howard suffered a major stroke last Wednesday. He was gone within four days, surrounded by his family and without extended suffering.

I first went to Combe in 1967 and have been a regular since '75. Getting to know him better was a privilege. I enjoyed his company at AUTOSPORT shows, awards evenings and the circuit's 60th anniversary celebrations - and through commenting for him.

It is hard to envision Combe without Howard's guiding light, but he's joined the pantheon of racing's legends looking down on its future. In wishing strength and comfort to Pat, daughters Emma and Karen and the loyal team, I imagine him reunited with old BRSCC muckers Tim Stock and John Nicol in heaven's Tavern, imbibing wine and reflecting on a good life.

It's hard to envision Castle Combe without Howard Strawford's guiding light"

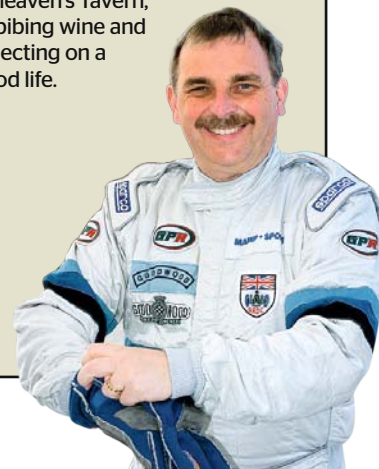

JOIN THE UK'S FASTEST SINGLE-MAKE SERIES!

Radical

SR Challenge

2013 CALENDAR

- 6-7 April ★
Snetterton 300
- 11-12 May ★
Brands Hatch GP
- 1-2 June ★
Brands Hatch Indy
- 6 July ★
Oulton Park International
- 17-18 August ★
Silverstone GP
- 28-29 September ★
Donington Park GP
- 26-27 October ★
Snetterton 300

The seven-round SR3 Challenge visits the UK's finest circuits as drivers in identical machinery battle it out for race and championship honours. Running within the highly-promoted MSVR package you can expect close racing in front of large crowds in a season that lasts from April to October.

Each meeting features two 15-minute qualifying sessions and a pair of 40-minute endurance races, with the opportunity for one or two drivers per car. Teams are limited to one set of tyres per weekend, limiting costs and levelling competition.

Selected rounds are televised on both Motors TV and Radical TV online with drivers racing for the chance to drive an SR8 RX in the opening round of the 2014 Radical Masters Euroseries.

RADICAL APPROVED USED CARS

- > Detailed refurbishment to production factory standards
- > 100-point technical inspection and pre-delivery report
- > Only manufacturer parts fitted by official Radical technicians
- > Suspension geometry reset to factory baseline settings
- > Engine hour confirmation or engine refresh with warranty by RPE
- > Owner's pack including documentation, manuals, servicing tools and data download equipment



SR3 RS

SR3 RS 1500cc

- > 260bhp 1500cc RPE-Suzuki engine
- > Six-speed paddleshift transmission with auto-blipper
- > 260mm floating disc brakes
- > Intrax triple-adjustable dampers
- > FIA fuel cell
- > £45,950



SR3 RS

SR3 RS 1500cc

- > 260bhp 1500cc RPE-Suzuki engine
- > Six-speed paddleshift transmission with auto-blipper
- > Full carbon composite bodywork
- > 260mm floating disc brakes front and rear
- > Intrax triple-adjustable dampers
- > £42,350



SR3 RS

SR3 RS 1500cc

- > 260bhp 1500cc RPE-Suzuki engine
- > Six-speed paddleshift transmission with auto-blipper
- > 280mm floating disc brakes
- > Intrax triple-adjustable dampers
- > Full Masters Euroseries FIA specification
- > £54,950



SR3

SR3 1500cc

- > 1500cc 250bhp Powertec-Suzuki engine
- > Six-speed sequential gearchange
- > Wilwood brakes front and rear
- > Aluminium rear wing
- > Air jacks
- > £18,950



SR4 CS

SR4 CS 1340cc

- > 1340cc 210bhp Powertec-Suzuki engine
- > Six-speed sequential gearchange
- > AVO trackday dampers
- > Aluminium rear wing
- > Ideal hillclimb/sprint specification
- > £23,995



SR8 RX

SR8 RX 2700cc

- > 430bhp RPX V8 engine
- > Six-speed paddleshift transmission with auto-blipper
- > Comprehensive datalogging package
- > 300mm floating disc brakes
- > only 20 hours from new
- > £62,450



Historic F1 and Grand Prix Masters fields will merge

Historics

Masters set to run Historic F1

Organiser merges GP categories and gains FIA tag for World Sportscars

MASTERS HISTORIC RACING WILL take over the running of the FIA's Historic Formula 1 championship and has also gained FIA status for its World Sportscar Masters series.

Subject to ratification by the FIA World Motor Sports Council, which sits in Geneva on March 8, MHR's Grand Prix Masters series will become FIA Masters Historic Formula 1. The move follows the original Thoroughbred Grand Prix entity's recent under-performance.

WSM will become the FIA Masters Historic Sports Car Championship using existing WSM regulations.

The F1 calendar opens with Barcelona's third Catalan Classic on April 12-14 and will include visits to Brands Hatch, Dijon, the Silverstone Classic, Nurburgring, Zandvoort, Spa and Jerez.

Masters' Rachel Bailey said: "It's a bit of a step change for us, and there has been a lot of work trying to

find solutions [to attract more entrants], but we are excited about the future, and working with the governing body.

"There will be separate FIA titles for Pre- and Post-Ground Effect F1 cars, but sporting regulations remain very similar. Competitors will notice very little difference."

Historic F1 is for three-litre cars of 1966-85 and traces its roots back to the Thoroughbred Grand Prix series that began in 1995.

IN BRIEF



Sterry's HRS claimed annual VSCC prize

HRS SPORTS DRIVER DUDLEY

Sterry claimed the VSCC's Pomeroy Trophy at Silverstone last weekend. Alastair Pugh's Frazer Nash won the Densham Trophy and Gillian Carr's Vauxhall A/D Type the Edwardian prize.

SINGLE-SEATER AND GINETTA

team Hillspeed will enter the Fun Cup in 2013. Richard Ollerenshaw's squad will run a petrol-engined car for F4 racer Struan Moore, his father Ian, international GT ace James Walker and ex-Radical and Monoposto champion Lee Atkins.

FORMULA 1 TYRE MAKER PIRELLI

will supply the Porsche Club championship in 2013. The Italian firm has signed a three-year deal that includes financial support. It also means Porsche Club racers will use slick tyres for the first time.

EXPERIENCED SINGLE-SEATER

team Mark Bailey Racing will run three cars in this season's F3 Cup. Stuart Wiltshire, Nick Robinson and Belgian Frank Thomas will drive for the squad.

FORMER MONOPOSTO CHAMPION

Tristan Cliffe will also return to the F3 Cup in 2013 after narrowly missing out on last year's drivers' title. He will again drive for his own Omicron Motorsport squad, which took the teams' title in its debut season last year.

DOUBLE NATIONAL MINI RACING

champion Len Brammer died last Wednesday. The Welshman won 850cc Se7en and 1000cc Miglia titles in 1970 and '71 and retired after returning to Minis in the early '90s. He raced an FF2000 Dulon and briefly a unique Fiat 850 special saloon between Mini stints.

THREE BMD MOTORSPORT BMW

E30 M3s, including the 1987 Jagermeister tribute car of Tom Houlbrook and Mark Astall shown at RaceRetro last weekend, will compete in this season's Future Classics series.



Jagermeister tribute car will race with CSCC

Stan Redmond 1948-2013



Redmond was a popular racer

HISTORIC FORMULA 5000 racer Stan Redmond died following injuries he sustained in a practice crash at Teretonga earlier this month.

Redmond, 64, was seriously hurt when his converted Lola T333CS crashed after contact with a slower car. He was practising ahead of the final round of the New Zealand Tasman Cup Revival Series (see AUTOSPORT, February 21).

Northern Ireland-born Stan was

in at the start of the Tasman Cup Revival in 1997 and contributed much to it.

He raced a McRae GM1 and a succession of late-model Lolas from when there were less than a handful of F5000 cars active in his adopted country.

He is survived by his widow, Joanna, their young son Tyler and daughter Ava, and Stan's older sons Stephen and Philip.

Single-seaters

New scholarship for Formula Ford

SCOTTISH KARTING ACE CIARAN

Haggerty will graduate to car racing in Scottish Formula Ford this season with help from a new scholarship.

'Racing for Scotland' will back Haggerty and junior karter Jamie Thorburn using the Border Reivers name that launched the career of triple Formula 1 world champion Jim Clark.

Jamie's father Stuart has carried the Border Reivers title for 20 years and will now pass it on to his son. Thorburn Jr will step up to Scottish Junior Blue karting, while Senior Blue champion Haggerty will race a 2009 Ray for Graham Brunton's Formula Ford team.

GT ace Jonny Adam will act as driver coach and mentor for the scheme. The Aston Martin junior driver will also carry Border Reivers branding with him in the marque's centenary year.

Scottish Motor Racing Club competitions secretary Brunton is masterminding the new scholarship. "I wanted to bridge the gap in Scottish motorsport between karting and car racing," he said. "Creating a home-grown racing ladder is exciting and we have partners who also see the merit."

Formula Ford gives you wings

The latest version of this entry-level single-seater series has undergone a drastic makeover for the 2013 season. *BEN ANDERSON* was among the first to try it out for size at a proper test

Perhaps hoping its revised car would strike a fresh chord on the heartstrings of UK motorsport, Formula Ford EcoBoost with wings made its full test debut at Brands Hatch on Valentine's Day.

It's fair to say that the fledgling relationship between Ford's latest engine technology and its long-standing single-seater formula hasn't exactly flourished yet. New (wingless) cars were introduced with 1.6-litre turbocharged propulsion last year, but grids were poor. Only retention of a separate class for outgoing Duratec-engined cars prevented calamity.

Ford has given the formula a facelift for this season, with standard-issue wings added front and rear. Engine power has also increased from 175bhp to 200bhp, to compensate for extra drag. The front wing is significantly larger than the rear. The idea is to give back the downforce lost when cars are following each other closely. The £3000 upgrade is expected to produce around 200kg of downforce at 150mph. That's almost half a Formula Renault 2.0 car and around a fifth that of an F3 car.

"The wings don't produce a huge amount of downforce," concedes Ford Motorsport boss Mike Norton. "Ours is an engineering formula so they have to work – they're not just cosmetic. Their performance is limited."

Ford wants the cars to have some downforce in high-speed corners but negligible levels in slow ones. The cars have no diffuser and run at a 40mm minimum ride height. "Ford is renowned for overtaking and we want to retain the spectacle," adds Norton. "To see cars just pounding around is a waste of time. We want the cars to be at each other, overtaking lap after lap."

AUTOSPORT was privileged to participate in the first proper running of the car, which completed straightline testing at Ford's Dunton base and a few laps at a wet Silverstone 'sampler day' before Christmas.

Our car was Ford's own Mygale, but



Revised formula will support BTCC

this is not a spec Formula and other models from rival constructors Sinter and Ray are planned. French firm Beta Epsilon (renamed since the company built cars for Formula Renault in 2010 as Barazi-Epsilon) is also set to launch a new car in '13.

Track conditions weren't ideal at our Brands test, and AUTOSPORT's first two runs on treaded Dunlops were mainly about survival. But the car didn't feel intimidating, despite slightly violent turbocharged power delivery and limited traction. This is important when you consider the car is aimed at drivers making the step from karting.

Joey Foster knows Formula Ford very well. The 2003 British Formula Ford runner-up (in the Zetec-engined days), Formula Ford Festival winner and three-time winner of the Walter Hayes Trophy for Kent-engined cars also completed some laps at Brands.

"It was a little bit tricky with the conditions but the car felt well-balanced," says Foster. "The boost doesn't come in quite where you want it, but the traction is there and the car doesn't move around when you get on the power. The gearshift is something to work on; you have to be quite forceful.

"The car feels like a big Formula Ford with turbo boost. The Duratecs were quite nimble, but this is heavy. I'm trying to think what it would be like if I was a kid just coming out of karting. The boost coming on in different places wouldn't inspire confidence."

This is something Ford is working hard to rectify. Multiple Formula Ford race winner Nick Tandy spent most of the day working with Ford engineers to tweak the electronic engine mapping. By the time AUTOSPORT jumped back aboard for a late-afternoon run on dry-weather Dunlop tyres, the electronics



TECH SPEC

| | |
|-----------------|----------------------------------|
| CHASSIS | Mygale |
| ENGINE | Ford EcoBoost |
| CAPACITY | 1600cc |
| POWER | 200bhp |
| GEARBOX | Hewland FTR six-speed sequential |
| BRAKES | AP Racing |
| WEIGHT | 475kg approx |
| TYRES | Dunlop slicks and wets |
| PRICE | £50,000 approx |

Revised car is quick but not intimidating



Tandy (right) and Norton (centre) have invested much in EcoBoost



Extra power will offset drag

that allow flatshifting through the sequential gearbox were fixed, and most creases in the turbo power delivery were ironed out – to the point where the turbo was barely noticeable.

The car was deeply impressive on slicks, particularly through the fifth-gear sweep of Surtees into the third-gear right-hander at Clearways. The chassis felt very stiff and physical to drive through the exit onto the start/finish straight, which was quite unexpected.

Tandy, whose JTR team will run several cars in the series this season, agrees: “During my final run I started to push faster through Surtees and it was really physical. It’s nowhere near as hard as an F3 car but you would expect that.

“The faster you go the harder it’s going to be to drive, and they were quite hard to drive before – especially with the wider front tyres from last year. I’m amazed at the way it goes through

Surtees. The only time it got out of shape was when I messed up the entry.”

Tandy managed a 46.8s lap in far-from-ideal conditions. This would have put him at the front of the grid for last year’s races at Brands. He reckons 45s are easily possible in better weather.

Where the car will sit in a table of lap times will be a point of interest this year, especially with renewed competition in the British junior single-seater market. Formula Renault BARC, which enjoyed a popularity boost in 2012, is working on a revised tyre compound and considering increasing the size of its mandatory air restrictor to raise power. Kieran Vernon was on pole with a 45.1s lap at Brands Indy in 2011.

Meanwhile, Jonathan Palmer is launching a brand-new championship, backed by the BRDC and based around a car built by legendary ex-Formula Ford constructor Ralph Firman. We have yet

to see where 175bhp Duratec-engined Formula 4 will fit in, and how the new-look Formula Ford will compare. A common issue for both is a prevailing perception that their steel spaceframe chassis aren’t as safe as carbonfibre cars such as the Renault Tatuus, despite the fact that they’ve both passed recent FIA crash tests.

“A 2007 Van Diemen chassis passed the first test without modifications,” says Norton. “If you show a parent a side-impact test they’re gobsmacked at the ferocity. We have to educate people that our car is exactly the same as a 2008 F3 car in terms of safety. The perception that you can only be safe in a carbonfibre car simply isn’t true.”

Ford’s latest iteration is a serious piece of kit, and certainly not to be dismissed lightly. But only time will tell whether it’s enough to make people fall in love with Formula Ford all over again. ☘

YOUR SAY

What you think of the motorsport news of the past week

Multi-make route is right one for Ford



Full marks for Ford's decision

How refreshing it is to read of Ford spurning the opportunity to create yet another spec formula and instead go with a multi-chassis series to promote its brand/technology (Ben Anderson's column, February 21, p77).

Motorsport has long been about showcasing variety, but the plethora of single-make formulas over the past 20 years has strangled creativity. Allowing different manufacturers to build cars, within tight regulations to keep costs in check, will allow up and coming drivers and engineers the chance to develop different chassis into winning cars, which is of far more use to F1 teams in the future, and it also gives the chance for new chassis builders to enter the market and show off their expertise.

Michael Skeet, Eastleigh, Hampshire

AUTOSPORT.COM

TOP FIVE ON OUR WEBSITE

1. ROSBERG FASTEST AT BARCELONA
2. WILLIAMS SURE EXHAUST OUTLET IS LEGAL
3. McLAREN STRUGGLING TO UNDERSTAND CAR
4. PEREZ PUTS McLAREN ON TOP ON DAY TWO
5. WILLIAMS, CATERHAM EXHAUSTS 'ILLEGAL'

AUTOSPORT+

TOP STORY ONLINE

WHAT WE LEARNED FROM SECOND F1 TEST

To read this exclusive feature and many others like it, log on to autosport.com/plus and choose which package you'd like. A month will cost £5.50, a year £46. Includes access to Forix – the ultimate stats website.

WIN!



ROAD ANGEL VANTAGE

This week's star letter will receive a Road Angel Vantage – a dedicated safety camera and blackspot locator that displays the legal speed limit of every road you drive, automatically and wirelessly updating its database every few minutes as you drive. For more details on Road Angel visit www.roadangelgroup.com Please ensure that your full address is included on all correspondence.

FROM THE FORUM - forums.autosport.com

WHAT OUR READERS ARE TALKING ABOUT RIGHT NOW

- Fantasy track competition
- Hamilton v Rosberg – 2013

CORRECTIONS AND CLARIFICATIONS

It is the policy of AUTOSPORT to correct significant errors as soon as possible. Please note the issue date and page number when contacting us on autosport.editorial@haynet.com

EDITORIAL CONTACT mail@autosport.com

I read with interest your

feature on the UK's young single-seater talent last week, but surely there is one glaring omission: Scott Malvern.

Not only did he win your coveted Club Driver of the Year Award in 2012 and also topped your National top 10, he has beaten several of the drivers mentioned in your feature, as well as being a multiple single-seater champion, double McLaren AUTOSPORT BRDC Award finalist and BRDC Rising Star.

What more does this driver have to do to prove his worth? He has already succeeded

where others who are far better heeled have failed and the only thing that's stalling his career is lack of funding. **P Baker** Maidstone, Kent

The piece covered British drivers who have raced, or are about to race, at a level above Formula Renault 2.0. That's why Scott and McLaren AUTOSPORT BRDC Award winners Oliver Rowland and Jake Dennis weren't included. Apologies for not making the cut-off point clearer. Malvern is, in fact, now considering a switch to tin-tops – features ed.

Three days after Danica

Patrick became the first woman to start the Daytona 500 from pole, an article on the website of the UK's second largest newspaper explained how Susie Wolff is "tipped to become the first ever woman racing driver". Appalling. **Tom Elliott** Penkridge, Staffordshire

In response to last week's

Bamber cartoon, just because a woman happened to win pole for the Daytona 500, why should that automatically equal a joke about pole dancing?

I would have hoped AUTOSPORT/Bamber would have been slightly more intelligent and a lot less misogynistic than that. **Cate Milton** Maidstone, Kent

I have read that the new

WRC promoter signed a contract back in October. With the lack of WRC promotion since then and there being no WRC on TV in the UK, it begs the question: what have they been doing since then? **Andy Maclean** Churchill, Oxfordshire

THE LATEST GEAR

Desirable new releases for motor racing fans: books, DVDs, models, art and gifts

THE RACE CENTRE

From £24

theracecentre.co.uk

The original Race Centre in Chandler's Ford was an AUTOSPORT favoured haunt, even if it was a long old drive away. The new venue in Surbiton is not only a lot closer for us, it's also much more spick and span, with brand-new racing pods and projector screens. But the essence of what made the original good – the ability to race against a group of your mates in cool cars on almost any circuit – remains firmly intact. Perfect for an office party or stag do.



CITROEN DS3 1:24 KIT

£22.95 (Free UK P+P)

grandprixmodels.com

French plastic kit firm Heller has released a 1:24-scale replica of Sebastien Loeb's 2012-spec Citroen DS3 WRC from the modern-day rally king's ninth and final world-title-winning season. The detail of the moulding and decals is very good – and you can upgrade your kit with photo-etched parts.



AUDI R18 1:43 MODEL

£54.99

autosport.com/shop

Spark's 1:43-scale diecasts are eye-wateringly pricey (£55 for a four-inch model!?) but they are works of art. Its Audi R18 e-tron Quattro, a replica of the #2 car driven to second at Le Mans last year by the four-ringed superteam of Rinaldo Capello, Tom Kristensen and Allan McNish, is no exception.

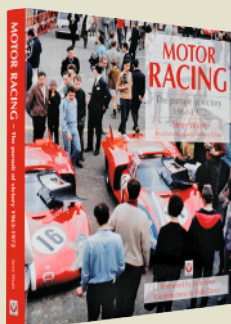

PURSUIT OF VICTORY BOOK

£45

autosport.com/shop

Motor Racing – The Pursuit of Victory 1963 – 1972 is Steve Wyatt's second book charting a care-free, easy-access era of motorsport that must have been an amateur snapper's and/or autograph hunter's paradise. A glance at the cover pic (one of over 400) leaves you in no doubt over how good it must've been.

HOT ON THE WEB THIS WEEK

YOUTUBE: BRUNDLE AND McRAE SWAP CARS AT SILVERSTONE



SEARCH FOR: Colin McRae testing Jordan F1 (6:01)

Back in 1996, reigning world rally champion Colin McRae got to thrash Martin Brundle's Jordan 196 F1 car at Silverstone, before McRae's employer Subaru repaid the favour by letting Brundle sample the Scot's Impreza 555 in the woods.

WHAT'S ON...

Your guide to the week ahead, including TV listings and online – plus opinion columns

NASCAR SPRINT CUP

Rd 2/36
Phoenix, Arizona, USA
March 3, nascar.com

GRAND-AM

Rd 2/12
Austin, Texas, USA
March 2, grand-am.com

V8 SUPERCARS

Rd 1/14
Adelaide, Australia
March 2-3
V8supercars.com.au

V8 STOCK CARS

Rd 1/12
Interlagos, Brazil
March 3
stockcar.globo.com

EURO F3 OPEN WINTER SERIES

Rd 2/2
Jerez, Spain
March 2, f3open.net

GT OPEN WINTER SERIES

Rd 2/2
Jerez, Spain
March 2, gtopen.net



Johnson: Daytona win; just 35 more races to go

AUTOSPORT SOAPBOX



If F1 wants more fans it should make decent toys, reckons GLENN FREEMAN

Who remembers their first toy racing cars from their childhood? I do: an Alfa Romeo and a Ferrari of mid-1980s vintage. I'm told the only reason I begged my parents to buy them for me was because I'd seen another child on a family holiday who had the same ones. At that time I had no idea what Formula 1 was, but these cars surpassed every other toy I'd had up to that point.

It was nearly a year later that I first caught a glimpse of "my cars!" in action

on TV. I was instantly hooked, and was at the beginning of a path that would lead to a career in motorsport journalism via 10 increasingly expensive years of karting.

I owe a lot to those cars, and the various companies that produced all the others I would own in the years that followed. So imagine my horror when I recently went on the hunt for the modern equivalents for a friend's child and could find nothing. As regular followers of our reviews in 'The Latest Gear' section will know, high-detail

(and high-price) models of racing cars are in plentiful supply today. But kids don't want a glorious 1:18 scale model to put on the shelf. They want little replicas of Vettel, Alonso and Hamilton they can push around a track mapped out on the living-room carpet, fuelling their interest in motorsport and making them the fans, or even competitors of the future.

Unsurprisingly, the Americans still get it. It has become an AUTOSPORT tradition that whenever someone

makes a trip to the US they come back with at least one IndyCar or NASCAR toy model, and the quality of them shows there are still companies out there producing this sort of thing.

I don't know the reasons for the lack of F1 versions today. Perhaps it's all down to the difficulty in obtaining the rights to make the cars in this modern, commercial era. If someone in the sport believes preventing avenues for engaging new fans is a good idea, then that is incredibly short-sighted. A glitzy computer game is good for people of a certain age, but modern games are so complex that it's unlikely to capture the imagination of a child when they are at their most impressionable.

Motorsport had it good in the days before satellite television. We were fortunate that our passion filled so much of the airtime when there were so few channels for people to watch. Now, with more forms of entertainment than ever vying for kids' attention, and TV coverage seemingly going the way of subscription-based broadcasters, F1 needs to work harder than ever to attract new fans.

Giving kids some toy cars to play with would be a good start.



Eddie Cheever in 'Glenn's' Alfa, Monaco GP 1985

@glenn_autosport



Television

THURSDAY FEBRUARY 28

1230-1300, 2330-0000 ESPN

NASCAR Now

1400-1630 Sky Sports F1 LIVE

Formula 1: Barcelona Winter Testing Day 1

1825-2130 Motors TV

NASCAR Nationwide: Daytona Replay

2100-2115 Sky Sports F1

F1: Barcelona Winter Testing

Day 1 Round-Up

2115-2135 Sky Sports F1

F1: Ted's Notebook, Barcelona Day 1

FRIDAY MARCH 1

0800-0900 Sky Sports 4

Racemax

1100-1130 ESPN

NASCAR Now

1240-1545 Motors TV

NASCAR Nationwide: Daytona Replay

1400-1630 Sky Sports F1 LIVE

F1: Barcelona Winter Testing Day 2

1630-1730 Sky Sports F1 LIVE

The F1 Show

2100-2115 Sky Sports F1

F1: Barcelona Winter Testing

Day 2 Round-Up

SATURDAY MARCH 2

0200-0300 Premier Sports

NASCAR Sprint Cup: Daytona Highlights

0300-0330 ESPN

NASCAR Now

0400-0425 Channel 5

Motorsport Mundial

1020-1330 Motors TV LIVE

NASCAR Nationwide: Phoenix

1130-1230 Sky Sports 1

The F1 Show

1400-1630 Sky Sports F1 LIVE

F1: Barcelona Winter Testing Day 3

2100-2115 Sky Sports F1

Formula 1: Barcelona Winter Testing

Day 3 Round-Up

2115-2135 Sky Sports F1

F1: Ted's Notebook, Barcelona Day 3

SUNDAY MARCH 3

1020-1330 Motors TV

NASCAR Nationwide: Phoenix Replay

1255-1355 Premier Sports

NASCAR Sprint Cup: Daytona Highlights

1330-1650, 2100-2305 Motors TV

Grand-Am: Austin Highlights

1400-1630 Sky Sports F1 LIVE

F1: Barcelona Winter Testing Day 4

1930-2330 Premier Sports LIVE

NASCAR Sprint Cup: Phoenix

2100-2115 Sky Sports F1

F1: Barcelona Winter Testing

Day 4 Round-Up

2115-2135 Sky Sports F1

F1: Ted's Notebook, Barcelona Day 4

MONDAY MARCH 4

0430-0530 Sky Sports 3

Racemax

0500-0600, 2100-2200 ESPN

NASCAR Sprint Cup: Phoenix Highlights

1445-1750, 2030-2340 Motors TV

NASCAR Nationwide: Phoenix Replay

1600-1830, 2030-2300 Sky Sports F1

F1: Barcelona Winter Testing Day 4

1830-1850, 2300-2320 Sky Sports F1

F1: Ted's Notebook, Barcelona Day 4

Online

AUTOSPORT+

Coming up in our premium web content this week

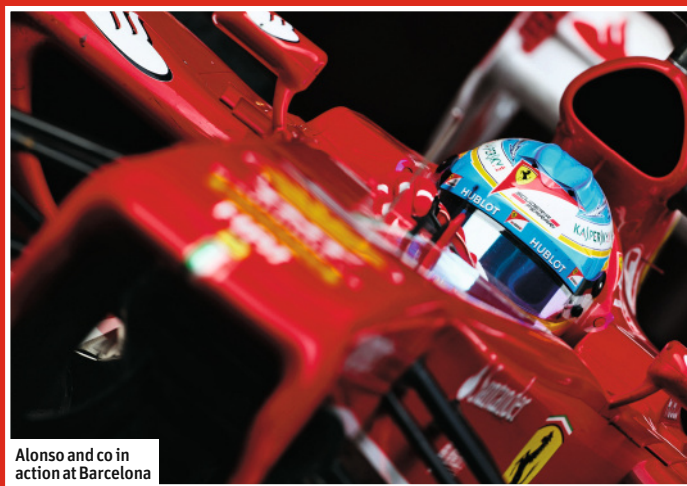

Alonso and co in action at Barcelona

F1's LAST CHANCE BEFORE MELBOURNE

It's the final pre-season test at Barcelona and AUTOSPORT will be there to bring you the latest. This is the big one: the last opportunity to iron out any bugs, and the final chance to see what the 2013 F1 machines can do before Australia.

SECRET INSIDER HITS THE TRACK

In his latest story, our secret F1 mechanic takes a look at F1 testing.



V8 SUPERCARS 2013 PREVIEW

Adelaide countdown: we assess the runners and riders in Australia's leading tin-top series.



REVVED UP OVER WHAT'S ON THE BOX

We cast a critical eye over the best and worst of this week's TV coverage

Professionalism – and politics – from Peugeot arrival in Africa



(IN THE GRAVELLY VOICE of that bloke that does all the Hollywood trailers): “From the people that brought you *The Deadliest Crash*, *Grand Prix: The Killer Years* and *Madness on Wheels: Rallying's Craziest Years* comes a story of one man's attempt to tame one of the world's great wildernesses... on a motorcycle.”

Last weekend on BBC4, the latest Bigger Picture production *Madness in the Desert: Paris to Dakar* hit the small screen. Following a similar format to its predecessors, it told “the story of how one

man's dream became the biggest motorsport event in the world and how the west took on the continent of Africa... and lost”.

From Thierry Sabine's 'eureka!' moment while lost in the Sahara, through to the corporate greed and political instability that forced the event to shift continents, this was a film that attempted to portray the physical, emotional and sporting endeavours the ultimate rally raid produced.

From the first event in 1978, where a merry band of blissfully-ignorant amateurs set off in their

road-going cars, bikes and trucks with only a map and their fingers crossed, there was some fantastic footage.

Of course, Mark Thatcher's involvement in 1981 – and his disappearance in the Algerian desert – provided the best comedy moment; and he's still in denial that it was his fault: “We weren't lost *per se* – it was that the car became completely immovable.”

Anne Charlotte Verney (the driver): “The thing I did not understand is he could not find where we were with all the machinery that he had. We were racing

then he said ‘I can't find'. That was the only thing that made me angry.”

It was the arrival of Peugeot in 1987 with its pseudo Group B cars that took the event – and the quality of footage – to the next level. The mass-starts were awesome, but inevitably led to fatalities as power levels soared. But the real tragedy was how the event lost contact with the African people. Where once it distributed wealth, by the 2000s paranoia and corporate disinterest meant the end was inevitable. Give it a watch. *Revved Up*

THE WEEK IN PICTURES

Our lensmen pounding the beat, from the States to Russia, via the south of France

TWILIGHT AT SEBRING

No, it's not the 12 Hours. It's the Penske mechanics working on the car of Helio Castroneves at the IndyCar test



KING RICHARD NOT IN A LEICESTER CAR PARK

Instead it's bested NASCAR monarch Petty at the Daytona launch of new muscle-car stamps



THE SHAPE AUDI FEARS?

The evo of Toyota's TS030 HYBRID broke cover at Paul Ricard last week



THAT'S WHY THEY CALL HIM 'ICE MAN'

Kimi Raikkonen was one of two F1 drivers (the other was Charles Pic) to contest the Race of Stars in the Moscow Hippodrome. But neither could beat local Kirill Ladygin



PICS: LEVITT/THACKER/LAT, LENORMAND/DPPI

FROM THE ARCHIVE

James Hylton wins at Talladega, 1972



Old tyres meant glory in Alabama

“Pretty soon the cars in front were in the pits or wrecked with tyre problems. It dawned on everyone our tyres were better”

THE 1972 TALLADEGA 500 WAS ONE OF THOSE RARE cases when not having money became an advantage. In a second-hand car and on old tyres, James Hylton drove to one of NASCAR's most unexpected victories.

Almost 41 years on from that win, now aged 78, Hylton has announced that he will retire at the end of this season, ending a career that spans six decades and includes 602 premier-class NASCAR starts. This month, 47 years after his Daytona debut, he made his final appearance at the circuit in the ARCA race. Barring an absurd turn of events, Talladega 1972 will go down as his second – and final – top-class win.

The race itself came down to tyres – or, more specifically, to the fact that Goodyear introduced a new tyre before Talladega that Hylton, among others, couldn't afford. In contrast to the richer teams able to buy the new treaded tyre, Hylton was running on an old-spec slick.

“I happened to have some left over from a previous race and I didn't have the money to buy the new treaded tyres,” said Hylton. “The treaded tyres, they could only run about 30 laps or so. Even though they slowed the cars down to where they wouldn't come apart, we could outrun them. We had them covered.”

Hylton began the race inconspicuously. From 22nd on the

grid he climbed steadily up the order, but the established stars – Bobby Allison, Buddy Baker and Richard Petty – had exclusive control at the front over the opening 23 laps.

It was at that point, however, that the race swung. The frontrunners were forced to pit due to tyre wear, and Hylton hit the front for the first time.

“Pretty soon the cars in front of me were in the pits wrecked or with tyre problems,” said Hylton. “That's when it dawned on everybody that the tyres were going to be the advantage.”

As the top teams were forced to continually pit, Hylton was able to simply drive away. By the closing stages he had just Ramo Stott, a man who had already finished in the leading positions at Talladega, for company.

Hylton had led 105 of the 187 laps as he took the white flag, but Stott was just a car length back. “I wasn't going to give it up, leading all day like that. So, yeah, I blocked him. I did everything I'd seen or known and it worked out. I made the right moves at the right time and he couldn't slingshot me.”

“The feeling I had at Talladega was better than the greatest feeling in the world. You're beating the million-dollar teams on a shoestring budget. You're king of the mountain. There's no other feeling like that.”

THIS WEEK IN...

Autosport



Kyalami Grand Prix testing

Mintex Rally to Blomqvist's Saab Turbo • Daytona 500 report
Warwick goes F2 • Perkins takes Australian F5000 title

MARCH 1 1979

FERRARI MARKED ITSELF OUT AS A

potential title contender during F1 winter testing this week in 1979, as the new T4 – the team's first ground-effect car – starred on its debut at Kyalami.

Jean-Pierre Jabouille ended up setting the pace in the turbo Renault RS02, but his performance came as little surprise given the high altitude of the venue. In contrast the new T4 was instantly quick, with Gilles Villeneuve and Jody Scheckter – who would go on to win the 1979 crown – both more than four seconds under lap-record pace.

Turbo power proved decisive over in England as heavy snow and ice disrupted the longest-ever Mintex International rally. In such Arctic conditions Stig Blomqvist dominated, giving the Saab Turbo its second international rally win (after Sweden) in as many weeks.



PICTURE ARCHIVE

NEXT WEEK

F1 SEASON PREVIEW

DON'T MISS IT!

INCLUDING: STIRLING MOSS ON HAMILTON, PLUS IN-DEPTH BUTTON & DI RESTA ANALYSIS

PHIL ANDREWS

■ Benelux FF1600 ■ Zandvoort ■ Van Diemen RF86 ■ May 19, 1986 ■ Overseas win after big crash on home soil



Leading the pack at Brands Hatch before massive shunt

THE 1986 SEASON WAS MY first in senior Formula Ford 1600 after a couple of years in the junior series. It was also my first foray in to Europe and I remember a real fun and relaxed feeling to it, as we got the ferry over to Holland.

However, the build-up to the race had been very fraught.

I had a semi-works deal with Van Diemen and a full works engine from Minister, so all looked good going in to the season. We were also a full 'Brummie' team in '86 as we ran under the 'Second City Racing' banner and were based in Birmingham.

The other really positive aspect for me in '86 was that I had Ashley Sallis as engineer. Ash was a real Formula Ford wizard and among many other things had masterminded Gerrit Van Kouwen's Festival win in 1984.

In pre-season testing we were absolutely on it everywhere, beating and equalling lap records. We ran both the RAC Townsend Thoresen and Esso FF1600 series but it didn't start well for us. That entire pre-season pace had gone and we just couldn't put our finger on the problem. Then, just before we went to Zandvoort, there was a race on the Brands GP circuit and

"The only guy who troubled me was Gerald van Uitert, but I had the measure of him and won by a country mile. The local guys were quite shocked about the pace we had"

I ended up having a monster shunt exiting Westfield Corner. I split the thing in half and we ended up putting what was left in the bin!

So we scrambled Van Diemen to get a new chassis sorted for the big EFDA European round at Zandvoort. Before that, we tested in a local Star of Mallory round, winning easily. That wasn't a surprise but when we analysed the

lap times we found I had broken the lap record by a long way.

So we arrived at Zandvoort with renewed confidence. The day before the race I got introduced to a chap called Allard Kalff and I thought as a local boy he might be very useful. Allard took the trouble to show me the lines and the secrets of the track, as I followed his FF2000 in a general test

session. Very useful. I qualified on pole by about a second, which in FF1600 terms is quite a margin.

The race itself was very straightforward. The only guy who troubled me in the first few laps was Gerald van Uitert in the Marlboro-backed car, but I had the measure of him and ended up winning by a country mile. The local guys were quite shocked about the pace we had. Our season from that point really took off and we ended up finishing third in the Esso series. It can all be traced back to that change of car prior to the Zandvoort weekend. We presumed that the chassis I wrote off at Brands must already have had a twist in it somewhere and that probably cost us a crack at the title.

We had a great night in Zandvoort and a few beers were sunk with the team. Then it was back down to earth the following day when we got pulled over by HM Customs. I had been responsible for the paperwork which was incorrect and we got held for six hours! A few miles down the road we got a double puncture on the truck. Happy days on the road! ✪

Phil Andrews was talking to Sam Smith

IN PROFILE



PHIL ANDREWS FINISHED THIRD

in both junior and senior Formula Ford 1600 series in 1985 and 1986, before moving up to F3 with Madgwick in 1987. A long F3000 career yielded little in the way results but plenty of strong performances, particularly in a Superpower Lola in the early '90s. Andrews, now 46, continued in F3000 up until 1994 before embarking on a GT and Sports Car career that took in British GT, the FIA Sportscar championship and American Le Mans Series.

TIMING FOR CHAMPIONS

The new Edox X-treme Pilot III is dedicated to rally drivers, true virtuosi of the tarmac and icy roads, and to all devotees of the automobile. This new limited edition is sporty, masculine and very "bad boy". Created for champions,

the new X-treme Pilot III Limited Edition is a real tool for drivers. Edox is the official timekeeping partner of Class-1 Powerboats and the FIA World Rally Championship. **Edox - Timing for Champions.**



EDOX

Maître Horloger - Les Genevez
depuis 1884

For further information tel: 01403 790902

RYAN

MOTORSPORT INSURANCE



On Track

We provide comprehensive cover for accident damage to vehicles whilst testing and competing in the UK or Worldwide. Cover is based on your requested levels of sum insured and excess. Single events covered, discounts available for multiple event policies. All levels covered – Sprints, Hillclimbs, Club, Hatchbacks, Sportscar, GT, Single Seaters.



Personal Accident

In the event of a big accident, Personal Accident insurance could be the most important insurance product you have purchased. Sums insured can include Mortgage loan amount and weekly wage protection, race contract instalments, and medical expenses if racing overseas. Cover available for any type of motorsport.



Track Days

Our specialist product is available to insure road going and track prepared cars for accident damage occurring on track days. All circuits in the UK and Europe can be covered, including Spa and Nurburgring Nordschleife. Discounts available to track day operators and organisations.

Log on for a quotation at: www.ryanmi.com

Or call: +44 (0) 1799 524202

Email: info@ryanmi.com