



IT'S WAR!

McLAREN AND FERRARI LEFT FUMING AS TITLE RIVALS CLASH

www.autosportmag.com

3 SEPTEMBER 1998 EVERY WEEK £2.40

AUTOSPORT



BELGIAN GP REPORT

DAMON ON TOP OF THE WORLD

Hill escapes carnage to give Jordan first win

F1'S MOST SENSATIONAL RACE

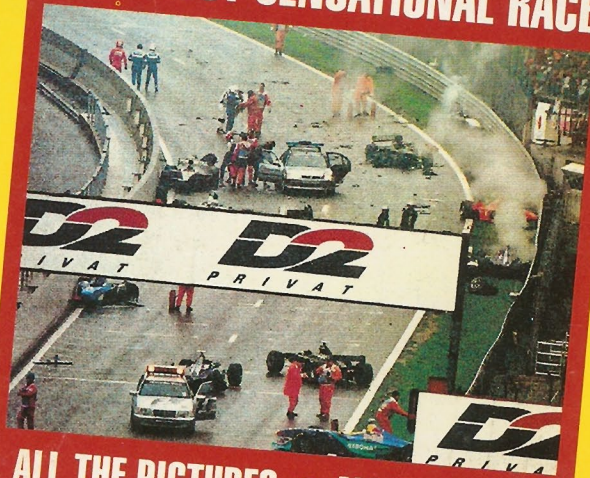

ALL THE PICTURES ● ALL THE NEWS

US \$4.95, DM 12.00, C\$ 6.95, 31 FF, 170 LF, 180 BF, 69.00 Asch, 9,000 IL



9 770269 946128



1 9 9 3

1 9 9 4

1 9 9 5

1 9 9 6

1 9 9 7

1 9 9 8

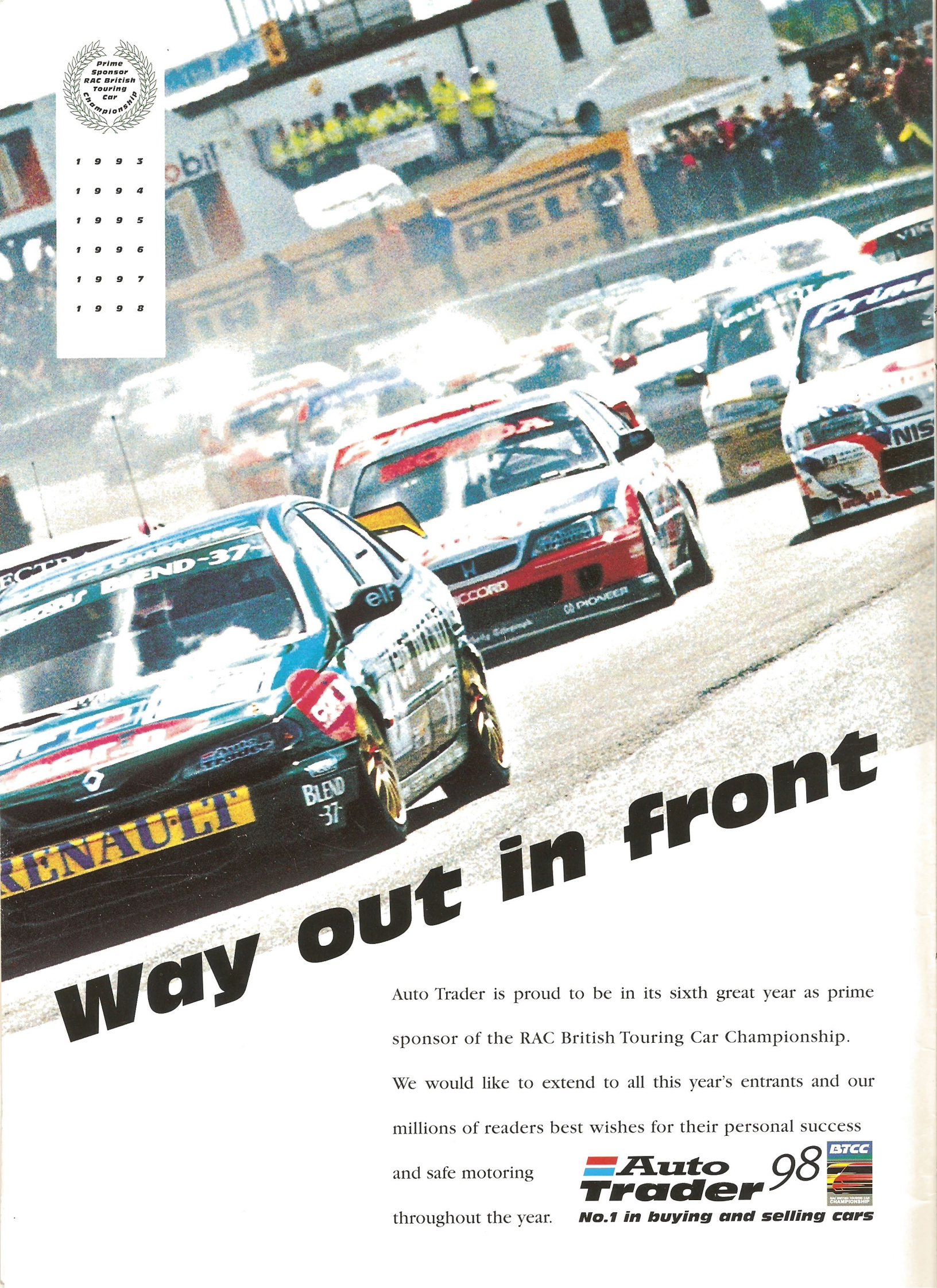

Way out in front

Auto Trader is proud to be in its sixth great year as prime sponsor of the RAC British Touring Car Championship.

We would like to extend to all this year's entrants and our millions of readers best wishes for their personal success and safe motoring

throughout the year.

Auto Trader 98 
No.1 in buying and selling cars

NEWS AND COMMENT

- McLaren and Ferrari in war of words** ... 4
The full inside story on the Coulthard-Schumacher incident
- Pit & Paddock** 6
Schuey Jr/Jordan wrangle deepens; drivers slam decision on safety car start; Villeneuve and Salo escape 180mph shunts
- Special Stage** 20
Burns to take McRae's seat at Subaru
- Fifth Column** 25
Crazy day at Spa, by Nigel Roebuck
- Inside line** 26
Gary Watkins looks forward to the Donington GT race
- Damon Hill's driver column** 55
Spa winner tells his own story of a dream weekend
- Last lap** 102
Murray Walker says it wasn't just tough for the drivers at Spa

FEATURES AND REPORTS

- Reid and Rydell battle ends in blows** .. 28
BTCC title rivals take a win apiece after clash on and off track
- Belgian Grand Prix report** 34
Full report from Spa-Francorchamps **Plus** complete qualifying rundown, lap-by-lap record, technical focus, Martin Brundle's view, team guide and postcard
- Fantasy Grand Prix** 50
Were you as mad as Michael or as delighted as Damon?
- Eddie Jordan: the morning after** 56
Damon's boss reflects on eight years of hard work – and a magical weekend
- Rodriguez takes Spa F3000** 58
Uruguayan scores maiden win in Belgium as Juan Pablo Montoya closes to within one point of the top of the table
- Bernoldi back on winning form** 62
Donington British Formula 3 victory puts the Brazilian back on the trail of the championship
- Huisman wraps up Supercup** 64
German wins at Spa to secure top Porsche title
- Letters 22, Jim Bamber cartoon 23**
- Armchair Enthusiast 27, TV listings 26**

34 Damon's finest victory Hill stars as rain causes chaos at Spa

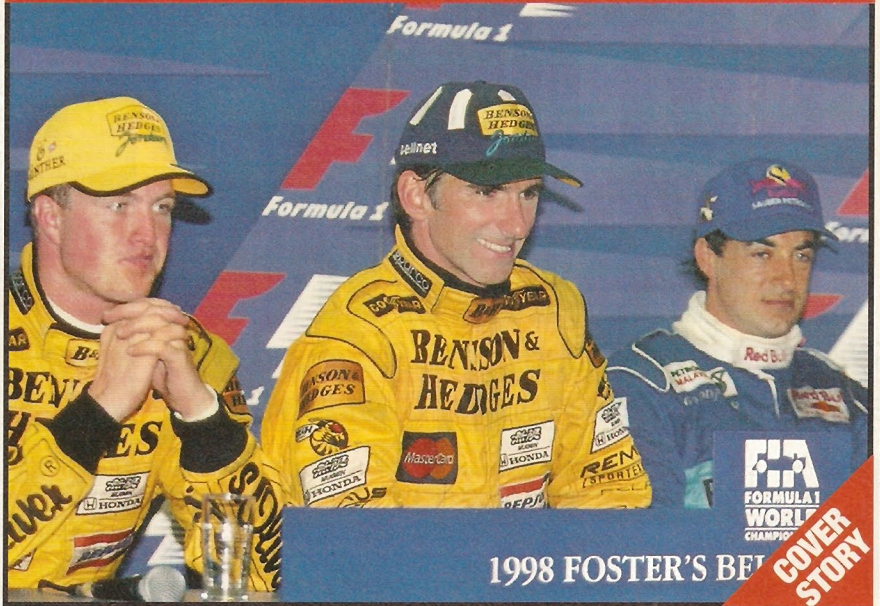

1998 FOSTER'S BEER FORMULA 1 WORLD CHAMPION COVER STORY

102 An unbelievable race



Murray's view of the Belgian GP

56 Jordan triumphs at last

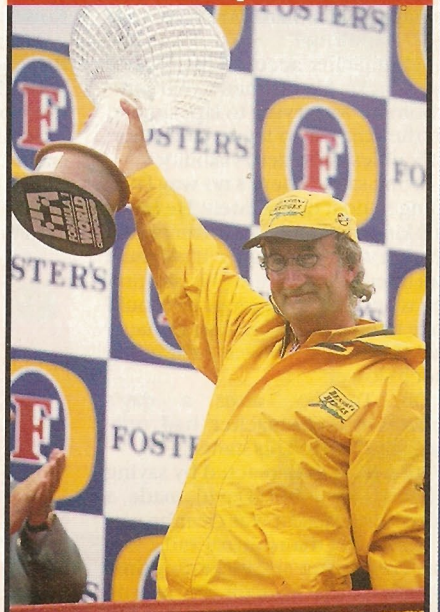

Silverstone team savours the glory

62 Bernoldi fires title warning



Renault ace wins Donington F3

28 Mansell's Brands agony Former F1 champ suffers double shunt in BTCC



HOW TO CONTACT US Editorial 0181-943 5998 (fax: 943 5922; telex: 895 2440) Advertising 0181-943 5858 Ads production 0181-943 5909 (fax: 5850)
Editorial, advertising and circulation: 38-42 Hampton Road, Teddington, Middlesex TW11 0JE
Customer Services: 01795 414817; e-mail: haymarket@galleon.co.uk **Back numbers:** 01235 534323; Publishing, trade and further subscription details on p102
AUTOSPORT is published by Haymarket Specialist Motoring Ltd, a subsidiary of Haymarket Magazines Ltd, 38-42 Hampton Road, Teddington, Middx

Online: www.autosportmag.com or for AOL: keyword autosport
Printed by St Ives (Peterborough) plc & BR Hubbard Printers Ltd, Sheffield
COPYRIGHT: Reproduction in whole or part of any text, photograph or illustration without the written permission of the publisher is strictly prohibited
ISSN 0269 946X
Main cover photos: Tee/LAT
Other cover photos: Action Images; LAT
Contents photos: Sutton Images; Stuart Niland; Elford/LAT

Printed in England **ABC** MEMBER OF THE ADVERTISING BUREAU OF CIRCULATION

CLUB AUTOSPORT

- Spectator killed at Castle Combe** 85
Safety is again called into question at Wiltshire track
- Tatuus unveils new Formula Ford** 86
Italian Formula Renault Sport kings launch FFord assault
- Barton destroys 6R4 on Epynt** 91
John Price wins but Lyndon Barton crashes out big time
- Full Bank Holiday race reports** 92
Complete coverage of a bumper weekend of National action
- The next great Briton** 100
Westley Barber is a star in France, he soon will be in Britain too

COULTHARD'S NOT DIRTY, SAYS IRVINE

Schumacher is wrong to accuse the Scot of underhand tactics, says Ferrari's number two. By Andrew Benson

Ferrari driver Eddie Irvine has defended David Coulthard against team mate Michael Schumacher's accusation that the McLaren star tried to take him out of the soaking wet Belgian Grand Prix.

The German stormed down to the McLaren pit after the incident and shouted at Coulthard: 'Are you trying to f***ing kill me?'

Schumacher accused his rival of dirty tricks. He claimed Coulthard, whom he was trying to lap, slowed on the straight to try to cause him difficulties in the zero visibility.

Irvine said: 'There's no way DC's going to do it deliberately. He is not that kind of person. No driver would do that to a colleague. If Michael had lifted off every time he couldn't see where he was going, he would have been last. He was just unlucky that this time there was a car going much slower.'

On Tuesday, after a day's reflection, Schumacher had only partially changed his stance.

He said: 'I over-reacted by saying what I did - but David made a mistake because it was clear he was going slower than normal and it was the wrong place and the wrong time to let someone through, because no one could expect it there. I don't

know why he did that. If he wanted to let me past, why did he not go off the racing line?'

'I don't want to believe that David did it deliberately, but I still want an explanation why he lapped in two minutes 16 seconds when I was approaching him when he could do 2m11s after the crash and before he slowed down.'

After the race, he said: 'We think that there may be something more behind it because we are fighting for the World Championship.'

Schumacher's comments do not seem to be borne out by the race times, for Coulthard was slow long before the German reached him.

In the eight laps before the crash,

“ There's no way DC's going to do that deliberately. He's not that kind of person ”

EDDIE IRVINE



Rose Sutton

apologise. We expect an apology and if we get one, we will accept it.'

Many observers felt that the violence of Schumacher's reaction was influenced by the realisation that he had suddenly lost a golden opportunity to move into the lead of the World Championship.

Schumacher's old rival, Damon Hill, said: 'Michael was upset at losing his chance to go top of the table, but that's no excuse. That behaviour is totally unacceptable.'

'Blaming others is a tactic he often uses when he has made a mistake.'



AP

How it happened

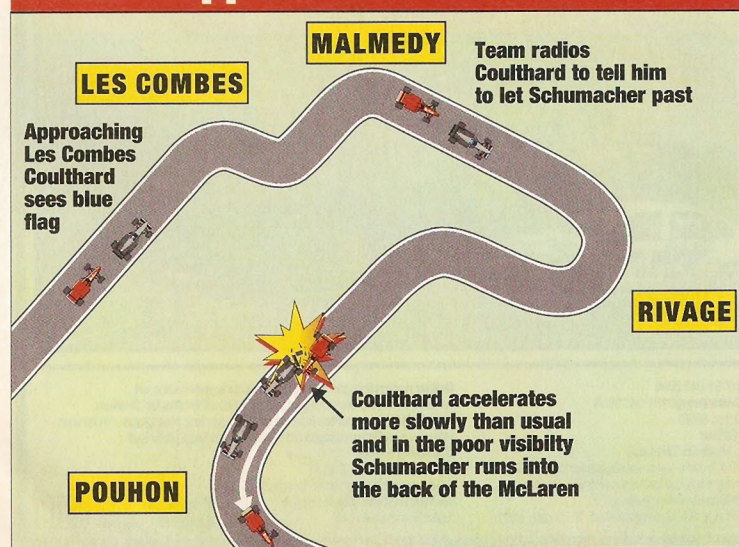

on lap 25, Coulthard dropped into the 2m14s bracket only three times. Otherwise, he was doing 2m15-16s laps, and on lap 21 he did a 2m18.284s - seven seconds slower than Schumacher on the same lap. At the same time, the Ferrari driver lapped most often at 2m10-11s, then slowed to 2m13s, 2m16s and 2m14s in the laps before the crash.

Norbert Haug, the sports boss of McLaren's engine supplier, Mercedes, has demanded an apology from the Ferrari star. He said he wanted to cool the situation before the next race of the season, the Italian Grand Prix on September 13. The drivers were expected to meet and discuss the incident at this week's Monza test.

Haug said: 'There is too much tension in the whole thing with Monza coming up. We want a sporting challenge, not a war, and the best way is for Michael to



Grim faces from Schumacher and Ferrari sporting



Schumacher's Ferrari three-wheeler goes into the pits, closely followed by David Coulthard's de-winged McLaren

He targets the innocent party to deflect from his own error.

'To think that David would make Michael run into the back of him is just too ridiculous for words.'

Schumacher rear-ended Coulthard's car because the Ferrari driver was unable to see the speed differential between the two cars in the huge clouds of spray.

Coulthard, who has a reputation as probably the cleanest and most honest driver in F1, was upset by Schumacher's behaviour.

He said: 'There was just no way I

wanted to get in his way and his behaviour in coming into the garage is unacceptable and disgusting. To accuse me of doing it deliberately is paranoia in the extreme.

'He really needs to get some help for controlling his anger after such an event. If, when he calms down, he is still accusing me of that, I've got no interest in talking to him.

'I had been on the radio five laps before the incident to ask my team to tell (race director) Charlie Whiting that I thought the safety car should be out.

'I did not deviate my line or weave or brake. I accelerated out of the lefthander but not at full throttle. I expected him to overtake into Pouhon, not run into the back of me. The stewards have access to our radio and telemetry. Ferrari can allege we did this, that and the next thing, but it's absolute bollocks.'

The stewards declared it a racing incident. McLaren's telemetry is thought to have shown what Coulthard described.

However, Ferrari technical boss Ross Brawn still said that for Coulthard to slow on a straight when he knew the driver behind could not see him was a 'mistake' he should have been 'punished' for.

Brawn said he could not 'condone' Schumacher's behaviour, but 'I can understand it. He was in a state of shock. If you're going down a straight at 137mph, and you hit a guy who has backed off, what are you going to think?' ■



Director Jean Todt after the German exited the race

Flash points

The La Source was the scene of McLaren/Ferrari collisions in both starts



Damon Hill leads away as Hakkinen and Schumacher appear to run each other close



The Finn's McLaren is tapped into a spin and ends up facing back the way it came



Johnny Herbert can do nothing to avoid a collision, which leaves Hakkinen stranded

The bitter arguments between McLaren and Ferrari after the Belgian Grand Prix were not limited to the crash that took Michael Schumacher out of the race. Each also accused the other of trying to engineer collisions at the start.

World Championship leader Mika Hakkinen retired at the second start after a spin caused by a clash of wheels with Schumacher. He was then hit by Sauber driver Johnny Herbert as he sat facing the wrong way. At the first start, David Coulthard was forced wide after he was hit by Eddie Irvine. He spun, triggering the 12-car pile-up.

McLaren boss Ron Dennis said: 'I'm not going to put fuel on the fire. The videos are clear, at each incident our drivers are exonerated.

We know what happened and so does anyone who watched the race. The first start was even more blatant as far as we are concerned.'

He felt Schumacher deliberately hit Hakkinen's car at the exit of the corner, knocking it into a spin.

Ferrari technical director Ross Brawn retorted: 'Hakkinen tried to put Michael off on the first corner. He makes no attempt to run tight at that corner, and he's tried to squeeze Michael against the wall. McLaren knew it was in a difficult position, that we were faster and that it had a problem with tyres. The perpetrator failed and got his comeuppance.'

Coulthard did not blame Irvine for their collision, and Schumacher said he considered the incident with Hakkinen 'nothing special.'



At the first start, Irvine's Ferrari and Coulthard's McLaren touched wheels

Jordan just misses chance to keep Ralf

Jordan narrowly missed out on racking up enough points to force Ralf Schumacher to stay at the team despite finishing first and second in the Belgian Grand Prix.

The German has issued a writ against his team claiming it is wrongfully trying to stop him leaving. Jordan's deal with Schumacher is understood to say that if it is four points or less behind the team lying fourth in the Constructors' Championship after the 13th race of the year, it can then exercise an option on the German.



Jordan: letters

That race was on Sunday, but despite leaping up to a total of 26 points, Jordan is six points adrift of fourth-placed Benetton, which is one point behind Williams. Had Williams driver Heinz-Harald Frentzen not scored points, Jordan would have achieved its goal.

The dispute is now finely poised. Schumacher's manager, Willi Weber, told Agence France Presse on Tuesday that Schumacher was free to leave Jordan. But that is probably a reference to the option date that passed on Sunday.

Jordan intends to continue to fight and is scheduled to go to court

next Wednesday (September 9).

It is understood there is no signed contract between the two parties. But Jordan claims a series of faxes exchanged between the two constitutes a binding agreement.

If Jordan wins, it is expected to keep Schumacher on to partner Damon Hill next year. If it loses, most expect Schumacher to go to Williams, where he would partner Champ Car star Alex Zanardi. But some sources suggest his chances at the World Champion team are not as high as they seem, and he may yet end up at British American Racing.

Sources say Williams's future engine supplier, BMW, has told team boss Frank Williams it is not too keen on Schumacher.

At Jordan, Brazilian Pedro Diniz has emerged as a strong contender, although he would be an unpopular choice with many team personnel. The Arrows driver, whose representatives were due to meet Jordan this week, is said to have a budget of more than £7 million.

Other possibles are test drivers Juan Pablo Montoya, Ricardo Zonta and Pedro de la Rosa. Tyrrell rookie Toranosuke Takagi is an outside bet.

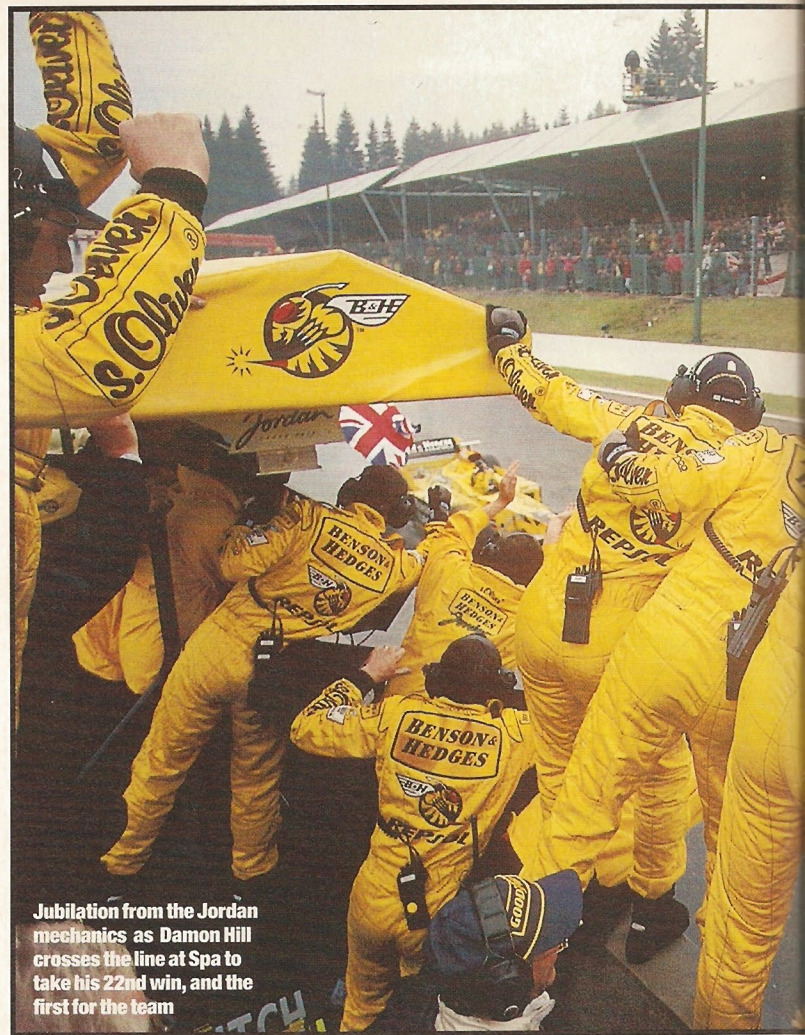

Jubilant from the Jordan mechanics as Damon Hill crosses the line at Spa to take his 22nd win, and the first for the team



Ralf Schumacher leaving the Williams HQ at Spa, but his next steps are not so clear

Schuey caught in 'greed' wrangle

Team boss Eddie Jordan has hit back at Michael Schumacher after being accused of being more interested in money than winning.

Schumacher said he did not make the remarks, attributed to him in a German newspaper article about his brother Ralf's contractual dispute with Jordan.

The article claimed Michael advised Ralf to drive for Williams next year rather than Jordan because the former is focused on winning while the latter is not.

Jordan said: 'Michael Schumacher gives the impression that he races for the love of it, but

he is the biggest money-grabber of the lot. He's doing a great job at Ferrari but he went there only because they offered him £20 million a year. It still grieves him that he had to pay us £150,000 for his first drive while Ralf came straight in as a paid racer.

'We gave Michael his first break (in 1991) when no one else would take a chance. But after one race he left us in the lurch because he was offered a better deal by Benetton.

'If it hadn't been for Jordan, he

may never have made it into F1.'

Jordan, who is talking to pay-driver Pedro Diniz about partnering Damon Hill in the team next year (see above), said: 'What right has he to accuse us of being money-grabbers?'

'I find it offensive coming from a guy who has taken so much money out of the sport. We are as ambitious as any team, and to fulfil that ambition we spend what it takes. Part of the problem we now face with Ralf is as a result of Michael's involvement.'



Schuey: denial

F1 calendar format unlikely to change

Next year's Formula 1 calendar looks certain to follow a similar format to this season's.

F1 boss Bernie Ecclestone had suggested he might move the South American races - Brazil and Argentina - from their traditional early-season dates to the end of the series. But Interlagos, home of the Brazilian Grand Prix, is understood to have been told its race will be on March 28 in 1999.

That should mean the calendar Ecclestone revealed to the teams at the end of July has proved accurate. Malaysia, the only new race, will be in October, before Japan.

Ford may go for a second team

Ford is likely to supply two teams with factory Formula 1 engines in the future.

The Blue Oval's European sport boss, Martin Whitaker, made the admission last weekend, declaring that there would be 'advantages' to two teams pushing each other along.

Ford would like to supply another team because it believes it has a good engine that is being under-used by Stewart.

Whitaker said: 'Right now we don't have that intention. But I can see it happening some way down the line. Healthy competition between teams is good.'

F1 insiders believe that Ford will supply Benetton in the year 2000 even though Stewart's exclusive works deal does not run out until the end of that season. Ford and Benetton have denied the rumours.

There has been speculation, considered wide of the mark, that the company could supply Williams with customer engines next year.

Whitaker said: 'It is important for Ford to start winning in Formula 1 and for it to be considered as a serious contender. If we can sell engines to competitive teams then we will.'

'We really need to get away from this situation where we look better if you turn the time sheets upside-down.'

News In Brief

FORMULA 1

Ralf Schumacher was questioned by Belgian police after colliding with a boy on his way into the Spa-Francorchamps circuit. The German, 23, was released without charge after the incident last Friday.

Finn Mika Salo was forced to apologise to race stewards after using abusive language following the first-lap crash at the Belgian Grand Prix. The Arrows driver, who was not able to re-start the race, went to see the stewards to give them his version of the accident and ask if he could leave the circuit. When told he could not, he swore.

Minardi's contract to use Ford V10s is expected to be confirmed imminently. The deal is likely to be called 'officially supported' to move away from the negative connotations of the term 'customer'.

Michael Schumacher had his fastest qualifying time at the Belgian GP erased after failing to slow down sufficiently for waved yellow warning flags. The decision made no difference to his grid position.

Former Formula 3000 racer Patrick Lemarie was scheduled to test for Tyrrell this week. The Frenchman is a childhood friend of Jacques Villeneuve, who will race for Tyrrell's owner BAR next year. He was expected to test yesterday (Wednesday) at Silverstone.

Former Sauber team director Max Welti, who was dropped after last season, has denied persistent rumours that he will move to Prost.

Ferrari is known to be evaluating the feasibility of using a V12 engine in F1, despite its denials at the Hungarian Grand Prix. But it remains very much a research project.

Jacques Villeneuve's race engineer Jock Clear, to whom the Canadian is close, is said to be considering an offer to move to Villeneuve's new team, British American Racing.

TOURING CARS

Former Grand Prix driver Tiff Needell earned a licence endorsement on the first corner of his British Touring Car Championship return with Nissan at Brands Hatch. His move on Ford driver Will Hoy at the start ended with the Mondeo in the gravel. The *Top Gear* presenter also renewed his rivalry with Hoy's team mate, Nigel Mansell, who called Needell an idiot after what he claimed was a brake test at Druids. 'He said, "I've forgiven you once (for their Donington collision in 1993) - I'm not going to do it again", ' joked Needell.

Vic Lee, whose team won the BTCC in 1991 and '92, reportedly has a manufacturer lined up for a planned return to the series next season.

Flat tyre could have cost Hill win

Damon Hill nearly lost the chance of giving Jordan its first Grand Prix win at the 126th attempt because of a deflating tyre.

After the race, the team discovered that there was a cracked rim on the right rear wheel of Hill's second set of tyres. The tyre was inflated only to 14 pounds per square inch (psi) when it should have been at around 19.

Jordan chief designer Mike Gascoyne said: 'When you see the rim, it's a wonder the tyre stayed up. We don't know what caused it - but it could have been something as simple as clipping a barrier.'

'It would explain why he was not

that quick in that middle stint and (team mate) Ralf (Schumacher) could close up on him.'

Hill said of his win: 'I'm very proud, and I'm extremely happy for Jordan. Those guys try and try and try, and it's never happened to them before. To win your first GP is special and you never forget it.'

Hill's victory makes Jordan only the second team outside the top four - Williams, McLaren, Ferrari and Benetton - to win a race since mid-way through 1987. The other was Ligier at Monaco in 1996.

Eddie's dream comes true Page 56



GP winners 1988-'98

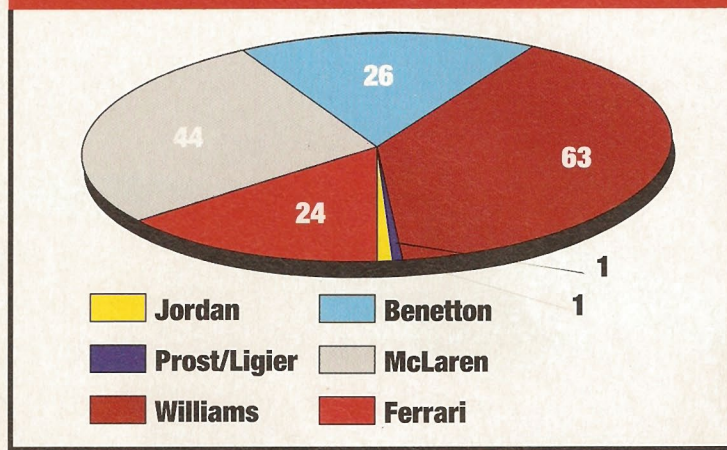

McLaren's big secret revealed

One of the technical innovations that has made the McLaren-Mercedes MP4-13 the best car of the year has been uncovered.

McLaren's title rival Ferrari has been marvelling at the ability of its opponent's cars to ride kerbs at the chicanes. This appears to be the result of a ground-breaking suspension design.

AUTOSPORT has learned that McLaren achieves the best ride of any car on the grid because its suspension can move vertically at the chassis mountings as well as at the wheel.

In conventional suspension, the push-rod that attaches the wheels

to the dampers pivots at the chassis. But McLaren has found a way of keeping the car stable while allowing the entire suspension assembly to move. In this way, each wheel's movement can be controlled independently more effectively than is normal.

A larger-than-normal hole in the chassis sides has given the game away. Usually the hole for the pushrod is small, but McLaren's is at least five centimetres high.

Without precise details it is impossible to say how McLaren controls the car's attitude. But there may be a complex link between the push-rod and the anti-roll bar.

Herbert faces Takagi threat

Briton Johnny Herbert will have to fight off a bid from Japanese rookie Toranosuke Takagi to keep his seat at Sauber for next year.

Team boss Peter Sauber is impressed by Takagi, who has started on occasion for Tyrrell this year. But with Honda deciding to postpone its entry into Formula 1 until 2000 (see page 12), the 24-year-old is facing the prospect of



Herbert: doubts

being left without a drive. Sources say Sauber's business partner, Fritz Kaiser, and sponsor Petronas, the Malaysian oil company, are both in favour of keeping Herbert. The Briton remains favourite for the seat, but the team is worried that he has not performed as well under pressure from Alesi as he did when unchallenged by team mates last season.

Alesi is rumoured to be keen on Takagi because he sees it as a way of securing a drive with Honda in the future. One drawback would be that the Japanese, like Alesi, does not have a reputation for being strong on the technical side. Takagi, who has a budget of £5 million, is also talking to Stewart and Arrows (see pages 10 and 11).

Giorgio Piola

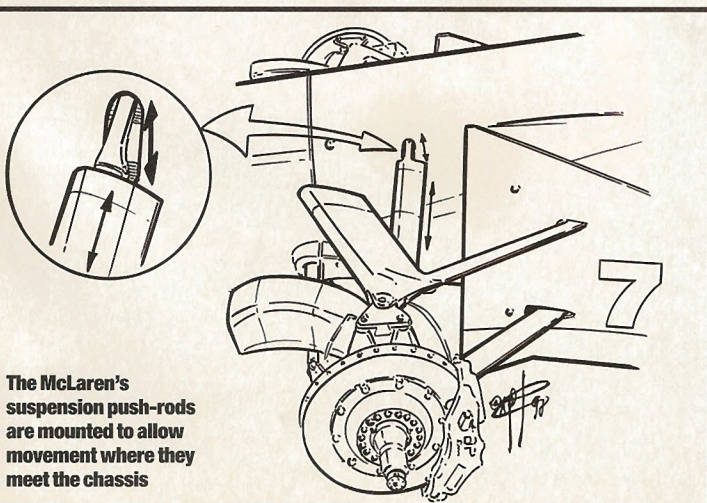

The McLaren's suspension push-rods are mounted to allow movement where they meet the chassis

The new Convertible Cam feeling of America's wide-

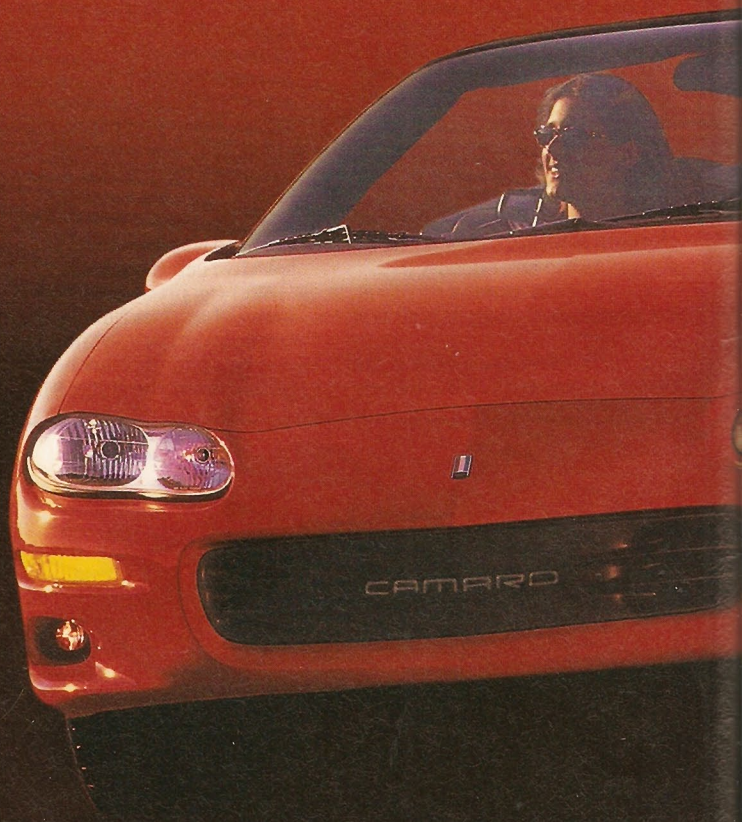

Summerfield Wilnot & Bühler

<http://www.chevroleteurope.com>

aro gives you the open spaces.



This is the new Camaro – pride of the Chevrolet Sports Car fleet. It is everything you like about America. Space. Power. Grace and ruggedness that defies description. Try the Camaro Convertible. Simply release two latches and down slips the electrically powered top. The sleek lines are now sleeker than ever. The contoured bucket seats and unobtrusive restraints will keep you riveted to your seat as you wind up the power. You'll love the deep roar of the 3.8-litre V6 193 bhp/142 kW engine.

Inside you'll get driver and passenger air bags, ABS and air conditioning as standard plus a 3 year/60,000 mile manufacturers warranty and full AA Roadside Assistance programme.

The Camaro can be yours for less than you'd imagine.

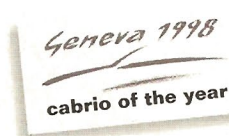

The new Camaro. Once you start driving it, you won't want to stop.

Call 0845 601 2121 for your nearest Chevrolet Retailer and ask for a test drive.

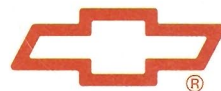

CHEVROLET®

Drivers slam start decision

Formula 1 drivers have attacked race officials' decision not to start the Belgian Grand Prix under the safety car.

Twelve cars were wrecked in one of the biggest pile-ups in Formula 1 history on the first lap of last weekend's race, which was started on a wet track and in the rain.

A safety car was used to control the pace at the start of the same race last year after a brief downpour soaked the track before the start.

This year's first-lap pile-up was caused by the McLaren of David Coulthard, who spun coming out of the first corner and careered across the track. That triggered a chain reaction that damaged 13 cars and caused the race to be stopped.

Coulthard was one of the vast majority of drivers who said the conditions were too bad not to use the safety car. All those involved in the accident said they had no idea what happened because they couldn't see anything.

Benetton's Alexander Wurz said:

'All I know is I hit something in the wet, but I don't know what it was. We were lucky no one was injured today. Twenty years ago we would have needed 11 new Grand Prix drivers for the next race.'

Damon Hill, who narrowly avoided Coulthard's car, said: 'You can't see zip. All you know is you're going 160mph and can't see your hand in front of your face.'

F1 boss Bernie Ecclestone defended his officials' decision. He said: 'We have been starting races in the wet for 30 years without a safety car. Why should this one be any different? We only lost three cars.'

The safety car was deployed on lap 27 following a number of crashes, but Jarno Trulli, who finished sixth, said he was surprised the race was allowed to start again on lap 33.

Coulthard said: 'The officials have a duty to give drivers safe racing conditions, and I felt at points in the race that conditions were unsafe. The inevitable is going to happen if you allow a race start in those conditions.'

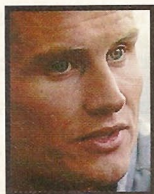

Coulthard: worry



Robert van den Brugghe/EPA



Goodyear has taken the fight to Bridgestone, but still looks set to bid the sport farewell

Goodyear pull-out looks certain

Tyre company Goodyear looks set to stick with its decision to pull out of Formula 1 at the end of this year.

Despite announcing its withdrawal from the sport last November, the American giant has continued to talk to its teams about 1999. However, sources say that there appears to be little chance of Goodyear deciding to stay in the sport and that it may even publicly re-confirm its decision this week.

Rumours had suggested that Goodyear would continue in F1 with Williams and Ferrari. The company's chief executive officer, Sam Gibara, is still talking to them.

However, the sport's rules dictate that if there are two tyre suppliers, as there are this year, then each has to be able to supply up to 40% of the teams if called upon to do so.

Until Goodyear does confirm its position, its contracted teams remain in an awkward position.

They will have to use the rival Bridgestone tyres next season, but the company is refusing to release data to them until it can be sure of Goodyear's decision. Teams are already advanced with their '99 cars, which they are having to design without any information about the tyres they will run on.

Montoya top of Stewart list

Williams test driver Juan Pablo Montoya has emerged as a leading contender to drive for the Stewart team next year.

The Colombian is said to be at the top of Stewart's list of potential drivers next year if he is not promoted to the Williams race team alongside CART champion Alex Zanardi (see right).

Montoya, who has also been linked to a Jordan seat, drove for the Stewart outfit in Formula Vauxhall in 1995.

Brazilian Rubens Barrichello is expected to see out the final year of his Stewart contract next season. He had also been linked with Williams, but his chances there are said to have faded. He is now not expected to exercise the buy-out clause in his contract, which is a reputed £2.2 million.

Others in the frame for the second Stewart seat are Johnny Herbert, current driver Jos Verstappen, Tyrrell's Toranosuke Takagi and Jordan test driver Pedro de la Rosa.

Herbert is considered most likely to stay at Sauber (see page seven), while Stewart is known to be disappointed in Verstappen's failure to match Barrichello since he replaced Jan Magnussen at June's French Grand Prix.

Stewart has an option on Verstappen's services for 1999 that runs out this month.

Zanardi agrees to join Williams

Champ Car star Alex Zanardi is said to have agreed a return to Formula 1 with Williams in 1999.

The 31-year-old is believed to have made up his mind to join the World Champion team after a trip home to Europe after the last Champ Car race to contemplate his future.

The Italian made the decision despite misgivings about leaving the atmosphere of the Ganassi team, for which he won last year's CART title.

Rumours at the Belgian Grand Prix last weekend said that the link would be announced at the Italian Grand Prix over the September 11-13 weekend. Zanardi is understood to want to clinch the CART Championship Series for a second time before announcing his move.

Mika Salo, meanwhile, has emerged as a possible team mate. Standing in the way is the Finn's contract with Arrows. The team's boss, Tom Walkinshaw, is said to be prepared to sell him for about £1.25 million.

However, it appears unlikely that Williams would want to buy a driver out of his contract.

Ralf Schumacher and Juan Pablo Montoya are also possibles.

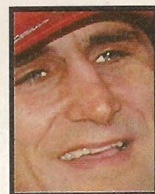

Zanardi: decision



The first-lap crash at Spa claimed no less than 12 cars. Amazingly though, no driver was seriously hurt, despite the violence of the incident



David Noels

Carnage followed David Coulthard's spin



Sutton

Trulli, Panis and Diniz walk away uninjured



Action Images

McLaren and Ferrari faced big repair bills

Zonta close to deal with BAR

McLaren test driver Ricardo Zonta looks to be on the verge of signing to partner Jacques Villeneuve at the new British American Racing team.

The 22-year-old Brazilian, the reigning Formula 3000 Champion, is said to be due to receive a contract from BAR this week.

Sources indicate, however, that there are complications. BAR boss Craig Pollock is thought initially to have been prepared to sign Zonta on a two-year contract and give McLaren the right to take him back at the end of it. But he is now said to be back-peddalling on allowing Zonta

to keep his links with McLaren.

A compromise is expected to be reached, because Pollock is under pressure to sign Zonta from Souza Cruz, the South American arm of his tobacco giant title sponsor, BAT. It is putting a lot of money into the team and wants a Brazilian driver.

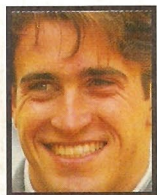

Zonta: F1 deal?

As an F1 rookie, Zonta is said not to be worried about potentially getting second-driver status.

The Brazilian is also talking to Jordan, Sauber and Minardi; BAR to Pedro Diniz, Pedro de la Rosa, Ralf Schumacher, Heinz-Harald Frentzen and Tyrrell reserve Tom Kristensen.

Arrows in struggle to keep line-up

Arrows is in danger of having to find two new drivers for next season, even though both Mika Salo and Pedro Diniz are under contract.

The Finn has moved into the frame at Williams, while Brazilian Diniz is due to have a meeting with Jordan this week.

Although the drivers' contracts last until the end of 1999, it is thought Arrows boss Tom Walkinshaw may consider selling Salo's for about £1.25 million. Pay driver Diniz is free to leave the team if he wants to.

Formula 1 boss Bernie Ecclestone is understood to be supporting Diniz's attempts to find a better team.

Diniz brings over £7 million of sponsorship to the sport and wants to move up the grid. He is thought to be concerned about Arrows' potential for '99, partly because it does not have an engine deal yet.

Toranosuke Takagi and Pedro de la Rosa are both talking to Arrows about next year.

● Arrows is facing a tough week. The accidents that befell its drivers at the Belgian Grand Prix left it with three badly damaged chassis, and it has only one undamaged car left. The team will not test this week as it works flat-out to prepare enough cars for the Italian Grand Prix, to which it must set off early next week.

Outcry over plans for more grooves

Grand Prix teams and drivers have objected to plans to introduce more grooves into tyres for 1999.

The sport's governing body, the FIA, has told teams that a fourth circumferential groove will be added for next year, as well as over 20 lateral grooves. The plans for lateral grooves, exclusively revealed in AUTOSPORT (July 2), are an attempt to keep speeds under control. Initial tests by Benetton last month suggested that they will have little effect.

Teams feel it is the wrong way to slow the cars. Many engineers and drivers believe that leaving

aerodynamic performance untouched while reducing mechanical grip is likely to lead to more accidents, as has happened this season. If a car gets out of shape, the driver does not have enough grip to catch the slide.

Damon Hill said: 'It's harder to stay on the road, but that puts more emphasis on the better drivers. I don't relish the idea of less rubber on the road. The tyres will get harder and the cars will become even more difficult to drive.'

Some suspected that the lack of mechanical grip might have had an influence on the huge crashes

suffered by Jacques Villeneuve and Mika Salo at the Belgian Grand Prix.

Teams are also worried that the tyre change has come too late. They will probably have to re-think their 1999 designs, on which they are well advanced.

Bigger changes are planned for 2000. There are proposals to ban diffusers, which account for as much as 40% of a car's aerodynamic downforce, and high noses.

Teams are also discussing freeing up electronics in the areas of differentials and traction control for '99. This follows a series of bitter disputes this year.

Tyre proposals

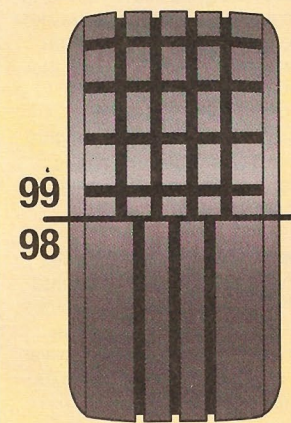

Graphic: Jim Bamber

News In Brief

TOURING CARS

Peugeot UK sports boss Mick Linford is still waiting to hear if he can use French-built 406s in next season's BTCC. 'We've got to be confident we have a car that will run in the top half-dozen,' he said. 'I believe that the only way we can achieve that is to have some heavy French involvement.'

Formula 1 safety car driver Oliver Gavin is among those linked with a potential BTCC seat next season. Gavin, the 1995 British Formula 3 Champion, is said to be on Nissan's list of drivers under consideration.

Among drivers talking to BTCC teams at Brands Hatch were former F1 racer Julian Bailey, TVR Tuscan Champion Bobby Verdon-Roe, Belgian Procar ace Vincent Radermecker and British Renault Spider Champion Bryce Wilson.

A Finnish delegation met BTCC boss Alan Gow at Brands Hatch during Friday's test day. The Helsinki street race is currently vying with the Bathurst 1000 - which Gow helps organise - for the title of Touring Car World Cup in 1999.

Dave Kelly, an engineer at works Vauxhall team Triple Eight, assisted independent Vectra driver Mark Lemmer at Brands Hatch. Bruno Schneider, employed by Triple Eight to engineer Lemmer, has now left the team.

GT Porsche racer Michael Bartels (below, right) finished on the podium on only his second German Super Touring outing of the season at the Salzburgring on Sunday. Bartels's Peugeot 406 was third at the Austrian track.

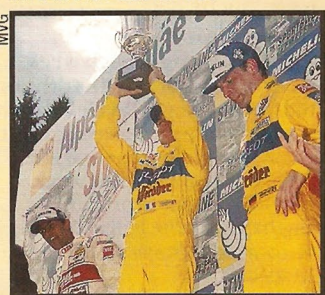

CHAMP CARS

Winless Champ Car ace Bryan Herta set fastest time in a big two-day test at the Laguna Seca road course last weekend. Herta's Team Rahal Reynard-Ford broke the track record, and was chased by Canadian Greg Moore's Forsythe Reynard-Mercedes and series leader Alex Zanardi's Ganassi Reynard-Honda.

Argentinian former Grand Prix star Carlos Reutemann has accepted an offer to test a Champ Car for the Della Penna Motorsports team. Team owner John Della Penna was born in Argentina and plans to run Reutemann in October.

GP duo survive big Spa shunts

World Champion Jacques Villeneuve and close friend Mika Salo have both survived the biggest accidents of their Grand Prix careers.

Both men crashed at Formula 1's most challenging corner, Eau Rouge, during practice for last weekend's Belgian Grand Prix. The left-right-left swerves are generally taken at over 180mph.

The accidents underlined the effectiveness of stringent safety measures introduced into F1 since the death of Ayrton Senna in 1994. Arrows driver Salo was told by doctors that he would probably not have survived the accident had it happened before 1996, when side-impact cockpit protection was introduced.

The 31-year-old Finn climbed out of his car unaided, but suffered concussion after smashing side-on into the barriers on the right-handed part of the corner. He was taken to hospital and given a brain scan before being declared fit.

Arrows did not know as AUTOSPORT went to press whether the accident was caused by

driver error or suspension failure.

Salo said: 'It all happened so quickly. The car had been so nice through there all weekend, and I had been nearly flat from the start. But that lap I turned in and it went 360 degrees immediately and then hit the wall. I remember everything until I saw the tyre wall coming towards me, and my next memory is being in the medical centre.'

Throughout Sunday Salo suffered a bad headache, and a swollen tongue after biting it in the accident.

Villeneuve lost control slightly later than Salo and spun up the hill, hitting the barriers rear-first. He escaped with a bruised knee.

The Canadian said: 'I just lost it. I thought: "This one could hurt." But it didn't. That's my best crash in F1, but I've had bigger ones on ovals.'

Villeneuve was trying to go too quickly on used tyres and race levels of fuel.

'We didn't have the right set-up when I tried it flat the first time,' he said, 'and the cool conditions meant it was more difficult to lean on the tyres.'



Salo: concussed

Safety first

Tyre wall plays a vital part in reducing risks at daunting Eau Rouge

Formula 1 drivers and engineers praised safety at Eau Rouge corner following the crashes of Jacques Villeneuve and Mika Salo.

The accidents were the first F1 crashes at Eau Rouge since Alex Zanardi - who is expected to replace Villeneuve at Williams next year - crashed his Lotus there in 1993 following active suspension failure. The Italian missed the rest of the year after the head-on crash.

Both Villeneuve and Salo were able to drive again last weekend after quick medical check-ups. The gravel

traps at Eau Rouge have been increased in size, and the tyre wall has been given extra cushioning.

Sauber driver Jean Alesi said: 'The tyres did a really good job of slowing Jacques's car, even though he hit them very hard.'

But some expressed concern. Benetton technical director Pat Symonds said: 'The worrying thing was the speed at which the car skipped over the gravel trap and the fact that it had lost so little speed before hitting the barrier. But the barrier did a good job.'



Terrorist threat to top names in F1

Michael Schumacher and Formula 1 boss Bernie Ecclestone have received threats claimed to be from Islamic terrorists.

Two unnamed groups sent the warnings on the eve of the Belgian Grand Prix. One was a death threat against 67-year-old Ecclestone, to be carried out unless he donated £170,000 to the charity Medecins sans Frontieres in Sudan.

The other was a letter that appeared to come from South America threatening to sabotage Michael Schumacher's Ferrari. Security was stepped up but Belgian police thought both were hoaxes.

Honda to name 2000 for F1 entry

Honda is expected to announce a return to Formula 1 in the year 2000 at its 50th anniversary party to be held next month.

The Japanese giant has decided to postpone a 1999 entry with its own car following a feasibility study. The decision to wait, predicted in AUTOSPORT (August 6), has been made to ensure the company is fully prepared.

F1 boss Bernie Ecclestone had been pushing Honda to enter in 1999 by saying he could not guarantee a place in 2000 because the sport's commercial structure is based on a maximum of 12 teams.

It is said, however, that Ecclestone back-pedalled because he did not want Honda to struggle in its first season. That, he feared, might put off other Japanese makes - Toyota in particular - looking at F1.

Honda will begin testing next year with a car commissioned from Italian manufacturer Dallara.

It is unclear who will drive. Although Japanese Tyrrell driver Toranosuke Takagi has been mentioned, he is rumoured to be not highly-rated by Honda. Sauber's Jean Alesi,

meanwhile, has been tipped as a possible race driver for 2000.

Many insiders had thought the Nakajima planning team - run by Tyrrell sporting director Satoru Nakajima, a former Honda-supported F1 driver - would head up the programme, but it is now understood that this will not happen.

Instead, Honda will put together the team itself. Harvey Postlethwaite, 54-year-old Tyrrell managing director, is expected to be employed as technical consultant.

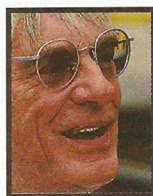

Ecclestone: fears

Designer joins Menu at Ford

Ford's new British Touring Car Championship team has pulled off another shock signing for 1999.

Only last week it was announced that star names Alain Menu and Anthony Reid had defected from the Williams Renault and Nissan teams respectively to drive the Mondeos next year.

Now comes the revelation that the man who designed this year's Laguna for Williams has upped sticks to join Menu at the Prodrive-run team.

Mark Ellis handed in his notice at Williams, where he had already started work on the '99 Laguna, last week. It is unclear when he will be able to start at Prodrive.

Prodrive's competitions chief David Lapworth said of the move: 'The precise roles haven't been defined yet, but we'd like him to be the chief designer.'

Menu, who was engineered by Ellis from 1995 to '97, added: 'I'm pleased: Mark knows what a winning Super Tourer is.'

Sister firm Prodrive Engineering has already started aerodynamic tests at the MIRA proving ground on a '98 Mondeo, which it returned to current race team West Surrey Racing just before the Brands Hatch BTCC round last weekend.

Design staffer George Howard Chappell, a former club racer, is believed to have driven the car.

Villeneuve's car ended up embedded in the tyre wall after his 180mph shunt at Eau Rouge. Inset: doctors said Salo was saved by the 1996 rule changes which strengthened cockpit sides

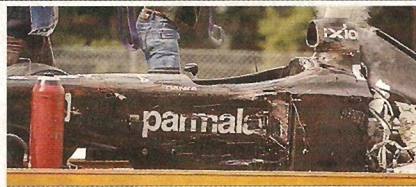

Anderson set for Arrows move

Jordan technical director Gary Anderson is to quit the team he helped form to join Arrows.

Sources say the 47-year-old has already committed to Arrows and that the decision will be confirmed early next week. The Irishman has also been courted by Prost.

Anderson has been with Jordan since it was launched in time for the 1991 season. But he and the team have increasingly been at loggerheads this year.

Jordan bosses are said to have wanted Anderson to stay, but only if he agreed to share out his responsibilities more. He has a reputation for poor delegation.

Tensions between the team and its technical director increased earlier this season when the car proved off the pace. But it has taken great strides forward following the introduction of an urgent programme to address its problems.

Former Tyrrell man Mike Gascoyne, who joined the team in July as chief designer, is expected to take on Anderson's role.

Prost, meanwhile, is widely expected to join forces with John Barnard, who quit as Arrows technical director in July.

The team is said to have been talking to Anderson because it was worried about Barnard's reputation for designing beautifully-detailed but very expensive cars.

Mansell hints at BTCC pull-out

Nigel Mansell hinted that he may not contest the final meeting in this season's British Touring Car Championship at Silverstone.

The 1992 World Champion crashed out of both races in a disastrous second BTCC outing at Brands Hatch on Monday.

'I hope I race (at Silverstone on September 20),' said Mansell. 'I'll wait and see. I'm just pleased to see I'm in one piece.' A Ford spokesman said Mansell would compete.

Mansell went out on Graham Hill on the first lap of the sprint race when his Ford Mondeo collided with independent driver Mark

Lemmer's Vauxhall Vectra.

In the feature race, he was involved in a clash with the Nissan of Tiff Needell, the man he blamed for the accident which hospitalised him in the TOCA Shoot-Out at Donington Park in 1993. He was then turfed off the road by the Honda of Peter Kox, who was lapping him.

Mansell said: 'I had a great start in the first race. Then I was nudged up the back.'

'In the second race I was just trying to keep out of everyone's way. Then I was nudged off again.'

Kox said: 'I respect him a lot as a racing driver, but he was all over the place on the track.'

Lemmer said: 'Nigel got on the outside out of Druids. All he had to do was go downhill and claim the next corner, but he came across. I don't know where he thought I'd disappeared to.'

Mansell himself criticised the Mondeo, implying that Ford is concentrating too much on its higher-profile

1999 programme: 'The car's just not competitive and there's no smokescreen to disguise it.'

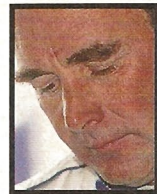

Mansell: nudged



Mansell lasted less than a lap in the sprint race before a collision with Mark Lemmer put them both out

Sutton

Rydell escapes ban for assault

British Touring Car Championship leader Rickard Rydell has escaped a ban following an assault on title rival Nissan Reid at Brands Hatch.

The Volvo star was shoved out of the lead of Monday's feature race by Nissan racer Reid five laps from the finish. Rydell then remonstrated with the Scot in *parc ferme*.

The stories of Reid and Rydell vary. Reid claims the Swede grabbed him by the scruff of the neck and pushed his head back. Rydell said he leaned into the Nissan to talk to Reid, and held him by the overalls because 'I didn't want him to get out until I'd spoken to him.'

The stewards severely reprimanded Rydell and imposed a £2000 fine. 'We consider it a matter of grave concern and wholly unacceptable,' said their verdict.

'We have taken into account that Rydell was clearly aggrieved by an on-track incident with Reid, the assault occurred immediately after the race, the assault was minor and consisted of holding and pushing Reid as opposed to actual violence.

The offence was out of character, and Rydell has apologised and shown remorse.'

Rydell accepted the punishment. 'You should be calm,' he said. 'I've spoken to Anthony a lot. We've shaken hands and there's no problem.'

Reid was penalised two seconds, which gave the win to the Volvo and dropped the Nissan to second. It also gave Rydell a 33-point title lead over Reid with four races left.

Reid was unhappy with the verdict, upheld on appeal to the stewards of the meeting. 'The signal that gives me is it's better to punt someone completely off the circuit,' he said. 'That way, all you will get is a licence endorsement and a fine. It has serious implications.'

Nissan had until Tuesday lunchtime to appeal both cases - Rydell's for being too lenient and Reid's for being too harsh - to the RACMSA, British motorsport's governing body.

Brands BTCC report Page 28



Rydell: punished

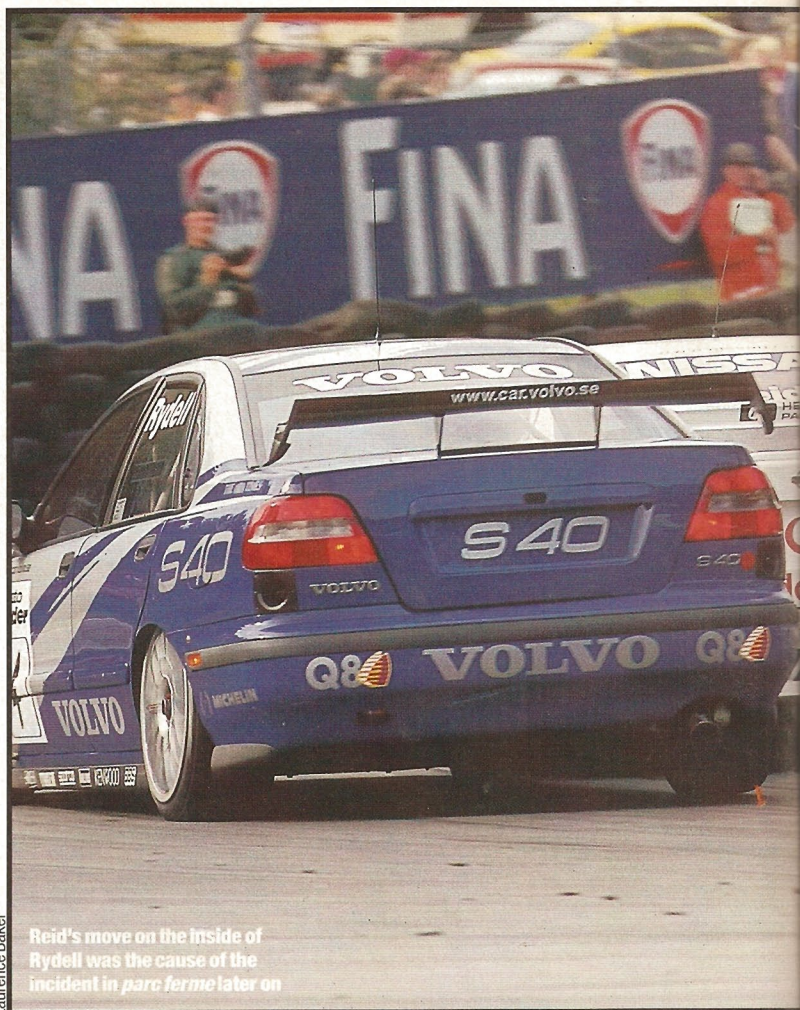

Laurence Baker

Reid's move on the inside of Rydell was the cause of the incident in *parc ferme* later on

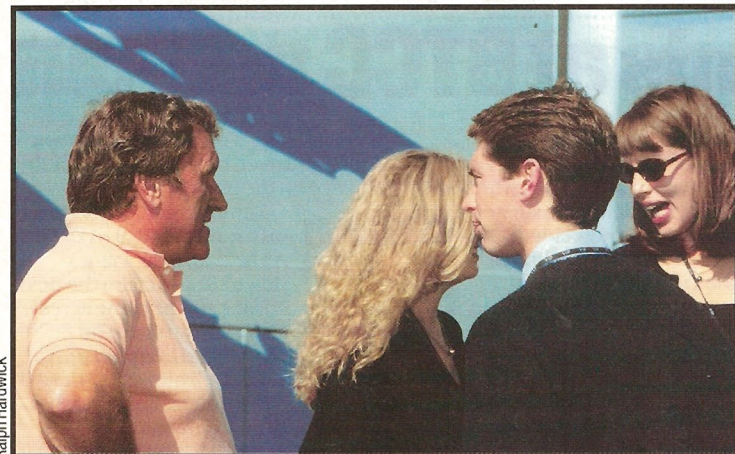

Ralph Hardwick

REIGNING BRITISH FORMULA 3 Champion Jonny Kane (right) could switch to touring cars. Northern Irishman Kane, who raced a Honda tin-top once last season, spoke to Volvo boss Tom Walkinshaw (left), Nissan, Renault and Peugeot at the Brands Hatch meeting

Nissan in offer for Thompson

Honda star James Thompson is believed to have had an offer from Nissan to join its touring car team for 1999.

However, the Englishman, one of the few men capable of filling the shoes of Ford-bound Anthony Reid, says he is committed to a third season with Honda.

'I've had offers from a lot of teams,' said Thompson, 'but I'm not moving anywhere. I've got no reason to. It's flattering, but I know next year's Honda's going to be fabulous. It's being built at the moment and I've already sat in it.'

Nissan is also known to be interested in Italian star Gabriele Tarquini. The ex-Formula 1 driver is

being courted by the Williams Renault outfit too.

Nissan works team boss Ray Mallock would only say: 'Any name that you throw at us could be correct.'

Honda, meanwhile, is yet to decide which team will take over its race programme from Prodrive in 1999. Some insiders still think the make will swap with Ford and appoint the Blue Oval's outgoing team, West Surrey Racing.

Italian squad JAS, which runs Honda's German effort, Formula 3 perennial Alan Docking Racing and even the Audi Sport UK operation (see top right) are believed to be the other contenders.

Renault wants Jones for BTCC

Former World Champion Alan Jones could still race in the final round of this year's British Touring Car Championship.

The Australian, who took the Formula 1 world title in 1980, is being lined up by Renault UK for the Silverstone meeting on September 20. However, he will only be entered if the team cannot win either the drivers' or manufacturers' titles.

Laguna driver Alain Menu lies third in the drivers' standings, almost out of contention. However, Renault is only 15 points behind Nissan in the manufacturers'

rankings, and would only be out of the reckoning if it dropped over 30 points behind in the penultimate meeting at Oulton Park next weekend.

Jones drove for the Williams-run Renault team in last year's Bathurst 1000. His participation would please series boss Alan Gow, who wants to set up other World Champions against part-time Ford driver Nigel Mansell in a match race.

As well as Menu, regular team mate Jason Plato and Jones, Williams could field a fourth car for

independent Renault Laguna racer Tommy Rustad, if the Norwegian clinches the indie title at Oulton.

That would enable the DC Cook Motorsport team, which runs Rustad, to enter Formula 3 racer Paula Cook - daughter of team owner Derek.

Rustad, placed at DCCM by Williams, is tipped as a potential number two to Plato at the works team.

'If I'm in a position to talk to them for next year it would be good to test with Alain and Jason,' said Rustad.



Jones: in frame

Menu ban suspended until end of season

Reigning British Touring Car Champion Alain Menu's race ban has been suspended until December 31.

The Swiss got his third licence endorsement of the year two weeks ago at Knockhill. However, he was put on a good behaviour bond by British motorsport's governing body, the RACMSA, last week.

The reprieve means that Williams Renault driver Menu, third in the standings, must avoid incidents.

'If I want to finish the season I've got to be careful,' he said, 'but even if you're careful you could still end up in trouble.'

ONLINE

KEEP ON TRACK

FOLLOW THE NEWS AS IT HAPPENS

AUTOSPORT ON AOL

Watch out for all the news Online first. To get your free AOL pack call 0800 279 1234 and don't forget to mention AUTOSPORT!

(please allow 2 weeks for delivery)

To receive **AUTOSPORT** Online, all you need is a PC and a modem. Simply call AOL on **0800 279 1234** mentioning **AUTOSPORT** and they will send you your free software. Because this is not a web site, there is no address as such. You merely type in keyword **'AUTOSPORT'** or find us in the sport section on the main AOL menu. With your free disc comes 10 hours free. Costs for AOL are £4.95 per month with 3 hours free, £2.35 per hour. Unlimited monthly access £16.95, unlimited annual access £179.40



Audi on verge of series withdrawal

Audi's future in the British Touring Car Championship is hanging in the balance.

The decision on whether to continue or quit is likely to be taken this month. Audi UK director Len Hunt said last weekend: 'We're having a big meeting, probably in September. We're committed to motorsport and want to carry on in whatever shape or form.'

The German make has had a disappointing season with its front-wheel-drive A4s, and has failed to match the glory days of the

four-wheel-drive quattro from the two previous seasons.

Audi Sport UK, which was set up at the end of 1995 to run the make's BTCC effort, is considering other options.

The team has expressed interest in taking over the Honda race team deal, and is holding out to operate Audi's Le Mans sportscar squad.

Team director John Wickham said: 'I had one discussion with Honda some time ago but I haven't heard anything since. It's very open.'

'We're discussing the sportscar, but nothing will be decided yet.'

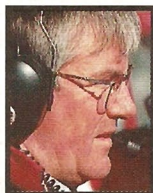

Wickham: talks

Harvey in Volvo for Bathurst

Peugeot driver Tim Harvey has been drafted into Volvo's line-up for next month's Bathurst 1000.

Harvey, 36, will join two-time Swedish Touring Car Champion Jan Nilsson in the second of the TWR Volvo S40s. They will back up the lead entry of British Touring Car Championship leader Rickard Rydell and veteran Jim Richards.

He replaces Gianni Morbidelli, who was unable to reach a financial agreement to contest the race.

Harvey, who has had three miserable seasons with Peugeot since leaving Volvo, is hoping the drive in the October 4 race could

lead to a promotion back into one of the BTCC's top teams.

'I'm delighted about the chance,' he said. 'I'd love to drive the Volvo next year. In '95 I was fifth in the championship and won two races. They haven't come close to that (with their second driver) since - me and Rickard could win the manufacturers' championship.'

Volvo sports boss Anders Kull said not to read too much into the drive. 'Driver choice is something we don't connect to Bathurst,' he said. 'We know Tim from before and he did well for Peugeot at Bathurst last year.'

Muller ready to sign for Vauxhall

Audi star Yvan Muller will join Vauxhall for next season's British Touring Car Championship.

The 29-year-old is understood to have told Nissan last week that he was unable to drive what is regarded as the top car in the series because he has already agreed to race for Vauxhall.

It is just one offer that Muller, highly-regarded in the BTCC paddock and tipped as a champion in the making, has rejected.

Frenchman Muller, believed to be signing this week, said: 'Maybe - it's a possibility. I have not signed with anybody yet - I have different proposals available.'

'During the last week I have heard I have signed with all sorts of teams, so maybe I can do one race with each. I don't need fuss. I just need to take my decision quietly.'

Despite Muller's flippancy, it is thought certain that he will line up in a Vectra run by works team Triple Eight, alongside two-time BTCC Champion John Cleland. That would leave Triple Eight co-owner Derek Warwick out of a drive, and could well force him to sell his shares in the team or face ending his racing career.

Cleland's attitude to his incident with Warwick at Knockhill two weeks ago, when the Scot hit the barriers and the former Grand Prix driver won, has reportedly irritated Vauxhall. Cleland is still insisting that his team mate was at fault, but is nevertheless thought likely to re-sign for an 11th season with the marque.

'I honestly haven't got a clue about next year - straight up,' he claimed.

Vauxhall sports boss Mike Nicholson was on holiday and unavailable for comment.



Muller: switch

Neal in secondary squad link

Nissan has played down reports that it could run a second two-car junior team in next season's British Touring Car Championship.

Alec Poole, touring car boss of Nissan Motorsports Europe, said the 'Nissan junior team' tag was coined to find backing for a team to do the Bathurst 1000.

Stories suggest, however, that Team Dynamics, which runs AUTOSPORT Cup independent Matt Neal in a year-old Primera, could run Neal and Nissan tester Steven Richards in the secondary squad next season.

Neal said: 'There has been talk about it. I'm obviously keen to fill Anthony (Reid)'s shoes in a works Nissan, and that's a reason they've given me for possibly not getting the drive.'

Depending on sponsorship, Richards and Neal will race at Bathurst in the factory Primera which *Top Gear* presenter Tiff Needell drove at Brands Hatch last weekend.

It will be fielded by Team Dynamics, with help from works Nissan team Ray Mallock Limited. This will be Neal's first run in a 1998 Nissan.



Neal: works seat?

Morbidelli looks to Champ Car drive

Volvo touring car driver Gianni Morbidelli is looking for a drive in the CART Championship Series.

The former Ferrari, Arrows and Minardi Formula 1 racer has had a bad season in the British Touring Car Championship and is looking at several different series.

'I am talking to Champ Car teams,' said the 30-year-old Italian. 'I am also talking with some teams in F1, because maybe there is a chance to be a test driver again, and I'd even like the chance to have a better season in the BTCC. I'm looking around 360 degrees - I'm taking a very large view.'

News In Brief

IRL

US motorsport power-broker Roger Penske has joined in the debate on peace between the CART Championship Series and the breakaway Indy Racing League. 'I indicated to Tony George (IRL boss) that it was in everyone's interest to get back together,' he said. Penske is reported to have proposed a three-litre naturally-aspirated engine formula to unite the two series.

A wheel flew into a grandstand during the IRL race at Atlanta on Saturday night, but no one was hurt. The cars of Billy Boat and Steve Knapp collided on the back stretch. Luckily, the stands there were closed and the only damage was to the empty seats.

Inaugural IRL co-champion Scott Sharp and regular runner Mark Dismore will drive for the Kelley Racing team until the end of 2000. Sharp has had two wins for Kelley this season.

SPORTSCARS

International sportscar racing could return to Mexico City for the first time since 1991. The Autodromo Hermanos Rodriguez is in talks with US motorsport magnate Don Panoz to host a round of the new American Le Mans Series next year. A date in the series has been pencilled in for September 12 next year.

The French ORECA team, Chrysler's factory squad, will build a limited run of GT2 Viper GTS-Rs for customers. ORECA expects to build about four chassis, priced at £200,000.

Rumours that the Homestead round of the FIA GT Championship scheduled for October 18 is in doubt are wide of the mark. A spokesman for the circuit said: 'We are proceeding with the plans for the race. There are no difficulties.'

Ex-Formula 3000 racer Phil Andrews is expected to team up with former tin-top racers Patrick Watts and Charlie Cox in the semi-works Saleen Mustang Ford run by the British GP Motorsport team at Donington this weekend. The same line-up is expected to contest the A1-Ring round on September 12.

FORMULA 3000

Portuguese F3000 racer Rui Aguas was unable to join the Redman Bright team for the Spa race on Saturday because sponsorship failed to materialise. Briton David Cook is due to return to the team at Enna in Italy this weekend.

Malaysia could host a round of the F3000 International Championship next season, according to rumour. A race at the Sepang circuit could become the series' first venture outside Europe in its 15-year history.

Papis gets Rahal dream drive

Italian Max Papis is the surprise signing for Champ Car front-running outfit Team Rahal.

The 28-year-old has agreed a multi-year deal to drive alongside American Bryan Herta in the two-car team.

Three-time Indycar champion and team boss Bobby Rahal will be retiring from the cockpit at the end of the season, paving the way for a new second driver.

'This is an amazing opportunity,' said Papis, who made his name in America in 1996 by finishing second in the US-based World Sports Car Series.

Papis, who drove in seven Grands Prix for Arrows in 1995, is an unexpected choice for the seat.

Rising Champ Car star Richie Hearn and Williams Formula 1 driver Heinz-Harald Frentzen had been linked to the drive.

An ex-Formula 1 driver, Papis entered Champ Cars in 1996 when he replaced the late Jeff Krosnoff at the Arciero-Wells team. Since then, the outfit has struggled with the uncompetitive Toyota engine.

Papis said: 'Driving for a front-

runner like Team Rahal has been my dream since coming to Champ Cars.' Rahal added: 'Max hasn't been able to show his true colours in a Champ Car.'

'His ability to perform well in a development programme led us to believe he's a good bet to do well in the environment our team can provide.'

Rahal, who starts testing Papis in November, said of the long-term deal: 'One-year contracts don't do anybody any good. I hope that our relationship will extend for many years to come.'



Papis: delighted



SWEDE KENNY BRACK HAS completed an Indy Racing League hat-trick with a third consecutive win at Atlanta Motor Speedway. Brack, who drives for American racing motorsports legend A.J. Foyt (left), now leads the IRL standings with two rounds to go. 'It's terrific for me, the team and the fans,' said Brack after Saturday's night race. Full report, page 67

Le Mans veteran calls it a day

Touring car legend and three-time Le Mans 24 Hours winner Klaus Ludwig will retire from racing at the end of the season.

The 48-year-old said that it had been his plan to stop driving since the beginning of the year.

'I made up my mind some time ago,' said Ludwig, who started his competition career in a BMW in 1970, 'but I didn't want to announce it before and have some kind of farewell tour. I'm getting near 50 and the cars are getting too fast. I'm having a fantastic season, so it's a good time to go.'

The German has won two races with AMG Mercedes in this

year's FIA GT Championship. But he said his inability to match the pace of team mates Bernd Schneider and Ricardo Zonta this year was another indication that it was time to stop.

Ludwig is probably best known for his successes in powerful touring cars. In the late-'70s he twice won the German Group 5 tin-top title before going on to win three German Touring Car Championship titles.

He vowed that his retirement after the Laguna Seca FIA GT race in October would be permanent. 'Hopefully I can now do something else in this sport,' he said.

Vasser signs again for Ganassi Racing

Former Champ Car title winner Jimmy Vasser has re-signed for a fifth season with Chip Ganassi Racing.

Team boss Ganassi refused to confirm the deal, expected to be announced this week, but said: 'Vasser and (Formula 1-bound Alex) Zanardi are the guys I want.'

After a disappointing 1997, when he played second fiddle to team mate Zanardi, Vasser had indicated he wanted to leave. But following a return to form this year, the 32-year-old has decided to stay.

Vasser, who has won twice this year, lies second in the points to Zanardi with five CART rounds left.

GT factories given weight penalty

Porsche and Mercedes have been handed a draconian weight penalty to try to close up the action in the FIA GT Championship.

The AMG Mercedes and factory Porsches will have to carry 50kg of ballast for the remaining four rounds of the FIA series, starting this weekend at Donington Park.

Series boss Stephane Ratel said: 'We came to the conclusion that the best way to bring the field together was to slow the factory cars a little.'

The move has the support of both manufacturers. Mercedes sports boss Norbert Haug said: 'In the times of Class 1 touring cars,

there were already concessions to create more exciting racing - we have no problem with this.'

His counterpart at Porsche, Herbert Ampferer, said: 'Anything reducing the gap between the top four and the rest of the grid can only be good for the series.'

Ampferer said he next expected his cars, which have yet to beat Mercedes this year, to be brought closer to his Stuttgart rivals.

And he welcomed the decision to penalise the Porsches as well as the unbeaten Mercedes.

Jean-Paul Driot, boss of the DAMS Panoz team, also praised the move. He explained that it would have

been foolish to try to bring GT1's 'second division' - DAMS, Zakspeed Porsche and Persson Mercedes - up to the factory cars. 'At the moment we are all quite well balanced,' he said.

But the move hasn't won universal praise. One of the eight factory drivers described it as 'a stupid idea'. He said: 'It wouldn't matter if you gave Porsche and Mercedes 100kg; no one else stands a chance.'



Haug: no problem

Donington Park



**FIA GRAND TOURING CAR
CHAMPIONSHIP
Sunday September 6 1998**

Starts 12.00 Noon - 500 kms

**Supported by:
FIA CUP FOR THOROUGHBRED GRAND PRIX CARS
OPEN FORTUNA BY NISSAN
LAMBORGHINI CUP**

**Admission: Adults £17 (£15 in Advance) - Accompanied Children (15 yrs and under) FREE
3 Day Entrance/Paddock Pass: £25**

Saturday 5th September: Qualifying & FIA European Historic Car Championship Races - Trackside admission £6

Friday 4th September: Qualifying for all races - Trackside admission FREE



PHOTOS: MICK WALKER

**CREDIT CARD HOTLINE 0115 912 9124
CIRCUIT OFFICE 01332 810048**

(Credit Card bookings may incur a handling/postage fee)

SEE THE BTCC FINALE WITH THERAMED 2 IN 1

Silverstone, September 20, 1998



The 1998 *AutoTrader* British Touring Car Championship has seen Theramed 2 in 1, the unique antibacterial liquid toothpaste and mouthwash, extend its successful sponsorship of the Vauxhall Sport team

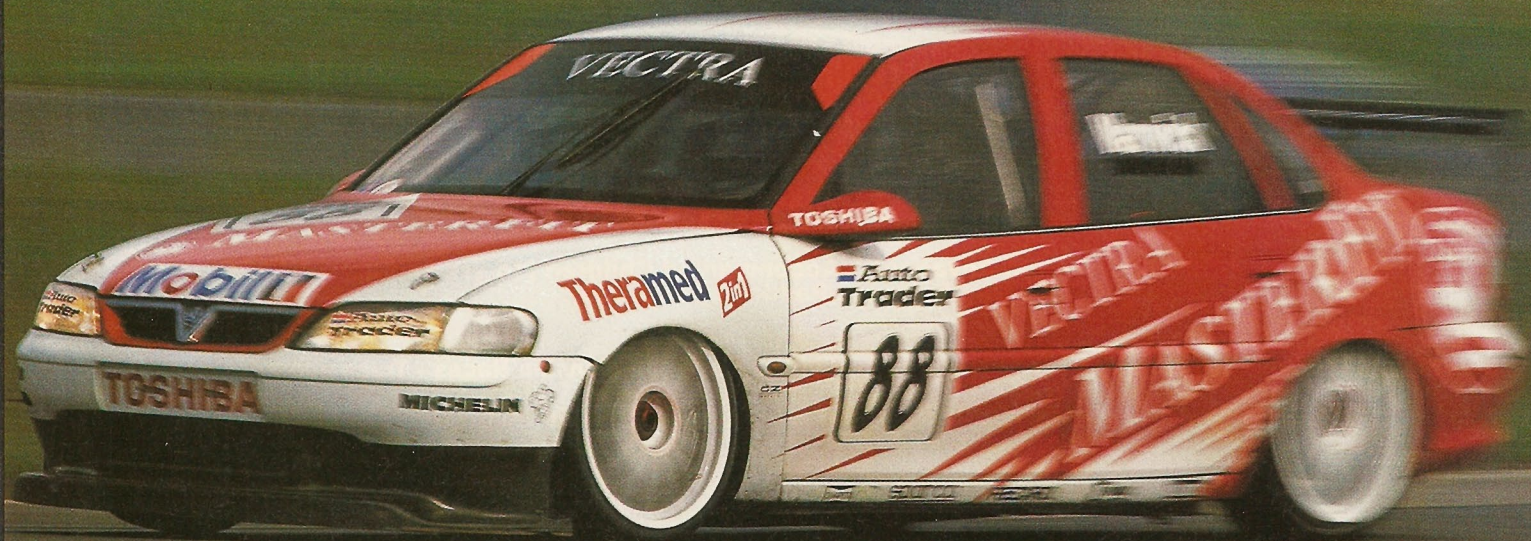

COMPETITION

For this year Theramed's presence has not only been confined to the track. A 20ft-high inflatable Theramed bottle has become a regular presence trackside drawing in fans to sample a hefty 50,000 trial packs of Cool mint, and Fresh Mint through the season.

The Theramed promotional team also distributed approximately 50,000 'Z cards' which featured a light-hearted survey and a competition offering a chance to win a sporty Vauxhall Tigra.

The results of the survey make interesting reading!

Theramed's vital statistics show four out of five BTCC fans saying their love lives are firing – if not on all cylinders, at least firing.

30% of men and 44% of women claim F1 status (glamorous and exciting) while a hopeful 18% of men and a more realistic 7% of women claim Le Mans standard performance (24-hour endurance).

27% of men admit their encounters are like Rally cars – 'quick and dirty' compared to 18% of women. Perhaps more worrying are the 6% of women and 4% of men who confess to the prowess of a dragster (all over in seconds).

When asked what car would represent their ideal man/woman, 46% of men and 33% of women felt they would be a Porsche Cabriolet 'an open top sports model'. Next most popular were VW Beetles 'fun and lively, not too serious'. The other options, Rolls-Royce's – 'loads of money, but not that exciting'; and Morris Minors – 'reliable, stands the test of time' – had little support from the fast-moving fans.

Perhaps the most controversial question was 'who are the worst drivers?' Back seat drivers were named and shamed roughly equally by men (15%) and women (18%), while 20% of men and 10% of women blamed Sunday drivers. We may live in a more equal society, but it's different on the roads: 60% of men said that women were the worst, while 75% of women accused men!

John Cleland and Derek Warwick return to the BTCC fray with the Theramed 2 in 1-backed Vauxhall Sport team at Silverstone on Sunday, September 20.

THERAMED IS OFFERING 10 PAIRS OF TICKETS TO READERS WHO CORRECTLY ANSWER THE FOLLOWING QUESTIONS.

1. How many victories has the Vauxhall Sport team scored during the 1998 BTCC?
2. According to the Theramed survey, what car did 33% of women feel represented their ideal partner?
3. What percentage of men surveyed thought that Sunday drivers were the 'worst drivers'?

Send entries to: Theramed 2 in 1 Competition, AUTOSPORT Magazine, 38-42 Hampton Road, Teddington, Middlesex TW11 0JE

Theramed
COMPLETE CARE 2in1



Rules boost for sports racers

Le Mans will hand the initiative back to open-top sports racing cars when it announces the rules for next year's 24 Hours in October.

Sports racers such as BMW's V12 LM and the Joest Porsche will get two vital concessions compared with their rivals in the GT class.

At the same time as increasing fuel capacity from 80 to 90 litres for the LMP1 sports racing class, the new top GT division, GT1-P, will have its tankage reduced from 100 to 90 litres. Secondly, Le Mans will allow the open cars to run with a rear diffuser for the first time.

Coupled with the planned ban

on anti-lock brakes and traction control in GT1-P, the new rules will give the sports racers a clear advantage in next year's race, according to a number of leading engineers.

One Le Mans-winning designer described the rules as 'the kiss of death for the GT cars'.

Porsche motorsport boss Herbert Ampferer said: 'I feel that the rules were well balanced; this will upset that balance'.

He explained that giving LMP1 chassis a performance break on the

basis of this year's race, which was dominated by GT cars, was a mistake. 'From my point of view BMW (the top marque in LMP1) wasn't ready for 1998,' he said, 'so it didn't show the potential of its new car. I'm sure we'll see it next year.'

Le Mans rules boss Alain Bertaut, a known fan of the open cars, is understood to have wanted to even out the differences in regulations between the two classes because he acknowledges that GT1-Ps are now pure-bred sports racers.



Ampferer: error

GONZALO RODRIGUEZ SCORED HIS first Formula 3000 win in the Belgian GP support race at Spa. The Uruguayan (right) said: 'I hope it will help me on the way to my dream of becoming the first Uruguayan Formula 1 driver of the modern era'

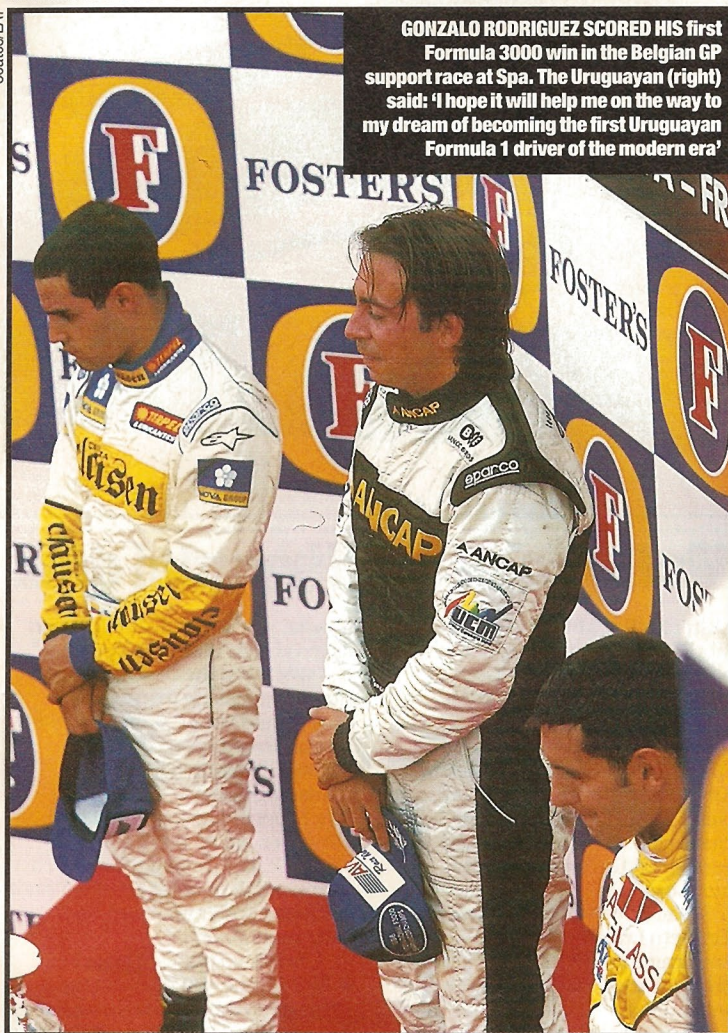

Coates/LAT

Nissan goes for open-top racer

Next year's Nissan Le Mans challenger looks certain to be an open-top sports racing car.

The Japanese marque, which finished third in the French endurance with a TWR-built GT1 car this year, is said to have decided to swap classes for reasons of time and cost.

No news has been forthcoming from Nissan apart from its decision to return to Le Mans next year, but it is known that veteran designer Nigel Stroud is penning an open-top LMP1. Only a major rules U-turn from Le Mans is likely to result in Nissan returning to the GT route.

Although Stroud has a big reputation in Japan as the designer of the Le Mans-winning Mazda 787B of 1991, it appears he has been retained by G-Force. The British constructor, builder of Indy Racing League and Formula Nippon cars, has confirmed that it is a 'consultant and subcontractor' for the project.

Indications are that Stroud is designing the car around a new engine to replace the twin-turbo V8 used in the R390 GT1 of 1997-'98. Nissan has several options: a new turbo version of the existing V8; a normally-aspirated variant of the same; or an engine based on the marque's four-litre IRL unit.

Nissan's NISMO competition arm, which will run the cars, is rumoured to be looking for a European base.

Onyx name could make comeback

One of the famous names in the history of Formula 3000 could return to the category next season.

Mike Earle, boss of the 1987 title-winning Onyx squad, is one of 20 parties to lodge payment for two T99/50 chassis with car-builder Lola in the past few weeks.

Earle's plans for next year's F3000 International Championship remain sketchy, but rumours suggest he could renew his links with former sponsor Marlboro.

Onyx, a race winner in the first three seasons of F3000, graduated to Formula 1 in 1989. Earle's links with the team ceased in early 1990.

Crash chassis clue to O'Connell's form

British Formula 3 frontrunner Martin O'Connell has traced his recent lack of form to a damaged Dallara chassis.

Rowan Racing, the team which has run O'Connell since the disbanding of the TOM'S GB outfit, has discovered rear bulkhead damage sustained in a crash at Silverstone in July.

Team boss Ray Rowan said: 'We've done everything and we can't change the handling. The only thing left is to buy a new tub.'

O'Connell is hoping to race the new monocoque in the next round at Thruxton.

Italian set for GT seat at Zakspeed

Max Angelelli, Italian Formula 3 Champion in 1992, looks set to join the Zakspeed Porsche GT team at Donington Park this weekend.

The Italian, who has raced Ferrari, Lotus and Toyota GT cars over the past three years, is expected to replace German tin-top veteran Armin Hahne in the team's FIA GT Championship line-up. The 31-year-old, who is said to have a four-race deal, is likely to share the team's second Porsche 911 GT1-98 with series rookie Andreas Scheld.

The team refused to confirm the deal, but said that it had been talking to a number of drivers.

News In Brief

FORMULA 3000

Belgian Mikke van Hool, a former British Formula 2 and 3 competitor, returns to racing next season. Van Hool will drive for Astromega, his family team, in the UK F3000 Championship, the revived and renamed British F2 series. Van Hool last raced in 1995.

The entry for next year's UK F3000 series has been restricted to 10 two-car teams to ease pressure on the category's parts suppliers.

FORMULA 3

New Speedsport driver Mark Boost has set his sights on a top-six finish in the final rounds of the British F3 Championship after qualifying eighth on his third F3 outing at Donington on Sunday. 'Now I know I've got the pace I just have to finish,' said the 21-year-old Formula Renault graduate. Boost's race ended with a spin on lap one.

Renault Spider graduate Mike Kirkham finally made his F3 debut with Speedsport at Donington. Kirkham drove away to win the National Class in his Dallara-HKS Mitsubishi F395/6.

The provisional entry for the British F3 round at Spa later this month is missing Italian outfits Prema Powerteam and Ghinzani, both of which were expected to enter. However, French series leader La Filiere and German frontrunners van Amersfoort Racing were among the foreign entries.

Austrian Robert Lechner, (below centre) a former frontrunner in the British Formula Ford Championship, scored his first two F3 victories at Salzburgring, his



home track, on Sunday. The GM Motorsport driver has closed to within nine points of German series leader Bas Leinders. Team boss Marian Hamprecht said: 'Now our aim is to win the championship.'

INTERNATIONAL

AUTOSPORT photographer Martyn Elford, stepson of former Le Mans winner Vic, celebrated his 40th birthday on September 1 (Tuesday).

Dale Earnhardt Jr, son of the NASCAR Winston Cup legend, will join the Dale Earnhardt Inc team in the premier stock car division in 2000. Earnhardt Jr is a major contender for the secondary NASCAR Busch Series title.

Burns back at Subaru in '99

Richard Burns will return to Subaru next season after a three-year spell with Mitsubishi.

The deal is expected to be confirmed tomorrow (Friday) with Burns taking over the seat made vacant by Colin McRae's departure to Ford for 1999.

The 27-year old Reading driver said that he was looking to become

the number one driver in a team for the first time in his career and so McRae's departure gives him that opportunity. Had he remained with Mitsubishi he would again be number two to World Champion Tommi Makinen. The Finn, while not yet formally confirmed, is expected to remain at the Rugby-based outfit that has so far given him two World Rally titles.

Burns's deal was rumoured to be worth around £1.3 million next season, although McRae's subsequent clinching of a £6.3 million contract may have pushed that figure higher.

Last week, Mitsubishi team manager Phil Short refused to comment on Burns's departure, insisting: 'We still have a meeting scheduled with him and his manager this week.'

Burns's career has therefore once again followed in McRae's tracks. Both drivers came to public notice in Peugeots and both moved on to international and world acclaim with Subaru. McRae remained loyal to the Banbury team while Burns opted to break for Mitsubishi in 1996 rather than compete for the crumbs left by Subaru's line-up of McRae and Carlos Sainz.

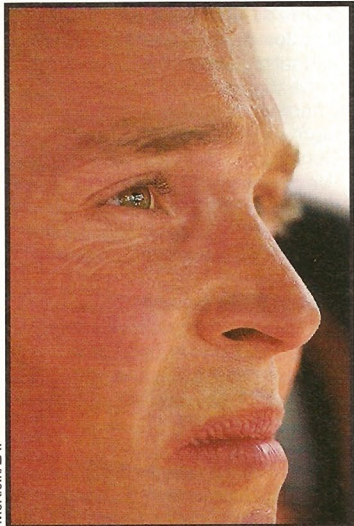

Burns has his sights firmly set on Subaru

McKlein/LAT

Burns has been supporting Tommi Makinen at Mitsubishi this season but wants number one status in 1999



Didier Auriol came close to being sacked by Toyota until he won the Catalunya Rally

Kolczak/Sutton

Auriol only 50/50 to stay at Toyota

Didier Auriol is currently tipped at only 50/50 to stay with Toyota for next season as the Frenchman continues to have meetings with Peugeot.

Auriol has been at the Cologne team since 1993 and, apart from a few one-off drives with other teams during Toyota's enforced absence in 1996 and early 1997, has remained a linchpin of the squad.

Toyota Team Europe president Ove Andersson met Auriol after the recent Neste Rally Finland and while each seemingly wishes to maintain the relationship,

there is some ground to cover between them. 'It's a question of finance,' admitted a spokesman for the team. 'They've given each other two weeks to sort the whole thing out.'

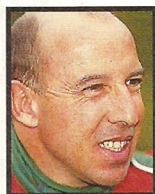

Auriol: Peugeot?

Auriol could be tempted away to Peugeot for a limited programme of events with the new 206WRC next season if the French team can match Auriol's demands.

Another 50/50 deal is that with Freddy Loix, originally expected to stay on with a third Corolla but who is now a probable replacement for Richard Burns at Mitsubishi.

McRae close to Hyundai deal

Alister McRae's bid to move into the World Rally Championship could be confirmed this month, when Hyundai knows the full extent of its 1999 programme.

The Korean team, run by Motor Sports Developments in Milton Keynes, learned during the recent Neste Rally Finland that it will be campaigning a World Rally Car version of the Hyundai Coupe next season.

So far, however, only Sweden's Kenneth Eriksson has been confirmed as driving the car, but McRae is expected to get the second slot.

'I haven't signed anything with

anyone yet,' insisted McRae when asked about rumours circulating last week that the deal had been done. 'I'm talking to everyone though and I hope something will be confirmed soon.'

David Whitehead, MSD's managing director, admitted, 'We're very interested in Alister. However, we've also had lots of people calling us and there's plenty of young talent out there. We've got nothing to offer until we know the full programme.'

Whitehead hopes Wayne Bell will continue to work with the team, even though the Australian is not expected to stay on full-time.



If Alister McRae (right) gets the Hyundai deal he'll be up against his brother, Colin, next year

DPP

News in Brief

Marcus Gronholm admits that he had tentative meetings with several teams last week following a string of offers in the immediate aftermath of his performance on the Neste Finland Rally. He says, however, that he will wait until Toyota's position on drivers is known before taking matters further.

Martin Brundle will not know if he is to get the chance to contest November's Network Q Rally until after San Remo. With Toyota currently embroiled in the championship battle, it is not clear if the team can allow itself to be diverted from the quest.

Top Australian band, The Whittlams, will be the star guests at API Rally Australia's Langley Park superstage. Three live performances will take place as the rally action concludes at the stage each evening.

Alister McRae believes he will not contest this month's Cyprus Rally with a Mike Taylor-run Toyota Corolla. 'We talked about it but nothing came of it so I don't think I'll be there,' said the Scot.

Jutta Kleinschmidt will take Tina Thorner with her for next year's Dakar rally raid in the Schlesler Buggy. Thorner, regular co-driver in Uwe Nittel's Mitsubishi Carisma, is making her Dakar debut.

Marcus Dodd will contest the British Rally Championship next year in a 1600cc Ford Puma Kit Car. Dodd will dovetail his BRC campaign with another assault on the Mintex series in his state-of-the-art Ford Escort WRC.

Stephanie Simmonite completed some tarmac testing in Cumbria in preparation for the Manx Rally. Simmonite's Ford Escort was rebuilt following an accident in last month's Ulster Rally, and has undergone a number of refinements. Former world ladies' champion Louise Aitken-Walker advised on set-up changes.

SEAT was also out testing the Ibiza near Bala, Wales, concentrating on set-ups for the Manx. 'We didn't change anything major from Ulster,' said a spokesman. 'It was just diff and anti-roll bar tweaks.'

Tapio Laukkanen's co-driver, Tapio Jarvi, will be unable to contest the Manx due to previous business commitments. Kaj Lindstrom, who is the newly-crowned Finnish champion co-driver, will deputise on next week's British Championship finale.

Ford recently ran its new 1400cc Puma Kit Car at its Boreham HQ. No problems were reported at the car's technical shakedown. There has been particular interest in the 1400cc Puma from competitors in Italy and Romania.

Rowe and Laukkanen stay loyal to Renault

Martin Rowe and Tapio Laukkanen will continue to be team mates at Renault in 1999, as exclusively predicted in AUTOSPORT (Special Stage, August 6).

The prospect of more World Championship outings next year is part of the reason for their decision.

Rowe is on the verge of clinching the British Championship in his second season with the French manufacturer, while Laukkanen has impressed the team with his speed since joining it at the beginning of the year.

Both drivers had other offers on the table, but were swayed by the proven performance of the Maxi Megane this season and the intention of Renault Dealer Rallying to contest four World Championship rounds next year.

'The car is reaching the peak of its development now,' said Rowe. 'I've had talks with

other people, but staying with Renault was the best all-round option. We know the car can do the business and it will be even better next year.'

'I'm very happy to be staying,' said Laukkanen. 'Obviously, the British Championship will be our main focus, but it is very good that we will be doing the same four World Championship rounds that we have done this year'. These are Corsica, Finland, San Remo and the Network Q Rally.

Andrew Luck, Renault UK motorsport director, was confident of his team's ability to continue the front-running role it has played this year: 'Continuity will prove crucial in Renault UK's efforts to keep

ahead of its rivals in the British Championship. I know there is still much to be achieved this year, but

I already relish the prospect of what's in store for 1999.'

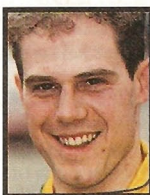

Rowe: World bid



Laukkanen: Stays



First with the news! How AUTOSPORT revealed Renault's plans



British teams gang up against Nissan

Mark Higgins will make his one and only appearance in this year's British Rally Championship on next week's Manx Rally, but teams have expressed concern that the reigning champion should not have the number one start slot.

One team manager insisted: 'Nissan hasn't done the whole series so why should Mark start first just because he's got number one on the door of his car?'

However, teams may have to grin and bear it because, as 1997 title holder, Higgins is FIA-seeded. Therefore, the Almera driver must start among the top four crews...

Bates finally takes Super Series win

Neal Bates finally managed to win a heat of the Australian Super Series this season, last weekend's Rally of Melbourne.

The Canberra driver rattled off a pair of victories over Aussie Champion Possum Bourne.

Bates had a reshelled Toyota Corolla WRC for the final event of the series and beat Bourne's Subaru by 18 and 20 seconds respectively. 'We've had a bit of a shitty year but this has picked us all up again,' he reflected. Prior to the event, Bates had won 25 stages to Bourne's 23 but suffered enough problems for Bourne to stay unbeaten.

Michelin backs 'champions'

Michelin has confirmed a three-year deal to back Michele Mouton's Race of Champions, the annual clash between the world's top rally stars in the Canary Islands each December.

Mouton's organisation has now run six consecutive events in the Canary Islands after starting the competition at Montlhery in 1988.

Michelin's decision comes as part of its centenary celebrations. Also, with the French company notching up its 150th rally victory when Carlos Sainz led a Toyota one-two in New Zealand last month, a rally event was the logical vehicle for its support.

This year's contest will take place

on December 4-6 and will include a gala dinner to celebrate Michelin's history. World Champions from Formula 1, Superbikes, rally raids and World Rally will all attend.

'It will be a unique gathering,' said Michelin competition director Pierre Dupasquier. Michelin has won 38 driver, rider or manufacturer World Championships since 1976 and in rallying has taken either the drivers or manufacturers title every year bar two since 1981.

Last year's 10th anniversary Race of Champions event was won by Carlos Sainz, who beat Colin McRae in the final. However, with three wins, Didier Auriol is still top driver.



Carlos Sainz's New Zealand success was Michelin's 150th World Championship rally win

AUTOSPORT

COUNTING THE COST

He accused Damon Hill of trying to kill him in Canada. He thinks David Coulthard only narrowly failed to finish the job in Belgium. It's a wonder Michael Schumacher can sleep at night with a persecution complex as big as his trophy cabinet.

His post-race altercation with Coulthard was the last thing the Scot needed after a bad day at the office. It was also out of order. Surely Michael can't seriously believe anybody would cause a collision in order to enhance their team's title prospects? Or maybe he can...

Schumacher may ultimately look back on Spa as the pivotal point in a failed championship bid. Yet we are fortunate to be counting the cost of a bizarre Belgian weekend in terms of the damage done to title chances and chassis, rather than lives.

The whole meeting was, in many respects, a chilling repeat of that dark Imola weekend in 1994: heavy shunts in successive days culminated in raceday carnage and wheels heading for spectator enclosures. Mika Salo was told by doctors that, without the cockpit head restraints introduced two years ago, his 180mph practice shunt would have killed him.

Although his escape owed as much to painstaking research as it did to good fortune, we are still reliant on the latter. Having watched in horror as wheels rained from the sky in the aftermath of the first lap shunt at Spa, it was ironic that we should learn of a spectator's tragic death due to an errant wheel at Castle Combe on Monday. In Atlanta, meanwhile, a wheel bounced into an empty grandstand during the IRL race.

It is impossible to legislate for every eventuality, and Spa endorsed the belief that we have come a long way. But there are still lessons we must learn. By design, wheels are no longer an immediate threat to drivers in an accident. But we must stop them reaching spectators. Quickly.



MARK SKEWIS
EDITOR

Editor
Mark Skewis
Deputy editor
James Baker
Managing editor
Stewart Williams
Grand Prix editors
Nigel Roebuck,
Andrew Benson
International news editors
Gary Watkins,
Marcus Simmons
Rallies editor
Keith Oswin
Club Autosport editor
Damien Smith
Art editor
Ben Martin
Chief sub-editor
John Leach
Sub-editor
Euan Doig
Editorial Manager
Laura Coppin
Club Autosport assistant
Tim Scott
Designer
Neil Earp
Picture editor
Mike Weston
Editorial assistant
Anthony Peacock
Editorial secretary
Samantha Jempson
National editor-at-large

Marcus Pyle
Grand Prix editor-at-large
Adam Cooper
Editor-at-large
Bruce Jones
Technical editor
Giorgio Piola
American editor
Gordon Kirby
Special Projects editor
Andy Hallbery
Art editors
Peter Charles, **Julia Gordon**
Designer
Liz Wallace
Managing editor
Robin Shute
Assistant editor
Simon Strang
On-line editor
Toby Gunton
On-line assistant
Matt Pardoe-Williams
Photographers
LAT Photographic
CORRESPONDENTS
International photo contributors
Sutton Images
Argentina **Antonio Watson**
Australia **Bob Jennings**
Austria **Gerhard Kuntschik**
Belgium **Dick Suter**
Brazil **Lito Cavalcanti**
Finland **Esa Illoinen**
France **Daniel Ortelli**

Germany **Ian Brown**,
Rene de Boer
Holland **Willem Staat**
Italy **Pino Allievi**,
Julian Thomas
Japan **Jiro Takahashi**
Mexico **Rosa Elena Torres**
South Africa **Colin Windell**
Spain **Raimon Duran**
USA **Jonathan Ingram**,
Jeremy Shaw
UK **Dud Candler**, **Peter Hughes**, **Julian Carter**,
Allison Lock, **Tim Baggs**,
Bill Henderson, **Kerry Dunlop**, **Paul Lawrence**,
Peter Scherer, **Jerry Sturman**, **Tim Whittington**,
Richard Wright,
Richard Young
Eire Linda Keen
Group Advertisement manager
Ian Havard
Advertisement manager
Gordon Henderson
Assistant Advertisement manager
Calum MacDougall
Display sales executives
Eugene Gallagher, **Guy Barnes**
Classified advertising
Ed Hole, **Ben Watt**, **Giles Robinson**, **Tania Wakeford**,
Charlie Masters

Autosport Directory
Rachel Burdekin, **Sean Worrell**
Special Projects manager
Joe Wheeler
Subscriptions manager
Julie Hamilton
Publishing manager
Paul Shoemith
Group Production manager
Meurig Evans
Production manager
Darren Jones
Design director
Paul Harpin
Advertisement director
Derek Redfern
Publisher
Jeremy Vaughan
Sales director
John Chambers
Publishing directors
Tony Schulz,
Peter Foubister

AUTOSPORT is published by
Haymarket Specialist Motoring
Ltd, a subsidiary of Haymarket
Magazines Ltd, 38-42 Hampton
Road, Teddington, Middlesex
TW11 0JE. Editorial director:
Mel Nichols; Managing Director:
Eric Verdon-Roe;
Chairman: Simon Taylor



Sutton Images

Rosset: full speed into Spa's lap one shunt

Crash, bang, wallop

Following the 'eventful' Belgian Grand Prix, I wish to pay tribute to the strength of the modern Formula One chassis that allowed 22 drivers to leave Spa on Sunday evening.

The frightening crash on the run down to Eau Rouge was a startling reminder of the potential danger of motorsport and I considered it nothing less than a miracle that the worst injury was nothing worse than a sore elbow to the unfortunate Rubens Barrichello.

More terrifying, however, was the speed at which Ricardo Rosset piled into the array of cars scattered across the track. This was the most dangerous aspect, as the cars' chassis would already have been seriously weakened by the initial impact.

The earlier shunts to Villeneuve and Salo were additional proof of the excellent work the FIA has done to improve safety. Without the extra side-impact regulations, neither would have walked away.

Unfortunately, no amount of technology could strengthen my chassis and by the end of 44 laps I was exhausted with no nails left - well done Damon!

Jonathan Crawford
Falkirk

Deep impact

So once again the World Championship is decided by a coming-together. It's a sad way for Michael Schumacher to lose it, and a sadder way for Hakkinen to win it.

Some will say it's poetic justice for Jerez last year, but the clash between David Coulthard's McLaren and Michael Schumacher's Ferrari has surely robbed us all of what could

have been one of the greatest championship title fights for a very long time.

It's not all over yet, but Monza will be difficult for Ferrari. If anybody can triumph over adversity it's Michael Schumacher, but I rather suspect that there will have been some wry Machiavellian smiles in the McLaren camp on Sunday night...

Peter Forrest
London

Give the fans a break

Picture the scene at the Hungarian Grand Prix. A brilliant victory following a stunning drive by Michael Schumacher, and in a fit of genuine excitement the fans manage to break through the fences to get as close to their heroes as possible.

Of course they know it is dangerous, but here is something to celebrate, something extraordinary that ordinary applause from the banking cannot truly convey.

So far, the response from the FIA has been rational and sensible. After all, if anyone was injured...

But there is another important consideration to bear in mind, which is the distance that the sporting bodies have put between the fans and the object of their affection. Look at the way spectators get treated at Grands Prix.

Immediate contact with the drivers is understandably limited, but access to the paddock and its environs is probably more closely guarded than Fort Knox.

And yet celebrities who 'have been a fan for years, but just never got round to seeing a race' sail through unhindered. Autographs are available, if you're very lucky, through a tiny hole in the fence.

And when was the last time you saw a driver during a pit lane walkabout? Come to think of it, when was the last time you saw anything in a pit lane walkabout?

Which other sport refuses its fans a victory procession, where they can see the winner? Imagine an FA Cup Final where the winning team instantly departs after the final whistle, or a Wimbledon final where Pete Sampras simply walks away when it's all over.

I'd like the FIA to consider the sport more from the perspective of the racegoer, and urge them to improve the show.

Of course the Hungarian fans invaded the track - the surprise is that it doesn't happen every race.

Steve Quick
Leicester



Sutton Images

Schumacher was brilliant at Spa. But has he just been robbed of a World Championship?

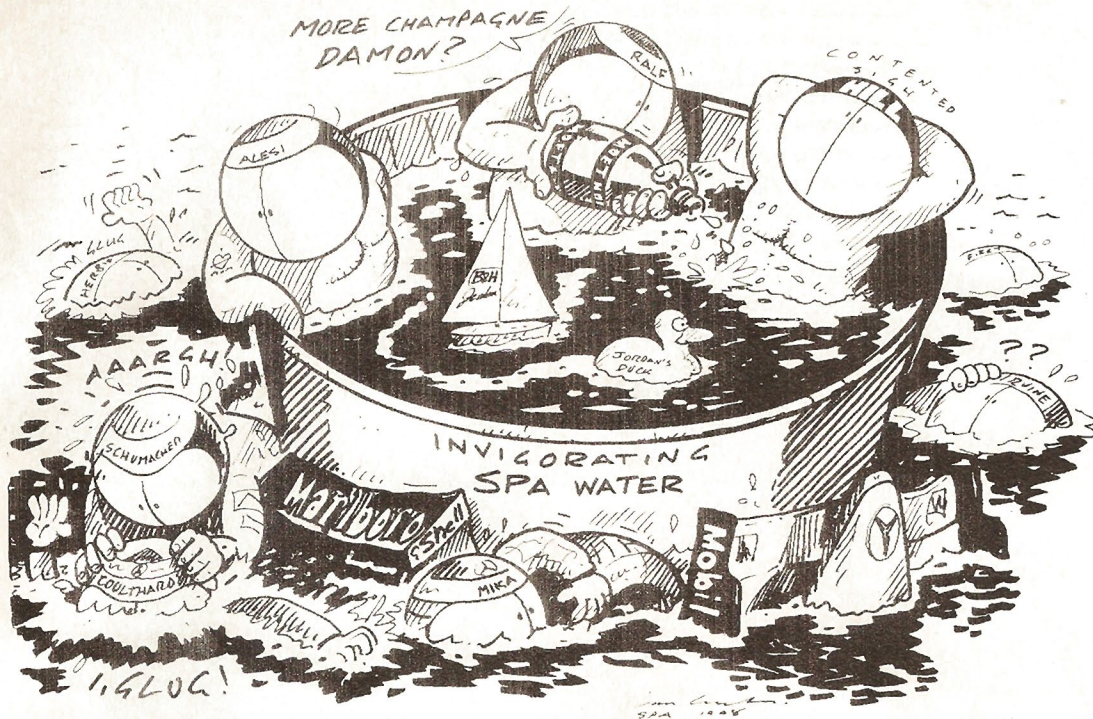

Eastern promise?

After hearing of Bernie Ecclestone's plans for the 1999 season and beyond, I fail to see how Formula One can be successful in Asia, and the USA.

Grands Prix at destinations such as Lebanon and Malaysia surely would not pull enough spectators to make a profit of any kind.

Contrary to popular belief, Formula One is not a truly global sport, and is very much a European sport. In the USA, a country that is very isolated from any sports outside of North America, the name Michael Schumacher leaves blank faces.

The bonus of more flexible tobacco laws cannot justify running Grands Prix in these countries. F1 needs to stay where the fans and the merchandise money is - Europe.

Ross Nicolson
e-mail

Called to the BAR

The arrival of British American Racing on the Formula 1 scene could well provide the extra impetus that the sport needs.

If the Reynard company can be as

successful in F1 as it was in Indycars, within the same short time-scale, then the top teams should sit up and take notice.

Once the domination of driver and constructors' championships has been completed by BAR, I hope the Reynard chassis could be made available to the smaller teams, as happens in Champ Cars.

The prospect of the smaller teams competing with front-running

Reynard chassis could really open up the championship and allow driver talent to shine through.

Mark Archer
High Wycombe

Getting it off your chest

I really must complain about the Postcard page at the end of every Grand Prix report in AUTOSPORT.

Your female readers never get any pictures of scantily clad men.



Renault Spiders have had some bad press recently, but provide very competitive racing

We are lucky if we get the occasional hunk like sprinter Colin Jackson who was in Hungary - but then he was fully clothed!

I have no objections to the semi-nude girlie pics, but play fair. I shall expect to see semi-nude toy boy pictures in future - and I want more than just bare chests!

Penny Wilkinson
Maidstone, Kent

Arachnophobia?

After the recent comments and accusations in the motoring press about Renault Sport and the Spider championship in particular, I want to add my own comments.

I have been racing now for six years and four of them have been in Renault Sport championships. To my mind, Renault does more for its teams and drivers than any other manufacturer on the TOCA package. It's enough to look at the quality of the drivers which the series has produced to recognise its achievements.

All I can say to everybody is keep up the good work. I'm sure that the championships will continue to go from strength to strength.

Duncan Vercoe
Banbury

Banking on your support

As some of you may be aware, there are moves a foot to demolish the famous banking at Monza.

A petition has been started to save the banking at the Italian circuit. Those who have already pledged their support include Jody Scheckter, Phil Hill, Stirling Moss, the Tyrrell Formula 1 team and the British Racing Drivers Club. We need some more heavyweights to join the fight.

Any support, bearing in mind the Italian Grand Prix is just around the corner, would be greatly appreciated.

You can e-mail Chris Balfe on ferrari@cableinet.co.uk or fax him on 0131 467 4857. You can also e-mail the Formula One Supporters Association on <http://move.to/fosa>.

You can write to us at AUTOSPORT letters, 38-42 Hampton Road, Teddington, Middlesex, TW11 0JE; fax us on 0181 943 5922 or e-mail us at either autosport@aol.com or Compuserve on 100634, 1072

What the papers say with Keith Oswin

I went to the beach on Sunday. Parked the car just as the Grand Prix was starting, had a bite to eat then went back to listen to the second attempt at getting the thing underway. Reckoned this was a dark day for McLaren and a red letter one for Ferrari. Obvious.

An hour and a half later the folks queuing at the nearby chip shop went bananas. The spontaneous applause was not for a nice piece of haddock but for Damon Hill winning the race with Ralf Schumacher second....

I know that Eddie's team usually has a decent run at Spa but a 1-2 and its first ever GP win? You're having a laugh...



But no. The *Sun* screamed 'One Hill of a race', the *Mirror* claimed 'Hill of a driver' (that's tabloids for you). The *Telegraph's* Tim Collings was more sedate with 'Hill brings order to the chaos'

while Derick Allsop's *Independent* piece was headlined: 'You tried to kill me - Schumacher'. Strong stuff...

I laughed at Collings' suggestion that, while Eddie danced an Irish jig and Damon did a 'Schumacher leap' on the podium, Jordan's commercial director Ian Phillips raised a glass of champagne. A glass? The bottle I can imagine, but just a glass? Not the Ian Phillips I know!

The result should have been 'La Source' (sorry) of undiluted euphoria because I doubt that there's a team in the paddock who begrudges Eddie's success. Those who've won lots of GPs will

know how hard it was, those who've yet to do so won't need reminding just at the moment.

But of course there was a nasty taste, and it wasn't just from the trackside catering. Schumacher, the one who should have won but didn't, came almost to blows with David Coulthard after the latter, almost certainly inadvertently given the conditions, effectively put the Ferrari out of the race. Accusing DC (loudly and offensively) of trying to kill him seemed a touch harsh, even having seen your slim title hopes go west, as it were... Will Schuey apologise or will it be 'picture but no sound' from now on?



The

**ADVANCED
COMPOSITES
GROUP**



Congratulates
JORDAN GRAND PRIX
ON THEIR BELGIAN GRAND PRIX 1-2
AND RED BULL SAUBER PETRONAS
ON THEIR 3rd PLACE

COMPLETE TOOLING AND STRUCTURAL
COMPOSITES PACKAGES SUPPLIED BY ACG

Composites House, Sinclair Close,
Heanor Gate Industrial Estate, Heanor, Derbyshire DE75 7SP

Tel: 01773 763441 Fax: 01773 530245

E-mail: info@acg.co.uk

Crazy day at Spa

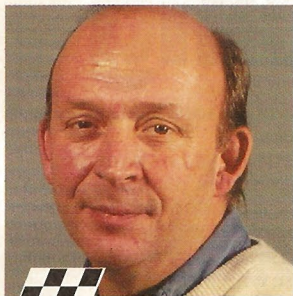

NIGEL ROEBUCK

No one objects to racing in the wet because the track is slippery. We're supposed to be the best drivers in the world, and we ought to be able to handle that. But not being able to see is a different thing, and that's what I don't like. Skill has nothing to do with it - doesn't matter if you're the World Champion, or driving in your first race...

No, this wasn't a driver talking about last Sunday's Belgian Grand Prix. This was Alain Prost in 1988, explaining why he chose to pull out at Silverstone, only a few laps into the race. The visibility, he said, had been intolerable, and if ever he were confronted with a similar situation, he would do the same again.

Prost was true to his word. At Adelaide, in 1989, the weather, if anything, was even worse, and he announced his intention to run one lap, then stop. Several of his colleagues said they would do the same; in the event, as Gerhard Berger put it, 'Only Alain had the balls to stick to his word.'

At the time, Prost was widely castigated for his decision. By and large, the argument always followed the lines that 'men are men', that *real* racing drivers get out there and compete, whatever the conditions. When it came to not being able to see, though, Prost thought that asinine. 'Do you drive flat out on an autoroute in fog?' he said. 'People say, "Oh, that's not the same - you can't compare driving on the road and on the track." Well, I think you can. If you drive flat out when you can't see anything...to me, that's just idiotic.'

Alain admitted that his opinions had been largely shaped by the accident to Didier Pironi, during practice at Hockenheim in 1982. He, Prost, was approaching the stadium at less than full speed, preparing to come into the pits, and in the hanging mist of spray Pironi never saw him. I happened to see the Ferrari hit the back of the Renault, vault over it, and somersault down the road, and have never forgotten it; how it must have seemed from Alain's vantage point I cannot imagine.

After Prost had withdrawn from the Australian Grand Prix that day, I watched the race with him in the McLaren pit cabin. His team mate Ayrton Senna was in the lead - but not for long: on the long Dequetteville straight, he charged into the back of Martin Brundle's Brabham, tearing off the left corner of the McLaren. 'I didn't see a thing,' Senna admitted, 'until I hit him. In fact, I felt the impact before I saw the Brabham...' Prost, looking at the TV screen, shook his head.

Later that afternoon, on the same straight, and for the same reason, Nelson Piquet's Lotus cannoned into Piercarlo Ghinzani's Osella. Piquet, whose helmet was cracked by the Osella's rear wheel, was vehement afterwards: 'There is a difference between being brave and

being stupid - to race today was stupid.'

Those two incidents in Adelaide came back to me on Sunday, when Giancarlo Fisichella's Benetton tanked into Shinji Nakano's Minardi at the approach to the Bus Stop. The difference between then and now, though, was that in 1989 we had not yet copied the American 'pace car' system; back then, the only alternatives available were to let the race run, or to stop it.

'I simply don't understand,' Fisichella said, 'why they waited so long to bring out the safety car. For 10 laps, before the accident, visibility had been zero.' Ironically, the safety car then did come out - as a consequence of the shunt its earlier employment might have prevented.

Mercifully, though, no one was hurt in any of the accidents on Sunday, including the *carambolage* at La Source, and that says much for the safety improvements to the cars, particularly in the cockpit area, progressively introduced by the FIA in recent years. The big mystery in the accident on the opening lap was quite how Ricardo Rosset failed to notice it, for most of it had happened by the time he arrived; visibility, of course, was limited, but everyone else at least seemed able to slow down; the Tyrrell was still travelling at a hell of a speed as it ploughed into the carnage.

The one shunt at Spa which, in my opinion, could have been avoided was that involving Coulthard and Schumacher. Sorry to those of you for whom the *wunderkind* can do wrong, but I go along with the paddock majority: in my opinion, the fault was all Michael's, and if he ultimately loses the World Championship by fewer than the 10 points tossed away on Sunday, he has no one but himself to blame.

Consider the situation at the time: one, he had a lead of over 35 seconds, and therefore was hardly under pressure; two, he was due to come

in for fuel and tyres a lap later; three, only a couple of minutes earlier, he had almost had what would have been a coming-together with Pedro Diniz, which should have served as a wake-up call, if one were needed

You could, if you were so inclined, add a fourth point. After the accident, Schumacher darkly suggested that Coulthard had taken him out deliberately, in an effort to aid the championship cause of his team mate Mika Hakkinen. If Michael truly believed that David and his team were capable of such a thing, it was pretty dim to sit a foot behind the McLaren in dead reckoning conditions.

I felt some sympathy for Schumacher, for until then - as usual - he had driven quite beautifully, and was on his way to an uncontested victory.

But any commiseration evaporated when he did his remarkably unattractive *gauleiter* act in the McLaren pit; at that moment, indeed, I recalled Max Mosley's promise of draconian punishment for anyone bringing the sport into disrepute.

If I had to pick one contemporary driver who embraces a code of ethics once taken for granted - but now largely forgotten - in motor racing, I would go unhesitatingly for David Coulthard, and I thought

contemptible Schumacher's hysterical assertions that David took him out deliberately. It was unconscionable that he should ascribe his own race track morals to one known for fighting fair.

Therefore, it was with pleasure that I later heard DC's robust response. 'Coming into the pit, and asking me if I was trying to "***** kill him" was totally unacceptable,' he said. 'I can't really find words to describe how disappointed I am with Michael, as a man. His behaviour was disgusting. He should get help.'

Couldn't agree more.

“ I can't really find words to describe how disappointed I am with Michael ”

DAVID COULTHARD



Giancarlo Fisichella sensibly decides not to hang around the remains of his Benetton as flames appear in the cockpit

What's on...

...the track

Sat Sep 5

Toyota Atlantic Championship
Vancouver (CDN), round 11 of 12

Sun Sep 6

CART Championship Series
Vancouver (CDN), round 15 of 19
FIA GT Championship
Donington (GB), round seven of 10
Indy Lights Championship
Vancouver (CDN), round 11 of 13
Japanese Formula 3 Championship
Sendai (J), round nine of 10
Formula Opel European Series
Zandvoort (NL), round eight of 10
International Sports Racing Series
Nurburgring (D), round six of eight
NASCAR Winston Cup
Darlington (USA), round 25 of 33
Italian Touring Car Championship
Enna (I), round seven of 10
Japanese Touring Car Championship
Sendai (J), round seven of nine
South American Touring Car Ch'ship
Obera (BR), round eight of 12

...the box

BBC 1

Sun Sep 6 1345-1410, 1610-1635
BTCC highlights from Brands Hatch

BBC2

Mon Sep 7 1420-1440 *Top Gear*
Motorsport

ITV

Sat Sep 5 1340-1440 *International*
Motor Racing, magazine

CHANNEL 5

Sun Sep 6 2355-0055 Champ Car
highlights from Vancouver

EUROSPORT

Thu Sep 3 1200-1330 *Motors*
Sat Sep 5 1030-1130 FIA GT
qualifying from Donington (GB)
1700-1800 FIA GT qualifying
0000-0030 Champ Car qualifying
from Vancouver (CDN)
Sun Sep 6 1400-1515 FIA GT race
from Donington, LIVE
2100-2200 FIA GT highlights
2200-0000 Champ Car race, LIVE
Mon Sep 7 1800-1900 FIA GT
highlights from Donington
Tue Sep 8 1300-1400 BTCC
highlights from Brands Hatch
Wed Sep 9 1600-1800 *Speedworld*

SKY SPORTS 1

Thu Sep 3 2315-2345 Formula 3
Wed Sep 9 1900-1930 *Full Throttle*

SKY SPORTS 2

Mon Sep 7 1300-1330 Drag Racing
2230-2300 *V-Max*, magazine

SKY SPORTS 3

Sat Sep 5 2200-0000 NASCAR
Sun Sep 6 1730-1800 Porsche
Supercup from Hockenheim

CEEFAK

See page 360 for motorsport news

INTERNET

www.autosportmag.com

AOL

Keyword AUTOSPORT

There's plenty of life left in FIA GT racing

Met a mate in the pub the other day. A bit of motorsport fan, he lives in Derby, but he reckoned he wouldn't be popping down the road to Donington Park for this weekend's FIA GT Championship bash.

'What's the point?' he said. 'It won't be much of a race; we already know who's going to win.'

I'll admit the domination of Mercedes this year is a bit of a turn-off, but there are, as I told my friend, a number of good reasons for turning out for the second visit of the FIA series to these shores.

Not least of them is that the Three-Pointed Star's unbeaten winning run came closer than you might imagine to being broken at Suzuka 10 days ago. I wasn't about to bet the next round of beers on a Porsche victory at in Britain, but I explained that the marque was edging ever-nearer to its Stuttgart rival. Had Ricardo Zonta's Mercedes not tipped the Porsche of Allan McNish off the track early on, we would have been treated to the race of the season in Japan.

Okay, so Porsche had a nightmare

Inside line

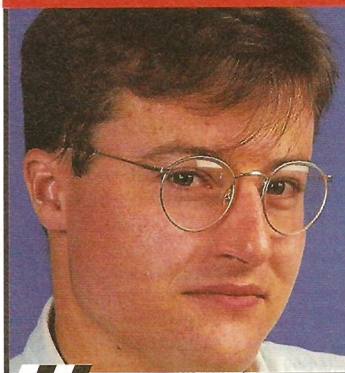

GARY WATKINS
INTERNATIONAL
NEWS EDITOR

at Donington last year. That was with the 911 GT1 Evo, however, a heavyweight behemoth that looked all at sea on the twists and turns of the Leicestershire track. This year's 911 GT1-98 is a true thoroughbred, though I doubt the going will be

quite as much to its liking as it was in Suzuka.

If it's thoroughbreds you want, Donington is the place to be. For a start the race offers the first chance to see the Le Mans-winning Porsche on British soil. Sorry to disappoint all those who went to the Goodwood Festival of Speed in June, but the chassis you saw in Sussex was the factory team's test car. The 911 GT1-98 raced by McNish and Yannick Dalmas this weekend is the genuine article.

Then there's Bernd Schneider. Though I never doubted his pedigree, the more I see the German drive, the more I understand the travesty that was his all-too-brief Formula 1 career.

I doubt if Schneider has ever driven better than he's doing this year. Every time he gets in the Mercedes CLK-LM, there's the potential for the kind of performance that leaves everyone – fellow AMG drivers included – gobsmacked. Zonta, the provisional poleman at Suzuka, was rendered more or less speechless by his team mate's pole position lap the weekend before last. Expect more of the same this weekend, so make an appointment with the Craner Curves if you're there for qualifying.

Not that we should write off young Zonta. Co-driver Klaus Ludwig, who's been around long enough to know, reckons the Brazilian is a star in the making. So with an F1 seat looking increasingly likely for next year, Leicestershire probably offers a last chance to witness his talents for an under-£20.

Let's hope, however, that it doesn't also represent the last opportunity to see the latest-generation of GT1 supercars racing in this country. Pessimists reckon the FIA GT Championship has little future as a home for full-blown factory teams running million-dollar machinery. If they're right, you'll have to cross the Channel and go to Le Mans to see sportscar racing's *creme de la creme* next year.

The future, some say, lies with the second division GT2 cars, the likes of the Chrysler Viper, Marcos and Porsche 911. With the Viper GTS-Rs lumbered with a 50-kilo weight penalty from now on, and the return to the front of sportscar veteran Cor Euser's Marcos LM600, the battle for class honours should be closer than ever at Donington. What's more, I get the feeling that the Porsche 911 GT2, particularly the lightweight Rook Racing examples, will be right back in the frame, too.

So, even if Mercedes heads into the distance – as in Hockenheim, Dijon and Hungary – at least my friend should get to see a race. ■

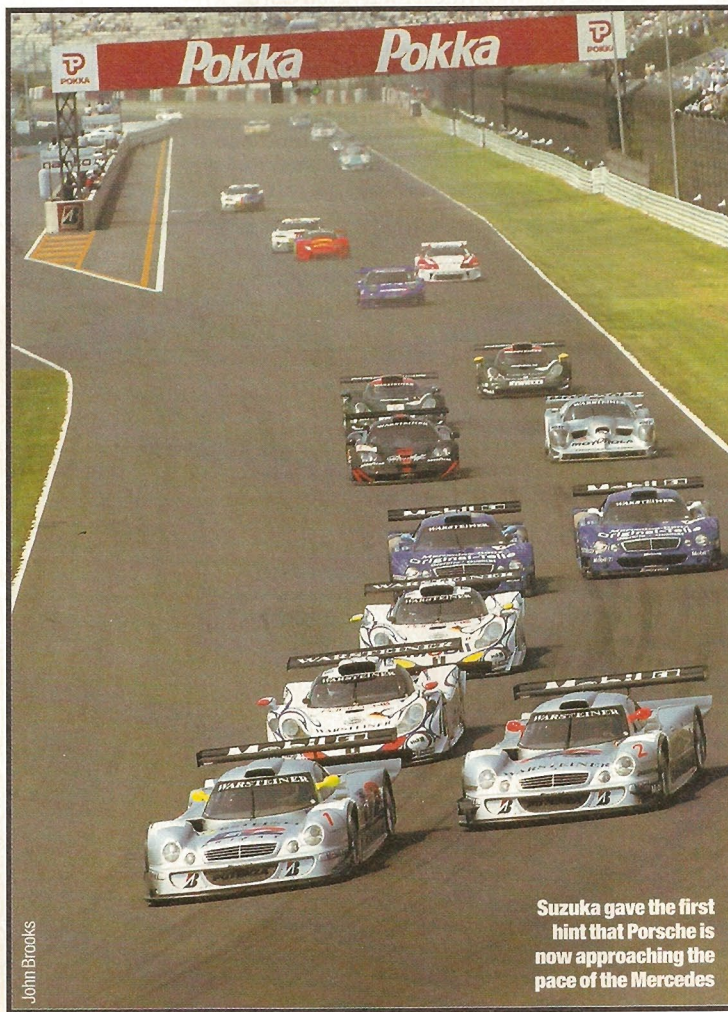

John Brooks

Suzuka gave the first hint that Porsche is now approaching the pace of the Mercedes

Armchair enthusiast

'The Chequered Flag' by Ivan Rendall. Published by Weidenfeld & Nicholson, price £24.99 plus £2.55 p&p

We often come across weighty tomes about the history of motorsport. This is one that differs in that it's interesting.

The book gives an informative and intellectual overview of the last 100 years of the sport, leaving very few stones unturned.

It offers detailed reviews of each year's racing and examines technical and commercial development. Best of all, it's presented in an attractive style, which is easy to read, avoiding the pomposity of several supposedly more authoritative volumes.

Having produced BBC2's 'The Power and the Glory', Ivan Rendall conveys a refreshing, sometimes cynical insight into the development of motor racing. He also remembers that there is life beyond Formula 1 – Indycar gets a good look in, along with NASCAR.

A major asset of the book is its photography. It is liberally sprinkled with pictures that go beyond the standard action shots and posed podiums. Some of the photos are incredibly rare, others movingly atmospheric, a few are heartbreakingly tragic.

'The Chequered Flag' is a thoroughly enjoyable read, and pretty good value, priced at just £24.99. It's available now from all good bookshops.

● Anthony Peacock & Laura Abbey-Taylor

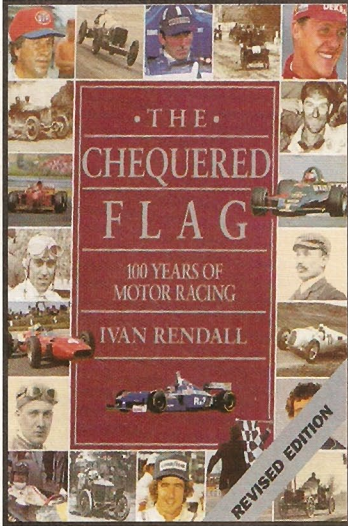

Anniversaries

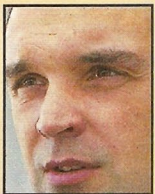

Muller: 29

Sep 3: Jorg Muller (born 1969), Ferdinand Porsche (b 1875, died January 30, 1952), Tommy Rustad (b 1968)

Sep 4: Pentti Airikkala (b 1945), Francois Chauche (b 1951), Michael Graf (b 1971), Chris Hall (b 1954), Hans-Peter Kaufmann (b 1953), Chris Smith (b 1966)

Sep 5: Nigel Bigwood (b 1954), David Brabham (b 1965), Robert Droogmans (b 1954), Taki Inoue (b 1963), Clay Regazzoni (b 1939), Jochen Rindt (d 1970)

Sep 6: Kenny Bernstein (b 1944), Syd Watkins (b 1928), Max Welts (b 1952)

Sep 7: Kelvin Burt (b 1967), Brian Hart (b 1936), Robbie Stirling (b 1960), Duncan Vercoe (b 1972)

Sep 8: Mike Berg (b 1970), David Grace (b 1949), Stefan Johansson (b 1956), Aguri Suzuki (b 1960)

Sep 9: Shaun van der Linde (b 1970), Bob Ward (b 1947)

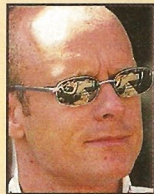

Rustad: 30

Then as now

10 YEARS AGO

Emerson Fittipaldi finally took the Indycar victory that he had been threatening all season at Mid-Ohio (AUTOSPORT, September 8, 1988). The Brazilian duelled with Mario Andretti throughout a race that was alternately wet, then dry. Rick Mears completed the podium.

Another wet race took place at the Nurburgring, where Jean-Louis Schlesser won the 1000km in a Sauber-Mercedes. Eddie Cheever and Martin Brundle brought their Jaguar home second, but their team mate, Johnny Dumfries, crashed his 'Big Cat' on the very first lap.

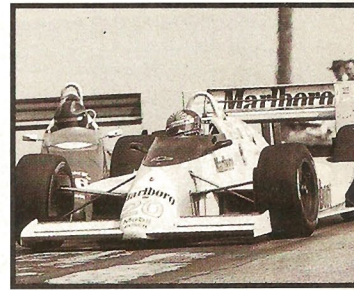

Fittipaldi breaks his '88 duck

20 YEARS AGO

John Taylor won the Ulster Rally in a Ford Escort, after a sluggish start. (AUTOSPORT, September 7, 1978). The rally had been characterised by the remarkable speed of Derek Boyd in a works Triumph TR7 V8. It all came to nought, however, when the Triumph coasted to a halt with no oil pressure just four stages from home. Malcolm Wilson was fifth, while Jimmy McRae could only manage eighth after restyling his Chevette in the Knockmany forest.

Jochen Mass was injured while testing his new ATS at Silverstone. He crashed at Stowe, breaking his left leg and kneecap. Elio de Angelis also tested a Shadow, and impressed the team by being right on the pace straight away.

Martini pulled the plug on its Formula 1 team, citing lack of finance.



Jochen Rindt enjoys the spoils of victory

30 YEARS AGO

Jochen Rindt added another Formula 2 victory to his CV, the Mediterranean Grand Prix at Enna-Pergusa (AUTOSPORT, August 30, 1968). The race had a thrilling finish when three cars crossed the line virtually simultaneously, but Rindt's Brabham was judged to have won from its sister car of Piers Courage and Ernesto Brambilla's Ferrari.

In Austria, Jo Siffert won the Zeltweg 500km in a three-litre Porsche 908, setting a new fastest lap in the process. Another Porsche, driven by Hans Hermann, was just 15 seconds behind.

40 YEARS AGO

A massive entry was announced for the 23rd running of the Tourist Trophy at Goodwood (AUTOSPORT, September 5, 1958). The works Aston Martin team consisted of such luminaries as Stirling Moss, Jack Brabham and Tony Brooks, while Masten Gregory and Innes Ireland were driving Tojeiro-Jaguars for Ecurie Ecosse. A works Ferrari was scheduled to appear, but the drivers were not yet confirmed. Porsche also had a dream team of Jean Behra and Wolfgang von Trips, while Ivor Bueb, Bruce Halford and Ross Jensen were driving for Lister-Jaguar.

Stirling Moss won the Kentish 100 Trophy for Formula 2 cars, driving a Cooper. He was challenged by Jack Brabham and Stewart Lewis-Evans all the way to the flag.

Wiscombe Park hillclimb circuit opened for the first time, and in appalling weather the inaugural BTD was set by AM Park in an AC.

From the archives... Russian gangsters and their moll, or merely innocent participants in the London-Sydney Marathon of 1968? You choose...





CRIME AND PUNISHMENT

An over-zealous, eleventh-hour move on Rickard Rydell brought Anthony Reid a two-second penalty at Brands, and cost him victory. Marcus Simmons reports

Laurence Baker

A sprint race victory safely in the bag, Anthony Reid chases down Rickard Rydell in search of the double, but the fates were not with him...

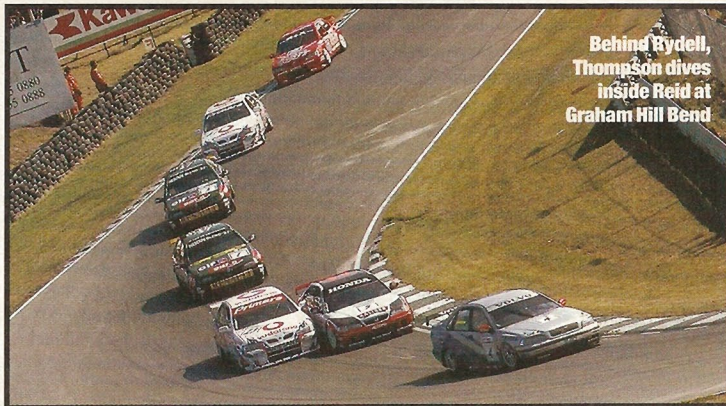

Behind Rydell, Thompson dives inside Reid at Graham Hill Bend

Dry-weather British Touring Car Championship rounds don't come much more exciting than the feature race at Brands Hatch on Bank Holiday Monday. A scintillating struggle between championship leader Rickard Rydell's Volvo S40 and closest challenger Anthony Reid's Nissan Primera went the Scot's way on the track, and the action scarcely abated after the chequered flag.

By that stage, acrimony reined. Rydell accused Reid of foul deeds on the track, Reid levelled the same charges at Rydell, and the Swede was given a severe reprimand for a post-race parc ferme fracas with the Scot which was handily captured by a TV cameraman.

In the end, Reid was stripped of his win by the imposition of a two-second penalty for his manoeuvre on Rydell at the Druids hairpin. And that kept up a phenomenon of this season's *Auto Trader* series: Reid has now won five of the last six BTCC sprint races, but is still yet to break his duck in the feature clashes.

For Rydell and the TWR Volvo team it was a return to the winner's circle for the first time since late June at Croft, and allowed them to peg the points gap to Reid's Ray Mallock Limited Nissan to 33. That's roughly equivalent to two race wins, with only four rounds to go.

But Reid was looking unbeatable at the beginning of the day. He was on pole position for the sprint race, and had demolished his opposition in the race morning warm-up, finding an even better set-up than the one he'd enjoyed in qualifying.

Rydell was alongside him on the grid, but was caught with excessive wheelspin at the getaway and was demoted by James Thompson's Prodrive Honda Accord on the way into Paddock Hill Bend. The second

Nissan of David Leslie was on the move too, and was abreast with Rydell into Paddock. The Scot clung on all the way round Druids before conceding third place, with reigning champion Alain Menu's Williams Renault Laguna right behind.

Then, at Graham Hill Bend, Rydell's rear bumper flew into the air, bounced off Leslie's bonnet and landed on the grass. 'Leslie was quite close to me, otherwise the bumper wouldn't have fallen off,' claimed Rydell. Leslie, however, blamed Menu. Menu blamed Leslie. Hmmm.

Still, it didn't trouble the Volvo too much. 'I guess it affected the balance

“I think Anthony forgot to brake – he certainly kept the throttle on 50 metres too long”

RICKARD RYDELL

a little bit,' Rickard speculated. Thompson, himself outpaced by Reid, did get away from the Volvo in the early going, but the Swedish machine had eroded most of the gap by the finish.

For Reid it looked too easy. An early safety car period, which was pretty much Nigel Mansell and Ford's sole contribution to the weekend, was the only obstacle the Nissan ace faced. After the re-start, he leapt away to be 0.61s clear of Thompson after one lap, 1.358s ahead after three and then a steady two seconds to the good for the remainder of the event. ▶

All photos: Griffiths & Bloxham/LAT



Reid thinks he's won the feature race...



...but a downcast Rydell will soon claim it

TOURING CARS

'98 so far

TEAM QUALIFYING

18	Muller	Bintcliffe	4
13	Hoy	Baird	5
3	Hoy	Mansell	1
20	Thompson	Kox	2
16	Reid	Leslie	6
11	Harvey	Radisich	11
15	Menu	Plato	7
12	Cleland	Warwick	8
2	Warwick	Figueiredo	0
20	Rydell	Morbidelli	2

SUPERGRID

Pos	Driver	Average
1	Thompson	3.73
2	Reid	3.82
3	Rydell	4.68
4	Leslie	5.14
5	Menu	6.09
6	Plato	6.32
7	Kox	8.09
8	Muller	9.05
9	Cleland	9.8
10	Warwick	10.5
11	Morbidelli	10.73
12	Neal	11.18
13	Hoy	12.32
14	Bintcliffe	13.86
15	Rustad	14.27
16	Needell	14.5
17	Radisich	14.95
18	Mansell	15
19	Harvey	15.82
19	Gravett	15.95
20	Baird	16.28
21	Lemmer	18.22
22	Figueiredo	18.5
23	Moen	19.29

DRIVER STATS

Driver	laps led
Reid	162
Rydell	148
Thompson	72
Menu	66
Leslie	65
Cleland	37
Hoy	23
Warwick	22
Plato	19
Morb'ili, Muller, Baird, Gravett	6
Mansell	5
Harvey	4
Rustad, Bintcliffe, Kox	1

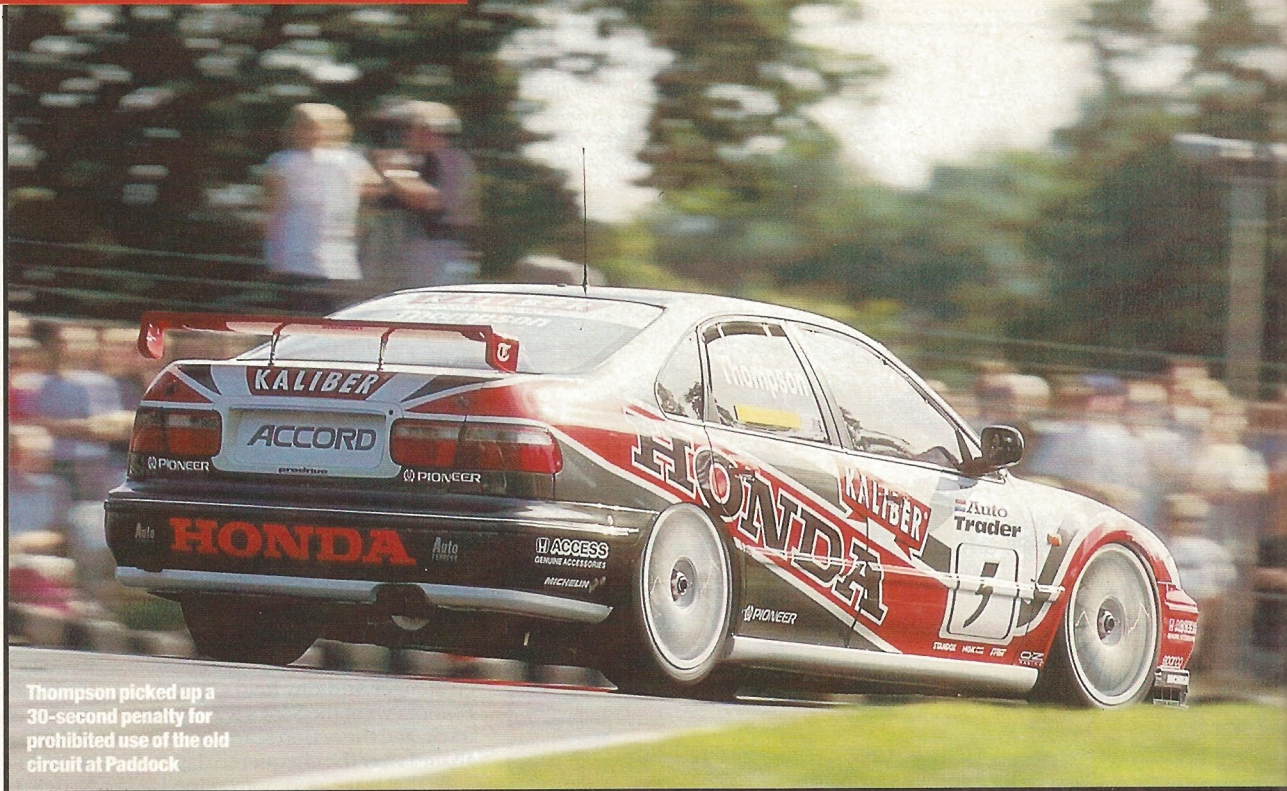

Thompson picked up a 30-second penalty for prohibited use of the old circuit at Paddock

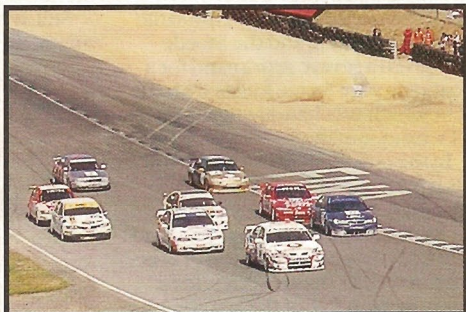

Will Hoy is off, so Needell leads the tail-ender formation

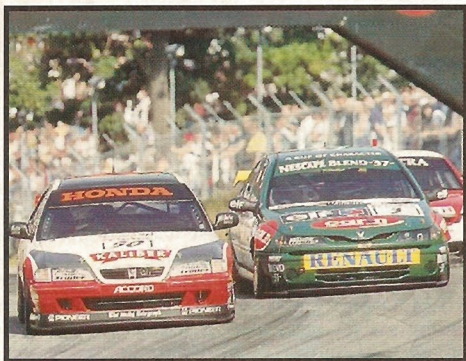

Kox, Plato and Cleland battle it out in the sprint (above), while Morbidelli discovers no fuel means no go (left)

◀ 'The team has worked really hard and the car is the class of the field,' Reid acknowledged.

Thompson, expecting to be soundly thrashed on race pace, grinned: 'Anthony was just too quick for us. I was pushing right to the very end - the main thing was to keep ahead of Rickard.'

Leslie, who felt his car was down on power, was a comfortable fourth ahead of Menu, who felt that this was as fast as the Renault could go. Jason Plato, in the sister Laguna, probably believed he could have lapped at the same pace, only for Peter Kox, driving the widest Honda in existence, to keep him at bay for sixth. John Cleland's Triple Eight Vauxhall Vectra gained on the duo and shadowed them to the flag. He came under attack on the final lap from Matt Neal, who had driven his independent Nissan Primera brilliantly from the back of the grid.

Neal made a lunge at Cleland at Paddock on the last lap, but the Scot was having none of it and slammed the door to keep eighth.

That was about it for Cleland on this day. The Vauxhall lapsed onto two cylinders on the green-flag lap

for the feature 50-lapper, and its driver was left to spectate one of the finest, and most controversial, races of the season.

Rydell converted his pole position into the race lead. But, unlike Reid earlier, there was no streaking away for the man at the front. Reid, Thompson, Menu, Plato, Leslie and Neal sat on his tail in a seven-car train. Because the Nissan doesn't like using the kerbs at the left-hand Surtees sweeper, Reid was never close enough to try a move into the tight Clearways right-hander. But, out of Clearways, the Primera's traction would allow the Scot to feint to the inside at Paddock.

It was gripping stuff, which was resolved - for the time being - on the seventh lap. Reid went for the inside of Rydell up to Druids, but Rydell covered the line. Reid lost momentum, allowing Thompson to squeeze inside him into the left-hander at Graham Hill Bend. Reid's misery wasn't over yet, for the Renaults of Menu and Plato had also railroaded him by Surtees.

Down in fifth, Reid was furious. 'Rickard braked really early into Druids,' he complained. 'He then

Brands Hatch team by team... Brands Hatch team by team... Brands Hatch team by team

AUDI



7 John Bintcliffe **Yvan Muller** **12**
After a promising test session, the A4s slid down the field in qualifying. Muller, however, climbed from the midfield in the feature race to fend off Kox for sixth. In the earlier race he struggled home 11th with a lack of grip, although there was suspicion Radisich had passed him under the safety car. Bintcliffe was out of the points in both races, after being thrown to the back of the sprint race grid for failing a ride-height check.

FORD



32 Will Hoy **Nigel Mansell** **55**
Oh dear - no finishes. Hoy was tipped into the gravel at the start of the sprint by Needell. In the feature he lasted most of the race before ploughing off at the same spot and into the barriers when 'something broke'. Mansell went off on first lap of sprint, taking Lemmer with him. In feature, he pitted early due to puncture, got drive-through pit-lane speeding penalty and was then taken off by Kox while being lapped.

HONDA



5 James Thompson **Peter Kox** **50**
Only the stewards stood between Thompson and an impressive points haul. Second in the sprint, he was fourth on road in feature after losing time at pit stop, only to be penalised down to ninth for using old circuit at Paddock. Kox was sixth in sprint, driving a sound defensive race against Plato. He was seventh later on, unable to pass Muller and a little sheepish after his move on Mansell.

NISSAN



8 David Leslie **Anthony Reid** **23**
Almost a perfect day for Reid, but stewards took a dim view of his move on Rydell in feature race and relegated him to second after sprint race victory. The lead Nissan was flying all weekend, taking pole in the one-shot showdown. Leslie felt his Primera was down on power in taking sprint-race fourth. Bigger problem in feature - he had suspension damage, ploughed through a hoarding and trickled into pits to retire.

Qualifying

Rydell and Reid continued their regular pattern of domination in the scrap for grid positions. This time both drivers took one pole each

There has rarely been anyone to touch Rickard Rydell or Anthony Reid in BTCC qualifying this season. And, sure enough, the men running one-two in the points standings produced the goods again at Brands Hatch to take their seasonal pole position totals to seven and nine respectively.

Rydell's TWR Volvo S40, unbeatable around the 1.2-mile Kent circuit in May, came up trumps in the morning qualifying session, pipping Reid's Ray Mallock Limited Nissan Primera by 0.031s. But, in the afternoon's one-shot showdown, the Scot turned the tables by 0.080s to become the first man this season to deprive the Swede of a Brands point.

The two men were in a class of their own in qualifying. In fact, Rydell thought that even Reid wouldn't get close to his blistering effort in the morning half-hour, changing out of his racesuit and into civvies long before the session had finished. On

his last run Reid was up on the Volvo at the mid-lap split, but the Nissan's relative aversion to kerbs meant that it lost time through Surtees, and Rydell was able to breathe a sigh of relief.

'I didn't think that I could go out and do a better time on the same tyres,' said Rydell of his Niki Lauda-like coolness. 'I was a little bit nervous when Anthony got close though.'

Rydell felt that the balance was not quite ideal, and that subsequently he lost time through Paddock Hill Bend in the one-shot showdown because of an over-cautious approach. Still, he was right with his main title rival.

Reid felt that his main reason for missing out on the earlier pole was encountering another car on the track. ('Yvan) Muller moved across out of Druids. He didn't hold me up, but he took a little bit of air off me down Graham Hill and that choked the speed a bit and put me 2kmh down on Cooper Straight. But that's the nature of the beast. It just goes to show, if you want

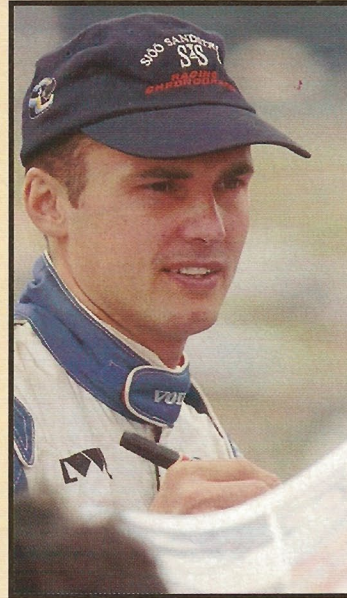

Laurence Baker

Rydell stayed cool, and stayed fastest

to improve racing, take the wings off.'

Closest challenger to Rydell and Reid was James Thompson. The Prodrive Honda man had had a desperate time in pre-race testing, but attributed his improvement in pace to changes made to the car on Saturday night. Other insiders in the camp reckoned he had also calmed down his driving and duly performed better in qualifying. 'Our mobile chicane's up there again,' laughed Thompson in deference to the Accord's lack of race-pace in testing.

Reigning champion Alain Menu looked as though he couldn't possibly go any quicker in his Williams Renault Laguna, which has struggled to get on front running pace at Brands this year. He took fourth in qualifying, but was edged out of the place in the one-shot showdown by the second Nissan of David Leslie. 'Fourth was the best we were hoping for and we got it,' said the philosophical Swiss.



Menu drove impressively for third place

Thompson was next in Reid's sights. In taking second, the Honda man had lost ground on Rydell, but now, pursued by the Nissan, he was in turn catching the Volvo. The concertina continued until Reid ducked into the pits. Often this season, the Mallock crew has lost ground during its stops, but on this occasion the team did Reid proud. Rydell's TWR boys only gave their man a tiny advantage, so Thompson - for whom Prodrive has been spectacularly brilliant this season -

was justifiably confident.

Sadly, it went wrong for the Englishman, whose airjack jammed, costing him around seven seconds over his rivals and dropping him to fourth behind Menu.

After guest appearances in the lead from Plato, Kox, independent Robb Gravett and Peugeot's Tim Harvey, who was driving a blinder, the race reverted to a Rydell versus Reid battle. With 15 laps to go the gap was just 0.4s, but it rose a little as Reid throttled back to save



Ralph Hardwick

Radisich scored with 10th in both races

slowed right down and brake tested me almost down to first gear. That allowed Thompson to drive right round the outside of me.' Rydell countered: 'Anthony hit me up the rear quite hard going into Druids, but I was prepared for that. That's racing.'

This was where the class of the Nissan started to show. Reid was after Plato's fourth spot, and he won it by squeezing inside the Renault at Paddock on the 11th lap. Two laps later, he pulled an identical manoeuvre on Menu. 'Anthony was catching me fast,' the Swiss recalled. 'There was no point in doing anything stupid to keep him behind.'



Commercial break: David Leslie finds his progress is hindered by an advertising hoarding

himself for a final charge.

Ten laps left, and the chase was back on. The Nissan hauled in the Volvo, and, on lap 46 of the 50, tried a move from a long way back into Druids. There was contact, Rydell skated wide and Reid was through. Skated wide and Reid was through. Skated the Swede, who tapped the Nissan at Clearways, but then fell back to trail Reid home by 1.400s.

That wasn't the end of it. In parc ferme there was a fracas between the two, in which it was alleged Rydell grabbed his rival by the neck. 'I went to speak to him,' said Rickard, 'and I leaned into his car. That's between us, and I don't have to talk about ▶

... Brands Hatch team by team... Brands Hatch team by team... Brands Hatch team by team...



9 Tim Harvey Paul Radisich 11
Harvey's 406, which has been outpaced by slugs all season, turned into green-and-gold missile in feature race and scorched through midfield pack to eighth. 'I enjoyed a race!' grinned disbelieving driver. Radisich also scraped a point for 10th, just as he had done in earlier sprint race. Starter motor failure forced Harvey to start sprint from rear, from where he took 15th place.



1 Alain Menu Jason Plato 3
Curiously anonymous day from normally combative Laguna drivers. Menu took his place in the train in sprint race and was unable to deviate from fifth, while Plato was caught behind Kox and took seventh. Menu benefited from goings on around him to finish third in the feature, while Plato was fourth. 'It was a pretty good result,' summed up Menu, aware that this is one of the Renault's weakest circuits.



88 Derek Warwick John Cleland 98
Only light on a metaphorically grey day was Cleland's eighth place finish in the sprint, the Scot gaining ground on others as their race pace fell away. Warwick had clipped Neal when safety car came out, and eventually an ingested air-filter caused him to retire his Vectra. Engine problems forced Cleland out at start of feature. Birthday boy Warwick ninth on road, but given 30-second penalty for using old circuit.

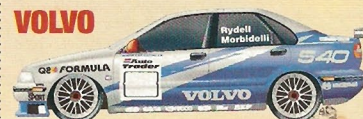

4 Rickard Rydell Gianni Morbidelli 14
Rydell was back on form and took pole for feature race. He led too, but was pushed aside by Reid into second, only to gain win when the Nissan was penalised. The Swede was third in the sprint, despite losing rear bumper on first lap. Morbidelli dropped out of sprint with suspension failure. Then he stopped in feature. Team director Roger Silman said: 'It was a significant supply problem to the engine with our fuel!'

Congratulations to Eddie, Damon, Ralf and everyone at Jordan Grand Prix in becoming the winning team we've always known you'd be!

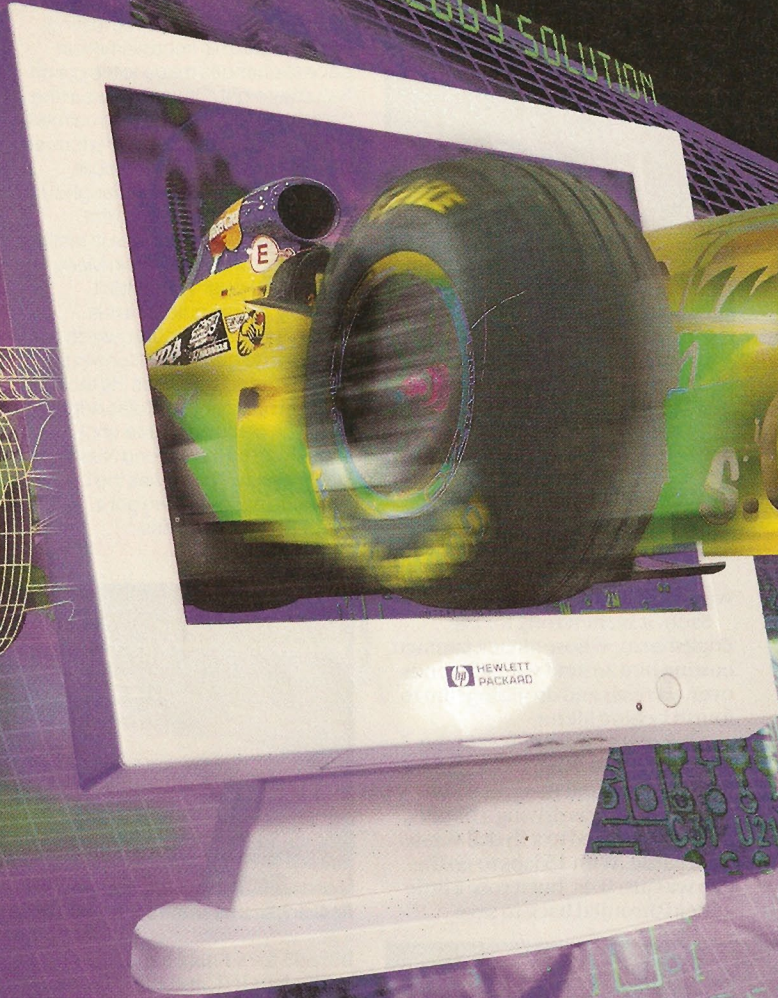

24 HOURS
GLOBAL
SERVICES AND SUPPORT
CONGRATULATIONS

What a Team!



HEWLETT
PACKARD

Technical Partners of



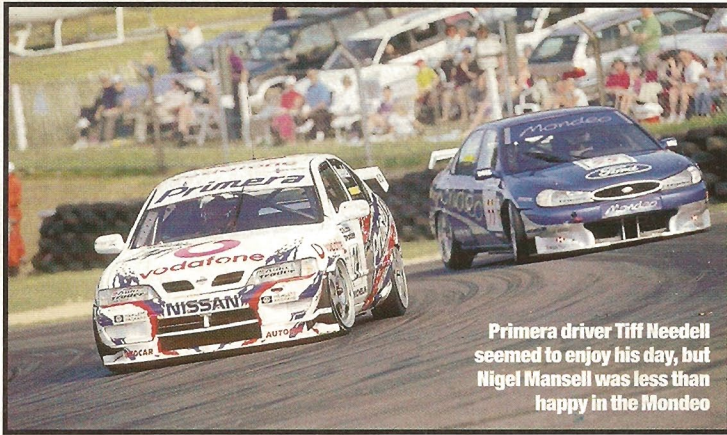

Primera driver Tiff Needell seemed to enjoy his day, but Nigel Mansell was less than happy in the Mondeo

◀ it. Because of the adrenalin I had to tell him what I thought.' Reid replied: 'I won't pass comment on that. I'll let the cameras decide.'

The drivers were, however, more vocal about the on-track incident. 'I was so far ahead I didn't have to defend,' Rydell grumbled. 'I think he forgot to put the brakes on - he certainly kept the throttle on 50 metres too long. He rammed me and I was on full opposite lock, close to going off.' Reid's response? 'My story's a little bit different, of course. I caught him quickly, we made contact, he slid a bit wide and that was that.'

Menu, quietly impressive all day, took third from Thompson, who

lost fourth position when he was given a 30-second penalty for prohibited use of the old circuit at Paddock. That dropped him to ninth and promoted Plato, who held station once he realised his quarry was at the mercy of the officials.

Leslie had managed to get ahead of Plato, but a few laps later endured one of the most bizarre incidents of the season when he slid straight off at Surtees and ploughed through a dangerously-sited advertising hoarding. Suspension damage caused the off-track excursion, and forced the Scot - and the advert - into the pits for the rest of the race. Another top performance by Neal gave the lanky man a fine fifth, while Audi A4 racer Yvan Muller fended off Kox for sixth.

The Dutchman earned himself some notoriety for taking Mansell out while lapping the tardy Ford Mondeo, which, for the second time was pitched into the barriers on the descent to Graham Hill Bend.

Once again a Mansell appearance had excitement and melodrama. The difference, this time, was that it wasn't confined to him. Rydell and Reid, two of the mildest-mannered, most pleasant men in motorsport, were at loggerheads. Next thing we know, someone will be telling us a Jordan won a Grand Prix! ■



Collins/Sutton

Yvan Muller knows all about good posture

AUTOSPORT CUP

An inspired Matt Neal raced out of his skin in both races at Brands

This weekend was a *tour de force* from Matt Neal, the Team Dynamics Nissan Primera driver for whom overall performances count for far more than points in the AUTOSPORT Cup for independents.

Neal started the sprint race from near the back of the grid because of an off during the one-shot showdown. He was soon past the Mardi Gras Motorsport Vauxhall Vectra of Mark Lemmer and Robb Gravett's Brookes Motorsport Honda Accord, and just managed to avoid the drama as Lemmer and Nigel Mansell went piling into the barriers before Graham Hill Bend. Lemmer was out with damage to the right front.

Neal was soon up behind the DC Cook Motorsport Renault Laguna of Tommy Rustad, which he passed at Clearways four laps after the safety car returned to the pits. Neal was on a mission, scything his way past the midfield works cars and storming his way up the order to ninth.

'I set myself a goal of the independent win and possibly a top 10 place,' grinned Neal. 'I thought the top 10 was unrealistic, but the Primera was absolutely awesome. I

had a lunge at John Cleland on the last lap. He closed the door and I was on the grass. It was hairy but I survived.' It was a stellar performance.

Rustad was shouldered down the order by the tail-end works cars, and then was shoved out of the way for second by Gravett at Druids on the last lap. The manoeuvre earned the reigning champion a three-second penalty, reinstating the Norwegian in his second place.

'I think he must have blacked out,' said a disbelieving Rustad. 'He was so fast he nearly went into the gravel himself.' Gravett retorted: 'I was surprised he didn't have the grace to let me by.'

There was less controversy in the feature race for the indie boys. While Neal was doing his own thing among the leading bunch, Rustad held a promising midfield position which evaporated with a tardy pit stop. That allowed Gravett into second, while Lemmer struggled home fourth.

Still Rustad leads by 28 points from Gravett, with Neal a further 10 in arrears. 'All Tommy has to do is trundle round and pick up the points,' acknowledged Neal.

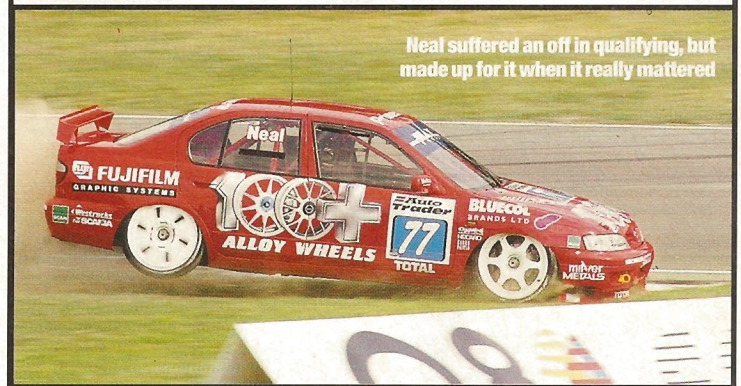

Neal suffered an off in qualifying, but made up for it when it really mattered

Brands Hatch (GB)

August 31, **Auto Trader RAC British Touring Car Championship**, rounds 21 & 22 of 26, 1x30 laps and 1x50 laps - 1x36.108 miles and 1x60.18 miles

SPRINT RACE

Pos	Driver (Nat)	Tyres	Car	Team	Result	Best lap	Qual	Grid
1	Anthony Reid (GB)	M	Nissan Primera	Ray Mallock Limited	25:31.825	44.967	44.583	1
2	James Thompson (GB)	M	Honda Accord	Prodrive	25:34.434	45.336	44.804	3
3	Rickard Rydell (S)	M	Volvo S40	TWR Racing	25:35.367	45.498	44.663	2
4	David Leslie (GB)	M	Nissan Primera	Ray Mallock Limited	25:36.541	45.494	44.998	4
5	Alain Menu (CH)	M	Renault Laguna	Williams Touring Car Eng	25:37.539	45.553	45.041	5
6	Peter Kox (NL)	M	Honda Accord	Prodrive	25:43.246	45.621	45.046	6
7	Jason Plato (GB)	M	Renault Laguna	Williams Touring Car Eng	25:43.605	45.679	45.092	7
8	John Cleland (GB)	M	Vauxhall Vectra	Triple Eight Race Eng	25:44.143	45.900	45.343	11
9 (I)	Matt Neal (GB)	M	Nissan Primera	Team Dynamics	25:44.468	45.578	46.577	19
10	Paul Radisich (NZ)	M	Peugeot 406	Motor Sport Developments	25:53.048	46.140	45.342	10
11	Yvan Muller (F)	M	Audi A4	Audi Sport UK	25:53.539	46.203	45.321	9
12	Tiff Needell (GB)	M	Nissan Primera	Ray Mallock Limited	25:53.739	46.060	45.391	12
13	John Bintcliffe (GB)	M	Audi A4	Audi Sport UK	25:54.219	45.948	no time	21
14	Tim Harvey (GB)	M	Peugeot 406	Motor Sport Developments	25:57.069	45.843	45.884	16
15 (I)	Tommy Rustad (N)	M	Renault Laguna	DC Cook Motorsport	25:58.888	45.977	45.425	13
16 (I)	Robb Gravett (GB)	M	Honda Accord	Brookes Motorsport	25:59.646	45.958	45.804	15
R	Derek Warwick (GB)	M	Vauxhall Vectra	Triple Eight Race Eng	17 laps-engine	46.018	no time	20
R	Gianni Morbidelli (I)	M	Volvo S40	TWR Racing	10 laps-susp	46.131	45.163	8
R	Will Hoy (GB)	M	Ford Mondeo	West Surrey Racing	4 laps-black flag	45.694	45.750	14
R	Mark Lemmer (GB)	D	Vauxhall Vectra	Mardi Gras Motorsport	0 laps-acc	-	46.088	17
R	Nigel Mansell (GB)	M	Ford Mondeo	West Surrey Racing	0 laps-acc	-	46.219	18

FEATURE RACE

Pos	Driver	Result	Best lap	Qual	Grid
1	Rydell	38:54.295	45.618	44.300	1
2	Reid	38:54.895	45.040	44.331	2
3	Menu	38:56.208	45.457	44.609	4
4	Plato	38:59.488	45.495	44.622	5
5 (I)	Neal	39:09.622	45.625	44.789	7
6	Muller	39:14.457	45.740	44.878	10
7	Kox	39:14.778	45.803	44.795	8
8	Harvey	39:22.999	45.844	45.401	19
9	Thompson	39:28.452	45.289	44.567	3
10	Radisich	39:28.579	46.036	45.201	18
11	Bintcliffe	39:29.112	45.908	45.064	14
12 (I)	Gravett	39:29.360	45.869	45.101	16
13 (I)	Rustad	39:38.604	45.848	45.022	13
14	Warwick	39:57.845	46.143	44.928	11
15	Needell	49 laps	45.993	45.110	17
16 (I)	Lemmer	49 laps	46.291	45.642	21
R	Hoy	28 laps-acc	45.941	45.087	15
R	Mansell	29 laps-acc	46.098	45.595	20
R	Morbidelli	26 laps-fuel	45.864	44.800	9
R	Leslie	15 laps-susp	45.935	44.648	6
R	Cleland	0 laps-engine-	-	45.016	12

(I) = Independent, M=Michelin, D=Dunlop **Winner's average speed** Race 1-84.90mph; Race 2-92.84mph. **Fastest Laps** Race 1 - Reid, 44.967, 96.359mph; Race 2 - Reid, 45.040, 96.202mph. **Laps led** Race 1: 1-30 Reid. Race 2: 1-19 Rydell; 20-23 Thompson; 24-25 Plato; 26 Kox; 27-30 Gravett; 31-32 Harvey; 33-45 Rydell; 46-50 Reid. **Championship positions after 22 of 26 rounds** 1, Rydell, 223; 2, Reid, 190; 3, Menu, 175; 4, Thompson, 164; 5, Plato, 133; 6, Leslie, 126; 7, Cleland, 101; 8, Muller, 78; 9, Warwick & Hoy, 57. **Manufacturers' Championship** 1, Nissan, 246; 2, Renault, 231; 3, Volvo, 228; 4, Honda, 191; 5, Vauxhall, 155; 6, Audi, 129; 7, Ford, 101; 8, Peugeot, 90. **AUTOSPORT Cup for Independents** 1, Rustad, 224; 2, Gravett, 192; 3, Neal, 184; 4, Moen, 92; 5, Lemmer, 70. **Scoring system** 15-12-10-8-6-5-4-3-2-1. Pole Position-1. Lap leader in feature race-1. **Next round** Oulton Park, September 13.

BELGIAN GRAND PRIX

Hill's Jordan grabs the lead at La Source on lap one, but little does Hakkinen know of the fate that is about to befall him...



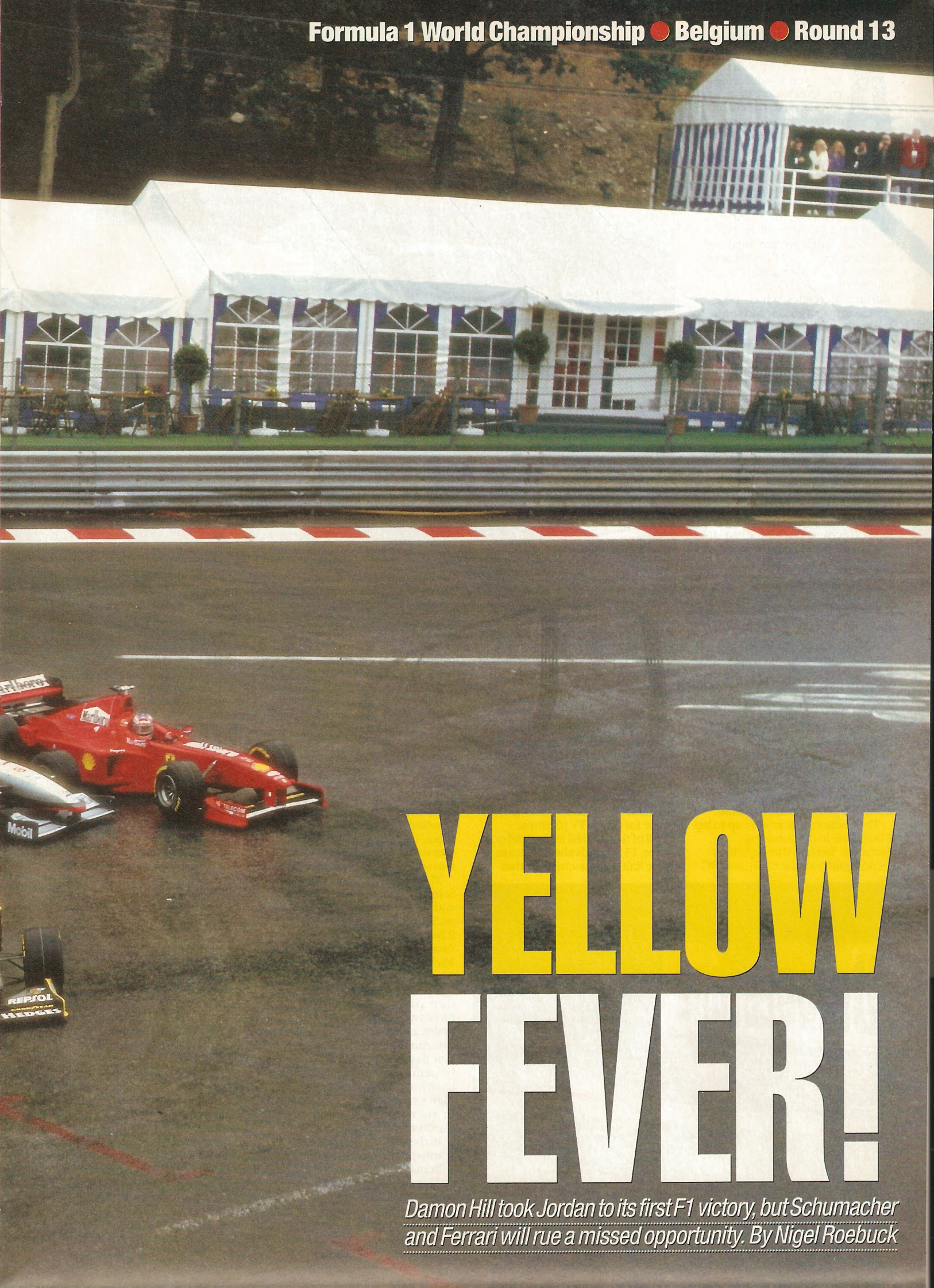

YELLOW FEVER!

Damon Hill took Jordan to its first F1 victory, but Schumacher and Ferrari will rue a missed opportunity. By Nigel Roebuck

A most unusual podium for 1998, you would have to say. After a more than unusual race. The character of Spa-Francorchamps, unique among Formula 1 venues in the modern era, invariably throws up something of a wild card race, but this particular Belgian Grand Prix went way beyond that.

It was wet when the 22 cars got on their way – and within a few seconds 13 of them were involved in an accident out of the La Source hairpin, the whole thing apparently triggered by David Coulthard's McLaren-Mercedes, which lost adhesion over a gutter, and spun across the road.

All but four drivers were able to take the restart, 55 minutes later, and at La Source there was again immediate drama. While Damon Hill's Jordan-Mugen Honda snatched the lead, World Championship contenders Mika Hakkinen and Michael Schumacher went into the hairpin side by side – and at the exit they touched, the McLaren spinning, then being unavoidably clobbered by Johnny Herbert's Sauber.

In the slippery conditions, Hill held off Schumacher for seven laps, but he had gambled on a drying

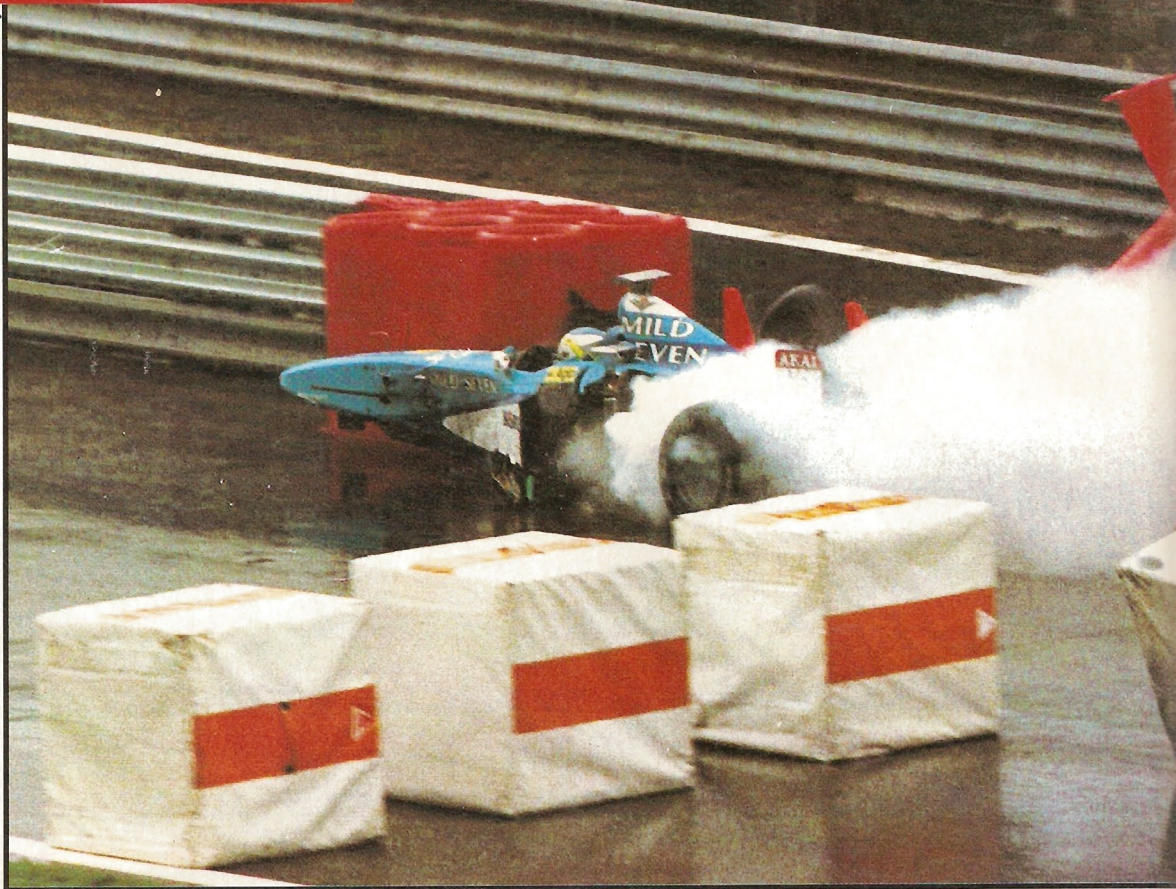

Courtesy/LAT

Trulli passes Tuero, on his way to sixth

afternoon, and ultimately could resist the Ferrari no longer. Thereafter, until lap 25, Michael was set fair, building up a 35-second lead over Damon, and looking certain to take over the championship lead from Hakkinen for the first time.

Then Schumacher came up to lap Coulthard, in the surviving McLaren. 'Let him through,' Ron Dennis said over the radio, and DC

moved to the right, and backed off, whereupon the Ferrari, following closely – unnecessarily closely, some thought, given its comfortable lead – hit the back of the McLaren. This impatience may prove ultimately to have cost Schumacher the World Championship.

His car's right front wheel and suspension gone, Schumacher – together with Coulthard – continued to the pits, and there Michael, apparently convinced that DC had deliberately taken him out, stormed to the McLaren pit, seemingly intent on doing him harm. Fortunately, he was physically restrained, but the incident hardly made for pretty TV pictures.

All of this left Hill in the lead once more, 15 seconds ahead of team mate Ralf Schumacher, but that

advantage was wiped out on lap 29, when the safety car came out, after another huge accident – again without injuries – between Shinji Nakano and Giancarlo Fisichella.

There were 10 laps to go when they got the signal to race again, and if Schumacher Jr had any thought of making a fight of it, he was swiftly – and wisely – disabused of it by the Jordan pit: looking at its first Grand Prix victory, at the 127th time of trying, the team was not about to put anything in jeopardy.

Jean Alesi, though, was close enough to keep the pressure on the yellow cars, the Sauber driver, as ever, inspired in treacherous conditions. 'I could keep up with them,' he said, 'but there was no chance to try anything: the visibility was simply too bad for that...'

Thus, on a day when Hakkinen, Schumacher, Jacques Villeneuve and 10 others were eliminated by accidents, Damon Hill scored his 22nd Grand Prix victory, and his first in almost two years. Mika and Michael might take issue, but most felt that the race had ended well.

We should have known better than to rely on local weather forecasters, for weather forecasting in this area is literally a contradiction in terms. Times without number, race day at Spa has dawned beautifully, only to sour abruptly later, but on this occasion at least it didn't surprise us: it was lousy in the morning, and then stayed lousy for the duration.

In the soaking conditions of the warm-up, the Ferraris were quickest, Schumacher ahead of Irvine, but if Hakkinen was next up, he was less satisfied with the wet performance of his car than were Michael and Eddie; team mate Coulthard, seventh, was one of several drivers to go off during the session.

Suggestions that the track would be dry by 2pm proved somewhat wide of the mark, but no rain fell within half an hour of the start time, so it was decided that, unlike last year, it would not be necessary to begin behind the safety car.

A correct decision, one thought – despite what happened within 15 seconds of the off. When the lights

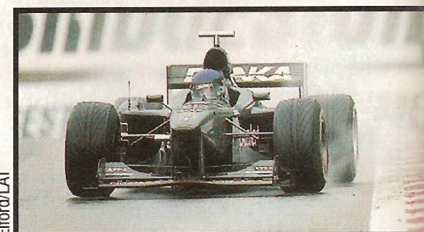

Elford/LAT

Diniz put in a fine wet-weather drive

went out, Hakkinen got away well, but undoubtedly the star of the getaway was Villeneuve, sixth on the grid, but up to second at the entry to La Source.

Schumacher did not get a good start, but Irvine did, and at La Source was threatening Coulthard for third place. At the exit of the hairpin, though, the McLaren suddenly slid across the road, hit the inside barrier, then bounced across to the left.

In an instant there was absolute mayhem, with cars cannoning into each other, left and right, and wheels and bits of bodywork bouncing all over the place. Immediately, the red flag was shown, and the miracle was that no one – save Barrichello, whose elbow took a knock – was injured.

Once the spray had settled, the scene was one of utter mechanical carnage. Littering the track were Coulthard's McLaren, Irvine's Ferrari, both Prosts, both Arrows, both Tyrrells, Barrichello's Stewart,



Elford/LAT

Michael Schumacher finally reeled Damon Hill in and slipped past him at the Bus Stop



On a day peppered with accidents, Giancarlo Fisichella's exit was among the most dramatic. After a collision with Shinji Nakano's Minardi, the Benetton driver's car caught fire and skewed off the circuit, leaving Nakano (inset) in a shower of debris

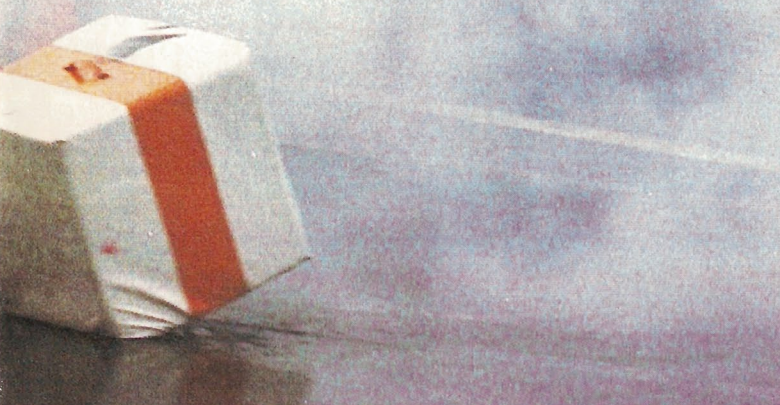

Coulthard slithered off the road, followed immediately by Wurz. David did manage to get back on the road, but now, of course, he was right at the tail of the field.

In the early laps, Hill led Schumacher by a little over a second, which was a surprise, for one had expected - at this track, and in these conditions - that Michael would quickly assert himself at the front.

'I was fine at first,' Damon said, 'but before the restart I'd changed the set-up of the car, because I had the feeling the track was going to start drying, and I wanted something that would work in that situation, as well. As it was, though, the rain kept on, and in the end I couldn't keep Michael back.'



Sutton Images

Kerbs don't frighten Heinz-Harald Frentzen

“ We were strong all weekend. I think the team really deserved a victory ”
DAMON HILL

In what was an extremely brave move, Schumacher went around the outside of the Jordan at the ultra-fast Blanchimont, then outbraked it into the Bus Stop. Once by, the Ferrari began to disappear, Michael pulling out nearly five seconds in a single lap. Barring a mechanical failure - which he hasn't had since Melbourne - he was surely going to walk this.

The rain never stopped. At no stage was it a downpour, more of a heavy and persistent drizzle, but it was enough to make visibility a

Herbert's Sauber, Wurz's Benetton, and Nakano's Minardi.

While the rescue crews set to work, the drivers began returning to the pits on foot, Irvine limping initially, but walking normally by the time he got back to Ferrari. Once the cars and the major bits and pieces of wreckage had been taken away, the already-wet track surface was hosed down, to remove any shards of carbon fibre - like razor blades to a tyre, of course.

At 1.55 they went to the grid once more, although now only 18 were present, for Barrichello decided against restarting, and Panis, Salo and Rosset were left without T-cars.

Hill may have made a mess of his first start, but his second was excellent, and at La Source the Jordan nosed into the lead,

narrowly ahead of Hakkinen. 'I think I had a little more momentum than Mika,' Damon said, 'and I decided I was going for it - after all, I had nothing to lose, and he did...'

Tucking in behind Hill lost Hakkinen a bit of pace, and at La Source he found himself side by side with Schumacher, who this time had got away well. At the exit of the turn, Michael, on the outside, held the McLaren in to a tight line; momentarily they touched, and then Mika's car looped into a slow spin, after which it was struck solidly by Herbert's Sauber. In disbelief, Hakkinen wandered back to his pit, thinking about his World Championship lead, now apparently lost.

A minute or so later, McLaren's day went from bad to worse, as



Teal

The appearance of the safety car on lap 29 brought the podium trio into close formation

In case any still doubted, Jean Alesi reminded us that he is a master of treacherous conditions



major problem, and constantly cars - including Irvine's Ferrari and Villeneuve's Williams - were slithering off, then rejoining.

After his incident, on lap 10, Irvine came in for a new wing, taking on fuel and tyres (wets, rather than the intermediates on which he had started), and a lap later Schumacher Jr made an early stop, preferring to change to wets as soon as possible. It was a good decision.

Five of the first six drivers came in, all of a bunch, at the end of lap 16, only Villeneuve staying out. 'We'd been talking about a pit stop for two laps, and Heinz-Harald made his decision quicker than I did, so when I decided to come in, he was already there. Therefore I had to do an extra lap, and I knew it was going to be hairy, because my rear tyres (intermediates) were dead, and on the previous lap I'd almost lost it several times on the straight...'

On the climb up to Les Combes, travelling at perhaps 180mph, ►

Teal



Sutton



BRUNDLE'S Talking Point

There was plenty to admire in Spa, and plenty to be thankful for, too...

Where to begin? At the start, I suppose. Or the two starts, to be precise. I was very surprised to see David Coulthard spear to the right like that but I was even more surprised to see some of the tail-enders creaming into the melee as hard as they did. Ralf Schumacher saw it happening, parked his car and just stayed out of the way. The mid-fielders didn't stand a chance but, as for the others, normally a sixth sense comes into play. After all, there wasn't much spray at that point.

I didn't think it was necessary to have the race start behind the safety car. If the accident had been caused by poor visibility or standing water then I and the Race Director would have been proved wrong. But it was a car losing it under traction – which

wasn't going to see that because you can't see anything in those conditions. The Clerk of the Course could see the waved fist so, in a way, that makes it a valid thing to do. But it also suggests that, a few seconds before he went into the back of Coulthard, his focus was one of anger and not one of calm. "I'm winning this race by half a minute." Then 'Bang!'

It reminded me of the time Ayrton Senna hit me in Adelaide. You are minding your own business and – wallop! Where did that come from?

Thank God the cars didn't fly. The incident I hated most was Fisichella's crash when you saw the front suspension whiz past his left ear. It's a miracle there were 22 GP drivers still on their feet after the race. When we think about Imola in 1994, just



Rose/Sutton

Villeneuve lost it when his tyres went off

than pleased with the decision.

In fact, for everyone in the Jordan pit, those last few laps were extraordinarily tense, not only because a first Grand Prix victory was in the offing, but also because it was by no means a certainty. The rain continued to come down, and Hill's car, as we have said, was on 'compromise' settings, by no means ideal for the conditions.

Plus, there was Alesi, driving beautifully, and showing again – as he always does when the elements are hostile – that when it comes to flair, courage and car control he still has very few equals. The Sauber was less than two seconds behind the second Jordan, and thus Ralf, while bearing in mind he was not to threaten Damon, was hardly in a

position to cruise.

Over the last three laps, though, Alesi began to drop back slightly. 'The visibility was simply too bad to try anything,' he said. 'The conditions today were extremely dangerous: up the hill to Les Combes, I was aquaplaning all over the place – and there were cars left at the trackside there...'

In the misty murk, the Jordans swept on, and finally Hill came over the line, a winner once again after two years, the Jordan crew scarcely able to take in that the long wait was over. 'We were strong all weekend,' Damon said. 'I think the team deserved a victory.' No arguments there.

So, too, did he, after a magnificent race, in which he never ran lower than second, and finally laid to rest the suggestion that he only won races because he was driving a Williams-Renault.

The joy – save in the case of Ralf, anyway – was unconfined everywhere. Sauber was thrilled with Alesi's place on the podium, and Frentzen, an admittedly undramatic fourth, was simply happy to be feeling well again. Arrows, after all its tribulations, could hardly have expected to leave Spa with some points, but Diniz got two of them, and the significance, financial and otherwise, of the final point – Trulli's – could hardly have been greater for Prost, for it was the team's first of the season.

In the Ferrari motorhome, meanwhile, Schumacher Sr continued to rage away, only too aware of the 10 points lost. Sorry, Michael, but they were there for the taking; there really was no need to snatch at them. ■



Wheel of misfortune: did Michael Schumacher pay the price for pushing too hard?

could have happened at any time. They chose not to run the safety car for the second start either but I guess they had to do that to vindicate the first decision.

Mika Hakkinen seemed to be slightly overcautious in the first corner of the second start. In the scramble which followed, it looked as if Mika gave it too much power as he spun. This was probably the first evidence of the Bridgestone runners not having as much grip as Goodyear, Coulthard then losing it, as did Wurz.

After the early fiasco the race seemed to settle down. Michael Schumacher was pushing so hard; when he made that move up the inside to lap Diniz, you thought: 'Hang on Michael, you've got a half a minute lead!'

Then we had a shot of Michael shaking his fist while trying to get past Coulthard. Obviously David

remember today and how fortunate everyone was. There were some horrible, horrible accidents.

I thought Damon Hill remained very calm throughout all of this. He didn't get flustered, even when Schumacher took the lead. For Michael to follow another car in the pouring rain through Blanchimont and gain enough speed to come up alongside before the Bus Stop is nothing short of superhuman. There are only a handful of people in the world who could drive an F1 car through there like that – by themselves. But to close on someone with a blind faith that says: 'Right, I'm going to stay on the throttle harder than you' – and actually nail him coming out of Blanchimont!

But I'm bound to say that Schuey's massive confidence finally bit him. That's how I saw it after an absolutely incredible race with a wonderful result for Jordan Grand Prix.



Eddie Irvine's off-track excursion forced an unscheduled pit stop to fit a new front wing

Rose/Sutton

BELGIAN GRAND PRIX

'98 so far...

TEAM QUALIFYING

9	Villeneuve	Frentzen	4
12	M Schumacher	Irvine	1
9	Fisichella	Wurz	4
3	Coulthard	Hakkinen	10
6	Hill	R Schumacher	7
5	Panis	Trulli	8
8	Alesi	Herbert	5
5	Diniz	Salo	0
7	Barrichello	Magnussen	0
5	Barrichello	Verstappen	1
1	Rosset	Takagi	12
8	Nakano	Tuero	5

SUPERGRID

Pos	Driver	Average
1	Hakkinen	1.46
2	Coulthard	2.92
3	M Schumacher	3.38
4	Irvine	5.84
5	Fisichella	6.77
6	Villeneuve	6.92
7	Frentzen	7.30
8	Hill	8.54
9	Wurz	8.92
10	R Schumacher	9.31
11	Alesi	10.54
12	Herbert	11.46
13	Barrichello	13.08
14	Trulli	14.15
15	Salo	15.00
16	Panis	15.54
17	Verstappen	15.83
18	Diniz	16.46
19	Takagi	17.23
20	Magnussen	18.71
21	Nakano	19.85
22	Tuero	19.92
23	Rosset	21.00

TYRE WAR

	Bridgestone	Goodyear
Wins	7	6
Poles	13	0
Points	169	188
Laps led	605	237
Fastest laps	8	5

FIRST LAP POSITION

Driver	gained/lost season
Coulthard	-13
Hakkinen	0
Fisichella	-1
M Schumacher	+2
Frentzen	+3
Wurz	0
Irvine	-2
Salo	0
Herbert	0
Trulli	0
Alesi	+6
Diniz	+7
Villeneuve	+1
Barrichello	0
Hill	+2
R Schumacher	+1
Magnussen	0
Panis	0
Nakano	+9
Rosset	0
Takagi	+8
Tuero	+8
Verstappen	+7

DRIVER STATS

Driver	laps led/completed
Villeneuve	0/785
Frentzen	0/618
M Schumacher	210/770
Irvine	1/722
Fisichella	24/669
Wurz	0/707
Coulthard	111/703
Hakkinen	472/685
Hill	26/688
R Schumacher	0/554
Panis	0/616
Trulli	0/542
Alesi	0/689
Herbert	0/621
Diniz	0/461
Salo	0/395
Barrichello	0/467
Verstappen	0/264
Rosset	0/376
Takagi	0/513
Nakano	0/656
Tuero	0/478
Magnussen	0/257



As ever Jean Alesi revelled in the soaking conditions to equal the Sauber team's best Grand Prix finish with a fine third place in the wheel tracks of the two Jordans



The party begins as Damon Hill (right) and Ralf Schumacher help Eddie Jordan (left) enjoy the moment he has waited seven years for, to taste that sweet F1 victory champagne

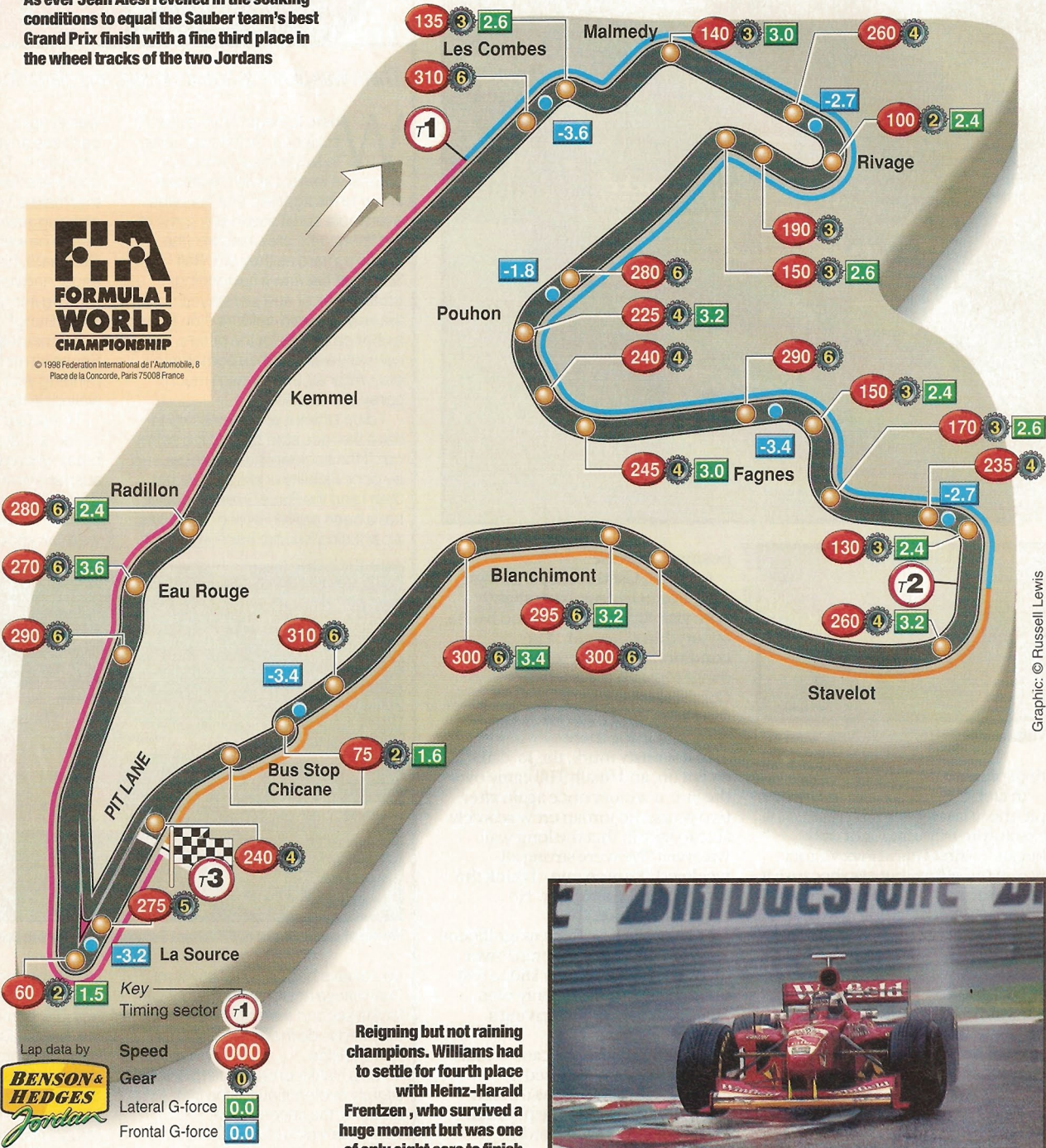

Reigning but not raining champions. Williams had to settle for fourth place with Heinz-Harald Frentzen, who survived a huge moment but was one of only eight cars to finish



START GRID

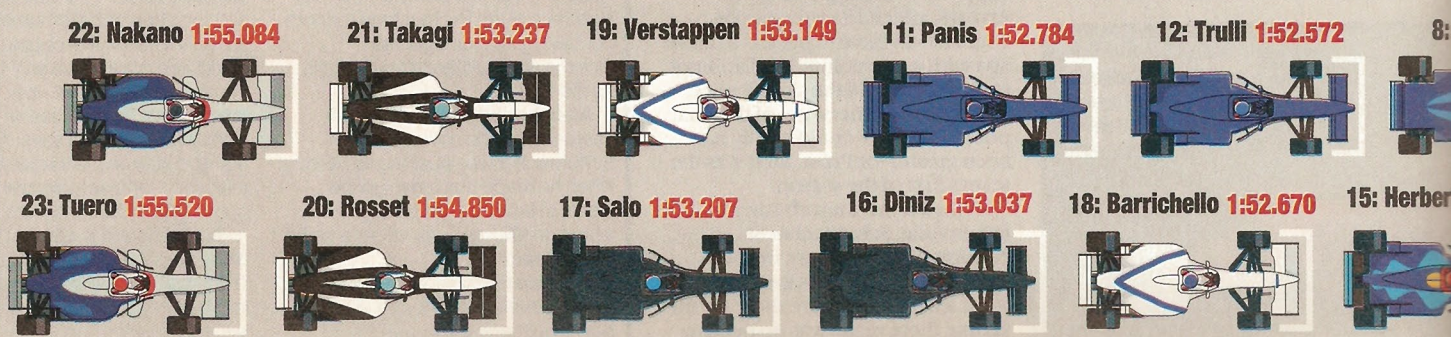

BELGIAN GP

Title chase

DRIVERS	
1 Hakkinen	77
2 M Schumacher	70
3 Coulthard	48
4 Irvine	32
5 Villeneuve	20
6 Wurz	17
7 Hill	16
8 Fisichella	15
9 Frenzen	13
10 R Schumacher	10
11 Alesi	7
12 Barrichello	4
13 Salo/Diniz	3
15 Herbert/Magnussen/Trulli	1

CONSTRUCTORS	
1 McLaren-Mercedes	125
2 Ferrari	102
3 Williams-Mecachrome	33
4 Benetton-Playlife	32
5 Jordan-Mugen Honda	26
6 Sauber-Petronas	8
7 Arrows	6
8 Stewart-Ford	5
9 Prost-Peugeot	1

TOTAL WINS		
DRIVER	CAREER	1998
M Schumacher	32	5
Hill	22	1
Villeneuve	11	
Hakkinen	7	6
Coulthard	4	1
Herbert	2	
Alesi	1	
Frenzen	1	
Panis	1	

TOTAL POLES		
DRIVER	CAREER	1998
Hill	20	
M Schumacher	17	
Villeneuve	13	
Hakkinen	10	9
Coulthard	8	3
Alesi	2	
Barrichello	1	
Frenzen	1	
Fisichella	1	1

FASTEST LAPS		
DRIVER	CAREER	1998
M Schumacher	33	5
Hill	19	
Villeneuve	9	
Frenzen	6	
Coulthard	8	4
Hakkinen	5	4
Alesi	4	

Round 13, Spa-Francorchamps. August 30, 1998

Lap distance: 4.330 miles. Lap record: Jacques Villeneuve - Williams FW19, 1997, 1m52.692s @ 138.315mph Weather: Wet



Results

POS	DRIVER	CAR	TYRES	LAPS	TIME/REASON	MPH
1	Damon Hill (GB)	Jordan-Mugen Honda	Goodyear	44	1:43:47.407	110.130
2	Ralf Schumacher (D)	Jordan-Mugen Honda	Goodyear	44	1:43:48.339	110.113
3	Jean Alesi (F)	Sauber-Petronas	Goodyear	44	1:43:54.647	110.002
4	Heinz-Harald Frenzen (D)	Williams-Mecachrome	Goodyear	44	1:44:19.650	109.563
5	Pedro Diniz (BR)	Arrows	Bridgestone	44	1:44:39.089	109.223
6	Jarno Trulli (I)	Prost-Peugeot	Bridgestone	42	1:44:42.230	104.207
7	David Coulthard (GB)	McLaren-Mercedes	Bridgestone	39	1:43:51.512	97.544
8	Shinji Nakano (J)	Minardi-Ford	Bridgestone	39	1:46:01.069	95.563
R	Giancarlo Fisichella (I)	Benetton-Playlife	Bridgestone	26	Accident	113.471
R	Michael Schumacher (D)	Ferrari	Goodyear	25	Accident	115.558
R	Eddie Irvine (GB)	Ferrari	Goodyear	25	Spin	113.407
R	Esteban Tuero (RA)	Minardi-Ford	Bridgestone	17	Electrics	104.546
R	Jacques Villeneuve (CDN)	Williams-Mecachrome	Goodyear	16	Accident	114.598
R	Toranosuke Takagi (J)	Tyrrell-Ford	Goodyear	10	Spin	110.336
R	Jos Verstappen (NL)	Stewart-Ford	Bridgestone	8	Engine	108.834
R	Mika Hakkinen (SF)	McLaren-Mercedes	Bridgestone	0	Accident	
R	Alexander Wurz (AUT)	Benetton-Playlife	Bridgestone	0	Accident	
R	Johnny Herbert (GB)	Sauber-Petronas	Goodyear	0	Accident	
DNS	Olivier Panis (F)	Prost-Peugeot	Bridgestone			
DNS	Rubens Barrichello (BR)	Stewart-Ford	Bridgestone			
DNS	Mika Salo (SF)	Arrows	Bridgestone			
DNS	Ricardo Rosset (BR)	Tyrrell-Ford	Goodyear			

Fastest pit stop 30.663s, Damon Hill

Fastest laps

SECOND TIMED - COOL, DRY

1 Hakkinen	1:50.319
2 Coulthard	1:50.702
3 Hill	1:51.368
4 Villeneuve	1:51.859
5 Irvine	1:51.972
6 M Schumacher	1:52.058
7 Alesi	1:52.102
8 Frenzen	1:52.136
9 R Schumacher	1:52.346
10 Fisichella	1:52.542
11 Wurz	1:53.020
12 Herbert	1:53.379
13 Takagi	1:53.898
14 Panis	1:53.933
15 Barrichello	1:54.071
16 Salo	1:54.814
17 Trulli	1:55.049
18 Diniz	1:55.302
19 Verstappen	1:55.451
20 Nakano	1:56.329
21 Rosset	1:56.604
22 Tuero	1:57.000

QUALIFYING - COOL, DRY

1 Hakkinen	1:48.682
2 Coulthard	1:48.845
3 Hill	1:49.728
4 M Schumacher	1:50.027
5 Irvine	1:50.189
6 Villeneuve	1:50.204
7 Fisichella	1:50.462
8 R Schumacher	1:50.501
9 Frenzen	1:50.686
10 Alesi	1:51.189
11 Wurz	1:51.648
12 Herbert	1:51.851
13 Trulli	1:52.572
14 Barrichello	1:52.670
15 Panis	1:52.784
16 Diniz	1:53.037
17 Verstappen	1:53.149
18 Salo	1:53.207
19 Takagi	1:53.237
20 Rosset	1:54.850
21 Nakano	1:55.084
22 Tuero	1:55.520

WARM UP - WET

1 M Schumacher	2:07.839
2 Irvine	2:08.608
3 Hakkinen	2:09.120
4 Fisichella	2:09.127
5 R Schumacher	2:09.539
6 Hill	2:10.076
7 Coulthard	2:10.258
8 Wurz	2:10.917
9 Barrichello	2:11.374
10 Alesi	2:11.546
11 Frenzen	2:11.860
12 Villeneuve	2:13.781
13 Diniz	2:13.853
14 Takagi	2:14.038
15 Herbert	2:14.147
16 Trulli	2:14.680
17 Salo	2:16.139
18 Rosset	2:16.174
19 Nakano	2:16.217
20 Verstappen	2:17.733
21 Tuero	2:20.842
22 Panis	2:26.065

RACE - WET

1 M Schumacher	2:03.766
2 Hill	2:05.630
3 Frenzen	2:06.284
4 Irvine	2:06.561
5 Alesi	2:07.597
6 Villeneuve	2:07.825
7 R Schumacher	2:08.399
8 Fisichella	2:09.528
9 Coulthard	2:10.950
10 Diniz	2:11.331
11 Trulli	2:11.701
12 Takagi	2:12.327
13 Verstappen	2:12.425
14 Nakano	2:13.230
15 Tuero	2:19.996

Wurz 1:51.648 2: Frenzen 1:50.686 5: Fisichella 1:50.462 4: Irvine 1:50.169 9: Hill 1:49.728 8: Hakkinen 1:48.682



1:51.851 14: Alesi 1:51.189 10: R Schumacher 1:50.501 1: Villeneuve 1:50.204 3: M Schumacher 1:50.027 7: Coulthard 1:48.845



Qualifying

by Andrew Benson

McLaren edges it

Neither Mika Hakkinen nor David Coulthard took Eau Rouge without lifting off the throttle, the ultimate racing driver's adrenaline trip, but they did not need to. When the gap between your team and the next is a second, you can afford to play it a little bit safe.

'For their ego,' Coulthard said, 'everyone tries to go flat through Eau Rouge, but if you set the car up only for there you screw it for the mid-part of the track, so you have to try to get the trade-off right for qualifying.'

What happens when a driver's desire for the ultimate rush in a racing car overtakes the laws of physics had been graphically illustrated twice in the space of the previous 24 hours. Both Jacques

Villeneuve and Mika Salo suffered huge accidents at what is arguably the most difficult corner in the world (see *Pit & Paddock*).

'I didn't take Eau Rouge flat,' Coulthard said. 'I tried on my third run but I did a Jacques and managed to catch it. I decided it was better to give away a little bit and gain it elsewhere around the lap.'

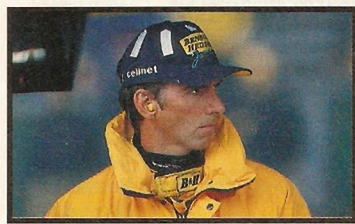

Hill managed to qualify 'best of the rest'

All photos: Sutton

Hakkinen had a ball in the fight for pole, even if his 'flat through Eau Rouge' claim was exaggerated



David Coulthard reckoned he stretched things a bit too far over the kerbs at the Bus Stop

With a wicked grin, Hakkinen claimed he had done it on the lap on which he stole pole position from under Coulthard's nose, but the Scot was having none of it. 'I've seen his telemetry,' he said. 'I know the truth!'

Even without the heroics later claimed by others, Hakkinen and Coulthard dominated qualifying for the Belgian Grand Prix. The Finn took yet another pole position - his ninth of the season - and Coulthard was only 0.163s behind him. Third-placed Damon Hill was a little over a second away from Hakkinen's best.

Coulthard said he was 'surprised' at the gap back to third, 'because earlier on in the session we felt we might be struggling a bit in our performance.' Struggling is a relative term. After the first runs, Coulthard was fastest, 0.328s ahead of



Schumacher lacked his usual Spa sparkle

Hakkinen. Michael Schumacher, third quickest at the time, was 0.764s off the pace.

Spa played host to the closest battle between the McLaren drivers for some time, and for a long while it appeared that Coulthard had the edge. David was quickest until the very last run, when Hakkinen sneaked ahead as the flag fell and the Scot could not respond.

Belgium team by team... Belgium team by team... Belgium team by team... Belgium team by team...

WILLIAMS

Williams FW20, Mecachrome V10



1 Villeneuve FW20/5

FW20/4 Frentzen **2**

After recent progress, Spa was a frustrating weekend for Williams. Villeneuve had a huge shunt at the top of Eau Rouge early on Friday afternoon, and the lost track time cost him as he struggled to find a set-up for qualifying, in which he managed sixth. Recovered from his Hungarian illness, Frentzen was ninth, having been held up by Takagi on his last run. Both men narrowly escaped the first lap shunt, although HHF had some wing

damage. Jacques was quickly up to fourth, but slipped to sixth when he spun exiting the Bus Stop on lap five. He struggled on intermediates and spun off on the straight on lap 17 just before his planned stop. Locked in a battle with Alesi, Frentzen was running in third when he had a trip through the gravel on lap 14, just before stopping for wets. He gained fourth when Schumacher crashed into Coulthard, and held it to the flag.

FERRARI

Ferrari F300, Ferrari V10



3 M Schumacher F300/188

F300/185 Irvine **4**

A dream race for Ferrari ended in heartbreak as Michael Schumacher's 10 points went down the drain. The new long-wheelbase spec showed promise on Friday when Michael was quickest, by 0.011s, but in qualifying he slipped to fourth. Eddie Irvine has never been happy with the handling on this year's car, but still lined up fifth, despite losing a lap which might have beaten Michael when he was put off line by the tardy Rosset. Eddie bruised

his knee in the first lap shunt, and had to start in Michael's spare. Schumacher tangled with Hakkinen on the restart, and took the lead from Hill on lap eight. He led by 37secs when he tangled with Coulthard on lap 25. Irvine slotted into third, but was not comfortable in the car. He lost the nose when he straightlined the Malmedy chicane on lap 10, and was sixth when he spun off on lap 25, just after his second stop.



Ferrari's struggle

Schuey finds the going tough

The King of Spa Michael Schumacher may be, but his crown slipped a little this year. He has virtually made the most challenging Grand Prix track of all his own, but this year he managed to lap just 0.392s quicker than his mere mortal team mate, Eddie Irvine, in qualifying last weekend.

Even more mystifying was that he did not seem to know why, and his team was even moved to suggest 'Michael did not drive that well today'. Ferrari was struggling and, according to Irvine, there was only one way to get his car to go quickly. 'The car is awful,' the Irishman said. 'To get it balanced we have to run it really stiff, and that makes it bad on the bumps and hard on the tyres. But, for me, it's the only way to get rid of the understeer.'

Schumacher's margin over his team mates at Spa has traditionally been measured in seconds, not fractions of them, and the ignominy was worsened this season because he was docked his best time after

Hakkinen on pole position.

Irvine had a lap that would have beaten Schumacher's time wrecked when he was blocked by Ricardo Rosset's Tyrrell at the Bus Stop. He said: 'Michael loves it here, but if I don't get understeer I can be right with him. Mind you, through Eau Rouge, he is mind-blowing. He's flat all the time, but I don't lose too much that way because if you are flat you can scrub a lot of speed off at the top trying to keep it together.'

Irvine was running more downforce than Schumacher, and that meant that despite the German being nearly seven mph quicker out of Eau Rouge, Irvine barely lost out at all elsewhere.

'Michael's car is not good,' said Ferrari spokesman Claudio Berro. 'Eddie's is better, but he has done very well today, and Michael not so well.'

Ferrari thought that its main deficit to McLaren was in its car's poor ability over the kerbs at the Bus Stop chicane. 'We lose 0.5s at the Bus Stop,' Berro said. 'Our exit speed from there is not good. In the middle

'In the back of my mind (I know that) I was a little bit quicker on that last run,' said Coulthard. 'I was up a couple of tenths on my sector time so it was going to be close, but I tried to sneak too much over the kerbs at the Bus Stop, bounced the car too much and ended up losing all the time I gained. That's a little disappointing, but that's the risk you take when you're qualifying, because you're always trying to push the limit slightly, and I went a little bit too far.'

Hakkinen said: 'It was an unbelievable session. It was just an incredible fight with David. I was quite surprised I was able to get pole today. David looked very strong. I knew the last run would be incredible fun if I could beat David's time. But I thought he could

probably go quicker as well. Great stuff. This track is fantastic to drive - all the corners are just so enjoyable.'

Both men were buzzing with the sheer thrill of lapping one of the greatest driver's circuits in the world close to the limit.

Coulthard chipped in: 'I agree that it's a fantastic track. It's amazing when your car's working well here. You're playing with your entry speed to make sure you can get more on the apex. Sometimes you overcook it, sometimes you get it right. It's all a bit of an adventure. At places like Monaco you're pleased when it's all over, but this is one of the circuits where you just wish qualifying would go on and on.'

Schumacher, a disappointed fourth and a long way off the pace (see right), would not have agreed. ■



Irvine was just a few tenths shy of Schumacher on a track the German normally loves

failing to slow down sufficiently for a yellow caution flag. That left him just 0.162s ahead of Irvine on official times.

The German admitted that he was 'concerned' about the size of the one second gap to title rival Mika

sector of the lap (from Les Combes to Stavelot), we have set the same time. But we lose out in the first and last sectors. Somehow we need to solve that, but I doubt we can do it for the race.'

Team by team... Belgium team by team... Belgium team by team... Belgium team by team... Bel

BENETTON

Benetton B198, Playlife V10



5 Fisichella B198/3

Benetton ended Sunday with three damaged cars and two very frustrated drivers. Throughout practice the team complained of a lack of grip. Only 12th on Friday, Fisichella managed to get up to seventh in qualifying, and was fortunate that an electrical failure occurred just after he'd finished his last lap. Wurz stopped with a gearbox failure with 14 minutes to go, and could not improve with the spare. He had to settle for 11th. Fisichella made

6 Wurz B198/7

a good first start in the race and just escaped the first lap shunt, but Wurz was stuffed hard into the pitwall. On the restart the Austrian damaged the spare when he tangled with Coulthard on the first lap. Fisichella got away badly second time around, and ran eighth early on. Retirements had helped him up to fifth when he ran hard and dramatically into the back of Nakano at the Bus Stop on lap 27, bringing out the safety car.

McLAREN

McLaren MP4-13, Mercedes V10



7 Coulthard MP4-13/7

Ron Dennis left Spa with a smile on his face after Ferrari failed to cut Mika Hakkinen's advantage. Narrowly beaten by Schumacher on Friday, after a heavy crash in the morning, Hakkinen did a brilliant job to edge out Coulthard and secure his ninth pole of the year. DC had a busy Sunday. In the warm-up he understeered into the barrier. He brushed wheels with Irvine at La Source at the start, and seconds later triggered the chaotic pile-up

8 Hakkinen MP4-13/5

when he spun to the right. He went off with Wurz at the restart, but got out of the gravel and recaptured the safety car queue. He made little progress until a change of tyres, and was eighth when he was hit by Schumacher. After a long stop he finished seventh. Hakkinen's afternoon was more straightforward. He made two bad starts, and after touching Schumacher, spun and was collected by Herbert the second time.

Hill makes the most of hard work from resurgent Jordan

Damon Hill took his Jordan team's mind off its legal dispute with Ralf Schumacher by qualifying third fastest for the Belgian Grand Prix.

Hill was around a second slower than the McLarens on the front row, but ahead of everyone else, including Michael Schumacher, the man acknowledged even by Hill as the king of Spa.

'Michael is the expert around Spa so there's a certain satisfaction in outqualifying him,' Hill said.

Hill's performance, which totally overshadowed that of his team mate, was proof if proof were needed of the remarkable progress Jordan has made since its appalling start to the season.

Jordan has turned itself around from a team that had scored no

points in the first half of the season - and rarely looked like it was going to - to one that is consistently fighting competitively for points, and can even contemplate the possibility of getting on to the podium in the dry.

'It's absolutely brilliant,' Hill said. 'A lot of it is down to the exceptionally hard work from Jordan and (engine supplier) Mugen Honda. To get where we are after the way we started the season is an exceptional effort. But I have to say I think I'm driving beautifully. The car set-up is great and I worked very well with my engineer.'

Another in a long line of engine developments from Mugen also helped the team make it count on the long straights.

The result brightened what in

other ways was a weekend full of rancour and arguments for Jordan. Schumacher has issued a writ to ensure his release from the team, and on Friday team boss Eddie Jordan laid into Ralf's brother, Michael, for accusing the team of being more interested in money than results (see *Pit & Paddock*).

However, after qualifying, Hill could afford to joke. 'Everyone has worked so hard at the Jordan factory and Eddie's had to spend loads of money,' he said with a wicked grin.

Schumacher was less content - he was down in eighth place, nearly 0.8s slower than Hill.

He said: 'I did not feel as comfortable in the car as I have done in recent races and I struggled with understeer.'

Brave Salo bounces back after smash

Mika Salo provided graphic evidence of the sheer bravery of Formula 1 drivers at the Belgian Grand Prix.

The 31-year-old Finn was taken to hospital after crashing at 180mph at Eau Rouge on Saturday morning (see *Pit & Paddock*), but still qualified less than a 0.2s slower than team mate Pedro Diniz.

For a while after his crash, it had looked as if Salo would not be able to take part in qualifying, which



Salo walks away from the wreck of his car

would have meant being forced to miss the race. However, after a quick brain scan in hospital in nearby Verviers, he flew back to the track in time for the start of qualifying.

Most people would have hesitated before getting back into a car after that, especially when it was suspected that something may have broken on the car. Racing drivers are made of sterner stuff than that.

A car was readied for Salo and he managed to sneak in two timed runs before the end of the session. Impressively, his first flying lap was quicker than Diniz had managed up to that point.

'He wasn't fazed at all,' said Arrows team manager John Walton.

The Brazilian sneaked ahead at the end, but Salo, nursing a huge headache, was not too perturbed.

'I am sure that after my accident I was not driving at my best today,' he said. 'But the car feels very comfortable to drive and I'm sure I'll be fine for the race.'



A good set-up helped Damon Hill qualify ahead of both Ralf and Michael Schumacher

Team by team... Belgium team by team... Belgium team by team... Belgium team by team...

JORDAN

Jordan 198, Mugen Honda V10



9 Hill 198/3 198/4 **R Schumacher** 10

Eddie Jordan's wildest dreams came true as Damon Hill led home a memorable one-two. Fourth on Friday, Damon was a delighted third in qualifying, having pipped Michael Schumacher on his final run. Ralf Schumacher lost track time with gearbox problems on Friday. Not as happy with his car, he qualified eighth. Both men had lucky escapes at the first start, Ralf having come to a halt on the grass. Hill had dropped to sixth at

the first attempt, but took the lead in determined style at the restart. He led for eight laps until Schumacher snuck by at the Bus Stop. Hill was a comfortable second, some 37s behind Michael, when the latter's shunt gave him the lead. After losing time on intermediates early on, Ralf charged up to third by lap 17. After the safety car interlude, he tucked in behind Hill, but was told not to pressure his team mate.

PROST

Prost AP01, Peugeot V10



11 Panis AP01/7 AP01/6 **Trulli** 12

Despite wrecking two cars, Alain Prost had his best day of the season as Jarno Trulli picked up a priceless point. Trulli missed much of Saturday morning with a transmission problem, and then had brake bothers in qualifying. He still earned a respectable 13th, new aero mods having improved the AP01. Panis was never happy with his car ('I feel it's driving me'), and started 15th. Both men were right in the middle of the

shunt, and higher qualifier Trulli had a second shot with the spare. Jarno made a bad start though, and despite getting through the carnage he was only 13th at the end of the first lap. He found the car good on intermediates in the early stages, and made steady progress up the field. Hampered by a gearbox problem, he got into sixth on lap 27 after the Schumacher and Fisichella shunts, and held the position to the flag.

Next week in **AUTOSPORT**

COUNTDOWN TO THE TITLE

THE 1998 F1 WORLD CHAMPION

VOTE FOR ONE CANDIDATE ONLY

1	HAKKINEN Mika Hakkinen World Championship leader, six wins, nine poles, four fastest laps, 77 points McLaren candidate	
2	SCHUMACHER Michael Schumacher Second in World Championship, five wins, no poles, five fastest laps, 70 points Ferrari candidate	
3	COULTHARD David Coulthard Third in World Championship, one win, three poles, four fastest laps, 48 points McLaren candidate	

Place an 'X' in the box next to your preferred candidate

FIND OUT WHO GETS AUTOSPORT'S VOTE

We analyse the championship run-in

PLUS!

Battle for British Rally glory

Contents correct at time of going to press

**ITALIAN
GRAND PRIX
PREVIEW**

GRAND PRIX SPORTIQUE

Presents



"MURRAY WALKER - 50 YEARS AND MORE"

by

Craig Warwick

Taken from an original
painting presented by
Damon Hill and Martin
Brundle to Murray Walker
from his friends at ITV, on
Sunday 12th July 1998 at the
RAC British Grand Prix,
Silverstone Circuit.

Signed by
**MURRAY WALKER
AND THE ARTIST**

Overall Print Size:
50 cms x 70 cms
19¾" x 27½"

Limited Edition : 850 prints

Price: £85.00 each
(+P&P £5 UK or £10 Overseas)

All major Credit Cards accepted

TO ORDER TELEPHONE: 01666 503776

PUBLISHERS: GRAND PRIX SPORTIQUE LTD. UPTON, TETBURY, GLOUCESTERSHIRE GL8 8LP, ENGLAND. FAX: 01666 504386

FERRARI'S LONG SHOT

After struggling with the long-wheelbase format at Hockenheim, Ferrari got it right for Spa. By Giorgio Piola

Ferrari was the centre of technical attention at the Belgian Grand Prix after the Italian team committed itself to using a longer-wheelbase version of its F300 in the attempt to keep up with McLaren.

By Saturday, the experiment that had failed so badly in the German Grand Prix two races ago had proved to be a success, and the spare car was converted to long-wheelbase-spec, joining the race cars of Michael Schumacher and Eddie Irvine.

The car is lengthened by 13cm at the rear by increasing the size of the spacer between the engine and the gearbox (1, below). But rather than just add a conventional spacer, Ferrari has worked hard on keeping the car as stiff as before by stretching a carbon-fibre shroud over the top of the 'box (dotted line). The carbon-fibre rear wing support is also illustrated below (2).

The long-wheelbase version of the car has also given Ferrari the chance to improve the airflow over the engine cover. A little tip has

Ferrari improved airflow over the engine cover of its F300 by reshaping the tip of the cover and lowering its sides

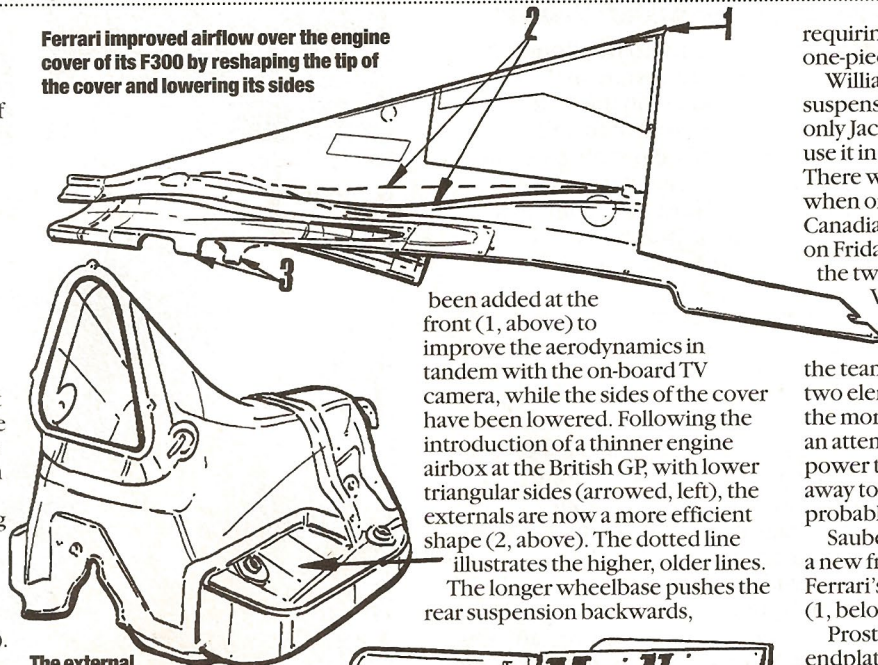

been added at the front (1, above) to improve the aerodynamics in tandem with the on-board TV camera, while the sides of the cover have been lowered. Following the introduction of a thinner engine airbox at the British GP, with lower triangular sides (arrowed, left), the externals are now a more efficient shape (2, above). The dotted line illustrates the higher, older lines. The longer wheelbase pushes the rear suspension backwards,

The external dimensions on the Ferrari are more efficient thanks to triangular sides

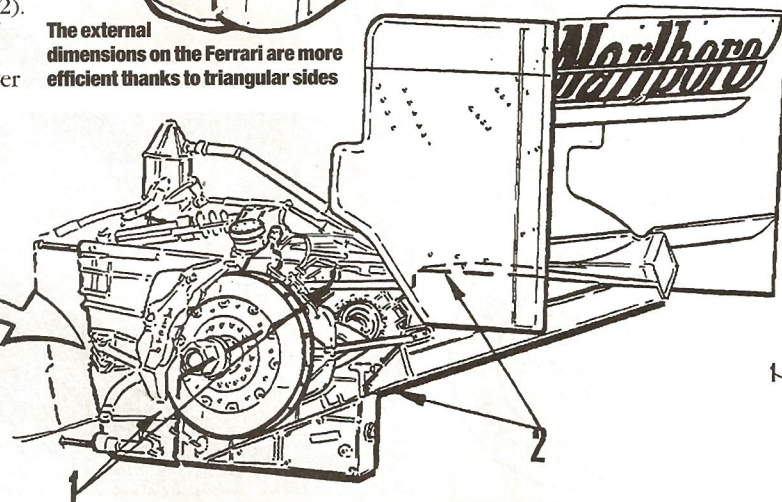

Extra length is gained by increasing size of the spacer between the engine and gearbox

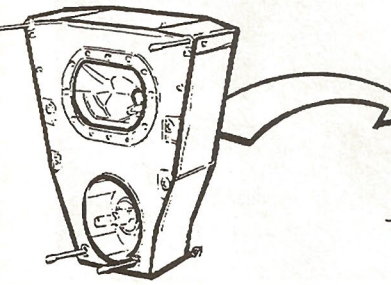

requiring new slats to be cut in the one-piece cover (3, left).

Williams had new front and rear suspension geometry for Spa, but only Jacques Villeneuve was able to use it in qualifying and the race. There were only three sets of it, and when one was destroyed in the Canadian's accident at Eau Rouge on Friday, the team decided to save the two remaining sets for Villeneuve.

Williams used the smallest rear wing of all the teams in qualifying, using only two elements at the top instead of the more conventional three. It was an attempt to make up for the power the Mecachrome V10 gives away to Ferrari, Mercedes and probably Mugen Honda.

Sauber made a step forward with a new front wing modelled on Ferrari's, with a curved side section (1, below) and large side fins (2).

Prost had new front wing endplates and large new barge boards, both similar to those on the McLaren, while Benetton used a new front wing, based around the new endplates used for the first time in Germany two races ago. The only other technical innovation was a new diffuser on the Minardi.

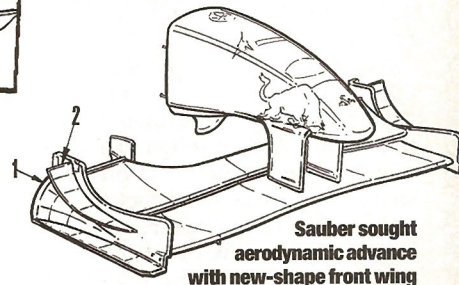

Sauber sought aerodynamic advance with new-shape front wing

Belgium team by team... Belgium team by team... Belgium team by team... Belgium team

SAUBER

Sauber C17, Petronas V10



14 Alesi C17/6

Third place for Jean Alesi was just reward after mechanical problems robbed the Frenchman of so many points earlier in the season. Despite being eighth on Friday, Jean was far from happy with the car, but the situation was improved and he qualified a promising seventh. Herbert, who lost track time with a Friday engine failure, was a frustrated 12th. 'It wallows in hard cornering,' he noted. Alesi escaped the shunt but

15 Herbert C17/1

after a good start Johnny was just caught up in it, and had the distinction of getting his car further down the hill than any other wreck! At the restart he collected the spun Hakkinen, and was out on the spot. Alesi got up to fourth, but lost out to both Williams drivers on lap 3. He later got them both back when they made mistakes. Schumacher's shunt guaranteed Alesi third, although he briefly held second before pitting on lap 28.

ARROWS

Arrows A19, Arrows V10



16 Diniz A19/1

From a weekend of carnage and mechanical turmoil Arrows salvaged two points as Pedro Diniz turned in another solid wet-weather drive. Clutch and electrical problems hampered the team on Friday, and new D-spec engines showed promise on Saturday morning – until both blew up. It was decided to revert to C-spec, and when Salo got out again he had a massive shunt at Eau Rouge. After a brain scan ('It was bigger than they

17 Salo A19/5

thought!') he was able to use the spare, with which he did a good job to take 18th, two places behind Diniz. Both cars were badly damaged in the shunt, and Pedro has first claim on a new spare, which had been built up overnight. He made a good start, went on to edge his way up to ninth through the worst of the weather, and thereafter had a steady run, with the retirements of Schumacher, Irvine and Fisichella sending him up the order.

Postcard

by Adam Cooper

Close to disaster

No visit to Spa is complete without a trip to Eau Rouge, if possible for qualifying, when the drivers are on the very limit. With the right pass you can stand on the inside at the very end of the old pit wall at the bottom of the hill, just as the cars make the first lefthand flick before the surge up to Raidillon. Bizarrely, considering the nickname of the chicane before the startline, the marshals' post here doubles as a bus stop. On a normal day you can catch the number 375 to Malmédy and beyond, but you won't see too much action while you're waiting...

For three days in August, the view is rather different. Nowhere else do you get such a clear impression of the awesome power and speed of F1 machinery, and coming so soon after the tame Hungaroring, it numbs the senses. Plus, there's always that dark fear of what might happen if someone gets it wrong.

The section from La Source to Eau Rouge has changed little over the years, and it would look familiar to drivers of days gone by. The grandstands opposite the old pit lane have been there for generations, and fans get an unusually close view of the action, in some places from just a couple of metres behind the barrier.

Usually spectators just see cars rushing down the hill at high speed, but this year they were in the prime spot to witness the first-lap accident. After the dust had settled, you could appreciate how close we'd come to disaster. The debris fences in that area are either pathetically low or non-existent, and yet by some sheer stroke of luck no wheels bounced over the top.

For the drivers too, it was a fortunate escape; you don't need me to tell you what a flying wheel could have done had it landed on a cockpit. There were also some pretty big hits in the middle of all that chaos, and despite losing the vital cushioning of corners and noses for second and third impacts, tubs remained intact.

As drivers clambered out and appreciated that all their colleagues were also in one piece, they might have noticed the Ayrton Senna memorial which sits on the grass in front of the stands. The chassis and cockpit improvements the Brazilian's death brought about have never been as conclusively tested as they were on Sunday. ■



Schuey's fans didn't have much to cheer



Ferrari had one wheel missing on Sunday



Eddie Jordan and Rowan Atkinson reckon the team's first win has *Benra* long time coming



It's a while since a Hill fan has had reason to jump the barrier

Belgium team by team...Belgium team by team...Belgium team by team...Belgium team by team...

STEWART

Stewart SF-2, Ford V10



18 SF-2/4 **Barrichello**

SF-2/3 **19** **Verstappen**

Spa was not a happy weekend for Stewart. Jos Verstappen was one of only two mechanical retirements amid all the carnage. The drivers were happy enough with the cars in practice, helped by suspension mods, but simply lacked pace. Former Spa pole man Rubens Barrichello qualified 14th, while Verstappen was three spots back. He'd lost much of the morning with an

engine failure. Barrichello was caught in the shunt, but Verstappen made it through with right-rear corner damage after getting a puncture. Barrichello had hurt his left arm, so Verstappen was able to start afresh in the spare car. This time he was faced with a spinning Hakkinen, and just managed to sneak through the gap. Despite the hold-up he got up to 10th, behind Diniz. His engine failed on lap nine.

TYRRELL

Tyrrell 026, Ford V10

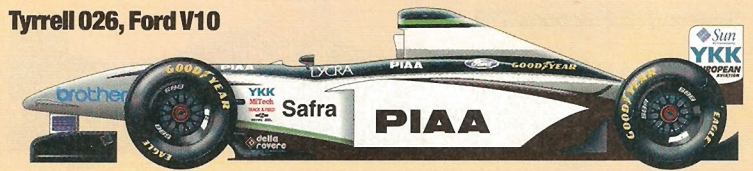

20 Rosset 026/4

026/5 **21** **Takagi**

Tyrrell went home disappointed with three damaged cars after a nightmare Sunday. As usual, Japanese youngster Tora Takagi quickly got into the groove, but in qualifying he had a throttle problem and had to take the spare halfway through. Had to settle for 19th, one place, but 1.613s, ahead of team mate Ricardo Rosset. Both men were caught in the shunt – unlike fellow backmarker Tuero, Rosset

seemed to have no idea anything was amiss, facing a blocked track at racing speed. Takagi took the spare for the restart. He did well out of the first corner scramble, and got up to 11th. He gained a spot when Verstappen retired, and nearly got Irvine when the latter pitted for a new nose. When Irvine came out, Takagi went wide at La Source, got on the grass, and scraped the barrier.



The Spa-Francorchamps circuit gives fans some stunning views of the cars in full flight



Most people would hide dressed like that



The Ardennes forests didn't provide the only beautiful scenery of the GP weekend



Alain Prost eyes up Panis' birthday cake



International spark plug thief is caught!

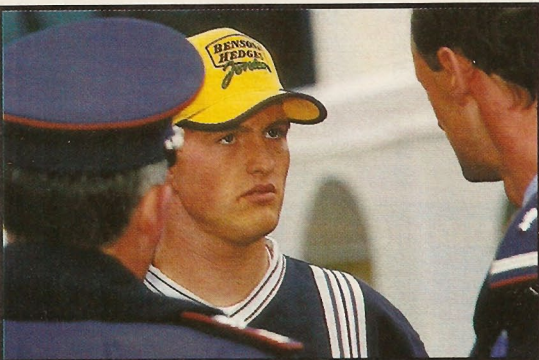

'All right son, think you're Michael Schumacher do you?'

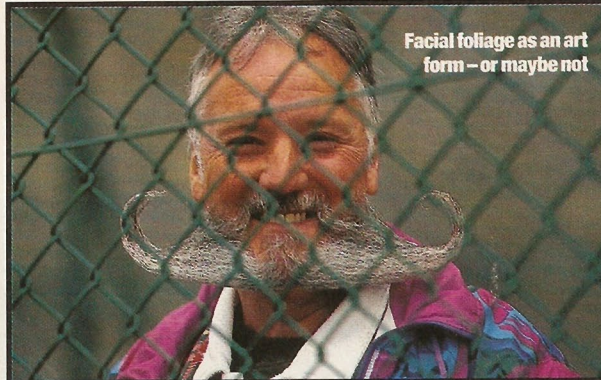

Facial foliage as an art form – or maybe not

Team... Belgium team by team... Belgium team by team... Belgium team by team... Belgium

MINARDI

Team by team written by Adam Cooper

Minardi M198, Ford V10

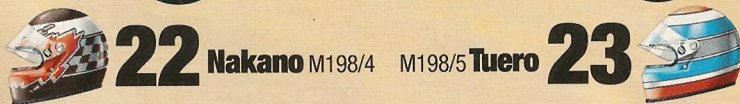

In qualifying, the Italian cars were well off the pace – even that of Rosset. Tuero obviously enjoyed the thrills of Spa, for on Friday he noted that '... today I got in touch for the very first time with my F1 car.' He clearly has to call again, for he qualified a distant 22nd, one spot behind team mate Shinji Nakano. The latter was forced to take the spare after a fuel pump problem early on. The Japanese

driver was caught in the shunt, but Tuero slowed and threaded his way through the mess. Using the T-car, Nakano got up to 12th at the restart. He was running ninth when he was hit by Fisichella. After repairs, he resumed to finish eighth. Tuero was 12th when he stopped with a gearbox problem on lap 18. Incredibly, his engine kept running for some time after he'd abandoned ship...

ITALIAN GRAND PRIX

**PREVIEW SEPTEMBER 10
REPORT SEPTEMBER 17**

FANTASY Grand Prix

SCALEXTRIC

Silverstone

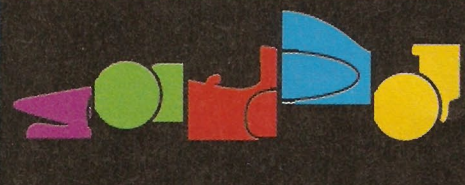
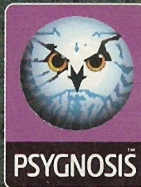

KING OF THE HILL

So, who said that modern Formula 1 was boring, then? We know how safe the cars are (just as well after that monstrous motorway pile-up on lap one) but we did all fear for the health of Murray Walker. There was so much going on that we thought Murray might suffer from emotional overload and explode.

Instead it was Schumi who was on the verge of combustion.

In the results this week you will see a zero for the four drivers who failed to make the restart. That is because the restart was declared an entirely new race and therefore they were not included in the official results.

STAR OF THE RACE

He may have inherited the lead, but the fact remains that Hill didn't make a single mistake, despite pressure from his team mate and the weight of expectation from everybody at Jordan.

HOW DID YOU DO IN BELGIUM?

DRIVERS

1	M Schumacher	6
2	J Villeneuve	0
3	M Hakkinen	1
4	D Coulthard	0
5	H-H Frenzen	18
6	D Hill	28
7	E Irvine	5
8	O Paris	0
9	G Fisichella	3
10	J Alesi	21
11	J Trulli	18
12	M Salo	0
13	R Schumacher	24
14	J Herbert	-5
15	A Wurz	-4
16	R Barrichello	0
17	J Magnussen	0
18	J Verstappen	-2
19	P Diniz	23
20	T Marques	0
21	S Nakano	13
22	T Takagi	-1

23	E Tuero	0
24	J-P Montoya	0
25	P de la Rosa	0
26	J Muller	0
27	L Badoer	0
28	D Franchitti	0
29	N Minassian	0
30	S Ayari	0
31	N Heidfeld	0
32	J Davies	0
33	A Zanardi	0
34	M Blundell	0
35	M Wilson	0
36	R Zonta	0
37	E Collard	0
38	N Larini	0
39	T Kristensen	0
40	G de Ferran	0

CHASSIS

41	Williams	14
42	Ferrari	0
43	McLaren	8

44	Benetton	-4
45	Jordan	20
46	Prost	12
47	Sauber	11
48	Stewart	-2
49	Arrows	13
50	Tyrrell	-1
51	Minardi	0

ENGINES

52	Mecachrome (Renault)	14
53	Ferrari	0
54	Mercedes	11
55	Peugeot	12
56	Mugen Honda	20
57	Ford V10 (works)	0
58	Sauber Petronas	16
59	Yamaha/Hart V10	13
60	Ford V10 (customer)	0

TYRES

61	Goodyear	10
62	Bridgestone	5

FINAL ENTRIES: FRIDAY NOON BEFORE EACH GRAND PRIX. DIAL 0891 891800

**Dial
0891 891 802**
Top 50 teams and
race results



TEAM POSITION CHECKLINE 0891 891 801

SUPER RESIN POLISH

Widely acclaimed, this is the ultimate easy to use combination cleaner, polish and sealant. For all vehicle paintwork types, colours and finishes, including metallic and clearcoats.



EXTRA GLOSS PROTECTION

Super tough sealant for all paint types. Provides extra protection and durability of shine for clean and blemish-free paintwork, especially after using Autoglym Super Resin Polish.



CAR GLASS POLISH

Contains specialist cleaning and polishing constituents which quickly and easily remove all common contaminants leaving a crystal clear finish, inside and out.

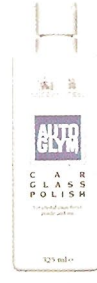

INSTANT TYRE DRESSING

Spray onto soiled or weathered tyres for a new look natural sheen. Use on wet or dry tyres. For a less glossy finish wipe tyres with a cloth before drying occurs.



BODYWORK SHAMPOO CONDITIONER

Removes traffic film and grime without harm to polished paintwork. Forms a glossy water repellent barrier which protects and beautifies.

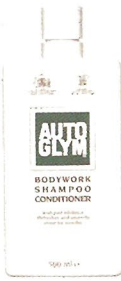

BUMPER CARE

Simple to use protective gel. Removes polish stains and ingrained grime from all unpainted exterior plastic and rubber trim, restoring original colour. Suitable for all colours.



LEATHER CARE CREAM

Contains natural oils and conditioners in purified water to gently clean, moisturise and protect leather upholstery against ageing, bleaching and cracking.



CAR INTERIOR SHAMPOO

A low foam cleaner with exceptional versatility. Removes stains and grime from upholstery, carpets, roof linings, vinyl, soft tops, leather and plastics.



CLEAN WHEELS

Super effective cleaner. Rapidly dissolves brake dust, traffic film, salt, grease and various forms of corrosion from alloy, steel and painted wheels and wheel trims.



VINYL & RUBBER CARE

Gently cleans all interior and exterior plastic, vinyl and rubber. Leaves a protective sheen to enhance appearance on fascias, vinyl roofs and similar areas.



ENGINE CLEANER

A powerful, non-corrosive, multi-surface cleaner for engines, components, wheels and machinery. Dissolves oil, grease, grime and traffic film from treated surfaces.



FAST GLASS

For rapid cleaning of glass, plastic, perspex and acrylic windows. Free of abrasives and silicones. Easily removes insects and bird droppings from paintwork and glass.



PERFECT POLISHING CLOTH

Specially developed, 100% cotton, lightweight material. Free of synthetic fibres and exactly the right degree of weave density for polishing fine surfaces.



METAL POLISH

Imparts a brilliant long lasting finish on polishable metal surfaces, including chromium, stainless steel, copper, brass, aluminium and alloys.



AQUA-DRY

A unique material which actually out-performs natural chamois. Super absorbent, faster to use, longer lasting and less expensive. Store wet or dry.



INTENSIVE TAR REMOVER

Instantly dissolves tar spots on paintwork, plastics and synthetic fabrics. Use to remove oil, grease, silicones, fuel stains and resinous tree sap.



Call Freephone 0800 515779



Autoglym Premium Car Care

The Autoglym Premium Car Care range is internationally respected by enthusiasts and professionals alike.

That is why motor manufacturers such as Aston Martin, Jaguar, Lotus, McLaren, Mercedes-Benz UK and Rolls-Royce use Autoglym extensively for vehicle preparation and display. It also explains why over 600 cars at The British International

Motor Show are prepared for public scrutiny and media attention using Autoglym products.

To help you find the products you are looking for just telephone the Freephone number above.

Be ready to tell us your postcode and we will give you the name, address and telephone number of your nearest 5 Star Stockist who carries the widest Autoglym Premium Car Care range.

Phone anytime between 9am and 5pm, Monday to Friday and one of our operators will be ready to help.

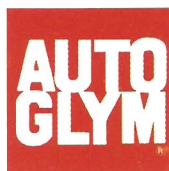

1997 FRENCH CHAMPIONS



1997 BRITISH CHAMPIONS

Ideal Birthday and Christmas presents

**MUD BLASTER
£1,245 + VAT**

Also available for hire

**JUNIOR GRASS
KART £895+VAT**

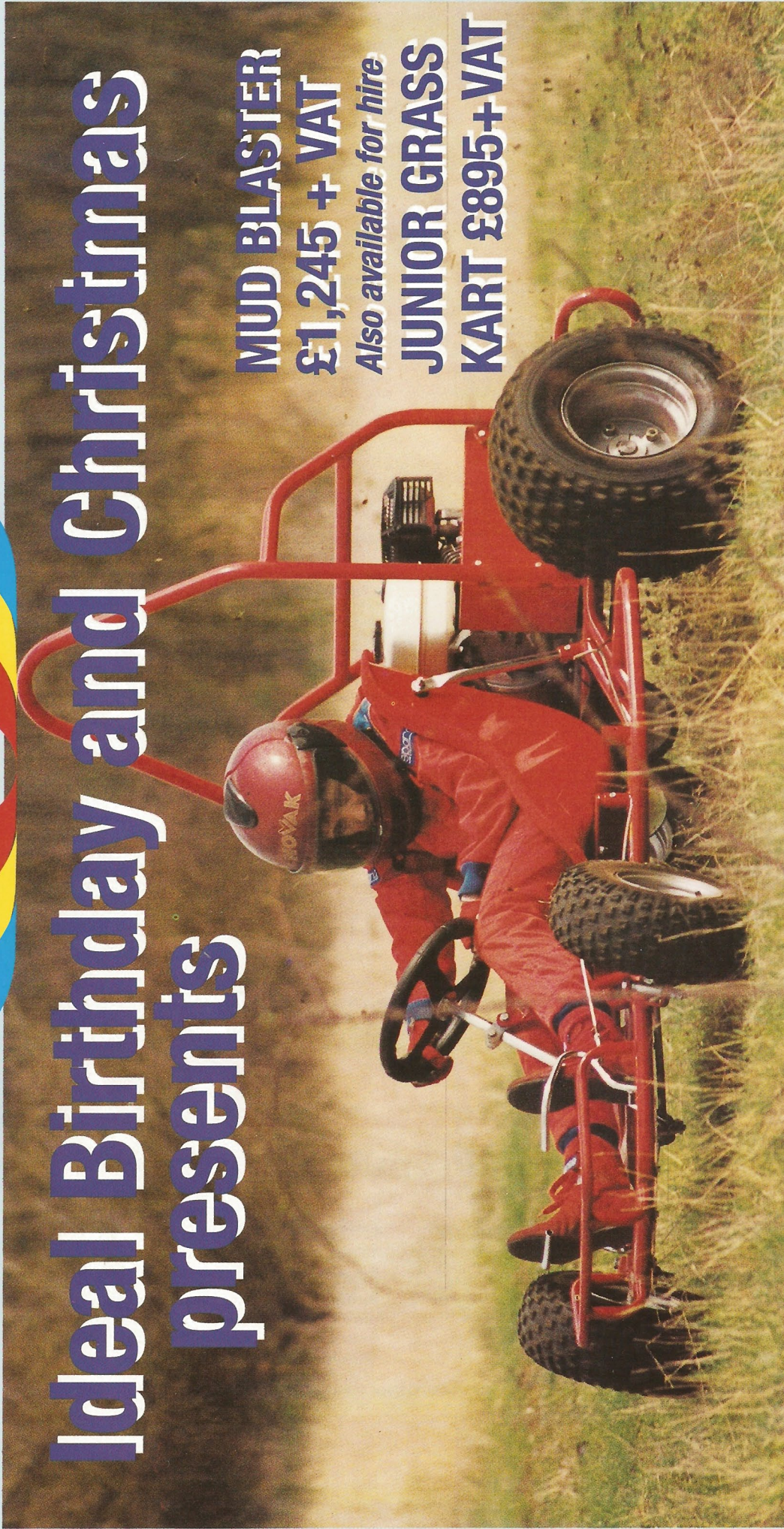

RACING



HONDA CADET



COMER CADET

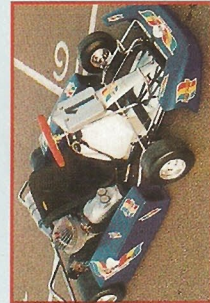

DEAVINSON FORMULA PRO



C.I.K. HOMOLOGATED CHASSIS



98 EVO-II RACING PRO-KART



98 FORMULA TKM & YAMAHA

CHIEFTAN
£3,495 + VAT
Also available for hire



**ORDER NOW TO
 GUARANTEE
 YOUR DELIVERY**

- **CORPORATE HOSPITALITY**
- **INDIVIDUAL ENTERTAINMENT**



- **100CC AND RACING PROKARTS**
- **OFF ROAD VEHICLES**

DEAVINSONS RACING, RYE HOUSE KART RACEWAY, RYE ROAD, HODDESDON, HERTS EN11 0EH, UK • TEL: +44 (0) 1992 460895 • FAX: +44 (0) 1992 468812 • INTERNET: www.deavinsons.co.uk

LEISURE

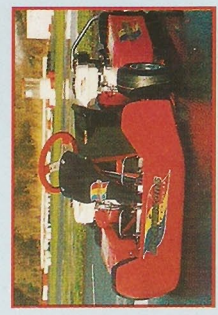

RENTAL PRO-KART

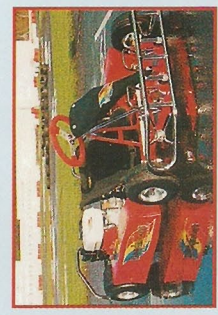

INDOOR RENTAL KART



CHIEFTAN ATV

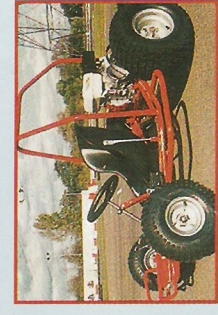

MUD BLASTER



JUNIOR GRASS KART

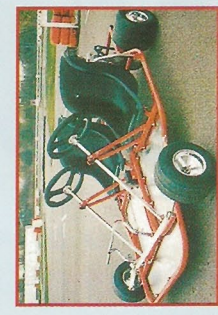

TWO SEATER

ALL RETAIL AND TRADE ENQUIRIES WELCOME

GOODWOOD

Near Chichester, Sussex

MOTOR CIRCUIT REVIVAL
18-19-20 SEPT '98

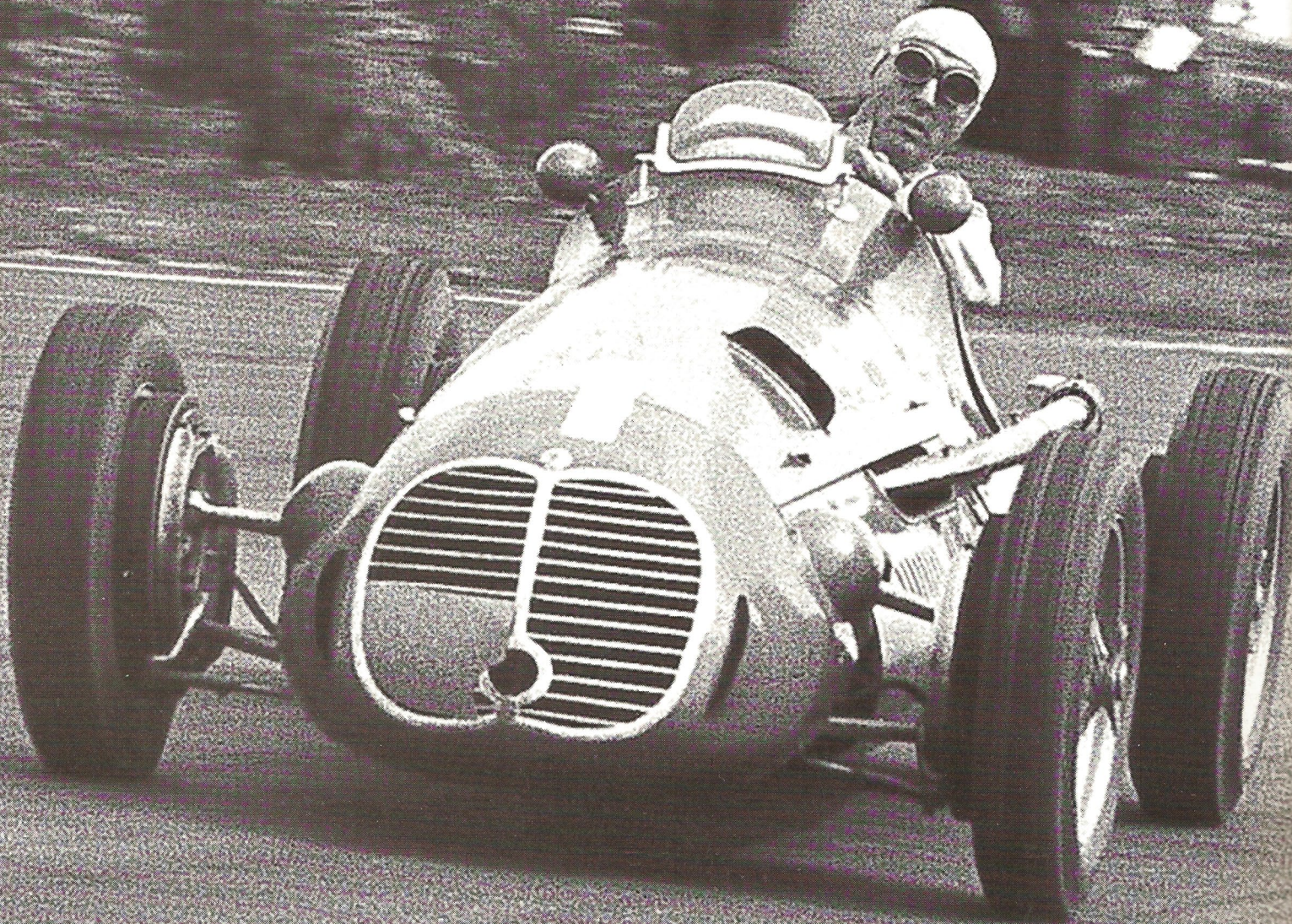

TICKETS: 01243 755055

"Be there - for a magical step back in time"

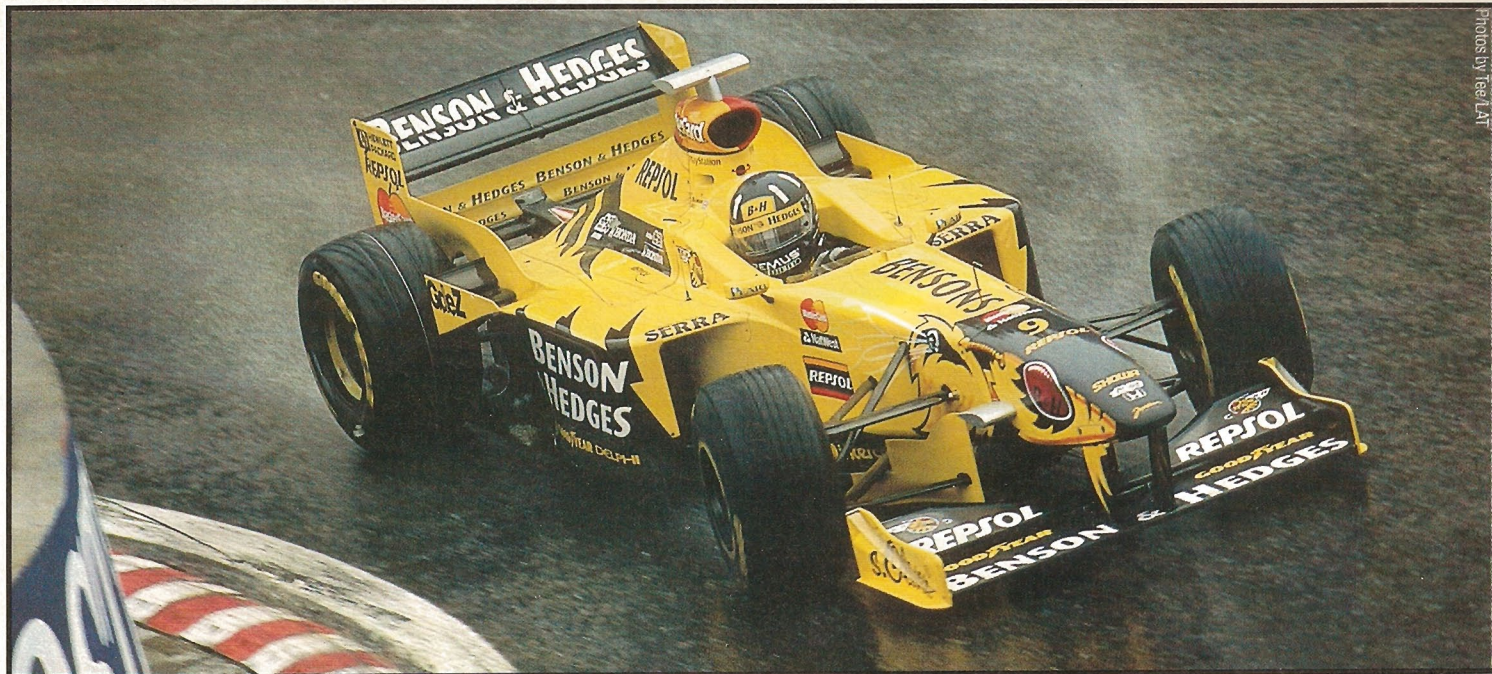

Photos by Lee LAT

Damon Hill led Jordan Grand Prix to a dream one-two result with team mate Ralf Schumacher in Belgium. Now that the first one is out of the way, will more victories follow?

We've really turned the corner

Some wins are better than others, but there has been nothing quite like the win I had on Sunday. A Jordan one-two is special enough, but because of the circumstances I think that maybe this was my best victory ever.

At the start of the season I said I'd be disappointed if I didn't win a race. After I said that we saw the pace of the McLarens and what would be needed, and it started to look like a bit of a forlorn hope. But in recent months things have really turned around. Now I've done it – and what a race to win!

It was very close at the first start – about as close as you could come. I don't know how I didn't hit the wheel that bounced across the road. I shut my eyes, expecting a thump, but nothing hit me. I was very lucky.

At the second start it was going my way as long as it wasn't raining. I was quicker on the straight and had the right level of downforce for drying conditions. It just started to rain more, and things began to tilt back towards Michael's favour. He had more wing on and he just kept on eating me up in the corners. I had to lift because of aquaplaning, and he passed me.

I was still thinking of ways of trying to catch him, and I was praying for it to dry out. He was pulling away, but I thought I could still catch him if it dried. My car would have been really good in the dry, but it didn't go that way, it rained the whole bloody time! Obviously I was happy to hear that he had retired...

After Michael went out I had to focus hard on staying on the track. Although the team told us to keep the one-two order, Ralf had to push me because he was under pressure from Alesi. All in all I felt I drove better than I have ever done on this circuit.

“ All the effort is starting to pay off. For a driver, that's all the tonic he needs ”

DAMON HILL

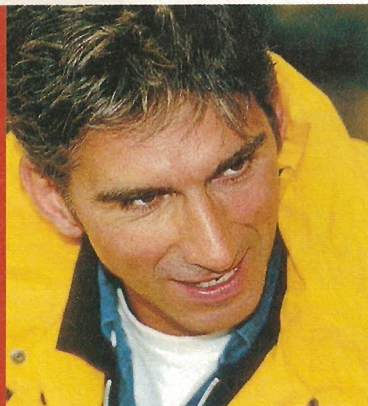

**DAMON HILL
JORDAN F1 DRIVER**

I was pleased for everyone in the team. It's tough when you work hard and don't get any reward, and I'm mindful of the responsibility I have. You've got to do your very best because everyone else is doing their best for you.

The start of the season was very tough. Things didn't look too good at the outset, but there's been a lot of hard work since then and all the effort is starting to pay off now. That's all the tonic a driver needs.

The main thing was to try to identify the problems accurately, and then be persistent enough to solve them. The team has not stopped trying improvements. There are new bits all the time, and there have been something in the order of 80 changes to the car this year.

I think that the old belief that if a

car is not quick out of the box it will never be quick is right – and this car is an exception to that rule! It really has been transformed, and it's not really the same car that it was at the start of the season.

You can't take away the fact that Goodyear has done an amazing job this year. Like us, they also came from behind. They really have brought the fight to Bridgestone, and that's a big part of it. But we're also performing well relative to the others; at Spa I was the quickest Goodyear runner in qualifying, which is quite an achievement for a team that had a nightmare start to the season. Mugen Honda has been a vital part of the package too. The engine was not terribly powerful, but they've closed the gap quite considerably, and made the engine

more driveable.

Things started to get better in Canada, and in the races after that we got a foothold on things, and were able to push ourselves forward. That really started to reap rewards when we got to Hockenheim. It was good because we were genuinely competitive, and scored a well-earned fourth there.

I always had in the back of my mind that the car seemed to go well on those type of circuits; Jordan had its best race ever at Hockenheim the previous year. It's no good if you've got a car that's only good at one type of track, as you have to be good everywhere. The big test was Hungary. And while we're not as good at those sort of places, the car has a better repertoire now.

When you think just how down in the dumps everyone was in Monaco, for Jordan to turn things around like this must be the most extraordinary thing which has ever happened to a team.

Of course, everyone was ecstatic after the race, but actually the qualifying session was very exciting, too. I was starting up my engine just as the other three went past my garage – David, Mika and Michael. So we all rolled out at exactly the same time, and there was all to play for. I could see Michael ahead of me, and I thought I was quicker than him. I could see where I was on the track when he was entering Pouhon, and next time round I seemed to have got a bit closer. That spurred me on because I figured I'd gained on him a bit. We were fighting for the same place on the grid and, dare I say it, the best man won!

I would never say that luck didn't play its part in Spa, but the truth is that we were in contention all weekend and we deserved our result. Eddie and the team have a right to be proud of what's been achieved. ■

After eight long seasons, Eddie Jordan's first win brought smiles to the faces of many in the paddock. Jordan was barely off the podium when he was handed a mobile phone - and on the other end was Bernie Ecclestone, who was already on his way home.

Many folk admire the 50-year-old Irishman, not least his fellow team bosses. Tom Walkinshaw was among the first to congratulate him, and David Richards stayed to the end, despite both his own cars being out of contention. As millions of TV viewers saw, Ron Dennis was providing physical comfort even before the end of the race...

It wasn't quite business as usual back in England on Monday, because the 'phone was ringing constantly.



Tevel/AT

A sight not often seen on a Jordan pit board



Sutton

Happy scenes in the team's motorhome

At least Jordan had had a chance to catch his breath, let it all sink in. Now that the initial euphoria has subsided, though, he's the first to admit it doesn't feel quite like he expected.

'I thought it would be a real high. I thought winning would be the ultimate thing in a way, and then when it happened, I now just want to be third in the championship.'

But just what does finally having a victory on the corporate CV actually mean?

'It means I want to do it again,' he

“ I like this, and I'd like it even more if I could do it again, but it's a very tall order ”

EDDIE JORDAN



First thoughts

What does F1 victory feel like? Eddie Jordan is a man who knows. By Adam Cooper

laughs. 'I like this, and I'd like it even more if I could do it again. It's a very tall order, as there are some great teams there. I never dreamed about being first and second, especially when you've got the McLarens and Ferraris out there, and with it being Michael Schumacher's weather. We owe a lot of credit to Goodyear, and a lot to Honda. What they've done since the start of this year in terms of the improvements in the engine is quite phenomenal.'

'But I was so impressed that we did it in style. This was a stylish way

to do it, not just to be first and second, but Ralf was second on a very, very good strategy, and he was strong at the end of the race. He was a good team player. It was not easy, but we had to finish first and second.'

'We had to be very sure that we defended the situation from Alesi, who is a bit of a star in the rain. That's what Ralf was asked to do, and he did it very well. He probably feels in his heart that he could have had a crack at Damon in front, but the team has to come first, and no one is bigger or greater than the team. It was nice to

hear from Jean that he didn't have the pace to keep up with Jordan.'

The closing laps were pretty unusual for Eddie. He had the luxury of knowing that if one car broke, the other was still there. On the other hand, there was the possibility of a terrible intra-team mix-up. Mixed feelings?

'Absolutely! The only thing I could think about was because of the size of Spa, and the conditions, the radios are always crap there. There was a time when we were reading out a list of instructions and there was no



Ron Dennis congratulates a slightly anxious EJ before the race is finished

know that was going to happen?" Eddie must have been pretty confident before the race, for he made a bet with a Swiss journalist that a Jordan would win. The poor fellow gave EJ odds of 10-1.

'That was great! But this race has cost me a goddamn fortune. Sixteen times the points money for every member of staff, plus Ralf's bonus money, plus Damon's money. It would have been cheaper for the company had they both crashed! But this is the most pleasurable money we'll ever have to pay out.'

On the subject of finance, what about the critics who've accused the team of underachieving, not making the most of its resources?

'You mean skimming off money on the side! I find that very irritating, to be honest. The problem is we get a disproportionate amount of coverage for the results that we've had, but that's the way we operate. Having said that, I would safely say there is no team in F1 which spends its money as cleverly and as prudently as we do. At the end of the day we are effectively the fifth team in F1, and getting closer now to the front bunch consistently. It also looks as if we're going to have a crack at third. It's going to be interesting.'

'The critics? This is not the time to talk about critics. But very often the critics help to motivate you and find new drive inside yourself. We all need to find that. I'm not saying

That winning feeling

commitment, I mean drive, pushing yourself even harder.'

EJ's no slouch at motivating other people, and some of his factory staff will be on cloud nine this week.

'We did a deal because they've had to work so hard, doing 12-hour shifts around the clock. I said anyone who wants to come to Spa, we'll take you by bus. You'll go over Friday, stay in a hotel in Brussels, get meals, transfer to the circuit, tickets for the race, and you've got to wear a hat and a flag and be part of the action. It cost 20 quid, as a token. We got two bus-loads there - 70 people. I tell you what, you want to see the state of them this morning. They were a grim bunch of fellows! These things often come back to bite you, but sometimes they give you that little extra buzz...' ■



The fan club had reason to imbibe deeply



Hill kept cool in the rain as all others fell by the wayside

reply from Ralf when we asked if he'd heard us. We assumed that he didn't hear what we were saying. Anyway, he drove sensibly.'

Of course, had Ralf's big brother not tangled with David Coulthard, the team would have been looking at a two-three result - still very impressive, but nothing like a win. It was seven years ago that Michael made his debut with the team, and helped to put both himself - and Jordan - on the map. On Friday EJ was right on

his personal rev limiter, effing and blinding about the double World Champion after reading disparaging quotes about the Jordan team in the German press. Was there some fate at work here?

'I don't know why, I always felt that a win would come as a bit of a surprise, but not by luck. I'm reasonably psychic, and have been for some time. When the accident happened with Schumacher, I felt I had seen it before. I felt "How did I



The team boss is held aloft by his two drivers

The ones that got away

Jordan has been in the position to win before, but never quite got there

Those with long memories may recall that Jordan has had more than one chance to win a race.

The near misses began virtually seven years ago to the day:

- 1991 Spa: Andrea de Cesaris was running second and catching leader Ayrton Senna. The World Champion was crippled by gearbox problems, but with three laps left, the Jordan's engine blew. Consider, too, that one Michael Schumacher had qualified three places ahead of de Cesaris, only to retire on lap one...
- 1996 Brazil: Rubens Barrichello had qualified second on the grid and had a real chance before he spun off.
- 1997 Argentina: In Argentina the full consequences of the Ralf Schumacher/Giancarlo Fisichella collision were not apparent until late in the race, for without the shunt, they might have beaten Jacques

Villeneuve and scored a one-two.

- 1997 Germany: Fisichella battled for the lead with Gerhard Berger at Hockenheim, before succumbing to a blown tyre.

- 1997 Spa: In finishing second at Spa, Fisichella won the 'human beings' race; overall winner M Schumacher was in an event all of his own...

Technical director Gary Anderson who has shared all the disappointments, wasn't at Spa. Jordan joked that that was probably just as well.

'He's still recovering from an operation, and bearing in mind he's supposed to be taking it easy I think the stress and strains of the race may not have helped him!

'Whatever Gary decides to do in the future, he can be proud that he won his first race with a Jordan'



Despite driving his first ever race at Spa and an indifferent performance in qualifying, Rodriguez was in control from the off

This was probably Uruguay's greatest motor racing moment since Oscar Gonzalez and Alfredo Uria shared the sixth-placed Maserati 250F in the 1956 Argentine GP. Victory in the 10th round of the FIA Formula 3000 Championship certainly meant a lot to Gonzalo Rodriguez.

'This is a very, very proud moment for me and my country,' he said, scarcely able to contain his joy. 'It feels just... well, fantastic, but to be honest I'm lost for the words I really want to say.'

Rodriguez's performances this year have been consistently brisk, but he has been blighted by all manner of minor irritants. Come Saturday, however, the Astromega Lola driver got it absolutely right on his first-ever visit to Spa.

'That's another nice part of this,' he beamed. 'To score my first F3000 win at a track with such a fantastic tradition makes it even better.'

There have been times this year when Rodriguez has been an obvious victory candidate from the moment the cars first hit the track, but this - strangely - wasn't one of them. Fifth in the opening qualifying session, he slipped back to sixth as



Courtesy/LAT

Fifth gave Muller his first points this year

“To score my first F3000 win at a track with such a tradition makes it even better”

GONZALO RODRIGUEZ



Series leader Nick Heidfeld struggled with his car's balance throughout

he was one of the few drivers who later failed to improve his position when a set-up change did little for his car's balance.

By the time the race was five minutes old, however, his credentials were obvious.

The race was docked a lap after Cyrille Sauvage stalled and caused the first start to be aborted, but the delay did not faze Juan Pablo Montoya. The pole winner started well enough to lead the field away, but Rodriguez and third-row neighbour Thomas Enge were simply sensational off the line. The Czech had snatched second place by La Source and Rodriguez stormed past front-row starter Nick Heidfeld to take third as the field streamed out of Raidillon and towards Les Combes.

On the following lap Rodriguez carried greater speed than Enge through Eau Rouge and towed past to take up pursuit of Montoya, who was never subsequently able to stretch his advantage much beyond a second. 'I felt I was potentially quicker than him over the lap,' said Rodriguez, 'but at the places where I was faster he had me covered.'

The chaser needed to keep an eye behind him, too, as Soheil Ayari had

Qualifying

Montoya pulled out all the stops to secure pole by two-tenths

This was good to watch. Juan Pablo Montoya was pushing hard and his Super Nova Lola was flicking sideways over any kerb you cared to look at. He was attacking fiercely enough to spin at Stavelot on his second flying lap of the day, but thereafter he settled down to just looking like an accident waiting to happen without turning into one.

'I was on old tyres when the circuit was at its fastest,' he explained, 'so I was having to try quite hard.'

That is 'quite' as in touching 152mph on the way through Eau Rouge. 'It's not flat through there,' he said. 'I do lift a bit.'

The data trace confirmed as much. He was down to 56% throttle for all of a nanosecond.

This approach was enough to give the Colombian a sixth pole position in 10 races, but arch-rival and championship leader Nick Heidfeld felt that he had the means to match Montoya.

He was two-tenths of a second adrift, but said he had made a mistake on his best lap. 'I am not

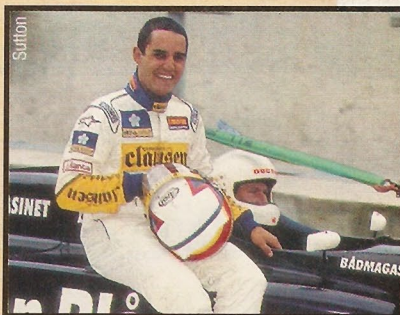

First on the grid usually brings a smile

sure that I would have beaten him without that,' he said, 'but it would have been close.' He was pleased enough and had every right to be – this was his first-ever visit to Spa.

Soheil Ayari was one of several drivers punished for using the wrong pit lane entry – and thus avoiding a possible random weight check – but the Frenchman had been consistently fast enough to hang on to third place even once he had been deprived of his best time of the day.

Alex Muller was delighted to line up fourth after the BMW Junior Team's dismal showing in Hungary. The secret, he said, was a useful test the previous weekend at the not-very-Spa-like Snetterton.

It was a disastrous day for Jason Watt and Max Wilson. They were first and second in last year's corresponding fixture, but only lined up on the 10th row this time. The fact that they both lost their fastest laps for using the wrong pit entry made precious little difference to the outcome, though Watt was additionally handicapped when he suffered fuel pump failure early in the final qualifying session.

he said, 'but at least I have closed the deficit to one point so the weekend has still been positive.' Super Nova has worked wonders to instil its firebrand with powers of reasoning in these last few months.

Ayari was happy to be on the podium after crashing out of the previous two races, but felt a tinge of frustration that was amplified by the fact that he had set the fastest lap. 'I was really quick through Eau Rouge,' he said. 'It was flat on most laps but then I hit the rev limiter too early on the following straight. Even when I picked up a tow there was nothing I could do to pass either of the guys ahead.'

Fourth place was enough to retain Heidfeld the series lead (just), but the German felt his sluggish start had been the least of his problems. 'The car just wasn't balanced through Eau Rouge,' he said. 'Rodriguez and Ayari both blew past me on the first lap because of that and I think that was what cost me most today.'

He was shadowed for virtually the whole race by former F3 rival Alex Muller, who was relieved to have scored some points at last.

The final point went to the reborn Marcelo Battistuzzi, who has progressed mightily in the past three races. This was his best showing yet, however, and there is no longer any evidence of the weary young man who was struggling to qualify earlier in the year. 'We have definitely made the car a lot better,' he said, 'and that has given me more confidence. And with that I feel I understand the car better and we are now able to go forward all the time.'

After his spirited start, Enge went in the other direction, though he was still happy to finish seventh. This, remember, was only his third F3000 start and he has still done absolutely no testing. After losing a place to Heidfeld on lap nine, the



Gareth Rees was the highest-placed Brit, but that was scant consolation for 12th place



Soheil Ayari looked threatening throughout the race but couldn't pass the leading pair

Rodriguez hits the top

Gonzalo Rodriguez could have asked for no better place to score his first win in F3000. By Simon Arron

drafted past Enge on lap four and was just as close to Rodriguez as the latter was to the leader.

They remained glued in the same order until lap 18. 'I was quite comfortable early on,' said Montoya, 'but then my gearshift started to stick a bit on the downshift.' Going into Les Combes he briefly engaged neutral, slid slightly wide and that was as much of an opening as Rodriguez needed. By the time Montoya had regained his composure, Gonzalo was through and able to pull away, despite a slight steering vibration which began after he had locked up his tyres at the Bus Stop chicane.

His only other fright came two hours after the chequered flag, when he was unexpectedly called to the stewards' office. A technical official thought he had spotted a rogue component on the winning car, but by the time Rodriguez and the team got there they were told to go away because it had been a standard Lola part and, therefore, a false alarm.

Once Rodriguez had escaped (from Montoya, that is, not the stewards' office) it was all the Colombian could do to hold off Ayari, but he took a balanced view of his defeat. 'If I had won I would be leading the championship again,'



Teal/LAT

LIVE FOR
SPEED
WITHOUT LEAVING HOME! WITH THE LATEST VIX DRIVING SEAT

- Put yourself in the driving seat and improve lap times with the VIX Driving Seat, Rumble Force Wheel and pedals
- Experience high speed thrills of your racing games as though you are sitting in the car
- Suitable for all ages (10yrs+) and compatible with Playstation, N64 and PC.
- Folds for easy storage

VIX SEAT ONLY
£79.95

VIX SEAT, RUMBLE WHEEL & PEDALS
£129.95

RUMBLE FORCE WHEEL & PEDALS
£64.95



24 Hour Credit Card Hotline **01386 554836**

OR CHEQUE/POSTAL ORDER TO G&C ENGINEERING PLC
COBHAM ROAD, PERSHORE, WORCESTERSHIRE. WR10 2DL

Due to our policy of continual product improvement the design may change without further notice
All prices include p&p to U.K. Mainland - Price on application for overseas deliveries



NICE MAN SPORTS

The Perfect Gift

Official Ferrari Merchandise from Evans Halshaw

Logo T Shirts, Various	Ferrari Mugs.....	£6.99
Designs from.....	Large Sports Bag.....	£75.00
Sweatshirts	Umbrellas from	£29.99
Waterproof Jackets.....	Cufflinks	£8.99
Casual Mens Shirts.....	Key Rings from	£4.99
Polar Fleece.....		

These are just a small selection of a wide range of items available for you to choose from. Why not call in or telephone Martin Harvey for more details.

Mail Order Line 0121 666 7363
24 Hour Delivery • Major Credit Cards Accepted



Evans Halshaw

Monaco House, Bristol Street, Birmingham.

FREE Ferrari Mug
With every order over £100

Audi drivers are no better than other drivers. Initially.

The Audi quattro Driving Experience is an exciting way for Audi drivers to broaden and improve their driving skills. A whole day's performance and safety driving tuition provides a real opportunity to explore the full potential of the Audi A4 2.8 quattro. Choose from six of the UK's top motor racing circuits, including Silverstone and Brands Hatch, and follow in the tracks of Audi's entries into the British Touring Car Championships.

The course costs £395pp and includes overnight accommodation and all meals. To reserve a place for yourself, or for the Audi driver in your life, call 0345 699777.

Audi 
Vorsprung durch Technik

1998 ITALIAN GRAND PRIX

13TH SEPTEMBER **MONZA**

Day return flight from **Stansted** including transfers, taxes, **race ticket** and after race time at leisure in **MILAN** prior to return flight home.

£279 P/PERSON
TICKET
UPGRADES
AVAILABLE

BOOK NOW

LAST FEW PLACES



Flight Options **0171 976 5600** 

28 CHURTON STREET, LONDON, SW1V 2LP

Down and out

Kurt Mollekens was inconsolable after events kept him from qualifying

The last time Kurt Mollekens raced he speared off the road at 150-something miles per hour and was extremely fortunate to end up with nothing more than scuffed ribs and a sore neck.

'I tell you what, though, today I feel a lot, lot worse than I did then,' he said after failing to qualify last weekend at Spa.

On the back of a high-profile press conference which divulged that his KTR team was to expand in 1999 and assume a role as a nursery for promising young Belgian drivers (*Pit & Paddock* last week), Mollekens came to his home race at Spa with high hopes – but failed to make the cut.

The blame hardly lay at his door. In the first qualifying session his transmission jammed in fifth almost as soon as he had left the pits. In the second he managed only a handful of laps before his gearbox spat out all its oil and he was helpless as, in the final few minutes of practice, a couple of stragglers improved their times by enough to push Kurt outside

the top 28. His weekend was over.

'This is the worst moment of my career, bar none,' he said. 'The shunt in Hockenheim was bad, obviously, and I felt pretty dreadful when I had to stay at home and watch the next race in Hungary. But this is definitely a more horrible feeling. Everyone had high hopes for this weekend and I can't believe it has ended like this. Obviously something must have been slightly out of alignment in the gearbox but we are not going to find out what until we have had a chance to strip it down.'

It was a tough blow for a man whose early-season form briefly allowed him to lead the FIA F3000 Championship.

'It's funny,' he said, 'but at the start of the year I received a couple of those good luck chain letters from other drivers and I sent them on. Then more started to arrive and I just threw them away. I mean, I don't believe in any of that stuff but the way things have been going recently it makes you wonder.'



Chronic gearbox trouble conspired against Mollekens in both qualifying sessions



Montoya led Rodriguez in the early stages, but the Uruguayan made his move on lap 18

22-year-old spun when he tried to repass him at the Bus Stop on the following lap; after that he settled down to make sure he got more miles under his belt. In his last race at Spa, two years ago, he was still racing in Formula Ford.

Last year's winner, Jason Watt, made more progress than anyone else all afternoon, but having started 20th his efforts only took him as far as eighth.

Oliver Martini survived an early clash with Stephane Sarrazin to take ninth, but the incident left the Frenchman unamused. 'I was coming alongside him on the way to the chicane and he just pulled in front of me,' stormed Sarrazin. 'I couldn't miss him, but while he spun and continued I broke my wing, picked up a puncture and clattered the guard-rail.'

Remarkably – by F3000 standards – Sarrazin was first of only three retirements and everybody else finished on the same lap.

Thomas Biagi rounded off the top 10 ahead of Werner Lupberger,

Gareth Rees and Max Wilson. Wilson, second here in 1997, was perplexed. 'The track just seems to be faster this year,' he said, 'and the set-up which was so good last time no longer seems to work.'

Rees, the best of only three Brits (Christian Horner failed to qualify), ran ahead of team mate Watt in the early part of the race as they both sliced their way into the top 10. 'Within the space of just three laps the car suddenly lost grip and I don't know why,' explained Rees after fading in the closing stages. Jamie Davies blamed a bad start and a short fifth gear for spending his afternoon at the tail of a midfield queue and Mark Shaw was classified 24th after an unintended pit stop. The Scot denied it was a ploy to get early access to the (admittedly particularly tasty) tomato-flavoured crisps in the back of the Redman Bright pit. 'It was just where I ended up when I tried to pass Sauvage and it went a bit wrong,' said Shaw, who took encouragement from setting the 11th fastest lap of the race. ■

Spa-Francorchamps (B)

August 29, FIA Formula 3000 International Championship, round 10 of 11, 29 laps – 122.931 miles

No	Driver	Team	Result	Best lap	Qualifying	Grid
1	Gonzalo Rodriguez (UR)	Astromega	1h 03m 10.530s	2m 10.190s	2m 08.957s	6
2	Juan Pablo Montoya (COL)	Super Nova	1h 03m 13.565s	2m 09.870s	2m 07.690s	1
3	Soheil Ayari (F)	Durango	1h 03m 14.885s	2m 09.792s	2m 08.118s	3
4	Nick Heidfeld (D)	West	1h 03m 24.026s	2m 10.063s	2m 07.875s	2
5	Alex Muller (D)	RTL Oreca	1h 03m 31.761s	2m 10.423s	2m 08.297s	4
6	Marcelo Battistuzzi (BR)	Apomatox	1h 03m 46.427s	2m 10.619s	2m 09.052s	9
7	Thomas Enge (CZ)	Auto Sport	1h 03m 46.992s	2m 10.758s	2m 08.902s	5
8	Jason Watt (DK)	Den Bla Avis	1h 03m 54.827s	2m 11.200s	2m 09.847s	20
9	Oliver Martini (I)	Auto Sport	1h 04m 00.762s	2m 11.325s	2m 09.353s	11
10	Thomas Biagi (I)	Prema	1h 04m 05.561s	2m 11.006s	2m 09.031s	8
11	Werner Lupberger (ZA)	Edenbridge	1h 04m 07.449s	2m 11.110s	2m 09.488s	24
12	Gareth Rees (GB)	Den Bla Avis	1h 04m 09.728s	2m 11.511s	2m 09.595s	16
13	Max Wilson (BR)	Edenbridge	1h 04m 10.171s	2m 11.395s	2m 09.816s	19
14	Andre Couto (MAC)	Prema	1h 04m 11.163s	2m 11.539s	2m 09.497s	15
15	Jamie Davies (GB)	DAMS	1h 04m 11.758s	2m 11.664s	2m 09.425s	13
16	Giovanni Montanari (I)	Draco	1h 04m 14.286s	2m 11.206s	2m 10.559s	26
17	Boris Derichebourg (F)	Super Nova	1h 04m 15.457s	2m 11.424s	2m 09.715s	18
18	Oliver Tichy (A)	Coloni	1h 04m 20.222s	2m 10.923s	2m 09.627s	17
19	Nicolas Minassian (F)	West	1h 04m 23.542s	2m 11.307s	2m 09.413s	12
20	Cyrille Sauvage (F)	GP Racing	1h 04m 27.114s	2m 11.178s	2m 09.351s	10
21	Bertrand Godin (CDN)	Durango	1h 04m 27.913s	2m 11.598s	2m 10.491s	24
22	Fabrice Walfisch (F)	Nordic	1h 04m 30.274s	2m 11.341s	2m 10.712s	27
23	Hidetoshi Mitsusada (J)	Nordic	1h 05m 06.909s	2m 12.689s	2m 10.815s	28
24	Mark Shaw (GB)	Redman Bright	1h 05m 07.248s	2m 11.138s	2m 10.535s	25
25	Gregoire de Galzain (F)	DAMS	1h 05m 14.840s	2m 12.061s	2m 10.317s	23
R	Bruno Junqueira (BR)	Draco	22 laps - fuel pressure	2m 11.732s	2m 10.254s	22
R	Dominik Schwager (D)	RTL Oreca	20 laps - spin	2m 11.880s	2m 09.890s	21
R	Stephane Sarrazin (F)	Apomatox	1h 20m 17.407s	2m 11.299s	2m 08.993s	7
NQ	Giorgio Vinella (I)	Coloni			2m 10.990s	29
NQ	Christian Horner (GB)	Arden			2m 11.014s	30
NQ	Kurt Mollekens (B)	Arden/KTR			2m 11.180s	31
NQ	Fabrizio Gollin (I)	GS Team			2m 11.378s	32
NQ	Gaston Mazzacane (ARG)	Astromega			2m 17.113s	33

All drivers using Lola T96/50 chassis powered by Zytek V8 engines.

Winner's average speed: 119.244mph. Fastest lap: Ayari, 2m 09.792s, 120.095mph. Championship positions: 1 Heidfeld 52; 2 Montoya 51; 3 Watt 24; 4 Rodriguez 23; 5 Sarrazin 19; 6 Mollekens and Ayari 16; 8 Wilson 9; 9 Davies 8; 10 Rees 7; 11 Derichebourg, Minassian and Couto 5; 14 Biagi, McGarrity, Junqueira and Schwager 3; 18 Sauvage, Muller and Mazzacane 2; 21 Martini and Battistuzzi 1.

Sutton

A proud Rodriguez confirms there's nothing quite like your first F3000 win

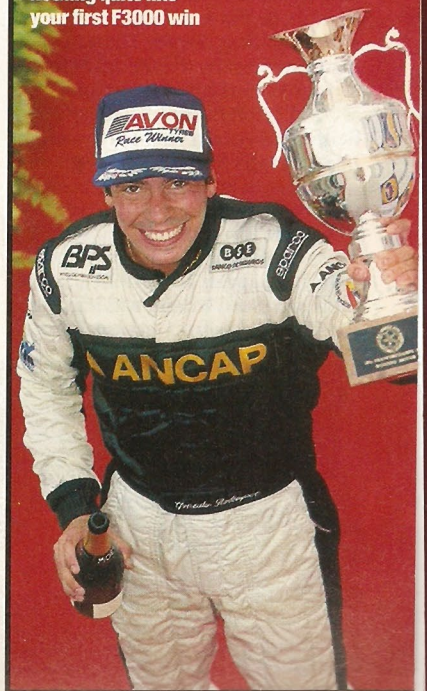



BERNOLDI BACK WITH A VENGEANCE

The Brazilian has had a bad run, but he's back on top form now. By Jaimes Baker

Enrique Bernoldi didn't quite reclaim the lead of the AUTOSPORT British Formula 3 Championship at Donington Park on Sunday, but you'd have thought that he'd won the title by the size of the smile he was wearing after the race.

A run of five wins from the first six races had been followed by a dismal spell in which he had crashed out three times and lost his once vast championship lead at Pembrey two weeks ago. At Donington, though, he put it all behind him with a faultless display. His win was made sweeter by the failure of table topper Mario Haberfeld to finish second. It left Bernoldi five points behind his countryman as the series heads into its final three races.

'I've had a lot of bad luck,' mused the Promatecme Renault driver, sitting in the top spot at the post-race press conference. 'I'm very happy to be here again. To be honest, I felt more pressure when I was leading the championship, but now I think



Hughes (centre) tries to nip inside Luciano Burti at Redgate as Kristian Kolby watches

we're looking good for the title. I'm confident. We just have to keep working hard.'

With the two rivals on the front row, the anticipation was high before the start. Haberfeld, though, seemed to creep then stop at the green as Bernoldi made a stunning start, controlling his wheelspin to perfection. He swept past poleman Haberfeld into Redgate.

Ricardo Mauricio tucked in

behind Haberfeld and Mario's Paul Stewart Racing team mate, Luciano Burti, followed him.

Into fifth came Warren Hughes. His getaway had put even Bernoldi's into the shade, the Geordie leaping up from his disappointing ninth place on the grid. 'I got a couple off the line and a couple more under braking for Redgate,' smiled Hughes. 'The problem here is that if you don't pass early on it's almost impossible when it settles down.'

The first lap ended with Speedsport's rookie, Mark Boost, off after McLeans and Pembrey star Narain Karthikeyan buried in the tyres at Coppice. 'I was past Burti and trying to keep up with Mario when the car went very light and I went off. It was totally my fault,' admitted the Indian. Boost had spun while trying to avoid Andrej Pavicevic, who had crept outside him through McLeans.

Out of Redgate for the second time Haberfeld encountered

problems getting into fifth gear and while he was blipping the throttle Mauricio took his second place.

With Boost's car in a dangerous spot, out came the pace car at the end of lap two. However, no sooner had the field caught it than it headed for the pits, catching everyone out. 'I don't know why it did that,' said Bernoldi. 'I caught him at Coppice and then he pulled off without warning. I was in third cruising round the chicane and I thought "Now I'm in trouble". Ricardo was alongside on the straight.'

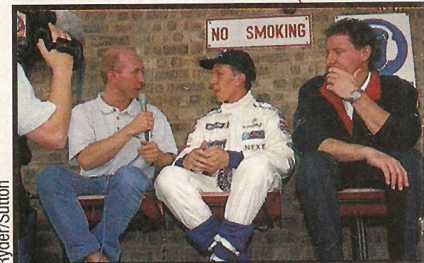

Burti tells Perry McCarthy how it's done

Haberfeld also tried to take advantage and as he headed for the inside it looked momentarily as though the top three might try to go into Redgate line-abreast. As we held our breath they squeezed through in the same order that they went in.

Hughes was also keen to make up another place and was putting Burti under increasing pressure from as close to his rear wing as it was possible to be without actually hitting it.

With six laps gone, Bernoldi had



No quarter given - (l-r) Haberfeld, Bernoldi and Mauricio head into Redgate side by side

Round 13: Donington

Qualifying

Mario Haberfeld got pole, but had to do some smooth talking to keep it

Everyone agreed that Mario Haberfeld deserved his pole position. Not just because his best lap of 1m03.918s was 0.311s faster than Enrique Bernoldi, but because of the top excuse he trotted out to explain how he did it on a lap where there were yellow flags waving at the most important corner.

'There are two lines through Coppice,' he said. 'You can go fast in and slow out or slow in and gain everything by being fast out for the long straight. I saw the yellows and lifted, saw that the car was off in a safe place and accelerated on the exit. On this occasion slow in, fast out was quicker.' Queue loud applause. 'That was a pretty special lap but the previous one was even better,' he added. 'but I got caught up behind another car at the chicane. It wasn't his fault, but he screwed my lap.'

Bernoldi had held pole for most of the session until Haberfeld leapt from fourth to eclipse him on the final lap. Third though, went to Ricardo Mauricio, who proved that blondes do have more fun, especially ones who only became blonde in the last week. It was by far his best qualifying since his pole at Pembrey last year. 'I've got nothing to lose. If I get a chance to get the lead, even only a slight one, I'm going to go for it,' he said proudly.

While sitting on the grid with the top three in the championship around

him a member of his team, who perhaps ought to remain nameless remarked, 'It's a bit like giving a baby a loaded gun.'

Previous round winner Luciano Burti took fourth, caught out by the



Happiness is: pole for Mario Haberfeld

fact that the track was cleaner than expected after the trucks had been out. 'We set the car up soft because we thought it would be slippery, but it was better than the test day,' he said.

Warren Hughes struggled initially with his ride height set two millimetres too low. Unfortunately, the first session was the faster and he was left ninth.

Once again, Martin O'Connell struggled way back in 12th. The Rowan team was convinced his crash at Silverstone two races ago had cracked the monocoque. 'We've tried everything,' said Ray Rowan. 'And we just can't get the thing to work.'

Kolby took the fastest lap but he started too far back to challenge the frontrunners



Bellanca/LAT



Mauricio held off Haberfeld the whole way

shame I was second fastest in the second session not the first, because I could keep up with the leaders really easily today.'

As his laps ran out, Haberfeld began to put increasing pressure on Mauricio, more in the hope that he would force the Alan Docking Racing driver into a mistake than to pose a real threat of passing. 'I was better than Ricardo under braking,' Mario said. 'But I had a traction problem out of the corners that meant I couldn't get close enough to have a real chance to overtake him. If I'd tried and gone off then Enrique would be leading the championship again.'

With a couple of laps to go though, he did try at Coppice, but only succeeded in losing momentum down the straight. Burti and Hughes closed right up but Mario held his line and his place.

Kolby took sixth, with Marc Hynes following him seventh and Pavicevic equalling his best result of eighth. 'I was eighth at Oulton Park in May,' he said. 'I didn't feel I deserved that because others didn't finish. But I did deserve this.'

Michael Bentwood scored his first points of the season in ninth and Collins took the final point, having fallen back after his clash with Spence.

Afterwards Haberfeld was philosophical about his shrinking title lead. 'Just because Enrique beat me I'm not disappointed,' he shrugged. 'I beat him in the last five races. So it's not the end of the world.'

With three races to go the outcome of the championship is almost impossible to call. But with so little between the two Brazilians it's likely to go down to the wire. ■

Donington Park (short) (GB)



August 30, **AUTOSPORT British Formula 3 Championship**, round 13 of 16, 20 laps – 39.2 miles

Pos	Driver (Nat)	Team	Chassis/Engine	Result	Best lap	Qual	Grid
1	Enrique Bernoldi (BR)	Promatecme UK	Dallara-Renault F397/8	22:47.041	1:05.327	1:04.229	2
2	Ricardo Mauricio (BR)	Alan Docking Racing	Dallara-Mugen Honda F397/8	22:49.872	1:05.481	1:04.275	3
3	Mario Haberfeld (BR)	Paul Stewart Racing	Dallara-Mugen Honda F397/8	22:50.280	1:05.415	1:03.918	1
4	Luciano Burti (BR)	Paul Stewart Racing	Dallara-Mugen Honda F397/8	22:50.692	1:05.361	1:04.275	4
5	Warren Hughes (GB)	Portman Arrows Racing	Dallara-Renault F397/8	22:51.337	1:05.434	1:04.680	9
6	Kristian Kolby (DK)	Fortec Motorsport	Dallara-Mugen Honda F397/8	22:51.794	1:05.226	1:04.515	6
7	Marc Hynes (GB)	Promatecme UK	Dallara-Renault F397/8	22:52.522	1:05.474	1:04.572	7
8	Andrej Pavicevic (AUS)	Fortec Motorsport	Dallara-Mugen Honda F397/8	23:01.079	1:05.963	1:04.720	10
9	Michael Bentwood (GB)	Speedsport	Dallara-Mugen Honda F397/8	23:02.104	1:05.768	1:04.887	14
10	Ben Collins (GB)	Intersport	Dallara-Opel Spiess F398	23:04.154	1:05.861	1:04.785	11
11	Martin O'Connell (GB)	Rowan Racing	Dallara-TOM'S Toyota F398	23:04.934	1:06.095	1:04.875	13
12	Tim Spouge (GB)	SS Sport	Dallara-Mugen Honda F398	23:08.872	1:06.057	1:05.018	16
13	Paula Cook (GB)	Portman Arrows Racing	Dallara-Renault F397/8	23:09.123	1:06.040	1:05.095	17
14	Warren Carway (IRL)	Rowan Racing	Dallara-TOM'S Toyota F398	23:19.851	1:06.620	1:05.567	19
15	Adam Wilcox (GB)	Intersport	Dallara-Opel Spiess F398	23:20.045	1:06.693	1:05.209	18
16 (N1)	Mike Kirkham (GB)	Speedsport	Dallara-Mugen Honda F397/8	23:36.301	1:07.326	1:06.763	20
17 (N2)	Steve Hayr (NZ)	Tarry Falcon Racing	Dallara-Mugen Honda F396	23:00.756	1:09.074	1:08.070	21
R	Yudai Igarashi (J)	Alan Docking Racing	Dallara-Mugen Honda F397/8	16 laps - accident	1:05.798	1:04.831	12
R	Jamie Spence (GB)	Martin Donnelly Racing	Dallara-Mugen Honda F397/8	14 laps - accident	1:05.588	1:04.898	15
R	Narain Karthikeyan (IND)	Carlin Motorsport	Dallara Mugen-Honda F397/8	0 laps - accident	no time	1:04.507	5
R	Mark Boost (GB)	Speedsport	Dallara-Mugen Honda F397/8	0 laps - accident	no time	1:04.647	8

Winner's average speed 103.08mph. **Scoring system** 20-15-12-10-8-6-4-3-2-1 +1 for fastest lap. **Championship positions after 13 of 16 rounds** 1, Haberfeld, 158; 2, Bernoldi, 153; 3, Burti, 119; 4, Hughes, 115; 5, O'Connell, 99; 6, Mauricio, 78; 7, Spence, 54; 8, Hynes, 51; 9, Manning, 49; 10, Kolby, 48; 11, Collins, 36; 12, Yoong, 27; 13, Karthikeyan, 20; 14, Wilcox, 14; 15, Pavicevic, 11; 16, David Cook, 10; 17, Igarashi, 8; 18, P Cook, 7; 19, Spouge, 6; 20, Bentwood, 2; 21, Milu Santavirta, 1. **National Class** 1, Scifleet, 237; 2, Carway, 97; 3, Hayr, 69; 4, Johnathan Ingram, 35; 5, Kirkham, 21; 6, Stephen White, 12. **Next round** Thruxton, Sept 13.



Bernoldi put his title chase back on track with his sixth win of the year

“ I have had a lot of bad luck, so I'm just glad to be back up here again ”

ENRIQUE BERNOLDI

opened up a 1.5s gap but Mauricio was also managing to pull away from Haberfeld.

Spence was now the man on the move. The Essex driver had started a miserable 15th and sliced past Michael Bentwood to snag a single championship point. It didn't last long though. As he closed on Ben Collins at Redgate the two touched and a very disgruntled Spence ended up in the gravel. 'I tried to go round the outside,' he said. 'But Ben, well, ninth place is like a win to him. I tried the same move with Martin O'Connell and while he didn't give me the corner at least he knows when the battle is lost.'

With his lead extending, the only thing Bernoldi lacked was the extra point for fastest lap. On lap 10 he got it, for all of four seconds, until Kristian Kolby crossed the line.

Having struggled in the pre-race test the Dane had got progressively faster during the meeting. 'It's all about qualifying,' he said. 'It's just a

Huisman wraps up the Porsche Supercup

Mastering streaming conditions at Spa for his fourth win made Patrick Huisman the Supercup champion

It was never going to be easy for Jurgen von Gartzzen to come between Patrick Huisman and the Porsche Supercup title, for he arrived at Spa as the only driver realistically capable of preventing the Dutchman from achieving his goal. The German was 35 points adrift, with 20 for a win and three rounds still to run.

Then, when Huisman secured his sixth consecutive pole for Walker Monroe-Manthey Racing by almost a second from team mate Oliver Mathai and von Gartzzen was outside the top 10, the lines were set.

Huisman made a clean start and was followed into the La Source hairpin by Mathai, Britain's Johnny Mowlem, Ralf Kelleners and Stephane Ortelli. Mowlem was edged wide on the exit and dropped to fifth as the field powered down to Eau Rouge. Ortelli moved past his Jurgen Alzen Motorsport team mate Kelleners for third, with the order settling as they powered up to Les

Combes, each driver wary of what lay ahead as they raced into the spray.

Enjoying the advantage of being at the front, Huisman completed the opening lap almost four seconds clear of Mathai, with Ortelli, Kelleners, Mowlem and Altfred Heger crossing the line at one second intervals. And this was just how Huisman wanted it to be: 'When I glanced in my rear view mirror at the end of the second lap I relaxed and eased the pace as I didn't want to make my team boss (Olaf Manthey) too nervous.'

Formula 1 veteran Jacques Laffite was revelling in a mighty battle for seventh with Patrick Simon and Porsche guest driver Vincent Vosse, with Vosse being spat out of the back by the regulars.

Meanwhile, Mowlem was lapping as fast as Huisman and started to haul in Ortelli and Kelleners, but his bid to get into the top three for the first time came to naught on lap 6 when he clashed with Kelleners on

the way into the Bus Stop. While the German spun across the grass, Mowlem kept going, now in fourth. But he had to retire two laps later with his water temperature soaring.

The top three continued untroubled to the finish, with Heger fourth while his team mate Simon shook off Laffite to move into fifth, with Kelleners climbing to sixth. But Simon spun off at the Bus Stop on the final lap, allowing Maurizio Monforte to round out the top six just ahead of a troubled von Gartzzen. Now the battle is to finish the season as runner-up behind new champion Huisman, with Mathai closing to within a point of von Gartzzen with Ortelli just a point behind in fourth.

PORSCHE SUPERCUP, ROUND 7 OF 9, SPA-FRANCORCHAMPS, 10 LAPS - 43.29 MILES, AUG 30 1 Patrick Huisman, 28m40.69s, 90.57mph; 2 Oliver Mathai, 28m43.60s; 3 Stephane Ortelli, 28m47.37s; 4 Altfred Heger, 28m53.31s; 5 Ralf Kelleners, 28m58.69s; 6 Maurizio Monforte, 29m01.10s; 7 Jurgen von Gartzzen, 29m04.66s; 8 Jacques Laffite, 29m05.55s; 9 Andrej Kulundzic, 29m07.44s; 10 Patrick Simon, 29m10.03s. **Fastest lap** Huisman, 2m50.06s, 91.66mph. **Championship positions** 1 Huisman, 128pts; 2 von Gartzzen, 83; 3 Mathai, 82; 4 Ortelli, 81; 5 Heger, 68; 6 Kelleners, 62. **Next round** Monza, Sep 13.



Charles Coates/LA

New Porsche Supercup champion Patrick Huisman heads the field up to La Source with team mate Oliver Mathai running second in his wake

Giovanardi grabs the lead in Italy

Works Alfa Romeo driver Fabrizio Giovanardi raced to a pair of wins when the Italian Superturismo series moved to Enna-Pergusa and took the championship lead from BMW's Emanuele Naspetti who had entered the Sicilian weekend with a one-point edge.

The high-speed track suited the heavy-powered, low-drag Alfa Romeo 156 and Giovanardi claimed his sixth straight pole. However, at the start of the sprint race he let his arch rival Naspetti slip through at the green light. But he was soon in the lead, going ahead in the second chicane complex section.

Naspetti's second place was never under threat, as he spent most of the race being trailed by his team mate Fabrizio de Simone. The latter and Alfa's Nicola Larini traded some paint on lap four, and Larini dropped back to lap 6s behind Rinaldo Capello's Audi A4.

Larini rallied and after a brief and successful battle with the improved Audi took third from de Simone in the last chicane on the final lap.

Giovanardi then secured another lights-to-flag win in the afternoon race. This time Larini got rid of his nemesis de Simone at the first corner, forcing him onto the grass. Naspetti ran second for the first six laps, but set his mind on scoring points and wisely avoided a dogfight with Larini when the Alfa driver took the inside line at the

Signori/Sutton Images



Fabrizio Giovanardi found his Alfa 156 well suited to Enna-Pergusa and collected two wins

third corner. Capello's Audi then grew ever larger in Naspetti's mirrors, but when the Audi went off the track after hitting a patch of oil, Capello eased off, deciding he was lucky enough just to have avoided serious damage.

De Simone fought his way up from the rear and finally came home fifth. While Christian Pescatori made it a double success in the privateers' class by finishing sixth, this helping Alfa Romeo to jump over BMW in the Makes Championship.

Fortunately for Naspetti, the next round is at Misano, a high-downforce track which should favour BMW.

● Carlo Marzetti

ITALIAN SUPERTURISMO CHAMPIONSHIP, ROUND 7 OF 11, ENNA-PERGUSA (I), 11 & 21 LAPS - 33.84 & 64.60 MILES, AUG 30, Race 1 1 Fabrizio Giovanardi (Alfa Romeo 156), 19m16.28s, 105.34mph; 2 Emanuele Naspetti (BMW 320i), 19m21.70s; 3 Nicola Larini (Alfa Romeo 156), 19m22.31s; 4 Fabrizio de Simone (BMW 320i), 19m22.58s; 5 Rinaldo Capello (Audi A4), 19m23.04s; 6 Christian Pescatori (Alfa Romeo 155), 19m44.52s; 7 Fabian Peroni (Audi A4), 19m48.52s; 8 Miguel Ramos (BMW 320i), 19m52.74s; 9 Moreno Soli (Audi A4), 19m58.19s; 10 Davide Bernasconi (Audi A4), 20m02.02s. **Fastest lap** Larini, 43.79s, 106.69mph. **Race 2** 1 Giovanardi, 37m02.13s, 104.65mph; 2 Larini, 37m02.97s; 3 Naspetti, 37m11.68s; 4 Capello, 37m17.79s; 5 de Simone, 37m26.83s; 6 Pescatori, 37m40.06s; 7 Peroni, 37m51.35s; 8 Emanuele Moncini (Alfa Romeo 155), 37m53.53s; 9 Sandro Sardelli (BMW 320i), 37m56.49s; 10 Soli, 38m71.93s. **Fastest lap** Giovanardi, 1m44.26s, 106.21mph. **Championship positions** 1 Giovanardi, 313pts; 2 Naspetti, 291; 3 Larini, 217; 4 Capello, 195; 5 de Simone, 194; etc. **Next round** Binetto, Sep 13.

Negri claims ILP hat-trick

Oswaldo Negri raced to his third consecutive win in the Pan-American Indy Lights Formula de las Americas series, maintaining his 100% record at Saltillo.

After a troubled Indy Lights series in the USA last year, Negri is finding his feet again and qualified on pole ahead of Waldemar Coronas. Then, when the lights flicked to green, he shot into a lead he wasn't to lose. And he was helped in his escape as Argentinian Mauro Fartuszek passed Cesar Jimenez for third on lap one and set about putting compatriot Coronas under pressure. However, it took him until lap 22 to pass Coronas and by then Negri was long gone and the gap was only reduced thanks to two periods when the race was run under yellow. However Negri was on the ball at each of the restarts and made good his escape.

Rafael Martinez, reigning Mexican Formula 3000 Champion Jimmy Morales and Horacio Richards rounded out the top six.

● Rosa Elena Torres

PAN-AMERICAN ILP CHAMPIONSHIP, ROUND 3/10, SALTILLO (MEX), 40 LAPS - 57.16 MILES, AUG 30 1 Oswaldo Negri, 42m30.08s, 80.69mph; 2 Mauro Fartuszek, 42m34.39s; 3 Waldemar Coronas, 42m37.43s; 4 Rafael Martinez, 42m37.53s; 5 Jimmy Morales, 42m39.62s; 6 Horacio Richards, 39 laps; etc. **Championship positions** 1 Negri, 64pts; 2 Eduardo Galicia & Alex Padilla, 29; 4 Martinez, 28; 5 Coronas, 27; etc. **Next round** Zacatecas, Sep 13.

Nine up for Gordon

Mark Martin is literally running into walls as he attempts to hang onto the Jeff Gordon juggernaut in the NASCAR Winston Cup. Martin's Valvoline Ford slipped up into the outside wall 20 laps from the finish at New Hampshire International Speedway, ending any chance of preventing Gordon from collecting his ninth win of the season.

On the upside, despite finishing second, Martin lost no ground on Gordon, as by virtue of leading the most laps he scored 180 points, matching Gordon's 180 for winning.

'We just got outrun,' said Martin, who has made a habit this year of finishing second to the two-time champion. 'At the end of the race, Gordon was just faster than us.'

NASCAR officials seized the tyres from Gordon's car after the race for inspection at the request of Jack Roush - Martin's car owner. They also took tyres from Martin's.

Gordon, who started on pole, was a relative non-factor until a final pit stop when crew chief Ray Evernham put two rightside tyres on the car while the rest of the field took four tyres. And suddenly Gordon started to fly.

'That's about the only racing we did today, those last 60 laps,' said Gordon. 'I can't believe the way things are going for this team.'

Neither can Jack Roush.

Ken Schrader's Chevrolet backed into the outside wall hard enough to

crush the fuel line. Schrader safely exited his burning car unhurt and placed no blame on Kenny Wallace.

Behind Gordon and Martin, John Andretti, Dale Jarrett and Jeff Burton completed the top five. Andretti appeared to have the strongest car most of the day, but spent his best laps trying to break free of traffic while the leaders drove through clear traffic. This result leaves Jarrett over 200 points behind Gordon and has all but left it as a two-horse title race.

● Stan Creekmore

NASCAR WINSTON CUP, ROUND 23 OF 33, NEW HAMPSHIRE INTERNATIONAL SPEEDWAY (USA), 300 LAPS - 300 MILES, AUG 30 1 Jeff Gordon (Chevrolet Monte Carlo), 2h48m55.10s, 112.10mph; 2 Mark Martin (Ford Taurus), 2h48m55.66s; 3 John Andretti (Pontiac Grand Prix), 300 laps; 4 Dale Jarrett (Ford Taurus), 300; 5 Jeff Burton (Ford Taurus), 300; 6 Kenny Wallace (Ford Taurus), 300; 7 Bobby Labonte (Pontiac Grand Prix), 300; 8 Rusty Wallace (Ford Taurus), 300; 9 Dale Earnhardt (Chevrolet Monte Carlo), 300; 10 Ricky Rudd (Ford Taurus), 300. **Next round** Darlington, Sep 6.

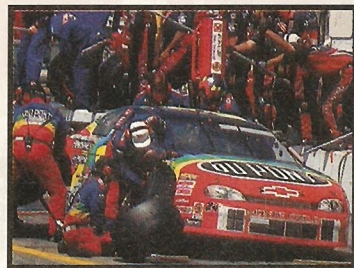

Fitting just two tyres helped Gordon win

Kirade/Sutton Images



Jones wins twice to land Australian crown for Audi

Brad Jones won his second Australian Super Touring Championship title on Sunday, but only after having to fight off an extremely serious challenge from his 24-year-old Audi team mate Cameron McConville in the final round at the Oran Park circuit on the outskirts of Sydney.

'This title means more to me than the first,' said Jones, 'as the competition was tougher this season. It's also a thrill for our team and Audi to go one-two in the championship.'

'Cameron (McConville) pushed me really hard, but at the same time we were able to work together on set-up and improving the car. Now we've got to win Bathurst.'

Going into the finale, the points scores were close after Jones's non-finish in the previous round at Winton and only seven points separated Jones, McConville and Volvo driver Jim Richards.

However, Richards had a disastrous weekend. He lost a spoiler from his Volvo S40 at more than 125mph at the end of the main straight during practice, but escaped without damage. Then the same thing happened on lap 21 of the 31-lap second heat, and he drove the car off the end of the straight and into a gravel trap.

Even before this, though, Richards was struggling, despite having tried a change of tyres from Michelin to Dunlop in an attempt to

get on the pace. He had finished only fourth in the first race, which effectively ended the veteran's bid for the title.

McConville had qualified on pole position for the first race and then won, beating Jones by just 0.6s after a dozen laps in a race that was stopped four laps ahead of schedule after Troy Searle's BMW and Tony Newman's Peugeot clashed and left Searle stranded in the middle of the circuit.

Then Jones, starting from pole in the second race, benefited from a 7.5s pit stop for the mandatory two-tyre change to stay ahead of McConville. Cameron McLean, in his privately-entered BMW 320i, sneaked ahead for several laps and Jones, desperate to take the chequered flag, pulled off a daring pass to regain the lead.

McConville crossed the line third behind McLean, saying he had been slowed by a tyre problem.

● Bob Jennings

AUSTRALIAN SUPER TOURING CHAMPIONSHIP, ROUND 8 OF 8, ORAN PARK (AUS), 12 & 31 LAPS - 14.17 & 36.60 MILES, AUG 30, Race 1 1 Cameron McConville (Audi A4), 21m21.91s; 2 Brad Jones (Audi A4), 21m22.51s; 3 Cameron McLean (BMW 320i), 21m26.99s; 4 Jim Richards (Volvo S40), 21m29.33s; 5 Peter Hills (Ford Mondeo), 21m43.71s; 6 Mark Adderton (Honda Accord), 21m47.26s. **Race 2** 1 Jones, 37m31.62s; 2 McLean, 37m32.53s; 3 McConville, 38m07.75s; 4 Trevor Sheumach (Audi A4), 38m17.83s; 5 Mark Zonneveld (Ford Mondeo), 30 laps; 6 Hills, 30. **Final championship positions** 1 Jones, 190pts; 2 McConville, 184; 3 Richards, 163; 4 McLean, 142; 5 Adderton, 79; 6 Hills, 70.



Brad Jones heads Cameron McLean past the chequered flag in the second race for the title

Reports In Brief

Heavy rain forced the cancellation of the seventh round of the Formula Nippon series at Fuji. Takuya Kurosawa had qualified his Hoshino Racing Lola on pole ahead of Ryo Michigami, Katsutomo Kaneishi, Yuji Tachikawa, Ralph Firman and Marc Goossens.

Robby McGehee won a crash-marred Formula Ford 2000 race at Atlanta Motor Speedway. His Tatuus chassis finished 0.16s ahead of the Van Diemen of Australian David Besnard. New Yorker Andy Lally brought his Bowman BC5 home third in a race in which six cars of the 30-car field were eliminated by accidents at the chicanes on the oval designed to slow cars, including a shunt by former Tour de France winner Greg LeMond.

Domenic Beninca won the Australian GT series with a flag-to-flag victory in the second heat of the final round at Oran Park after finishing second to John Bove's Ferrari F355, while title rival Peter Fitzgerald fell from contention with third in the final race.

Neal Bates and Coral Taylor took their first Australian Rally Championship victory of the season when they won the Rally of Melbourne. Driving a Toyota Corolla WRC, they finished ahead of the Subaru WRX of Possum Bourne and Craig Vincent, who have an unassailable title lead.

Dirk Klynsmith

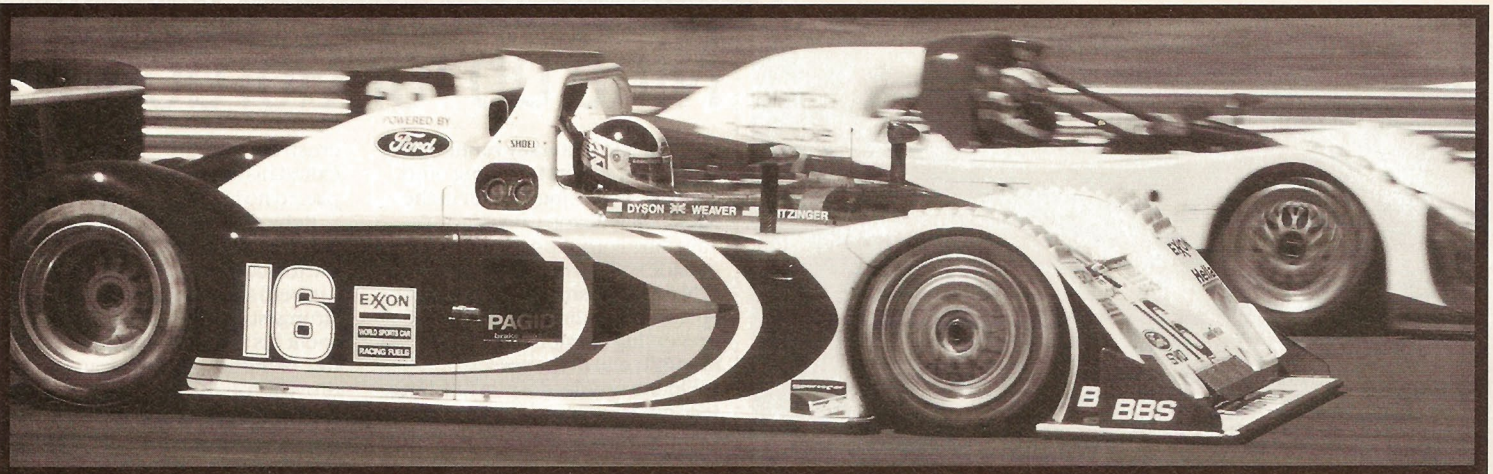

**WORLD'S
LARGEST
HARDCORE
RACING
TRADE
SHOWS**

NEW FALL DATES! EXCITING NEW HOST CITY!
**Performance
Racing Industry WEST**
6TH ANNUAL
TRADE SHOW **SACRAMENTO**

OCTOBER 22-24, 1998
SACRAMENTO, CA
THE TRADE SHOW FOR THE EXPLODING WEST COAST RACING MARKETPLACE!
350 RACING PRODUCT MANUFACTURERS EXHIBITING IN 550 BOOTHS!

NOW IN THE WORLD CAPITAL OF MOTORSPORTS!
**Performance
Racing Industry**
11TH ANNUAL
TRADE SHOW **INDIANAPOLIS**

THURSDAY, FRIDAY, SATURDAY
SHOW DAYS!
DECEMBER 3-5, 1998
INDIANAPOLIS, IN
THE TRADE SHOW FOR THE WORLDWIDE HARDCORE RACING MARKET!
900 RACING PRODUCT MANUFACTURERS EXHIBITING IN 1,950 BOOTHS!

AVOID LONG LINES & DELAYS. PRE-REGISTER TODAY—IT'S EASY!

Send or fax for pre-registration credentials, hotel and travel information. Only legitimate members of the racing trade will be allowed into the show.
Attendees must submit racing business identification to obtain credentials.

CALL TODAY!
P.O. BOX 9327 • SOUTH LAGUNA, CA 92677 • USA • FAX 949/499-0410 **949/499-5413**

PRODUCED BY THE PUBLISHERS OF PERFORMANCE RACING INDUSTRY

©1998 by Laguna Coast Publishing, Inc.

From Formula One to Touring Cars

Del West Lightweight Valvetrain and Pneumatic Valve Control Systems

Del West precision-manufactured titanium valvetrain components are the standard in major racing series around the globe, specified by the makers of everything from the exotic, 17,000-rpm engines in Formula One to the turbocharged engines of CART and the pushrod V8s of NASCAR. Even in rev-limited series like touring cars, Del West lightweight titanium valves provide engine designers with greater flexibility.

In addition to titanium valves and valvetrain components, we design and manufacture an engine-specific pneumatic valve control system, now racing in Formula 1. That system is just one reason why engine builders and engine designers depend on Del West for engineering support, as well as the ultimate quality in manufacturing.

Del West products don't just live in the harsh environment of today's high-speed racing engines; they thrive on it.



For additional information, contact

Del West Engineering
28128 West Livingston
Valencia, California 91355 U.S.A.
Telephone: 805-295-5700
Fax: 805-295-8300

Del West S.A.
Chemin de Marjolin 75-77
C.P. 358, 1860 Aigle CH
Telephone: 02-44-66-96-36
Fax: 02-44-66-96-38





Williams/Sutton Images

AJ Foyt listens while Kenny Brack tells how he reckons he'll make it three IRL wins in a row. Which is just what the Swede managed

Brack makes it three

Kenny Brack clinched his Indy Racing League hat trick by winning at Atlanta

At the 50-lap mark lap mark, the first night race at the Atlanta Motor Speedway, some lights atop the grandstand in Turn 4 went out. That left the exit of the corner in the dark, which is where Kenny Brack is leaving his competition in the Indy Racing League.

Brack won his third straight race in one of AJ Foyt's Dallara-Auroras and took a clear championship lead with two races remaining. That means Brack and his Foyt's team are looking at a \$1.25m payday in the season finale at Las Vegas.

The typically laconic Swede had this assessment of his hot streak: 'I know AJ has a good team, but there are other people who can win races, too. So you have to race with them.' That's Brack's version of a good ol' American racing saying: you have to take home the trophies one at a

time. Meanwhile, one by one, the other contenders are throwing away any chance to catch him.

In the IRL's first appearance at AMS in front of 50,000 fans, who saw average lap speeds of 222mph on the 1.5-mile, high-banked track, former points leaders Scott Sharp and Tony Stewart faltered. The Kelley Racing entry of Sharp broke a gearbox input shaft when second on lap 135.

Despite turning laps of 228mph in testing at night, Stewart qualified 25th at 213mph on a sultry evening as a result of engines built by his Team Menard that failed miserably. 'We came in thinking we could dominate the front row,' said team mate Robbie Buhl, who qualified 21st. The team used engines rebuilt after the previous race at Pikes Peak, a one-mile flat track that has very different demands on engines from the 28-degree high banks in Atlanta.

Stewart drafted through the field and led for 12 laps. But once he lost 'dancing partner' Eddie Cheever, he slipped from third to fifth. 'There's nothing we did that couldn't have been cured by 40 more horsepower,' said team manager Larry Curry.

Stewart left Atlanta 25 points behind Brack and Sharp dropped to a 36-point deficit in a league where the difference between first and fifth is 20 points.

Driving the Dallara-Aurora of Nienhouse Motorsports, still winless Davey Hamilton overtook both in the points after finishing second, 0.94s behind Brack, who blew by Hamilton with ease at Turn 1 with 14 laps to go. This was 63 laps after Brack made up a lap lost when he got caught in the pits during a caution near the halfway mark after Greg Ray spun due to a cut tyre.

Brack made up his lap with the benefit of the subsequent yellow for

BMW's van der Linde takes battle to Nissan

Shaun van der Linde dominated the latest round of the South African Touring Car Championship with a pole position, two convincing wins and a new lap record at Port Elizabeth's Aldo Scribante circuit.

This success for BMW breathed new life into the series which so far seemed to be the preserve of the

Nissan Primeras of 1997 champion Giniel de Villiers and Duncan Vos.

Van der Linde's BMW team mate Michael Briggs started the first race from pole and led for four laps before giving way to van der Linde. He was later caught in a collision and had to retire, opening the way for Terry Moss to finish second, after

working his Audi forward from fifth. De Villiers fell to sixth after fluffing his start from the front row and had to make do with third place. Vos rose from the back of the grid to wrestle fourth from Anthony Taylor's Audi.

Van der Linde was 3s clear of de Villiers midway through the second race when his exhaust started to separate from the manifold and he lost power. But he just held on.

● Colin Windell



Colin Watling

Shaun van der Linde had only won once this year. Then on Sunday he added two more

Stephan Gregoire's spin in Turn 4. 'I'm learning how to drive faster after getting slowed in the pits,' joked Brack, whose first win came after a charge at Charlotte when he missed the pits during a yellow.

Surprisingly, the G-Forces of Scott Goodyear and Jeff Ward were dominant for most of the race. Their previous problem has been finding consistency, one that raised its head at the end, when both had handling difficulties that dropped Goodyear to fourth and Ward to sixth.

Brack's team mate Billy Boat, who took his second consecutive pole, also made up a lap lost after stalling in the pits. But he collided with Marco Greco at Turn 2, collecting Robby Unser and Steve Knapp, whose G-Force nearly flipped after hitting the wall on the backstraight.

The bad news for the competition is the two remaining races are to be held on 1.5-mile banked tracks that have proven to be Elysian Fields for Brack's Dallara-Aurora. 'If it's meant to be, we'll win the championship,' said Brack, ever the race-by-racer.

● Jonathan Ingram

INDY RACING LEAGUE, ROUND 9 OF 11, ATLANTA (USA), 208 LAPS - 312 MILES, AUG 29 1 Kenny Brack (Dallara-Aurora), 2h17m15.29s, 140.03mph; 2 Davey Hamilton (Dallara-Aurora), 2h17m16.23s; 3 Eddie Cheever (Dallara-Aurora), 208 laps; 4 Scott Goodyear (G Force-Aurora), 208; 5 Tony Stewart (Dallara-Aurora), 208; 6 Jeff Ward (G Force-Aurora), 208; 7 Mark Dismore (Dallara-Aurora), 208; 8 Arie Luyendyk (G Force-Aurora), 207; 9 Andy Michner (Riley & Scott-Aurora), 206; 10 Raul Boesel (G Force-Aurora), 202. **Fastest lap** Billy Boat, 24.06s, 224.16mph. **Championship positions** 1 Brack, 282pts; 2 Hamilton, 259; 3 Stewart, 257; 4 Sharp, 246; 5 Goodyear, 228; 6 Ward, 208. **Next round** Texas Motor Speedway, Sep 20.

Reports in Brief

Gabriel Furlan all but clinched his fourth SudAm Formula 3 title when he won the latest round at Rio Cuarto in Argentina. He was helped on his way by Leonardo Nienkotter and Jaime Melo Jr clashing just after the start and taking out Furlan's GF Motorsport team mate Martin Basso as well as themselves. Nienkotter's PropCar team mate 'duda' Pamplona then ran a distant second until his halfshaft failed, allowing Rodrigo Sperafico to claim the position ahead of Daniel Belli.

Honda driver Juan Manuel Silva scored his second win in a row when he won the first of the two Argentinian TC2000 races at Bahia Blanca, with Ford's Daniel Cingolani winning the second.

Aris Vovos drove to a memorable victory when he won the Rally Elpa-Halkidiki, a co-efficient 20 round of the FIA European Rally series. He powered his Subaru Impreza WRC past the Ford Escort WRCs of Yianni Papadimitriou and Leonidas Kirkos. Title aspirant Alex Fiorio started strongly, but retired his Ford Escort Cosworth with overheating. Jean-Pierre Richelmi also featured at the front until his Subaru hit power steering problems and then rolled out of the event. All this left the way clear for Ercan Kazaz to finish fourth in a Nissan Almera GTi.

SOUTH AFRICAN TOURING CAR CHAMPIONSHIP, ROUND 7 OF 10, ALDO SCRIBANTE (ZA), 2 x 20 LAPS - 2 x 30.82 MILES, AUG 30, Race 1 1 Shaun van der Linde (BMW 318iS), 23m15.30s, 79.54mph; 2 Terry Moss (Audi A4), 23m22.36s; 3 Giniel de Villiers (Nissan Primera), 23m22.52s; 4 Duncan Vos (Nissan Primera), 23m23.09s; 5 Anthony Taylor (Audi A4), 23m23.69s; 6 Mark Peters (BMW 318iS), 23m43.26s. **Race 2** 1 van der Linde, 23m05.68s, 80.16mph; 2 de Villiers, 23m05.04s; 3 Moss, 23m24.74s; 4 Marco dos Santos (Nissan Sentra), 23m25.46s; 5 Michael Briggs (BMW 318iS), 23m33.42s; 6 Peters, 23m34.24s. **Championship positions** 1 de Villiers, 200pts; 2 Vos, 131; 3 van der Linde, 123. **Next round** Kyalami, Sep 26.

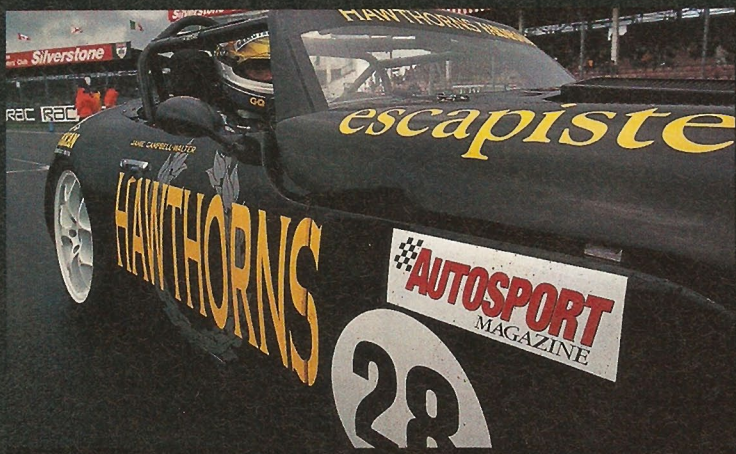

EXCLUSIVE **AUTOSPORT** READER OFFER

Join us at the AUTOSPORT Tower on October 3 & 4 for the Hill House Hammond Silverstone Golden Jubilee Race Day. The day will feature the annual Autumn Gold Cup Championship Races including Privilege Insurance GTs, the AUTOSPORT British Formula 3 Championship, TVR Tuscans, BRDC Louis Vuitton Historic Sports Cars, MGF Cup, Pirelli Porsche Cup and more

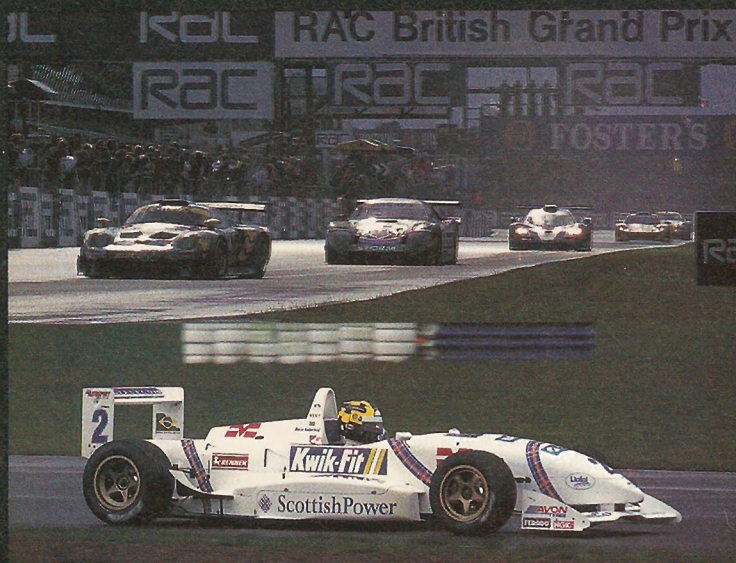

SILVERSTONE CELEBRATES 50 YEARS

SPECIAL PACKAGE INCLUDES:

- General admission
- Private grandstand seating at the start/finish line
- Private toilet facilities
- Programme
- AUTOSPORT gift bag
- £25 for two-day ticket

AUTOSPORT
TOWER



TO BOOK TICKETS CALL THE HOTLINE NUMBER
0181 943 5076

Places are strictly on a first come, first served basis

The German Super Touring Championship made its annual foray beyond its national borders to hold its eighth round at the Salzburgring. It arrived at the high-speed, tyre-eating circuit with BMW's Johnny Cecotto holding an 83-point lead over rival Peugeot driver Laurent Aiello. By the time they left, the gap was down to just 24, throwing the title race wide open.

Tom Kristensen put his Honda Accord on pole for the first time, while Aiello was second fastest, ahead of a trio of Opels driven by Eric Helary, Manuel Reuter and Uwe Alzen. Michael Bartels showed how he has readapted to touring cars by lining up sixth in the second of the three works Peugeots, with Honda's Gabriele Tarquini, Audi's Christian Abt and Emanuele Pirro, and Nissan's Roland Asch completing the top 10. For BMW, things were far from easy, with Joachim Winkelhock 14th and Cecotto 16th.

Kristensen had a clutch problem at the start of the 12-lap sprint race and dropped to fifth, while a gearbox problem forced Asch to start from the pits. So Aiello took the lead from Helary and Reuter, then a broken clutch accounted for Helary after a lap. He missed the main race too.

The order stayed the same until the last lap, when Reuter moved over to let Alzen up to second, crossing the line almost six seconds after Aiello. Abt was fourth ahead of Tarquini, Peugeot's Jorg van Ommen, Pirro and Kristensen. Cecotto and Winkelhock struggled to finish 12th and 13th for BMW.

Reuter took the lead at the start of the main race, with Aiello and Alzen right on his tail as the field negotiated the narrow chicane. However, not all made it through, as Peter Mamerow piled his BMW into Prinz Leopold von Bayern's similar car.

There was change at the front, with Aiello outraking Reuter into



Peugeot's Laurent Aiello leads the field at the start of the first German Super Touring race at the Salzburgring

Aiello throws a double

Two wins for the Peugeot ace have thrown the German Super Touring title race open

the Fahrerlagerkurve. Once ahead, Aiello stayed there to record his second win of the day.

A misunderstanding between team mates Pirro and Abt sent the latter into the barriers on lap six.

Alzen pitted from third with a puncture on lap 17. Reuter came in with the same problem a lap later. This opened the way for Pirro to be second and Bartels third.

Three laps before the end of the race, Winkelhock also suffered a burst tyre that sent his BMW spearing

off into the barriers. Cecotto could do little to cheer the BMW team, managing to finish only 10th.

A delighted Aiello said: 'I think we have found something on our car this weekend which might prove decisive and let me defend my title.'

● Rene de Boer

GERMAN SUPER TOURING CHAMPIONSHIP, ROUND 8 OF 10, SALZBURGRING, 12 & 24 LAPS - 31.73 & 63.46 MILES, AUG 30, Race 1 1 Laurent Aiello (Peugeot 406), 17m14.61s, 110.10mph; 2 Uwe Alzen (Opel Vectra), 17m20.50s; 3 Manuel Reuter (Opel Vectra), 17m21.27s; 4 Christian Abt (Audi A4),

17m23.55s; 5 Gabriele Tarquini (Honda Accord), 17m24.97s; 6 Jorg van Ommen (Peugeot 406), 17m26.00s; 7 Emanuele Pirro (Audi A4), 17m27.04s; 8 Tom Kristensen (Honda Accord), 17m28.01s; 9 Michael Krumm (Nissan Primera), 17m34.93s; 10 Michael Bartels (Peugeot 406), 17m36.92s. **Fastest lap** Aiello, 1m25.36s, 111.52mph. **Race 2** 1 Aiello, 34m30.64s, 110.48mph; 2 Pirro, 34m35.60s; 3 Bartels, 34m38.25s; 4 Tarquini, 34m40.45s; 5 van Ommen, 34m41.84s; 6 Krumm, 34m44.77s; 7 Kristensen, 34m48.57s; 8 Alexander Burgstaller (Opel Vectra), 34m50.53s; 9 Frank Biela (Audi A4), 34m50.84s; 10 Johnny Cecotto (BMW 320i), 34m52.08s. **Fastest lap** Abt, 1m24.92s, 112.09mph. **Championship positions** 1 Cecotto, 476pts; 2 Aiello, 452; 3 Alzen, 370; 4 Helary, 347; 5 Reuter, 340; 6 Winkelhock, 326. **Next round** Oscherleben, Sep 13.

Lechner peaks on home ground with two victories

Local hero Robert Lechner left no one in doubt that he planned to win both German Formula 3 races at the Salzburgring.

The little Austrian had never won at this level before, but was confident of success.

This confidence proved well founded as he put his GM Dallara on pole. Pierre Kaffer was second and Thomas Jager and Norman Simon occupied the second row, with points leader Bas Leinders fifth.

Simon locked up at the new chicane on the first lap, collided with Lechner and forced Leinders to go through the gravel trap, which left him at the tail of the 21-car field.

Meanwhile, Kaffer led from Timo Scheider and Lechner. The Austrian was on the move, though, and took the lead on lap 15 before scoring his first win at this level. Second place for Wolf Henzler, who started 11th, gave him the championship lead.

Kaffer briefly led on the opening

lap of the second race, but Lechner raced clear for his second win. Kaffer finished second, with Leinders working his way from 14th to third after a battle with Henzler. Contact bent one of Henzler's front wings and he fell to seventh, handing the series lead back to Leinders.

● Rene de Boer

GERMAN F3 CHAMPIONSHIP, ROUND 8 OF 10, SALZBURGRING (A), 2 x 19 LAPS - 2 x 50.24 MILES, AUG 30, Race 1 1 Robert Lechner (Dallara-Opel F397), 25m42.60s, 118.69mph; 2 Wolf Henzler (Martini-Opel MK73), 25m43.96s; 3 Pierre Kaffer (Martini-Opel MK73), 25m44.76s; 4 Timo Scheider (Martini-Opel MK73), 25m45.42s; 5 Steffen Widmann (Dallara-Opel F397), 25m46.42s; 6 Johan Stureson (Dallara-Opel F397), 25m48.55s; 7 Christijan Albers (Dallara-Opel F398), 25m49.05s; 8 Tim Bergmeister (Dallara-Opel F397), 25m49.05s; 9 Wouter van Eeuwijk (Dallara-Opel F397), 25m49.51s; 10 Jeffrey van Hooydonk (Dallara-Opel F398), 25m50.04s. **Race 2** 1 Lechner, 25m25.06s, 119.19mph; 2 Kaffer, 25m28.54s; 3 Leinders, 25m37.76s; 4 Albers, 25m38.07s; 5 Norman Simon (Dallara-Opel F397), 25m42.25s; 6 Lucas Luhr (Dallara-Opel F397), 25m42.55s; 7 Henzler, 25m46.32s; 8 van Hooydonk, 25m46.60s; 9 van Eeuwijk, 25m49.60s; 10 Petr Krizan (Dallara-Opel F396), 25m51.22s. **Championship positions** 1 Leinders, 160pts; 2 Henzler, 152; 3 Lechner, 151; 4 Kaffer, 129; 5 Scheider, 94; 6 Albers, 93; etc. **Next round** Oscherleben, Sep 13.

Reports In Brief

Stefan Mucke landed the German Formula ADAC title with four races to run by winning both races at the Salzburgring. Andre Lotterer bagged two more victories, to bring his tally to 11 from 16 starts in the Formula Junior class.

Andrea Bellichi closed in on the European Renault Spider Trophy when he won at the Hungaroring. He started from pole and led all the way, with Ralf Druckenmuller claiming third, ahead of Julian Westwood. The latter trails Bellichi by 50 points with two rounds to go. Sports car star John Nielsen qualified seventh and ran fourth before retiring.

Bruno Besson won the Formula Renault Eurocup race at the Hungaroring, ahead of Hoover Orsi, with Giuliano Losacco a distant third. Besson now leads the series by 12 points from Briton Matthew Davies, who finished the race in sixth position.



Double winner Robert Lechner (11) gets sideways behind Pierre Kaffer in the first race

AUTOSPORT

TEL: 0181 943 5858
FAX: 0181 943 5850

CLASSIFIED

Advertisements can be supplied by fax or in electronic format, preferably as Macintosh format floppy, Syquest, 3 1/2 or 5 1/4 optical or CD Rom. Other formats please check with us first. For urgent copy we have ISDN: 0181 742 2363, Email: asclass@gnome.digitalpress.co.uk

Telephone advertisements must be pre-paid by credit card at £2.35 (inc vat) per word, minimum charge £47.00 (inc vat) for 20 words. All classified advertising closes Monday 4.30pm subject to space availability. **Pre-paid ads by post** - Cheques or PO with order. **Classified Display** - £27.03 (inc vat) per single column centimetre. Minimum space 4cm £108.10 (inc vat). Any photograph to be included in an advertisement, Black & White or Colour Print. **Appointments** - £31.72 (inc vat) per single column centimetre. Minimum space 6.5cm £206.21 (inc vat). **Box Numbers** - £58.75 (inc vat). **Replies should be addressed to Autosport Advertising, 38-42 Hampton Road, Teddington, Middlesex TW11 0JE.** Autosport reserves the right to refuse or withdraw advertisements at their discretion and does not accept liability for printer's or clerical errors, although every care is taken to avoid mistakes. **Trade Descriptions Act 1968.** Advertisers should pay close attention to the requirements of the Act, particularly regarding accurate descriptions of all goods offered for sale. **Cancellations.** Accepted no later than three weeks prior to copy date and by written confirmation.

Terry Nightingale offers his



Ex-Ray Mallock 1971 Mk11B Formula 3, 1600 Lotus Twin Cam, fully restored to the highest spec. Full FIA papers, many spares, 1996 German and 1997 British Championship winner, eligible German/French/British Championships. Would p/x for pre-71 F2 or Atlantic car.

£12,000

Tel. 01799 524380 or
07050 185577 anytime

71224



40ft Transporter. With additional 3ft of stowage. Can accommodate two large saloon cars. Ample locker space. Comfortable living area with all usual amenities. Sleeps five. 12v and 240v. Three car awning. £26,000 plus VAT. Also (if required) 1994 Leyland Daf 300/75 unit. £16,500 plus VAT. Can be seen at Donington 4th & 5th September.

Tel: 01525 220123.

71896

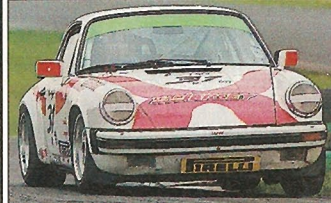

PORSCHE 911 3.2 (PIRELLI PORSCHE CUP CAR CLASS 2)

Highest placed 911 in 1997 Class 2 championship. Not raced this year. Ideal for either Porsche Cup and/or track days. (Road legal). Very safe, reliable car. **£16,995 including wets, drys, etc.** (P.I. system available at extra cost)

Tel: RICHARD TRUE for more info
01534 875017 (home)
0979 715659 (mobile)

70726

HARRIER RACING LTD

are offering for sale

THE 1998 HARRIER FORD GT1 WORKS RACER

£140,000 + vat

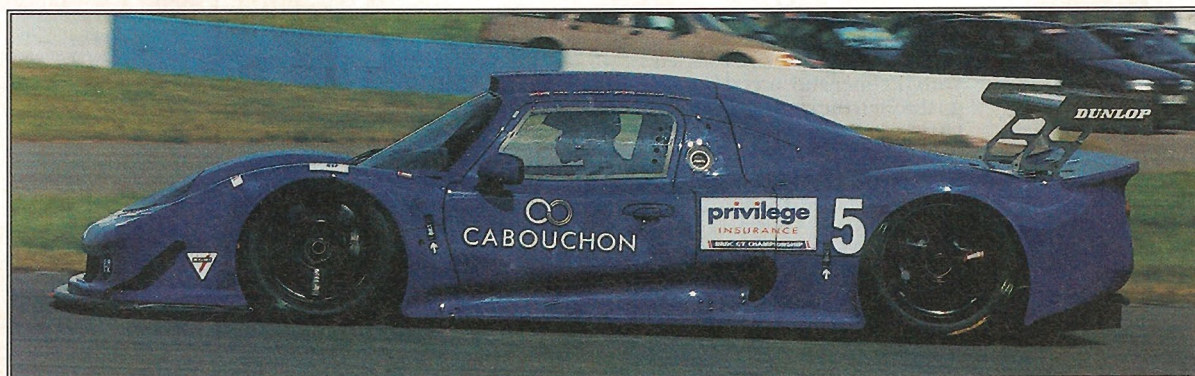

Chris Ward running second in the British Grand Prix round of the BRDC GT Championship, Silverstone July 1998

This Harrier has a Ford Cosworth 2 litre, 600 HP turbo engine prepared by Mountune. The car has competed in only 3 BRDC GT races since being built and has proven an extremely competitive GT1 race car. It is the only 1998 fully race prepared car by the Harrier works factory and comes complete with a Hewland six speed sequential gearbox, a PYE System 3 - data logging package and upgraded carbon brakes. It comes with many spares including 12 wheels, brakes, wings, gear ratios and turbos. This car is eligible for Daytona, Sebring and Le Mans as well as the 1999 BRDC GT Championship.

Please call Lester Ray on 01932 348600

71833

**New Ford Explorers
4x4 Right Hand Drive**



4.0 litre V6, 5speed manual, airconditioned, ABS, powerseats, 2 airbags, alloywheels, cruise control, cassette, tilt steering, power windows/locks/seats. **£14,990**
LIMITED models with 5speed automatic transmission, alarm, Overheadcam 205hp engine, leather seats, centre console, power sunroof, 16" chrome wheels **£16,490**
 Prices include Pre-paid seafreight to Southampton.
 www.OPERT.com
 111 Spring Street, Ramsey, New Jersey 07446 USA

Fred Opert Racing
 Fax: # 1-201-3278222
 Tel: # 1-201-3271111

FOR SALE



X 250

ISRS / WSC / CAN AM
 Available as turn key package.
 800 kilo class, 3.4 Ferrari engine, spares package. Or: Available seats at Le Mans Autumn Cup.
 Also new A/P 7 inch clutch packs, A/P rear air jacks, A/P 6 piston brake calipers, new and used.
01933, 663319 Phone/Fax

71888

CAN-AM

**CAN-AM/WSC
CHEVY KUDZU**

Currently 5th in Can-Am points. 90+% finish rate last 2.5 years. 7th 1998 Daytona 24hr. 4th 1998 Sebring 12 hr. 3rd 1998 Homestead. Driven in 1998 by Lyn St. James and Pete Halsmer. Complete roller & spares, 46ft. FRP gooseneck trailer with awning.

PACKAGE PRICE \$125,000
ASK FOR MIKE MADDEN
Tel: (419) 535 5665 or
Fax: (419) 535 6868
Oh., USA

27268

FORMULA FORD 2000

HISTORIC PALAGER. 1976. Lovingly restored and race prepared to a very high standard. Raced currently in 750 MC/Semsec. Some spares. £6,500 o.n.o. Tel: 01580 860657, 0860 658458. (71895)

FORMULA 3

DALLARA FORMULA 3. With spares, ready to race, and Marcia Formula 3000, less engine, original conditions, transport arranged to UK. Fax: Italy 0039 3099 18819. (27309)

FORMULA RENAULT

**FORMULA RENAULT
SWIFT FR90**

Eligible for BARC Formula Renault, Mono Posto, has also been 2nd overall & class winner at New Brighton Hillclimb. Spares include bodywork, wheels and many tyres.

£4,400 ono
 many p/x road car or motorhome.
 Also no. plates for Subaru owners:
R555JHS + S55WRC
Tel: 0151 604 1141

26802

HILLCLIMB & SPRINT

MGB GT V8. 1976, David Franklins modified road going car, only 54,000 miles, near concours condition. 280 bhp, 5 speed, lsd. £10,750. For full specification please Tel: David on 01275 845226 day or 01275 845515 evenings. North Somerset. (27147)

HISTORIC

WANTED: F1 car suitable for TGP, 1978-85, any condition considered. Your offer. Please fax 0049 6588 992216 or e-mail: rpm@cos.de (71885)

MARCUS DODD'S 1998 MINTEX NATIONAL CHAMPIONSHIP CAR



- Escort RS Cosworth Group A car, NIFMC.
- Full works specification LHD car.
- Available in tarmac or gravel specification.
- Car is in immaculate condition and fully rebuilt, with build and life sheets.
- Please phone or fax for specification and price.
- Seriously for sale.
- Please phone **MARCUS DODD** or **IAN PLUMMER**
Phone (+44) 1202 666060 Fax (+44) 1202 666767

71518

CATERHAM

MATTHEW MARSH'S

Caterham 1400 K Series
 100% winning record 1998

11 STARTS - 11 WINS
 Minister engine
 Engineered by Rat Race Motorsport

£14,500

Tel: 0181 830 5677
07000 334567

In the paddock at Thruxton 6th Sept

71806

CARS FOR SALE



OFFERS FOR SALE

Vauxhall Junior 8 Valve Complete	£4,995
Update Kit for above inc. engine	£7,500
Vauxhall Lotus/Open, new planks less engine	£5,750
Formula First, complete with trailer	£5,250
Formula First, complete with spare wheels	£4,995

**VECTRA VR6 SRI CHALLENGE 1998 SPECIFICATION
FOR SALE OR RENTAL**

Royale RP21 1976 Classic F/F 1600, superb	£7,500
Royale RP26 1979 Classic F/F 1600 with spares	£3,250
Swift FR95 Renault Sport, Solas motor	£0ffers

(NOTE: SOME PRICES PLUS VAT)

CALL FOR STOCK LIST WITH FULL DETAILS OF CARS ON

Phone/Fax: 01480 433280 0860 954238 Mobile

DEALERS FOR VAN DIEMEN, ROYALE, REYNARD, VAUXHALL

FULL BROKERAGE SERVICE AVAILABLE WORLDWIDE

71648

**HOSPITALITY
COACH**

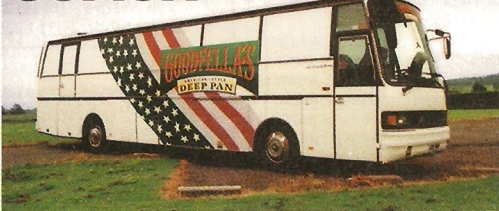

1983 Setra converted to a high standard C/W. H&C water, fridge, cooker, freezer, mains electric hook up and on board w.c. Fully screened VIP area to rear. Full service history, mechanically sound and recently resprayed in white.

FOR FULL DETAILS TEL 01264 738085 PRICE £35,000 ONO

71523

**IF YOU WANT TO
ADVERTISE IN THE
COLOUR GALLERY
PLEASE CALL
0181-943 5858**

FOR SALE

Van Diemen Formula Ford Zetec 97.
 Rolling chassis.

£8,500

Swift Renault Sport 95, chassis.

£1,200

Works Ermolli Renault Sport 97/98. Rolling chassis. (Engine may be available).

£8,500

Migale Zetec '97 Formula Ford. Rolling chassis, ex-Richard Tarling, lap record holder, pole position World Finals.

£9,000 o.n.o.

Tel: 01889 579255/578558
0976 281399

71631

FORMULA FORD

VAN DIEMEN RF90. Professionally prepared & rebuilt. Unused this season, in excellent condition. £6,250 o.n.o. Tel: 01443 209823. (71649)

LAMBORGHINI

**LAMBORGHINI
DIABLO SVR**

This very special limited edition car with chassis No. 007, was the winner of the 1997 Lamborghini Trophy. It has been fully maintained by Lamborghini, and has clocked 6,000 km. It can be viewed at **Donnington** on 4/5/6 September 1998.

**For further details call
John Stevens on
0171 663 6666**

£P.O.A.

71454

RACING SALOONS

ALFA ROMEO 33



170 bhp, Leda Suspension, spares, slicks + wets. Hot match or Autotalia Championship. 1997 newcomer award in Autotalia. Offers around £5,000. Call Geoff on 0498 604456

71527

1996 SEAT IBIZA 2 LITRE 16V

Class Winner & Runner Up overall at Lydden Circuit Semsec 1997. B.R.M., 210 bhp, fully sorted by G. Tech. Ready to race in 1998 season.

Price £9,995

Daytime Tel: 01227 710590
Evening Tel: 01227 711862

71517

VECTRA VR6 SRI CHALLENGE

Front running car, 1998 spec. with fastest lap at Thruxton, freshly rebuilt engine, loads of spares, wheels etc. Sensibly priced for quick sale (will consider rental).

Ring for details

Tel: 01564 205118
Mobile: 07970 940213

71521



PEUGEOT 205 1.6

The quickest all steel 205 there is. All the right parts. Professionally prepared to show standard. Cost £12k in parts alone. Phone for full spec. Suitable for race/rally/hillclimb/sprint. Would clean up in Pagid Championship. Van load of spares available.

£6,995

Will take car/bike, classic or modern in p/x

Tel: (01702) 520121 AFTER 6PM
No dreamers, tyre kickers or canvassers

27317

RACING CARS

RACE CAR CLEARANCE

TIGA SF89. Ex Paul Cope/John Pugsley. Complete with many spares, wheels etc. and excellent trailer. £10,000 as Sports 2000 with Nelson engine, or £12,000 as Castle Combe type GT with demon ultra short stroke Philspeed Pinto all steel dry sump.

MITSUBISHI STARION TURBO. Ex 'Mad' Mike Jones rally car (Tulip, RAC etc.). Originally Prodsports, most recently raced in Combe Handy Gas. Many spares, virtually mechanically a complete car, engine box, axle etc and some Race and Rally spares including tyres (slick, road and knobby) Turbo etc etc. Never a road car, always raced or rallied. Would make good cheap club rally car. £3,000.

CHEVETTE 2600 HSR LOTUS 16V. T/C special sabbon racer. Rebuilt engine. ZF 5 speed box. Jaguar LSD axle. AP vented front brakes. New 15" Revolutions with new Avon slicks. Extensively raced. Combe, Thruxton etc. Ideal for series at Pembrey, Oulton, Knockhill. £3,000.

This is a retirement sale. All cars are near Bristol. I have owned them for many years. Will consider interesting part exchanges (road or race)

**MALCOLM STEVENS
TEL: 01749 860569**

71837

LOTUS ELAN S4. 1970 - HSCC 1997 Standard GT Championship winner. Race prepared and ready to win. The car was completely rebuilt for the '97 season receiving a new chassis, all new suspension, rebuilt engine, gearbox and diff. as well as a rewire. The car has a full roll cage and 13 gallon fuel tanks for endurance races. FIA and HSCC papers. £15,500. Call Steve (W) 01483 426966, (H) 01252 703312. (27291)

LOTUS 23B. 1963, restored Cedric Selzer, many spares, +8 wheels, +16 tyres + enclosed trailer. USS78,000. Request information Fax: (0034) 962 877 291. Spain. (27294)

SLICK 50/BLUE CORAL GOLF GTi MKI CAMPAIGN

Ultimate spec., top 10 car. Fresh engine rebuild, unused wets and many spares etc.

No ACCIDENT DAMAGE ... EVER!

Ready to race.

£4,250 o.n.o.

Home: 0181 399 8908
Work: 01344 864313

71660



EUROCAR V8

Brand new car, built and prepared to latest 98 spec. Currently the only NEW complete car for sale, in white. Immaculate and ready to race.

For further details: (01420) 564041

70806

RALLY CARS

METRO 6R4

Unused (200 miles)

Clubman car 1st registered
1st March 1998

£25,000

**Ian Harrison Rolling Road
Car Tuning Specialist
Accrington**

Tel: 01254 234692

27313

SPECIFICATION OF SUBARU LEGACY J177 TVU - NO PRO/ST1/0115

This car was built new by PRODRIVE in 1992 to full GpN specification and was purchased by us 2 years ago and has since been modified to Clubman GpA specification. **BODY:** Japanese spec WRXRA shell with multi-point cage, Recarro seats, electric fire eater system, Premier bag tank, Kevlar spare wheel holder and finished in white with multi-coloured graphics.

ENGINE: WRXRA engine with solid lifters, GpA large intercooler, Impreza turbo (40 miles only), GpA intake systems, GpA exhaust system, and GpA engine mountings running on Prodrive management system. **TRANSMISSION:** STI clutch cover with HELIX paddle clutch disc, new 5spd straight cut dog box with front LSD and uprated centre viscous coupling and rose jointed quick shift gear lever (cost over £10,000) plate type rear LSD with uprated output shafts.

SUSPENSION/BRAKES: Fully adjustable HI-TEC dampers with remote reservoirs (same as PRO-FLEX), WRXRA brakes with competition pads.

This is a genuine works built car and not to be confused with other "lookalikes", and has never been seriously damaged and is in exceptional condition for a competition car. The car comes complete with 8 spare wheels and some spares.

PRICE: £24,950 ono

For further details contact:

**Charles Smith on
01584 875443**

27066

TOURING CARS

**ANDY ROUSE
RS500 TOURING CAR**

Fully rebuilt, all Group A spec. Air jacks etc., etc. Unraced since rebuilt.

£23,000

Tel: 01189 788997

27311

VINTAGE RACING

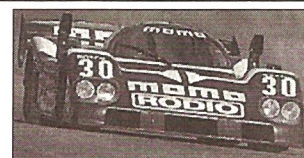

'90 NISSAN GTP

Brabham factory entry. Momo Team '91-'92 Bell/Moretti.

NEW 3-litre twin-turbo V-6. Easy to maintain. Many spares. \$225,000.

**Benton Bryan
(423) 637-6441. TN**

26390

WESTFIELD

WESTFIELD SEIGHT

Post office red, black trim, highback Cobra seats, full carpets, weather gear, full harness belts and RAC bar. Rintec 15" alloys, new Avons and set of new soft compound Yokohama AO32R competition tyres. 3500 V8 John Noble built engine, typhoon cams, holley carb electronic ignition, over 200 bhp recorded on rolling road. Completed September 1996, under 1,000 dry miles, 5 speed, L.S.D. A stunning, electrifying road or track day/hill climb car. In unmarked condition.

£15,950 o.n.o.

incl. spare short motor

**Martin Rigney
Tel: Sheffield (0114) 230 9709
Mobile: 0831 822966**

71525/55/56

To advertise
your
Racing Car
please call
**0181
943 5858**



Simpson Engineering offers for sale:

- ISRS Sportscar Project, honeycomb chassis utilising XJR12 suspension components, complete with new T85 gearbox.....£25,000
- Ferrari 348 4.4 litre V8 engine, developed to produce 500 bhp, complete with management, engine harness and flywheel. Dyno time only.....£17,500
- Ferrari engine, as above having done one race.....£16,500
- Standard Ferrari 348 engine very low mileage, complete, excellent condition.....£8,500
- Chevron B36 split rim sportscar wheels, uprights, do-nuts, FT/FG gear ratios and sundry other Chevron parts.....£P.O.A.

Contact: Robin Smith

Tel: 44-(0)1594-528185/6 Fax: 44-(0)1594-529411

69159

FOR SALE

Group A, Toyota Celica 185. Ex Kankhuen UHA. 1995 tarmac specification. Lightweight shell/latest spec. Engine on Toyota management system. Aluminium suspension/wide track. This car has only completed 3 tarmac rallies from new and is in excellent condition.

**Contact 01846 638653/01868 723220
Fax: 01846 639129**

27316

AWNINGS



HIGH QUALITY TRANSPORTER AWNINGS

FREESTANDING FRAME STRUCTURES

Tel: 01962 736316
FAX: 01962 735098

ALRESFORD TECTONICS
ALUMINIUM & P.V.C. STRUCTURES



Alfred Bull



Transporter Awnings

WOODBRIDGE MEADOWS - GUILDFORD - SURREY GU1 1BB
TEL 01483 561897 • FAX 01483 573448

'SIMPLY THE BEST'

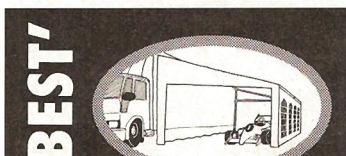

- Quality
- Durability
- Flexibility
- UK and export enquiries welcome

DEANS
TRANSPORTER AWNINGS

Tel: 01942 241399
FAX: 01942 241904

The #1 Best Selling Instant Shelter

E-Z UP INSTANT SHELTERS

- Sets up in 60 seconds
- 4 sizes & 23 colours available
- Optional side walls & accessories
- Durable all-steel double truss design
- Over 300 in stock for next day delivery!

E-Z UP SHELTERS ARE PERFECT FOR:
Boating • Picnics • Camping • Sales Booths • Race Pits
Parties • Sports Events and More!

Authorised Distributor
MAYFLOWER MARQUEES
Unit 6, Penn Street Works, Penn Street, Nr Amersham,
Bucks HP7 0PU

Tel: (Sales) 01494 712131 Fax: 01494 713337

Chequered Flag Awnings

Tele/Fax: 01694 781544 (24 hours)
International agents and exports required
Banners produced with sign writing and graphic services available.



A professional look at a Clubman price
Free Standing specialists. Variety of Uses.

3x3x2.3 £525 4.6x3x2.3 £650 4.6x4.6x2.5 £950

Larger sizes available on request
SPECIAL SPRING OFFER
Free colour scheme with your awning.

68942

BRAKES



HAWK BRAKE

FERRO CARBON DISC PADS

CAMBRIDGE MOTORSPORT LTD.
Caxton Road, Great Gransden, Nr Sandy,
Bedfordshire, SG19 3RH, England
e mail cambridge.motorsport@dial.pipex.com

☎ 01767 677 969 Fax: 01767 677 026

CORNER WEIGHT EQUIPMENT

CORNER WEIGHT SCALES. Intercomp. SW11, just serviced at Millcentre. Quick sale required so only £675 o.n.o. Re-advertised due to time wasters. Tel: 01386 860658. (68501)

COMMUNICATIONS

Professional Communications Headsets



- Aviation quality
- Noise cancelling microphone with spring tension boom mic
- 2 speakers with volume control
- Chrome plated fittings
- Ventilated cushion headpad
- Fully adjustable with positive, customised fit
- Available immediately for Motorola and Kenwood radios

Shenfield Communications
RAIKES LANE, LICHFIELD, STAFFS. WS14 0EJ
TEL: 01543 480855
FAX: 01543 480051

71887

ALARMS

Direct-express
the first name for direct supply at lowest prices!

TOTALLY U.K. LEGAL
cobra RADAR DETECTORS from just **£99**

<http://www.direct-express.co.uk>
Call. 01527.833212.....e:mail..radar@direct-express.co.uk

DRIVE AVAILABLE

DRIVES AVAILABLE

At MPH we have decided that the hire of rally cars is a business in which you can never satisfy everyones needs. So for the 1999 season we have decided to look to one make championships e.g.: Ford KA, Skoda Trophy, Nissan Micra or anything else you may require.

Our intention is to prepare and run cars for any of these championships to individual customer specifications and budgets from our workshops in the North East of England by our fully trained rally technicians.

TEL/FAX: 00 44 (0)1642 711440
WITH YOUR INDIVIDUAL REQUIREMENTS

27113

THE ZIP YOUNG GUNS

GARY PAPPETT MAKES HISTORY IN CLASS 'B' FVJ
'Dices for the Lead' Snetterton
'Fastest Lap of the Race' Thruxton
'On the Podium' Snetterton

THINK OF WHAT WE COULD DO WITH A CLASS 'A' CAR!

Drives Available
in a team dedicated to winning at a realistic budget

ZIP KART
01992 463371
M. Hines

71881

To advertise in Marketplace please call 0181 943 5858

DATA ACQUISITION

P.I. SYSTEMS 2 - Club expert super data analysis software, with beacon. Costs new £3,000. Offers. Tel: 0171 937 6867. (71900)

challenger motorsport

Require the following:
WANTED
Any Pi or Stack or Astralrap Systems or part of

EQUIPMENT
Tel: 01908 560929

71886

P. J. MOTORSPORT
Dashboard and data logging specialist



New and used equipment from stock.
Competitive Prices.
Ring John Knpton: 01283 820625



71046

ENGINES

SCAT V4 ALUMINIUM RALLY ENGINE. 280 bhp, 260 lbs, FT, dry sumped, totally complete. Geoff 01527 575355 anytime. (27182)

CARRILLO

Finest quality American connecting rods stocked for many different cars and bikes - Specials made to order.

- Well equipped engine test facilities for hire - up to 800 BHP
- DYNAMIC BALANCING;
- SERVICING & SALE OF DYNAMOMETERS
- Export Orders Welcome.



Arisdale House, Arisdale Ave, S. Ockendon, Essex, RM15 5AS.
Tel: 01708-857108 Fax: 01708-855917

48865

EXHAUSTS

ROLLCENTRE EXHAUST SYSTEMS. Specialist exhaust manufacture, silencing noise checks. Contact David Short on 01480 463104, fax: 01480 494547, e-mail: rollcentre@aol.com (68087)

EXHAUST SYSTEMS

BTB EXHAUSTS. Manufacturers of motorsport manifolds and systems. Mandrel tube bending, free noise testing. ISO 9002. Tel: 01327 261797, fax: 01327 263577. (68744)

GEARBOXES

BPA Engineering

SPECIALIST TRANSMISSION SERVICES

Hewland Build & Rebuild
New & S/H Spares

*Gearboxes & Axles Rebuilt
Gears & Spares Manufactured*

CONTACT: ANDREW BRITTEN
TEL: 01256 895757
FAX: 01256 895151

106362

HEWLAND

Sales and Service

- ★ Rebuilds, Repairs and Modifications
- ★ All gearboxes – current and historic
- ★ Prototype design and development projects

Blueprint assembly is our standard

pds racing

153 BARNSELY ROAD
HEMSWORTH, PONTEFRAC
WEST YORKSHIRE WF9 4PQ
Tel/Fax: (0977) 611928 028557

PowerHaus II

PORSCHE GEAR CENTRAL

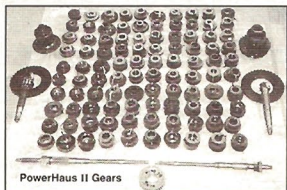

COMPLETE SELECTION OF CLOSE RATIO GEARS, SPECIAL MAINSHAFTS (904, G-50, ETC.), RING AND PINIONS AND LIMITED SLIP AND LOCKED DIFFERENTIALS FOR ALL STREET AND RACE PORSCHEs 1964 TO 1998

PowerHaus II

PHONE 515.469.3063 FAX 515.469.6404
ALL MAJOR CREDIT CARDS ACCEPTED • WEBSITE SOON
1100 University Manor Suite 15 • Fairfield, Iowa 52556 USA

IN-CAR VIDEO

IN-CAR CAMERA & VIDEO RECORDER

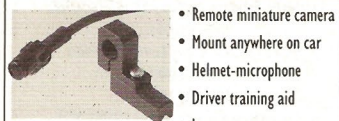

- Remote miniature camera
- Mount anywhere on car
- Helmet-microphone
- Driver training aid
- Impress sponsors

- Superb quality picture
- Integral 4" colour screen
- High quality TV playback
- Playback at track
- Race proven design



Radical Motorsport
27 St. Davids Square,
Peterborough PE1 5QA
01733 344198
www.radicalms.co.uk

INSURANCE

Competition Car Insurance

Insurance for competitors by competitors

- Road use
 - On event accident
 - Storage & Transit
 - Service vehicles including spares & tools
 - Personal Injury
- TEL: 0115 941 5255
FAX: 0115 941 5215
For further information contact
Richard Egger or Tracey Saucedo

D.C.

Special & High Risk Motorsport Insurances

THE ONLY WORLDWIDE & EXCLUSIVE SPECIALISTS IN PHYSICAL 'ON-TRACK' CRASH DAMAGE FOR CARS, BOATS & BIKES

There is someone near you ready and able to assist

Offices: Belgium • Switzerland • Holland • Canada • USA

Agents: Italy • Australia • Japan

Belgium: Tel 32.3/605.0433 Fax 32.3/605.2045

USA: Tel 1.888/322.3544 Fax 1.317/329.9996

Canada: Tel 1.888/322.3544 Fax 1.905/403.8760

Holland: Tel/Fax 31.33/494.8996

GSM 31.654/314533

Switzerland: Tel 41.71/644.8022 Fax 41.71/644.8030

LAPTIMING EQUIPMENT

ROLLCENTRE LT32 LAPTIMER. The most reliable, affordable, simple and easy to fit Lap Timer available. It will work with Single seaters, Saloons, Karts, and Bikes. Instant Lap time as you do it, 32 Lap recall afterwards. 30 day money back guarantee if not satisfied. 1 years warranty. Rollcentre 01480 464052, Fax 01480 494547, E mail Rollcentre@aol.com. (68086)

KARTING

BUCKMORE PARK

INTERNATIONAL OUTDOOR KART CIRCUIT



Six-hour Autumn Hire Pro-kart Team Enduro

"I started my career at Buckmore Park and I still rate it as the finest karting circuit in the country."

– Johnny Herbert,
British Grand Prix winner

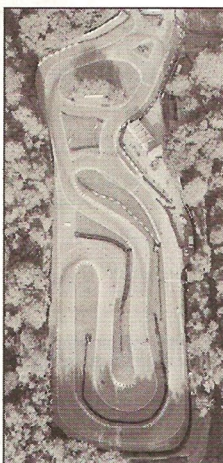

Sunday
27th September 1998

- 75mph Twin hire Pro-karts.
- Timed qualifying.
- Mechanical and medical back-up.
- Computerised lap scoring.
- Electronic scoreboard and CCTV monitoring.
- Helmet, gloves and suits provided.
- Tactical fuel and driver changes.
- Three to ten members per team.
- Wet weather tyres and oversuits.
- Superb trophies and special prizes.

Entry Fee: £425 per team.

Contact: Buckmore Park Kart Club Ltd.
Buckmore Park Kart Circuit, Maidstone Road, Chatham, Kent ME5 9QG.
www.buckmore.co.uk E-mail: sales@buckmore.co.uk

Tel: 01634 201562 Fax: 01634 686104

LIVERIES

STICKERS

Suppliers to Racing Teams, Event Organisers, Sponsors, Competitors, Magazines, Trains and Planes

Ring **Robin Stretton**

Boost

Orchard Lane, Alton, Hampshire GU34 1DP
01420 542722 Fax 542999

MEMORABILIA

GRAND PRIX TOPGEAR
FOR F1 COLLECTORS ITEMS

WE BUY AND SELL ORIGINAL TEAM ITEMS ORIGINAL BODY PARTS, WHEELS, TEAM CLOTHING, RACE SUITS, HELMETS, SIGNED ITEMS, EVEN COMPLETE F1 CARS

HUGE STOCK OF DRIVER SIGNED PHOTOS, CAPS, AND OTHER INTERESTING ITEMS

WE SELL THE REAL THING!
www.topgear.org
Visit our showroom weekdays – please phone first.
Open Saturdays 10.30 till 3pm

BROCHURE REQUEST LINE: (UK ONLY)
0897 16 11 55
Call cost £1.50 covers cost of brochure and postage

GRAND PRIX TOPGEAR
THE OLD MILL, MILL END, STANFORD, HERTS SG11 1LR
Tel: (0)7000 553949 • Fax: (0)7000 727 929
E-mail: fi@topgear.org

MINI-LITE WHEELS

TECH-DEL Ltd.

manufacturer of the
MINILITE WHEEL
25b Chertsey Road
Chobam, Surrey GU24 8PD, England
Tel: +44 (0) 1276 855502
Fax: +44 (0) 1276 857534



PAINTING

GILLES VILLENEUVE, FERRARI 126 C2

Original oil painting by renowned artist
Arthur Benjamins
Size: 36" x 27"
Offers in excess
£2,500

PHONE: 01227 458553
or email: stan@redpen.co.uk

PARTS

CITROEN 2CV

IF YOU'VE GOT THE CAR
WE'VE GOT THE PARTS

PHONE FOR FREE
CATALOGUE

ECAS 2CV PARTS

TEL: 01785 282882
FAX: 01785 282883

PUBLICATIONS

COLLECTORS CARBOOKS. Specialists in out of print motoring literature. We can supply any new book in print and we also have the widest range in Europe of out of print motoring and mtor racing books on display! Worldwide mail order. Free book search. Close to junction 12 to 13 off the M1. Free car parking behind shop. Open Monday to Saturday 10am to 5pm. Tel: 01525 290088. Fax: 01525 290044. 14 Bedford Street, Woburn, Beds MK17 9QB.

RACING SCHOOLS

Jim Russell Racing Drivers School U.K. Ltd.

Start on Pole!

Choose the International Racing Drivers Course that leads the field

Available in:

- Formula Vauxhall Juniors •
- Vectra Super Touring Cars •
- Caterham Sports Cars

Course Dates:

10 – 15 August
7 – 12 September 29 September – 4 October
2 – 8 November



For details phone:
01332 811430



RACEWEAR

UK IMPORTER



Call us NOW with your requirements. Sport II, M2 RS, SR Pro, Mag 4, M3, XFM-1, Mag R, Mag 5, Vortex, helmet bags and accessories.

demon tweeks
01978 664466

ROLLCAGES

ROLLCENTRE ROLL CAGES. Off the shelf cages or custom fit. Contact Peter on 01480 464052, fax: 01480 494547, or e-mail: rollcentre@aol.com (43287)



Fully fitted Roll Cage Kits available from stock: in either CDS 5-M or T45
Ford - Escort
Cosworth & RS2000
Mitsubishi - Lancer Evo 3 + 4 + 5
Vauxhall - Astra and Corsa
Peugeot - 205/106/306
Skoda - Felicia
Nissan Sunny
VW - Golf
Mini
 Prices from £295

BARRO CLOSE, DRAYTON FIELDS, DRAYTON, NORTHANTS, NN11 5BY 01480 494547 Fax: 01480 494548

SPARES & ACCESSORIES



PTFE ProGold

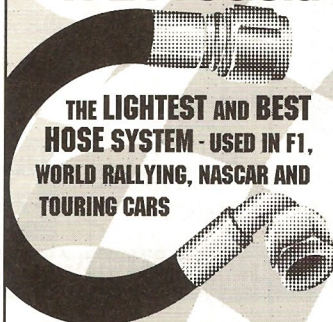

THE LIGHTEST AND BEST HOSE SYSTEM - USED IN F1, WORLD RALLYING, NASCAR AND TOURING CARS

FREE BROCHURE & STOCKIST CALL 44(0)1753 552266 EXT 225



RACEWEAR & EMBROIDERY
OUR EQUIPMENT COULD SAVE YOUR LIFE

TOE TO HEAD PROTECTION

NOMEX BOOTSfrom £75
 NOMEX GLOVESfrom £35
 NOMEX GLAVAfrom £16
 PROBAN SUITfrom £50
 FIA NOMEX 2 LAYER SUITSfrom £250

ALL PRICES + VAT

HELMETS

Arai BELL SHOEI SIMPSON TOP TEK

FROM £83 - ZERO RATES
 DON'T SKIMP ON YOUR LIFE INSURANCE!
 SEND FOR OUR FULL PRICE LIST
 JAYBRAND RACEWEAR, 363 DOGSTHORPE ROAD, PETERBOROUGH PE1 3RD
 TEL: 01733 568247 FAX: 01733 568249

GRAND PRIX RACEWEAR

First for racewear
No.1 in Europe for Helmets

Arai BELL SHOEI SIMPSON stand21 sparco

POWER ROAD • CHISWICK • LONDON W4 5PY

0181 987 5500



1ST CHOICE FOR PERFORMANCE HOSE

Full range of coolant, fuel, turbo, vacuum, performance hose kits & lightweight kart hose* available in tough temperature resistant silicone. Various colours available.

demon tweeks
01978 664466

MasterCard **Trident** VISA
 Racing Supplies

AN/NAS Bolts, Washers, Locknuts, K Nuts, Anchor Nuts
 Heatshield Materials, Blue Silicon Water Hoses
 Versachem Adhesives & Sealants
 Silicon & Neoprene Ducting, Rod Ends, Instruments
 Mintex, Advance Tapes, Camloc, Dzus, Würth
 Alcon, Tilton, Earls

TEL: 01327 857822 FAX: 01327 858096
 Unit 31, Silverstone Circuit, Towcester, Northants NN12 8TN
<http://www.racecar.co.uk/trident>

Graham Goode Racing

Ford Cosworth & Subaru Impreza Specialists
 • Performance is everything •

SUPPLIERS TO MANY TOP RACE AND RALLY TEAMS THROUGHOUT THE WORLD

SEND FOR OUR COSWORTH OR SUBARU BROCHURE. £3.00 INC P+P OR FOR FURTHER INFORMATION
 MAIL ORDER 24 HOUR WORLDWIDE DESPATCH INT. +44 116 244 0080

VIEW OUR WEBSITE AT <http://www.grahamgoode.com>

Visit our purpose built complex at: Lutterworth Road Leicester England LE2 8PH (just off M1 junc. 21) Fax: 0116 244 0140 E-mail: sales@grahamgoode.com

TORQUE TO THE PROFESSIONALS 0116 244 0080



Unit 12, Isabel House, 46 Victoria Road, Surbiton, Surrey, KT6 4JL
 Tel: 0181 390 8076 Fax: 0181 390 4402

Automotive Division of John Handley (Bearings) Ltd

APPROVED DISTRIBUTORS FOR 'ROSEJOINT'
 BEARINGS DELIVERIES - EX STOCK



STOCKISTS OF ROSEJOINT® BEARINGS, ALSO LOCKNUTS, SPACERS AND DUSTSEALS



RACEPARTS (UK) LTD

Unit 3, Rockfort Industrial Estate, Wallingford, Oxon OX10 9DA
 Tel: +44(0) 1491 837740/837142 Fax: +44(0) 1491 836689 E-Mail: sales@raceparts.co.uk

Our Racetech Products Include: Quick release steering wheel couplings and steering wheels - Electrical & Mechanical instruments - Electronic tachometers - Adjustable brake balance bar assemblies - Race mirrors - Thermal paint kits - Suspension springs - Refuelling eqpt.

Official distributors for: CASTROL SRF - Racing Brake Fluid
 ADA PRODUCTS - Corner weight gauges, Camber castor guage
 AEROQUIP - Hose & Fittings : SYMETRICS - Dry Break Couplings
 SAENZ - Connecting Rods : HEWLAND - Gearboxes, Ratios & Spares GKN - CV Joints & Boots : MOLLART & APEX - Universal Joints SUPERTRAPP - Silencers : NMB - Rod Ends & Spherical Bearings FERODO - Brake Pads : AP - Brakes & Clutches : DZUS - Fasteners VARLEY - Batteries : SERCK - Oil Coolers : LZEL - Luminescence

Worldwide Export Service



MARDI GRAS MOTORSPORT
Saloon Car Preparation

DISTRIBUTORS AND AGENTS FOR:

	DMS technologies RACING BATTERIES	
		
		
		
		

Contact Martin Sharpe or Dick Richards
Unit 9/39, Silverstone Circuit, Towcester, Northampton NN12 8TL
Tel/Fax 01327 858006



Racer's Hardware

SOLE UK AGENT FOR AURORA RACING BEARINGS

ALSO:

COIL SPRINGS * AVO SHOCKS * WELLER WHEELS * OUTLAW ALUMINIUM CALIPERS * BRAKE PROP. VALES & BALANCE BARS * TILTON MASTERS CYLINDER KITS * REMOTE RESERVOIRS * BRAIDED HOSE & FITTINGS * ELLIOT, AUTOMETER, MURPHY RACETECH & TIM TACHOS & GAUGES * QUICK RELEASE S/WHEELS (13"/15"/17") * AIR CRAFT SWITCHES * TOTAL SEAT BELTS * SIMPSON & MORE

CALL FOR FREE CATALOGUE

RAPID MAIL ORDER
TEL (01733) 211311/211258 FAX (01733) 211258

• BOSS • CALVIN KLEIN • DOLCE & GABBANA •

WORLDWIDE CLOTHING LIMITED

WORLDWIDE HOUSE • BROAD ST. • RAMSGATE • KENT
CT11 1NQ • TEL 01843 588954 • FAX 01843 853947
7 DAYS A WEEK 8am to 11pm

Designer...

Pullovers, Sports Shirts, Jeans, Socks, Ties, Silk Underwear, Swimming Shorts, Jackets, Kate Winslet and Leonardo DiCaprio T-Shirts, 7 Choices of logo from Titanic, Baseball Caps, Leather Belts, Gucci, Benneton, Adidas, Nike, Timberland, Dolce & Gabbana, Tommy Hilfiger, Reebok, Lacoste, Nautica, Filia, Versace, Calvin Klein, Armani, Hugo Boss, Ralph Lauren and lots more!

ALL SIZES S/M/L/XL/XXL/XXXL

Telephone or Fax your address for a FREE colour brochure

BUY AT WHOLESALE PRICES! **PRICES START AT £10.00** **FREE Postage & Packaging**

• GUCCI • VERSACE • ARMANI • TOMMY HILFIGER • ADIDAS • FILA • LACOSTE • NAUTICA • NIKE • HUGO • REEBOK • TIMBERLAND • BOSS • CALVIN KLEIN • DOLCE & GABBANA •

SPONSORSHIP

CONGRATULATIONS TO JORDAN GRAND PRIX (HOPE THE BOOK HELPED!)

Based on years of experience finding money for young, unknown, sometimes unsuccessful drivers, this simple system saves time, money and heartache. It gets fast results without cold-calling or large amounts of wasted proposal preparation – perfect for the amateur sponsorship hunter.

The secret? It works because we understand the problem of getting noticed in a swamped sponsorship market, when you have so little time available, and perhaps not very much in the way of a racing background. Our basic assumptions are a) you want to drive a race car, b) you're not wealthy or connected. No gimmicks, no nonsense, just straight talk, hard facts and good, quick results.

Sounds too good to be true? It might, but this guide is already used by racers in FF, FRS, F3, and even F1. Sounds a bit like a con? It might, but we've never once had a guide returned, and we also put money back into racing to prove our good faith – you can find our logos on cars in FF and F3.

So why keep watching when you could be out there racing?

Start your career today at the Special Jordan Celebration price of just £14.99 including P+P!!

Send name, address & cheque for £14.99 to:
SportsWorks Publishing
Suite 525/J, 29-30 Warwick Street, London W1R 5RD, UK

CAR TRANSPORTER
TRAILER SPECIALISTS.

BRIAN JAMES TRAILERS

Est. 1979

Quality, value for money, choice and customer service really do count at Brian James Trailers.



Auto Trailer, a remarkable automatic tilt-bed system revolutionises trailer loading. Designed for ultimate ease of use.



Race Shuttle, unique fully enclosed GRP moulded body system keeps a large range of cars clean and dry.

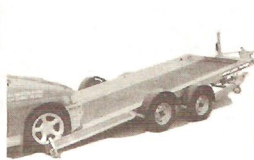

AD Series Evolution, excellent loading performance from hydraulic tilt operation. High quality and versatile.



A-Series, quality design with low centre of gravity and excellent towing stability. Ready for many years of service.



MINNO, designed to transport small race and classic cars. Light and easy to handle. Can be stored in your garage.



CLUB Tilt-bed, light duty tilt-bed car transporter trailer. Includes full deck and spare wheel in an unrivalled value package.

Brian James Trailers .Silverstone area.

Tel : (01327) 260733

Fax : (01327) 262438

DASTLE RACEBOX

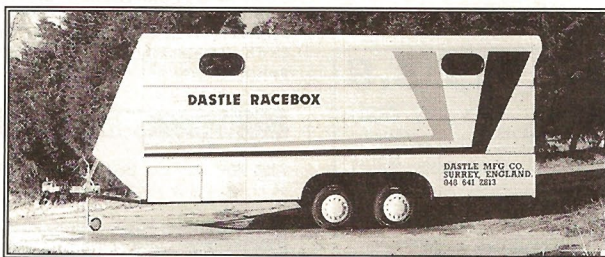

- Lightweight Van Trailer/Working Facility
- From 12 to 20 ft floor length versions
- Worktop, cupboards and storage shelves
- Side access door

For your racing to realise its full potential, start with the right equipment. Talk to us about The Dastle Racebox.

Call or write for details:

Guildford, Surrey GU5 9QQ. Tel/Fax: (01483) 202813

<http://www.racecar.co.uk/dastle>

58418

H.G.C.H.

AMERICAN MOTOR HOME HIRE



- ◆ Available for Motor Racing and Hospitality
- ◆ 8m x 5m awning available

For further details

Tel/Fax: 0161 456 4122

or 0385 111031

70685

moose trailers



Manufacturers of the Moose Workstation & Clubman Trailers. Prices start from £4,900 + VAT for the clubman - 2,600kg gross. Workstation prices dependent on Bespoke requirements. Quotations available on application.

For full details on both the Clubman and Workstation trailers, please call **0151 647 9100**

68950

1988 Mercedes 811D 7.5T (non-HGV) with nicely built Luton body by W. H. Bence. Only 51,082 kms (31,600mils). Used by Team Gillard for Euro/World karting Championships. Repainted '97, new tyres, towbar, nice living area with fridge, stove, water, plenty of cupboards, 3 seater table and 2 bunks over cab. Rear portion configured as mobile workshop. Very suitable for independent racer at home or abroad. Good condition.

£9,250 + VAT

CALL MR TURNER

TEL: 01451 861042/FAX: 861044

71174



40ft Wilson double-deck trailer. Two stage tail lift freshly painted yellow and black. Will take six Caterhams or single seaters. Available with Alfred Bull awning (needs small repairs). MOT to April '99.

£14,000

Phone Clive 01327 858877

71178

PRG
Engineering

TRAILER TECHNOLOGY



Millennium and Eurolite Series

Superior by design all integral chassis, tilt and fixed bed car transporters giving excellent all-round performance.

Race Hauler



Quality fully enclosed car transporters, available in many sizes.

WE MANUFACTURE ALL TYPES OF CAR TRANSPORTERS

Phone for full details

TEL (01270) 812402 FAX (01270) 811293

26423



AMERICAN MOTOR HOMES DIRECT SALES + HIRE

Hire a six berth motor home from only £100 per day (01362) 858544 Chris (Sales) (01494) 564357 Graham (Hire)

70586

RACE TRANSPORTERS

SPECIALIST VEHICLES

INDIVIDUALLY DESIGNED RACE CAR & MOTOR CYCLE TRANSPORTERS, SUPPORT UNITS, HOSPITALITY UNITS AND EVENT TRAILERS.





REFURBS AND REFITS ALSO AVAILABLE

BUILT BY THE BEST - FOR THE BEST

TELEPHONE

01904 431612

BROOKLANDS, OUTGANG LANE, OSBALDWICK, YORK, YO19 5UP FACSIMILE: 01904 431419

- FORMULA ONE • MOTORCYCLES • TOURING CARS • F3000 • SUPER BIKES • WORLD RALLY SERIES • G.T. • FORMULA ONE • MOTORCYCLES • TOURING CARS • F3000 • SUPER BIKES • WORLD RALLY SERIES • G.T. • FORMULA ONE • MOTORCYCLES • TOURING CARS • F3000 • SUPER BIKES • WORLD RALLY SERIES

71015

TRAILERS & TRANSPORTERS

MERCEDES 307D ALUMINIUM BOX TYPE TRANSPORTER. Carries 1 car, 1987, MoT & tax February 99, new engine, 5 speed, awning 240V facilities. Expansion forces sale. £3,295 o.n.o. Tel: 0850 656543 or 01977 612099. (27208)

FOR SALE - CANCELLED ORDER. Covered trailer 3,500kg gross. Over wheels, beaver, twin axle, 16ft x 7ft6", bflg, full ramp tail, aluminium tread plate, solid nose and canvas covered body. £3,000 + VAT. Tel: 0151 647 9100. (27177)

BOX TRAILER. Takes saloon plus sleeps 3 people, heating, cooking etc. Need's to go behind lorry or motorhome. Currently towed by Dave Longhurst. £3,000. Phone: 01243 586107, mobile: 0860 587363. (27199)

*To advertise in
Marketplace please call
0181 943 5858*

TEST DAY



GENERAL PRACTICE

*Every Wednesday Morning
£55.00.*

*Please phone to book
01455 842931*

*Off the A47,
between Leicester & Hinckley.*

WEB SITES

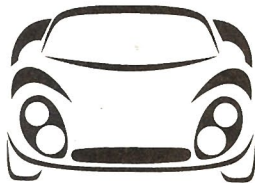

racecar

Dauer 962LM - Fastest Road Car in the World?

Probably ...

Go to www.racecar.co.uk/dauer

Telephone + 44 (0) 1483 203781 Fax + 44 (0) 1483 203261

WHEELS & TYRES

FOR ALL YOUR



RACING TYRES
Inc. ACB 10 Formula Ford
Contact 62806

BMTR LTD.

**Tel: 0121 331 1122
Fax: 0121 331 1144**

WALTHAM SERVICES

FOR



**COMPETITION TYRES
WELLER &
COMPOMOTIVE WHEELS**

**TEL: 01245 491702
0860 255312
FAX: 01245 344172**

WIRING & TELEMETRY

(longevity) n. long life 1. lasting
or extending over a long time
2. well established.

**Longus
Aevum**

Tony James is the longest established wiring harness manufacturer dedicated to motor sport

**TONY JAMES
COMPONENT WIRING LTD**

E10 Speedwell Way · Harleston Industrial Estate ·
Harleston · Norfolk IP20 9EH · England
Tel: 01379 854485 · Fax: 01379 852718

PUBLICATIONS

COLLECTORS CARBOOKS. Specialists in out of print motoring literature. We can supply any new book in print and we also have the widest range in Europe of out of print motoring and motor racing books on display! Worldwide mail order. Free book search. Close to junction 12 to 13 off the M1. Free car parking behind shop. Open Monday to Saturday 10am to 5pm. Tel: 01525 290088. Fax: 01525 290044. 14 Bedford Street, Woburn, Beds MK17 9QB. (27168)

SPORTS & PERFORMANCE

BIZZARINI

BIZZARRINI P538. 'Ex Giotto'. Tel: France 33 4 92 38 04 11, fax: 33 45 92 38 04 12. (26983)

BMW

BMW 635 CSI HIGHLINE. 1989 G, Zinnobar red/Lotus white leather. Switchable auto, fDsh, 92,000 miles, beautiful condition. £10,800 o.n.o. Tel: 0181 455 4824 H, or 0802 804604 mobile. (27153)

BMW M5 3.8

(K) reg, Avus blue/grey cloth. E/s - Esr, NRMB/sus., w/alloys. OBC, a/con, average miles, fBMWsh warranty. Excellent condition.

£18,995

**Tel: 0191 422 4200
0850 944465**

CATERHAM



**Woodcote Sports Cars
Caterham/Lotus 7 Specialist**

1995 5 speed live 1700, BRG/alloy, cycle wings £11,950
1997 5 speed 1600, BRG/yellow £15,500
1997 4 speed 1600, red/alloy £12,250
1997 5 speed live, 1600, red/alloy £12,750
1994 5 speed 2.0 Vauxhall, BRG/yellow £16,950
1998 4 speed 1700, red wings £14,000
1993 5 speed 1700, anniversary green £14,250
1996 5 speed 1700, anniversary green £16,000

**PLUS MORE IN STOCK - WANTED: ANY 7
7 Kits built to your specification
Located 5 minutes from Caterham
Tel/Fax: 0181 641 9897 · Mobile: 0831 240733
www.Racecar.co.uk/Woodcote**

CATERHAM 2.0 VAUXHALL. 1996 (P), BRG/yellow, 1600 miles from new. Leather trim, wide track suspension, many other extras. £17,500. Phone: 01628 482003. (71908)

CATERHAM SEVENS. Authorised Centre for NEW AND PRE-OWNED CARS. Stock constantly changing. For SERVICE, REPAIRS, PARTS etc. call CLASSIC CARRIAGE CO. 01455 841616. (25468)

CATERHAM SUPER 7 1700. 155 bhp, G reg, pearl yellow, cycle wings, prisoner alloys, leather, chrome rollbar, high vis weather gear. £12,500. Tel: 01256 770575. Private. (27249)

SUPER 7

2.0 litre turbo 240+ bhp. Unique factory built, every go faster, safety & comfort option. Ideal track day & road car. 4,000 miles only. Blindingly fast with no temperament.

£22,000

Tel: 01481 720850

EXOTIC SUPERCAR



**THE WORLD'S MOST
EXOTIC SUPERCAR
McLAREN F1**

Powered by a BMW V-12 engine, 627 bhp at 7,400 rpm, and more than 479 ft lbs of torque at 4,000-7,000 rpm. At 240 mph, the McLaren F1 is officially the world's fastest road car. Better acceleration over 130 mph than a Formula 1 car. Ask for pre-owned cars.

Contact: Joerg Schaefer
Tel: 49 171 614 1044 mobile
Fax: 49 6126 59640
in Germany

FERRARI

FERRARI 355 F1 GTS. 1998, LHD, perfect. Tel: France 33 612 455 218. Ferrari 355 Spyder. LHD, 1997, perfect. Tel: France 33 612 455 218. (26976)

FORD

FORD GT40. Race car, 1965. Tel: France 33 4 92 38 04 11, fax: 33 4 92 38 04 12. (26979)

FORD REPLICA



FORD GT40 MK1

1974 N reg, by GTD Developments. Professionally built with attention to detail, rosso, black leather, 1,500 miles only. A/C, 5.0 ltr SVO GT40 engine, 300 hp, ap clutch, 4 point harness. Original smiths instruments. Wide BRM 17" wheels and tyres (15" also available). Fabulous looking car.

£26,950

Tel: (01590) 641212 or (0468) 803485 Hampshire

LAMBORGHINI

LAMBORGHINI LM 002. Race car, Paris Dakar. 300,000FF. Tel: Lux 352 45 38 20. (26978)

LANCIA

WALKERS

FACTORY APPOINTED INTEGRALE SPECIALISTS FOR UK

96 N Ferrari 355 GTS, rosso/nero, LHD	£67,500
New Evo 'Martini 6', delivery miles	£20,000
92 J Evo 'Club Italia', no. 4 of 15	£27,000
94 L Evo Kat, Monza red/alcantara	£23,500
94 L Evo Kat, white/beige alcantara	£23,500
94 L Evo Kat, pearl white/blue leather	£19,995
92 K Evo, met. black/sage alcantara	£17,000
92 K Evo, Monza red/leather	£17,000
92 J Evo, white, sage/alcantara	£17,000
92 K Evo, met. black/leather	£16,000
92 J Evo, Monza red	£16,000
92 J Evo, met. black/alcantara	£15,000
91 Evo, Monza red, big seats	£14,000
90 F 16v, Winner red/alcantara	£9,995
89 F 16v, met. black/alcantara	£9,500
775 Lancia Beta Monte Carlo	£6,995

Prices include 12 months road fund
Warranty & Breakdown Cover - Fully serviced
<http://www.walkers-garage.co.uk>



**NORTHALLERTON
01609 777221**

LANCIA STRATOS STREET VERSION. Yellow, 5,000 km only. Perfect original, LHD. Tel: Belgium 32 2 215 16 99 or 32 75 819 820, fax: 32 2 215 16 69. (26974)

LEFT HAND DRIVE

LHD - BEST PRICES IN BELGIUM. Mercedes/Porsche 966/Boxter/CLK/SLK. RHD Rovers. Tel: 0032 652 1418 or mobile: 0032 7546 1418, fax: 0032 3 324 5955. (27176)

IMPORTS FROM JAPAN

JAPANESE CARS & SPARES FROM JAPAN

We supply Race/Rally and high performance street cars from Japan
New models are also available for first delivery in your country

TOYOTA ~ NISSAN ~ HONDA
MITSUBISHI ~ SUBARU ~ MAZDA

Tel: 81 3 3465 5798 Fax: 81 3 3466 6234
Mobile: 81 8 0655 1174

CONTACT: T. HORI ~ DELTA POINT CO. LTD.

For more information at

<http://www1.tobi.com/deltapoint/>

71889/3538/40/42/44/46

MASERATI

MASERATI V8 REBODY 450 5. 100% alloy, 340 CV, RHD, Borrani wheels. Tel: France 33 4 92 38 04 11, fax: 33 4 92 38 04 12. (26981)

PORSCHE

PORSCHE 928 S4 GTS STROSEK. LHD, 95/96 European Championship winning car, ready to race. Phone for full spec. £18,000. Tel: W 07000 9911911, H 0121 686 1865. (27197)

PORSCHE 959 GR B. 1985, 400 CV, silver. Fax: France 33 1 47 45 76 59. (26980)

PORSCHE GT2 993. 1997, 9,000km, left hand drive, Bugatti blue with black/grey leather interior. A/c. 480 bhp. EPOA. Tel: 0181 209 0481, 0836 560300. No canvassers. Private Sale. (27146)

REPLICA FORD

RS200 REPLICA

Professionally built by Mercury Motorsport. Bills for parts exceeding £26,000. Metallic Blue, 17" wheels with new tyres, leather interior, CD player and new Cosworth engine.

£20,000 ovno

Tel: 01245 400 890
Mobile: 0797 0678 776

27112/262/33/34/35

SUBARU

H.D.C. SUBARU

Suppliers of new & used spares for Legacy/Impreza. Standard/modified.

Tel: 01422 846868
Fax: 01706 812072

Specialising in Subaru's for over 14 years

27226/34/35/36/37

SALOONS

HUMPHREY'S & FOULKES

Importers for Mitsubishi EVO5's and Subaru WRX for 15 years.

For best prices
Tel: 01686 625316
Fax: 01686 622192

27131/235/363/738

VENTURI

VENTURI 400 GT TROPHY. LHD, number 34 of 50 produced. Road registered, brand new, never used. 400 bhp, 980 kg. Awesome performance, quicker than any Ferrari!! £49,500. Tel: 0181 209 0481 or 0836 560300. N/C. (27043)

WESTFIELD

WESTFIELD SEIGHT

Post office red, black trim, highback Cobra seats, full carpets, weather gear, full harness belts and RAC bar. Rimec 15" alloys, new Avons and set of new soft compound Yokohama AO32R competition tyres. 3500 V8 John Noble built engine, typhoon cams, holley carb electronic ignition, over 200 bhp recorded on rolling road. Completed September 1996, under 1,000 dry miles, 5 speed, L.S.D. A stunning, electrifying road or track day/hill climb car. In unmarked condition.

£15,950 o.n.o.
incl. spare short motor
Martin Rigney
Tel: Sheffield (0114) 230 9709
Mobile: 0831 822966

71526/95/96

SPORTS & CLASSICS

A

ALFA ROMEO ORIGINAL PININFARINA. Canvas softtops or famous Haartz 'Stayfast' canvas. Crafted by original supplier to Alfa in Italy. Also original material seat covers for Alfas from 1947-1996. Concours correct vinyl or cloth, or a much nicer than original, vat dyed leather on request. Shipped direct from Italy, no customs duty on importation. Call USA office to arrange shipping. Re-Originals - Tel: 281 807 1945, fax: 807 1946. (26938)

ALFA ROMEO SPIDER 2.0i. LHD, 1986, 73,000 miles, red, black leather interior. Excellent car. £6,250. Tel: 0171 724 2320. (27310)

ASTON MARTIN VANTAGE VOLANTE. 1988, white with black mohair hood. Magnolia trim piped with black. X pack, left hand drive, 1 owner, 4,000 miles, FSH, concours condition. EPOA. Also left hand drive Lagonda 1986, 20,000n white, as new. EPOA. Also LHD Virage, factory 6.3 conversion, 500 bhp, 5 speed, wide body, black/black leather, 12,000 km. £65,000. Tel: 0181 209 0481 or 0836 560300. (27045)

AUSTIN HEALEY 3000. 2 seater, overdrive, wires, ice blue, hide seats, beautiful condition, any trial. £15,950. Tel: 0116 232 1779, eves: 01332 843016. (27303)

BIG HEALEY RESTORATIONS

All aspects of Austin Healey repair undertaken, conversant with Big Healeys since 1958 with many concours wins (1993 Australasian Healey, meet outright winner Perth Western Australia).

- Engine rebuilding
- Gearbox - overdrive rebuilding
- RHD steering conversion kits

Cylinder Heads:

Unleaded - Gas Flowed - Polished and Ported - Go green 100/4 - 100/6 - 3000 - Sprite

- Austin Healeys bought and sold - usually a small selection available.

Full servicing, tuning and repair.

Tel: (44) 01623 871908

27192/24

B

1926 BENTLEY



3L SS 100 mph mod, chassis LM 1350, reg UE 1354, Green Label, 1/18 built, 6 exist, 10'10" std w/b frame w. VDP replica 4-pass, 2-dr Weymann-Type fabric body, 6k mi on older total resto, Hoffman & Moundtort, UK eng, twin SU sloper G5s, 6.1:1 CR, drilled pistons, A-type gearbox, 3.79 rear, new top/side curtains, repainted 94, exc cond, owner's/tech manuals.

£124,500 US Dollars o.b.o.

Tel: 941 947 6700 days

Fax: 941 947 1126, FL., U.S.A.

27128/33

BENTLEY TURBO R. Original factory LHD, 1992, 12,000 miles, FSH, 1 owner, virtually as new. EPOA. Tel: 0181 209 0481 or 0836 560300. (27044)

BENTLEY

1931, 8 litre,
CHYF5012, ENYX51A,
just run in since total
mech restoration,
counterbalanced crank,
Swearingen rockers,
shell mains, full flow
oil filter, new two-seat
body, fabric covered.

\$395,000

Ph.: 214 824 2851 days
Fax: 214 824 2658, TX

166/1/33

C

CORVETTE ROADSTER. 1965, 350 manual knock-offs, met green, leather. MoT, hard top. £17,500. Tel: 01763 242663 home. (27289)

F

FERRARI 308 GTS. 1979, 1 owner since 1980, RHD, modified for sprint and hill climb, fitted twin KKK. Intercooled turbo chagers. Uprated suspension by Nigel Mansel's sports cars at vast expense. All bills and history file, totally standard looks with astonishing specification. £28,500. P/x accepted. Tel: York 01904 700277. (27077)

FERRARI 328 GTS. 1987, pre-abs, red/cream, 13,000 miles, Fsh. CD, a/c. Immaculate condition. £45,950. Tel: 01932 846615 home, 01932 254025 office. Private Sale. (27207)

Ferrari Specialist - Mobile Service

Clutches from £345 fitted. Major servicing from £350. Vehicle inspection and valuations available at reasonable prices.

15 years experience in repairing Ferraris. All work guaranteed at fixed prices - So No Nightmares!

Any Ferrari problems contact Terry Keyes on 01923 822920 or 0468 363668

23804/17/48/49/50/51

TITANIUM Shift knob for BMW

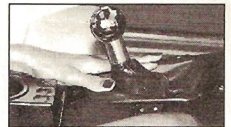

Custom made, Euro designed shift knobs for BMW & Ferrari. Strongest and lightest - proven in F1 racing and aerospace.

Own the finest in performance, style and quality, easy installation. We accept Visa & M.C. Call now!



TITANIUM CAVALLINO

(714) 444 3054

(9-5 PST)

Dealers welcome

www.TitaniumCavallino.com

27308/35/36/37/38

FERRARI ENGINE 365. £7,000. V12. Tel: France 33 4 92 38 04 11, fax: 33 4 92 38 04 12. Ferrari 250 GT Drogo. 1962, LHD, FIA papers, 300CV, dry sump GT0 engine, GT0 gearbox. 1,200,000FF. Tel: France 33 4 92 38 04 11, fax: 33 4 92 38 04 12. Ferrari Daytona 1972. Red/cream. 545,000FF. LHD. Perfect. Tel: Belgium 32 4 247 47 42. (26975)

FORD ESCORT RS1600 MK1. 1972, maize yellow, mint. Original road car. Comprehensive history. Virgin engine. Offers £9,000. Tel: 01332 780406, Derbyshire. (27301)

FORD RS COLLECTION

1 RS 200 # 166, 250 hp less than 60 miles \$55,000
1 RS 200 # 159, 350 hp less than 200 miles \$65,000
1 RS 200 # 104, 350 hp less than 500 miles \$65,000

All are LHD and have been in storage most of their lives. They are in the UK and can be viewed by appointment, these cars are NOT legal for the USA.

DEREK CLARSON
Indianapolis, U.S.A.
Tel: 317 271 0720
Fax: 317 271 3879

27141/33/34/35

J



JAGUAR E-TYPE ROADSTER

1961, 3.8, Chassis 850207. Same owner last 30 years, original owners manual, history, professional restoration to concours. All photo's, bills, mohair, hood, factory hardtop.

£52,000 o.n.o.

Phone: 00618 9586 7235 Western Australia

27261/34

JAGUAR E-TYPE 4.2 FHC 2+2 SERIES 1

1968, silver blue with blue leather, c.w.w., s/exhaust, present owner 16 years. Genuine original car with some history.

£8,500

Tel: 01869 277000 0411 234364
OXON

27206/35

JAGUAR 1990 XJS 3.6 LITRE. Mid blue, 75,000. Excellent condition, full service history, £2,000 recently spent on service. Must be seen. A steal at £9,500 o.n.o. Tel: H 01962 886640, D 01962 864024. (27185)

INTERNATIONAL JAGUAR SPARES DAY

Sunday 25th October 1998
National Agricultural Centre
Stoneleigh, Warks.

Organised by Jaguar Car Club
All Under Cover - Opens 9.30 am
ADMISSION £3.50

ENQUIRIES TO JOHN SALWAY - 01483 421333
In Association with JEC
Supported by Jaguar World

23804/17/48/49/50/51

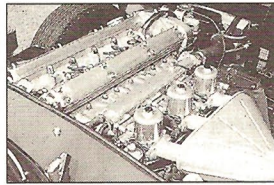
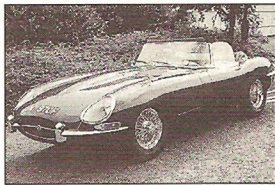

Sept 1967 Jaguar E-Type 4.2 Roadster

Finished in Canyon Red with Biscuit hide upholstery. Permanently stored in a humidity controlled garage since professional restoration by E-Type specialists (full photo journal). Only 3,062 recorded miles since rebuild. Recently fitted with uprated brakes by Cooper, along with a heavy duty sway bar.

£33,000

Contact Ken Sleeth on 0191 261 4999 or Julian McGill on 01423 879236

2711604/35

Retro
Classics Limited 19 Fitzroy Place, Lombard Road, London SW11 5RE

XK120 ROADSTER. Decent running and driving car. Red/black interior. Steel wheels. New interior/sidescrims. Some new chrome. New tyres. Very presentable. Value at **£15,800**

XK120 ROADSTER, LHD. Silver/red int. spats. Newly refub. Running in. Excellent. **£28,500**

ALLOY XK120 ROADSTER "NUMBER 3". Third RHD, 120 ever built. Numbers matching. Red, 41,000 miles only. Historic show car and a unique opportunity. Offers over **£60,000**

XK120 DROPHEAD SE. Wire wheels. Complete. Needs thorough restoration. **£6,900**

XK140 SE DROPHEAD. Excellent body/chassis. C-Type engine, cream with matching wire wheels. New electrics. Very sound and attractive genuine ex-California car. **£19,900**

XK150SE FIXED HEAD. Well restored chassis/suspension/brakes/engine. Rust free body to be prepared and painted. Overdrive. Perfect winter project. **£9,900**

XK120 SE ROADSTER. Wire wheels, C-type head, Brooklands plus standard screen. Runs. For restoration. **£10,300**

We can locate the XK of your choice, or carry out XK inspections and reports on your behalf.
Please call Paul at:
Retro Classics Limited, London
0171 924 4150, fax: 0171 924 2140
evenings Tel: 0171 937 1206

27140/24

XK120 OTS or XK140 DHC

One must go. 120 is BRG/tan and lightly restored. 140 is BRG/tan, totally restored. Bucket seats, Getrag gearbox, c.w.w. Also bench seat, manual box and chrome trimmed disc wheels.

£40,000 each
Tel: 01628 475565

27229/34/35

JAGUAR XJ 220 S. Race car, 700CV, LHD. Tel: France 33 4 92 38 04 11, fax: 33 4 92 38 04 12. Jaguar XJR 15. 1991. The \$1 Million Challenge. Only 50 built. Tel: France 00 33 4 92 38 04 11, fax: 00 33 4 92 38 04 12. (26977)

JENSEN 541S. 1961, dark blue, original dark blue leather, silver wires, owner 17 years. This is a genuine and well maintained car with full MoT. A comfortable, stylish and rare sports four-seater, easy to maintain and quick enough for modern driving. £6,000 o.n.o. Tel: 01625 583351. Private Sale. (27270)

LOTUS ELAN SPRINT. 1973, 77,000 miles, restored 1987 to show standard. Owned 13 years. Used summer only. The Best you will ever see! Stunning. £12,850 o.n.o. Tel: 01582 665003. (27305)

LOTUS ESPRIT S3 2.2. 1983, ice blue, half leather, 29,000 miles, fsh, Clifford immobiliser, glass sunroof, electric windows, new battery. £8,600. Tel: 01489 785165. (27184)

LOTUS EUROPA TWIN CAM 5-SPEED SPECIAL WANTED: I would prefer a good car although a small amount of work not object to. Please help me in my search. Tel: 01695 421405. (26918)

MERCEDES 350 SL. October 1972, dark blue with red upholstery, 120,000 miles. Historic tax Feb 98, MoT. Only 2 owners from new. Very good condition. £10,000. Tel: 0802 636230, 01483 488975. (27297)

MG MIDGET. 1978, 1491cc, green, 1 lady owner last 9 years, MoT'd until June 1999. Good condition, well maintained. £3,000 o.n.o. Tel: 01594 530336 or 0836 645663. (27254)

MGB GT V8. 1976, David Franklins modified road going car, only 54,000 miles, near concours condition. 280 bhp, 5 speed, lsd. £10,750. For full specification please Tel: David on 01275 845226 day or 01275 845515 evenings, North Somerset. (27147)

MORGAN 4/4 2 SEATER. 1969, metallic blue, beige interior, fully restored by Morgan to original spec, new chassis and bodywork. Fully documented all mechanicals and electricals renewed. Immaculate car. £14,250. Tel: 01323 898392. (27198)

2711604/35

P

PORSCHE 356B. 1962, ruby red with grey leather, extensive £15k+ body restoration, history. £14,750. Will take interesting Italian p/x. Tel: 01705 484378. Trade. (27148)

Porsche 912
1967, original yellow. Bodywork in good condition. Californian import, as yet unregistered. Spent considerable time in San Diego Motor Museum. Ideal entry level Porsche or investment, as only 33,000 of this marque were made.

£8,250
Phone 01865 864188
evenings or weekends

27180/34

R

ROLLS ROYCE 1937 PHANTOM II

One of a kind, Henley Roadster by Brewster/Inskip, New York. Probably the most important PII in the world. 35,000 original miles, drive anywhere.

PRIVATE SALE
BYRON J. YORK
203 431 0368 - CT, U.S.A.
or NORM HATHAWAY
914 669 8958, NY, U.S.A.

27171/34

T

TALBOT LAGO BARCHETTA. 1959, BMW V8, 150CV, gearbox ZF, 4 speeds, eligible Mille Miglia. Only 2 Barchettas built with the V8 BMW 2500cc. Tel: France: 33 4 92 38 04 11, fax: 33 4 92 38 04 12. (26982)

1967 TOYOTA 2000 GT
This very rare and special model was imported only for Toyota franchise owners. This particular car was brought to the USA for the current owner. The car is completely original with the 6-cylinder dohc 1988-cc 150-bhp engine. This coupé is in pristine condition with 14,900 miles.

\$120,000
Contact: Kim Stevens
516 423 6644

26927/33/34/35/36/35

ENGLISH COLLECTION

1961 DB4 Ser III with o/d, chrome wires, beautiful condition inside & out, excellent mechanics, some factory history, last owner 10 years . . . **£36,950**

1964 Healey 3000 MK III BJ8 Ph 1. Triple concours winner, nut and bolt restoration, photo history, magnificent car in every respect. Private collector 8 years **£25,950**

1995 MG TF 1500. Chrome wires. Reg: 9732 TF included. Ground up restoration & beautiful. Last owner 9 years, part of private collection **£21,500**

1935 Hudson Straight Eight Saloon. RHD, rare Earls Court Show car. Reg: CMD 524, total restoration in 1990 and absolutely superb throughout . **£12,950**

1990 (H) Virage. Manual, 37k, storm red **£36,950**

1980 Rolls Spirit. Cobalt blue, fRsh **£10,950**

1965 Mercedes 190. Auto, royal blue, 43k, fsh **£6,950**

1965 Rolls Cloud III. MPW convertible **SOLD**

PART EX - OLD OR NEW
PAUL COOMBES
TEL: 0161 950 1182
FAX: 0161 661 3789

27129/33

US COLLECTIONS

1966 SHELBY MUSTANG GT 350

Built by Shelby American, Los Angeles, California. Just completed a professional ground up restoration, there is none better, a real knock out. Sapphire blue with white stripes.

Priced at \$48,000 F.O.B.
OFFERED BY PRIVATE COLLECTOR
Contact Dave at 305 661 0805 or fax: 305 883 6606
Serious enquiries only - Florida, U.S.A.

27241/33

1965 CHEVROLET CORVETTE CONVERTIBLE. 396 CID/425 hp, 4-speed, post-traction, red/red-white top, tele steering, am/fm, knock-off wheels, hard top - matching numbers. A very nice example of a repainted, unrestored car, showing very little use since completion **\$54,000**

1957 CORVETTE. 283 hp, S.L., 3 speed spd, polo white/red interior, hard top, radio, heater, soft top delete. A very nice older restoration, showing very little use, converted to 4 barrel carburettor, the 7014360 F.I. unit is included **\$45,000**

1963 CORVETTE SPLIT-WINDOW COUPÉ. 327-360 hp, F.I., four speed, radio, knock off wheels, silver blue with dark blue interior, body and frame restored, showing very little use, interior original. The original F.I. unit comes with the car. **\$32,000**

Tel: 207 642 4610
Maine, U.S.A. 27170/33/35

Vintage Racing Services Inc.

1964 BOBSY MKII
superb history and documentation, original
1988 BUICK/NASCAR
restored, superb ex Bobby Allison grand national
1966 CHEVRON B15 FORMULA B
freshly restored, all steel twin cam, spares
1965 ELVA MK VIII/BMW
beautiful, rare, fast, spares. The best available
1965 ELVA GT-160 COUPÉ
one of 3 built, beautiful, race ready
1972 G.R.D. FORMULA B
freshly restored, all steel twin cam, spares
1961 LOLA MKII FORMULA JUNIOR
very rare, beautiful and ready
1957 LOTUS 11
fresh FWB (1500cc) Sprite trans, attractive and very quick
1962 LOTUS 19 SPORTS RACER
superb, Seltzer restoration, 2.5 Climax
1959 LOTUS 18 FORMULA JUNIOR
beautiful and race ready
1967 MCKEE MK7 CAN-AM SPORTS RACER
simply the best available
1979 MARCH 792 FORMULA 2
superb fresh Hart 2 litre and FT ready
1957 MGA COUPÉ
fast and interesting
1958 MGA TWIN CAM
excellent for road or race
1965 FORSGRINE D SPORTS RACER
race ready
1960 BEACH MK IV SPORTS RACER
1st in class '96 SVRA Summit
1966 LOTUS 31 FORMULA FORD
best of everything

VINTAGE RACING SERVICES
1785 BARNUM AVENUE
STRATFORD, CONNECTICUT 06497
TEL: 203 377 6745 - FAX: 203 386 0486

27262/34

STEVES BRITISH CONNECTION U.S.A.

1968 Lotus 7, Fiat twin cam drive train and components, LHD **\$8,500**

1965 Jaguar XKE Coupé, Series I, needs restoration, LHD **\$6,500**

1959 MGA Coupé, totally restored, w/w, LHD **\$9,900**

1962 MGA Deluxe, nice driver, LHD **\$10,000**

WORLD WIDE SHIPPING
OTHER EUROPEAN
SPORTS CARS AVAILABLE
Tel: 630 553 9023 Fax: 815 786 3372
ILL., U.S.A.

27211/34/35/36/37

AMERICAN CARS IN UK

AMERICAN CARS

We are the United Kingdom's largest and longest established dealers in classic American cars and trucks from the 1950's onwards. At our warehouse we have a huge selection of vehicles including several Cadillac convertibles. We also import specific vehicles to order from California including the Chevy Tahoe 4x4 LT, the ultimate vehicle in its class.

If you want a show winning piece of Detroit Iron, a late model daily driver or a rust free cruiser, call for details and stock list.

Tel: 0171-627 5775
Fax: 0171-498 7556

Dream Cars, 8-10 Ingate Place,
London SW8 3NS, England

27140/34

AUSTRALIA

JAGUAR XK150 COUPÉ 3.4
1956, restored new clutch, red/beige trim. Outstanding condition. JAG 150.

Tel: 0061 14 969 029
or 0061 2 9358 1163
+ 9 hours GMT - Australia

26711/20/31



B3 Technologies is a dynamic and innovative company specialising in the design and manufacture of Formula One racing car components. Due to expansion, we are currently seeking talented individuals to fill the following vacancies.

DESIGN ENGINEERS and DESIGN DRAUGHTSMEN

The roles involve the design and detailing of a range of race car components to an exceptionally high standard.

The successful applicants will have received formal mechanical engineering training and have working experience in the motor racing field, preferably Formula One. A knowledge of CADD5 or CATIA would be advantageous along with the ability to work to tight deadlines.

STRESS AND CALCULATION ENGINEERS

The applicants must be experienced in the motor racing field and be qualified to relevant degree standard. A knowledge of appropriate software for stress and car dynamics calculations is essential and both of these roles form an integral part of the design process. They also require close involvement with both in-house and on-track testing.

CNC MILLER

The ideal candidate will be apprenticeship-served, together with experience of working to high standards within the Motorsport or Aerospace industries. A knowledge of Heidenhain programming language would be advantageous.

COMPOSITES TECHNICIAN

The successful candidate will have current all-round experience of composite materials and processes at a high level. This position will involve working closely with all aspects of pattern, tooling and component manufacture.

The above positions will suit enthusiastic and highly motivated individuals who enjoy working in a demanding environment. In return, we offer friendly working conditions and very competitive remuneration packages.

Please apply in writing, including a CV, to
**John Barnard, B3 Technologies Ltd.,
Northfield House, Broadford Park, Shalford,
Guildford, Surrey GU4 8EP**

71890/36



The team's commitment to innovative technical progress has secured them an enviable reputation as one of the most successful and forward thinking companies in the motor racing industry. As part of this commitment, the company seeks dedicated professionals who share an enthusiasm for success.

NO.1 TEST TEAM MECHANIC

We are currently looking for a professional No.1 Mechanic to join our Test Team.

The successful applicant will need motor racing experience in major formulas, and the flexibility to travel under demanding schedules. As an integral member of a team, the successful applicant will also have excellent technical problem solving skills and be able to produce a consistently high standard of work.

Please apply in writing with full CV and present salary details to:

**Human Resources
Benetton Formula Ltd
Enstone, Oxfordshire OX7 4EE**

Closing date: 11 September 1998

Due to expansion, Xtrac has the following opportunities to work on our successful range of transmission systems. Applicants should have appropriate qualifications and experience gained in the racing, automotive or aerospace industries.

GEAR BOX ASSEMBLERS

CNC TURNERS

CNC MILLERS

CNC GEARCUTTERS

INSPECTORS

CNC GRINDERS

DESIGN ENGINEERS

The Benefits: Competitive salary, holiday pay, sick pay scheme, contributory pension plan and life assurance.

To apply, contact Jane Gilham, Human Resources Manager, for an application form or send your CV to her at **Xtrac Limited, Hogwood Lane, Finchampstead, Wokingham, RG40 4QW.**

Tel 0118 932 8222 Fax: 0118 932 8257

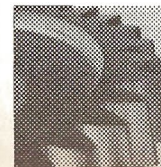

**WILLIAMS
MOTORSPORT LIMITED**



ENGINEERING BUYER

A proactive member of the team responsible to the Production Manager for all proprietary race car components procurement. This will involve sourcing components and services with class leading suppliers to achieve the highest quality and value for money whilst meeting challenging project timescales.

Candidates should be CIPS trained, with several years motorsport purchasing experience and a proven track record gained over at least five years. Good interpersonal and negotiating skills are essential along with a thorough understanding of modern manufacturing processes. Knowledge of import/export procedures also an advantage.

The ability to rapidly develop your existing computer skills is essential, but above all, you will be a dedicated team player with a flexible approach to working hours.

Applications for the above position, including full career details and current salary, should be forwarded to:

Terry Brice, Production Manager
Williams Motorsport Ltd, c/o BMW Motorsport Ltd,
Station Road, Grove, Wantage, Oxon, OX12 0JU

71265/36



DYNAMIC
Suspensions
A Subsidiary of Multimatic Inc.

Dynamic Suspensions, the world's fastest growing race-car damper manufacturer and suspension engineering facility has vacancies in the following responsible positions:

Damper Sub-Assembly Technicians:

This position requires young and enthusiastic motorsport oriented persons to enter into motorsport at a base level with the ability to climb to greater levels of experience. Training will be given if required.

Damper Technicians:

This position requires experienced and enthusiastic technicians to build damper units to racing specifications. The position also requires a minimum qualification of 1-3 years experience in the automotive industry. Specific training will be given if required

Race Support Technicians:

This position requires experienced technicians to support and liaise with specific teams and drivers to improve and to tune suspension parameters for optimum performance. The position requires an engineering ability with good understanding of maths, physics and automotive/race car fundamentals. Minimum qualifications must include an HNC in Engineering. Experience in damper technology would be an advantage.

Communication skills and presentation are also of utmost importance.

In return we offer an excellent salary and benefits package. A pension scheme is available after 12 months service.

*Please apply in writing enclosing CV to: Dynamic Suspensions,
20 Fison Way, Thetford, Norfolk IP24 1HJ*

71651/36

BRISTOL

BIRMINGHAM

ENFIELD

LEICESTER

LEEDS

MANCHESTER

NEWCASTLE

SLOUGH

With an enviable reputation in Motorsport, this company is seen as a symbol of success in international motor racing. As part of their continued commitment to excellence and to further strengthen the team, an opportunity now exists for career engineers who have the determination and expertise to share this future vision of success.

RACE ENGINEER

competitive salary + comprehensive benefits

Proven experience at the top level of international motor racing is a pre-requisite in an environment which will require you to provide an innovative approach to develop ideas and design concepts. You will need to be fully conversant with modern data acquisition analysis software and CAD systems and be encouraged to think and work autonomously, whilst providing the design team with your experience and knowledge.

Ref: 552

MECHANICAL DESIGN ENGINEERS

competitive salary + comprehensive benefits

Responsible for taking projects from concept through to complete component design. You will need to have a diverse approach to the solution of technical problems, as well as the ability to work under pressure to tight deadlines. You will have proven design capabilities either from within motor racing or a leading automotive manufacturer. Knowledge of modern CAD systems and a track record of academic success in a high technology discipline are advantageous.

Ref: 553

If you need to work as part of a dynamic results-orientated team, and possess the enthusiasm and dedication to compete and win at the highest level, then please apply in strictest confidence to our retained consultant Sandy Seta, quoting the relevant reference number, at ATA Advertising Selection, Bankfield House, 132 New Walk, Leicester LE1 7JA. Alternatively apply on line via the Monster Board at <http://www.monster.co.uk>

reynard



An opportunity to work for the most successful race car manufacturer of all time. The Reynard Group is continuing to expand and currently has the following openings:

REYNARD RACING CARS

Senior Transmission Designer –
Champ Car/Formula Nippon
Drawing Office

With a minimum of 5 years experience of high level motorsport transmissions you will be able to take a project from concept to detail drawings and connected development with minimum supervision. 2D CAD experience is a pre-requisite while familiarity with 3D CAD would be an advantage.

This is an exciting position requiring travel to tests and races in the USA throughout the year.

REYNARD SPECIAL VEHICLE PROJECTS

Experienced Design Engineers

Working on a variety of exciting projects you will be qualified to at least HND level with a minimum of 2 years component design experience in either the automotive or aerospace industry.

If you are interested, please apply in writing marking your application for the relevant position, including your CV and current remuneration details to: Ms C Lock, Reynard Centre, Telford Rd, Bicester, Oxon OX6 0UY.

Closing date: 11/09/98

71661/36



Denmans Lane, Fontwell, Sussex BN18 0SU.
Tel: 01243 544192. Fax: 01243 544488.

COMPOSITE LAMINATORS

We are currently looking for professional laminators to join our expanding composite department.

Successful candidates will need to be fully skilled in mould making as well as component lay up and previous experience in Aerospace/ Formula One/ Indy car manufacture is essential.

Please apply in writing with full CV and present salary to:

**Mr Kevin Emmett, G-Force Composites Limited,
Denmans Lane, Fontwell, Sussex BN18 0SU**

71901/36

If you want to advertise
in Appointments call
Tania on
0181 943 5858

AUTOSPORT

CLASSIFIED

WRITE YOUR AD IN BLOCK LETTERS BELOW:

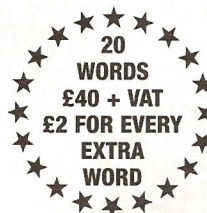

NAME _____
ADDRESS _____

POST CODE _____
DAYTIME TEL _____

ACCESS VISA
AMEX DINERS

CARD NUMBER _____

EXPIRY DATE CHEQUE NUMBER _____

SIGNATURE _____

MARKETPLACE
RACING AND COMPETITION
SPORTS AND CLASSICS
A-Z DIRECTORY
SUB-HEADING _____
NO. OF INSERTIONS _____
Box No's UK £50.00 (replies by Airmail £6 extra)

TELEPHONE 0181-943 5858 OR FAX (24 hrs) ON 0181-943 5850

DEADLINE for all classified is 4.30pm on Monday preceding publication. To place advertisements out of office hours dial 0181-943 5858 and dictate advert onto answering machine giving name and address and telephone number clearly.

WE REGRET NO ALTERATIONS, CANCELLATIONS OR REFUNDS POSSIBLE ON LINEAGE

TICK SECTION AND FILL IN SUB-HEADING

PRE-PAID ONLY.

BOXED ADVERTISEMENTS



WESTFIELD SE1 V8

(TVR Works Tuscan spec. V8). Fortune spent. Only 2000 mls since professional build for circuit use (but never raced). Estimated 375bhp. Road legal with full MoT. Black, with white 16" alloys. Seriously fast and absolutely spotless. A gift at £15,950 ono. Too much detail to list. Please phone 01254 663777 or 0831 128013

**WHY NOT ADVERTISE IN A BOX?
SINGLE INSERTION PRICES START AT
£92 + VAT B&W
£175.50 + VAT COLOUR**

ADVERTISING SERVICES

Fever Design. High quality, low cost creative solutions with the finest digital equipment. We create ads to suit your specific needs. For the best position on the grid call Fever! Advertising/livery/promotional design. Fever: The podium team. Tel: (Michael) 0961 103566. (Ben) 0411 656581 or 0181-673 0665 (eve).

AMERICAN MOTORHOMES HIRE

36ft American Motorhome Hospitality/Hire. For all your motoring events UK/Europe. 3M Awning. Full catering available. Includes driver. For details, call/fax RJC Leisure 01428 605252.
American Motorhomes for Hire with or without 5m x 8m hospitality awning. Delivered anywhere, many dates available. Phone/Fax H.G.C.H. on 01663 766871 or Mobile 0385 111031.

BRAKES

AFT Carbon Kevlar Brake Pads to suit most applications, outperform other carbon pads. 'Brakes with attitude'. Call 01203 684179.

HAWK RACING BRAKE PADS. Latest ferro carbon compounds. O.E., AP, Alcon and Wilwood fittings. Cambridge Motorsport, Caxton Road, Great Gransden, Nr Sandy, Beds SG19 3AH. Tel: 01767 677969. Fax: 01767 677026.

CAMSHAFTS

Kent Performance Cams. From Hot Rod to Formula 1 – used by championship winners! Units 2-4, Shorncliffe Industrial Estate, Folkestone, Kent, CT20 3SP. Tel: 01303 248666. Fax: 01303 252508.
Piper Cams. Europe's leading supplier of competition and performance camshafts. We offer everything from profile design and selection to the manufacture of race winning touring car cams. With the most comprehensive computerised profile design facilities in the country, backed up with the latest CNC manufacturing facilities, our service is unrivalled. Total confidentiality assured. Tel: 01233 500200.

CARBON FIBRE COMPONENTS

High quality Autoclave cured composite components. All motorsport categories. From drawings to finished panels. Crosby Composites, Unit C, Nigel Court, Brackley, Northants. Tel: 01280 840630.

CHAMPIONSHIPS

Formula Palmer Audi. Jonathan Palmer has created a new 250bhp single seater series competing for the ultimate prize of a fully funded F3000 drive in 1999. Contact Gary Church. Tel: 01403 733233. Fax: 01403 733222. Mobile: 0802 811044.

CHASSIS BUILDERS

Arch Motor & Manufacturing Co Ltd, Redwings Way, Huntingdon, Cambs, OE18 7HD. Tel: 01480 459661. Fax: 01480 450923. Manufacturers of tubular and monocoque chassis, suspension and ancillaries. Rapid chassis repairs and full race car restorations.

CLOTHING/SAFETY

Demon Tweaks, 75, Ash Road South, Wrexham Industrial Estate, Wrexham, Clwyd LL13 9UG. Tel: 01978 664466. Fax: 01978 664467.

COMMERCIAL PROPERTY SERVICES

A full commercial property service provided to include lease renewal/rent review negotiations, development site appraisals, planning applications/appeals. Contact Tim Norris-Jones BA (Hons) ASVA. NJ Commercial. Tel: 01865 481408.

COVERS

Thoroughbred Covers Ltd. Custom made for single seaters, karts, road cars, tool chests. Outdoor suitable for trailing and storage. Indoor dust covers. 349 Kirkstall Road, Leeds LS4 2HD. Tel: 0113 279 5079. Fax: 0113 231 0835.

DYNAMIC BALANCING

Burton Performance Centre Ltd: Specialists in dynamic balancing since 1963. All engine types undertaken. Plus full machine shop facilities (Certificated to ISO 9001/BS5750), 627a Eastern Avenue, Ilford, Essex IG2 6PN. Tel: 0181-554 2281. Fax: 0181-554 4828.

DYNAMOMETERS AND ENGINE PREPARATION

Deltic Performance Engineering Ltd. Sole importers of Dynopak™ portable hub-driven hydraulic dynamometers. Demonstrations • Sales • Service. Dynamic Balancing, Engine Building & Testing, Car Preparation, all Formulas, Road - Race. Tel: 01953 884999. Fax: 01953 883525. Mobile: 0585 912156. e-mail: deltic@globalnet.co.uk www.deltic.co.uk
Warrior Automotive Research Ltd. Competition engine building and dyno services in all current formulae from Formula Ford to DFR – race – rally – historic. Phone for cost effective dyno and build prices. Uckfield, Sussex. Tel: 01825 764833.

ELECTRICAL HARNESSING/ INTERCONNECT PRODUCTS

Tony James Component Wiring Ltd. Specialising in the design and manufacture of wiring harnesses for motorsport. Also stockists of military connectors, heatshrink sleeving, wire and moulded parts. Certificated to ISO 9002:1994 part 2. E10 Speedwey Way, Harleston Ind. Est., Harleston, Norfolk IP20 9EH. Tel: 01379 854485. Fax: 01379 852718.

ENGINES/GEARBOXES/PISTONS

Accralite Pistons (A Division of J.L.S. Ltd), Spon Lane, Smethwick, West Midlands B66 1QJ. Tel: 0121-525 6450/7733. Fax: 0121-553 5951. We manufacture in the UK quality forged pistons for high performance engines.

Arias Pistons Ltd. Fully forged pistons for every competition application, in bore diameters from 60 to 140mm. Manufactured as custom-designed single engine sets or production quantities. Brookers Road Industrial Estate, Billingshurst, Sussex. Tel: +44 (0)1403 784022. Fax: +44 (0)1403 782022.

EXHAUSTS

BTB Exhausts Ltd. manufacturers of motorsport manifolds and systems. Contact Joe Ellis, Unit 3, Great Central Way, Woodford Halse, Nr. Daventry, Northants NN11 3PZ. Tel: 01327 261797. 24hr Fax: 01295 750233.

F1 HIRE

Show cars – simulators, display items, tyres/flags, body parts – everything for special events. 07000 553949.

FIRE/SAFETY SYSTEMS

Lifeline Sales and Service Enquiries for BCF and Zero 2000 systems to Lifeline Fire and Safety Systems Ltd, 1 Portway Close (off Torrington Avenue), Coventry CV4 9UY. Tel: 01203 471207 or Fax: 01203 474777.

Race & Rally Car Fire Protection. Spa Lite environmentally friendly system available plus Halon 1211. All systems meet FIA and RACMSA requirements. Spa Design Ltd, The Boathouse, Litchfield Street, Fazeley, Tamworth, B78 3QN, UK. Tel: 01827 288328. Fax: 01827 260528.

FREIGHT FORWARDING

Rapid International. Import/export by air, sea or road. Contact Ken Moore, 4 Crown Way, Horton Road, West Drayton, Middlesex UB7 8HZ. Tel: 01895 446442. Fax: 01895 444492.

FUEL CELLS

AERO TEC LABORATORIES. FIA approved FT5/FT3 lightweight, flexible fuel cells. Standard and custom manufactured. 40 Clarke Road, Mount Farm, Bletchley, Milton Keynes, MK1 1LG. Contact Kevin Molloy. Tel: 01908 270590. Fax: 01908 270591.

FUEL SAFE UK & USA – Fuel cells and refuelling equipment. FIA, IMSA, USAC approved. Standard and custom manufactured. Tel: 07000 383572. Fax: 07000 383532.

GRAPHICS

Helmet Paintwork by Mike Fairholme Designs. Sole approved painter of Arai helmets. Silver Birches, Corby Birkholme, Nr Grantham, Lincs NG33 4LE. Tel: 01476 550630. Fax: 01476 550029.

SIGN deSIGN. Race team graphics and design. Suppliers to the motorsport industry, including TOCA, BTCC and F3000. Tel: 01271 323 771. Fax: 01271 327 007. E-mail: sign.design@BTInternet.com

HOSE & FITTINGS

Think Automotive Ltd. See 'Oil Coolers'.

HOSPITALITY

AWH Motorsport Hospitality. For the very best located, luxury hospitality suites at Brands Hatch, Silverstone and Donington Park. Other events also available. The AWH Group, Alyandra House, 26 Market Street, Nottingham NG1 6HW. Tel: 0115 950 9998. Fax: 0115 950 7048.
Speedsport Promotions Ltd. Market leaders in corporate hospitality. Full package available at all venues. Speedsport Promotions Ltd, Unit 6E & 6F, Silverstone Circuit, Silverstone, Near Towcester, Northants NN12 8TN. Tel: 01327 858167. Fax: 01327 858518.

INSTRUMENTATION

Think Automotive Ltd. See 'Oil Coolers'.

KARTING

Silverstone Circuits Limited gets you closer to the action with indoor and outdoor RAC Motorsports Association licenced kart tracks. Professionally, fully trained Marshals and Event Co-ordinators with high tech timing equipment • The ultimate in corporate karting entertainment • Individual bookings for groups of 1 to 100 drivers • Kart race tuition • ARKS courses • Cadet karts • Children's birthday parties • 1350m Stowe Circuit – twin engine kart events • Gift vouchers available. Open 7 days a week. Tel: 01327 320425/6/7. Fax: 01327 858268.
SRS Racing Kart School. Kart race tuition – individual prep. The new A.R.K.S. courses. Race hire/sales/preparation/corporate days/off road/all terrain courses. Podium House, Great Staughton, Huntingdon, Cambs, PE19 4DA. Tel: 01480 860823. Fax: 01480 861297.

LEGAL SERVICES

Johnson & Gaunt Solicitors with first hand knowledge and experience of motorsports, motorsports law and tribunal representation. Contact Tim Elkins for help with contracts and commercial matters or Roger Rose for tribunal or court representation.
Johnson & Gaunt, 47 North Bar, Banbury, Oxon OX16 0TL. Tel: 01295 256271. Fax: 01295 266451.
Freeth Cartwright Hunt Dickinson Solicitors. Experienced legal advice on all aspects of motorsport including: RACMSA tribunals, commercial agreements for teams, sponsors and drivers; contractual disputes; racing accidents and personal injury. Contact Simon J. Taylor at Express Building, 29 Upper Parliament Street, Nottingham NG1 2AQ.

Tel: 01159 369369. Fax: 01159 350353.
Pickworths Solicitors. 6 Victoria Street, St Albans, Herts AL1 3JB. A leading team of experienced motorsport lawyers, offering a complete range of legal services. Contact Peter Goodman on: 01727 844511. Fax: 01727 844277.

MEDICAL & FIRST AID

Advanced Healthcare Technology Ltd. Hyde House, The Hyde, London NW9 6LH. The leading supplier of all standard and specialist medical and first aid equipment to the motorsport industry. Tel: 0181 201 3829. Fax: 0181 205 2716.

MEMORABILIA

Grand Prix Topgear. No 1 for F1 Memorabilia – clothing body parts, signed items, bought and sold. See our ad under Marketplace 'Memorabilia'. Tel: 01279 843999.

The Tifosi Shop. Ferrari merchandise, models, memorabilia. Mail order: (0)1895 819300. Fax: (0)1895 819333. E-mail: hallifax@ctc-mundo.net
Willow Bank House, Oxford Road, Uxbridge, Middlesex, UB8 1LU. Shop: Talacrest Limited, 74 Station Road, Egham, Surrey, TW20 9LF, UK.
Collector's Studio Toronto. Signed original F1 and Indy memorabilia. Helmets, uniforms, prints, models: Senna, Schumacher, Villeneuve, more. Buy/sell worldwide. Tel/Fax: 001-416-975-5442. http://www.cstudio.net Email: cstudio@ican.net
Formula 1 Trading. For our latest list of F1 memorabilia e-mail us at F1TRADING@AOL.COM or call 01483 772263 or Mobile 0370 582706.
We have a large selection of Formula One Memorabilia such as signed photographs, race used suits and helmets, gloves/caps/tyres/books/visors/signed minicar sport and star autographs. Millennium House, 261 Timberlog Lane, Basildon, Essex, SS14 1PA. Tel: 01268 558333.

MOTORHOMES

American Motorhomes for hire with or without 5m hospitality awning. Delivered anywhere. Many dates available. Phone/fax H.G.C.H. 0161-456 4122, 0385 111031.

MOTORSPORT PRINTS

Peter Ratcliffe Legends in Time. The largest collection of signed motorsport prints in the world specialising in Formula One. Please visit our Galleries at 3 Windsor High Street, Windsor. Tel/Fax: 01753 851998. Also, Thames Avenue, Windsor (behind Theatre Royal). Tel: 01753 622555. Office: 01344 874874. Fax: 01344 622221.

OIL COOLERS

Cooling Technology by Serck Marston. Full range of oil coolers, oil cooler kits and components available. Contact the specialists at Serck Marston Racing Components Division, Units 9 & 10 Bullsbrook Road, Brook Industrial Estate, Hayes Middlesex UB4 0JZ. Tel: 0181 813 7470. Fax: 0181 813 7499.
The world's leading oil cooler specialist, manufacturers of Mocal equipment. Distributors of Aeroquip hose and fittings for oil, fuel, coolant and brakes. Aston Monze and Aero filler caps. Oil and fuel pumps. Classic instruments plus much more. Think Automotive Ltd, 292 Worton Road, Isleworth, Middx TW7 6EL. Tel: 0181-568 1172. Fax: 0181 847 5338.

PHOTOGRAPHY

Chris Dixon Photography – The Professionals Choice. A polite and specialist service to the motorsport industry. Contact: Chris Dixon, Flat 1, 13 Fairmile Avenue, Streatham, London SW16 6AG. Tel: 0181 677 6575. Mobile: 0831 674055.

PIT DISPLAYS

Showtrax. The leading pit display system designed to be smart, tough and long lasting. Used by professional teams throughout the world. Overhead gantries. Colourworks. Tel: 01525 840460. Fax: 01525 840760. Email: showtrax@colourworks.demon.co.uk

PROPSHAFTS/DRIVESHAFTS

Reco-Prop (UK) Ltd, Unit 4, Newtown Trading Estate, Chase Street, Luton, Bedfordshire LU1 3QZ, England. Contact Peter MacPhail. Tel: 01582 412110/480959. Fax: 01582 480432. Manufacturers and suppliers of propshafts, driveshafts, and CV joints. All makes and models, specials for all motorsport applications, modification, balancing, repairs, plus related spares.

RACE CAR PREPARATION/ ROLLING ROAD

Pitstop Racing. Professional race and test day support. Services include full race preparation, transport, arrive and drive, engine building, in-house rolling road, any formula. Tel: 01993 850654.

RACING SCHOOLS

Silverstone Driving Centre. Single seater and saloon race tuition, from novice to public races. Also circuit coaching for experienced drivers. Corporate day packages also available. ARDS Member, approved by RACMSA. Tel: (01327) 857177. Fax: (01327) 858268.

RADIATORS/INTERCOOLERS

Aluminium Radiators by Docking Engineering. Aluminium water radiators and cooling systems manufactured to your requirements by motorsports leading supplier. We supply quality prototypes and production components direct to teams and manufacturers worldwide. Contact Docking Engineering, Unit 15 Silverstone Circuit, Silver-

stone, Northants, NN12 8TL. Tel: +44 (0)1327 857164. Fax: +44 (0)1327 858011.

Cooling Technology by Serck Marston. We manufacture aluminium, copper/brass racing and performance radiators, oil coolers and intercoolers. Contact the specialists at Serck Marston Racing Components Division, Units 9 & 10 Bullsbrook Road, Brook Industrial Estate, Hayes, Middlesex UB4 0JZ. Tel: 0181 813 7470. Fax: 0181 813 7499.

RADIO SYSTEMS

Specialists in pit to car radio systems. Available for single seater, GT, saloon, rally and karts. Full installation and back-up service available. Autotel Race Radio. Tel: 01508 528837.

RALLY SCHOOLS

Silverstone Driving Centre. Tarmac and loose stage tuition from novice to expert. Corporate day packages also available. BARS member, approved by RACMSA. Tel: (01327) 857177. Fax: (01327) 858268.

ROD END & SPHERICAL BEARINGS

Goldline Bearings Ltd. Exclusive distributors of Ampeg Goldline and Silverline bearings. ISO9002 quality assured. Stafford Park 17, Telford, TF3 3DG. Contact Mike Jones/Ryan Currier. Tel: 01952 292401. Fax: 01952 292403.

SHOCK ABSORBER DYNAMOMETERS

Dynamic Suspensions Limited. Suspension systems and damper test equipment from F1 to Rallying. Contact 20 Fison Way, Theford, Norfolk IP24 1HJ. Tel: 01842 755744. Fax: 01842 752626.
SPA Engineering offer a wide range of test machines to suit all formulas worldwide. Extensive data displays in easy to understand formats with all types of shock absorbers. SPA, The Boat House, Lichfield Street, Fazeley, Tamworth, Staffs B78 3QN. Phone 01827 260026. Fax 01827 260528.

SPARES & ACCESSORIES

Burton Power Products. Ford/Lotus/Cosworth high performance engine components and accessories. Fast Mail Order service. Catalogue/Parts list available on request. 627a Eastern Avenue, Ilford, Essex IG2 6PN. Tel: 0181-554 2281. Fax: 0181-554 4828.

Demon Tweaks, 75, Ash Road South, Wrexham Industrial Estate, Wrexham, Clwyd LL13 9UG. Tel: 01978 664466. Fax: 01978 664467.

Phoenix – Crankshafts. Cranks with rods made to order. 37 The Business Village, Wexham Road, Slough, Berks SL2 2EJ. Tel: Slough 01753 821303. Fax: 01753 692485.

Titan Motorsport Manufacturing Co. Ltd. Harley Industrial Park, Paxton Hill, St. Neots, Cambs. PE19 4RA. Designers and manufacturers of competition dry sump oil pumps, race engine and race car components. Tel: 01480 474402. Fax: 01480 405668.

SPONSORSHIP

Need Sponsoring? Call 01707 665636 for an information pack on Sponsor Me! – matching sponsors to the best opportunities available today. (www.sponsor-me.co.uk)

SUPERCARGERS

Eaton Supercargers. O.E. quality blowers available through the only official Eaton European aftermarket distributor. For engine sizes 1.5-5.5 litres. Supercarrier UK. Tel: 01264 334277.

SUSPENSION

Demon Tweaks, 75, Ash Road South, Wrexham Industrial Estate, Wrexham, Clwyd LL13 9UG. Tel: 01978 664466. Fax: 01978 664467.

Dynamic Suspensions Limited. Suspension systems and damper test equipment from F1 to Rallying. Contact 20 Fison Way, Theford, Norfolk IP24 1HJ. Tel: 01842 755744. Fax: 01842 752626.

Eibach. Complete UK motorsport service. Contact: Eibach Suspension Technology Ltd, Unit 5, Swannington Road, Broughton Astley, Leics. LE9 6LU. Tel: 01455 286524. Fax: 01455 285853.

Gamma Suspension Ltd. For all types of race and rally suspension, parts and services. Unit 1, Park Drive Industrial Estate, Braintree, Essex CM7 1AP. Tel: 01376 326531. Fax: 01376 326530.

Pilot. Revolving service for Bilstein shocks. UK and export markets. Experienced capability. Pilot Brands International Ltd., Unit 5 Swannington Road, Broughton Astley, Leics LE9 6TU. Tel: 01455 285850. Fax: 01455 285853.

TAPE

TESA – Europe's Number One Adhesive Tape Manufacturer. Highest quality race tapes and other tapes available exclusively from: SpeedSport Promotions Ltd., Units 6E/6F, Silverstone Circuit, Silverstone, Nr. Towcester, Northants NN12 8TN. Tel: 01327 858167/858527. Fax: 01327 858518.

WHEELS & TYRES

Hoosier Racing Tyres. M&N Performance. Tel: 01327 312702. Fax: 01327 312701. Mobile: 0976 238747.
Tecnomagis. Extra light magnesium race wheels, all Formula, GT 1 and 2, Saloon, Race or Rally. Also classic Campagnolo for Italian sports cars and Tecnomagis motor-cycle wheels. Autorano Ltd, of Salisbury. Tel: 01722 410203. Fax: 01722 320831.

WEBSITES

www.redfernacing.co.uk
www.sponsor-me.co.uk

CLUB AUTOSPORT

ALL THE NATIONAL RACE, RALLY & HISTORIC NEWS PLUS FULL RESULTS ROUND-UP

EDITOR **DAMIEN SMITH** ASSISTANT EDITORS **TIM SCOTT, KEITH OSWIN, ANTHONY PEACOCK** EDITOR-AT-LARGE **MARCUS PYE**

Castle Combe spectator killed

The safety of Castle Combe circuit has been brought into question again after a spectator was killed by an errant wheel on Monday.

The accident occurred during the second TVR Tuscan qualifying session, when series leader Bobby Verdon-Roe crashed at Camp, the final corner. A front hub sheared, the wheel broke loose and Verdon-Roe had no way of being able to control the car. He was unable to brake and hit a barrier at 100mph.

The wheel bounced high over the barrier and hit a man standing halfway up the spectator banking. Rescue and medical services were on hand almost immediately, but

attempts to resuscitate the victim failed. The casualty has been named as Lee Noble, a guest of one of the TVR sponsors, not the same Noble who designed Ultima sportscars.

Verdon-Roe said: 'I felt a problem at the kink on the straight and it felt like the tyre had a flat spot. It's ironic it happened to my car because it is brand new and so well prepared.'

Castle Combe's circuit manager, Howard Strawford, defended the circuit: 'If anyone asked where the safest place to stand at Combe, I would say Camp

Corner. My wife was there two minutes before it happened. It was a freak accident.'

The tragedy comes under two months since Porsche preparation specialist Mike Jordan criticised the safety of Castle Combe following four big accidents at Camp during one meeting (see *National News* July 9, 1998).

After consideration, the Tuscan drivers decided to race on Monday, although Verdon-Roe, Steve Sutcliffe, John Read, Nigel Tustain, Steve Cole and TVR boss Peter Wheeler decided not to start.

A minute's silence was observed on the grid, before it was announced that the 1999 race would be named in the memory of the victim.

The meeting was marred further by accidents in other races later in the day. Philip Hopkins, an ex-British Formula 3 racer, suffered two broken legs in the GT race when his Ultima spun into the marshals' post on the entry to Camp.

Then Caterham racer Hugh Hayden was lucky to escape injury when his car hit the start of the pit-road banking on the entry to Camp and rolled.

Finally Caterham Roadsports racer Ross Bygrave escaped injury when his car rolled an incredible 13 times on the approach to Tower.



BV-R: lost wheel



Jeff Braham/AT

DANE NICOLAS KIESA came out on top from a seven-car lead battle to score his and the ADR Motorsport team's first Formula Ford win at Brands Hatch last weekend
● Report, page 92

Atlantic ready to take Zetec route

Atlantic Racing, the new team that has joined the Renault Spider Cup, will enter Formula Ford next year.

The team, set up by entrepreneur Gareth West, took over running the Sun-backed Spiders when BRC Engineering pulled out of the series last week. It ran the cars, for Daniel Eaves, Mark Cole and Lee Adams, at Brands Hatch last weekend.

Although it intends to continue in Spiders next year, West, a regional FFord racer, is keen to enter single-seaters.

'We're definitely going to run a team of FFords next year,' said Jon Kingston, the former BRC driver

who has taken a commercial role at Atlantic.

The team, which has ex-FFord engineer Andy Welch on its books, looks likely to run 1997 FFord winter series champion Greg Caton.

'There's a strong possibility that we'll have Greg on board - he's an excellent driver,' said Kingston. 'I don't see why we can't run him at the front.'

Although Caton has tested the new Tatuus (see separate story), Kingston said there was no decision which car the team would use. 'We're still evaluating several chassis,' he said.

Meira ends Manor victory run

Brazilian Vitor Meira scored Van Diemen's first 1998 Formula Renault Sport victory at Brands Hatch, as Doug Bell kept the title chase alive.

Meira beat Manor Motorsport's Bell to break the team's 12-race winning streak with the Tatuus chassis. It was also the first FRS success for Martin Donnelly Racing.

'I have to take my hat off to Van Diemen and the team,' said Meira. 'They have all worked so hard to make the chassis competitive.'

Bell's second place was enough to keep the championship race going. His team mate and series leader Aluizio Coelho spun out of the lead.

Bell is now 30 points behind the Brazilian, the equivalent of a win, with two races remaining. He needs to win both, with Coelho finishing outside of the top five.

'I'm under no illusions - it's still very difficult,' said Bell. 'But there's now a fresh light on the situation, and hopefully I can put pressure on Al.'



Bell: still hopeful

Tatuus Zetec tests **P86** Stewart in BRM **P89** National Reports **P92** Westley Barber **P100**

Humble Pye

The magic of a summer hillclimb at Gurston Down is just as powerful as ever



MARCUS PYE

Never before have I attended my first hillclimb of the season as late as the last weekend of August, but Sunday's visit to Gurston Down's Auto Windscreens RAC British Championship round reminded me why I fell in love with this great sport at Great Auclum in the 1960s.

Although time may have faded the reality, it always seemed to be sunny there in its late-July/early-August Saturday slot, as the contenders and the often tattered remnants of their cars returned from their annual pilgrimage to the Channel Islands (if the boats were running) to face the shortest, sharpest, hill in the series's history.

The sun blazed in rural Wiltshire (this time at least, for the organisers lost an event earlier this summer), where I was pleased to introduce CLUB AUTOSPORT editor Damien Smith to the delights of this historic discipline, in which high technology abounds in a quaint rural setting, without ever looking incongruous.

Just as I was enthralled by it, as a lad, and remain so as an all-too-occasional competitor, Damien came away amazed by the spectacle. A 600bhp Formula 1-engined car slam-dunking over Deer's Leap, but ten yards away, always leaves a lasting impression, while the friendliness of the drivers is refreshing too.

Having missed the scene, and the extraordinary camaraderie of the paddock 'family' this year, I was also looking forward to seeing the latest crop of cars and drivers in action. None were more impressive than the motorcycle-engined brigade which, having made the modern 1100cc Racing Car class its own, is now running amok in the 1600cc division.

When Ian Chard gets his gruff supercharged Triumph Daytona-powered OMS on full song, it has the potential to recapture the record he held in a 1400cc Jedi until Graeme Wight Jr's run on Sunday.

I am probably not alone in reckoning that the potent combo could also make the Run-Off at Gurston. Given that this was the exclusive domain of V8s – for the first time ever? – it could ultimately prove embarrassing.

Tatuus unveils Formula Ford

The long-awaited Tatuus Formula Ford chassis has finally been unveiled in Italy.

The Italian manufacturer, which dominates Formula Renault, took the wraps off its first non-'slicks and wings' car at Monza before taking the prototype to the Hungaroring for its first test last week.

John Booth, the boss of Tatuus' British importers Manor Motorsport, was present at the test, which was carried out by the reigning winter series champion, Greg Caton.

The car completed around 120 laps of the Hungarian Grand Prix circuit during the two-day evaluation, with Caton setting a time 0.1s quicker than a Mygale SJ98 driven by German Formula 3 racer Robert Lechner.

Booth said: 'Greg did a cracking job and the new car went very well. It's an extremely tidy design with very efficient aerodynamics.'

Caton, who drove a Haywood Racing Mygale SJ97 to the winter series title and who has twice raced a works Swift SC98Z in Britain this year, was also complimentary about the car. 'It's brilliant. Every time we made a change to the set-up, it went quicker. I've tested this year's Mygale and I thought the Tatuus actually felt a little better, but it's hard to compare because I'd never been to the Hungaroring before.'

The car has been returned to the factory for modifications. It will then be shipped to Britain, where Manor will begin a testing

programme at the end of September.

The chance of the Tatuus racing before the end of the year appears to be slim, with Booth and Tatuus' boss Gianfranco de Bellis concerned about developing the car for 1999.

Manor itself, the team which lost its 100% record in Formula Renault Sport this year at Brands Hatch last Monday, is unlikely to run a Formula Ford team, although Booth did not rule it out completely. He said: 'Manor is just developing the car, although we may run one sometime. It would be nice to win with the car for the sake of vanity, but we have no plans to race it.'

Booth has been encouraged by the interest the car has generated: 'There has already been a lot of

interest from teams, but Van Diemen, Swift and Mygale have established networks of customers so we are not expecting to take the market by storm straight away.'

De Bellis made it clear that his priority is to make the car a winner in Britain. He said: 'The target is to develop the car and race it in Britain next year. We've had contact with teams about running the car but it is early days. Hopefully the teams will see its potential in testing and we will find a good outfit to run it.'

As expected, the car uses a mono damper configuration on the front suspension, while the bodywork resembles the marque's FRS RC98, particularly the 'jet fighter' style sidepods.

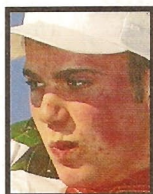

Caton: Tatuus test

CLUB AUTOSPORT

ALL THE NATIONAL RACE, RALLY & HISTORIC NEWS PLUS FULL

LEADERBOARD, RESULTS, NEWS, RACE REPORTS, JAMES BAKER, GORDON DUNCAN

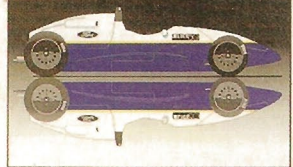

Manor to debut Tatuus FFord

Manor Motorsport will debut the new Tatuus Formula Ford chassis at the Hungaroring circuit during the weekend of the Hungarian Grand Prix.

AUTOSPORT broke the story of Tatuus' FFord plans on 10 April, 1997

Gas Vectra meets Brands deadline

The gas-powered Vauxhall Vectra Challenge car met its race deadline at Brands Hatch, despite only testing for the first time last week.

The car, which is powered by liquid petroleum gas (see *National News* August 27), was raced by former Volkswagen Vento driver Steve Deeks, who ran inside the top 10 before retiring with a broken driveshaft.

Deeks said: 'This is the third time the car has run and in total we've done just 36 laps of Brands. We're 8bhp down and are 40 kilos too heavy but everybody is working hard on the project.'

Mondello gets ready for endurance race

Endurance racing returns to Mondello Park this weekend, with the Serie Internationale Group N holding a four hour race.

It is the first time the series, which has visited eight countries in three years, has appeared in Eire.

Last month the series raced at Snetterton in two-part three hour event, where the Carlsson Motorsport team's Mercedes SLK of Stephane van Dyck and Klaus Burger beat the BMW M3 of Luca Capellari and Filippo Salvarini.

Guy Povey, Ian Donaldson and Des Smalls could be the best hope of a British victory in their BMW M3.

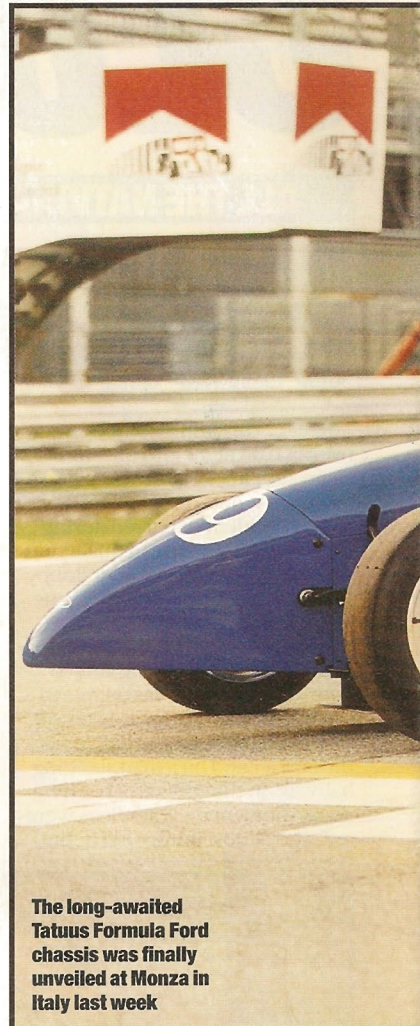

The long-awaited Tatuus Formula Ford chassis was finally unveiled at Monza in Italy last week

Zetec comp

Tatuus' rivals in the Formula Ford

RALPH FIRMAN – VAN DIEMEN

INTERNATIONAL 'There is always competition – Tatuus is just another company for us to race against. I don't think any more or less of them than Mygale, Swift or whoever. It has done well in Formula Renault Sport, but people assume that it will be just as good in Formula Ford, which is not logical. After all, it has tried to dominate the FF2000 market in the USA like it has FRS in Europe but has failed to do so.'

Hill to put in star turn at Mondello

Belgian Grand Prix winner Damon Hill will make a guest appearance at Mondello Park on September 20, during the Leinster Motor Races.

Hill will arrive directly from Goodwood, where he is due to race the Ferrari 250 GTO once driven by his late father, Graham.

Before winning last weekend's Grand Prix, Hill said he would be at Mondello on behalf of Jordan and its sponsor Benson & Hedges.

It will be the first time two world champions have come to a single Mondello event, as double World Rally Champion Carlos Sainz is also scheduled to visit on Saturday.

News in Brief

Zip Team Young Guns driver Gary Paffett secured the Formula Vauxhall Junior Class B title at Brands Hatch on Monday. With only Yuya Sakamoto to beat, Paffett took seventh place overall while the Japanese retired.

Johan Fourie flew into Brands at the weekend after racing in his native South Africa on Saturday. The John Village Automotive driver won both Formula Ford races at Port Elizabeth and is now close to securing his national title. He finished 10th in Monday's FVJ race.

Factory Van Diemen driver Daniel Wheldon was excluded from second place at Brands, dealing a further blow to his title chances. The 20-year-old passed series leader Jenson Button under yellow flags at Clearways.

Jeroen Bleekemolen made a sensational British Formula Ford debut at Brands, finishing fifth in a factory Swift SC98Z. The 16-year-old, who has already clinched the Dutch championship, switched from his usual Geva Racing Swift following the TOCA test last week.

Neale Blunden scored a surprise victory in the Formula Ford First Division at Brands in his Jamun M97. It was the marque's only appearance this year in the national series. Blunden lies second in the Kent County series.

British Rally Championship title contender Martin Rowe swapped his Renault Maxi Megane for a Spider in a test last weekend at Brands Hatch. 'It was a whole new experience' said the 27 year-old, who was blighted by a gearbox problem. 'I'd love to do a race, but it might be difficult to arrange.'

Former touring car racer Ian Cantwell failed to make his Renault Spider debut at Brands. His Orbit Motorsport car blew its engine in practice and Cantwell will now have to wait to make his debut at the Oulton Park race.

Ian Flux missed the Castle Combe Tuscan race after hitting budget problems. The former champion's car-destroying shunt at Oulton in May sapped the finances badly but Streber team boss Chris Smith hopes to get Fluxie out again before long. 'We're working at getting him out for the next race at Brands,' said Smith on Monday.

James Kaye made his National Saloon debut at Castle Combe when he stood in for Lionel Abbott in the Saab 93. With Lionel nursing a broken wrist following a cycling accident, Kaye rejoined the team eight years after sharing a Saab with Abbott in the Nurburgring 24 hours. The former touring car racers last outing was in the Spa 24 hour race in July. 'I've just come to help out,' reckoned James.

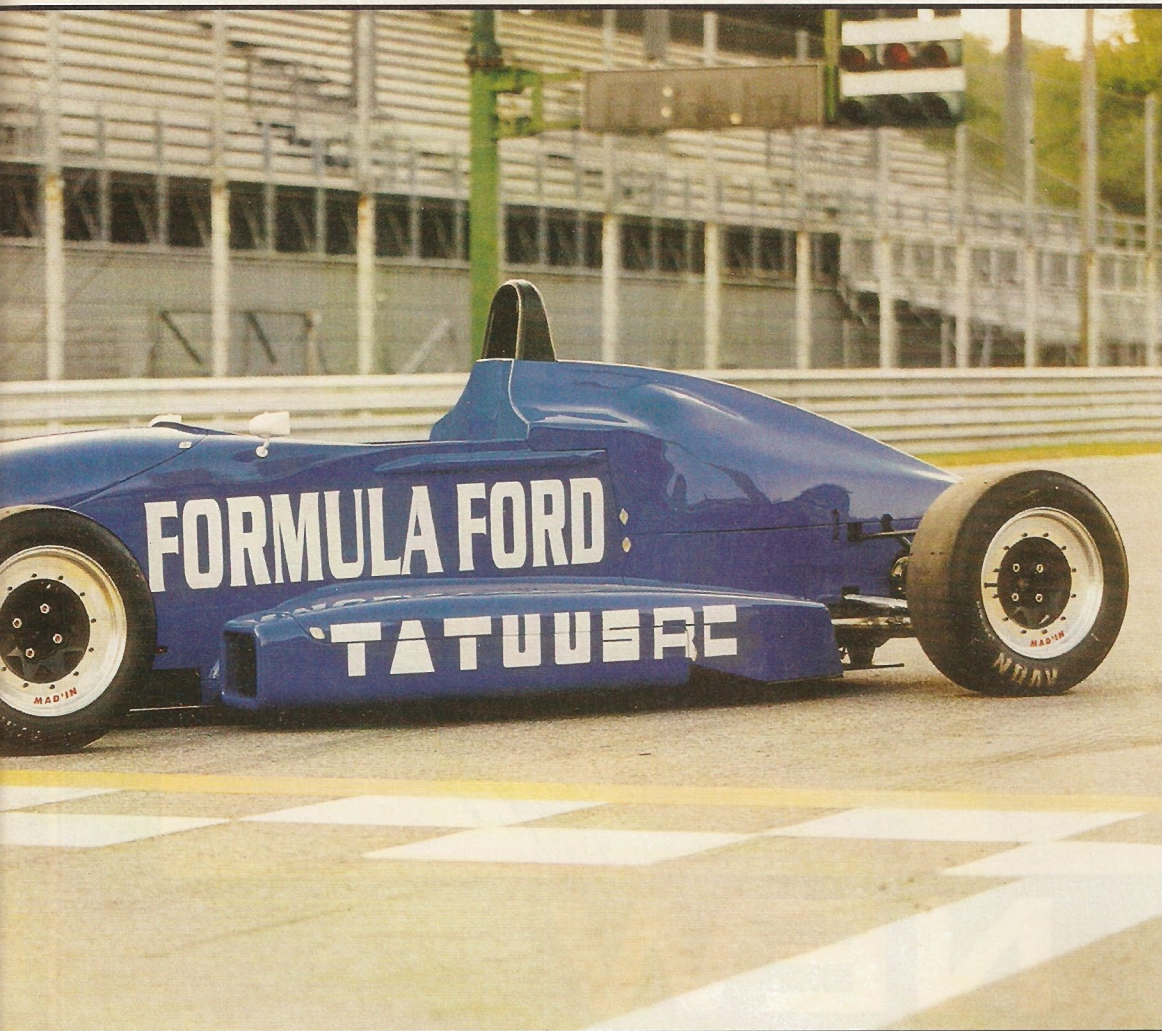

Competition to get even hotter
chassis stakes say they are not afraid of the new Italian challenger

JIM WARREN – HAYWOOD RACING (MYGALE'S BRITISH IMPORTER) 'It won't be long before the Tatuus is there or thereabouts. There's always a catch up period though – it's taken us three seasons with Mygale to get where we are. I don't think that while we and Van Diemen are here it'll corner the market (like it has done in FRS).

'I'm obviously very happy with Mygale and I'll stick with them, so I'm looking forward to the battle Tatuus and Van Diemen next year.'

GAVIN WILLS – SWIFT 'Formula Ford is one of the few categories left with a free choice on chassis – so we welcome the competition.

'Tatuus is a good manufacturer and its record speaks for itself. It will be interesting to see how the car progresses, because Tatuus may get on top of the formula straight away or it may take it a while. Zetec Formula Ford has its own peculiarities and quirks, and it takes time in every category to get things just right.'



The sleek chassis does resemble the FRS

Euroseries Formula Opel Preview

Van Der Linde gets set to hit back

Former championship leader Etienne van der Linde is expected to get his Euroseries Formula Opel title chances back on track at Zandvoort this weekend.

The South African, who led the championship before the last rounds at Donington Park, drives for AR Motorsport which will be on familiar territory as the Dutch circuit is its designated test track.

AR's team boss Ronald Heiligers said: 'We should have

some advantage because it is our test circuit but this doesn't always mean much. We've been competitive at other teams' home circuits this year, so who knows?'



VD Linde: favourite

New series leader Andrew Kirkaldy is cautious about his chances. The Paul Stewart Racing driver said: 'You always have to believe you can win but van der Linde will probably take at least one race. I've just got to finish as high up as possible.'

Opel winter series plan for Germany

The Euroseries Formula Opel could be in line to stage its first winter series this November.

The series organiser, the European Formula Drivers Association, plans to run an event at the Nurburgring in Germany.

EFDA boss Dan Partel said he envisages the event will run with a format of heats followed by a final.

'I have to talk to the teams but the German organisers have said they'd like to do it,' said Partel. 'It'll give prospective drivers a shot at FOpel.'

The winter series would not be in lieu of the proposed Nationals' Cup at Kyalami, South Africa.

Peter Ratcliffe

LEGENDS IN TIME

THE COLLECTION THE DRIVERS SIGN

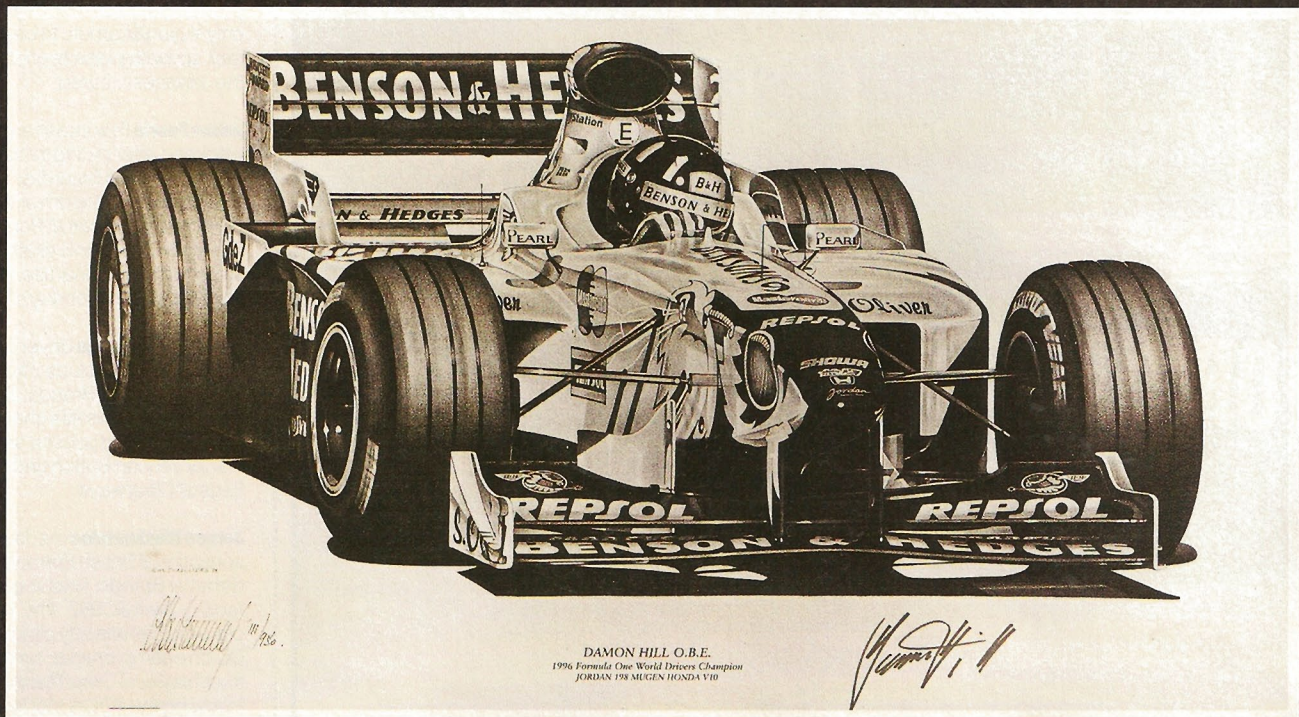

NEW

SIGNED BY DAMON HILL O.B.E.

1998 Belgian Grand Prix Winner

Even Hollywood will find the 1998 Belgian Grand Prix a hard act to follow,
the only thing missing was a pretty girl !

We did however get the happy ending.

In the dreadful conditions and carnage at Spa Damon Hill kept his cool and drove a faultless
race to bring home the first victory for Eddie Jordan and the team.

Hard work and belief in themselves has paid off and put Jordan Grand Prix amongst the
elite of Grand Prix winners.

We are proud to release this year's picture of Damon Hill in the Jordan 198 which is produced
under licence from Damon Hill Grand Prix Limited and is an official Damon Hill product.

Alan Stammers' latest superb creation measures 36" x 29" (91 x 66 cm approx). Each print of
the 950 worldwide edition is hand signed by Damon Hill and comes complete with a photograph
of Damon signing the prints as well as a numbered certificate of authenticity.

If you want to collect a high quality and genuine piece of Damon Hill history in 1998 this is it !

CALL NOW TO ORDER
£229.00 + £7.50 P&P (£9.50 Int)

P.O. BOX 1105
ASCOT
BERKS
SL5 7SU
ENGLAND

Peter Ratcliffe

LEGENDS IN TIME

TEL: (01753) 622555
FAX: (01344) 622221



VISIT OUR GALLERY IN THAMES AVENUE WINDSOR BEHIND THE THEATRE ROYAL TEL: 01753 622 555

LAT

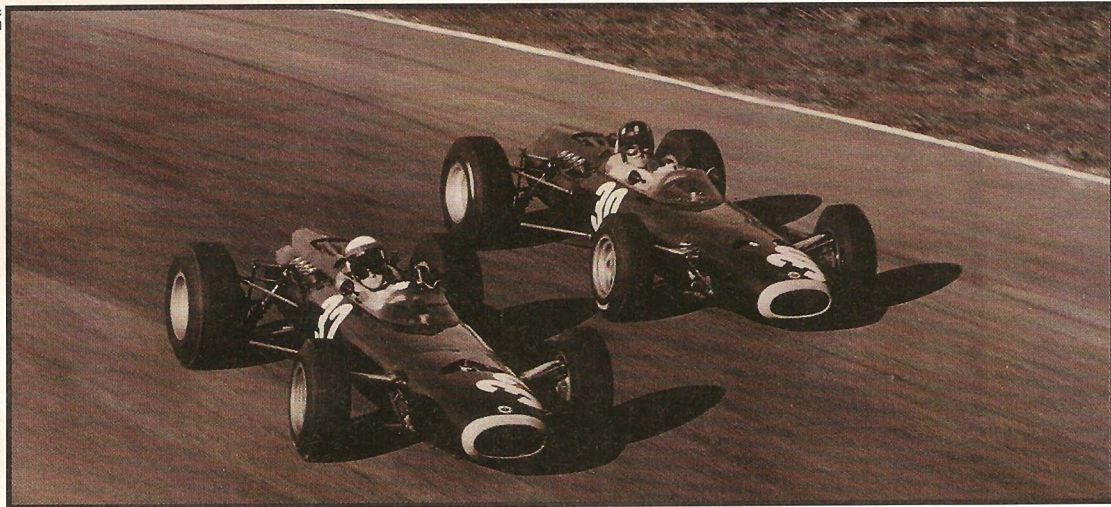

Jackie Stewart (left) beat team mate Graham Hill to win the 1965 Italian GP at Monza. Stewart will drive a similar BRM P261 at Goodwood

Stewart to star at Goodwood

Triple World Champion Jackie Stewart is the latest star to add his weight to Goodwood's Motor Circuit Revival spectacular on September 18-20.

The 59-year-old will drive a BRM P261 in the 'Dream Grid' demonstration.

Stewart took his maiden World Championship race victory in a P261 at the 1965 Italian Grand Prix at Monza. The chassis he will drive at Goodwood, owned by the Donington Collection, dates back to 1965, but is actually the car



Jackie: record

which Stewart drove to victory in the 1966 Tasman series and placed third in the 1967 French GP.

'I need it like a hole in the head at the moment,' said the Formula 1 team owner, 'but I thought I'd go because I hold the outright lap record for the circuit. It will be a lovely day - I have so many fond memories of the place.'

Goodwood Road Racing Company spokesman Rob Widdows said: 'Jackie doesn't drive much these days so we're pleased

he has decided to come. It will be great to see that famous tartan helmet in a BRM again.'

Former Grand Prix driver and Le Mans winner Jackie Oliver, who was confirmed to attend last week, will compete in the Tourist Trophy race, sharing a Porsche Abarth Carrera with inaugural World Sportscar Champion Bob Garretson.

Oliver, the former boss of the Arrows F1 team, will be up against 1996 World Champion Damon Hill who will be driving his father Graham's Ferrari 250 GTO with historic ace Willie Green.

Berridge on a roll at Donington

The FIA's Historic racing series support its GT Championship at Donington this weekend, with a scintillating Thoroughbred Grand Prix race taking centre stage.

Reigning champion Bob Berridge has won four races on the trot with his ex-Keke Rosberg Williams FW08B, but trails Class B leader Tony Smith (in an ex-Alan Jones FW06) by seven points.

Berridge expects intensified opposition in the 31-car field from the Lotuses of Joaquin Folch and Steve Hitchins, Richard Eyre's FW08 and Paul Ingram's Shadow.

Local man Mike Wrigley (Tyrrell 012), John Wilson (FW08C) and

Mike Littlewood (Ferrari 312T5) are the 'wild cards,' but Berridge needs Mike Whatley (Ensign N175) to beat Smith to improve his chances of scooping back-to-back titles.

Sweden's Bengt Winqvist needs to repeat last year's Donington win in the big Ford Falcon on Saturday to secure the Touring Car crown.

Bill Shepherd heads the chase in Uniclup Automotive's similar machine, but will be harder to stop in the GT counter when he switches to his AC Cobra speciality.

Entries from seasoned rivals Tony Thompson (Lotus 27) and Denis Welch (Merlyn) ensure a stunning Lurani Trophy Formula Junior finale.

First standout for FPA Winter series

Formula First frontrunner Mark McLoughlin has been given a leg up into the Formula Palmer Audi Winter series by existing backers EC Soft and Team Brask.

'I'm very excited, but my priority is to win the Formula First title,' said the 18-year-old from Finmere, near Silverstone. He is currently second to Danny Watts in the points table.

'Formula Palmer Audi provides the perfect environment for talented youngsters like Mark,' said his manager and team principal Lars-Christian Brask. 'The package Jonathan Palmer has put in place grooms drivers for Formula 1.'

Kilty gets maximum and switches to Lola

A ninth victory from as many starts at Colerne on Monday secured Roger Kilty back-to-back Farndon Engineering RAC British Sprint Championships three rounds early, with a maximum points score.

Kilty's 63.24s best was 1.78s clear of brilliant local engineer Dave Cutcliffe's 2-litre Van Diemen-BDG, which beat the 3.5-litre Ford DFR Formula 1-powered F3000 cars of John Garnett and Carl Amos.

Kilty will join the F3000 chassis brigade next year, having acquired a Lola T90/50 from Garnett. The DFR from his Pilbeam MP47 will be installed in it over the winter.

News In Brief

Colin Low secured the Champion of Oulton Class B FF1600 series with his eighth win from nine rounds on Monday. Chris Bennett had already followed in brother Mike's footsteps by taking the Class A title.

Arch Motors's Bruce Robinson clinched the Global Lights title at Oulton, while Jon Minshaw's sixth victory sealed the XR2 Challenge.

Three Lola T222 Can-Am cars are due out in next year's International Supersports Cup series, with T70 graduate Peter Schleifer and Denis Galland set to join Geoff Hobbs.

Father and son Rick and Rob Hall are racing Peter Austin's Ford Falcon Sprint in Saturday's FIA Historic Touring Car finale at Donington.

Aerobatic ace Tony Bianchi, equally well known for his Historic racing exploits in a Talbot Lago and the Allard Farrellac, is to run two cars in the 1999 Intermarque and Porsche Open series under the umbrella of his new corporate entertainment company, Aeroticar Motorsport.

Former Grand Prix drivers Howden Ganley, Tim Schenken and John Watson are among the guests due to help Murray Walker celebrate 50 years of motorsport commentary at Prescott's Auto Windscreens RAC British Hillclimb Championship round this weekend. Meet Murray at the classic Cheltenham venue.

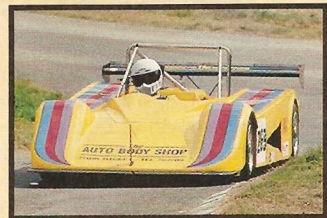

Marcus Pye

Following a one-two in their Sports Libre class at Gurston in their ex-Jim Robinson Pilbeam MP43, Charlie and Justin (above) Smith and most of the Guernsey hillclimbers dashed home to compete at Val des Terres on Monday. Inspired by Ray Rowan's 29.58s record, the Westfield V8 graduates are determined to get a lot closer than 31s next season.

British Hillclimb champion David Grace may retire from the sport if nobody buys Richard Brown's share in the all-conquering Gould Ralt this winter. 'I'd love to be able to finance a young hotshoe like Alan Thompson or Graeme Wight Jr, but I may have to sell the lot to repay Richard,' he said at Gurston.

Tony Metcalf trimmed Ken Bailey's long-standing Formula Ford record at Harewood to 61.54s at Sunday's annual Trackrod MC Hillclimb. 'It's taken me six years,' said the Van Diemen RF91 driver, 'but because it wasn't a BARC event, nobody is sure if it will affect the targets for their championship finals meeting.'

Marcus Pye



WITH A 146MPH CHARGE over the finish line, Hillclimb Clubmans star Alan Thompson finished a fine eighth in British champion David Grace's DFR-powered Gould Ralt GR37 at Gurston Down on Sunday. 'The car is incredible. The harder I pushed it, the better it felt,' said the recently qualified doctor. 'This has been the best weekend of my life.'

The Paintbox • 2 Bank Street
Worcester • WR1 2EW

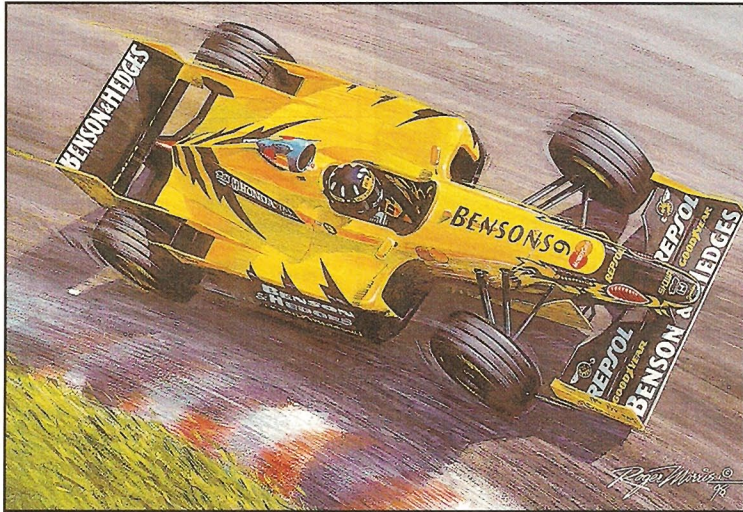

"Jordan 198"
IMAGE SIZE 11" x 12".
MOUNTED 20" x 15 1/2"
by Roger Morris
£35.00 INC. POSTAGE



TEL / FAX • 01905 619944

Del West Is on the Move

Del West Engineering has relocated its U.S. headquarters operation. We haven't moved far, just a couple of exits up the freeway north of Los Angeles, which means only our address has changed. We even have the same postal code, and our phone and fax numbers also remain the same. Our European offices, in Aigle, Switzerland, are right where they've always been.

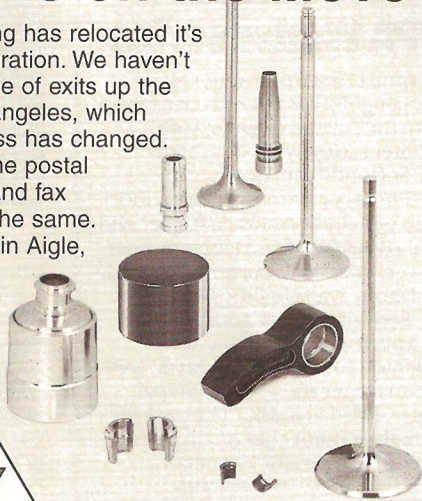

Del West Engineering, Inc.

Lightweight Valvetrain Component Design and Manufacture

U.S. Headquarters
Del West Engineering
(New Address)
28128 West Livingston
Valencia, CA 91355 U.S.A.
(No Changes)
Telephone: 805-295-5700
Fax: 805-295-8300

European Offices
Del West S.A.
(No Changes)
Chemin de Marjolin 75-77
C.P. 358, 1860 Aigle CH
(No Changes)
Telephone: 02-44-66-96-36
Fax: 02-44-66-96-38

**STACK
STACK
STACK**

SAVE 25%!



**On selected Stack
Dash systems with
Predictive Lap
Timing!**

**Ask about the Stack
Advantage**

*"I would never
have won both
my F3 races this
season without
the Stack
Predictive
Lap Timing
System!"*

**Darren Manning,
Speedsport
British F3
Race Winner**



Darren the dominator

Darren Manning was in a class of his own in qualifying.... he extended the gap over his nearest opposition to more than half a second on Friday.

**Motoring News July 15th, 1998
British GP F3 support race report**

"The first time we used the Stack data acquisition system it helped our student find over 1.5 seconds in one afternoon!"

**Alan Longland
Operations Manager
Silverstone Driving Centre**

5% savings available on selected systems for a limited period only

**STACK
STACK
STACK**

Stack UK Tel: 01869 240404 Fax: 01869 245500 Email:sales@stackhdi.com
Stack USA Tel: 888 867 5183 Fax: 888 364 2609 Email:sales@stackinc.com
GB Demon Tweaks 01978 664466 **GB** P.J. Motorsport 01283 820625
B Van Den Bossche 38 77 3040 **I** Gi Effe 0131 216 505
CH HORAG 071 644 8020 **J** SARD 0565 63 1166
D ISA Racing 02651 96250 **NL** Verlinden Tech. 05554 27050
F Danielson 86 21 22 55 **USA** Epic Technologies 861 479 4766

News In Brief

Price scores a clean sweep

Newly-crowned Safety Devices National Rally Champion John Price took another win last weekend at the Mewla National Rally with his Metro 6R4.

His sixth maximum score from seven rounds ensured Price a full tally of championship points, as only the best six scores count.

Bob Fowden was the early leader in an Escort Cosworth, having recently returned to rallying. A puncture dropped him down the order but he fought back to finish second overall, just under a minute behind the winner.

Eian Pritchard was third in another Escort Cosworth. The Builtl Wells-based driver benefitted from the high attrition rate.

John Morgan's ex-works Nissan Sunny won Formula 2 and Group N was claimed by Gareth Thomas in his Escort Cosworth.

The destination of the title is already decided, but the remaining top 10 places have still to be resolved. Each of the potential runners-up retired on the Mewla.

By far the most spectacular accident befell the Metro 6R4 of Lyndon Barton on stage four,

Piccadilly. The car went flying after a crest and rolled an estimated 11 times. Amazingly, nobody was hurt, although co-driver John Vance was taken to hospital as a precaution.

Having led the event, Chris Griffiths' Subaru Impreza joined the list of retirements after hitting a large boulder.

In addition to Barton and Griffiths, the Escort Cosworths of Terry Rooke and Steve Scott also failed to finish. The final placings will therefore be decided at the last round of the series, the Wexford stages on September 19-20.

Gwynndaf Evans will demonstrate his SEAT Ibiza Evo II Kit Car at this weekend's Maidstone Motor Show. SEAT Cupra Sport is backing the event and will exhibit one of the 370bhp Cordoba Ice Racing Cars. The show is open from 0900 on Saturday and Sunday, at the Kent County Show Ground in Detling.

DJB 93B, the Mini Cooper S which won the 1965 RAC Rally in Rauno Aaltonen's hands, re-emerged at Monday's National Mini Cooper Day at Curborough. After the RAC, it won the '66 Scottish Rally with Tony Fall. 'Written off' by the works after the '66 Gulf-London rally, it was rebuilt privately. It is currently owned by Phil Short, manager of the Mitsubishi Ralliart World Championship team, who is not claiming it to be the original!

Stephen Harron, the 1996 Northern Ireland Rally Champion, returns to the sport on this weekend's Lakeland Stages. Harron will drive a McKinstry Subaru on his home event, and faces strong opposition from this year's Woodland Furniture series regulars, including joint leaders John McKeown and Raymond Johnston. The 96 cars start from Enniskillen's Ashbury Hotel at 1030 on Saturday.

The 10th Classic Marathon from Paris to Tangiers starts on Saturday. Lasting for nine days, the longest route in the event's history takes in some classic Rally de Maroc sections on a lap of the country. Ten drivers who competed in 1988's inaugural event, including winner Ron Gammons in the same MGB, are among the 150 starters.

Former circuit racer, hillclimber and multiple land speed record holder Alex Postan is contesting the Classic Marathon with wife Jane in a 1959 Austin-Healey Sprite.

The route for the Trackrod Forest Stages Rally on September 26 includes two of the longest stages in the Mintex Championship. Dalby, a former RAC Rally stage, at 20.92 miles, is shortly followed by the 19.45 mile Langdale test.

Top Legends Cars rookie John Mickel plans to race a Eurocar V6 as well next season. Like Vauxhall BTCC racer Derek Warwick, Mickel is a former Superstox World champion.

MGF racer Nigel Reuben made his Flemings Thoroughbred Sports Car debut at Oulton Park on Saturday. The former circuit regular surprised regulars by finishing a class winning seventh in his MGB.

A blown engine cost Drayton Manor Park Metro Cup racer Brian Marshall third in class at Oulton. Having turned up a week early for his race - after a five hour trip from Kent, and discovered his mistake at signing-on - this drama marked the end of a painful eight days...

No pain, no gain... The Metro 6R4 of Lyndon Barton and John Vance spirals out of control at about 100mph after a fifth gear crest. All involved emerged from the incident unscathed, but Vance was taken to hospital suffering from shock.



BTRDA heads for Woodpecker rally

Andy Burton returns to the Woodpecker Stages this weekend as defending champion, having won last year's event with his hybrid Peugeot 306R4.

This year however, Burton could find himself embroiled in the battle for the BTRDA Silver Star title, which is currently fought between Steve Winter's Metro 6R4 and the Mitsubishi Lancer of Theo Bengry.

The Gold Star title race is wide open, with any of the top nine drivers in with a chance of inheriting Pete Littler's crown. Richard Roberts currently leads the Gold Star series. The rally starts in Ludlow on Saturday.

Carty and Patterson rev up for Speyside

Jim Carty and Jimmy Paterson will resume their duel on the Speyside Stages this Saturday, part of the Scottish Rally Championship.

Both title contenders need to score highly, but top local seed Andy Horne could upset their plans. As Brian Lyall's main rival in last year's Scottish Championship, Horne undoubtedly has the speed.

If the top seeds fail, that might favour other contenders including Andy Kelly and Stuart McQueen whose Group N cars are both still inside the championship top 10.

The 10am start will take place in Elgin's main shopping precinct.

Chicks star at racing's cutting edge

Team Extreme Headless Chicks won this year's Wisborough Green 12 Hour Lawnmower Race last weekend.

Run on the grounds of Brinsbury Agricultural College in West Sussex, this was the 26th running of the annual event. It attracted a bumper entry this year, but the winning Extreme Headless Chicks mower, was consistently the quickest, averaging a heady 26.1 mph over the 313.6 miles it completed.

The team beat second placed finishers Northerners Kick Grass by just four miles.

The weather was dry for this 'endurance classic', but the tractor normally used to wet the circuit to

reduce the amount of dust was called into use only once.

Not that the race was without incident though: the AUTOSPORT-backed mower number 20 rolled in the middle of the night. The other AUTOSPORT vehicle, number 21, endured problems early on but was running cleaner by the end of the race on Sunday morning.

The two entries hardly helped their cause by arriving late for the start, and it meant that mower number 20 only got going at 2130, while number 21 started even later at 2245.

Despite the delay, the pair still managed to finish 26th and 31st.



Autosport 1's pilot cuts a dash as he tries to draft eighth placed This Way Up Racing

Meira breaks Manor domination

Vitor Meira fended off Doug Bell's Tatuus to score the first win for Martin Donnelly Racing's Formula Renault Sport team at Brands Hatch. It also marked the first success for Van Diemen in this year's series.

Manor Motorsport's unbeaten run, therefore, came to an end, but for title contender Bell, second was good enough after the championship leader, Aluizio Coelho, had spun out.

Coelho had arrived at the Kent circuit knowing that a win with fastest lap would be enough for him to lift the crown. He set about the task by taking pole position, despite pitting mid-session to replace his engine management system. Bell qualified second, while Meira signalled his intentions by taking third, ahead of Chris Clark's Martello Tatuus. The Redgrave Racing Van Diemens of Tim Mullen and Jean de Pourtales filled the third row.

The expectation of another race of Manor domination was crushed as soon as the lights went green, when Meira got a brilliant start and surged up the inside of Coelho to take the lead before they had dived into Paddock. Coelho held off Bell for second, while Mullen slotted into fourth. The following Clark twice hit the Ulsterman from behind as they rounded Druids, damaging the Tatuus' front wing.

Clark then hit Mullen's rear tyre even harder at Clearways and dropped to seventh, but with Mullen also delayed the leading trio managed to break clear. 'To hit me once is an accident, twice probably isn't, and three times must be love,' said a less-than-pleased Mullen.

While Bell held a watching brief, Coelho had crawled all over the back of Meira in the opening laps. He finally got past his compatriot on lap five with one of the moves of the season that saw the pair run side-by-side for almost an entire lap. Coelho dragged on to Meira's tail and tried to go round the outside at Paddock. Meira held firm, but Coelho managed to stay on the outside up the hill and around Druids, and braved it out into Graham Hill bend which finally gave him the inside

line to complete the move at Surtees. His lead lasted all of 100 yards though, as he spun into the gravel at Clearways.

'It was really weird why the car snapped sideways like that - I think there was a combination of factors, but there's no excuses,' Coelho admitted. While he pirouetted, his car was shaved by Meira, while Bell had to slam on the anchors and came to a complete stop, allowing Mullen to fly through into second and bear down on Meira.

On the pit straight, the Brazilian moved to the outside to block, forcing Mullen on to the grass. The Ulsterman held it together, but lost out to Bell as he rejoined the track. His car was damaged, and he would gradually fall away from the leading duo to finish a lonely third.

Meira initially had an advantage of over a second, but Bell relentlessly reeled him in. Over the final six laps the pair were right together, but Meira's drive was faultless and Bell wasn't willing to take any risks. Bell's second place, with fastest lap, has given him some hope in the title race.

Fourth went to Star Cup winner Robbie Kerr as he returned to form with a strong drive. He was initially caught behind de Pourtales, but got past on lap four and drove clear.

Tor Sriachavanon also passed the Frenchman, but couldn't get on terms with Kerr, leaving de Pourtales to take a fine sixth with Juan Jose Font on his tail. Clark had earlier clashed with the Venezuelan at Paddock and retired in the gravel, while Star Cup challenger Gavin Jones spun in avoidance. He made it back to eighth, but Kerr is now virtually uncatchable for the Star Cup.

● Tim Scott

FORMULA RENAULT SPORT (25 LAPS) 1 Vitor Meira (Van Diemen RF98) 18m43.70s (96.45mph); 2 Doug Bell (Tatuus RC98) 18m43.98s; 3 Tim Mullen (Van Diemen RF97); 4 Robbie Kerr (Tatuus RC97); 5 Tor Sriachavanon (Tatuus RC98); 6 Jean de Pourtales (Van Diemen RF97); 7 Juan Jose Font (Tatuus RC98); 8 Gavin Jones (Tatuus RC97); 9 John Bender (Van Diemen RF98); 10 Judit Forro (Van Diemen RF97). **Star Cup** 1 Kerr 18m57.71s (95.27mph); 2 Jones 19m05.76s; 3 Forro. **Fastest laps** Bell 44.24s (97.92mph); Kerr 44.75s (96.81mph). **Championship positions after 13 rounds** 1 Aluizio Coelho 332pts; 2 Bell 302; 3 Mullen 242; 4 Meira 196; 5 Font 190; 6 Sriachavanon 140. **Star Cup** 1 Kerr 134pts; 2 Jones 106. **Next round** Oulton Park Sept 13/13

Quick Nic shrugs off rivals

Tim Scott watched the young Dane take his first win

Nicolas Kiesa took an accomplished first career victory, leading from lights to flag. The Dane was well clear of Dan Wheldon by the end, but the runner-up was later excluded, leaving Derek Hayes to inherit second place and keep his title chances very much alive.

Kiesa had planted his ADR Motorsport Van Diemen on pole by just 0.031s from championship leader Jenson Button's Haywood Racing Mygale, with Wheldon third in his works Van Diemen. An extremely impressive fourth went

to newly-crowned Dutch champion Jeroen Bleekemolen on his first visit to the Kent circuit. The 16-year old was driving a works-run Swift, and had given a clear indicator of its potential. Button's team mate, Hayes, was fifth ahead of Craig Murray's Mick Gardner Van Diemen. With just 0.331s covering the top 10 a close race was guaranteed.

Kiesa sprinted from the line to take the lead from Button into Paddock, as Wheldon held third and Murray passed Bleekemolen for fourth. Kiesa began to pull away from Button, who was working hard to fend off Wheldon.

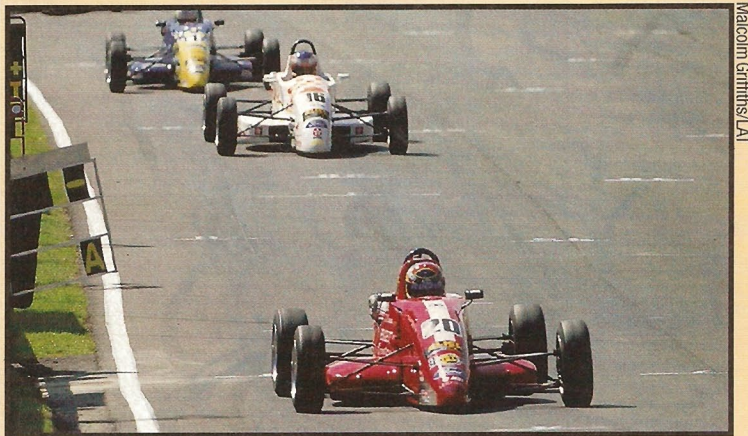

Winner Nicolas Kiesa pulled out his lead as Jenson Button (16) and Dan Wheldon battled

Walker wins as Pizzonia eyes title

Formula Vauxhall Junior returnee Leighton Walker led from start to finish to record his second career victory, two years after recording his first, also at Brands Hatch. In the end it was a comfortable win, but runner-up Antonio Pizzonia took another step towards clinching the championship by finishing ahead of his title rival, Richard Lyons.

Walker started the weekend as he meant to continue by taking pole position in his Paston Racing car, but it was a close run thing.

Pizzonia's Lewis Motorsport car was just 0.038s behind, and the top 16 were covered by less than a second. The Brazilian's team mate, Milos Pavlovic, put in his best performance of the season for third.

Team JLR's Richard Lyons, who needed to beat Pizzonia to maintain his title hopes, was fourth ahead of the third Lewis car of James Hanson and John Village Automotive's Tomas Scheckter.

Walker made a great start to lead into Paddock as Pizzonia claimed second. Lyons grabbed third from Pavlovic around the outside at Paddock, and immediately moved on to Pizzonia's tail. From there, the top four began to pull away from the pack led by Class B star Gary

Paffett and Scheckter, but Walker was equal to all Pizzonia's advances.

With the leading quartet together, it was a case of combining defence with attack, and a failed attempt to take the lead by Pizzonia allowed Lyons to dive down the inside of him at Paddock on lap four. The Ulsterman immediately lost his advantage though, as Pizzonia came back through at Clearways. From there the status quo continued as the leaders spread out slightly, but another factor was coming into play.

Scheckter was on a charge as he put together the drive of the race, dealing with Paffett at Paddock on lap six, before rapidly pursuing the next target. In doing so, Scheckter twice broke the lap record. He stole past Pavlovic on the inside at Druids on lap 15, and joined the battle between Pizzonia and Lyons.

This scrap had intensified as Pizzonia struggled with a bent rear wishbone, and it allowed the leader Walker to make a break. He steadily built on his 1.6s lead and would not be challenged again, and in the end the ecstatic 20-year old made it look relatively easy.

'Pizzonia pressurised me at first, but when I realised he was battling with Lyons I really put my head down and built the gap. It's the first



Martin Donnelly Racing's Vitor Meira took a hard-fought first '98 victory for Van Diemen

FORD FIESTAS August 30/31

Cullen makes break through

Irishman Michael Cullen scooped his maiden Fiesta win following a thriller in which eight cars circulated as one. As usual, there were plenty of incidents which reduced the train of cars to four. This quartet crossed the line covered by just 0.70s.

Series leader Simon Clarke could manage only fifth after an incident with Neal Gordon at Clearways, but nevertheless he extended his advantage to a useful 20 points with just three rounds to go.

Qualifying had seen Colin Stancombe take pole with a sub-record 55.59s following a cagey session in which drivers waited for other cars to get a tow round the tight Indy circuit. 'It can be worth half a second if you get it right,' said Stancombe. With under one second covering the top 18 cars it was easy to see their reasoning.

Series returnee Ian Churchill, Henry Taylor, David Gibson, Clarke and Cullen made up the top six. Rae Claydon should have been seventh, but lost his time when a wire was found to be detached on an engine management part. That left Jason Bartella, Alan Morrison, Steven Phillips and Neal Gordon to round out the top 10.

Churchill leapt into the race lead with Stancombe and Gibson side by side into Paddock, before Gibson pressed home the advantage at Druids. Churchill kept his lead to the end of the lap, but Gibson stunned onlookers by taking him around the outside at Paddock on lap two. Stancombe added to the erstwhile leader's misery by further demoting him soon after. Taylor was fourth, just ahead of Clarke, with Morrison, Cullen and Gordon forming the eight car group which broke away.

Jason Bartella had been right with them, but a second-lap spin dropped him down the order. Up front, Gibson maintained his lead while places were traded behind, with Morrison making stealthy progress to be fourth by lap four. Churchill's run came to an end when officials black-flagged him after an eagle-eyed observer spotted his car was dropping fuel.

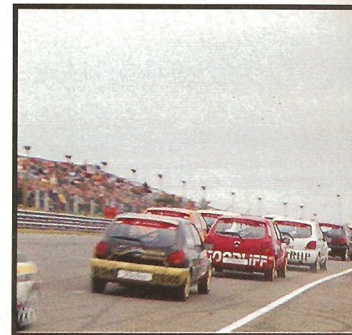

The Fiesta pack charges into Paddock

Clarke and Gordon had dropped off the back of the group after an incident at Clearways on lap 10. With Churchill's demise, the group was down to five cars. The crowd was gripped as they went at it hammer and tongs, Cullen still making his presence felt as he edged ever closer to the front.

Morrison snatched the lead from Gibson on lap 19, edging the leader out wide through Clearways. Gibson found himself out so wide that he ploughed through the gravel trap and resumed a detached fifth. He slipped to sixth on the final lap when Clarke demoted him further.

If Morrison thought that the win was his, Cullen had other ideas and edged up alongside on the way out of Clearways on the last lap. Morrison wasn't about to let his Harlow Motorsport team mate past and edged him left on to the grass, but Cullen responded by slipping past in the shadow of the line to snatch the verdict by 0.02s.

'That's my first win in England,' said Cullen. 'My car was brilliant - it was so consistent. It's all down to Harlow. When the others were sliding about, my car wasn't.'

Stancombe was third, just 0.20s back with Taylor, Clarke and Gibson completing the top six.

● Dud Candler.

FORD CREDIT FIESTAS (20 LAPS) 1 Michael Cullen 18m58.72s (76.16mph); 2 Alan Morrison 18m58.74s; 3 Colin Stancombe; 4 Henry Taylor; 5 Simon Clarke; 6 David Gibson; 7 Daniel Buxton; 8 Rae Claydon; 9 Neal Gordon; 10 Michael Tegerdine. **Fastest lap** Stancombe 55.84s (77.58s) **record**. **Championship positions after 12 rounds** 1 Clarke 170; 2 Gordon & Morrison 150; 4 Peter Cate 109; 5 Claydon 107; 6 Gibson 104. **Next round** Oulton Park Sept 12/13.

Bleekemolen lost out to Hayes and Marcos Ambrose in the fracas. Hayes charged past Murray to take fourth on lap five, as the leaders closed up, making a seven-car battle.

By lap seven Button was pushing Kiesa hard, and the Dane ran over the infield at Surtees. As he rejoined Button tried to go round the outside and slid wide, leaving the door open for Wheldon. At the time though, Clearways was under yellow flags, so Wheldon passing Button caused him to be excluded later on. With his momentum lost, Button was also passed on the pit straight by the charging Hayes.

With Kiesa enjoying a slender lead from Wheldon, the Mygales continued to battle. Button retook third at Clearways on lap 10, but Hayes fought back at Druids two laps later. The infighting allowed Murray, Ambrose and Bleekemolen to stay in touch with the battle.

Hayes was pushing Wheldon hard for second, and it was clear that Wheldon was beginning to hold the pack up. This gave Kiesa the decisive break he needed, and by lap 16 he had extended his lead to 1.5s. From there the Dane could pull away gradually as Wheldon's defence remained watertight, and Kiesa scored his and ADR Motorsport's first single-seater win.

'I'm thrilled,' he said. 'I concentrated hard on making a break because I knew they wouldn't be able to catch me.'

Were Hayes not fighting for the title he might have taken more risks to pass Wheldon, but his efforts were cut short when the race was

red-flagged four laps from the end after Murray and Ambrose tangled at Druids. They were collected by Mark McKenna's Haywood Mygale and Sepp Koster's works Swift.

With Wheldon's exclusion Hayes was elevated to second from Murray and Ambrose, with the Australian escaping any censure except a licence endorsement for the final incident. Button was left in fifth, ahead of the lucky Bleekemolen, who actually crashed on the same lap as the red flags emerged.

Robert Collard's works Van Diemen was a lonely seventh, while Koster, in a one-off drive for Swift, took eighth after a great battle with Frenchman Jean-Christophe Ravier. Ravier was also later excluded, having punted off Barry Horne on lap one.

In the First Division, polesitter Mark Fullalove lost out in the race to circuit expert Neale Blunden, marking a great seasonal debut for the Jamun marque. Third place was enough for Oliver Smith to take the First Division championship lead.

FORMULA FORD (20 LAPS) 1 Nicolas Kiesa (Van Diemen RF98) 15m34.174s (92.83mph); 2 Derek Hayes (Mygale SJ98) 15m36.210s; 3 Craig Murray (Van Diemen RF98); 4 Marcos Ambrose (Van Diemen RF98); 5 Jenson Button (Mygale SJ98); 6 Jeroen Bleekemolen (Swift SC98Z); 7 Robert Collard (Van Diemen RF98); 8 Sepp Koster (Swift SC98Z); 9 Tom Sisley (Van Diemen RF98); 10 Robin Liddell (Vector MG98). **First Division** 1 Neale Blunden (Jamun M97) 2 Mark Fullalove (Van Diemen RF97); 3 Oliver Smith (Van Diemen RF97). **Fastest laps** Hayes 45.952s (94.293mph); Blunden 46.824s (92.537mph). **Championship positions after 12 rounds** 1 Button 123pts; 2 Hayes 112; 3 Ambrose 83; 4 Kiesa 76; 5 Murray 72; 6 Wheldon 71. **First Division** 1 O Smith 94pts; 2 Jeremy Smith 93; 3 Tom Herridge 81. **Next round** Oulton Park September 13/14.



The victorious Leighton Walker (2) proved too quick for second-placed Antonio Pizzonia

pole and first win for Paston since 1995 (when Ben Collins won at Silverstone), so it's great for me and the team,' he said.

Scheckter was still flying, though, so Lyons let him through at Druids on lap 19 to try and pass Pizzonia. The plan backfired, as Pizzonia's defence remained solid and Scheckter couldn't progress further. By finishing second with Lyons in fourth, Pizzonia has left himself requiring just one fifth place from the final two rounds to clinch the crown.

'For me, it was perfect,' said Pizzonia. 'I wasn't worried about Leighton, I was just happy to keep Tomas and Richard behind me.'

Pavlovic lost touch with the leaders but still took a fine fifth

place. Team JLR's Robert Bell came out on top of a fierce battle with Paffett, whose seventh place secured him the Class B crown.

Gavin Poyer came up from 13th on the grid to take eighth ahead of James Hanson, who struggled with a down-on-power engine.

● Tim Scott

FORMULA VAUXHALL JUNIOR (24 LAPS) 1 Leighton Walker 18m39.798s (92.92mph); 2 Antonio Pizzonia 18m43.121s; 3 Tomas Scheckter; 4 Richard Lyons; 5 Milos Pavlovic; 6 Robert Bell; 7 Gary Paffett; 8 Gavin Poyer; 9 James Hanson; 10 Johan Fourie. **Class B** 1 Paffett 18m52.314s (91.89mph); no other finishers. **Fastest laps** Scheckter 45.833s (94.538mph) **record**; Paffett 46.319s (93.546mph). **Championship points after 14 rounds** 1 Pizzonia 182pts; 2 Lyons 150; 3 Scheckter 94; 4 Fourie 70; 5 Bell 69; 6 Walker 53. **Class B** 1 Paffett 259pts; 2 Sakamoto 132. **Next round** Oulton Park, September 12/13.



Irish duo Michael Cullen and Alan Morrison crossed the line in a spectacular photo finish

VAUXHALL VECTRAS August 30/31

Graves restores his title challenge



Malcolm Griffiths/LAT

Simon Graves took an accomplished victory in the Vectras to close on title leader Mark Blair

Simon Graves resurrected his Vauxhall Vectra Challenge title hopes with a dominant lights-to-flag display at Brands Hatch, although he still trails series leader Mark Blair by six points with two rounds to go.

'It's an excellent result for the team, who've worked hard to get things sorted,' said Graves. 'We've changed a few things in testing and we're back in with a shout for the title.'

Qualifying on Sunday saw the top 10 covered by under a second, Graves bettering early pace setter Flavio Figueiredo to set a sub-record time of 50.93s. It was an eventful session with title rival Figueiredo clashing with Jason Yeomans, the duo then having a heated discussion in the pit lane.

Blair had the scare of a broken driveshaft on his second lap, but got

it together to earn a second row place with Yeomans. The ADR Motorsport crew performed miracles to get Blair back out, as they changed the offending item in just three minutes!

Dave Pinkney and series debutant David Henderson filled row three, with Henderson's team mate, ex-BTCC driver Patrick Watts, on row four in his first Vectra outing alongside Graham Coomes.

Come race time, Graves and Figueiredo were side by side on the dash to Paddock, but it was Graves who emerged ahead. Figueiredo was already in trouble with a loss of power steering - a problem which had blighted his car in qualifying.

Blair and Yeomans were right with them, the top four gradually drawing clear of the chasing group headed by Pinkney. Figueiredo

attacked Graves on occasions, but somehow you could sense that he would never get past. Graves bagged the point for fastest lap as early as lap two.

Likewise, Blair always had just enough to keep Yeomans behind him and so safely secured the third place points. 'A disappointing result, but as Brands is my least favourite circuit, perhaps it's not as bad as it might have been,' he said.

Pinkney was always at the head of a four-car group for fifth, a place he was able to make safer as the battle behind saw Coomes splitting the rookie team mates Henderson and Watts. Watts got by Coomes at midway to take seventh spot. A flag infringement had cost Mark Nichol his qualifying time, but he stormed back from a 10s penalty to take ninth.

Steve Deeks gave the liquid petroleum gas-powered car its race debut and ran in the top 10 until he was sidelined by a broken driveshaft. The car sounded rather fruitier than its rivals and is a welcome addition to the championship. At least Deeks went further than the hapless Paula Sears, who coasted in on the first lap with driveshaft failure on the scholarship car.

● Dud Candler

VAUXHALL VECTRAS (22 LAPS) 1 Simon Graves 19m02.27s (83.51mph); 2 Flavio Figueiredo 19m03.34s; 3 Mark Blair; 4 Jason Yeomans; 5 Dave Pinkney; 6 David Henderson; 7 Patrick Watts; 8 Graham Coomes; 9 Mark Nichol; 10 C Suzanne. **Fastest lap** Graves 51.28s (84.49mph). **Championship positions** 1 Blair 131; 2 Graves 125; 3 Figueiredo 113; 4 Yeomans 60; 5 Pinkney 58; 6 Coomes 52. **Next round** Oulton Park Sept 12/13.

MALLORY PARK August 31

Willis and Hodgs

Eurocar V8 title leader Mike J

Mike Jordan endured a trying weekend, the Eurocar V8 championship leader only managing a sixth and a fifth place in the two events. This allowed Mark Willis and Steve Hodgson to steal the glory with a win apiece on the Mallory mile.

In the first race, Chris Dawkins led away, followed by Willis, with Barry Lee in third. Dawkins initially built himself a small lead, but Willis then relentlessly reeled him in. He overtook at Island turn on lap seven. Willis immediately started to

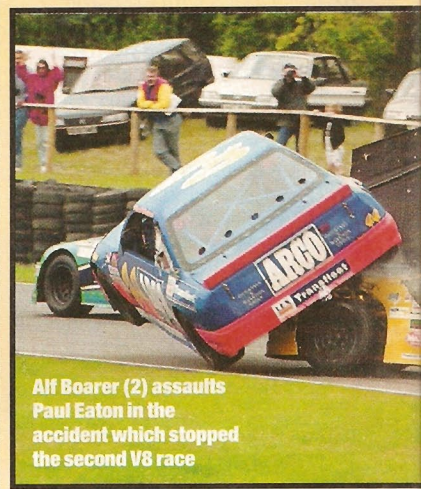

Aif Boarer (2) assaults Paul Eaton in the accident which stopped the second V8 race

handed a five second penalty, dropping him from second to fourth.

Vercoe spun off but resumed to finish fourth behind Tobia Masini. It was Masini's first-ever podium visit in this country, which gave the Italian great enjoyment. 'OK, so I was lucky with the pair in front of me clashing, but at least I'd driven up from seventh on the grid.'

Hill then appealed, and more than three hours after the race had ended, it was decided that Hill wouldn't get a penalty after all and he was reinstated in second.

The drive of the race, unnoticed by many, came from title hopeful Jamie Hunter, who had hired a Menu Motorsport car after a bizarre incident in the paddock on Saturday. It had left Hunter with a suspected broken wrist and he drove all weekend with it strapped up and in considerable pain.

Hunter's fifth place finish leaves him second in the points table, eight adrift of new leader Hart. Dropped scores favour Hart as the series heads to Oulton Park in a week's time. He's looking like a good bet for the championship.

● Dud Candler

RENAULT SPIDERS (20 LAPS) 1 Nick Hart 16m43.33s (86.43mph); 2 Simon Hill 16m50.69s; 3 Tobia Masini; 4 Duncan Vercoe; 5 Jamie Hunter; 6 Simon Wiseman; 7 Lee Adams; 8 Andy Priaulx; 9 James Aspinall; 10 Stephen Baber. **Fastest lap** Hart 49.28s (86.96mph) **record.** **Championship positions** 1 Hart 302; 2 Hunter 294; 3 Dan Eaves; 4 Vercoe 214; 5 David Henderson 160; 6 Masini 141. **Next round** Oulton Park Sept 12/13.

RENAULT SPIDERS August 30/31

Hart storms into series lead

Nick Hart shrugged off a total loss of his instruments on the rolling start lap to dominate the Renault Spider Cup round in his ASCOM-backed car at Brands Hatch on Monday.

The victory elevated him to the head of the points table, while erstwhile leader Daniel Eaves retired with a blown engine.

Local knowledge paid dividends in qualifying, as circuit instructors Hart and Simon Hill filled the front row spots. Duncan Vercoe and Mark Cole occupied the second row, but points leader Eaves was back on row four. Like Eaves, Cole was destined not to finish the race.

Unbeknown to him at the time, Hart had suffered a loss of power to

his dashboard on the rolling start lap and said: 'I was paranoid about the speed gun at the start, so I had to be extra careful.'

It saw the front row men nip and tuck on the run to Paddock, Hill just able to edge across before turning in. When he ran a little wide at Clearways before the lap was out, Hart redressed the situation.

Former hillclimb champion Andy Priaulx blew his chances with two offs on the second lap. He had been fourth after a super opening tour. Vercoe slipped through into second on lap 13 as Hill slithered wide at Clearways. The scrap between the pair would see them clash at Surtees on the last lap, something that led to Hill being



Jeff Boxham/LAT

Eventual winner Nick Hart (2) and Simon Hill battle it out on the opening lap of the race

DONINGTON August 30/31

Winks on top in Porsche thriller

Des Winks took a thrilling victory in the 10th round of the Porsche Cup after forging his Carrera 993 ahead of the Carrera 2 of Adrian Slater in an absorbing contest. Equally fierce battles raged in the classes as Marcus Fothergill and Tom McHugh bagged well-earned wins.

Richard True underlined his arrival as a pacesetter by topping the qualifying times, but it was second-fastest Slater who bagged pole position in the draw for the top four grid places.

Slater then pulled off another of his dragster starts to head the field into Redgate. Winks set off in pursuit and gradually narrowed the gap, using his greater pace down the Craner Curves to erode Slater's early advantage.

Slater however, driving with ever-growing confidence, tenaciously fended off his adversary for nine laps. 'I just waited and bided my time,' said Winks, who saw his chance under braking for Goddards on the 10th lap.

With a brave move, Winks went all the way around the outside to grab the lead even though he then bounced across the grass in the middle of the corner. However, at

Jordan endured a day to forget

pull out a lead and crossed the line a full two seconds ahead of Dawkins to take his third victory of the season. Third place went to Hodgson after he had pestered Lee before taking the place on lap 13 at Island.

Malcolm Prior made an excellent start in the second race, ahead of Alf Boarer and the determined Dawkins, the pair vying for second. By the end of the first lap, however, it was Kevin Clarke leading Dawkins and Boarer, but Ian Mitchell had a major off at Lake, which brought out the red flags. As the cars reassembled, the Clerk of

the Course decided that the entire grid should retire to the paddock to repair all the damage and return to battle out the final race at the end of the meeting.

At the restart, with rain starting to fall, Clarke again took the lead, but was pressed heavily by Dawkins. After a tremendous scrap, involving Clarke, Hodgson and Dawkins, the race was red-flagged after a huge incident involving Paul Eaton, from which he escaped unharmed. As a result, Hodgson won, with second-placed Dawkins ahead of Clarke.

Peter Falding further extended his championship lead with a convincing victory in the first V6 race, ahead of John Haffey and Rick Lemmon. Steve Dance won the second encounter, with Shane Bland second. Falding could only follow up his previous success with a well-deserved third.

Andy Steward improved his championship position with a fine win in the first Pickup race, ahead of Gillian Philp and third-placed Gordon White. Steward and White again took first and second places in the second race, with Dave Longhurst in third.

In the first Legends race, championship leader Paul Hughes resisted the advances of Peter Morton and Gary Thomas to take a well deserved win. John Mickel led Richard Nelson across the line under yellows in the second race, following an incident on the last lap. The final race was won by Gary Thomas at the last corner from Darren Hill.

The Beetle race was concluded in



the same moment, Slater hit engine trouble and lost power with a suspected bent valve. 'I did think it was going to be two wins in a row,' he said after limping home 10th.

With True challenging hard on the final lap, Winks could not relax for a moment. 'That's a deserved win,' said Winks on the podium after beating True by a length. True said: 'I nearly got him on the exit of Coppice on the last lap,' after he had pushed hard in the closing stages. Robert Babikan held on to third with a gritty performance as Peter Chambers and Chris Heeley chased.

In class two, Fothergill took an important victory as title-rival Paul Doran hit gearbox trouble. Team-mates Dave Benett and Piers Masarati chased Fothergill home after Russell Busst was edged wide and on to the grass at the first corner. Doran, meanwhile, was still struggling to find gears and then spun on the exit of Redgate.

'My best race of the season,' said a jubilant McHugh after inflicting a rare defeat upon Adrian Grieves in a marvellous class three battle. Bernard Yeoh and Andrew Sweetenham also played a key part in the contest.

A thrilling three-way battle in the BMW Challenge on Monday boiled down to a two-horse dash for the line, with David Kempton's M3 edging out the similar car of Nigel Greensall by just 0.25s.

Peter Challis's polesitting M5 led Greensall until the latter moved narrowly ahead at Coppice on lap

two, but their leading margin over Kempton diminished as they fought.

Approaching the chicane on lap seven, Kempton slipstreamed past Challis then took the lead when Greensall ran wide at the right-left flick. Moments later Challis slid off into the gravel at the Old Hairpin to leave Kempton and Greensall centre stage.

Amid backmarkers, Greensall regained the lead at the chicane but at the same spot on the last lap, with the finishing line in sight, Kempton squeezed by once more.

Nick Dudfield stretched his lead of the BARC Formula Renault Championship, coming from behind to calmly pip Stuart Wood's Tatuus for victory.

Wood was faster away than



Andy Steward improved his Pickup Truck title chances with a fine double victory

Gary Kinchen's favour, following a first-lap dash from the penultimate row of the grid. He crossed the line in a photo finish ahead of Chris Ryan.

Russell Dixon's Van Diemen won the Star of the Midlands championship race, ahead of Neil Plimmer, whilst Danny Watts was victorious in Formula First.

● Jonathan Hackett

EUROCAR V8 - RACE ONE (20 LAPS) 1 Mark Willis 11m53.31s (102.91mph); 2 Chris Dawkins 11m55.58s; 3 Steve Hodgson; 4 Barry Lee; 5 Paul Eaton; 6 Mike Jordan. **Fastest lap** Dawkins 34.94s (103.03mph). **RACE TWO (20 LAPS)** 1 Hodgson 8m30.12s (89.63mph); 2 Dawkins 8m30.15s; 3 Kevin Clarke; 4 Tony Gale; 5 Jordan; 6 Willis.

EUROCAR V6 - RACE ONE (20 LAPS) 1 Peter Falding 12m23.44s (98.25mph); 2 John Haffey 12m24.82s; 3 Rick Lemmon; 4 Mark Proctor; 5 Shane Bland; 6 Steve Dance. **Fastest lap** Ian Fewings 36.53s (98.54mph). **RACE TWO (20 LAPS)** 1 Dance 14m10.92s (97.24mph); 2 Bland 14m11.10s; 3 Falding; 4 Lemmon; 5 Tick Steward; 6 Haffey. **Fastest lap** Falding 36.33s (99.09mph).

LEGENDS - RACE ONE (7 LAPS) 1 Paul Hughes 4m46.25s (89.50mph); 2 Gary Thomas 4m46.90s; 3

Peter Morton; 4 Shaun McLaughlin; 5 John Mickel; 6 Tick Steward. **Fastest lap** Hughes 40.22s (89.50mph). **RACE TWO - (7 LAPS)** 1 Mickel 5m10.17s (90.43mph); 2 Richard Nelson 5m10.70s; 3 Simon Durrell; 4 Morton; 5 Thomas; 6 Darren Hill. **Fastest lap** Hughes 39.51s (91.11mph). **RACE THREE (10 LAPS)** 1 Thomas 8m30.12s (89.60mph); 2 Hill 8m30.15s; 3 Hughes; 4 Mickel; 5 Morton; 6 Mike Ives. **Fastest lap** Mickel 39.76s (90.54mph).

PICKUP TRUCKS - RACE ONE (20 LAPS) 1 Andy Steward 12m26.56s (97.95mph); 2 Graham White 12m26.79s; 3 Dave Longhurst; 4 Jeff Simpson; 5 Lee Caroline; 6 Alistair Lane. **Fastest lap** Lane 36.39s (98.92mph). **RACE TWO (20 LAPS)** 1 Steward 12m25.92s (98.19mph); 2 White 12m26.15s; 3 Caroline; 4 Mike Jordan; 5 Dave Briggs; 6 Tony Proctor. **Fastest lap** Jordan 36.48s (98.68mph).

STAR OF MIDLAND FF1600 (20 LAPS) 1 Russell Dixon 12m45.85s (104.49mph); 2 Neil Plimmer 12m46.27s; 3 Philip Leech; 4 Arnaud Martin. **Class winners** Dixon; James Ebbrell. **Fastest laps** Plimmer 34.23s (105.17mph); Ebbrell 36.05s (99.86mph).

BIG BOYS TOYS BEETLE CUP (20 LAPS) 1 Gary Kinchen 14m34.35s (83.91mph); 2 Chris Ryan 14m34.53s; 3 Matthew French; 4 Marc Lord; 5 John Aitkenhead; 6 Philip Santer. **Fastest lap** French 42.51s (84.68mph).

BRSCC FORMULA FIRST (20 LAPS) 1 Danny Watts 12m14.14s (99.57mph); 2 Mark McLoughlin 12m14.58s; 3 Adam Blair; 4 Paul Munn; 5 James Andrews; 6 David French. **Fastest lap** McLoughlin 36.08s (99.77mph).

polesitter Dudfield's Tatuus - though neither was quite as quick as Anthony Dunn's leap from sixth to third in the Martini, but Dudfield took the lead on lap two.

Wood said: 'I made a good start, then a couple of mistakes nearly dropped me to fourth, but then I got my act together.' He did, and having seen off Dunn's threat, went on to finish just 0.7s behind Dudfield.

The Thundersports event turned into a high-speed demonstration drive by Mike Wilds, who finished over half a minute clear of his nearest competitor and set a best lap of over 102mph.

Jeff Wilson's Osella led at the start, but Wilds' Chevron passed him approaching the Craner Curves before cruising on to victory.

Championship leader David Hudson's steady drive to second in class ensured Wilds didn't make up too many points in the title race.

The Formula 250 Superkarts race witnessed the closest finish of the day, less than 0.2s separating victor Mark Owens from John Riley.

● Paul Lawrence & Tim Baggs

PIRELLI PORSCHE CUP (12 LAPS) 1 Des Winks (Carrera 993) 16m23.410s (85.98mph); 2 Richard True (Carrera 993) 16m23.723s; 3 Robert Babikan (Carrera 2). **Class winners** Winks; Marcus Fothergill (944S2); Tom McHugh (944). **Fastest lap** Winks 1m20.652s (87.36mph) **record**.

FORMULA 250 SUPERKARTS (10 LAPS) 1 Mark Owens (ADE/Rotax) 12m20.20s (95.19mph); 2 John Riley (F1/Rotax) 12m20.38s; 3 Nick Padley (Anderson/Rotax). **Fastest lap** Paul Wilkinson (F1/Rotax) 1m13.16s (96.30mph).

BARC FORMULA RENAULT (12 LAPS) 1 Nick Dudfield (Tatuus RC96) 14m45.64s (95.47mph); 2 Stuart Wood (Tatuus RC96) 14m46.31s; 3 Anthony Dunn (Martini MK72). **Class winners** Dudfield; Jeremy Timms (Orion FR93). **Fastest laps** Dudfield 1m12.80s (96.79mph); Lee Fitzpatrick (Swift SC94R) 1m15.66s (93.12mph).

BMW CHALLENGE (10 LAPS) 1 David Kempton (M3) 13m56.71s (84.21mph); 2 Nigel Greensall (M3) 13m56.96s; 3 Jonathan Rowland (M3). **Class winners** Kempton; Greensall; Mark Grady (M3); Stuart Laws (323). **Fastest laps** Kempton 1m20.84s (87.15mph) **record**; Greensall 1m22.14s (85.78mph) **record**; Peter Seldon (325) 1m25.46s (82.45mph) **record**; Terry Trust (325i) 1m28.28s (79.81mph) **record**.

RJB THUNDERSPORTS (10 LAPS) 1 Mike Wilds (Chevron B31/36) 11m51.51s (99.03mph); 2 Jeff Wilson (Osella PA7) 12m23.65s; 3 Mike Simpson (March 74S). **Class winners** Wilds; Ray Harper (Mallcock Mk20B); David Beckett (Nerus Silhouette OSR); Nicholas Pearce (Tiga S79); Terry Davison (Nomad Mk3). **Fastest laps** Wilds 1m08.73s (102.52mph); Harper 1m15.63s (93.16mph); Lawrence Benson (Chevron B8) 1m16.44s (92.18mph); David Hudson (Sturdgess S11) 1m18.08s (90.24mph); Davison 1m22.93s (84.96mph).

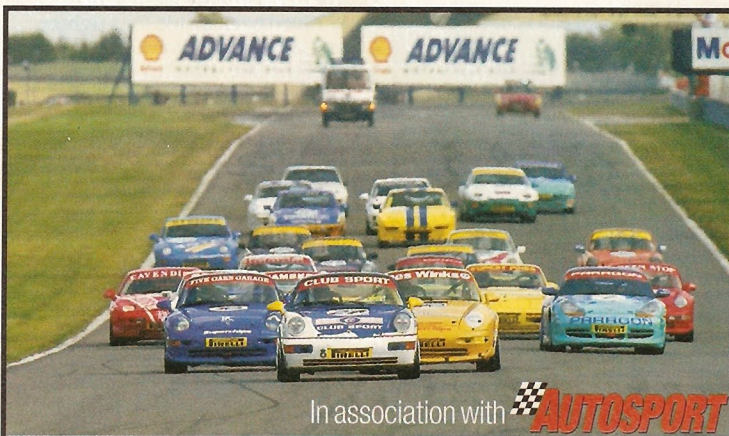

The Porsche Cup field roars down towards Redgate, with Adrian Slater leading Des Winks

Mark Walker

In association with **AUTOSPORT**

Peugeot roars for golden Helmut

Helmut Holfeld's late charge in the Compomotive Wheels Rallycross Championship continued as the Dubliner took his third win of the year.

'No, I'm not doing the maths. I'm just going for it,' said Holfeld, 'but I think today has put me six points clear of Dermot (Carnegie) with Barry (Squibb) about 14 behind!'

For Squibb, the series' third visit to Lydden was a disaster. It started well enough, though, with the Escort driver rattling the passenger door on Holfeld's Peugeot as he hammered past to win the first heat.

With fastest time here backed up by FTD - at 2m31.7s - in the second, Squibb secured pole for the Final and put his feet up while Holfeld fought off Carnegie in the third.

Squibb led the Final away but slithered a little off line through the Devil's Elbow on the first lap and lost sufficient momentum that Holfeld was able to outdrag him on the run up to North Bend. Squibb nosed into the Peugeot in the turn, but Holfeld was on top of things and powered away to win unchallenged.

Squibb, working against a puncture and an as yet unidentified transmission problem, fought off Carnegie to run home second, with Steve Mundy and Andy Grant next.

Squibb appeared to be fighting fit at the start of the Superfinal though, where a searing start carried him ahead of pole starter Holfeld and Carnegie. He thundered through Chessons at the head of the queue but as he bounced out on to the Dover Slope a cloud of smoke and flame signalled the end of his race.

'It's lost all drive,' stormed Squibb. 'I felt a bit rough in the A Final, but was okay at the start. Coming off Chessons it lost everything. I couldn't even run round for points.'

While Squibb parked, Holfeld was flying away at the front while Carnegie pushed as hard as he dared in a car which had no brakes.

Behind them, Mundy was as obstructive as possible to Andy Grant and the unfeasibly fast Nova of Mike Turpin. 'I don't know how the engine kept going,' said Mundy. 'The oil pressure went in the heats and it had no boost in the Superfinal.'

Mundy was given some breathing room on the final lap when Turpin

slipped ahead of Grant. The Escort driver was having none of it though and swiftly fought back to fourth.

Turpin did his usual disappearing act in the 1650cc race, shading a fine second place battle in which Dave Ward had his hands full with Trevor Gamble. Adrian Creegan's new Nova was a notable fourth.

The up to and over 2150cc classes produced some great races during merged heats, but were split for the Finals. Alan Harber stayed just ahead of Brian Cooke in the small capacity final, with Martyn Tinker third after waging war with Ray Morgan in a ferocious battle.

Richard Wakeling won the 1400cc class to narrow the gap to leader Mark Kaye, who contained Des Wheatley for second.

A handful of Belgians boosted the Euro2000 entry and provided the winner in the shape of Patrick Van Mechelen's new Opel Corsa. Tonino Soens, in Van Mechelen's old car, ran second until displaced by Barry Rogers. Championship leader Paul Broatch missed the Final after problems in the qualifying heats.

● Tim Whittington

COMPOMOTIVE WHEELS RALLYCROSS CHAMPIONSHIP, ROUND 8. ALL FINALS OVER 4.5 LAPS Supercars

1 Helmut Holfeld (Peugeot 306), 3m19.2s; 2 Barry Squibb (Ford Escort), 3m22.4s; 3 Dermot Carnegie (Ford Escort); 4 Steve Mundy (Ford Fiesta); 5 Andy Grant (Ford Escort); 6 John Sampson (Rover 200). **Modified Cars up to 1400cc** 1 Richard Wakeling (Mini), 3m46.8s; 2 Mark Kaye (Mini), 3m52.0s; 3 Des Wheatley (Rover Metro); 4 Richard Irwin (Rover Metro); 5 Paul Hebden (Mini); 6 Tania Jeffery (Mini). **Modified Cars up to 1650cc** 1 Mike Turpin (Vauxhall Nova), 3m36.9s; 2 Dave Ward (Vauxhall Corsa), 3m38.9s; 3 Trevor Gamble (Ford Fiesta); 4 Adrian Creegan (Vauxhall Nova); 5 Alan Tapscott (Vauxhall Nova); 6 Andy Scott (Toyota MR2).

Modified Cars up to 2150cc 1 Alan Harber (Vauxhall Nova), 3m40.3s; 2 Brian Cooke (Peugeot 205), 3m41.8s; 3 Martyn Tinker (Vauxhall Nova); 4 Ray Morgan (Ford Escort); 5 Keiron Pearce (Ford Fiesta); 6 Mike Sellar (Ford Fiesta). **Euro2000** 1 Patrick Van Mechelen (Opel Corsa), 3m44.5s; 2 Barry Rogers (Vauxhall Nova), 3m45.3s; 3 Tonino Soens (Opel Corsa); 4 Richard Moroney (Ford Escort); 5 Ken Lane (Ford Escort); 6 Dave Liptrott (Ford Fiesta). **Colway Tyres up to 1650cc** 1 Phil Baines (Talbot Sunbeam), 4m02.9s; 2 Paul Simon (Ford Fiesta), 4m08.6s; 3 Richard Novell (Ford Fiesta). **Colway Tyres over 1650cc** 1 Paul Gee (Vauxhall Astra), 4m04.8s; 2 Malcolm Paterson (Ford Escort), 4m12.3s; 3 Peter Chapman (Ford Escort). **Minicross 20th Anniversary Race** 1 James Guest, 3m17.7s; 2 Nicholas Fredenham, 3m18.5s; 3 Ralph Budd; 4 Andy Smith, 3m20.3s; 5 Paul Buckmaster; 6 Tracy Hathaway. **Superfinal** 1 Holfeld, 3m18.9s; 2 Carnegie, 3m23.6s; 3 Mundy 3m29.2s; 4 Grant, 3m39.8s; 5 Turpin, 3m40.8s; 6 Ward, 3m41.2s.

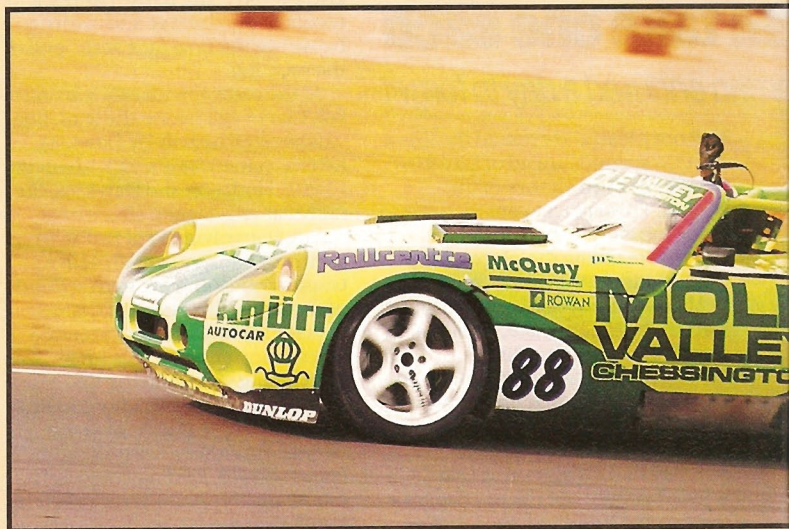

Martin Short put in a storming drive in the second race to take victory. It was rendered unimpaired by the incident in the first race.

Short's hollow day

Tuscan victory was an empty one. By Paul Lawrence

Martin Short's victory in the second TVR Tuscan race was overshadowed by the incident in qualifying when a wheel from defending champion Bobby Verdon-Roe's car cleared the barriers at Camp Corner and claimed the life of a spectator.

Short led the opening Tuscan race until contact with Phil Hindley sent him spinning at Tower. The team mates had differing views, but it left Hindley ahead and Short back in seventh, fortunate to have been avoided by the chasing pack.

However, Hindley had no easy time of it, as Jamie Campbell-Walter and Ian McKellar gave chase. McKellar's charge was spoilt by a broken diff carrier, which severely restricted his pace in the second half. I was suffering for traction,' he said.

Campbell-Walter had no such troubles, and crawled all over Hindley as his car came on strong in the closing stages. Hindley stood his ground, though, and Jamie had to look at the outside into Camp on the final corner. Then, as Hindley went in deep, JC-W dived back inside for a tighter exit and the cars were side-by-side over the line. Hindley got the verdict, by one hundredth of a second!

Having finished only sixth in the first race, Short went into the second on a mission and pulled off a stunning start to brave it out with JC-W on the run to Quarry. They were still side-by-side at Old Paddock, where Short edged ahead to take a lead he would never lose.

That fact doesn't tell the story of a race-long battle with McKellar, who moved through to second with Hindley and Campbell-Walter on his tail. McKellar tried

everything in his extensive repertoire, but Short was a match for him and defended his lead to take a sweet victory.

'I couldn't have asked for anything better, said an ecstatic Short, while McKellar had driven superbly for second. 'I had a bad qualifying but it worked out OK,' he said. Hindley outfumbled JC-W on the final lap to take third and the championship lead.

Suzi Hart-Banks was a surprised, but jubilant, MGF winner after the battling Alastair Lyall and James Rhodes were relegated to fifth and sixth by false start penalties.

'I can't believe they took it off us,' said Lyall after fighting mightily to get to the head of the race. Rhodes got dumped back to fifth when Lyall charged ahead on the opening lap, but tigered back to lead before his brakes started to fade.

Lyall went back ahead but it was all in vain as the penalty had already been applied. 'I wasn't going to get in amongst it,' said Suzi of the title-contender's battle, but her victory was well-deserved after a gritty drive to get ahead of Brian Heerey and a troubled Matt Kelly.

Richard Carter drove well in the HEAT FF1600 counter, despite pressure from rival Robin Parsons.

In the Pagid Saloons race, Russell Humphrey bagged another win as Brian Cox chased. Traffic cost Cox any chance of making a challenge.

The Mobile Windscreens GT race should have been romped by Philip Hopkins, but his Ultima-Chevrolet speared off the road on the run to Camp and a violent impact with the marshals post left Philip with a broken leg and the car wrecked. Geoff Thorne's Lola thus won, from the Mallock of Jerry Irwin.

Hugh Hayden and Ross Bygrave were lucky to emerge unharmed from violent accidents in the Caterham rounds. Roadsports victory took Dave Clark to the title while Mark Humphrey fended off



Helmut Holfeld's Peugeot (left) and Barry Squibb's Escort disputing the Supercar final

SNETTERTON August 31

Bland's Reynard on the boil

Brilliant,' declared a jubilant Daron Bland after a decisive ARP F3 victory promoted him to the Boiling Point series lead.

The Reynard driver made a stupendous start from pole to lead, but Dave Williams' Ralt was hard on his heels and the Bristolian took a long look at Riches on lap two.

Bland held his nerve and profited when an error at Sear by Williams allowed him the space he needed. A fast start by Ian Walker earned third, while a clash between Keith Baldwin and Neil Cox safeguarded Chris Willie's fourth.

James Pickford maintained his perfect Formula 600 record over Nick Farley. Lack of motivation saw Stefan Hodgetts relinquish third to Anthony Nicklin in sight of the flag.

Graham Presley's Alfa 75 Turbo carved its way to the front of the AutoItalia field, but Mike Sweeney hunted it down in his De Tomaso Pantera. Scott Winnard worked his Ferrari into the lead of the second, pursued by the indecently-rapid Fiat Strada of Graham Neale.

Andy Thompson's Tomcat/Vento victory was confidently taken. Dave Pierce's last-lap lunge cost him dear as Adrian Churchill and Anthony George pounced. Pierce regained third while Clinton Ogbourne was a close observer in the lead Vento.

Ray Mears controlled a massive slide at Riches to lead the second

Alfa race. Adie Hawkins nipped by but was soon trailing the polesitter once more. Hawkins shadowed the leader's every move to no avail.

Proton winner Stephen Stokoe led home a trail of damaged cars. Ray Byford finished second with Robert Oldershaw third after an ill-tempered clash with David Porter.

The other Alfa event fell to Presley while Nigel James outran the LM 3000 field for a sixth time.

● Lewis Beales

BOILING POINT ARP FORMULA 3 (15 LAPS) 1 Daron Bland (Reynard 863) 17m 28.08s (100.57mph); 2 Dave Williams (Ralt RT32B) 17m 36.49s; 3 Ian Walker (Argo JM18). **Class winners** Bland and Williams (99.77mph). **Fastest laps** Bland 1m 08.90s (101.99mph); Williams 1m 09.55s (101.03mph).

OIL EXTREME FORMULA 600 (10 LAPS) 1 James Pickford 12m 20.74s (94.86mph); 2 Nick Farley 12m 31.00s; 3 Anthony Nicklin. **Fastest lap** Pickford 1m 13.25s (95.93mph).

CHRIS KNOTT INSURANCE ALFA ROMEOs, CLASSES A-D (10 LAPS) 1 Graham Presley (75) 13m 40.48s (85.64mph); 2 Paul Buckley (75) 13m 52.87s;

3 Alan Marshall (75). **Class winners** Presley, David Thomas (Sud); Dave Streater (Arna T); Enzo Buscaglia (75); **Fastest lap** Presley 1m 20.80s (86.97mph). **CLASSES E&F (10 LAPS)** 1 Ray Mears (33) 14m 37.31s (80.09mph); 2 Adie Hawkins (33) 14m 37.94s; 3 Simon Frost (33). **Class winners** Chris Oxborough (75T); Mears. **Fastest lap** Hawkins 1m 26.45s (81.28mph).

SPORTSCAR LM 3000 (20 LAPS) 1 Nigel James 23m 10.17s (101.09mph); 2 Michael Millard 23m 17.56s; 3 Chris Gilbert. **Fastest lap** James 1m 08.66s (102.34mph).

BRSCC AUTOITALIA CHALLENGE, CLASSES A-D (10 LAPS) 1 Mike Sweeney (De Tomaso Pantera) 13m 41.35s (85.55mph); 2 Graham Presley (Alfa Romeo 75) 13m 42.46s; 3 John Day (Lancia Beta). **Class winners** Sweeney, John Rutter (Hawk HF3000 Stratos Replica); Day; Giovanni Di Gennaro (Fiat 128); **Fastest lap** Sweeney 1m 17.73s (90.40mph). **CLASSES E-H (10 LAPS)** 1 Scott Winnard (Ferrari 328 GTB) 14m 40.48s (79.81mph); 2 Graham Neale (Fiat Strada Abarth) 14m 50.06s; 3 Colm Flanagan (Alfa Romeo 33). **Class winners** Winnard; Neale; Flanagan; Ian Brookfield (AlfaSud Ti). **Fastest lap** Winnard 1m 25.68s (82.01mph).

BRSCC PROTON COUPE CHALLENGE (10 LAPS) 1 Stephen Stokoe 14m 21.78s (81.54mph); 2 Ray Byford 14m 38.38s; 3 Robert Oldershaw. **Fastest lap** Stokoe 1m 25.06s (82.61mph) **Record**.

BRSCC TOMCAT/VENTO CHALLENGE (10 LAPS) 1 Andy Thompson (Rover 220 Turbo) 13m 47.68s (84.90mph); 2 Adrian Churchill (Rover 220 Turbo) 13m 52.50s; 3 David Pierce (Rover 220 Turbo). **Class winners** Thompson and Clinton Ogbourne (VW Vento VR6). **Fastest laps** Pierce 1m 21.70s (86.01mph); Ogbourne 1m 22.20s (85.48mph) **Record**.

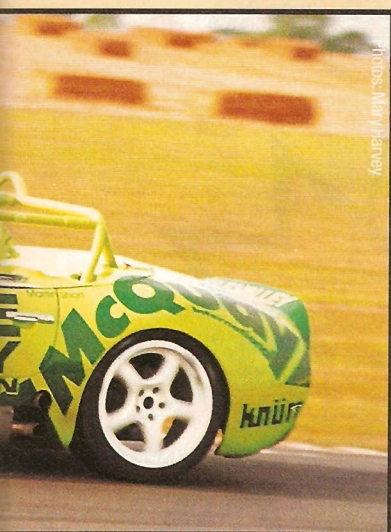

ant after the death of a spectator in qualifying

Ben McLoughlin and Edward Horner in the Superlights.

Toni Ruokonen took a dominant National Saloons victory as Ian Griswold battled up to second and Tim Munday saw off Chris Armeftis for Super Coupe spoils.

TVR TUSCAN CHALLENGE - RACE ONE (14 LAPS) 1 Phil Hindley 14m 10.99s (108.97mph); 2 Jamie Campbell-Walter 14m 11.00s; 3 Ian McKellar; 4 Gavin Cooper. **Fastest lap** McKellar 59.64s (111.06mph). **RACE TWO (10 LAPS)** 1 Martin Short 10m 12.45s (108.15 mph); 2 McKellar 10m 12.56s; 3 Hindley; 4 Campbell-Walter. **Fastest lap** Hindley 59.69s (110.97mph).

MGF CUP (15 LAPS) 1 Suzi Hart-Banks 17m 51.48s (92.73mph); 2 Brian Heerey 17m 55.45s; 3 Matthew Kelly; 4 Mark Hazell. **Fastest lap** Heerey 1m 09.76s (94.95mph) **establishes record**.

LOMBARD CATERHAM SUPERLIGHTS (25 LAPS) 1 Mark Humphrey 31m 08.83s (88.61mph); 2 Ben McLoughlin 31m 08.96s; 3 Edward Horner; 4 Nigel Taylor. **Class winners** Humphrey; Rupert Douglas-Pennant 31m 28.86s (87.67mph). **Fastest lap** Stephen Worley 1m 03.30s (104.64mph).

PTP CATERHAM ROADSPORTS (10 LAPS) 1 David Clark 11m 50.80s (93.19mph); 2 Rob Garoff 11m 52.19s; 3 Thomas Jakobitsch; 4 Peter Mangion. **Class winners** Clark; Richard Blue 12m 00.83s (91.89mph). **Fastest lap** Gerry Taylor 1m 08.69s (96.43mph) **record**.

DUNLOP NATIONAL SALOONS (15 LAPS) 1 Toni Ruokonen (Honda Integra) 17m 05.18s (96.91mph); 2 Ian Griswold (Honda Integra) 17m 10.14s; 3 Brian Ward (Honda Integra); 4 Andy Middlehurst (Nissan Primera). **Fastest lap** Griswold 1m 07.52s (98.10mph) **record**.

PAGID SALOONS (10 LAPS) 1 Russell Humphrey (Vauxhall Astra) 11m 55.98s (92.51mph); 2 Brian Cox (Peugeot 205) 11m 58.71s; 3 Nick Williamson (Rover 220); 4 Nick Cleal (Vauxhall Astra). **Class winners** Humphrey; Tim Hanlon (Peugeot 205GT) 12m 37.13s (87.48mph); Julian Howell (Rover Mini) 12m 42.59s (86.86mph). **Fastest lap** Cox 1m 10.34s (94.17mph).

MOBILE WINDSCREENS SPECIAL GT (6 LAPS) 1 Geoff Thorne (Lola T86/90) 6m 24.88s (103.26mph); 2 Jeremy Irwin (Mallock Mk34) 6m 34.40s; 3 Dave Green (Daren Mk6); 4 Richard Borthwick (Shrike P16). **Class winners** John Barnard (LM3000) 6m 39.37s (99.51mph); Thorne; Borthwick 6m 36.31s (100.28mph). **Fastest lap** Phillip Hopkins (Ultima-Chevrolet Mk4) 59.69s (110.97mph).

HEAT FF1600 (10 LAPS) 1 Richard Carter (Van Diemen RF92) 11m 01.57s (100.12mph); 2 Robin Parsons (Swift SC92F) 11m 01.89s; 3 Paul Barnes (Swift SC92F); 4 John Hutchinson (Van Diemen RF90). **Class winners** Carter; Hugh Elliott (Van Diemen RF89) 11m 23.88s (96.85mph). **Fastest lap** Parsons 1m 04.85s (102.14mph).

UKWebsites.com SUPER COUPE CUP (10 LAPS) 1 Tim Munday (VW Polo G40) 12m 11.40s (90.56mph); 2 Chris Armeftis (Renault 5GT) 12m 12.21s; 3 Peter Studer (VW Polo G40); 4 Bob Smith (Renault 5GT). **Class winners** Munday; Armeftis (90.46mph); Phil Bennett (Rover 216GT) 12m 33.23s (87.94mph); Mark Taylor (Honda CRX) 12m 16.69s (89.91mph); Adam Simmons (Renault Clio) 12m 39.70s (87.19mph). **Fastest lap** Armeftis 1m 12.01s (91.98mph).



Daron Bland scored a super ARP F3 win to take the Boiling Point F3 championship lead

OULTON PARK August 31

Alacrity the key to Alaric's escape

Frantic Formula Ford 1600 Faction topped the Bank Holiday bill, but while Alaric Gordon and Colin Low had clear runs to Champion of Oulton wins, the order behind was far from settled.

Simon Kinsey led the Pre-'87 pursuit, from Martyn Porter and Malcolm Barfoot, but a spin at Fosters dropped the outgoing champion to fourth and left Barfoot to fend off Porter for second.

Barfoot repeated his result in the Post-'87 race, having shrugged off close attention from Colin Nield and Paul Wighton throughout.

There was little to separate Doug Anderson and Matt Edwards into the first corner of their Super Road Saloons clash. With Edwards down to fourth at Fosters, Anderson's team mate, Tony Caig, slotted into second as they pulled clear of Neil Sampson. While Edwards got third back, he slowed within sight of the line, handing it back to Sampson.

Dave Bartrum's Escort Cosworth was never headed in the Ford Modified Saloons, while Brian O'Connor's similar car held second.

In their eagerness to claim the upper hand, front-row men Peter Hughes and Andrew Lennie tripped over each other at the start of the XR3i Challenge, to leave Keith Riley and Graeme Whitehead in front.

Lennie separated them on lap three, but as he made his bid for victory, Riley made contact at Fosters and Whitehead retook second.

Marc Nordon turned his pole position into a lights-to-flag Mighty Minis win. Stuart Clark held second for the most part, with Bob Bennetts and Stephen King never more than inches behind. Bennetts caught Clark off guard on lap seven then, after a further exchange, Bennetts clinched the place by 0.01s.

The Super Classic FF1600 laurels were going Peter Eccleston's way until a second-lap spin at Fosters. Colin Boal had caught the back of Simon Davey at Cascades, and took the lead he held to the end. Davey retained second after a great dice with Mark Jackson.

Nick Beaumont had the Ford Si lead from the opening lap, after Jason Hughes's initial battle with Mike Gorton saw Gorton tapped into the Fosters tyre wall. Hughes continued to hold second, and race debutant Ben Roper snatched third from Brian Taylor a lap from home.

Michael Blackburn's tussle with Pete Wilkinson and Tony Mumford gave Jon Minshaw a convincing XR2 victory, while Bob Brooks converted his Global Lights pole into a comfortable win.

● Peter Scherer

CHAMPION OF OULTON PRE-'87 FF1600 (10 LAPS) 1 Colin Low (Reynard 84FF) 11m 13.36s (88.42mph); 2 Malcolm Barfoot (Van Diemen RF86) 11m 26.16s; 3 Simon Kinsey (Van Diemen RF85). **Fastest lap** Low 1m 06.11s (90.06mph).

CHAMPION OF OULTON POST-'87 FF1600 (10 LAPS) 1 Alaric Gordon (Mondiale M93/5S) 11m 05.44s (89.48mph); 2 Barfoot (Van Diemen RF91) 11m 10.13s; 3 Colin Nield (Mondiale M94S). **Fastest lap** Paul Wighton (Swift SC92F), 1m 05.16s (91.38mph).

SUPER CLASSIC FF1600 (10 LAPS) 1 Colin Boal (Mondiale M89S) 11m 22.00s (87.30mph); 2 Simon Davey (Reynard 89) 11m 28.78s; 3 Mark Jackson (Swift FB88). **Class winners** Boal; Karl Leatherbarrow (Van Diemen RF80). **Fastest lap** Boal 1m 06.73s (89.23mph); Nigel Bancroft (Van Diemen RF79), 1m 09.73s (85.39mph).

FORD MODIFIED & RIPSPEED SUPER ROAD SALOONS, CLASS D (10 LAPS) 1 David Bartrum (Escort Cosworth) 11m 44.92s (84.46mph); 2 Brian O'Connor (Escort Cosworth) 11m 53.04s; 3 Jonathan Edwards (Ford Escort RS2000). **Class winners** Bartrum; Edwards; Rob Stafford (Ford Fiesta XR2); Rob Alman (Ford Fiesta XR2); Roger Ebdon (Ford Fiesta XR2). **Fastest lap** Bartrum 1m 08.82s (86.52mph).

RIPSPEED SUPER ROAD SALOONS, CLASSES A-C (10 LAPS) 1 Doug Anderson (Peugeot 205) 12m 23.54s (80.08mph); 2 Tony Caig (Ford Fiesta XR2) 12m 26.84s; 3 Neil Sampson (Ford Capri). **Class winners** Sampson; Anderson; Caig. **Fastest laps** Anderson 1m 12.71s (81.89mph) **Record**; Matt Edwards (Ford Escort) 1m 12.73s (81.86mph) **Record**. **FORD FIESTA XR2 CHALLENGE (10 LAPS)** 1 Jon Minshaw 12m 34.0s (78.96mph); 2 Michael Blackburn 12m 40.21s; 3 Peter Wilkinson. **Fastest lap** Minshaw 1m 14.36s (80.07mph).

FORD ESCORT XR3i CHALLENGE (10 LAPS) 1 Keith Riley 13m 01.96s (76.14mph); 2 Graeme Whitehead 13m 03.89s; 3 Andrew Lennie. **Fastest lap** Peter Hughes 1m 16.28s (78.05mph).

FORD FIESTA SIs (8 LAPS) 1 Nick Beaumont 8m 41.97s (79.85 mph); 2 Jason Hughes 8m 43.90s; 3 Ben Roper. **Fastest lap** Mike Gorton 1m 12.66s (81.94mph).

MIGHTY MINIS (10 LAPS) 1 Marc Nordon 14m 02.77s (70.65mph); 2 Bob Bennetts 14m 14.52s; 3 Stuart Clark. **Fastest lap** Nordon 1m 23.06s (71.68mph) **Record**.

GLOBAL LIGHTS (10 LAPS) 1 Bob Brooks 11m 20.35s (87.51mph); 2 Bruce Robinson 11m 26.17s; 3 Colin Waterhouse. **Fastest lap** Brooks 1m 06.97s (88.91mph).

Richard Styles



GINETTA G27 CHAMPIONSHIP PROMOTIONAL DAY

RACE A
GINETTA G27
RACE CAR
IN 1999

DONINGTON PARK CIRCUIT THURSDAY 17th SEPTEMBER

- ❑ **Drive a Ginetta G27** race car on the Donington circuit, novices and competition licence holders welcome. No competition licence necessary.
- ❑ **Up to six race cars on display** – all seriously 'FOR SALE' and ready to race. Talk to the owners and drive the cars.
- ❑ **Hospitality suite** and refreshments available.
- ❑ **Seminar** "How to get a competition licence".
- ❑ **Race drivers** on hand with their cars to provide advice and circuit drives.
- ❑ **Teams on hand** to discuss "arrive and drive" packages
- ❑ **Call now** to reserve one of the limited places and to receive an information pack.

Price
Guide
£8 -10K

Economical –
Friendly – Fun –
Motor Racing
at an affordable
price...

ARRIVE AND
DRIVE

CALL MARTIN PHAFF
Ginetta Cars
01142 610099

**RESERVE A
PLACE !!!**

Come to Donington to learn about the 1999 Ginetta G27 Championship.

10 rounds-economical, friendly and exciting racing !

If you cannot be present on the 17th call for the information pack.

We will ask those who are driving for a deposit of £100, which will be refunded at the end of the day.

Potential Championship sponsors welcome – please talk to us

Ward hangs on to win

Joe Ward proved equal to the challenge from Howard Brearley and Edd Sharpe

There was little to separate Joe Ward, Howard Brearley and Edd Sharpe in the Flemings Thoroughbred Sports Car race. Brearley slipped ahead on the eighth lap, but was on the wrong line for Cascades and lost out to both Ward and Sharpe.

Having already retaken Sharpe's tail happy Aston Martin on the last lap, Brearley launched one more attack on Ward at Lodge. The reigning champion Ward held on to both his line and victory.

Both parts of the Cockshoot Cup fell to John Hewitt's Midget, with Arto Kesterlian's MGB taking a brace of seconds. Hewitt was on the podium with a third victory too, when Mike Peters shared his Midget in the Abingdon Classic Cup.

The Moss International MGBCV8 race went to Peter Collis, after contact at Old Hall left Tom Stewart battling to regain second from Dave Tilley. Stewart eventually squeezed through at Fosters.

Jason Burgess made it three successive Metro Cup wins, after passing Rupert Lloyd down the Avenue on the final lap. Chris Hughes fell back in third after the trio had run wheel-to-wheel.

A decisive start from Paul

Clarence's Midget left him clear in the Anglia Phoenix Challenge, while Colin Pendle took his TR7 V8 to its fifth successive win in the Cox & Buckles TR race.

Graeme Adams won the Halfords Midget race and David Clewley the combined MGT & F race.

● Peter Scherer

FLEMINGS THOROUGHbred SPORTS (10 LAPS) 1 Joe Ward (TVR Griffith) 11m30.28s (86.26mph); 2 Howard Brearley (TVR Tuscan) 11m30.65s; 3 Edd Sharpe (Aston Martin DB4). **Class winners** Jim Baynam (TVR Tuscan); Nigel Reuben (MGB); Harvey Cooke (Jaguar E); Ward. **Fastest lap** Brearley 1m07.19s (88.62mph).

MGCC ANGLIA PHOENIX CHALLENGE (10 LAPS) 1 Paul Clarence (Midget) 12m27.39s (79.66mph); 2 Chris Roche (RV8) 12m32.53s; 3 John Spencer (Midget). **Class winners** Clarence; Roche; Marc White (Midget); Andrew Talbot (Metro). **Fastest lap** Clarence 1m13.48s (81.03mph).

TR REGISTER (10 LAPS) 1 Colin Pendle (V78) 12m02.81s (82.37mph); 2 Alan Price (V78) 12m03.55s; 3 Alan Tomkins (4). **Class winners** Chris Burbury (5); Dave Bailey (4); Tomkins; Pendle; Jon Wolfe (Spitfire). **Fastest lap** Pendle 1m10.80s (84.10mph).

MG COCKSHOOT CUP - RACE ONE (7 LAPS) 1 John Hewitt (Midget) 8m25.99s (82.37mph); 2 Arto Kesterlian (B) 8m26.58s; 3 Paul Greaves (Midget). **Class winners** Paul Newton (Midget); Mark Ashworth (B); Hewitt. **Fastest lap** Kesterlian 1m10.81s (84.08mph). **RACE TWO (7 LAPS)** 1 Hewitt 8m26.87s (82.23mph); 2 Kesterlian 8m30.40s; 3 David Ecob. **Class winners** Prutton; Ashworth; Hewitt. **Fastest lap** Hewitt 1m10.88s (84.00mph).

MOSS INTERNATIONAL MGBCV8 (10 LAPS) 1 Peter Collis (BGTV8) 11m28.70s (86.45mph); 2 Tom Stewart (BGTV8) 11m32.44s; 3 Dave Tilley (BV8). **Class winners** Spencer McCarthy (B); Graham Grove (RV8);

Steve Jones

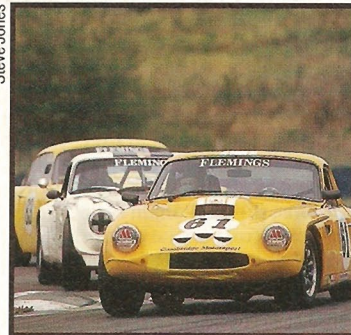

Joe Ward just held off Brearley and Sharpe

Peter Hall (BGTV8); Collis. **Fastest lap** Stewart 1m06.38s (89.70mph).

MG MIDGETS (10 LAPS) 1 Graeme Adams 11m43.41s (84.65mph); 2 Richard Wildman 11m53.19s; 3 Peter May. **Class winners** Adams; David Ecob; Bill Lancashire. **Fastest lap** Adams 1m09.03s (86.25mph).

MG METRO CUP (10 LAPS) 1 Jason Burgess 13m04.91s (75.86mph); 2 Rupert Lloyd 13m05.39s; 3 Chris Hughes. **Class winners** Rob Preece; Robert Welch; Burgess. **Fastest lap** Burgess 1m16.83s (77.50mph). **MGF ABINGDON TROPHY, T TYPES & MMM REGISTER (10 LAPS)** 1 David Clewley (TB) 13m29.49s (73.55mph); 2 Malcolm Gammons (F) 13m30.45s; 3 John Dignan (F). **Class winners** Gammons; Richard Green (TC); Clewley; Mike Dowley (PB). **Fastest lap** Clewley 1m18.98s (75.39mph).

ABINGDON CLASSIC CUP (10 LAPS) 1 John Hewitt/Mike Peters (MG Midget) 12m51.42s (77.18mph); 2 Peter Hiley/Andrew Hiley (MGB) 13m02.69s; 3 Graeme Adams (MG Midget). **Class winners** George Edney/Peter Edney (MG T); Hiley/Hiley; Colin Pendle (Triumph TR7 V8); Hewitt/Peters. **Fastest laps** Adams 1m08.43s (87.01mph).

barrier and Ian Chard's Jedi record.

Terry Beddis did a superb job to win the 2-litre split in Mark Coley's Pilbeam, claiming Justin Fletcher's scalp with a 29.80s shot. Mark Lawrence's OMS took the 1100cc pot from Jedi duo Lee and Crocker.

Guernseyman Charlie Smith recovered from a huge spin over Deer's Leap to take the big Sports Libre class. Peter Herbert was close to his 1400cc ModProd mark, while Jonathan Williamson and Richard Allen reset their marque targets.

● Marcus Pye

AUTO WINDSCREENS RAC BRITISH HILLCLIMB CHAMPIONSHIP, ROUND 14, BTD Roger Moran (4.0 Pilbeam-Judd/J&F EV MP72-3) 27.45s. **Top 12 Run-Off** 1 Moran 27.45s; 2 Tim Mason (3.5 Pilbeam-Judd/Connaught CV MP50M) 27.80s; 3 Roy Lane (4.0 Pilbeam-Judd/J&F EV MP58-9) 27.96s; 4 David Grace (3.5 Gould Ralt-DFR/L&P GR37) 28.15s; 5 Simon Durling (4.0 Pilbeam-DFL/J&F MP58-8) 28.16s; 6 Rob Turnbull (3.5 Gould Ralt-DFR/L&P GR37) 28.33s; 7 Tim Coventry (3.5 Pilbeam-Judd/Connaught CV MP50) 28.38s; 8 Alan Thompson (3.5 Gould Ralt-DFR/L&P GR37) 28.47s; 9 Deryk Young (3.5 Pilbeam-Judd EV MP58-1) 28.81s; 10 Chris Cannell (4.0 Pilbeam-DFL/J&F MP58-3) 28.85s; 11 Richard Fry (3.5 Gould Ralt-Judd CV GR37) 29.56s; 12 Karl Davison (3.5 Pilbeam-Judd EV MP72-2) 29.58s. **Class winners** Peter Herbert (1.4 Westfield SE) 34.73s; Tom New (2.0 Caterham 7) 31.81s; Richard Jones (3.2t Porsche 911) 32.69s; Martin Groves (1.7 Mallock Mk20B) 31.63s; Paul Haimes (2.0 Mallock Mk18/20) 30.45s. **Equals record**: Charlie Smith (2.6 Pilbeam-Hart MP43-3) 31.25s; Dean Kidsley (0.5 Jedi Mk4/95) 33.45s; Mark Lawrence (1.1 OMS) 31.17s; Graeme Wight Jr (1.6 Pilbeam-BDA MP62-9) 29.85s. **Record**: Terrence Beddis (2.0 Pilbeam-Vauxhall MP62-14) 29.80s; Moran 27.56s. **Record**: Richard Allen (3.2 Ferrari 328GTB) 37.19s. **Record**: Jonathan Williamson (3.2 Porsche Carrera) 34.53s. **Record**: Championship positions 1 Grace 98pts; 2 Moran 93; 3 Lane 80; 4 Mason 74; etc.

RACMSA Leaders 1 Groves, Wight Jr and New 81pts; 4 Herbert 78; etc. **Next round** Sep 6, Prescott.

Gilmore clinches Star of Tomorrow crown

Matthew Gilmore added the DHL Star of Tomorrow FF1600 title to his collection at Kirkistown on Saturday.

The Belfast teenager took third place in his misfiring Van Diemen behind the similar car of Jason Curran and Ian Newport's well driven Crossle 67F, but that was all he needed to take the title. Later in the day he stormed through from the back of the grid to follow Curran across the line for second place in the main FF1600 race.

Chris Paul took an accident-hit Ford of Ireland Zetec round, run in two halves because of a red flag. Paul's Van Diemen RF96 had Neil Shanahan's RF98 for company in the first half, but shortly after the restart Shanahan went out with suspension damage, leaving Paul to take the win on aggregate from Philip Kehoe and Mark O'Connor.

Mark Kershaw scored his first Formula Opel victory in the first of two races, taking the win ahead of team mate Michael Keohane. But the on form Dubliner had to settle for second place behind series leader Jason Pollock in the other.

Elsewhere the Turkington brothers, Gary and Colin, took wins in the Northern Ireland FF Zetec and Metro events respectively, while Brian Hearty beat Paul Newport to the flag in the Formula Vee A race. Earlier, the B event had been won by Paul Heavey.

Peter McGill took a win in the Pre-85 FF1600 thrash after a challenging Tommy Reid stopped on the last lap with mechanical bothers.

● Richard Young

FORMULA VEE - RACE A (12 LAPS) 1 Brian Hearty (Sheane FV93) 13m42.68s (79.39mph); 2 Paul Newport (Leastone JH002) 13m43.00s; 3 Karl Lennon (Sheane). **Fastest Lap** Newport, 1m07.28s (80.89mph). **RACE B (12 LAPS)** 1 Paul Heavey (Leastone JH002) 11m47.85s (76.89mph); 2 Greg Murphy (Sheane FV97) 11m47.85s; 3 Matthew Dunne (Sheane FV97). **Fastest Lap** Heavey 1m08.31s (79.67mph).

FORMULA OPEL - RACE ONE (18 LAPS) 1 Mark Kershaw 17m28.68s (93.42mph); 2 Michael Keohane 17m31.00s; 3 Peter Duke. **Fastest Lap** Duke, 57.60s (94.49mph). **RACE 2 (18 LAPS)** 1 Jason Pollock 17m34.47s (92.91mph); 2 Kershaw 17m34.86s; 3 Vivian Daly. **Fastest Lap** Kershaw 57.58s (94.52mph). **DHL STAR OF TOMORROW FF 1600 (12 LAPS)** 1 Jason Curran (Van Diemen RF92) 12m48.57s (84.98 mph); 2 Ian Newport (Crossle 67F) 12m50.73s; 3 Matthew Gilmore (Van Diemen RF92). **Fastest Lap** Newport 1m03.04s (86.34mph).

PRE-95 FF 1600 (12 LAPS) 1 Peter McGill (Reynard FF84) 13m05.39s (83.16mph); 2 Ivor Mairs (Mondiale M845) 13m07.23s; 3 John Morrow (Mondiale M845). **Fastest Lap** Morrow 1m03.62s (85.55mph). **FORD OF IRELAND FF ZETEC (2 X 6 LAPS)** 1 Chris Paul (Van Diemen RF96) 13m00.00s; 2 Philip Kehoe (Van Diemen RF98) 13m01.00s; 3 Mark O'Connor (Swift 5C97Z). **Fastest Lap** Kehoe, 59.79s (91.03mph). **KIRKISTOWN METROS (12 LAPS)** 1 Colin Turkington 17m51.61s (60.95mph); 2 Noel Robinson 17m52.66s; 3 Mark Leatham. **Fastest Lap** Robinson, 1m27.13s (62.46mph).

NORTHERN IRELAND FF1600 (15 LAPS) 1 Jason Curran (Van Diemen RF92) 16m02.14s (84.85mph); 2 Matthew Gilmore (Van Diemen RF92) 16m04.17s; 3 Tim Woodside (Mondiale M945). **Class winners** Curran; John Morrow (Mondiale M845). **Fastest Lap** Gilmore 1m02.64s (86.89mph).

NORTHERN IRELAND FF ZETEC (15 LAPS) 1 Gary Turkington (Van Diemen RF97) 15m08.53s (89.86mph); 2 George McAlpin (Mygale J598) 15m13.19s; 3 Alan Ring (Mygale J598). **Fastest Lap** McAlpin, 59.57s (91.36mph).

Moran close to record

His title may have been ceded, but Roger Moran flung his Pilbeam-Judd MP72 to within 0.31s of Andy Priaulx's hill record in another thrilling Auto Windscreens RAC British Championship run-off.

An inspired Moran snatched his class record back from Tim Mason to qualify top, and won the day with a tail-out traversal of the Karousel. Roger's final run was a personal best to the mid-way split at 14.7s but a slither at Ashes left him 0.02s shy.

Mason drove his Gould-rejuvenated MP50 to a brilliant second, regaining the place from Roy Lane, who completed a Pilbeam-Judd clean sweep with two diametrically opposed runs which stopped the clock identically.

New champion Grace qualified circumspectly, having slid wide at the Karousel, and had to play

second fiddle to guest co-driver Alan Thompson initially. The Clubmans hotshoe excelled to qualify fifth, but Grace bounded back to fourth with a 147mph blast through the finish. Young Thompson fell to eighth with an overheating engine.

Gurston school principal Simon Durling was a precise fifth, ahead of a frantic Rob Turnbull and Tim Coventry, split by 0.05s. Derek Young and the hairy Chris Cannell, 0.04s apart, completed the scorers.

Leaders title protagonists Tom New and Martin Groves had easy passages, but Graeme Wight Jr had to fight for his maximum to equal them in a the 1600 Racing Car class. The Scot had to push to head off Devon's Steve Snell (Ralt RT3) in the morning, but when Snell and Nigel Sillence (OMS) relegated him to third again, Wight shattered the 30s



Marcus Pye

Roger Moran takes off over Deer's Leap en route to his fifth RAC win of the season

The young pretender

Westley Barber is on course to claim France's Campus Cup crown – before his 17th birthday! By Tony Dodgins

Westley Barber has made a habit of starting young. At nine, he became the youngest national Cadet karting champion. Today, he stands on the verge of winning the French Renault/Elf Campus Cup series and equalling US Champ Car ace Paul Tracy's achievement of winning a national single-seater competition at 16.

'I actually wanted a motorbike,' he grins, 'but my dad said no. We bought a kart instead.'

The grin is infectious. In fact, such is the teenager's affable nature that

he has been selected to give a bit of karting advice to Princes William and Harry. He's not averse to chewing the fat with Tom Cruise when the star puts in an appearance at the local Daytona kart circuit in Milton Keynes. However, if the talent is precocious, the personality is not. The feet stay firmly on the ground.

Barber moved into Formula TKM and then attracted a works drive with an Italian outfit to compete in Europe and the world championships. Things went well, but Formula A karting budgets have become astronomical, so he and father Reg took a rain check when he was 15 to plan a proper assault on cars – and save cash.

Reg is a devoted racing father, but there is no silver spoon. He is the proprietor of Reg's Fish Bar in Eaglestone, Milton Keynes, with another shop in Saffron Walden, Essex. Paul Getty he is not. Reg knew there would be one crack at racing and one crack only.

Enter Elf. Barber Sr knew his son would need a basic course of instruction before his ARDS test, so he shelled out £1000 to enter him in Elf Oil UK's Fastrack competition in association with the Silverstone Driving Centre last October.

Westley was just 15, but he made the final. Three fully-supported

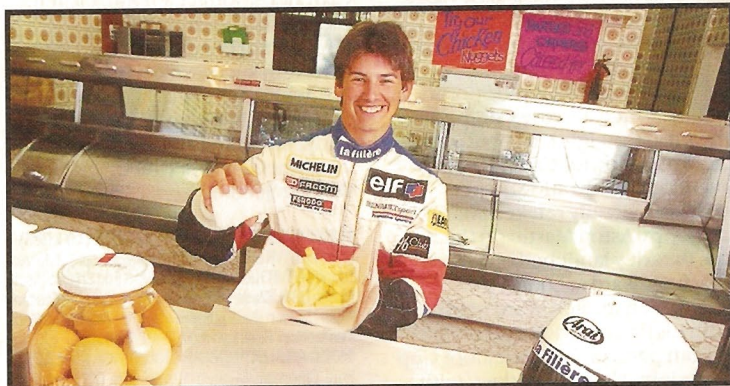

The secret of his success? Westley tucks into a helping of his father's fish and chips



Elf scholars. L-r: Barber, Simpson and Tee

places at Elf's Le Mans-based La Filiere academy were at stake. He won the competition outright, with Guarin Simpson and Jonathan Tee taking the other two scholarships. Just 16, Barber left his Northampton home in January to take up full-time residence at La Filiere.

'I know it's a bit of a cliché, but it really has been a dream come true for me,' he says. 'There we were, agonising over how best to make the step into cars. Suddenly, I found myself in a professional environment totally dedicated to teaching you all you need to know about being a professional racing driver.'

The teenager has grabbed his

certainly gives you added incentive to pick it up quickly.'

Communication will obviously be more important in F3, but by then he hopes to be much more fluent. If you're struggling terribly, though, the instructors can speak English.

'In Campus, it's not been too big a handicap. The cars are set up identically, the mechanics rotate and there's nothing you can do to the cars to improve them,' says Barber. 'They want to see what you get out of it on a basic level.'

'The only place you can really have a bit of input is with the slicks. They stay with you, not with the car, for two races. I guess that's so you can't

CLUB SPORT

Fri/Sat/Sun Sep 4/5/6; Donington Park (GB)

BARC. FIA GTs, Thoroughbred Grand Prix Cars, Open Fortuna, Lamborghinis, Historic GTs, Historic Touring Cars, Formula Junior. Qualifying: Fri 1140, Sat 0925. Racing (Sun): 1030. Admission: Sat £6, Sun £17. Children U15: Free. Tel: 01332 810048

Sat/Sun Sep 5/6; Mondello Park (EI)

MGCC. Formula Opel, Formula Ford Zetec, Formula Ford 1600, Formula Vee, Italian Cup, Fiat Unos, Historic, Group N Touring Cars. Qualifying (Sat): 1300. Racing (Sun): 1100. Admission: £8. Children: £1. Tel: 00 353 45 860200

Sat Sep 5; Oulton Park (GB)

JCC. Classic Sports, Jaguar XKs, Jaguar Challenge, Centurion Challenge, Welsh Sports/Saloons, Sports Racing Cars, MG Cup, Cockshoot Cup. Admission: £10. Children: £1. Qualifying: 0830. Racing: 1330. Tel: 01829 760301

Sat Sep 5; Silverstone (GB)

SRC. 2CVs, Legends, Peugeot 306s, Junior Single Seaters, Global Lights. Qualifying: 1030. Racing: 1315. Admission: Free. Tel: 01327 857271

Sat/Sun Sep 5/6; Croft (GB)

AMOC. MGBCV8, Ferrari Challenge, Classic Sports Cars and Saloons, Formula 3 Clubmans, Aston Martins, Anglo American Challenge, Classic Porsches, Thoroughbred Sports Cars, Pre war Sports Cars, Allcomers race. Qualifying (Sat): 0930. Racing: Sat 1530, Sun 1200. Admission: Sat £6, Sun £11, weekend £15. Children: £2. Tel: 01325 721815

Sun Sep 6; Cadwell Park (GB)

BRSCC. Classic Formula Ford 1600, Porsche 924s, Road Saloons, Modified Production Saloons, Fiat Racing Challenge, Karts, Monopostos. Qualifying: 0900. Racing: 1300. Admission: £10. Children: £1. Tel: 01507 343248

Sun Sep 6; Thruxton (GB)

750MC. Formula Vee, Clubsports 2000, Lotus 7, Kit Cars, Formula 4, Hot Hatches. Qualifying: 0900. Racing: 1430. Admission: £10. Children: Free. Tel: 01264 772607

Sat/Sun 5/6 Sep; Prescott (GB)

RAC British Hillclimb Championship. Practice (Sat): 0930. Event (Sun): 1000. Admission: Sat £5, Sun £7. Children U14: Free. Tel: 01242 673136

“ I know it's a bit of a cliché, but it really has been a dream come true for me ”

WESTLEY BARBER

chance with both hands. So far, he has won five of the eight Campus races at circuits such as Le Mans, Magny-Cours, Nogaro and Ledenon, and finished second in the rest. He is already the youngest British driver to win a car race, and is 99.9% certain to lift the series crown when the competition concludes this October.

He is the most successful driver since the Campus Cup began in 1993, so La Filiere has taken to him, too. Next year, he moves into the academy's team in Class B French Formula 3. The budget is around £150,000 and the Barbers have the winter to raise £50,000.

'The La Filiere people have been superb,' says Westley. 'I have to admit I had a few reservations at first. Not being able to speak French was a worry, but we have six hours of tuition a week and attending regular technical seminars in the language

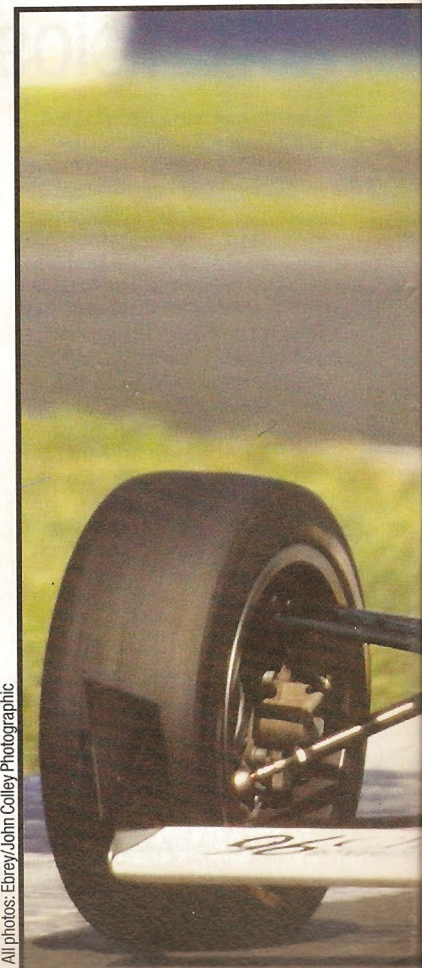

All photos: Ebrey/John Colley Photographic

Westley Barber's rapid rise

deliberately flat-spot them on the slow-down lap to give the next guy in that car square wheels! It does mean marginal gains if you can drive smoothly and look after the rubber.'

The 16-year-old is the youngest of the 23 Campus regulars and, amazingly, will still be too young to hold a driving licence when he starts F3 testing later this year. 'The camaraderie is excellent (see panel) and my chief rivals have already offered to drive me around,' he says. 'I get on really well with the Campus instructor, Laurent Senechal, and Henri Pescarolo has been very friendly. He is very influential and it's great to feel you can just go and chat to someone with that much experience.'

While some might balk at graduating to F3 at 17, preferring a year in Formule Renault, for example, Westley is confident that he is making the right move.

'It did enter my mind that it was going a bit too fast, but if you do happen to do well, great. If not, it's not

too big a deal. F3 is always regarded as a two-year project and I think the B class will be very strong in France next year. It could mean you have a genuine shot at winning the title in your first season in the A category.'

Confidence, as you can see, is not a problem. Above all, however, Barber is grateful for the opportunity. 'You look around today and see that so much of a driver's success depends on manufacturer or corporate initiatives. Renault, of course, supports La Filiere, and when you look at people like Dario Franchitti in Champ Cars and Mark Webber in GTs, you can't help but be impressed by people like Mercedes. Those guys are not Germans and it shows real vision. It gives young drivers something to aim at. The same with Elf. Here I am, a young Englishman racing in France and learning in an international environment. It's invaluable and thanking Elf somehow seems wholly inadequate. I only hope I can go on delivering.' ■

University Campus

La Filiere is more than a school for motor racing. It's a school for life

You can't just go and race in the Campus championship. Even if you've got the necessary £80,000 or so, you have to be selected. All 23 drivers are young, aspiring professionals. The average age is just 18. They live together in apartments at the University of Le Mans, where they eat, sleep and breathe motor racing.

'My UK school was really good.

tend to keep away from the guy who finished next to you in the race, just so nothing goes wrong on the bus! We play cards to pass the time. A lot of the circuits are at least five hours from Le Mans and it can seem a long old haul when we go back.

'The season starts at the end of March and really finishes at the end of July, while France has August off. It resumes in September and then



The La Filiere school, where young hopefuls come to learn the art of motorsport

They agreed to "suspend" me, saying it was too good a chance to miss,' says Westley Barber. 'La Filiere is a pretty good school for life. You don't have your friends there and you have to get on with people.'

'There are a few tantrums after the races. If you've had a crash with someone, you do get upset, but we kiss and make up. At the end of the year, I don't think there's anyone who hates anyone. It's interesting to learn about the senses of humour of other nationalities. The funniest are the Brazilians. Weird, but hilarious.'

'We travel to the races together on a bus which Elf provides. You always

there's the Renault finals meeting and a chance to race in Zhuhai, China, or Macau if you're selected. Since January, I've been back to England four times. Three visits were for non-championship races.

'On average, we have one test day a week, then there's the technical seminars and the French tuition. We also have instruction in dealing with sponsors and how to handle the press. I'm in the gym an hour and a half a day, Monday to Friday as well. It really has been a fantastic experience. My only regret is crashing while leading at Pau. I really wanted to win there.'

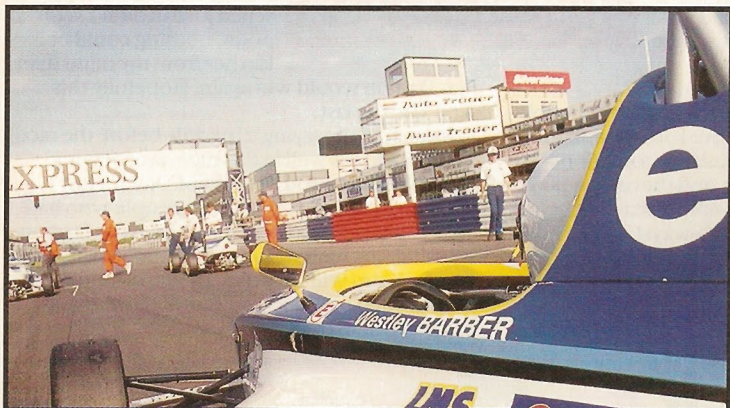

The Campus Cup visited Silverstone for one of three non-championship races in the UK



A season of French Class B F3 with the motorsport school's team awaits the leader of this year's Campus Cup series

Thank you Damon!

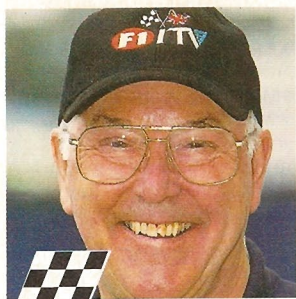

MURRAY WALKER
ITV F1 COMMENTATOR

The Belgian GP was gigantically demanding from the point of view of Martin Brundle and myself, because the two of us were on the air for two hours and 40 minutes. It was a fantastic event, and a pretty impactful day altogether.

I was shocked but not particularly surprised by the accident after the first start, and I was mighty, mighty thankful that nobody was hurt. You can't blame anyone in that situation, where the road is wet, they can't see where they are going, they're trying to gain position, and there are 22 of them bunched together. It's just a very unfortunate thing.

And the race itself was quite incredible. Where I stand on the David Coulthard/Michael Schumacher collision is that it was another racing accident. I haven't talked to McLaren and Ferrari, and maybe there are things that I don't know which would colour my attitude. But my understanding is that McLaren told Coulthard to move over, and he did so.

Whether he backed off, which is allegedly Ferrari's complaint, or not, I don't know. But I would have thought it was inadvisable if he did. But it's all too easy to pontificate when you're not the one who's driving. Whatever, Schumacher was obviously so close that an accident was unavoidable. I was grimly reminded, and I said so at the time, of Didier Pironi running into Alain Prost at Hockenheim in 1982. It was miraculous that they were both perfectly alright, even more so that Giancarlo Fisichella was unhurt after his car-shattering clash with Shinji Nakano.

As for what happened afterwards, there's going to be an awful lot of contention and letters to AUTOSPORT about the 'evil kraut' and all the rest of it. But look at it from Michael's point of

view. It's not surprising that he would think, in the heat of the moment and with the adrenalin flowing, that there was some fiendish plan between McLaren and Coulthard to take him out. In which case it was not unreasonable and very understandable that he goes storming down the pitlane and attempts to have it out, a la Nigel Mansell.

David is a super bloke, but I think he was a bit po-faced in complaining about Michael saying 'you effing tried to kill me', because it's virtually an everyday word these days, sadly. Having said that, I think he handled Schumacher's red mist outburst with outstanding composure and dignity. Not for one moment would I think that David would even think of accepting a suggestion that he would interfere with Schumacher's progress, even if McLaren had suggested it to him, which I'm sure they didn't.

Should they have stopped the race? Conditions were very bad and there were people going off all over the place, but I don't think they should have stopped it. I think the conditions were marginally improving, and the ones who did finish proved it was possible to stay on the track. The throttle works both ways!

Obviously I was overjoyed for Damon, for Eddie Jordan, for Mugen Honda, and Goodyear. Damon richly deserved to win, and he did bloody well to beat Schumacher in qualifying. I

thought he drove a World Champion's race I was relieved that Ralf Schumacher did what he was told to do, and held station. I was bit worried that maybe with the Williams thing in the offing, and the warts that I understand are flying about, he might say, 'Sod it, this is my chance to win. Bugger Damon Hill, I'm going to try to pass him.'

I was pleased at his maturity, and responsibility, and the fact that he drove a damn good race. But I was unashamedly especially pleased for Damon.

Last year I couldn't believe his luck and mine in Hungary, when until that last lap he showed every sign of winning, totally against the odds. For the first half of this season, when Jordan didn't score a point, nothing could be further from my mind than

that Damon would win again. Hopefully this won't be the last.

I was actually saying to people before the race, 'If Damon does well in this race, our viewing figures will go through the roof.' Not for last Sunday of course, because the people who had given up watching Grands Prix because Damon wasn't doing well wouldn't have been watching. But the word will very quickly spread and they'll be watching from Monza. Thanks Damon for bringing them back!

“ I think David was a little bit po-faced in complaining about Michael ”

MURRAY WALKER



Who's a happy boy then? Damon can't conceal his delight at his Spa win and Murray wants to thank him for boosting ITV's viewing figures

Sutton Images

How to contact us

Editorial, tel: 0181-943 5998, fax: 0181-943 5922. Advertising, tel: 0181-943 5858, fax: 0181-943 5850. Ad production, tel: 0181-943 5909, fax: 0181-943 5850. Autosport Photographic, tel: 0181-943 5918. Autosport incorporating Autoclassic is published weekly by Haymarket Specialist Motoring Publications Ltd, 38-42 Hampton Road, Teddington, Middlesex, TW11 0JE. Reproduction in whole or in part of any text, photograph or illustration without written permission from the publisher is strictly prohibited. While due care is taken to ensure the contents of Autosport are accurate, the publishers and printers cannot accept liability for errors and omissions. Advertisements are accepted for publication in Autosport only upon Haymarket Publishing Services Limited's Standard Terms of Acceptance of Advertising, copies of which are available from the Advertising Sales Department of Autosport. Editorial, Advertisement and Circulation: 38-42 Hampton Road, Teddington, Middlesex, TW11 0JE. Circulation trade enquiries: Frontline Ltd, Park House, 117 Park Road, Peterborough, Cambs, PE1 2TS. Tel: 01733 555161. Subscriptions: (not US/Canada/Mexico) Autosport, PO Box 280, Sittingbourne, Kent, ME9 8FB.

Tel: 01795 414817, fax: 01795 414600, e-mail: haymarket@galleon.co.uk Rates: UK £122.40, Eire and Europe/overseas surface mail £140, Middle East/Africa/India £172, Rest of the world £211. Autosport (USPS 454230) is published 51 times a year by Haymarket Specialist Magazines Ltd in the United Kingdom. US/Canada/Mexico rates: USA \$169, (Canada/Mexico \$208) from EWA, 205 US Hwy 22, Green Brook, NJ 08812. Call: (732) 424 7811 fax: (732) 424 7814. Second-class postage paid at Duellen NJ 08812. Postmaster: send address corrections to: EWA, 205 US Hwy 22, Green Brook NJ 08812. E-mail address is ewa@ewacars.com. Postage is free for all subscriptions. Back numbers: Haymarket Reprints, PO Box 200, Abingdon, Oxfordshire, OX14 3PG. Tel: 01235 534323. USA newsstand: Eastern News, 1130 Cleveland Road, Standusky, Ohio 44870. Printed in England by St Ives plc. Cover and centre sections printed by: BR Hubbard Ltd, Callywhite Lane, Dronfield, Sheffield. Colour origination Advertising: Primary Colours Ltd, 23 Grove Park Terrace, Chiswick, London, W4 30E. Editorial: Colour Systems, 90-92 Pentonville Road, London, N1 9PS. Registered at the post office as a newspaper. © Autosport 1998.

WHAT DO YOU WANT FROM AN F1 WEBSITE?

- ★ UP-TO-THE-MINUTE NEWS
- ★ TOP QUALIFYING AND RACE REPORTS
- ★ EXCLUSIVE COMMENT FROM ITV'S ON-SCREEN TEAM
- ★ THE LATEST TEAM AND DRIVER FACTS
- ★ TRANSCRIPTS OF ALL PRESS CONFERENCES

- ★ GREAT ACTION PHOTOGRAPHS
- ★ YOUR CHANCE TO BUY TOP ITV TEAM GEAR
- ★ PLUS: SUBSCRIBE TO OUR CHANNEL AND GET THE LATEST NEWS PLUS EXCLUSIVE WALLPAPERS DELIVERED TO YOUR DESKTOP

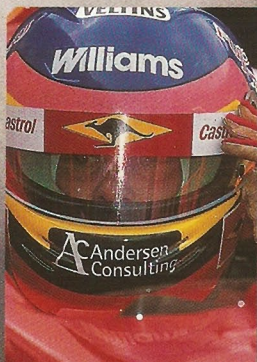

IT'S ALL AVAILABLE ON

WWW.ITV-F1.COM

FROM THE TEAM THAT BRINGS YOU F1 RACING MAGAZINE



Your one stop Motorsport shop...



SAMCO Sport

From £6.98

Silicone hose available in 45°, 90°, 135° elbows, straight lengths and reducers.



From £6.95

Race springs for all applications.



BP RACING



BP RACING



BP RACING

Vast range of AP Racing discs, calipers, clutches, differentials, fluids and master cylinders.



Sparco RECARO OMP COBRA FIA

FIA Approved Seats from Sparco, MomoCorse, OMP, Cobra, Recaro & Corbeau. Harnesses from Sabelt, TRS, Willans, Luke, MomoCorse & OMP

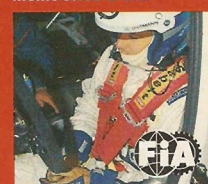

FIA



From £92.00

FIA Approved electrical, mechanical, single and dual chamber available.

FIA Approved racing fuel cells and tailored bag tanks, also pumps, vents & filler necks, hose & refuelling systems



FIA



Longacre

Full range of set up equipment from Longacre, Intercomp, Pace, Dunlop and Champion.

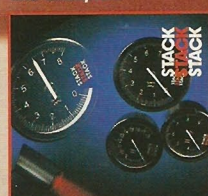

STACK STACK

Full range of Dash logger systems, pressure sensors, accessories and parts. Gauges available from Elliot, Racetech, Armtech, SPA Design & Smiths.



FIA

Sparco, OMP & Safety Devices provide clubman, multi point and weld in roll cages, available in steel or light weight alternatives. FIA/ONSIRAC Approved.

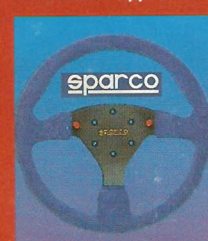

Sparco

Sparco, OMP & Momo Steering wheels available in suede or leather for saloon & single seater.



Arai HELMETS

GP3K £390.00

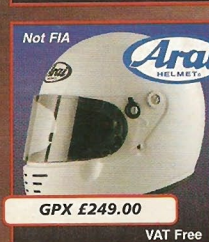

Not FIA Arai HELMETS

GPX £249.00



BELL HELMETS

Sport 2 £288.00



BORG

F1 £450.00



OMP

Helmet Bag £17.51



Braces from £20.51



Visors from £25.00

VISORS

Sparco from	£25.00
Bieffe from	£38.30
Shoef from	£48.00
Arai from	£48.00
Bell from	£51.00
Bell tear offs	£11.33

HELMET PAINTING SERVICE

Complete paint & design service for your individual or corporate identity. Single colour from £125.00



Sparco

Circuit £179.00



Sparco

Pro Rally £350.00



SHOEI

Quattro £495.00

Many more helmets available please call!

WORRY FREE PURCHASE

If you have not chosen the most suitable size of helmet, we will arrange free collection & re-delivery of a replacement. (UK only)



Top Driver £75.00



Sparco

Sprint, 2 layer £195.00



OMP

Trend, 3 layer £171.42



Racing, 3 layer £190.00



Clubman £50.79

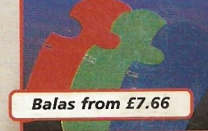

Balas from £7.66



from £22.17

SUITS

FIA Approved

Sparco Sprint	2L	£195.00
Sparco 2	2L	£340.00
Sparco Prima	3L	£410.00
OMP Trend	3L	£171.42
OMP Super First	3L	£274.28
Momo Racing	3L	£190.00

L = 2 or 3 layer Nomex

NOMEX BOOTS

FIA Approved

Sparco Top Driver	HT	£75.00
Sparco Racing	LT	£61.00
OMP Clubman	LT	£50.79
OMP Formula	HT	£96.27
Momo Pista	LT	£70.16
Momo Corsa	HT	£79.10

HT = High top LT = Low top

NOMEX GLOVES

FIA Approved

Sparco Budget	£24.00
Sparco Profi	£40.00
OMP Rally	£22.17
OMP Challenger	£28.79
OMP Professional	£42.27
Momo Rally Top	£38.29

BALACLAVAS

FIA Approved from £7.66

UNDERWEAR SETS

FIA Approved from 54.04

KIT BAGS

Sparco Trip Bag, Holds full kit including helmet from £28.00

TO ORDER 1998

call our direct sales hotline on **:01978 664466** or fax: **01978 664467**

American Express, Visa/Barclaycard, Diners Club Mastercard, JCB or Switch orders taken by telephone. Cheques, postal orders or bankdrafts made payable to Demon Tweeks. Goods despatched by next day £5.95 or 2 day £4.95. All prices shown are subject to alteration without notice. **IMPORTANT VAT must be added to all advertised prices**

FREE

Tel: **0930 106060**

Calls to 0930 numbers cost 50p per minute at all times. (Calls should last no longer than 1 1/2 minutes)



MasterCard VISA Diners Club International AMERICAN EXPRESS DELTA JCB SWITCH TRANSAX

demon tweeks Direct

Dept 115, 75 Ash Road South, Wrexham Industrial Estate, Wrexham, North Wales. LL13 9UG